

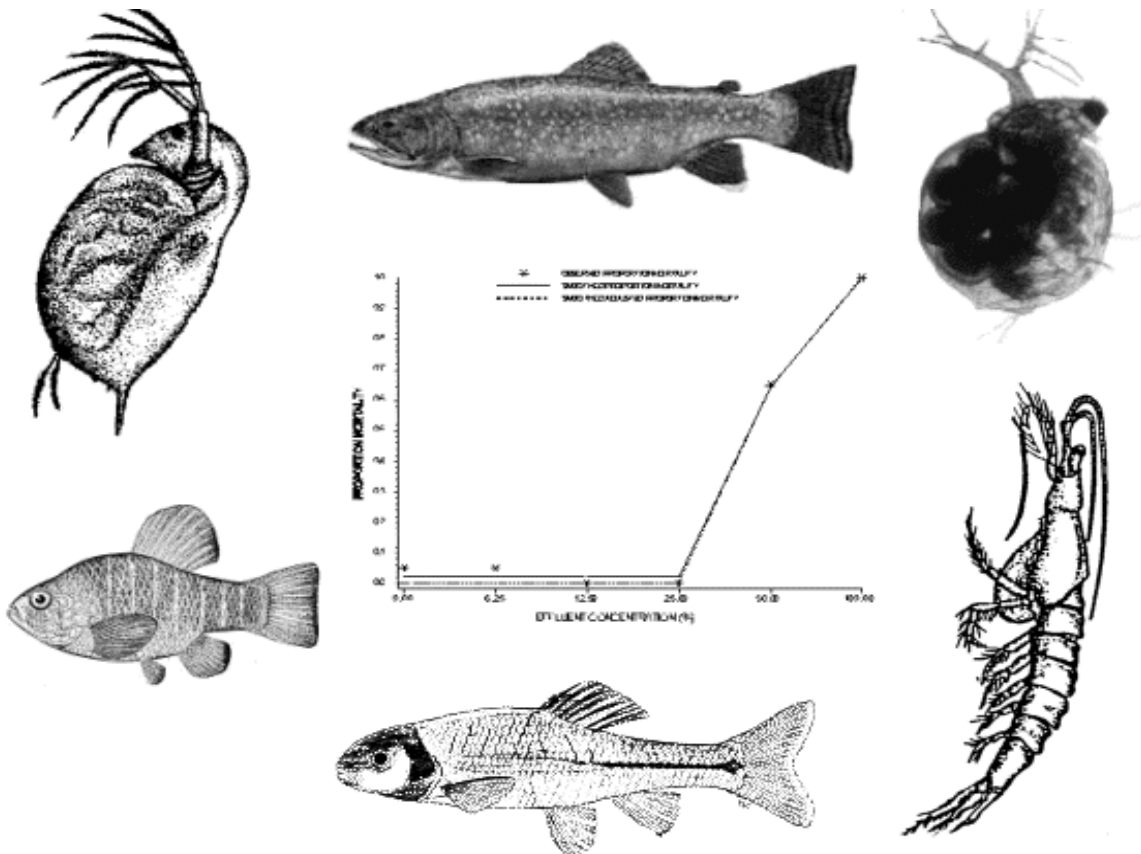

Methods for Measuring the Acute Toxicity of Effluents and Receiving Waters to Freshwater and Marine Organisms

Fifth Edition

October 2002



U.S. Environmental Protection Agency
Office of Water (4303T)
1200 Pennsylvania Avenue, NW
Washington, DC 20460

EPA-821-R-02-012

DISCLAIMER

The Engineering and Analysis Division, of the Office of Science and Technology, has reviewed and approved this report for publication. Neither the United States Government nor any of its employees, contractors, or their employees make any warranty, expressed or implied, or assumes any legal liability or responsibility for any third party's use of or the results of such use of any information, apparatus, product, or process discussed in this report, or represents that its use by such party would not infringe on privately owned rights.

CONTENTS

	<u>Page</u>
Figures	vi
Tables	vii
1. Introduction	1
2. Types of Tests	2
3. Health and Safety	5
General Precautions	5
Safety Equipment	5
General Laboratory and Field Operation	5
Disease Prevention	6
Safety Manuals	6
Waste Disposal	6
4. Quality Assurance	7
Introduction	7
Facilities, Equipment, and Test Chambers	7
Test Organisms	7
Laboratory Water Used for Culturing and Test Dilution Water	7
Effluent Sampling and Sample Handling	8
Test Conditions	8
Quality of Test Organisms	8
Food Quality	8
Acceptability of Acute Toxicity Test Results	9
Analytical Methods	9
Calibration and Standardization	9
Replication and Test Sensitivity	10
Variability in Toxicity Test Results	10
Demonstrating Acceptable Laboratory Performance	18
Documenting Ongoing Laboratory Performance	18
Reference Toxicants	21
Record Keeping	21
5. Facilities and Equipment	22
General Requirements	22
Cleaning Test Chambers and Laboratory Apparatus	23
Apparatus and Equipment for Culturing and Toxicity Tests	23
Reagents and Consumable Materials	24
Test Organisms	26
6. Test Organisms	27
Test Species	27
Sources of Test Organisms	28
Life Stage	29
Laboratory Culturing	29
Holding and Handling Test Organisms	29
Transportation to the Test Site	29
Test Organism Disposal	30
7. Dilution Water	31
Types of Dilution Water	31
Standard, Synthetic Dilution Water	31

CONTENTS (CONTINUED)

Use of Receiving Water as Dilution Water	33
Use of Tap Water as Dilution Water	35
Dilution Water Holding	36
8. Effluent and Receiving Water Sampling and Sample Handling	37
Effluent Sampling	37
Effluent Sample Types	37
Effluent Sampling Recommendations	38
Receiving Water Sampling	39
Effluent and Receiving Water Sample Handling, Preservation, and Shipping	39
Sample Receiving	40
Persistence of Effluent Toxicity During Sample Shipment and Holding	40
9. Acute Toxicity Test Procedures	41
Preparation of Effluent and Receiving Water Samples for Toxicity Tests	41
Preliminary Toxicity Range-finding Tests	43
Multi-Concentration (Definitive) Effluent Toxicity Tests	43
Receiving Water Tests	43
Static Tests	44
Flow-Through Tests	45
Number of Test Organisms	45
Replicate Test Chambers	45
Loading of Test Organisms	46
Illumination	46
Feeding	46
Test Temperature	46
Stress	47
Dissolved Oxygen Concentration	47
Test Duration	50
Acceptability of Test Results	50
Summary of Test Conditions for the Principal Test Organisms	50
10. Test Data	67
Biological Data	67
Chemical and Physical Data	67
11. Acute Toxicity Data Analysis	71
Introduction	71
Determination of the LC50 from Definitive, Multi-Effluent-Concentration Acute Toxicity Tests	72
The Graphical Method	72
The Spearman-Karber Method	76
The Trimmed Spearman-Karber Method	78
The Probit Method	81
Determination of No-Observed-Adverse-Effect Concentration (NOAEC) from Multi-Concentration Tests, and Determination of Pass or Fail (Pass/Fail) for Single-Concentration (Paired) Tests	83
General Procedure	88
Single Concentration Test	95
Multi-Concentration Test	98
12. Report Preparation and Test Review	109
Report Preparation	109
Introduction	109
Plant Operations	109

CONTENTS (CONTINUED)

Source of Effluent, Receiving Water, and Dilution Water	109
Test Conditions	110
Test Organisms	110
Quality Assurance	110
Results	110
Conclusions and Recommendations	110
Test Review	111
Sampling and Handling	111
Test Acceptability Criteria	111
Test Conditions	111
Statistical Methods	111
Concentration-Response Relationships	112
Reference Toxicant Testing	112
Test Variability	113
Cited References	114
Bibliography	119
Appendices	124
A. Distribution, Life Cycle, Taxonomy, and Culture Methods	125
A.1. <i>Ceriodaphnia dubia</i>	125
A.2. <i>Daphnia</i> (<i>D. magna</i> and <i>D. pulex</i>)	140
A.3. Mysids (<i>Mysidopsis bahia</i> and <i>Holmesimysis costata</i>)	159
A.4. Brine Shrimp (<i>Artemia salina</i>)	178
A.5. Fathead Minnow (<i>Pimephales promelas</i>)	185
A.6. Rainbow Trout, <i>Oncorhynchus mykiss</i> and Brook Trout, <i>Salvelinus fontinalis</i>	201
A.7. Sheepshead minnow (<i>Cyprinodon variegatus</i>)	209
A.8. Silversides: Inland Silverside (<i>Mendia beryllina</i>), Atlantic Silverside (<i>M. menidia</i>), and Tidewater Silverside (<i>M. peninsulae</i>)	224
B. Supplemental List of Acute Toxicity Test Species	238
C. Dilutor Systems	240
D. Plans for Mobile Toxicity Test Laboratory	253
D.1. Tandem-Axle Trailer	253
D.2. Fifth Wheel Trailer	256
E. Check Lists and Information Sheets	257
E.1. Toxicity Test Field Equipment List	257
E.2. Information Check List for On-Site Industrial or Municipal Toxicity Test	259
E.3. Daily Events Log	264
E.4. Dilutor Calibration Form	265
E.5. Daily Dilutor Calibration Check	266

FIGURES

<u>Number</u>	<u>Page</u>
1. Control (cusum) charts	20
2. Approximate times required to replace water in test chambers in flow-through tests	47
3. Rawson's nomograph for obtaining oxygen saturation values in freshwater at different temperatures at sea level	49
4. Example of data sheet for effluent toxicity tests	69
5. Check list on back of effluent toxicity data sheet	70
6. Flowchart for determination of the LC50 for multi-effluent-concentration acute toxicity tests	73
7. Plotted data and fitted line for graphical method, using all-or-nothing data	75
8. Example of input for computer program for Trimmed Spearman-Kärber Method	80
9. Example of output from computer program for Trimmed Spearman-Kärber Method	82
10. Example of input for computer program for Probit Method	84
11. Example of output for computer program for Probit Method	85
12. Flowchart for analysis of single-effluent-concentration test data	86
13. Flowchart for analysis of multi-effluent-concentration test data	87
14. Plot of mean survival proportion data in Table 29	99

TABLES

<u>Number</u>	<u>Page</u>
1. Intra-laboratory precision of LC50s from static acute toxicity tests with aquatic organisms using reference toxicants	11
2. Intra- and inter-laboratory precision of acute toxicity tests with <i>Daphnia magna</i> , using a standard effluent	12
3. Inter-laboratory precision of acute toxicity tests with aquatic organisms, using reference toxicants	13
4. Interlaboratory study of acute toxicity test precision, 1990: Summary of responses using KCL as the reference toxicant	14
5. National inter-laboratory study of acute toxicity test precision, 1991: Summary of responses using reference toxicants	15
6. National interlaboratory study of acute toxicity test precision, 2000: Precision of LC50 point estimates for reference toxicant, effluent, and receiving water sample types	16
7. Preparation of synthetic freshwater using reagent grade chemicals	33
8. Preparation of synthetic freshwater using mineral water	34
9. Preparation of synthetic seawater using reagent grade chemicals	34
10. Percent unionized NH ₃ in aqueous ammonia solutions: Temperatures between 15-26°C and pH's 6.0-8.9	42
11. Oxygen solubility (mg/L) in water at equilibrium with air at 760 mm Hg	48
12. Summary of test conditions and test acceptability criteria for <i>Ceriodaphnia dubia</i> acute toxicity tests with effluents and receiving waters (Test Method 2002.0)	51
13. Summary of test conditions and test acceptability criteria for <i>Daphnia pulex</i> and <i>D. magna</i> acute toxicity tests with effluents and receiving waters (Test Method 2021.0)	53
14. Summary of test conditions and test acceptability criteria for fathead minnow, <i>Pimephales promelas</i> , acute toxicity tests with effluents and receiving waters (Test Method 2000.0) ..	55
15. Summary of test conditions and test acceptability criteria for rainbow trout, <i>Oncorhynchus mykiss</i> , and brook trout, <i>Salvelinus fontinalis</i> , acute toxicity tests with effluents and receiving waters (Test Method 2019.0)	57
16. Summary of test conditions and test acceptability criteria for mysid, <i>Mysidopsis bahia</i> , acute toxicity tests with effluents and receiving waters (Test Method 2007.0)	59
17. Summary of test conditions and test acceptability criteria for sheepshead minnow, <i>Cyprinodon variegatus</i> , acute toxicity tests with effluents and receiving waters (Test Method 2004.0) .	61

TABLES (CONTINUED)

<u>Number</u>	<u>Page</u>
18. Summary of test conditions and test acceptability criteria for silverside, <i>Menidia beryllina</i> , <i>M. menidia</i> , and <i>M. peninsulae</i> , acute toxicity tests with effluents and receiving waters (Test Method 2006.0)	63
19. Summary of test conditions and test acceptability criteria for west coast mysid, <i>Holmesimysis costata</i> , acute toxicity tests with effluents and receiving waters	65
20. Mortality data (number of dead organisms) from acute toxicity tests used in examples of LC50 determinations (20 organisms in the control and all test concentrations)	76
21. Coefficients for the Shapiro Wilk's test	90
22. Quantiles of the Shapiro Wilk's test statistic	92
23. Critical values for Wilcoxon's rank sum test five percent significance level	95
24. Data from an acute single-concentration toxicity test with <i>Ceriodaphnia</i>	95
25. Example of Shapiro Wilk's test: Centered observations	96
26. Example of Shapiro Wilk's test: Ordered observations	96
27. Example of Shapiro Wilk's test: Table of coefficients and differences	97
28. Example of Wilcoxon's rank sum test: Assigning ranks to the control and 100% effluent concentrations	98
29. Fathead minnow survival data	100
30. Centered observations for Shapiro Wilk's example	100
31. Ordered centered observations for the Shapiro Wilk's example	101
32. Coefficients and differences for the Shapiro Wilk's example	102
33. ANOVA table	103
34. ANOVA table for Dunnett's Procedure example	105
35. Calculated t values	106
36. Dunnett's "t" values	107

SECTION 1

INTRODUCTION

1.1 This manual describes acute toxicity tests for use in the National Pollutant Discharge Elimination System (NPDES) Permits Program to identify effluents and receiving waters containing toxic materials in acutely toxic concentrations. With the exception of the *Holmesimysis costata* Acute Test (Table 19), the methods included in this manual are referenced in Table IA, 40 CFR Part 136 regulations and, therefore, constitute approved methods for acute toxicity tests. They are also suitable for determining the toxicity of specific compounds contained in discharges. The tests may be conducted in a central laboratory or on-site, by the regulatory agency or the permittee. The *Holmesimysis costata* Acute Test (Table 19) is specific to Pacific Coast waters and is not listed at 40 CFR Part 136 for nationwide use. This method has been proposed but not yet approved at 40 CFR Part 136.

1.2 The data are used for NPDES permits development and to determine compliance with permit toxicity limits. Data can also be used to predict potential acute and chronic toxicity in the receiving water, based on the LC50 and appropriate dilution, application, and persistence factors. The tests are performed as a part of self-monitoring permit requirements, compliance biomonitoring inspections, toxics sampling inspections, and special investigations. Data from acute toxicity tests performed as part of permit requirements are evaluated during compliance evaluation inspections and performance audit inspections.

1.3 Modifications of these tests are also used in toxicity reduction evaluations and toxicity identification evaluations to identify the toxic components of an effluent, to aid in the development and implementation of toxicity reduction plans, and to compare and control the effectiveness of various treatment technologies for a given type of industry, irrespective of the receiving water (USEPA, 1988a; USEPA, 1988b; USEPA, 1989a; USEPA, 1989b; USEPA, 1991a).

1.4 This methods manual serves as a companion to the short-term chronic toxicity test methods manuals for freshwater and marine organisms (USEPA, 2002a; USEPA, 2002b), the NPDES compliance inspection manual (USEPA, 1988c), and the manual for evaluation of laboratories performing aquatic toxicity tests (USEPA, 1991b). In 2002, EPA revised previous editions of each of the three methods manuals (USEPA, 1993a; USEPA, 1994a; USEPA, 1994b).

1.5 Guidance for the implementation of toxicity tests in the NPDES program is provided in the Technical Support Document for Water Quality-based Toxics Control (USEPA, 1991c).

1.6 The use of any test species or test conditions other than those described in Tables 12-18 in this manual and referenced in Table 1A, 40 CFR 136.3, shall be considered a major modification to the method and subject to application and approval of alternate test procedures under 40 CFR 136.4 and 40 CFR 136.5.

1.7 These methods are restricted to use by, or under the supervision of, analysts experience in the use or conduct of, and interpretation of data from, aquatic toxicity tests. Each analyst must demonstrate the ability to generate acceptable test results with the methods using the procedures described in this methods manual.

1.8 This manual was prepared in the established EMSL-Cincinnati format (USEPA, 1983a).

SECTION 2

TYPES OF TESTS

2.1 The selection of the test type will depend on the NPDES permit requirements, the objectives of the test, the available resources, the requirements of the test organisms, and effluent characteristics such as fluctuations in effluent toxicity.

2.2 Effluent acute toxicity is generally measured using a multi-concentration, or definitive test, consisting of a control and a minimum of five effluent concentrations. The tests are designed to provide dose-response information, expressed as the percent effluent concentration that is lethal to 50% of the test organisms (LC50) within the prescribed period of time (24-96 h), or the highest effluent concentration in which survival is not statistically significantly different from the control.

2.3 Use of pass/fail tests consisting of a single effluent concentration (e.g., the receiving water concentration or RWC) and a control is not recommended. If the NPDES permit has a whole effluent toxicity limit for acute toxicity at the RWC, it is prudent to use that permit limit as the midpoint of a series of five effluent concentrations. This will ensure that there is sufficient information on the dose-response relationship. For example, the effluent concentrations utilized in a test may be: (1) 100% effluent, (2) $(RWC + 100)/2$, (3) RWC, (4) $RWC/2$, and (5) $RWC/4$. More specifically, if the RWC = 50%, appropriate effluent concentrations may be 100%, 75%, 50%, 25%, and 12.5%.

2.4 Receiving (ambient) water toxicity tests commonly employ two treatments, a control and the undiluted receiving water, but may also consist of a series of receiving water dilutions.

2.5 A negative result from an acute toxicity test does not preclude the presence of chronic toxicity. Also, because of the potential temporal variability in the toxicity of effluents, a negative test result with a particular sample does not preclude the possibility that samples collected at some other time might exhibit acute (or chronic) toxicity.

2.6 The frequency with which acute toxicity tests are conducted under a given NPDES permit is determined by the regulatory agency on the basis of factors such as the variability and degree of toxicity of the waste, production schedules, and process changes.

2.7 Tests may be static (static non-renewal or static renewal), or flow-through.

2.7.1 STATIC TESTS

2.7.1.1 Static non-renewal tests - The test organisms are exposed to the same test solution for the duration of the test.

2.7.1.2 Static-renewal tests - The test organisms are exposed to a fresh solution of the same concentration of sample every 24 h or other prescribed interval, either by transferring the test organisms from one test chamber to another, or by replacing all or a portion of solution in the test chambers.

2.7.2 FLOW-THROUGH TESTS

2.7.2.1 Two types of flow-through tests are in common use: (1) sample is pumped continuously from the sampling point directly to the dilutor system; and (2) grab or composite samples are collected periodically, placed in a tank adjacent to the test laboratory, and pumped continuously from the tank to the dilutor system. The flow-through method employing continuous sampling is the preferred method for on-site tests. Because of the large volume (often 400 L/day) of effluent normally required for flow-through tests, it is generally considered too costly and impractical to conduct these tests off-site at a central laboratory.

2.8 Advantages and disadvantages of the types of tests are as follows:

2.8.1 STATIC NON-RENEWAL TESTS

2.8.1.1 Advantages:

1. Simple and inexpensive.
2. Very cost effective in determining compliance with permit conditions.
3. Limited resources (space, manpower, equipment) required; would permit staff to perform many more tests in the same amount of time.
4. Smaller volume of effluent required than for static renewal or flow-through tests.

2.8.1.2 Disadvantages:

1. Dissolved oxygen (DO) depletion may result from high chemical oxygen demand (COD), biological oxygen demand (BOD), or metabolic wastes.
2. Possible loss of toxicants through volatilization and/or adsorption to the exposure vessels.
3. Generally less sensitive than static renewal or flow-through tests, because the toxic substances may degrade or be adsorbed, thereby reducing the apparent toxicity. Also, there is less chance of detecting slugs of toxic wastes, or other temporal variations in waste properties.

2.8.2 STATIC-RENEWAL, ACUTE TOXICITY TESTS

2.8.2.1 Advantages:

1. Reduced possibility of dissolved oxygen (DO) depletion from high chemical oxygen demand (COD) and/or biological oxygen demand (BOD), or ill effects from metabolic wastes from organisms in the test solutions.
2. Reduced possibility of loss of toxicants through volatilization and/or adsorption to the exposure vessels.
3. Test organisms that rapidly deplete energy reserves are fed when the test solutions are renewed, and are maintained in a healthier state.

2.8.2.2 Disadvantages:

1. Require greater volume of effluent than non-renewal tests.
2. Generally less sensitive than flow-through tests, because the toxic substances may degrade or be adsorbed, thereby reducing the apparent toxicity. Also, there is less chance of detecting slugs of toxic wastes, or other temporal variations in waste properties.

2.8.3 FLOW-THROUGH TESTS

2.8.3.1 Advantages:

1. Provide a more representative evaluation of the acute toxicity of the source, especially if sample is pumped continuously directly from the source and its toxicity varies with time.
2. DO concentrations are more easily maintained in the test chambers.
3. A higher loading factor (biomass) may be used.
4. The possibility of loss of toxicant due to volatilization, adsorption, degradation, and uptake is reduced.

2.8.3.2 Disadvantages:

1. Large volumes of sample and dilution water are required.
2. Test equipment is more complex and expensive, and requires more maintenance and attention.
3. More space is required to conduct tests.
4. Because of the resources required, it would be very difficult to perform multiple or overlapping sequential tests.

SECTION 3

HEALTH AND SAFETY

3.1 GENERAL PRECAUTIONS

3.1.1 Development and maintenance of an effective health and safety program in the laboratory requires an ongoing commitment by laboratory management, and includes (1) the appointment of a laboratory health and safety officer with the responsibility and authority to develop and maintain a safety program, (2) the preparation of a formal, written, health and safety plan, which is provided to each laboratory staff member, (3) an ongoing training program on laboratory safety, and (4) regularly scheduled, documented, safety inspections.

3.1.2 Collection and use of effluents in toxicity tests may involve significant risks to personal safety and health. Personnel collecting effluent samples and conducting toxicity tests should take all safety precautions necessary for the prevention of bodily injury and illness which might result from ingestion or invasion of infectious agents, inhalation or absorption of corrosive or toxic substances through skin contact, and asphyxiation due to lack of oxygen or presence of noxious gases.

3.1.3 Prior to sample collection and laboratory work, personnel must determine that all required safety equipment and materials have been obtained and are in good condition.

3.1.4 Guidelines for the handling and disposal of hazardous materials must be strictly followed.

3.2 SAFETY EQUIPMENT

3.2.1 PERSONAL SAFETY GEAR

3.2.1.1 Personnel must use safety equipment, as required, such as rubber aprons, laboratory coats, respirators, gloves, safety glasses, hard hats, and safety shoes.

3.2.2 LABORATORY SAFETY EQUIPMENT

3.2.2.1 Each laboratory (including mobile laboratories) must be provided with safety equipment such as first aid kits, fire extinguishers, fire blankets, emergency showers, and eye fountains.

3.2.2.2 Mobile laboratories should be equipped with a telephone to enable personnel to summon help in case of emergency.

3.3 GENERAL LABORATORY AND FIELD OPERATIONS

3.3.1 Guidance in Material Safety Data Sheets should be followed for reagents and other chemicals purchased from supply houses. Incompatible materials should not be stored together.

3.3.2 Work with effluents must be performed in compliance with accepted rules pertaining to the handling of hazardous materials (see Safety Manuals, Subsection 3.5). Personnel collecting samples and performing toxicity tests should not work alone.

3.3.3 Because the chemical composition of effluents is usually only poorly known, they must be considered as potential health hazards, and exposure to them should be minimized. Fume and canopy hoods over the test areas must be used whenever necessary.

3.3.4 It is advisable to cleanse exposed parts of the body immediately after collecting effluent samples.

3.3.5 All containers must be adequately labeled to indicate their contents.

3.3.6 Strong acids and volatile organic solvents employed in glassware cleaning must be used in a fume hood or under an exhaust canopy over the work area.

3.3.7 Good housekeeping contributes to safety and reliable results.

3.3.8 Electrical equipment or extension cords not bearing the approval of Underwriter Laboratories must not be used. Ground-fault interrupters must be installed in all "wet" laboratories where electrical equipment is used.

3.3.9 Mobile laboratories must be properly grounded to protect against electrical shock.

3.4 DISEASE PREVENTION

3.4.1 Personnel handling samples which are known or suspected to contain human wastes should be immunized against hepatitis B, tetanus, typhoid fever, and polio.

3.5 SAFETY MANUALS

3.5.1 For further guidance on safe practices when collecting effluent samples and conducting toxicity tests, check with the permittee and consult general industrial safety manuals, including USEPA (1986) and Walters and Jameson (1984).

3.6 WASTE DISPOSAL

3.6.1 Wastes generated during toxicity testing must be properly handled and disposed of in an appropriate manner. Each testing facility will have its own waste disposal requirements based on local, state, and Federal rules and regulations. It is extremely important that these rules and regulations be known, understood, and complied with by all persons responsible for, or otherwise involved in, performing testing activities. Local fire officials should be notified of any potentially hazardous conditions.

SECTION 4

QUALITY ASSURANCE

4.1 INTRODUCTION

4.1.1 Development and maintenance of a toxicity test laboratory quality assurance (QA) program requires an ongoing commitment by laboratory management, and includes the following: (1) appointment of a laboratory quality assurance officer with the responsibility and authority to develop and maintain a QA program; (2) preparation of a quality assurance plan with data quality objectives; (3) preparation of written descriptions of laboratory standard operating procedures (SOP's) for test organism culturing, toxicity testing, instrument calibration, sample chain-of-custody, laboratory sample tracking system, etc.; and (4) provision of adequate, qualified technical staff and suitable space and equipment to assure reliable data.

4.1.2 QA practices within an aquatic toxicology laboratory must address all activities that affect the quality of the final effluent toxicity data, such as: (1) effluent sampling and handling; (2) the source and condition of the test organisms; (3) condition and operation of equipment; (4) test conditions; (5) instrument calibration; (6) replication; (7) use of reference toxicants; (8) record keeping; and (9) data evaluation.

4.1.3 Quality control practices, on the other hand, consist of the more focused, routine, day-to-day activities carried out within the scope of the overall QA program. For more detailed discussion of quality assurance, and general guidance on good laboratory practices related to toxicity testing, see: FDA, 1978; USEPA, 1975; USEPA, 1979a; USEPA, 1980a; USEPA, 1980b; USEPA, 1991b; DeWoskin, 1984; and Taylor, 1987.

4.1.4 Guidance for the evaluation of laboratories performing toxicity tests and laboratory evaluation criteria may be found in USEPA 1991b.

4.2 FACILITIES, EQUIPMENT, AND TEST CHAMBERS

4.2.1 Separate test organism culturing and toxicity testing areas should be provided to avoid possible loss of cultures due to cross-contamination. Ventilation systems should be designed and operated to prevent recirculation or leakage of air from chemical analysis laboratories or sample storage and preparation areas into organism culturing or toxicity testing areas, and from toxicity test laboratories and sample preparation areas into culture rooms.

4.2.2 Laboratory and toxicity test temperature control equipment must be adequate to maintain recommended test water temperatures. Recommended materials must be used in the fabrication of the test equipment which comes in contact with the effluent (see Section 5, Facilities and Equipment).

4.3 TEST ORGANISMS

4.3.1 The test organisms used in the procedures described in this manual are listed in Section 6, Test Organisms. The organisms should appear healthy, behave normally, feed well, and have low mortality in cultures, during holding, and in test controls. Test organisms should be positively identified to species.

4.4 LABORATORY WATER USED FOR CULTURING AND TEST DILUTION WATER

4.4.1 The quality of water used for test organism culturing and for dilution water used in toxicity tests is extremely important. Water for these two uses should come from the same source. The dilution water used in effluent toxicity tests will depend in part on the objectives of the study and logistical constraints, as discussed in detail in Section 7, Dilution Water. The dilution water used for internal quality assurance tests with organisms, food, and reference toxicants should be the water routinely used with success in the laboratory. Types of water are discussed in Section

5, Facilities and Equipment. Water used for culturing and test dilution should be analyzed for toxic metals and organics at least annually or whenever difficulty is encountered in meeting minimum acceptability criteria for control survival and reproduction or growth. The concentration of the metals, Al, As, Cr, Co, Cu, Fe, Pb, Ni, and Zn, expressed as total metal, should not exceed 1 µg/L each, and Cd, Hg, and Ag, expressed as total metal, should not exceed 100 ng/L each. Total organochlorine pesticides plus PCBs should be less than 50 ng/L (APHA, 1992). Pesticide concentrations should not exceed USEPA's Ambient Water Quality chronic criteria values where available.

4.5 EFFLUENT SAMPLING AND SAMPLE HANDLING

4.5.1 Sample holding times and temperatures must conform to conditions described in Section 8, Effluent and Receiving Water Sampling and Sample Handling.

4.6 TEST CONDITIONS

4.6.1 The temperature of test solutions must be measured by placing the thermometer or probe directly into the test solutions, or by placing the thermometer in equivalent volumes of water in surrogate vessels positioned at appropriate locations among the test vessels. Temperature should be recorded continuously in at least one vessel during the duration of each test. Test solution temperatures should be maintained within the limits specified for each test. DO concentration and pH in test chambers should be checked daily throughout the test period, as prescribed in Section 9, Acute Toxicity Test Procedures.

4.7 QUALITY OF TEST ORGANISMS

4.7.1 The health of test organisms is primarily assessed by the performance (survival, growth, and/or reproduction) of organisms in control treatments of individual tests. The health and sensitivity of test organisms is also assessed by reference toxicant testing. In addition to documenting the sensitivity and health of test organisms, reference toxicant testing is used to initially demonstrate acceptable laboratory performance (Subsection 4.14) and to document ongoing laboratory performance (Subsection 4.15).

4.7.2 Regardless of the source of test organisms (in-house cultures or purchased from external suppliers), the testing laboratory must perform at least one acceptable reference toxicant test per month for each toxicity test method conducted in that month (Subsection 4.15). If a test method is conducted only monthly, or less frequently, a reference toxicant test must be performed concurrently with each effluent toxicity test.

4.7.3 When acute or short-term chronic toxicity tests are performed with effluents or receiving waters using test organisms obtained from outside the test laboratory, concurrent toxicity tests of the same type must be performed with a reference toxicant, unless the test organism supplier provides control chart data from at least the last five monthly acute toxicity tests using the same reference toxicant and test conditions.

4.7.4 The supplier should also certify the species identification of the test organisms, and provide the taxonomic reference (citation and page) or name(s) of the taxonomic expert(s) consulted.

4.7.5 If a routine reference toxicant test fails to meet test acceptability criteria, then the reference toxicant test must be immediately repeated.

4.8 FOOD QUALITY

4.8.1 The nutritional quality of the food used in culturing and testing fish and invertebrates is an important factor in the quality of the toxicity test data. This is especially true for the unsaturated fatty acid content of brine shrimp nauplii, *Artemia*. Suitable trout chow, *Artemia*, and other foods must be obtained as described in this manual.

4.8.2 Problems with the nutritional suitability of the food will be reflected in the survival, growth, and reproduction of the test organisms in cultures and toxicity tests. If a batch of food is suspected to be defective, the performance of organisms fed with the new food can be compared with the performance of organisms fed with a food of known quality in side-by-side tests. If the food is used for culturing, its suitability should be determined using a short-term chronic test which will determine the effect of food quality on growth or reproduction of each of the relevant test species in culture, using four replicates with each food source. Where applicable, foods used only in acute toxicity tests can be compared with a food of known quality in side-by-side, multi-concentration acute tests, using the reference toxicant regularly employed in the laboratory QA program.

4.8.3 New batches of food used in culturing and testing should be analyzed for toxic organics and metals or whenever difficulty is encountered in meeting minimum test acceptability criteria for control survival and reproduction or growth. If the concentration of total organochlorine pesticides exceeds 0.15 µg/g wet weight, or the concentration of the total organochlorine pesticides plus PCBs exceeds 0.30 µg/g wet weight, or toxic metals (Al, As, Cr, Co, Cu, Pb, Ni, Zn, expressed as total metal) exceed 20 µg/g wet weight, the food should not be used (for analytical methods see AOAC, 1990 and USDA, 1989). For foods (e.g., such as YCT) which are used to culture and test organisms, the quality of food should meet the requirements for the laboratory water used for culturing and test dilution water as described in Section 4.4 above.

4.9 ACCEPTABILITY OF ACUTE TOXICITY TEST RESULTS

4.9.1 For the test results to be acceptable, control survival must equal or exceed 90%.

4.9.2 An individual test may be conditionally acceptable if temperature, DO, and other specified conditions fall outside specifications, depending on the degree of the departure and the objectives of the tests (see test condition summaries). The acceptability of the test will depend on the experience and professional judgment of the laboratory analyst and the reviewing staff of the regulatory authority. Any deviation from test specifications must be noted when reporting data from a test.

4.10 ANALYTICAL METHODS

4.10.1 Routine chemical and physical analyses for culture and dilution water, food, and test solutions, must include established quality assurance practices outlined in Agency methods manuals (USEPA, 1979a; USEPA, 1993b).

4.10.2 Reagent containers should be dated when received from the supplier, and the shelf life should not be exceeded. Also, working solutions should be dated when prepared, and the recommended shelf life should be observed.

4.11 CALIBRATION AND STANDARDIZATION

4.11.1 Instruments used for routine measurements of chemical and physical parameters such as pH, DO, temperature, conductivity, salinity, alkalinity, and hardness must be calibrated and standardized prior to use each day according to the instrument manufacturer's procedures as indicated in the general section on quality assurance (see EPA Methods 150.1, 360.1, 170.1, and 120.1; USEPA, 1979b). Calibration data are recorded in a permanent log.

4.11.2 Wet chemical methods used to measure hardness, alkalinity, and total residual chlorine must be standardized prior to use each day according to the procedures for those specific EPA methods (see EPA Methods 130.2 and 310.1; USEPA 1979b).

4.12 REPLICATION AND TEST SENSITIVITY

4.12.1 The sensitivity of toxicity tests will depend in part on the number of replicates per concentration, the significance level selected, and the type of statistical analysis. If the variability remains constant, the sensitivity of the test will increase as the number of replicates is increased. The minimum recommended number of replicates varies with the objectives of the test and the statistical method used for analysis of the data.

4.13 VARIABILITY IN TOXICITY TEST RESULTS

4.13.1 Factors which can affect test success and precision include: the experience and skill of the laboratory analyst; test organism age, condition, and sensitivity; dilution water quality; temperature control; and the quality and quantity of food provided. The results will depend upon the species used and the strain or source of the test organisms, and test conditions such as temperature, DO, food, and water quality. The repeatability or precision of toxicity tests is also a function of the number of test organisms used at each toxicant concentration. Jensen (1972) discussed the relationship between sample size (numbers of fish) and the standard error of the test, and considered 20 fish per concentration as optimum for Probit Analysis.

4.13.2 Test precision can be estimated by using the same strain of organisms under the same test conditions, and employing a known toxicant, such as a reference toxicant. The single-laboratory (intra-laboratory) and multi-laboratory (inter-laboratory) precision of acute toxicity tests with several common test species and reference toxicants are listed in Tables 1-4. Intra- and inter-laboratory precision are described by the mean, standard deviation, and relative standard deviation (percent coefficient of variation, or CV) of the calculated endpoints from the replicated tests.

4.13.3 Intra-laboratory precision data from 268 acute toxicity tests with four species and five reference toxicants are listed in Tables 1 and 2. The precision, expressed as CV%, ranged from 3% to 86%. More recent CV values reported by Jop et al. (1986), Dorn and Rogers (1989), Hall et al. (1989), and Cowgill et al. (1990), fell in a somewhat lower range (8% to 41%).

4.13.4 Inter-laboratory precision of acute toxicity tests from 253 reference toxicant tests with seven species, listed in Tables 2, 3, 4, and 5 (expressed as CV% for LC50s), ranged from 11% to 167%. Table 6 shows interlaboratory precision data from a study of acute toxicity test methods using reference toxicant, effluent, and receiving water sample types (USEPA, 2001a; USEPA, 2001b). Averaged across sample types, total interlaboratory precision (expressed as CV% for LC50s) ranged from 13% to 38.5% for the acute methods.

4.13.5 No clear pattern of differences were noted in the intra- or inter-laboratory test precision with the species listed, although the test results with some toxicants, such as cadmium, appear to more variable than those with other reference toxicants.

4.13.6 Additional information on toxicity test precision is provided in the Technical Support Document for Water Quality-Based Toxics Control (see pp. 2-4, and 11-15; USEPA, 1991c).

TABLE 1. INTRA-LABORATORY PRECISION OF LC50S FROM STATIC ACUTE TOXICITY TESTS WITH AQUATIC ORGANISMS USING REFERENCE TOXICANTS¹

TEST ORGANISM	REFERENCE TOXICANT ²										
	N	SDS			N	NAPCP			N	CD	
		LC50	CV (%)			LC50	CV (%)			LC50	CV (%)
<i>Pimephales promelas</i> (96 h, 21 °C) ³	9	8.6	20		12	0.14	40		9	0.15	120
<i>Daphnia magna</i> (24 h, 20 °C) ⁴	8	20.9	28		10	0.69	14		11	0.121	49
<i>Daphnia magna</i> (24 h, 26 °C) ⁴	10	12.9	48		9	0.67	25		9	0.026	77
<i>Daphnia magna</i> (48 h, 20 °C) ⁴	10	13.5	29		10	0.42	21		9	0.038	58
<i>Daphnia magna</i> (48 h, 26 °C) ⁴	9	10.8	33		9	0.48	23		8	0.009	35
<i>Daphnia pulex</i> (24 h, 20 °C) ⁴	9	18.4	23		9	0.64	15		5	0.147	30
<i>Daphnia pulex</i> (24 h, 26 °C) ⁴	10	13.9	25		9	0.62	25		10	0.063	45
<i>Daphnia pulex</i> (48 h, 20 °C) ⁴	10	12.6	32		9	0.48	16		10	0.042	45
<i>Daphnia pulex</i> (48 h, 26 °C) ⁴	9	10.2	36		8	0.47	32		6	0.006	14
<i>Mysidopsis bahia</i> (96 h, 25 °C) ⁵									13	0.346	9

¹ Precision expressed as percent coefficient of variation, where CV% = (standard deviation X 100)/mean.

² SDS = Sodium dodecyl (lauryl) sulfate; NAPCP = Sodium pentachlorophenate; CD = Cadmium; N = Number of tests; toxicant concentration in mg/L.

³ *Pimephales promelas* tests were performed in soft, synthetic freshwater; total hardness, 40-48 mg/L as CaCO₃, by J. Dryer, Aquatic Biology Section, EMSL-Cincinnati.

⁴ *Daphnia* data from Lewis and Horning, 1991. Tests with *D. magna* used hard reconstituted water (total hardness, 180-200 mg/L as CaCO₃); tests with *D. pulex* used moderately-hard reconstituted water (total hardness, 80-100 mg/L as CaCO₃).

⁵ Mysid tests were performed in 25 ppt salinity, natural seawater. Data were provided by Steve Ward, Environmental Services Division, U.S. Environmental Protection Agency, Edison, New Jersey. Personal communication, November 14, 1990.

TABLE 2. INTRA- AND INTER-LABORATORY PRECISION OF ACUTE TOXICITY TESTS WITH *DAPHNIA MAGNA*, USING A STANDARD EFFLUENT^{1,2}

LABORATORY	INTER-LABORATORY PRECISION: <u>LC50s FROM REPLICATE TESTS</u>		INTRA-LABORATORY PRECISION ³
	24 H	48 H	
INDUSTRY			
1	14.4	4.2	---
	11.4	4.9	
2	13.9	6.8	6.4
	16.6	6.1	
	13.7	6.1	
3	11.7	3.5	---
	17.4	7.1	
GOVERNMENT			
1	14.0	4.4	4.0
	10.0	4.4	
	10.8	4.1	
2	13.2	4.5	---
	14.1	4.5	
3	11.6	4.2	---
COMMERCIAL			
1	20.1	4.9	---
	20.1	4.7	
2	8.9	3.7	---
	12.3	5.6	
3	14.8	9.0	3.0
	25.4	9.1	
	26.4	8.6	
N	20	20	3
MEAN	15.0	5.52	4.47
SD	4.75	1.75	1.75
CV%	31.6	31.6	39.1

¹ From Table 2, p. 191, Grothe and Kimerle, 1985. Tests performed at 20°C ±2°C; dilution water hardness, 100mg/L as CaCO₃; dilution water alkalinity, 76 mg/L as CaCO₃; effluent hardness, approx. 1000 mg/L as CaCO₃; effluent alkalinity, 310 mg/L as CaCO₃; effluent dilutions - 56%, 32%, 18%, 10%, 5.6%, 3.1%, 1.7%.

² LC50 expressed in percent effluent.

³ Intra-laboratory precision expressed as the weighted mean CV(%).

TABLE 3. INTER-LABORATORY PRECISION OF ACUTE TOXICITY TESTS WITH AQUATIC ORGANISMS, USING REFERENCE TOXICANTS¹

TEST ORGANISM	REFERENCE TOXICANT					
	SILVER			ENDOSULFAN		
	N	LC50	CV (%)	N	LC50	CV (%)
1. <i>Pimephales promelas</i> (96 h, 22°C)						
96-h static test (Meas)	10	14.0	53	12	2.03	38
96-h flow-through test (Meas)	9	7.49	40	12	0.96	46
2. <i>Oncorhynchus mykiss</i> (96 h, 12°C)						
96-h static test (Meas)	10	34.5	88	12	1.15	50
96-h flow-through test (Meas)	9	11.5	33	12	0.40	42
3. <i>Daphnia magna</i> (48 h, 20°C)						
48-h static (Meas)	12	10.6	166	11	328	51
4. <i>Mysidopsis bahia</i> (96 h, 22°C)						
96-h static test (Nom)	6	210	27	5	0.84	62
96-h flow-through test (Nom)	6	251	22	6	1.02	58
96-h flow-through test (Meas)	6	192	58	5	0.94	167
5. <i>Cyprinodon variegatus</i> (96 h, 22°C)						
96-h static test (Nom)	4	1122	35	6	2.41	37
96-h flow-through test (Nom)	5	1573	50	6	1.69	46
96-h flow-through test (Meas)	5	1216	50	6	0.81	46

¹ Data for *Pimephales promelas* (fathead minnow), *Oncorhynchus mykiss* (rainbow trout), and *Daphnia magna* were taken from USEPA, 1983b.

Data for, *Mysidopsis bahia*, and *Cyprinodon variegatus* (sheepshead minnow) were taken from USEPA, 1981. Six laboratories participated in each study. Test salinity was 28‰.

LC50s expressed in µg/L.

In the studies with the freshwater organisms, the water hardness for five of the six laboratories ranged between 36 and 75 mg/L. However, the water hardness for the sixth laboratory was 255 mg/L, resulting in LC50 values for silver more than an order of magnitude larger than for the other five. These values were rejected in calculating the CV%. The mean weights of test fish were from 0.05-0.26 g for fathead minnows, and 0.22-1.32 g for rainbow trout. *Daphnia* were ≤24-h old.

In studies with the marine organisms, only one LC50 (presumably the combined LC50 from duplicate tests) was reported for each toxicity test. LC50s for flow-through tests with *Mysidopsis bahia* and *Cyprinodon variegatus* were calculated two different ways -- (1) on the basis of the nominal toxicant concentrations (Nom), and (2) on the basis of measured (Meas) toxicant concentrations. Test organism age was ≤2 days for *Mysidopsis bahia*, and 28 days for *Cyprinodon variegatus*. The salinity of test solutions was 28‰.

N, the total number of LC50 values used in calculating the CV(%) varied with organism and toxicant because some data were rejected due to water hardness, lack of concentration measurements, and/or because some of the LC50s were not calculable.

² CV% = Percent coefficient of variation = (standard deviation x 100)/mean.

TABLE 4. INTER-LABORATORY STUDY OF ACUTE TOXICITY TEST PRECISION, 1990: SUMMARY OF RESPONSES USING KCL AS THE REFERENCE TOXICANT¹

TEST TYPE	NO. LABS SUBMITTING VALID DATA	TEST PRECISION (CV%) ²								
		GRAPH ³ METHOD			STAT ⁴ METHOD			TOTAL ⁵		
		N	LC50	CV%	N	LC50	CV%	N	LC50	CV%
<i>Pimephales promelas</i> (96 h, 22°C) ⁶	17	6	944	28.8	13	832	27.8	17	864	29.6
<i>Pimephales promelas</i> (24 h, 25°C) ⁷	6	6	832	11.5	6	832	11.5	–	–	–
<i>Ceriodaphnia dubia</i> (48 h, 25°C) ⁷	11	11	256	53.1	11	264	48.5	–	–	–
<i>Mysidopsis bahia</i> (96 h, 22°C) ⁸	14	7	292	32.9	11	250	36.0	14	268	37.3

¹ Interlaboratory study of toxicity test precision conducted in 1990 by the Environmental Monitoring Systems Laboratory - Cincinnati, U.S. Environmental Protection Agency, Cincinnati, Ohio 45268, in cooperation with the states of New Jersey and North Carolina, and the Office of Water Enforcement and Permits, U.S. Environmental Protection Agency, Washington, DC.

² Percent coefficient of variation = (standard deviation X 100)/mean. Calculated for LC50 from acute tests. LC50s expressed as mg/L KCl added to the dilution water.

³ LC50 estimated by the Graphical Method.

⁴ LC50 estimated by Probit, Litchfield-Wilcoxon, or Trimmed Spearman-Kärber method.

⁵ LC50 usually reported for only one method of analysis for each test. Where more than one LC50 was reported for a test, the lowest value was used to calculate the statistics for "Total."

⁶ Data from the New Jersey Department of Environmental Protection: static daily-renewal tests, using moderately-hard synthetic freshwater.

⁷ Data from North Carolina certified laboratories: static non-renewal tests, using moderately-hard reconstituted freshwater.

⁸ Data from the New Jersey Department of Environmental Protection: static daily-renewal tests, using 25 ppt salinity, FORTY FATHOMS[®] synthetic seawater.

TABLE 5. NATIONAL INTERLABORATORY STUDY OF ACUTE TOXICITY TEST PRECISION, 1991: SUMMARY OF RESPONSES USING REFERENCE TOXICANTS¹

Test Type	No. Labs Submitting Data	LC50	CV% ²
<i>Pimephales promelas</i> (48 h, 25°C) ³	203	896 ⁴	28.6
<i>Ceriodaphnia dubia</i> (48 h, 25°C) ³	171	432 ⁴	39.8
<i>Mysidopsis bahia</i> (48 h, 25°C) ⁵	61	532 ⁴	30.1
<i>Menidia beryllina</i> (48 h, 25°C) ⁵	39	164 ⁶	42.2

¹ From a national study of interlaboratory precision of toxicity test data performed in 1991 by the Environmental Monitoring Systems Laboratory - Cincinnati, U.S. Environmental Protection Agency, Cincinnati, OH 45268. Participants included Federal, state, and private laboratories engaged in NPDES permit compliance monitoring. LC50s were estimated by the graphical or Spearman-Kärber method.

² Percent coefficient of variation = (standard deviation X 100)/mean.

³ Static non-renewal tests, using moderately-hard synthetic freshwater (total hardness = 80-100 mg/L as CaCO₃).

⁴ Expressed as mg KCl added per liter of dilution water.

⁵ Static non-renewal tests, using 30 ppt modified GP2 artificial seawater.

⁶ Expressed as µg Cu⁺⁺ added per liter of dilution water.

TABLE 6. NATIONAL INTERLABORATORY STUDY OF ACUTE TOXICITY TEST PRECISION, 2000: PRECISION OF LC50 POINT ESTIMATES FOR REFERENCE TOXICANT, EFFLUENT, AND RECEIVING WATER SAMPLE TYPES¹.

Method	Sample Type	CV (%) ²		
		Within-lab ³	Between-lab ⁴	Total ⁵
<i>Pimephales promelas</i>	KCl	7.62	19.7	21.1
	Municipal effluent	10.3	19.2	21.8
	Receiving water	-	-	17.2
	Average	8.96	19.4	20.0
<i>Ceriodaphnia dubia</i>	KCl	14.6	15.2	21.1
	Municipal effluent	9.68	32.8	34.2
	Receiving water	-	-	31.8
	Average	12.1	24.0	29.0
<i>Cyprinodon variegatus</i>	KCl	-	-	26.0
	Municipal effluent	-	-	19.4
	Receiving water	-	-	32.5
	Average	-	-	26.0
<i>Menidia beryllina</i>	CuSO ₄ ⁶	-	-	-
	Industrial effluent	9.91	49.7	50.7
	Receiving water	-	-	26.3
	Average	9.91	49.7	38.5
<i>Holmesimysis costata</i> ⁷	Zn (48 h test)	19	-	
	Zn (96 h test)	23	-	
	Zn (interlaboratory trial 1)	-	-	24
	Zn (interlaboratory trial 2)	-	-	1
	Average	21		13

¹ From EPA's WET Interlaboratory Variability Study (USEPA, 2001a; USEPA, 2001b).

² CVs were calculated based on the within-laboratory component of variability, the between-laboratory component of variability, and total interlaboratory variability (including both within-laboratory and between-laboratory components). For the receiving water sample type, within-laboratory and between-laboratory components of variability could not be calculated since the study design did not provide within-laboratory replication for this sample type. The study design also did not provide within-laboratory replication for the *Cyprinodon variegatus* Acute Method.

- ³ The within-laboratory (intralaboratory) component of variability for duplicate samples tested at the same time in the same laboratory.
- ⁴ The between-laboratory component of variability for duplicate samples tested at different laboratories.
- ⁵ The total interlaboratory variability, including within-laboratory and between-laboratory components of variability. The total interlaboratory variability is synonymous with interlaboratory variability reported from other studies where individual variability components are not separated.
- ⁶ Precision estimates were not calculated for the reference toxicant sample type since the majority of results for this sample type were outside of the test concentration range (ie., >100).
- ⁷ *Holmesimysis costata* Acute Test data were from Martin *et al.* (1989). Zn was tested in two intralaboratory trials and in two interlaboratory trials. Data from this study was only reported to two significant figures.

4.14 DEMONSTRATING ACCEPTABLE LABORATORY PERFORMANCE

4.14.1 It is a laboratory's responsibility to demonstrate its ability to obtain consistent, precise results with reference toxicants before it performs toxicity tests with effluents for permit compliance purposes. To meet this requirement, the intra-laboratory precision, expressed as percent coefficient of variation (CV%), of each type of test to be used in a laboratory should be determined by performing five or more tests with different batches of test organisms, using the same reference toxicant, at the same concentrations, with the same test conditions (i.e., the same test duration, type of dilution water, age of test organisms, feeding, etc.), and same data analysis methods. A reference toxicant concentration series (0.5 or higher) should be selected that will consistently provide partial mortalities at two or more concentrations.

4.15 DOCUMENTING ONGOING LABORATORY PERFORMANCE

4.15.1 Satisfactory laboratory performance is demonstrated by performing at least one acceptable test per month with a reference toxicant for each toxicity test method conducted in the laboratory during that month. For a given test method, successive tests must be performed with the same reference toxicant, at the same concentrations, in the same dilution water, using the same data analysis methods. Precision may vary with the test species, reference toxicant, and type of test. Each laboratory's reference toxicity data will reflect conditions unique to that facility, including dilution water, culturing, and other variables; however, each laboratory's reference toxicity results should reflect good repeatability.

4.15.2 A control chart should be prepared for each combination of reference toxicant, test species, test condition, and endpoint. Toxicity endpoints from five or six tests are adequate for establishing the control charts. In this technique, a running plot is maintained for the toxicity values (X_i) from successive tests with a given reference toxicant (Figure 1), and endpoints (LC50s) are examined to determine if they are within prescribed limits. The types of control charts illustrated (see USEPA, 1979a) are used to evaluate the cumulative trend of results from a series of samples, thus reference toxicant test results should not be used as a *de facto* criterion for rejection of individual effluent or receiving water tests. The mean (\bar{x}) and upper and lower control limits ($\pm 2S$) are recalculated with each successive test result. After two years of data collection, or a minimum of 20 data points, the control chart should be maintained using only the 20 most recent data points.

4.15.3 Laboratories should compare the calculated CV (i.e., standard deviation / mean) of the LC50 for the 20 most recent data points to the distribution of laboratory CVs reported nationally for reference toxicant testing (Table 3-3 in USEPA, 2000b). If the calculated CV exceeds the 75th percentile of CVs reported nationally, the laboratory should use the 75th and 90th percentiles to calculate warning and control limits, respectively, and the laboratory should investigate options for reducing variability.

4.15.4 The outliers, which are values falling outside the upper and lower control limits, and trends of increasing or decreasing sensitivity, are readily identified. At the $P_{0.05}$ probability level, one in 20 tests would be expected to fall outside of the control limits by chance alone. If more than one out of 20 reference toxicant tests fall outside the control limits, the laboratory should investigate sources of variability, take corrective actions to reduce identified sources of variability, and perform an additional reference toxicant test during the same month. In those instances when the laboratory can document the cause for the outlier (e.g., operator error, culture health or test system failure), the outlier should be excluded from the future calculations of the control limits. If two or more consecutive tests do not fall within the control limits, the results must be explained and the reference toxicant test must be immediately repeated. Actions taken to correct the problem must be reported.

4.15.5 If the toxicity value from a given test with the reference toxicant falls well outside the expected range for the test organisms when using the standard dilution water, the laboratory should investigate sources of variability, take corrective actions to reduce identified sources of variability, and perform an additional reference toxicant test during the same month. Performance should improve with experience, and the control limits for point estimates should gradually narrow. However, control limits of $\pm 2S$, by definition, will be exceeded 5% of the time, regardless of how well a laboratory performs. Highly proficient laboratories which develop a very narrow control limit may be unfairly penalized if a test which falls just outside the control limits is rejected *de facto*. For this reason, the width

of the control limits should be considered in determining whether or not a reference toxicant test result falls “well” outside the expected range. The width of the control limits may be evaluated by comparing the calculated CV (i.e., standard deviation / mean) of the LC50 for the 20 most recent data points to the distribution of laboratory CVs reported nationally for reference toxicant testing (Table 3-3 in USEPA, 2000b). In determining whether or not a reference toxicant test result falls “well” outside the expected range, the result also may be compared with upper and lower bounds for $\pm 3S$, as any result outside these control limits would be expected to occur by chance only 1 out of 100 tests (Environment Canada, 1990). When a result from a reference toxicant test is outside the 99% confidence intervals, the laboratory must conduct an immediate investigation to assess the possible causes for the outlier.

4.15.6 Reference toxicant test results should not be used as a *de facto* criterion for rejection of individual effluent or receiving water tests. Reference toxicant testing is used for evaluating the health and sensitivity of organisms over time and for documenting initial and ongoing laboratory performance. While reference toxicant test results should not be used as a *de facto* criterion for test rejection, effluent and receiving water test results should be reviewed and interpreted in the light of reference toxicant test results. The reviewer should consider the degree to which the reference toxicant test result fell outside of control chart limits, the width of the limits, the direction of the deviation (toward increased test organism sensitivity or toward decreased test organism sensitivity), the test conditions of both the effluent test and the reference toxicant test, and the objective of the test.

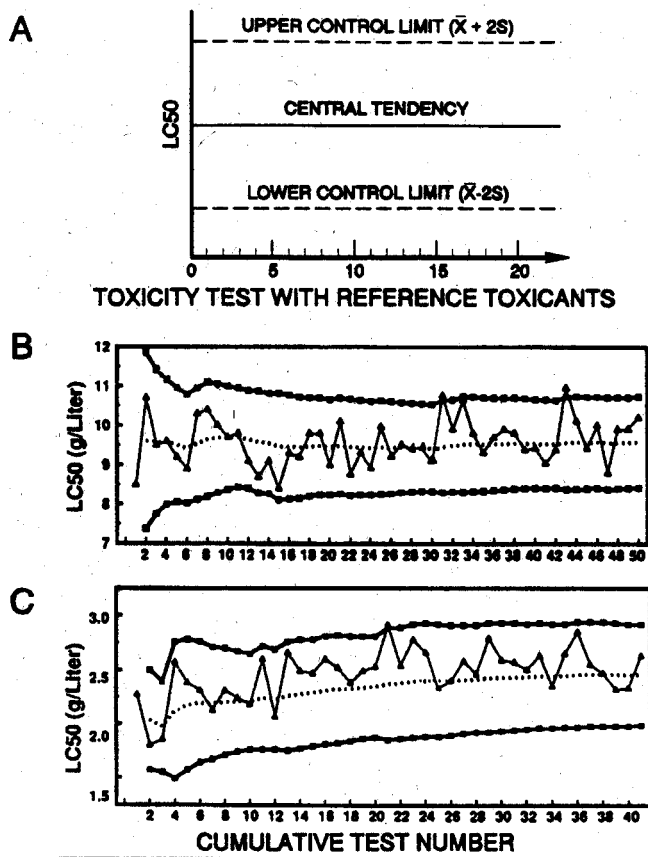

Figure 1. Control (cusum) charts: A, General case; B and C, 48-h acute tests with sodium chloride. (B) Fathead minnow (*Pimephales promelas*), and (C) *Ceriodaphnia dubia*, with the individual LC50s (Triangles), cumulative LC50 means (dotted line), and upper and lower control limits of two standard deviations (squares). (Provided by the Environmental Services Division, U.S. Environmental Protection Agency, Kansas City, KS).

4.16 REFERENCE TOXICANTS

4.16.1 Reference toxicants such as sodium chloride (NaCl), potassium chloride (KCl), cadmium chloride (CdCl₂), copper sulfate (CuSO₄), sodium dodecyl sulfate (SDS), and potassium dichromate (K₂Cr₂O₇), are suitable for use in the NPDES and other Agency programs requiring aquatic toxicity tests. EMSL-Cincinnati hopes to release EPA-certified solutions of cadmium and copper, with accompanying toxicity data for the recommended test species, for use as reference toxicants through cooperative research and development agreements with commercial suppliers, and will continue to develop additional reference toxicants for future release. Standard reference materials can be obtained from commercial supply houses, or can be prepared inhouse using reagent grade chemicals. The regulatory agency should be consulted before reference toxicant(s) are selected and used.

4.17 RECORD KEEPING

4.17.1 Proper record keeping is important. A complete file should be maintained for each individual toxicity test or group of tests on closely related samples. This file should contain a record of the sample chain-of-custody; a copy of the sample log sheet; the original bench sheets for the test organism responses during the toxicity test(s); chemical analysis data on the sample(s); detailed records of the test organisms used in the test(s), such as species, source, age, date of receipt, and other pertinent information relating to their history and health; information on the calibration of equipment and instruments; test conditions employed; and results of reference toxicant tests. Laboratory data should be recorded on a real-time basis to prevent the loss of information or inadvertent introduction of errors into the record. Original data sheets should be signed and dated by the laboratory personnel performing the tests.

4.17.2 The regulatory authority should retain records pertaining to discharge permits. Permittees are required to retain records pertaining to permit applications and compliance for a minimum of 3 years [40 CFR 122.41(j)(2)].

SECTION 5

FACILITIES AND EQUIPMENT

5.1 GENERAL REQUIREMENTS

5.1.1 Effluent toxicity tests may be performed in a fixed or mobile laboratory. Facilities should include equipment for rearing and/or holding organisms.

5.1.2 The facilities must be well ventilated and free of toxic fumes. Sample preparation, culturing, and toxicity testing areas should be separated to avoid cross contamination of cultures or toxicity test solutions with toxic fumes. Laboratory ventilation systems should be checked to ensure that return air from chemistry laboratories and/or sample handling areas is not circulated to test organism culture rooms or toxicity test rooms, or that air from toxicity test rooms does not contaminate culture areas. Air pressure differentials between such rooms should not result in a net flow of potentially contaminated air to sensitive areas through open or loosely-fitting doors.

5.1.3 Control of test solution temperature can best be achieved using circulating water baths, heat exchangers, or environmental chambers. Photoperiod can be controlled using automatic timers in the laboratory or environmental chambers.

5.1.4 Water used for rearing, holding, and testing organisms may be reconstituted synthetic water, ground water, surface water, or dechlorinated tap water. Dechlorination can be accomplished by carbon filtration, laboratory water conditioning units, or the use of sodium thiosulfate. After dechlorination, total residual chlorine should be non-detectable. Sodium thiosulfate may be toxic to the test organisms, and if used for dechlorination, paired controls with and without sodium thiosulfate should be incorporated in effluent toxicity tests. Use of 3.6 mg (anhydrous) sodium thiosulfate/L will reduce 1.0 mg chlorine/L. After dechlorination, total residual chlorine should be non-detectable.

5.1.4.1 A good quality, laboratory grade deionized water, providing a resistance of 18 megaohm-cm, must be available in the laboratory and in sufficient quantity for laboratory needs. Deionized water may be obtained from MILLIPORE[®], Milli-Q[®], MILLIPORE QPAK[™]₂ or equivalent system. If large quantities of high quality deionized water are needed, it may be advisable to supply the laboratory grade water deionizer with preconditioned water from a CULLIGAN[®], CONTINENTAL[®], or equivalent, mixed-bed water treatment system.

5.1.5 Air used for aeration must be free of oil and fumes. Oil-free air pumps should be used where possible. Particulates can be removed from the air using BALSTON[®] Grade BX or equivalent filters (Balston, Inc., Lexington, MA), and oil and other organic vapors can be removed using activated carbon filters (BALSTON[®], C-1 filter, or equivalent).

5.1.6 During rearing, holding, and testing, test organisms should be shielded from external disturbances such as rapidly changing light conditions (especially salmonids) and pedestrian traffic.

5.1.7 Materials used for exposure chambers, tubing, etc., that come in contact with the effluent and dilution water should be carefully chosen. Tempered glass and perfluorocarbon plastics (TEFLON[®]) should be used whenever possible to minimize sorption and leaching of toxic substances, and may be reused after cleaning. Containers made of plastics, such as polyethylene, polypropylene, polyvinyl chloride, TYGON[®], etc., may be used to ship, store, and transfer effluents and receiving waters, but they should not be reused unless absolutely necessary, because they could carry over adsorbed toxicants from one test to another. However, these containers may be repeatedly reused for storing uncontaminated waters such as deionized or laboratory-prepared dilution waters and receiving waters. Glass or disposable polystyrene containers can be used as test chambers. The use of large (≥ 20 L) glass carboys is discouraged for safety reasons.

5.1.8 New plastic products should be tested for toxicity before general use by exposing organisms to them under ordinary test conditions.

5.1.9 Equipment which cannot be discarded after each use because of cost, must be decontaminated according to the cleaning procedures listed below. Fiberglass, in addition to the previously mentioned materials, can be used for holding and dilution water storage tanks, and in the water delivery system. All material should be flushed or rinsed thoroughly with dilution water before using in the test.

5.1.10 Copper, galvanized material, rubber, brass, and lead must not come in contact with holding or dilution water, or with effluent samples and test solutions. Some materials, such as neoprene rubber (commonly used for stoppers), may be toxic and should be tested before use.

5.1.11 Silicone adhesive used to construct glass test chambers absorbs some organochlorine and organophosphorus pesticides, which are difficult to remove. Therefore, as little of the adhesive as possible should be in contact with water. Extra beads of adhesive inside the containers should be removed.

5.2 CLEANING TEST CHAMBERS AND LABORATORY APPARATUS

5.2.1 New plasticware used for effluent or dilution water collection or organism test chambers does not require thorough cleaning before use. It is sufficient to rinse new sample containers once with sample dilution water before use. New glassware must be soaked overnight in 10% acid (see below) and rinsed well in deionized water and dilution water.

5.2.2 All non-disposable sample containers, test vessels, tanks, and other equipment that has come in contact with effluent must be washed after use in the manner described below to remove surface contaminants as described below:

1. Soak 15 min in tap water, and scrub with detergent, or clean in an automatic dishwasher.
2. Rinse twice with tap water.
3. Carefully rinse once with fresh, dilute (10%, V:V) hydrochloric or nitric acid to remove scale, metals, and bases. To prepare a 10% solution of acid, add 10 mL of concentrated acid to 90 mL of deionized water.
4. Rinse twice with deionized water.
5. Rinse once with full-strength, pesticide-grade acetone to remove organic compounds (use a fume hood or canopy).
6. Rinse three times with deionized water.

5.2.3 All test chambers and equipment should be thoroughly rinsed with the dilution water immediately prior to use in each test.

5.3 APPARATUS AND EQUIPMENT FOR CULTURING AND TOXICITY TESTS

5.3.1 Culture units -- see Appendix. It is preferable to obtain test organisms from in-house culture units. If it is not feasible to maintain cultures in-house, test organisms can be obtained from commercial sources, and should be shipped to the laboratory in well oxygenated water in insulated containers to minimize excursions in water temperature during shipment. The temperature of the water in the shipping containers should be measured on arrival, to determine if the organisms were subjected to obvious undue thermal stress.

5.3.2 Samplers -- automatic samplers, preferably with sample cooling capability, that can collect a 24-h composite sample of 2 L or more.

5.3.3 Sample containers -- for sample shipment and storage (see Section 8, Effluent and Receiving Water Sampling and Sample Handling).

- 5.3.4 Environmental chamber or equivalent facility with temperature control (20°C or 25°C)
- 5.3.5 Water purification system -- MILLIPORE® MILLI-Q®, MILLIPORE® QPAK™₂, or equivalent. Depending on the quantity of high grade water needed, a first-stage pre-conditioner deionizer, such as a Culligan® or Continental® System, or equivalent, may be needed to provide feed water to the high-purity system.
- 5.3.6 Balance -- analytical, capable of accurately weighing to 0.0001 g.
- 5.3.7 Reference weights, Class S -- for documenting the performance of the analytical balance(s). The balance(s) should be checked with reference weights which are at the upper and lower ends of the range of the weighings made when the balance is used. A balance should be checked at the beginning of each series of weighings, periodically (such as every tenth weight) during a long series of weighings, and after the last weight of a series is taken.
- 5.3.8 Test chambers -- borosilicate glass or non-toxic disposable plastic test chambers are suitable. Test chamber volumes are indicated in the method summaries. To avoid potential contamination from the air and excessive evaporation of test solutions during the test, the chambers should be covered with safety glass plates or sheet plastic, 6 mm (¼ in) thick.
- 5.3.9 Volumetric flasks and graduated cylinders -- Class A, borosilicate glass or non-toxic plastic labware, 10-1000 mL for making test solutions.
- 5.3.10 Volumetric pipets -- Class A, 1-100 mL.
- 5.3.11 Serological pipets -- 1-10 mL, graduated.
- 5.3.12 Pipet bulbs and fillers -- PROPIPET®, or equivalent.
- 5.3.13 Droppers, and glass tubing with fire polished edges, 4 mm ID -- for transferring test organisms.
- 5.3.14 Wash bottles -- for rinsing small glassware and instrument electrodes and probes.
- 5.3.15 Glass or electronic thermometers -- for measuring water temperature.
- 5.3.16 Bulb-thermograph or electronic-chart type thermometers -- for continuously recording temperature.
- 5.3.17 National Bureau of Standards Certified thermometer (see USEPA Method 170.1; USEPA 1979b).
- 5.3.18 pH, DO, and specific conductivity meters -- for routine physical and chemical measurements. Unless the test is being conducted to specifically measure the effect of one of the above parameters, a portable, field-grade instrument is acceptable.
- 5.3.19 Refractometer -- for measuring effluent, receiving, and test solution salinity.
- 5.3.20 Amperometric titrator -- for measuring total residual chlorine.

5.4 REAGENTS AND CONSUMABLE MATERIALS

- 5.4.1 Reagent water -- defined as MILLIPORE® MILLI-Q®, MILLIPORE® QPAK™₂ or equivalent water (see Subsection 5.3.5 above).
- 5.4.2 Effluent, dilution water, and receiving water -- see Section 7, Dilution Water, and Section 8, Effluent and Receiving Water Sampling and Sample Handling.
- 5.4.3 Reagents for hardness and alkalinity tests (see USEPA Methods 130.2 and 310.1; USEPA 1979b).

5.4.4 Standard pH buffers 4, 7, and 10 (or as per instructions of instrument manufacturer) for instrument calibration (see USEPA Method 150.1; USEPA 1979b).

5.4.5 Specific conductivity and salinity standards (see USEPA Method 120.1; USEPA 1979b).

5.4.6 Laboratory quality control check samples and standards for the above chemistry methods.

5.4.7 Reference toxicant solutions (see Section 4, Quality Assurance).

5.4.8 Membranes and filling solutions for dissolved oxygen probe (see USEPA Method 360.1; USEPA 1979b), or reagents for modified Winkler analysis.

5.4.9 Sources of Food for Cultures and Toxicity Tests.

5.4.9.1 All food should be tested for nutritional suitability, and chemically analyzed for organic chlorine, PCBs, and toxic metals (see Section 4, Quality Assurance).

5.4.9.2 Brine Shrimp (*Artemia*) -- see Appendix A.

1. Brine Shrimp (*Artemia*) Cysts.

There are many commercial sources of brine shrimp cysts. The quality of the cysts may vary from one batch to another, and the cysts in each new batch (can or lot) should be evaluated for nutritional suitability and chemical contamination. The nutritional suitability (see Leger et al., 1985, 1986) of each new batch is checked against known suitable reference cysts by performing a side-by-side growth and/or reproduction tests using the "new" and "reference" cysts. If the results of tests for nutritional suitability or chemical contamination do not meet standards, the *Artemia* should not be used.

2. Frozen Adult Brine Shrimp

Frozen adult brine shrimp are available from pet stores and other commercial sources.

5.4.9.3 Trout Chow

Starter or No. 1 pellets, prepared according to current U.S. Fish and Wildlife Service specifications, are available from commercial sources. (The flake food, TETRAMIN[®] or BIORIL[®], can be used regularly as a substitute for trout chow in preparing food for daphnids, and can be used as a short-term substitute for trout chow in feeding fathead minnows.)

5.4.9.4 Dried, Powdered Leaves (CEROPHYLL[®])

Dried, powdered, cereal leaves (e.g., CEROPHYLL[®] or equivalent) are available from commercial suppliers. Dried, powdered, alfalfa leaves obtained from health food stores have been found to be a satisfactory substitute for cereal leaves.

5.4.9.5 Yeast

Packaged dry yeast, such as Fleischmann's, or equivalent, can be purchased at the local grocery store.

5.4.9.6 Flake Fish Food

The flake foods, TETRAMIN[®] and BIORIL[®], are available at most pet supply shops.

5.5 TEST ORGANISMS

5.5.1 Test organisms are obtained from inhouse cultures or commercial suppliers (see Section 6, Test Organisms).

SECTION 6

TEST ORGANISMS

6.1 TEST SPECIES

6.1.1 The species used in characterizing the acute toxicity of effluents and/or receiving waters will depend on the requirements of the regulatory authority and the objectives of the test. It is essential that good quality test organisms be readily available throughout the year from inhouse or commercial sources to meet NPDES monitoring requirements. The organisms used in toxicity tests must be identified to species. If there is any doubt as to the identity of the test organisms, representative specimens should be sent to a taxonomic expert to confirm the identification.

6.1.2 Toxicity test conditions and culture methods are provided in this manual for the following principal test organisms:

Freshwater Organisms:

1. *Ceriodaphnia dubia* (daphnid) (Table 12).
2. *Daphnia pulex* and *D. magna* (daphnids) (Table 13).
3. *Pimephales promelas* (fathead minnow) (Table 14).
4. *Oncorhynchus mykiss* (rainbow trout) and *Salvelinus fontinalis* (brook trout) (Table 15).

Estuarine and Marine Organisms:

1. *Mysidopsis bahia* (mysid) (Table 16).¹
2. *Cyprinodon variegatus* (sheepshead minnow) (Table 17).
3. *Menidia beryllina* (inland silverside), *M. menidia* (Atlantic silverside), and *M. peninsulae* (tidewater silverside) (Table 18).

6.1.3 The test species (AFS, 1991) listed in Subsection 6.1.2 are the recommended acute toxicity test organisms. They are easily cultured in the laboratory, are sensitive to a variety of pollutants, and are generally available throughout the year from commercial sources. Summaries of test conditions for these species are provided in Tables 12-18. Guidelines for culturing and/or holding the organisms are provided in Appendix A.

6.1.4 Additional species may be suitable for toxicity tests in the NPDES Program. A list of alternative acute toxicity test species and minimal testing requirements (i.e., temperature, salinity, and life stage) for these species are provided in Appendix B. Table 19 provides a summary of test conditions for *Holmesimysis costata*, which should also be considered an alternative acute toxicity test species. The *Holmesimysis costata* Acute Test (Table 19) is specific to Pacific Coast waters and is not listed at 40 CFR Part 136 for nationwide use. It is important to note that these species may not be as easily cultured or tested as the species on the list in 6.1.2, and may not be available from commercial sources.

6.1.5 Some states have developed culturing and testing methods for indigenous species that may be as sensitive or more sensitive than the species recommended in 6.1.2. However, EPA allows the use of indigenous species only where state regulations require their use or prohibit importation of the species in 6.1.2. Where state regulations prohibit importation or use of the recommended test species, permission must be requested from the appropriate state agency prior to their use.

¹ The genus name of this organism was formally changed to *Americamysis* (Price *et al.*, 1994); however, the method manual will continue to refer to *Mysidopsis bahia* to maintain consistency with previous versions of the method.

6.1.6 Where states have developed culturing and testing methods for indigenous species other than those recommended in this manual, data comparing the sensitivity of the substitute species and one or more of the recommended species must be obtained in side-by-side toxicity tests with reference toxicants and/or effluents, to ensure that the species selected are at least as sensitive as the recommended species. These data must be submitted to the permitting authority (State or Region) if required. EPA acknowledges that reference toxicants prepared from pure chemicals may not always be representative of effluents. However, because of the observed and/or potential variability in the quality and toxicity of effluents, it is not possible to specify a representative effluent.

6.1.7 Guidance for the selection of test organisms where the salinity of the effluent and/or receiving water requires special consideration is provided in the Technical Support Document for Water Quality-Based Toxics Control (USEPA, 1991c).

1. Where the salinity of the receiving water is <1‰, freshwater organisms are used regardless of the salinity of the effluent.
2. Where the salinity of the receiving water is ≥1‰, the choice of organisms depends on state water quality standards and/or permit requirements.

6.2 SOURCES OF TEST ORGANISMS

6.2.1 INHOUSE CULTURES

6.2.1.1 Inhouse cultures should be established wherever it is cost effective. If inhouse cultures cannot be maintained, test organisms should be purchased from experienced commercial suppliers (see Appendix for sources).

6.2.2 COMMERCIAL SUPPLIERS

6.2.2.1 All of the principal test organisms listed in Subsection 6.1.2 are available from commercial suppliers.

6.2.3 FERAL (NATURAL OCCURRING, WILD CAUGHT) ORGANISMS

6.2.3.1 The use of test organisms taken from the receiving water has strong appeal, and would seem to be the logical approach. However, it is impractical for the following reasons:

1. Sensitive organisms may not be present in the receiving water because of previous exposure to the effluent or other pollutants.
2. It is often difficult to collect organisms of the required age and quality from the receiving water;
3. Most states require collection permits, which may be difficult to obtain. Therefore, it is usually more cost effective to culture the organisms in the laboratory or obtain them from private, state, or Federal sources. Fish such as fathead minnows, sheepshead minnows, and silversides, and invertebrates such as daphnids and mysids, are easily reared in the laboratory or purchased.
4. The required QA/QC records, such as the single laboratory precision data, would not be available.
5. Since it is mandatory that the identity of test organisms is known to the species level, it would be necessary to examine each organism caught in the wild to confirm its identity, which would usually be impractical or, at the least, very stressful to the organisms.
6. Test organisms obtained from the wild must be observed in the laboratory for a minimum of one week prior to use, to assure that they are free of signs of parasitic or bacterial infections and other adverse effects. Fish captured by electroshocking must not be used in toxicity testing.

6.2.3.2 Guidelines for collection of feral organisms are provided in USEPA, 1973; USEPA 1990a.

6.2.4 Regardless of their source, test organisms should be carefully observed to ensure that they are free of signs of stress and disease, and in good physical condition. Some species of test organisms, such as trout, can be obtained from stocks certified as "disease-free."

6.3 LIFE STAGE

6.3.1 Young organisms are often more sensitive to toxicants than are adults. For this reason, the use of early life stages, such as first instars of daphnids and juvenile mysids and fish, is required for all tests. In a given test, all organisms should be approximately the same age and should be taken from the same source. Since age may affect the results of the tests, it would enhance the value and comparability of the data if the same species in the same life stages were used throughout a monitoring program at a given facility.

6.4 LABORATORY CULTURING

6.4.1 Instructions for culturing and/or holding the recommended test organisms are included in Appendix A.

6.5 HOLDING AND HANDLING TEST ORGANISMS

6.5.1 Test organisms should not be subjected to changes of more than 3EC in water temperature or 3‰ in salinity in any 12 h period.

6.5.2 Organisms should be handled as little as possible. When handling is necessary, it should be done as gently, carefully, and quickly as possible to minimize stress. Organisms that are dropped or touch dry surfaces or are injured during handling must be discarded. Dipnets are best for handling larger organisms. These nets are commercially available or can be made from small-mesh nylon netting, silk bolting cloth, plankton netting, or similar material. Wide-bore, smooth glass tubes (4 to 8 mm inside diameter) with rubber bulbs or pipettors (such as a PROPIPETTE® or other pipettor) should be used for transferring smaller organisms such as daphnids, mysids, and larval fish.

6.5.3 Holding tanks for fish are supplied with a good quality water (see Section 5, Facilities and Equipment) with a flow-through rate of at least two tank-volumes per day. Otherwise, use a recirculation system where the water flows through an activated carbon or undergravel filter to remove dissolved metabolites. Culture water can also be piped through high intensity ultraviolet light sources for disinfection, and to photodegrade dissolved organics.

6.5.4 Crowding should be avoided. The DO must be maintained at a minimum of 4.0 mg/L for marine and warm water, freshwater species, and 6.0 mg/L for cold-water, freshwater species. The solubility of oxygen depends on temperature, salinity, and altitude. Aerate if necessary.

6.5.5 Fish should be fed as much as they will eat at least once a day with live or frozen brine shrimp or dry food (frozen food should be completely thawed before use). Brine shrimp can be supplemented with commercially prepared food such as Tetramin® or BioRil® flake food, or equivalent. Excess food and fecal material should be removed from the bottom of the tanks at least twice a week by siphoning.

6.5.6 Fish should be observed carefully each day for signs of disease, stress, physical damage, and mortality. Dead and abnormal specimens should be removed as soon as observed. It is not uncommon to have some fish (5-10%) mortality during the first 48 h in a holding tank because of individuals that refuse to feed on artificial food and die of starvation.

6.5.7 A daily record of feeding, behavioral observations, and mortality should be maintained.

6.6 TRANSPORTATION TO THE TEST SITE

6.6.1 Organisms are transported from the base or supply laboratory to a remote test site in culture water or standard dilution water in plastic bags or large-mouth screw-cap (500 mL) plastic bottles in styrofoam coolers. Adequate DO is maintained by replacing the air above the water in the bags with oxygen from a compressed gas cylinder, and sealing the bags. Another method commonly used to maintain sufficient DO during shipment is to aerate with an airstone which is supplied from a portable pump. The DO concentration must not fall below 4.0 mg/L for marine and warm-water, freshwater species, and 6.0 mg/L for cold-water, freshwater species.

6.6.2 Upon arrival at the test site, organisms are transferred to receiving water if receiving water is to be used as the test dilution water. All but a small volume of the holding water (approximately 5%) is removed by siphoning, and replaced slowly over a 10 to 15 min period with dilution water. If receiving water is used as dilution water, caution must be exercised in exposing the test organisms to it, because of the possibility that it might be toxic. For this reason, it is recommended that only approximately 10% of the test organisms be exposed initially to the dilution water. If this group does not show excessive mortality or obvious signs of stress in a few hours, the remainder of the test organisms are transferred to the dilution water.

6.6.3 A group of organisms must not be used for a test if they appear to be unhealthy, discolored, or otherwise stressed, or if mortality appears to exceed 10% preceding the test. If the organisms fail to meet these criteria, the entire group must be discarded and a new group obtained. The mortality may be due to the presence of toxicity, if receiving water is used as dilution water, rather than a diseased condition of the test organisms. If the acclimation process is repeated with a new group of test organisms and excessive mortality occurs, it is recommended that an alternative source of dilution water be used.

6.6.4 In static tests, marine organisms can be used at all concentrations of effluent by adjusting the salinity of the effluent to a standard salinity (such as 25‰) or to the salinity approximating that of the receiving water, by adding sufficient dry ocean salts, such as Forty Fathoms[®], or equivalent, GP2 or hypersaline brine.

6.6.5 Saline dilution water can be prepared with deionized water or a freshwater such as well water or a suitable surface water. If dry ocean salts are used, care must be taken to ensure that the added salts are completely dissolved and the solution is aerated 24 h before the test organisms are placed in the solutions. The test organisms should be acclimated in synthetic saline water prepared with the dry salts. Caution: addition of dry ocean salts to dilution water may result in an increase in pH. (The pH of estuarine and coastal saline waters is normally 7.5-8.3.)

6.6.6 All effluent concentrations and the control(s) used in a test should have the same salinity. However, if this is impractical because of the large volumes of water required, such as in flow-through tests, the highest effluent concentration (lowest salinity) that could be tested would depend upon the salinity of the receiving water and the tolerance of the test organisms. The required salinities for toxicity tests with estuarine and marine species are listed in Tables 16-19. However, the tolerances of other candidate test species would have to be determined by the investigator in advance of the test.

6.6.7 Because of the circumstances described above, when performing flow-through tests of effluents discharged to saline waters, it is advisable to acclimate groups of test organisms to each of three different salinities, such as 10, 20, and 30‰, prior to transporting them to the test site. It may also be advisable to maintain cultures of these test organisms at a series of salinity levels, including at least 10, 20, and 30‰, so that the change in salinity upon acclimation at the desired test dilutions does not exceed 6‰.

6.7 TEST ORGANISM DISPOSAL

6.7.1 When the toxicity test is concluded, all test organisms (including controls) should be humanely destroyed and disposed of in an appropriate manner.

SECTION 7

DILUTION WATER

7.1 TYPES OF DILUTION WATER

7.1.1 The type of dilution water used in effluent toxicity tests will depend largely on the objectives of the study:

7.1.1.1 If the objective of the test is to estimate the absolute acute toxicity of the effluent, a synthetic (standard) dilution water is used. If the test organisms have been cultured in water which is different from the test dilution water, a second set of controls, using culture water, should be included in the test.

7.1.1.2 If the objective of the test is to estimate the acute toxicity of the effluent in uncontaminated receiving water, the test may be conducted using dilution water consisting of a single grab sample of receiving water (if non-toxic), collected either upstream and outside the influence of the outfall, or with other uncontaminated natural water (ground or surface water) or standard dilution water having approximately the same characteristics (hardness and/or salinity) as the receiving water. Seasonal variations in the quality of surface waters may affect effluent toxicity. Therefore, the hardness of fresh receiving water, and the salinity of saline receiving water samples should be determined before each use. If the test organisms have been cultured in water which is different from the test dilution water, a second set of controls, using culture water, should be included in the test.

7.1.1.3 If the objective of the test is to determine the additive or mitigating effects of the discharge on already contaminated receiving water, the test is performed using dilution water consisting of receiving water collected immediately upstream or outside the influence of the outfall. A second set of controls, using culture water, should be included in the test.

7.1.2 An acceptable dilution water is one which is appropriate for the objectives of the test; supports adequate performance of the test organisms with respect to survival, growth, reproduction, or other responses that may be measured in the test (i.e., consistently meets test acceptability criteria for control responses); is consistent in quality; and does not contain contaminants that could produce toxicity. Receiving waters, synthetic waters, or synthetic waters adjusted to approximate receiving water characteristics may be used for dilution provided that the water meets the above listed qualifications for an acceptable dilution water. USEPA (2000a) provides additional guidance on selecting appropriate dilution waters.

7.1.3 When dual controls (one control using culture water and one control using dilution water) are used (see Subsections 7.1.1.1 - 7.1.1.3 above), the dilution water control should be used to determine test acceptability. It is also the dilution water control that should be compared to effluent treatments in the calculation and reporting of test results. The culture water control should be used to evaluate the appropriateness of the dilution water source. Significant differences between organism responses in culture water and dilution water controls could indicate toxicity in the dilution water and may suggest an alternative dilution water source. USEPA (2000a) provides additional guidance on dual controls.

7.2 STANDARD, SYNTHETIC DILUTION WATER

7.2.1 Standard, synthetic, dilution water is prepared with deionized water and reagent grade chemicals or mineral water (Tables 7 and 8) and commercial sea salts (FORTY FATHOMS[®], HW MARINEMIX[®]) (Table 9). The source water for the deionizer can be groundwater, or tap water.

7.2.2 DEIONIZED WATER USED TO PREPARE STANDARD, SYNTHETIC, DILUTION WATER

7.2.2.1 Deionized water is obtained from a MILLIPORE® MILLI-Q®, MILLIPORE® QPAK™₂, or equivalent system. It is advisable to provide a preconditioned (deionized) feed water by using a Culligan®, Continental®, or equivalent, system in front of the MILLIPORE® System to extend the life of the MILLIPORE® cartridges.

7.2.2.2 The recommended order of the cartridges in a four-cartridge deionizer (i.e., MILLI-Q® System or equivalent) is: (1) ion exchange, (2) ion exchange, (3) carbon, and (4) organic cleanup (such as ORGANEX-Q®, or equivalent), followed by a final bacteria filter. The QPAK™₂ water system is a sealed system which does not allow for the rearranging of the cartridges. However, the final cartridge is an ORGANEX-Q® filter, followed by a final bacteria filter. Commercial laboratories using this system have not experienced any difficulty in using the water for culturing or testing. Reference to the MILLI-Q® systems throughout the remainder of the manual includes all MILLIPORE® or equivalent systems.

7.2.3 STANDARD, SYNTHETIC FRESHWATER

7.2.3.1 To prepare 20 L of standard, synthetic, moderately hard, reconstituted water, use the reagent grade chemicals in Table 7 as follows:

1. Place 19 L of MILLI-Q®, or equivalent, deionized water in a properly cleaned plastic carboy.
2. Add 1.20 g of MgSO₄, 1.92 g NaHCO₃, and 0.080g KCl to the carboy.
3. Aerate overnight.
4. Add 1.20 g of CaSO₄•2 H₂O to 1 L of MILLI-Q® or equivalent deionized water in a separate flask. Stir on magnetic stirrer until calcium sulfate is dissolved, add to the 19 L above, and mix well.
5. For *Ceriodaphnia* culture and testing, add sufficient sodium selenate (Na₂SeO₄) to provide 2 µg selenium per liter of final dilution water.
6. Aerate the combined solution vigorously for an additional 24 h to dissolve the added chemicals and stabilize the medium.
7. The measured pH, hardness, etc., should be as listed in Table 7.

7.2.3.2 To prepare 20 L of standard, synthetic, moderately hard, reconstituted water, using 20% mineral water such as PERRIER® Water, or equivalent (Table 8), follow the instructions below.

1. Place 16 L of MILLI-Q® or equivalent deionized water in a properly cleaned plastic carboy.
2. Add 4 L of PERRIER® Water, or equivalent.
3. Aerate vigorously for 24 h to stabilize the medium.
4. The measured pH, hardness, and alkalinity of the aerated water will be as indicated in Table 8.
5. This synthetic water is referred to as diluted mineral water (DMW) in the toxicity test methods.

7.2.4 STANDARD, SYNTHETIC SEAWATER

7.2.4.1 To prepare 20 L of a standard, synthetic, reconstituted seawater (modified GP2), with a salinity of 31‰ (Table 9), follow the instructions below. Other salinities can be prepared by making the appropriate dilutions.

1. Place 20 L of MILLI-Q® or equivalent deionized water in a properly cleaned plastic carboy.
2. Weigh reagent grade salts listed in Table 9 and add, one at a time, to the deionized water. Stir well after adding each salt.
3. Aerate the final solution at a rate of 1 L/h for 24 h.
4. Check the pH and salinity.

Larger or smaller volumes of modified GP2 can be prepared by using proportionately larger or smaller amounts of salts and dilution water.

7.2.4.2 Synthetic seawater can also be prepared by adding commercial sea salts, such as FORTY FATHOMS[®], HW MARINEMIX[®] or equivalent, to deionized water. For example, thirty-one parts per thousand (31‰) FORTY FATHOMS[®] can be prepared by dissolving 31 g of product per liter of deionized water. The salinity of the resulting solutions should be checked with a refractometer.

7.3 USE OF RECEIVING WATER AS DILUTION WATER

7.3.1 If the objectives of the test require the use of uncontaminated surface water as dilution water, and the receiving water is uncontaminated, it may be possible to collect a sample of the receiving water close to the outfall, but upstream from or beyond the influence of the effluent. However, if the receiving water is contaminated, it may be necessary to collect the sample in an area "remote" from the discharge site, matching as closely as possible the physical and chemical characteristics of the receiving water near the outfall.

7.3.2 The sample should be collected immediately prior to the test, but never more than 96 h before the test begins. Except where it is used within 24 h, or in the case where large volumes are required for flow-through tests, the sample should be chilled to 4°C during or immediately following collection, and maintained at that temperature prior to use in the test.

7.3.3 In the case of freshwaters, the regulatory authority may require that the hardness of the dilution water be comparable to the receiving water at the discharge site. This requirement can be satisfied by collecting an uncontaminated surface water with a suitable hardness, or adjusting the hardness of an otherwise suitable surface water by addition of reagents as indicated in Table 7.

7.3.4 In an estuarine environment, the investigator should collect uncontaminated water having a salinity as near as possible to the salinity of the receiving water at the discharge site. Water should be collected at slack high tide, or within one hour after high tide. If there is reason to suspect contamination of the water in the estuary, it is advisable to collect uncontaminated water from an adjacent estuary. At times it may be necessary to collect water at a location closer to the open sea, where the salinity is relatively high. In such cases, deionized water or uncontaminated freshwater is added to the saline water to dilute it to the required test salinity. Where necessary, the salinity of a surface water can be increased by the addition of artificial sea salts, such as FORTY FATHOMS[®] or equivalent, a natural seawater of higher salinity, or hypersaline brine. Instructions for the preparation of hypersaline brine by concentrating natural seawater are provided below.

7.3.5 Receiving water containing debris or indigenous organisms, that may be confused with or attack the test organisms, should be filtered through a sieve having 60 µm mesh openings prior to use.

TABLE 7. PREPARATION OF SYNTHETIC FRESHWATER USING REAGENT GRADE CHEMICALS¹

	Reagent Added (mg/L) ²				Approximate Final Water Quality		
	NaHCO ₃	CaSO ₄ •2H ₂ O	MgSO ₄	KCl	pH ³	Hardness ⁴	Alkalinity ⁴
Very soft	12.0	7.5	7.5	0.5	6.4-6.8	10-13	10-13
Soft	48.0	30.0	30.0	2.0	7.2-7.6	40-48	30-35
Moderately Hard	96.0	60.0	60.0	4.0	7.4-7.8	80-100	57-64
Hard	192.0	120.0	120.0	8.0	7.6-8.0	160-180	110-120
Very hard	384.0	240.0	240.0	16.0	8.0-8.4	280-320	225-245

¹Taken in part from Marking and Dawson (1973).

²Add reagent grade chemicals to deionized water.

³Approximate equilibrium pH after 24 h of aeration.

⁴Expressed as mg CaCO₃/L.

TABLE 8. PREPARATION OF SYNTHETIC FRESHWATER USING MINERAL WATER¹

Water Type	Volume of Mineral Water Added (mL/L) ²	Proportion of Mineral Water (%)	Approximate Final Water Quality		
			pH ³	Hardness ⁴	Alkalinity ⁴
Very Soft	50	2.5	7.2-8.1	10-13	10-13
Soft	100	10.0	7.9-8.3	40-48	30-35
Moderately Hard	200	20.0	7.9-8.3	80-100	57-64
Hard	400	40.0	7.9-8.3	160-180	110-120
Very Hard ⁵	---	---	---	---	---

¹From Mount et al., 1987; data provided by Philip Lewis, EMSL-Cincinnati.

²Add mineral water to MILLI-Q[®] water or equivalent to prepare DMW (Diluted Mineral Water).

³Approximate equilibrium pH after 24 h of aeration.

⁴Expressed as mg CaCO₃/L.

⁵Dilutions of PERRIER[®] Water form a precipitate when concentrations equivalent to "very hard water" are aerated.

TABLE 9. PREPARATION OF SYNTHETIC SEAWATER USING REAGENT GRADE CHEMICALS^{1,2,3}

Compound	Concentration (g/L)	Amount (g) Required for 20 L
NaCl	21.03	420.6
Na ₂ SO ₄	3.52	70.4
Kcl	0.61	12.2
Kbr	0.088	1.76
Na ₂ B ₄ O ₇ •10 H ₂ O	0.034	0.68
MgCl ₂ •6 H ₂ O	9.50	190.0
CaCl ₂ •2 H ₂ O	1.32	26.4
SrCl ₂ •6 H ₂ O	0.02	0.400
NaHCO ₃	0.17	3.40

¹Modified GP2.

²The constituent salts and concentrations were taken from USEPA, 1990b. The salinity is 30.89 G/L.

³GP2 can be diluted with deionized (DI) water to the desired test salinity.

7.3.6 When receiving water is used as dilution water in flow-through tests, it is preferable to pump the dilution water continuously to the acclimation chamber and/or dilutor. However, where it is not feasible to pump the dilution water continuously, grab samples of the dilution water are transported to the test site in tanks, and continuously pumped from the tanks to the acclimation chamber and/or dilutor.

7.3.7 HYPERSALINE BRINE

7.3.7.1 Hypersaline brine (HSB) has several advantages that make it desirable for use in toxicity testing. It can be made from any high quality, filtered seawater by evaporation, and can be added to deionized water to prepare dilution water, or to effluents or surface waters to increase their salinity.

7.3.7.2 The ideal container for making HSB from natural seawater is one that (1) has a high surface to volume ratio, (2) is made of a non-corrosive material, and (3) is easily cleaned (fiberglass containers are ideal). Special care should be used to prevent any toxic materials from coming in contact with the seawater being used to generate the brine. If a heater is immersed directly into the seawater, ensure that the heater materials do not corrode or leach any substances that would contaminate the brine. One successful method used is a thermostatically controlled heat exchanger made from fiberglass. If aeration is used, use only oil-free air compressors to prevent contamination.

7.3.7.3 Before adding seawater to the brine generator, thoroughly clean the generator, aeration supply tube, heater, and any other materials that will be in direct contact with the brine. A good quality biodegradable detergent should be used, followed by several thorough deionized water rinses. High quality (and preferably high salinity) seawater should be filtered to at least 10 μm before placing into the brine generator. Water should be collected on an incoming tide to minimize the possibility of contamination.

7.3.7.4 The temperature of the seawater is increased slowly to 40°C. The water should be aerated to prevent temperature stratification and to increase water evaporation. The brine should be checked daily (depending on the volume being generated) to ensure that the salinity does not exceed 100‰ and that the temperature does not exceed 40°C. Additional seawater may be added to the brine to obtain the volume of brine required.

7.3.7.5 After the required salinity is attained, the HSB should be filtered a second time through a 1- μm filter and poured directly into portable containers (20 L CUBITAINERS® or polycarbonate water cooler jugs are suitable). The containers should be capped and labeled with the date the brine was generated and its salinity. Containers of HSB should be stored in the dark and maintained under room temperature until used.

7.3.7.6 If a source of HSB is available, test solutions can be made by following the directions below. Thoroughly mix together the deionized water and brine before mixing in the effluent.

7.3.7.7 Divide the salinity of the HSB by the expected test salinity to determine the proportion of deionized water to brine. For example, if the salinity of the brine is 100‰ and the test is to be conducted at 25‰, $100\text{‰} \div 25\text{‰} = 4.0$. The proportion of brine is 1 part in 4 (one part brine to three parts deionized water).

7.3.7.8 To make 1 L of seawater at 25‰ salinity from a hypersaline brine of 100‰, 250 mL of brine and 750 mL of deionized water are required.

7.4 USE OF TAP WATER AS DILUTION WATER

7.4.1 The use of tap water as dilution water is discouraged unless it is dechlorinated and fully treated. Tap water can be dechlorinated by deionization, carbon filtration, or the use of sodium thiosulfate. Use of 3.6 mg/L (anhydrous) sodium thiosulfate will reduce 1.0 mg chlorine/L (APHA, 1992, p. 4-36). Following dechlorination, total residual chlorine should not exceed 0.01 mg/L. Because of the possible toxicity of thiosulfate to test organisms, a control lacking thiosulfate should be included in toxicity tests utilizing thiosulfate-dechlorinated water.

7.4.2 To be adequate for general laboratory use following dechlorination, the tap water is passed through a deionizer and carbon filter to remove toxic metals and organics, and to control hardness and alkalinity.

7.5 DILUTION WATER HOLDING

7.5.1 A given batch of dilution water should not be used for more than 14 days following preparation because of the possible build-up of bacterial, fungal, or algal slime growth and the problems associated with it. The container should be kept covered and the contents should be protected from light.

SECTION 8

EFFLUENT AND RECEIVING WATER SAMPLING AND SAMPLE HANDLING

8.1 EFFLUENT SAMPLING

8.1.1 The effluent sampling point is ordinarily the same as that specified in the NPDES discharge permit (USEPA, 1979c). Conditions for exception would be: (1) better access to a sampling point between the final treatment and the discharge outfall; (2) if the effluent is chlorinated prior to discharge to the receiving waters, it may also be desirable to take samples prior to contact with the chlorine to determine toxicity of the unchlorinated effluent; or (3) in the event there is a desire to evaluate the toxicity of the influent to publicly owned treatment works or separate process waters in industrial facilities prior to their being combined with other process waters or non-contact cooling water, additional sampling points may be chosen.

8.1.2 The decision on whether to collect grab or composite samples is based on the requirements of the NPDES permit, the objectives of the test, and an understanding of the short and long-term operations and schedules of the discharger. If the effluent quality varies considerably with time, which can occur where holding times within the treatment facility are short, grab samples may seem preferable because of the ease of collection and the potential of observing peaks (spikes) in toxicity. However, the sampling duration of a grab sample is so short that full characterization of an effluent over a 24-h period would require a prohibitive number of separate samples and tests. Collection of a 24-h composite sample, however, may dilute toxicity spikes, and average the quality of the effluent over the sampling period. Sampling recommendations are provided below.

8.1.3 Aeration during collection and transfer of effluents should be minimized to reduce the loss of volatile chemicals.

8.1.4 Details of date, time, location, duration, and procedures used for effluent sample and dilution water collection should be recorded.

8.2 EFFLUENT SAMPLE TYPES

8.2.1 The advantages and disadvantages of effluent grab and composite samples are listed below:

8.2.1.1 Grab Samples

Advantages:

1. Easy to collect; require a minimum of equipment and on-site time.
2. Provide a measure of instantaneous toxicity. Toxicity spikes are not masked by dilution.

Disadvantages:

1. Samples are collected over a very short period of time and on a relatively infrequent basis. The chances of detecting a spike in toxicity would depend on the frequency of sampling, and the probability of missing spikes is high.

8.2.1.2 Composite Samples:

Advantages:

1. A single effluent sample is collected over a 24-h period.
2. The sample is collected over a much longer period of time than grab samples and contains all toxicity spikes.

Disadvantages:

1. Sampling equipment is more sophisticated and expensive, and must be placed on-site for at least 24 h.
2. Toxicity spikes may not be detected because they are masked by dilution with less toxic wastes.

8.3 EFFLUENT SAMPLING RECOMMENDATIONS

8.3.1 When tests are conducted on-site, test solutions can be renewed daily with freshly collected samples.

8.3.2 When tests are conducted off-site, samples are collected once, or daily, and used for test initiation and renewal.

8.3.3 Sufficient sample must be collected to perform the required toxicity and chemical tests. A 4-L (1-gal) CUBITAINER® will provide sufficient sample volume for most tests (see Tables 12-19).

8.3.4 The following effluent sampling methods are recommended:

8.3.4.1 Continuous Discharges

1. If the facility discharge is continuous, but the calculated retention time of the continuously discharged effluent is less than 14 days and the variability of the effluent toxicity is unknown, at a minimum, four grab samples or four composite samples are collected over a 24-h period. For example, a grab sample is taken every 6 h (total of four samples) and each sample is used for a separate toxicity test, or four successive 6-h composite samples are taken and each is used in a separate test.
2. If the calculated retention time of a continuously discharged effluent is greater than 14 days, or if it can be demonstrated that the wastewater does not vary more than 10% in toxicity over a 24-h period, regardless of retention time, a single grab sample is collected for a single toxicity test.
3. The retention time of the effluent in the wastewater treatment facility may be estimated from calculations based on the volume of the retention basin and rate of wastewater inflow. However, the calculated retention time may be much greater than the actual time because of short-circuiting in the holding basin. Where short-circuiting is suspected, or sedimentation may have reduced holding basin capacity, a more accurate estimate of the retention time can be obtained by carrying out a dye study.

8.3.4.2 Intermittent Discharges

8.3.4.2.1 If the facility discharge is intermittent, a grab sample is collected midway during each discharge period. Examples of intermittent discharges are:

1. When the effluent is continuously discharged during a single 8-h work shift (one sample is collected), or two successive 8-h work shifts (two samples are collected).
2. When the facility retains the wastewater during an 8-h work shift, and then treats and releases the wastewater as a batch discharge (one sample is collected).

3. When the facility discharges wastewater to an estuary only during an outgoing tide, usually during the 4 h following slack high tide (one sample is collected).

8.3.4.3 At the end of a shift, clean up activities may result in the discharge of a slug of toxic waste, which may require sampling and testing.

8.4 RECEIVING WATER SAMPLING

8.4.1 Logistical problems and difficulty in securing sampling equipment generally preclude the collection of composite receiving water samples for toxicity tests. Therefore, it is common practice to collect a single grab sample and use it throughout the test.

8.4.2 The sampling point is determined by the objectives of the test. In rivers, grab samples should be collected at mid-stream and mid-depth, if accessible. At estuarine and marine sites, samples should be collected at mid-depth.

8.4.3 To determine the extent of the zone of toxicity in the receiving water downstream from the outfall, receiving water samples are collected at several distances downstream from the discharge. The time required for the effluent-receiving-water mixture to travel to sampling points downstream from the outfall, and the rate and degree of mixing, may be difficult to ascertain. Therefore, it may not be possible to correlate downstream toxicity with effluent toxicity at the discharge point unless a dye study is performed. The toxicity of receiving water samples from five stations downstream from the discharge point can be evaluated using the same number of test vessels and test organisms as used in one effluent toxicity test with five effluent dilutions.

8.5 EFFLUENT AND RECEIVING WATER SAMPLE HANDLING, PRESERVATION, AND SHIPPING

8.5.1 Unless the samples are used in an on-site toxicity test the day of collection (or hand delivered to the testing laboratory for use on the day of collection), it is recommended that they be held at 0-6°C until used to inhibit microbial degradation, chemical transformations, and loss of highly volatile toxic substances.

8.5.2 Composite samples should be chilled as they are collected. Grab samples should be chilled immediately following collection.

8.5.3 If the effluent has been chlorinated, total residual chlorine must be measured immediately following sample collection.

8.5.4 Sample holding time begins when the last grab sample in a series is taken (i.e., when a series of four grab samples are taken over a 24-h period), or when a 24-h composite sampling period is completed. If the data from the samples are to be acceptable for use in the NPDES Program, the lapsed time (holding time) from sample collection to first use of each grab or composite sample must not exceed 36 h. EPA believes that 36 h is adequate time to deliver the samples to the laboratories performing the tests in most cases. In the isolated cases, where the permittee can document that this delivery time cannot be met, the permitting authority can allow an option for on-site testing or a variance for an extension of shipped sample holding time. The request for a variance in sample holding time, directed to the USEPA Regional Administrator under 40 CFR 136.3(e) should include supportive data which show that the toxicity of the effluent sample is not reduced (e.g., because of volatilization and/or sorption of toxics on the sample container surfaces) by extending the holding time beyond more than 36 h. However, in no case should more than 72 h elapse between collection and first use of the sample. In static-renewal tests, each grab or composite sample may also be used to prepare test solutions for renewal at 24 h, 48 h, and/or 72 h after first use, if stored at 0-6°C, with minimum head space, as described in Subsection 8.5. Guidance for determining the persistence of the sample is provided in Subsection 8.7.

8.5.5 To minimize the loss of toxicity due to volatilization of toxic constituents, all sample containers should be "completely" filled, leaving no air space between the contents and the lid.

8.5.6 SAMPLES USED IN ON-SITE TESTS

8.5.6.1 Samples collected for on-site tests should be used within 24 h.

8.5.7 SAMPLES SHIPPED TO OFF-SITE FACILITIES

8.5.7.1 Samples collected for off-site toxicity testing are to be chilled to 0-6°C during or immediately after collection, and shipped iced to the performing laboratory. Sufficient ice should be placed with the sample in the shipping container to ensure that ice will still be present when the sample arrives at the laboratory and is unpacked. Insulating material should not be placed between the ice and the sample in the shipping container unless required to prevent breakage of glass sample containers.

8.5.7.2 Samples may be shipped in one or more 4-L (1 gal) CUBITAINERS® or new plastic "milk" jugs. All sample containers should be rinsed with source water before being filled with sample. After use with receiving water or effluents, CUBITAINERS® and plastic jugs are punctured to prevent reuse.

8.5.7.3 Several sample shipping options are available, including Express Mail, air express, bus, and courier service. Express Mail is delivered seven days a week. Saturday and Sunday shipping and receiving schedules of private carriers vary with the carrier.

8.6 SAMPLE RECEIVING

8.6.1 Upon arrival at the laboratory, samples are logged in and the temperature is measured and recorded. If the samples are not immediately prepared for testing, they are stored at 0-6°C until used.

8.6.2 Every effort must be made to initiate the test with an effluent sample on the day of arrival in the laboratory, and the sample holding time should not exceed 36 h before first use unless a variance has been granted by the NPDES permitting authority.

8.7 PERSISTENCE OF EFFLUENT TOXICITY DURING SAMPLE SHIPMENT AND HOLDING

8.7.1 The persistence of the toxicity of an effluent prior to its use in a toxicity test is of interest in assessing the validity of toxicity test data, and in determining the possible effects of allowing an extension of the holding time. Where a variance in holding time (>36 h, but ≤ 72 h) is requested by a permittee (see Subsection 8.5.4 above), information on the effects of the extension in holding time on the toxicity of the samples must be obtained by comparing the results of multi-concentration acute toxicity tests performed on effluent samples held 36 h with toxicity test results using the same samples after they were held for the requested, longer period. The portion of the sample set aside for the second test must be held under the same conditions as during shipment and holding.

SECTION 9

ACUTE TOXICITY TEST PROCEDURES

9.1 PREPARATION OF EFFLUENT AND RECEIVING WATER SAMPLES FOR TOXICITY TESTS

9.1.1 When aliquots are removed from the sample container, the head space above the remaining sample should be held to a minimum. Air which enters a container upon removal of sample should be expelled by compressing the container before reclosing, if possible (i.e., where a CUBITAINER[®] used), or by using an appropriate discharge valve (spigot).

9.1.2 It may be necessary to first coarse-filter samples through a sieve having 2-4 mm mesh openings to remove debris and/or break up large floating or suspended solids. If samples contain indigenous organisms that may attack or be confused with the test organisms, the samples must be filtered through a sieve with 60 μm mesh openings. Caution: filtration may remove some toxicity.

9.1.3 At a minimum, pH, conductivity or salinity, and total residual chlorine are measured in the undiluted effluent or receiving water, and pH and conductivity are measured in the dilution water.

9.1.4 It is recommended that total alkalinity and total hardness also be measured in the undiluted test water (effluent or receiving water) and the dilution water.

9.1.5 Total ammonia is measured in effluent and receiving water samples where toxicity may be contributed by unionized ammonia (i.e., where total ammonia ≥ 5 mg/L). The concentration (mg/L) of unionized (free) ammonia in a sample is a function of temperature and pH, and is calculated using the percentage value obtained from Table 10, under the appropriate pH and temperature, and multiplying it by the concentration (mg/L) of total ammonia in the sample.

9.1.6 Effluents and receiving waters can be dechlorinated using 6.7 mg/L anhydrous sodium thiosulfate to reduce 1 mg/L chlorine (Standard Methods, 18th Edition, APHA, 1992, p. 9-32; note that the amount of thiosulfate required to dechlorinate effluents is greater than the amount needed to dechlorinate tap water). Since thiosulfate may contribute to sample toxicity, a thiosulfate control should be used in the test in addition to the normal dilution water control.

9.1.7 The DO concentration in the samples should be near saturation prior to use. Aeration may be used to bring the DO and other gases into equilibrium with air, minimize oxygen demand, and stabilize the pH. However, aeration during collection, transfer, and preparation of samples should be minimized to reduce the loss of volatile chemicals.

9.1.8 If the samples must be warmed to bring them to the prescribed test temperature, supersaturation of the dissolved oxygen and nitrogen may become a problem. To avoid this problem, samples may be warmed slowly in open test containers. If DO is still above 100% saturation after warming to test temperature, samples should be aerated moderately (approximately 500 mL/minute) for a few minutes using an airstone. If DO is below 4.0 mg/L after warming to test temperature, the solutions must be aerated moderately (approximately 500 mL/min) for a few minutes, using an airstone, until the DO is within the prescribed range (≥ 4.0 mg/L when using warm water species, or ≥ 6.0 mg/L when using cold water species). Caution: avoid excessive aeration.

9.1.9 Mortality due to pH alone may occur if the pH of the sample falls outside the range of 6.0-9.0. Thus, the presence of other forms of toxicity (metals and organics) in the sample may be masked by the toxic effects of low or high pH. The question about the presence of other toxicants can be answered only by performing two parallel tests, one with an adjusted pH, and one without an adjusted pH. Freshwater samples are adjusted to pH 7.0, and marine samples are adjusted to pH 8.0, by adding 1N NaOH or 1N HCl dropwise, as required, being careful to avoid overadjustment.

TABLE 10. PERCENT UNIONIZED NH₃ IN AQUEOUS AMMONIA SOLUTIONS: TEMPERATURES 15-26°C AND pH's 6.0-8.9¹

pH	Temperature (°C)															
	15	16	17	18	19	20	21	22	23	24	25	26				
6.0	0.0274	0.0295	0.0318	0.0343	0.0369	0.0397	0.0427	0.0459	0.0493	0.0530	0.0568	0.0610				
6.1	0.0345	0.0372	0.0400	0.0431	0.0464	0.0500	0.0537	0.0578	0.0621	0.0667	0.0716	0.0768				
6.2	0.0434	0.0468	0.0504	0.0543	0.0584	0.0629	0.0676	0.0727	0.0781	0.0901	0.0901	0.0966				
6.3	0.0546	0.0589	0.0634	0.0683	0.0736	0.0792	0.0851	0.0915	0.0983	0.1134	0.1134	0.1216				
6.4	0.0687	0.0741	0.0799	0.0860	0.0926	0.0996	0.107	0.115	0.124	0.133	0.143	0.153				
6.5	0.0865	0.0933	0.1005	0.1083	0.1166	0.1254	0.135	0.145	0.156	0.167	0.180	0.193				
6.6	0.109	0.117	0.127	0.136	0.147	0.158	0.170	0.182	0.196	0.210	0.226	0.242				
6.7	0.137	0.148	0.159	0.171	0.185	0.199	0.214	0.230	0.247	0.265	0.284	0.305				
6.8	0.172	0.186	0.200	0.216	0.232	0.250	0.269	0.289	0.310	0.333	0.358	0.384				
6.9	0.217	0.234	0.252	0.271	0.292	0.314	0.338	0.363	0.390	0.419	0.450	0.482				
7.0	0.273	0.294	0.317	0.342	0.368	0.396	0.425	0.457	0.491	0.527	0.566	0.607				
7.1	0.343	0.370	0.399	0.430	0.462	0.497	0.535	0.575	0.617	0.663	0.711	0.762				
7.2	0.432	0.466	0.502	0.540	0.581	0.625	0.672	0.722	0.776	0.833	0.893	0.958				
7.3	0.543	0.586	0.631	0.679	0.731	0.786	0.845	0.908	0.975	1.05	1.12	1.20				
7.4	0.683	0.736	0.793	0.854	0.918	0.988	1.061	1.140	1.224	1.31	1.41	1.51				
7.5	0.858	0.925	0.996	1.07	1.15	1.24	1.33	1.43	1.54	1.65	1.77	1.89				
7.6	1.08	1.16	1.25	1.35	1.45	1.56	1.67	1.80	1.93	2.07	2.21	2.37				
7.7	1.35	1.46	1.57	1.69	1.82	1.95	2.10	2.25	2.41	2.59	2.77	2.97				
7.8	1.70	1.83	1.97	2.12	2.28	2.44	2.62	2.82	3.02	3.24	3.46	3.71				
7.9	2.13	2.29	2.46	2.65	2.85	3.06	3.28	3.52	3.77	4.04	4.32	4.62				
8.0	2.66	2.87	3.08	3.31	3.56	3.82	4.10	4.39	4.70	5.03	5.38	5.75				
8.1	3.33	3.58	3.85	4.14	4.44	4.76	5.10	5.46	5.85	6.25	6.68	7.14				
8.2	4.16	4.47	4.80	5.15	5.52	5.92	6.34	6.78	7.25	7.75	8.27	8.82				
8.3	5.18	5.56	5.97	6.40	6.86	7.34	7.85	8.39	8.96	9.56	10.2	10.9				
8.4	6.43	6.90	7.40	7.93	8.48	9.07	9.69	10.3	11.0	11.7	12.5	13.3				
8.5	7.97	8.54	9.14	9.78	10.45	11.16	11.90	12.7	13.5	14.4	15.2	16.2				
8.6	9.83	10.5	11.2	12.0	12.8	13.6	14.5	15.5	16.4	17.4	18.5	19.5				
8.7	12.07	12.9	13.8	14.7	15.6	16.6	17.6	18.7	19.8	21.0	22.2	23.4				
8.8	14.7	15.7	16.7	17.8	18.9	20.0	21.2	22.5	23.7	25.1	26.4	27.8				
8.9	17.9	19.0	20.2	21.4	22.7	24.0	25.3	26.7	28.2	29.6	31.1	32.6				

¹Table provided by Teresa Norberg-King, Environmental Research Laboratory, Duluth, Minnesota. Also see Emerson, et. al., 1975, Thurston, et. al., 1974, and USEPA, 1985.

9.2 PRELIMINARY TOXICITY RANGE-FINDING TESTS

9.2.1 USEPA Regional and State personnel generally have observed that it is not necessary to conduct a toxicity range-finding test prior to initiating a static, acute, definitive toxicity test. However, when preparing to perform a static test with a sample of completely unknown quality, or before initiating a flow-through test, it is advisable to conduct a preliminary toxicity range-finding test.

9.2.2 A toxicity range-finding test ordinarily consists of a down-scaled, abbreviated static acute test in which groups of five organisms are exposed to several widely-spaced sample dilutions in a logarithmic series, such as 100%, 10.0%, 1.00%, and 0.100%, and a control, for 8-24 h. **Caution:** if the sample must also be used for the full-scale definitive test, the 36-h limit on holding time (Section 8, , Effluent and Receiving Water Sampling and Sample Handling, Subsection 8.5.4) must not be exceeded before the definitive test is initiated.

9.2.3 It should be noted that the toxicity (LC50) of a sample observed in a range-finding test may be significantly different from the toxicity observed in the follow-up definitive test because: (1) the definitive test is usually longer; and (2) the test may be performed with a sample collected at a different time, and possibly differing significantly in the level of toxicity.

9.3 MULTI-CONCENTRATION (DEFINITIVE) EFFLUENT TOXICITY TESTS

9.3.1 The tests recommended for use in determining discharge permit compliance in the NPDES program are multi-concentration, or definitive, tests which provide (1) a point estimate of effluent toxicity in terms of a LC50, or (2) a no-observed-adverse-effect concentration (NOAEC) defined in terms of mortality, and obtained by hypothesis testing. The tests may be static non-renewal, static renewal, or flow-through.

9.3.2 The tests consist of a control and a minimum of five effluent concentrations. USEPA recommends the use of a ≥ 0.5 dilution factor for selecting effluent test concentrations. Effluent test concentrations of 6.25%, 12.5%, 25%, 50%, and 100% are commonly used, however, test concentrations should be selected independently for each test based on the objective of the study, the expected range of toxicity, the receiving water concentration, and any available historical testing information on the effluent. USEPA (2000a) provides additional guidance on choosing appropriate test concentrations.

9.3.3 When these tests are used in determining compliance with permit limits, effluent test concentrations should be selected to bracket the receiving water concentration (RWC). This may be achieved by selecting effluent test concentrations in the following manner: (1) 100% effluent, (2) $[RWC + 100]/2$, (3) RWC, (4) $RWC/2$, and (5) $RWC/4$. For example, where the RWC = 50%, appropriate effluent concentrations may be 100%, 75%, 50%, 25%, and 12.5%.

9.3.4 If acute/chronic ratios are to be determined by simultaneous acute and short-term chronic tests with a single species, using the same sample, both types of tests must use the same test conditions, i.e., temperature, water hardness, salinity, etc.

9.4 RECEIVING WATER TESTS

9.4.1 Receiving water toxicity tests generally consist of 100% receiving water and a control. The total hardness or salinity of the control should be comparable to the receiving water.

9.4.2 The data from the two treatments are analyzed by hypothesis testing to determine if test organism survival in the receiving water differs significantly from the control. A minimum of four replicates and 10 organisms per replicate are required for each treatment (see Tables 12-19).

9.4.3 In cases where the objective of the test is to estimate the degree of toxicity of the receiving water, a definitive, multi-concentration test is performed by preparing dilutions of the receiving water, using a ≥ 0.5 dilution series, with a suitable control water.

9.5 STATIC TESTS

9.5.1 Static tests may be non-renewal or renewal.

9.5.2 An excess volume of each dilution is prepared to provide sufficient material for toxicity testing and routine chemical analyses. The solutions are well mixed with a glass rod, TEFLON® stir bar, or other means. Aliquots of each sample concentration are delivered to the test chambers, and the chambers are arranged in random order. The test solutions are brought to the required temperature, and the test organisms are added. The remaining volumes of each sample concentration are used, as necessary, for the chemical analyses.

9.5.3 Saline dilution water can be prepared by adding dry salts (FORTY FATHOMS® or equivalent, or modified GP2) or hypersaline brine to de-ionized water, or a suitable surface freshwater, to adjust the salinity of the entire dilution series. If saline receiving water is used as the diluent, a salinity control must be prepared using deionized water and dried sea salts to determine if the addition of sea salts alone has an adverse effect on the test organisms. It may be desirable to conduct static toxicity tests at several salinities.

9.5.4 If the effluent has low salinity, but the test is to be conducted with a salt water organism, the test solutions may be prepared by adding dry ocean salts or hypersaline brine to a sufficient quantity of 100% effluent to raise the salinity to the required level, which will depend on the objectives of the test and the policy of the regulatory agency. After the addition of the dried salts, stir gently for 30 to 60 min, preferably with a magnetic stirrer, to ensure that the salts are in solution. It is important to check the final salinity with a refractometer.

9.5.5 Addition of dry salts to effluents and dilution water may change the pH and affect the toxicity of the waste. If the objective of the test is to determine the toxicity of the effluent at the original pH, the pH of the salinity-adjusted solutions can be brought to the required level by dropwise addition of 1N HCl or 1N NaOH. It is recommended that a concurrent test be conducted with salinity-adjusted effluent in which the pH has not been altered after adding the salt.

9.5.6 The volume of the effluent used must be sufficient to prepare all percent concentrations of the effluent needed for the toxicity test and for routine chemical analysis. For example, to conduct tests with *Menidia*, the use of 200 mL of test solution in each of duplicate exposure vessels and five concentrations of effluent (10 exposure vessels), would require a total of 1 L of 100% effluent. However, to provide sufficient volumes of test solutions for routine chemical analysis and for toxicity testing, additional effluent would be required (1.5-2.0 L).

9.5.7 A standard control lacking thiosulfate should be included in tests where the dilution water was prepared by dechlorinating tap water with thiosulfate.

9.5.8 If, within 1 h of the start of the test, 100% mortality has occurred in the higher effluent concentrations (such as 100% and 50%), additional concentrations of effluents, such as 3.1%, 1.6%, and 0.8%, are added to the test at the lower end of the concentration series.

9.5.9 pH drift during acute, static-renewal, or non-renewal toxicity tests may contribute to artifactual toxicity when ammonia or other pH-dependent toxicants (such as metals) are present. This problem can be minimized by conducting a test in a static-renewal mode rather than a non-renewal mode, or the problem can be avoided by conducting the test in a flow-through mode, rather than a static-renewal or non-renewal mode.

9.6 FLOW-THROUGH TESTS

9.6.1 Flow-through tests are usually performed with the same effluent concentrations that are used for static tests, except that where the receiving water is saline and the effluent is not, 100% effluent cannot be tested with a marine organism. Examples of flow-through test systems are provided in the Appendix. Small organisms, such as mysids and daphnids, are confined in screened enclosures placed in the flow-through chambers. More than one species may be used in the same test chamber in a given test, if segregated.

9.6.2 The dilutor system should be operated long enough prior to adding the test organisms to calibrate the dilutor and make the necessary adjustments in the temperature, flow rate through the test chambers, and aeration. The flow rate through the proportional dilutor must provide for a minimum of five 90% replacements of water volume in each test chamber every 24 h (see Figure 2). This replacement rate should provide sufficient flow to maintain an adequate concentration of dissolved oxygen. The dilutor should also be capable of maintaining the test concentration at each dilution within 5% of the starting concentration for the duration of the test. The calibration of the dilutor should be checked carefully before the test begins to determine the volume of effluent and dilution water used in each portion of the effluent delivery system and the flow rate through each test chamber. The general operation of the dilutor should be checked at least at the beginning and end of each day during the test.

9.6.3 The control consists of the same dilution water, test conditions, procedures, and organisms used in testing the effluent. In the event a test is to be conducted with salt water organisms, where each effluent dilution has a different salinity, a static control is prepared for the lowest (or highest, in the case of high salinity, e.g. brine wastes) salinity level used in the flow-through test to determine if salinity alone has any adverse effects on the test organisms.

9.7 NUMBER OF TEST ORGANISMS

9.7.1 A minimum of 20 organisms of a given species are exposed to each effluent concentration (Jensen, 1972). Small fish and invertebrates are captured with 4- to 8-mm inside diameter pipettes. Organisms larger than 10 mm can be captured by dip net. In a typical toxicity test involving five effluent concentrations and a control (six concentrations x 20 organisms per concentration), fish and other large test organisms are captured from a common pool and distributed sequentially to the test chambers until the required number of organisms are placed in each. The test chambers are then positioned randomly. To avoid carryover of excess culture water in transferring small organisms to the test chambers, it may be advantageous to distribute small organisms, such as daphnids, mysids, and larval fish, first to small holding vessels, such as weighing boats, petri dishes, or small beakers. The water in the intermediary holding vessels is then drawn down to a small volume and the entire lot is transferred to a test chamber. In the case of daphnids, both excessive handling and carryover of culture water can be avoided by placing the tip of the transfer pipettes below the surface of the water in the test chambers and allowing the organisms to swim out of the pipettes without discharging the contents.

9.8 REPLICATE TEST CHAMBERS

9.8.1 Two or more test chambers are provided for each effluent concentration and the control. Although the data from duplicate chambers are usually combined to determine the LC50 and confidence interval, the practice of dividing the test population for each effluent concentration between two or more replicate chambers has several advantages and is considered good laboratory practice because it: (1) permits easier viewing and counting of test organisms; (2) more easily avoids possible violations of loading limits, which might occur if all of the test organisms are placed in a single test vessel; and (3) ensures against the invalidation of the test which might result from accidental loss of a test vessel, where all of the test organisms for a given treatment are in a single chamber.

9.9 LOADING OF TEST ORGANISMS

9.9.1 A limit is placed on the loading (weight) of organisms per liter of test solution to minimize the depletion of dissolved oxygen, the accumulation of injurious concentrations of metabolic waste products, and/or stress induced by crowding, any of which could significantly affect the test results. However, the probability of exceeding loading limits is greatly reduced with the use of very young test organisms.

9.9.2 For both renewal and non-renewal static tests, loading in the test solutions must not exceed the following live weights: 1.1 g/L at 15°C, 0.65 g/L at 20°C, or 0.40 g/L at 25°C.

9.9.3 For flow-through tests, the live weight of test organisms in the test chambers must not exceed 7.0 g/L of test solution at 15°C, or 2.5 g/L at 25°C.

9.10 ILLUMINATION

9.10.1 Light of the quality and intensity normally obtained in the laboratory during working hours is adequate (10-20 $\mu\text{E}/\text{m}^2/\text{s}$ or 50-100 ft-c). A uniform photoperiod of 16 h light and 8 h darkness can be achieved in the laboratory or environmental chamber, using automatic timers.

9.11 FEEDING

9.11.1 Where indicated in the test summary tables (Tables 12-19), food is made available to test organisms while holding before they are placed in the test chambers. The organisms are fed at test renewal, 48 h after the test is initiated, if Regional or State policy requires a 96-h test duration.

9.11.2 Where *Artemia* nauplii are fed, the nauplii are first concentrated on a NITEX[®] screen and then are resuspended in fresh or salt water, depending on the salinity of the test solutions, using just enough water to form a slurry that can be transferred by pipette. It should be noted that *Artemia* nauplii placed in freshwater usually die in 4 h, generally are not eaten after death, and decay rapidly, whereas those placed in saline water remain viable and can serve as food for the duration of the test.

9.11.3 Problems caused by feeding, such as the possible alteration of the toxicant concentration, the build-up of food and metabolic wastes and resulting oxygen demand, are common in static test systems. Where feeding is necessary, excess food should be removed daily by aspirating with a pipette.

9.11.4 Feeding does not cause the above problems in flow-through systems. However, it is advisable to remove excess food, fecal material, and any particulate matter that settles from the effluent, from the bottom of the test vessels daily by aspirating with a pipette.

9.12 TEST TEMPERATURE

9.12.1 Test temperature will depend on the test species and objectives of the test (see Tables 12-19). Where acute and short-term chronic toxicity tests are performed simultaneously with the same species to determine acute:chronic ratios, both tests must be performed at the chronic test temperature. The average daily temperature of the test solutions should be maintained within $\pm 1^\circ\text{C}$ of the selected test temperature, for the duration of the test. This can be accomplished for static tests by use of a water bath or environmental chamber, and in flow-through tests by passing the effluent and/or dilution water through separate coils immersed in a heating or cooling water bath prior to entering the dilutor system. Coils should be made from materials recommended in Section 5, Facilities and Equipment.

9.13 STRESS

9.13.1 Minimize stress on test organisms by avoiding unnecessary disturbances.

9.14 DISSOLVED OXYGEN CONCENTRATION

9.14.1 Aeration during the test may alter the results and should be used only as a last resort to maintain the required DO. Aeration can reduce the apparent toxicity of the test solutions by stripping them of highly volatile toxic substances, or increase its toxicity by altering the pH. However, the DO in the test solution should not be permitted to fall below 4.0 mg/L for warm water species and 6.0 mg/L for cold water species. Oxygen saturation values in fresh and saline waters can be determined from Figure 3 and Table 11, respectively.

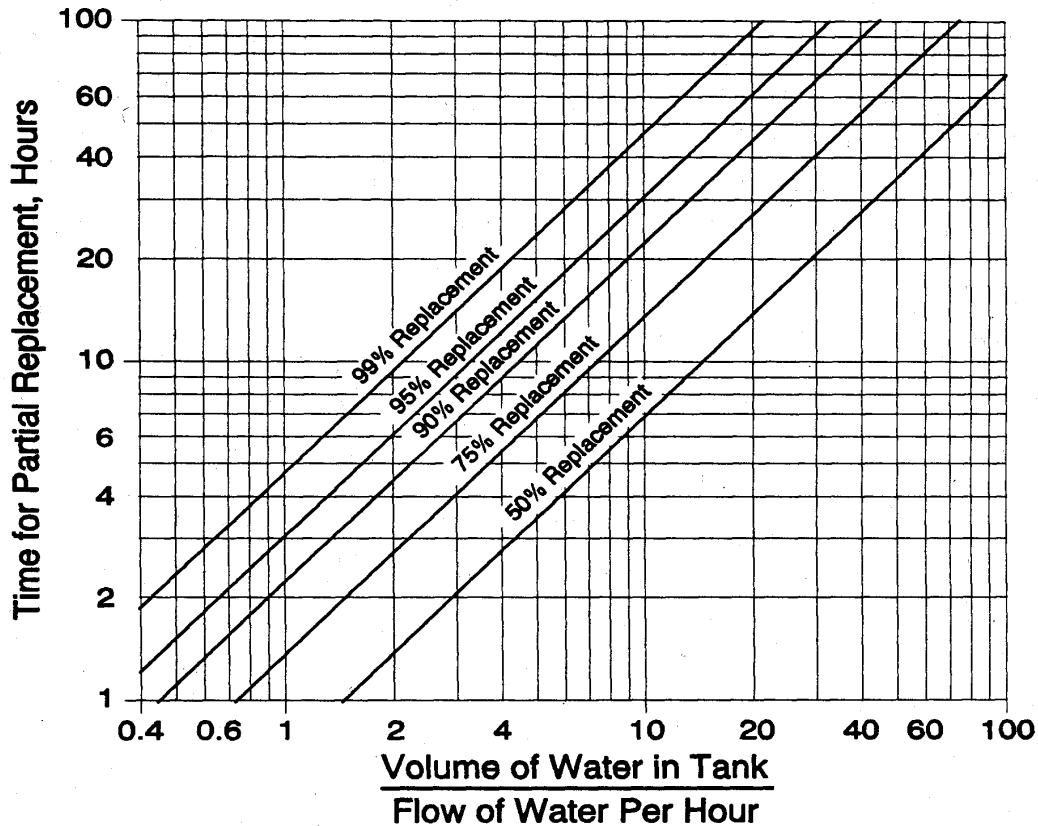

Figure 2. Approximate times required to replace water in test chambers in flow-through tests. For example: for a chamber containing 4 L, with a flow of 2 L/h, the above graph indicates that 90% of the water would be replaced every 4.8 h. The same time period (such as hours) must be used on both axes, and the same unit of volume (such as liters) must be used for both volume and flow (From: Sprague, 1969).

TABLE 11. OXYGEN SOLUBILITY (MG/L) IN WATER AT EQUILIBRIUM WITH AIR AT 760 MM HG (AFTER RICHARDS AND CORWIN, 1956)

Temp °C	Salinity (‰)									
	0	5	10	15	20	25	30	35	40	45
0	14.2	13.8	13.4	12.9	12.5	12.1	11.7	11.2	10.8	10.6
1	13.8	13.4	13.0	12.6	12.2	11.8	11.4	11.0	10.6	10.3
2	13.4	13.0	12.6	12.2	11.9	11.5	11.1	10.7	10.3	10.0
3	13.1	12.7	12.3	11.9	11.6	11.2	10.8	10.4	10.0	9.8
4	12.7	12.3	12.0	11.6	11.3	10.9	10.5	10.1	9.8	9.5
5	12.4	12.0	11.7	11.3	11.0	10.6	10.2	9.8	9.5	9.3
6	12.1	11.7	11.4	11.0	10.7	10.3	10.0	9.6	9.3	9.1
8	11.5	11.2	10.8	10.5	10.2	9.8	9.5	9.2	8.9	8.7
10	10.9	10.7	10.3	10.0	9.7	9.4	9.1	8.8	8.5	8.3
12	10.5	10.2	9.9	9.6	9.3	9.0	8.7	8.4	8.1	7.9
14	10.0	9.7	9.5	9.2	8.9	8.6	8.3	8.1	7.8	7.6
16	9.6	9.3	9.1	8.8	8.5	8.3	8.0	7.7	7.5	7.3
18	9.2	9.0	8.7	8.5	8.2	8.0	7.7	7.5	7.2	7.1
20	8.9	8.6	8.4	8.1	7.9	7.7	7.4	7.2	6.9	6.8
22	8.6	8.4	8.1	7.9	7.6	7.4	7.2	6.9	6.7	6.6
24	8.3	8.1	7.8	7.6	7.4	7.2	6.9	6.7	6.5	6.4
26	8.1	7.8	7.6	7.4	7.2	7.0	6.7	6.5	6.3	6.1
28	7.8	7.6	7.4	7.2	7.0	6.8	6.5	6.3	6.1	6.0
30	7.6	7.4	7.1	6.9	6.7	6.5	6.3	6.1	5.9	5.8
32	7.3	7.1	6.9	6.7	6.5	6.3	6.1	5.9	5.7	5.6

CORRECTION FACTORS FOR OXYGEN SATURATION AT VARIOUS ALTITUDES

ALTITUDE		PRESSURE	
FT	M	MM	FACTOR
0	0	760	1.00
330	100	750	1.01
665	200	741	1.03
990	300	732	1.04
1310	400	723	1.05
1640	500	714	1.06
1970	600	705	1.08
2300	700	696	1.09
2630	800	687	1.11
2950	900	679	1.12
3280	1000	671	1.13
3610	1100	663	1.15
3940	1200	655	1.18
4270	1300	647	1.17
4600	1400	639	1.19
4930	1500	631	1.20
5250	1600	623	1.22
5580	1700	615	1.24
5910	1800	608	1.25
6240	1900	601	1.26
6580	2000	594	1.28
6900	2100	587	1.30
7220	2200	580	1.31
7550	2300	573	1.33
7880	2400	566	1.34
8200	2500	560	1.36

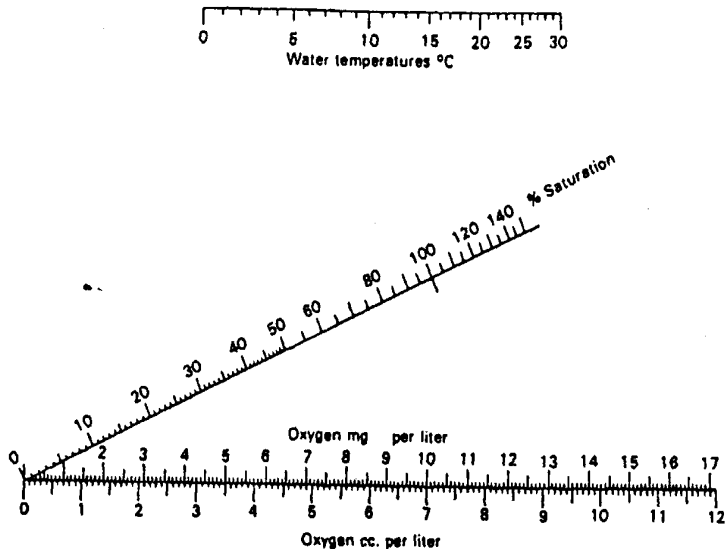

Figure 3. Rawson's nomograph for obtaining oxygen saturation values in freshwater at different temperatures at sea level. When a straightedge is used to connect the water temperature on the upper scale and the concentration on the lower scale, the percent saturation can be read from the point of intersection on the diagonal scale. To determine the percent saturation at locations above sea level, factors are provided to convert oxygen concentrations measured at various altitudes to sea level values in the table at the upper left. For example, an oxygen concentration of 6.4 mg/L measured in a body of water at an altitude of 1000 m and a temperature of 15°C would be equivalent to a concentration of 6.4×1.13 , or 7.2 mg/L, at sea level. To determine the percent saturation, a straightedge is used to connect the point at 15°C on the temperature scale with the point, 7.2 mg/L on the concentration scale, and the percent saturation is read at the point of intersection (68%) on the diagonal scale. (From Welch, 1948).

9.14.2 In static tests, low DOs commonly occur in the higher concentrations of wastewater. Aeration is accomplished by bubbling air through a pipet at the rate of 100 bubbles/min. If aeration is necessary, all test solutions must be aerated. It is advisable to monitor the DO closely during the first few hours of the test. Samples with a potential DO problem generally show a downward trend in DO within 4 to 8 h after the test is started. Unless aeration is initiated during the first 8 h of the test, the DO may be exhausted during an unattended period, thereby invalidating the test.

9.14.3 In most flow-through tests, DO depletion is not a problem in the test chambers because aeration occurs as the liquids pass through the dilutor system. If the DO decreases to a level that would be a source of additional stress, the turnover rate of the solutions in the test chambers must be increased sufficiently to maintain acceptable DO levels. If the increased turnover rate does not maintain adequate DO levels, aerate the dilution water prior to the addition of the effluent, and aerate all test solutions. To reduce the potential for driving off volatile compounds in the wastewater, aeration may be accomplished by bubbling air through a 1 mL pipet at a rate of no more than 100 bubbles/min, using an air valve to control the flow.

9.14.4 Caution must be exercised to avoid excessive aeration. Turbulence caused by aeration should not result in a physical stress to the test organisms. When aeration is used, the methodology must be detailed in the report. For safety reasons, pure oxygen should not be used to aerate test solutions.

9.15 TEST DURATION

9.15.1 Test duration may vary from 24 to 96 h depending on the objectives of the test and the requirements of the regulatory authority. For specific information on test duration, see the tables summarizing the test conditions below.

9.16 ACCEPTABILITY OF TEST RESULTS

9.16.1 For the test results to be acceptable, survival in controls must be at least 90%. Tests in which the control survival is less than 90% are invalid, and must be repeated. In tests with specific chemicals, the concentration of the test material must not vary more than 20% at any treatment level during the exposure period.

9.16.2 Upon subsequent completion of a valid test, the results of all tests, valid and invalid, are reported to the regulatory authority with an explanation of the tests performed and results.

9.17 SUMMARY OF TEST CONDITIONS FOR THE PRINCIPAL TEST ORGANISMS

9.17.1 Summaries of the test conditions for the daphnids, *Ceriodaphnia dubia*, *Daphnia pulex*, and *D. magna*, fathead minnows, *Pimephales promelas*, rainbow trout, *Oncorhynchus mykiss*, brook trout, *Salvelinus fontinalis*, the mysids, *Mysidopsis bahia* and *Holmesimysis costata*, sheepshead minnows, *Cyprinodon variegatus*, and silversides, *Menidia beryllina*, *M. menidia*, and *M. peninsulae*, are provided in Tables 12-19.

TABLE 12. SUMMARY OF TEST CONDITIONS AND TEST ACCEPTABILITY CRITERIA FOR *CERIODAPHNIA DUBIA* ACUTE TOXICITY TESTS WITH EFFLUENTS AND RECEIVING WATERS (TEST METHOD 2002.0)¹

1. Test type:	Static non-renewal, static-renewal, or flow-through (available options)
2. Test duration:	24, 48, or 96 h (available options)
3. Temperature: ²	20°C ±1°C; or 25°C ±1°C (recommended) Test temperatures must not deviate (i.e., maximum minus minimum temperature) by more than 3°C during the test (required)
4. Light quality:	Ambient laboratory illumination (recommended)
5. Light intensity:	10-20 µE/m ² /s (50-100 ft-c) (recommended) (ambient laboratory levels)
6. Photoperiod:	16 h light, 8 h darkness (recommended)
7. Test chamber size:	30 mL (recommended minimum)
8. Test solution volume:	15 mL (recommended minimum)
9. Renewal of test solutions:	After 48 h (required minimum)
10. Age of test organisms:	Less than 24-h old (required)
11. No. organisms per test chamber:	5 for effluent and receiving water tests (required minimum)
12. No. replicate chambers per concentration:	4 for effluent and receiving water tests (required minimum)
13. No. organisms per concentration:	20 for effluent and receiving water tests (required minimum)
14. Feeding regime:	Feed YCT and <i>Selenastrum</i> while holding prior to the test; newly-released young should have food available a minimum of 2 h prior to use in a test; add 0.1 mL each of YCT and <i>Selenastrum</i> 2 h prior to test solution renewal at 48 h (recommended)
15. Test chamber cleaning:	Cleaning not required
16. Test chamber aeration:	None (recommended)

¹ For the purposes of reviewing WET test data submitted under NPDES permits, each test condition listed above is identified as required or recommended (see Subsection 12.2 for more information on test review). Additional requirements may be provided in individual permits, such as specifying a given test condition where several options are given in the method.

² Acute and chronic toxicity tests performed simultaneously to obtain acute/chronic ratios must use the same temperature and dilution water.

TABLE 12. SUMMARY OF TEST CONDITIONS AND TEST ACCEPTABILITY CRITERIA FOR *CERIODAPHNIA DUBIA* ACUTE TOXICITY TESTS WITH EFFLUENTS AND RECEIVING WATERS (TEST METHOD 2002.0) (CONTINUED)

17. Dilution water:	Moderately hard synthetic water prepared using MILLIPORE MILLI-Q® or equivalent deionized water and reagent grade chemicals or 20% DMW (see Section 7, Dilution Water), receiving water, ground water, or synthetic water, modified to reflect receiving water hardness (available options)
18. Test concentrations:	Effluents: 5 and a control (required minimum) Receiving Waters: 100% receiving water and a control (recommended)
19. Dilution series:	Effluents: ≥0.5 dilution series (recommended) Receiving Waters: None, or ≥0.5 dilution series (recommended)
20. Endpoint:	Effluents: Mortality (required) Receiving Waters: Mortality (required)
21. Sampling and sample holding requirements:	Effluents: Grab or composite sample first used within 36 h of completion of the sampling period (required) Receiving Waters: Grab or composite sample first used within 36 h of completion of the sampling period (recommended)
22. Sample volume required:	1 L (recommended)
23. Test acceptability criterion:	90% or greater survival in controls (required)

TABLE 13. SUMMARY OF TEST CONDITIONS AND TEST ACCEPTABILITY CRITERIA FOR *DAPHNIA PULEX* AND *D. MAGNA* ACUTE TOXICITY TESTS WITH EFFLUENTS AND RECEIVING WATERS (TEST METHOD 2021.0)¹

1. Test type:	Static non-renewal, static-renewal, or flow-through (available options)
2. Test duration:	24, 48, or 96 h (available options)
3. Temperature: ²	20°C ±1°C; or 25°C ±1°C (recommended) Test temperatures must not deviate (i.e., maximum minus minimum temperature) by more than 3°C during the test (required)
4. Light quality:	Ambient laboratory illumination (recommended)
5. Light intensity:	10-20 µE/m ² /s (50-100 ft-c) (ambient laboratory levels) (recommended)
6. Photoperiod:	16 h light, 8 h darkness (recommended)
7. Test chamber size:	30 mL (recommended minimum)
8. Test solution volume:	25 mL (recommended minimum)
9. Renewal of test solutions:	After 48 h (required minimum)
10. Age of test organisms:	Less than 24-h old (required)
11. No. organisms per test chamber:	5 for effluent and receiving water tests (required minimum)
12. No. replicate chambers per concentration:	4 for effluent and receiving water tests (required minimum)
13. No. organisms per concentration:	20 for effluent and receiving water tests (required minimum)
14. Feeding regime:	Feed YCT and <i>Selenastrum</i> while holding prior to the test; newly-released young should have food available a minimum of 2 h prior to use in a test; add 0.1 mL each of YCT and <i>Selenastrum</i> 2 h prior to test solution renewal at 48 h (recommended)
15. Test chamber cleaning:	Cleaning not required
16. Test chamber aeration:	None (recommended)
17. Dilution water:	Moderately hard synthetic water prepared using MILLIPORE MILLI-Q [®] or equivalent deionized water and reagent grade chemicals or 20% DMW (see Section 7, Dilution Water), receiving water, ground water, or synthetic water, modified to reflect receiving water hardness (available options)

¹ For the purposes of reviewing WET test data submitted under NPDES permits, each test condition listed above is identified as required or recommended (see Subsection 12.2 for more information on test review). Additional requirements may be provided in individual permits, such as specifying a given test condition where several options are given in the method.

² Acute and chronic toxicity tests performed simultaneously to obtain acute/chronic ratios must use the same temperature and dilution water.

TABLE 13. SUMMARY OF TEST CONDITIONS AND TEST ACCEPTABILITY CRITERIA FOR *DAPHNIA PULEX* AND *D. MAGNA* ACUTE TOXICITY TESTS WITH EFFLUENTS AND RECEIVING WATER (TEST METHOD 2021.0) (CONTINUED)

18. Test concentrations:	Effluents: 5 and a control (required minimum)
	Receiving Waters: 100% receiving water and a control (recommended)
19. Dilution series:	Effluents: ≥ 0.5 dilution series (recommended)
	Receiving Waters: None, or ≥ 0.5 dilution series (recommended)
20. Endpoint:	Effluents: Mortality (required)
	Receiving Waters: Mortality (required)
21. Sampling and sample holding requirements:	Effluents: Grab or composite sample first used within 36 h of completion of the sampling period (required)
	Receiving Waters: Grab or composite sample first used within 36 h of completion of the sampling period (recommended)
22. Sample volume required:	1 L (recommended)
23. Test acceptability criterion:	90% or greater survival in controls (required)

TABLE 14. SUMMARY OF TEST CONDITIONS AND TEST ACCEPTABILITY CRITERIA FOR FATHEAD MINNOW, *PIMEPHALES PROMELAS*, ACUTE TOXICITY TESTS WITH EFFLUENTS AND RECEIVING WATERS (TEST METHOD 2000.0)^{1,2}

1. Test type:	Static non-renewal, static-renewal, or flow-through (available options)
2. Test duration:	24, 48, or 96 h (available options)
3. Temperature: ³	20°C ±1°C; or 25°C ±1°C (recommended) Test temperatures must not deviate (i.e., maximum minus minimum temperature) by more than 3°C during the test (required)
4. Light quality:	Ambient laboratory illumination (recommended)
5. Light intensity:	10-20 µE/m ² /s (50-100 ft-c) (ambient laboratory levels) (recommended)
6. Photoperiod:	16 h light, 8 h darkness (recommended)
7. Test chamber size:	250 mL (recommended minimum)
8. Test solution volume:	200 mL (recommended minimum)
9. Renewal of test solutions:	After 48 h (required minimum)
10. Age of test organisms:	1-14 days; less than or equal to 24-h range in age (required)
11. No. organisms per test chamber:	10 for effluent and receiving water tests (required minimum)
12. No. replicate chambers per concentration:	2 for effluent tests (required minimum) 4 for receiving water tests (required minimum)
13. No. organisms per concentration:	20 for effluent tests (required minimum) 40 for receiving water tests (required minimum)
14. Feeding regime:	<i>Artemia</i> nauplii are made available while holding prior to the test; add 0.2 mL <i>Artemia</i> nauplii concentrate 2 h prior to test solution renewal at 48 h (recommended)
15. Test chamber cleaning:	Cleaning not required
16. Test solution aeration:	None, unless DO concentration falls below 4.0 mg/L; rate should not exceed 100 bubbles/min (recommended)

¹ *Cyprinella leedsii* (Bannerfish shiner, formerly *Notropis leedsii*; AFS, 1991) can be used with the test conditions in this table, where it is the required test organism in NPDES permits.

² For the purposes of reviewing WET test data submitted under NPDES permits, each test condition listed above is identified as required or recommended (see Subsection 12.2 for more information on test review). Additional requirements may be provided in individual permits, such as specifying a given test condition where several options are given in the method.

³ Acute and chronic toxicity tests performed simultaneously to obtain acute/chronic ratios must use the same temperature and dilution water.

TABLE 14. SUMMARY OF TEST CONDITIONS AND TEST ACCEPTABILITY CRITERIA FOR FATHEAD MINNOW, *PIMEPHALES PROMELAS*, ACUTE TOXICITY TESTS WITH EFFLUENTS AND RECEIVING WATERS¹ (TEST METHOD 2000.0) (CONTINUED)

17. Dilution water:	Moderately hard synthetic water prepared using MILLIPORE MILLI-Q [®] or equivalent deionized water and reagent grade chemicals or 20% DMW (see Section 7, Dilution Water), receiving water, ground water, or synthetic water, modified to reflect receiving water hardness. (available options)
18. Test concentrations:	Effluents: 5 and a control (required minimum) Receiving Waters: 100% receiving water and a control (recommended)
19. Dilution series:	Effluents: ≥ 0.5 dilution series (recommended) Receiving Waters: None, or ≥ 0.5 dilution series (recommended)
20. Endpoint:	Effluents: Mortality (required) Receiving Waters: Mortality (required)
21. Sampling and sample holding requirements:	Effluents: Grab or composite sample first used within 36 h of completion of the sampling period (required) Receiving Waters: Grab or composite sample first used within 36 h of completion of the sampling period (recommended)
22. Sample volume required:	2 L for effluents and receiving waters (recommended)
23. Test acceptability criterion:	90% or greater survival in controls (required)

TABLE 15. SUMMARY OF TEST CONDITIONS AND TEST ACCEPTABILITY CRITERIA FOR RAINBOW TROUT, *ONCORHYNCHUS MYKISS*, AND BROOK TROUT, *SALVELINUS FONTINALIS*, ACUTE TOXICITY TESTS WITH EFFLUENTS AND RECEIVING WATERS (TEST METHOD 2019.0)¹

1. Test type:	Static non-renewal, static-renewal, or flow-through (available options)
2. Test duration:	24, 48, or 96 h (available options)
3. Temperature:	12°C ±1°C (recommended) Test temperatures must not deviate (i.e., maximum minus minimum temperature) by more than 3°C during the test (required)
4. Light quality:	Ambient laboratory illumination (recommended)
5. Light intensity:	10-20 µE/m ² /s (50-100 ft-c) (ambient laboratory levels) (recommended)
6. Photoperiod:	16 h light, 8 h darkness. Light intensity should be raised gradually over a 15 min period at the beginning of the photoperiod, and lowered gradually at the end of the photoperiod, using a dimmer switch or other suitable device. (recommended)
7. Test chamber size:	5 L (recommended minimum) (test chambers should be covered to prevent fish from jumping out)
8. Test solution volume:	4 L (recommended minimum)
9. Renewal of test solutions:	After 48 h (required minimum)
10. Age of test organisms:	Rainbow Trout: 15-30 days (after yolk sac absorption to 30 days) (required) Brook Trout: 30-60 days (required)
11. No. organisms per test chamber:	10 for effluent and receiving water tests (required minimum)
12. No. replicate chambers per concentration:	2 for effluent tests (required minimum) 4 for receiving water tests (required minimum)
13. No. organisms per concentration:	20 for effluent tests (required minimum) 40 for receiving water tests (required minimum)
14. Feeding regime:	Feeding not required
15. Test chamber cleaning:	Cleaning not required
16. Test solution aeration:	None, unless DO concentration falls below 6.0 mg/L; rate should not exceed 100 bubbles/min (recommended)

¹ For the purposes of reviewing WET test data submitted under NPDES permits, each test condition listed above is identified as required or recommended (see Subsection 12.2 for more information on test review). Additional requirements may be provided in individual permits, such as specifying a given test condition where several options are given in the method.

TABLE 15. SUMMARY OF TEST CONDITIONS AND TEST ACCEPTABILITY CRITERIA FOR RAINBOW TROUT, *ONCORHYNCHUS MYKISS*, AND BROOK TROUT, *SALVELINUS FONTINALIS*, ACUTE TOXICITY TESTS WITH EFFLUENTS AND RECEIVING WATERS (TEST METHOD 2019.0) (CONTINUED)

17. Dilution water:	Moderately hard synthetic water prepared using MILLIPORE MILLI-Q [®] or equivalent deionized water and reagent grade chemicals or 20% DMW (see Section 7, Dilution Water), receiving water, ground water, or synthetic water, modified to reflect receiving water hardness (available options)
18. Test concentrations:	Effluents: 5 and a control (required minimum) Receiving Waters: 100% receiving water and a control (recommended)
19. Dilution series:	Effluents: ≥ 0.5 dilution series (recommended) Receiving Waters: None, or ≥ 0.5 dilution series (recommended)
20. Endpoint:	Effluents: Mortality (required) Receiving Waters: Mortality (required)
21. Sampling and sample holding requirements:	Effluents: Grab or composite sample first used within 36 h of completion of the sampling period (required) Receiving Waters: Grab or composite sample first used within 36 h of completion of the sampling period (recommended)
22. Sample volume required:	20 L for effluents (recommended) 40 L for receiving waters (recommended)
23. Test acceptability criterion:	90% or greater survival in controls (required)

TABLE 16. SUMMARY OF TEST CONDITIONS AND TEST ACCEPTABILITY CRITERIA FOR MYSID, *MYSIDOPSIS BAHIA*, ACUTE TOXICITY TESTS WITH EFFLUENTS AND RECEIVING WATERS (TEST METHOD 2007.0)¹

1. Test type:	Static non-renewal, static-renewal, or flow-through (available options)
2. Test duration:	24, 48, or 96 h (available options)
3. Temperature ² :	20°C ±1°C; or 25°C ±1°C (recommended) Test temperatures must not deviate (i.e., maximum minus minimum temperature) by more than 3°C during the test (required)
4. Light quality:	Ambient laboratory illumination (recommended)
5. Light intensity:	10-20 µE/m ² /s (50-100 ft-c) (ambient laboratory levels) (recommended)
6. Photoperiod:	16 h light, 8 h darkness (recommended)
7. Test chamber size:	250 mL (recommended minimum)
8. Test solution volume:	200 mL (recommended minimum)
9. Renewal of test solutions:	After 48 h (required minimum)
10. Age of test organisms:	1-5 days; less than or equal to 24-h range in age (required)
11. No. organisms per test chamber:	10 for effluent and receiving water tests (required minimum)
12. No. replicate chambers per concentration:	2 for effluent tests (required minimum) 4 for receiving water tests (required minimum)
13. No. organisms per concentration:	20 for effluent tests (required minimum) 40 for receiving water tests (required minimum)
14. Feeding regime:	<i>Artemia</i> nauplii are made available while holding prior to the test; feed 0.2 mL of concentrated suspension of <i>Artemia</i> nauplii ≤ 24-h old, daily (approximately 100 nauplii per mysid) (recommended)

¹ For the purposes of reviewing WET test data submitted under NPDES permits, each test condition listed above is identified as required or recommended (see Subsection 12.2 for more information on test review). Additional requirements may be provided in individual permits, such as specifying a given test condition where several options are given in the method.

² Acute and chronic toxicity tests performed simultaneously to obtain acute/chronic ratios must use the same temperature, salinity, and dilution water.

TABLE 16. SUMMARY OF TEST CONDITIONS AND TEST ACCEPTABILITY CRITERIA FOR MYSID, *MYSIDOPSIS BAHIA*, ACUTE TOXICITY TESTS WITH EFFLUENTS AND RECEIVING WATERS¹ (TEST METHOD 2007.0) (CONTINUED)

15. Test chamber cleaning:	Cleaning not required
16. Test solution aeration:	None, unless DO concentration falls below 4.0 mg/L; rate should not exceed 100 bubbles/min (recommended)
17. Dilution water:	5-30% ±10%; Uncontaminated source of seawater, deionized water mixed with hypersaline brine or artificial sea salts (HW MARINEMIX [®] , FORTY FATHOMS [®] , modified GP2, or equivalent) prepared with MILLI-Q [®] or equivalent deionized water (see Section 7, Dilution Water); or receiving water (available options)
18. Test concentrations:	Effluents: 5 and a control (required minimum) Receiving Waters: 100% receiving water and a control (recommended)
19. Dilution series:	Effluents: ≥0.5 dilution series (recommended) Receiving Waters: None, or ≥0.5 dilution series (recommended)
20. Endpoint:	Effluents: Mortality (required) Receiving Waters: Mortality (required)
21. Sampling and sample holding requirements:	Effluents: Grab or composite sample first used within 36 h of completion of the sampling period (required) Receiving Waters: Grab or composite sample first used within 36 h of completion of the sampling period (recommended)
22. Sample volume required:	1 L for effluents (recommended) 2 L for receiving waters (recommended)
23. Test acceptability criterion:	90% or greater survival in controls (required)

TABLE 17. SUMMARY OF TEST CONDITIONS AND TEST ACCEPTABILITY CRITERIA FOR SHEEPSHEAD MINNOW, *CYPRINODON VARIEGATUS*, ACUTE TOXICITY TESTS WITH EFFLUENTS AND RECEIVING WATERS (TEST METHOD 2004.0)¹

1. Test type:	Static non-renewal, static-renewal, or flow-through (available options)
2. Test duration:	24, 48, or 96 h (available options)
3. Temperature: ²	20°C ±1°C; or 25°C ±1°C (recommended) Test temperatures must not deviate (i.e., maximum minus minimum temperature) by more than 3°C during the test (required)
4. Light quality:	Ambient laboratory illumination (recommended)
5. Light intensity:	10-20 µE/m ² /s (50-100 ft-c) (ambient laboratory levels) (recommended)
6. Photoperiod:	16 h light, 8 h darkness (recommended)
7. Test chamber size:	250 mL (recommended minimum)
8. Test solution volume:	200 mL (recommended minimum)
9. Renewal of test solutions:	After 48 h (required minimum)
10. Age of test organisms:	1-14 days; less than or equal to 24-h range in age (required)
11. No. organisms per test chamber:	10 for effluent and receiving water tests (required minimum)
12. No. replicate chambers per concentration:	2 for effluent tests (required minimum) 4 for receiving water tests (required minimum)
13. No. organisms per concentration:	20 for effluent tests (required minimum) 40 for receiving water tests (required minimum)
14. Feeding regime:	<i>Artemia</i> nauplii are made available while holding prior to the test; add 0.2 mL <i>Artemia</i> nauplii concentrate 2 h prior to test solution renewal at 48 h (recommended)
15. Test chamber cleaning:	Cleaning not required
16. Test solution aeration:	None, unless DO concentration falls below 4.0 mg/L; rate should not exceed 100 bubbles/min (recommended)

¹ For the purposes of reviewing WET test data submitted under NPDES permits, each test condition listed above is identified as required or recommended (see Subsection 12.2 for more information on test review). Additional requirements may be provided in individual permits, such as specifying a given test condition where several options are given in the method.

² Acute and chronic toxicity tests performed simultaneously to obtain acute/chronic ratios must use the same temperature, salinity, and dilution water.

TABLE 17. SUMMARY OF TEST CONDITIONS AND TEST ACCEPTABILITY CRITERIA FOR SHEEPSHEAD MINNOW, *CYPRINODON VARIEGATUS*, ACUTE TOXICITY TESTS WITH EFFLUENTS AND RECEIVING WATERS (TEST METHOD 2004.0) (CONTINUED)

17. Dilution water:	5-32% ±10%; Uncontaminated source of seawater, deionized water mixed with hypersaline brine or artificial sea salts (HW MARINEMIX [®] , FORTY FATHOMS [®] , modified GP2, or equivalent) prepared with MILLI-Q [®] or equivalent deionized water (see Section 7, Dilution Water); or receiving water (available options)
18. Test concentrations:	Effluents: 5 and a control (required minimum) Receiving Waters: 100% receiving water and a control (recommended)
19. Dilution series:	Effluents: ≥0.5 dilution series (recommended) Receiving Waters: None, or ≥ 0.5 dilution series (recommended)
20. Endpoint:	Effluents: Mortality (required) Receiving Waters: Mortality (required)
21. Sampling and sample holding requirements:	Effluents: Grab or composite sample first used within 36 h of completion of the sampling period (required) Receiving Waters: Grab or composite sample first used within 36 h of completion of the sampling period (recommended)
22. Sample volume required:	1 L for effluents (recommended) 2 L for receiving waters (recommended)
23. Test acceptability criterion:	90% or greater survival in controls (required)

TABLE 18. SUMMARY OF TEST CONDITIONS AND TEST ACCEPTABILITY CRITERIA FOR SILVERSIDE, *MENIDIA BERYLLINA*, *M. MENIDIA*, AND *M. PENINSULAE*, ACUTE TOXICITY TESTS WITH EFFLUENTS AND RECEIVING WATERS (TEST METHOD 2006.0)¹

1. Test type:	Static non-renewal, static-renewal, or flow-through (available options)
2. Test duration:	24, 48, or 96 h (available options)
3. Temperature: ²	20°C ±1°C; or 25°C ±1°C (recommended) Test temperatures must not deviate (i.e., maximum minus minimum temperature) by more than 3°C during the test (required)
4. Light quality:	Ambient laboratory illumination (recommended)
5. Light intensity:	10-20 µE/m ² /s (50-100 ft-c) (ambient laboratory levels) (recommended)
6. Photoperiod:	16 h light, 8 h darkness (recommended)
7. Test chamber size:	250 mL (recommended minimum)
8. Test solution volume:	200 mL (recommended minimum)
9. Renewal of test solutions:	After 48 h (required minimum)
10. Age of test organisms:	9-14 days; less than or equal to 24-h range in age (required)
11. No. organisms per test chamber:	10 for effluent and receiving water tests (required minimum)
12. No. replicate chambers per concentration:	2 for effluent tests (required minimum) 4 for receiving water tests (required minimum)
13. No. organisms per concentration:	20 for effluent tests (required minimum) 40 for receiving water tests (required minimum)
14. Feeding regime:	<i>Artemia</i> nauplii are made available while holding prior to the test; add 0.2 mL <i>Artemia</i> nauplii concentrate 2 h prior to test solution renewal at 48 h (recommended)
15. Test chamber cleaning:	Cleaning not required
16. Test solution aeration:	None, unless DO concentration falls below 4.0 mg/L; rate should not exceed 100 bubbles/min (recommended)

¹ For the purposes of reviewing WET test data submitted under NPDES permits, each test condition listed above is identified as required or recommended (see Subsection 12.2 for more information on test review). Additional requirements may be provided in individual permits, such as specifying a given test condition where several options are given in the method.

² Acute and chronic toxicity tests performed simultaneously to obtain acute/chronic ratios must use the same temperature, salinity, and dilution water.

TABLE 18. SUMMARY OF TEST CONDITIONS AND TEST ACCEPTABILITY CRITERIA FOR SILVERSIDE, *MENIDIA BERYLLINA*, *M. MENIDIA*, AND *M. PENINSULAE*, ACUTE TOXICITY TESTS WITH EFFLUENTS AND RECEIVING WATERS (TEST METHOD 2006.0) (CONTINUED)

17. Dilution water:	5-32‰ ±10%; Uncontaminated source of seawater, deionized water mixed with hypersaline brine or artificial sea salts (HW MARINEMIX [®] , FORTY FATHOMS [®] , modified GP2, or equivalent) prepared with MILLI-Q [®] or equivalent deionized water (see Section 7, Dilution Water); or receiving water (available options) 1-32‰ ±10% for <i>M. beryllina</i> ; 15-32‰ ±10% for <i>M. menidia</i> ; and <i>M. peninsulae</i>
18. Test concentrations:	Effluents: 5 and a control (required minimum) Receiving Waters: 100% receiving water and a control (recommended)
19. Dilution series:	Effluents: ≥0.5 dilution series (recommended) Receiving Waters: None, or ≥0.5 dilution series (recommended)
20. Endpoint:	Effluents: Mortality (required) Receiving Waters: Mortality (required)
21. Sampling and sample holding requirements:	Effluents: Grab or composite sample first used within 36 h of completion of the sampling period (required) Receiving Waters: Grab or composite sample first used within 36 h of completion of the sampling period (recommended)
22. Sample volume required:	1 L for effluents (recommended) 2 L for receiving waters (recommended)
23. Test acceptability criterion:	90% or greater survival in controls (required)

TABLE 19. SUMMARY OF TEST CONDITIONS AND TEST ACCEPTABILITY CRITERIA FOR WEST COAST MYSID, *HOLMESIMYSIS COSTATA*, ACUTE TOXICITY TESTS WITH EFFLUENTS AND RECEIVING WATERS¹

NOTE: This method is specific to Pacific Coast waters and is not listed at 40 CFR Part 136 for nationwide use. This method has been proposed but not yet approved at 40 CFR Part 136.

1. Test type:	Static non-renewal or static-renewal
2. Test duration:	24, 48, or 96 h
3. Temperature:	15°C ± 1°C for organisms collected South of Pt Conception, CA 13°C ± 1°C for organisms collected North of Pt Conception, CA
4. Light quality:	Ambient laboratory illumination
5. Light intensity:	10-20 µE/m ² /s (50-100 ft-c) (ambient laboratory levels)
6. Photoperiod:	16 h light, 8 h darkness
7. Test chamber size:	1000 mL (minimum)
8. Test solution volume:	200 mL (minimum)
9. Renewal of test solutions:	Minimum, at 48 h
10. Age of test organisms:	3 to 4 days post-hatch juveniles
11. No. organisms per test chamber:	Minimum, 5 for effluent and receiving water tests
12. No. replicate chambers per concentration:	Minimum, 5 for effluent tests and receiving water tests
13. No. organisms per concentration:	Minimum, 25 for effluent tests and receiving water tests
14. Feeding regime:	<i>Artemia</i> nauplii are made available while holding prior to the test; feed 0.2 mL of concentrated suspension of <i>Artemia</i> nauplii ≤24-h old, daily approximately 40 nauplii per mysid)

¹ Acute and chronic toxicity tests performed simultaneously to obtain acute/chronic ratios must use the same temperature and salinity.

TABLE 19. SUMMARY OF TEST CONDITIONS AND TEST ACCEPTABILITY CRITERIA FOR WEST COAST MYSID, *HOLMESIMYSIS COSTATA*, ACUTE TOXICITY TESTS WITH EFFLUENTS AND RECEIVING WATERS (CONTINUED)

15. Test chamber cleaning:	Cleaning not required
16. Test solution aeration:	None, unless DO concentration falls below 4.0 mg/L; rate should not exceed 100 bubbles/min
17. Dilution water:	34 ± 2‰ salinity; Uncontaminated seawater (1 µm filtered) or hypersaline brine or equivalent (see Section 7, Dilution Water)
18. Test concentrations:	Effluents: Minimum of five effluent concentrations and a control Receiving Waters: 100% receiving water and a control
19. Dilution series:	Effluents: ≥0.5 dilution series Receiving Waters: None, or ≥0.5 dilution series
20. Endpoint:	Effluents: Mortality Receiving Waters: Mortality
21. Sampling and sample holding requirements:	Effluents: Grab or composite sample first used within 36 h of completion of the sampling period Receiving Waters: Grab or composite sample first used within 36 h of completion of the sampling period
22. Sample volume required:	1 L for effluents 2 L for receiving waters
23. Test acceptability criterion:	90% or greater survival in controls

SECTION 10

TEST DATA

10.1 BIOLOGICAL DATA

10.1.1 Death is the "effect" used for determining toxicity to aquatic organisms in acute toxicity tests.

10.1.2 Death is not as easily determined for some organisms. The criteria usually employed in establishing death are: (1) no movement of gills or appendages; and (2) no reaction to gentle prodding.

10.1.3 The death of some organisms, such as mysids and larval fish, is easily detected because of a change in appearance from transparent or translucent to opaque. General observations of appearance and behavior, such as erratic swimming, loss of reflex, discoloration, excessive mucus production, hyperventilation, opaque eyes, curved spine, hemorrhaging, molting, and cannibalism, should also be noted in the daily record.

10.1.4 The test chambers should be checked for early mortality during the first few hours of the test. The number of surviving organisms in each test chamber is recorded at the end of each 24-h period (Figure 4). When recognizable, dead organisms should be removed during each observation period.

10.1.5 The species, source, and age of the test organisms should be recorded.

10.2 CHEMICAL AND PHYSICAL DATA

10.2.1 In static tests, at a minimum, pH, salinity or conductivity, and total residual chlorine are measured in the highest concentration of test solution and in the dilution water at the beginning of the test, at test solution renewal, and at test termination. If total residual chlorine is not detected in effluent or dilution water at test initiation, it is unnecessary to measure total residual chlorine at test solution renewal or at test termination. It is also unnecessary to measure total residual chlorine in laboratory prepared synthetic dilution waters. DO, pH, and temperature are measured in the control and all test concentrations at the beginning of the test, daily thereafter, and at test termination.

10.2.1.1 It is recommended that total alkalinity and total hardness also be measured in the control and highest effluent concentration at the beginning of the test and at test solution renewal.

10.2.1.2 Total ammonia is measured in samples where toxicity may be contributed by unionized ammonia (where total ammonia might be ≥ 5 mg/L).

10.2.1.3 The DO should be monitored closely (every 2 h) for the first 4 to 8 h, to guard against rapid DO depletion, and is measured daily thereafter in all effluent concentrations in which there are surviving organisms, and at test termination. It is recommended that test solution DO be recorded continuously in the test chamber at the highest test solution concentration or in a surrogate vessel at a comparable test solution concentration and containing the standard complement of test organisms.

10.2.1.4 At a minimum, test solution temperature is measured at the beginning of the test, and daily thereafter. Temperature measurements are made by placing thermometers or other temperature sensing devices directly in test solutions or in a comparable volumes of water in chambers positioned in several locations among the test vessels to determine test solution temperatures. It is recommended that test solution temperature be recorded continuously in at least one test chamber or in a comparable volume of water in a surrogate vessel which is comparable to the test chambers.

10.2.2 In flow-through tests, at a minimum, pH, salinity or conductivity, total alkalinity, total hardness, and total residual chlorine are measured daily in the highest effluent concentration. DO and temperature are measured at the beginning of the test, daily thereafter in the control and all test concentrations, and at test termination.

10.2.3 The measurement of specific conductance is recommended because it is a very useful parameter in detecting transient fluctuations in the chemical characteristics of effluents, and will indicate errors in test dilutions.

10.2.4 Where acute toxicity test methods are utilized to determine permit limits for toxic chemicals, at a minimum, the concentration of the test material must be measured in each test concentration at test initiation, daily thereafter, and at test termination.

10.2.5 Methods used for chemical analysis should be those specified for Section 304(h) of the CWA (USEPA, 1993b). For salinity measurements, a refractometer may be used if calibrated with a sample of known salinity.

<p>1. EXPOSURE CHAMBER</p> <p>Total capacity: _____ mL</p> <p>Test solution volume: _____ mL</p> <p>Test solution surface area: _____ cm²</p> <p>Water depth (constant): _____ cm</p> <p>(cyclic): _____ to _____ cm</p> <p>3. AERATION</p> <p>None: _____</p> <p>Slow: _____ (Bubbles or mL/min)</p> <p>Moderate: _____ " "</p> <p>Vigorous: _____ " "</p> <p>From: _____ AM/PM; ____/____/____ (DATE)</p> <p>To: _____ AM/PM; ____/____/____ (DATE)</p>	<p>2. FEEDING SCHEDULE</p> <p>Not Fed: _____</p> <p>Fed daily: _____</p> <p>Fed irregularly: (describe): _____</p> <p>Food used: _____</p> <p>4. SCREENED ANIMAL ENCLOSURES</p> <p>Not used: _____</p> <p>Used: _____ (cm) Diameter</p>
--	---

5. Condition/appearance of surviving organisms at end of test: (i.e., alive but immobile; loss of orientation; erratic movement; etc.) _____

6. Comments: _____

NPDES NO: _____ Inspection Date: _____ Outfall number: _____

Facility Name: _____ Test Date: _____ Macro Test: _____

City Name: _____ Inspection Code: _____ Type Macro: _____

County Name: _____ Type Inspection: _____ Expo Time: _____

Receiving Water: _____ Date Info to WSD: _____ Results: _____

Permit Issued: _____ Date Info to State: _____ Fish Test: _____

Permit Expires: _____ Date of WMD Action: _____ Type Fish: _____

SIC Code: _____ Date of Static Action: _____ Expo Time: _____

Present Treatment: _____ Type of Action: _____ Results: _____

Remarks: _____ Annual Status Update: _____ Remarks: _____

Figure 5. Check list on back of effluent toxicity data sheet.

SECTION 11

ACUTE TOXICITY DATA ANALYSIS

11.1 INTRODUCTION

11.1.1 The objective of acute toxicity tests with effluents and receiving waters is to identify discharges of toxic effluents in acutely toxic amounts. Data are derived from tests designed to determine the adverse effects of effluents and receiving waters on the survival of the test organisms. The recommended effluent toxicity test consists of a control and five or more concentrations of effluent (i.e., multi-effluent-concentration, or definitive tests), in which the endpoint is (1) an estimate of the effluent concentration which is lethal to 50% of the test organisms in the time period prescribed by the test, expressed as the LC50, or (2) the highest effluent concentration at which survival is not significantly different from the control (No-Observed-Adverse-Effect Concentration, or NOAEC). Receiving water tests may be single concentration or multi-concentration tests. The LC50 is determined by the Graphical, Spearman-Kärber, Trimmed Spearman-Kärber, or Probit Method. The NOAEC is determined by hypothesis testing.

11.1.2 Some states require tests consisting of a control and a single concentration of effluent with a pass/fail endpoint. Control survival must be 90% or greater for an acceptable test. The test "passes" if survival in the control and effluent concentration equals or exceeds 90%. The test "fails" if survival in the effluent is less than 90%, and is significantly different from control survival (which must be 90% or greater), as determined by hypothesis testing.

11.1.3 The toxicity of receiving (surface) water can be determined with (1) a paired test consisting of four replicates each of a suitable control and 100% surface water, or (2) a multi-concentration test. The results of the first type of test (100% receiving water and a control) are analyzed by hypothesis testing. The results of the second type of test may be analyzed by hypothesis testing or used to determine an LC50.

11.1.4 The data analysis methods recommended in this manual have been chosen primarily because they are (1) well-tested and well-documented, (2) applicable to most types of test data sets for which they are recommended, but still powerful, and (3) most easily understood by non-statisticians. Many other methods were considered in the selection process, and it is recognized that the methods selected are not the only possible methods of analysis of acute toxicity data.

11.1.5 ROLE OF THE STATISTICIAN

11.1.5.1 The use of the statistical methods described in this manual for routine data analysis does not require the assistance of a statistician. However, if the data appear unusual in any way, or fail to meet the necessary assumptions, a statistician should be consulted. The choice of a statistical method to analyze toxicity test data and the interpretation of the results of the analysis of the data can become problematic if there are anomalies in the data. Analysts who are not proficient in statistics are strongly advised to seek the assistance of a statistician before selecting alternative methods of analysis and using the results.

11.1.6 INDEPENDENCE, RANDOMIZATION, AND OUTLIERS

11.1.6.1 A critical assumption in the statistical analysis of toxicity data is statistical independence among observations. Statistical independence means that given knowledge of the true mean for a given concentration or control, knowledge of the error in any one actual observation would provide no information about the error in any other observation. One of the best ways to insure independence is to properly follow randomization procedures. The purpose of randomization is to avoid situations where test organisms are placed serially, by level of concentration, into test chambers, or where all replicates for a test concentration are located adjacent to one another, which could introduce bias into the test results.

11.1.6.2 Another area for potential bias of results is the presence of outliers. An outlier is an inconsistent or questionable data point that appears unrepresentative of the general trend exhibited by the majority of the data. Outliers may be detected by tabulation of the data, plotting, and by an analysis of the residuals. An explanation should be sought for any questionable data points. Without an explanation, data points should be discarded only with extreme caution. If there is no explanation, the statistical analysis should be performed both with and without the outlier, and the results of both analyses should be reported. For a discussion of techniques for evaluating outliers, see Draper and John (1981).

11.2 DETERMINATION OF THE LC50 FROM DEFINITIVE, MULTI-EFFLUENT-CONCENTRATION ACUTE TOXICITY TESTS

11.2.1 The method used to estimate the LC50 from multi-concentration acute toxicity tests depends on the shape of the tolerance distribution, and how well the effluent concentrations chosen characterize the cumulative distribution function for the tolerance distribution (i.e., the number of partial mortalities). A review of effluent acute toxicity data from the last 248 tests performed by the Ecological Support Branch, Environmental Services Division, EPA Region 4, indicated the following pattern in the number of partial mortalities: (1) no partial mortalities (all or nothing response) - 28%; (2) one partial mortality - 54%; (3) two or more partial mortalities - 16%; (4) LC50 occurring at one of the test concentrations - 2%.

11.2.1.1 Four methods for estimating the LC50 are presented below: the Graphical Method, the Spearman-Kärber Method, the Trimmed Spearman-Kärber Method, and the Probit Method. The analysis scheme is shown in Figure 6. Included in the presentation of each method is a description of the method, the requirements for the method, a description of the calculations involved in the method or a description of the computer program, and an example of the calculations.

11.2.1.2 The Probit Method, the Spearman-Kärber Method, and the Trimmed Spearman-Kärber Method are designed to produce LC50 values and associated 95% confidence intervals. It should be noted that software used to calculate point estimates occasionally may not provide associated 95% confidence intervals. This situation may arise when test data do not meet specific assumptions required by the statistical methods, when point estimates are outside of the test concentration range, and when specific limitations imposed by the software are encountered. USEPA (2000a) provides guidance on confidence intervals under these circumstances.

11.2.2 THE GRAPHICAL METHOD

11.2.2.1 Description

1. The Graphical Method is a mathematical procedure for calculating the LC50.
2. The procedure estimates the LC50 by linearly interpolating between points of a plot of observed percent mortality versus the base 10 logarithm (\log_{10}) of percent effluent concentration.
3. It does not provide a confidence interval for the LC50 estimate.
4. Use of the Graphical Method is only recommended when there are no partial mortalities.

11.2.2.2 Requirements

1. The only requirement for the Graphical Method is that the observed percent mortalities bracket the 50%.

DETERMINATION OF THE LC50 FROM A MULTI-EFFLUENT-CONCENTRATION ACUTE TOXICITY TEST

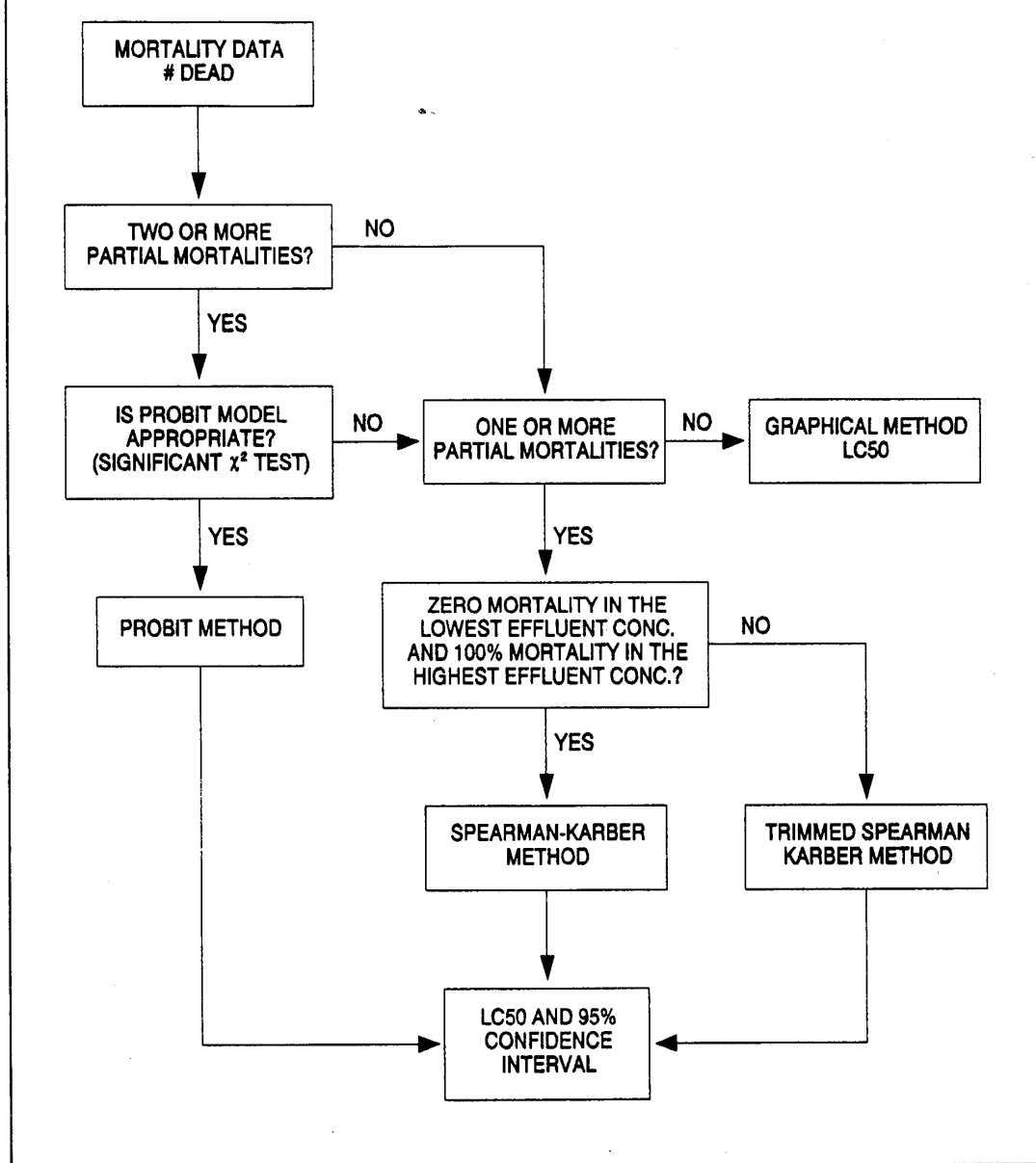

Figure 6. Flowchart for determination of the LC50 for multi-effluent-concentration acute toxicity tests.

11.2.2.3 General Procedure

1. Let p_0, p_1, \dots, p_k denote the observed proportion mortalities for the control and the k effluent concentrations. The first step is to smooth the p_i if they do not satisfy $p_0 \leq \dots \leq p_k$. The smoothing replaces any adjacent p_i 's that do not conform to $p_0 \leq \dots \leq p_k$, with their average. For example, if p_i is less than p_{i-1} , then:

$$p_{i-1}^s = p_i^s = (p_i + p_{i-1})/2$$

where: p_i^s = the smoothed observed proportion mortality for effluent concentration i .

2. Adjust the smoothed observed proportion mortality in each effluent concentration for mortality in the control group using Abbott's formula (Finney, 1971). The adjustment takes the form:

$$p_i^a = (p_i^s - p_0^s) / (1 - p_0^s)$$

where: p_0^s = the smoothed observed proportion mortality for the control.

3. Plot the smoothed, adjusted data on 2-cycle semi-log graph paper with the logarithmic axis (the y axis) used for percent effluent concentration and the linear axis (the x axis) used for observed percent mortality.
4. Locate the two points on the graph which bracket 50% mortality and connect them with a straight line.
5. On the scale for percent effluent concentration, read the value for the point where the plotted line and the 50% mortality line intersect. This value is the estimated LC50 expressed as a percent effluent concentration.

11.2.2.4 Example Calculation

1. All-or-nothing data (Graphical Method) in Table 20 are used in the calculations. Note that in this case, the data must be smoothed and adjusted for mortality in the controls.
2. To smooth the data, the observed proportion mortality for the control and the lower three effluent concentrations must be averaged. The smoothed observed proportion mortalities are as follows: 0.0125, 0.0125, 0.0125, 0.0125, 1.0, and 1.0.
3. The smoothed responses are adjusted for control mortality (see 11.2.2.3), where the smoothed response for the control (p_0^s) = 0.0125. The smoothed, adjusted response proportions for the effluent concentrations are as follows: 0.0, 0.0, 0.0, 1.0, and 1.0.
4. A plot of the smoothed, adjusted data is shown in Figure 7.
5. The two points on the graph which bracket the 50% mortality line (0% mortality at 25% effluent, and 100% mortality at 50% effluent) are connected with a straight line.
6. The point at which the plotted line intersects the 50% mortality line is the estimated LC50. The estimated LC50 = 35% effluent.

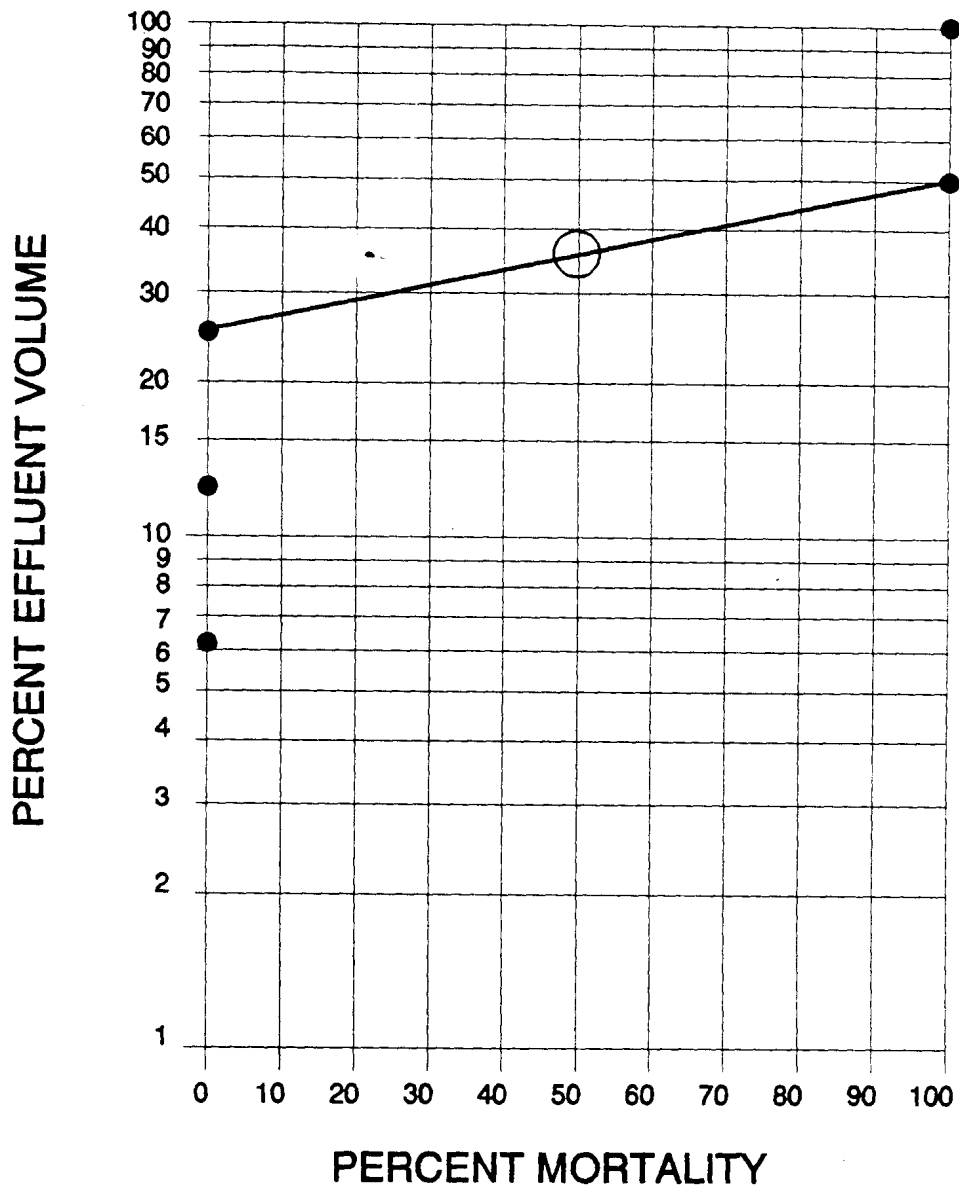

Figure 7. Plotted data and fitted line for graphical method, using all-or-nothing data.

TABLE 20. MORTALITY DATA (NUMBER OF DEAD ORGANISMS) FROM ACUTE TOXICITY TESTS USED IN EXAMPLES OF LC50 DETERMINATIONS (20 ORGANISMS IN THE CONTROL AND ALL TEST CONCENTRATIONS)

Effluent Conc. (%)	Method of Analysis			
	Graphical	Spearman-Karber	Trimmed Spearman-Karber	Probit
CONTROL	1	1	1	0
6.25%	0	1	0	0
12.5%	0	0	2	3
25.0%	0	0	0	9
50.0%	20	13	0	20
100.0%	20	20	16	20

11.2.3 THE SPEARMAN-KARBER METHOD

11.2.3.1 Description

1. The Spearman-Karber Method is a nonparametric statistical procedure for estimating the LC50 and the associated 95% confidence interval (Finney, 1978).
2. This procedure estimates the mean of the distribution of the \log_{10} of the tolerance. If the log tolerance distribution is symmetric, this estimate of the mean is equivalent to an estimate of the median of the log tolerance distribution.
3. If the response proportions are not monotonically non-decreasing with increasing concentration (constant or steadily increasing with concentration), the data are smoothed.
4. Abbott's procedure is used to "adjust" the test results for mortality occurring in the control.
5. Use of the Spearman-Karber Method is recommended when partial mortalities occur in the test solutions, but the data do not fit the Probit model.

11.2.3.2 Requirements

1. To calculate the LC50 estimate, the following must be true:
 - a. The smoothed adjusted proportion mortality for the lowest effluent concentration (not including the control) must be zero.
 - b. The smoothed adjusted proportion mortality for the highest effluent concentration must be one.
2. To calculate the 95% confidence interval for the LC50 estimate, one or more of the smoothed adjusted proportion mortalities must be between zero and one.

11.2.3.3 General Procedure

1. The first step in the estimation of the LC50 by the Spearman-Karber Method is to smooth the observed response proportions, p_i , if they do not satisfy $p_0 \leq \dots \leq p_k$ (see 11.2.2.3, Step 1).
2. Adjust the smoothed observed proportion mortality in each effluent concentration for mortality in the control group using Abbott's formula (see 11.2.2.3, Step 2).

- Plot the smoothed adjusted data on 2-cycle semi-log graph paper with the logarithmic axis (the y axis) used for percent effluent concentration and the linear axis (the x axis) used for observed percent mortality.
- Calculate the \log_{10} of the estimated LC50, m , as follows:

$$m = \sum_{i=1}^{k-1} \frac{(p_{i+1}^a - p_i^a) (X_i + X_{i+1})}{2}$$

where: p_i^a = the smoothed adjusted proportion mortality at concentration i
 X_i = the \log_{10} of concentration i
 k = the number of effluent concentrations tested, not including the control.

- Calculate the estimated variance of m as follows:

$$V(m) = \sum_{i=2}^{k-1} \frac{p_i^a (1 - p_i^a) (X_{i+1} - X_{i-1})^2}{4(n_i - 1)}$$

where: X_i = the \log_{10} of concentration i
 n_i = the number of organisms tested at effluent concentration i
 p_i^a = the smoothed adjusted observed proportion mortality at effluent concentration i
 k = the number of effluent concentrations tested, not including the control.

- Calculate the 95% confidence interval for m : $m \pm 2.0 \sqrt{V(m)}$
- The estimated LC50 and a 95% confidence interval for the estimated LC50 can be found by taking base₁₀ antilogs of the above values.
- With the exclusion of the plot in item 3, the above calculations can be carried out using the Trimmed Spearman-Kärber computer program mentioned in 11.2.4.3 and 11.2.4.4.

11.2.3.4 Example Calculation

- Mortality data from a definitive, multi-concentration, acute toxicity test are given in Table 20. Note that the data must be smoothed and adjusted for mortality in the controls.
- To smooth the data, the observed proportion mortality for the control, and the observed proportion mortality for the 6.25%, 12.5%, and 25% effluent concentrations must be averaged. The smoothed observed proportion mortalities are as follows: 0.025, 0.025, 0.025, 0.025, 0.65, and 1.00.
- To adjust the smoothed, observed proportion mortality in each effluent concentration for mortality in the control group, Abbott's formula must be used. After smoothing and adjusting, the proportion mortalities for the effluent concentrations are as follows: 0.000, 0.000, 0.000; 0.641, and 1.000.
- The data will not be plotted for this example. For an example of the plotting procedures, see 11.2.2.4.

5. The \log_{10} of the estimated LC50, m , is calculated as follows:

$$\begin{aligned} m &= [(0.0000 - 0.0000)(0.7959 + 1.0969)]/2 + \\ & \quad [(0.0000 - 0.0000)(1.0969 + 1.3979)]/2 + \\ & \quad [(0.6410 - 0.0000)(1.3979 + 1.6990)]/2 + \\ & \quad [(1.0000 - 0.6410)(1.6990 + 2.0000)]/2 \\ &= 1.656527 \end{aligned}$$

6. The estimated variance of m , $V(m)$, is calculated as follows:

$$\begin{aligned} V(m) &= (0.0000)(1.0000)(1.3979 - 0.7959)^2/4(19) + \\ & \quad (0.0000)(1.0000)(1.6990 - 1.0969)^2/4(19) + \\ & \quad (0.6410)(0.3590)(2.0000 - 1.3979)^2/4(19) \\ &= 0.0010977 \end{aligned}$$

7. The 95% confidence interval for m is calculated as follows:

$$1.656527 \pm 2 \sqrt{0.0010977} = (1.5902639, 1.7227901)$$

8. The estimated LC50 is as follows: $\text{antilog}(1.656527) = 45.3\%$.

9. The upper limit of the 95% confidence interval for the estimated LC50 is as follows:

$$\text{antilog}(1.7227901) = 52.8\%$$

10. The lower limit of the 95% confidence interval for the estimated LC50 is as follows:

$$\text{antilog}(1.5902639) = 38.9\%$$

11.2.4 THE TRIMMED SPEARMAN-KARBER METHOD

11.2.4.1 Description

1. The Trimmed Spearman-Karber Method is a modification of the Spearman-Karber nonparametric statistical procedure for estimating the LC50 and the associated 95% confidence interval (Hamilton, et al, 1977).
2. This procedure estimates the trimmed mean of the distribution of the \log_{10} of the tolerance. If the log tolerance distribution is symmetric, this estimate of the trimmed mean is equivalent to an estimate of the median of the log tolerance distribution.
3. Use of the Trimmed Spearman-Karber Method is only appropriate when the requirements for the Probit Method and the Spearman-Karber Method are not met.

11.2.4.2 Requirements

1. To calculate the LC50 estimate with the Trimmed Spearman-Karber Method, the smoothed, adjusted, observed proportion mortalities must bracket 0.5.
2. To calculate a confidence interval for the LC50 estimate, one or more of the smoothed, adjusted, observed proportion mortalities must be between zero and one.

11.2.4.3 General Procedure

1. Smooth the observed proportion mortalities as described in 11.2.2.3, Step 1.
2. Adjust the smoothed observed proportion mortality in each effluent concentration for mortality in the control group using Abbott's formula (see 11.2.2.3, Step 2).
3. Plot the smoothed, adjusted data as described in 11.2.2.3, Step 3.
4. Calculate the amount of trim to use in the estimation of the LC50 as follows:

$$\text{Trim} = \max(p_1^a, 1 - p_k^a)$$

where: p_1^a = the smoothed, adjusted proportion mortality for the lowest effluent concentration, exclusive of the control.
 p_k^a = the smoothed, adjusted proportion mortality for the highest effluent concentration.
 k = the number of effluent concentrations, exclusive of the control.

5. Due to the intensive nature of the calculation for the estimated LC50 and the calculation for the associated 95% confidence interval using the Trimmed Spearman-Kärber Method, it is recommended that the data be analyzed by computer.
6. A computer program which estimates the LC50 and associated 95% confidence interval using the Trimmed-Karber Method, can be obtained through the Environmental Monitoring and Support Laboratory (EMSL), 26 W. Martin Luther King Drive, Cincinnati, OH 45268. The program can be obtained from EMSL-Cincinnati by sending a diskette with a written request to the above address.
7. The modified program automatically performs the following functions:
 - a. Smoothing.
 - b. Adjustment for mortality in the control.
 - c. Calculation of the trim.
 - d. Calculation of the LC50.
 - e. Calculation of the associated 95% confidence interval.

11.2.4.4 Example Calculation Using the Computer Program

1. Data from Table 20 are used to illustrate the analysis using the Trimmed Spearman-Kärber program.
2. The program requests the following input (see Figure 8):
 - a. Output destination (D = disk file or P = printer).
 - b. Title for output.
 - c. Control data.
 - d. Data for each toxicant concentration.

TRIMMED SPEARMAN-KARBER METHOD. VERSION 1.5

ENTER DATE OF TEST:

08/19/93

ENTER TEST NUMBER:

1

WHAT IS TO BE ESTIMATED?

(ENTER "L" FOR LC50 AND "E" FOR EC50)

L

ENTER TEST SPECIES NAME:

Fathead minnow

ENTER TOXICANT NAME:

Effluent

ENTER UNITS FOR EXPOSURE CONCENTRATION OF TOXICANT:

%

ENTER THE NUMBER OF INDIVIDUALS IN THE CONTROL:

20

ENTER THE NUMBER OF MORTALITIES IN THE CONTROL:

1

ENTER THE NUMBER OF CONCENTRATIONS

(NOT INCLUDING THE CONTROL; MAX = 10):

5

ENTER THE 5 EXPOSURE CONCENTRATIONS (IN INCREASING ORDER):

6.25 12.5 25 50 100

ARE THE NUMBER OF INDIVIDUALS AT EACH EXPOSURE CONCENTRATION EQUAL(Y/N)?

Y

ENTER THE NUMBER OF INDIVIDUALS AT EACH EXPOSURE CONCENTRATION:

20

ENTER UNITS FOR DURATION OF EXPERIMENT

(ENTER "H" FOR HOURS, "D" FOR DAYS, ETC.):

H

ENTER DURATION OF TEST:

96

ENTER THE NUMBER OF MORTALITIES AT EACH EXPOSURE CONCENTRATION:

0 2 0 0 16

WOULD YOU LIKE THE AUTOMATIC TRIM CALCULATION(Y/N)?

Y

Figure 8. Example of input for computer program for Trimmed Spearman-Karber Method.

3. The program output includes the following (see Figure 9):
 - a. A table of the concentrations tested, number of organisms exposed, and mortalities.
 - b. The amount of trim used in the calculation.
 - c. The estimated LC50 and the associated 95% confidence interval.
4. The analysis results for this example are as follows:
 - a. The observed proportion mortalities smoothed and adjusted for mortality in the control.
 - b. The amount of trim used to calculate the estimate:

$$\text{trim} = \max \{0.00, 0.205\} = 0.205.$$

- c. The estimate of the LC50 is 77.1% with a 95% confidence interval of (69.7%, 85.3%).

11.2.5 THE PROBIT METHOD

11.2.5.1 Description

1. The Probit Method is a parametric statistical procedure for estimating the LC50 and the associated 95% confidence interval (Finney, 1978).
2. The analysis consists of transforming the observed proportion mortalities with a probit transformation, and transforming the effluent concentrations to \log_{10} .
3. Given the assumption of normality for the \log_{10} of the tolerances, the relationship between the transformed variables mentioned above is approximately linear.
4. This relationship allows estimation of linear regression parameters, using an iterative approach.
5. The estimated LC50 and associated confidence interval are calculated from the estimated linear regression parameters.

11.2.5.2 Requirements

1. To obtain a reasonably precise estimate of the LC50 with the Probit Method, the observed proportion mortalities must bracket 0.5.
2. The \log_{10} of the tolerance is assumed to be normally distributed.
3. To calculate the LC50 estimate and associated 95% confidence interval, two or more of the observed proportion mortalities must be between zero and one.

11.2.5.3 General Procedure

1. Due to the intensive nature of the calculations for the estimated LC50 and associated 95% confidence interval using the Probit Method, it is recommended that the data be analyzed by a computer program.
2. A machine-readable, compiled, version of a computer program to estimate the LC1 and LC50 and associated 95% confidence intervals using the Probit Method can be obtained from EMSL-Cincinnati by sending a diskette with a written request to the Environmental Monitoring Systems Laboratory, 26 W. Martin Luther King Drive, Cincinnati, OH 45268.

TRIMMED SPEARMAN-KARBER METHOD, VERSION 1.5

DATE: 08/18/93 TEST NUMBER: 1 DURATION: 96 H
TOXICANT: Effluent
SPECIES: Fathead minnow

RAW DATA: Concentration --- ---- (%)	Number Exposed	Mortalities
.00	20	1
6.25	20	0
12.50	20	2
25.00	20	0
50.00	20	0
100.00	20	16

SPEARMAN-KARBER TRIM: 20.51%

SPEARMAN-KARBER ESTIMATES: LC50: 77.11
95% Lower Confidence: 69.74
95% Upper Confidence: 85.26

NOTE: MORTALITY PROPORTIONS WERE NOT MONOTONICALLY INCREASING.
ADJUSTMENTS WERE MADE PRIOR TO SPEARMAN-KARBER ESTIMATION.

WOULD YOU LIKE TO HAVE A COPY SENT TO THE PRINTER(Y/N)?

Figure 9. Example of output from computer program for Trimmed Spearman-Karber Method.

11.2.5.4 Example Using the Computer Program

1. Data from Table 20 are used to illustrate the operation of the Probit program for calculating the LC50 and the associated 95% confidence interval.
2. The program begins with a request for the following initial input (see Figure 10):
 - a. Desired output of abbreviated (A) or full (F) output?
 - b. Output designation (P = printer, D = disk file).
 - c. Title for the output.
 - d. Control data.
 - e. The number of exposure concentrations
 - f. Data for each toxicant concentration
3. The program output includes the following (see Figure 11):
 - a. A table of the observed proportion responding, and the proportion responding adjusted for controls.
 - b. The calculated chi-squared statistic for heterogeneity and the tabular value. This test is one indicator of how well the data fit the model. The program will issue a warning when the test indicates that the data do not fit the model.
 - c. The estimated LC50 and 95% confidence limits.
 - d. A plot of the fitted regression line with observed data overlaid on the plot.
4. The results of the data analysis for this example are as follows:
 - a. The observed proportion mortalities were not adjusted for mortality in the control.
 - b. The test for heterogeneity was not significant (the calculated Chi-square was less than the tabular value), thus the Probit Method appears to be appropriate for this data.
 - c. The estimate of the LC50 is 22.9% with a 95% confidence interval of (18.8%, 27.8%).

11.3 DETERMINATION OF NO-OBSERVED-ADVERSE-EFFECT CONCENTRATION (NOAEC) FROM MULTI-CONCENTRATION TESTS, AND DETERMINATION OF PASS OR FAIL (PASS/FAIL) FOR SINGLE-CONCENTRATION (PAIRED) TESTS

11.3.1 Determination of the No-Observed-Adverse-Effect Concentration (NOAEC), for multi-concentration toxicity tests, and pass or fail (Pass/Fail) for single-concentration toxicity tests is accomplished using hypothesis testing. The NOAEC is the lowest concentration at which survival is not significantly different from the control. In Pass/Fail tests, the objective is to determine if the survival in the single treatment (effluent or receiving water) is significantly different from the control survival.

11.3.2 The first step in these analyses is to transform the responses, expressed as the proportion surviving, by the arc-sine-square-root transformation (Figures 12 and 13). The arc-sine-square-root transformation is commonly used on proportionality data to stabilize the variance and satisfy the normality requirement. Shapiro Wilk's test may be used to test the normality assumption.

11.3.3 If the data do not meet the assumption of normality and there are four or more replicates per group, then the non-parametric test, Wilcoxon Rank Sum Test, can be used to analyze the data.

11.3.4 If the data meet the assumption of normality, the F test for equality of variances is used to test the homogeneity of variance assumption. Failure of the homogeneity of variance assumption leads to the use of a modified t test, where the pooled variance estimate is adjusted for unequal variance, and the degrees of freedom for the test are adjusted.

EPA PROBIT ANALYSIS PROGRAM
 USED FOR CALCULATING LC/EC VALUES
 Version 1.5

Do you wish abbreviated (A) of full (F) output? A
 Output to printer or disk file (P / D)? P
 Title ? PROBIT EXAMPLE

Number of responders in the control group = ? 0
 Number of exposure concentrations, exclusive of controls ? 5

Input data starting with the lowest exposure concentration

Concentration = ? 6.25
 Number responding = ? 0
 Number exposed = ? 20

Concentration = ? 12.5
 Number responding = ? 3
 Number exposed = ? 20

Concentration = ? 25
 Number responding = ? 9
 Number exposed = ? 20

Concentration = ? 50
 Number responding = ? 20
 Number exposed = ? 20

Concentration = ? 100
 Number responding = ? 20
 Number exposed = ? 20

Number	Conc.	Number Resp.	Number Exposed
1	6.2500	0	20
2	12.5000	3	20
3	25.0000	9	20
4	50.0000	20	20
5	100.0000	20	20

Do you wish to modify your data ? n
 The control response rate = 0
 Do you wish to modify it? n

Figure 10. Example of input for computer program for Probit Method.

EPA PROBIT ANALYSIS PROGRAM
 USED FOR CALCULATING LC/EC VALUES
 Version 1.5

PROBIT EXAMPLE

Conc.	Number Exposed	Number Resp.	Observed Proportion Responding	Proportion Responding Adjusted for Controls
6.2500	20	0	0.000	0.000
12.5000	20	3	0.1500	0.1500
25.0000	20	9	0.4500	0.4500
50.0000	20	20	1.0000	1.0000
100.0000	20	20	1.0000	1.0000

Chi - Square for Heterogeneity (calculated) = 3.076

Chi - Square for Heterogeneity (tabular value at 0.05 level) = 7.815

PROBIT EXAMPLE

Estimated LC/EC Values and Confidence Limits

Point	Exposure Conc.	Lower 95% Confidence Limits	Upper Limits
LC/EC 1.00	7.924	4.147	10.959
LC/EC 50.00	22.872	18.787	27.846

Figure 11. Example of output for computer program for Probit Method.

DETERMINATION OF PASS OR FAIL FROM A SINGLE -EFFLUENT-CONCENTRATION ACUTE TOXICITY TEST

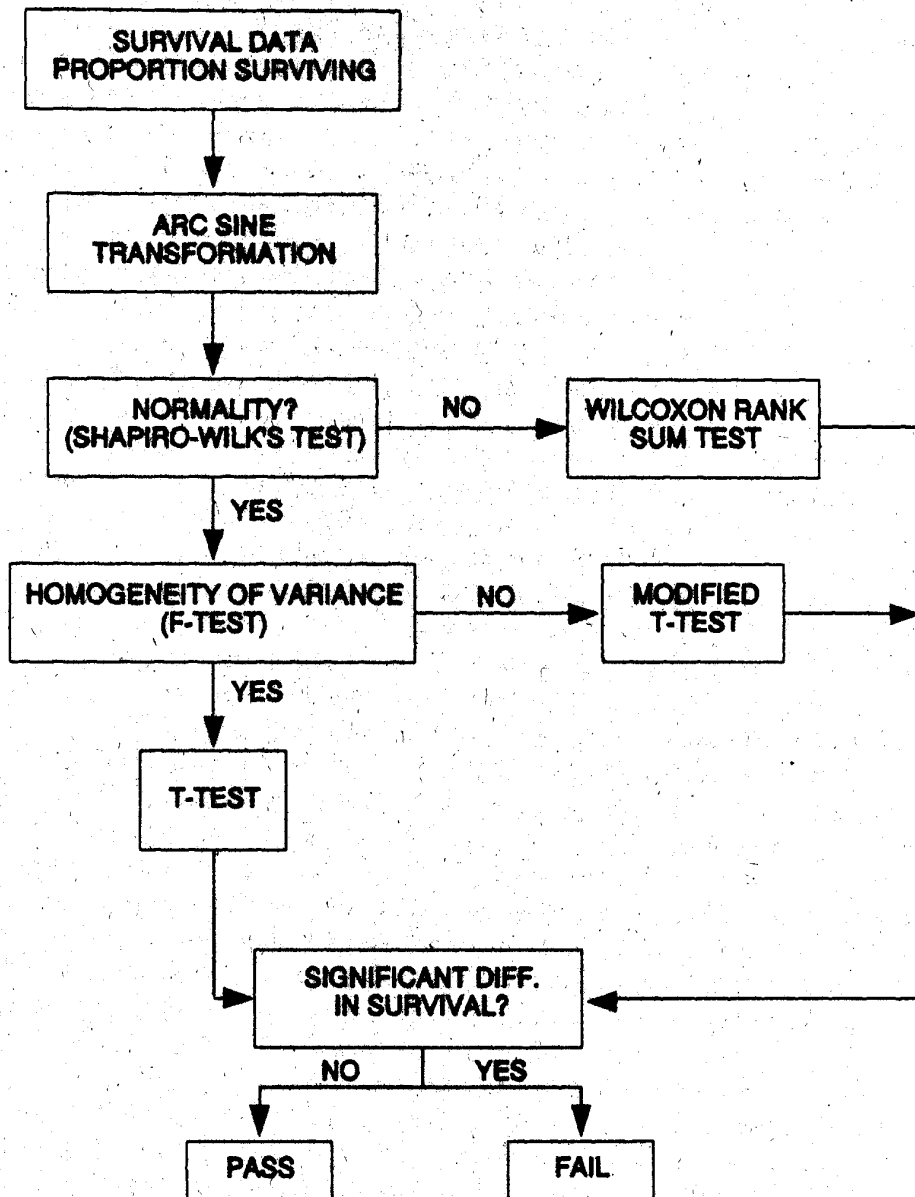

Figure 12. Flowchart for analysis of single-effluent concentration test data.

DETERMINATION OF THE NOAEC FROM A MULTI-EFFLUENT-CONCENTRATION ACUTE TOXICITY TEST

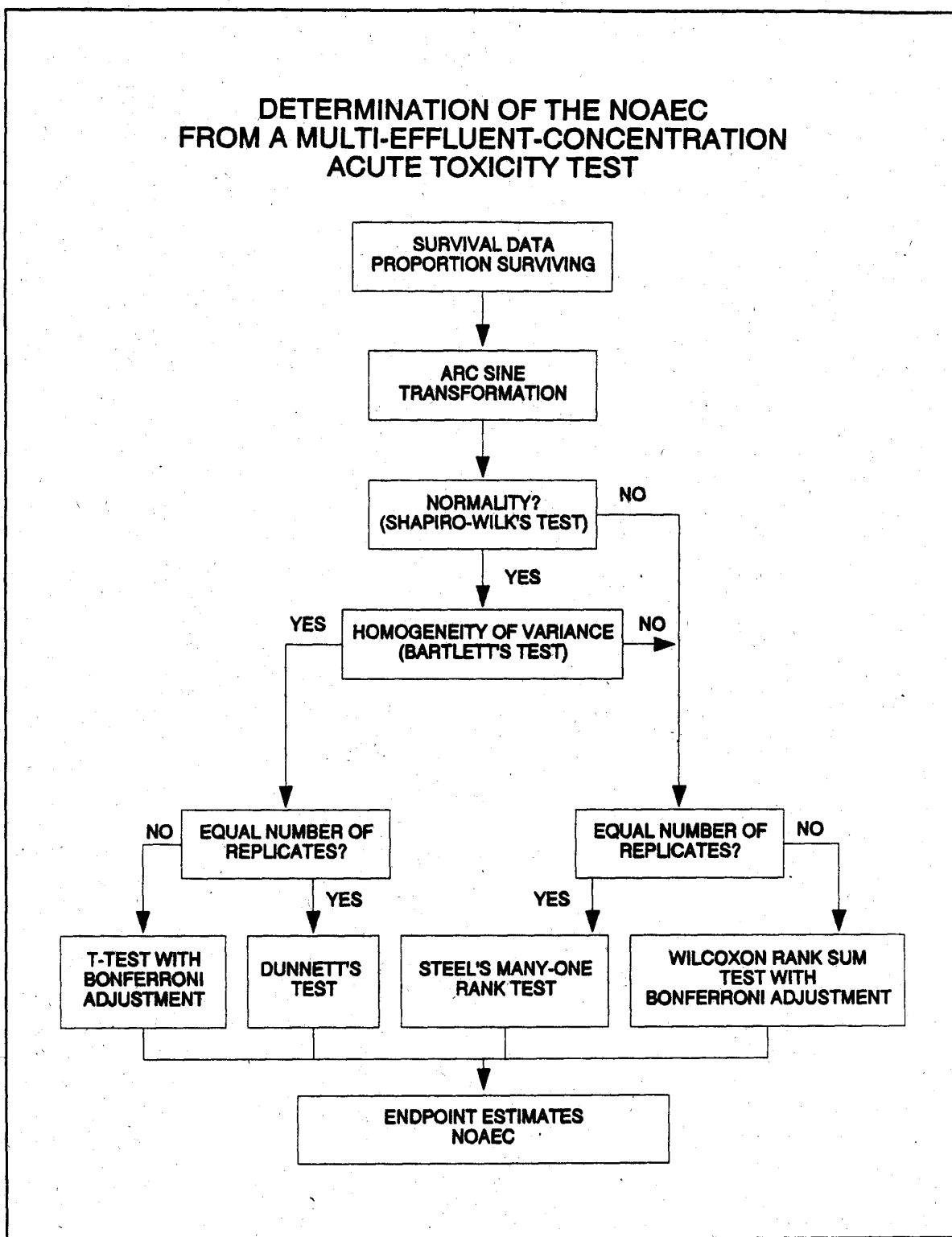

Figure 13. Flowchart for analysis of multi-effluent-concentration test data.

11.3.5 GENERAL PROCEDURE

11.3.5.1 Arc Sine Square Root Transformation

11.3.5.1.1 The arc sine square root transformation consists of determining the angle (in radians) represented by a sine value. In this transformation, the proportion surviving is taken as the sine value, the square root of the sine value is calculated, and the angle (in radians) for the square root of the sine value is determined. Whenever the proportion surviving is 0 or 1, a special modification of the transformation must be used (Bartlett, 1937). Illustrations of the arc sine square root transformation and modification are provided below.

1. Calculate the response proportion (RP) for each replicate within a group, where:

$$RP = (\text{number of surviving organisms})/(\text{number exposed})$$

2. Transform each RP to arc sine, as follows.
 - a. For RPs greater than zero or less than one:

$$\text{Angle (in radians)} = \text{arc sine} \sqrt{RP}$$

- b. Modification of the arc sine when $RP = 0$.

$$\text{Angle (in radians)} = \text{arc sine} \sqrt{\frac{1}{4n}}$$

where n = number animals/treatment rep.

- c. Modification of the arc sine when $RP = 1.0$.

$$\text{Angle} = 1.5708 \text{ radians} - (\text{radians for } RP=0)$$

11.3.5.2 Shapiro Wilk's Test

11.3.5.2.1 After the data have been transformed, test the assumption of normality using Shapiro Wilk's test. The test statistic, W , is obtained by dividing the square of an appropriate linear combination of the sample order statistics by the usual symmetric estimate of variance (D). The calculated W must be greater than zero and less than or equal to one. This test is recommended for a sample size of 50 or less, and there must be more than two replicates per concentration for the test to be valid.

1. To calculate W , first center the observations by subtracting the mean of all the observations within a concentration from each observation in that concentration.
2. Calculate the denominator, D , of the test statistic:

$$D = \sum_{i=1}^n (X_i - \bar{X})^2$$

where: X_i = the i th centered observation

\bar{X} = the overall mean of the centered observations.

- Order the centered observations from smallest to largest.

$$X^{(1)} \leq X^{(2)} \leq \dots \leq X^{(i)}$$

where: $X^{(i)}$ denotes the i th ordered observation.

- From Table 21, for the number of observations, n , obtain the coefficients a_1, a_2, \dots, a_k , where k is $n/2$ if n is even, and $(n - 1)/2$ if n is odd.
- Compute the test statistic, W , as follows:

$$W = \frac{1}{D} \left[\sum_{i=1}^k a_i (X^{(n-i+1)} - X^{(1)}) \right]^2$$

11.3.5.2.2 The decision rule for the test is to compare the critical value from Table 22 to the computed W . If the computed value is less than the critical value, conclude that the data are not normally distributed.

11.3.5.3 F Test

11.3.5.3.1 The F test for equality of variances is used to test the homogeneity of variance assumption. When conducting the F test, the alternative hypothesis of interest is that the variances are not equal.

11.3.5.3.2 To make the two-tailed F test at the 0.01 level of significance, put the larger of the two sample variances in the numerator of F.

$$F = \frac{S_1^2}{S_2^2} \text{ where } S_1^2 > S_2^2$$

11.3.5.3.3 Compare the calculated F with the 0.005 level of a tabulated F value with n_1-1 and n_2-1 degrees of freedom, where n_1 and n_2 are the number of replicates for each of the two groups (Snedecor and Cochran, 1980). If the calculated F value is less than or equal to the tabulated F, conclude that the variances of the two groups are equal.

11.3.5.4 T Test

11.3.5.4.1 If the variances for the two groups are found to be statistically equivalent, then the equal variance t test is the appropriate test.

TABLE 21. COEFFICIENTS FOR THE SHAPIRO WILK'S TEST (CONOVER, 1980)

iⁿ	2	3	4	5	6	7	8	9	10
1	0.7071	0.7071	0.6872	0.6646	0.6431	0.6233	0.6052	0.5888	0.5739
2	-	0.0000	0.1667	0.2413	0.2806	0.3031	0.3164	0.3244	0.3291
3	-	-	-	0.0000	0.0875	0.1401	0.1743	0.1976	0.2141
4	-	-	-	-	-	0.0000	0.0561	0.0947	0.1224
5	-	-	-	-	-	-	-	0.0000	0.0399

iⁿ	11	12	13	14	15	16	17	18	19	20
1	0.5601	0.5475	0.5359	0.5251	0.5150	0.5056	0.4968	0.4886	0.4808	0.4734
2	0.3315	0.3325	0.3325	0.3318	0.3306	0.3290	0.3273	0.3253	0.3232	0.3211
3	0.2260	0.2347	0.2412	0.2460	0.2495	0.2521	0.2540	0.2553	0.2561	0.2565
4	0.1429	0.1586	0.1707	0.1802	0.1878	0.1939	0.1988	0.2027	0.2059	0.2085
5	0.0695	0.0922	0.1099	0.1240	0.1353	0.1447	0.1524	0.1587	0.1641	0.1686
6	0.0000	0.0303	0.0539	0.0727	0.0880	0.1005	0.1109	0.1197	0.1271	0.1334
7	-	-	0.0000	0.0240	0.0433	0.0593	0.0725	0.0837	0.0932	0.1013
8	-	-	-	-	0.0000	0.0196	0.0359	0.0496	0.0612	0.0711
9	-	-	-	-	-	-	0.0000	0.0163	0.0303	0.0422
10	-	-	-	-	-	-	-	-	0.0000	0.0140

iⁿ	21	22	23	24	25	26	27	28	29	30
1	0.4643	0.4590	0.4542	0.4493	0.4450	0.4407	0.4366	0.4328	0.4291	0.4254
2	0.3185	0.3156	0.3126	0.3098	0.3069	0.3043	0.3018	0.2992	0.2968	0.2944
3	0.2578	0.2571	0.2563	0.2554	0.2543	0.2533	0.2522	0.2510	0.2499	0.2487
4	0.2119	0.2131	0.2139	0.2145	0.2148	0.2151	0.2152	0.2151	0.2150	0.2148
5	0.1736	0.1764	0.1787	0.1807	0.1822	0.1836	0.1848	0.1857	0.1864	0.1870
6	0.1399	0.1443	0.1480	0.1512	0.1539	0.1563	0.1584	0.1601	0.1616	0.1630
7	0.1092	0.1150	0.1201	0.1245	0.1283	0.1316	0.1346	0.1372	0.1395	0.1415
8	0.0804	0.0878	0.0941	0.0997	0.1046	0.1089	0.1128	0.1162	0.1192	0.1219
9	0.0530	0.0618	0.0696	0.0764	0.0823	0.0876	0.0923	0.0965	0.1002	0.1036
10	0.0263	0.0368	0.0459	0.0539	0.0610	0.0672	0.0728	0.0778	0.0822	0.0862
11	0.0000	0.0122	0.0228	0.0321	0.0403	0.0476	0.0540	0.0598	0.0650	0.0697
12	-	-	0.0000	0.0107	0.0200	0.0284	0.0358	0.0424	0.0483	0.0537
13	-	-	-	-	0.0000	0.0094	0.0178	0.0253	0.0320	0.0381
14	-	-	-	-	-	-	0.0000	0.0084	0.0159	0.0227
15	-	-	-	-	-	-	-	-	0.0000	0.0076

TABLE 21. COEFFICIENTS FOR THE SHAPIRO WILK'S TEST (CONTINUED)

i^n	31	32	33	34	35	36	37	38	39	40
1	0.4220	0.4188	0.4156	0.4127	0.4096	0.4068	0.4040	0.4015	0.3989	0.3964
2	0.2921	0.2898	0.2876	0.2854	0.2834	0.2813	0.2794	0.2774	0.2755	0.2737
3	0.2475	0.2462	0.2451	0.2439	0.2427	0.2415	0.2403	0.2391	0.2380	0.2368
4	0.2145	0.2141	0.2137	0.2132	0.2127	0.2121	0.2116	0.2110	0.2104	0.2098
5	0.1874	0.1878	0.1880	0.1882	0.1883	0.1883	0.1883	0.1881	0.1880	0.1878
6	0.1641	0.1651	0.1660	0.1667	0.1673	0.1678	0.1683	0.1686	0.1689	0.1691
7	0.1433	0.1449	0.1463	0.1475	0.1487	0.1496	0.1505	0.1513	0.1520	0.1526
8	0.1243	0.1265	0.1284	0.1301	0.1317	0.1331	0.1344	0.1356	0.1366	0.1376
9	0.1066	0.1093	0.1118	0.1140	0.1160	0.1179	0.1196	0.1211	0.1225	0.1237
10	0.0899	0.0931	0.0961	0.0988	0.1013	0.1036	0.1056	0.1075	0.1092	0.1108
11	0.0739	0.0777	0.0812	0.0844	0.0873	0.0900	0.0924	0.0947	0.0967	0.0986
12	0.0585	0.0629	0.0669	0.0706	0.0739	0.0770	0.0798	0.0824	0.0848	0.0870
13	0.0435	0.0485	0.0530	0.0572	0.0610	0.0645	0.0677	0.0706	0.0733	0.0759
14	0.0289	0.0344	0.0395	0.0441	0.0484	0.0523	0.0559	0.0592	0.0622	0.0651
15	0.0144	0.0206	0.0262	0.0314	0.0361	0.0404	0.0444	0.0481	0.0515	0.0546
16	0.0000	0.0068	0.0131	0.0187	0.0239	0.0287	0.0331	0.0372	0.0409	0.0444
17	-	-	0.0000	0.0062	0.0119	0.0172	0.0220	0.0264	0.0305	0.0343
18	-	-	-	-	0.0000	0.0057	0.0110	0.0158	0.0203	0.0244
19	-	-	-	-	-	-	0.0000	0.0053	0.0101	0.0146
20	-	-	-	-	-	-	-	-	0.0000	0.0049

i^n	41	42	43	44	45	46	47	48	49	50
1	0.3940	0.3917	0.3894	0.3872	0.3850	0.3830	0.3808	0.3789	0.3770	0.3751
2	0.2719	0.2701	0.2684	0.2667	0.2651	0.2635	0.2620	0.2604	0.2589	0.2574
3	0.2357	0.2345	0.2334	0.2323	0.2313	0.2302	0.2291	0.2281	0.2271	0.2260
4	0.2091	0.2085	0.2078	0.2072	0.2065	0.2058	0.2052	0.2045	0.2038	0.2032
5	0.1876	0.1874	0.1871	0.1868	0.1865	0.1862	0.1859	0.1855	0.1851	0.1847
6	0.1693	0.1694	0.1695	0.1695	0.1695	0.1695	0.1695	0.1693	0.1692	0.1691
7	0.1531	0.1535	0.1539	0.1542	0.1545	0.1548	0.1550	0.1551	0.1553	0.1554
8	0.1384	0.1392	0.1398	0.1405	0.1410	0.1415	0.1420	0.1423	0.1427	0.1430
9	0.1249	0.1259	0.1269	0.1278	0.1286	0.1293	0.1300	0.1306	0.1312	0.1317
10	0.1123	0.1136	0.1149	0.1160	0.1170	0.1180	0.1189	0.1197	0.1205	0.1212
11	0.1004	0.1020	0.1035	0.1049	0.1062	0.1073	0.1085	0.1095	0.1105	0.1113
12	0.0891	0.0909	0.0927	0.0943	0.0959	0.0972	0.0986	0.0998	0.1010	0.1020
13	0.0782	0.0804	0.0824	0.0842	0.0860	0.0876	0.0892	0.0906	0.0919	0.0932
14	0.0677	0.0701	0.0724	0.0745	0.0765	0.0783	0.0801	0.0817	0.0832	0.0846
15	0.0575	0.0602	0.0628	0.0651	0.0673	0.0694	0.0713	0.0731	0.0748	0.0764
16	0.0476	0.0506	0.0534	0.0560	0.0584	0.0607	0.0628	0.0648	0.0667	0.0685
17	0.0379	0.0411	0.0442	0.0471	0.0497	0.0522	0.0546	0.0568	0.0588	0.0608
18	0.0283	0.0318	0.0352	0.0383	0.0412	0.0439	0.0465	0.0489	0.0511	0.0532
19	0.0188	0.0227	0.0263	0.0296	0.0328	0.0357	0.0385	0.0411	0.0436	0.0459
20	0.0094	0.0136	0.0175	0.0211	0.0245	0.0277	0.0307	0.0335	0.0361	0.0386
21	0.0000	0.0045	0.0087	0.0126	0.0163	0.0197	0.0229	0.0259	0.0288	0.0314
22	-	-	0.0000	0.0042	0.0081	0.0118	0.0153	0.0185	0.0215	0.0244
23	-	-	-	-	0.0000	0.0039	0.0076	0.0111	0.0143	0.0174
24	-	-	-	-	-	-	0.0000	0.0037	0.0071	0.0104
25	-	-	-	-	-	-	-	-	0.0000	0.0035

TABLE 22. QUANTILES OF THE SHAPIRO WILK'S TEST STATISTIC¹ (CONOVER, 1980)

n	0.01	0.02	0.05	0.10	0.50	0.90	0.95	0.98	0.99
3	0.753	0.756	0.767	0.789	0.959	0.998	0.999	1.000	1.000
4	0.687	0.707	0.748	0.792	0.935	0.987	0.992	0.996	0.997
5	0.686	0.715	0.762	0.806	0.927	0.979	0.986	0.991	0.993
6	0.713	0.743	0.788	0.826	0.927	0.974	0.981	0.986	0.989
7	0.730	0.760	0.803	0.838	0.928	0.972	0.979	0.985	0.988
8	0.749	0.778	0.818	0.851	0.932	0.972	0.978	0.984	0.987
9	0.764	0.791	0.829	0.859	0.935	0.972	0.978	0.984	0.986
10	0.781	0.806	0.842	0.869	0.938	0.972	0.978	0.983	0.986
11	0.792	0.817	0.850	0.876	0.940	0.973	0.979	0.984	0.986
12	0.805	0.828	0.859	0.883	0.943	0.973	0.979	0.984	0.986
13	0.814	0.837	0.866	0.889	0.945	0.974	0.979	0.984	0.986
14	0.825	0.846	0.874	0.895	0.947	0.975	0.980	0.984	0.986
15	0.835	0.855	0.881	0.901	0.950	0.975	0.980	0.984	0.987
16	0.844	0.863	0.887	0.906	0.952	0.976	0.981	0.985	0.987
17	0.851	0.869	0.892	0.910	0.954	0.977	0.981	0.985	0.987
18	0.858	0.874	0.897	0.914	0.956	0.978	0.982	0.986	0.988
19	0.863	0.879	0.901	0.917	0.957	0.978	0.982	0.986	0.988
20	0.868	0.884	0.905	0.920	0.959	0.979	0.983	0.986	0.988
21	0.873	0.888	0.908	0.923	0.960	0.980	0.983	0.987	0.989
22	0.878	0.892	0.911	0.926	0.961	0.980	0.984	0.987	0.989
23	0.881	0.895	0.914	0.928	0.962	0.981	0.984	0.987	0.989
24	0.884	0.898	0.916	0.930	0.963	0.981	0.984	0.987	0.989
25	0.888	0.901	0.918	0.931	0.964	0.981	0.985	0.988	0.989
26	0.891	0.904	0.920	0.933	0.965	0.982	0.985	0.988	0.989
27	0.894	0.906	0.923	0.935	0.965	0.982	0.985	0.988	0.990
28	0.896	0.908	0.924	0.936	0.966	0.982	0.985	0.988	0.990
29	0.898	0.910	0.926	0.937	0.966	0.982	0.985	0.988	0.990
30	0.900	0.912	0.927	0.939	0.967	0.983	0.985	0.988	0.990
31	0.902	0.914	0.929	0.940	0.967	0.983	0.986	0.988	0.990
32	0.904	0.915	0.930	0.941	0.968	0.983	0.986	0.988	0.990
33	0.906	0.917	0.931	0.942	0.968	0.983	0.986	0.989	0.990
34	0.908	0.919	0.933	0.943	0.969	0.983	0.986	0.989	0.990
35	0.910	0.920	0.934	0.944	0.969	0.984	0.986	0.989	0.990
36	0.912	0.922	0.935	0.945	0.970	0.984	0.986	0.989	0.990
37	0.914	0.924	0.936	0.946	0.970	0.984	0.987	0.989	0.990
38	0.916	0.925	0.938	0.947	0.971	0.984	0.987	0.989	0.990
39	0.917	0.927	0.939	0.948	0.971	0.984	0.987	0.989	0.991
40	0.919	0.928	0.940	0.949	0.972	0.985	0.987	0.989	0.991
41	0.920	0.929	0.941	0.950	0.972	0.985	0.987	0.989	0.991
42	0.922	0.930	0.942	0.951	0.972	0.985	0.987	0.989	0.991
43	0.923	0.932	0.943	0.951	0.973	0.985	0.987	0.990	0.991
44	0.924	0.933	0.944	0.952	0.973	0.985	0.987	0.990	0.991
45	0.926	0.934	0.945	0.953	0.973	0.985	0.988	0.990	0.991
46	0.927	0.935	0.945	0.953	0.974	0.985	0.988	0.990	0.991
47	0.928	0.936	0.946	0.954	0.974	0.985	0.988	0.990	0.991
48	0.929	0.937	0.947	0.954	0.974	0.985	0.988	0.990	0.991
49	0.929	0.937	0.947	0.955	0.974	0.985	0.988	0.990	0.991
50	0.930	0.938	0.947	0.955	0.974	0.985	0.988	0.990	0.991

11.3.5.4.2 Calculate the following test statistic:

$$t_i = \frac{\bar{X}_1 - \bar{X}_2}{S_p \sqrt{\frac{1}{n_1} + \frac{1}{n_2}}}$$

where: \bar{X}_1 = Mean for the control

\bar{X}_2 = Mean for the effluent concentration

$$S_p = \frac{\sqrt{(n_1-1)S_1^2 + (n_2-1)S_2^2}}{n_1+n_2-2}$$

S_1^2 = Estimate of the variance for the control

S_2^2 = Estimate of the variance for the effluent concentration

n_1 = Number of replicates for the control

n_2 = Number of replicates for the effluent concentration

11.3.5.4.3 Since we are concerned with a decrease in survival from the control, a one-tailed test is appropriate. Thus, compare the calculated t with a critical t, where the critical t is at the 5% level of significance with n_1+n_2-2 degrees of freedom. If the calculated t exceeds the critical t, the mean responses are declared different.

11.3.5.5 Modified T Test

11.3.5.5.1 If the F test for equality of variance fails, the t test is still a valid test. However, the denominator and the degrees of freedom for the test are modified.

11.3.5.5.2 The t statistic, with the modification for the denominator, is calculated as follows:

$$t = \frac{\bar{X}_1 - \bar{X}_2}{\sqrt{\frac{S_1^2}{n_1} + \frac{S_2^2}{n_2}}}$$

where: \bar{X}_1 = Mean for the control

\bar{X}_2 = Mean for the effluent concentration

S_1^2 = Estimate of the variance for the control

S_2^2 = Estimate of the variance for the effluent concentration

n_1 = Number of replicates for the control

n_2 = Number of replicates for the effluent concentration

11.3.5.5.3 Additionally, the degrees of freedom for the test are adjusted using the following formula:

$$df' = \frac{(n_1 - 1)(n_2 - 1)}{(n_2 - 1)C^2 + (1 - C)^2(n_1 - 1)}$$

$$C = \frac{\frac{S_1^2}{n_1}}{\frac{S_1^2}{n_1} + \frac{S_2^2}{n_2}}$$

11.3.5.5.4 The modified degrees of freedom is usually not an integer. Common practice is to round down to the nearest integer.

11.3.5.5.5 The modified t test is then performed in the same way as the equal variance t test. The calculated t is compared to the critical t at the 0.05 significance level with modified degrees of freedom. If the calculated t exceeds the critical t, the mean responses are found to be statistically different.

11.3.5.6 Wilcoxon Rank Sum Test

11.3.5.6.1 If the data fail the test for normality and there are four or more replicates per group, the non-parametric Wilcoxon Rank Sum Test may be used to analyze the data. If less than four replicates were used, a non-parametric alternative is not available.

11.3.5.6.2 The Wilcoxon Rank Sum Test consists of jointly ranking the data and calculating the rank sum for the effluent concentration. The rank sum is then compared to a critical value to determine acceptance or rejection of the null hypothesis.

11.3.5.6.3 To carry out the test, combine the data for the control and the effluent concentration and arrange the values in order of size from smallest to largest. Assign ranks to the ordered observations, a rank of 1 to the smallest, 2 to the next smallest, etc. If ties in rank occur, assign the average rank to each tied observation. Sum the ranks for the effluent concentration.

11.3.5.6.4 If the survival in the effluent concentration is significantly less than that of the control, the rank sum for the effluent concentration would be lower than the rank sum of the control. Thus, we are only concerned with comparing the rank sum for the effluent concentration with some "minimum" or critical rank sum, at or below which the effluent concentration survival would be considered to be significantly lower than the mortality in the control. For a test at the 5% level of significance, the critical rank sum can be found in Table 23.

TABLE 23. CRITICAL VALUES FOR WILCOXON'S RANK SUM TEST FIVE PERCENT CRITICAL LEVEL

No. of Replicates in Control	No. of Replicates per Effluent Concentration							
	3	4	5	6	7	8	9	10
3		10	16	23	30	39	49	59
4	6	11	17	24	32	41	51	62
5	7	12	19	26	34	44	54	66
6	8	13	20	28	36	46	57	69
7	8	14	21	29	39	49	60	72
8	9	15	23	31	41	51	63	72
9	10	16	24	33	43	54	66	79
10	10	17	26	35	45	56	69	82

11.3.6 SINGLE CONCENTRATION TEST

11.3.6.1 Data from an acute effluent toxicity test with *Ceriodaphnia* are provided in Table 24. The proportion surviving in each replicate is transformed by the arc sine square root transformation prior to statistical analysis of the data (Figure 12).

TABLE 24. DATA FROM AN ACUTE SINGLE-CONCENTRATION TOXICITY TEST WITH *CERIODAPHNIA*

	Replicate	Proportion Surviving	
		Control	100% Effluent Concentration
RAW DATA	A	1.00	0.40
	B	1.00	0.30
	C	0.90	0.40
	D	0.90	0.20
ARC SINE TRANSFORMED DATA	A	1.412	0.685
	B	1.412	0.580
	C	1.249	0.685
	D	1.249	0.464
	\bar{X}	1.330	0.604
	S^2	0.0088	0.0111

TABLE 25. EXAMPLE OF SHAPIRO WILK'S TEST: CENTERED OBSERVATIONS

Treatment	Replicate			
	A	B	C	D
Control	0.082	0.082	-0.081	-0.081
100% Effluent	0.081	-0.024	0.081	-0.140

11.3.6.2 After the data have been transformed, test the assumption of normality via the Shapiro Wilk's test.

11.3.6.2.1 The first step in the test for normality is to center the observations by subtracting the mean of all observations within a concentration from each observation in that concentration. The centered observations are listed in Table 25.

11.3.6.2.2 Calculate the denominator, D, of the test statistic:

$$D = \sum_{i=1}^8 (X_i - \bar{X})^2$$

For this set of data, $\bar{X} = 0$ and $D = 0.060$.

11.3.6.2.3 Order the centered observations from smallest to largest. The ordered observations are listed in Table 26.

11.3.6.2.4 From Table 21, for $n = 8$ and $k = n/2 = 4$, obtain the coefficients a_1, a_2, \dots, a_k . The a_i values are listed in Table 27.

11.3.6.2.5 Compute the test statistic, W, as follows:

$$W = \frac{1}{0.060} \cdot (0.2200)^2 = 0.0807$$

The differences, $X^{(n-i+1)} - X^{(i)}$, are listed in Table 27.

11.3.6.2.6 From Table 22, the critical W value for $n = 8$ and a significance level of 0.01, is 0.749. Since the calculated W, 0.807, is not less than the critical value the conclusion of the test is that the data are normally distributed.

TABLE 26. EXAMPLE OF SHAPIRO WILK'S TEST: ORDERED OBSERVATIONS

i	$X^{(i)}$
1	-0.140
2	-0.081
3	-0.081
4	-0.024
5	0.081
6	0.081
7	0.082
8	0.082

TABLE 27. EXAMPLE OF SHAPIRO WILK'S TEST: TABLE OF COEFFICIENTS AND DIFFERENCES

i	a _i	X ⁽ⁿ⁻ⁱ⁺¹⁾ - X ⁽ⁱ⁾	
1	0.6052	0.222	X ⁽⁸⁾ - X ⁽¹⁾
2	0.3164	0.163	X ⁽⁷⁾ - X ⁽²⁾
3	0.1743	0.162	X ⁽⁶⁾ - X ⁽³⁾
4	0.0561	0.105	X ⁽⁵⁾ - X ⁽⁴⁾

11.3.6.3 The F test for equality of variances is used to test the homogeneity of variance assumption.

11.3.6.3.1 From Table 24, obtain the sample variances for the control and the 100% effluent. Since the variability of the 100% effluent is greater than the variability of the control, S² for the 100% effluent concentration is placed in the numerator of the F statistic and S² for the control is placed in the denominator.

$$F = \frac{0.0111}{0.0088} = 1.2614$$

11.3.6.3.2 There are four replicates for the control and four replicates for the 100% effluent concentration. Thus there are three degrees of freedom for the numerator and the denominator. For a two-tailed test at the 0.01 level of significance, the critical F value is 47.467. The calculated F, 1.2614, is less than the critical F, 47.467, thus the conclusion is that the variances of the control and 100% effluent are equal.

11.3.6.4 The assumptions of normality and homogeneity of variance have been met for this data set. An equal variance t test will be used to compare the mean responses of the control and 100% effluent.

11.3.6.4.1 To perform the t test, obtain the values for X₁, X₂, S₁², and S₂² from Table 24. Calculate the t statistic as follows:

$$t = \frac{1.330 - 0.604}{0.0997 \sqrt{\frac{1}{4} + \frac{1}{4}}}$$

where:

$$S_p = \sqrt{\frac{(4-1)0.0088 + (4-1)(0.0111)}{4+4-2}}$$

11.3.6.4.2 For a one-tailed test at the 0.05 level of significance with 6 degrees of freedom, the critical t value is 1.9432. Since the calculated t, 10.298, is greater than the critical t, the conclusion is that the survival in the 100% effluent concentration is significantly less than the survival in the control.

11.3.6.5 If the data had failed the normality assumption, the appropriate analysis would have been the Wilcoxon Rank Sum Test. To provide an example of this test, the survival data from the t test example will be reanalyzed by the nonparametric procedure.

11.3.6.5.1 The first step in the Wilcoxon Rank Sum Test is to combine the data from the control and the 100% effluent concentration and arrange the values in order of size, from smallest to largest.

11.3.6.5.2 Assign ranks to the ordered observations, a rank of 1 to the smallest, 2 to the next smallest, etc. The combined data with ranks assigned is presented in Table 28.

TABLE 28. EXAMPLE OF WILCOXON'S RANK SUM TEST: ASSIGNING RANKS TO THE CONTROL AND 100% EFFLUENT CONCENTRATIONS

Rank	Proportion Surviving	Control or 100% Effluent
1	0.20	100% EFFLUENT
2	0.30	100% EFFLUENT
3.5	0.40	100% EFFLUENT
3.5	0.40	100% EFFLUENT
5.5	0.90	CONTROL
5.5	0.90	CONTROL
7.5	1.00	CONTROL
7.5	1.00	CONTROL

11.3.6.5.3 Sum the ranks for the 100% effluent concentration.

11.3.6.5.4 For this set of data, the test is for a significant reduction in survival in the 100% effluent concentration as compared to the control. The critical value, from Table 23, for four replicates in each group and a significance level of 0.05 is 11. The rank sum for the 100% effluent concentration is 10 which is less than the critical value of 11. Thus the conclusion is that survival in the effluent concentration is significantly less than the control survival.

11.3.7 MULTI-CONCENTRATION TEST

11.3.7.1 Formal statistical analysis of the survival data is outlined in Figure 13. The response used in the analysis is the proportion of animals surviving in each test or control chamber. Concentrations at which there is no survival in any of the test chambers are excluded from statistical determination of the NOAEC.

11.3.7.2 For the case of equal numbers of replicates across all concentrations and the control, the determination of the NOAEC endpoint is made via a parametric test, Dunnett's Procedure, or a nonparametric test, Steel's Many-one Rank Test, on the arc sine transformed data. Underlying assumptions of Dunnett's Procedure, normality and homogeneity of variance, are formally tested. The test for normality is the Shapiro Wilk's Test, and Bartlett's Test is used to test for the homogeneity of variance. If either of these tests fail, the nonparametric test, Steel's Many-one Rank Test, is used to determine the NOAEC endpoints. If the assumptions of Dunnett's Procedure are met, the endpoints are estimated by the parametric procedure.

11.3.7.3 If unequal numbers of replicates occur among the concentration levels tested, there are parametric and nonparametric alternative analyses. The parametric analysis is a t-test with a Bonferroni adjustment. The Wilcoxon Rank Sum Test with the Bonferroni adjustment is the nonparametric alternative.

11.3.7.4 Example of Analysis of Survival Data

11.3.7.4.1 This example uses survival data from a fathead minnow test. The proportion surviving in each replicate must first be transformed by the arc sine square root transformation procedure. The raw and transformed data, means and standard deviations of the transformed observations at each toxicant concentration and control are listed in Table 29. A plot of the survival proportions is provided in Figure 14.

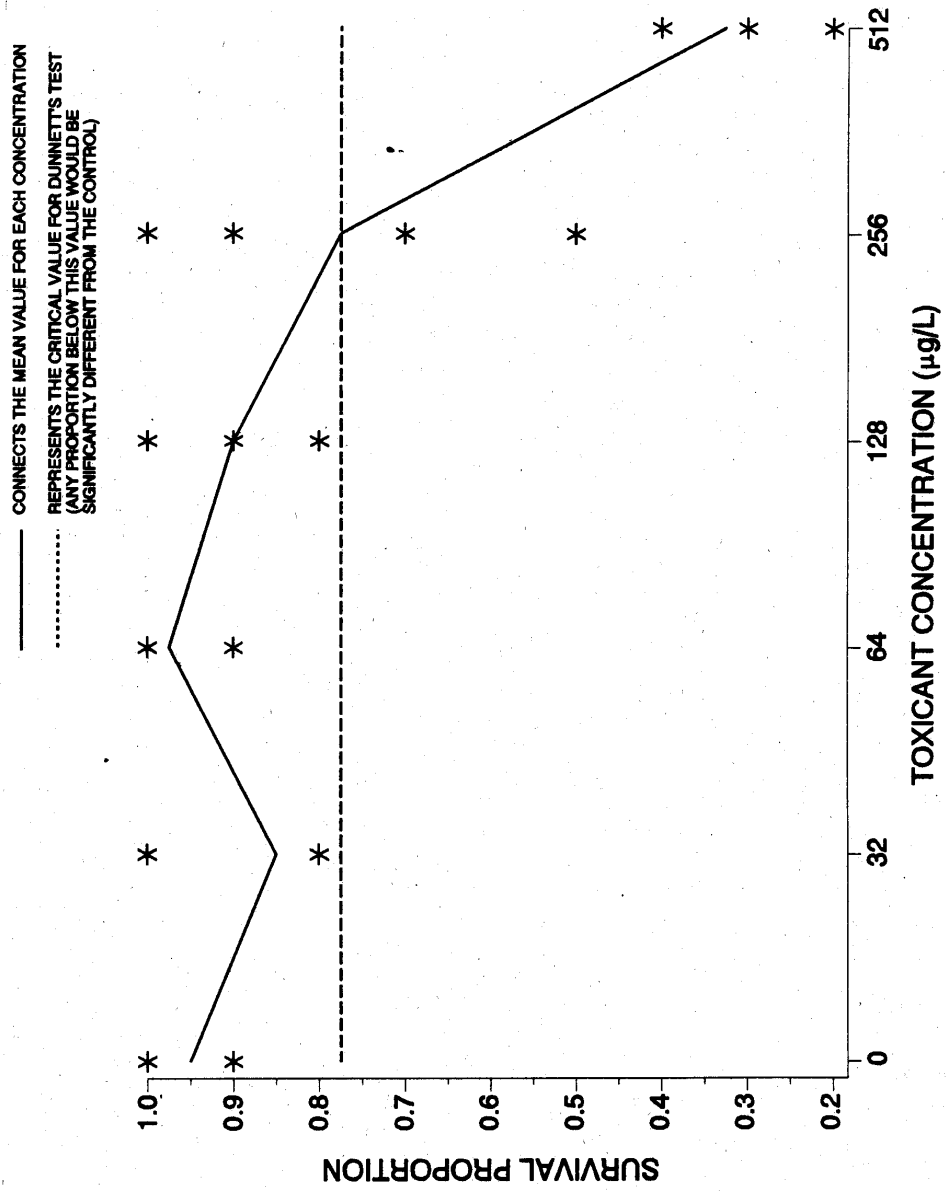

Figure 14. Plot of mean survival proportion data in Table 29.

11.3.7.4.2 Test for Normality

1. The first step of the test for normality is to center the observations by subtracting the mean of all observations within a concentration from each observation in that concentration. The centered observations are summarized in Table 30.

TABLE 29. FATHEAD MINNOW SURVIVAL DATA

	Replicate	Control	Toxicant Concentration (µg/L)				
			32	64	128	256	512
RAW	A	1.0	0.8	0.9	0.9	0.7	0.4
	B	1.0	0.8	1.0	0.9	0.9	0.3
	C	0.9	1.0	1.0	0.8	1.0	0.4
	D	0.9	0.8	1.0	1.0	0.5	0.2
ARC SINE TRANS- FORMED	A	1.412	1.107	1.249	1.249	0.991	0.685
	B	1.412	1.107	1.412	1.249	1.249	0.580
	C	1.249	1.412	1.412	1.107	1.412	0.685
	D	1.249	1.107	1.412	1.412	0.785	0.464
MEAN(\bar{Y}_i)		1.330	1.183	1.371	1.254	1.109	0.604
S_i^2		0.0088	0.0232	0.0066	0.0155	0.0768	0.0111
i		1	2	3	4	5	6

TABLE 30. CENTERED OBSERVATIONS FOR SHAPIRO WILK'S EXAMPLE

Replicate	Control	Toxicant Concentration (µg/L)				
		32	64	128	256	512
A	0.082	-0.076	-0.122	-0.005	-0.118	0.081
B	0.082	-0.076	0.041	-0.005	0.140	-0.024
C	-0.081	0.229	0.041	-0.147	0.303	0.081
D	-0.081	-0.076	0.041	0.158	-0.324	-0.140

2. Calculate the denominator, D, of the statistic:

$$D = \sum_{i=1}^n (X_i - \bar{X})^2$$

where: X_i = the ith centered observation
 \bar{X} = the overall mean of the centered observations
n = the total number of centered observations

3. For this set of data: n = 24 (number of observations)

$$\bar{X} = \frac{1}{24}(0.000) = 0.000$$

$$D = 0.4265$$

4. Order the centered observations from smallest to largest

$$X^{(1)} \leq X^{(2)} \leq \dots \leq X^{(n)}$$

where: $X^{(i)}$ denotes the i th ordered observation.

The ordered observations for this example are listed in Table 31.

TABLE 31. ORDERED CENTERED OBSERVATIONS FOR THE SHAPIRO WILK'S EXAMPLE

i	$X^{(i)}$	i	$X^{(i)}$
1	-0.324	13	-0.005
2	-0.147	14	0.041
3	-0.140	15	0.041
4	-0.122	16	0.041
5	-0.118	17	0.081
6	-0.081	18	0.081
7	-0.081	19	0.082
8	-0.076	20	0.082
9	-0.076	21	0.140
10	-0.076	22	0.158
11	-0.024	23	0.229
12	-0.005	24	0.303

5. From Table 21, for the number of observations, n , obtain the coefficients a_1, a_2, \dots, a_k , where k is approximately $n/2$ if n is even; $(n-1)/2$ if n is odd. For the data in this example, $n=24$ and $k=12$. The a_i values are listed in Table 32.
6. Compute the test statistic, W , as follows:

$$W = \frac{1}{D} \left[\sum_{i=1}^k a_i (X^{(n-i+1)} - X^{(1)}) \right]^2$$

The differences $X^{(n-i+1)} - X^{(i)}$ are listed in Table 32. For the data in this example,

$$W = \frac{1}{0.4265} (0.6444)^2 = 0.974$$

7. The decision rule for this test is to compare W as calculated in #6 to a critical value found in Table 23. If the computed W is less than the critical value, conclude that the data are not normally distributed. For the data in this example, the critical value at a significance level of 0.01 and $n = 24$ observations is 0.884. Since $W = 0.974$ is greater than the critical value, conclude that the data are normally distributed.

TABLE 32. COEFFICIENTS AND DIFFERENCES FOR SHAPIRO WILK'S EXAMPLE

i	a _i	X ⁽ⁿ⁻ⁱ⁺¹⁾ - X ⁽ⁱ⁾	
1	0.4493	0.627	X ⁽²⁴⁾ - X ⁽¹⁾
2	0.3098	0.376	X ⁽²³⁾ - X ⁽²⁾
3	0.2554	0.298	X ⁽²²⁾ - X ⁽³⁾
4	0.2145	0.262	X ⁽²¹⁾ - X ⁽⁴⁾
5	0.1807	0.200	X ⁽²⁰⁾ - X ⁽⁵⁾
6	0.1512	0.163	X ⁽¹⁹⁾ - X ⁽⁶⁾
7	0.1245	0.162	X ⁽¹⁸⁾ - X ⁽⁷⁾
8	0.0997	0.157	X ⁽¹⁷⁾ - X ⁽⁸⁾
9	0.0764	0.117	X ⁽¹⁶⁾ - X ⁽⁹⁾
10	0.0539	0.117	X ⁽¹⁵⁾ - X ⁽¹⁰⁾
11	0.0321	0.065	X ⁽¹⁴⁾ - X ⁽¹¹⁾
12	0.0107	0.0	X ⁽¹³⁾ - X ⁽¹²⁾

11.3.7.4.3 Test for Homogeneity of Variance

1. The test used to examine whether the variation in mean proportion surviving is the same across all toxicant concentrations including the control, is Bartlett's Test (Snedecor and Cochran, 1980). The test statistic is as follows:

$$B = \frac{[(\sum_{i=1}^P V_i) \ln \bar{S}^2 - \sum_{i=1}^P V_i \ln S_i^2]}{C}$$

where: V_i = degrees of freedom for each toxicant concentration and control, V_i = (n_i - 1)
n_i = the number of replicates for concentration i.
ln = log_e
i = 1, 2, ..., p where p is the number of concentrations including the control

$$\bar{S}^2 = \frac{(\sum_{i=1}^P V_i S_i^2)}{\sum_{i=1}^P V_i}$$

$$C = 1 + [3(p-1)]^{-1} [\sum_{i=1}^P 1/V_i - (\sum_{i=1}^P V_i)^{-1}]$$

2. For the data in this example, (See Table 29) all toxicant concentrations including the control have the same number of replicates (n_i = 4 for all i). Thus, V_i = 3 for all i.

3. Bartlett's statistic is therefore:

$$\begin{aligned}
 B &= [(18)1n(0.0236) - 3\sum_{i=1}^P 1n(S_i^2)]/1.1296 \\
 &= [18(-3.7465) - 3(-24.7516)]/1.1296 \\
 &= 6.8178/1.1296 \\
 &= 6.036
 \end{aligned}$$

4. B is approximately distributed as chi square with p - 1 degrees of freedom, when the variances are in fact the same. Therefore, the appropriate critical value for this test, at a significance level of 0.01 with five degrees of freedom, is 15.086. Since B = 6.036 is less than the critical value of 15.086, conclude that the variances are not different.

11.3.7.4.4 Dunnett's Procedure

1. To obtain an estimate of the pooled variance for the Dunnett's Procedure, construct an ANOVA table (Table 33).

TABLE 33. ANOVA TABLE

Source	DF	Sum of Squares (SS)	Mean Square (MS) (SS/DF)
BETWEEN	P - 1	SSB	$S_B^2 = SSB/(P-1)$
WITHIN	N - P	SSW	$S_W^2 = SSW/(N-P)$
Total	N - 1	SST	

where: p = number toxicant concentrations including the control
 N = total number of observations $n_1 + n_2 \dots + n_p$
 n_i = number of observations in concentration i

$$SSB = \sum_{i=1}^P T_i^2/n_i - G^2/N \quad \text{Between Sum of Squares}$$

$$SST = \sum_{i=1}^P \sum_{j=1}^{n_i} Y_{ij}^2 - G^2/N \quad \text{Total Sum of Squares}$$

$$SSW = SST - SSB \quad \text{Within Sum of Squares}$$

G = the grand total of all sample observations, $G = \sum_{i=1}^P T_i$

T_i = the total of the replicate measurements for concentration "i"

Y_{ij} = the jth observation for concentration "i" (represents the proportion surviving for toxicant concentration i in test chamber j)

2. For the data in this example:

$$n_1 = n_2 = n_3 = n_4 = n_5 = n_6 = 4$$

$$N = 24$$

$$T_1 = Y_{11} + Y_{12} + Y_{13} + Y_{14} = 5.322$$

$$T_2 = Y_{21} + Y_{22} + Y_{23} + Y_{24} = 4.733$$

$$T_3 = Y_{31} + Y_{32} + Y_{33} + Y_{34} = 5.485$$

$$T_4 = Y_{41} + Y_{42} + Y_{43} + Y_{44} = 5.017$$

$$T_5 = Y_{51} + Y_{52} + Y_{53} + Y_{54} = 4.437$$

$$T_6 = Y_{61} + Y_{62} + Y_{63} + Y_{64} = 2.414$$

$$G = T_1 + T_2 + T_3 + T_4 + T_5 + T_6 = 27.408$$

$$SSB = \sum_{i=1}^P T_i^2/n_i - G^2/N$$

$$= \frac{1}{4}(131.495) - \frac{(27.408)^2}{24} = 1.574$$

$$SST = \sum_{i=1}^P \sum_{j=1}^{n_i} Y_{ij}^2 - G^2/N$$

$$= 33.300 - \frac{(27.408)^2}{24} = 2.000$$

$$SSW = SST - SSB = 2.000 - 1.574 = 0.4260$$

$$S_B^2 = SSB/(p - 1) = 1.574/(6 - 1) = 0.3150$$

$$S_w^2 = SSW/(N - p) = 0.426/(24 - 6) = 0.024$$

3. Summarize these calculations in the ANOVA table (Table 34).

TABLE 34. ANOVA TABLE FOR DUNNETT'S PROCEDURE EXAMPLE

Source	DF	Sum of Squares (SS)	Mean Square (MS) (SS/DF)
BETWEEN	5	1.574	0.315
WITHIN	18	0.426	0.024
Total	23	2.002	

4. To perform the individual comparisons, calculate the t statistic for each concentration, and control combination as follows:

$$t_i = \frac{(\bar{Y}_1 - \bar{Y}_i)}{S_w \sqrt{(1/n_1) + (1/n_i)}}$$

where: \bar{Y}_i = mean proportion surviving for concentration i
 \bar{Y}_1 = mean proportion surviving for the control
 S_w = square root of within mean square
 n_1 = number of replicates for control
 n_i = number of replicates for concentration i.

5. Table 35 includes the calculated t values for each concentration and control combination. In this example, comparing the 32 $\mu\text{g/L}$ concentration with the control the calculation is as follows:

$$t_2 = \frac{(1.330 - 1.183)}{[0.155\sqrt{(1/4) + (1/4)}]} = 1.341$$

6. Since the purpose of this test is to detect a significant reduction in proportion surviving, a one-sided test is appropriate. The critical value for this one-sided test is found in Table 36. For an overall alpha level of 0.05, 18 degrees of freedom for error and five concentrations (excluding the control) the critical value is 2.41. The mean proportion surviving for concentration "i" is considered significantly less than the mean proportion surviving for the control if t_i is greater than the critical value. Since t is greater than 2.41, the 512 $\mu\text{g/L}$ concentration has significantly lower survival than the control. Hence the NOAEC for survival is 256 $\mu\text{g/L}$.

TABLE 35. CALCULATED T VALUES

Toxicant Concentration ($\mu\text{g/L}$)	i	t_i
32	2	1.341
64	3	-0.374
128	4	0.693
256	5	2.016
512	6	6.624

7. To quantify the sensitivity of the test, the minimum significant difference (MSD) that can be detected statistically may be calculated.

$$MSD = d S_w \sqrt{(1/n_i) + (1/n)}$$

- where: d = the critical value for the Dunnett's procedure
 S_w = the square root of the within mean square
 n = the common number of replicates at each concentration (this assumes equal replication at each concentration)
 n_i = the number of replicates in the control.

8. In this example:

$$\begin{aligned} MSD &= 2.41(0.155)\sqrt{(1/4) + (1/4)} \\ &= 2.41 (0.155)(0.707) \\ &= 0.264 \end{aligned}$$

9. The MSD (0.264) is in transformed units. To determine the MSD in terms of percent survival, carry out the following conversion.

- (1) Subtract the MSD from the transformed control mean.

$$1.330 - 0.264 = 1.066$$

- (2) Obtain the untransformed values for the control mean and the difference calculated in 1.

$$[\text{Sine} (1.330)]^2 = 0.943$$

$$[\text{Sine} (1.066)]^2 = 0.766$$

- (3) The untransformed MSD (MSD_u) is determined by subtracting the untransformed values from 2.

$$MSD_u = 0.943 - 0.766 = 0.177$$

10. Therefore, for this set of data, the minimum difference in mean proportion surviving between the control and any toxicant concentration that can be detected as statistically significant is 0.177.

11. This represents a decrease in survival of 19% from the control.

TABLE 36. DUNNETT'S "T" VALUES (MILLER, 1981)

	(One-tailed) d_k^{α}								
	$\alpha = .05$								
	1	2	3	4	5	6	7	8	9
5	2.02	2.44	2.58	2.85	2.98	3.08	3.16	3.24	3.30
6	1.94	2.34	2.56	2.71	2.83	2.92	3.00	3.07	3.12
7	1.89	2.27	2.48	2.62	2.73	2.82	2.89	2.95	3.01
8	1.86	2.22	2.42	2.55	2.66	2.74	2.81	2.87	2.92
9	1.83	2.18	2.37	2.50	2.60	2.68	2.75	2.81	2.86
10	1.81	2.15	2.34	2.47	2.56	2.64	2.70	2.76	2.81
11	1.80	2.13	2.31	2.44	2.53	2.60	2.67	2.72	2.77
12	1.78	2.11	2.29	2.41	2.50	2.58	2.64	2.69	2.74
13	1.77	2.09	2.27	2.39	2.48	2.55	2.61	2.68	2.71
14	1.76	2.08	2.25	2.37	2.46	2.53	2.59	2.64	2.69
15	1.75	2.07	2.24	2.36	2.44	2.51	2.57	2.62	2.67
16	1.75	2.06	2.23	2.34	2.43	2.50	2.56	2.61	2.65
17	1.74	2.05	2.22	2.33	2.42	2.49	2.54	2.59	2.64
18	1.73	2.04	2.21	2.32	2.41	2.48	2.53	2.58	2.62
19	1.73	2.03	2.20	2.31	2.40	2.47	2.52	2.57	2.61
20	1.72	2.03	2.19	2.30	2.38	2.46	2.51	2.56	2.60
24	1.71	2.01	2.17	2.28	2.36	2.43	2.48	2.53	2.57
30	1.70	1.99	2.15	2.25	2.33	2.40	2.45	2.50	2.54
40	1.68	1.97	2.13	2.23	2.31	2.37	2.42	2.47	2.51
60	1.67	1.95	2.10	2.21	2.28	2.35	2.39	2.44	2.48
120	1.86	1.93	2.08	2.18	2.26	2.32	2.37	2.41	2.45
α	1.64	1.92	2.06	2.16	2.23	2.29	2.34	2.33	2.42

TABLE 36. DUNNETT'S "T" VALUES (MILLER, 1981) (CONTINUED)

	(One-tailed) d_k^{α}								
	$\alpha = 0.1$								
	1	2	3	4	5	6	7	8	9
5	3.37	3.90	4.21	4.43	4.50	4.73	4.85	4.94	5.03
6	3.14	3.61	4.88	4.07	4.21	4.33	4.43	4.51	4.39
7	3.00	3.42	3.56	3.83	3.96	4.07	4.15	4.23	4.30
8	2.90	3.20	3.51	3.67	3.79	3.88	3.96	4.03	4.09
9	2.82	3.19	3.40	3.55	3.64	3.75	3.82	3.89	3.94
10	2.76	3.11	3.31	3.45	3.56	3.64	3.71	3.78	3.83
11	2.72	3.06	3.25	3.38	3.46	3.56	3.63	3.69	3.74
12	2.68	3.01	3.19	3.32	3.42	3.50	3.56	3.62	3.67
13	2.65	2.97	3.15	3.27	3.37	3.44	3.91	3.56	3.61
14	2.62	2.94	3.11	3.23	3.32	3.40	3.46	3.51	3.56
15	2.60	2.91	3.08	3.20	3.29	3.36	3.42	3.47	3.52
16	2.58	2.38	3.05	3.17	3.28	3.33	3.39	3.44	3.48
17	2.57	2.86	3.03	3.14	3.23	3.30	3.36	3.41	3.45
18	2.55	2.84	3.01	3.12	3.21	3.27	3.33	3.38	3.42
19	2.54	2.83	2.99	3.10	3.18	3.25	3.31	3.36	3.40
20	2.53	2.81	2.97	3.08	3.17	3.23	3.29	3.34	3.38
24	2.40	2.77	2.92	3.03	3.11	3.17	3.22	3.27	3.31
30	2.46	2.72	2.87	2.97	3.05	3.11	3.16	3.21	3.24
40	2.42	2.68	2.82	2.92	2.99	3.06	3.10	3.14	3.18
60	2.39	2.64	2.78	2.87	2.94	3.08	3.04	3.06	3.12
120	2.36	2.60	2.73	2.82	2.90	2.94	2.90	3.03	3.06
α	2.33	2.56	2.68	2.77	2.34	2.90	2.83	2.97	3.00

SECTION 12

REPORT PREPARATION AND TEST REVIEW

12.1 REPORT PREPARATION

The following general format and content are recommended for the report:

12.1.1 INTRODUCTION

1. Permit number
2. Toxicity testing requirements of permit
3. Plant location
4. Name of receiving water body
5. Contractor (if contracted)
 - a. Name of firm
 - b. Phone number
 - c. Address
6. Objective of test

12.1.2 PLANT OPERATIONS

1. Product(s)
2. Raw materials
3. Operating schedule
4. Description of waste treatment
5. Schematic of waste treatment
6. Retention time (if applicable)
7. Volume of discharge (MGD, CFS, GPM)
8. Design flow of treatment facility at time of sampling

12.1.3 SOURCE OF EFFLUENT, RECEIVING WATER, AND DILUTION WATER

1. Effluent Samples
 - a. Sampling point (including latitude and longitude)
 - b. Sample collection method
 - c. Collection dates and times
 - d. Mean daily discharge on sample collection date
 - e. Lapsed time from sample collection to delivery
 - f. Sample temperature when received at the laboratory
 - g. Physical and chemical data
2. Receiving Water Samples
 - a. Sampling point (including latitude and longitude)
 - b. Sample collection method
 - c. Collection dates and times
 - d. Streamflow (at time of sampling)
 - e. Lapsed time from sample collection to delivery
 - f. Sample temperature when received at the laboratory
 - g. Physical and chemical data

3. Dilution Water Samples
 - a. Source
 - b. Collection date(s) and time(s) (where applicable)
 - c. Pretreatment
 - d. Physical and chemical characteristics (pH, hardness, salinity, etc.)

12.1.4 TEST CONDITIONS

1. Toxicity test method used (title, number, source)
2. Endpoint(s) of test
3. Deviations from reference method, if any, and reason(s)
4. Date and time test started
5. Date and time test terminated
6. Type and volume of test chambers
7. Volume of solution used per chamber
8. Number of organisms per test chamber
9. Number of replicate test chambers per treatment
10. Feeding frequency, and amount and type of food
11. Acclimation temperature of test organisms (mean and range)
12. Test temperature (mean and range)

12.1.5 TEST ORGANISMS

1. Scientific name
2. Age
3. Life stage
4. Mean length and weight (where applicable)
5. Source
6. Diseases and treatment (where applicable)

12.1.6 QUALITY ASSURANCE

1. Reference toxicant used routinely; source; date received; lot no.
2. Date and time of most recent reference toxicant test; test results and current cusum chart
3. Dilution water used in reference toxicant test
4. Physical and chemical methods used

12.1.7 RESULTS

1. Provide raw toxicity data in tabular form, including daily records of affected organisms in each concentration (including controls) and replicate, and in graphical form (plots of toxicity data)
2. Provide table of endpoints: LC50, NOAEC, Pass/Fail (as required in the applicable NPDES permit)
3. Indicate statistical methods used to calculate endpoints
4. Provide summary table of physical and chemical data
5. Tabulate QA data

12.1.8 CONCLUSIONS AND RECOMMENDATIONS

1. Relationship between test endpoints and permit limits.
2. Action to be taken.

12.2 TEST REVIEW

12.2.1 Test review is an important part of an overall quality assurance program (Section 4) and is necessary for ensuring that all test results are reported accurately. Test review should be conducted on each test by both the testing laboratory and the regulatory authority.

12.2.2 SAMPLING AND HANDLING

12.2.2.1 The collection and handling of samples are reviewed to verify that the sampling and handling procedures given in Section 8 were followed. Chain-of-custody forms are reviewed to verify that samples were tested within allowable sample holding times (Subsection 8.5.4). Any deviations from the procedures given in Section 8 should be documented and described in the data report (Subsection 12.1).

12.2.3 TEST ACCEPTABILITY CRITERIA

12.2.3.1 Test data are reviewed to verify that test acceptability criteria (TAC) requirements for a valid test have been met. Any test not meeting the minimum test acceptability criteria is considered invalid. All invalid tests must be repeated with a newly collected sample.

12.2.4 TEST CONDITIONS

12.2.4.1 Test conditions are reviewed and compared to the specifications listed in the summary of test condition tables provided for each method. Physical and chemical measurements taken during the test (e.g., temperature, pH, and DO) also are reviewed and compared to specified ranges. Any deviations from specifications should be documented and described in the data report (Subsection 12.1).

12.2.4.2 The summary of test condition tables presented for each method identify test conditions as required or recommended. For WET test data submitted under NPDES permits, all required test conditions must be met or the test is considered invalid and must be repeated with a newly collected sample. Deviations from recommended test conditions must be evaluated on a case-by-case basis to determine the validity of test results. Deviations from recommended test conditions may or may not invalidate a test result depending on the degree of the departure and the objective of the test. The reviewer should consider the degree of the deviation and the potential or observed impact of the deviation on the test result before rejecting or accepting a test result as valid. For example, if dissolved oxygen is measured below 4.0 mg/L in one test chamber, the reviewer should consider whether any observed mortality in that test chamber corresponded with the drop in dissolved oxygen.

12.2.4.3 Whereas slight deviations in test conditions may not invalidate an individual test result, test condition deviations that continue to occur frequently in a given laboratory may indicate the need for improved quality control in that laboratory.

12.2.5 STATISTICAL METHODS

12.2.5.1 The statistical methods used for analyzing test data are reviewed to verify that the recommended flowcharts for statistical analysis were followed. Any deviation from the recommended flowcharts for selection of statistical methods should be noted in the data report. Statistical methods other than those recommended in the statistical flowcharts may be appropriate (see Subsection 11.1.4), however, the laboratory must document the use of and provide the rationale for the use of any alternate statistical method. In all cases (flowchart recommended methods or alternate methods), reviewers should verify that the necessary assumptions are met for the statistical method used.

12.2.6 CONCENTRATION-RESPONSE RELATIONSHIPS

12.2.6.1 The concept of a concentration-response, or more classically, a dose-response relationship is “the most fundamental and pervasive one in toxicology” (Casarett and Doull, 1975). This concept assumes that there is a causal relationship between the dose of a toxicant (or concentration for toxicants in solution) and a measured response. A response may be any measurable biochemical or biological parameter that is correlated with exposure to the toxicant. The classical concentration-response relationship is depicted as a sigmoidal shaped curve, however, the particular shape of the concentration-response curve may differ for each coupled toxicant and response pair. In general, more severe responses (such as acute effects) occur at higher concentrations of the toxicant, and less severe responses (such as chronic effects) occur at lower concentrations. A single toxicant also may produce multiple responses, each characterized by a concentration-response relationship. A corollary of the concentration-response concept is that every toxicant should exhibit a concentration-response relationship, given that the appropriate response is measured and given that the concentration range evaluated is appropriate. Use of this concept can be helpful in determining whether an effluent possesses toxicity and in identifying anomalous test results.

12.2.6.2 The concentration-response relationship generated for each multi-concentration test must be reviewed to ensure that calculated test results are interpreted appropriately. USEPA (2000a) provides guidance on evaluating concentration-response relationships to assist in determining the validity of WET test results. All WET test results (from multi-concentration tests) reported under the NPDES program should be reviewed and reported according to USEPA guidance on the evaluation of concentration-response relationships (USEPA, 2000a). This guidance provides review steps for 10 different concentration-response patterns that may be encountered in WET test data. Based on the review, the guidance provides one of three determinations: that calculated effect concentrations are reliable and should be reported, that calculated effect concentrations are anomalous and should be explained, or that the test was inconclusive and the test should be repeated with a newly collected sample. It should be noted that the determination of a valid concentration-response relationship is not always clear cut. Data from some tests may suggest consultation with professional toxicologists and/or regulatory officials. Tests that exhibit unexpected concentration-response relationships also may indicate a need for further investigation and possible retesting.

12.2.7 REFERENCE TOXICANT TESTING

12.2.7.1 Test review of a given effluent or receiving water test should include review of the associated reference toxicant test and current control chart. Reference toxicant testing and control charting is required for documenting the quality of test organisms (Subsection 4.7) and ongoing laboratory performance (Subsection 4.15). The reviewer should verify that a quality control reference toxicant test was conducted according to the specified frequency required by the permitting authority or recommended by the method (e.g., monthly). The test acceptability criteria, test conditions, concentration-response relationship, and test sensitivity of the reference toxicant test are reviewed to verify that the reference toxicant test conducted was a valid test. The results of the reference toxicant test are then plotted on a control chart (see Subsection 4.15) and compared to the current control chart limits (± 2 standard deviations).

12.2.7.2 Reference toxicant tests that fall outside of recommended control chart limits are evaluated to determine the validity of associated effluent and receiving water tests (see Subsection 4.15). An out of control reference toxicant test result does not necessarily invalidate associated test results. The reviewer should consider the degree to which the reference toxicant test result fell outside of control chart limits, the width of the limits, the direction of the deviation (toward increasing test organism sensitivity or toward decreasing test organism sensitivity), the test conditions of both the effluent test and the reference toxicant test, and the objective of the test. More frequent and/or concurrent reference toxicant testing may be advantageous if recent problems (e.g., invalid tests, reference toxicant test results outside of control chart limits, reduced health of organism cultures, or increased within-test variability) have been identified in testing.

12.2.8 TEST VARIABILITY

12.2.8.1 The within-test variability of individual tests should be reviewed. Excessive within-test variability may invalidate a test result and warrant retesting. For evaluating within-test variability, reviewers should consult EPA guidance on upper and lower percent minimum significant difference (PMSD) bounds (USEPA, 2000b).

12.2.8.2 USEPA guidance on WET variability recommends incorporating upper and lower bounds using the PMSD to control and minimize within-test method variability and increase test sensitivity (USEPA, 2000b). The minimum significant difference (MSD) is the smallest difference between the control and another test treatment that can be determined as statistically significant in a given test, and the PMSD is the MSD represented as a percentage of the control response. The equation and examples of MSD calculations are shown in Subsection 11.3.7.4.4.

12.2.8.3 To assist in reviewing within-test variability, EPA recommends maintaining control charts of PMSDs calculated for successive effluent tests (USEPA, 2000b). A control chart of PMSD values characterizes the range of variability observed within a given laboratory, and allows comparison of individual test PMSDs with the laboratory's typical range of variability. Control charts of other variability and test performance measures, such as the MSD, standard deviation or CV of control responses, or average control response, also may be useful for reviewing tests and minimizing variability.

CITED REFERENCES

- AFS. 1991. Common and scientific names of fishes of the United States and Canada. Special Publ. 20, American Fisheries Society, Bethesda, Maryland.
- AOAC. 1990. Agricultural chemicals, contaminants; drugs. Vol.1, Official methods of analysis. 15th edition. Association of Official Analytical Chemists, Arlington, VA.
- APHA. 1992. Standard methods for the examination of water and wastewater. 18th edition, Part 8010E. American Public Health Association, Washington, DC.
- Bartlett, M.S. 1937. Some examples of statistical methods of research in agriculture and applied biology. J. Royal Statist. Soc. Suppl. 4:137-183.
- Bidwell, J.P., and S. Spotte. 1985. Artificial Seawaters: formulas and methods. Jones and Barlett, Publ., Boston, Massachusetts. 349 pp.
- Casarett, L.J. and J. Doull. 1975. Toxicology: the basic science of poisons. Macmillan Publishing Co., New York.
- Conover, W.J. 1980. Practical nonparametric statistics. Second edition. John Wiley and Sons, New York, New York.
- Cowgill, U.M. 1987. Critical analysis of factors affecting the sensitivity of zooplankton and the reproducibility of toxicity test results. Wat. Res. 21(12):1453-1462.
- Cowgill, U.M., D.P. Milazzo, and B.D. Landenberger. 1990. The reproducibility of the three brood *Ceriodaphnia* test using the reference toxicant sodium lauryl sulfate. Arch. Environ. Contam. Toxicol. 19:513-517.
- DeGraeve, G.M., W.H. Clement, and M.F. Arthur. 1989. A method for conducting laboratory toxicity degradation evaluations of complex effluents. Battelle Columbus Division, Columbus, Ohio. 22 pp.
- DeWoskin, R.S. 1984. Good laboratory practice regulations: A comparison. Research Triangle Institute, Research Triangle Park, N. Carolina. 63 pp.
- Dorn, P.B., and J.H. Rogers. 1989. Variability associated with identification of toxics in National Pollutant Discharge Elimination System (NPDES) effluent toxicity tests. Environ. Toxicol. Chem. 8:893-902.
- Draper, N.R. and John, J.A. 1981. Influential observations and outliers in regression. Technometrics 23:21-26.
- Emerson, K., R.C. Russo, R.B. Lund, and R.V. Thurston. 1975. Aqueous ammonia equilibrium calculations; effect of pH and temperature. J. Fish. Res. Bd. Can. 32(12):2379-2383.
- Environment Canada. 1990. Guidance Document on Control of Toxicity Test Precision Using Reference Toxicants. Report EPS 1/RM/12.
- FDA. 1978. Good laboratory practices for non-clinical laboratory studies. Part 58. Fed. Reg. 43(247):60013-60020. December 22, 1978.
- Finney, D.J. 1971. Probit analysis. 3rd ed. Cambridge University Press, London. 333 pp.
- Finney, D.J. 1978. Statistical method in biological assay. 3rd ed. Charles Griffin & Co. Ltd, London. 508 pp.
- Finney, D.J. 1985. The median lethal dose and its estimation. Arch. Toxicol. 56:215-218.

- Grothe, D.R. and R.A. Kimerle. 1985. Inter- and intra-laboratory variability in *Daphnia magna* effluent toxicity test results. *Environ. Toxicol. Chem.* 4(2):189-192.
- Hall, W.S., J.B. Patoczka, R.J. Mirenda, B.A. Porter, and B. Miller. 1989. Acute toxicity of industrial surfactants to *Mysidopsis bahia*. *Arch. Environ. Contam. Toxicol.* 18:765-772.
- Hamilton, M.A., R.C. Russo, and R.V. Thurston. 1977. Trimmed Spearman-Kärber method for estimating median lethal concentrations. *Environ. Sci. Tech.* 11(7):714-719.
- Jensen, A.L. 1972. Standard error of LC50 and sample size in fish bioassays. *Water. Res.* 6:85-89.
- Jop, K.M., J.H. Rogers, Jr., P.B. Dorn, and K.L. Dickson. 1986. Use of hexavalent chromium as a reference toxicant in aquatic toxicity tests. In: T.M. Poston, and R. Purdy, eds., *Aquatic Toxicology and Environmental Fate*, ASTM STP 921, American Society for Testing and Materials, Philadelphia, Pennsylvania. pp. 390-403.
- Leger, P., D.A. Bengtson, K.L. Simpson, and P. Sorgeloos. 1986. The use and nutritional value of *Artemia* as a food source. *Oceanogr. Mar. Biol. Ann. Rev.* 24:521-623.
- Leger, P., P. Sorgeloos, O.M. Millamena, and K.L. Simpson. 1985. International study of *Artemia*. XXV. Factors determining the nutritional effectiveness of *Artemia*: The relative impact of chlorinated Hydrocarbons and essential fatty acids in San Francisco Bay and San Pablo Bay *Artemia*. *J. Exper. Mar. Biol. Ecol.* 93:71-82.
- Lewis, P.A. and W.B. Horning, II. 1991. Differences in acute toxicity test results of three reference toxicants on *Daphnia* at two temperatures. *Environ. Tox. Chem.* 10(10): In press.
- Lewis, P.A. and C.I. Weber. 1985. A study of the reliability of *Daphnia* acute toxicity tests. In: R.D. Cardwell, R. Purdy, and R.C. Bahner, eds., *Aquatic toxicology and hazard assessment: seventh symposium*, ASTM STP 854, American Society for Testing and Materials, Philadelphia, Pennsylvania. pp. 73-86.
- Marking, L.L. and V.K. Dawson. 1973. Toxicity of quinaldine sulfate to fish. *Invest. Fish Contr. No. 48.*, U.S. Fish & Wildlife Service, Department of the Interior, Washington, D.C., 8 pp.
- Martin, M., J.W. Hunt, B.S. Anderson, S.L. Turpen, and F.H. Palmer. 1989. Experimental evaluation of the mysid *Holmesimysis costata* as a test organism for effluent toxicity testing. *Environ. Toxicol. Chem.* 8: 1003-1012.
- Miller, R.G. 1981. *Simultaneous statistical inference*. Springer-Verlag, New York. 299 pp.
- Mount, D.I., T.J. Norberg-King, R. Keen, and J.T. Taraldsen. 1987. A reference test water for cladocerans. Abstract, 11th Annual Symposium, Aquatic Toxicology and Hazard Assessment, American Society for Testing and Materials, May 10-12, 1987, Cincinnati, OH.
- Price, W.W., R.W. Heard, and L. Stuck. 1994. Observations on the genus *Mysidopsis* Sars, 1864 with the designation of a new genus, *Americamysis*, and the descriptions of *Americamysis alleni* and *Americamysis stucki* (Peracarida: Mysidacea: Mysidae), from the Gulf of Mexico. *Procedure. Biol. Soc. Wash.* 107: 680-698.
- Richards, F.A. and N. Corwin. 1956. Some oceanographic applications of recent determinations of the solubility of oxygen in sea water. *Limnol. Ocenogr.* 1(4):263-267.
- Snedecor, G.W. and W.G. Cochran. 1980. *Statistical methods*. Seventh edition. Iowa State University Press, Ames. 593 pp.
- Spotte, S., Adams, G., and P.M. Bubucis. 1984. GP2 as an artificial seawater for culture or maintenance of marine organisms. *Zool. Biol.* 3:229-240.

- Sprague, J.B. 1969. Measurement of pollutant toxicity to fish. I. Bioassay methods for acute toxicity. *Water Res.* 3:793-821.
- Taylor, J.K. 1987. Quality assurance of chemical measurements. Lewis Publ., Inc., Chelsea, Michigan.
- Thurston, R.V., R.C. Russo, and K. Emerson. 1974. Aqueous ammonia equilibrium calculations. Tech. Rep. No. 741. Fisheries Bioassay Laboratory, Montana State University, Bozeman. 18 pp.
- USDA. 1989. Methods which detect multiple residues. Vol. 1. Pesticide analysis manual. U.S. Department of Health and Human Services, Washington, DC.
- USEPA. 1973. Biological field and laboratory methods for measuring the quality of surface waters and effluents. C.I. Weber, ed. U.S. Environmental Protection Agency, Methods Development and Quality Assurance Research Laboratory, Cincinnati, Ohio. EPA 670/4-73-001. 200 pp.
- USEPA. 1975. Methods for acute toxicity tests with fish, macroinvertebrates, and amphibians. Environmental Research Laboratory, U.S. Environmental Protection Agency, Duluth, Minnesota.
- USEPA. 1979a. Handbook for analytical quality assurance in water and wastewater laboratories. U.S. Environmental Protection Agency, Environmental Monitoring and Support Laboratory, Cincinnati, Ohio. EPA-600/4-79-019.
- USEPA. 1979b. Methods for chemical analysis of water and wastes. Environmental Monitoring and Support Laboratory, U.S. Environmental Protection Agency, Cincinnati, Ohio. EPA-600/4-79-020.
- USEPA. 1979c. Interim NPDES compliance biomonitoring inspection manual. Office of Water Enforcement, U.S. Environmental Protection Agency, Washington, DC. (MCD-62).
- USEPA. 1980a. Proposed good laboratory practice guidelines for toxicity testing. Paragraph 163.60-6. Fed. Reg. 45:26377-26382, April 18, 1980.
- USEPA. 1980b. Physical, chemical, persistence, and ecological effects testing; good laboratory practice standards (proposed rule). 40 CFR 772, Fed. Reg. 45:77353-77365, November 21, 1980.
- USEPA. 1981. Results: Interlaboratory comparison--acute toxicity tests using estuarine animals. S.C. Schimmel. Environmental Research Laboratory, U.S. Environmental Protection Agency, Gulf Breeze, Florida. 15 pp.
- USEPA. 1983a. Guidelines and format for EMSL - Cincinnati methods. Kopp, J.F. Environmental Monitoring and Support Laboratory, U.S. Environmental Protection Agency, Cincinnati, OH 46268. EPA-600/8-83-020.
- USEPA. 1983b. Analysis of an interlaboratory comparative study of acute toxicity tests with freshwater aquatic organisms. S.J. Broderius. Environmental Research Laboratory, U.S. Environmental Protection Agency, Duluth, Minnesota. 54 pp.
- USEPA. 1985. Ambient water quality criteria for ammonia - 1984. Office of Water Regulations and Standards, Office of Water, U.S. Environmental Protection Agency, Washington, DC. EPA/440/5-85/001.
- USEPA. 1986. Occupational health and safety manual. Office of Administration, U.S. Environmental Protection Agency, Washington, DC.
- USEPA. 1988a. Methods for aquatic toxicity identification evaluations: Phase III, toxicity confirmation procedures. D.I. Mount. Environmental Research Laboratory, U.S. Environmental Protection Agency, Duluth, Minnesota. EPA-600/3-88/036.

- USEPA. 1988b. Methods for aquatic toxicity identification evaluations: Phase II, toxicity identification procedures. D.I. Mount, and L. Anderson-Carnahan. Environmental Research Laboratory, U.S. Environmental Protection Agency, Duluth, Minnesota. EPA-600/3-88/035.
- USEPA. 1988c. NPDES compliance inspection manual. Office of Water Enforcement and Permits, U.S. Environmental Protection Agency, Washington, D.C.
- USEPA. 1989a. Toxicity reduction evaluation protocol for municipal wastewater treatment plants. J.A. Botts, J.W. Braswell, J. Zyman, W.L. Goodfellow, and S.B. Moore. Risk Reduction Engineering Laboratory, U.S. Environmental Protection Agency, Cincinnati, Ohio 45268. EPA/600/2-88/062.
- USEPA. 1989b. Generalized methodology for conducting industrial toxicity reduction evaluations (TREs). J.A. Fava, D. Lindsay, W.H. Clement, R. Clark, G.M. DeGraeve, J.D. Cooney, S. Hansen, W. Rue, S. Moore, and P. Lankford. Risk Reduction Engineering Laboratory, U.S. Environmental Protection Agency, Cincinnati, Ohio 45268. EPA/600/2-88/070.
- USEPA. 1989c. Short-term Methods For estimating the chronic toxicity of effluents and surface waters to freshwater organisms. C.I. Weber, W.H. Peltier, T. J. Norberg-King, W.B. Horning, II, F.A. Kessler, J.R. Menkedick, T.W. Neiheisel, P.A. Lewis, D.J. Klemm, Q.H. Pickering, E.L. Robinson, J.M. Lazorchak, L.J. Wymer, and R.W. Freyberg. Environmental Monitoring Systems Laboratory, U.S. Environmental Protection Agency, Cincinnati, Ohio. EPA-600/4-89/001.
- USEPA. 1990a. Macroinvertebrate field and laboratory methods for evaluating the biological integrity of surface waters. D.J. Klemm, P.A. Lewis, F. Kessler, and J.M. Lazorchak. Environmental Monitoring Systems Laboratory, Office of Modeling, Monitoring Systems, and Quality Assurance, Office of Research and Development, U.S. Environmental Protection Agency, Cincinnati, Ohio. 45268 EPA/600/4-90/030.
- USEPA. 1990b. Supplemental methods and status reports for short-term saltwater toxicity tests. G. Morrison and G. Chapman. ERL Contrib. No. 1199. Environmental Research Laboratory, U.S. Environmental Protection Agency, Narragansett, Rhode Island. 127 pp.
- USEPA. 1991a. Methods for aquatic toxicity identification evaluations: Phase I, toxicity characterization procedures. T. Norberg-King, D.I. Mount, E. Durhan, G. Ankley, L. Burkhard, J. Amato, M. Lukasewycz, M. Schubauer-Berigan, and L. Anderson-Carnahan. Environmental Research Laboratory, U.S. Environmental Protection Agency, Duluth, Minnesota. EPA/600/6-91/003.
- USEPA. 1991b. Manual for evaluation of laboratories performing aquatic toxicity tests. D.J. Klemm, L.B. Lobring, and W.H. Horning, II. Environmental Monitoring Systems Laboratory, Office of Modeling, Monitoring Systems, and Quality Assurance, Office of Research and Development, U.S. Environmental Protection Agency, Cincinnati, Ohio 45268. EPA/600/4-90/031.
- USEPA. 1991c. Technical support document for water quality-based toxic control. Office of Water, U.S. Environmental Protection Agency, Washington, DC. EPA/505/2-90/001. 387 pp.
- USEPA. 1993a. Methods for measuring the acute toxicity of effluents to freshwater and marine organisms. Weber, C.I. (ed.). Environmental Monitoring Systems Laboratory, U. S. Environmental Protection Agency, Cincinnati, OH 45268. EPA/600/4-90/027F.
- USEPA. 1993b. Table 1. In: Guidelines establishing test procedures for the analysis of pollutants. Code of Federal Regulations, Vol. 40, Part 136. U.S. Environmental Protection Agency, Washington, DC.

- USEPA. 1994a. Short-term methods For estimating the chronic toxicity of effluents and receiving waters to freshwater organisms. 3rd edition. Environmental Monitoring Systems Laboratory, U.S. Environmental Protection Agency, Cincinnati, Ohio. EPA-600/4-91/002.
- USEPA. 1994b. Short-term methods For estimating the chronic toxicity of effluents and receiving waters to marine and estuarine organisms. 2nd edition. Environmental Monitoring Systems Laboratory, U.S. Environmental Protection Agency, Cincinnati, Ohio. EPA-600/4-91/003.
- USEPA. 2000a. Method guidance and recommendations for whole effluent toxicity (WET) testing (40 CFR Part 136). Office of Water, U.S. Environmental Protection Agency, Washington, D.C. 20460. EPA/821/B-00/004.
- USEPA. 2000b. Understanding and accounting for method variability in whole effluent toxicity applications under the national pollutant discharge elimination system program. Office of Wastewater Management, U.S. Environmental Protection Agency, Washington, D.C. 20460. EPA/833/R-00/003.
- USEPA. 2001a. Final report: interlaboratory variability study of EPA short-term chronic and acute whole effluent toxicity test methods, Vol. 1. Office of Water, U.S. Environmental Protection Agency, Washington, D.C. 20460. EPA/821/B-01/004.
- USEPA. 2001b. Final report: interlaboratory variability study of EPA short-term chronic and acute whole effluent toxicity test methods, Vol. 2: Appendix. Office of Water, U.S. Environmental Protection Agency, Washington, D.C. 20460.
- USEPA. 2002a. Short-term methods for estimating the chronic toxicity of effluents and receiving waters to freshwater organisms. Fourth edition. Office of Water, U. S. Environmental Protection Agency, Washington, DC 20460. EPA/821/R-02/013.
- USEPA. 2002b. Short-term methods for estimating the chronic toxicity of effluents and receiving waters to marine and estuarine organisms. Third edition. Office of Water, U. S. Environmental Protection Agency, Washington, DC 20460. EPA/821/R-02/014.
- Walters, D.B. and C.W. Jameson. 1984. Health and safety for toxicity testing. Butterworth Publ., Woburn, MA.
- Welch, P.S. 1948. Limnological methods. McGraw-Hill Book Company, New York.

BIBLIOGRAPHY

- Abram, F.S.H. 1973. Apparatus for control of poison concentration in toxicity studies with fish. *Water Res.* 7:1875-1879.
- Bartlett, M.S. 1936. Square root transformation in analysis of variance. *Suppl. J. Royal. Statist. Soc.* 3:68-78.
- Bengtson, B.E. 1972. A simple principle for dosing apparatus in aquatic systems. *Arch. Hydrobiol.* 70:413-415.
- Bennett, B.M. 1952. Estimation of LD50 by moving average angles. *J. Hygiene* 50:157-164.
- Benoit, D.A., V.R. Mattson, and D.L. Olson. 1982. A continuous-flow mini-dilutor system for toxicity testing. *Water Res.* 16:457-464.
- Bishop, W.E., R.D. Cardwell, and B.B. Heidolph, eds. 1983. *Aquatic toxicology and hazard assessment. Proceedings of the sixth annual symposium on aquatic toxicology.* ASTM STP 802, American Society for Testing and Materials, Philadelphia, Pennsylvania.
- Branson, D.R. and K.L. Dickson, eds. 1981. *Aquatic toxicology and hazard assessment. Proceedings of the fourth annual symposium on aquatic toxicology.* ASTM STP 737, American Society for Testing and Materials, Philadelphia, Pennsylvania.
- Brooke, L.T., D.J. Call, D.L. Geiger, and C.B. Northcott, eds. 1984. *Acute toxicities of organic chemical to fathead minnows (*Pimephales promelas*).* Vol. I. Center for Lake Superior Environmental Studies, Univ. Wisconsin, Superior, Wisconsin.
- Brungs, W.A. and D.I. Mount. 1967. A device for continuous treatment of fish in holding chambers. *Trans. Amer. Fish. Soc.* 96:55-57.
- Buikema, A.L. 1983. Inter- and intralaboratory variation in conducting static acute toxicity tests with *Daphnia magna* exposed to effluents and reference toxicants. American Petroleum Institute, API Publ. 4362, Washington, D.C.
- Buikema, A.L. and J. Cairns, Jr., eds. 1980. *Aquatic invertebrate bioassays.* ASTM STP 715, American Society for Testing and Materials, Philadelphia, Pennsylvania.
- Buikema, A.L., D.R. Lee, and J. Cairns, Jr. 1976. A screening bioassay using *Daphnia pulex* for refinery wastes discharged into freshwater. *J. Test. Eval.* 4(2):119-125.
- Buikema, A.L., Jr., B.R. Niederlehner, and J. Cairns, Jr. 1982. Biological monitoring. Part IV - toxicity testing. *Water Res.* 16:239-262.
- Cairns, J. Jr., K.L. Dickson, and A.W. Maki, eds. 1978. *Estimating the hazard of chemical substances to aquatic life.* ASTM STP 657, American Society for Testing and Materials, Philadelphia, Pennsylvania.
- Cairns, J., Jr. and D.I. Mount. 1990. *Aquatic toxicology.* *Environ. Sci. Technol.* 24(2):154-161.
- Casarett, L.J. and J. Doull. 1975. *Toxicology: the basic science of poisons.* Macmillan Publishing Co., New York.
- Cline, T.F. and G. Post. 1972. Therapy for trout eggs infected with *Saprolegnia*. *Prog. Fish-Cult.* 34:148-151.
- Davey, E.W., J.H. Gentile, S.J. Erickson, and P. Betzer. 1970. Removal of trace metals from marine culture media. *Limnol. Oceanogr.* 15:486-488.

- Davis, H.S. 1953. Culture and diseases of game fishes. University of California Press, Berkeley. 332 pp.
- DeFoe, D.L. 1975. Multichannel toxicant injection system for flow-through bioassays. J. Fish. Res. Bd. Can. 32:544-546.
- Eaton, J.G., R.R. Parrish, and A.C. Hendricks, eds. 1980. Aquatic toxicology. Proceedings of the third annual symposium on aquatic toxicology. ASTM STP 707, American Society for Testing and Materials, Philadelphia, Pennsylvania.
- Esenhart, C. 1947. Inverse sine transformation. Tech. Stat. Analysis, Chapt. 16, McGraw-Hill, New York, New York.
- FDA. 1978. Good laboratory practices for nonclinical laboratory studies. Part 58, Fed. Reg. 43(247):60013-60020, December 22, 1978.
- Finney, D.J. 1964. Statistical method in biological assay. 2nd ed. Hafner Publ. Company, New York, New York. 668 pp.
- Freeman, R.A. 1971. A constant flow delivery device for chronic bioassay. Trans. Amer. Fish. Soc. 100:135-136.
- Granmo, A. and S.O. Kollberg. 1972. A new simple water flow system for accurate continuous flow tests. Water Res. 6:1597-1599.
- Hart, W.B, P. Douderoff, and J. Greenbank. 1945. The evaluation of the toxicity of industrial wastes, chemicals and other substances to fresh-water fishes. Atlantic Refining Company, Philadelphia, Pennsylvania. 330 pp.
- Herwig, N. 1979. Handbook of drugs and chemicals used in the treatment of fish diseases. Charles C. Thomas, Pub., Springfield, Illinois. 272 pp.
- Hoffman, G.L. and F.P. Meyer. 1974. Parasites of freshwater fishes. THF Publ., Inc., Neptune City, New Jersey. 224 pp.
- Hoffman, G.L. and A.J. Mitchell. 1980. Some chemicals that have been used for fish diseases and pests. Fish Farming Experimental Station, U.S Fish and Wildlife Service, P.O. Box 860, Stuttgart, Arkansas 72160. Mimeograph. 8 pp.
- Kenaga, E.E. 1982. Predictability of chronic toxicity from acute toxicity of chemicals in fish and aquatic invertebrates. Environ. Toxicol. Chem. 1(4):347-348.
- Kester, D.R., I.W. Dredall, D.N. Connors, and R.M. Pytokowicz. 1967. Preparation of artificial seawater. Limnol. Oceanogr. 12:176-179.
- Lichatowich, J.A., P.W. O'Keefe, J.A. Strand, and W.L. Templeton. 1973. Development of methodology and apparatus for the bioassay of oil. In: Proceedings of joint conference on prevention and control of oil spills. American Petroleum Institute, U.S. Environmental Protection Agency, and U.S. Coast Guard, Washington, D.C. pp. 659-666.
- Lowe, J.I. 1964. Chronic exposure of spot, *Leiostomus xanthurus*, to sublethal concentrations of toxaphene in seawater. Trans. Amer. Fish. Soc. 93:396-399.
- Marking, L.L. and R.A. Kimerle, eds. 1979. Aquatic toxicology and hazard evaluation. Proceedings of the second annual symposium on aquatic toxicology. ASTM STP 667, American Society for Testing and Materials, Philadelphia, Pennsylvania.
- Martin, M., J.W. Hunt, B.S. Anderson, S.L. Turpen, and F.H. Palmer. 1989. Experimental evaluation of the mysid *Holmesimysis costata* as a test organism for effluent toxicity testing. Environ. Toxicol. Chem. 8: 1003-1012.
- Mayer, F.L. and J.L. Hamelink, eds. 1977. Aquatic toxicology and hazard evaluation. Proceedings of the first annual symposium. ASTM STP 634, American Society for Testing and Materials, Philadelphia, Pennsylvania.

- Mayes, M.A., H.C. Alexander, and D.C. Dill. 1983. A study to assess the influence of age on the response of fathead minnows in static acute toxicity tests. *Bull. Environ. Contam. Toxicol.* 31:139-147.
- Mount, D.I. and W.A. Brungs. 1967. A simplified dosing apparatus for fish toxicological studies. *Water Res.* 1:21-29.
- Nebeker, A.V. and A.B. Lemke. 1968. Preliminary studies on the tolerance to aquatic insects to heated waters. *J. Kans. Entomol. Soc.* 41:413-418.
- NTIS. 1990. Water pollution effects of metals on fresh water fish. April 1971-April 1990 (A bibliography from the NTIS database). National Technical Information Service, Springfield, Virginia. PB90-866534/WMB.
- NTIS. 1990. Toxic substances: effects on fish. January 1978-July 1989 (A bibliography from Pollution Abstracts). National Technical Information Service, Springfield, Virginia. PB90-866898/WMB.
- Pearson, J.G., R.B. Foster, and W.B. Bishop, eds. 1982. *Aquatic toxicology. Proceedings of the fifth annual symposium on aquatic toxicology.* ASTM STP 766, American Society for Testing and Materials, Philadelphia, Pennsylvania.
- Post, G.W. 1983. *Textbook of fish health.* T.F.H. Publ., Neptune, New Jersey. 256 pp.
- Reichenbach-Klinke, H. and B. Elkan. 1965. *The principal diseases of lower vertebrates.* Academic Press, New York. 600 pp.
- Riley, C.W. 1975. Proportional dilutor for effluent bioassays. *JWPCF* 47:2620-2626.
- Schimmel, S.C., D.J. Hansen, and J. Forester. 1974. Effects of Aroclor 1254 on laboratory-reared embryos and fry of sheepshead minnows (*Cyprinodon variegatus*). *Trans. Amer. Fish. Soc.* 103:582-586.
- Schimmel, S.C. and D.J. Hansen. 1974. Sheepshead Minnow (*Cyprinodon variegatus*): An estuarine fish suitable for chronic (entire lifecycle) bioassays. *Proceedings of the 28th Annual Conference of the Southeastern Association of Game and Fish Commissioners.* pp. 392-398.
- Skarheim, H.P. 1973. Tables of the fraction of ammonia in the undissociated form. SERL Report No. 73.5. University of California, Berkeley. 33 pp.
- Sniewzko, S.F. (ed.). 1970. *A symposium on diseases of fishes and shell-fishes.* Spec. Publ. No. 5, Amer. Fish. Soc., Washington, D.C. 526 pp.
- Sprague, J.B. and A. Fogels. 1977. Watch the Y in bioassay. *Proceedings of the 3rd Aquatic Toxicity Workshop, Halifax, N.S., Nov. 2-3, 1976. Environm. Prot. Serv. Tech. Rpt. No. EPS-5-AR-77-1, Halifax, Canada.* pp.107-118.
- Stephan, C.E. 1977. Methods for calculating an LC50. In: F.L. Mayer and J.L. Hamelink, eds., *Aquatic Toxicology and Hazard Evaluation, ASTM STP 634, American Society for Testing and Materials, Philadelphia, Pennsylvania.* pp. 65-84.
- Stephan, C.E. 1982. Increasing the usefulness of acute toxicity tests. In: J.G. Pearson, R.B. Foster, and W.E. Bishop, eds., *Aquatic Toxicity and Hazard Assessment. ASTM STP 766, American Society for Testing and Materials, Philadelphia, Pennsylvania.* pp. 69-81.
- Tebo, L.B. 1986. Effluent monitoring - historical perspective. pp. 12-31, In: Ward, C.H., and B.T. Walton, eds., *Environmental Hazard Assessment of Effluents, Proc. Pelston Workshop, Cody, Wyoming, August 22-27, 1982. Spec. Publ. Soc. Environ. Tox. Chem. Pergamon Press, New York, NY.* 366 pp.

- USEPA. 1972. Recommended bioassay procedure for fathead minnow *Pimephales promelas* Rafinesque chronic tests. U.S. Environmental Protection Agency, National Water Quality Laboratory, Duluth, Minnesota. 13 pp.
- USEPA. 1973a. Water quality criteria 1972. A report of the Committee on Water Quality Criteria, Environmental Studies Board, National Academy of Engineering, National Academy of Sciences, Washington, D.C. U. S. Environmental Protection Agency, Washington, D.C. EPA-R3-73-033. 594 pp.
- USEPA. 1973b. Impairment of the flavor of fish by water pollutants. Ecological Research Series No. EPA/R373010. U. S. Environmental Protection Agency, Washington, D.C. 80 pp.
- USEPA. 1975. Methods for acute toxicity tests with fish, macroinvertebrates and amphibians. U.S. Environmental Protection Agency, National Water Quality Research Laboratory, Duluth, Minnesota. 61 pp.
- USEPA. 1978a. Manual for construction of toxicity-testing proportional dilutors. Environmental Research Laboratory, U.S. Environmental Protection Agency, Duluth, Minnesota. EPA-600/3-78-072.
- USEPA. 1978b. Manual for construction and operation of toxicity-testing proportional dilutors. Environmental Research Laboratory, U.S. Environmental Protection Agency, Duluth, Minnesota. PB-287-606-8BE.
- USEPA. 1978c. Methods for measuring the acute toxicity of effluents to aquatic life. 1st ed. Environmental Monitoring and Support Laboratory, U.S. Environmental Protection Agency, Cincinnati, Ohio. EPA/600/4-78/012.
- USEPA. 1978d. Methods for measuring the acute toxicity of effluents to aquatic life. 2nd ed. Environmental Monitoring and Support Laboratory, U.S. Environmental Protection Agency, Cincinnati, Ohio. EPA 600/4-78/012.
- USEPA. 1979. Good laboratory practice standards for health effects. Paragraph 772.110-1, Part 772 - Standards for development of test data. Fed. Reg. 44:27362-27375, May 9, 1979.
- USEPA. 1981a. IERL-RTP procedures manual: Level 1 environmental assessment biological tests. Industrial Environmental Research Laboratory, U.S. Environmental Protection Agency, Research Triangle Park, N. Carolina. EPA-600/8-81-024.
- USEPA. 1981b. Effluent toxicity screening test using *Daphnia* and mysid shrimp. Environmental Monitoring and Support Laboratory, U.S. Environmental Protection Agency, Cincinnati, Ohio.
- USEPA. 1982. Methods for organic chemical analysis of municipal and industrial wastewater. Environmental Monitoring and Support Laboratory, U.S. Environmental Protection Agency, Cincinnati, Ohio. EPA-600/4-82-057.
- USEPA. 1984. Development of water quality-based permit limitations for toxic pollutants: national policy. Fed. Reg. 49(48):9016-9019. Friday, March 9, 1984.
- USEPA. 1985. Methods for measuring the acute toxicity of effluents to freshwater and marine organisms. 3rd ed. Environmental Monitoring and Support Laboratory, U. S. Environmental Protection Agency, Cincinnati, Ohio. EPA 600/4-85/013.
- van Duijn, C., Jr. 1973. Diseases of fishes. 3rd ed., Charles C. Thomas Publ., Springfield, Illinois. 309 pp.
- Walters, D.B. and C.W. Jameson. 1984. Health and safety for toxicity testing. Butterworth Publ., Woburn, Massachusetts.

Zarogian, G. E., G. Pesch, and G. Morrison. 1969. Formulation of an artificial sea water media suitable for oyster larvae development. *Amer. Zool.* 9:1141.

Zillioux, E.J., H.R. Foulk, J.C. Prager, and J.A. Cardin. 1973. Using *Artemia* to assay oil dispersant toxicities. *JWPCF* 45:2389-2396.

APPENDICES

A.	Distribution, Life Cycle, Taxonomy, and Culture Methods	125
	A.1. <i>Ceriodaphnia dubia</i> —Prepared by Philip A. Lewis and James M. Lazorchak . .	125
	A.2. <i>Daphnia</i> (<i>Daphnia magna</i> and <i>D. pulex</i>)—Prepared by Philip A. Lewis and James M. Lazorchak	140
	A.3. Mysids (<i>Mysidopsis bahia</i> and <i>Holmesimysis costata</i>)—Prepared by Stephen H. Ward	159
	A.4. Brine Shrimp (<i>Artemia salina</i>)—Prepared by Philip A. Lewis and David A. Bengtson	178
	A.5. Fathead Minnow (<i>Pimephales promelas</i>)—Prepared by Donald J. Klemm, Quentin H. Pickering, and Mark E. Smith	185
	A.6. Rainbow Trout (<i>Oncorhynchus mykiss</i>) and Brook Trout (<i>Salvelinus fontinalis</i>)—Prepared by Donald J. Klemm	201
	A.7. Sheepshead Minnow (<i>Cyprinodon variegatus</i>)—Prepared by Donald J. Klemm	209
	A.8. Silversides: Inland Silverside (<i>Menidia beryllina</i>), Atlantic Silverside, (<i>M. menidia</i> , and Tidewater Silverside (<i>M. peninsulae</i>)—Prepared by Douglas P. Middaugh and Donald J. Klemm . . .	224
B.	Supplemental List of Acute Toxicity Test Species—Prepared by Margarete A. Heber	238
C.	Dilutor Systems—Prepared by William H. Peltier	240
D.	Plans for Mobile Toxicity Test Laboratory—Prepared by William H. Peltier	253
	D.1. Tandem-Axle Trailer	253
	D.2. Fifth Wheel Trailer	256
E.	Check Lists and Information Sheets—Prepared by William H. Peltier	257
	E.1. Toxicity Test Field Equipment List	257
	E.2. Information Check List for On-Site Industrial or Municipal Toxicity Test . . .	259
	E.3. Daily Event Log	264
	E.4. Dilutor Calibration Form	265
	E.5. Daily Dilutor Calibration Check	266

APPENDIX A

DISTRIBUTION, LIFE CYCLE, TAXONOMY, AND CULTURE METHODS

A.1. *CERIODAPHNIA DUBIA*

1. SYSTEMATICS

1.1 MORPHOLOGY AND TAXONOMY

1.1.1 *Ceriodaphnia* are closely related and morphologically similar to *Daphnia*, but are smaller and have a shorter generation time (USEPA, 1986). They are generally more rotund, lack the prominent rostral projection typical of *Daphnia*, and do not develop the dorsal helmets and long posterior spines often observed in *Daphnia*.

1.1.2 With *Ceriodaphnia dubia*, the female has a heavy, setulated pecten on the postabdominal claw (Figure 1A), and the male has long antennules (Figure 1C), in contrast to the closely related *C. reticulata*, where the female has heavy, triangular denticles in the pecten of the postabdominal claw (Figure 2A), and the male has very short antennules (Figure 2C). Some clones having intermediate characters may be hybrids or phenotypic variants of *C. dubia* (USEPA, 1986). Detailed descriptions of the males and females of both species and the variant were given by USEPA (1986).

1.1.3 Although males are very similar to females, they can be recognized by their rapid, erratic swimming habit, smaller size, denser coloration, extended antennules and claspers, and rostrum morphology.

2. ECOLOGY AND LIFE HISTORY

2.1 DISTRIBUTION

2.1.1 *C. dubia*, has been reported from littoral areas of lakes, ponds, and marshes throughout most of the world, but it is difficult to ascertain its true distribution because it has been reported in the literature under several other names (*C. affinis*, *C. quadrangula*, and *C. reticulata*). It has also been suggested that reports of *C. dubia* in New Zealand and parts of Asia may be yet another unnamed species (Berner, personal communication).

2.2 ECOLOGY

2.2.1 *Ceriodaphnia* ecology and life history are very similar to those of other daphnids. Specific information on the ecology and life history of *Ceriodaphnia dubia* is either not available or is widely scattered throughout the literature. However, it is known to be a pond and lake dwelling species that is usually common among the vegetation in littoral areas (Fairchild, 1981). In the Lake of Velence, Hungary, *C. dubia* was most common in regions where "grey" and "dark brown" waters merged (Pal, 1980). In Par Pond (Savannah River Plant, Aiken, SC) the *Ceriodaphnia* were much more abundant in the heated water (effluent from the nuclear reactor) than in the ambient area (Vigerstad and Tilly, 1977), and in a reservoir in Russia, animals from the heated water were larger and heavier than those living under normal water temperatures (Kititsyna and Sergeeva, 1976). In Iran they are common in warmer, montane, oligotrophic lakes (Smagowicz, 1976).

2.2.2 In Lake Kinneret, Israel, *Ceriodaphnia reticulata* are abundant only between March and June, with a peak in May when the temperature ranges between 20 and 22°C. When summer temperatures reached 27-28°C, the *Ceriodaphnia* were reduced in size and egg production became significantly less, leading to a progressive decline of the population (Gophen, 1976). In Lake Parvin, France, the period of development was from June to September (Devaux, 1980).

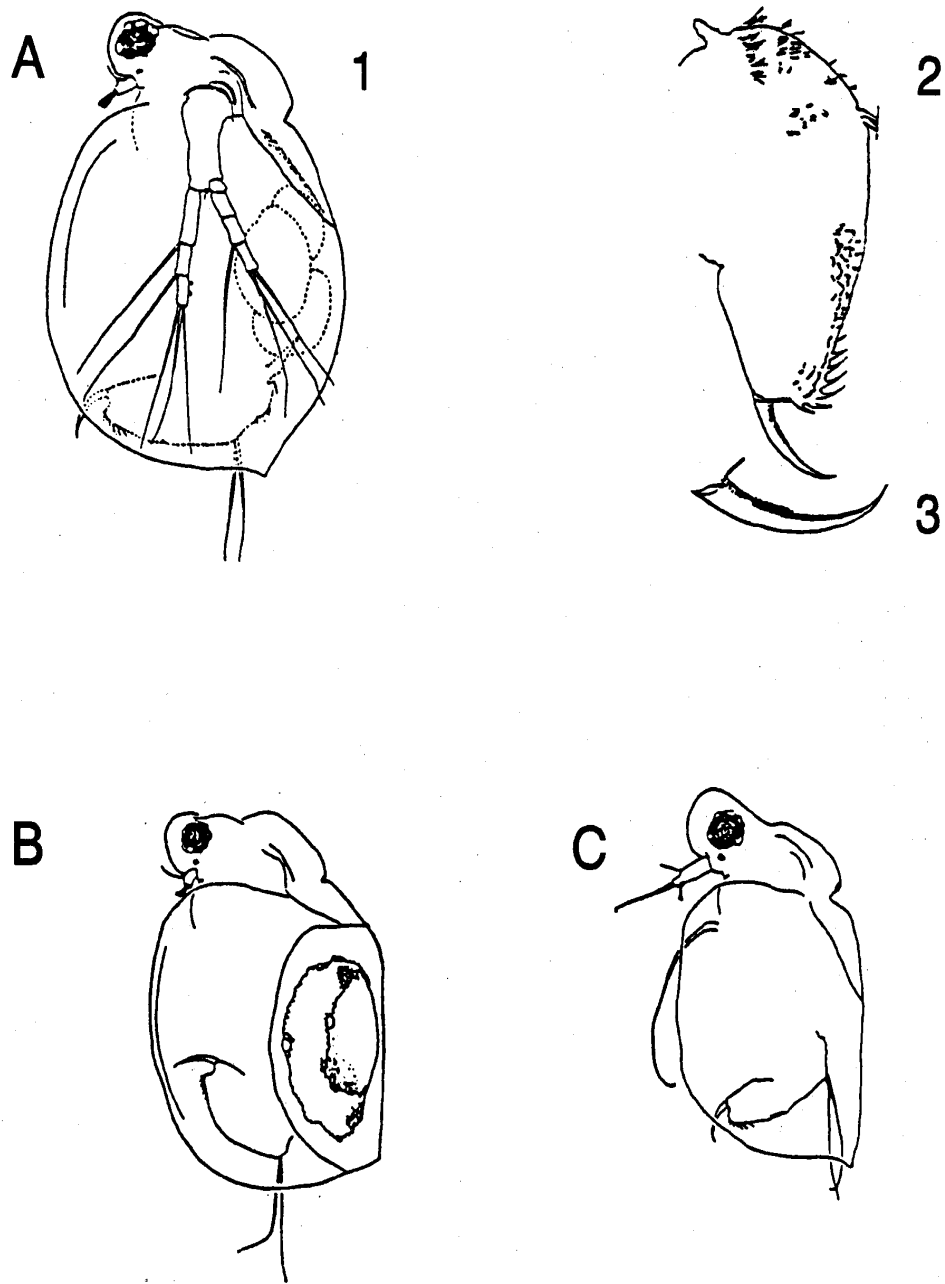

Figure 1. *Ceriodaphnia dubia*. A. (1) parthenogenetic female, (2) postabdomen, and (3) claw; B. ehippial female; C. Male. (From USEPA, 1986)

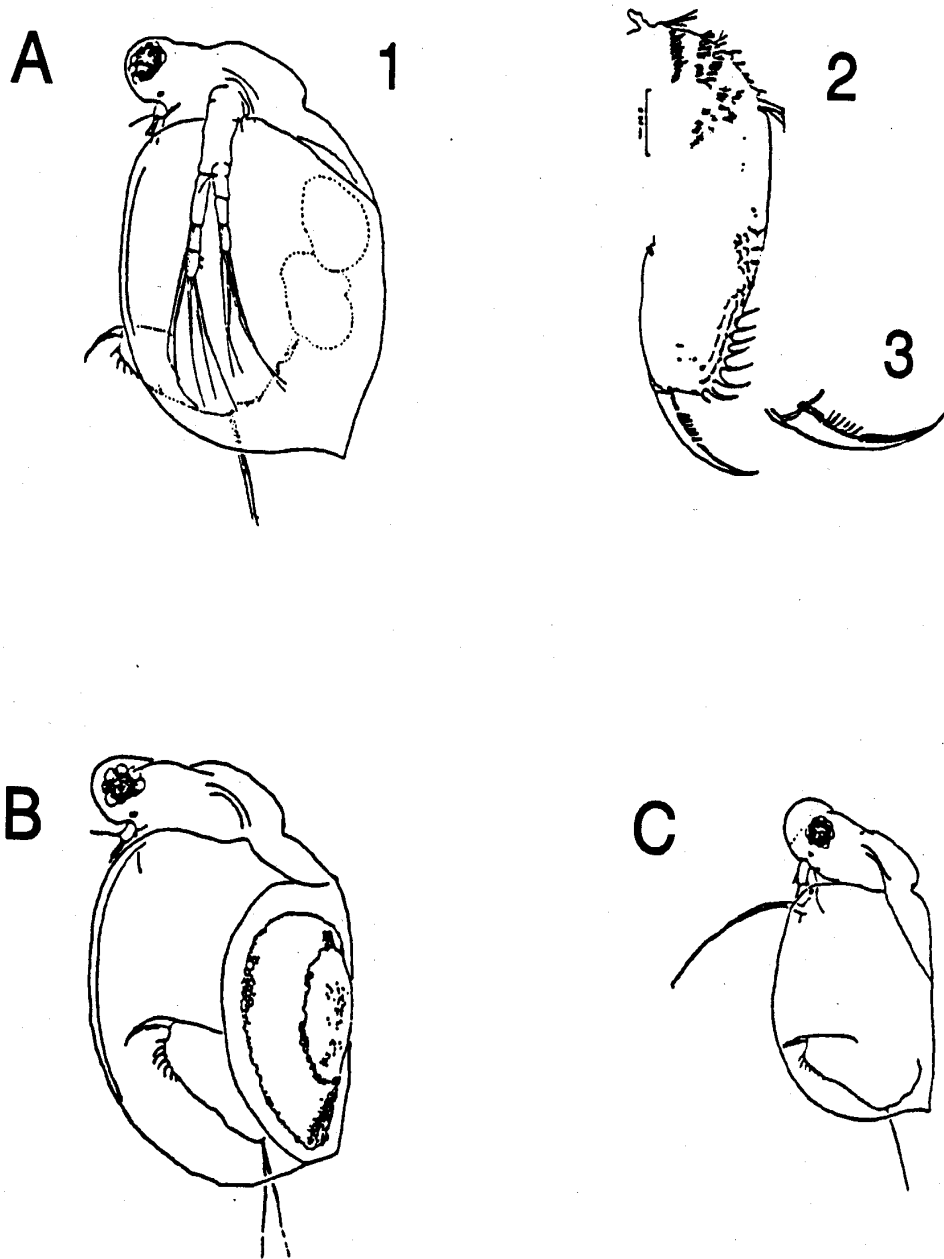

Figure 2. *Ceriodaphnia reticulata*. A. (1) parthenogenetic female, (2) postabdomen, (3) and claw; B. ephippial female; C. Male. (From USEPA, 1986)

2.2.3 *Ceriodaphnia* typically swim with an erratic, jerking motion for a period of time, and hang motionless in the water between swimming bouts. This swimming behavior results in a mean speed of 1.5-2.5 mm/s. When approached by a predator, however, it flees by swimming away quickly along a straight path (Wong, 1981).

2.2.4 During most of the year, populations of *Ceriodaphnia* consist almost entirely of females; the males appearing principally in autumn. Production of males appears to be induced primarily by low water temperatures, high population densities, and/or a decrease in available food. As far as is presently known, *C. dubia* reproduce only by cyclic parthenogenesis in which the males contribute to the genetic makeup of the young during the sexual stage of reproduction.

2.2.5 The females tend to aggregate during sexual reproductive activity, when ephippia are produced (Brandl and Fernando, 1971). Ephippia are embryos encased in a tough covering, and are resistant to drying. They can be stored for long periods and shipped through the mail in envelopes, like seeds. When placed in water at the proper temperature, ephippia hatch in a few days producing a new parthenogenetic population.

2.2.6 *Ceriodaphnia* have many predators, including fish, the mysid *Mysis relicta*, *Chaoborus* larvae, and copepods. As with *Daphnia*, it also reacts to intense predation with defensive strategies. *Ceriodaphnia reticulata* (possibly *C. dubia*) in a Minnesota lake, reacted to the copepod, *Cyclops vernalis*, by producing large offspring and growing to a large size at the expense of early reproduction (Lynch, 1979). They reacted to fish predators by producing smaller offspring in larger numbers.

2.3 FOOD AND FEEDING

2.3.1 Cladocera are polyphagous feeders and find their food in the seston. Daphnids, including the *Ceriodaphnia*, are classified as fine mesh filter feeders by Geller and Mueller (1981). These fine mesh filter feeders are most abundant in eutrophic lakes during summer phytoplankton blooms when suspended bacteria are available as food only for filter-feeding species with fine mesh.

2.3.2 Lynch (1978) examined the gut contents of *Ceriodaphnia reticulata* (possibly *C. dubia*) from a Minnesota pond and found bacteria, detritus and partially digested algae. In this pond, *Ceriodaphnia* and *Daphnia pulex* shared the same resource base and had very similar diets, but the *Ceriodaphnia* fed more intensively on diatoms. The *Ceriodaphnia* were considered to be less sensitive to low food levels than *Daphnia*, because of their high rate of population growth during periods of low food levels in late summer.

2.4 LIFE CYCLE

2.4.1 Four distinct periods may be recognized in the life cycle of *Ceriodaphnia*: (1) egg, (2) juvenile, (3) adolescent, and (4) adult. The life span of *Ceriodaphnia*, from the release of the egg into the brood chamber until the death of the adult, is highly variable depending on the temperature and other environmental conditions. Generally the life span increases as temperature decreases, due to lowered metabolic activity. For example, the average life span of *Ceriodaphnia dubia* is about 30 days at 25°C, and 50 days at 20°C. One female was reported to have lived 125 days and produced 29 broods at 20°C (Cowgill et al., 1985).

2.4.2 Typically, a clutch of 4 to 10 eggs is released into the brood chamber, but clutches with as many as 20 eggs are common. The eggs hatch in the brood chamber and the juveniles, which are already similar in form to the adults, are released in approximately 38 h, when the female molts (casts off her exoskeleton or carapace). The total number of young produced per female varies with temperature and other environmental conditions. The most young are produced in the range of 18-25°C (124 young per female in a 28-day life span at 24°C) (113 young per female in a 77-day life span at 18°C) but production falls off sharply below 18°C (13 young per female in a 24-day life span at 12°C) (McNaught and Mount, 1985).

2.4.3 The time required to reach maturity (produce their first offspring) in *C. dubia* varies from three to five days and appears to be dependent on body size and environmental conditions. A study of the growth and development of parthenogenetic eggs by Shuba and Costa (1972) revealed that at 24°C the embryos matured to free-swimming juveniles in approximately 38 h. The eggs that did not develop fully usually were aborted after 12 hours.

2.4.4 The growth rate of the organism is greatest during its juvenile stages (early instars), and the body size may double during each of these stages. Each instar stage is terminated by a molt. Growth occurs immediately after each molt while the new carapace is still elastic.

2.4.5 Following the juvenile stages, the adolescent period is very short, and consists of a single instar. It is during the adolescent instar that the first clutch of eggs reaches full development in the ovary. Generally, eggs are deposited in the brood chamber within minutes after molting, and the young which develop are released just before the next molt.

2.4.6 In general, the duration of instars increases with age, but also depends on environmental conditions. A given instar usually lasts approximately 24 h under favorable conditions. However, when conditions are unfavorable, it may last as long as a week. Four events take place in a matter of a few minutes at the end of each adult instar: (1) release of young from the brood chamber to the outside, (2) molting, (3) increase in size, and (4) release of a new clutch of eggs into the brood chamber. The number of young per brood is highly variable, depending primarily on food availability and environmental conditions. *C. dubia* may produce as many as 25 young in a single brood, but more commonly the number is six to ten. The number of young released during the adult instars reaches a maximum at about the fourth instar, after which there is a gradual decrease.

3. CULTURING METHODS

3.1 *Ceriodaphnia* are available from commercial biological supply houses. Guidance on the source of culture animals to be used by a permittee for self-monitoring effluent toxicity tests should be obtained from the permitting authority. Only a small number of organisms (20-30) are needed to start a culture. Before test organisms are taken from a culture, the culture should be maintained for at least two generations using the same food, water, and temperature as will be used in the toxicity tests.

3.2 Cultures of test organisms should be started at least three weeks before the brood animals are needed, to ensure an adequate supply of neonates for the test. Only a few individuals are needed to start a culture because of their prolific reproduction.

3.3 Starter animals may be obtained from an outside source by shipping in polyethylene bottles. Approximately 20-30 animals and 3 mL of food (see below) are placed in a 1-L bottle filled full with culture water. Animals received from an outside source should be transferred to new culture media gradually over a period of 1-2 days to avoid mass mortality.

3.4 It is best to start the cultures with one animal, which is sacrificed after producing young, embedded, and retained as a permanent microscope slide mount to facilitate identification and permit future reference. The species identification of the stock culture should be verified by a taxonomic authority. The following procedure is recommended for making slide mounts of *Ceriodaphnia* (Beckett and Lewis, 1982):

1. Pipet the animal onto a watch glass.
2. Reduce the water volume by withdrawing excess water with the pipet.
3. Add a few drops of carbonated water (club soda or seltzer water) or 70% ethanol to relax the specimen so that the post-abdomen is extended. (Optional: with practice, extension of the postabdomen may be accomplished by putting pressure on the cover slip).
4. Place a small amount (one to three drops) of mounting medium on a glass microscope slide. The recommended mounting medium is CMCP-9/9AF Medium, prepared by mixing two parts of CMCP-9 with

one part of CMCP-9AF. For more viscosity and faster drying, CMC-10 stained with acid fuchsin may be used.

5. Using a forceps or a pipet, transfer the animal to the drop of mounting medium on the microscope slide.
6. Cover with a cover slip and exert minimum pressure to remove any air bubbles trapped under the cover slip. Slightly more pressure will extend the postabdomen.
7. Allow mounting medium to dry.
8. Make slide permanent by placing CMC-10 around the edges of the coverslip.
9. Identify to species (see Pennak, 1989, and USEPA, 1986).
10. Label with waterproof ink or diamond pencil.
11. Store for permanent record.

3.5 CULTURE MEDIA

3.5.1 Although *Ceriodaphnia* stock cultures can be successfully maintained in some tap waters, well waters, and surface waters, use of synthetic water as the culture medium is recommended because (1) it is easily prepared, (2) it is of known quality, (3) it yields reproducible results, and (4) allows adequate growth and reproduction. Culturing may be successfully done in hard, moderately hard or soft reconstituted water, depending on the hardness of the water in which the test will be conducted. The quality of the dilution water is extremely important in *Ceriodaphnia* culture. The use of MILLIPORE MILLI-Q® or SUPER-Q®, or equivalent, to prepare reconstituted water is highly recommended. The use of diluted mineral water (DMW) for culturing and testing is widespread due to the ease of preparation.

3.5.2 The chemicals used and instructions for preparation of reconstituted water are given in Section 7, Dilution Water. The compounds are dissolved in distilled or deionized water and the media are vigorously aerated for several hours before using. The initial pH of the media is between 7.0 and 8.0, but it will rise as much as 0.5 unit after the test is underway.

3.6 MASS CULTURE

3.6.1 Mass cultures are used only as a "backup" reservoir of organisms. Neonates from mass cultures are not to be used directly in toxicity tests.

3.6.2 One-liter or 2L glass beakers, crystallization dishes, "battery jars," or aquaria may be used as culture vessels. Vessels are commonly filled to three-fourths capacity. Cultures are fed daily. Four or more cultures are maintained in separate vessels and with overlapping ages to serve as back-up in case one culture is lost due to accident or other unanticipated problems, such as low DO concentrations or poor quality of food or laboratory water.

3.6.3 Mass cultures which will serve as a source of brood organisms for individual culture should be maintained in good condition by frequent renewal of the medium and brood organisms. Cultures are started by adding 40-50 neonates per liter of medium. The stocked organisms should be transferred to new culture medium at least twice a week for two weeks. After two weeks, the culture is discarded and re-started with neonates in fresh medium. Using this schedule, 1-L cultures will produce 500 to 1000 neonate *Ceriodaphnia* each week.

3.6.6 Reserve cultures also may be maintained in large (80-L) aquaria or other large tanks.

3.7 INDIVIDUAL CULTURE

3.7.1 Individual cultures are used as the immediate source of neonates for toxicity tests.

3.7.2 Individual organisms are cultured in 15 mL of culture medium in 30-mL (1 oz) plastic cups or 30-mL glass beakers. One neonate is placed in each cup. It is convenient to place the cups in the same type of board used for toxicity tests.

3.7.3 Organisms are fed daily and are transferred to fresh medium a minimum of three times a week, typically on Monday, Wednesday, and Friday. On the transfer days, food is added to the new medium immediately before or after the organisms are transferred.

3.7.4 To provide cultures of overlapping ages, new boards are started weekly, using neonates from adults which produce at least eight young in their third or fourth brood. These adults can be used as sources of neonates until 14 days of age. A minimum of two boards are maintained concurrently to provide backup supplies of organisms in case of problems.

3.7.5 Cultures which are properly maintained should produce at least 20 young per adult in three broods (seven days or less at 25°C). Typically, 60 adult females (one board) will produce more than the minimum number of neonates (120) required for two tests.

3.7.6 Records should be maintained on the survival of brood organisms and number of offspring at each renewal. Greater than 20% mortality of adults or less than an average of 20 young per adult on a board at 25°C during a one-week period would indicate problems, such as poor quality of culture media or food. Organisms on that board should not be used as a source of test organisms.

3.8 CULTURE MEDIUM

3.8.1 Moderately hard synthetic water prepared using MILLIPORE MILLI-Q® or equivalent deionized water and reagent grade chemicals or 20% DMW is recommended as a standard culture medium (see Section 7, Dilution Water).

3.9 CULTURE CONDITIONS

3.9.1 *Ceriodaphnia* should be cultured at the temperature at which they will be used in the toxicity tests (20°C or 25°C ± 2°C).

3.9.2 Day/night cycles prevailing in most laboratories will provide adequate illumination for normal growth and reproduction. A 16-h/8-h day/night cycle is recommended.

3.9.3 Clear, double-strength safety glass or 6 mm plastic panels are placed on the culture vessels to exclude dust and dirt, and reduce evaporation.

3.9.4 The organisms are delicate and should be handled as carefully and as little as possible so that they are not unnecessarily stressed. They are transferred with a pipet of approximately 2-mm bore, taking care to release the animals under the surface of the water. Any organism that is injured during handling should be discarded.

3.10 FOOD PREPARATION AND FEEDING

3.10.1 Feeding the proper amount of the right food is extremely important in *Ceriodaphnia* culturing. The key is to provide sufficient nutrition to support normal reproduction without adding excess food which may reduce the toxicity of the test solutions, clog the animal's filtering apparatus, or greatly decrease the DO concentration and increase mortality. A combination of Yeast, CEROPHYLL®, and Trout chow (YCT) or flake food, along with the unicellular green alga, *Selenastrum capricornutum*, will provide suitable nutrition if fed daily.

3.10.2 The YCT and algae are prepared as follows:

3.10.2.1 Digested trout chow (or flake food):

1. Preparation of trout chow requires one week. Use starter or No. 1 pellets prepared according to

- current U.S. Fish and Wildlife Service specifications, or flake food.
2. Add 5.0 g of trout chow pellets or flake food to 1 L of MILLI-Q[®] water. Mix well in a blender and pour into a 2-L separatory funnel. Digest prior to use by aerating continuously from the bottom of the vessel for one week at ambient laboratory temperature. Water lost due to evaporation is replaced during digestion. Because of the offensive odor usually produced during digestion, the vessel should be placed in a fume hood or other isolated, ventilated area.
 3. At the end of digestion period, place in a refrigerator and allow to settle for a minimum of 1 h. Filter the supernatant through a fine mesh screen (i.e., NITEX[®] 110 mesh). Combine with equal volumes of supernatant from CEROPHYLL[®] and yeast preparations (below). The supernatant can be used fresh, or frozen until use. Discard the sediment.

3.10.2.2 Yeast:

1. Add 5.0 g of dry yeast, such as FLEISCHMANN'S[®] to 1 L of MILLI-Q[®] water.
2. Stir with a magnetic stirrer, shake vigorously by hand, or mix with a blender at low speed, until the yeast is well dispersed.
3. Combine the yeast suspension immediately (do not allow to settle) with equal volumes of supernatant from the trout chow (above) and CEROPHYLL[®] preparations (below). Discard excess material.

3.10.2.3 CEROPHYLL[®] (Dried, Powdered, Cereal Leaves):

1. Place 5.0 g of dried, powdered, cereal leaves in a blender. Dried, powdered, alfalfa leaves obtained from health food stores have been found to be a satisfactory substitute for cereal leaves.
2. Add 1 L of MILLI-Q[®] water.
3. Mix in a blender at high speed for 5 min, or stir overnight at medium speed on a magnetic stir plate.
4. If a blender is used to suspend the material, place in a refrigerator overnight to settle. If a magnetic stirrer is used, allow to settle for 1 h. Decant the supernatant and combine with equal volumes of supernatant from trout chow and yeast preparations (above). Discard excess material.

3.10.2.4 Combined YCT Food:

1. Mix equal (approximately 300 mL) volumes of the three foods as described above.
2. Place aliquots of the mixture in small (50-mL to 100-mL) screw-cap plastic bottles and freeze until needed.
3. Freshly prepared food can be used immediately, or it can be frozen until needed. Thawed food is stored in the refrigerator between feedings, and is used for a maximum of two weeks.
4. It is advisable to measure the dry weight of solids (dry 24 h at 105°C) in each batch of YCT before use. The food should contain 1.7 - 1.9 g solids/L. Cultures or test solutions should contain 12-13 mg solids/L.

3.10.3 Algal (*Selenastrum*) Food

3.10.3.1 Algal Culture Medium

1. Prepare (five) stock nutrient solutions using reagent grade chemicals as described in Table 1.
2. Add 1 mL of each stock solution, in the order listed in Table 1, to approximately 900 mL of MILLI-Q[®] water. Mix well after the addition of each solution. Dilute to 1 L and mix well. The final concentration of macronutrients and micronutrients in the culture medium is given in Table 2.

TABLE 1. NUTRIENT STOCK SOLUTIONS FOR MAINTAINING ALGAL STOCK CULTURES AND TEST CONTROL CULTURES

STOCK SOLUTION	COMPOUND	AMOUNT DISSOLVED IN 500 ML MILLI-Q® WATER
1. MACRONUTRIENTS		
A.	MgCl ₂ •6H ₂ O	6.08 g
	CaCl ₂ •2H ₂ O	2.20 g
	NaNO ₃	12.75 g
B.	MgSO ₄ •7H ₂ O	7.35 g
C.	K ₂ HPO ₄	0.522 g
D.	NaHCO ₃	7.50 g
2. MICRONUTRIENTS:		
	H ₃ BO ₃	92.8 mg
	MnCl ₂ •4H ₂ O	208.0 mg
	ZnCl ₂	1.64 mg ^a
	FeCl ₃ •6H ₂ O	79.9 mg
	CoCl ₂ •6H ₂ O	0.714 mg ^b
	Na ₂ MoO ₄ •2H ₂ O	3.63 mg ^c
	CuCl ₂ •2H ₂ O	0.006 mg ^d
	Na ₂ EDTA•2H ₂ O	150.0 mg
	Na ₂ SeO ₄	1.196 mg ^e

^aZnCl₂ - Weigh out 164 mg and dilute to 100 mL. Add 1 mL of this solution to Stock #2.

^bCoCl₂•6H₂O - Weigh out 71.4 mg and dilute to 100 mL. Add 1 mL of this solution to Stock #2.

^cNa₂MoO₄•2H₂O - Weigh out 36.6 mg and dilute to 10 mL. Add 1 mL of this solution to Stock #2.

^dCuCl₂•2H₂O - Weigh out 60.0 mg and dilute to 1000 mL. Take 1 mL of this solution and dilute to 10 mL. Take 1 mL of the second dilution and add to Stock #2.

^eNa₂SeO₄ - Weigh out 119.6 mg and dilute to 100 mL. Add 1 mL of this solution to Stock #2.

TABLE 2. FINAL CONCENTRATION OF MACRONUTRIENTS AND MICRONUTRIENTS IN THE CULTURE MEDIUM

MACRONUTRIENT	CONCENTRATION (MG/L)	ELEMENT	CONCENTRATION (MG/L)
NaNO ₃	25.5	N	4.20
MgCl ₂ •6H ₂ O	12.2	Mg	2.90
CaCl ₂ •2H ₂ O	4.41	Ca	1.20
MgSO ₄ •7H ₂ O	14.7	S	1.91
K ₂ HPO ₄	1.04	P	0.186
NaHCO ₃	15.0	Na	11.0
		K	0.469
		C	2.14
MICRONUTRIENT	CONCENTRATION (μG/L)	ELEMENT	CONCENTRATION (μG/L)
H ₃ BO ₃	185	B	32.5
MnCl ₂ •4H ₂ O	416	Mn	115
ZnCl ₂	3.27	Zn	1.57
CoCl ₂ •6H ₂ O	1.43	Co	0.354
CuCl ₂ •2H ₂ O	0.012	Cu	0.004
Na ₂ MoO ₄ •2H ₂ O	7.26	Mo	2.88
FeCl ₃ •6H ₂ O	160	Fe	33.1
Na ₂ EDTA•2H ₂ O	300	--	----
Na ₂ SeO ₄	2.39	Se	1.00

3. Immediately filter the medium through a 0.45 μm pore diameter membrane at a vacuum of not more than 380 mm (15 in.) mercury, or at a pressure of not more than one-half atmosphere (8 psi). Wash the filter with 500 mL deionized water prior to use.
4. If the filtration is carried out with sterile apparatus, filtered medium can be used immediately, and no further sterilization steps are required before the inoculation of the medium. The medium can also be sterilized by autoclaving after it is placed in the culture vessels.
5. Unused sterile medium should not be stored more than one week prior to use, because there may be substantial loss of water by evaporation.

3.10.3.2 Algal Cultures

3.10.3.2.1 Two types of algal cultures are maintained: (1) stock cultures, and, (2) "food" cultures.

3.10.3.2.2 Establishing and Maintaining Stock Cultures of Algae

1. Upon receipt of the "starter" culture (usually about 10 mL), a stock culture is initiated by aseptically transferring one milliliter to each of several 250-mL culture flasks containing 100 mL algal culture medium (prepared as described above). The remainder of the starter culture can be held in reserve for up to six months in a refrigerator (in the dark) at 4°C.
2. The stock cultures are used as a source of algae to initiate "food" cultures for *Ceriodaphnia* toxicity tests. The volume of stock culture maintained at any one time will depend on the amount of algal food required for the *Ceriodaphnia* cultures and tests. Stock culture volume may be rapidly "scaled up" to several liters, if necessary, using 4-L serum bottles or similar vessels, each containing 3 L of growth medium.
3. Culture temperature is not critical. Stock cultures may be maintained in environmental chambers with cultures of other organisms if the illumination is adequate (continuous "cool-white" fluorescent lighting of approximately $86 \pm 8.6 \mu\text{E}/\text{m}^2/\text{s}$, or 400 ft-c).
4. Cultures are mixed twice daily by hand or stirred continuously.
5. Stock cultures can be held in the refrigerator until used to start "food" cultures, or can be transferred to new medium weekly. One-to-three milliliters of 7-day old algal stock culture, containing approximately 1.5×10^6 cells/mL, are transferred to each 100 mL of fresh culture medium. The inoculum should provide an initial cell density of approximately 10,000-30,000 cells/mL in the new stock cultures. Aseptic techniques should be used in maintaining the stock algal cultures, and care should be exercised to avoid contamination by other microorganisms.
6. Stock cultures should be examined microscopically weekly, at transfer, for microbial contamination. Reserve quantities of culture organisms can be maintained for 6-12 months if stored in the dark at 4°C. It is advisable to prepare new stock cultures from "starter" cultures obtained from established outside sources of organisms every four to six months.

3.10.3.2.3 Establishing and Maintaining "Food" Cultures of Algae

1. "Food" cultures are started seven days prior to use for *Ceriodaphnia* cultures and tests. Approximately 20 mL of 7-day-old algal stock culture (described in the previous paragraph), containing 1.5×10^6 cells/mL, are added to each liter of fresh algal culture medium (i.e., 3 L of medium in a 4-L bottle, or 18 L in a 20-L bottle). The inoculum should provide an initial cell density of approximately 30,000 cells/mL. Aseptic techniques should be used in preparing and maintaining the cultures, and care should be exercised to avoid contamination by other microorganisms. However, sterility of food cultures is not as critical as in stock cultures because the food cultures are terminated in 7-10 days. A one-month supply of algal food can be grown at one time, and the excess stored in the refrigerator.
2. Food cultures may be maintained at 25°C in environmental chambers with the algal stock cultures or cultures of other organisms if the illumination is adequate (continuous "cool-white" fluorescent

lighting of approximately $86 \pm 8.6 \mu\text{E}/\text{m}^2/\text{s}$, or 400 ft-c).

3. Cultures are mixed continuously on a magnetic stir plate (with a medium size stir bar) or in a moderately aerated separatory funnel, or are mixed twice daily by hand. If the cultures are placed on a magnetic stir plate, heat generated by the stirrer might elevate the culture temperature several degrees. Caution should be exercised to prevent the culture temperature from rising more than 2-3°C.

3.10.3.3 Preparing Algal Concentrate for Use as *Ceriodaphnia* Food

1. An algal concentrate containing 3.0 to 3.5×10^7 cells/mL is prepared from food cultures by centrifuging the algae with a plankton or bucket-type centrifuge, or by allowing the cultures to settle in a refrigerator for approximately two-to-three weeks and siphoning off the supernatant.
2. The cell density (cells/mL) in the concentrate is measured with an electronic particle counter, microscope and hemocytometer, fluorometer, or spectrophotometer, and used to determine the concentration required to achieve a final cell count of 3.0 to 3.5×10^7 cells/mL.
3. Assuming a cell density of approximately 1.5×10^6 cells/mL in the algal food cultures at 7 days, and 100% recovery in the concentration process, a 3-L, 7-10 day culture will provide 4.5×10^9 algal cells. This number of cells would provide approximately 150 mL of algal cell concentrate (1500 feedings at 0.1 mL/feeding) for use as food. This would be enough algal food for four *Ceriodaphnia* tests.
4. Algal concentrate may be stored in the refrigerator for one month.

3.11 FEEDING

3.11.1 Cultures should be fed daily to maintain the organisms in optimum condition so as to provide maximum reproduction. Stock cultures which are stressed because they are not adequately fed may produce low numbers of young, large number of males, and ephippial females. Also, their offspring may produce few young when used in toxicity tests.

1. If YCT is frozen, remove a bottle of food from the freezer 1 h before feeding time, and allow to thaw.
2. Mass cultures are fed daily at the rate of 7 mL YCT and 7 mL algae concentrate/L culture.
3. Individual cultures are fed at the rate of 0.1 mL YCT and 0.1 mL algae concentrate per 15 mL culture.
4. YCT and algal concentrate should be thoroughly mixed by shaking before dispensing.
5. Return unused YCT food mixture and algae concentrate to the refrigerator. Do not re-freeze YCT. Discard unused portion after one week.

3.12 FOOD QUALITY

3.12.1 The quality of food prepared with newly acquired supplies of yeast, trout chow, dried cereal leaves, or algae, should be determined in side-by-side comparisons of *Ceriodaphnia* survival and reproduction, using the new food and food of known, acceptable quality, over a seven-day period in control medium.

4. TEST ORGANISMS

4.1 Neonates, or first instar *Ceriodaphnia* less than 24 hours old, taken from the 3rd or 4th brood, are used in toxicity tests. To obtain the necessary number of young for an acute toxicity test, it is recommended that the animals be cultured in individual 30 mL beakers or plastic cups for seven days prior to the beginning of the test. Neonates are used from broods of at least eight young. Fifty adults in individual cultures will usually supply enough neonates for one toxicity test.

4.2 Use a disposable, widemouth pipette to transfer *Ceriodaphnia*. The diameter of the opening should be approximately 4 mm. The tip of the pipette should be kept under the surface of the water when the *Ceriodaphnia* are released to prevent air from being trapped under the carapace. Liquid containing adult *Ceriodaphnia* can be poured from one container to another without risk of injuring the animals.

SELECTED REFERENCES

- Beckett, D.C., and P.A. Lewis. 1982. An efficient procedure for slide mounting of larval chironomids. *Trans. Am. Microsc. Soc.* 101(1):96-99.
- Brandl, Z., and C.H. Fernando. 1971. Microaggregation of the cladoceran *Ceriodaphnia affinis* Lilleborg with a possible reason for microaggregation of zooplankton. *Can. J. Zool.* 49:775.
- Cowgill, U.M., K.I. Keating, and I.T. Takahashi. 1985. Fecundity and longevity of *Ceriodaphnia dubia/affinis* in relation to diet at two different temperatures. *J. Crust. Biol.* 5(3):420-429.
- Devaux, J. 1980. Contribution to limnological study of Lake Pavin, France. 2: Relationship between abiotic parameters, phytoplankton and zooplankton in the 0-20 meter zone. *Hydrobiologia* 68(1):17-34.
- Fairchild, G.W. 1981. Movement and micro distribution of *Sidia crystalline* and other littoral micro Crustacea. *Ecology* 62(5):1341-1352.
- Geller, W., and H. Mueller. 1981. The filtration apparatus of Cladocera filter mesh sizes and their implications on food selectivity. *Oecologia (Berl.)* 49(3):316-321.
- Gophen, M. 1976. Temperature dependence of food intake, ammonia excretion, and respiration in *Ceriodaphnia reticulata*, Lake Kinneret, Israel. *Freshwat. Biol.* 6(5):451-455.
- Kititsyna, L.A., and O.A. Sergeeva. 1976. Effect of temperature increase on the size and weight of some invertebrate populations in the cooling reservoir of the Kinakhovsk State Regional Electric Power Plant. *Ekologiya* 5:99-102.
- Lynch, M. 1978. Complex interactions between natural coexploiters - *Daphnia* and *Ceriodaphnia*. *Ecology* 59(3):552-564.
- Lynch, M. 1979. Predation, competition, and zooplankton community structure: An experimental study. *Limnol. Oceanogr.* 24(2):253-272.
- McNaught, D.C., and D.I. Mount. 1985. Appropriate durations and measures for *Ceriodaphnia* toxicity tests. In: R.C. Bahner and D.J. Hansen (eds.), *Aquatic Toxicology and Hazard Assessment: Eighth Symposium*. ASTM STP 891, American Society for Testing and Materials, Philadelphia, PA. pp. 375-381.
- Norberg, T.J., and D.I. Mount. 1985. Diets for *Ceriodaphnia reticulata* life-cycle tests. In: R.D. Cardwell, R. Purdy and R.C. Bahner (eds.), *Aquatic Toxicology and Hazard Assessment: Seventh Symposium*. ASTM STP 854. American Society for Testing and Materials, Philadelphia, PA. pp. 42-52.
- Pal, G. 1980. Characterization of water quality regions of the Lake of Velence, Hungary with planktonic crustaceans. *Allattani Kozl.* 67(1-4):49-58.
- Pennak, R.W. 1989. *Fresh-water invertebrates of the United States*. 3rd ed. Protozoa to Mollusca. John Wiley & Sons, New York, NY.
- Shuba, T., and R.R. Costa. 1972. Development and growth of *Ceriodaphnia reticulata* embryos. *Trans. Am. Microsc. Soc.* 91(3):429-435.
- Smagowicz, K. 1976. On the zooplankton of Lake Zeribar, Western Iran. *Acta Hydrobiol.* 18(1):89-100.

- USEPA. 1986. Taxonomy of *Ceriodaphnia* (Crustacea: Cladocera) in U.S. Environmental Protection Agency cultures. D.B. Berner. U. S. Environmental Protection Agency, Environmental Monitoring and Support Laboratory, Cincinnati, OH. EPA/600/4-86/032
- USEPA. 1989. Culturing of *Ceriodaphnia dubia*. Supplemental report for video training tape. U. S. Environmental Protection Agency, Washington, D.C. EPA/505/8-89/002a.
- Vigerstad, T.J., and L.J. Tilly. 1977. Hyper-thermal effluent effects on helio planktonic Cladocera and the influence of submerged macrophytes. *Hydrobiologia* 55(1):81-86.
- Wong, C.K. 1981. Predatory feeding behavior of *Epischura lacustris* (Copepoda: Calanoida) and prey defense. *Can. J. Fish. Aquat. Sci.* 38:275-279.

APPENDIX A

DISTRIBUTION, LIFE CYCLE, TAXONOMY, AND CULTURE METHODS

A.2. *DAPHNIA (D. MAGNA AND D. PULEX)*

1. SYSTEMATICS

1.1 MORPHOLOGY AND TAXONOMY

1.1.1 The generalized anatomy of a parthenogenetic female is shown in Figure 1. *Daphnia pulex* is an extremely variable species consisting of several reproductively isolated clonal groups and is often not distinguishable from other species (such as *D. obtusa*) that have large teeth on the middle pecten of the postabdominal claw (Figure 2C) (Lynch, 1985; Dodson, 1981). Probably the most distinctive feature of the parthenogenetic female *D. pulex* is the long second abdominal process of the abreptor (postabdomen) that extends beyond the base of the anal setae (Figure 2A).

1.1.2 *D. pulex* is a wide ranging species that shows little variation throughout its range. Two of its most distinctive characteristics are the deeply sinuate posterior margin of the abreptor (Figures 3A and 3D) and the ridges on the head which run parallel to the mid-dorsal line (Figure 3B).

1.1.3 *D. pulex* is much smaller than *D. magna*, attaining a length of up to 3.5 mm compared to 5.0 or 6.0 mm for *D. magna*. Although the two species can often be separated by size, they can be differentiated with certainty only by examining the postabdominal claws for size and number of spines using a compound microscope. *D. pulex* has 5-7 stout teeth on the middle pecten (Figure 2C) while *D. magna* has a uniform row of 20 or more small teeth (Figure 3E). Another characteristic for separating the neonates of the two species is the location of the nuchal organ which is higher up on the posterior margin of the head in *D. magna* than in *D. pulex* (Schwartz and Hebert, 1984). For a more complete taxonomic discussion of the two species see Brooks (1957).

2. DISTRIBUTION

2.1 *D. magna* has a worldwide distribution in the northern hemisphere. In North America it appears to be absent from the eastern United States (except for Northern New England) and Alaska (Figure 4). *D. pulex* occurs over most of North America except the tropics and high arctic (Figure 5), and probably occurs in Europe and South America as well. Both species often occur in the same pools but *D. pulex* usually out-competes *D. magna* in mixed populations and takes over as the sole inhabitant by summer's end (Modlin, 1982; Lynch, 1983).

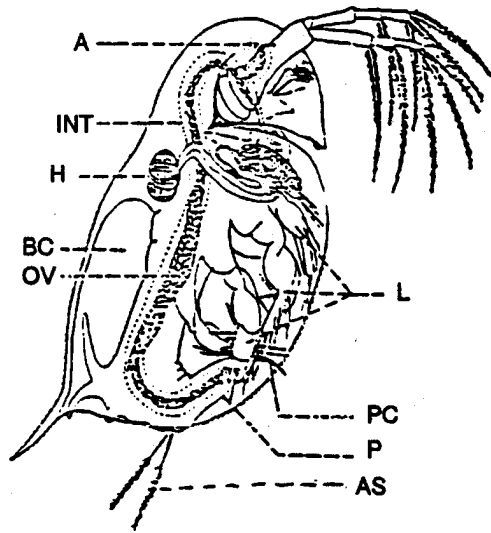

Figure 1. Generalized anatomy of a female *Daphnia*, X70; A, antenna; AS, anal setae; BC, brood chamber; H, heart; INT, intestine; L, legs; OV, ovary; P, postabdomen; PC, postabdominal claw. (From Pennak, 1989).

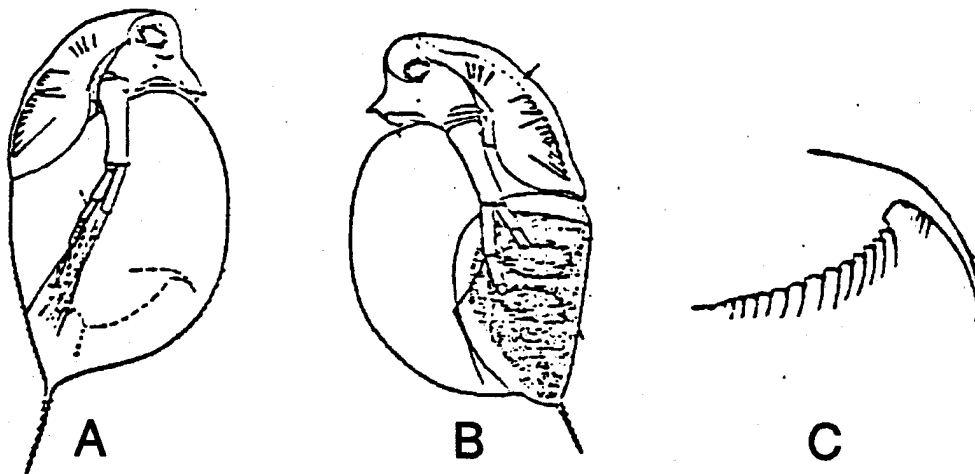

Figure 2. Female *Daphnia pulex*. A, lateral aspect (note smoothly rounded posterior margin of postabdomen); B, ehippial female; C, postabdomen showing large spines on the claw. (From Brooks, 1957)

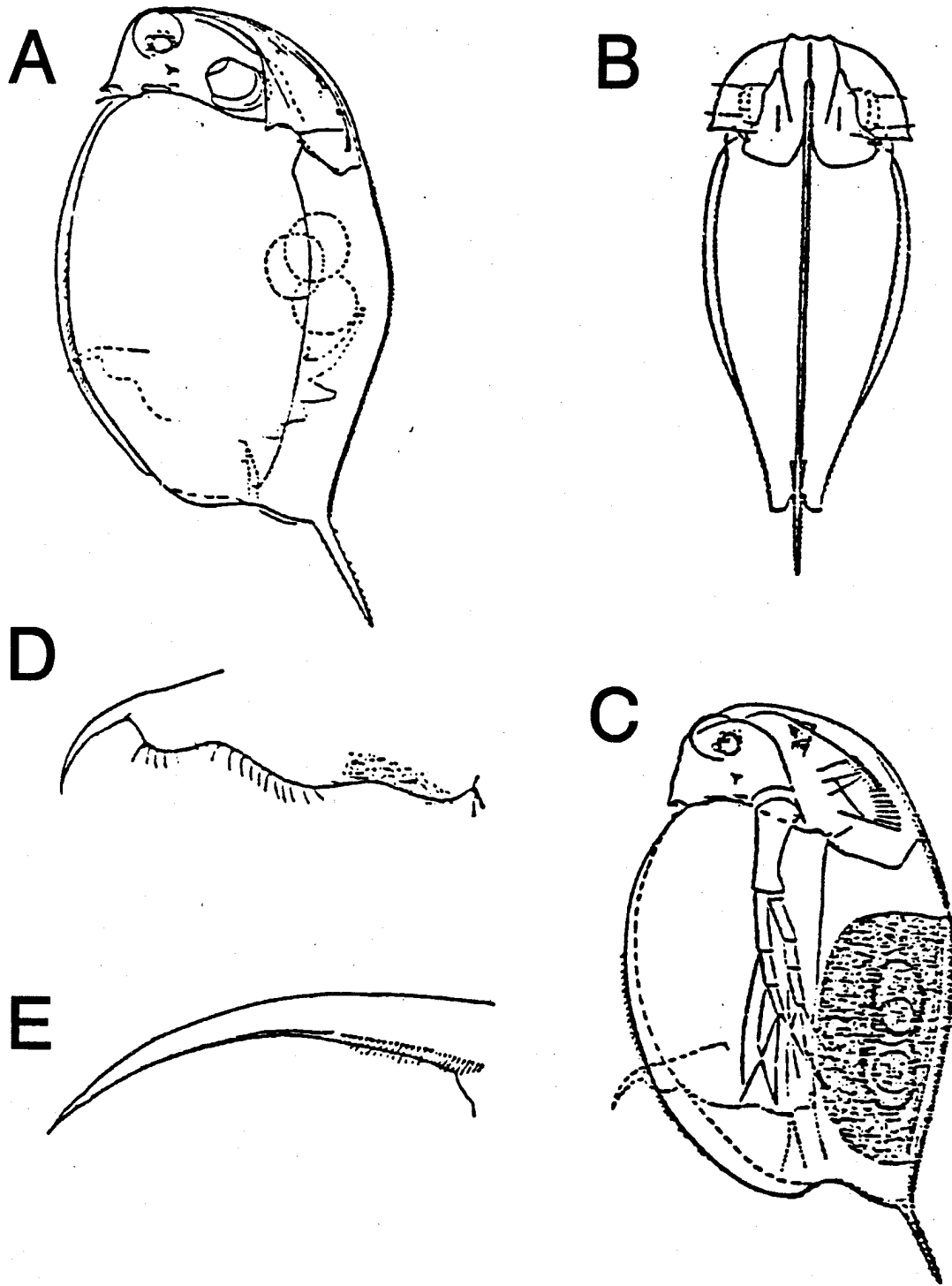

Figure 3. Female *D. Magna*. A. lateral aspect; B. dorsal aspect; C. ephippial female; D. postabdomen showing sinuate posterior margin; E. postabdominal claw. (From Brooks, 1957)

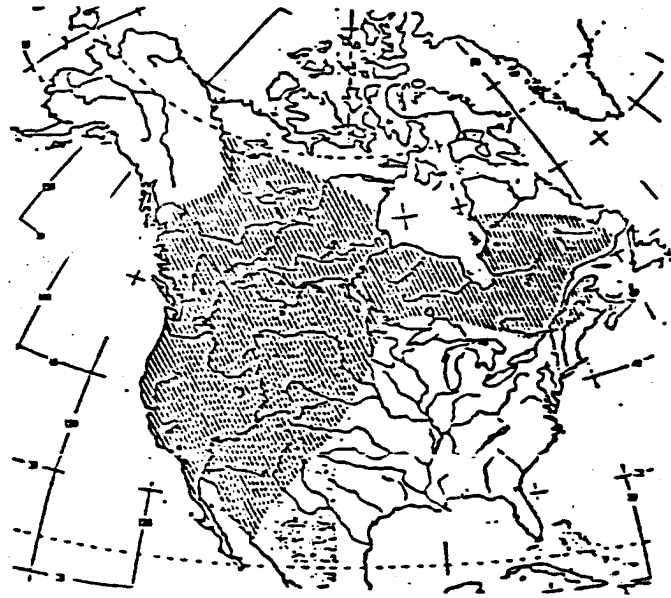

Figure 4. Map showing the North American distribution of *D. magna*.

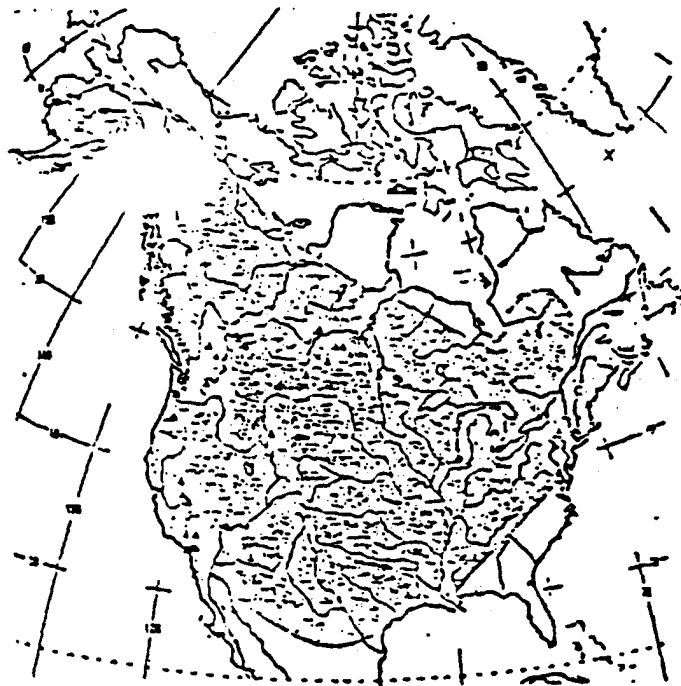

Figure 5. Map showing the North American distribution of *D. pulex*.

3. ECOLOGY AND LIFE HISTORY

3.1 GENERAL ECOLOGY

3.1.1 *D. magna* is principally a lake dweller and is restricted to waters in northern and western North America exceeding a hardness of 150 mg/L (as CaCO₃) (Pennak, 1989). In the Netherlands, *D. magna* are found in shallow ponds with muddy bottoms rich in organic matter and with low oxygen demand (3 to 4 mg/L). *D. pulex* is principally a pond dweller where the oxygen content is higher, but is also found in lakes. It is generally considered a clean water species being dominant in nature during periods of low turbidity. However, Scholtz, et al. (1988) found that high turbidity had little effect on survival and reproduction in laboratory studies.

3.1.2 *Daphnia* populations are generally sparse in winter and early spring, but as water temperatures reach 6°C to 12°C, they increase in abundance and subsequently may reach population densities as high as 200 to 500 individuals/L (Pennak, 1989). Populations in ponds decline to very low numbers during the summer months. In autumn there may be a second population pulse, followed by a decline to winter lows.

3.1.3 During most of the year, populations of *Daphnia* consist almost entirely of females, the males being abundant only in spring or autumn when up to 56% of the offspring of *D. magna* may be males (Barker and Hebert, 1986). Males are distinguished from females by their smaller size, larger antennules, modified postabdomen, and first legs, which are armed with a stout hook used in clasping. Production of males appears to be induced principally by low temperatures or high densities and subsequent accumulation of excretory products, and/or a decrease in available food. These conditions may induce the appearance of sexual (resting) eggs (embryos) in cases called ephippia (Figures 2B and 3C), which are cast off during the next molt. It appears that the shift toward male and sexual egg production is related to the metabolic rate of the parent. Any factor which tends to lower metabolism may be responsible. Ruvinsky et al. (1978) suggested that the genome of the animal has two developmental programs based on identical sets of chromosomes. The female program consistently functions under a wide range of conditions, whereas the male program is turned on by specific ecological stimuli. The eggs from which the males and females develop have identical chromosome sets. Sex determination is based on changes in chromatin structure when the mother receives a specific signal that sexual reproduction is needed for adaptation to extreme conditions.

3.1.4 *D. magna* reproduce only by cyclic parthenogenesis in which males contribute to the genetic makeup of the young during the sexual stage of reproduction, whereas *D. pulex* may reproduce either by cyclic or obligate parthenogenesis in which the zygotes develop within the ephippium by ameiotic parthenogenesis with no genetic contribution from the males. Thus, the ephippial and live-born offspring are genetically identical to their mothers. Both forms may be present in the same population resulting in cyclic populations exhibiting considerable genetic variation early in the year and an obligate population with a low range of genotypic values. After 25 generations of asexual reproduction the variation in the cyclic parthenogenesis group becomes about the same as that in the obligate group (Lynch, 1984). These populations exhibiting a low range of genotypic values are much more vulnerable to perturbations such as nutrient introduction or toxic discharges. The clonal makeup of a *Daphnia* population is effected by food, oxygen, temperature and predation (Weider, 1985; Brookfield, 1984).

3.1.5 Ephippia are small and lightweight and can be dried and stored for long periods making them easy to transport. They may be shipped in envelopes like seeds. Upon arrival at the new location the ephippia can be hatched in a few days when placed in water at the proper temperature (Schwartz and Hebert, 1987).

3.1.6 *Daphnia* are preyed upon by many predators and have developed behavioral and morphological antipredator defenses to make themselves more difficult to catch and consume. Dodson (1988) showed that *D. pulex* responded to a possible chemical stimuli released by the predator which resulted in the daphnids retreating from the vicinity of the predators. Certain clones of *D. pulex* may develop morphological changes when predators are present but not when they are absent from the pond. Some of these changes are of such magnitude that they have been described as separate species. *D. minnehaha* is a morphological variation of *D. pulex* which develops spines in response to the

stimuli of predators (Krueger and Dodson, 1981). Different genotypes of *D. pulex* react in different ways to the predator (*Chaoborus*) factor and to temperature (Havel, 1985).

3.2 FOOD AND FEEDING

3.2.1. Both *D. pulex* and *D. magna* are well adapted to live in algal blooms, which are high in proteins and carbohydrates, where they feed on algae and bacteria. *D. magna* prefers bacteria to algae as food (Ganf, 1983; Hadas et al., 1983) while *D. pulex* uses bacteria as food only when algal biomass declines (Borsheim and Olsen, 1984). Food type and abundance affect the sensitivity of *Daphnia* to pollutants and their reproduction rate. Keating and Dagbusan (1986) showed that both *D. pulex* and *D. magna* fed diatoms were more tolerant of pollutants than those fed only green algae. Lipid reserves are a good indication of the nutritional condition of the animals (Holm and Shapiro, 1984; Tessier and Goulden, 1982).

3.3 LIFE HISTORY

3.3.1 Four distinct periods may be recognized in the life history of *Daphnia*: (1) egg, (2) juvenile, (3) adolescence, and (4) adult (Pennak, 1989). The life span of *Daphnia*, from the release of the egg into the brood chamber until the death of the adult, is highly variable depending on the species and environmental conditions (Pennak, 1989). Generally the life span increases as temperature decreases, due to lowered metabolic activity. The average life span of *D. magna* is about 40 days at 25°C, and about 56 days at 20°C. The average life span of *D. pulex* at 20°C is approximately 50 days. Typically, a clutch of 6 to 10 eggs is released into the brood chamber, but as many as 57 have been reported. The eggs hatch in the brood chamber and the juveniles, which are already similar in form to the adults, are released in approximately two days when the female molts (casts off her exoskeleton or carapace). The time required to reach maturity (produce their first offspring) in *D. pulex* varies from six to 10 days (mean = 7.78 days) and also appears to be dependent on body size. The growth rate of the organism is greatest during its juvenile stages (early instars), and the body size may double during each of these stages. *D. pulex* has three to four juvenile instars, whereas *D. magna* has three to five instars. Each instar stage is terminated by a molt. Growth occurs immediately after each molt while the new carapace is still elastic.

3.3.2 Following the juvenile stages, the adolescent period is very short, and consists of a single instar. It is during the adolescent instar that the first clutch of eggs reaches full development in the ovary. Generally, eggs are deposited in the brood chamber within minutes after molting, and the young which develop are released just before the next molt.

3.3.3 *D. magna* usually has 6-22 adult instars, and *D. pulex* has 18-25. In general, the duration of instars increases with age, but also depends on environmental conditions. A given instar generally lasts approximately two days under favorable conditions, but when conditions are unfavorable, may last as long as a week.

3.3.4 Four events take place in a matter of a few minutes at the end of each adult instar: (1) release of young from the brood chamber to the outside, (2) molting, (3) increase in size, and (4) release of a new clutch of eggs into the brood chamber. The number of young per brood is highly variable for *Daphnia*, depending primarily on food availability and environmental conditions. *D. magna* and *D. pulex* may both produce as many as 30 young during each adult instar, but more commonly the number is six to 10. The number of young released during the adult instars of *D. pulex* reaches a maximum at the tenth instar, after which there is a gradual decrease (Anderson and Zupancic, 1937). Scholtz et al. (1988) reported that nearly all of the eggs that are oviposited by *D. pulex* became neonates, indicating a highly successful hatching rate. The maximum number of young produced by *D. magna* occurs at the fifth adult instar, after which it decreases (Anderson and Jenkins, 1942).

4. CULTURING METHODS

4.1 SOURCES OF ORGANISMS

4.1.1 *Daphnia* are available from commercial biological supply houses. Only a small number of organisms (20-30) are needed to start a culture. *D. pulex* is preferred over *D. magna* by some biologists because it is more widely distributed, is tolerant of a wider range of environmental conditions, and is easier to culture. However, the neonates are smaller, swim faster and are more difficult to count, and produce more "floaters" than *D. magna* and, therefore, are somewhat more difficult to use in toxicity tests. Guidance on the source and species of *Daphnia* to be used by a permittee for effluent toxicity tests should be obtained from the permitting authority.

4.1.2 Cultures of test organisms should be started at least three weeks before the brood animals are needed, to ensure an adequate supply of neonates for the test.

4.1.3 Starter animals may be obtained from an outside source by shipping in polyethylene bottles. Approximately 20-30 animals and 3 mL of food (see below) are placed in a 1-L bottle filled full with culture water. Animals received from an outside source should be transferred to new culture media gradually over a period of 1-2 days to avoid mass mortality.

4.1.4 It is best to start the cultures with one animal, which is sacrificed after producing young, embedded, and retained as a permanent microscope slide mount to facilitate identification and permit future reference. The species identification of the stock culture should be verified by a taxonomic authority. The following procedure is recommended for making slide mounts of *Daphnia* (Beckett and Lewis, 1982):

1. Pipet the animal onto a watch glass.
2. Reduce the water volume by withdrawing excess water with the pipet.
3. Add a few drops of carbonated water (club soda or seltzer water) or 70% ethanol to relax the specimen so that the post-abdomen is extended. (Optional: with practice, extension of the postabdomen may be accomplished by putting pressure on the cover slip).
4. Place a small amount (one to three drops) of mounting medium on a glass microscope slide. The recommended mounting medium is CMCP-9/9AF Medium, prepared by mixing two parts of CMCP-9 with one part of CMCP-9AF. For more viscosity and faster drying, CMC-10 stained with acid fuchsin may be used.
5. Using a forceps or a pipet, transfer the animal to the drop of mounting medium on the microscope slide.
6. Cover with a cover slip and exert minimum pressure to remove any air bubbles trapped under the cover slip. Slightly more pressure will extend the postabdomen.
7. Allow mounting medium to dry.
8. Make slide permanent by placing CMC-10 around the edges of the coverslip.
9. Identify to species (see Pennak, 1989).
10. Label with waterproof ink or diamond pencil.
11. Store for permanent record.

4.2 CULTURE MEDIA

4.2.1 Although *Daphnia* stock cultures can be successfully maintained in some tap waters, well waters, and surface waters, use of synthetic water as the culture medium is recommended because (1) it is easily prepared, (2) it is of known quality, (3) it yields reproducible results, and (4) allows adequate growth and reproduction. Reconstituted hard water (total hardness of 160 -180 mg/L as CaCO₃) is recommended for *D. magna* culturing, and reconstituted moderately hard water (total hardness of 80-90 mg/L CaCO₃) is recommended for *D. pulex* culturing. The quality of the dilution water is important in *Daphnia* culture. The use of MILLIPORE MILLI-Q® or SUPER-Q®, or equivalent, to prepare reconstituted water is highly recommended. The use of diluted mineral water (DMW) for culturing and testing is widespread due to the ease of preparation.

4.2.2 The chemicals used and instructions for preparation of reconstituted water are given in Section 7, Dilution Water. The compounds are dissolved in distilled or deionized water and the media are vigorously aerated for several hours before using. The initial pH of the media is between 7.0 and 8.0, but it will rise as much as 0.5 unit after the test is underway.

4.3 CULTURE CONDITIONS

4.3.1 *Daphnia* can be cultured successfully over a wide range of temperatures, but should be protected from sudden changes in temperature, which may cause death. The optimum temperature is approximately 20°C, and if ambient laboratory temperatures remain in the range of 18-26°C, normal growth and reproduction of *Daphnia* can be maintained without special temperature control equipment. *D. magna* can survive when the DO concentration is as low as 3 mg/L but *D. pulex* does best when the DO concentration is above 5 mg/L. Therefore it is recommended that the DO concentration in the culture be maintained at 5 mg/L or above. Unless the cultures are too crowded or overfed, aeration is usually not necessary.

4.3.2 Illumination

4.3.2.1 The variations in ambient light intensities (10-20 $\mu\text{E}/\text{m}^2/\text{s}$, or 50-100 ft-c) and prevailing day/night cycles in most laboratories do not seem to affect *Daphnia* growth and reproduction significantly. However, a minimum of 16 h of illumination should be provided each day.

4.3.3 Culture Vessels

4.3.3.1 Culture vessels of clear glass are recommended since they allow easy observation of the *Daphnia*. A practical culture vessel is an ordinary 4-L glass beaker, which can be filled with approximately 3 L medium (reconstituted water). Maintain several (at least five) culture vessels, rather than only one. This will ensure back-up cultures so that in the event of a population "crash" in one or several chambers, the entire *Daphnia* population will not be lost. If a vessel is stocked with 30 adult *Daphnia*, it will provide approximately 300 young each week.

4.3.3.2 Initially, all culture vessels should be washed well (see Section 5, Facilities and Equipment). After the culture is established, clean each chamber weekly with distilled or deionized water and wipe with a clean sponge to rid the vessel of accumulated food and dead *Daphnia* (see section on culture maintenance below). Once per month, wash each vessel with detergent during medium replacement. Rinse three times with tap water and then with culture medium to remove all traces of detergent.

4.3.4 Weekly Culture Media Replacement

4.3.4.1 Careful culture maintenance is essential. The medium in each stock culture vessel should be replaced three times each week with fresh medium.

This is best accomplished by changing solutions Monday, Wednesday, and Friday, as follows:

1. Place about 300 mL of the old media in a temporary holding vessel.
2. Transfer about 25 or 30 adults from the old culture vessel to the holding vessel using a wide bore pipette.
3. Discard the remaining *Daphnia* along with the media.
4. Clean the culture vessel as described above.
5. Fill the newly-cleaned vessel with fresh medium.
6. Gently transfer (by pouring) the contents of the temporary holding vessel (old medium with the *Daphnia*) into the vessel containing the new medium making sure that none of the animals stick to the sides of the vessel.

7. Feed the animals

4.3.4.2 If the medium is not replaced three times weekly, waste products will accumulate, which could cause a population crash or the production of males and/or sexual eggs.

4.3.4.3 *Daphnia* cultures should be thinned whenever the population exceeds 200 individuals per stock vessel to prevent over-crowding, which may cause a population crash, or the production of males and/or ephippia. A good time to thin the populations is on Monday, Wednesday, and Friday, before feeding. To transfer *Daphnia*, use a 15-cm disposable, jumbo bulb pipette, or 10-mL "serum" pipette which has had the delivery tip cut off and fire polished. The diameter of the opening should be approximately 5 mm. A serum pipette, a pipette bulb, such as a PROPIPETTE[®], or (MOPET[®]) portable, motorized pipettor, will provide the controlled suction needed when selectively collecting *Daphnia*.

4.3.4.4 Liquid containing adult *D. pulex* and *D. magna* can be poured from one container to another without risk of air becoming trapped under their carapaces. However, the very young *Daphnia* are much more susceptible to air entrapment and for this reason should be transferred from one container to another using a pipette. The tip of the pipette should be kept under the surface of the liquid when the *Daphnia* are released.

4.3.4.5 Each culture vessel should be covered with a clear plastic sheet or glass plate to exclude dust and dirt, and minimize evaporation.

4.4 FOOD PREPARATION AND FEEDING

4.4.1 Feeding the proper amount of the right food is extremely important in *Daphnia* culturing. The key is to provide sufficient nutrition to support normal reproduction without adding excess food which may reduce the toxicity of the test solutions, clog the animal's filtering apparatus, or greatly decrease the DO concentration and increase mortality. YCT, a combination of Yeast, CEROPHYLL[®], and Trout chow (or flake food), along with the unicellular green alga, *Selenastrum capricornutum*, will provide suitable nutrition if fed daily.

4.4.2 The YCT and algae are prepared as follows:

4.4.2.1 Digested trout chow (or flake food):

1. The preparation requires one week. Use starter or No. 1 pellets prepared according to current U.S. Fish and Wildlife Service specifications, or flake food.
2. Add 5.0 g of trout chow pellets or flake food to 1 L of MILLI-Q[®] water. Mix well in a blender and pour into a 2-L separatory funnel. Digest prior to use by aerating continuously from the bottom of the vessel for one week at ambient laboratory temperature. Water lost due to evaporation is replaced during digestion. Because of the offensive odor usually produced during digestion, the vessel should be placed in a fume hood or other isolated, ventilated area.
3. At the end of digestion period, place in a refrigerator and allow to settle for a minimum of 1 h. Filter the supernatant through a fine mesh screen (i.e., NITEX[®] 110 mesh). Combine with equal volumes of supernatant from CEROPHYLL[®] and yeast preparations (below). The supernatant can be used fresh, or frozen until use. Discard the sediment.

4.4.2.2 Yeast:

1. Add 5.0 g of dry yeast, such as FLEISCHMANN'S[®] to 1 L of MILLI-Q[®] water.
2. Stir with a magnetic stirrer, shake vigorously by hand, or mix with a blender at low speed, until the yeast is well dispersed.
3. Combine the yeast suspension immediately (do not allow to settle) with equal volumes of supernatant from the trout chow (above) and CEROPHYLL[®] preparations (below). Discard excess

material.

4.4.2.3 CEROPHYLL® (Dried, Powdered, Cereal Leaves):

1. Place 5.0 g of dried, powdered, cereal leaves in a blender. Dried, powdered, alfalfa leaves obtained from health food stores have been found to be a satisfactory substitute for cereal leaves.
2. Add 1 L of MILLI-Q® water.
3. Mix in a blender at high speed for 5 min, or stir overnight at medium speed on a magnetic stir plate.
4. If a blender is used to suspend the material, place in a refrigerator overnight to settle. If a magnetic stirrer is used, allow to settle for 1 h. Decant the supernatant and combine with equal volumes of supernatant from trout chow and yeast preparations (above). Discard excess material.

4.4.2.4 Combined YCT Food:

1. Mix equal (approximately 300 mL) volumes of the three foods as described above.
2. Place aliquots of the mixture in small (50-mL to 100-mL) screw-cap plastic bottles and freeze until needed.
3. Freshly prepared food can be used immediately, or it can be frozen until needed. Thawed food is stored in the refrigerator between feedings, and is used for a maximum of one week.
4. It is advisable to measure the dry weight of solids in each batch of YCT before use. The food should contain 1.7 - 1.9 g solids/L. Cultures or test solutions should contain 12-13 mg solids/L.

4.4.3 Algal (*Selenastrum*) Food

4.4.3.1 Algal Culture Medium

1. Prepare (five) stock nutrient solutions using reagent grade chemicals as described in Table 1.
2. Add 1 mL of each stock solution, in the order listed in Table 1, to approximately 900 mL of MILLI-Q® water. Mix well after the addition of each solution. Dilute to 1 L and mix well. The final concentration of macronutrients and micronutrients in the culture medium is given in Table 2.
3. Immediately filter the medium through a 0.45µm pore diameter membrane at a vacuum of not more than 380 mm (15 in.) mercury, or at a pressure of not more than one-half atmosphere (8 psi). Wash the filter with 500 mL deionized water prior to use.
4. If the filtration is carried out with sterile apparatus, filtered medium can be used immediately, and no further sterilization steps are required before the inoculation of the medium. The medium can also be sterilized by autoclaving after it is placed in the culture vessels.
5. Unused sterile medium should not be stored more than one week prior to use, because there may be substantial loss of water by evaporation.

4.4.3.2 Algal Cultures

4.4.3.2.1 Two types of algal cultures are maintained: (1) stock cultures, and, (2) "food" cultures.

4.4.3.2.2 Establishing and Maintaining Stock Cultures of Algae

1. Upon receipt of the "starter" culture (usually about 10 mL), a stock culture is initiated by aseptically transferring one milliliter to each of several 250-mL culture flasks containing 100 mL algal culture medium (prepared as described above). The remainder of the starter culture can be held in reserve for up to six months in a refrigerator (in the dark) at 4°C.
2. The stock cultures are used as a source of algae to initiate "food" cultures for *Daphnia* toxicity tests. The volume of stock culture maintained at any one time will depend on the amount of algal food required for the *Daphnia* cultures and tests. Stock culture volume may be rapidly "scaled up" to

several liters, if necessary, using 4-L serum bottles or similar vessels, each containing 3 L of growth medium.

3. Culture temperature is not critical. Stock cultures may be maintained in environmental chambers with cultures of other organisms if the illumination is adequate (continuous "cool-white" fluorescent lighting of approximately $86 \pm 8.6 \mu\text{E}/\text{m}^2/\text{s}$, or 400 ft-c).
4. Cultures are mixed twice daily by hand or stirred continuously.
5. Stock cultures can be held in the refrigerator until used to start "food" cultures, or can be transferred to new medium weekly. One-to-three milliliters of 7-day old algal stock culture, containing approximately 1.5×10^6 cells/mL, are transferred to each 100 mL of fresh culture medium. The inoculum should provide an initial cell density of approximately 1,000-30,000 cells/mL in the new stock cultures. Aseptic techniques should be used in maintaining the stock algal cultures, and care should be exercised to avoid contamination by other microorganisms.
6. Stock cultures should be examined microscopically weekly, at transfer, for microbial contamination. Reserve quantities of culture organisms can be maintained for 6-12 months if stored in the dark at 4°C. It is advisable to prepare new stock cultures from "starter" cultures obtained from established outside sources of organisms every four to six months.

TABLE 1. NUTRIENT STOCK SOLUTIONS FOR MAINTAINING ALGAL STOCK CULTURES AND TEST CONTROL CULTURES

STOCK SOLUTION	COMPOUND	AMOUNT DISSOLVED IN 500 ML MILLI-Q® WATER
1. MACRONUTRIENTS		
A.	MgCl ₂ •6H ₂ O	6.08 g
	CaCl ₂ •2H ₂ O	2.20 g
	NaNO ₃	12.75 g
B.	MgSO ₄ •7H ₂ O	7.35 g
C.	K ₂ HPO ₄	0.522 g
D.	NaHCO ₃	7.50 g
2. MICRONUTRIENTS:		
	H ₃ BO ₃	92.8 mg
	MnCl ₂ •4H ₂ O	208.0 mg
	ZnCl ₂	1.64 mg ^a
	FeCl ₃ •6H ₂ O	79.9 mg
	CoCl ₂ •6H ₂ O	0.714 mg ^b
	Na ₂ MoO ₄ •2H ₂ O	3.63 mg ^c
	CuCl ₂ •2H ₂ O	0.006 mg ^d
	Na ₂ EDTA•2H ₂ O	150.0 mg
	Na ₂ SeO ₄	1.196 mg ^e

^aZnCl₂ - Weigh out 164 mg and dilute to 100 mL. Add 1 mL of this solution to Stock #2.

^bCoCl₂•6H₂O - Weigh out 71.4 mg and dilute to 100 mL. Add 1 mL of this solution to Stock #2.

^cNa₂MoO₄•2H₂O - Weigh out 36.6 mg and dilute to 10 mL. Add 1 mL of this solution to Stock #2.

^dCuCl₂•2H₂O - Weigh out 60.0 mg and dilute to 1000 mL. Take 1 mL of this solution and dilute to 10 mL. Take 1 mL of the second dilution and add to Stock #2.

^eNa₂SeO₄ - Weigh out 119.6 mg and dilute to 100 mL. Add 1 mL of this solution to Stock #2.

TABLE 2. FINAL CONCENTRATION OF MACRONUTRIENTS AND MICRONUTRIENTS IN THE CULTURE MEDIUM

MACRO NUTRIENT	CONCENTRATION (MG/L)	ELEMENT	CONCENTRATION (MG/L)
NaNO ₃	25.5	N	4.20
MgCl ₂ •6H ₂ O	12.2	Mg	2.90
CaCl ₂ •2H ₂ O	4.41	Ca	1.20
MgSO ₄ •7H ₂ O	14.7	S	1.91
K ₂ HPO ₄	1.04	P	0.186
NaHCO ₃	15.0	Na	11.0
		K	0.469
		C	2.14

MICRO NUTRIENT	CONCENTRATION (μG/L)	ELEMENT	CONCENTRATION (μG/L)
H ₃ BO ₃	185	B	32.5
MnCl ₂ •4H ₂ O	416	Mn	115
ZnCl ₂	3.27	Zn	1.57
CoCl ₂ •6H ₂ O	1.43	Co	0.354
CuCl ₂ •2H ₂ O	0.012	Cu	0.004
Na ₂ MoO ₄ •2H ₂ O	7.26	Mo	2.88
FeCl ₃ •6H ₂ O	160	Fe	33.1
Na ₂ EDTA•2H ₂ O	300	--	----
Na ₂ SeO ₄	2.39	Se	1.00

4.4.3.2.3 Establishing and Maintaining "Food" Cultures of Algae

1. "Food" cultures are started seven days prior to use for *Daphnia* cultures and tests. Approximately 20 mL of 7-day-old algal stock culture (described in the previous paragraph), containing 1.5×10^6 cells/mL, are added to each liter of fresh algal culture medium (i.e., 3 L of medium in a 4-L bottle, or 18 L in a 20-L bottle). The inoculum should provide an initial cell density of approximately 30,000 cells/mL. Aseptic techniques should be used in preparing and maintaining the cultures, and care should be exercised to avoid contamination by other microorganisms. However, sterility of food cultures is not as critical as in stock cultures because the food cultures are terminated in 7-10 days. A one-month supply of algal food can be grown at one time, and the excess stored in the refrigerator.
2. Food cultures may be maintained at 25°C in environmental chambers with the algal stock cultures or cultures of other organisms if the illumination is adequate (continuous "cool-white" fluorescent lighting of approximately $86 \pm 8.6 \mu\text{E}/\text{m}^2/\text{s}$, or 400 ft-c).
3. Cultures are mixed continuously on a magnetic stir plate (with a medium size stir bar) or in a moderately aerated separatory funnel, or are mixed twice daily by hand. If the cultures are placed on a magnetic stir plate, heat generated by the stirrer might elevate the culture temperature several degrees. Caution should be exercised to prevent the culture temperature from rising more than 2-3°C.

4.4.3.3 Preparing Algal Concentrate for Use as *Daphnia* Food

1. An algal concentrate containing 3.0 to 3.5×10^7 cells/mL is prepared from food cultures by centrifuging the algae with a plankton or bucket-type centrifuge, or by allowing the cultures to settle in a refrigerator for approximately two-to-three weeks and siphoning off the supernatant.
2. The cell density (cells/mL) in the concentrate is measured with an electronic particle counter, microscope and hemocytometer, fluorometer, or spectrophotometer, and used to determine the concentration required to achieve a final cell count of 3.0 to $3.5 \times 10^7/\text{mL}$.
3. Assuming a cell density of approximately 1.5×10^6 cells/mL in the algal food cultures at 7 days, and 100% recovery in the concentration process, a 3-L, 7-10 day culture will provide 4.5×10^9 algal cells. This number of cells would provide approximately 150 mL of algal cell concentrate.
4. Algal concentrate may be stored in the refrigerator for one month.

4.5 FEEDING

4.5.1 Feeding rate and frequency are important in maintaining the organisms in optimal condition so that they achieve maximum reproduction. Stock cultures which are stressed because they are not adequately fed may produce low numbers of young, large numbers of males, and ephippial females. When the young taken from these inadequately fed *Daphnia* cultures are used in toxicity tests, they may show higher than acceptable mortality in controls and greater than normal sensitivity to toxicants. Steps to follow when feeding the YCT and algal diet are as follows:

1. If YCT is frozen, remove a bottle of the food from the freezer at least 1 h before feeding time, and allow to thaw.
2. Mass cultures are fed Monday, Wednesday, and Friday at the rate of 4.5 mL YCT and 2 mL of algae concentrate per 3-L culture.
3. On Tuesday and Thursday the culture water is stirred to re-suspend the settled algae and another 2 mL of algal concentrate is added.
4. The YCT and algal concentrate is thoroughly mixed by shaking before dispensing.
5. Return unused YCT food mixture and algal concentrate to the refrigerator. Do not re-freeze the YCT. Discard unused portion of YCT after one week.

4.5.2 The quality of food prepared with newly acquired supplies of yeast, trout chow, and dried cereal leaves, or algae, should be determined in side-by-side comparisons of *Daphnia* survival and reproduction tests, using the new food and food of known, acceptable quality, over a seven-day period in control medium.

SELECTED REFERENCES

- Adema, D.M.M. 1978. *Daphnia magna* as a test animal in acute and chronic toxicity tests. *Hydrobiologia* 59(2):125-134.
- Alibone, M.R. and P. Fair. 1981. The effects of low pH on the respiration of *Daphnia magna* Straus. *Hydrobiologia* 85:185-188.
- Anderson, B.G. and J.C. Jenkins. 1942. A time study of the events in the life span of *Daphnia pulex*. *Biol. Bull.* 83:260-272.
- Anderson, B.G. and L.J. Zupancic, Jr. 1937. Growth and variability in *Daphnia pulex*. *Biol. Bull.* 73:444-463.
- Barker, D.M. and P.D.N. Hebert. 1986. Secondary sex ratio of the cyclic parthenogen *Daphnia magna* (Crustacea: Cladocera) in the Canadian arctic. *Can. J. Zool.* 64:1137-1143.
- Beckett, D.C., and P.A. Lewis, 1982. An efficient procedure for slide mounting of larval chironomids. *Trans. Am. Microsc. Soc.* 101(1):96-99.
- Berge, W.F. Ten. 1978. Breeding *Daphnia magna*. *Hydrobiologia* 59(2):121-123.
- Biesinger, K.E. and G.M. Christensen. 1972. Effects of various metals on survival, growth, reproduction, and metabolism of *Daphnia magna*. *J. Fish. Res. Bd. Can.* 29:1691-1700.
- Borsheim, K.Y. and Y. Olsen. 1984. Grazing activities by *Daphnia pulex* on natural populations of bacteria and algae. *Verh. Internat. Verein. Limnol.* 22:644-648.
- Brookfield, J.F.Y. 1984. Measurement of the intraspecific variation in population growth rate under controlled conditions in the clonal parthenogen *Daphnia magna*. *Genetica* 63:161-174.
- Brooks, J.L. 1957. The systematics of North American *Daphnia*. *Mem. Conn. Acad. Arts Sci.* 13:1-180.
- Buikema, A.L., Jr., J.G. Geiger and D.R. Lee. 1980. *Daphnia* toxicity tests. In: A.L. Buikema, Jr., and John Cairns, Jr. (eds.), *Aquatic Invertebrate Bioassays*. ASTM STP 715, American Society for Testing and Materials, Philadelphia, Pennsylvania. pp. 48-69.
- Buikema, A.L., Jr., D.R. Lee and J. Cairns, Jr. 1976. A screening bioassay using *Daphnia pulex* for refinery wastes discharged into freshwater. *J. Testing Eval.* 4(2):119-125.
- Canton, J.H. and D.M.M. Adema. 1978. Reproducibility of short-term and reproduction toxicity experiments with *Daphnia magna* and comparison of the sensitivity of *Daphnia magna* with *Daphnia pulex* and *Daphnia cucullata* in short-term experiments. *Hydrobiologia* 59(2):135-140.
- Carvalho, G.R. and R.N. Hughes. 1983. The effect of food availability, female culture-density and photoperiod on ephippia production in *Daphnia magna* Straus (Crustacea: Cladocera). *Freshw. Biol.* 13:37-46.
- Davis, P. and G.W. Ozburn. 1969. The pH tolerance of *Daphnia pulex*. (Leydig, emend., Richard). *Can. J. Zool.* 47:1173-1175.
- Dodson, S.I. 1981. Morphological variation of *Daphnia pulex* Leydig (Crustacea: Cladocera) and related species from North America. *Hydrobiologia* 83:101-114.

- Dodson, S.I. 1984. Predation of *Heterocope septentrionalis* on two species of *Daphnia*: Morphological defenses and their cost. *Ecology* 65(4):1249-1257.
- Dodson, S.I. 1988. The ecological role of chemical stimuli for the zooplankton: Predation-avoidance behavior in *Daphnia*. *Limnol. Oceanogr.* 33(6,part 2):1431-1439.
- Doma, S. 1979. Ehippia of *Daphnia magna* Straus - A technique for their mass production and quick revival. *Hydrobiologia* 67(2):183-188.
- France, R.L. 1982. Comment on *Daphnia* respiration in low pH water. *Hydrobiologia* 94:195-198.
- Ganf, G.G. 1983. An ecological relationship between *Aphanizomenon* and *Daphnia pulex*. *Aust. J. Mar. Freshwat. Res.* 34:755-773.
- Geiger, J.G., A.L. Buikema, Jr. and J. Cairns, Jr. 1980. A tentative seven-day test for predicting effects of stress on populations of *Daphnia pulex*. In: J.G. Eaton, P.R. Parrish, and A.C. Hendricks (eds.), ASTM STP 707, American Society for Testing and Materials, Philadelphia, Pennsylvania. pp. 13-26.
- Gophen, M. and B. Gold. 1981. The use of inorganic substances to stimulate gut evacuation in *Daphnia magna*. *Hydrobiologia* 80:43-45.
- Gulati, R.D. 1978. The ecology of common planktonic Crustacea of the freshwaters in the Netherlands. *Hydrobiologia* 59(2):101-112.
- Hadas, O., U. Bachrach, Y. Kott and B.Z. Cavari. 1983. Assimilation of *E. coli* cells by *Daphnia magna* on the whole organism level. *Hydrobiologia* 102:163-169.
- Havas, M. 1981. Physiological response of aquatic animals to low pH. In: R. Singer (ed.), *Effects of Acidic Precipitation on Benthos*. North American Benthological Society, Box 878, Springfield, Illinois 62705. pp. 49-65.
- Havel, J.E. 1985. Cyclomorphosis of *Daphnia pulex* spined morphs. *Limnol. Oceanogr.* 30(4):853-861.
- Holm, N.P. and J. Shapiro. 1984. An examination of lipid reserves and the nutritional status of *Daphnia pulex* fed *Aphanizomenon flos-aquae*. *Limnol. Oceanogr.* 29(5):1137-1140.
- How, M. J. 1980. The application and conduct of ring tests in aquatic toxicology. *Water Res.* 14:293-296.
- Ingersoll, C.G. and R.W. Winner. 1982. Effect on *Daphnia pulex* (De Geer) of daily pulse exposure to copper or cadmium. *Environ. Toxicol. Chem.* 1:321-327.
- Keating, K.I. and B.C. Dagbusan. 1986. Diatoms in daphnid culture and bioassay. *Environ. Toxicol. Chem.* 5:299-307.
- Krueger D.A. and S.I. Dodson. 1981. Embryological induction and predation ecology in *Daphnia pulex*. *Limnol. Oceanogr.* 26(2):219-223.
- LeBlanc, G.A. 1982. Laboratory investigation into the development of resistance of *Daphnia magna* (Straus) to environmental pollutants. *Environ. Pollut. (Ser. A)* 27:309-322.
- Lee, D.R. and A.L. Buikema, Jr. 1979. Molt-Related sensitivity of *Daphnia pulex* in toxicity testing. *J. Fish. Res. Bd. Can.* 36:1129-1133.

- Leonhard, S.L. and S.C. Lawrence. 1981. *Daphnia magna* (Straus), *Daphnia pulex* (Leydig) Richard. In: S. G. Lawrence, ed., Manual for the Culture of Selected Freshwater Invertebrates, Can. Spec. Publ. Fish. Aquat. Sci. 54:31-50.
- Lewis, P.A. and C.I. Weber. 1985. A study of the reliability of *Daphnia* acute toxicity tests. In: R.D. Cardwell, R. Purdy and R.C. Bahner (eds.), Aquatic Toxicology and Hazard Assessment: Seventh Symposium. ASTM STP 854, American Society for Testing and Materials, Philadelphia, Pennsylvania. pp. 73-86.
- Lynch, M. 1983. Ecological genetics of *Daphnia pulex*. *Evolution* 37(2): 358-374.
- Lynch, M. 1984. The limits to life-history evolution in *Daphnia*. *Evolution* 38(3):465-482.
- Lynch, M. 1985. Speciation in the Cladocera. *Verh. Internat. Verein. Limnol.* 22:3116-3123.
- Modlin, R.F. 1982. Successional changes, variations in population densities, and reproductive strategies of Cladocera in two temporary ponds in north Alabama. *J. Freshwat. Ecol.* 1(6):589-598.
- Nebeker, A. V. 1982. Evaluation of a *Daphnia magna* renewal life-cycle test method with silver and endosulfan. *Water Res.* 16:739-744.
- Parent, S. and R.D. Cheetham. 1980. Effects of acid precipitation on *Daphnia magna*. *Bull. Environ. Contam. Toxicol.* 25:298-304.
- Pennak, R.W. 1989. Fresh-water invertebrates of the United States. 3rd ed. Protozoa to Mollusca. John Wiley & Sons, New York, NY.
- Pucke, S.C. 1981. Development and standardization of *Daphnia* culturing and bioassays. M.S. Thesis, University of Cincinnati.
- Ruvinsky, A.O., S.F. Cellarius, and Yu. G. Cellarius. 1978. The possible role of genome activity changes in the sex determination of *Daphnia pulex*. *Theor. Appl. Genet.* 52:269-271.
- Scholtz, S., M.T. Seaman and A.J.H. Pieterse. 1988. Effects of turbidity on life history parameters of two species of *Daphnia*. *Freshwat. Biol.* 20:177-184.
- Schultz, T.W., S.R. Freeman and N.N. Dumont. 1980. Uptake, depuration and distribution of selenium in *Daphnia* and its effects on survival and ultrastructure. *Arch. Environ. Contam. Toxicol.* 9:23-40.
- Schwartz, S.S. and P.D.N. Hebert. 1984. Subgeneric distinction in the genus *Daphnia*: A new diagnostic trait. *Trans. Am. Microsc. Soc.* 103(4):341-346.
- Schwartz, S.S. and P.D.N. Hebert. 1987. Methods for the activation of the resting eggs of *Daphnia*. *Freshwat. Biol.* 17:373-379.
- Tessier, A.J. and C.E. Goulden. 1982. Estimating food limitation in cladoceran populations. *Limnol. Oceanogr.* 27(4):707-717.
- USEPA. 1977. Chemical/biological implications of using chlorine and ozone for disinfection. R.M. Carlson, and R. Caple. Environmental Research Laboratory, U.S. Environmental Protection Agency, Duluth, Minnesota. 55804. EPA-600/3-77-066. 87 pp.
- USEPA. 1978a. The *Selenastrum capricornutum* Printz, algal assay bottle test. W.E. Miller, J.C. Greene and T.

- Shiroyama. Environmental Research Laboratory, U. S. Environmental Protection Agency, Corvallis, Oregon. EPA-600/9-78-018. 126 pp.
- USEPA. 1978b. Methods for measuring the acute toxicity of effluents to aquatic organisms. 2nd ed. W.H. Peltier. Environmental Monitoring and Support Laboratory, U.S. Environmental Protection Agency, Cincinnati, Ohio. EPA-600/4-78-012.
- USEPA. 1981. Effluent toxicity screening test using *Daphnia* and mysid shrimp. Weber, C.I., and W.H. Peltier. Environmental Monitoring and Support Laboratory, U. S. Environmental Protection Agency, Cincinnati, Ohio.
- Vijverberg, J. 1989. Culture techniques for studies on the growth, development and reproduction of copepods and cladocerans under laboratory and *in situ* conditions: a review. *Freshw. Biol.* 21:317-373.
- Walton, W.E., S.M. Compton, J.D. Allan and R.E. Daniels. 1982. The effect of acid stress on survivorship and reproduction of *Daphnia pulex* (Crustacea: Cladocera). *Can. J. Zool.* 60:573-579.
- Weider, L.J. 1985. Spatial and temporal genetic heterogeneity in a natural *Daphnia* population. *J. Plankton Res.* 7(1):101-123.
- Winner, R.W. 1984. Selenium effects on antennal integrity and chronic copper toxicity in *Daphnia pulex* (deGreer). *Bull. Environ. Contam. Toxicol.* 33:605-611.
- Winner, R.W., T. Keeling, R. Yeager and M.P. Farrell. 1977. Effect of food type on the acute and chronic toxicity of copper to *Daphnia magna*. *Freshw. Biol.* 7:343-349.

APPENDIX A

DISTRIBUTION, LIFE CYCLE, TAXONOMY, AND CULTURE METHODS

A.3. MYSIDS (*MYSIDOPSIS BAHIA* AND *HOLMESIMYSIS COSTATA*)

1. DISTRIBUTION

1.1 Mysids (Figure 1) are small shrimp-like crustaceans found in both the marine and freshwater environments. The mysid(s) that currently are of primary interest in the NPDES program are the estuarine species, *Mysidopsis bahia* (now identified as *Americamysis bahia*; Price *et al.*, 1994) and the marine species, *Holmesimysis costata*. It occurs primarily at salinities above 15‰; Stuck *et al.* (1979a) and Price (1982) found greatest abundances at salinities near 30‰. Three sympatric species of *Mysidopsis*, *M. almyra*, *M. bahia*, and *M. bigelowi*, have been cultured and used in toxicity testing. The distribution of *Mysidopsis* species has been reported by Stuck *et al.* (1979b), Price (1982), and Heard *et al.* (1987).

1.2 *M. bahia* occurs primarily at salinities above 15‰; Stuck *et al.* (1979a) and Price (1982) found greatest abundances at salinities near 30‰. Three sympatric species of *Mysidopsis*, *M. almyra*, *M. bahia*, and *M. bigelowi*, have been cultured and used in toxicity testing. The distribution of *Mysidopsis* species has been reported by Stuck *et al.* (1979b), Price (1982), and Heard *et al.* (1987).

1.3 *H. costata* (Holmes 1900; previously referred to as *Acanthomysis sculpta*) is a west coast species that lives in the surface canopy of the giant kelp *Macrocystis pyrifera* where it feeds on zooplankters, kelp, epiphytes, and detritus. There are few references to the ecology of this mysid species (Holmquist, 1979; Clutter, 1967, 1969; Green, 1970; Turpen *et al.*, 1994). *H. costata* is numerically abundant in kelp forest habitats and is considered to be an important food source for kelp forest fish (Clark 1971, Mauchline 1980). *H. costata* eggs develop for about 20 days in their marsupium (abdominal pouch) before the young are released as juveniles; broods are released at night during molting. Females release their first brood at 55 to 70 days post-release (at 12°C), and may have multiple broods throughout their approximately 120-day life.

1.4 Other marine mysids that have been used in toxicity testing and held or cultured in the lab include *Metamysidopsis elongata*, *Neomysis americana*, *Neomysis awatschensis*, *Neomysis intermedia*, and recently for the Pacific coast, *Holmesimysis sculpta* and *Neomysis mercedis*. A freshwater species, *Mysis relicta*, presently not used in toxicity testing, but found in the same habitat as *Daphnia pulex*, might be considered in the future for toxicity testing.

2. *MYSIDOPSIS BAHIA*

2.1 LIFE CYCLE

2.1.1 In laboratory culture, *Mysidopsis bahia* reach sexual maturity in 12 to 20 days, depending on water temperature and diet (Nimmo *et al.*, 1977). Normally, the female will have eggs in the ovary at approximately 12 days of age. The lamellae of the marsupium pouch have formed or are in the process of forming when the female is approximately 4 mm in length (Ward, 1993). Unlike *Daphnia*, the eggs will not develop unless fertilized. Mating takes place at night and lasts only a few minutes (Mauchline, 1980).

2.1.2 Brood pouches are normally fully formed at approximately 15 days (approximately 5 mm in body length), and young are released in 17 to 20 days (Ward, 1993). The number of eggs deposited in the brood and the number of young produced per brood are a direct function of body length as well as environmental conditions. Mature females have produced as many as 25 Stage I larvae (egg-shaped embryo) per brood (8-9 mm in body length) in natural and artificial seawater (FORTY FATHOMS®) but average 11 ± 6 Stage III larvae (final stage before larvae

are released), with increasing numbers correlated with increasing body length (Ward, 1993). A new brood is produced every 4 to 7 days.

2.1.3 At time of emergence, juveniles are immobile, making them susceptible to predation by adult mysids. The juveniles are planktonic for the first 24-48 hours and then settle to the bottom, orient to the current, and actively pursue food organisms such as *Artemia*. Carr et al. (1980) reported that the stage in the life cycle of *M. almyra* most sensitive to drilling mud was the juvenile molt, which occurs between 24 and 48 hours after release from the brood pouch. Ward (1989) found a relationship between CaCO_3 level and growth and reproduction and that *M. bahia* were more sensitive to cadmium during molting (24-72 h post release) in high or low levels of CaCO_3 . Work done by Lee and Buikema (1979) for *Daphnia pulex* also showed increased sensitivity during molting.

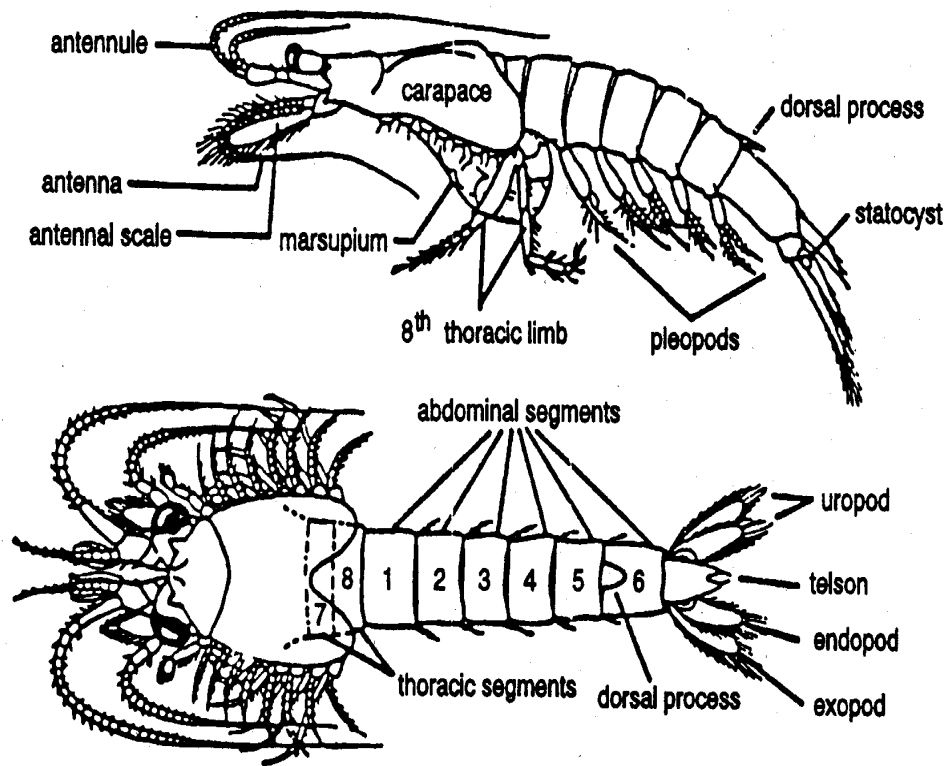

Figure 1. Lateral and dorsal view of a mysid with morphological features identified (From Stuck et al., 1979a).

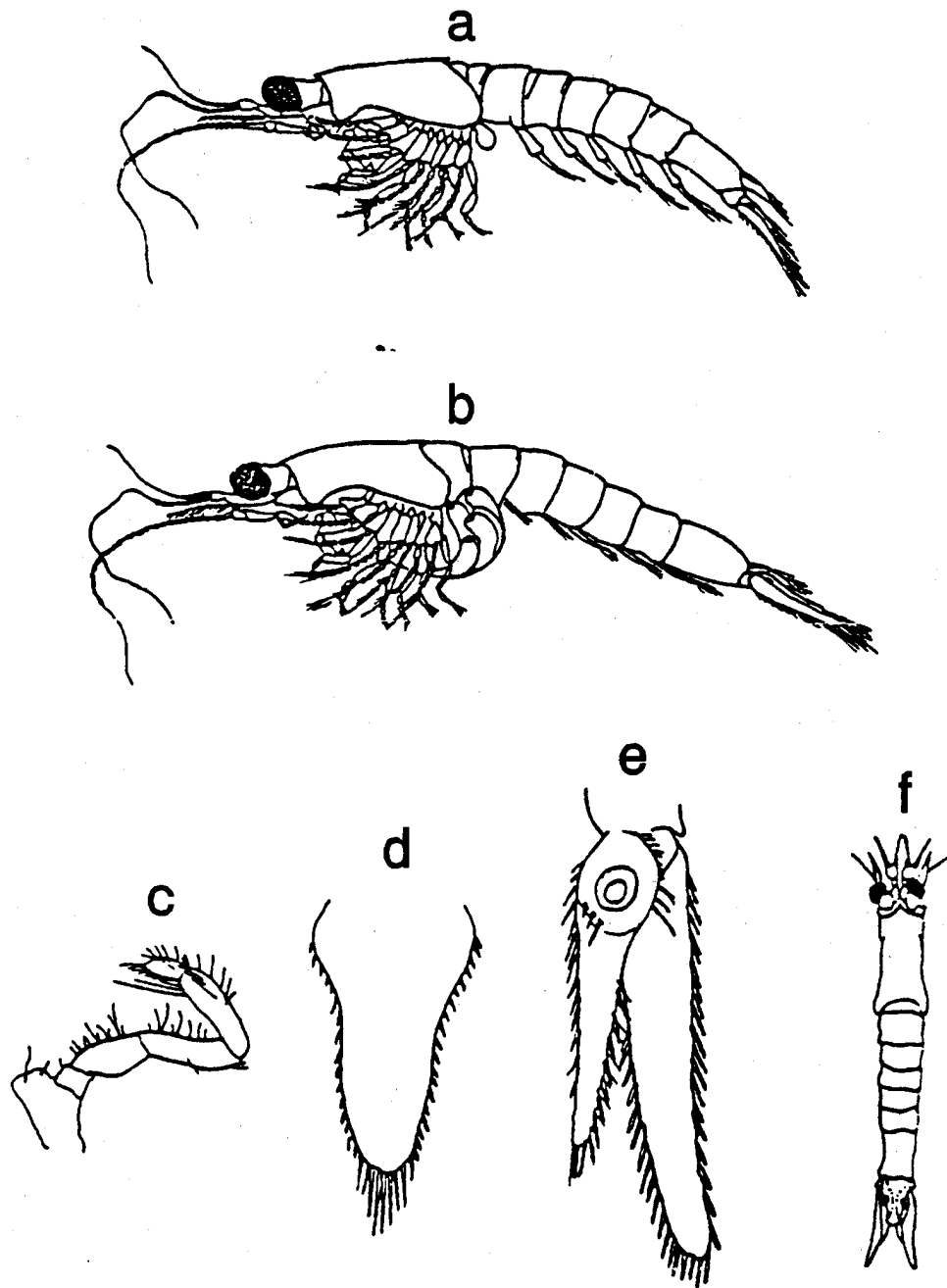

Figure 2. Morphological features most useful in identifying *Mysidopsis bahia*. a. male; b. female; c. thoracic leg 2; d. telson; e. right uropod, dorsal; f. male, dorsal (redrawn from Molenock, 1969; Heard et al., 1987). Note gonad in area where marsupium is located on female and length of male pleopods as compared to female. Also note the 3 spines on the endopod of the uropod (e).

TABLE 1. GENUS *MYSIDOPSIS*: COMMON AND SPECIFIC CHARACTERS OF SPECIES KNOWN FROM U.S. ATLANTIC AND GULF OF MEXICO WATERS (HEARD, ET AL., 1987 AND MODIFIED IN PART FROM BRATTEGARD, 1969)

	M. Eclipses	M. Brattisroemi	M. Mortenseni	M. Furca	M. Almyra	M. Bahia	M. Bigelowi	M. sp. (Inshore)	M. sp. (Offshore)
Anterior dorsal margin of carapace	Triangular	Triangular	Triangular	Rounded	Rounded	Triangular	Triangular	Triangular	Triangular
Presence of distal segment on antennal	yes	yes	yes	yes	no	no	no	no	no
Length/breadth ratio of antennal scale	2-2.5	3-3.5	3.5-4	4	6	6	5.4	5.4	5.2
# segments in carpopodopus of thoracic endopods 3-8	3	3	3	3	2	2	2	2	2
# segments in exopod of male pleopod 4	?	6	6-7	7	7	7	7-8	7	7
# spines on uropodal endopod	8-9	10-20	18-31	20-40	1	1-4	5 (occ. 3-4)	3-4 (occ. 2 or 5)	5 (occ. 4)
Length of terminal pair(s) of telson spines relative to lateral margin spines	Almost twice as long	slightly longer	Slightly longer	> twice as long	Gradually increasing	Gradually increasing	Abruptly increasing	Abruptly increasing	Abruptly increasing
# of pairs of apical telson spines	1	1	1	2	4-8	3-6	3	3-4	3
# setae on inner margin of segment 6 of second thoracic endopod	ca 3	ca 4	ca 3	ca 3	2-3	2-3	6-12	6-12	6-12
# setae on inner margin of segment 5 of second thoracic endopod	ca 5	ca 4	ca 2	ca 3	7-18	7-18	2	2	5-7

2.2 MORPHOLOGY AND TAXONOMY

2.2.1 Since *Mysidopsis bahia* occur with two other species of *Mysidopsis*, an understanding of the taxonomy of *M. almyra*, *M. bahia*, and *M. bigelowi* is important for culturing and testing practices. The taxonomic key of Heard et al. (1987) is suggested (see Table 1 for morphological guide to *Mysidopsis*).

2.2.2 Adults of *M. bahia* range in length from 4.4 mm to 9.4 mm (Molenock, 1969), measured from the anterior margin of the carapace to the end of uropods. The mature females are normally larger than the males and the pleopods of the female are smaller than those of the male (Ward, 1993) (Figure 2). *Mysidopsis bahia* can be positively identified as male or female when they are 4 mm in body length (Ward, 1993). Living organisms are usually transparent, but may be tinted yellow, brown or black. *Mysidopsis bigelowi* can be readily distinguished from *M. almyra* and *M. bahia* by the morphology of the second thoracic leg. *Mysidopsis bigelowi* has a greatly enlarged endopod of the thoracic limb 2 ("first leg") and the limb has a distinctive row of 6 to 12 spiniform setae on the inner margin of the sixth segment (Heard et al., 1987). *Mysidopsis bahia* can also be distinguished from other species of *Mysidopsis* by the number of apical spines on the telson (4-5 pairs) and the number of spines on the inner uropods distal to the statocyst (normally 2-3) (Figure 2).

2.2.3 Heard et al. (1987) state that the most reliable character for separating adult *M. almyra* and *M. bahia* is the number of spines on the inner uropods (*M. almyra* will always have a single spine). Further, Price (1982) found that for all stages of development for both species, the shape of the anterior margin of the carapace (rostral plate) could be used to distinguish *M. almyra* (broadly rounded) from *M. bahia* (more produced). Figure 2 illustrates the morphological features most useful in identifying *M. bahia* (redrawn Molenock, 1969; Heard et al., 1987).

2.3 CULTURE METHODS

2.3.1 SOURCE OF ORGANISMS

2.3.1.1 Starter cultures of mysids can be obtained from commercial sources, particularly in the Gulf of Mexico region for *M. almyra* and *M. bahia*.

2.3.1.2 Mysids of different species can also be collected by plankton tows or dip nets (approximately 1.0 mm mesh size) in estuarine systems. Heard et al. (1987) have identified specimens of *M. bahia* along the eastern coast, however, it has been principally identified as a subtropical species found in the Gulf of Mexico and along the east coast of Florida. Since many species of mysids may be present at a given collection site, the identification of the organisms selected for culture should be verified by an experienced taxonomist. The permittee should consult the permitting authority for guidance on the source of test organisms (indigenous or laboratory reared) before use.

2.4 CULTURING SYSTEM

2.4.1 Stock cultures can be maintained in continuous-flow or closed recirculating systems. In laboratory culture of *M. bahia*, recirculating systems are probably the most common practice. During the past ten years, a number of closed recirculating systems have been described. Since no single recirculating technique is the best in all respects, the system adopted will depend on the facilities and equipment available and the objectives of the culturing activities. Two other species of mysid, *M. almyra* and *M. bigelowi*, have also been successfully reared in the system described in this section (Ward, 1991). Further, there now exist a number of review papers (Venables, 1987 and Lussier et al., 1988) that describe in detail techniques developed by others that will be very helpful in culturing *Mysidopsis*.

2.4.2 Closed recirculating systems are unique because the re-used seawater they contain develops an unusual set of characteristics caused primarily by metabolic waste produced by the mysids. The accumulation of waste products and suspended particles in the water column is prevented by passing the seawater through a biological filtration system, in which ammonia and nitrite are oxidized by nitrifying bacteria.

2.5 CULTURE TANKS

2.5.1 Stock cultures of mysids are maintained in a closed recirculating system. The system should consist of four 200-L glass aquaria. However, smaller tanks, such as 80-L glass aquaria, can be used. When setting up a system, it is important to consider surface to volume ratio since this will determine how many mysids can be held in each aquarium. If smaller tanks must be used, the 20-gallon "high" form is recommended. Figure 3 (Ward, 1984; 1991) illustrates the main components of the biological filtration system. The flow rate through the filter is controlled by the water valve and is maintained between 4-5 L/min. This flow will be sufficient to establish a moderate current (from the filter return line) in the aquarium to allow the mysids (which are positively rheotactic) to align themselves with the current formed.

2.5.2 The filtration system consists of commercially-available under-gravel filter plates and external power filter. Each aquarium has two filter plates, forming a false bottom on each side of the tank, on which 2 cm of crushed coral are placed. The external power filter (Eheim, model 2017) canister is layered as shown in Figure 3 with a thin layer of filter fiber between each layer of carbon and crushed oyster shells. There has been some modification of the original filtration system (Ward, 1984), with crushed coral instead of oyster shells used on the filter bed, because crushed coral does not dissolve in seawater as readily as crushed oyster shells. If the system described above cannot be used, an acceptable alternative is an airlift pumping arrangement (Spotte, 1979). Crushed coral and oyster shells are commercially available and should be washed with deionized water and autoclaved before use.

2.6 CULTURE MEDIA

2.6.1 A clean source of filtered natural seawater (0.45 μm pore diameter) should be used to culture *Mysidopsis bahia*, however, artificial seasalts (FORTY FATHOMS[®]) have also been successfully used (Ward, 1993). A salinity range between 20 and 30‰ can be used (25‰ is suggested) to culture *M. bahia*. Leger and Sorgeloos (1982) reported success in culturing *M. bahia* in a formula following Dietrich and Kalle (Kalle, 1971), and still report continued use of this formula (Leger et al., 1987b). Other commercial brands have also been used (Reitsema and Neff, 1980; Nimmo and Iley, 1982; Nimmo et al., 1988) with varying degrees of success. The culture methods presented in Ward (1984; 1991) have been tried with a number of commercial brands of artificial seawater listed in Bidwell and Spotte (1985). Commercial brands of seasalts can be extremely variable in the amount of NaHCO_3 they provide, which, if not controlled, can affect growth and reproduction (Ward; 1989, 1991). In a comparative study, Ward (1993) found normal larval development within the marsupium using both natural seawater and FORTY FATHOMS[®] (i.e., Stage I - embryo; Stage II - eyeless larva; Stage III - eyed larva which is the final stage before release) and stressed the importance of proper preparation of the seasalts and monitoring of conditions in the tank.

2.6.2 The culture media should be aged to allow the build-up of nitrifying bacteria in the filter substrate. To expedite the aging process, 15 mL of a concentrated suspension of *Artemia* should be added daily. If using natural or artificial seawater, the carbonate alkalinity level should be maintained between 90 and 120 mg/L. It is also important to establish an algal community, *Spirulina subsalsa*, in the filter bed (Ward, 1984) and a healthy surface dwelling diatom community, *Nitzschia* sp., on the walls (Ward, 1991) in conjunction with the transfer of part of the biological filter from a healthy tank, when possible. After seven days, the suitability of the medium is checked by adding 20 adult mysids. If the organisms survive for 96 hours, the culture should be suitable for stocking.

2.6.3 If brine solutions are used, 100‰ salinity must not be exceeded. This corresponds to a carbonate alkalinity value of approximately 50 mg/L, which will allow relatively normal physiological mechanisms associated with CaCO_3 to occur during certain phases of the life cycle for *M. bahia* (Ward, 1989).

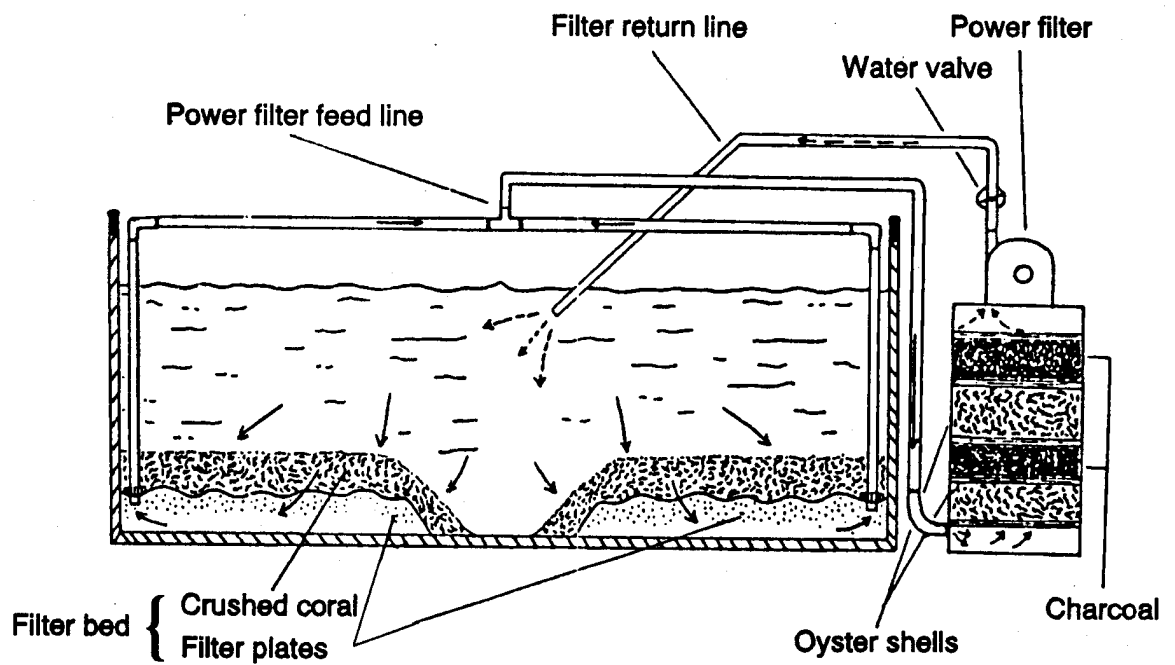

Figure 3. Closed recirculating system showing the two phases of the biological filtration system which consists of the filter bed and external power filter (from Ward, 1984; Ward, 1991).

2.7 ENVIRONMENTAL FACTORS

2.7.1 Temperature must be maintained within a range of 24°C to 26°C. Twelve to sixteen hours illumination should be provided daily at 50 to 100 ft-c. The daily light cycle can be provided by combining overhead room lights, cool-white fluorescent bulbs (approx. 50 ft-c, 12L:12D), with individual Grow-lux fluorescent bulbs placed horizontally over each tank (approx. 65 ft-c, 10L:14D). This procedure will avoid acute illumination changes by allowing the room lights to turn on one hour before and one hour after the aquaria lights. A timing device, such as an electronic microprocessor-based timer (ChronTrol[®], model CD, or equivalent) can be used to control the light cycle. These procedures are fully outlined in Ward (1984; 1991).

2.7.2 Good aeration ($\geq 60\%$ saturation by vigorous aeration with an air stone), a 10-20 percent exchange of seawater per week, and carbonate in the filtration system are essential in helping to control pH drops caused by oxidation of $\text{NH}_4\text{-N}$ and $\text{NO}_2\text{-N}$ by bacteria.

2.7.3 The single most important environmental factor when culturing *Mysidopsis bahia* or other organisms in recirculators is the conversion of ammonia to nitrite, and nitrite to nitrate by nitrifying bacteria. Spotte (1979) has suggested upper limits of 0.1 mg total $\text{NH}_4\text{-N/L}$, 0.1 mg $\text{NO}_2\text{-N/L}$ and 20 mg $\text{NO}_3\text{-N/L}$ for good laboratory operation of recirculating systems. For the recirculating system and techniques described here for mysids, the levels of ammonia, nitrite and nitrate never exceeded 0.05 mg of total ammonia-N/L ($\text{NH}_{3(\text{aq})}$ and NH_4^+), 0.08 mg $\text{NO}_2\text{-N/L}$ and 18 mg $\text{NO}_3\text{-N/L}$ (Ward, 1991). The toxicity of ammonia is based primarily on unionized ammonia (NH_3) and the proportion of NH_3 species to NH_4^+ species is dependent on pH, ionic strength and temperature. It is strongly recommended that the concentrations of total ammonia, nitrite and nitrate do not exceed those reported here. The ammonia, nitrite, and nitrate levels can be checked by using color comparison test kits such as those made by LaMotte Chemical or equivalent methods.

2.7.4 Bacterial oxidation of excreted ammonia by two groups of autotrophic nitrifying bacteria (*Nitrosomonas* and *Nitrobacter*), results in an increase of hydrogen ions, which causes a drop in pH and subsequent loss of buffering capacity. Typically, the culturist responds to the change in pH by adding Na_2CO_3 or NaHCO_3 . However, such efforts to buffer against a drop in pH will result in an increase in alkalinity and the uncontrolled use of carbonates can affect reproduction, especially at higher alkalinity values (Ward; 1989, 1991). Therefore, when using carbonates to buffer against pH changes, alkalinity values should not exceed 120 mg/L, which is easily measured by using a titrator kit such as that available from LaMotte Chemical or equivalent methods.

2.7.5 Figure 4 (Ward, 1991) depicts juvenile production per aquarium, no buffer added, over a period of 24 weeks. A regression line was calculated for these data and the slope and correlation coefficient were analyzed by Student's t test. The data showed that even when the pH dropped as low of 7.5, there was a significant increase ($P < 0.001$) in juvenile production. However, the pH should be maintained above 7.8 by the controlled use of NaHCO_3 and frequent water exchanges.

2.8 FEEDING

2.8.1 Frequent feeding with live food is necessary to prevent cannibalism of the young by the adults. McKenny (1987) suggests feeding densities of 2-3 *Artemia* per mL of seawater and Lussier et al. (1988) suggest a feeding rate of 150 *Artemia* nauplii per mysid daily.

2.8.2 In the *M. bahia*-*Artemia* predator-prey relationship, it is also important to provide sufficient quantities of nutritionally viable free-swimming stage-I nauplii (Ward, 1987); final hatching from the membranous-sac (pre-nauplii) into stage-I nauplii does not always occur. *Artemia* cysts that have been incubated for 24 h should be periodically examined with a stereozoom microscope to enumerate free-swimming stage-I nauplii and prenauplii (membranous-sac stage).

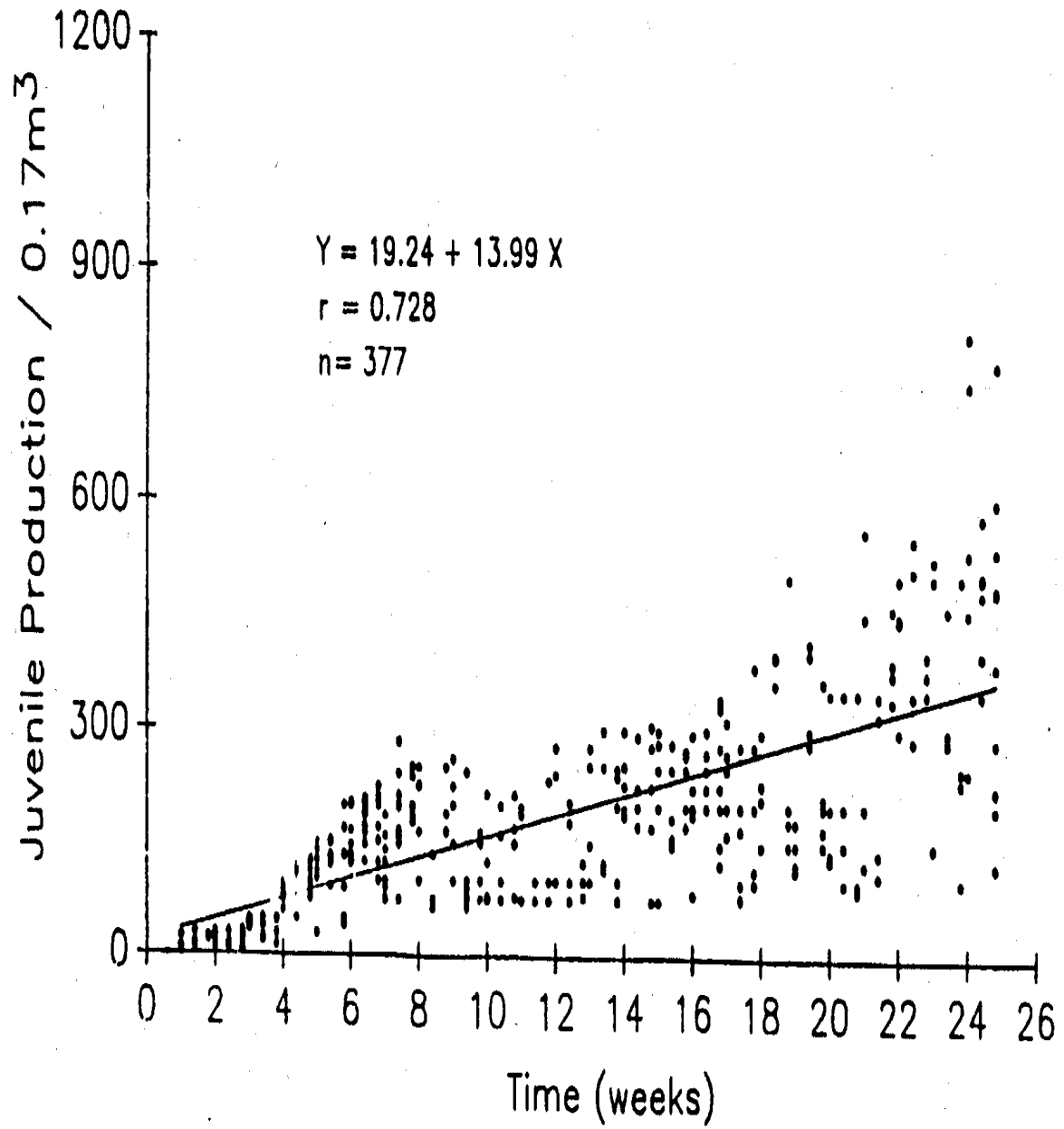

Figure 4. Juvenile production per aquarium over time (from Ward, 1991).

2.8.3 It has also been found that heavy metals can affect the hatchability of *Artemia* (Rafiee et al., 1986; Liu and Chen, 1987), therefore, when using natural seawater the level of metals should always be checked.

2.8.4 Ward (1987; 1991) has tried different brands of *Artemia* from different geographic origins and lot numbers; many achieved stage I nauplii and still caused variability in production of mysids which suggests that they were nutritionally lacking. Leger et al. (1985; 1987a) have drawn attention to poor larval survival of *M. bahia* and low levels of certain polyunsaturated fatty acids found in the *Artemia* fed. The enhancement of *Artemia* has also been studied and there are numerous techniques that have been successful (Leger et al., 1986).

2.8.5 Ward (1987; 1991) has found that it is important to control the flow of seawater in recirculating systems (keep below 5 L/min) so that *Artemia* does not become limiting to the mysid. Newly hatched *Artemia* should be fed to mysids at least twice a day. To supply *Artemia* to the mysid population on the weekend and prevent cannibalism of newly released mysids, an automatic feeder such as described by Schimmel and Hansen (1975) or Ward (1984; 1991) could be used. Ward (1991) designed a system to hatch *Artemia* when personnel were not available to set up *Artemia* for the following morning and afternoon feeding, such as Monday. Cysts were placed in two 4-L Erlenmeyer flasks (dry), an airstone was placed in each flask, and two vessels overhead were filled with 3500 mL of 30‰ seawater each. The previously described timer (ChronTrol[®], Model CD) was used to open the normally closed solenoids, allowing the seawater to gravity feed and hydrate the cysts.

2.8.6 It is possible that a surface dwelling diatom community acts as a secondary food that supplements deficient brands of *Artemia*, especially for newly released juveniles. Ward (1991) has observed that a strong fertilizing action is caused by the excretory products of the mysid population. As the concentration of nitrate increases (nitrification) to about 5 mg/L (in approximately 7-10 weeks in an aquarium), a bloom of surface dwelling diatoms, principally *Nitzschia*, but including *Amphora* and *Cocconeis*, occurs in natural or artificial seawater (Ward, 1993). It is interesting to note that, at the same time, there is a dramatic increase in the number of juveniles observed in the aquaria (Figure 4). The diatoms form layers on the walls of the aquarium and swarms of newly released juveniles have been found among them, possibly feeding upon them.

2.8.7 *Nitzschia* has been identified as a food source for the marine mud snail, *Ilyanassa obsoleta* (Collier, 1981), and the sea urchin, *Lytechinus pictus* (Hinegardner and Tuzzi, 1981). The diatom, *Skeletonema*, has also been used as a supplemental food for *M. bahia* (Venables, 1987). De Lisle and Roberts (1986) reported on the use of rotifers, *Branchionus plicatilis*, as a superior food for juvenile mysids. Rotifers are active swimmers, ranging in size from 100-175 µm as compared to 420-520 µm for *Artemia*, and would provide a good alternative food source if their fatty acid profile is adequate.

2.9 CULTURE MAINTENANCE

2.9.1 To avoid an excessive accumulation of algal growth on the internal surfaces of the aquaria, the walls and internal components should be scraped periodically and the shell substrate (coral or oyster) turned over weekly. Also, the filter plates must be completely covered so that the biological filter functions properly. After a culture tank has been in operation for approximately 2-3 months, detritus builds up on the bottom, which is removed with a fish net after first removing the mysids. The rate of water flow through the tanks should be maintained between 4-5 L/min, and 10-20% of the seawater in each aquarium should be exchanged weekly.

2.9.2 Some culturists have noted problems with hydrozoan pests in their cultures and there are procedures for their eradication, if necessary (Lawler and Shepard, 1978; Hutton et al., 1986).

2.10 PRODUCTION LEVEL

2.10.1 At least four aquaria should be maintained to insure a sufficient number of organisms on a continuing basis. If each 200-L aquarium is initially stocked with between 200 and 500 adults (do not exceed 500 adults), they will provide sufficient numbers of test organisms (Figure 4) each month. If the cultures are correctly

maintained, at least 20 percent of the adult population should consist of gravid females (have a visible oostegite brood pouch with young). It is also advantageous to cull older mysids in the population every 4-6 weeks and to move mysids among the four aquaria to diversify the gene pool.

2.11 TEST ORGANISMS

2.11.1 Juvenile *Mysidopsis bahia*, one to five days old, are used in the acute toxicity test and the survival, growth and fecundity test (USEPA, 1994). To obtain the necessary number for a test, there are a number of techniques available. A mysid generator such as the one described by Reistsema and Neff (1980) has been successfully used. Another method to obtain juveniles is to take approximately 200 adult females (bearing embryos in their brood pouches) from the stock culture and place them in a large (10 cm X 15 cm) standard fish transfer net (2.0 to 3.0 mm openings) that is partially submerged in an 8-L aquarium containing 4 L of clean culture medium. As the juveniles are released from the brood pouches, they drop through the fish net into the aquarium. The adults and juveniles in the aquarium are fed twice daily 24-hour post hydrated *Artemia*. The adults are allowed to remain in the net for 48 h, and are then returned to the stock tanks. The juveniles that are produced in the small tank may be used in the toxicity tests over a five-day period. Another method for obtaining juveniles (Ward 1987; 1989) is simply to remove juveniles from the stock culture with a fine mesh net, place them in 2-L PYREX[®] crystalline dishes with media, positioned on a light table that has an attached viewing plate (2 mm squares), and remove juveniles less than 2 mm in length (approximately 24 h old).

3. *HOLMESIMYSIS COSTATA*

3.1 MORPHOLOGY AND TAXONOMY

3.1.1 Laboratories unfamiliar with the test organism should collect preliminary samples to verify species identification. Refer to Holmquist (1979) or send samples of mysids and any similar co-occurring organisms to a qualified taxonomist. Request certification of species identification from any organism supplier. Records of verification should be maintained along with a few preserved specimens. A review by Holmquist (1979) considered previous references to *Acanthomysis sculpta* in California to be synonymous with *Holmesimysis costata* and this is considered definitive at this time.

3.2 SOURCE OF BROODSTOCK AND TRANSPORT

3.2.1 Broodstock of *H. costata* are collected by sweeping a small-mesh (0.5-1 mm) hand net through the water just under the surface canopy blades of giant kelp *Macrocystis pyrifera*. Although this method collects mysids of all sizes, attention should be paid to the number of gravid females collected because these are used to produce the juvenile mysids used in toxicity testing. Gravid females are identified by their large, extended marsupia filled with young. Mysids should be collected from waters remote from sources of pollution to minimize the possibility of physiological or genetic adaptation to toxicants.

3.2.2 Mysids can be transported for a short time (< 3 h) in tightly covered 20 L plastic buckets. The buckets should be filled to the top with seawater from the collection site, and should be gently aerated or oxygenated to maintain dissolved oxygen above 60% saturation. Transport temperatures should remain within 3°C of the temperature at the collection site.

3.2.3 For longer transport times of up to 36 h, mysids can be shipped in sealed plastic bags filled with seawater. The following transport procedure has been used successfully:

- 1) fill the plastic bag with one L of dilution water seawater,
- 2) saturate the seawater with oxygen by bubbling pure oxygen for at least 10 minutes,
- 3) place 25-30 adult mysids, or up to 100 juvenile mysids in each bag,
- 4) for adults add about 20 *Artemia* nauplii per mysid, for 100 juveniles add a pinch (10 to 20 mg) of

- ground Tetramin® flake food and 200 newly-hatched *Artemia* nauplii,
- 5) seal the bag securely, eliminating any airspace, and
- 6) place it within a second sealed bag in an ice chest.

Do not overfeed mysids in transport, as this may deplete dissolved oxygen, causing stress or mortality in transported mysids. A well-insulated ice chest should be cooled to approximately 15°C by adding one 1-L blue ice block for every five 1-L bags of mysids (organisms will tolerate the temperature range of 12 to 16°C). Wrap the ice in newspaper and a plastic bag to insulate it from the mysid bags. Pack the bags tightly to avoid shifting within the cooler.

3.3 HOLDING AND CULTURING

3.3.1 After collection, the mysids should be transported directly to the laboratory and placed in seawater tanks or aquaria equipped with flowing seawater or adequate aeration and filtration. Initial flow rates should be adjusted so that any temperature change occurs gradually (0.5°C per h). Broodstock will be collected and maintained at two temperatures as follows: 1) maintain the water temperature of $15 \pm 1^\circ\text{C}$ for mysids collected south of Pt. Conception, CA and 2) maintain the water temperatures of $13 \pm 1^\circ\text{C}$ for mysids collected north of Pt. Conception, CA. Mysids can be cultured in tanks ranging from 4 to 1000 L. Tanks should be equipped with gentle aeration and blades of *Macrocystis* to provide habitat. Static culture tanks can be used if there is constant aeration, temperature control, and frequent water changes (one half the water volume changed at least twice a week). Maintain culture density below 20 animals per L by culling out adult males or juveniles.

3.4 FEEDING

3.4.1 Adult mysids should be fed 100 *Artemia* nauplii per mysid per day. Juveniles should be fed 5 to 10 newly released *Artemia* nauplii per juvenile per day and a pinch (10 to 20 mg) of ground Tetramin® flake food per 100 juveniles per day. Static chambers should be carefully monitored and rations adjusted to prevent overfeeding and fouling of culture water.

3.5 TEST ORGANISMS

3.5.1 Juvenile *Holmesimysis costata* three to four days old, are used in the acute toxicity test and the survival and growth test (Hunt *et al.*, 1997; USEPA, 1995). To obtain the necessary number for a test, there are a number of techniques available for the acute toxicity test and the survival and growth test (USEPA, 1995). Approximately 150 gravid female mysids will typically produce approximately 400 juveniles. Gravid females can be identified by their large, extended marsupia filled with (visible) eyed juveniles. Marsupia appear distended and gray when females are ready to release young, due to presence of the juveniles. Gravid females are easily isolated from other mysids using the following technique: 1) use a small dip net to capture about 100 mysids from the culture tank, 2) transfer the mysids to a screen-bottomed plastic tube (150 μm -mesh, 25-cm diameter) partly immersed in a water bath or bucket, 3) lift the screen-tube out of the water to immobilize mysids on the damp screen, 4) gently draw the gravid females off the screen with a suction bulb and fire-polished glass tube (5-mm I.D.), and 5) collect gravid females in a separate screen tube. Re-immerses the screen continuously during the isolation process; mysids should not be exposed to air for more than a few seconds at a time.

3.5.2 Four to five days before a toxicity test begins, transfer gravid females into a removable, 2-mm-mesh screened cradle suspended within an aerated 80-L aquarium. Before transfer, make sure there are no juveniles in with the adult females. Extraneous juveniles are excluded to avoid inadvertently mixing them with the soon-to-be released juveniles used in testing. Provide the gravid females with newly hatched *Artemia* nauplii (approximately 200 per mysid) to help stimulate juvenile release. *Artemia* can be provided continuously throughout the night from an aerated reservoir holding approximately 75,000 *Artemia*. Direct the flow from the feeder into the screened compartment with the females, and add a few blades of *Macrocystis* for habitat. The females are placed within the screened compartment so that as the juveniles are released, they can swim through the mesh into the bottom of the

aquarium. Outflows on flow-through aquaria should be screened (150- μ m-mesh) to retain juveniles and allow some *Artemia* to escape.

3.5.3 Juveniles are generally released at night, so it is important to turn off all lights at night to promote release. In the morning, the screened compartment containing the females should be removed and placed in a separate aquarium. Juveniles should be slowly siphoned through a wide-diameter hose into a 150- μ m-mesh screen-bottom tube (25 cm diam.) immersed in a bucket filled with clean seawater. Once the release aquarium is emptied, it should be washed with hot fresh water to eliminate stray juveniles that might mix with the next cohort.

3.5.4 After collection, the number of juveniles should be estimated visually or by counting subsamples with a small beaker. If there are not enough juveniles, the juveniles from previous or subsequent releases can be combined so that the test is initiated with three and/or four-day old juveniles. Mysids 2-days old and younger have higher mortality rates, while mysids older than four days may vary in their toxicant sensitivity or survival rate (Hunt *et al.*, 1989; Martin *et al.*, 1989).

3.5.5 Test juveniles should be transferred to additional screen-tubes (or to 4-L static beakers if flowing seawater is unavailable). The screen-tubes are suspended in a 15-L bucket so that dilution water seawater (0.5 L/min) can flow into the tube, through the screen, and overflow from the bucket. Check water flow rates (< 1 L/min) to make sure that juveniles or *Artemia* nauplii are not forced down onto the screen. The height of the bucket determines the level of water in the screen tube. About 200 to 300 juveniles can be held in each screen-tube (200 juveniles per static 4-L beaker). Juveniles should be fed 40 newly hatched *Artemia* nauplii per mysid per day and a pinch (10 to 20 mg) of ground Tetramin[®] flake food per 100 juveniles per day. A blade of *Macrocystis* (well rinsed in seawater) should be added to each chamber. Chambers should be gently aerated and temperature controlled at $15 \pm 1^\circ\text{C}$ (or $13 \pm 1^\circ\text{C}$ if collected north of Pt. Conception). Half of the seawater in static chambers should be changed at least once between isolation and test initiation.

3.5.6 The day juveniles are isolated is designated day 0 (the morning after their nighttime release). The toxicity test should begin on day three or four. For example, if juveniles are isolated on Friday, the toxicity test would begin on the following Monday or Tuesday. Pool all of the test juveniles into a 1-L beaker. Using a 10-mL wide-bore pipet or fire-polished glass tube (approximately 2-3 mm I.D), place one or two juveniles into as many plastic cups (one for each test chamber). These cups should contain enough clean dilution seawater to maintain water quality and temperature during the transfer process (approximately 50 mL per cup). When each of the cups contains one or two juveniles, repeat the process, adding mysids until each cup contains 10 organisms. Carefully pour or pipet off excess water in the cups, leaving less than 5 mL with the test mysids. This 5 mL volume can be estimated visually after initial measurements. Carefully pour or pipet the juveniles into the test chambers immediately after reducing the water volume. Gently rocking the water back and forth before pouring may help prevent juveniles from clinging to the walls of the randomization cups. Juveniles can become trapped in drops; have a squirt bottle ready to gently rinse down any trapped mysids. If more than 5 mL of water is added to the test solution with the juveniles, report the amount on the data sheet. Be sure that all water used in culture, transfer, and test solutions is within 1°C of the test temperature. Because of the small volumes involved in the transfer process, temperature control is best accomplished in a constant-temperature room.

3.5.7 Immobile mysids that do not respond to a stimulus are considered dead. The stimulus should be two or three gentle prods with a disposable pipet. Mysids that exhibit any response clearly visible to the naked eye are considered living. The most commonly observed movement in moribund mysids is a quick contraction of the abdomen. This or any other obvious movement qualifies a mysid as alive.

SELECTED REFERENCES

- Anderson, J.W., Neff, B.A. Cox, H.E. Tatem, and G.H. Hightower. 1974. Characteristics of dispersions and water-soluble extracts of crude and refined oils and their toxicity to estuarine crustaceans and fish. *Mar. Biol.* 27:75-88.
- Anonymous. 1979. Test 6: *Mysidopsis bahia* life cycle. *Fed. Reg.* 44(53):16291.
- Astthorsson, O.S., and R. Ralph. 1984. Growth and molting of *Neomysisinteger* (Crustacea, Mysidacea). *Mar. Biol.* 79:55-61.
- Bahner, L.H., C.D. Craft, and D.R. Nimmo. 1975. A saltwaterflow-through bioassay method with controlled temperature and salinity. *Progr. Fish-Cult.* 37:126-129.
- Bahner, L.H., A.J. Wilson, Jr., J.M. Sheppard, J.M. Patrick, Jr., L.R. Goodman, and G.E. Walsh. 1977. KEPONE® bioconcentration, accumulation, loss, and transfer through estuarine food chains. *Chesapeake Sci.* 18:299-308.
- Bidwell, J.P., and S. Spotte. 1985. *Artificial Seawaters*. Jones and Bartlett Publishers, Inc., Boston, Ma.
- Brattegard, T. 1969. Marine biological investigations in the Bahamas. 10. Mysidacea from shallow water in the Bahamas and southern Florida. Part I. *Sarsia* 39:17-106.
- Breteler, R.J., J.W. Williams, and R.L. Buhl. 1982. Measurements of chronic toxicity using the opossum shrimp *Mysidopsis bahia*. *Hydrobiologia.* 93:189-194.
- Buikema, A.L., Jr., B.R. Niederlehner, and J. Cairns, Jr. 1981. The effects of simulated refinery effluent and its components on the estuarine crustacean, *Mysidopsis bahia*. *Arch. Environm. Contam. Toxicol.* 10:231-240.
- Carr, R.S., L.A. Reitsema, and J.M. Neff. 1980. In: *Proceedings of Research on Environmental Fate and Effects of Drilling Fluids and Cutting*. Vol. II, Amer. Petrol. Inst., pp. 944-960.
- Clark, W. 1971. Mysids of the southern kelp region. In: W. North, ed., *Biology of Giant Kelp Beds (Macrocystis) in California*. J. Cramer Publisher, Lehre, Germany: p 369-380.
- Clutter, R.I. 1967. Zonation of nearshore mysids. *Ecology.* 48(2): 200-208.
- Clutter, R.I. 1969. The microdistribution and social behavior of some pelagic mysids. *J. Exp. Mar. Biol. Ecol.* 3: 125-155.
- Collier, J.R. 1981. Methods of obtaining and handling eggs and embryos of the marine mud snail *Ilyanassa obsoleta*. pp. 217-232, In: *Laboratory animal management, marine invertebrates*. National Academy Press, Washington, DC.
- Cripe, G.M., D.R. Nimmo, and T.L. Hamaker. 1981. Effects of two organophosphate pesticides on swimming stamina of the mysid *Mysidopsis bahia*. In: Vernberg, F.J., A. Calabrese, F.P. Thurberg, and W.B. Vernberg, eds., *Biological Monitoring of Marine Pollutants*. Academic Press, New York. pp. 21-36.
- De Lisle, P.F., and M.H. Roberts, Jr. 1986. The effects of acclimation on the mysid, *Mysidopsis bahia* Molenock. *Comparative Biochemistry and Physiology* 85A(2):383-387.
- Farrell, D.H. 1979. Guide to the shallow-water mysids from Florida. *Fla. Dept. Environ. Reg., Techn. Ser.* 4(1):1-69.

- Fotheringham, N., and S.L. Brunenmeister. 1975. Common marine invertebrates of the northwestern Gulf coast. Gulf Publ. Co., Houston, Texas.
- Gentile, S.M., J.H. Gentile, J. Walker, and J.F. Heltshe. 1982. Chronic effects of cadmium on two species of mysid shrimp: *Mysidopsis bahia* and *M. bigelowi*. *Hydrobiol.* 93:195-204.
- Green, J.M. 1970. Observations on the behavior and larval development of *Acanthomysis sculpta* (Tattersall), (Mysidacea). *Can. J. Zool.* 48: 289-292.
- Heard, R.W. 1982. Guide to the common tidal marsh invertebrates of the northeastern Gulf of Mexico. Publ. No. MASGP-79-004, Mississippi-Alabama Sea Grant Consortium, Ocean Springs, Mississippi.
- Heard, R.W., W.W. Price, and K.C. Stuck. 1987. Mysid identification workshop. The Gulf Coast Research Laboratory, Ocean Springs, Mississippi (unpublished).
- Hinegardner, R.T., and M.M.R. Tuzzi. 1981. Laboratory culture of the sea urchin *Lytechinus pictus*. In: Laboratory animal management, marine invertebrates. National Academy Press, Washington, DC. pp. 291-302.
- Holmquist, C. 1979. *Mysis costata* and its relations (Crustacea, Mysidacea). *Zool. Jb. Syst.* 106: 471-499.
- Hunt, J.W., B.S. Anderson, S.L. Turpen, A.R. Coulen, M. Martin, F.H. Palmer, and J.J. Janik. 1989. Marine bioassay project fourth report: Experimental evaluation of effluent toxicity testing protocols with giant kelp, mysids, red abalone, and topmelt. Report 89-5WQ. California State Water Resources Control Board, Sacramento, CA.
- Hunt, J.W., B.S. Anderson, S.L. Turpen, M.A. Englund, and W.J. Piekarski. 1997. Precision and sensitivity of a seven-day growth and survival toxicity test using the west coast marine mysid crustacean *Holmesimysis costata*. *Environ. Toxicol. Chem.* 16: 824-834.
- Hutton, C.H., P.F. Delisle, M.H. Roberts, and D.A. Hepworth. 1986. *Chrysaora quinquecirrha*: a predator on mysids (*Mysidopsis bahia*) in culture. *Progr. Fish-Cult.* 48:154-155.
- Jacobs, F., and G.C. Grant. 1974. Acute toxicity of unbleached kraft mill effluent (UKME) to the opossum shrimp, *Neomysis americana* Smith. *Water Res.* 8:439-445.
- Jensen, J.P. 1958. The relation between body size and number of eggs in marine malacostraces. *Meddr. Danm. Fisk.-og Havunders* 2:1-25.
- Johns, D.M., W.J. Berry, and W. Walton. 1981. International study on *Artemia*. XVI. Survival, growth and reproductive potential of the mysid *Mysidopsis bahia* Molenock fed various geographical strains of the brine shrimp *Artemia*. *J. Exp. Mar. Biol. Ecol.* 53:209-219.
- Kalle, K. 1971. Salinity: general introduction. In: O. Kinne, ed., *Marine Ecology*, Vol. 1, part 2. London, Wiley-Interscience. pp. 683-688.
- Lawler, A.R., and S.L. Shepard. 1978. Procedures for eradication of hydrozoan pests in closed-system mysid culture. *Gulf Res. Rept.* 6:177-178.
- Lee, D.R., and A.L. Buikema, Jr. 1979. Molt-Related sensitivity of *Daphnia pulex* in toxicity testing. *J. Fish. Res. Bd. Can.* 36:1129-1133.
- Leger, P., D.A. Bengtson, K.L. Simpson, and P. Sorgeloos. 1986. The use and nutritional value of *Artemia* as a food source. *Oceanogr. Mar. Biol. Ann. Rev.* 24:521-623.

- Leger, P., J.F. De Queiroz, and P. Sorgeloos. 1987a. The effect of broodstock diet on reproductive activity and offspring quality in the marine crustacean *Mysidopsis bahia* (Molenock). Proceedings of Aquaculture Europe, Amsterdam, Holland, June 2-5, 1987. (In Press).
- Leger, P., D.M. Johns, and P. Sorgeloos. 1987b. Description of a standard bioassay with the marine crustacean *Mysidopsis bahia* (M.) for the evaluation of the nutritional effectiveness of *Artemia* nauplii and metanauplii. In: P. Sorgeloos, D.A. Bengtson, W. Declair, and E. Jaspers, eds., *Artemia* Research and its Applications. Vol. 3. Morphology, Genetics, Strain characterization, Toxicology. Universa. Press, Wetteren, Belgium. (In Press).
- Leger, P., and P. Sorgeloos. 1982. Automation in stock-culture maintenance and juvenile separation of the mysid, *Mysidopsis bahia* (Molenock). *Aquacult. Eng.* 1:45-53.
- Leger, P., P. Sorgeloos, O.M. Millamena, and K.L. Simpson. 1985. International study on *Artemia*. XXV. Factors determining the nutritional effectiveness of *Artemia*: The relative impact of chlorinated Hydrocarbons and essential fatty acids in San Francisco Bay and San Pablo Bay *Artemia*. *J. Exper. Mar. Biol. Ecol.* 93:71-82.
- Liu, P.C., and J.C. Chen. 1987. Effects of heavy metals on the hatching rates of brine shrimp *Artemia salina* cysts. *J. World Aquacult. Soc.* 18(2):78-83.
- Lussier, S.M., A. Kuhn, M.J. Chammas, and J. Sewall. 1988. Techniques for the laboratory culture of *Mysidopsis* species (Crustacea: Mysidacea). *Environ. Toxicol. Chem.* 7:969-977.
- Lussier, S.M., J.H. Gentile, and J. Walker. 1985. Acute and chronic effects of heavy metals and cyanide on *Mysidopsis bahia* (Crustacea: Mysidacea). *Aquat. Toxicol.* 7:25-35.
- Martin, M., J.W. Hunt, B.S. Anderson, S.L. Turpen, and F.H. Palmer. 1989. Experimental evaluation of the mysid *Holmesimysis costata* as a test organism for effluent toxicity testing. *Environ. Toxicol. Chem.* 8: 1003-1012.
- Mauchline, J. 1980. The biology of mysids and euphausiids. *Adv. Mar. Biol.* 18. 369 pp.
- Molenock, J. 1969. *Mysidopsis bahia*, a new species of mysid (Crustacea: Mysidacea) from Galveston Bay, Texas. *Tulane Stud. Zool. Bot.* 15(3): 113-116.
- Morgan, M.D. 1982. The ecology of Mysidacea. *Developments in Hydrobiology* 10. W. Junk, Publ., The Hague, Netherlands. 232 pp.
- Nesler, T.P., and E.P. Bergersen, eds. 1991. Mysids in fisheries: hard lessons from headlong introductions. Proceedings of a symposium held at the 118th Annual Meeting of the American Fisheries Society, September 9-15, 1988, Toronto, Ontario. *Amer. Fish. Soc. Symp.* 9. 199 pp.
- Nimmo, D.R., L.H. Bahner, R.A. Rigby, J.M. Sheppard, and A.J. Wilson, Jr. 1977. *Mysidopsis bahia*: an estuarine species suitable for life-cycle toxicity tests to determine the effects of a pollutant. In: F.L. Mayer and J.L. Hamelin, eds., *Aquatic Toxicology and Hazard Evaluation*, ASTM STP 634, American Society for testing and Materials, Philadelphia, Pennsylvania. pp. 109-111.
- Nimmo, D.R., and T.L. Hamaker. 1982. Mysids in toxicity testing - a review. *Hydrobiol.* 93:171-178.
- Nimmo, D.R., T.L. Hamaker, J.C. Moore, and C.A. Sommers. 1979. Effect of Diflubenzuron on an estuarine crustacean. *Bull. Environm. Contam. Toxicol.* (22):767-770.

- Nimmo, D.R., T.L. Hamaker, E. Matthews, and J.C. Moore. 1981. An overview of the acute and chronic effects of first and second generation pesticides on an estuarine mysid. In: Vernberg, F.J., A. Calabrese, F.P. Thurberg, and W.B. Vernberg, eds., *Biological Monitoring of Marine Pollutants*. Academic Press, New York. pp. 3-19.
- Nimmo, D.R., T.L. Hamaker, E. Matthews, and W.T. Young. 1982. The long-term effects of suspended particulates on the survival and reproduction of the mysid shrimp, *Mysidopsis bahia*, in the laboratory. In: G.F. Mayer, ed., *Ecological Stress and the New York Bight: Science and Management*. Estuarine Res. Found., Columbia, S. Carolina. pp. 41-50.
- Nimmo, D.R., T.L. Hamaker, J.C. Moore, and R.A. Wood. 1980. Acute and chronic effects of Dimilin on survival and reproduction of *Mysidopsis bahia*. In: J.G. Eaton, P.R. Parrish, and A.C. Hendricks, eds., *ASTM STP 707*, American Society for Testing and Materials, Philadelphia, Pennsylvania. pp. 366-376.
- Nimmo, D.R., R.J. Miranda, and C.A. Carlson. 1991. Culturing the estuarine mysid, *Mysidopsis bahia*: a synopsis of three case studies. In: T.P. Nesler and E. P. Bergersen, eds., *Mysids in fisheries: hard lessons from headlong introductions*. Proceedings of a symposium held at the 118th Annual Meeting of the American Fisheries Society, September 9-15, 1988, Toronto, Ontario. Amer. Fish. Soc. Symp. 9, pp. 160-168.
- Nimmo, D.R., R.A. Rigby, L.H. Bahner, and J.M. Sheppard. 1978. The acute and chronic effects of cadmium on the estuarine mysid, *Mysidopsis bahia*. *Bull. Environm. Contam. Toxicol.* 19(1):80-84.
- Price, W.W. 1982. Key to the shallow water Mysidacea of the Texas coast with notes on their ecology. *Hydrobiol.* 93(1/2):9-21.
- Price, W.W., A.P. McAllister, R.M. Towsley, and M. DelRe. 1986. Mysidacea from continental shelfwaters of the northwestern Gulf of Mexico. *Contrib. Marine Sci.* 29:45-58.
- Price, W.W., R.W. Heard, and L. Stuck. 1994. Observations on the genus *Mysidopsis* Sars, 1864 with the designation of a new genus, *Americamysis*, and the descriptions of *Americamysis alleni* and *Americamysis stucki* (Peracarida: Mysidacea: Mysidae), from the Gulf of Mexico. *Procedure. Biol. Soc. Wash.* 107: 680-698.
- Rafiee, P., C.O. Matthews, J.C. Bagshaw, and T.H. MacRae. 1986. Reversible arrest of *Artemia* development by cadmium. *Can. J. Zool.* 64:1633-1641.
- Reitsema, L.A. 1981. The growth, respiration, and energetics of *Mysidopsis almyra* (Crustacea; Mysidacea) in relation to temperature, salinity, and hydrocarbon exposure. Ph.D. thesis, Texas A&M University, College Station, Texas.
- Reitsema, L.A., and J.M. Neff. 1980. A recirculating artificial seawater system for the laboratory culture of *Mysidopsis bahia* (Crustacea; Pericaridea). *Estuaries* 3:321-323.
- Roberts, M.H., J.E. Warinner, C.F. Tsai, D. Wright, and L.E. Cronin. 1982. Comparison of estuarine species sensitivities to three toxicants. *Arch. Environm. Contam. Toxicol.* 11:681-692.
- Salazar, M.H., S.C. U'ren, and S.A. Steinert. 1980. Sediment bioassays for San Diego dredging project. Naval Oceans Systems Center, San Diego, Calif. Techn. Rept. 570. 46 pp.
- Schimmel, S.C., and D.J. Hansen. 1975. An automatic brine shrimp feeder for aquatic bioassays. *J. Fish. Res. Board Can.* 32: 314-316.
- Shuba, P.J., H.E. Tatem, and J.H. Carroll. 1978. Biological assessment methods to predict the impact of open-water disposal of dredged material. Techn. Rept. D-78-50. U.S. Army Engineer Waterways Experiment Station, Vicksburg, Mississippi. 77 pp.

- Spotte, S. 1979. Fish and invertebrate culture. John Wiley and Sons, New York, NY, 179 pp.
- Stuck, K.C., H.M. Perry, and R.W. Heard. 1979a. An annotated key to the Mysidacea of the North Central Gulf of Mexico. *Gulf Res. Rept.* 6(3):225-238.
- Stuck, K.C., H.M. Perry, and R.W. Heard. 1979b. Records and range extensions of Mysidacea from coastal and shelf water of the Eastern Gulf of Mexico. *Gulf Res. Rept.* 6(3):39-248.
- Tattersall, W.M., and Tattersall. 1951. The British Mysidacea. Royal Soc. London. 460 pp.
- Turpen, S.L., J.W. Hunt, B.S. Anderson, and J.S. Pearse. 1994. Population structure, growth and fecundity of the kelp forest mysid, *Holmesmysis costata* in Monterey Bay, California. *J. Crust. Biol.* 14(4): 657-664.
- USEPA. 1978a. Methods for acute static toxicity tests with mysid shrimp (*Mysidopsis bahia*). P.W. Borthwick. In: Bioassay Procedures for the Ocean Disposal Permit Program. U. S. Environmental Protection Agency, Environmental Research Laboratory, Gulf Breeze, Florida. EPA-600/9-78-010. pp. 61-63.
- USEPA. 1978b. Culturing the mysid (*Mysidopsis bahia*) in flowing seawater or a static system. D.R. Nimmo, T.L. Hamaker, and C.A. Sommers. In: Bioassay Procedures for the Ocean Disposal Permit Program, U. S. Environmental Protection Agency, Environmental Research Laboratory, Gulf Breeze, Florida. EPA-600/9-78-010. pp. 64-68.
- USEPA. 1978c. Entire life cycle toxicity test using mysids (*Mysidopsis bahia*) in flowing water. D.R. Nimmo, T.L. Hamaker, and C.A. Sommers. In: Environmental Protection Agency, Environmental Research Laboratory, Gulf Breeze, Florida. EPA-600/9-78-010. pp. 64-68.
- USEPA. 1981a. Acephate, aldicarb, carbophenothion, DEF, EPN, ethoprop, methyl parthion, and phorate: their acute and chronic toxicity, bioconcentration potential, and persistence as related to marine environments. EPA-600/4-81-041.
- USEPA. 1981b. Acute toxicity test standard using mysid shrimp in static and flow-through systems. Toxic Substances Control Act, Section 4. Office of Toxic Substances, Health and Environmental Review Division, U. S. Environmental Protection Agency, Washington, D.C. 19 pp.
- USEPA. 1981c. Chronic toxicity test standard using mysid shrimp in a flow-through system. Toxic Substances Control Act, Section 4. Office of Toxic Substances, Health and Environmental Review Division, U. S. Environmental Protection Agency, Washington, D.C. 43 pp.
- USEPA. 1981d. Technical support document for using mysid shrimp in acute and chronic toxicity tests. Toxic Substances Control Act, Section 4. Office of Toxic Substances, Health and Environmental Review Division, U. S. Environmental Protection Agency, Washington, D.C. 43 pp.
- USEPA. 1982. Culturing and chronic toxicity of *Mysidopsis bahia* using artificial seawater. D.R. Nimmo, and E.S. Iley, Jr. Office of Toxic Substances, U. S. Environmental Protection Agency, Washington, D.C. Publ. PA 902.
- USEPA. 1984. Acute toxicity of eight laboratory-prepared generic drilling fluids to mysids (*Mysidopsis bahia*). T.W. Duke, P.R. Parish, R.M. Montgomery, S.D. Macauley, and G.M. Cripe. U. S. Environmental Protection Agency, Wash., D.C. EPA 600/S3-84-067.
- USEPA. 1987. Optimization of environmental factors during the life cycle of *Mysidopsis bahia*. C.L. McKenney, Jr. Environmental Research Brief, U. S. Environmental Protection Agency, Gulf Breeze, Florida. EPA 600/M-87/004.

- USEPA. 1990. Mysid (*Mysidopsis bahia*) survival, growth, and fecundity toxicity test. Supplemental report for training videotape. Office of Water, U. S. Environmental Protection Agency, Washington, D.C. EPA/505/8-90-006a.
- USEPA. 1994. Short-term methods for estimating the chronic toxicity of effluents and receiving waters to marine and estuarine organisms, 2nd ed. Environmental Monitoring Systems Laboratory, U.S. Environmental Protection Agency, Cincinnati, OH. EPA/600/4-91/003.
- USEPA, 1995. Short-term methods for estimating the chronic toxicity of effluents and receiving waters to west coast marine and estuarine organisms. National Exposure Research Laboratory, U.S. Environmental Protection Agency, Cincinnati, OH. EPA/600/R-95-136.
- Venables, B. 1987. (Rapporteur) *Mysidopsis* sp.: life history and culture. A report from a workshop held in Gulf Breeze, Florida, October 15-16, 1986. (Unpublished Report) Institute of Applied Sciences, North Texas State Univ., Denton, Tx. 41 pp.
- Ward, S.H. 1984. A system for laboratory rearing of the mysid, *Mysidopsis bahia* Molenock. *Progr. Fish-Cult.* 46(3):170-175.
- Ward, S.H. 1987. Feeding response of the mysid *Mysidopsis bahia* reared on *Artemia*. *Progr. Fish-Cult.* 49(1):29-33.
- Ward, S.H. 1989. The requirements for a balanced medium in toxicological experiments using *Mysidopsis bahia* with special reference to calcium carbonate. In: U.M. Cowgill and L.R. Williams, eds., *Aquatic Toxicology and Hazard Assessment*, ASTM STP 1027, American Society for Testing and Materials, Philadelphia, Pennsylvania. pp. 402-412.
- Ward, S.H. 1991. Techniques to enhance laboratory culture of *Mysidopsis bahia* Molenock. In: T.P. Nesler and E. P. Bergersen, eds., *Mysids in fisheries: hard lessons from headlong introductions*. Proceedings of a symposium held at the 118th Annual Meeting of the American Fisheries Society, September 9-15, 1988, Toronto, Ontario. *Amer. Fish. Soc. Symp.* 9, pp. 181-192.
- Ward, S.H. 1993. A comparison of natural and artificial seawater for culturing and toxicity testing with *Mysidopsis bahia*. In: W. Landis, J.S. Hughes, and M.A. Lewis, eds. *Proceedings of the First Symposium on Environmental Toxicology and Risk Assessment*, April 14-16, 1991, Atlantic City, New Jersey. ASTM STP 1179, American Society for Testing and Materials, Philadelphia, Pennsylvania.
- Whittmann, K.J. 1984. Ecophysiology of marsupial development and reproduction in Mysidacea (Crustacea). *Oceanogr. Mar. Biol. Ann. Rev.* 22:393-428.
- Williams, A.B. 1972. A ten-year study of meroplankton in North Carolina estuaries: Mysid shrimps. *Ches. Sci.* 13(4):254-262.

APPENDIX A

DISTRIBUTION, LIFE CYCLE, TAXONOMY, AND CULTURE METHODS

A.4. BRINE SHRIMP (*ARTEMIA SALINA*)

1. SYSTEMATICS

1.1 MORPHOLOGY AND TAXONOMY

1.1.1 The taxonomic status of *Artemia* has long been controversial because there is considerable morphological variability over parts of its range. The present consensus is that there is a single cosmopolitan species, *Artemia salina*, which has numerous intergrading physiological and morphological varieties (Pennak, 1989). Brine shrimp belong to the subclass Branchiopoda which is characterized by many pairs of flattened appendages on the thorax (Figure 1), in contrast to other members of the Crustacea that have no more than six pairs. Probably the most distinctive feature of *Artemia salina* is the compressed, triangular, and blade-shaped distal segment of the second antenna of the male (Figure 2). The mature adult is 8-10 mm long with a stalked lateral eye, sensorial antennulae, a linear digestive tract and 11 pairs of thoracopods. In the male the antennae are transformed into muscular claspers used to secure the female during copulation.

2. DISTRIBUTION

2.1 *Artemia* are found nearly worldwide in saline lakes and pools. In North America, they have been reported throughout the western United States, in Nebraska and Connecticut and in Saskatchewan, Canada. They are probably more widely distributed than indicated because of limited effort in collecting from many areas of the country. They are absent from many suitable habitats, probably because of their limited dispersal methods.

3. ECOLOGY AND LIFE HISTORY

3.1 GENERAL ECOLOGY

3.1.1 The ecological conditions under which brine shrimp live are highly variable. The salinity can exceed 300‰, where most other life cannot survive. Favored by the absence of predators and food competitors in such places, *Artemia* develop very dense populations. Although not a marine species, they sometimes occur in bays and lagoons where brines are formed by evaporation of seawater (salt pans). They are more commonly found in highly saline lakes, such as the Great Salt Lake, where the shoreline may become ringed with brown layers of accumulated brine shrimp cysts. Brine shrimp are also common in evaporation basins used for the commercial production of salt.

3.1.2 The reproductive habits of different populations vary considerably. In parts of Europe parthenogenesis is the rule, males being rare or absent, but in North America most *Artemia* populations seem to be diploid with males common.

3.1.3 The principal mechanism of *Artemia* dispersion is transportation of the cysts by wind or waterfowl and by deliberate or accidental human inoculation.

3.1.4 Growth of brine shrimp is influenced by many factors and the tolerance of these factors is strain dependent. Optimum temperature for most strains ranges between 25 and 35°C but strains have been reported thriving at 40°C. Most geographical strains do not survive temperatures below 6°C except as cysts. These cysts are tolerant of temperatures from far below 0°C to near the boiling point of water. Although *Artemia* can survive and reproduce under a wide range of salinity, they are seldom found in nature in salinities below 45‰ or above 200‰. The pH tolerance of *Artemia* varies from neutral to highly alkaline but the cysts will hatch best at a pH of 8 or higher.

3.1.5 Many predators including many zooplankton that populate natural salt waters, many salt water fish, several insect groups (odonates, hemipterans and beetles), and birds feed on brine shrimp in situations where they can tolerate the conditions.

3.2 FOOD AND FEEDING

3.2.1 Brine shrimp are typically filter-feeders that consume organic detritus, microscopic algae and bacteria. Blooms of microscopic algae are favorite habitats of *Artemia*, and large populations develop in such areas where they feed on the algae and heterotrophic bacteria that are produced by these blooms. Brine shrimp populations have done well in cultures when fed algae, rice bran (Sorgeloos et al., 1979), soybean meal or whey powder (Bossuyt and Sorgeloos, 1979). The nauplii do not need food for four days after hatching.

3.3 LIFE HISTORY

3.3.1 Most strains of *Artemia* produce cysts that float (cysts from the Mono Lake, California strain sink). These cysts remain in diapause as long as they are kept dry or under anaerobic conditions. Upon hydration, the embryo in the cyst becomes activated. After several hours the outer membrane bursts and the embryo emerges still encased in the hatching membrane. Soon the hatching membrane is ruptured and the free-swimming nauplius is born. The first instar is brownish-orange colored and has three pairs of appendages (Figure 3). The larva grows through about 15 molts and becomes differentiated into male or female after the tenth molt. Copulation is initiated when the male grasps the female with its modified antennae (Figure 4). The fertilized eggs develop either into free-swimming nauplii, or they are surrounded by a thick shell and deposited as cysts which are in diapause.

4. METHODS FOR HATCHING ARTEMIA CYSTS

4.1 SOURCES OF CYSTS

4.1.1 Brine shrimp cysts are available from many commercial sources, representing several geographical strains. The cysts from any source can vary from batch to batch in terms of nutritional quality for the test organisms. Therefore, it is recommended that each new batch purchased should be analyzed chemically, and that a side-by-side feeding test be performed on their nutritional suitability by comparing the response of the test organisms with the new cysts and cysts of known quality (ASTM, 1993). A list of sources of cysts is provided at the end of this chapter.

4.2 STORAGE OF CYSTS

4.2.1 Sealed cans of *Artemia* cysts can be stored for years at room temperature, but once opened, should be used up within two months. After each use, the can should be tightly covered with a plastic lid and stored in the refrigerator. If the entire contents of a can will not be used up in two months, it is recommended that the portion that is expected to be unused be placed in a tightly closed container and frozen until needed.

4.3 HATCHING OF CYSTS

4.3.1 A 2-L separatory funnel makes a convenient brine shrimp hatching vessel, but nearly any transparent or translucent (preferably colorless) conical shaped container that will hold water may be used. A satisfactory apparatus can be prepared by removing the bottom of a 2 L plastic soft drink bottle and inserting a rubber stopper with a flexible tube and pinch cock. The hatching chambers must be clean and free from toxic material. All detergents should be completely removed by rinsing well with deionized water.



Figure 1. Drawing of male (A) and female (B) brine shrimp (From Kuenen and Bass-Becking, 1938).



Figure 2. Head of adult male showing triangular distal segment of antennae modified as claspers (From Persoone et al., 1980a).

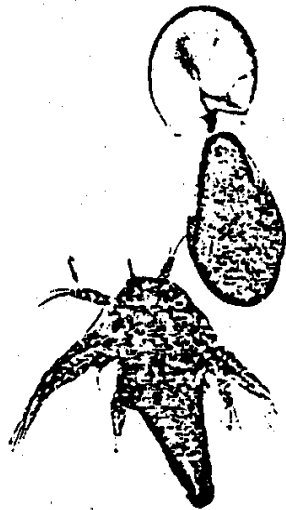

Figure 3. Pre-nauplius and freshly hatched first instar (From Persoone et al., 1980a).



Figure 4. Male and female brine shrimp nauplius preparing to copulate (From Persoone et al., 1980a).

4.3.2 Salinity of the water used for hatching brine shrimp cysts should be between 25 and 35‰. Natural sea water or water made up from artificial sea salts may be used. The hatching medium can be prepared by placing 1800 mL of deionized water in the hatching chamber and adding 50-70 g non-iodized salt. After the salt is added, lower a 1 mL pipette or glass tube fitted to an air supply into the vessel, so that the tip rests on the bottom, and bubble air vigorously through it to dissolve the salt.

4.3.3 Add the desired quantity of cysts to the vessel. Approximately 15 mL of cysts in a 2-L hatching vessel will provide enough brine shrimp nauplii to feed three large stock cultures of mysids in 76-L aquaria, or 1000-1500 newly hatched fish in four to six 8-L tanks.

4.3.4 Continue the aeration to keep the cysts and newly hatched nauplii from settling to the bottom where the DO would quickly be depleted and the newly hatched animals would die.

4.3.5 The area in which the cysts are hatched should be provided with approximately 20 $\mu\text{E}/\text{m}^2/\text{s}$ (100 ft-c) of illumination.

4.3.6 The cysts will hatch in about 24 h at a temperature of 25°C. Hatching time varies with incubation temperature and the geographic strain of *Artemia* used.

4.4 HARVESTING THE NAUPLII

4.4.1 When the brine shrimp nauplii first emerge from the cyst, they are enclosed in a membranous sac (Figure 3). To be taken as food by the test organisms, the pre-nauplii must emerge from the sac and swim about (Stage I or first instar nauplius).

4.4.2 The first instar (Stage I) nauplii do not feed. Their value as food for the test organisms decreases from birth until they begin feeding. Because they do not feed in the hatching vessels, it is important to harvest and use the nauplii soon after hatching. The nauplii can be easily harvested in the following manner:

1. After approximately 24 h at 25°C, remove the pipet supplying air and allow the nauplii to settle to the bottom of the hatching chamber. The empty egg shells will float to the top and the newly hatched nauplii and unhatched eggs will settle to the bottom. A light trained on the bottom of the separatory funnel will hasten the settling process.
2. After approximately 5 min, using the stopcock, drain off the nauplii into a 250 mL beaker.
3. After another 5 min, again drain the nauplii into the beaker.
4. The nauplii are further concentrated by pouring the suspension into a small cylinder which has one end closed with #20 plankton netting or they may be washed through a 150 μm net or screen.
5. The concentrate is resuspended in 50 mL of appropriate culture water, mixed well, and dispensed with a pipette. (Mysids require approximately 100-150 nauplii/mysid/day).
6. Discard the remaining contents of the hatching vessel and wash the vessel with hot soap and water.
7. Prepare fresh salt water for each new hatch.

4.4.3 To have a fresh supply of *Artemia* nauplii daily, at least two hatching vessels should be used, so that the newly-hatched can be harvested daily.

4.5 FEEDING ASSAY

4.5.1 Before using brine shrimp nauplii from a new batch of cysts for routine feeding of cultures and test organisms, they should be tested for their ability to support life, growth, and reproduction of the test animals. Two treatments with four replicates each are required for this test. In Treatment (A), the test organisms are fed the nauplii from the new batch of *Artemia* cysts, and in Treatment (B), the test organisms are fed nauplii of known, good quality, such as from the reference *Artemia* cysts or from a batch of *Artemia* cysts that have been successfully used in culturing and testing.

4.5.2 If there is no significant difference in the survival, growth, and/or reproduction of the organisms in the two treatments at the end of a 7-day period, it is assumed that the new batch of *Artemia* cysts is satisfactory. If the survival, growth, and/or reproduction in treatment A is significantly less than the response in treatment B over a 7-day test period it is assumed that the new batch of brine shrimp cysts are unsuitable for use as a food source for the organisms tested.

4.5.3 Test chambers and all test conditions during the feeding assay should be similar to those planned for use in the subsequent toxicity tests.

SELECTED REFERENCES

- ASTM. 1993. Standard practice for using brine shrimp nauplii as food for test animals in aquatic toxicology. Standard E1203-87, Annual Book of ASTM Standards, Vol. 11.04, American Society for Testing and Materials, Philadelphia, PA.
- Beck, A.D. and Bengtson, D.A. 1982. International study on *Artemia* XXII: Nutrition in aquatic toxicology - Diet quality of geographical strains of the brine shrimp, *Artemia*. In: J.G. Pearson, R.B. Foster, and W.E. Bishop (eds.), Aquatic Toxicology and Hazard Assessment: Fifth Conference. ASTM STP 766, American Society for Testing and Materials, Philadelphia, PA. pp. 161-169.
- Beck, A.D., Bengtson, D.A., and Howell, W.H. 1980. International study on *Artemia*. V. Nutritional value of five geographical strains of *Artemia*: Effects of survival and growth of larval Atlantic silversides, *Menidia menidia*. In: G. Persoone, P. Sorgeloos, D.A. Roels, and E. Jaspers, eds. The brine shrimp, *Artemia*. Vol. 3. Ecology, culturing, use in aquaculture. Universa Press, Wetteren, Belgium. pp. 249-259.
- Bengtson, D.A.S., Beck, A.D., Lussier, S.M., Migneault, D., and Olney, C.B. 1984. International study on *Artemia*. XXXI. Nutritional effects in toxicity tests: Use of different *Artemia* geographical strains. In: G. Persoone, E. Jaspers, and C. Claus, (eds.). Ecotoxicological testing for the marine environment, Vol. 2. State Univ. Ghent and Inst. Mar. Sci. Res., Bredene, Belgium. pp. 399-416.
- Bossuyt, E. and Sorgeloos, P. 1979. Technological aspects of the batch hatching of *Artemia* in high densities. In: G. Persoone, P. Sorgeloos, O. Roels and E. Jaspers (eds.), The brine shrimp *Artemia*. Vol. 3. Ecology, culturing, use in aquaculture. Universa Press, Wetteren, Belgium. pp. 133-152.
- Browne, R.A. 1982. The cost of reproduction in brine shrimp. *Ecology* 63(1):43-47.
- Johns, D.M., Berry, W.J., and Walton, W. 1981. International study on *Artemia*. XVI. Survival, growth and reproductive potential of the mysid, *Mysidopsis bahia* Molenock fed various geographical strains of the brine shrimp, *Artemia*. *J. Exp. Mar. Biol. Ecol.* 53:209-219.
- Kuenen, D.J. and Baas-Becking, L.G.M. 1938. Historical notes on *Artemia salina* (L.). *Zool. Med.* 20:222-230.
- Leger, P., Bengtson, D.A., Simson, K.L., and Sorgeloos, P. 1986. The use and nutritional value of *Artemia* as a food source. *Oceanogr. Mar. Biol. Ann. Rev.* 24:521-623.
- Lenz, P.H. 1980. Ecology of an alkali-adapted variety of *Artemia* from Mono Lake, California, U.S.A. In: G. Persoone, P. Sorgeloos, O. Roels, and E. Jaspers (eds.), The brine shrimp *Artemia*. Vol. 3. Ecology, culturing, use in aquaculture. Universa Press, Wetteren, Belgium. pp. 79-96.
- Nikonenko, Y.M. 1986. Adaptation of *Artemia salina* to toxicants. *Hydrobiol. J.* 22(5):94-98.
- Pennak, R.W. 1989. Fresh-water invertebrates of the United States. Protozoa to mollusca. John Wiley and Sons, New York, New York. pp. 358-359.
- Persoone, G., Sorgeloos, P., Roels, O., and Jaspers, E., (eds.). 1980a. The brine shrimp *Artemia*. Vol. 1. Morphology, genetics, radiobiology, toxicology. Universa Press, Wetteren, Belgium. 318 pp.
- Persoone, G., Sorgeloos, P., Roels, O., and Jaspers, E., (eds.). 1980b. The brine shrimp *Artemia*. Vol. 2. Physiology, biochemistry, molecular biology. Universa Press, Wetteren, Belgium. 636 pp.
- Persoone, G., Sorgeloos, P., Roels, O., and Jaspers, E., (eds.). 1980c. The brine shrimp *Artemia*. Vol. 3. Ecology, culturing, use in aquaculture. Universa Press, Wetteren, Belgium. 428 pp.

Sorgeloos, P. 1980. Life history of the brine shrimp *Artemia*. In: G. Persoone, P. Sorgeloos, D.A. Roels, and E. Jaspers (eds.), The brine shrimp, *Artemia*. Vol. 1. Morphology, genetics, radiobiology, toxicology. Universa Press, Wetteren, Belgium. pp. ixx-xxii.

Sorgeloos, P., Baesa-Mesa, M., Bossuyt, E., Bruggeman, E., Dobbeler, J., Versichele, D., Lavina, E., and Bernardine, A. 1979. Culture of *Artemia* on rice bran: The conversion of waste-products into highly nutritive animal protein. *Aquaculture* 21:393-396.

Usher, R.R. and Bengtson, D.A. 1981. Survival and growth of sheepshead minnow larvae and juveniles on diet of *Artemia* nauplii. *Prog. Fish-Cult.* 43:102-105.

APPENDIX A

DISTRIBUTION, LIFE CYCLE, TAXONOMY, AND CULTURE METHODS

A.5 FATHEAD MINNOW (*PIMEPHALES PROMELAS*)

1. MORPHOLOGICAL AND ANATOMICAL CHARACTERISTICS

1.1 Fathead minnows vary greatly in many characteristics throughout their wide geographic range. The morphology and characters for identification are taken from Clay (1962), Hubbs and Lagler (1964), Eddy and Hodson (1961), Scott and Crossman (1973), and Trautman (1981). Adults (Figure 1) are small fish, typically 43 mm to 102 mm, and averaging about 50 mm, in total length. The standard lengths are usually less than four and one-half times the body depth. The first rudimentary ray of the dorsal fin is more or less thickened and distinctly separated from the first well-developed ray by a membrane. The lateral line is usually incomplete, but may be complete in specimens from some geographic areas. The scales are cycloid and moderate in size. Andrews (1970), reporting on fish collected in Colorado, noted that no scales were found on fish smaller than 14 mm, and the average length for first scale formation was 16.3 mm. The scales in the lateral series number 41 to 54.

1.2 The mouth is terminal. The snout does not extend beyond the upper lip and is decidedly oblique. Nuptial tubercles occur on mature males only, are large and well-developed on the snout, and rarely extend beyond the nostrils. They occur in three main rows, with a few on the lower jaw. In addition to nuptial tubercles, the males have an elongate, fleshy, or spongy pad extending in a narrow band from the nape to the dorsal fin. The pad is wide anteriorly, and narrows to engulf the first dorsal ray. In addition, the sides of the body become almost black except for two wide vertical bars which are light in color. In contrast to the males, the mature females remain quite drab.

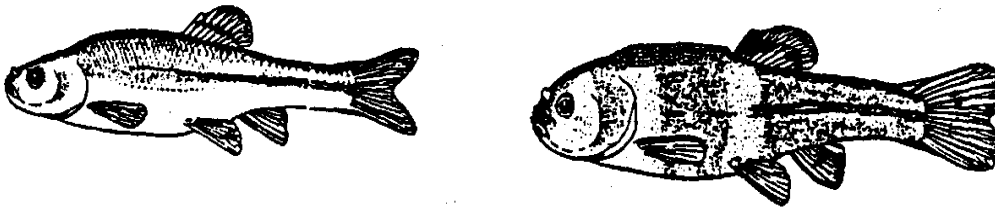

Figure 1. Fathead minnow: adult female (left) and breeding male (right). (From Eddy and Hodson, 1961).

1.3 The peritoneum is brownish-black, and the intestine is long and coiled one or more times.

1.4 Some external markings occur infrequently. Young occasionally have a dusky band on the snout and opercules. Other young and adults, from clear and weedy waters, have a distinct, lateral band across the body. The band may be absent in breeding males or, if present, becomes very diffuse anteriorly. This band is usually most apparent on preserved specimens. Dymond (1926), Trautman (1981), and others described the saddle-like pattern often associated with breeding males in which a light area develops just behind the head and another beneath the dorsal fin, the areas between producing a saddle affect. A dark spot is usually present in front of the dorsal fin in mature males, and a narrow, dark, vertical bar or spot is present at the base of the caudal fin, but often is not very distinct.

2. TAXONOMY

2.1 The specific name (*Pimephales promelas*) appears to be incorrectly applied to this fish because the fathead minnow does not fit the description originally given by Rafinesque (1820) (Lee et al., 1980). Common names include "northern fathead minnow", and "blackhead minnow," in addition to fathead minnow. The holotype was collected near Lexington, Kentucky.

2.2 Some geographic variations have been noted in the morphology of the fathead minnow. Vandermeer (1966) indicated that the introduction of this species outside its native range may have resulted in some local deviations from the broad patterns of geographic variation in taxonomic characters. Some populations have been designated as subspecifically distinct: *Pimephales promelas promelas*, the northern form; *P. p. harveyensis*, the Harvey Lake form, from Isle Royal in Lake Superior and *P. p. confertus*, the southern form (Hubbs and Lagler, 1949, 1964). However, Taylor (1954), Vandermeer (1966), and others expressed doubt concerning the validity of assigning subspecific status to the variants and recommended against their recognition. Vandermeer (1966), in a statistical analysis of the geographic variations in taxonomic characters, stated that two of the three described subspecies intergrade clinally.

2.3 Of the eight characters measured, two showed a north-south trend; (1) eye diameter, with the northern fish having smaller eyes, and (2) completeness of the lateral line, with the northern fish having the least complete lateral line. However, Scott and Crossman (1973), indicated that some Canadian populations exhibit a nearly complete lateral line. The American Fisheries Society (1980) does not recognize any of the fathead minnow subspecies.

3. DISTRIBUTION

3.1 The fathead minnow is widely distributed in North America (Figure 2). It is a popular bait fish, and the ease with which it is propagated has led to its widespread introduction both within and outside the native range of the species. It has been so widely distributed in the eastern and southwestern United States by bait transportation that it is difficult to determine its original range. The presumed native distribution (Vandermeer, 1966; Scott and Crossman, 1973; Lee, et al., 1980) extended from the Great Slave Lake in the northwest to New Brunswick, in eastern Canada, southward throughout the Mississippi valley in the United States, to southern Chihuahua in Mexico. Distribution records for this species also now include Oregon (Andreasen, 1975), and the Central Valley (Kimsey and Fisk, 1964) and other locations in California (Andreasen, 1975), but there are no records for British Columbia.

3.2 This species is found in a wide range of habitats. It is most abundant in muddy brooks, streams, creeks, ponds, and small lakes, is uncommon or absent in streams of moderate and high gradients and in most of the larger and deeper impoundments, and is tolerant of high temperature and turbidity, and low oxygen concentrations.

3.3 Species associated with the fathead minnow seem to vary greatly throughout its range (Scott and Crossman, 1973; Trautman 1981). Trautman (1981) reported that fathead minnows and bluntnose minnows, *Pimephales notatus* (Rafinesque), were competitors, and that fathead minnows occurred in greatest numbers only where bluntnose minnows were absent or comparatively few in number. He also stated that the fathead minnow may hybridize with the bluntnose minnow.

3.4 The fathead minnow is primarily omnivorous, although Coyle (1930) reported algae to be one of its main foods in Ohio. Elsewhere in the United States, young fish have been reported to feed on organic detritus from bottom deposits, and unicellular and filamentous algae and planktonic organisms. Adults feed on aquatic insects, worms, small crustaceans, and other animals. Scott and Crossman (1973) and others regard the fathead minnow as a highly desirable forage fish, providing food for other fishes and birds.

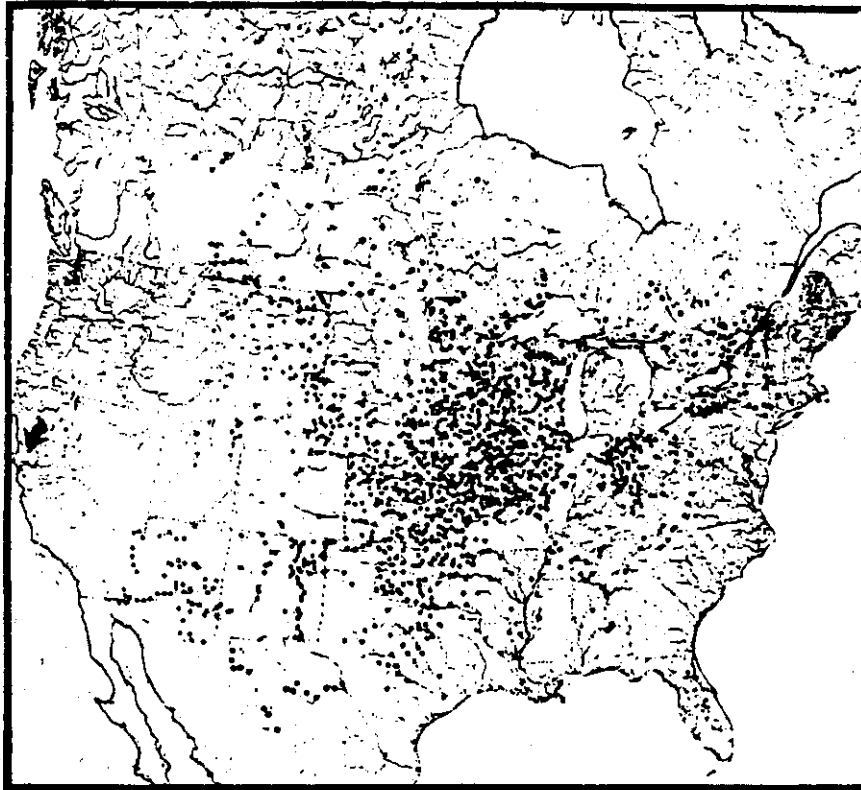

Figure 2. Map showing the distribution of the fathead minnow in North America. Open circles represent transplanted populations. Most Atlantic slope records are probably transplanted populations. (From Lee et al., 1980).

4. GENERAL LIFE HISTORY

4.1 The natural history and spawning behavior (Markus, 1934; Flickinger, 1973; Andrews and Flickinger, 1974; and others) of the fathead minnow are well known because of the early interest in raising the fish for bait and for feeding other pond fish, such as bass. Sexual dimorphism occurs at maturity. Breeding males develop a conspicuous, narrow, elongated, gray, fleshy pad of spongy tubercles on the back, anterior to the dorsal fin, and two or three rows of strong nuptial tubercles across the snout. The sides of the body become almost black except for two wide vertical bars which are light in color. In contrast, the females remain quite drab.

4.2 The initiation of spawning varies with temperature throughout its geographic range. Isaak (1961), Carlander (1969), and others reported that, in the wild, fathead minnows begin spawning in the spring, when the water temperature reaches 16-18°C, and continue to spawn throughout most of the summer. The minimum spawning temperature, however, may vary with population and latitude.

4.3 Markus (1934) reported that spawning always occurred at night, whereas Isaak (1961) observed spawning during the day, as well as at night. Gale and Buynak (1982) and others reported that spawning often began before dawn and usually was completed before noon. Observations of the fathead minnow cultures at EPA's Newtown Facility also indicate the majority of fathead minnows spawn in early morning.

4.4 Breeding males are very territorial and select sites for spawning, such as the underside of a log or branch, rock, board, tin can, or almost any other solid inanimate object, usually in water from 7 cm to 1 m in depth. A receptive female is sought out and brought into position below the nest site. After circling below the nesting site, the female is nudged and lifted on the male's back until she lies on her side immediately below the undersurface of the spawning substrate, where she releases a small number of eggs (usually 100 to 150) at a time. The eggs are adhesive and attach to the underside of the spawning substrate. The females have a urogenital structure (ovipositor) to help deposit the eggs on the underside of objects. Flickinger (1966) indicated that the ovipositor is noticeable at least a month prior to spawning. The reported size of the eggs varies from 1.15 mm (Markus, 1934) to 1.3 mm in diameter (Wynne-Edwards, 1932).

4.5 Immediately after the eggs are laid, they are fertilized by the male, and the female is driven off. Once eggs are deposited in the nest, the male becomes very aggressive and will use the large tubercles on his snout to help drive off all intruding small fishes. In addition to fertilizing and guarding the eggs, the male agitates the water around the eggs, which ventilates them and keeps them free of detritus. Some males will spawn with several females on the same substrate, so that the nest may contain eggs in various stages of development. The number of eggs per nest may vary from as few as nine or 10 to as many as 12,000.

4.6 The ovaries of the females contain eggs in all stages of development, and they spawn repeatedly as the eggs mature. A female may deposit eggs in more than one nest. Although the average number of eggs per spawn is generally 100 to 150, large females may lay 400 to 500 eggs per spawn.

4.7 Gale and Buynak (1982), in a study using five captive pairs of fathead minnows in separate outdoor pools, observed that each pair produced 16 to 26 clutches of eggs between May and August. The time between spawns, which ranged from 2-16 days, was affected by water temperature. As the temperature increased, the intervals between spawning sessions become shorter and more uniform. In their study, from nine to 1,136 (mean of 414) eggs were deposited per spawn. The average number of eggs deposited per spawn ranged from 371 to 480, and the total number of eggs spawned per female ranged from 6,803 to 10,164 (mean of 8,604). The length of the spawning period during a given season also varied greatly between females. The authors suggested that the fecundity of fathead minnows is much higher than has generally been recognized, but they noted that fecundity of fish in the natural environment, where conditions might be more or less favorable, might differ from that of captive fish.

4.8 The incubation time depends on temperature, and is 4.5 to 6 days at 25°C. The newly-hatched young (larvae) are about 5 mm long, white in color, and have large black eyes. The general appearance and typical pigmentation of the various larval stages are illustrated in Figures 3A-3M. In a warm, food-rich environment, growth is rapid. Markus (1934) stated that fish hatched in May in Iowa reached adult size and were spawning by late July. Hubbs and Cooper (1935) and others noted that such rapid growth is unlikely in more northerly waters, and that the young do not spawn the first year. In cooler water the adult size is probably not reached until the second year. The males generally grow faster than the females, a characteristic of minnow species.

4.9 The fathead minnow is short lived, and rarely survives to the third year. However, Scott and Crossman (1973) stated that longevity varies throughout the geographic range of the species. Post-spawning mortality was reported to be great by several authors, but was not observed by Gale and Buynak (1982). However, in defending their territory, male fish, may become weakened by a lack of food over a prolonged period and their resistance to disease may be lowered. Also, at spawning time, many waters are warm and somewhat stagnate, favoring the spread of fish parasites and disease.

5. CULTURE METHODS

5.1 OUTSIDE SOURCES OF FATHEAD MINNOWS

5.1.1 Fathead minnows are available from commercial biological supply houses. Fish obtained from outside sources for use as brood stock or in toxicity tests may not always be of suitable age and quality. Fish provided by supply houses should be guaranteed to be of (1) the correct species, (2) disease free, (3) in the requested age range,

(4) and in good condition. The latter can be done by providing the record of the date on which the eggs were laid and hatched, and information on LC50 of contemporary fish using reference toxicants.

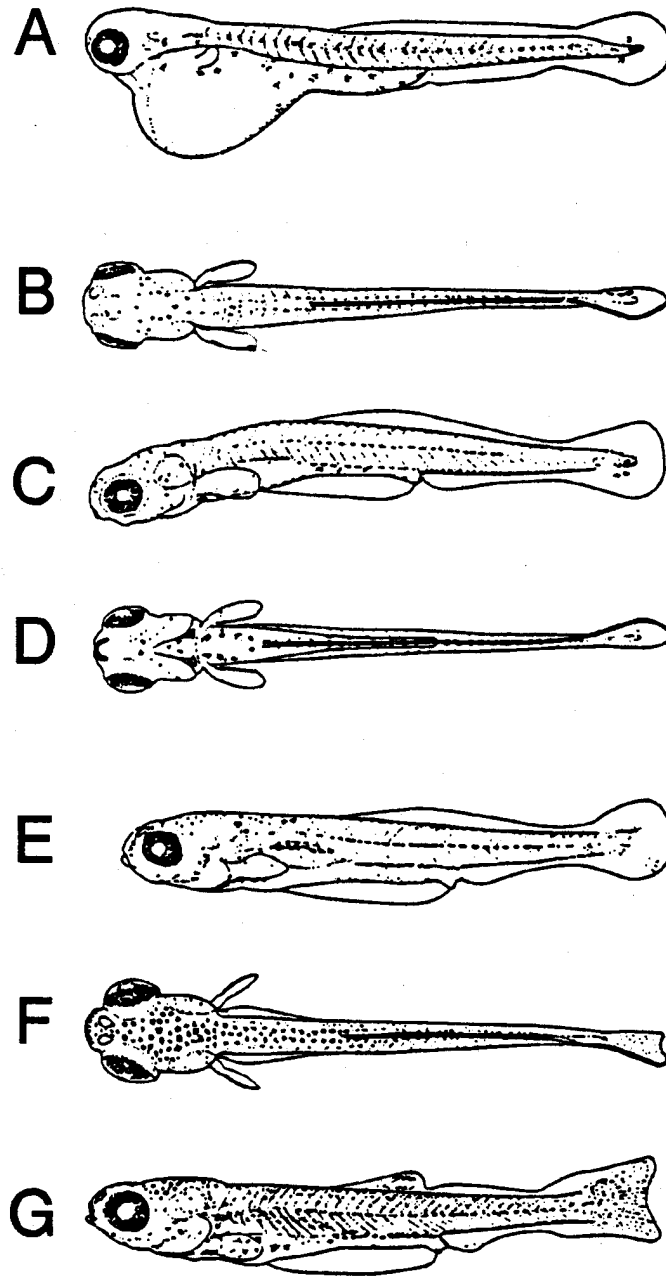

Figure 3. Fathead minnow (*Pimephales promelas*) larvae: A. protolarva, lateral view, 4.3 mm TL; B. protolarva, dorsal view, 5.6 mm TL; C. protolarva, lateral view, 5.6 mm TL; D. protolarva, ventral view, 5.6 mm TL; E. mesolarva, lateral view, 6.9 mm TL; F. mesolarva, dorsal view, 7.9 mm TL; G. mesolarva, lateral view, 7.9 mm TL; (From Snyder et al., 1977).

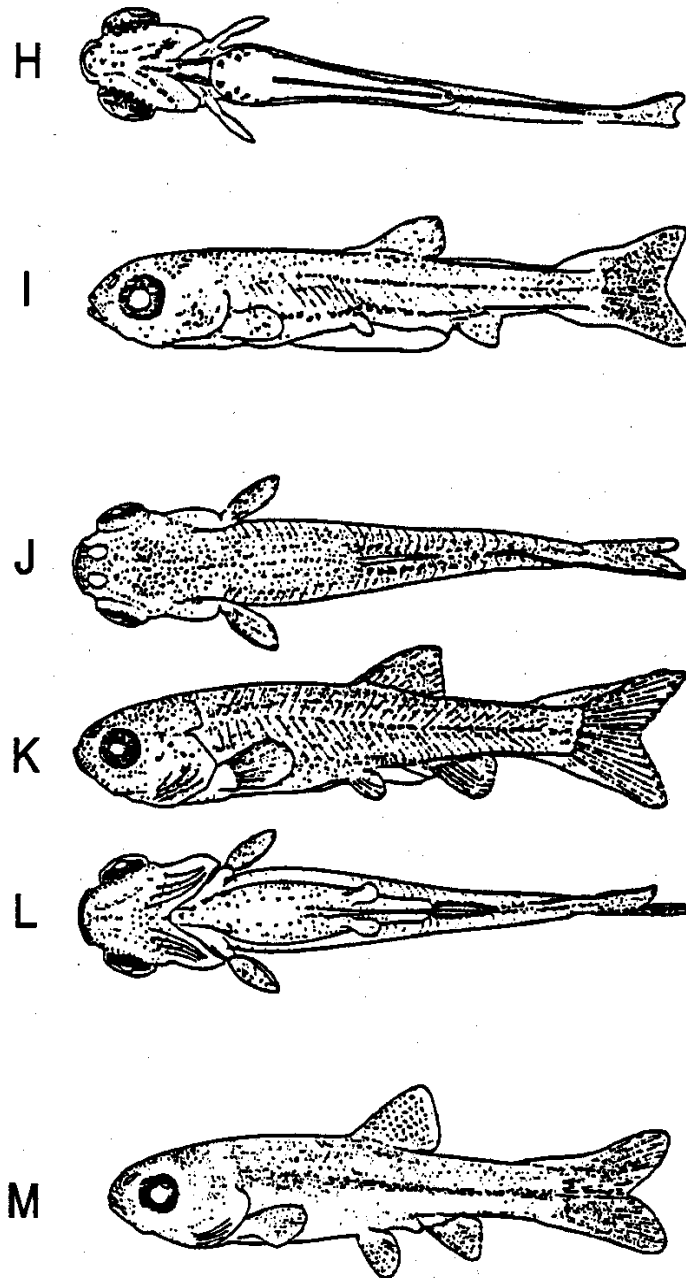

Figure 3. Fathead minnow (*Pimephales promelas*) larvae. H. mesolarva, ventral view, 7.9 mm TL; I. metalarva, lateral view, 9.3 mm TL; J. metalarva, dorsal view, 14.3 mm TL; K. metalarva, lateral view, 14.3 mm TL; L. metalarva, ventral view, 14.3 mm TL; M. late metalarva, lateral view, 19.6 mm TL (CONTINUED) (from Snyder et al., 1977).

5.2 INHOUSE SOURCES OF FATHEAD MINNOWS

5.2.1 Problems in obtaining suitable fish from outside laboratories can be avoided by developing an inhouse laboratory culture facility. Fathead minnows can be easily cultured in static, recirculating, or flow-through systems.

5.2.2 Flow-through systems require large volumes of water and may not be feasible in some laboratories. The culture tanks should be shielded from extraneous disturbances using opaque curtains, and should be isolated from toxicity testing activities to prevent contamination.

5.2.3 To avoid the possibility of inbreeding of the inhouse brood stock, fish from an outside source should be introduced yearly into the culture unit.

5.2.4 The inhouse culture facility consists of the following components:

5.2.4.1 Water Supply

5.2.4.1.1 Water Quality

5.2.4.1.1.1 Reconstituted (synthetic) water or dechlorinated tap water can be used, but natural water may be preferred. To determine water quality, it is desirable to analyze the water for toxic metals and organics quarterly (see Section 4, Quality Assurance). Temperature, dissolved oxygen, pH, hardness, and alkalinity should also be measured periodically.

5.2.4.1.1.2 If a static or recirculating system is used, it is necessary to equip each tank with an outside activated carbon filter system, similar to those sold for tropical fish hobbyists (or one large activated carbon filter system for a series of tanks) to prevent the accumulation of toxic metabolic wastes (principally nitrite and ammonia) in the water.

5.2.4.1.2 Dissolved oxygen

5.2.4.1.2.1 The DO concentration in the culture tanks should be maintained near saturation, using gentle aeration with 15 cm air stones if necessary. Brungs (1971), in a carefully controlled long-term study, found that the growth of fathead minnows was reduced significantly at all DO concentrations below 7.9 mg/L. Soderberg (1982) presented an analytical approach to the re-aeration of flowing water for culture systems.

5.2.4.2 Maintenance

5.2.4.2.1 Adequate procedures for culture maintenance must be followed to avoid poor water quality in the culture system. The spawning and brood stock culture tanks should be kept free of debris (excess food, detritus, waste, etc.) by siphoning the accumulated materials (such as dead brine shrimp nauplii or cysts) from the bottom of the tanks daily with a glass siphon tube attached to a plastic hose leading to the floor drain. The tanks are more thoroughly cleaned as required. Algae, mostly diatoms and green algae, growing on the glass of the spawning tanks are left in place, except for the front of the tank, which is kept clean for observation. To avoid excessive build-up of algal growth, the walls of the tanks are periodically scraped. The larval culture tanks are cleaned once or twice a week to reduce the mass of fungus growing on the bottom of the tank.

5.2.4.2.2 Activated charcoal and floss in the tank filtration systems should be changed weekly, or more often if needed. Culture water may be maintained by preparation of reconstituted water or use of dechlorinated tap water. Distilled or deionized water is added as needed to compensate for evaporation.

5.2.4.2.3 Before new fish are placed in tanks, salt deposits are removed by scraping or with 5% acid solution, the tanks are washed with detergent, sterilized with a hypochlorite solution, and rinsed well with hot tap water and then with laboratory water.

5.2.5 SPAWNING TANKS AND CULTURE CONDITIONS

5.2.5.1 For breeding tanks, it is convenient to use 60 L (15 gal) or 76 L (20 gal) aquaria. The spawning unit is designed to simulate conditions in nature conducive to spawning, such as water temperature and photoperiod. Spawning tanks must be held at a temperature of $25 \pm 2^\circ\text{C}$. Each aquarium is equipped with a heater, if necessary, a continuous filtering unit, and spawning substrates. The photoperiod for the culture system should be maintained at 16 h light and 8 h darkness. For the spawning tanks, this photoperiod must be rigidly controlled. A convenient photoperiod is 5:00 AM to 9:00 PM. Fluorescent lights should be suspended about 60 cm above the surface of the water in the brood and larval tanks. Both DURATEST[®] and cool-white fluorescent lamps have been used, and product similar results. An illumination level of 10-20 $\mu\text{E}/\text{m}^2/\text{s}$ (50-100 ft-c) is adequate.

5.2.6 SPAWNING BEHAVIOR AND CONDITIONS

5.2.6.1 To simulate the natural spawning environment, it is necessary to provide substrates (nesting territories) upon which the eggs can be deposited and fertilized, and which are defended and cared for by the males. The recommended spawning substrates consist of inverted half-cylinders, such as 7.6 cm x 7.6 cm (3 in. X 3 in.) sections of schedule 40, PVC pipe. The substrates should be placed equi-distant from each other on the bottom of the tanks.

5.2.6.2 To establish a breeding unit, 15-20 pre-spawning adults six to eight months old are taken from a "holding" or culture tank and placed in a 76 L spawning tank. At this point, it is not possible to distinguish the sexes. However, after less than a week in the spawning tank, the breeding males will develop their distinct coloration and territorial behavior, and spawning will begin. As the breeding males are identified, all but two are removed, providing a final ratio of 5-6 females per male. The excess spawning substrates are used as shelter by the females.

5.2.6.3 Sexing of the fish to ensure a correct female/male ratio in each tank can be a problem. However, the task usually becomes easier as experience is gained (Flickinger, 1966). Sexually mature females usually have large bellies and a tapered snout. The sexually mature males are usually distinguished by their larger overall size, dark vertical color bands, and the spongy nuptial tubercles on the snout. Unless the males exhibit these secondary breeding characteristics, no reliable method has been found to distinguish them from females. However, using the coloration of the males and the presence of an enlarged urogenital structures and other characteristics of the females, the correct selection of the sexes can usually be achieved by trial and error.

5.2.6.4 Sexually immature males are usually recognized by their aggressive behavior and partial banding. These undeveloped males must be removed from the spawning tanks because they will eat the eggs and constantly harass the mature males, tiring them and reducing the fecundity of the breeding unit. Therefore, the fish in the spawning tanks must be carefully checked periodically for extra males.

5.2.6.5 A breeding unit will remain in their spawning tank about four months. Thus, each brood tank or unit is stocked with new spawners about three times a year. However, the restocking process is rotated so that at any one time the spawning tanks contain different age groups of brood fish.

5.2.7 EMBRYO COLLECTION

5.2.7.1 Fathead minnows spawn mostly in the early morning hours. They should not be disturbed except for a morning feeding (approximately 8:00 AM) and daily examination of substrates for eggs in late morning or early afternoon. In nature, the male protects, cleans, and aerates the eggs until they hatch. In the laboratory, however, it is necessary to remove the eggs from the tanks to prevent them from being eaten by the adults, and for ease of handling for purposes of recording embryo count and hatchability, and for the use of the newly hatched for young fish for toxicity tests.

5.2.7.2 Daily, beginning six to eight hours after the lights are turned on (i.e., 11:00 AM - 1:00 PM), the substrates in the spawning tanks are each lifted carefully and inspected for embryos. Substrates without embryos are

immediately returned to the spawning tank. Those with embryos are immersed in clean water in a collecting tray, and replaced with a clean substrate. A daily record is maintained of each spawning site and estimated number of embryos on the substrate.

5.2.8 EMBRYO INCUBATION

5.2.8.1 Three different methods are described for embryo incubation.

5.2.8.1.1 Incubation of Embryos on the Substrates: Several (2-4) substrates are placed on end in a circular pattern (with the embryos on the inner side) in 10 cm of water in a tray. The tray is then placed in a constant temperature water bath, and the embryos are aerated with a 2.5 cm airstone placed in the center of the circle. The embryos are examined daily, and the dead and fungused embryos are counted, recorded, and removed with forceps. At an incubation temperature of 25°C, 75-100% hatch occurs in five days. At 22°C, embryos incubated on aerated tiles require seven days for 50% hatch.

5.2.8.1.2 Incubation of Embryos in a Separatory Funnel: The embryos are removed from the substrates with a rolling action of the index finger ("rolled off")(Gast and Brungs, 1973), their total volume is measured, and the number of embryos is calculated using a conversion factor of approximately 430 embryos/mL. The embryos are incubated in about 1.5 L of water in a 2 L separatory funnel maintained in a water bath. The embryos are stirred in the separatory funnel by bubbling air from the tip of a plastic micro-pipette placed at the bottom, inside the separatory funnel. During the first two days, the embryos are taken from the funnel daily, those that are dead and fungused are removed, and those that are alive are returned to the separatory funnel in clean water. The embryos hatch in four days at a temperature of 25°C. However, usually on day three the eyed embryos are removed from the separatory funnel and placed in water in a plastic tray and gently aerated with an air stone. Using this method, the embryos hatch in five days.

5.2.8.1.2.1 Hatching time is greatly influenced by the amount of agitation of the embryos and the incubation temperature. If on day three the embryos are transferred from the separatory funnel to a static, unaerated container, a 50% hatch will occur in six days (instead of five) and a 100% hatch will occur in 7 days.

5.2.8.1.3 Incubation in Embryo Incubation Cups: The embryos are "rolled off" the substrates, and the total number is estimated by determining the volume. The embryos are then placed in incubation cups attached to a rocker arm assembly (Mount, 1968). Both flow-through and static renewal incubation have been used. On day one, the embryos are removed from the cups and those that are dead and fungused are removed. After day one, only dead embryos are removed from the cups. Most of the embryos will hatch in five days if incubated at 25°C.

5.2.8.1.4 During the incubation period, the eggs are examined daily for viability and fungal growth, until they hatch. Unfertilized eggs, and eggs that have become infected by fungus, should be removed with forceps using a table top magnifier-illuminator. Non-viable eggs become milky and opaque, and are easily recognized. The non-viable eggs are very susceptible to fungal infection, which may then spread throughout the egg mass. Removal of fungused eggs should be done quickly, and the spawning substrates should be returned to the incubation tanks as quickly as possible so that the good eggs are not damaged by desiccation.

5.2.9 LARVAE REARING TANKS

5.2.9.1 Newly-hatched larvae are transferred daily from the egg incubation apparatus to small rearing tanks, using a large bore pipette, until the hatch is complete. New rearing tanks are set up on a daily basis to separate fish by age group. Approximately 1500 newly hatched larvae are placed in a 60 L (15 gal) or 76 L (20 gal) all-glass aquarium for 30 days. A density of 150 fry per liter is suitable for the first four weeks. The water temperature in the rearing tanks is allowed to follow ambient laboratory temperatures of 20-25°C, but sudden, extreme, variations in temperature must be avoided.

5.2.10 HOLDING OR CULTURE TANKS FOR REPLACEMENT SPAWNERS

5.2.10.1 Replacement spawners (brood stock) are cultured from larvae produced in the spawning tanks. After 30 days in a larval rearing tank, a number of juveniles, equivalent to 2-4 days hatch are transferred to brood stock tanks for a 30-60 day growth period. The sub-adults then are transferred to 500-L brood stock tanks to provide about 500 sub-adult fish per month for the brood tank rotation. The surplus fish are transferred to 2000-L fiber glass, or equivalent, holding tanks.

5.2.10.2 Surplus young males removed from spawning tanks, and other surplus mature males, are placed in all-male holding tanks for future use as spawners. Similarly, young and surplus mature females are held in all-female holding tanks until needed as spawners. Tanks holding replacement spawners need not be temperature-controlled, but for ease of transfer to the spawning tanks, it is preferable to hold the water temperature close to that of the spawning tanks ($25 \pm 2^\circ\text{C}$).

5.2.11 FOOD AND FEEDING

5.2.11.1 Newly hatched brine shrimp nauplii or frozen adult brine shrimp and commercial fish starter are fed to the fish cultures in volumes based on age, size, and number of fish in the tanks. The amount of food and feeding schedule affects both growth and egg production.

5.2.11.2 Fish from hatch to 30 days old are fed starter food at the beginning and end of the work day, and newly hatched brine shrimp nauplii (from the brine shrimp culture unit) twice a day, usually mid-morning and mid-afternoon. Utilization of older (larger) brine shrimp nauplii may result in starvation of the young fish because they are unable to ingest the larger food organisms (see Appendix A.4 for instructions on the preparation of brine shrimp nauplii). Avoid introducing *Artemia* cysts and empty shells when the brine shrimp nauplii are fed to the fish larvae. Some of the mortality of the larval fish observed in cultures could be caused from the ingestion of these materials.

5.2.11.3 Fish older than four weeks are fed frozen brine shrimp and commercial fish starter (#1 and #2), which is ground fish meal enriched with vitamins. As the fish grow, larger pellet sizes are used, as appropriate.

5.2.11.4 The spawning fish and pre-spawners in holding tanks usually are fed all the adult frozen brine shrimp and tropical fish flake food or dry commercial fish food (No. 1 or No. 2 granules) that they can eat (*ad libitum*) at the beginning of the work day and in the late afternoon (i.e., 8:00 AM and 4:00 PM). The fish are fed twice a day, twice with dry food and once with adult shrimp, during the week, and once a day on weekends.

5.2.12 DISEASE CONTROL

5.2.12.1 Fish are observed daily for abnormal appearance or behavior. Bacterial or fungal infections are the most common diseases encountered. However, if normal precautions are taken, disease outbreaks will rarely, if ever, occur. Hoffman and Mitchell (1980) have put together a list of some chemicals that have been used commonly for fish diseases and pests.

5.2.12.2 Treatment of individual lots of infected fish should be carried out separate from the main culture. Use of treated fish should be avoided, if possible, and diseased cultures should be replaced.

5.2.12.3 In aquatic culture systems where filtration is utilized, the application of certain antibacterial agents should be used with caution. A treatment with a single dose of antibacterial drugs can interrupt nitrate reduction and stop nitrification for various periods of time, resulting in changes in pH, and in ammonia, nitrite and nitrate concentrations (Collins et al., 1976). These changes could cause the death of the culture organisms.

5.2.12.4 To prevent possible rapid spread of disease, do not transfer equipment from one tank to another without first disinfecting tanks and nets. If an outbreak of disease occurs, any equipment, such as nets, airlines, tanks, etc., which has been exposed to diseased fish should be disinfected with sodium hypochlorite. Also to avoid the contamination of cultures or spread of disease, each time nets used to remove live or dead fish from tanks, they are first sterilized with sodium hypochlorite or formalin, and rinsed in hot tap water. Before a new lot of fish is transferred to culture tanks, the tanks are cleaned and sterilized as described above.

5.2.13 RECORD KEEPING

5.2.13.1 Records are kept in a bound notebook, include: (1) type of food and time of feeding for all fish tanks; (2) time of examination of the tiles for embryos, the estimated number of embryos on the tile, and the tile position number; (3) estimated number of dead embryos and embryos with fungus observed during the embryonic development stages; (4) source of all fish; and (5) daily observation of the condition and behavior of the fish.

5.2.14 REFERENCE TOXICANTS

5.2.14.1 It is recommended that static acute toxicity tests be performed monthly with a reference toxicant. Fathead minnow larvae one to 14 days old are used to monitor the acute toxicity of the reference toxicant to the test fish produced by the culture unit.

6. TEST ORGANISMS

6.1 Fish 1-14 days old are used in acute toxicity tests.

6.2 If the fish are kept in a holding tank or container, most of the water should be siphoned off to concentrate the fish. The fish are then transferred one at a time randomly to the test chambers until each chamber contain 10 fish. Alternately, fish may be placed one to two at a time into small beakers or plastic containers until they each contain five fish. Two of these beakers/plastic containers (total of 10 fish) are then assigned to each randomly-arranged control and exposure chamber.

6.3 The fish are transferred directly to the test vessels or intermediate chambers using a large-bore, fire-polished glass tube (6 mm to 9 mm I.D. X 30 cm long) equipped with a rubber bulb, or a large volumetric pipet with tip removed and fitted with a safety type bulb filler. The glass or plastic containers should only contain a small volume of dilution water.

6.4 It is important to note that larvae should not be handled with a dip net. Dipping small fish with a net may result in damage to the fish and cause mortality.

SELECTED REFERENCES

- American Fisheries Society. 1980. A list of common and scientific names of fishes from the United States and Canada. 4th ed. American Fisheries Society, Committee on Names of Fishes. 174 pp.
- ASTM. 1993. Standard practice for using brine shrimp nauplii as food for test animals in aquatic toxicology. Designation: E 1203-87, Annual Book of Standards, Vol. 11.04, ASTM, Philadelphia, PA.
- Andreasen, J.K. 1975. Occurrence of the fathead minnow, *Pimephales promelas*, in Oregon. Calif. Fish Game 6(3):155-156.
- Andrews, A.K. 1970. Squamation chronology of the fathead minnow, *Pimephales promelas*. Trans. Amer. Fish. Soc. 99(2):429-432.
- Andrews, A.K. 1971. Altitudinal range extension for the fathead minnow (*Pimephales promelas*). Copeia 1:169.
- Andrews, A. and Flickinger, S. 1974. Spawning requirements and characteristics of the fathead minnow. Proc. Ann. Conf. Southeastern Assoc. Game Fish Comm. 27:759-766.
- Benoit, D.A. and Carlson, R.W. 1977. Spawning success of fathead minnows on selected artificial substrates. Prog. Fish. Cult. 39(2):67-69.
- Brown, B.E. 1970. Exponential decrease in a population of fathead minnows. Trans. Am. Fish. Soc. 99(4):807-809.
- Brungs, W.A. 1971a. Chronic effects of elevated temperature on the fathead minnow (*Pimephales promelas* Rafinesque). Environmental Research Laboratory. U.S. Environmental Protection Agency, Duluth, MN. EPA 600/8-81/011.
- Brungs, W.A. 1971b. Chronic effects of low dissolved oxygen concentrations on fathead minnows (*Pimephales promelas*). J. Fish. Res. Bd. Can. 28:1119-1123.
- Buttner, J.K. and Duda, S.W. 1988. Maintenance and reproduction of fathead minnows in the laboratory. Aquatic Ecology Section, Department of Biological Sciences, SUNY College at Brockport, Brockport, NY 14420.
- Carlander, K. 1969. Handbook of freshwater fishery biology, Vol. 1. Iowa State Univ. Press, Ames, IA.
- Chiasson, A.G. and Gee, J.H. 1983. Swim bladder gas composition and control of buoyancy by fathead minnows (*Pimephales promelas*) during exposure to hypoxia. Can. J. Zool. 61(10):2213-2218.
- Clay, W. 1962. The Fishes of Kentucky. Kentucky Dept. Fish and Wildlife Res., Frankfort, KY.
- Coble, D.W. 1970. Vulnerability of fathead minnows infected with yellow grub to largemouth bass predation. J. Parasitol. 56(2):395-396.
- Collins, M.T., Gratzner, J.B., Dawe, D.L., and Nemetz, T.G. 1976. Effects of antibacterial agents on nitrification in aquatic recirculating systems. J. Fish. Res. Bd. Can. 33:215-218.
- Coyle, E.E. 1930. The algal food of *Pimephales promelas* (fathead minnow). Ohio J. Sci. 30(1):23-35.
- Cross, F.B. 1967. Handbook of fishes of Kansas. Univ. Kansas Mus. Natur. Hist. Misc. Publ. 45:1-357.

- Denny, J.S. 1987. Guidelines for the culture of fathead minnows *Pimephales promelas* for use in toxicity tests. Environmental Research Laboratory, U.S. Environmental Protection Agency, Duluth, MN. EPA 600/3-87-001.
- Dixon, R.D. 1971. Predation of mosquito larvae by the fathead minnow, *Pimephales promelas* Rafinesque. *Manit. Entomol.* 5:68-70.
- Drummond, R.A. and Dawson, W.F. 1970. An inexpensive method for simulating diel patterns of lighting in the laboratory. *Trans. Am. Fish Soc.* 99:434-435.
- Dymond, 1926. The Fishes of Lake Nipigon. Univ. Toronto Stud. Biol. Ser. 27 Publ. Ont. Fish. Res. Lab 27:1-108.
- Eddy, S. and Hodson, A.C. 1961. Taxonomic keys to the common animals of the north central states. Burgess Publ. Co., Minneapolis, Minnesota.
- Flickinger, S.A. 1966. Determination of sexes in the fathead minnow. *Trans. Amer. Fish. Soc.* 98(3):526-527.
- Flickinger, S.A. 1973. Investigation of pond spawning methods for fathead minnows. *Proc. Ann. Conf. Southeast. Assoc. Game and Fish Commiss.* 26:376-391.
- Gale, W.F. and Buynak, G.L. 1982. Fecundity and spawning frequency of the fathead minnow--A fractional spawner. *Trans. Amer. Fish. Soc.* 111:35-40.
- Gast, M.H. and Brungs, W.A. 1973. A procedure for separating eggs of the fathead minnow. *Prog. Fish. Cult.* 35:54.
- Guest, W.C. 1977. Technique for collecting and incubating eggs of the fathead minnow. *Prog. Fish. Cult.* 39(4):188.
- Hedges, S. and Ball, R. 1953. Production and harvest of bait fishes in ponds. In: Michigan Dept. Conservation. Misc. Publ. 6, Lansing, Michigan. pp. 1-30.
- Held, J.W. and Peterka, J.J. 1974. Age, Growth, and food habits of the fathead minnow, *Pimephales promelas*, in North Dakota saline lakes. *Trans. Am. Fish. Soc.* 103(4):743-756.
- Hendrickson, G.L. 1979. *Ornithodiplostomum ptychocheilus*: migration to the brain of the fish intermediate host, *Pimephales promelas*. *Exp. Parasit.* 48:245-258.
- Herwig, N. 1979. Handbook of drugs and chemicals used in the treatment of fish diseases. Charles C. Thomas, Publ., Springfield, IL. 272 pp.
- Hoffman, G.L. 1958. Studies on the life cycle of *Ornithodiplostomum ptychocheilus* (Faust) (Trematoda: Strigeoidea) and the "self cure" in infected fish. *J. Parasitol.* 44(4):416-421.
- Hoffman, G.L. and Mitchell, A.J. 1980. Some chemicals that have been used for fish diseases and pests. *Fish Farming Exp. Sta., Stuttgart, AR.* 72160. 8 pp.
- Hubbs, C.L. and Cooper, G.P. 1935. Age and growth of the long eared and the green sunfishes in Michigan. *Pap. Mich. Acad. Sci. Arts. Letts.* 20:669-696.
- Hubbs, C.L. and Lagler, K.F. 1949. Fishes of Isle Royale, Lake Superior, Michigan. *Pap. Mich. Acad. Sci. Arts. Letts.* 33:73-133.
- Hubbs, C.L. and Lagler, K.F. 1964. Fishes of the Great Lakes Region. Univ. Mich. Press, Ann Arbor, MI.

- Ingram, R. and Wares, II, W.D. 1979. Oxygen consumption in the fathead minnow (*Pimephales promelas* Rafinesque) II: Effects of pH, osmotic pressure, and light level. *Comp. Biochem. Physiol.* 62A:895-897.
- Isaak, D. 1961. The ecological life history of the fathead minnow, (*Pimephales promelas* Rafinesque). Doctoral dissertation, Univ. Minnesota. Microfilm 6104598, Univ. Microfilms International. Ann Arbor, MI. 150 pp.
- Kimsey, J.B. and Fisk, L.O. 1964. Freshwater nongame fishes of California. Calif. Dept. Fish and Game., Sacramento, CA.
- Klak, G.E. 1940. Neascus infestation of blackhead, blunt nosed, and other forage minnows. *Trans. Amer. Fish. Soc.* 69:273-278.
- Klinger, S.A., Magnuson, J.J., and Gallepp, G.W. 1982. Survival mechanisms of the central mudminnow (*Umbra limi*), fathead minnow (*Pimephales promelas*), and brook stickleback (*Culea inconstans*) for low oxygen in winter. *Environ. Biol. Fish.* 7(20):113-120.
- Konefes, J.L. and Bachmann, R.W. 1972. Growth of the fathead minnow (*Pimephales promelas*) in tertiary treatment ponds. *Proc. Iowa Acad. Sci.* 77:104-111.
- Lee, D.S., Gilbert, C.R., Hocutt, C.H., Jenkins, R.E., McAllister, D.E., and Stauffer, R., Jr. 1980. Atlas of North American freshwater fishes. Publ. 1980-12, N. Carolina State Museum Nat. Hist., Raleigh, NC. 27611.
- Lord, R.R., Jr. 1927. Notes on the use of the blackhead minnow, *Pimephales promelas*, as a forage fish. *Trans. Am. Fish. Soc.* 57:92-99.
- Manner, H.W. and Casimira, C.M. 1974. Early embryology of the fathead minnow *Pimephales promelas* Rafinesque. *Anat. Rec.* 180(1):99-109.
- Manner, H.W., VanCura, M., and Muehlman, C. 1977. The ultrastructure of the chorion of the fathead minnow, *Pimephales promelas*. *Trans. Amer. Fish. Soc.* 106(1):110-114.
- Markus, H. 1934. Life history of the blackhead minnow (*Pimephales promelas*). *Copeia* 1934:116-122.
- McMillan, V. 1972. Mating of the fathead. *Nat. Hist.* 81(5):73-78.
- Ming, F.W. and Noakes, D.L.G. 1984. Spawning site selection and competition in minnows (*Pimephales notatus* and *P. promelas*) (Pisces, Cyprinidae). *Biol. Behav.* 9(3):227-234.
- McCarragher, D.B. and Thomas, R. 1968. Some ecological observations on the fathead minnow, *Pimephales promelas*, in the alkaline waters of Nebraska. *Trans. Am. Fish. Soc.* 97(1):52-55.
- Mount, D.I. 1968. Chronic toxicity of copper to fathead minnows (*Pimephales promelas* Rafinesque). *Wat. Res.* 2:214-223.
- Nagel, T. 1976. Technique for collecting newly hatched fathead minnow fry. *Prog. Fish. Cult.* 38(3):137.
- Pickering, Q.H., Horning, W.B., and Hall, C. 1985. Techniques used to transfer live fish and invertebrates from the Environmental Monitoring and Support Laboratory, U.S. Environmental Protection Agency, Cincinnati, OH. 18 pp.
- Radcliff, L. 1931. Propagation of minnows. *Trans. Amer. Fish. Soc.* 61:131-137.

- Rafinesque, C.S. 1820. Ichthyologia Ohiensis, or natural history of the fishes inhabiting the river Ohio and its tributary streams, preceded by a physical description of the Ohio and its branches. Lexington, KY. 90 pp.
- Richardson, L.R. 1937. Observations on the mating and spawning of *Pimephales promelas* (Rafinesque). Can. Field-Natur. 51(1):1-4.
- Scott, W. and Crossman, E. 1973. Freshwater fishes of Canada. Fish. Res. Bd. Can. Bull. 184. 966 pp.
- Smith, H.T., Schreck, C.B., and Maughan, O.E. 1978. Effect of population density and feeding rate on the fathead minnow (*Pimephales promelas*). J. Fish. Biol. 12:449-455.
- Smith, R.J.F. 1978. Seasonal changes in the histology of the gonads and dorsal skin of the fathead minnow, *Pimephales promelas*. Can. J. Zool. 56:2103-2109.
- Smith, R.J.F. and Murphy, B.D.. 1974. Functional morphology of the dorsal pad in fathead minnows (*Pimephales promelas*). Trans. Am. Fish. Soc. 103(1):65-72.
- Snyder, D.E., Snyder, M.B.M., and Douglas, S.C. 1977. Identification of golden shiner, *Notemigonus crysoleucas*, spotfin shiner, *Notropis spilopterus*, and fathead minnow, *Pimephales promelas*, larvae. J. Fish. Res. Board Can. 34:1397-1409.
- Soderberg, R.W. 1982. Aeration of water supplies for fish culture in flowing water. Prog. Fish-Cult. 44(2):89-93.
- Syrett, R.F. and Dawson, W.F. 1972. An inexpensive electronic relay for precise water temperature control. Prog. Fish. Cult. 34(4):241-242.
- Syrett, R.F. and Dawson, W.F. 1975. An inexpensive solid state temperature controller. Prog. Fish. Cult. 37(3):171-172.
- Taylor, W.R. 1954. Records of fishes in the John N. Lowe collection from the Upper Peninsula of Michigan. Misc. Publ. Mus. Zool. Univ. Michigan. 87. 50 pp.
- Trautman, M.B. 1981. The fishes of Ohio. Rev. ed., Ohio State Univ. Press., Columbus, Ohio. 782 pp.
- Vandermeer, J.H. 1966. Statistical analysis of geographic variation of the fathead minnow, *Pimephales promelas*. Copeia 1966(3):457-466.
- Westman, J. 1938. Studies on the reproduction and growth of the bluntnose minnow *Hydorhynchus notatus* (Rafinesque). Copeia 1938:57-61.
- Wynne-Edwards, V.C. 1932. The breeding habits of the black-headed minnow (*Pimephales promelas* Raf.). Trans. Amer. Fish. Soc. 62:382-383.

APPENDIX A

DISTRIBUTION, LIFE CYCLE, TAXONOMY, AND CULTURE METHODS

A.6 RAINBOW TROUT, *ONCORHYNCHUS MYKISS* AND BROOK TROUT, *SALVELINIUS FONTINALIS*

1. RAINBOW TROUT

1.1 SYSTEMATICS AND TAXONOMY

1.1.1 Rainbow trout are native to the streams of the Pacific coast where several varieties or strains have developed. The seagoing form is known as the steelhead trout and is thought to be identical to the strictly freshwater rainbow form. Many other strains, for example, the inland lake form (Kamloops trout) are found in other watersheds. Because of the ease with which the eggs can be transported, different strains have been distributed all over the world.

1.1.2 Rainbow trout are a variable species that differ considerably over the whole of their range. Populations in different regions and watersheds of North America have been referred to over the years by different scientific names (e.g. species, distinct subspecies, or variants of a single species and different regional common names). In recent years the validity of the generic name, *Salmo*, for some western North American trout species has been questioned. Fish taxonomists agree that native "*Salmo*" trouts of the northern Pacific Ocean drainage are closely related with Pacific salmon *Oncorhynchus* spp. The American Society of Ichthyologists and Herpetologists and the American Fisheries Society have accepted *Oncorhynchus* as the appropriate generic name for all native Pacific drainage trouts that are presently called *Salmo*, based on new data and evidence by Smith and Stearly (1989). Furthermore, the Names of Fishes Committee of the American Fisheries Society has adopted the specific name, *Oncorhynchus mykiss*, for the rainbow trout and its anadromous form, steelhead trout. The new names for the other North American species affected are the following: Apache trout (*O. apache*), cutthroat trout (*O. clarki*), Gila trout (*O. gilae*), golden trout (*O. aguabonita*), and Mexican golden trout (*O. chrysogaster*).

1.2 DISTRIBUTION

1.2.1 The native range of the rainbow trout group (all varieties) in North America is west of the Rocky Mountains and along the eastern Pacific Ocean, but the species (*Oncorhynchus mykiss*) has now been introduced into many parts of the continent (Figure 1). Except for the northern and southern extremes of the rainbow trout range, anadromous populations occur in all coastal rivers. This species, under all its common names (rainbow trout, Kamloops trout, steelhead trout, steelhead, coast rainbow trout, and silver trout), has been so widely introduced in North America outside its natural range as to suggest it may occur throughout the United States in all suitable habitats. Rainbow trout are widely introduced and established in appropriate cold water habitats all over the world.

1.3 GENERAL LIFE HISTORY

1.3.1 In its natural environment of flowing streams of the western mountains, the rainbow trout (Figure 2) thrives best at temperatures ranging from 3°C in the winter to 21°C in the summer, but the optimum temperature is between 10-16°C. The rainbow trout can withstand higher and lower temperature if it is acclimated gradually. However, the rainbow trout's growth is impeded by extremes of temperature, for example, above 27°C which it can tolerate only for short periods of time.



Figure 1. Map showing the distribution of the rainbow trout in North America. (Modified from Lee et al., 1980).

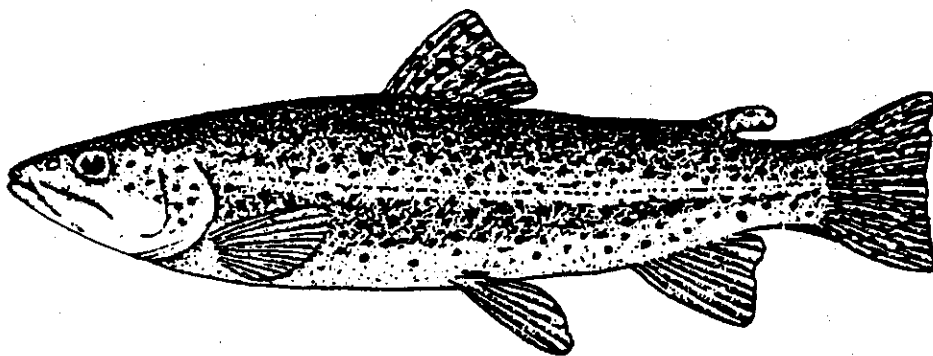

Figure 2. Rainbow trout (Modified from Eddy and Underhill, 1974).

1.3.2 Rainbow trout are basically spring spawners, but they can spawn at the beginning of summer or early winter, depending on climate, elevation, and genetic strain. If the spawning occurs in late fall or in winter, the eggs do not hatch until spring. Prior to the spawning season adult males develop a kype (elongated hooked snout) on the lower jaw and their colors intensify. Males and females usually migrate upstream and select spawning sites in beds of fine, clean gravel in riffles or runs above pools in streams. Long journeys may be made by lake-dwelling rainbow (or Kamloops) and steelhead trouts or anadromous, ocean-run rainbow steelheads. If the rainbow trout are confined to land-locked lakes, they move into shallow shoals or reefs of gravel and sand for spawning. Females dig out pits or sweep out depressions (redds) in the gravel or sand and later spawn with males. Males are capable of displaying aggressive behavior on the spawning grounds and can drive other males away from a redd occupied by a female. In general, one or more males court the digging female by sliding along side and crossing over her body and rubbing their snout against her caudal peduncle with body pressing and body vibrations. The female deposits her eggs, which are 3-5 mm in diameter, demersal, and pink to orange in color. The eggs are immediately fertilized by one or more males, fall into spaces between the gravel, and are covered with loose gravel or sand to depths of 20 cm or more by the female. Females are capable of digging and spawning in several redds with the same male or different males. The number of eggs released can range from 400-3000, depending on the size of the female.

1.3.3 Eggs usually hatch in approximately four to seven weeks. The time of hatching, however, varies greatly with region and habitat. If the stream temperature averages 7°C, eggs will hatch in about 48 days. The newly hatched fish, called alevins, have a yolk sac, which is absorbed in three to seven days. After the yolk sac is absorbed, the young are called fry, and begin feeding in 10-15 days. In general, rainbow trout feed on a variety of invertebrates. Also, depending on their size and the habitat in which they live, other fishes and fish eggs, especially salmon, can be important food. The fry of lake-resident spawners move up or down the spawning river to the lake, or they may spend as much as one to three years in the streams. The stream-resident spawners remain in the streams, whereas the steelhead trout, which are stream-spawners, migrate to the sea, usually after 1-4 years in freshwater.

1.3.4 The growth of rainbow trout is highly variable with the area, habitat, type of life history, and quantity and type of food. Some males may be good breeders at two years of age, but few females produce eggs until their third year of life. Rainbow trout young attain fingerling size of about 76 mm by the end of their first summer. The length may range between 178-204 mm at the end of the second year, 279-382 mm after the third year, 356-406 mm after the fourth year, and 406 mm or more after the fifth year. Lake- and ocean-run rainbows may grow over twice as fast as this. However, the average length of rainbow trout (or Kamloops trout) is 305-458 mm and that of steelhead trout is 508-762 mm. Under favorable conditions of artificial propagation, yearlings average about 28 g, 2-year-olds about 255 g, 3-year-olds between 0.45-9 kg, and 4-year-olds between 1.4-1.8 kg. Returning sea-run individuals weigh up to 18 kg, or even more, but usually between 1.4-9 kg with the majority weighing less than 5.4 kg. Some western varieties weight up to 23 kg, but the midwest rainbows are much smaller. Those in streams are rarely over 1.4 kg, but in some large lakes (e.g., Lake Superior) and in some western lakes they may reach 7 kg or much larger. The life expectancy of rainbow trout can be as low as three or four years in many streams and Lake populations, but that of seagoing steelhead rainbow trout and Great lakes populations would appear to be 6 to 8 years (Scott and Crossman, 1973).

1.4 GENERAL DESCRIPTION

1.4.1 Adult rainbow trout are bluish or olive green above and silvery on the sides, with a broad pink lateral stripe that is enhanced during the spawning season. The back, the sides, and the dorsal and caudal fins are profusely dotted with small dark spots. Their color is variable with habitat, size, and sexual condition. Stream forms and spawners are generally darker with color more intense, lake forms lighter, brighter, and more silvery. Different color types are often called by different names, e.g., darker stream fish often called rainbows; larger, brighter, silvery fish in western lakes often called Kamloops trout, and large silvery specimens returning from the sea and in the Great Lakes or tributaries called steelhead trout. The scales are large, numbering 120 to 150 in the lateral line. The caudal fin is very slightly forked. The dorsal fin has 11 rays, and the anal fin has from 10 to 12 rays.

1.4.2 Young rainbow trout are typically blue to green on the dorsal surface, silver to white on the sides and white ventrally. There are 5-10 dark marks on the back between the head and dorsal fin. Also, there are 5-10 short, dark,

oval parr marks widely spaced on the sides, straddling the lateral line with some small dark spots above but not below the lateral line. The dorsal fin has a white to orange tip and a dark leading edge, or a series of bars or spots. The adipose fin is edged with black, and the anal fin has an orange to white tip.

2. BROOK TROUT

2.1 SYSTEMATICS AND TAXONOMY

2.1.1 Brook trout can be found exhibiting some variation in growth rate and color throughout its range, but is considered a stable and well-defined species (American Fishery Society, 1980). Male brook trout may be crossed with female lake trout (*Salvelinus namaycush*) to produce fertile hybrids that are known as splake. Troutman (1981) and other papers cited in this section indicate that brook trout can naturally and artificially hybridize with brown trout (*Salmo trutta*) and rainbow trout (*Oncorhynchus mykiss*). For additional information and discussion on freshwater and anadromous brook trout stocks and systematic notes of brook trout, see Scott and Crossman (1973) and other papers cited in this section.

2.2 DISTRIBUTION

2.2.1 The native range of the brook trout (Figure 3) is eastern North America, extending throughout much of eastern Canada from Hudson Bay and Ungava Bay drainages and Labrador; southward through the New England States and in the Appalachian Mountains to the headwaters of the Savannah, Chattahoochee, and Tennessee Rivers in the Carolinas and Georgia. In the Great Lakes, brook trout are native to Lake Superior and tributaries to the northern tip of the Lower Peninsula, the interior of the Great Lakes basin. They are also native to a few far-northern headwaters of the upper Mississippi river system, and western Minnesota and northeastern Iowa.

2.2.2 The brook trout has been widely introduced to higher elevations in western North America. This species is also found in temperate regions of other continents. Inland forms are found in colder lakes and streams, and sea-run (anadromous) forms are found in the northeastern North American coastal water areas.

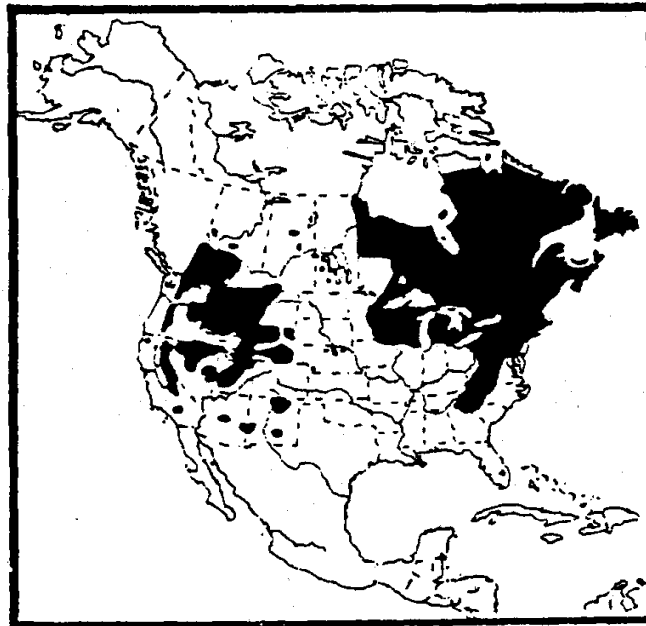

Figure 3. Map showing the distribution of the brook trout in North America. (Modified from Lee et al., 1980).

2.3 GENERAL LIFE HISTORY

2.3.1 Brook trout (Figure 4) are generally found in clear brooks, streams, and rivers in which the mean temperature rarely exceeds 10°C. The optimum temperature is reported as ranging from 7 to 13°C, but they may be found living in waters with temperatures ranging from 1 to 22°C (Piper et al. 1982). The brook trout usually inhabits waters which flow less swiftly than those inhabited by the rainbow. Brook trout also thrive in the small cold-water lakes of the Great Lakes region, provided that suitable spawning conditions exist.

2.3.2 Brook trout spawn in late summer or autumn, the date varying with latitude and temperature, usually from late October to December when the water temperature is suitable although some may start spawning in September in certain streams flowing into large lakes. Some females are capable of spawning when they are a year old, while others do not mature until the second year. When the spawning season occurs, brook trout move upstream into small head waters or brooks where they select gravel and sand substrates usually in shallow riffle areas or the tail-ends of pools for the spawning beds. Spawning usually occurs during the day.

2.3.3 The female prepares a nest (redd), similar to those of the rainbow trout, by sweeping out a depression in the gravel and sand substrate. During preparation of the redd, the male starts courtship by quivering around the female and driving off all intruders. When the female is ready to spawn, she takes a position above and close to the redd. The male gets close to her side and arches his body over hers, discharging milt as the female deposits her eggs. Occasionally second male may join them in the spawning. After spawning, the male leaves.

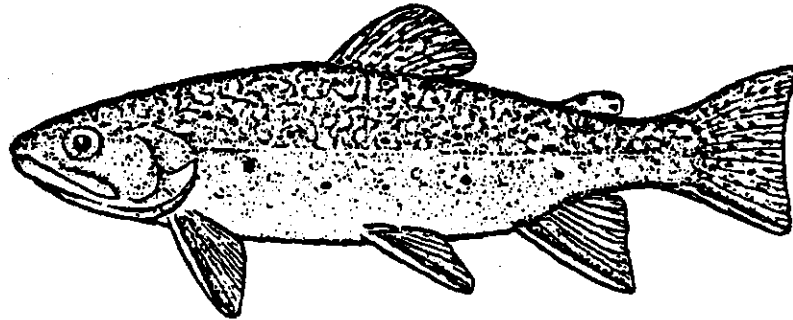

Figure 4. Brook trout. (Modified from Eddy and Underhill, 1974).

2.3.4 The eggs are 3.5 to 5.0 mm in diameter, are adhesive, and adhere to the gravel at the bottom of the redd. The female pushes loose gravel and sand to the center, covering the entire redd, and then desert the nest. A female may spawn several times, and the number of eggs can vary from 100 to 5000, depending on the size of the female.

2.3.5 The eggs remain in the redd until the water temperature rises during the following spring. If the level of DO is adequate, the eggs will hatch in approximately 75 days at an average water temperature of 6.1°C, and in approximately 50 days at an average temperature of 10°C. The upper lethal temperature limit for developing eggs is about 11.7°C (Scott and Crossman, 1973).

2.3.6 After the eggs hatch, the larvae (sac fry) remain in the gravel of the redd until the yolk is absorbed. Depending on the water temperature, it may take from one to three months for the yolk sac to be absorbed (Lagler,

1956). While the yolk sac is absorbed, the fry work themselves free from the gravel and start feeding. They become free swimming at about 38 mm long. Under natural conditions, newly hatched brook trout establish small feeding territories in the stream and feed on small aquatic insects, insect larvae, and other organisms.

2.3.7 Growth of brook trout is extremely variable, depending on the suitability of the environment. The average length attained at various ages may approximate 8.9 cm the first year; 15.2 cm the second year, 22.9 cm the third year, 30.5 cm the fourth year, and 33 cm the fifth year. Brook trout generally do not exceed a length of 54 cm and a weight of 1.5 kg (Trautman, 1981). However, Scott and Crossman (1973) reported a brook trout as large as 6.6 kg. Rumors of larger brook trout have been circulated, but none have been verified. Brook trout may overpopulate small streams, resulting in large numbers of small trout less than 25.4 cm long. Wild brook trout seldom live longer than five years, and rarely live more than eight years.

2.4 GENERAL DESCRIPTION

2.4.1 The sides of large young and adult brook trout are dark olive, sprinkled with light spots and red spots outlined with purplish or blue hue. Some forms have red spots with light brown margins. The scales are cycloid, small, in about 215 to 250 rows at the lateral line. The top of the head and back is dark olive and heavily vermiculated. There are no black or brown spots on the head, back, adipose, or caudal fin. The anterior rays of the pectoral, pelvic, and anal fins are milk-white, bordered posteriorly with a dusky hue and the remainder of the fins yellowish or reddish.

2.4.2 The back of young or immature brook trout is olive, the sides are lighter and more silvery, and the belly is whitish. There are between 8-12 rectangular parr marks on the sides, also a few yellow and blue spots, but no black spots.

2.4.3 The dorsal fin has 10 rays, and the anal fin has 9 rays. The belly of breeding males is red, and some males may develop a hook (or kype) at the front of the lower jaw. The tail or caudal fin is slightly notched in the young but is generally square in older brook trout.

3. HOLDING AND ACCLIMATION PROCEDURES FOR TROUT STOCKS

3.1 SOURCES OF ORGANISMS

3.1.1 Trout fry are obtained from commercial hatcheries during March through July. However, if trout are needed for toxicity testing, it is advisable to contact the hatchery for its trout hatching and rearing schedule. If trout must be ordered from out-of-state, the State Fish and Game Agency should be contacted concerning regulations on fish importation. The recommended age for test organisms is approximately 15-30 days (after yolk sac absorption to 30 days) for rainbow trout and 30-60 days for brook trout. Trout are purchased 36 to 48 h prior to their use as testing organisms, but they must have time to stabilize over the acclimation period. Trout should appear disease-free and unstressed, with fewer than 5% of the animals dying during the 24-48 hours preceding use in a toxicity test.

3.1.2 Trout fry are usually transported in plastic bags of at least 4-mil plastic or thicker in shipping containers. The bags are partially filled with water saturated with oxygen. During warm weather the shipping containers are cooled with ice or cold packs to prevent temperature increases which will result in the loss of fish. Trout should be acclimated gradually from the temperature of the transportation unit to that of holding environment. Upon arrival at the destination the plastic bags should be allowed to float unopened in the holding tank for about 30 minutes to acclimate the fish.

3.2 HOLDING CONDITIONS

3.2.1 Trout are held in 200 L (50 gal) or larger tanks supplied with a flow-through water system, or with recirculated water and a biological filtration system. The holding water should be moderately hard and free of chlorine, have low concentrations of metals, and should have a pH between 6 and 9. Provide a daily photoperiod of

16 hours light, 8 hours darkness with an illumination at 10-20 $\mu\text{E}/\text{m}^2/\text{s}$ (50-100 ft-c, or ambient laboratory levels). A 15 min dimmer timer should be used to gradually increase or decrease the illumination when lights are turned on or off. The gradual increase and decrease of illumination at the beginning and ending of the photoperiod is important because trout tend to jump when startled by a sudden change in light intensity. Holding water temperature is maintained at $12^\circ\text{C} \pm 2^\circ\text{C}$ and is aerated as close as possible to saturation. Measurements of temperature, DO, pH, conductivity, and ammonia are made on holding water daily.

3.3 FEEDING

3.3.1 Trout are fed fine texture trout chow. The fry in the holding tank are fed (*ad libitum*) up to 24 hours before the start of the acute toxicity test. Dead or moribund fish should be removed from the holding tanks every day. Excess food and feces are vacuum-siphoned off the bottom of the tank daily.

3.3.2 Daily records should be maintained for organism survival, health, and acclimation conditions.

4. TEST ORGANISMS

4.1 Rainbow trout fry 15-30 days old, and Brook trout 30-60 days old, are used in acute tests (see summary tables of test conditions in Section 9, Acute Toxicity Test Procedures). The fry in the holding tank are not fed for 24 hours prior to the start of the test. The fry are caught carefully with a fine mesh net and placed gently in the 5 L (4 L test solution volume) test chambers, until 10 fish are reached per test chamber. Larger test chambers or 5 fish/chambers may be necessary if DO or pH problems are encountered. Placement of the test chambers is random.

4.2 After the fish are introduced, the behavior should be noted and recorded throughout the test period. At the beginning and ending of the photoperiod, during the test, the light intensity should be raised and lowered gradually over a 15 min period using a dimmer switch or suitable device. Between observations the test vessels are covered to act as a dust barrier and to prevent fish from jumping out.

SELECTED REFERENCES

- American Fisheries Society. 1980. A list of common and scientific names of fishes from the United States and Canada. Special Publication No. 12. Amer. Fish. Soc., Bethesda, MD.
- Bailey, R.M and Robins, C.R. 1989. Changes in North American fish names, especially as related to the International Code of Zoological Nomenclature, 1985. Bull. Zool. Nomencl. 45(2):92-103.
- Eddy, S. and Hodson, A.C. 1970. Taxonomic keys to the common animals of the north central states. Burgess Publ. Co., Minneapolis, MN.
- Eddy, S. and Underhill, J.C. 1974. Northern fishes. Univ. Minnesota Press, Minneapolis, MN.
- Hubbs, C.L. and Lagler, K.F. 1967. Fishes of the Great Lakes Region. Univ. Michigan Press, Ann Arbor, MI.
- Lagler, K.F. 1956. Freshwater Fishery Biology. Wm. C. Brown Co., Publ., Dubuque, IA.
- Lee, D.S., Gilbert, C.R., Hocutt, C.H., Jenkins, R.E., McAllister, D.E., and Stauffer, R., Jr. 1980. Atlas of North American freshwater fishes. Publ. 1980-12, North Carolina State Museum Nat. Hist., Raleigh, NC.
- Leitritz, E. and Lewis, R.C. 1976. Trout and salmon culture (Hatchery methods). California Dept. Fish and Game, Fish Bulletin 164. Sacramento, CA.
- National Academy of Sciences. 1974. Fishes - Guidelines for the breeding, care, and management of laboratory animals. Printing and Publishing Office, National Academy of Sciences, Washington, D.C.
- Piper, R.G., McElwain, I.B., Orme, L.E., McCraren, J.P., Fowler, L.G., and Leonard, J.R. 1982. Fish hatchery management. U.S. Dept. Interior, Fish and Wildlife Service, Washington, D.C.
- Scott, W.B. and Crossman, E.J. 1973. Freshwater fishes of Canada. Fisheries Research Board of Canada, Ottawa, Canada.
- Smith, G.R. and Stearly, R.F. 1989. The classification and scientific names of rainbow and cutthroat trouts. Fisheries 14(1):4-10.
- Trautman, M.B. 1981. The fishes of Ohio. Ohio State Univ. Press and Ohio Sea Grant Program, Center Lakes Erie Area Research, Columbus, OH.
- Willers, B. 1991. Trout Biology: A natural history of trout and salmon. Lyons and Burfoud, 31 West 21 Street, New York, NY. 10010.

APPENDIX A

DISTRIBUTION, LIFE CYCLE, TAXONOMY, AND CULTURE METHODS

A.7 SHEEPSHEAD MINNOW (*CYPRINODON VARIEGATUS*)

1. MORPHOLOGY AND TAXONOMY

1.1 The sheepshead minnow (*Cyprinodon variegatus*) belongs to the family Cyprinodontidae (killifishes), which includes 45 genera and 300 species worldwide, occurring on all continents except Australia. Most species are freshwater, but some occur in brackish and coastal marine waters. There are thirteen species in the Genus *Cyprinodon* in the United States (American Fisheries Society, 1980). The sheepshead minnow is the only marine species, and is widely distributed in the coastal waters of the Atlantic and Gulf of Mexico.

1.2 Adult sheepshead minnows (see Hardy, 1978, for a complete description) can attain a total length of 93 mm, but the average standard length report for adults is 35-50 mm. The males are usually somewhat longer than females. The fish have the following morphological characteristics: lack a lateral line; have 24-29 lateral scale rows; have a large elongate humeral scale just above the pectoral base; the dorsal fin has nine to 13 rays; the anal fin has nine to 12 rays; the caudal fin has 14-16 principal rays and a total of 28-29 rays; the pectoral fin has 14-17 rays, and the ventral fin has five to seven rays.

1.3 The body of males is short, compressed, and deep. The depth increases with age. The upper profile is evenly elevated. The males are olivaceous above with a lustrous steel blue or bluish green area on the back from nape to dorsal or beyond, and have a series of poorly defined dark bars on the sides and a belly that is yellowish white to deep orange. The dorsal fin ocellus on posterior rays is lacking or developed as faint dusky spot.

1.4 The females are light olive, brown, brassy, or light orange above with 14 dark crossbars on the lower sides alternating with seven to eight crossbars on the back. The lower sides and belly are yellowish or white. The dorsal fin is olive or dusky and has one or two prominent ocelli on the posterior rays.

2. LIFE HISTORY

2.1 DISTRIBUTION AND GENERAL ECOLOGY

2.1.1 Sheepshead minnows occur in estuaries along the Atlantic and Gulf coasts (Figure 1). They are a schooling, euryhaline species that inhabit a variety of shallow water habitats, such as coves, bays, ponds, inlets, harbors, bayous, salt marshes, and along open beaches. In some cases, they may be very abundant where the bottom is partially sandy, emergent vegetation lacking, and little current or wave action are present. This species may establish populations in inland lakes containing relatively high concentrations of dissolved salts. They are tolerant of extreme changes in water temperatures, ranging from 0-40°C, and in salinities, ranging from 0.1-149‰ (Simpson and Grunter, 1956; Nordlie, 1987).

2.1.2 This omnivorous fish is an important component of the estuarine ecosystem serving as a link in transferring energy from lower trophic levels, detritus and benthic plants and animals, to carnivores in higher trophic levels (Hansen and Parrish, 1977). Sheepshead minnows serve as forage fish for commercially and recreationally valued fish species, such as the black drum (*Pogonias cromis*), red drum (*Sciaenops ocellata*), bluefish (*Pomatomus saltatrix*), spotted seatrout (*Cynoscion nebulosus*), striped bass (*Morone saxatilis*), and snook (*Centropomus undecimalis*) (Gunter, 1945; Darnell, 1958; Grant, 1962; Sekavec, 1974, and Carter et al., 1973).

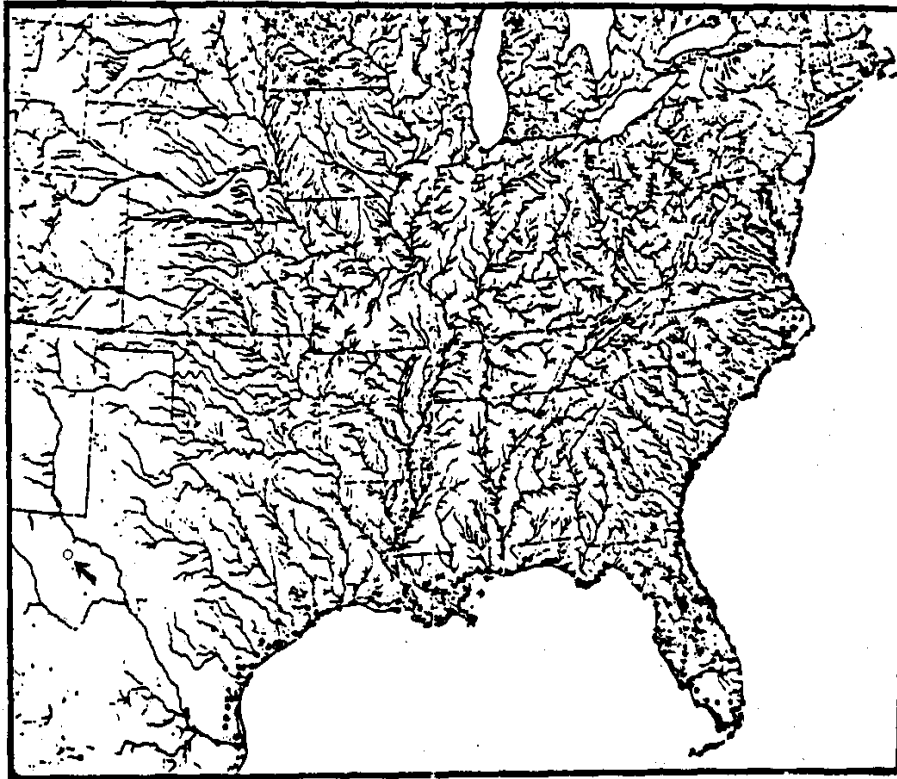

Figure 1. Map showing the distribution of the sheepshead minnow (*Cyprinodon variegatus*) in North America. Open circles represent transplanted populations (From Lee et al., 1980).

2.2 GENERAL SPAWNING BEHAVIOR

2.2.1 Sheepshead minnows (Figures 2, 3, 4) spawn at depths of 2.5-60 cm in shallow bays, tide pools, mangrove lagoons, and pools in shallow, gently flowing streams, and other similar habitats over bottoms of sand, black silt, or mud. Males occupy territories up to 0.3-0.6 m in diameter and may or may not construct nest pits. Spawning may take place out of both pit and territory. Besides temperature, Martin (1972) reported that sudden changes in salinity can initiate spawning activities. Eggs (Figure 2) are demersal, adhesive or semi-adhesive with very minute attachment filaments (threads) more or less evenly distributed over the chorion. They stick to a variety of substrates, such as plants, sand, rocks, logs, and to each other. Sometimes they stick to plants near the surface, and at other times become partially buried in the bottom. The yolk contains one very large and many minute oil globules. Adults spawn possibly throughout the year on the Gulf coast of the United States. Hansen and Parrish (1977) reported that in an estuary near Pensacola, Florida, spawning may occur during any month of the year. Ripe females are found April to October in North Carolina, throughout the summer in the Chesapeake Bay, May to August in Delaware Bay, May to September in New Jersey and New York, and June to mid-July in Massachusetts.

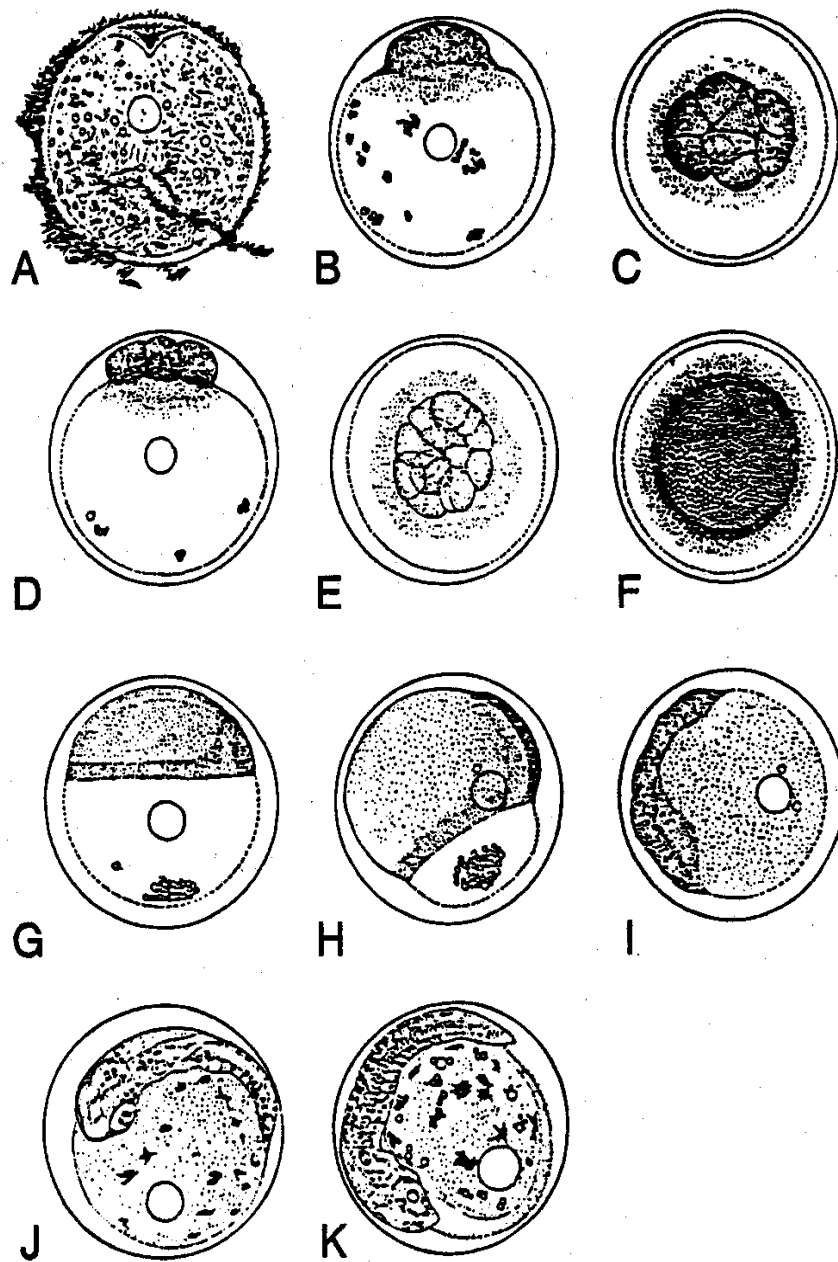

Figure 2. Sheepshead minnow (*Cyprinodon variegatus*). A. unfertilized egg; B. blastodisc stage; C-D. 8-cell stage; E. 16-cell stage; F. late cleavage; G. germ ring formed; H. blastoderm over 1/4 of yolk; I. early embryo; J. embryo 48-hours old; K. tail-free embryo. (From Kuntz, 1916).

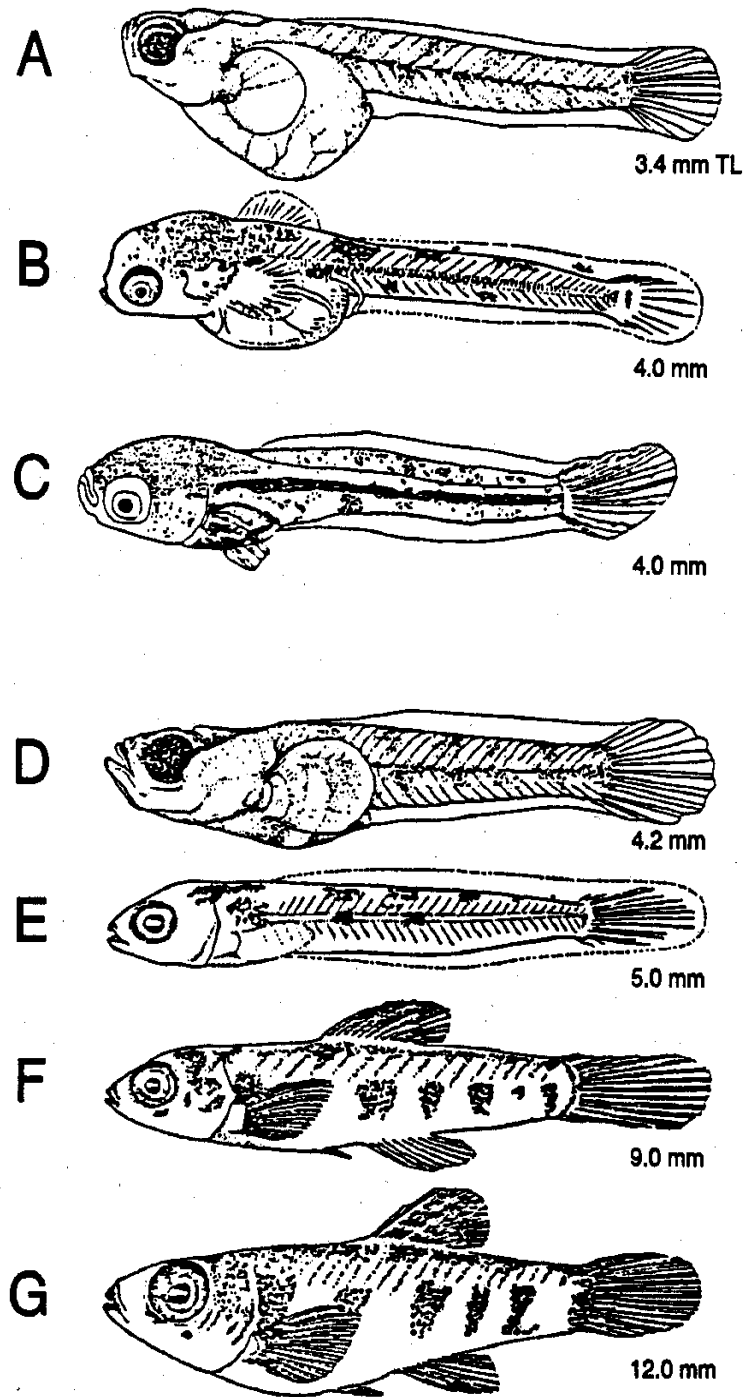

Figure 3. Sheepshead minnow (*Cyprinodon variegatus*). A-E. yolk-sac larvae; F. larvae; G. juvenile; (B-C, E-G, from Kuntz, 1916; A, D, from Foster, 1974).

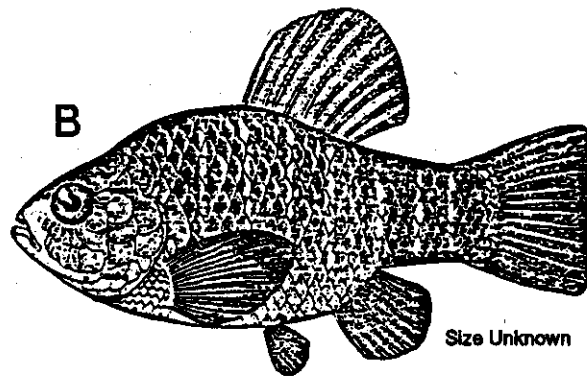
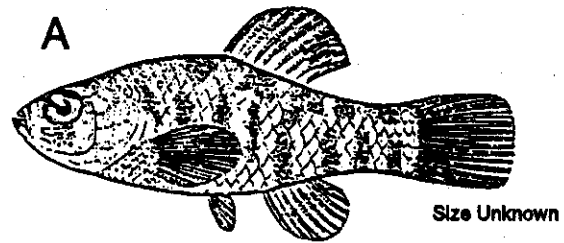

Figure 4. Sheepshead minnow (*Cyprinodon variegatus*). A. juvenile; B. adult (From Jordan and Evermann, 1896-1900).

3. CULTURE METHODS AND FACILITIES

3.1 SOURCES OF ORGANISMS

3.1.1 Juvenile and adult sheepshead minnows (Figure 4) for use as brood stock spawners may be obtained from commercial biological supply houses or taken by seine in coastal estuaries of the Atlantic coast and Gulf of Mexico. They may also be obtained from young fish raised to maturity in the laboratory. Feral brood stock and first generation laboratory fish may be preferred, to minimize inbreeding. A continuous supply of wild stock, however, may be more cost effective. Neither fish nor eggs of feral stock should contain excessive contaminants nor exhibit excessive mortality, and the fish should demonstrate normal behavior. Before being used as a source of gametes, field-caught adults should be maintained and observed in the laboratory for at least one week to permit detection of disease and to allow time for acute mortality resulting from stress of capture. Injured or diseased fish should be discarded.

3.2 LABORATORY CULTURE FACILITIES

3.2.1 Sheepshead minnows can be cultured in a static, recirculated, or flow-through systems. Flow-through systems require large volumes of water and may not be feasible in some laboratories.

3.3 LABORATORY YEAR-ROUND SPAWNING

3.3.1 In the laboratory, adults may be kept in breeding condition year round. Females may spawn a number of times at intervals of one to seven days, and will generally produce an average of 10 to 30 eggs per spawning (USEPA, 1978a). To obtain large number of eggs at one particular time, adult fish of 27 mm standard length or greater should be used. If fish are taken in the field, they should be acclimated for at least one to two weeks in 20-30‰ salinity, a water temperature of 25-28°C, and a photoperiod of 16 h light and 8 h dark.

3.3.2 Sheepshead minnows can be continuously cultured in the laboratory from eggs to adults. The eggs (embryos, larvae, juveniles, and adults (Figures 2, 3, 4) should be kept in rearing and holding tanks of appropriate size and maintained at ambient laboratory temperature. The larvae should be fed sufficient newly-hatched *Artemia* nauplii daily to assure that live nauplii are always present. At the juvenile stage, they are fed frozen adult brine shrimp and a commercial flake food. Adult fish are fed flake food two or three times daily, supplemented with frozen adult brine shrimp.

3.3.3 Sheepshead minnows normally reach sexual maturity three to five months after hatching, and have an average standard length of approximately 27 mm for females and 34 mm for males, if held at a temperature of 25-30°C in rearing tanks of adequate size, and fed adequately. At this time, the males begin to exhibit sexual dimorphism and initiate territorial behavior. When the fish reach sexual maturity, and are to be used to obtain large number of embryos by natural spawning, the brood stock should be kept in a temperature controlled system at 18-20°C. To initiate spawning, the spawners are moved to spawning tanks with a temperature of 25°C. Adults can be maintained in natural or artificial seawater in a flow-through, static, or recirculating, aerated system consisting of an all-glass aquarium, or equivalent (see USEPA, 1985 and USEPA, 1987).

3.3.4 Static systems are equipped with an undergravel filter. Recirculating systems are equipped with an outside biological filter constructed in the laboratory using a reservoir system of crushed coral, crushed oyster shells, or dolomite and gravel, charcoal, floss, (see Spotte, 1973; 1979, Bower, 1983 for information on filters and conditioning the biological filter), or a commercially available cartridge filter or an equivalent system. The culture conditions should include seawater at 20-30‰, and a photoperiod of 16 h light and 8 h dark. Water temperature may be controlled or maintained at ambient laboratory levels.

3.4 OBTAINING EGGS (EMBRYOS) FOR TOXICITY TESTS

3.4.1 Embryos can be shipped to the laboratory from an outside source or obtained from adults held in the laboratory. Ripe eggs can be obtained either by natural spawning or by intraperitoneal injection of the females with human chorionic gonadotrophin (HCG) hormone. If the culturing system for adults is temperature controlled, natural spawning can be induced to obtain large number of embryos by raising the temperature to 25°C. Natural spawning is preferred because repeated spawning can be obtained from the same brood stock, whereas with hormone injection, the brood stock is sacrificed in obtaining gametes. It should be emphasized that the injection and hatching schedules given below are to be used only as guidelines. Response to the hormone varies with brood stock and temperature. Time-to-hatch and percent hatch also vary among stocks and among batches of embryos obtained from the same stock, and are dependent on temperature, DO, and salinity.

3.5 NATURAL SPAWNING

3.5.1 Adult fish should be maintained at 18-20°C in a temperature controlled system. The number of spawning chambers and fish to be spawned should be based on the requirements for providing sufficient numbers of viable embryos. As indicated above, an adult female in spawning condition will generally produce an average 10 to 30 eggs per spawn. To obtain embryos for a test, adult fish (generally, at least eight-to-ten females and three males) are transferred to a spawning chamber in a 57 L (15 gal) aquarium with the correct photoperiod and temperature (16 h light/8 h dark, and a temperature of 25°C), seven to eight days before the larval fish are needed. The spawning tank is fitted with a spawning chamber and an embryo collection tray. The spawning chamber consists of a basket of 3-5 mm NITEX® mesh, approximately 20 x 35 x 22 cm high (USEPA, 1978a), designed to fit into the aquarium. Spawning generally will begin within 24 h or less. The embryos will fall through the bottom of the spawning chamber and lightly adhere onto a collecting screen or tray placed on the bottom of the tank. The collecting tray should be checked for embryos the next morning. The number of eggs produced is highly variable. The number of spawning units required to provide the fish needed to perform a toxicity test (generally two to four) as determined by experience. If the collecting trays do not contain sufficient embryos after the first 24 h, discard the embryos, replace the tray, and collect the embryos for another 24 h. To help keep the embryos clean, the adults are fed while the screens are removed. Spawning fish should be shielded from excessive outside disturbance, e.g. an opaque curtain should surround the entire culture system. Care should also be taken so that outside light sources do not interfere with the photoperiod.

3.5.2 The embryos are collected in a tray placed on the bottom of the tank. The collecting trays are fabricated from plastic fluorescent light fixture diffusors (grids), with cells approximately 14 mm deep x 14 mm square. A screen consisting of 250-500 µm mesh is attached to one side (bottom) of the grid with silicone adhesive. The depth and small size of the grid protects the embryos from predation by the adult fish. The collecting trays with newly-spawned embryos are removed from the spawning tank, and the embryos are collected from the screens by washing them with a wash bottle or removing them gently with a fine brush. The embryos from several spawning units are generally pooled in a single container to provide a sufficient number to conduct the test(s). The embryos are transferred to a petri dish, or equivalent, filled with fresh culture water, and are examined using a dissecting microscope or other suitable magnifying device. Damaged and infertile eggs are discarded (see Figure 2). The embryos are then placed in incubation dishes (e.g. KIMAX® or PYREX® crystallizing dishes, Carolina culture dishes, or equivalent; see Subsection 3.8, Embryo Incubation and Hatching Facility). It is recommended that the embryos be obtained from fish cultured inhouse, rather than from outside sources, to eliminate the uncertainty of damage caused by shipping and handling that may not be observable, but which might affect the results of the test. After sufficient number embryos are collected for the test, the adult fish are returned to the (18-20°C) culture holding tanks.

3.6 SUSTAINED NATURAL EMBRYO PRODUCTION

3.6.1 Sustained (long-term), daily, embryo production can be achieved by maintaining mature fish (ratio of approximately 12-15 males to 50-60 females) in tanks, such as a 285-L LIVING STREAM® tank, or equivalent, at a temperature of 23-25°C. Embryos are collected seven or eight days prior to starting the acute or chronic toxicity

tests for less than 24 hr or older larvae. Embryos are produced daily, and when needed, collecting trays are placed on the bottom of the tank. The next morning, the embryo collectors are removed, and the embryos are washed into a shallow glass culture dish using artificial seawater. Four collecting trays, each approximately 20 cm x 45 cm, will cover the bottom of a 285 L tank.

3.7 FORCED SPAWNING

3.7.1 Human chorionic gonadotrophin (HCG) is reconstituted with sterile saline or Ringer's solution immediately before use. The standard HCG vial contains 1,000 IU, which is reconstituted in 10 mL of saline. Freeze-dried HCG, which comes with premeasured and sterilized saline, is the easiest to use. The reconstituted HCG may be used for several weeks if kept in the refrigerator.

3.7.2 Each female is injected with HCG on two consecutive days. The HCG is injected into the peritoneal cavity, just below the skin, using the smallest needle possible. A 50 IU dose (0.5 mL of reconstituted hormone solution) is recommended for females approximately 27 mm in standard length. A larger or smaller dose may be used for fish which are significantly larger or smaller than 27 mm. It may be helpful if fish that are to be injected are maintained at 20°C before injection, and the temperature raised to 25°C on the day of the first injection. Injected females should be isolated from males.

3.7.3 With injections made on days one and two, females which are held at 25°C should be ready for stripping on Days 4, 5, or 6. Ripe females should show pronounced abdominal swelling, and release at least a few eggs in response to a gentle squeeze. Eggs are stripped from the ripe females and mixed with sperm derived from excised, macerated testes. At least ten females and five males are used per test to ensure that there is a sufficient number of viable embryos.

3.7.4 Prepare the testes immediately before stripping the eggs from the females. Remove the testes from three-to-five males. The testes are paired, dark-grey organs along the dorsal midline of the abdominal cavity. If the head of the male is cut off and pulled away from the rest of the fish, most of the internal organs can be pulled out of the body cavity, leaving the testes behind. The testes are placed in a few mL of seawater until the eggs are ready.

3.7.5 Strip the eggs from the females into a dish containing 50-100 mL of seawater, by firmly squeezing the abdomen. Sacrifice the females and remove the ovaries if all the ripe eggs do not flow out freely. Break up any clumps of ripe eggs and remove clumps of ovarian tissue and under-ripe eggs. Ripe eggs are spherical, approximately 1.0-1.7 mm in diameter, and almost clear. Place the testes in a fold of NITEX® screen (250-500 µm mesh), dampen with seawater, and macerate while holding over the dish containing the eggs. Rinse the testes with seawater to remove the sperm from the tissue, and wash the remaining sperm and testes into the dish with the eggs. Let the eggs and sperm stand together for 10-15 minutes, swirling occasionally.

3.7.6 Pour the contents of the dish into a crystallizing dish or equivalent and insert an airstone. Aerate gently, so that the water moves slowly over the eggs, and incubate at 25°C for 60-90 min. After this period of time, wash the fertilized eggs on a NITEX® screen, place them in clean seawater in an incubation chamber.

3.8 EMBRYO INCUBATION AND HATCHING FACILITY

3.8.1 Embryos are incubated in KIMAX® or PYREX® crystallizing dishes, Carolina culture dishes, or equivalent, at a temperature of 25°C and 14-h light/10-h dark photoperiod. An air stone is placed in each dish, and the contents are gently aerated for the duration of the incubation. The water in the incubation chambers is replaced daily. Approximately 24 h prior to hatching, the salinity of the seawater in the incubation chambers is changed to that of the test salinity, if different. The salinity must remain within the 20-30‰ range. The embryos should hatch in 6 to 7 days at 25°C, and in 4 to 5 days at 30°C.

3.9 FEEDING AND STOCKING DENSITY

3.9.1 The sheepshead minnow cultures should be provided a sufficient amount of high quality nutrition without over-feeding. The adult and juvenile sheepshead minnows are fed, frozen adult brine shrimp and flake food, ad libitum, daily. The larvae are fed newly hatched *Artemia* nauplii and crushed flake food, ad libitum, daily. Methods for culturing brine shrimp are discussed in Appendix A.4. The stocking of adult fish in the holding tanks depends on the biological filter system (see Subsection 3.11, Biological Filters and Substrate Conditioning). A circular, 1.3 m (48 in.) diameter, 880 L (235 gal), fiberglass tank will hold approximately 30-50 adult fish with a varied sex ratio. A stocking density of about 300 larvae is suitable in a 76 L aquarium. Brood stock should be replaced with feral fish annually, or whenever the fecundity of the females diminishes, and they appear spent with age and from frequent breeding.

3.10 CULTURE TANKS

3.10.1 Larvae, juvenile, and adult fish should be kept in holding and rearing tanks of appropriate size. The tanks can be all-glass aquaria, fiberglass tanks, or equivalent. All tanks should have appropriate biological filtration systems, and the culture filtration system should be conditioned properly before adding the fish (see Spotte, 1973, 1979; Bower, 1983).

3.11 BIOLOGICAL FILTERS AND SUBSTRATE CONDITIONING

3.11.1 Holding and rearing aquaria and tanks can accommodate as many fish as its biological filter will permit. The substrate conditioning for the undergravel or outside filters is also important to the life and health of the fish. Substrate conditioning is the process to develop nitrifying bacteria (*Nitrosomonas* and *Nitrobacter*) that can convert ammonia and nitrite to nitrate. A conditioned filter bed is defined as one in which the capacity for ammonia and nitrite oxidation is sufficient to keep pace with the production of ammonia by the fish. Consult Spotte (1973; 1979) or Bower (1983) for a thorough understanding of the biological filter and conditioning process.

3.12 CULTURE WATER

3.12.1 Artificial seawater is prepared by dissolving FORTY-FATHOMS® or equivalent artificial sea salts in deionized water to a salinity of 20-30‰. Synthetic sea salts are packaged in plastic bags and mixed with deionized (MILLI-Q® or equivalent) water. The instructions on the package of sea salts should be followed carefully, and the salts should be mixed in a separate container, and not in the culture tank. The deionized water used in hydration should be in the temperature range of 21-26°C. Seawater made from artificial sea salts is conditioned (see Spotte, 1973, 1979; Bower, 1983) before it is used for culturing by aerating mildly for at least 24 h.

3.12.2 Adequate aeration will bring the pH and concentration of dissolved oxygen and other gases into equilibrium. The concentration of dissolved oxygen in the water supply should be 90-100% saturation before it is used. If a residue or precipitate is present, the solution should be filtered before use. The seawater should be monitored periodically to insure a constant salinity.

3.13 CULTURE CONDITIONS

3.13.1 Holding and rearing tanks and any area used for manipulating live sheepshead minnows should be located in a room or space separated from that in which toxicity test(s) are to be conducted. The salinity of the culture systems should be between 20 and 30‰. Water temperature for the brood stock should be maintained at 18-20°C. A photoperiod of 14 h illumination (10-20 $\mu\text{E}/\text{m}^2/\text{s}$, or 50-100 ft-c) and 10 h dark, should be provided. The holding and rearing tanks should be aerated so that the DO is not less than 1.0 ppm below saturation at any given temperature, with 5.0 ppm (60% saturation) being the absolute lowest limit.

3.14 CULTURE MAINTENANCE

3.14.1 Replace approximately 10% of the culture water every two weeks, or 25% monthly. The culture water should be clear. If the water appears cloudy or discolored, replace at least 50% of it. Replacement water should be well oxygenated and at the same temperature and salinity as the culture water. Salinity is maintained at the proper level by adding deionized water to compensate for evaporation. A replenisher, made of the trace elements, iodine (KI) and bromine (KBr), is added (1 mL/400 L) to the culture water each week, or commercial trace elements replenisher should be used as directed by the artificial sea salt manufacturer.

3.14.2 To avoid excessive build up of algal growth, periodically scrape the walls of culture system. Some of the algae will serve as a supplement to the diet of the fish. A partial activated carbon "charcoal" change in the filtration systems should be done monthly or as needed. The detritus (dead brine shrimp nauplii and cysts, adult brine shrimp, other organic material accumulation) should be siphoned from the bottom of rearing and holding aquaria or tanks each week or as needed.

3.15 WATER QUALITY MONITORING

3.15.1 Checking the chemistry of the sea water is critical to the success of the marine culture system. The water quality will determine whether the life support processes in the filter bed work at reasonable and steady rates. The culture water is checked routinely for temperature, alkalinity, pH, DO, total ammonia, nitrite, and nitrate. More frequent monitoring of these parameters is recommended during periods of organism procurement and starting new culture systems with inside underground filters and outside-of-tank biological filtration. The DO should be maintained at greater than 60% saturation. The pH should not go below 7.5 with an acceptable range between 7.5 and 8.3. Low pH levels can result from overcrowding, overfeeding, or waste accumulation, especially in static or recirculating culture systems.

3.15.2 Acceptable pH levels can be re-established by siphoning off 50-75% of the water and replacing it with conditioned artificial seawater of the same temperature. Also, sodium bicarbonate or commercially available liquid buffers can be added to the tanks whenever the pH falls below 7.5. Un-ionized ammonia, total ($\text{NH}_3 + \text{NH}_4$), and nitrite ion (NO_2) levels should not exceed 0.1 ppm in the holding tanks. It is recommended that the ammonia and nitrite concentrations be determined prior to starting new culture systems. It is recommended that nitrate (NO_3) concentrations be determined prior to starting new culture systems, and the nitrate ion concentrations should not exceed 20 mg/L.

3.15.3 A specific schedule for water quality monitoring should be established for each culture system. All water quality measurements and data are recorded in the culture and environmental conditions log books.

3.16 DISEASE CONTROL AND TREATMENT

3.16.1 Discussions of identification and treatment of common parasites of marine fish culturing can be found in Spotte (1973), Sindermann (1970), and Bower (1983). Several commercial companies sell various kinds of medication to treat common parasites of marine fish.

3.16.2 A colorless medication, FORMALITE II[®], has been used successfully for the treatment of the protozoan parasites, *Chilodonella*, *Costia*, *Trichoina*, *Scyphidia*, *Trichophrya*, and *Ichthyophirius*.

4. TEST ORGANISMS

4.1 Sheepshead minnows 1-14 days old are used in the acute toxicity test. If the larvae are used one or two days after hatching, they can be held in the crystallizing or culture dishes. If they are to be used later, they should be placed in larger holding aquarium or tanks. Prior to beginning the test, the larvae can be transferred to small beakers or plastic cups, using a large-bore, fire-polished glass tube (6 mm to 9 mm I.D. x 30 cm long) equipped with a rubber bulb.

4.2 If the larvae are to be moved to holding aquaria, a large-bore, fire-polished glass tube should also be used to move them. It is important to note that larvae and fry should not be handled with a dip net. Dipping larvae and fry with a net can result in very high mortality. Some of the water in the holding aquarium or tank containing the larvae should be siphoned off before they are transferred using the large-bore tube. This should make them easier to catch. The same large-bore, fire-polished glass tube discussed above should be used to gently transfer the fish from the holding vessels to the test vessels. As the fish are counted, they can be transferred to small plastic cups before they are added to the test vessels. It is more convenient to first transfer five fish to each of several small beakers or plastic containers with a few mL of 20-30‰ saline dilution water. The appropriate number of fish (multiples of five) can then be added to the test vessels.

SELECTED REFERENCES

- American Fisheries Society. 1980. A list of common and scientific names of fishes from the United States and Canada. Special Publication No. 12. American Fisheries Society, Bethesda, MD.
- American Society for Testing and Materials (ASTM). 1989. Standard practice for the use of brine shrimp nauplii as food for test animals in aquatic toxicology. Designation: E 1203-87, Annual Book of Standards, Vol. 11.04, ASTM, Philadelphia, PA.
- Andreasen, J.K. and Spears, R.W. 1983. Toxicity of Texan petroleum well brine to the sheepshead minnow (*Cyprinodon variegatus*), a common estuarine fish. Bull. Environ. Contam. Toxicol. 30(3):277-283.
- Battalora, M.S.J., Ellender, R.D., and Martin, B.J. 1985. Gnotobiotic maintenance of sheepshead minnow larvae. Prog. Fish-Cult. 47(2):122-125.
- Bower, C.E. 1983. The basic marine aquarium. Charles C. Thomas, Publ., Springfield, IL.
- Carter, M.A., Burns, L.A., Cavinder, T.R., Dugger, K.R., Fore, P.L., Hicks, D.B., Revells, H.L., and Schmidt, T.W. 1973. Ecosystems analysis of the Big Cypress Swamp and estuaries. Surveillance and Analysis Division and South Florida Ecological Study, Region IV, U.S. Environmental Protection Agency, Atlanta, GA. EPA 904/9-74/002.
- Clark, J.R., Borthwick, P.W., Goodman, L.R., Patrick, J.M., Jr., Lores, E.M., and Moore, J.C. 1987. Effects of aerial thermal fog applications of Fenthion on caged pink shrimp, mysids, and sheepshead minnows. Am. Mosquito Control Assoc. 3:466-472.
- Darnell, R.M. 1958. Food habits of fishes and larger invertebrates of Lake Pontchartrain, Louisiana, an estuarine community. Publ. Inst. Mar. Sci. Univ. Texas. 5:354-416.
- Drummond, R.A. and Dawson, W.F. 1970. An inexpensive method for simulating diel patterns of lighting in the laboratory. Trans Amer. Fish. Soc. 99(2):434-435.
- Foster, W.R. 1974. Cyprinodontidae - Killifishes. In: A.J. Lippson and R. L. Moran. Manual for identification of early developmental stages of fishes of the Potomac River Estuary. Power Plant Siting Program, Md. Dep. Nat. Resour. PPSP-MP-13, pp. 127-142.
- Grant, G.S. 1962. Predation of bluefish on young Atlantic menhaden in Indian River, Delaware. Chesapeake Sci. 3(1): 45-47.
- Gunter, G. 1945. Studies of marine fishes of Texas. Publ. Inst. Mar. Sci. Univ. Texas. 1(1):1-190.
- Hansen, D.J., Parrish, P.R., Lowe, J.I., Wilson, A. 1971. Chronic toxicity, uptake, and retention of Aroclor[®] 1254 in two estuarine fishes. Bull. Environ. Contam. Toxicol. 6:113-119.
- Hansen, D.J., Schimmel, S.C., and Forester, J. 1974. Aroclor[®] 1254 in eggs of sheepshead minnows (*Cyprinodon variegatus*). Effect of fertilization success and survival of embryos and fry. Proc. 27th Ann. Conf. Southeast. Assoc. Game Fish Comm. Oct. 1973. Hot Springs, AR. pp. 420-426.
- Hansen, D.J. and Parrish, P.R. 1977. Suitability of sheepshead minnows (*Cyprinodon variegatus*) for life-cycle toxicity tests. Aquatic Toxicology and Hazard Evaluation. ASTM STP 634. F.L. Mayer and J.L. Hamelink, Eds. American Society of Testing and Materials, Philadelphia, PA. pp. 117-126.

- Hansen, D.J., Schimmel, S.C., and Forrester, J. 1977. Endrin: Effects on the entire life-cycle of a salt water fish. *J. Toxicol. Environ. Health.* 3:721-733.
- Hardy, J.D. 1978. Development of fishes of the Mid-Atlantic Bight. An atlas of egg, larval, and juvenile stages. Vol. II. Anguillidae through Syngnathidae. Fish and Wildlife Service, U.S. Dept. Interior, FWS/OBS-78/12, pp. 141-151.
- Holland, H.T. and Coppage, D.L. 1970. Sensitivity to pesticides in three generations of sheepshead minnows. *Bull. Environ. Contam. Toxicol.* 5(1): 362-367.
- Hollister, T.A., Heitmuller, P.T., Parrish, P.R., and Dyar, E.E. 1980. Studies to determine relationships between time and toxicity of an acidic effluent and an alkaline effluent to two estuarine species. In: Easton, J.G., P.R. Parrish, and A.C. Hendricks, eds., *Aquatic toxicology and hazard assessment, ASTM STP 707*, American Society for Testing and Materials, Philadelphia, PA. pp. 251-265.
- Jordan, D.S. and Evermann, B.W. 1896-1900. The fishes of North and Middle America. A description catalogue of the species of fishlike vertebrates found in the waters of North America, north of the isthmus of Panama. *U.S. Natl. Museum Bull.* 47 (in 4 parts). 3313 pp., 92 pls.
- Kilby, J.D. 1955. The fishes of two Gulf coastal marsh areas of Florida. *Tulane Stud. Zool.* 2(8):175-247. Kuntz, A. 1916. Notes on the embryology and larval development of five species of teleostean fishes. *Bull. U.S. Bur. Fish.* 34(831):409-429.
- Kutz, A. 1916. Notes on the embryology and larval development of five species of teleostean fishes. *Bull. U.S. Bur. Fish.* 34(831):409-429.
- Lee, D.S., Gilbert, C.R., Hocutt, C.H., Jenkins, R.E., McAllister, D.E., and Stautter, R., Jr. 1980. Atlas of North American freshwater fishes. Publ. 1980-12, North Carolina State Museum Natural History, Raleigh, NC.
- Martin, F.D. 1972. Factors influencing local distribution of *Cyprinodon variegatus* (Pisces: Cyprinodontidae). *Trans. Am. Fish. Soc.* 101(1):89-93.
- Martin, B.J. 1980. Effects of petroleum compounds on estuarine fishes. *Govt. Reports Announcements & Index (GRA&I)*, Issue 11.
- Nordlie, F.G. 1987. Plasma osmotic Na⁺ and Cl⁻ regulation under euryhaline conditions in *Cyprinodon variegatus* Lacepede. *Comp. Biochem. Physiol. A*, 86A(1):57-61.
- Perschbacher, P.W. and Strawn, K. 1986. Feeding selectivity and standing stocks of *Fundulus grandis* in an artificial brackishwater pond, with comments on *Cyprinodon variegatus*. *Contrib. Mar. Sci.* 29: 103-111.
- Sekavec, G. B. 1974. Summer Foods, length-weight relationship, and condition factor of juvenile ladyfish, *Elops saurus* Linnaeus, from Louisiana Coastal Streams. *Trans. Amer. Fish. Soc.* 3: 472-476.
- Schimmel, S.C. and Hansen, D.J. 1974. Effects of Aroclor[®] 1254 on the embryo and fry of sheepshead minnows. *Trans. Amer. Fish. Soc.* 103(3):522-586.
- Schimmel, S.C., Parrish, P.R., Hansen, D.J., Patrick, J.M., Jr., and Forester, J. 1975. Endrin: effects on several estuarine organisms. *Proc. 28th Ann. Conf. Southeast. Assoc. Game Fish. Comm.* pp. 187-194.
- Schimmel, S.C. and Hansen, D.J. 1975. Sheepshead minnow (*Cyprinodon variegatus*): An estuarine fish suitable for chronic (entire life-cycle) bioassays. *Proc. 28 Ann. Conf. Southeast. Assoc. Game Fish Comm.* pp. 392-398.

- Schimmel, S.C., Hansen, D.J., and Forester, J. 1974. Effects of Aroclor® 1254 on the embryo and fry of sheepshead minnow. *Trans. Amer. Fish. Soc.* 103(3):522-586.
- Seligmann, E.B., Jr. 1951. *Cyprinodon variegatus reverindi* (Poey) and other aquatic notes. *Aquarium* 20(9):234-236.
- Sindermann, C.J. 1970. *Principal diseases of marine fish and shellfish.* Academic Press, New York, NY.
- Simpson, D.G. and Gunter, G. 1956. Notes on habitats, systematics characters, and life histories of Texas salt water cyprinodontes. *Tulane Stud. Zool.* 4:113-134.
- Spotte, S. 1973. *Marine aquarium keeping.* John Wiley and Sons, New York, NY.
- Spotte, S.H. 1979. *Fish and invertebrate culture: water management in closed systems.* Wiley-Interscience Publication, John Wiley and Sons, New York, NY.
- USEPA. 1973. Ecosystem analysis of the Big Cypress Swamp and estuaries. M.A. Carter, L.A. Burns, T.R. Cavinder, K.R. Dugger, P.L. Fore, D.B.Hicks, H.L. Revells, and T.W. Schmidt. Surveillance and Analysis Division, U.S. Environmental Protection Agency, Athens, GA. EPA 904/9-74-002.
- USEPA. 1978a. Laboratory culture of sheepshead minnow (*Cyprinodon variegatus*). D.J. Hansen. In: Bioassay procedures for the ocean disposal permit program. U.S. Environmental Protection Agency, Environmental Research Laboratory, Gulf Breeze, Florida. EPA-600/9-78-010, pp. 107-108.
- USEPA. 1978b. Bioassay procedures for the ocean disposal permit program. Environmental Research Laboratory, Gulf Breeze, Florida. EPA-600/9-78-010.
- USEPA. 1978c. Chronic toxicity of chlordane, Trifluralin, and pentachlorophenol to sheepshead minnows (*Cyprinodon variegatus*). P.R. Parrish, E.E. Dyar, J.M. Enos, and W.G. Wilson. Environmental Research Laboratory, U.S. Environmental Protection Agency, Gulf Breeze, FL 32561. EPA-600/3-78-010.
- USEPA. 1978d. Life-cycle toxicity test using sheepshead minnows (*Cyprinodon variegatus*). D.J. Hansen, P.R. Parish, S.C. Schimmel, and L.R. Goodman. In: Bioassay procedures for the ocean disposal permit program, U.S. Environmental Protection Agency, Environmental Research Laboratory, Gulf Breeze, FL. EPA 600/9-78-010, pp. 109-117.
- USEPA. 1985. Distribution, life cycle, taxonomy, and culture methods. Silversides (*Menidia*). D.J. Middaugh. In: W.H. Peltier and C.I. Weber, eds. *Methods for measuring the acute toxicity of effluents to freshwater and marine organisms.* Environmental Monitoring and Support Laboratory, U.S. Environmental Protection Agency, Cincinnati, OH. EPA 600/4-85/013. pp. 126-137.
- USEPA. 1987a. Guidance manual for conducting complex effluent and receiving water larval fish growth-survival studies with the sheepshead minnow (*Cyprinodon variegatus*). M.M. Hughes, M.A. Heber, S.C. Schimmel, and W.J. Berry. Contribution No. 104. In: Schimmel, S.C., ed. *Users guide to the conduct and interpretation of complex effluent toxicity tests at estuarine/marine sites.* Contribution No. 796. Environmental Research Laboratory, U.S. Environmental Protection Agency, Narragansett, RI.
- USEPA. 1987b. Methods for spawning, culturing and conducting toxicity-tests with early life stages of four atherinid fishes: the inland silverside, *Menidia beryllina*, Atlantic silverside, *M. menidia*, tidewater silverside, *M. peninsulae*, and California grunion, *Leuresthes tenuis*. D.P. Middaugh, M.J. Hemmer, and L.R. Goodman. Office of Research and Development, U.S. Environmental Protection Agency, Washington, D.C. 20460. EPA-600/8-87-004.

- USEPA. 1988. Short-term methods for estimating the chronic toxicity of effluents and receiving water to marine and estuarine organisms. C.I. Weber, W.B. Horning, II, D.J. Klemm, T.W. Neiheisel, P.A. Lewis, E.L. Robinson, J. Menkedick, and F. Kessler. eds. Environmental Monitoring and Support Laboratory, U.S. Environmental Protection Agency, Cincinnati, OH 45268. EPA-600/4-87-028.
- USEPA. 1990. Sheepshead minnow and inland silverside larval survival and growth toxicity tests. Supplemental report for training videotape. Office of Research and Development, U. S. Environmental Protection Agency, Washington, D.C. EPA-600/3-90/075.
- Usher, R.R. and Bengtson, D.A. 1981. Survival and growth of sheepshead minnow larvae and juveniles on diet of *Artemia nauplii*. Prog. Fish-Cult. 43(2):102-105.
- Ward, G.S. and Parrish, P.R. 1980. Evaluation of early life-stage toxicity tests with embryos and juveniles of sheepshead minnows (*Cyprinodon variegatus*). In: Aquatic toxicology, ASTM STP 707. J.G. Eaton, P.R. Parrish, and A.C. Hendricks, Eds. American Society of Testing and Materials, Philadelphia, PA. pp. 243-247.

APPENDIX A

DISTRIBUTION, LIFE CYCLE, TAXONOMY, AND CULTURE METHODS

A.8 SILVERSIDES: INLAND SILVERSIDE (*MENIDIA BERYLLINA*) ATLANTIC SILVERSIDE (*M. MENIDIA*), AND TIDEWATER SILVERSIDE (*M. PENINSULAE*)

1. MORPHOLOGY AND TAXONOMY

1.1 Adult Atlantic silversides attain a total length of up to 117 mm (Figure 1A and 1B). Females in general are slightly larger than males. The first dorsal fin has three to seven, usually four or five spines. The second dorsal fin has one spine and eight or nine rays; the anal fin has one spine and 19 to 29, usually 21 to 26, rays; and the pectoral fin has 12 to 16, usually 14 or 15, rays (Robbins, 1969). Atlantic silverside embryos are easily distinguished from those of the closely related inland silverside, *Menidia beryllina*. The former have a bundle of elastic filaments attached to the chorion at one small area of insertion (Figure 1C and 1D). These filaments, typically longer than the diameter of the egg, are all the same diameter. In contrast, inland silverside eggs possess one or two thick, elongated filaments, up to 50 mm long and four to nine shorter, thinner filaments (Figures 1E and 1F).

2. GENERAL LIFE HISTORY

2.1 DISTRIBUTION

2.1.1 Silversides occur in estuaries along the Atlantic, Gulf, and Pacific coasts (Figures 2-4). The Atlantic silverside, *Menidia menidia*, is a resident of estuaries from Maine to northern Florida. It occurs at intermediate to high salinities, typically of 12 to 30 parts per thousand (ppt), and remains in Atlantic estuaries throughout most of the year (De Sylva et al., 1962; Dahlberg, 1972). Recent evidence indicates an offshore migration at northern latitudes in the fall and reappearance of adults in estuaries in late spring (Conover and Kynard, 1984). This species is an important component in estuarine ecosystems, serving as forage fish for commercially and recreationally valued species such as striped bass, bluefish and spotted seatrout (Merriman, 1941; Bayliff, 1950; Middaugh, 1981).

2.1.2 Although the culturing methods described in this section were written primarily for *Menidia menidia*, they are also suitable for the inland silverside, *M. beryllina*, and the tidewater silverside, *M. peninsulae* (USEPA, 1987). The staff of the Environmental Research Laboratory, Gulf Breeze, Florida, have developed procedures for spawning, culturing, and testing of other fishes, including the California grunion, *Leuresthes tenuis*, and the topsmelt, *Atherinops affinis*. The availability of these fishes as test organisms will permit the use of indigenous fish in toxicity tests of wastes discharged along the entire coast line of the contiguous United States and Alaska.

2.2 SPAWNING BEHAVIOR

2.2.1 The Atlantic silverside spawns during spring and summer. Spawning runs generally occur during April - June or July at northern latitudes, and March through July or August at southern latitudes (Bayliff, 1950; Hildebrand and Schroeder, 1928; Middaugh and Lempesis, 1976). Spawning occurs in the upper intertidal zone during daytime high tides (Middaugh, 1981). Eggs are deposited on a variety of substrates which provide protection from thermal stress and desiccation (Middaugh et al., 1981; Conover and Kynard, 1981). Females typically release 200 to 800 eggs, 1.0-1.2 mm diameter, as they spawn. Individuals may spawn up to five or six times, at two week intervals, during the reproductive season. The life span is generally 12-15 months, although year class-2 fish are occasionally found (Beck, 1979).

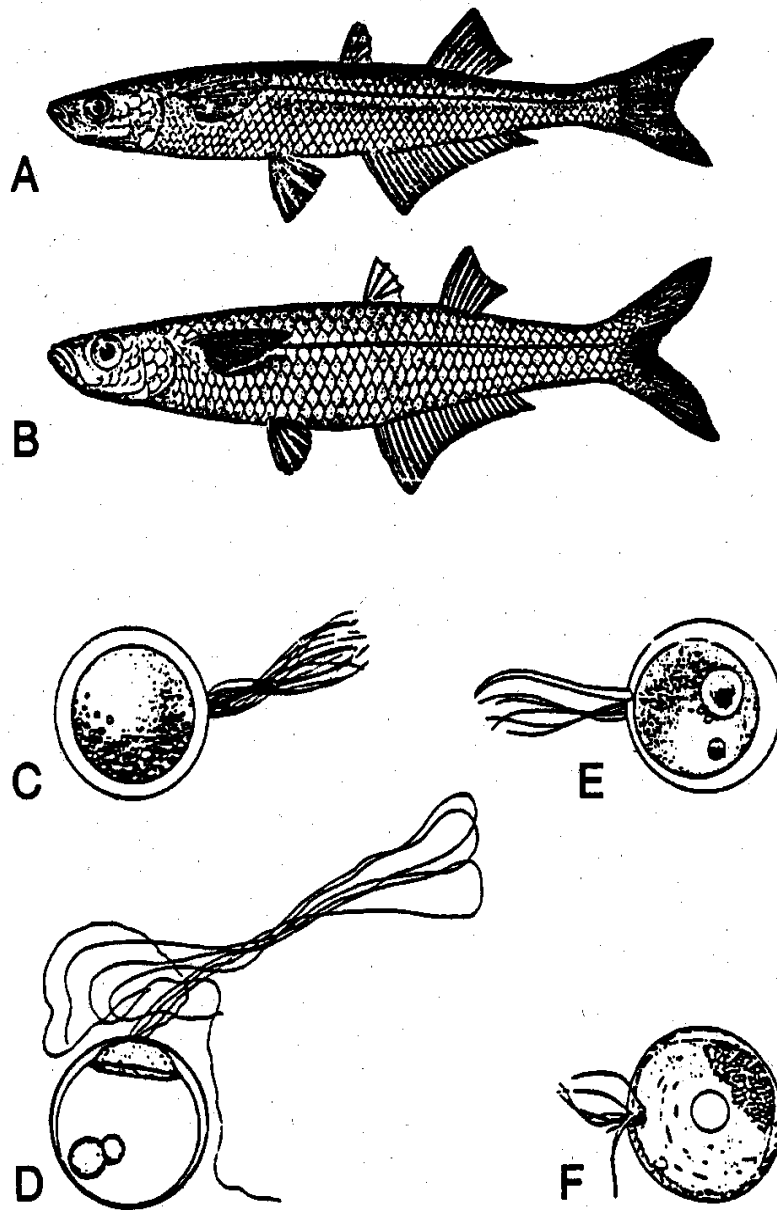

Figure 1. Silverside (*Menidia*): A-D, *M. menidia*, (Atlantic silverside); A, adult; ca. 95 mm SL (Massachusetts); B, adult, ca 102 mm SL (Florida); C, unfertilized egg (diagrammatic); D, developing embryo (note that filaments are all equal in diameter); E-F, *M. beryllina* (inland silverside); E, unfertilized egg (diagrammatic); F, developing embryo (note one thick filament and several thin filaments). (A, B from Kendall, 1902; C from Wang, 1974; D from Ryder, 1883; E from Wang, 1974; F from Hildebrand, 1922.)

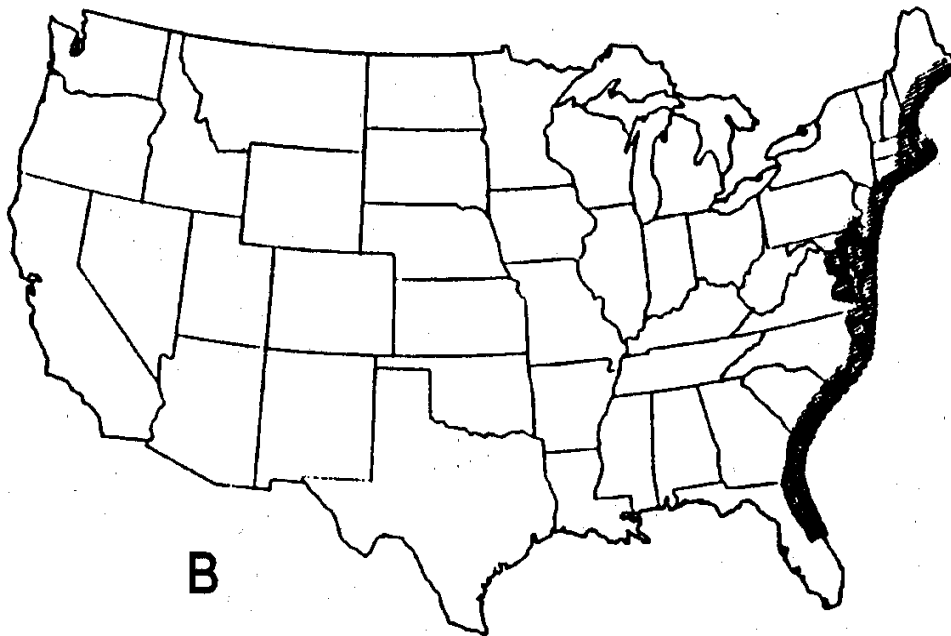
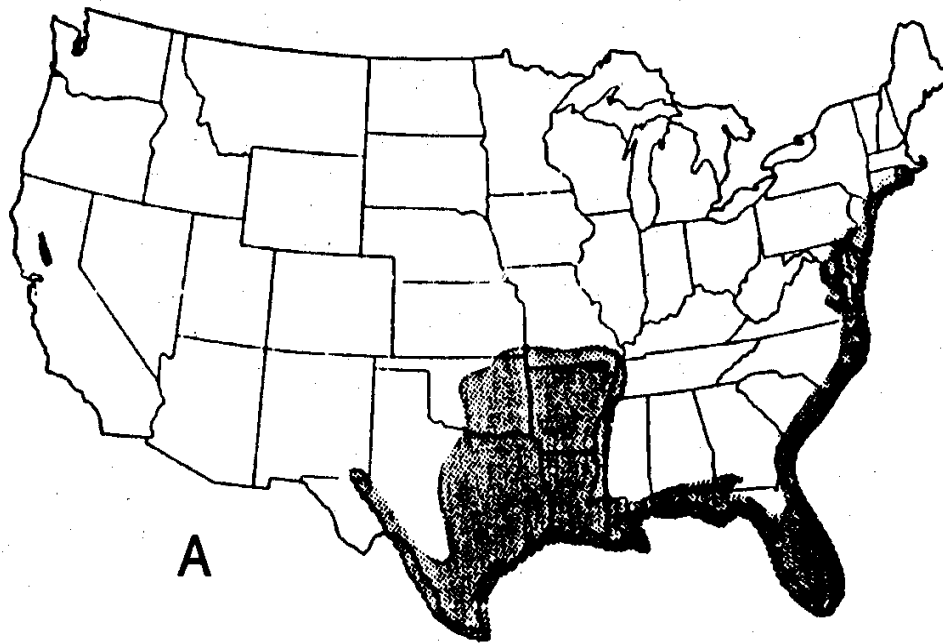
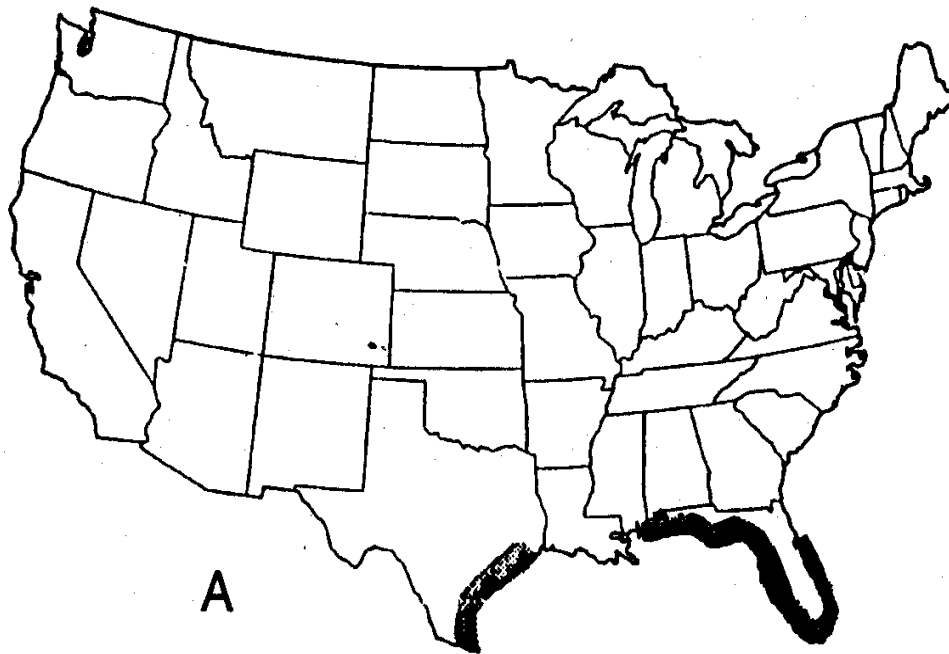
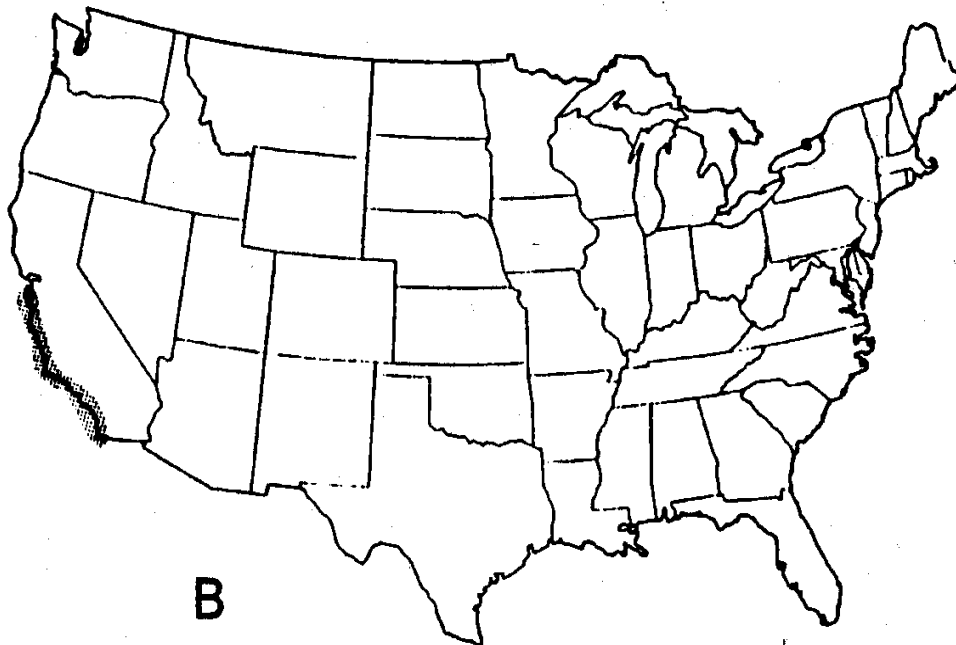

Figure 2. Biographical Distribution: A, inland silverside, *Menidia beryllina*; B, Atlantic silverside, *M. menidia*. (From USEPA, 1987).



A



B

Figure 3. Biogeographical Distribution: A, tidewater silverside, *Menidia peninsulae*; B, California grunion, *Leuresthes tenuis*. (From USEPA, 1987).

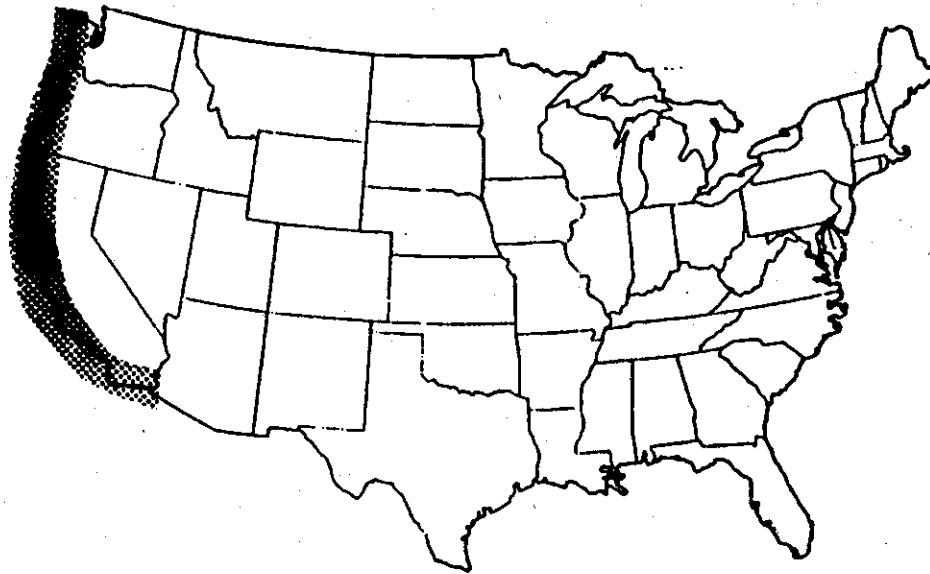

Figure 4. Biogeographical Distribution: Topsmelt, *Atherinops affinis*. (From USEPA, 1987).

3. CULTURING METHODS

3.1 SOURCES OF ORGANISMS

3.1.1 *Menidia* may be obtained from commercial biological supply houses or collected in the field.

3.1.1.1 The optimal time for collecting ripe *M. menidia* in the field is just prior to daytime high tides between 8:00 AM and Noon (usually one to four days after the occurrence of a new or full moon), when prespawning schools move into the upper intertidal zone (Middaugh, 1981; Middaugh et al., 1981). Since the Atlantic silverside prefers relatively high salinities, it is recommended that collections be made in areas with salinities of 20‰ or greater. Sandy beaches, bordering open but protected estuarine bays, are suitable for collecting adults. A 1 x 10 m bag seine with knotless 5 mm mesh is ideal for collecting. Since Atlantic silversides typically reside in shallow water, 1.5 m deep, they are easily captured by seining close to shore. It is important to avoid total beaching of the bag seine when collecting *M. menidia*. These fragile fish will quickly die if removed from water and, more importantly, ripe females often abort their eggs if stranded. Ideally, the bag portion of the seine, containing captured adults, should remain in water 5-15 cm deep (Middaugh and Lempesis, 1976).

3.1.1.2 It is possible to transport the spawn (fertilized eggs) or adults to the laboratory. The following procedure is recommended for stripping, fertilizing and transporting eggs from the field to the laboratory:

1. Immediately after seining (while still on the beach) three to five ripe females should be dipped into a bucket of seawater to remove sand and detritus.
2. Eggs are stripped into a glass culture dish containing seawater or onto a nylon screen (0.45-1.0 mm mesh) (Figure 5), which is then gently lowered into a culture dish of seawater with the eggs on the upper surface of the screen (Barkman and Beck, 1976). If excessive pressure is

required to strip the eggs, the female should be discarded. Mature eggs, 1.0-1.2 mm in diameter, are clear, and have an amber hue.

3. Milt from several males can then be stripped into the culture dish and mixed with the eggs by gently tilting the dish from side to side. Upon contact with seawater, adhesive threads on mature eggs uncoil, making enumeration and separation difficult. If eggs are stripped directly into the culture dish, one end of a nylon string may be dipped into the dish and gently rolled so the embryos adhere (Middaugh and Lempeis, 1976). The Barkman and Beck (1976) technique for attaching the eggs to nylon screening minimizes the natural clumping tendency due to entanglement of the filaments on *M. menidia* eggs.
4. Strings of embryos or embryos on screens may be transported to the laboratory by placing them in an insulated glass container filled with seawater at the approximate temperature and salinity of fertilization. If gravid fish are transported to the laboratory for subsequent spawning, care must be taken to avoid overcrowding of fish in transport containers. Continuous, vigorous aeration is required and any increase in container water temperature should be minimized (Beck, 1979). A mass culture system for incubating the screen-adhered eggs and collecting the hatched larvae in a flowing seawater system (Figure 5) was described in detail by Beck (1979). A similar procedure utilizing a recirculating system was described by Middaugh and Lempeis (1976).

3.2 Laboratory Year-round Spawning

3.2.1 Atlantic, inland, and tidewater silversides may be spawned in the laboratory on a year-round basis. Procedures described by Middaugh and Takita (1983), and Middaugh and Hemmer (1984), provide for maintenance of a brood stock of 30 to 50 fish, sex ratio 1:1, in 1.3 m diameter, circular holding tanks which are part of a recirculating seawater system (Figure 6). The photoperiod should be adjusted to 14 L:10 D (lights on at 5:00 AM and off at 7:00 PM, intensity 10-20 $\mu\text{E}/\text{m}^2/\text{s}$, or 50-100 ft c), with the water temperature maintained at 18-20°C for fish from northern latitudes, and 20-25°C for southern latitudes. Suitable salinities for the culture units would be 25-30 ppt for the Atlantic and tidewater silversides, and 7‰ for the inland silverside. Fish are fed 8 g Tetramin[®] each morning and afternoon, and concentrated *Artemia* nauplii (hatch obtained from approximately 15 mL of eggs after 48 h of incubation at 25°C) in mid-afternoon (see section on *Artemia* culture). Excess food should be siphoned from the holding tanks weekly. Filter media (activated charcoal) located in a reservoir tray should be changed weekly, immediately after cleaning the holding tanks. To induce spawning by the Atlantic silverside, the circulation current velocity in the holding tanks should be reduced to zero (from 8 to 0 cm/sec) twice daily by turning off the seawater circulation pump from midnight to 1:00 AM, and from Noon to 1:00 PM. Atlantic silversides will spawn in response to interrupted current velocities during daytime (Noon to 1:00 PM). Spawning of the tidewater silverside also is enhanced by reducing the current velocity twice daily, but spawns primarily during nighttime. No interruption in current is necessary to enhance spawning by the inland silverside.

3.2.2 A suitable spawning substrate can be made by cutting enough 25 cm lengths of No. 18 nylon string to form a small bundle, and tying a string around the middle of the bundle to form a "mop." The mop is suspended just below the surface of the water, in contact with the side of the holding tanks. Spawning fish will deposit eggs on this substrate. The mops are removed from the holding tanks daily and suspended in incubation vessels. Typical egg production ranges from 300 to 1200 per spawn. Fish generally can be expected to spawn three to four days each week.

3.2.3 It is essential that light-tight curtains surround the holding tanks. These curtains should remain closed except during periodic feedings, tanks cleaning, and during removal and replacement of spawning substrates.

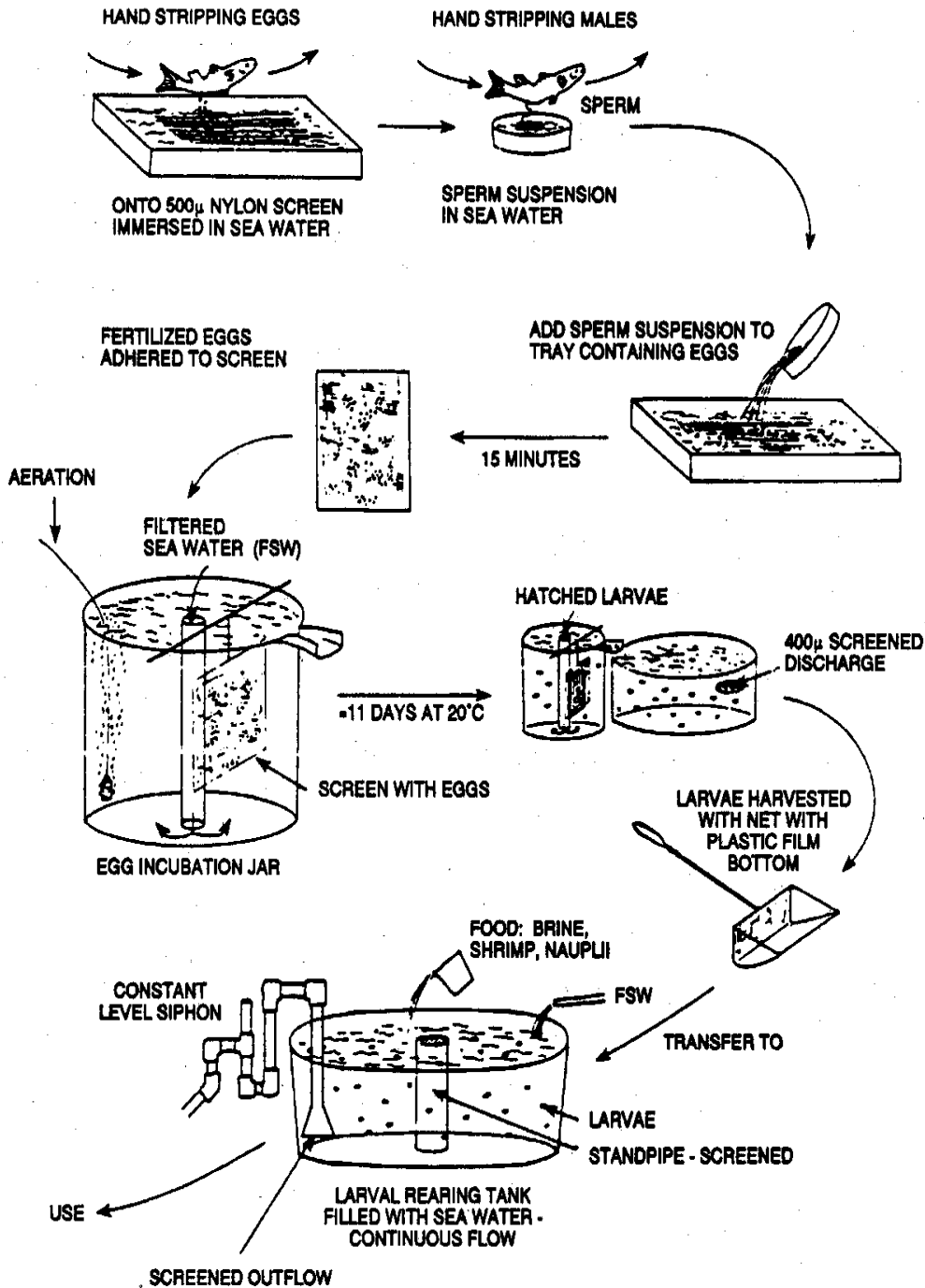

Figure 5. Techniques for collection of silverside eggs in the field, and production of larvae in the laboratory (From Beck, 1979).

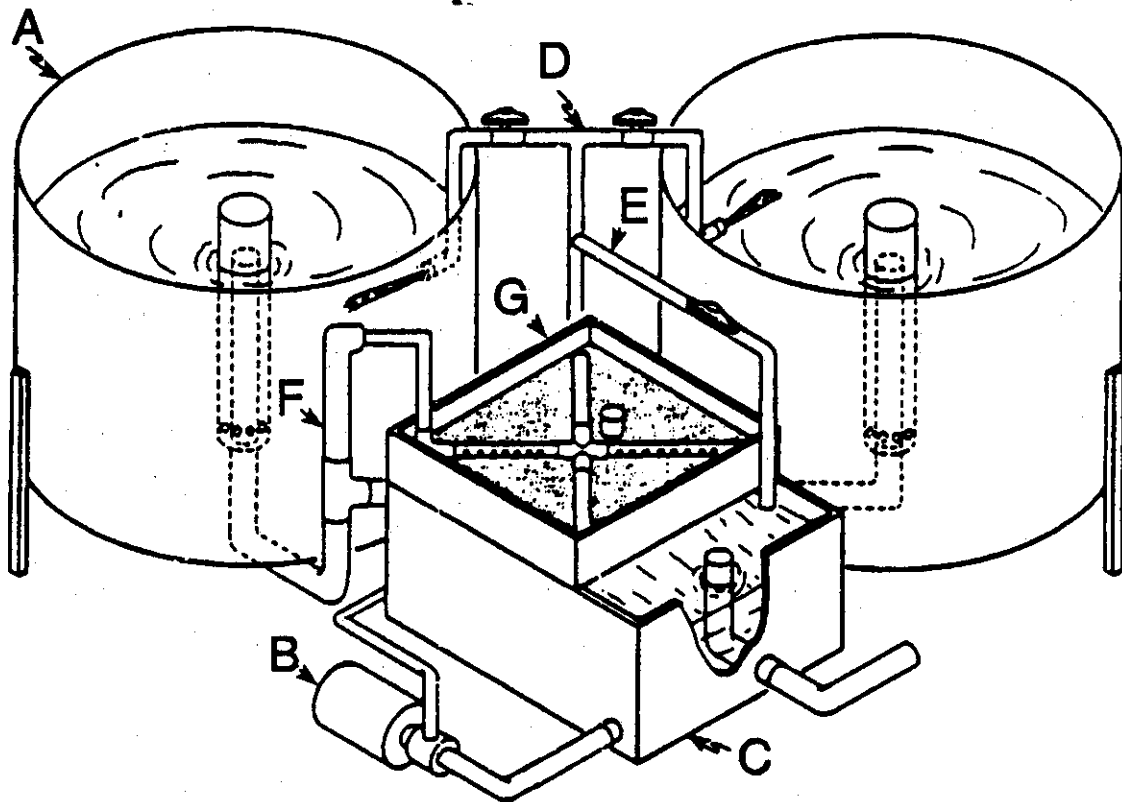

Figure 6. Holding and spawning system utilized in the culture of silversides (*Menidia*). A, 1.3 m diameter tanks; B, circulation pump; C, reservoir; D, seawater distribution system; E, by-pass line; F, seawater return line; and G, reservoir filter system. (From Middaugh and Hemmer, 1984).

3.2.4 Embryos attached to nylon screening or nylon string may be suspended in a culture system such as shown in Figure 6. The culture chambers for embryos should be constructed of glass. Upon hatching, larvae may be transferred from the collection container to a 90 cm diameter glass or fiberglass tank with a volume of 350 L. Tanks receive a continuous flow of seawater at 2 L/min. Water is introduced at the tank periphery causing a gentle current sufficient to induce orientation to water movement and normal schooling behavior. Water is discharged from the tank by two automatic siphons. Siphon openings are protected by a 400 μ m nylon screen to prevent escape of larvae. An inverted funnel is used at the siphon to decrease the velocity of discharge water, thus preventing impingement of larvae.

3.2.5 Embryos can also be incubated in small (4-10 L) glass aquaria, by placing the nylon screening or strings just below the surface of the water. Gentle aeration should be provided by an airstone positioned near the bottom of the holding aquaria.

3.3 CULTURE MEDIA

3.3.1 Use natural seawater if it is available and unpolluted. Otherwise use synthetic seawater prepared by adding artificial marine salts, such as FORTY FATHOMS[®], to deionized water. If synthetic seawater is used, it should be aged for a least one week before being utilized in culture aquaria.

3.4 CULTURE CONDITIONS

3.4.1 The salinity maintained during incubation should be similar to that of the water from which the adults were taken, if collected in the field, or at which the adults are being maintained in the laboratory, if the embryos originate from laboratory brood stock. Water temperature should be maintained at 20 to 25 °C depending upon the latitude where fish are collected. Provide a photoperiod of 12-14 h of illumination daily at 10-20 $\mu\text{E}/\text{m}^2/\text{s}$, or 50-100 ft-c (12 h minimum light/24 h). Embryos will hatch in seven to 14 days, depending upon the incubation temperature and salinity (Middaugh and Lempesis, 1976).

3.5 FEEDING AND STOCKING DENSITY

3.5.1 Upon hatching, *Menidia* larvae should be fed immediately. Newly hatched brine shrimp (*Artemia*) nauplii (less than eight hours old) are fed to the larvae twice daily. It is essential to feed *M. menidia* and *M. peninsulae* larvae newly-hatched brine shrimp nauplii (USEPA, 1987). Utilization of older, larger, brine shrimp nauplii will result in starvation of the larvae since they are unable to ingest the larger food organisms. Three to four days after hatching, the fish are able to consume older (larger) brine shrimp nauplii. Because of their small size *M. beryllina* larvae must be fed a mixohaline rotifer, *Branchionus plicatilis* from day of hatch through day five. Thereafter, they are able to consume newly-hatched and older *Artemia* nauplii (USEPA, 1987; USEPA 1988). Methods for culturing brine shrimp are discussed in the Appendix. A stocking density of about 300 larvae is suitable in an 76 L aquarium.

3.6 CULTURE MAINTENANCE

3.6.1 To avoid excessive build up of algal growths, periodically scrape the walls of aquaria. Activated charcoal in the aquarium filtration systems should be changed weekly and detritus (dead brine shrimp nauplii or cysts) siphoned from the bottom of holding aquaria each week. Salinity may be maintained at the proper level by addition of distilled or deionized water to compensate for evaporation.

4. TEST ORGANISMS

4.1 Fish one to 14 days old are used in acute toxicity tests. Most of the water in the holding aquarium should be siphoned off before removal of larvae. Larvae can then be siphoned from the holding tanks into a holding vessel. It is essential that larvae not be handled with a dip net, because it will result in very high mortality. A large-bore, fire-polished glass tube, 6 mm I.D. x 500 mm long (1/4 in. ID x 18 in. long), equipped with a rubber squeeze bulb should be used to transfer the larvae from the holding vessel to the test vessels. It is more convenient to first transfer five fish to each of several small beakers containing 20 mL of saline dilution water. The appropriate number of fish (multiples of five) can then be added to test vessels.

SELECTED REFERENCES

- Anderson, B.S., D.P. Middaugh, J.W. Hunt, and S.L. Turpen. 1991. Copper toxicity to sperm, embryos, and larvae of topsmelt, *Antherinops affinis*, with notes on induced spawning. *Mar. Environ. Res.* 31:17-35.
- Anderson, W.D., J.K. Dias, R.K. Dias, D.M. Cupka, and N.A. Chamberlain. 1977. The macrofauna of the surf zone off Folly Beach, S. Carolina. NOAA Tech. Rept. NMFS SSRF-704. 23 pp.
- ASTM. 1993. Standard practice for using brine shrimp nauplii as food for test animals in aquatic toxicology. Designation: E 1203-87, Annual Book of ASTM Standards, Vol. 11.04, American Society for Testing and Materials, Philadelphia, PA.
- Barkman, R.C. and A.D. Beck. 1976. Incubating eggs of the Atlantic silverside on nylon screen. *Prog. Fish-Cult.* 38:148-150.
- Bayliff, W.H. 1950. The life history of the silverside, *Menidia menidia* (Linnaeus). *Contr. Chesapeake Biol. Lab., Publ.* 90:1-27.
- Beck, A.D. 1979. Laboratory culture and feeding of the Atlantic silverside, *Menidia menidia*. Conference on aquaculture and cultivation of fish fry and its live food. Polish Hydrobiological Soc. Syzmbark, Poland, September, 1977. *Spec. Publ. No. 4, European Mar. Soc.* pp. 63-85.
- Bengtson, D.A. 1985. Laboratory experiments on mechanisms of competition and resource partitioning between *Menidia menidia* (L.) and *Menidia beryllina* (Cope) (Osteichthyes: Atherinidae). *J. Exp. Mar. Biol. Ecol.* 92(1):1-18.
- Bigelow, H.B. and W.C. Schroeder. 1953. Fishes of the Gulf of Maine. U.S. Fish Wildl. Serv. Fish. Bull. 53:1-577.
- Briggs, P.T. 1975. Shore-zone fishes in the vicinity of Fire Island Inlet, Great South Bay, New York. *N.Y. Fish Game.* 22:1-12.
- Chernoff, B., J.V. Conner, and C.F. Bryan. 1981. Systematics of the *Menidia beryllina* complex (Pisces:Atherinidae) from the Gulf of Mexico and its tributaries. *Copeia.* 2:319-335.
- Chesmore, A.P., D.J. Brown, and R.D. Anderson. 1973. A study of the marine resources of Essex Bay. *Mass. Div. Mar. Fish. Monogr. Ser. No. 13.* 38 pp.
- Clark, F.N. 1925. The life history of *Leuresthes tenuis*, an atherine fish with tide controlled spawning habits. *Calif. Fish. Game Comm. Bull.* 10:1-51.
- Conover, D.O. 1979. Density, growth, production and fecundity of the Atlantic silverside, *Menidia menidia* (Linnaeus), in a central New England estuary. M.S. Thesis, Univ. Massachusetts, Amherst. 59 pp.
- Conover, D.O. 1984. Adaptive significance of temperature-dependent sex determination in a fish. *Am. Nat.* 123(3):297-313.
- Conover, D.O. and B.E. Kynard. 1981. Environmental sex determination: Interaction of temperature and genotype in a fish. *Science.* 213:577-579.
- Conover, D.O. and B.E. Kynard. 1984. Field and laboratory observations of spawning periodicity and behavior of a northern population of the Atlantic silverside, *Menidia menidia* (Pisces: Atherinidae). *Environm. Biol. Fish.* 11(3):161-171.

- Conover, D.O. and S. Murawski. 1982. Offshore winter migration of the Atlantic silversides, *Menidia*. Fish. Bull. 80:145-149.
- Dahlberg, M.D. 1972. An ecological study of Georgia coastal fishes. U.S. Fish Wildl. Serv. Fish. Bull. 70(2):323-353.
- DeSylva, D.P., F.A. Kalber, Jr., and C.N. Schuster. 1962. Fishes and ecological conditions in the shore zone of the Delaware River Estuary, with notes on other species collected in deeper water. Univ. Delaware Mar. Labs., Information Serv., Publ. No. 5., 164 pp.
- Elston, R. and B. Bachen. 1976. Diel feeding cycle and some effects of light on feeding intensity of the Mississippi silverside, *Menidia audens*, in Clear Lakes, California. Trans. Amer. Fish. Soc. 105:84-88.
- Gettor, C.D. 1981. Ecology and survival of the key silverside, *Menidia conchorum*, an atherinid fish endemic to the Florida keys. Ph.D. Thesis, University of Miami, Coral Gables, FL. 128 pp.
- Goodman, L.R., D.J. Hansen, D.M. Cripe, D.P. Middaugh, and J.C. Moore. 1985. A new early life-stage toxicity test using the California grunion, *Leuresthes tenuis*, and results with chlorpyrifos. Ecotoxicol. Environ. Safety 10:12-21.
- Goodman, L.R., M.J. Hemmer, D.P. Middaugh, and J.C. Moore. 1992. Effects of fenvalerate on the early life-stages of topsmelt (*Atherinops affinis*). Environ. Toxicol. 11(3):409-414.
- Goodman, L.R., D.P. Middaugh, D.J. Hansen, P.K. Higdon, and G.M. Cripe. 1983. Early life-stage toxicity test with tidewater silversides (*Menidia peninsulae*) and chlorine-produced oxidants. Environ. Toxicol. Chem. 2:337-342.
- Gosline, W.A. 1948. Speciation in the fishes of the genus *Menidia*. Evol. 2:306-313.
- Hemmer, M.J., D.P. Middaugh, and V. Comparetta. 1992. Comparative acute sensitivity of larval topsmelt, *Atherinops affinis*, and inland silversides, *Menidia beryllina*, to eleven chemicals. Environ. Toxicol. Chem. 11(3):401-408.
- Hildebrand, A.E. 1922. Notes on habits and development of eggs and larvae of the silversides *Menidia menidia* and *Menidia beryllina*. Bull. U. S. Bur. Fish. 38:113-120.
- Hildebrand, S.F. and W.C. Schroeder. 1928. Fishes of Chesapeake Bay. Bull. U.S. Bur. Fish. 43(1):366 pp.
- Hillman, R.E., N.W. Davis, and J. Wennemer. 1977. Abundance, diversity and stability in shore zone fish communities in an area of Long Island Sound affected by the thermal discharge of a nuclear power station. Estuarine Coastal Mar. Sci. 5:355-381.
- Hubbs, C. 1982. Life history dynamics of *Menidia beryllina* from Lake Texoma. Am. Midl. Nat. 107(1):1-12.
- Johnson, M.S. 1975. Biochemical systematics of the atherinid genus *Menidia*. Copeia. 1975:662-691.
- Kendall, W.C. 1902. Notes on the silversides of the genus *Menidia* of the east coast of the United States, with descriptions of two new subspecies. Rept. U.S. Comm. Fish and Fisheries of 1901, pp. 241-267.
- Koltes, K.H. 1984. Temporal patterns in three-dimensional structure and activity of schools of the Atlantic silverside *Menidia*. Mar. Biol. 78:113-122.

- Koltes, K.H. 1985. Effects of sublethal copper concentrations on the structure and activity of Atlantic Silverside schools. *Trans. Am. Fish. Soc.* 14:413-422.
- Loosanoff, V.L. 1937. The spawning run of the Pacific surf smelt, *Hypomesus pretiosus* (Girard). *Intern. Rev. ges. Hydrobiol. Hydrogr.* 36:170-183.
- Martin, F.D. and G.B. Drewry. 1978. Development of fishes of the mid-Atlantic bight. An atlas of egg, larval and juvenile stages. Volume VI, Stromateidae through Ogcocephalidae. Biological Services Program, Fish and Wildlife Service, U.S. Department Interior. FWS/OBS-78-12.
- McMullen, D.M. and D.P. Middaugh. 1985. The effect of temperature and food density on survival and growth of *Menidia peninsulae* larvae (Pisces: Atherinidae). *Estuaries.* 8(1):39-47.
- McMullen, D.M. 1982. The effect of temperature and food density on growth and survival of larval *Menidia peninsulae*. M.S. Thesis, Univ. West Florida. 33 pp.
- Merriman, D. 1941. Studies of the striped bass (*Roccus saxatilis*) of the Atlantic coast. U.S. Fish Wildl. Serv. Fish Bull. 35:1-77.
- Middaugh, D.P. 1981. Reproductive ecology and spawning periodicity of the Atlantic silverside, *Menidia* (Pisces: Atherinidae). *Copeia.* 4:766-776.
- Middaugh, D.P., B.S. Anderson, and M.J. Hemmer. 1992. Laboratory spawning of topsmelt, *Atherinops affinis*, with notes on culture and growth of larvae. *Environ. Toxicol. Chem.* 11(3):393-399.
- Middaugh, D.P., R.G. Domey, and G.I. Scott. 1984. Reproductive rhythmicity of the Atlantic silverside. *Trans. Amer. Fish. Soc.* 113:472-478.
- Middaugh, D.P. and M.J. Hemmer. 1984. Spawning of the tidewater silverside, *Menidia peninsulae* (Goode and Bean) in response to tidal and lighting schedules in the laboratory. *Estuaries.* 7(2):139-148.
- Middaugh, D.P., M.J. Hemmer, and Y. Lamadrid-Rose. 1986. Laboratory spawning cues in *Menidia beryllina* and *M. peninsulae* (Pisces: Atherinidae) with notes on survival and growth of larvae at different salinities. *Environ. Biol. Fishes.* 15(2):107-117.
- Middaugh, D.P., H.W. Kohn III, and L.E. Burnett. 1983. Concurrent measurement of intertidal environmental variables and embryo survival for the California grunion, *Leuresthes tenuis*, and Atlantic silverside, *Menidia menidia* (Pisces:Atherinidae). *Calif. Fish and Game.* 69(2):89-96.
- Middaugh, D.P. and P.W. Lempeis. 1976. Laboratory spawning and rearing of a marine fish, the silverside, *Menidia menidia*. *Mar. Biol.* 35:295-300.
- Middaugh, D.P., G.I. Scott, and J.M. Dean. 1981. Reproductive behavior of the Atlantic silverside, *Menidia menidia* (Pisces, Atherinidae). *Environ. Biol. Fish.* 6(3/4):269-276.
- Middaugh, D.P. and J.M. Shenker. 1988. Salinity tolerance of young topsmelt, *Atherinops affinis*, cultured in the laboratory. *Calif. Fish Game.* 74:231-235.
- Middaugh, D.P., J.M. Shenker, M.J. Hemmer, and T. Takita. 1989. Laboratory culture of embryonic and larval jacksmelt, *Atherinopsis californiensis*, and topsmelt, *Atherinops affinis*, with notes on identification of each species. *Calif. Fish Game.* 76:4-12.

- Middaugh, D.P. and T. Takita. 1983. Tidal and diurnal spawning cues in the Atlantic silverside, *Menidia menidia*. Environ. Biol. Fish. 8(2):97-104.
- Moore, C.J. 1980. Spawning of *Menidia menidia* (Pisces:Atherinidae). Copeia. 1980:886-887.
- Mulkana, M.S. 1966. The growth and feeding habits of juvenile fishes in two Rhode Island estuaries. Gulf Res. Rep. 2:97-168.
- Penttila, D. 1977. Studies of the surf smelt (*Hypomesus pretiosus*) in Puget Sound. State of Washington, Dept. Fish., Techn. Rept. No. 42. pp. 47.
- Richards, C.E. and M. Castagna. 1970. Marine fishes of Virginia's eastern shore (inlet and marsh, seaside waters). Chesapeake Sci. 11:235-248.
- Robbins, T.W. 1969. A systematic study of the silverside *Membras Ronaparte* and *Menidia* (Linnaeus) (Atherinidae, Teleostei). Ph.D. Dissertation, Cornell University. 282 pp.
- Rubinoff, I. 1958. Raising the atherinid fish, *Menidia menidia*, in the laboratory. Copeia, 1958(2):146-147.
- Rubinoff, I. and E. Shaw. 1960. Hybridization in two sympatric species of atherinid fishes, *Menidia menidia* (Linnaeus) and *Menidia beryllina* (Cope). Amer. Mus. Nov. 1999:1-13.
- Ryder, J.A. 1883. On the thread-bearing eggs of the silverside, *Menidia*. Bull. U.S. Fish Comm. 3:193-196.
- Stoeckel, J.N. and R.C. Heidinger. 1988. Overwintering of the inland silverside in southern Illinois. North Amer. J. Fish. Manage. 8:127-131.
- Thomson, D.A. and K.A. Muench. 1976. Influence of tides and waves on the spawning behavior of the Gulf of California grunion, *Leuresthes sardina* (Jenkins and Evermann). Southern Calif. Acad. Sci. Bull. 75:198-203.
- Thompson, W.F. and J.B. Thompson. 1919. The spawning of the grunion. Calif. Fish and Game Comm. Bull. 3:1-29.
- USEPA. 1981. Nutritional requirements of marine larval and juvenile fish. Environmental Research Laboratory, K.L. Simpson, P.S. Schauer, C.R. Seidel, and L.M. Richardson. U.S. Environmental Protection Agency, Narragansett, Rhode Island. EPA-600/S3-81/049.
- USEPA. 1987. Methods for spawning, culturing and conducting toxicity-tests with early life stages of four atherinid fishes: the inland silverside, *Menidia beryllina*, Atlantic silverside, *M. menidia*, tidewater silverside, *M. peninsulae*, and California grunion, *Leuresthes tenuis*. D.P. Middaugh, M.J. Hemmer, and L.R. Goodman. Office of Research and Development, U.S. Environmental Protection Agency, Washington, D.C. 20460. EPA-600/8-87-004.
- USEPA. 1988. Short-term methods for estimating the chronic toxicity of effluents and receiving waters to marine and estuarine organisms. C.I. Weber, W.B. Horning, II, D.J. Klemm, T.W. Neiheisel, P.A. Lewis, E.L. Robinson, J. Menkedick, and F. Kessler. Environmental Monitoring and Support Laboratory, U.S. Environmental Protection Agency, Cincinnati, Ohio 45268. EPA-600/4-87/028.
- USEPA. 1990. Sheepshead minnow and inland silverside larval survival and growth toxicity tests. Supplemental report for training videotape. Office of Research and Development, U. S. Environmental Protection Agency, Washington, DC. EPA-600/3-90/075.

- Walker, B.W. 1949. Periodicity of spawning by the grunion, *Leuresthes tenuis*, an atherine fish. Ph.D. Dissertation, Univ. California, Los Angeles. 166 pp.
- Walker, B.W. 1952. A guide to the grunion. Calif. Fish and Game 38:409-420.
- Wang, J.C. 1974. Antherinidae - silversides. In: Lippson, A.J., and R.L. Moran, Manual for identification of early developmental stages of fishes of the Potomac River estuary. pp. 143-151. Power Plant Siting Program, Maryland Dept. Nat. Resour., Baltimore, Maryland. PPSP-MP-13. 282 pp.
- Wexler, M. 1983. The fish that spawns on land. Nat. Wildl. 21(3):33-36.
- Wurtzbaugh, W. and H. Li. 1985. Diel migration of a zooplanktivorous fish (*Menidia beryllina*) in relation to the distribution of its prey in a large eutrophic lake. Limnol. Oceanogr. 30(3):565-576.
- Yan, H-Y. 1984. Occurrence of spermatozoa and eggs in the gonad of a tidewater silverside, *Menidia beryllina*. Copeia. 2:544-545.

APPENDIX B

SUPPLEMENTAL LIST OF ACUTE TOXICITY TEST SPECIES

TEST ORGANISM		TEST TEMP (°C)	LIFE STAGE
FRESHWATER SPECIES: VERTEBRATES - WARMWATER			
<i>Cyprinella leedsi</i> ¹	Bannerfin shiner	25	1-14 days
<i>Lepomis macrochirus</i>	Bluegill sunfish	20,25	" "
<i>Ictalurus punctatus</i>	Channel catfish	"	" "
FRESHWATER SPECIES: INVERTEBRATES - COLDWATER			
<i>Pteronarcys spp.</i>	Stoneflies*	12	larvae
<i>Pacifastacus leniusculus</i>	Crayfish*	"	juveniles
<i>Baetis spp.</i>	Mayflies*	"	nymphs
<i>Ephemerella spp.</i>	"	"	"
FRESHWATER SPECIES: INVERTEBRATES - WARMWATER			
<i>Hyaella spp.</i>	Amphipods	20,25	juveniles
<i>Gammarus lacustris</i>	"	"	"
<i>G. fasciatus</i>	"	"	"
<i>G. pseudolimnaeus</i>	"	"	"
<i>Hexagenia limbata</i>	Mayflies	"	nymphs
<i>H. bilineata</i>	"	"	"
<i>Chironomus spp.</i>	Midges	"	larvae

*Stoneflies, crayfish, and mayflies may have to be field collected and acclimated for a period of time to ensure the health of the organisms and that stress from collection is past. Species identification must be verified.

¹ Test conditions for *Cyprinella leedsi* and *Holmesimysis costata* are found in Table 14 and Table 19, respectively, in Section 9.

SUPPLEMENTAL LIST OF ACUTE TOXICITY TEST SPECIES (CONTINUED)

TEST ORGANISM		TEST TEMP (°C)	SALINITY (‰)	LIFE STAGE
MARINE AND ESTUARINE SPECIES: VERTEBRATES - COLDWATER				
<i>Parophrys vetulus</i>	English sole	12	32-34	1-90 days
<i>Citharichys sitigmaeus</i>	Sanddab	"	"	" "
<i>Pseudopleuronectes americanus</i>	Winter flounder	"	"	post metamorphosis
MARINE AND ESTUARINE SPECIES: VERTEBRATES - WARMWATER				
<i>Paralichthys dentatus</i>	Flounder	20,25	32-34	1-90 days
<i>P. lethostigma</i>	"	"	"	" "
<i>Fundulus simillis</i>	Killifish	"	20-32	1-30 days
<i>Fundulus heteroclitus</i>	Mummichog	"	25-32	" "
<i>Lagodon rhomboides</i>	Pinfish	"	20-32	1-90 days
<i>Orthipristis chrysoptera</i>	Pigfish	"	15-30	" "
<i>Leostomus xanthurus</i>	Spot	"	10-30	" "
<i>Gasterosteus aculeatus</i>	Threespine stickleback	"	20-32	1-30 days
<i>Atherinops affinis</i>	Topsmelt	21	10-30	7-15 days
MARINE AND ESTUARINE SPECIES: INVERTEBRATES - COLDWATER				
<i>Pandalus jordani</i>	Oceanic shrimp	12	25-32	juvenile
<i>Strongylocentrotus droebachiensis</i>	Green sea urchin	"	32-34	gametes/embryo
<i>Strongylocentrotus purpuratus</i>	Purple sea urchin	"	"	" "
<i>Dendraster excentricus</i>	Sand dollar	"	"	" "
<i>Cancer magister</i>	Dungeness crab	"	"	juvenile
<i>Holmesimysis costata</i> ²	Mysid	"	"	1-5 days
MARINE AND ESTUARINE SPECIES: INVERTEBRATES - WARMWATER				
<i>Callinectes sapidus</i>	Blue crab	20,25	10-30	juvenile
<i>Palaemonetes pugio</i>	Grass shrimp	"	10-32	1-10 days
<i>P. vulgaris</i>	" "	"	"	" "
<i>P. intermedius</i>	" "	"	"	" "
<i>Penaeus setiferus</i>	White shrimp	"	20-32	post-larval
<i>Penaeus duorarum</i>	Pink shrimp	"	"	" "
<i>Penaeus aztecus</i>	Brown shrimp	"	"	" "
<i>Crangon septemspinosa</i>	Sand shrimp	"	25-32	" "
<i>Mysidopsis almyra</i>	Mysid	"	10-32	1-5 days
<i>Neomysis americana</i>	"	"	"	" "
<i>Metamysidopsis elongata</i>	"	"	"	" "
<i>Crassostrea virginica</i>	American oyster	"	20-32	embryo
<i>Crassostrea gigas</i>	Pacific oyster	"	25-32	"
<i>Arbacia punctulata</i>	Purple sea urchin	"	32-34	gametes/embryo

² Test conditions for *Holmesimysis costata* are found in Table 19.

APPENDIX C

DILUTOR SYSTEMS

Two proportional dilutor systems are illustrated: the solenoid valve system, and the vacuum siphon system.

1. Solenoid and Vacuum Siphon Dilutor Systems

The designs of the solenoid and vacuum siphon dilutor systems incorporate features from devices developed by many other Federal and state programs, and have been shown to be very versatile for on-site bioassays in mobile laboratories, as well as in fixed (central) laboratories. The Solenoid Valve system is fully controlled by solenoids (Figures 1, 2, and 3), and is preferred over the vacuum siphon system. The Vacuum Siphon system (Figures 1, 4, and 5), however, is acceptable. The dilution water, effluent, and pre-mixing chambers for both systems are illustrated in Figures 6, 7, and 8. Both systems employ the same control panel (Figure 9).

If in the range-finding test, the LC50 of the effluent falls in the concentration range, 6.25-100%, pre-mixing is not required. The pre-mixing chamber is bypassed by running a TYGON[®] tube directly from the effluent in-flow pipe to chamber E-2 (see Figures 3 and 5), and Chambers E-1 and D-1 and the pre-mixing chamber are deactivated.

The dilutor systems described here can also be used to conduct tests of the toxicity of pure compounds by equipping the control panel with an auxiliary power receptacle to operate a metering pump to deliver an aliquot of the stock solution of the pure compound directly to the mixing chamber during each cycle. In this case, chamber E-1 is de-activated and chamber D-1 is calibrated to deliver a volume of 2000 mL, which is used to dilute the aliquot to the highest concentration used in the toxicity test.

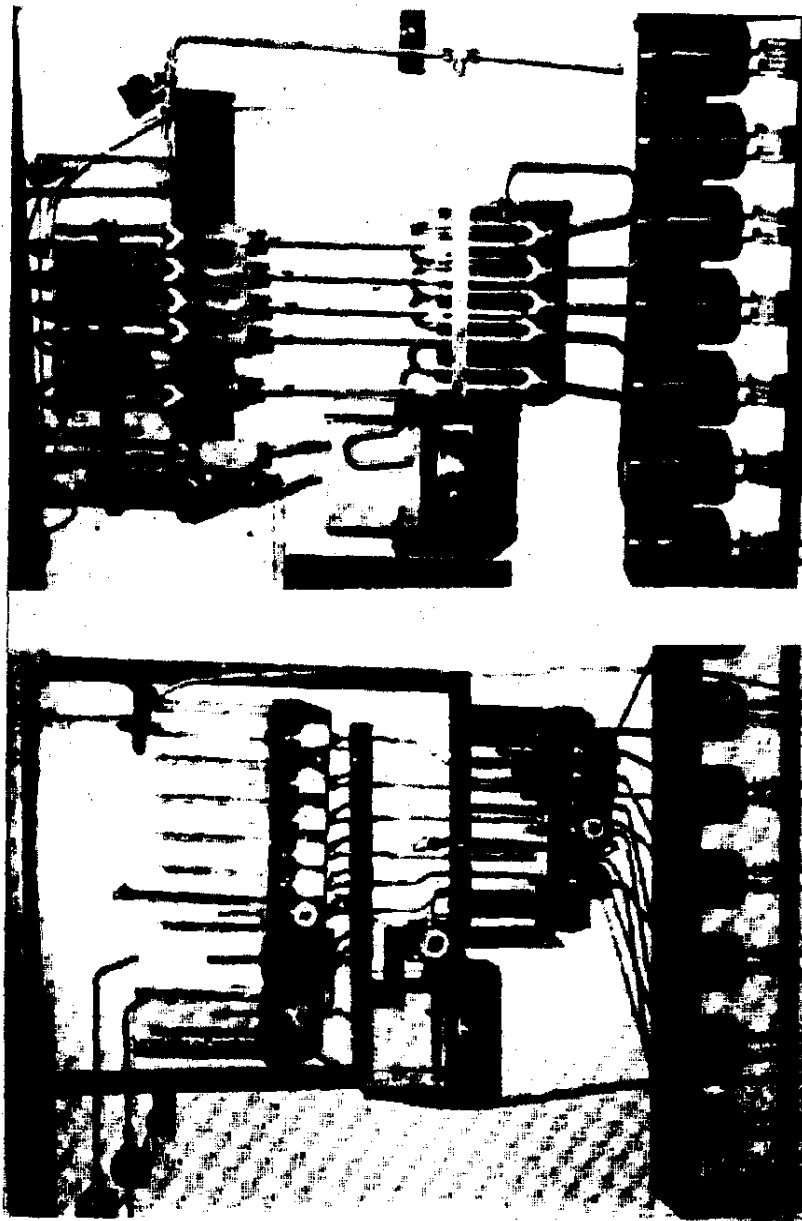

Figure 1. Photographs of the solenoid valve system (left), and the vacuum siphon system (right).

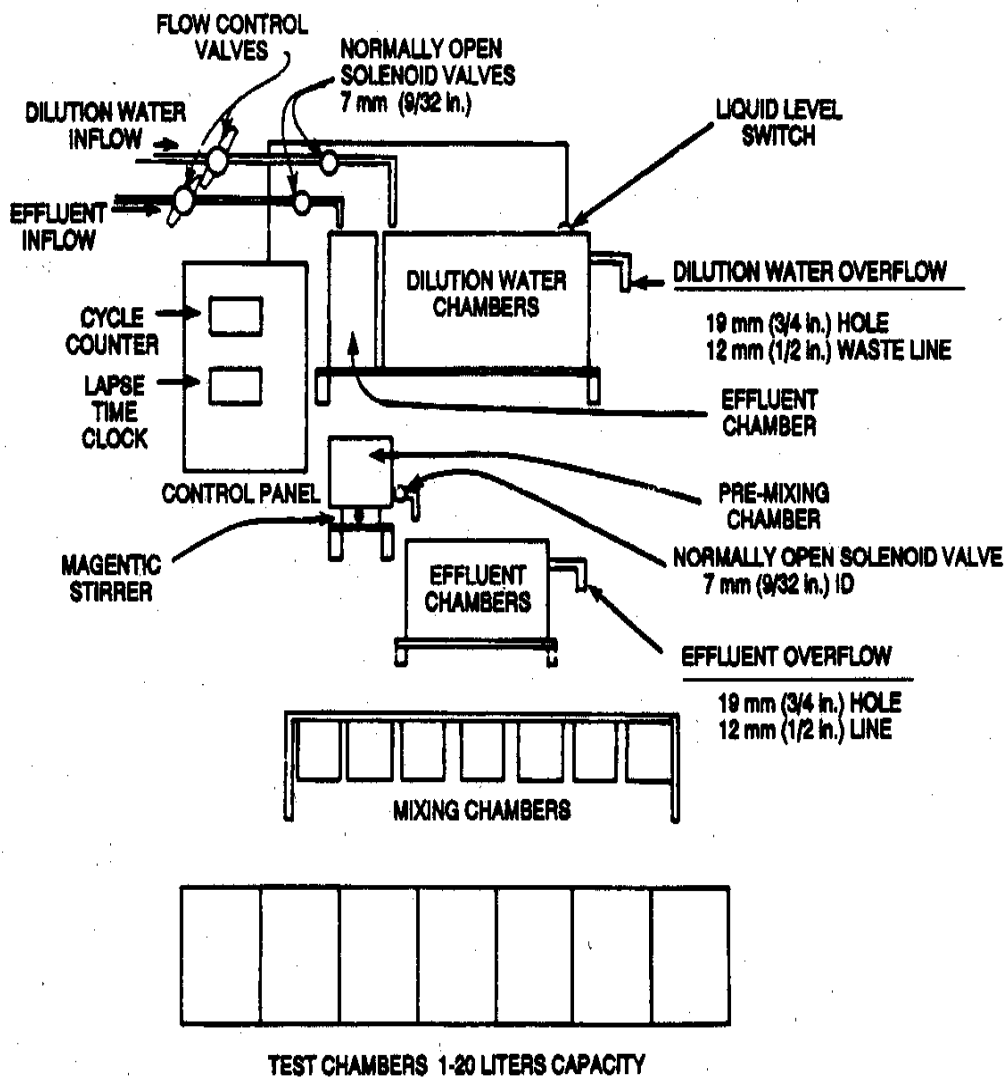
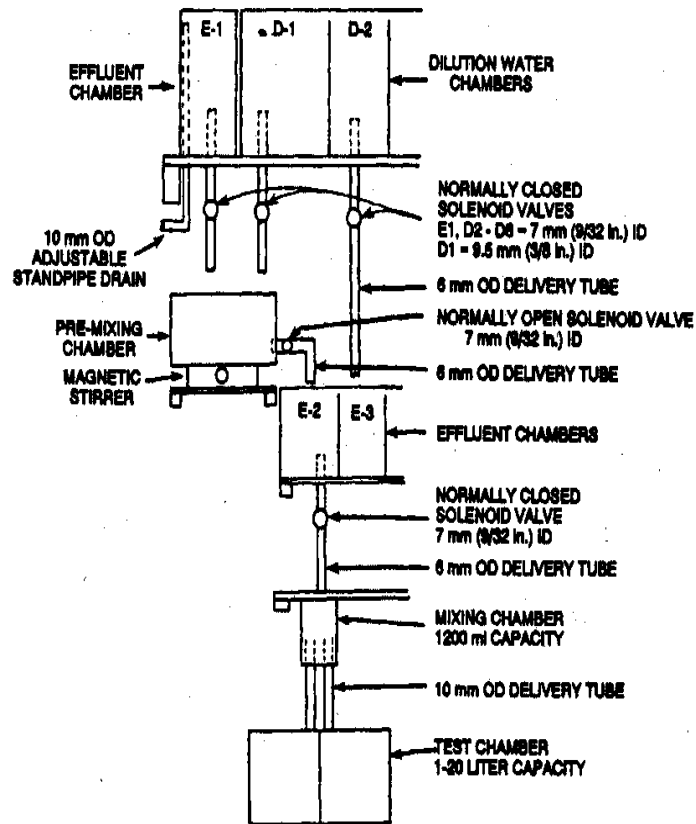

Figure 2. Solenoid valve dilutor system, general diagram (not to scale).



NOTE: WHEN 100% EFFLUENT IS USED AS THE HIGHEST EFFLUENT CONCENTRATION, E-1, D-1, AND THE PRE-MIXING CHAMBER ARE BYPASSED BY CONNECTING A TYGON TUBE TO THE EFFLUENT INFLOW, AND RUNNING IT DIRECTLY TO E-2. IN THIS CASE, SOLENOIDS FOR E-1 AND D-1, AND THE PRE-MIXING CHAMBER ARE DISCONNECTED. D-2 + E-3 = 80% EFFLUENT; D-3 + E-4 = 85% EFFLUENT, ETC.

Figure 3. Solenoid valve dilutor system, detailed diagram (not to scale).

SOLENOID SYSTEM EQUIPMENT LIST

1. Dilator Glass.
2. Stainless Steel Solenoid Valves
 - a. 3, normally open, two-way, 55 psi, water, 1/4" pipe size, 9/32" orifice size, ASCO 8262152, for incoming effluent and dilution water pipes and mixing chamber pipe.
 - b. 1, normally closed, two-way, 15 psi, water, 3/8" pipe size, 3/8" orifice size, ASCO 8030865, for D-1 chamber evacuation pipe.
 - c. 12, normally closed, two-way, 36 psi, water, 1/4" pipe size, 9/32" orifice size. ASCO 8262C38, for remaining dilution chambers (D2-D6) and effluent chamber (E1-E6) evacuation pipes.
3. Stainless steel tubing, seamless, austenitic, 304 grade for freshwater and 316 grade for saline water.
 - a. 10 ft of 3/8" OD, 0.035" wall thickness, for dilution water and effluent pipes.
 - b. 60 ft of 1/4" OD, 0.035" wall thickness, for dilution water and effluent pipes.
 - c. 1 ft of 3/4" OD, 0.035" wall thickness, for standpipe in D1 chamber.
4. Swagelok tube connectors, stainless steel.
 - a. 4, male tube connectors, male pipe size 1/4", tube OD 3/8".
 - b. 2, male tube connectors, male pipe size 1/2", tube OD 3/8".
 - c. 26, male tube connectors, male pipe size 1/4", tube OD 1/4".
 - d. 2, male tube connectors, male pipe size 3/8", tube OD 3/8".
 - e. 2, male adaptor, tube to pipe, male size 1/2", tube OD 3/8".
5. 7, 1200 mL stainless steel beakers.
6. Several lbs each of Neoprene stoppers, sizes 00, 0, and 1; 1 lb of size 5.
7. 14 - aquarium (1-20 liters).
8. Magnetic stirrer.
9. 2 - PVC ball valves, 1/2" pipe size.
10. Dilutor control panel - see Fig. 9 and equipment list.
11. Plywood sheeting, exterior grade: one - 4' x 8' x 3/4", one - 4' x 8' x 1/2".
12. Pineor redwood board, 1" x 8", 20 ft.
13. Epoxy paint, 1 gal.
14. Assorted wood screws, nails, etc.
15. 25 ft - 14" ID, TEFLON[®] tubing, to connect the mixing chambers to the test chambers.

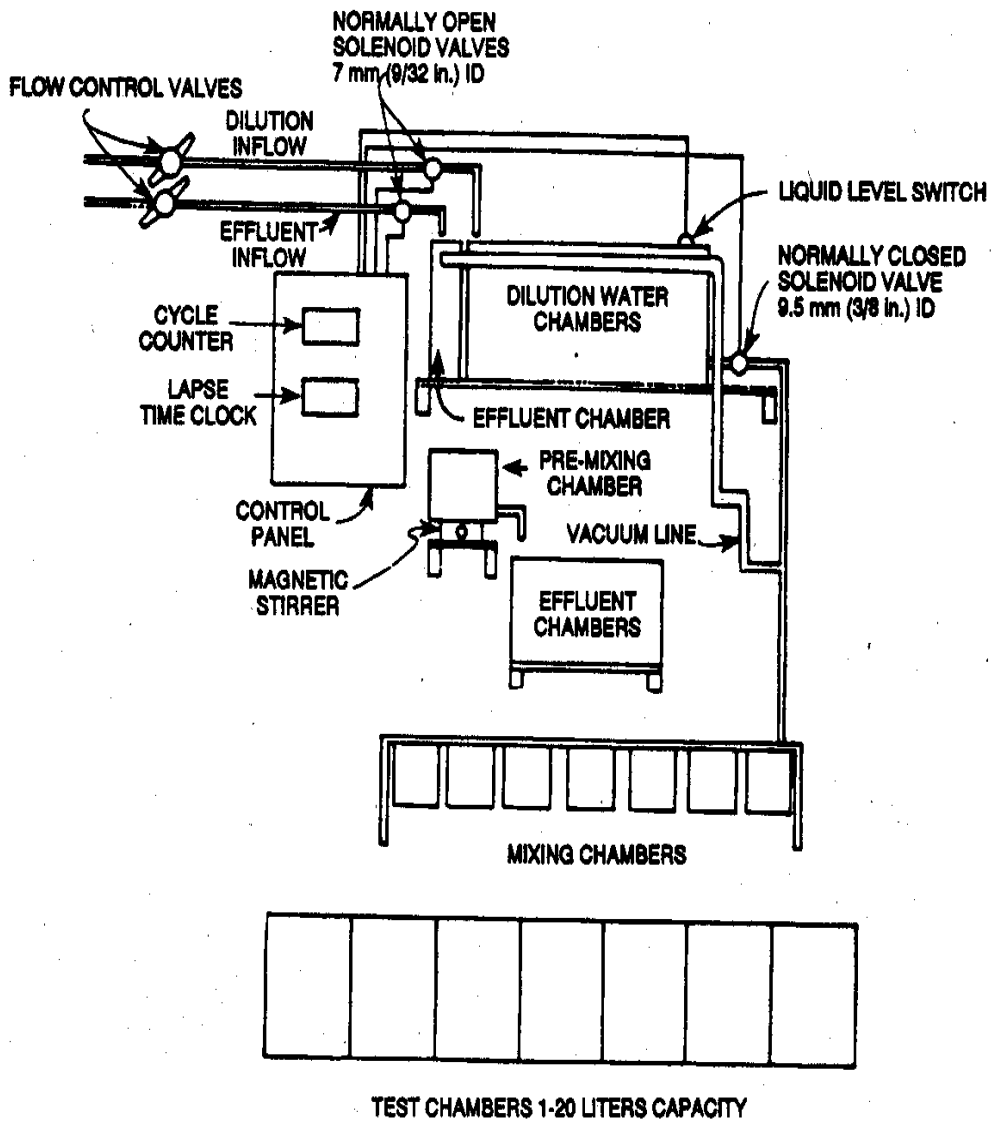

Figure 4. Vacuum siphon dilutor system, general diagram (not to scale).

VACUUM SIPHON SYSTEM EQUIPMENT LIST

1. Dilutor Glass.
2. Stainless steel solenoid valves.
 - a. 2, normally open, two-way, 55 psi, water, 1/4" pipe size, 9/32" orifice size, ASCO 8262152, for incoming effluent and dilution water pipes.
 - b. 2, normally closed, two-way, 15 psi, water, 3/8" pipe size, 3/8" orifice size, ASCO 8030865, for dilution water chamber D-6 and effluent chamber E-2.
3. Stainless steel tubing, seamless, austenitic, 304 grade for freshwater and 316 grade for saline water.
 - a. 60 ft of 3/8" OD, 0.035" wall thickness, for dilution water and effluent pipes.
 - b. 20 ft of 5/16" OD, 0.035" wall thickness, for standpipes in mixing chambers.
 - c. 1 ft of 3/4" OD, 0.035" wall thickness, for standpipe in D1 chamber.
4. Swagelok tube connectors, stainless steel.
 - a. 4, male tube connectors, male pipe size 1/4", tube OD 3/8".
 - b. 2, male tube connectors, male pipe size 3/8", tube OD 3/8".
 - c. 2, male adaptor, tube to pipe, male pipe size 1/2", tube OD 3/8".
 - d. 2, male tube connectors, male pipe size 1/2", tube OD 3/8".
5. 7, 1,200 mL stainless steel beakers.
6. Several lbs each of Neoprene stoppers, sizes 00, 0, and 1; 1 lb of size 5.
7. 14 - aquarium (1-20 liters).
8. Magnetic stirrer.
9. 2, PVC Ball valves, 1/2" pipe size.
10. Dilutor control panel equipment - see Fig. 9 and equipment list.
11. 7, 120 mL NALGENE[®] bottles.
12. 3 ft, 1-in-2 aluminum bar, for siphon support brackets.
13. Stainless steel set screws, box of 50, for securing SS tubing in siphon support brackets.
14. Stainless steel hose clamps, box of 10, size #4 or 5, (need 3 boxes).
15. 6, NALGENE[®] T's, 5/16" OD.
16. 12, TYGON[®] Y connectors, 3/8" I.D.
17. TYGON[®] tubing, 3/8" OD, 10 ft.
18. Plywood sheeting, exterior grade: one - 4' x 8' x 3/4", one - 4' x 8' x 1/2".
19. Pine or redwood board, 1" x 8", 20 ft.
20. Epoxy paint, 1 gal.
21. Assorted wood screws, nails, etc.
22. 25 ft of 5/16" ID, TEFLON[®] tubing, to connect the mixing chambers to the test chambers.

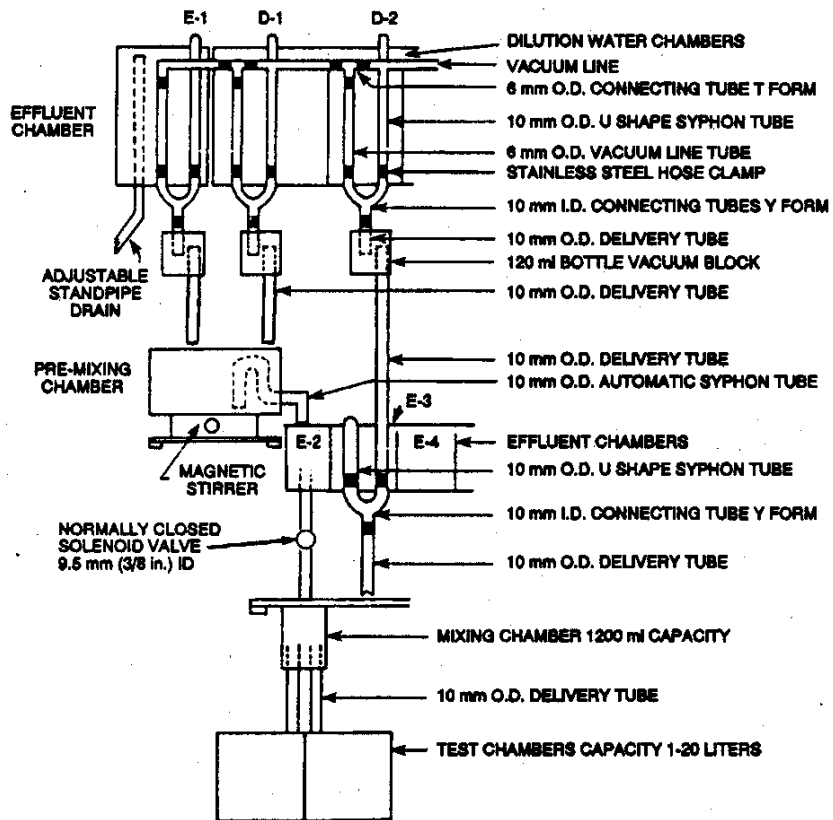
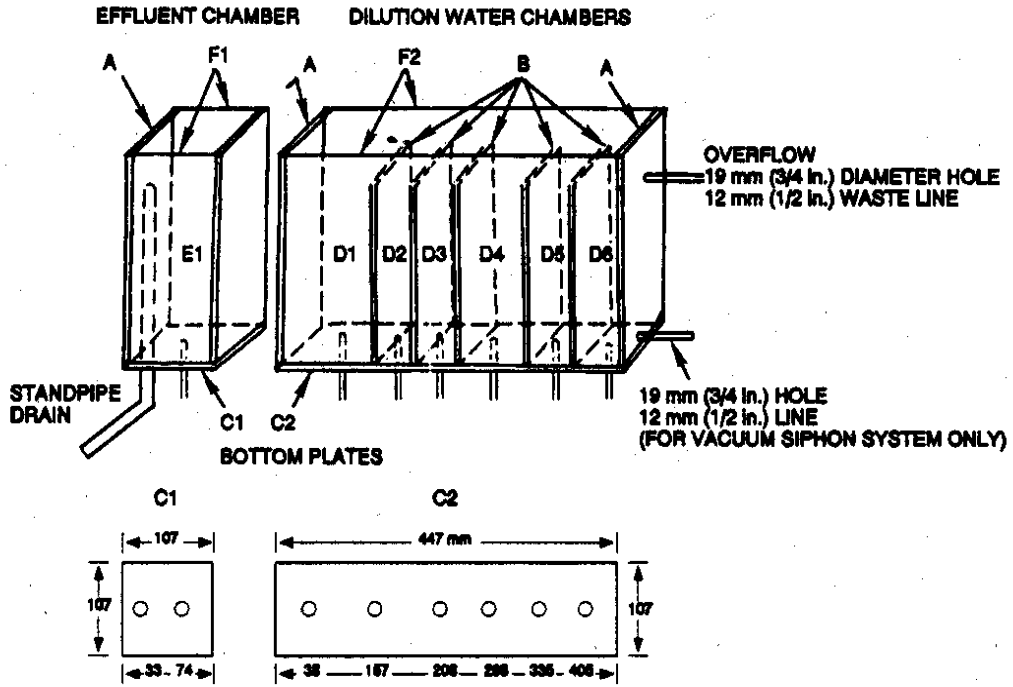

Figure 5. Vacuum siphon dilutor system, detailed diagram (not to scale).



DRAIN HOLES IN BOTTOM PLATE (C1 AND C2) SHOWN FOR SOLENOID VALVE DILUTOR SYSTEM. FOR VACUUM SIPHON DILUTOR SYSTEM, DRAIN HOLE IS REQUIRED ONLY FOR CHAMBER E1.

INDIVIDUAL PART SIZE AND NUMBER OF PIECES USING 6 mm (1/4 in.) PLATE GLASS. NOTE: 1.6 mm (1/16 in.) No. 304 GRADE (FOR FRESH WATER) OR No. 316 GRADE (FOR SALINE WATER) STAINLESS STEEL MAY BE SUBSTITUTED FOR GLASS.

	LENGTH	WIDTH	NO. PIECES (16)
A:	251 mm	95 mm	4 (END PLATES)
B:	200 mm	95 mm	5 (PARTITIONS)
C1:	107 mm	107 mm	1 (BOTTOM PLATE FOR E1)
C2:	447 mm	107 mm	1 (BOTTOM PLATE FOR D1-D6)
F1:	107 mm	251 mm	2 (FRONT AND BACK PANELS FOR E1)
F2:	447 mm	251 mm	2 (FRONT AND BACK PANELS FOR D1-D6)

INSIDE CELL MEASUREMENTS AND APPROXIMATE VOLUMES

	WIDTH	LENGTH	HEIGHT	VOLUME
E1:	95 mm	95 mm	251 mm	2365 mL
D1:	125 mm	95 mm	200 mm	2375 mL
D2:	40 mm	95 mm	200 mm	780 mL
D3:	50 mm	95 mm	200 mm	980 mL
D4:	60 mm	95 mm	200 mm	1140 mL
D5:	60 mm	95 mm	200 mm	1140 mL
D6:	70 mm	95 mm	200 mm	1330 mL

Figure 6. Effluent and dilution water chambers (not to scale).

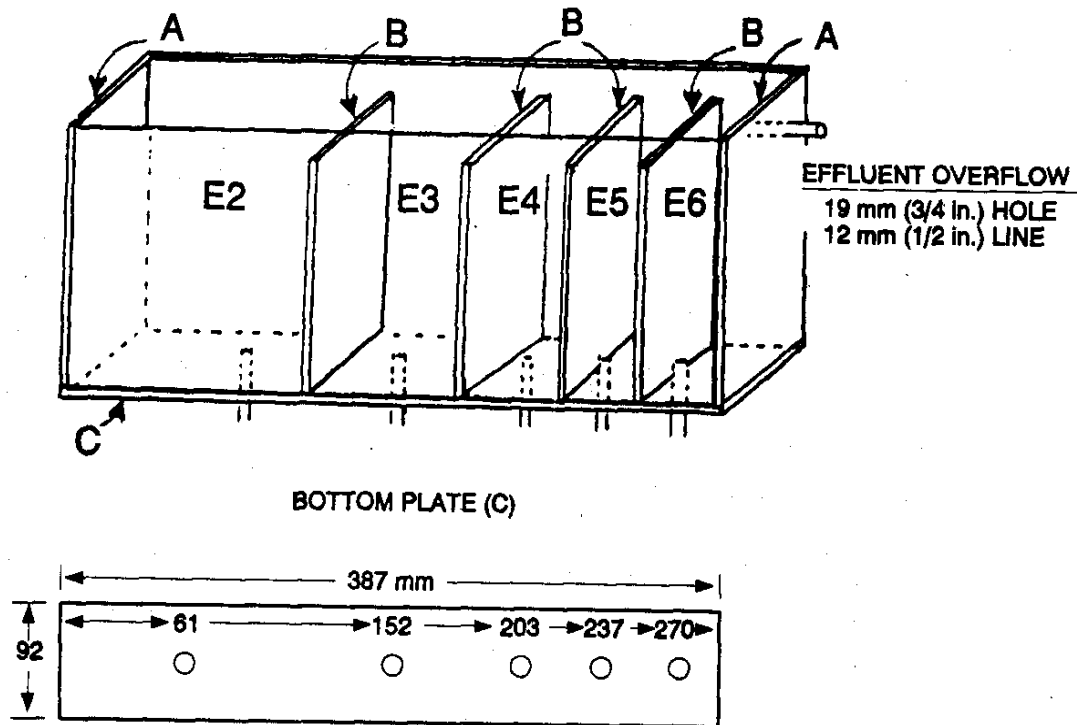

DRAIN HOLES IN BOTTOM PLATE (C) SHOWN FOR SOLENOID VALVE DILUTOR SYSTEM ONLY. FOR VACUUM SIPHON DILUTOR SYSTEM, A DRAIN HOLE IS REQUIRED ONLY FOR CHAMBER E2.

INDIVIDUAL PART SIZE AND NUMBER OF PIECES USING A 6 mm (1/4 in.) PLATE GLASS ARE SHOWN BELOW. NOTE: 1/16 in. No. 304 (FOR FRESH WATER) OR No. 316 STAINLESS STEEL (FOR SALINE WATER) MAY BE SUBSTITUTED FOR GLASS.

	LENGTH	WIDTH	NO. PIECES (9)
A	180 mm	80 mm	= 2 (END PLATES)
B	155 mm	80 mm	= 4 (PARTITIONS)
C	296 mm	92 mm	= 1 (BOTTOM PLATE)
D	296 mm	180 mm	= 2 (FRONT AND BACK PLATES)

INSIDE CHAMBER MEASUREMENTS AND APPROXIMATE VOLUMES.

	WIDTH	LENGTH	HEIGHT	VOLUME
E2:	110 mm	80 mm	x 155 mm	= 1364 mL
E3:	60 mm	80 mm	x 155 mm	= 744 mL
E4:	30 mm	80 mm	x 155 mm	= 372 mL
E5:	30 mm	80 mm	x 155 mm	= 372 mL
E6:	30 mm	80 mm	x 155 mm	= 372 mL

Figure 7. Effluent chambers (not to scale).

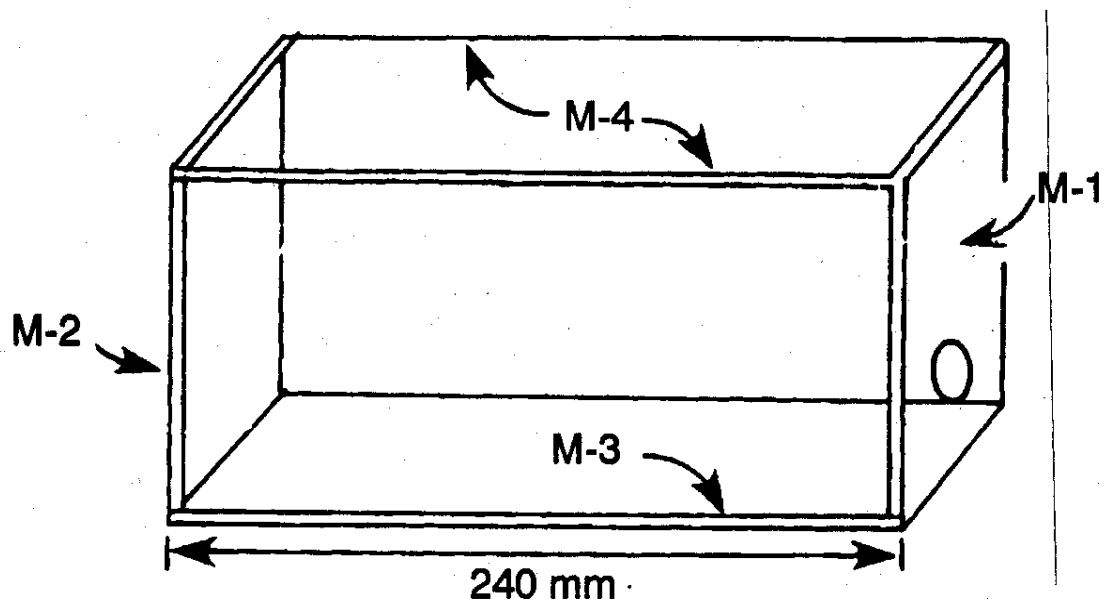

SIDE VIEW

END VIEW

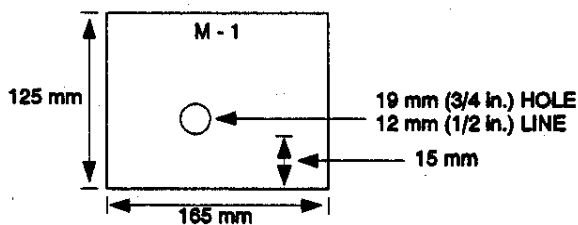

INDIVIDUAL PART SIZE AND NUMBER OF PIECES USING
6 mm (1/4 in.) PLATE GLASS. APPROXIMATE CAPACITY
4360 mL.

M-1	125 mm	x	153 mm	-	1	(END PLATE, WITH HOLE)
M-2	125 mm	x	153 mm	-	1	(END PLATE)
M-3	240 mm	x	165 mm	-	1	(BOTTOM PLATE)
M-4	240 mm	x	125 mm	-	2	(SIDE PLATES)

Figure 8. Pre-mixing chamber (not to scale).

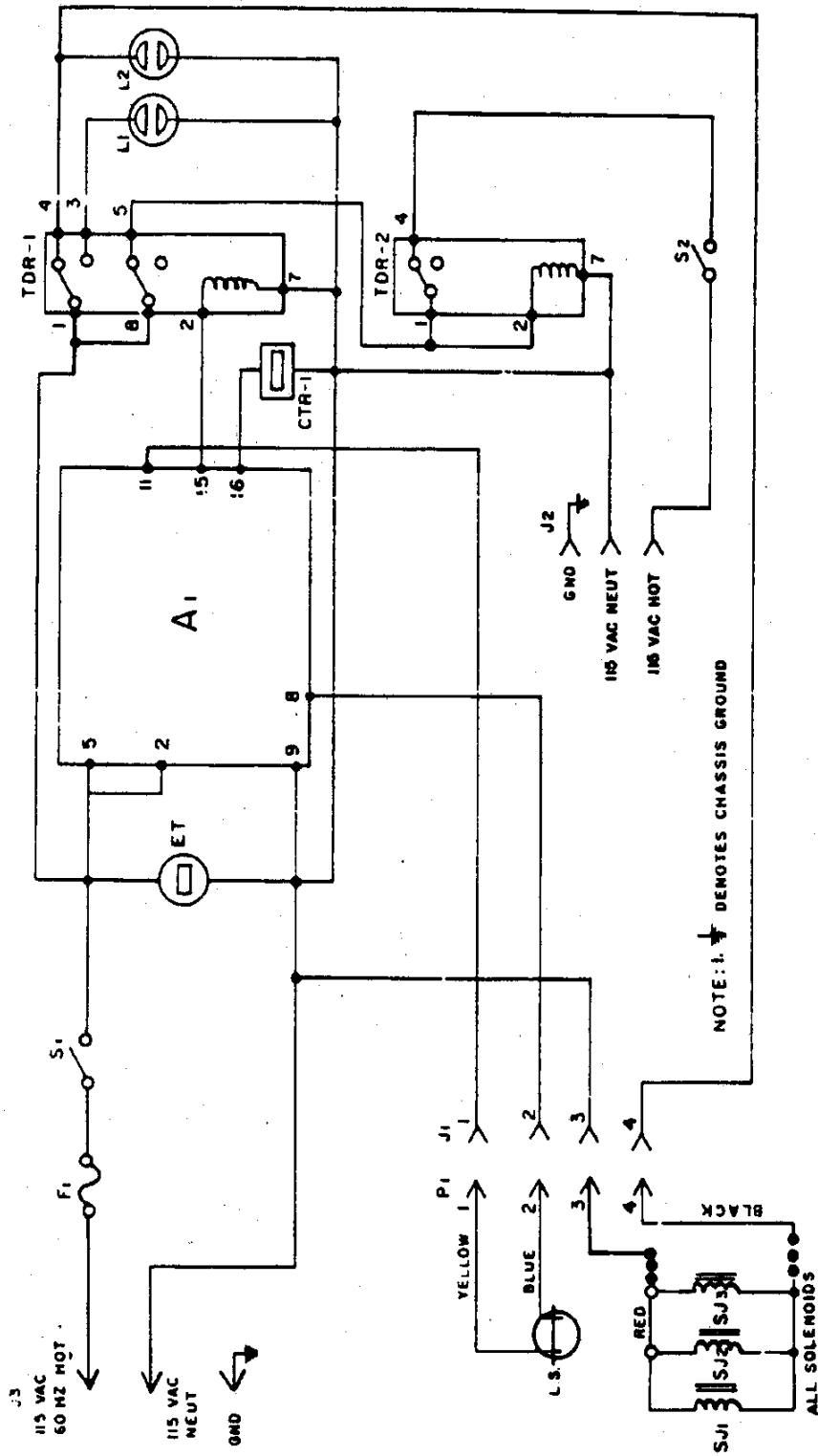

Figure 9. Dilutor control panel wiring diagram.

DILUTOR CONTROL PANEL EQUIPMENT LIST*

Designation	CKT Description	Manufacturer
A ₁	Encapsulated amplifier	Cutler Hammer 13535H98C
CTR-1	Cycle counter	Redington #P2-1006
ET	Elapsed time indicator	Conrac #636W-AA H&T
F ₁	Input power fuse	Little fuse 342038
J ₁	Receptacle	Amphenol 91PC4F
J ₂	Aux A.C. output jack	Stand. 3-prong AC Rept.
J ₃	Main input power cord	Stand. 3-prong AC male plug
L ₁	Fill indicator light	Dialco 95-0408-09-141
L ₂	Emptying indicator light	Dialco 95-0408-09-141
L.S.	Liquid level sensor (Dual Sensing Probe)	Cutler Hammer 13653H2
P ₁	Plug	Amphenol 91MC4M
S ₁	On-off main power switch (spst)	Cutler Hammer 7580 K7
S ₂	On-off aux power switch (spst)	Cutler Hammer 7580 K7
SJ ₁	Solenoid	(See Solenoid and Vacuum System equipment lists)
SJ ₂	"	" " "
SJ ₃	"	" " "
SJ ₄ -SJ ₆	Additional Solenoids for Solenoid Valve System	" " "
TDR-1	Time delay relay	Dayton 5x829
TDR-2	Aux time delay relay	Dayton 5x829

*Consult local electric supply house.

APPENDIX D

PLANS FOR MOBILE TOXICITY TEST LABORATORY

D.1. TANDEM-AXLE TRAILER

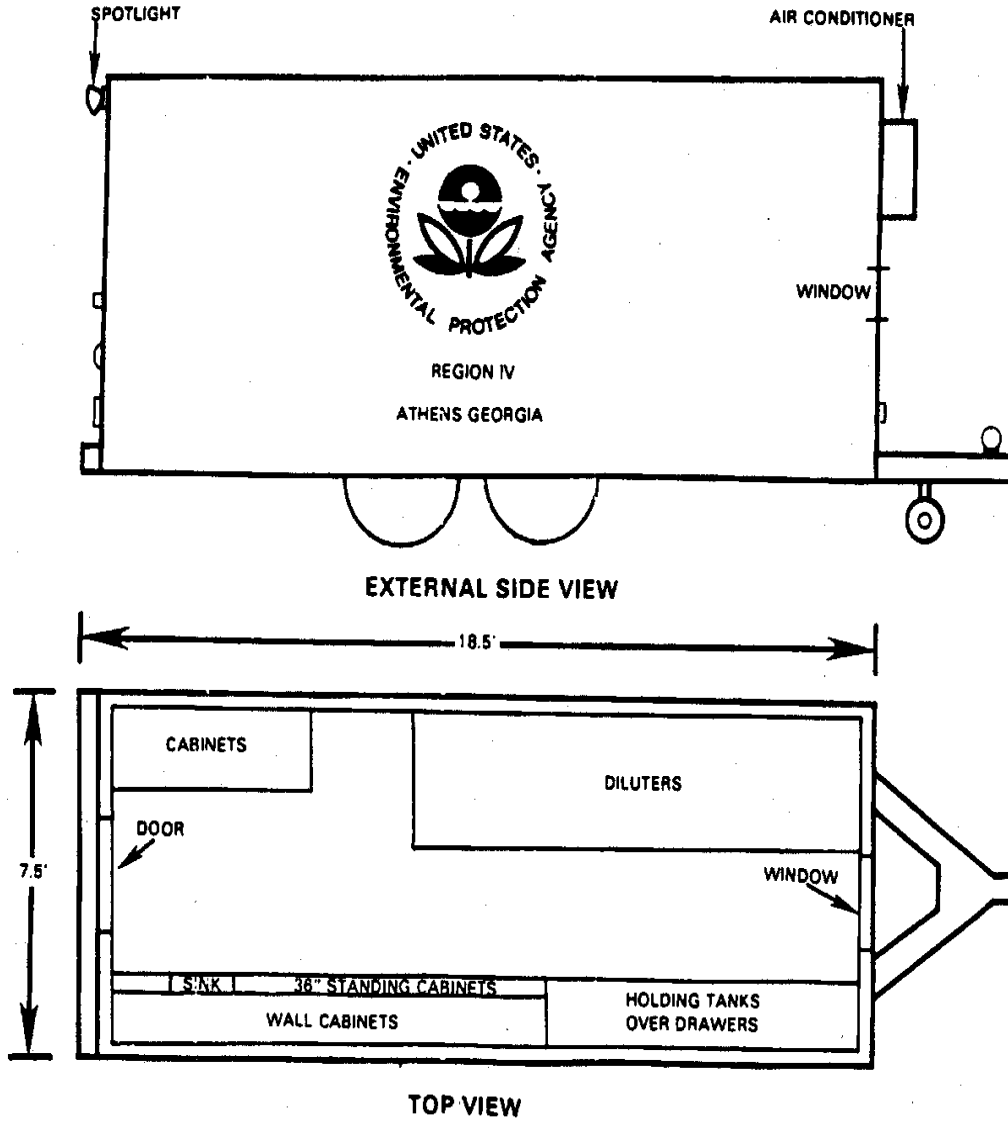

Figure 1. Mobile bioassay laboratory, tandem axle trailer. Above - external side view; below - internal view from above.

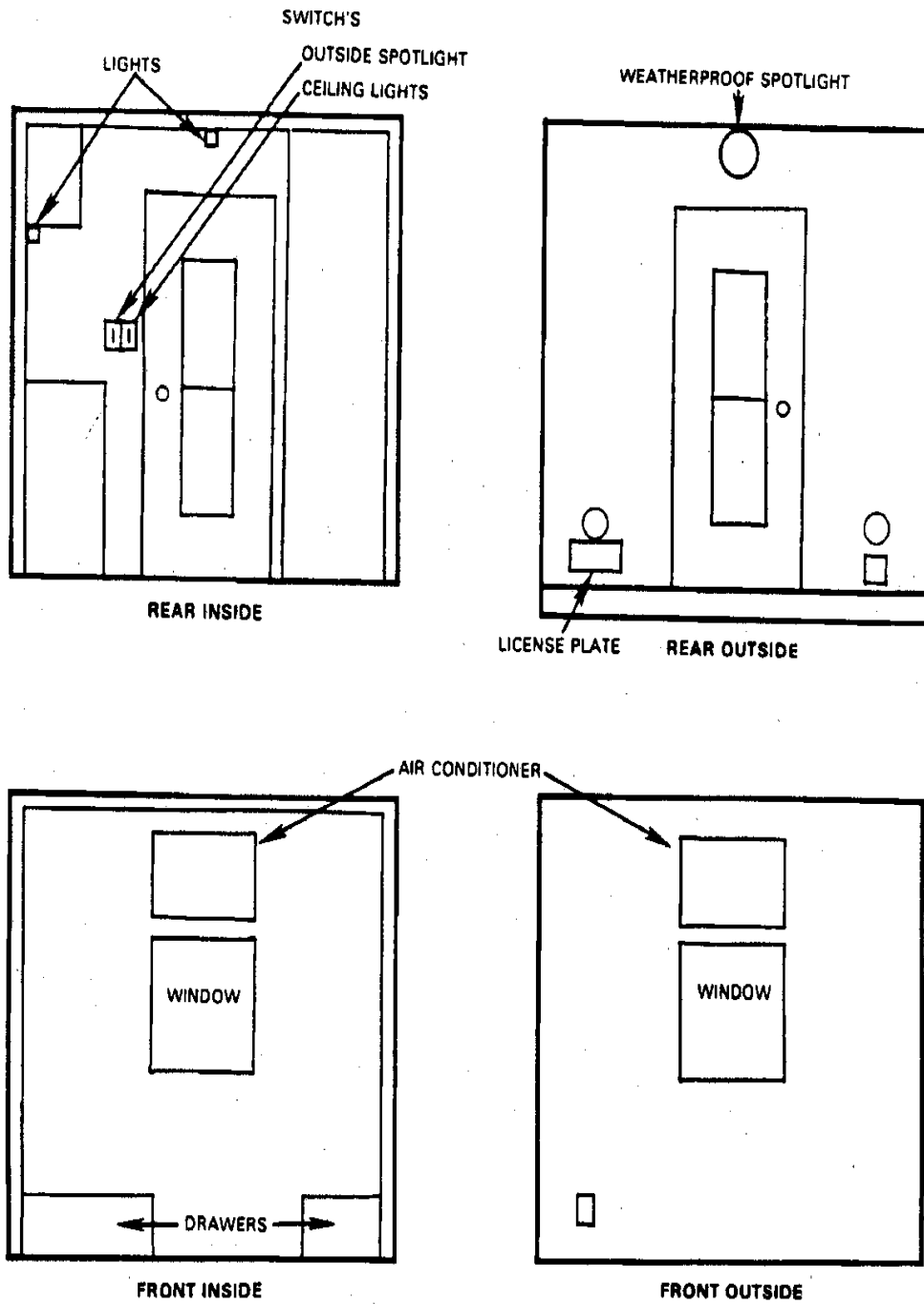

Figure 2. Mobile bioassay laboratory, tandem-axle trailer, external and internal end views.

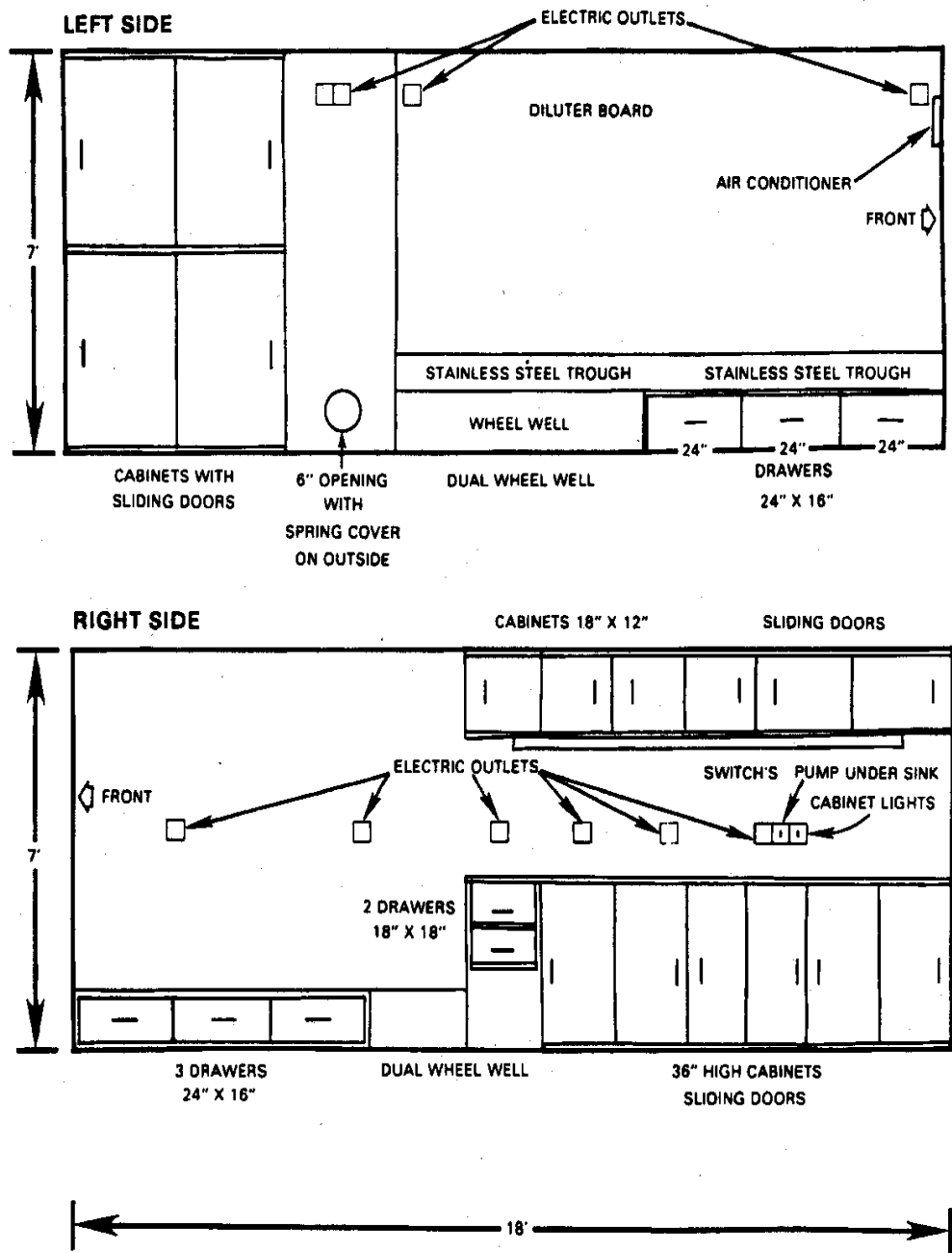

Figure 3. Mobile bioassay laboratory, tandem-axle trailer, internal views of side walls.

APPENDIX D

PLANS FOR MOBILE TOXICITY TEST LABORATORY

D.2. FIFTH WHEEL TRAILER

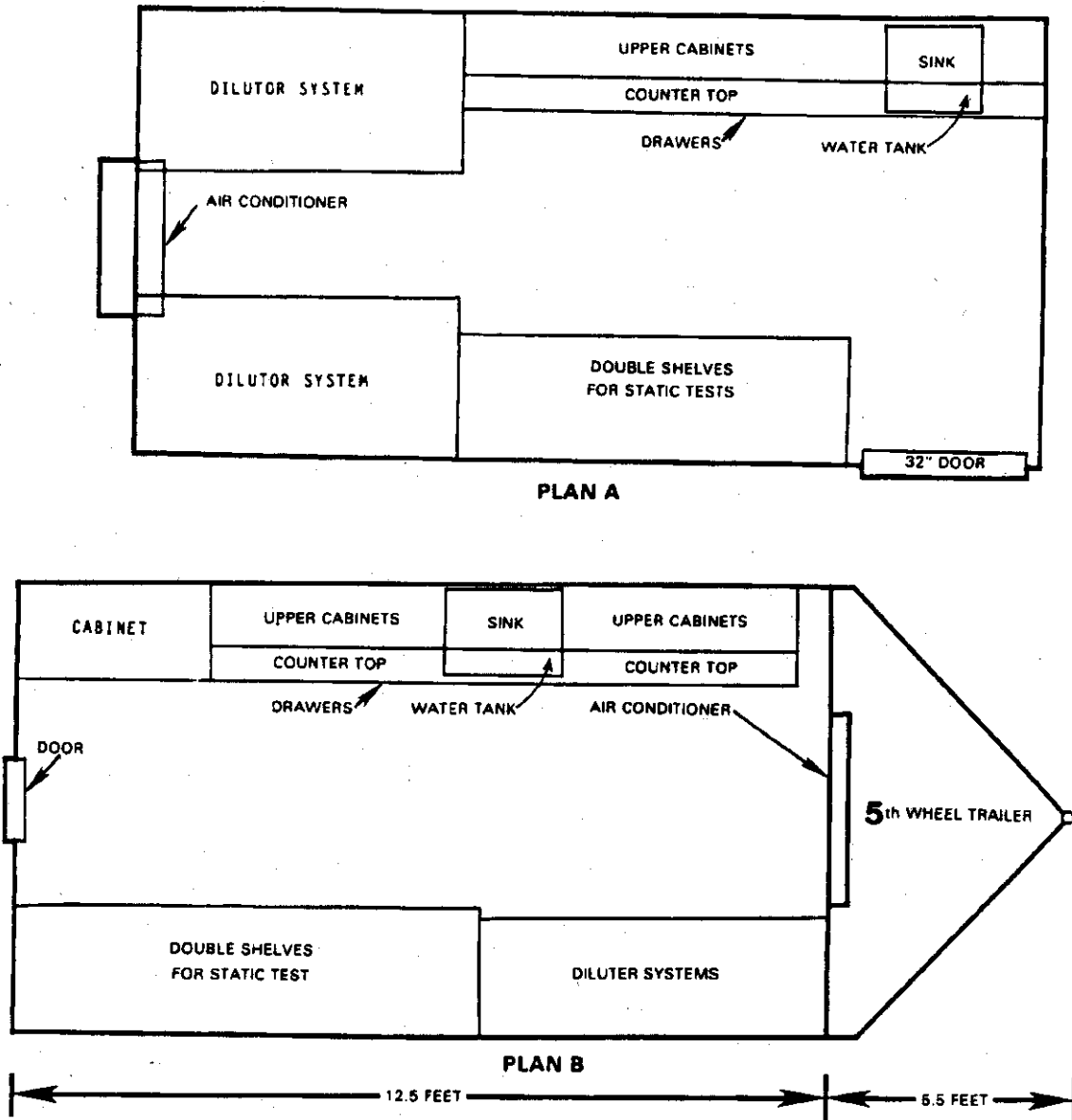

Figure 4. Mobile bioassay trailer, fifth-wheel trailer, internal view from above.

APPENDIX E

CHECK LISTS AND INFORMATION SHEETS

E.1. TOXICITY TEST FIELD EQUIPMENT LIST

Truck

Boards
 Cinder blocks
 Drums: 500 gal nalgene
 55 gal metal - diesel fuel
 22 gal
 Gas can 5 gal
 Jacks
 Jumper cables
 Oil
 Pumps: (2) Homelite
 Hoses & couplings
 Shovels
 Spare tires (trailer, generator)

Brine shrimp eggs
 Broom
 Brushes (wash)
 Buckets
 Camera
 Chlorine kit (w/chem)
 Cleanser
 Clip board (lg, sm)
 Cork borer set
 Culture dishes (200 mL, *Daphnia*)
 Daphnia food
 Data sheets: Bioassay (static)
 Bioassay (flow-thru)
 Dilutor volume delivery
 Calibrator delivery sheet
 Daily events log

Trailer

Acetone
 Aerators (battery operated)
 Air line: Clamps
 Aerators (battery operated)
 Air line: Clamps
 Stones
 Tubing
 Valves

 Alcohol
 Aluminum foil
 Alkalinity analysis (0.02 N H₂SO₄)
 Boots: safety
 wading
 Batteries D cell
 Beakers: 150 mL nalgene
 200 mL glass (3 boxes)
 Bottles: D.O.
 wash
 Sample
 VOA vials
 500 mL plastic
 Glass organic
 Qt. w/teflon liner

Dish pan
 Dish rack
 Dissolved oxygen:
 KCL membrane solution
 Membranes
 Meter (YSI)
 Probes
 Reagent: MnSO₄
 Alkaline azide
 H₂SO₄
 0.0375 Na thiosulfate

 Starch
 Distilled H₂O
 Emergency road kit
 Enamel pans (lg, sm)
 Erlenmeyer flasks: 500 mL (2)
 1000 mL
 2000 mL

 Extension cords
 Fire extinguisher
 First aid kit
 Fish nets, (lg, sm)
 Flash light
 Generator: Oil
 Filter - fuel
 Funnel
 Grease gun (wheels)
 Credit card
 Lock/key
 Siphon hose

E.1. TOXICITY TEST FIELD EQUIPMENT LIST (CONT.)

- Glass cutter
- Gloves (plastic)
- Graduated cylinders:
 - 25 mL, 50 mL, 100 mL
 - 250 mL, 500 mL, 1000 mL, 2000 mL
- Ground wire & rod
- Hand soap
- Hard hats
- Hardness analysis:
 - Buffer
 - EDTA
 - indicator
- HCl (20%)
- Heaters:
 - Aquarium
 - Space
- Hose:
 - Clamps
 - Connectors
- Ice chests
- Jars:
 - 750 mL (4 boxes)
 - 3 gal (glass) (1)
 - 5 gal (glass) (1)
 - Sample jugs (2)
- Kimwipes (lg, sm)
- Lab coats (2)
- Level
- Light 110 V
- Log book
- Magnetic stirrers:
 - Lighted
 - Other
- Mop
- Paper towels
- Parachute cord
- Parafilm
- Pencils, pens
- pH:
 - Meters, Orion
 - Meters, corning
 - Buffers, 4,7,10
 - Probes (extras)
- Pipets:
 - Bulbs
 - Eyedroppers
 - Volumetric (1 mL, 5 mL, 10 mL)
- Plastic bags
- Quality assurance - SPCP
- Rain gear
- Reconstituted hard water
- Refractometer
- Respirators (cartridges)
- Rubber bands
- Ruler
- Safety glasses
- Safety manual
- Sample labels
- Scissors
- Screen bioassay cups
- Sea salts
- Separatory funnels & racks
- Silent giants
- Silicon sealant
- Solenoids (spare)
- Stainless steel tubing pieces
- Standard Methods Hand Book
- Stirring bars
- Stoppers (assorted)
- Submersible pumps:
 - lg, sm.
 - screens
- Super ice
- Tablets (paper)
- Tape:
 - Cellophane
 - Color coded
 - Electrician
 - Masking
 - Nylon
- Thermometers:
 - Dial
 - Glass
- Tools (lock/key)
- Tygon tubing, 1/8", 1/4", 3/8"
- Volumetric flasks (1000 mL, 2000 mL)
- WD40
- Weigh boats
- Wire tags

APPENDIX E

CHECK LISTS AND INFORMATION SHEETS

E.2. INFORMATION CHECK LIST FOR ON-SITE INDUSTRIAL
OR MUNICIPAL WASTE TOXICITY TEST

1. PRE-TRIP INFORMATION

Facility Name: _____

Address: _____

Phone number: _____

Plant Representative(s): _____

Names, Titles, Addresses of Company Personnel:

A. To Receive Correspondence: _____

B. To Receive Carbons: _____

Date of Notification Letter: _____

State Making Notification and Arrangements: _____

Special Plant Safety/Security Requirements for EPA Personnel to Observe:

Local Accommodation Recommendations: _____

Directions to Plant: _____

Availability of Power Hookups (three 20-amp, 110-V Circuits): _____

Distance from Power Source to Trailer: _____ (Feet)

Trailer Location: _____

Possible Source of Dilution Water: _____

Major Products: _____

Raw Materials: _____

Name of Receiving Water: _____

Schedule of Plant Operation (continuous, weekdays only, etc.): _____

Treatment Steps: _____

Treatment Level (BPT, BAT, etc.): _____

Wastewater Retention Time by Lagoon or Treatment Step:

<u>Lagoon Designation</u>	<u>Retention Hours</u>	<u>Time Days</u>
_____	_____	_____
_____	_____	_____
_____	_____	_____
_____	_____	_____
_____	_____	_____

Total Wastewater Retention Time: _____ Hours; _____ Days

Retention Time Determination: _____ Calculated; _____ Actual

Calculation method: _____

Description of Wastewater Tap Point: _____

Description of Outfall (surface, submerged diffuser, etc.): _____

Description of Other Waste Disposal Alternatives in Use (spray irrigation, deepwell, municipal discharge, etc.): _____

2. ON-SITE INFORMATION

Wastewater General Characteristics:

Color: _____

Odor: _____

Solids: _____

Other: _____

Serial Number(s) of Discharge(s) to be Tested: _____

Description of Receiving Water: _____ Uniflow; _____ Tidal;
_____ Approximate amplitude, feet

Color: _____

Odor: _____

Solids: _____

Salinity: High tide _____; Low tide _____

Other: _____

7Q10: _____; Ave. flow _____

Description of Receiving Water Zone of Dilution: _____

Location and Description of Water Sampling Point(s): _____

Fresh: _____

Salt: _____

Dilution Waste General Characteristics:

Color: _____

Odor: _____

Solids: _____

Other: _____

Description of Toxicity Test Anomalies (plant production changes, power failure, rain events, etc.):

Duration		Anomaly
Time & Date	Time & Date	
_____	_____	_____
_____	_____	_____
_____	_____	_____
_____	_____	_____
_____	_____	_____

Description of Plant maintenance: _____

Attach: DIAGRAM OF WASTEWATER TREATMENT FACILITIES.

3. FOLLOW-UP INFORMATION

Date of follow-up letter: _____

Wastewater Flow (data supplied by discharger):

<u>Week Prior to Testing</u>		<u>Week of Testing</u>	
<u>Date</u>	<u>Discharge (MGD)</u>	<u>Date</u>	<u>Discharge (MGD)</u>
_____	_____	_____	_____
_____	_____	_____	_____
_____	_____	_____	_____
_____	_____	_____	_____
_____	_____	_____	_____
_____	_____	_____	_____
_____	_____	_____	_____

Average Discharge (MGD): _____

Organisms Tested On-site or In-Lab:

<u>Species</u>	<u>Flow-thru test duration (h)</u>	<u>Static test duration (h)</u>	<u>Test Location</u>	<u>Dates</u>	<u>Results</u>
_____	_____	_____	_____	_____	_____
_____	_____	_____	_____	_____	_____
_____	_____	_____	_____	_____	_____
_____	_____	_____	_____	_____	_____
_____	_____	_____	_____	_____	_____

Possible Recommended Action as a Result of These Findings:

APPENDIX E

CHECK LISTS AND INFORMATION SHEETS

E.4. DILUTOR CALIBRATION FORM

Calibration Site: _____ Calibrator: _____
 Dilutor Number: _____ Date: _____

Effluent Concentration (%)	100.0	50.0	25.0	12.5	6.25	3.12	1.56
Dilution Water (mL)	0	500	750	876	938	969	984
Trial 1							
2							
3							
Average							
Effluent (mL)	1000	500	250	125	62	31	16
Trial 1							
2							
3							
Average							

Mixing Chamber (%): _____
 Wastewater (mL): _____
 Dilution Water (mL): _____

	Dilution Water	Effluent
Vol (mL)		
Trial 1		
2		
3		
Average		

Remarks:

