

Annual Report

1st NATO/CCMS Pilot Study "Clean Products and Processes" Phase II

sponsored by



hosted by



Cetraro (CS) – Italy, 11 – 15 May 2003



ITM - CNR

Presentations

Participants

Final Remarks

2004 Host Country

CD Info

Introduction

The Council of the North Atlantic Treaty Organization (NATO) established in 1969 the Committee on the Challenges to Modern Society (CCMS) with the aim to create a network of Countries for exchanging information, ideas, knowledge, technologies on topics of interest for the Society. In particular, the achievement of a sustainable growth is one of the issues that the CCMS Pilot Study on Clean Products and Processes considers as really important for the next future: in order to produce "in harmony" with the environment, while successfully competing, industries need cleaner and economically attractive technologies. The series of meetings held during the Phase I of the Pilot Study had the positive fallout of the creation of an international infrastructure which actively shared expertises in cleaner processes. The Phase II, which is in progress, will focus on increasing the collaboration among countries in solving common problems and on in-depth discussions and assessments in the already identified industry sectors of importance.

The NATO Committee on the Challenges to Modern Society (CCMS) has sponsored until now five Pilot Study meetings on Clean Products and Processes – Phase I:

- ❖ the first meeting was held in Cincinnati, Ohio, USA, in 1998;
- ❖ the second meeting in Belfast, Northern Ireland, in 1999;
- ❖ the third meeting in Copenhagen, Denmark, in 2000;
- ❖ the fourth meeting in Oviedo, Spain, in 2001;
- ❖ the fifth and concluding meeting in Vilnius, Lithuania, in 2002.

The five years of activity have been very useful for creating the infrastructure for the Pilot Study network; five more years of Phase II have been approved (November 2002-October 2007).

The meeting held in Calabria, Italy, on May 2003, was the first meeting of the NATO/CCMS Pilot Study on Clean Products and Processes-Phase II. It was hosted by the Institute on Membrane Technology, ITM-CNR, Rende (CS), Italy.

Its object was the discussion about the progresses made worldwide in developing clean technologies in the logic of the sustainable growth. The aim of the meeting was the exchange of experience among all countries involved on problems related to the environmental impact of industrial productions. Techniques and methodologies developed for improving the performance of existing productive cycles and/or for defining new cleaner systems of productions were illustrated. The share of the knowledge would help in reaching possible solutions to specific problems, especially among countries with similar environmental impact.



ITM - CNR

Sunday, May 11, 2003

Introduction

Participants

Final Remarks

2004 Host Country

CD Info

- ❖ **A Review on the Membrane Research Activities in Italy**
Enrico Drioli
- ❖ **Overview of the Meeting Agenda, Technical Program and Tours**
Daniel Murray
- ❖ **Report on 2002 Meeting**
Jurgis Staniskis
- ❖ **Selection and Use of Environmental Indicators in Different NATO Member States**
Horst Pohle
- ❖ **Life Cycle (Impact) Assessment**
David Pennington
- ❖ **Sustainability Indicators and Reporting Mechanisms in European Regions**
Annik Fet
- ❖ **Environmental Management Accounting (EMA)**
Gyula Zilahy
- ❖ **TRACI-Tool for the Reduction and Assessment of Chemical and other Environmental Impacts**
Dan Murray



ITM - CNR

Monday, May 13, 2003

Introduction

Participants

Final Remarks

2004 Host Country

CD Info

- ❖ **Design and Simulation of Environmental Conscious Chemical Processes**
Teresa Mata
- ❖ **Beyond the Molecular Frontier: Challenges for Chemistry and Chemical Engineering**
Tomas Chapman
- ❖ **Programme on Sustainable Industrial Development in Lithuania**
Jurgis Staniskis
- ❖ **Clean Products and Processes Update - University of Natal**
Chris Buckley
- ❖ **Break-through of Water Reuse in Textile Industry through Development of Generic Water Recycle Schemes**
Henrik Wenzel
- ❖ **Ionic Liquid Research and Application**
Jim Swindall
- ❖ **Some Case Studies on Clean Products and Processes**
David Wolf, Chaim Forgacs



ITM - CNR

Introduction

Participants

Final Remarks

2004 Host Country

CD Info

Wednesday, May 14, 2003

- **Process Intensification in European Union : Current Work and Future Plans, *Giorgos Gallios***
- **Wettability Determination as an Important Factor in Design and Environmental Performance of Some Industrial Processes, *Andrzej Doniec***
- **Development and Integration of New Processes for Greenhouse Gases Management in Multi-Plant Chemical Production Complexes, *Ralph Pike***
- **Studies on the Purification of Nonwater Media by Ceramic Membranes, *Gueorgui G. Kagramanov***
- **Alternatives for the Separation of Organic Acids as Examples of Process Intensification, *José Coca***
- **Process Intensification by Modeling and Modifying Packed Bed Reactor, *Antonio Martins***
- **New Technologies for Improving Gas Liquid Transfer Processes and Catalytic Reactions, *Alessandra Criscuoli***
- **Rationalization of Productive Cycles in the Agro-Food Industries by Innovative Processes, *Alfredo Cassano***
- **Slovak By-products in Intensification of Wastewater Treatment Processes, *M. Vaclavikova***
- **Reuse of Waste Materials from Zinc Industry for Sorption of Hydrogen Sulfide, *Aysel Atimtay***
- **Experience with Cleaner Production in the Ledeko, Inc. Agricultural Enterprise, Letovice, The Czech Republic, *František Božek***
- **Establishing and Managing Waste Minimisation Clubs in South Africa, *Chris Buckley***
- **Network of Excellence – TELES, *Viorel Harceag***
- **Topics for Cooperation**



ITM - CNR

Thursday, May 15, 2003

Introduction

Participants

Final Remarks

2004 Host Country

CD Info

- ❖ **Sustainable Development using Macroeconomic and Microeconomic Indicators**
Peter Glavič
- ❖ **"Food grade" MgCO₃·3H₂O – clean chemical production from waste brine**
Stefka Tepavitcharova and Christo Balarew
- ❖ **Chemical Dispersants and Bioremediation for the Treatment of Oil Spills**
José Coca
- ❖ **Cleaner Production Policy in context of Market Economy & Sustainable Development for Ukraine and other countries of transition economy**
William Zadorsky
- ❖ **Evaluation of the Progress of the Pilot Study and Open Discussion**
Subhas Sikdar
- ❖ **Annual Report Presentation**
Dan Murray
- ❖ **Discussion on Future Directions for the Pilot Study**
Dan Murray
- ❖ **Meeting Wrap Up**
Subhas Sikdar



ITM - CNR

Introduction

Presentations

Final Remarks

2004 Host Country

CD Info



Bulgaria



Czech Republic



Denmark



Germany



Greece



Hungary



Israel



Italy



Lithuania



Norway



Slovak Republic



Poland



Portugal



Romania



Russia



Slovenia



Spain



South Africa



Turkey



Ukraine



U.K.



USA



Sweden



ITM - CNR

Introduction

Presentations

Participants

2004 Host Country

CD Info

Final Remarks

The 2003 NATO CCMS Meeting has been an useful opportunity to point out the common interest among participants on topic related to environmental concerns. It has been characterized by intensive discussions in all the presentations; various suggestions for further activities have been also presented.

Six topics for cooperation have been underlined during the five days of Workshop, and coordinators have been indicated:

[1] Sustainability metrics-reporting mechanisms

(Coordinator: **Annik Magerholm Fet**, Faculty of Social Sciences and Technology Management, Department of Industrial Economics and Technology Management, Norwegian University of Science and Technology, e-mail: fet@iot.ntnu.no)

[2] Train the trainers implement EMA

(Coordinator: **Gyula Zilahy**, Hungarian Cleaner Production Centre, Budapest University of Economic Sciences and Public Administration, e-mail: zilahy@enviro.bke.hu)

[3] Education and training on sustainable production

(Coordinator: **Peter Glavic**, University of Maribor, Faculty of Chemistry and Chemical Engineering, e-mail: glavic@uni-mb.si)

[4] Cleaner production policy in transition economy Countries

(Coordinator: **William Zadorsky**, Ukrainian Ecological Academy of Sciences, Ukrainian State University of Chemical Engineering, e-mail: ecofond@ecofond.dp.ua)

[5] Indicators for potential new sustainable technologies

(Coordinator: **Enrico Drioli**, ITM – CNR at University of Calabria, e-mail: e.Drioli@itm.cnr.it)

[6] Waste minimization club

(Coordinator: **Chris Buckley**, Pollution Research Group, University of Natal, e-mail: BUCKLEY@nu.ac.za)



ITM - CNR

Introduction

Presentations

Participants

2004 Host Country

CD Info

Final Remarks

The possibility to organize specific projects to be carried out under the umbrella of the CCMS Pilot Study, with financial sponsorship from International Agencies or other organizations has been also analyzed.

Prof. Drioli suggested, in particular, the use of the FP6 instruments for elaborating specific joint projects on the topics of interest and the creation of a roadmap of the FP6 projects (by ITM-CNR; Italy) suitable for that purpose. Prof. Drioli was asked to elaborate a short report on the opportunities existing in the FP6 of the European Union.

During the meeting technical visits to industrial sites of the region were organized and in particular to:

1. Amarelli Liquorice

C/da Amarelli S.S. 106 - 87068 Rossano Scalo CS (Italy)

tel. +39/0983511219 - fax +39/0983510512

amarelli@mediterranea-net.it, www.amarelli.it

2. OSAS agro-foods

Contrada Ciparsia

87012 Castrovillari (CS)

tel 0981 - 480960 , fax 0981 – 480903

3. Mediterranea R.&S.

Mediterranea R. & S.

C/da Coretto

87046 Montalto Uffugo CS

4. GIAS

Gruppo Industriale Alimenti Surgelati - Mongrassano



ITM - CNR

Introduction

Presentations

Participants

Final Remarks

CD Info

2004 Host Country

At the end of the Workshop the host Country for the 2004 meeting has been chosen:

Hungary!





ITM - CNR

Introduction

Presentations

Participants

Final Remarks

2004 Host Country

Notice

This report was prepared under the auspices of the North Atlantic Treaty Organization's Committee on the Challenges of Modern Society (NATO/CCMS) as a service to the technical community by the United States Environmental Protection Agency (U.S. EPA) and the Institute of Membrane Technology at the University of Calabria, Italy. The views expressed in these proceedings are those of the individual authors and do not necessarily reflect the views and policies of the U.S. EPA. Scientists in EPA's Office of Research and Development have prepared the EPA sections, and those sections have been reviewed in accordance with EPA's peer and administrative review policies and approved for presentation and publication. This report was produced as a result of a cooperative agreement with U.S. EPA's National Risk Management Research Laboratory (NRMRL) and the Institute of Membrane Technology (ITM) at the University of Calabria, Italy. This report was produced and edited by Dr. Maria A. Liberti, ITM, and reviewed by Mr. Daniel J. Murray and Dr. Subhas K. Sikdar of NRMRL. Mention of trade names or specific applications does not imply endorsement or acceptance by U.S. EPA or the University of Calabria.

EPA/625/C-03/009
NATO Report Number 266
December 2003
www.nato.int/ccms

A Review on the Membrane Research Activities in Italy

Prof. Enrico Drioli

Research Institute on Membrane Technology, c/o
University of Calabria, Via P. Bucci, cubo 17/c,
Rende (CS), Italy

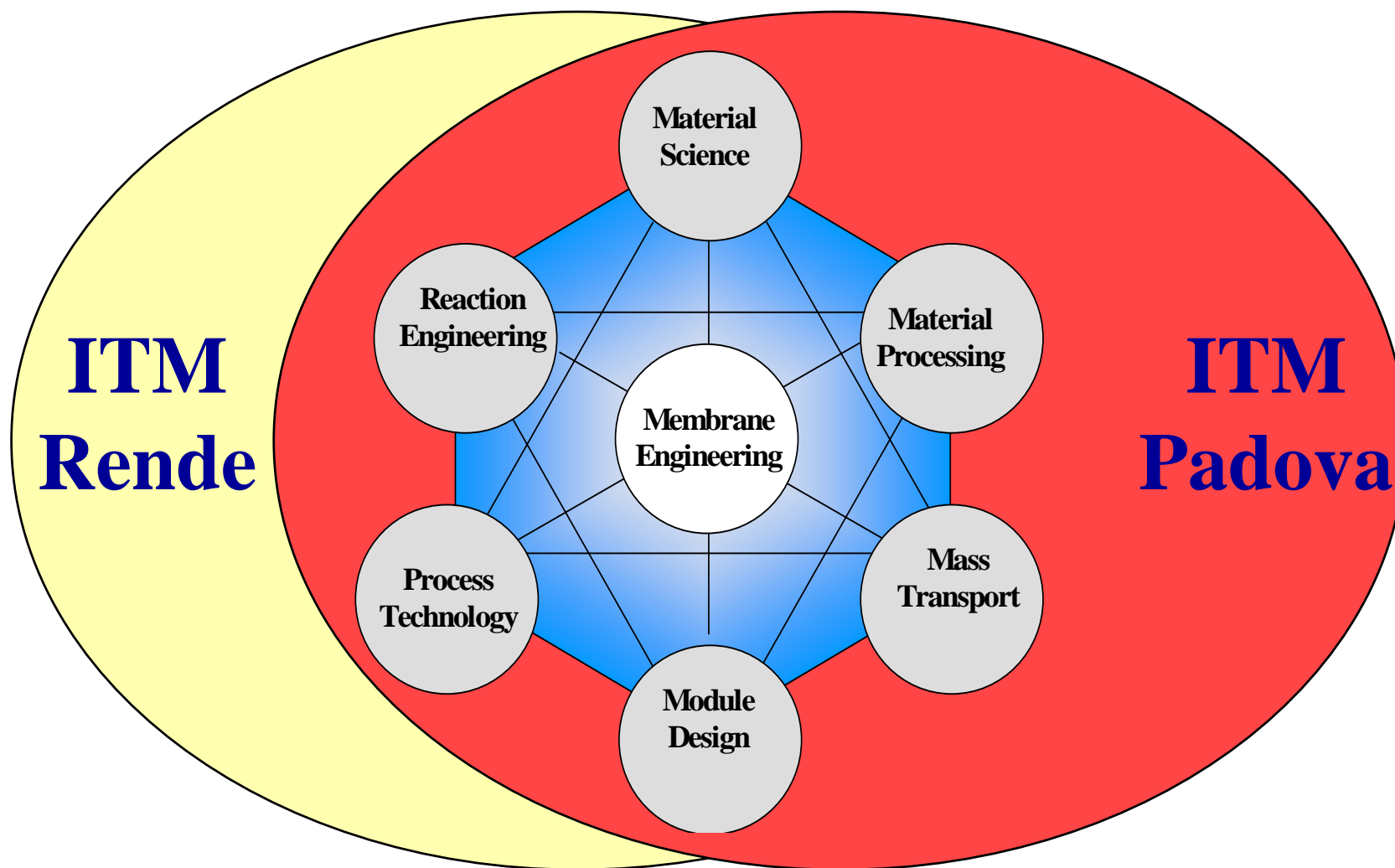

Membrane Science

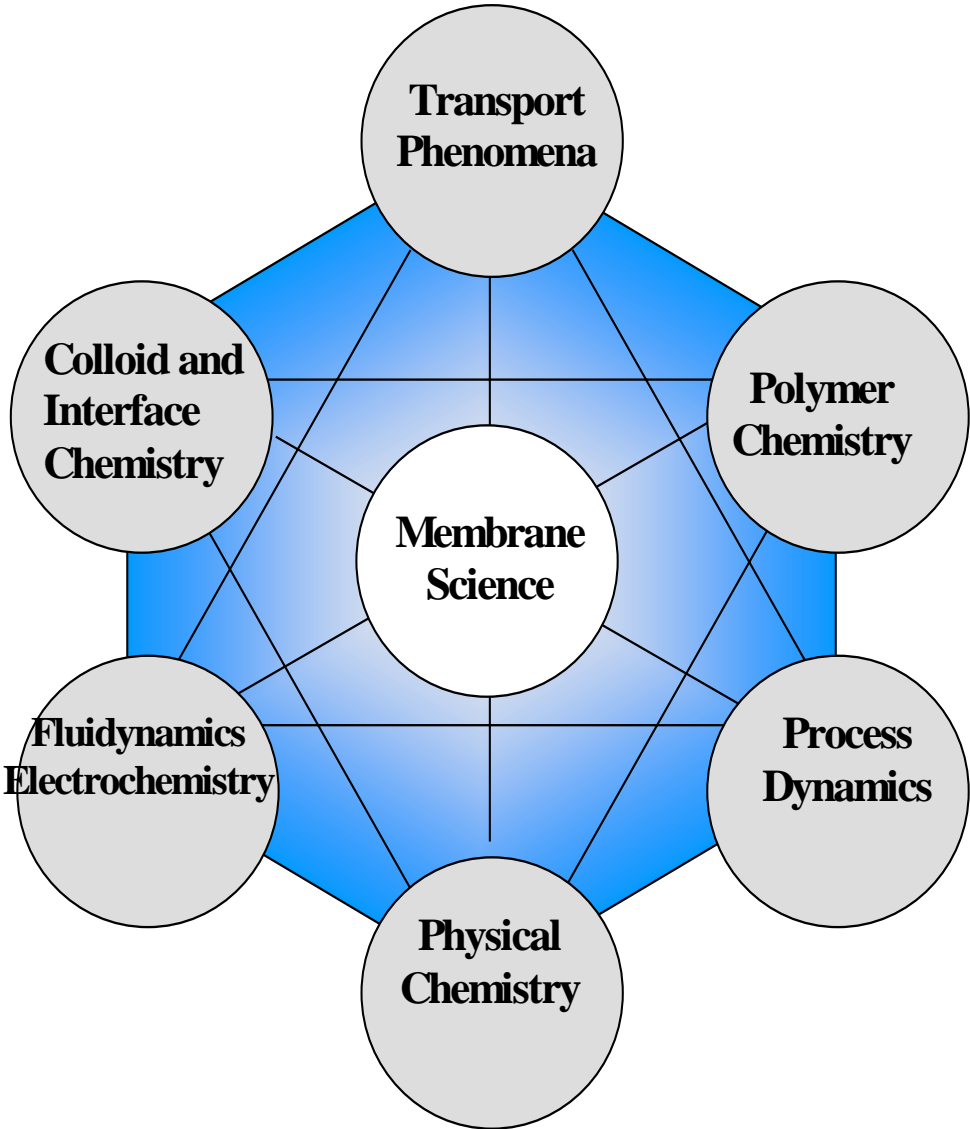

- **Section Rende**
c/o Università della Calabria
Via Pietro Bucci, cubo17/C,
87030 Rende, Italy
Tel.:0984 492039/402706
Fax.:0984 402103
E-mail: e.drioli@itm.cs.cnr.it
- **Section Padova**
c/o Dipartimento di chimica
organica. Università di Padova
Via Francesco Marzolo 1,
35131 Padova, Italy
Tel.:0498 275261/8275253
Fax.:0498 275 239
E-mail:
gianfranco.scorrano@unipd.it
- Director : Prof. Enrico Drioli
- Permanent researchers : **XXX**
- Other staff : **XXX**
- PhD students : **XXX**
- Contracts, scholarships : **XXX**
- Others : **XXX**
- Responsible : Prof. Gianfranco Scorrano
- Permanent researchers : **XXX**
- Other staff : **XXX**
- PhD students : **XXX**
- Contracts, scholarships : **XXX**
- Others : **XXX**

- The **Institute on Membrane Technology (ITM-CNR)** is a structure created by the National Research Centre of Italy (CNR – Consiglio Nazionale delle Ricerche) for the development, at national and international level, of membrane science and technology.
- The Institute is located in the existing structure of the **University of Calabria, Rende (Cosenza)**, and has a section located at the **University of Padova** (which is involved in the synthesis of new materials to be used in the preparation of membranes).

Personnel

- The Institute has **28 units of permanent staff** and about **30 temporary units** constituted by visiting professors, researchers, Ph.D. students, post-doctoral fellowships, high-educational fellowships from **national and international Institutions**.
- It is a **multidisciplinary Institute** based on backgrounds in chemical engineering; process engineering; chemistry (organic and physical); biological science; food science; material science and physics.

Collaborations

- A significant **exchange of young researchers**, e.g. with Spain, France, Holland, Slovakia, Poland, Russia, Algeria, Argentina, South Korea, China, Japan, USA, is strongly encouraged to **integrate research activities at international level**.
- Formal **bilateral and multilateral agreements** with Japan, South Korea, China, Russia, France, Marocco, and Egypt have been approved.

Research activities

- The activity of the Institute is focused on the **research and development of membrane science and technology**. The main research activities are related to the following topics:
 - 1 Catalytic membranes and catalytic membrane reactors;
 - 2 Integrated membrane operations;
 - 3 Membrane distillation and membrane contactors;
 - 4 Membrane preparation and characterisation;
 - 5 Fundamental studies of transport phenomena in organic and inorganic membranes.
 - 6 Polymeric membranes for artificial organs

Examples of research topics

- Catalytic membranes and catalytic membrane reactors
 - Inorganic membranes,
 - *e.g.* steam reforming, partial oxidation of methane to syngas
 - Biocatalytic membranes
 - *e.g.* enzyme membrane reactions, continuous membrane fermentations, enantioselective membranes
- Integrated membrane operations. Integration of classical engineering processes with membrane separation technology
 - Wastewater treatment and product recovery in leather industry
 - Production of fruit juices
 - Etc..

Examples of research topics (2)

- Membranes as artificial organs
- Membrane distillation and membrane contactors
 - Potable water production from seawater and brackish water
 - *Water/alcohol separations*
 - *Purification of physiological solutions*
 - *Preparation of water with controlled gas composition*
- Transport phenomena in organic, inorganic and hybrid membranes
 - Experimental study of fundamental aspects of mass transport in relation to membrane preparation and membrane structure.
 - Theoretical support by molecular dynamics simulations.

- 1 Understanding transport phenomena through membranes by theoretical studies of weak intermolecular interactions
- 2 Catalytic membranes and degradation of organic pollutants
- 3 Polymeric membranes incorporating fullerenes and nanotubes
- 4 Transition metal complexes in membrane-mimetic systems
- 5 Supramolecular chemistry. Reactivity and molecular recognition in micelles, vesicular aggregates and polymeric membranes

Some new technologies

Membrane contactors

Membrane crystallizers

Emulsion membrane reactors

Selection of collaboration projects of ITM-CNR

Brite-Euram1
Grace
PERMOD
Murst
INCO-Copernicus

Research activities on membranes in **academic institutes** in Italy

- University of Calabria
 - see also ITM-CNR
- University of Turin
 - Polymers for membrane formation, synthesis and applications
 - Molecular imprinting polymers
 - Inverse phase transfer catalysis
 - Bioremediation of waste water
- Polytechnic of Milan
 - Material properties and transport phenomena of membranes
- University of Perugia
 - Inorganic and protonic membranes for fuel cells

Academic research activities (2)

- University of Genua
 - UF, MF, RO, PV, Membrane reactors
 - Wastewater treatment
- University of Bologna
 - Membrane separations and diffusion in polymers
 - Thermodynamics and thermomechanical properties of polymeric fluids
 - Chemical processes in microelectronics
 - Catalytic membranes and kinetics of heterogeneous processes
 - Membrane distillation
 - Pervaporation
- University of Palermo
 - Anodic ceramic membranes

Membrane processes and research activities in the **Italian industry**

Industrial membrane activities

- Membrane activities in the Italian industry concern both **application** and **research**, and are currently experiencing a **strong growth**.
- Typical examples are in food and dairy industry, energy conversion, (waste)water treatment, electrochemical applications, integrated processes *et cetera*.
- Many R&D projects are carried out in **close collaboration** with other research institutes and are **financed by the European Union and national government**.
- There is no more industrial production of new membranes in Italy

- Belco SpA - Biomedical applications
- FilterPar Srl - Water treatment (UF, MF)
- Millipore SpA - Pure and ultrapure water (sales in Italy)
- Permacare - Water treatment (RO, NF, UF, MF)
- Separem - Impermeable and breathable tissues

Raw material production

- Ausimont - Production of fluorinated polymers

Water and wastewater treatment

- Purification, demineralisation, Ind. effluent recycling
 - Bono Sistemi SpA
- Equipment manufacture
 - Culligan Italiana
 - Hydro air research
 - FDT Srl
 - Hytek Srl
- Water purification, pyrogene-free steam production
 - Stilmas SpA
- Technology development
 - Tecnomil

- Impianti Elettrochimici O. De Nora
 - Chlor alkali plants to produce chlorine, caustic soda, caustic potash, and downstream derivatives such as hydrochloric acid and sodium hypochlorite.
 - Materials and services for mercury and diaphragm chlor-alkali plants and their revamping and upgrading.
- Tecno Project Industriale
 - Treatment of air and industrial gases
 - CO₂ production and recovery

Miscellaneous membrane operations

- Purification of pharmaceutical products & intermediates
 - Bracco SpA
- Filtration and filtration equipment manufacture
 - Diemme Filter division
- Filtration, concentration, purification in pharmaceutical, chemical, biotechnological, food and beverage industry. Membrane processes and membrane unit production.
 - Koch Membrane Systems
 - Permeare Srl

Selected institutions

- The *National Institute for Alternative Energy* (*ENEA*) was founded to study the use of nuclear energy. With the decision of the Italian government to **freeze the use of nuclear energy**, ENEA has focussed on **new energy sources** and on **new processes for energy conversion**:
- Membrane and Membrane Reactor development
 - Metal membranes, Integrated systems separator/reactor
- Process development
 - Methanol partial oxidation, water gas shift reaction, hydrogen purification, fuel cells

De Nora Group

- The *De Nora Group* was originally established to design, manufacture and install **electrochemical plants, electrolyzers and electrodes.**



- Nuvera Fuel Cells, one of the joint ventures of the De Nora Group, is an international company based in Milan and Cambridge (USA), producing from small portable fuel cell units to large industrial power plants.
- Nuvera has extensive collaborations with ITM-CNR in the development of combustion cells and membrane reactors.



1 kW Hydrogen
Power Module

www.nuvera.com



Enel GreenPower
CNR-ITM

Membrane systems for the
treatment and valorization of gas
emissions from geothermal plants

PROPOSTA DI RICERCA AI SENSI D.M. 593, Art. 5

⇒ Enel GreenPower: Firms controlled by Enel and finalized to the production of renewable energy (geothermal, mini-hydro, wind, photovoltaic, biomass, and biogas plants)

Via Andrea Pisano, 120 - PISA

⇒ CNR-ITM: Istituto per la Tecnologia delle Membrane
c/o Università della Calabria, Arcavacata di Rende (CS)

Waste gaseous fraction emission

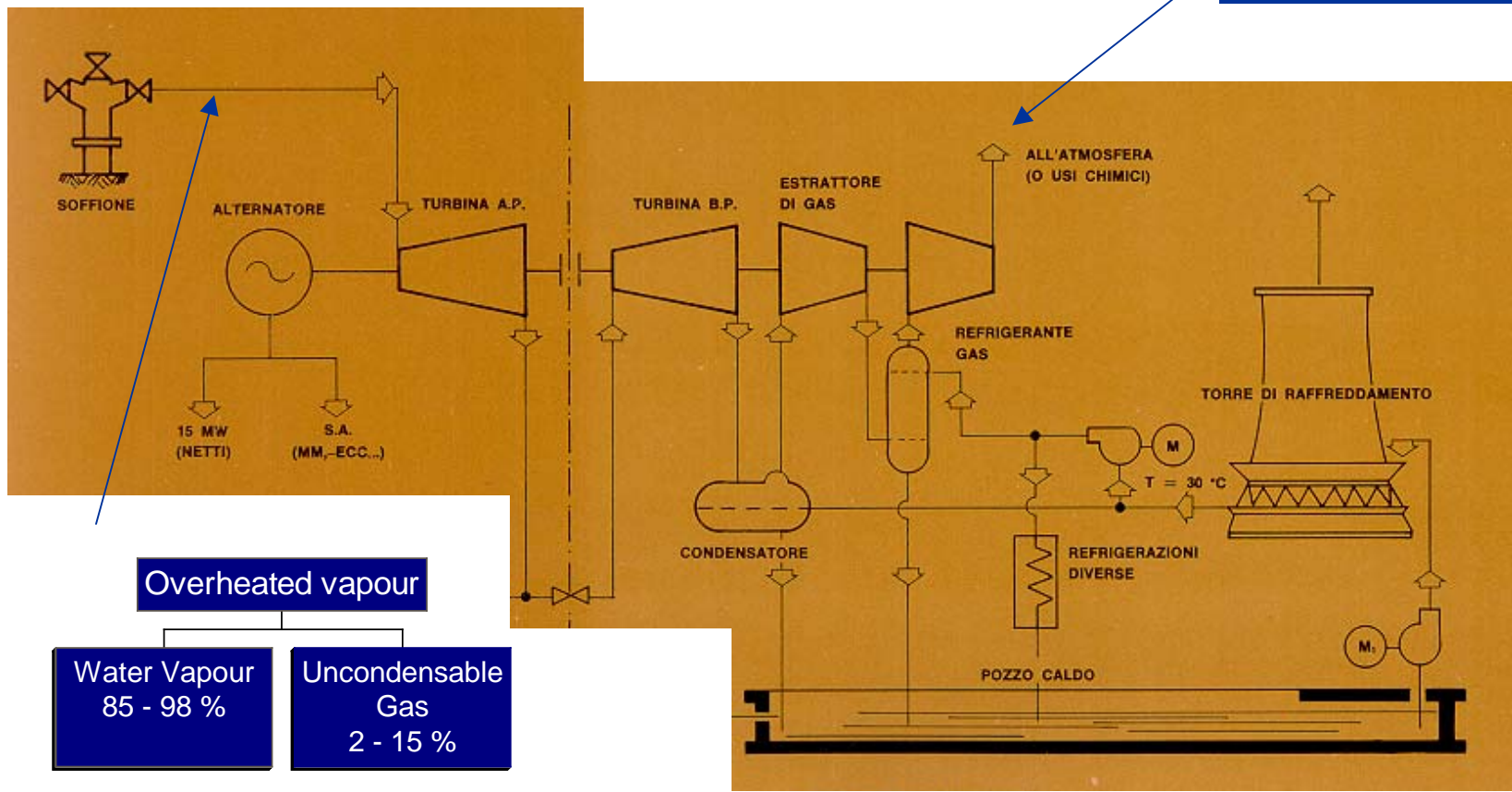

Overheated vapour

- Water Vapour 85 - 98 %
- Uncondensable Gas 2 - 15 %



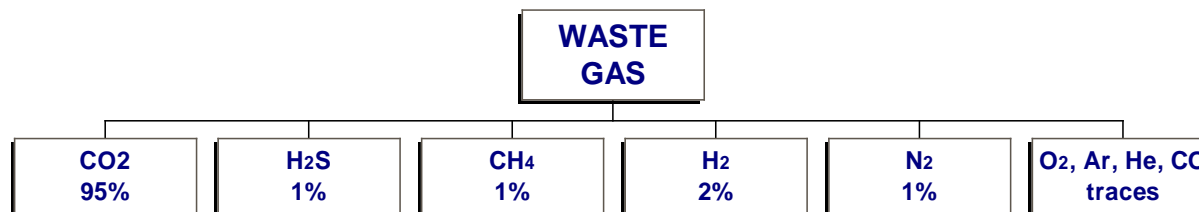

Residual Geothermic Gas is regulated by the actual legislation as waste and it's subjected to a specific control

Being able to transform this critical problem in an opportunity through the application of innovative technology of membrane systems is the aim of this project.

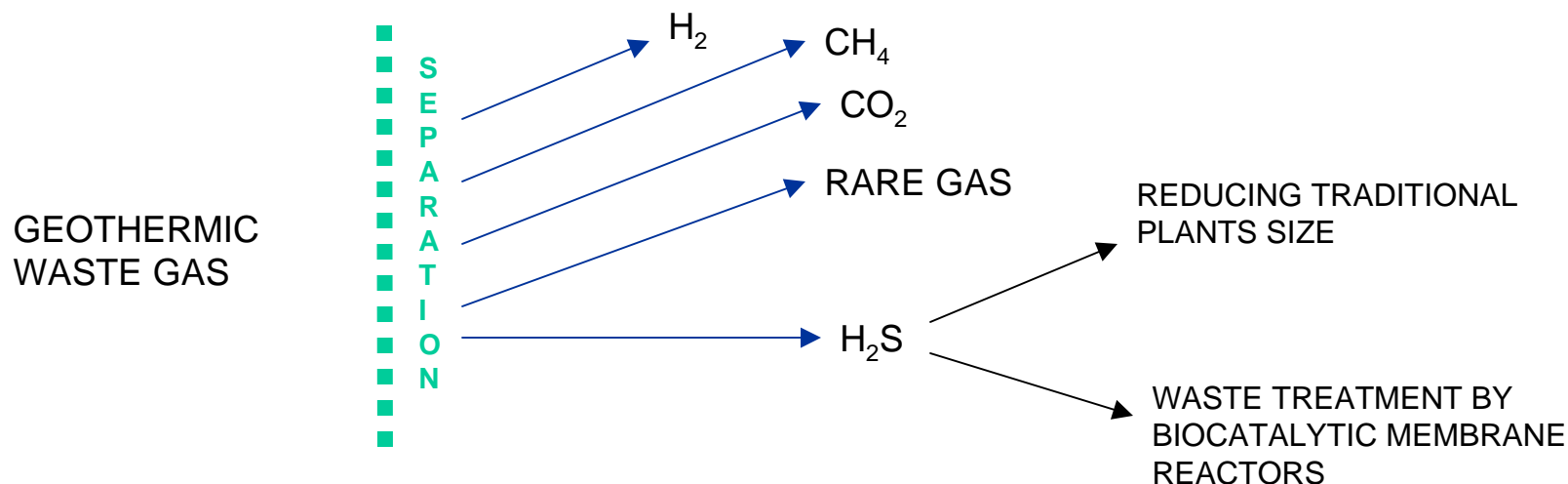

- Separation through membrane systems of gaseous components and recovery of those commercially or energetically of interest (CO₂, H₂, CH₄)
- H₂S separation from waste fluid: size reduction of traditional plants
- H₂S reduction through biocatalytic membrane reactors

H₂S REDUCTION THROUGH BIOCATALYTIC MEMBRANE REACTORS

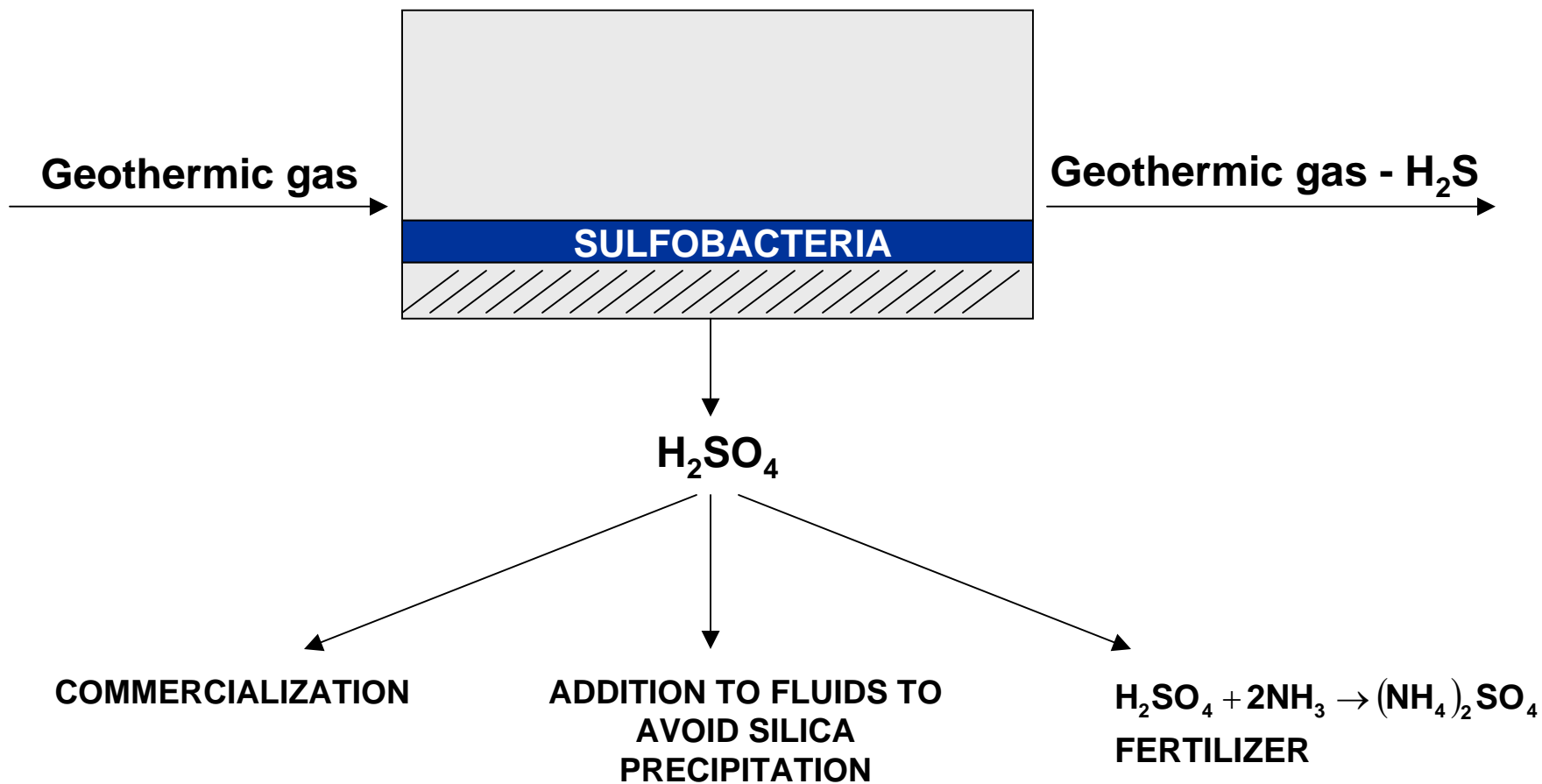

⇒ SIDE PROCESS OF GAS **COMMERCIALLY (CO₂) AND ENERGETICALLY (H₂, CH₄) OF INTEREST** ASSOCIATED TO THE TRADITIONAL PROCESS OF GEOTHERMAL PRODUCTION

⇒ REALIZATION OF **LOW BUDGET PROCESSES OF H₂S SEPARATION AND TREATMENT** (⇒ reduction of the volumes involved through separation of H₂S from total gas; ⇒ biocatalytic conversion)

⇒ POSSIBILITY OF EXPLOITING GEOTHERMIC RESERVOIR RECENTLY NOT in USE (low entalpic fluids but rich in uncondensable gas)

⇒ **INNOVATIVE AND PATENTABLE KNOW-HOW** (innovative use of membrane systems)

- Tecnoalimenti is a **non-profit organisation** dedicated to promotion and execution of **research programs in the food sector**, in particular focussed on the **small and medium enterprises**. Activities further comprise feasibility and market studies, financial consultancy, implementation of quality systems, scientific publishing and organisation of conferences.
- Tecnoalimenti collaborates with numerous other companies in the food sector and other institutes such as **ITM-CNR**
- A selection of the research projects involves wastewater treatment, cheese production methods, recovery of useful products from wine production waste.

- Traditionally one of the strong industries in Italy.

e.g. Parmalat has membrane based processes for, and corresponding research efforts in the field of:

- production of calcium-enriched milk
- milk and cream concentration for production of yoghurt and typical cheeses
- production of long-lasting milk by pasteurisation through membranes
- production of clear fruit juices
- demineralisation of water

Conclusions and outlook

- Membrane research has a **bright future** in Italy. An increasing attention for a **healthy environment, low energy consumption** and **increased product quality** will promote the application of membrane based-processes.
- Considerable growth is expected in the traditionally strong industries, such as the food, beverage and dairy industry, and the leather and textile industry, which have a relatively high environmental impact.
- Among the many other promising sectors, also on a world-wide scale, are drinking water production and new processes for energy conversion (*e.g.* fuel cells).

NATO CCMS Pilot Study on Clean Products and Processes Phase II

Sixth Annual Meeting
Cetraro, Italy
Meeting Overview

Dan Murray, Co-Director

Meeting Organizers

- Professor Enrico Drioli
- Ms. Alessandra Criscuoli
- Ms. Mariella Liberti
- Dr. Subhas Sikdar

Program Overview

- Technical Program
 - Workshop on Environmental/Sustainability Indicators
 - Topical Symposium on Process Intensification
- Field Trip/Industrial Visits
- Special Events
- Closing Session

Technical Program

- Workshop on Environmental/Sustainability Indicators
- Pilot Project Updates
- Delegate Open Forum
- Topical Symposium on Process Intensification
- Tutorial on Setting Up Waste Minimization "Clubs"

Field Trip/Industrial Visits

Amarelli Liquorice

OSAS Agro-Foods

Mediterranea R.&S.

Altomonte

Church of Santa Maria della
Consolazione

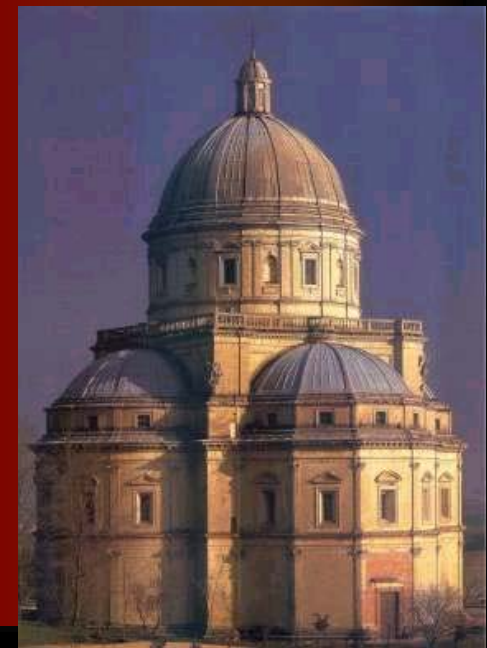

Special Events

- Institute on Membrane Technology (ITM)
- Rector of the University of Calabria
- Mayor of Cosenza City
- Dinner in Old Cosenza/Rende



Closing Session

- 2002 Annual Report Presentation
- Evaluation of Progress of Pilot Study
- Topics and Focus for 2004 Meeting
- Selection of Host Country and Dates for 2004 Annual Meeting
- Meeting Wrap Up

We'll Remember the Technical Presentations...



...the Beautiful Sights...



...the VIPs...



...the Food and Drink...



...the Dancing...



...and the Friends and Colleagues!





NATO CCMS Pilot Study on Cleaner Products and
Processes

2002 5th Annual Meeting
Vilnius, Lithuania

SUMMARY

Prof. Jurgis K. STANIŠKIS

*The Institute of Environmental Engineering, Kaunas
University of Technology, Kaunas, Lithuania*

Technical data

Number of participants

46



Meeting with President of the Republic of Lithuania Valdas Adamkus at the Presidential Palace

Technical data

Countries

Germany, Czech Republic,
Ukraine, Bulgaria, Poland,
Italy, Sweden, Russia, UK,
Spain, USA, Denmark,
Portugal, Turkey, Norway,
Hungary, Moldova,
Slovenia, Lithuania



Representative
of UNEP



Technical data

Number of presentations 27

Number of Tour de Table
Presentations 10



Technical data

Visited companies:

1. JSC "Alytaus tekstilė"
(textile)

2. JSC "Snaigė"
(refrigerator production)

3. JSC "Alita"
(wine and sparkling wine)



Technical data

Special topic: Industrial Ecology



Arunas Kundrotas
Minister of
Lithuanian Ministry
of Environment



Prof. Lennart
Nielsen
Royal Stockholm
Technical Institute
(Sweden)



Nerijus Datkunas
Financial director
JSC "Utenos
trikotazas"



Arunas
Pasvenskas
General director
JSC "Klaipedos
kartonas"

Selected papers for the journal “Clean Technologies and Environmental Policy”

1. Huhtala A. “Strategies and Mechanisms to Promote Cleaner Production Financing”
2. Staniskis J.K., Stasiskiene Z. “Cleaner Production Financing: Possibilities and Barriers”
3. Staniskis J.K., Arbaciauskas V. “Industrial Ecology in University Curricula: New International MSc Programme in Cleaner Production and Environmental Management”
4. Fet A. “Industrial Ecology and Eco-Efficiency. Introduction to the Concepts”
5. Karlsson M. “Extended Producer Responsibility in Cleaner Production”
6. Kruopiene J. “Chemicals Risk Management in Enterprises”



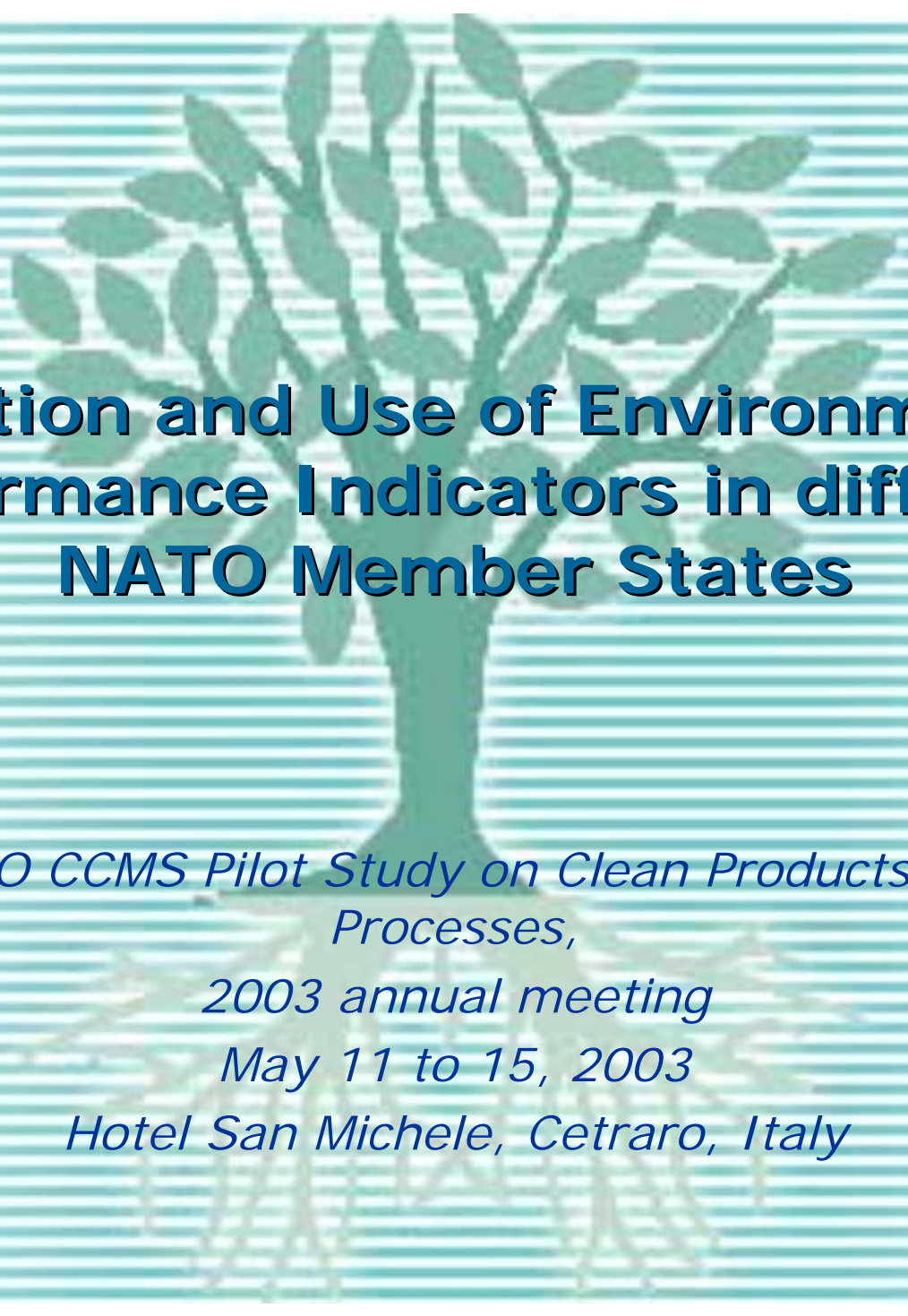

Selection and Use of Environmental Performance Indicators in different NATO Member States

*NATO CCMS Pilot Study on Clean Products and
Processes,
2003 annual meeting
May 11 to 15, 2003
Hotel San Michele, Cetraro, Italy*

What is an indicator?

An indicator depicts a detail of a complex phenomenon ...



- the way an increased temperature indicates the condition of one physiological function, but not of the body as a whole-

... Sustainable development is a complex phenomenon.



Economy



Environment



Society

Environmental Indicators on different levels

➤ (inter)national level

actors: political decision-makers

information on national environmental issues

(e.g. annual CO₂-emissions per capita, acidification of soils ...)

➤ regional/ local level

actors: political decision-makers, local authorities, public

information on regional environmental issues

(e.g. annual CO₂-emissions due to industrial areas or volume of motorvehicle traffic, damage to forests in the region ...)

➤ organisational level

actors: management

information on organisational environmental issues

(e.g. annual CO₂-emissions of one process/ facility, NO₃-concentration in nearby river ...)

Environmental Indicators for Organisations

- Avail -

Environmental Performance Indicators can be used to:

- identify weak points in production processes
- compare facilities, parts of organisations or organisations with each other (= benchmarking) or over timelines
- support ongoing improvement processes in areas, where emissions and material intensities can be influenced by employees
- present and analyse trends for internal purposes
- present environmental performance of organisation in external communication

Environmental Indicators for Organisations

– Selection Criteria -

... for Indicators:

- **Significance**

⇒ concerning organisation's activities and their environmental impacts

- **Sensitivity**

⇒ to reflect changes in environmental impacts

- **Measurability**

⇒ of the respective issue

Environmental Indicators for Organisations

– Selection Criteria –

... for Indicator Systems:

- **Comparability**
 - ⇒ timelines comparison and benchmarking
- **Balance**
 - ⇒ good and bad aspects of performance
- **Continuity**
 - ⇒ assessment over same time units
- **Timeliness**
 - ⇒ update frequency allowing action to be taken
- **Clarity**
 - ⇒ clear and understandable indicators

Environmental Indicators for Organisations – Categories –

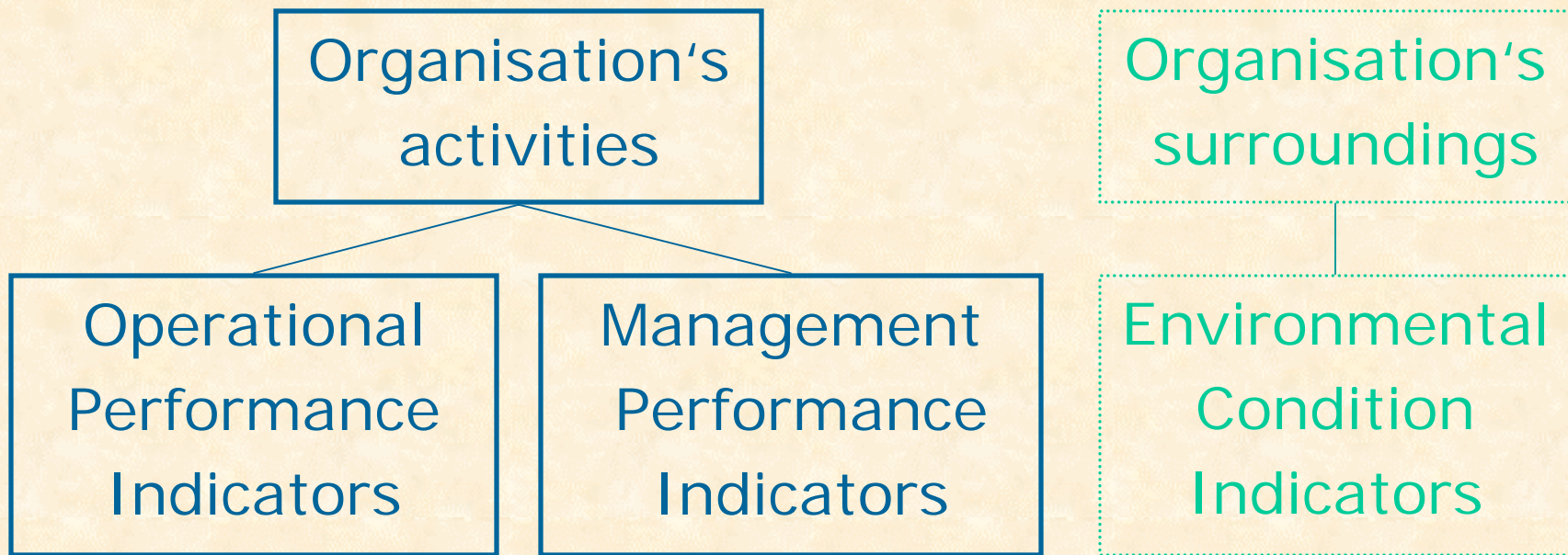

Environmental Indicators for Organisations – Framework -

OPERATIONAL PERFORMANCE INDICATORS (OPIs)			MANAGEMENT PERFORMANCE INDICATORS (MPIs)		ENVIRONMENTAL CONDITION INDICATORS (ECIs)	
1			2		3	
INPUT INDICATORS	PHYSICAL FACILITIES AND EQUIPMENT INDICATORS	OUTPUT INDICATORS	SYSTEM INDICATORS	FUNCTIONAL AREA INDICATORS	ENVIRONMENTAL MEDIA INDICATORS	BIO- AND ANTHROPO- SPHERE INDICATORS
1.1	1.2	1.3	2.1	2.2	3.1	3.2
Materials	Design	Products provided by the organisation	Implementation of policies and programmes	Administration and planning	Air	Flora
1.1.1	1.2.11.3.1	2.1.1	2.2.1	3.1.1	3.2.1
Energy	Installation	Services provided by	Conformance	Purchasing and	Water	Flora

Environmental Indicators for Organisations – Implementation and Use –

Determination of significant environmental issues

Data Collection and Analysis

Development and Establishment of Indicator System

Regular Update

Regular Revision of Indicator System

external communication

internal controlling:
material-/ energy flows
improvement potentials



Environmental Indicators for Organisations – Development -

... In practical context of ...

**Environmental
management systems
(EMS)**

*(e.g. EMAS 761/ 2001, ISO
14001)*

Environmental Reporting

*(may be part of EMS, e.g. in the
case of EMS certified after EMAS
761/ 2001 or ISO 14001)*

... In research projects & standardisation initiatives:

**Indicator Systems
(intersectoral)**

*(e.g. ISO 14031/ TR 14032,
GRI, WBCSD)*

**Sector Specific Indicator
Systems**

*(EPI Finance, CEFIC
„Responsible Care“)*

Environmental Indicators for Organisations - International Standards and Projects -

General indicator systems:

- ISO 14031 „**E**nvironmental **P**erformance **E**valuation“/
TR 14032 „Examples of **EPE**“
- WBCSD „Measuring Eco-Efficiency – A Guide to reporting
Eco-Efficiency“ (2000)
- GRI „Sustainability Reporting Guidelines“ (2002)

Sector specific indicator systems:

- EPI Finance (2000)
- CEFIC „Responsible Care“ (started 1985)

Environmental Indicators for Organisations

- Present Use -

- Common practice: use of a few indicators for external communication (e.g. in environmental reporting)
- Few organisations employ full, consistent indicator framework as an internal controlling instrument (e.g. in environmental cost accounting)
- Up to now, no comprehensive up-to-date survey on the use of indicators by organisations exists

Suggestion

Compilation of an Information pool concerning the application of environmental indicators in organisations:

- Which and how many indicators are used?
- How many organisations make use of full indicator frameworks?
- What are dominant motivations for use of indicators?

as a helpful tool for:

- Organisations in the process of implementing indicators,
- Benchmarking among organisations already using indicators

Example:

1. Operational Performance Indicators

1.3. Output Indicators

1.3.3 Wastes Indicators

Example: Pharmaceuticals & Biotechnology
Aventis SA, France

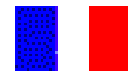

Hazardous Waste

Hazardous Waste Generated

in absolute

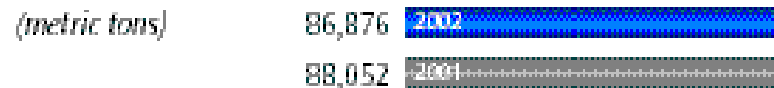

and relative figures



2002 (metric tons)	Prescription Drugs	Human Vaccines
recycled	20,348	1,001
incinerated	63,588	1,148
landfilled	685	105

taken from: 2002 Sustainability Report

Life Cycle (Impact) Assessment



Dr. David Pennington

Soil & Waste Unit

Institute for Environment & Sustainability

Joint Research Centre

European Commission

(david.pennington@jrc.it)

Available Impact and Resource Consumption Indicators

Illustration of Life Cycle Assessment

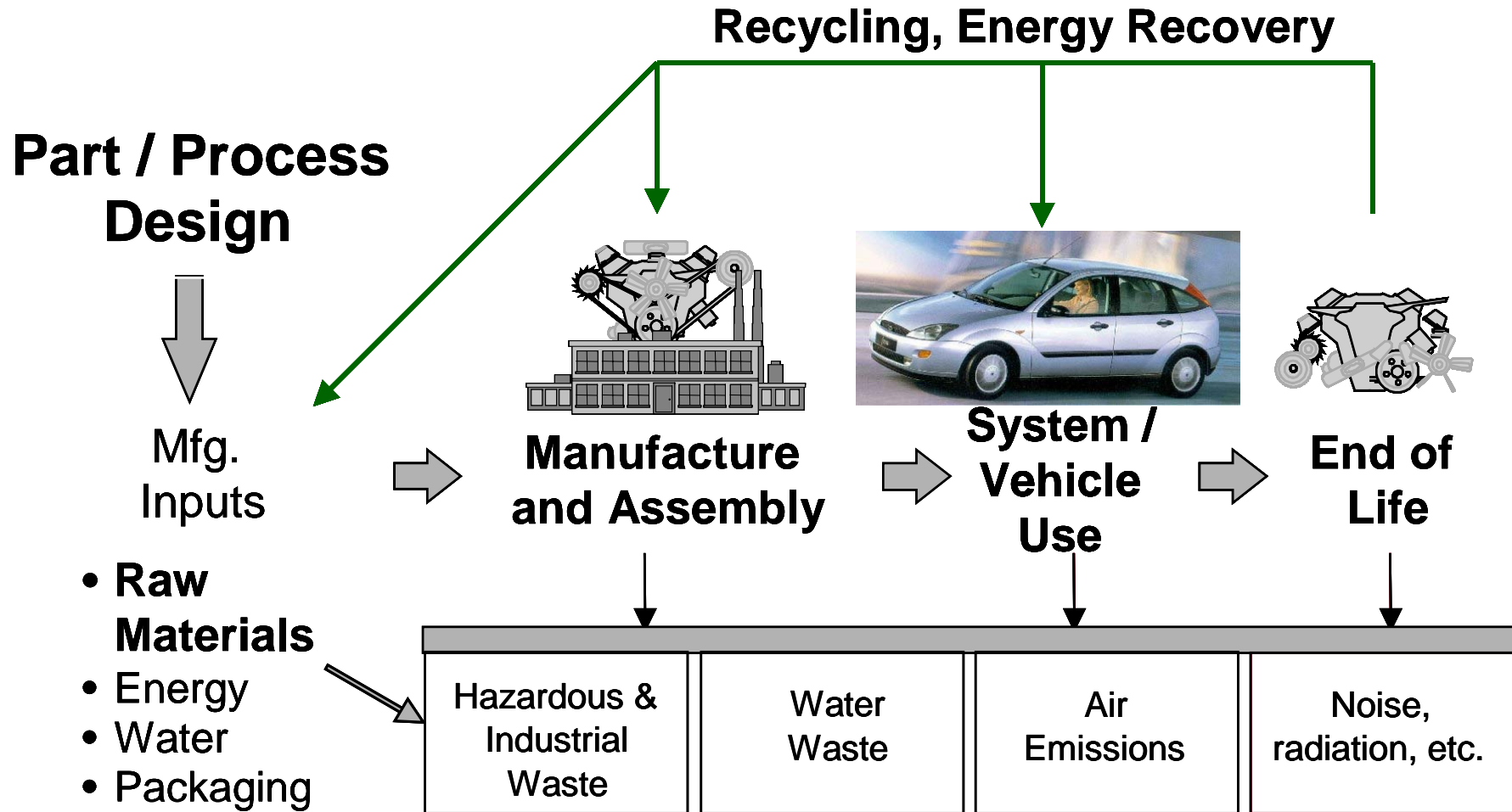

Life cycle of an automobile (Adams and Schmidt 1998)

Emissions Inventory

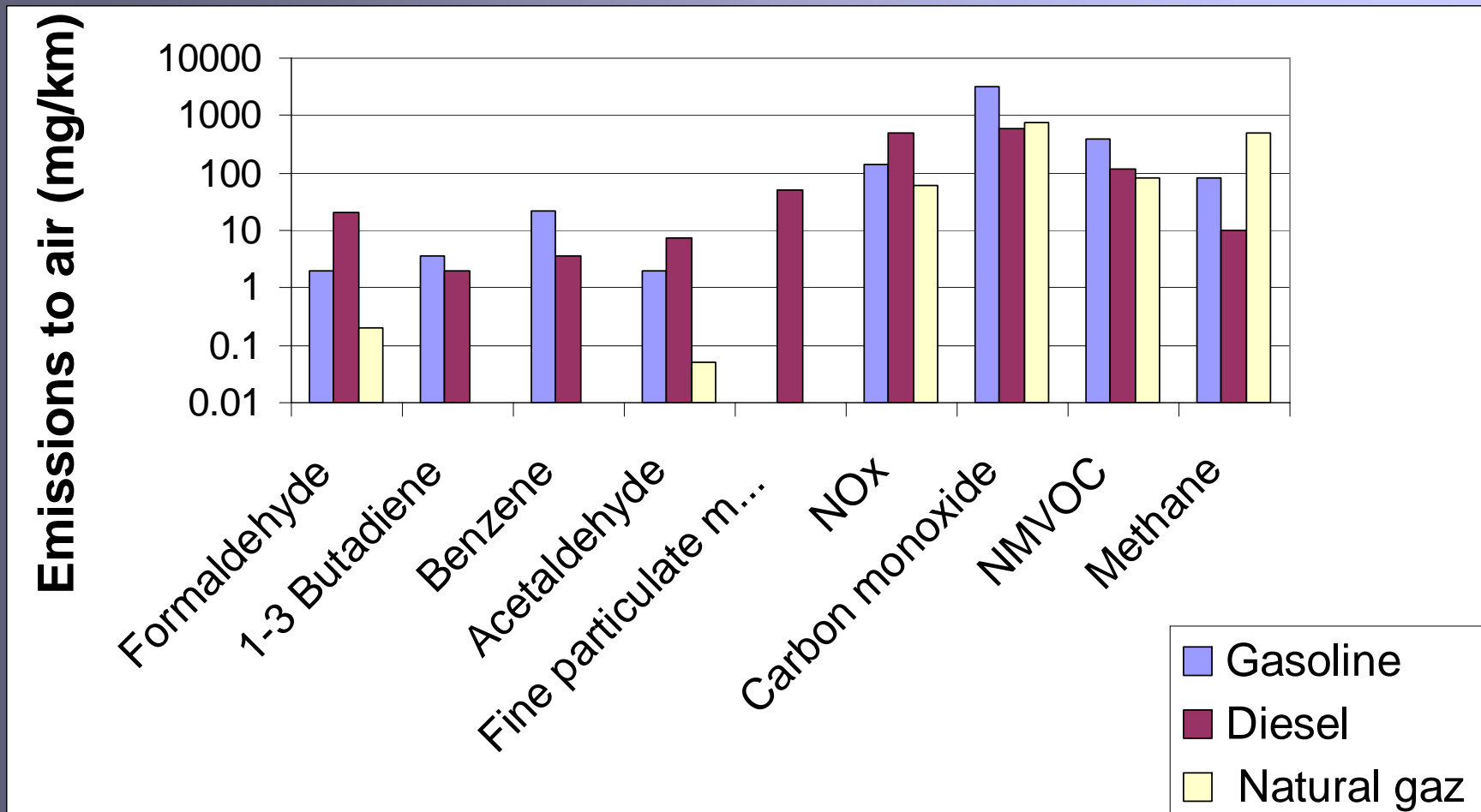

Risk & Impacts (for Diesel Vehicles)

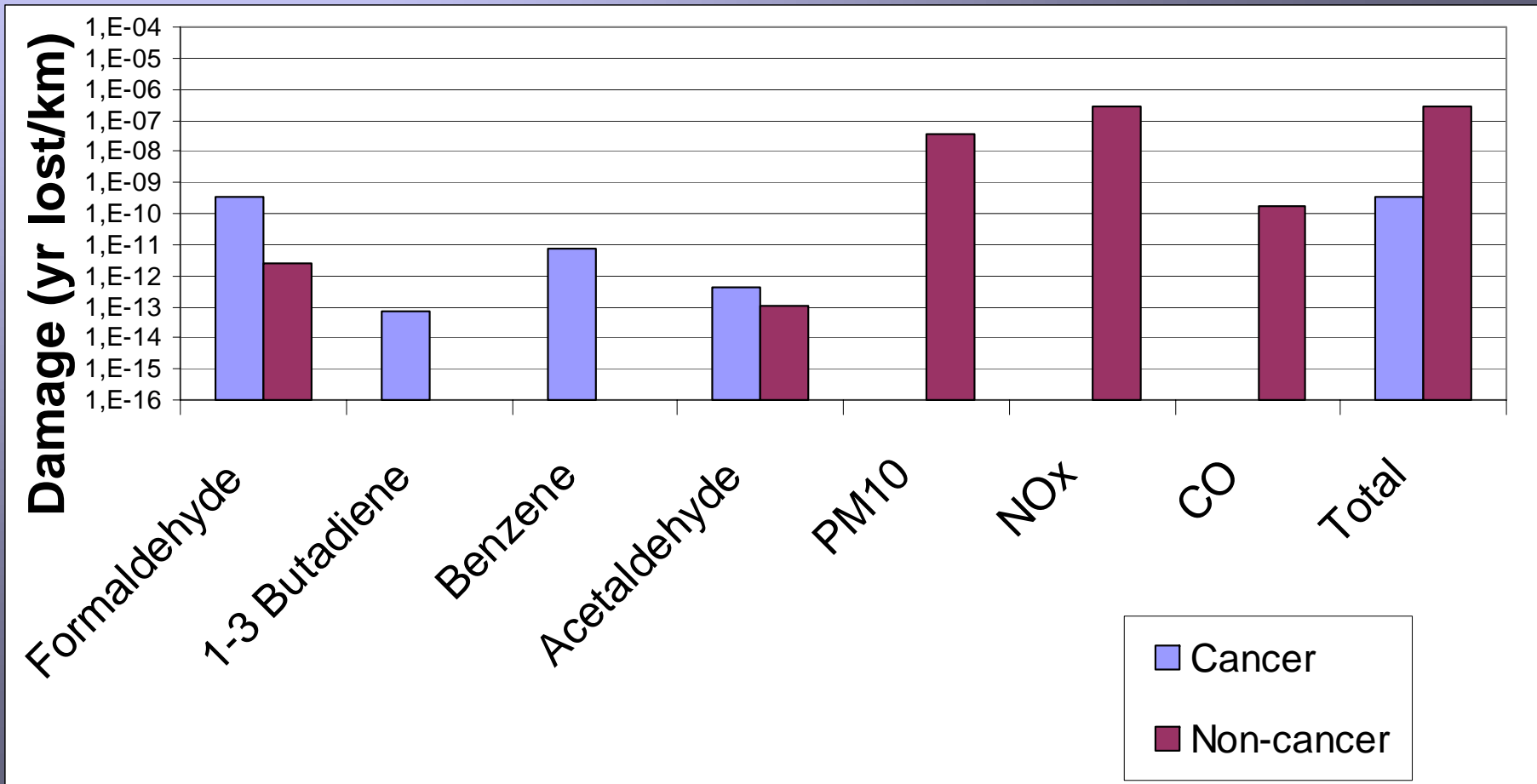

Comparisons: Different types of fuel use

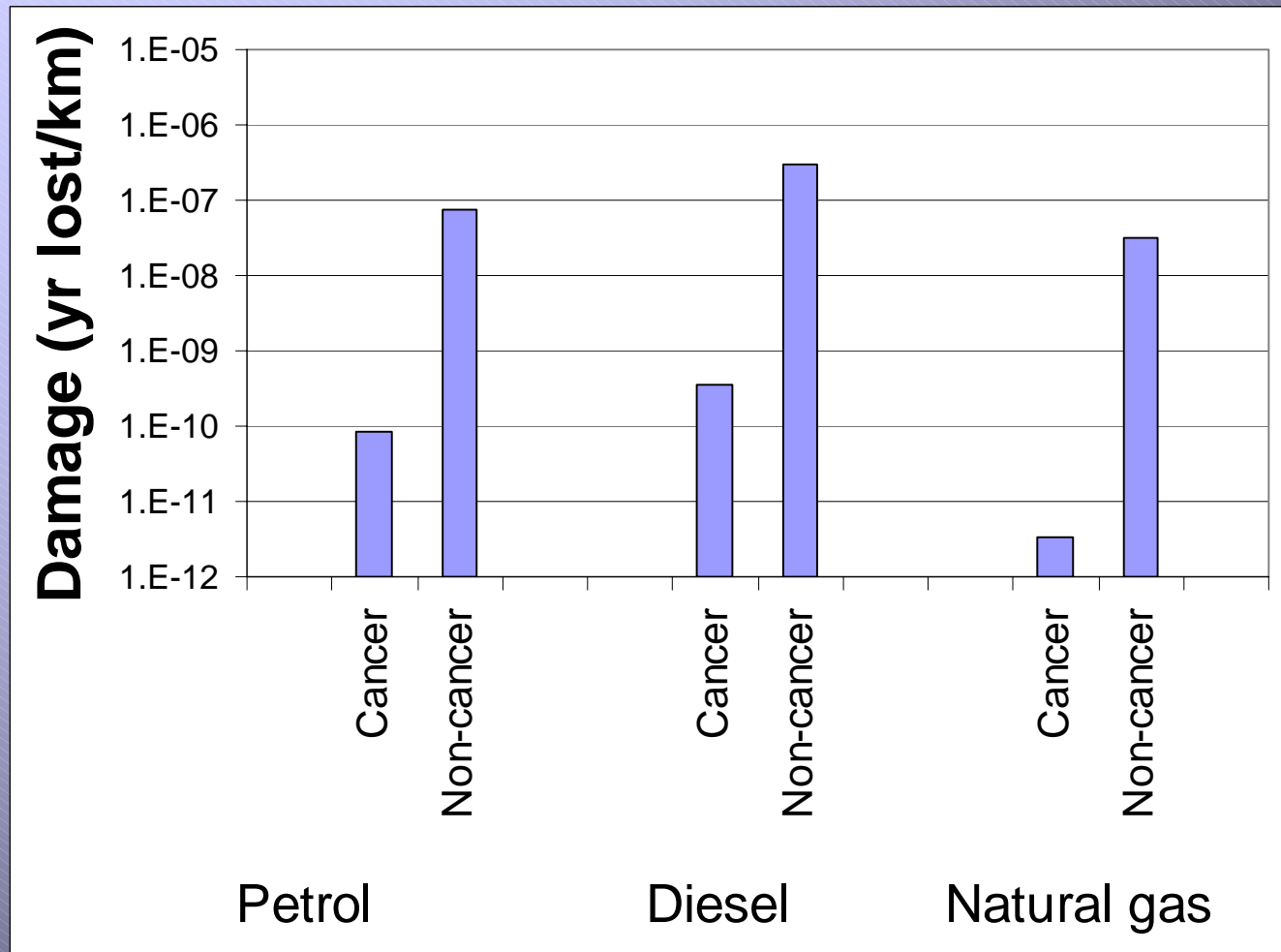

- Diesel causes: 4 times more damage than petrol
10 times more than natural gas

Emissions to Accidents (Annual impacts)

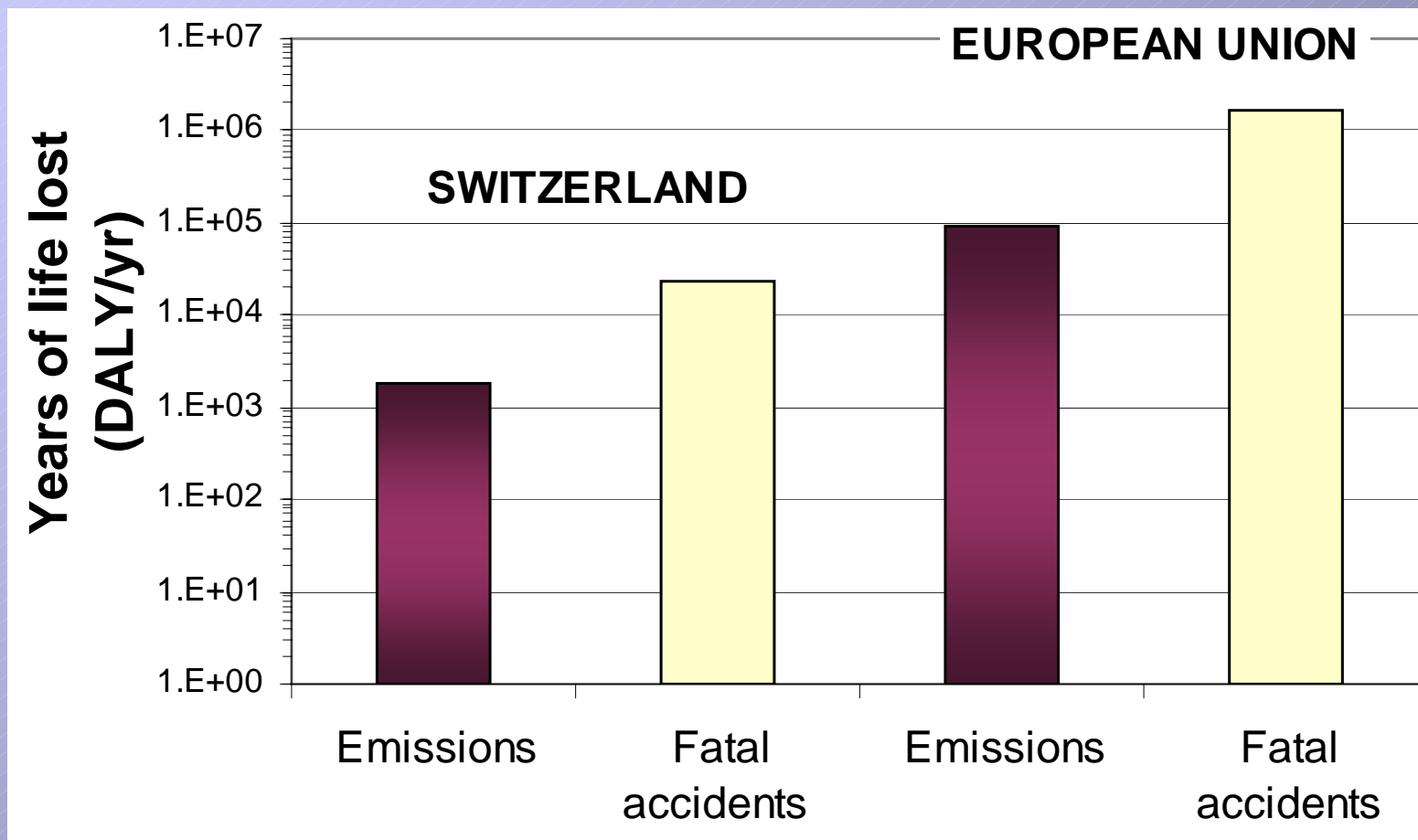

Damage of emissions on human health equivalent to 6 - 8 % fatal road accidents

In terms of Money?

- **For 100 km:**

	Human health	Fuel
Gasoline:	0.7 Euro	8.1 Euro
Diesel:	2.9 Euro	4.5 Euro
Natural Gas :	0.3 Euro	
- **Switzerland per year: 380 millions Euro**
(3.5 million cars, 13,790 km/car, 100,000 Euro per DALY)

Why the big LCA picture?

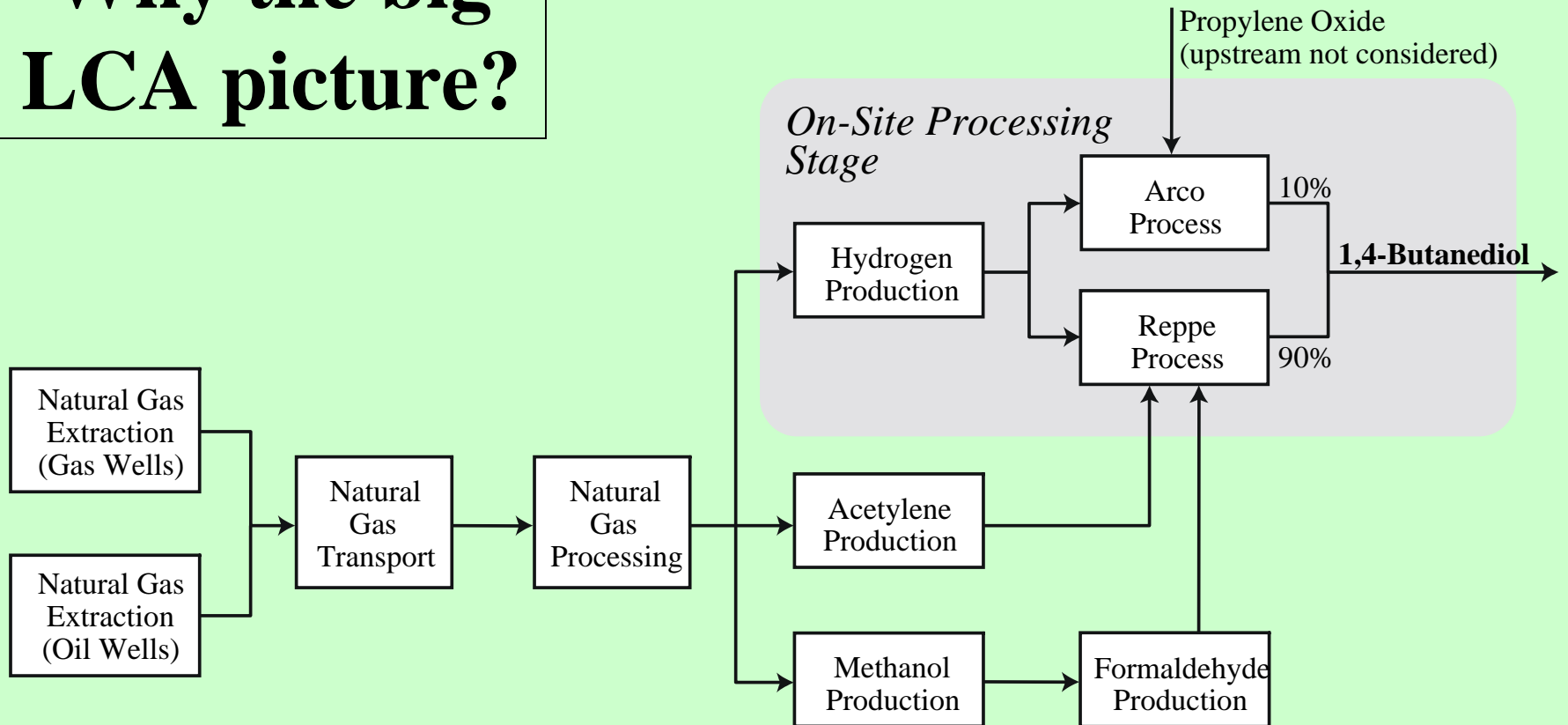

1,4 butanediol (BDO) derived from natural gas

(energy consumption and associated processes not shown) (U.S. EPA 1997)

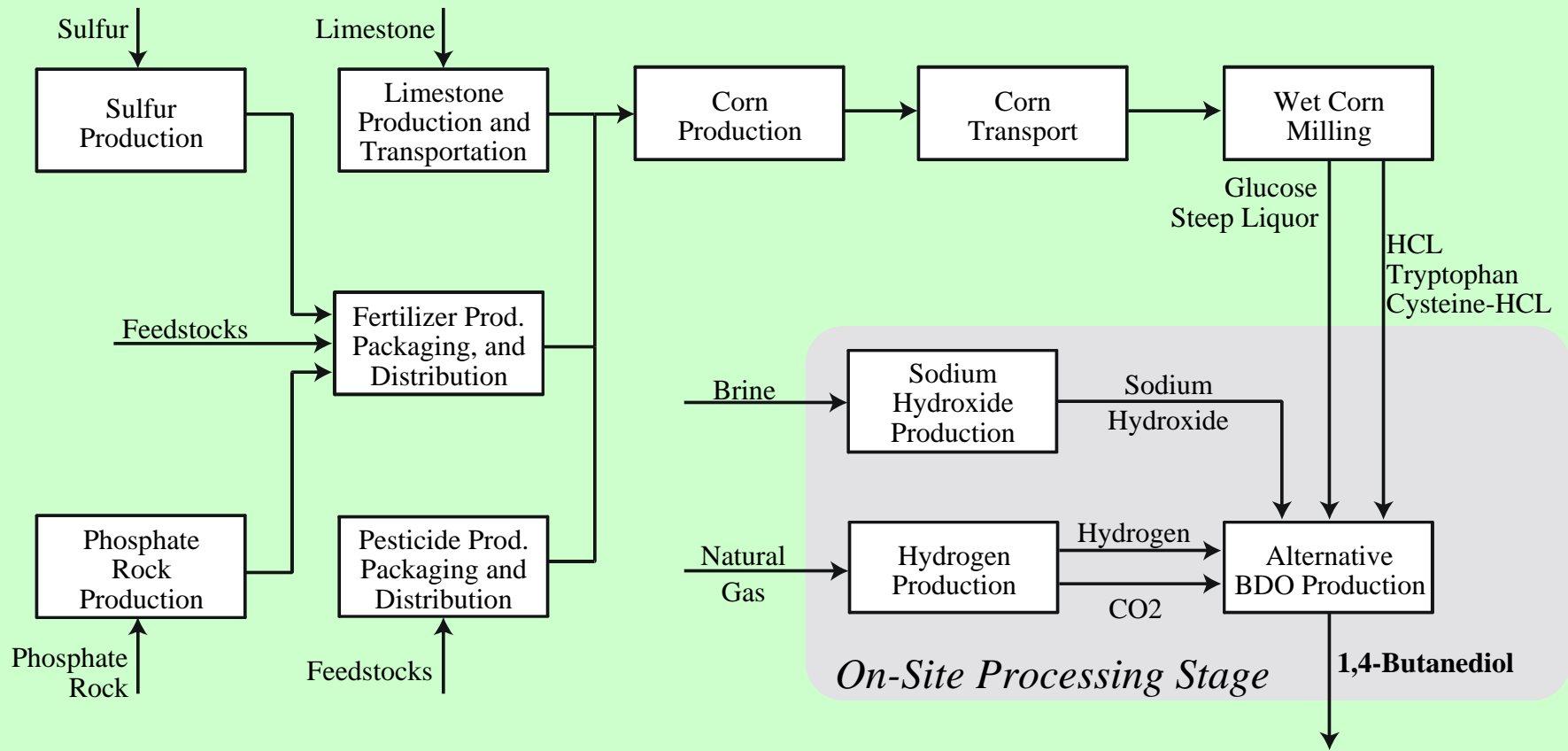

Bio-derived BDO from corn production

(energy consumption and associated processes not shown) (U.S. EPA 1997)

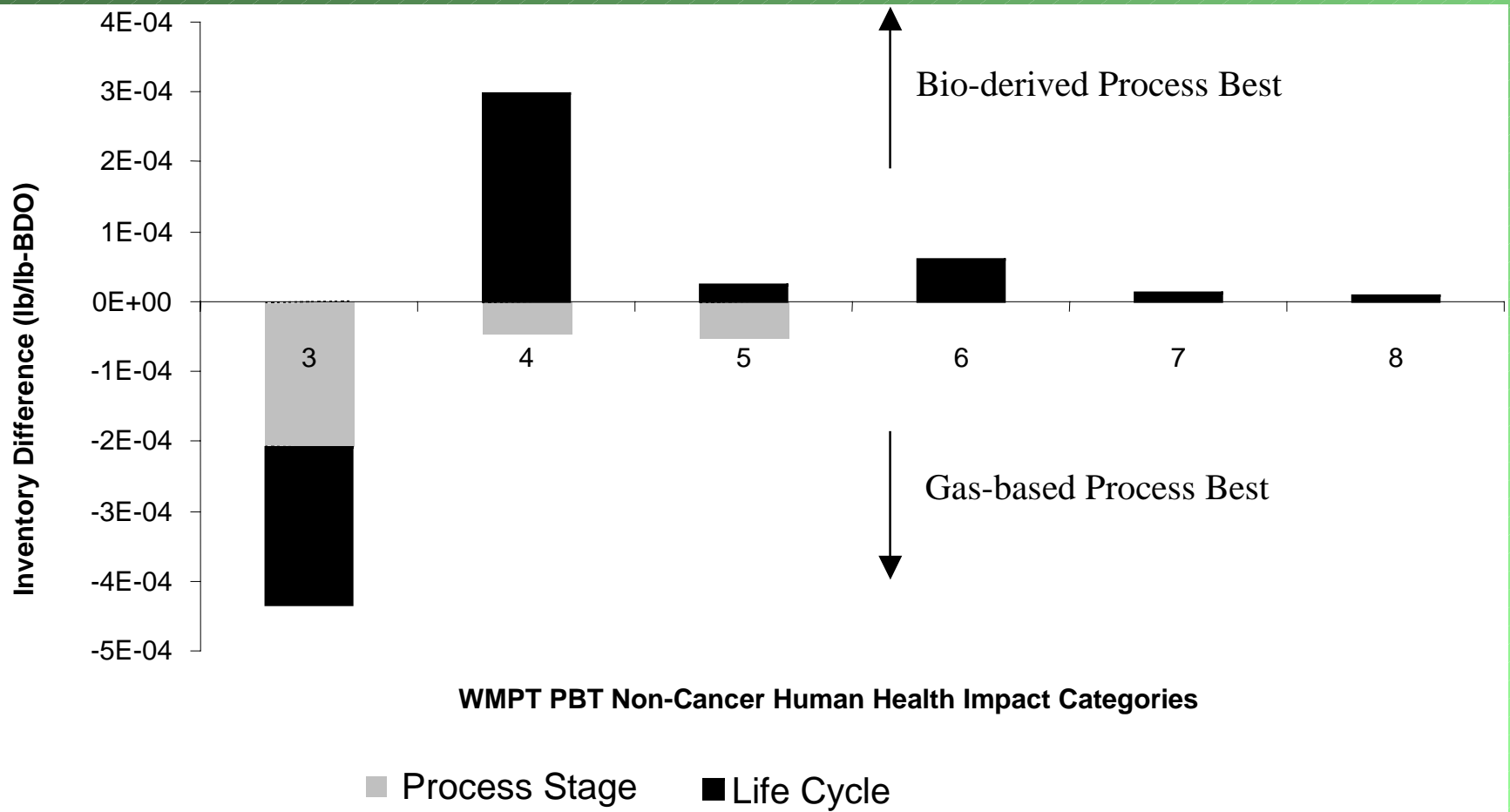

Differences between BDO alternatives
(organic emissions, non-cancer human health PBT scores)

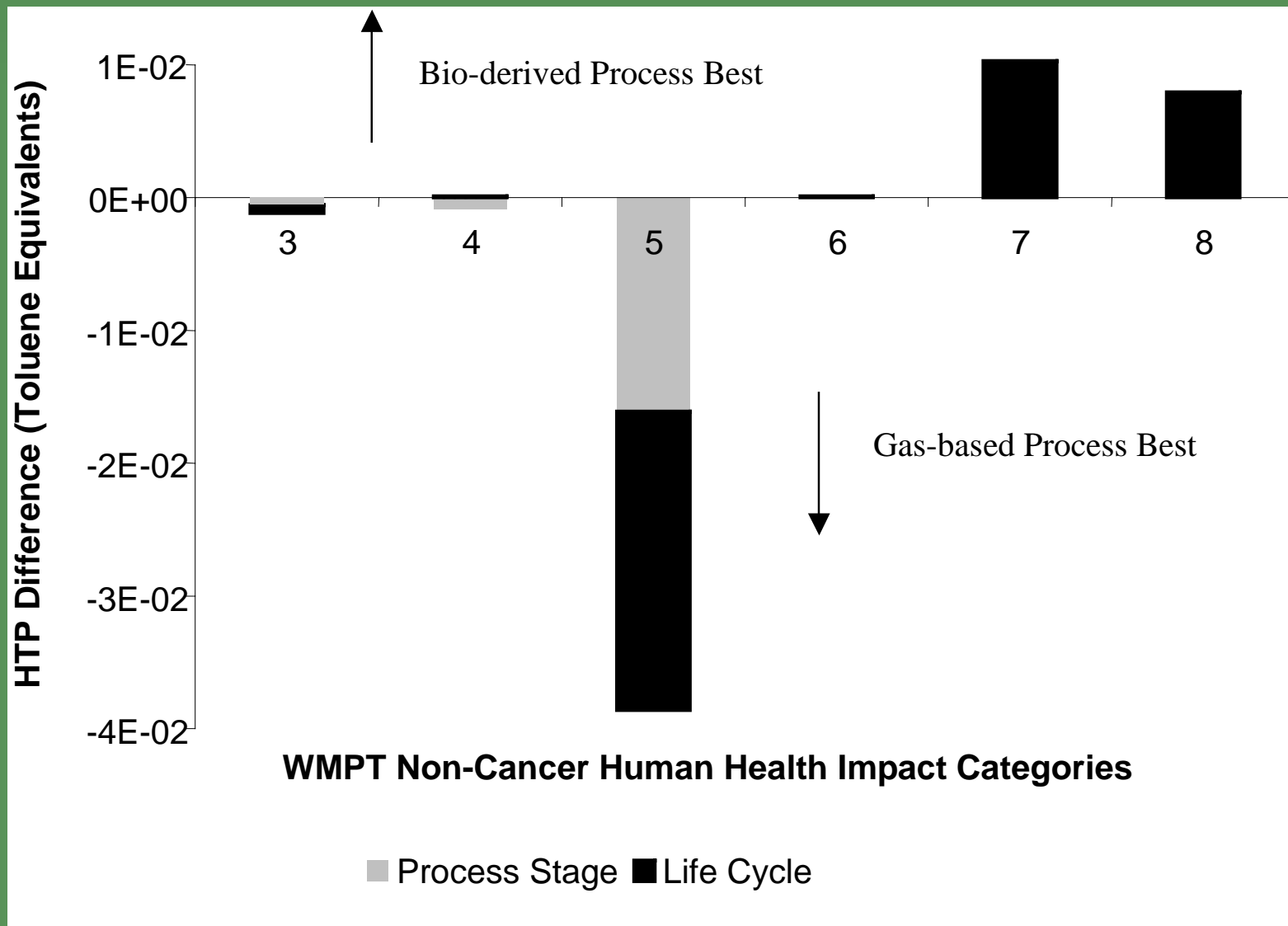

Differences between BDO alternatives

(PBT scores vs. toluene equivalency potentials, organic emissions, non-cancer human health effects)

Many Impact (incl. Resource Consumption) Categories & Indicators

Metrics	Natural Gas-Based		Bio-Based	
	Processing	Life Cycle	Processing	Life Cycle
N/A	0	6.31E-07	0	1.30E-04

Land Use for Resource Extraction/Production in Acre-Years per Pound of BDO

Component	Comparison Metric	Natural Gas-Based		Bio-Based	
		Processing	Life Cycle	Processing	Life Cycle
FGD Solids	1.67	2E-06	3E-06	3E-05	3E-05
Fly Ash	1.67	4E-06	7E-06	6E-05	7E-05
Slag	1.04	4E-07	6E-07	5E-06	5E-06
Depleted Uranium	0.17	3E-08	6E-08	5E-07	5E-07
Other Solids	2.22	0	0	4E-04	4E-04
Total	N/A	5E-06	8E-06	7E-05	4E-04

Land Used for Solid Waste Disposal in Cubic Yards.

Phases and applications of an LCA

(ISO14040 Series)

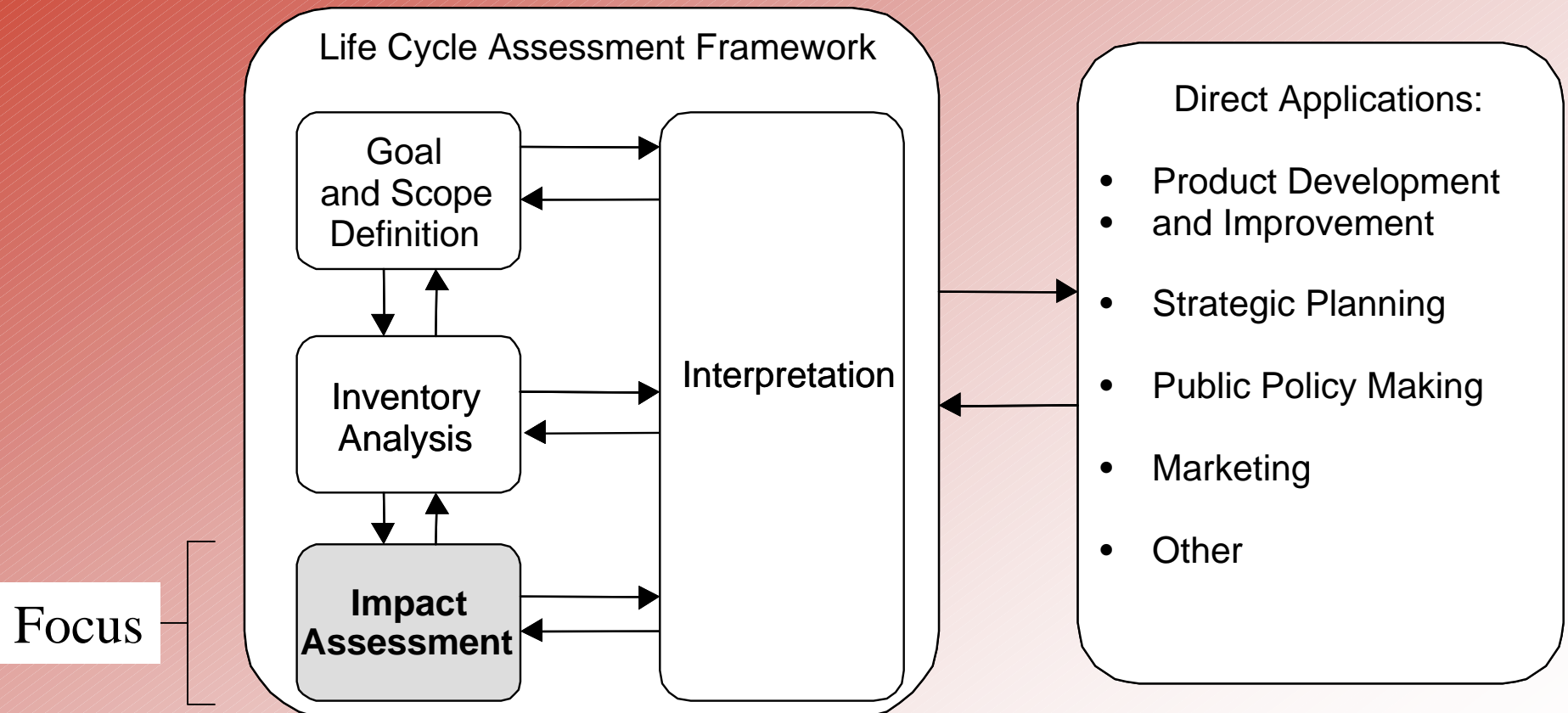

Elements of LCIA (ISO 14042)

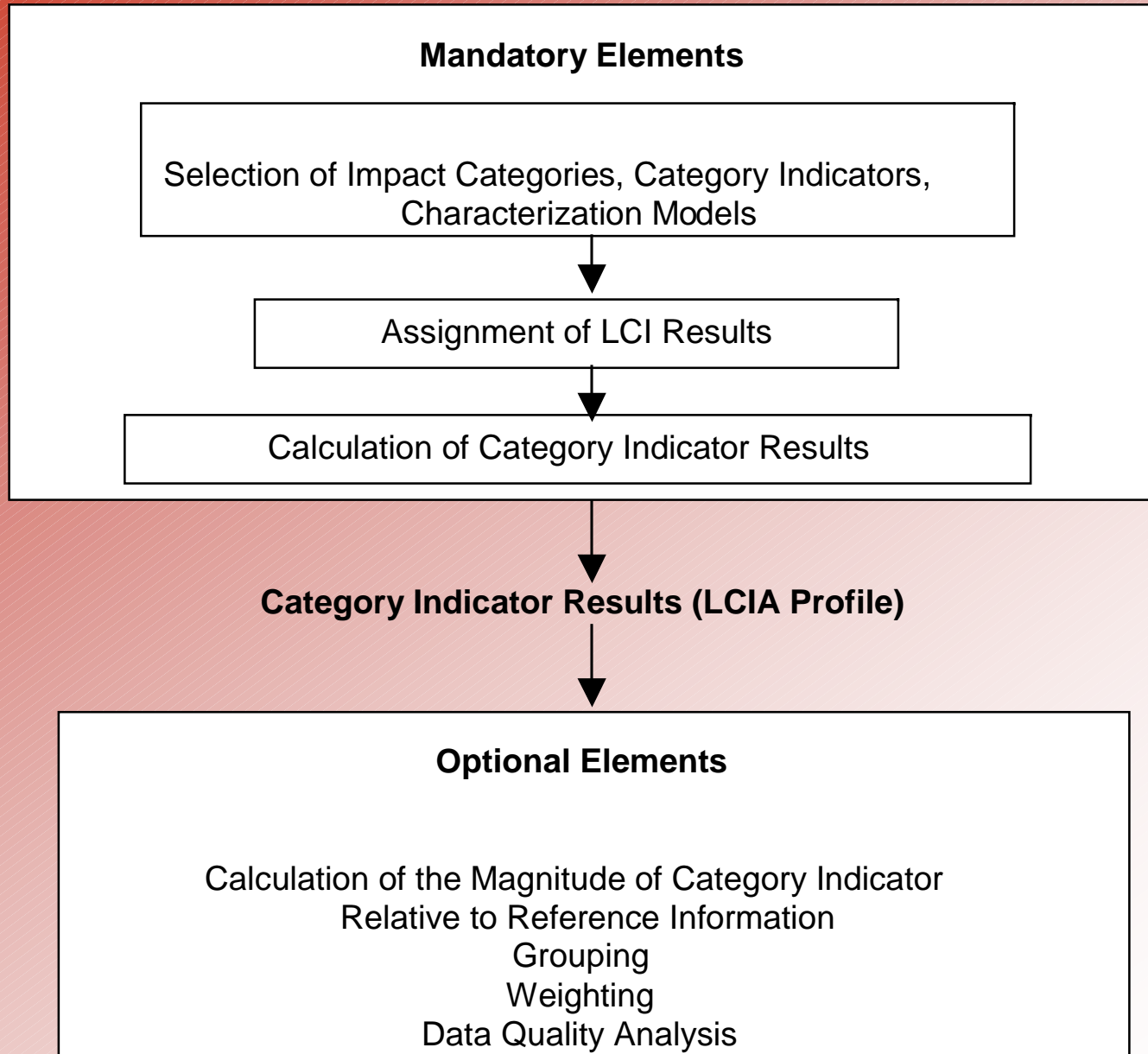

Table 1 ISO requirements/recommendations for selecting impact categories & indicators (ISO, 1999)

ISO 14042 requirements

- a) The selection of impact categories, category indicators and characterisation models shall be consistent with the goal and scope of the LCA study
- b) The **sources** for impact categories, category indicators and characterisation models shall be referenced
- c) The selection of impact categories, category indicators and characterisation models shall be justified
- d) Accurate and descriptive **names** shall be provided for the impact categories and category indicators
- e) The selection of impact categories shall reflect a **comprehensive set of environmental issues** related to the product system being studied, taking the goal and scope into consideration
- f) The **environmental mechanism** and **characterisation model** which relate the LCI results and category indicator and provide a basis for characterisation factors shall be described
- g) The appropriateness of the characterisation model used for deriving the category indicators in the context of the goal and scope of the study shall be described

ISO 14042 recommendations

- a) The impact categories, category indicators, and characterisation models should be **internationally accepted**, i.e. based on an international agreement or approved by a competent international body
- b) The impact categories should **represent** the aggregated emissions or resource use of the product system on the category endpoint(s) through the category indicators
- c) **Value choices and assumptions** made during the selection of impact categories, category indicators and characterisation models should be **minimised**
- d) The impact categories, category indicators and characterisation models should **avoid double counting** unless required by the goal and scope definition
- e) The characterisation model for each category indicator should be scientifically and technically valid, and **based upon a distinct identifiable environmental mechanism and/or reproducible empirical observation**
- f) The category indicators should be **environmentally relevant**
- g) It should be identified to what extent the characterisation model and the characterisation factors are **scientifically and technically valid**

Table 2 General items to address when discussing category indicators

- 1) **Essentials** (extent of quantification, regionalisation and comprehensiveness, incl. environmental relevance) of the indicator set
- 2) **Sensitivity** of the indicator for the intervention changes
- 3) Description of environmental **mechanism** and characterisation **model**, incl. extent of relying on reproducible empirical observations and scientific/technical validity
- 4) **Extent of representation** of the category endpoints through aggregated interventions
- 5) Extent of and description of **value choices and assumptions** (on the levels of model and data)
- 6) Extent of double counting and other **consistency issues**
- 7) **Applicability** regarding the data available

Models & Environmental Mechanisms

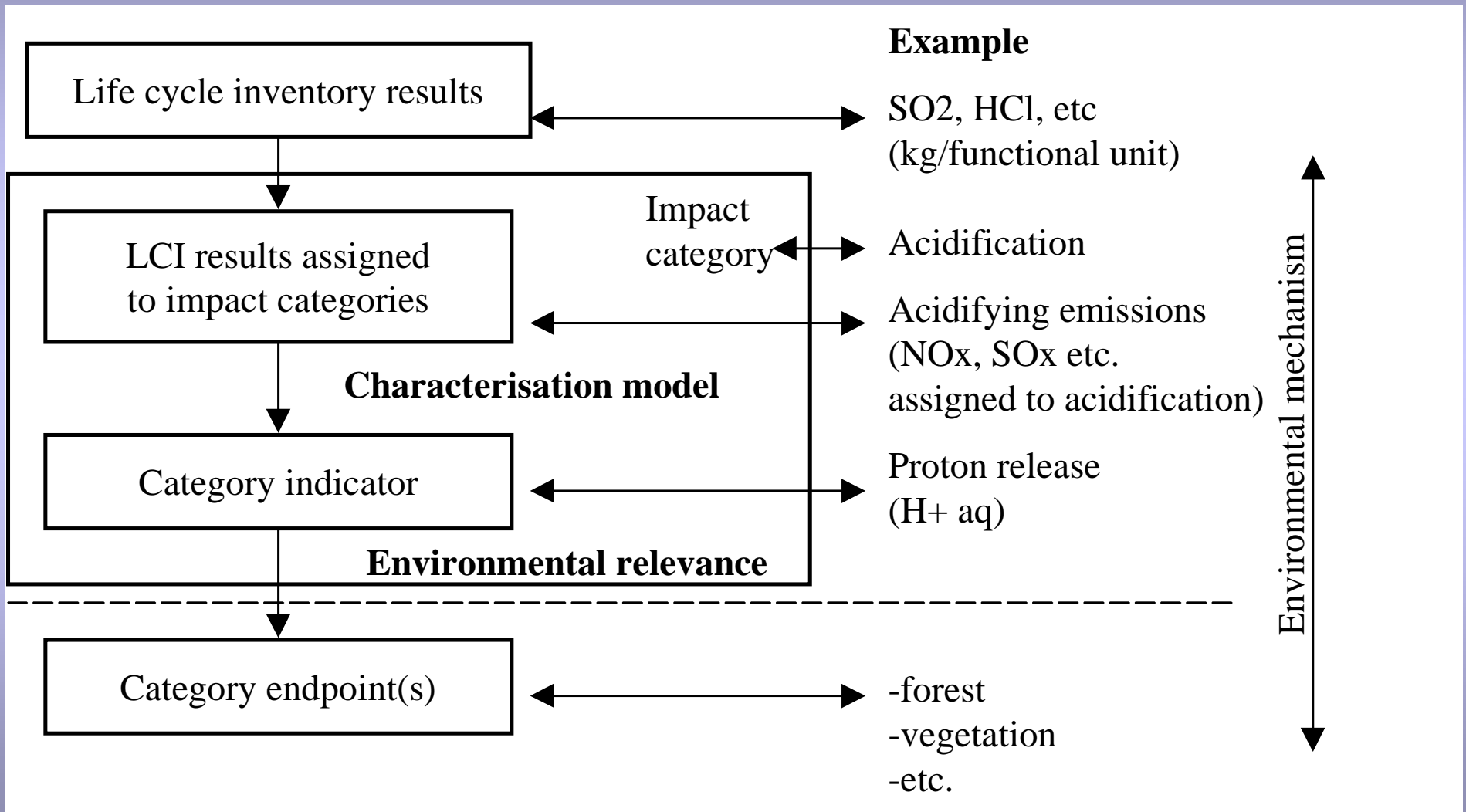

Simple (linear) calculations

$$\begin{array}{l} \text{Category} \\ \text{Indicator} \\ \text{Values} \end{array} = \begin{pmatrix} & \text{CO}_2 & \text{CCl}_4 & \text{CBrH}_3 \\ \text{GW} & 1 & 1400 & \\ \text{OD} & & 1.1 & 0.6 \\ \text{HT} & & 14000 & 12000 \end{pmatrix} \cdot \begin{pmatrix} \text{CO}_2 & 2100 \text{ kg} \\ \text{CCl}_4 & 0.5 \text{ kg} \\ \text{CBrH}_3 & 0.3 \text{ kg} \end{pmatrix} = \begin{pmatrix} \text{GW} & 2800 \text{ kg}_{\text{CO}_2\text{-equ}} \\ \text{OD} & 0.73 \text{ kg}_{\text{CFC11-equ}} \\ \text{HT} & 10600 \text{ kg}_{\text{toluene-equ}} \end{pmatrix}$$

Characterisation factors

LCI results

Category indicators

Weighting:

$$\begin{array}{l} \text{Weighted} \\ \text{Results} \end{array} = \begin{pmatrix} \text{GW} & \text{OD} & \text{HT} \\ 0.2 & 800 & 0.4 \end{pmatrix} \cdot \begin{pmatrix} \text{GW} & 2800 \text{ kg}_{\text{CO}_2\text{-equ}} \\ \text{OD} & 0.73 \text{ kg}_{\text{CFC11-equ}} \\ \text{HT} & 10600 \text{ kg}_{\text{toluene-equ}} \end{pmatrix} = 560 + 584 + 4240 = 5384$$

Category weights

Category indicator values

Weighted indicator results

Which Indicators and Impact Categories?

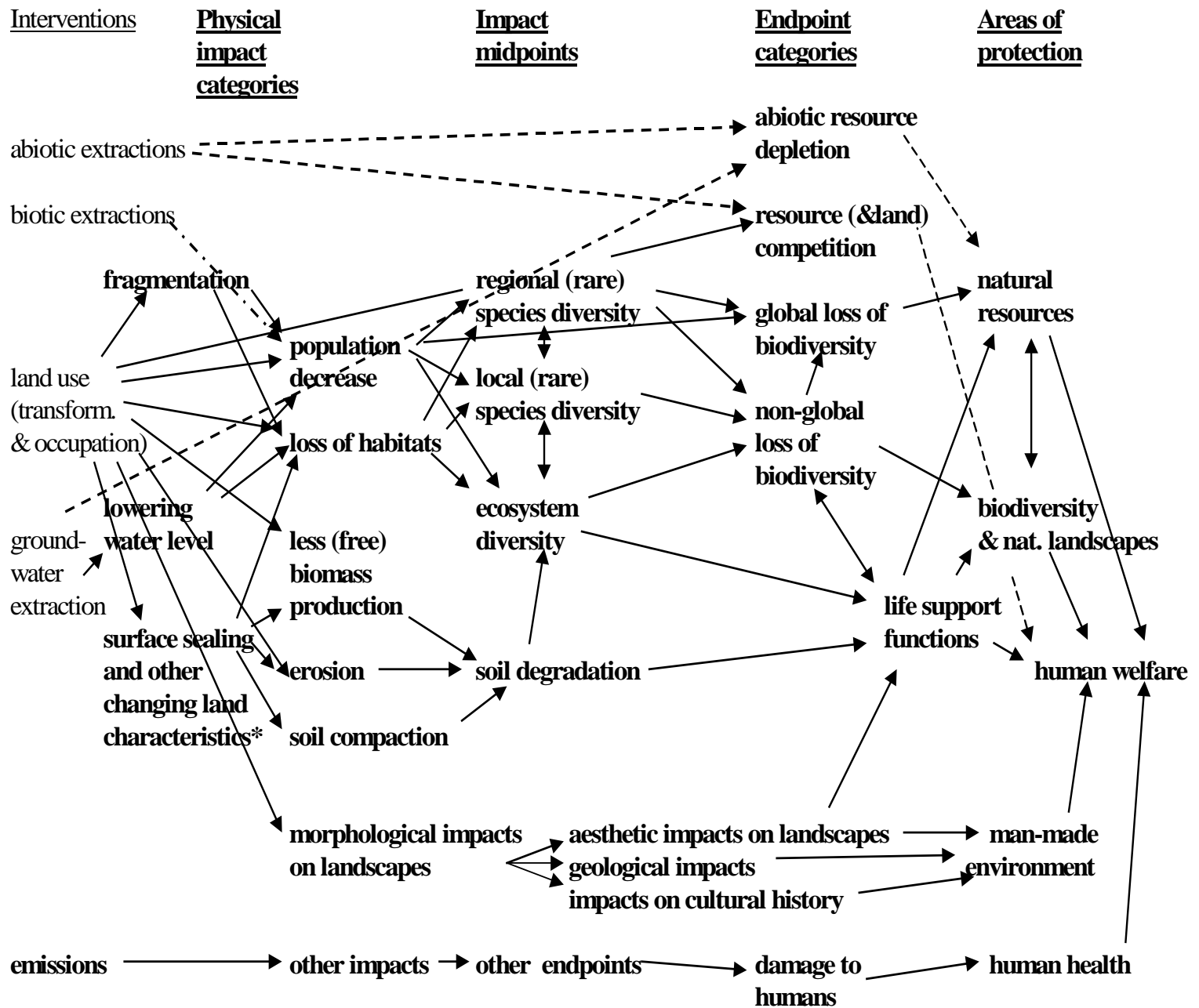

Midpoint or endpoint indicators?

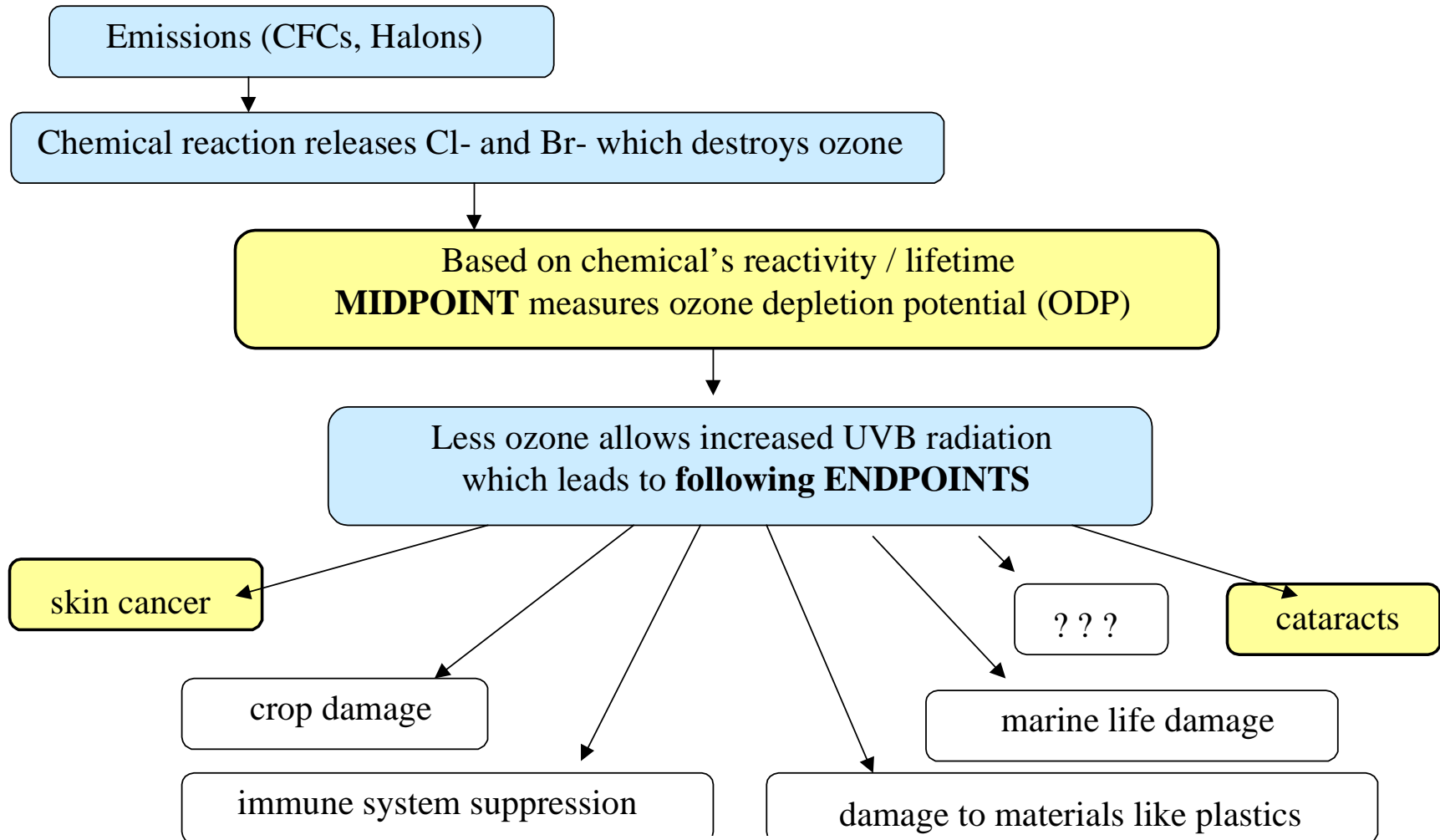

(Ozone Depletion Example)

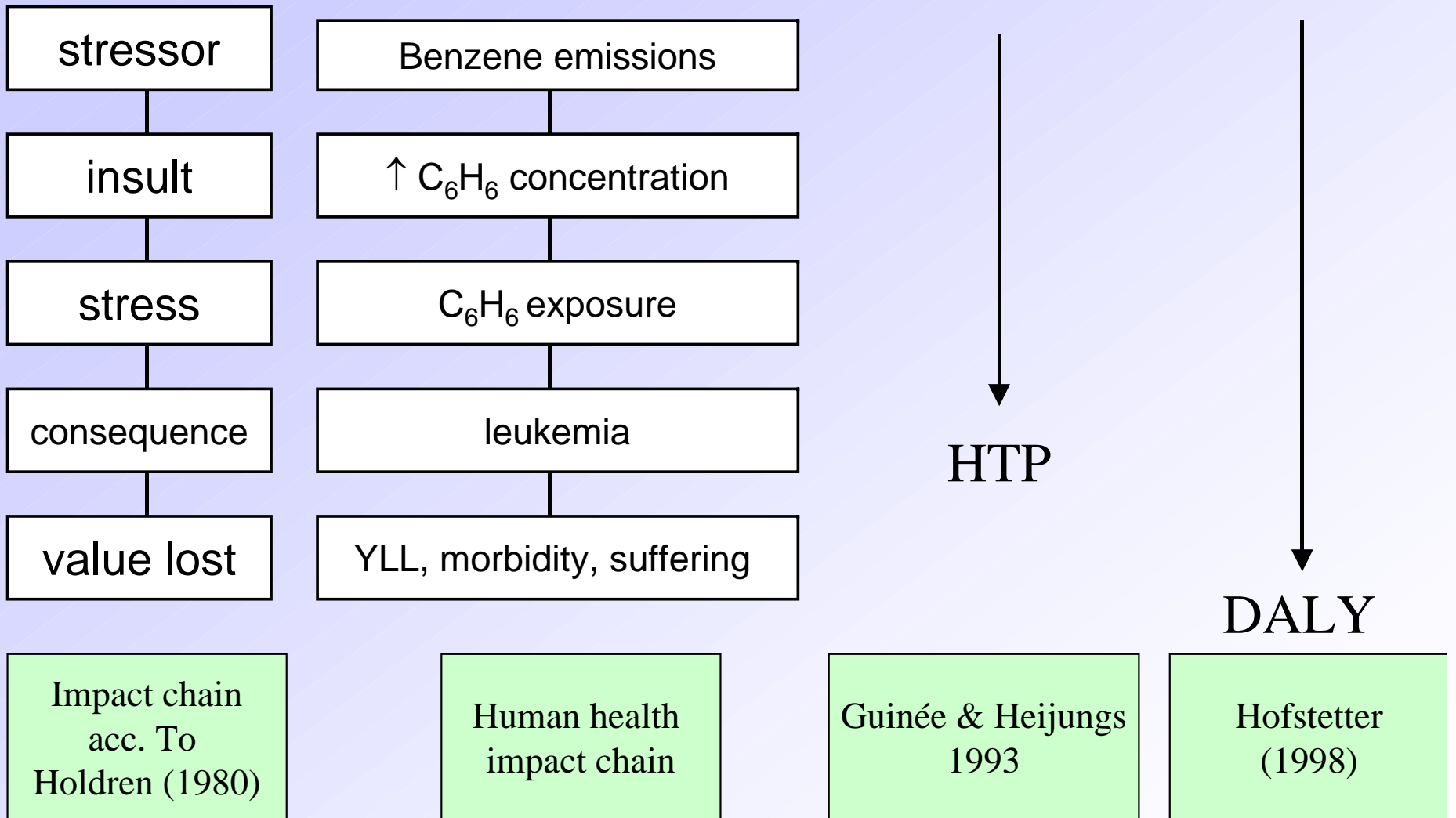

(Toxicological Effects on Humans Example)

Temporal/Spatial Specific Indicators?

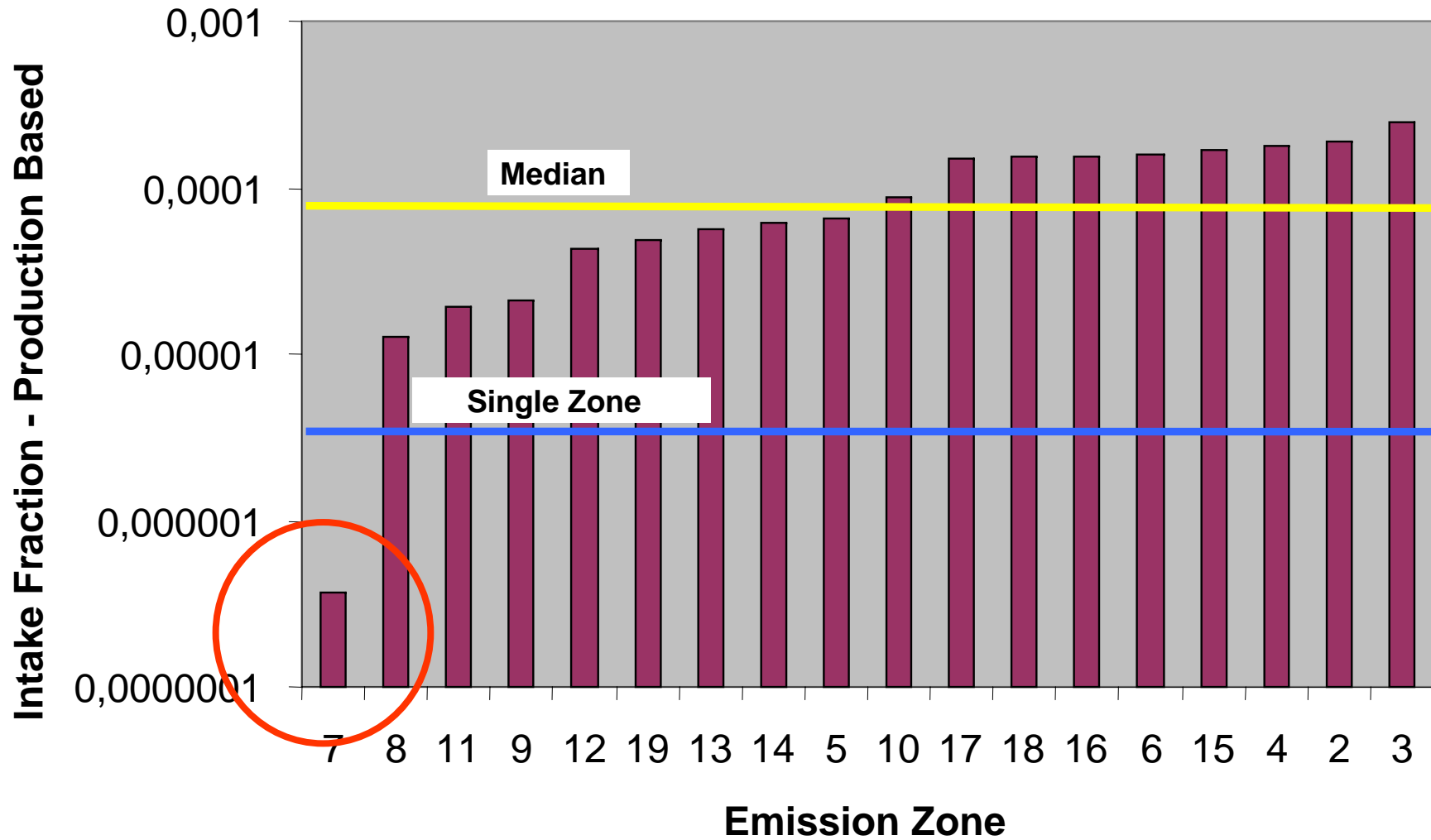

(Human intake example for different zones in Japan)

Many Tools Exist: Models, Databases, ...

(Problems: heterogeneity, quality, state-of-the-art,)

P2P Impacts _ □ ×

CAS No. 50-00-0

Preferred Name Formaldehyde

Acid Rain Precursor	N	Fine Fiber	N	Ozone Depleter	N
Aquatic Toxicant	N	Global Warmer	N	Particulate	N
BOD	Y	Hazardous Waste	Y	Pathogen	N
Carcinogen	N	Human Health Toxicant	N	Radioactive	N
COD	Y	Metal	N	Smog Former	Y
Corrosive	N	Nutrient	N	Solid Waste	N
Dissolved Solid	N	Odorant	Y	Suspended Solid	N

Human Health Non-Carcinogen	1
Human Health Carcinogen	2
Aquatic Toxicity	3
Bio Accumulation	1
Persistence	1

WMPT Cutoffs

Persist	Bio Acc	Toxicity	Metal
3	3	3	3
2	2	2	2
1	1	1	1

Clicking on a **blue** name will bring up a definition; Black values are defaults.
Red values are user-supplied. Restore returns them to WMPT values, if available, or to default values.
Yellow values are calculated using WMPT data.
These cannot be changed directly. Changing WMPT data or cut-offs can change them.

Conclusions

(Recommended LC(I)A literature)

Metrics for environmental comparison of process alternatives in a holistic framework.

Pennington D.W., Norris G., Hoagland T. and Bare J., Process Design Tools for the Environment, Sikdar S.K. and El-Halwagi M.M., editors, Taylor and Francis (UK), 2001

Life-cycle impact assessment: Striving towards best practice.

Udo de Haes H., Joliet O., Finnveden G., Goedkoop M., Hauschild M., Hertwich E., Hofstetter P., Klöpffer W., Krewitt W., Lindeijer E., Mueller-Wenk R., Olson S., Pennington D., Potting J., Steen B. SETAC Press, Pensacola, Florida, US. 2002.

Life Cycle Assessment: Current Impact Assessment Practice (Part 2)

D. W. Pennington^{1*}, J. Potting², G. Finnveden³, E. Lindeijer⁴, O. Joliet¹, G. Rebitzer^{1.}, Environment International, Submitted.

ISO 14040 Series (especially 14042)

Sustainability Indicators and Reporting Mechanisms in Regions

Annik Magerholm Fet

Norwegian University of Science and Technology (NTNU)

NATO CCMS Pilot Study on Clean Products and Processes

2003 Annual Meeting

Cetraro, Italy

May 11, 2003

Background:

- The European Government recognizes the importance of coordinated sustainable management actions, however, efficient tools to harmonize measurements in different regions are still lacking.
- A proposed project “Sustainability Reporting in European Regions” (SUREER) will fill this gap by establishing Sustainability Reporting (SR) in European regions, based on the “triple bottom line” indicators of the Global Reporting Initiative (GRI).

Outline:

- Introduction to the proposed project SUREER
- Discussion on how this can contribute to the development of a set of sustainability indicators
- Recommendations for Future Activities for the NATO CCMS program

The consortium consists of:

- Norwegian University of Science and Technology, Norway, represented by Prof. Annik Magerholm Fet (Coordinator).
- Kaunas University of Technology, Lithuania, represented by Prof. Jurgis K. Staniskis.
- Technical University Graz, Austria, represented by Prof. DI Dr. Michael Nardoslawsky.
- University of Kaiserslautern, Germany, represented by Prof. Dr. Heiner Müller-Merbach.
- Aristotle University of Thessaloniki, Greece, represented by Dr. George Gallios.
- University of Malta, Malta, represented by Prof. Lino Briguglio

Objectives of the project

- The main objective of SUREER is to establish a framework for Sustainability Reporting (SR) in small European regions, consisting of an **indicator database (IDA)** integrated in a reporting procedure (Generic Process Model, GPM) delivered as manual for SR users, which is applicable for the organizations in all regions.

Achievable main goals

- The development of an indicator database (IDA) including
 - core indicators,
 - additional indicators for regions and
 - business specific indicators
 - Further a set of cross cutting indicators and systemic indicators.
- The development of an evaluation method for the application of indicators.
- The development of a generic process model (GPM) for a common procedure guideline for sustainability reporting in different geographical regions.
- The development of an evaluation method for the implementation of Sustainability Reports
- Combined sustainability reports for at least 6 European regions.
- Sustainability reports for at least 36 SMEs (6 in each partner country)
- Capacity building among universities, communities and companies, transferred through the cooperative work among participants from different regions in Europe.

Further goals

- Indicate core indicators that can be used in different sized organizations.
- Develop sector specific indicators for particular industries.
- Develop cross-cutting indicators that present environmental performance together with one of the other two dimensions in the triple bottom line.
- Develop systemic indicators that link the companies and communities activities.
- Reach quality improvement over time by outlining the options to move from moderate to good and high application levels of indicators.

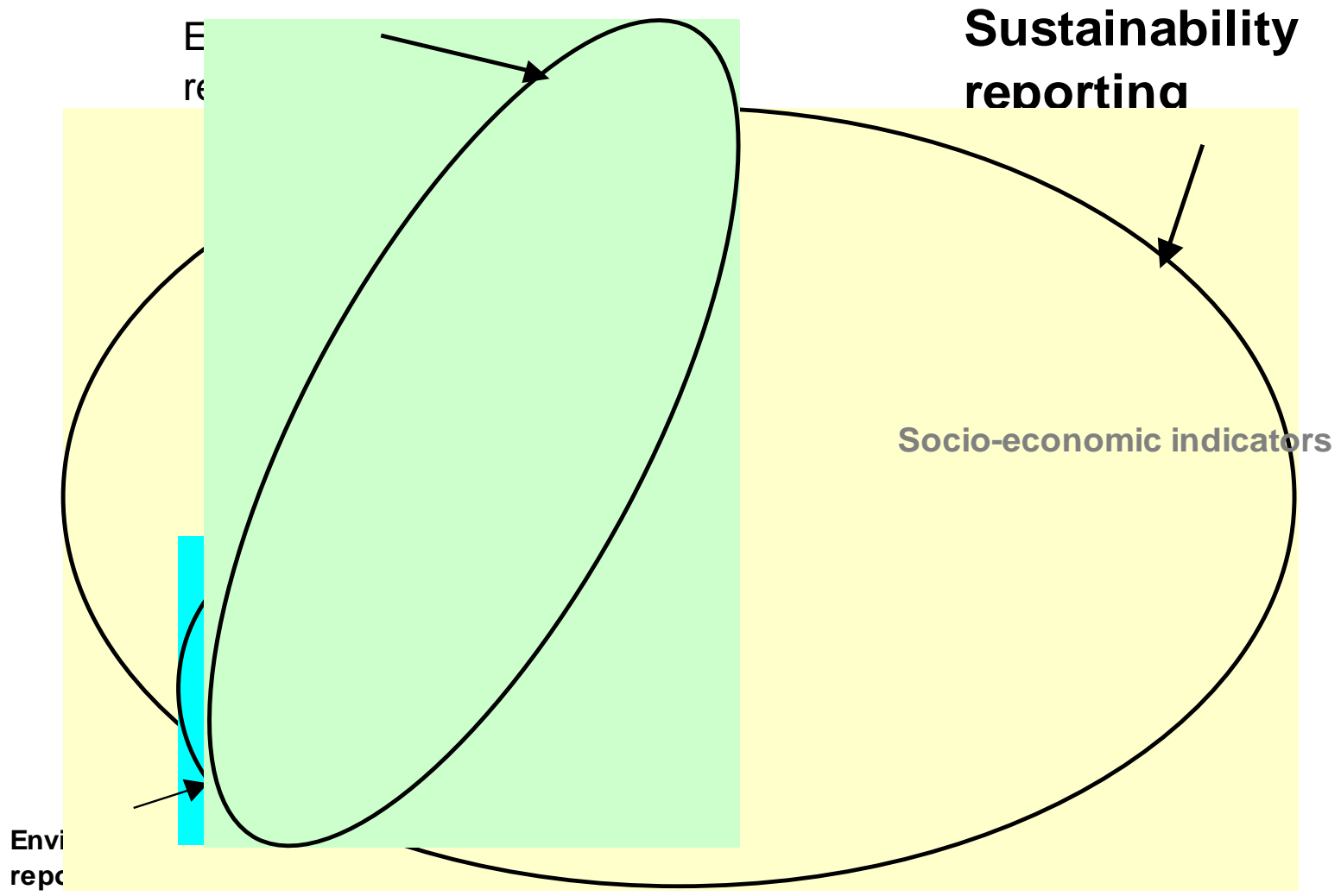

Global Reporting Initiative (GRI) - guidelines



- the first global framework for comprehensive sustainability reporting, encompassing the "triple bottom line" of economic, environmental, and social issues.
- will become the generally accepted, broadly adopted framework for preparing, communicating and requesting information about corporate performance.
- give guidance to reporters on selecting generally applicable and organisation specific indicators, as well as integrated sustainability indicators. Forward-looking indicators and targets for future years are also included.

THE INDICATOR FRAMEWORK

Category: The groupings of economic, environmental, or social issues of concern to stakeholders

Aspect: The general subsets of indicators that are related to a specific category. A given category may have several aspects, which may be defined in terms of issues, impacts, or affected stakeholder groups.

Indicator: The specific measurements of an individual aspect that can be used to track and demonstrate performance. These are often, but not always, quantitative.

According to GRI, aspects and indicators are derived from an extensive, multi-stakeholder consultative process.

Categories and aspects:

	CATEGORY	ASPECT
ECONOMIC	Direct Economic Impacts	Customers Suppliers Employees Providers of capital Public sector
ENVIRONMENTAL	Environmental	Materials Energy Water Biodiversity Emissions, effluents, and waste Suppliers Products and services Compliance Transport Overall
SOCIAL	Labour Practices and Decent Work	Employment Labour/management relations Health and safety Training and education Diversity and opportunity
	Human Rights	Strategy and management Non-discrimination Freedom of association and collective bargaining Child labour Forced and compulsory labour Disciplinary practices Security practices Indigenous rights
	Society	Community Bribery and corruption Political contributions Competition and pricing
	Product Responsibility	Customer health and safety Products and services Advertising Respect for privacy

PERFORMANCE INDICATORS

The GRI performance indicators are classified along the following lines:

Core indicators (or general applicable indicators) are those relevant to most reporters; and of interest to most stakeholders.

Additional indicators (or business specific indicators) are viewed as leading practice in economic, environmental, or social measurement, and providing information of interest to stakeholders who are particularly important to the reporting entity.

INTEGRATED PERFORMANCE INDICATORS

A fourth dimension, grouped in

Systemic indicators related to the activity of an organisation to the larger economic, environmental, and social systems of which it is a part. For example, an organisation could describe its performance relative to an overall system.

Cross-cutting indicators directly related to two or more dimensions of economic, environmental, and social performance as a ratio. Eco-efficiency measures are the best-known examples

WBCSD Eco-efficiency Indicators: The Framework

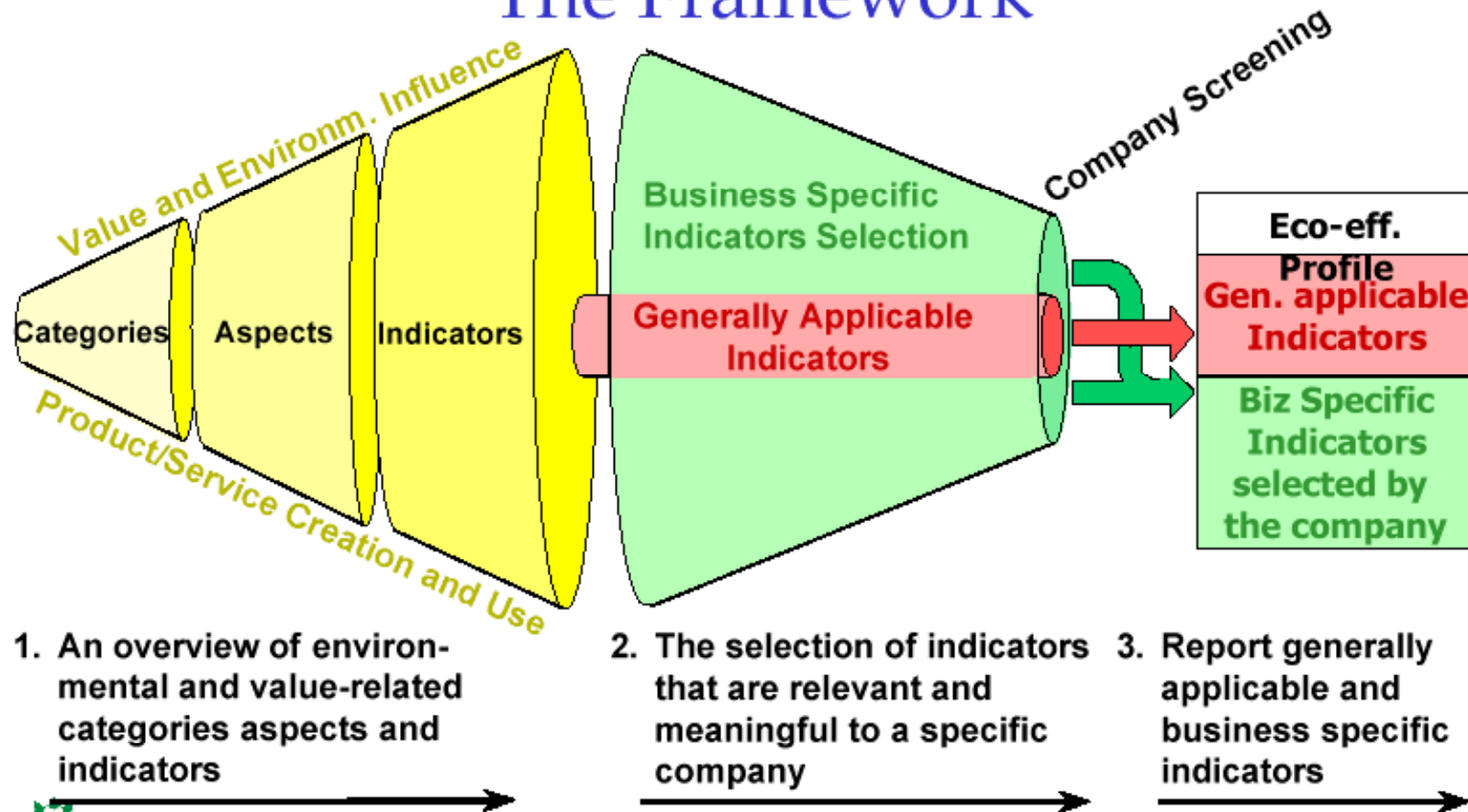

The Eco-efficiency Concept

*Eco-efficiency = product or service value
environmental influence*

*Eco-efficiency indicator = economic performance indicator
environmental performance indicator*

Methodology

A systems engineering methodology (SEM) moving from the

- analysis of the regional systems and
- the identification of stakeholders' priorities to
- the definition of the requirements for indicators,
- further to the development and selection of **indicators**, which are exploitable to improve the systems and
- to the development of the **indicator database** and
- the reporting procedure.

The indicator database will reflect the mutual process between legislation and organizations' activities. This will be accomplished by analysing and developing indicators from the bottom to the top and vice versa

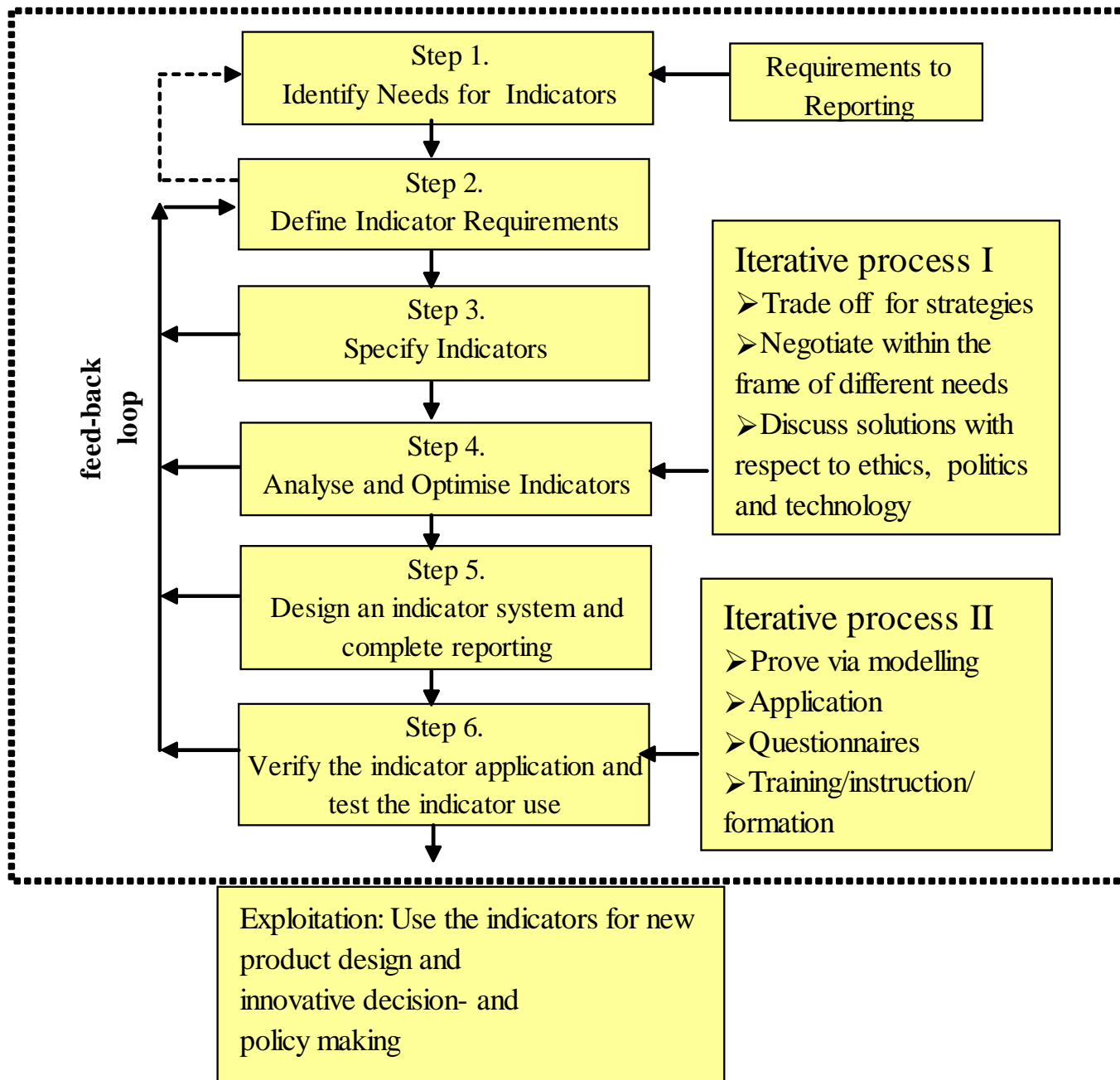

”Bottom up” versus ”top down”

**From company reporting
and indicators to
Sector reporting and
indicators to
Municipal reporting and
indicators to
Regional reporting and
indicators**

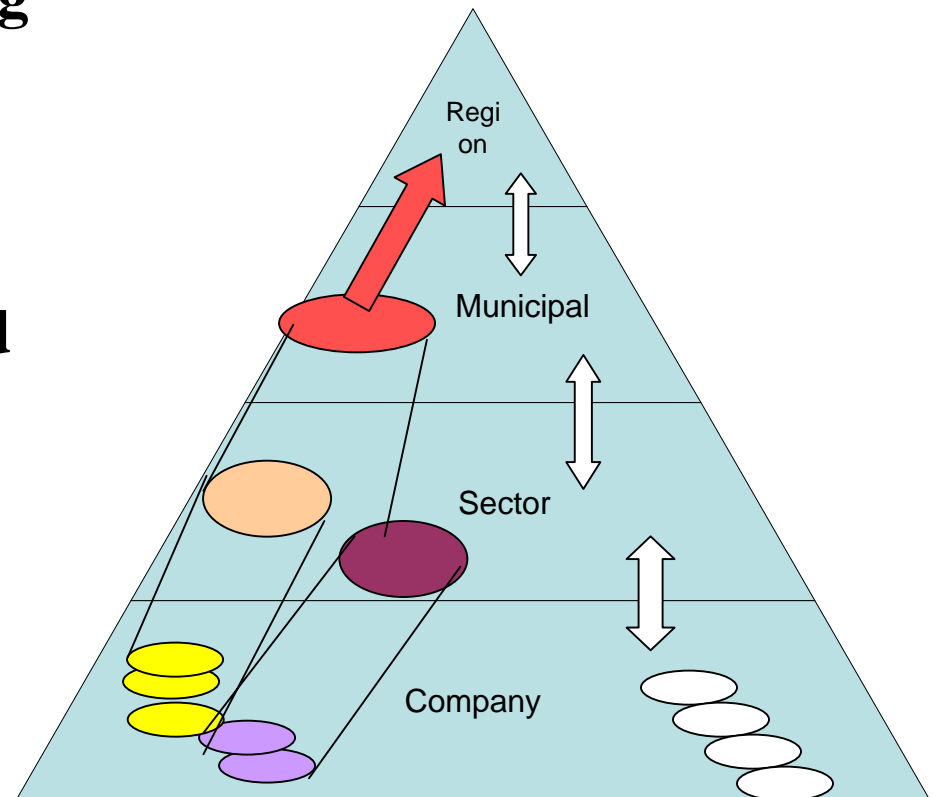

Reporting structure

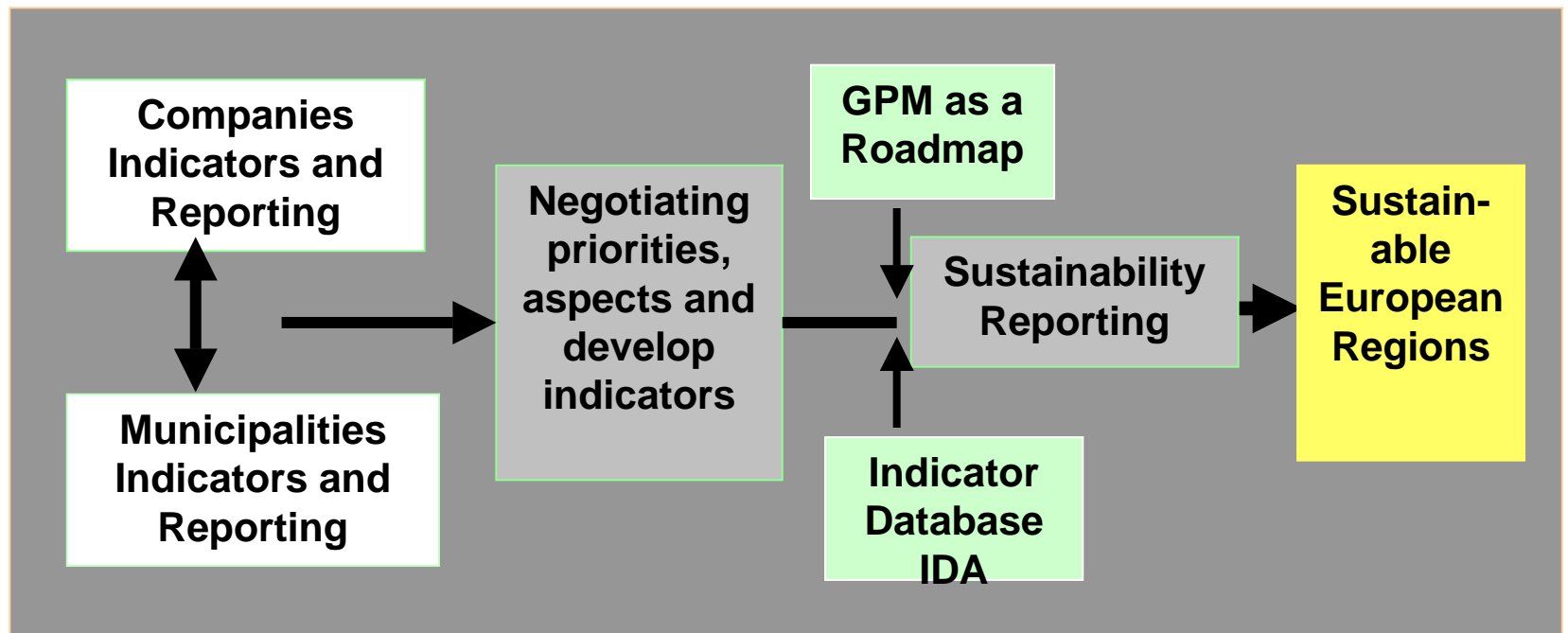

Suggestions for NATO-supported project:

1. Agree about definitions and terminologies for performance indicators
2. Test a set of core-indicators in different regions
3. Develop/test business specific indicators
4. Develop systemic indicators for municipalities and regions
5. Test a reporting structure for a few regions
6. Use/develop criteria for sustainability regions and evaluate the reports against these

Environmental Management Accounting

Gyula Zilahy

11th May, 2003



[Http://hcpc.bke.hu](http://hcpc.bke.hu)

e-mail: cleaner@enviro.bke.hu

NATO CCMS Pilot Study, Cetraro, 2003

Financial considerations and the environment

- Impacts of the environment on the economy:
 - Limited resources: raw materials and energy
- Impacts of the economy on the environment:
 - Excessive use of resources
 - Pollution of the environment



[Http://hcpc.bke.hu](http://hcpc.bke.hu)

e-mail: cleaner@enviro.bke.hu

The need for quantification

There is a need to quantify the changes in the environment in financial terms, i.e. in money units:

- To gain a more reliable picture of human welfare;
- To be able to compare different solutions;
- To help decision-makers involve environmental issues in their decisions.



[Http://hcpc.bke.hu](http://hcpc.bke.hu)

e-mail: cleaner@enviro.bke.hu

The definition of EMA

"a sub-area of accounting that deals with activities, methods and systems for recording, analyzing and reporting the environmental issues and impacts and ecological impacts of a defined economic system." (Schaltegger)



[Http://hcpc.bke.hu](http://hcpc.bke.hu)

e-mail: cleaner@enviro.bke.hu

Levels of EMA

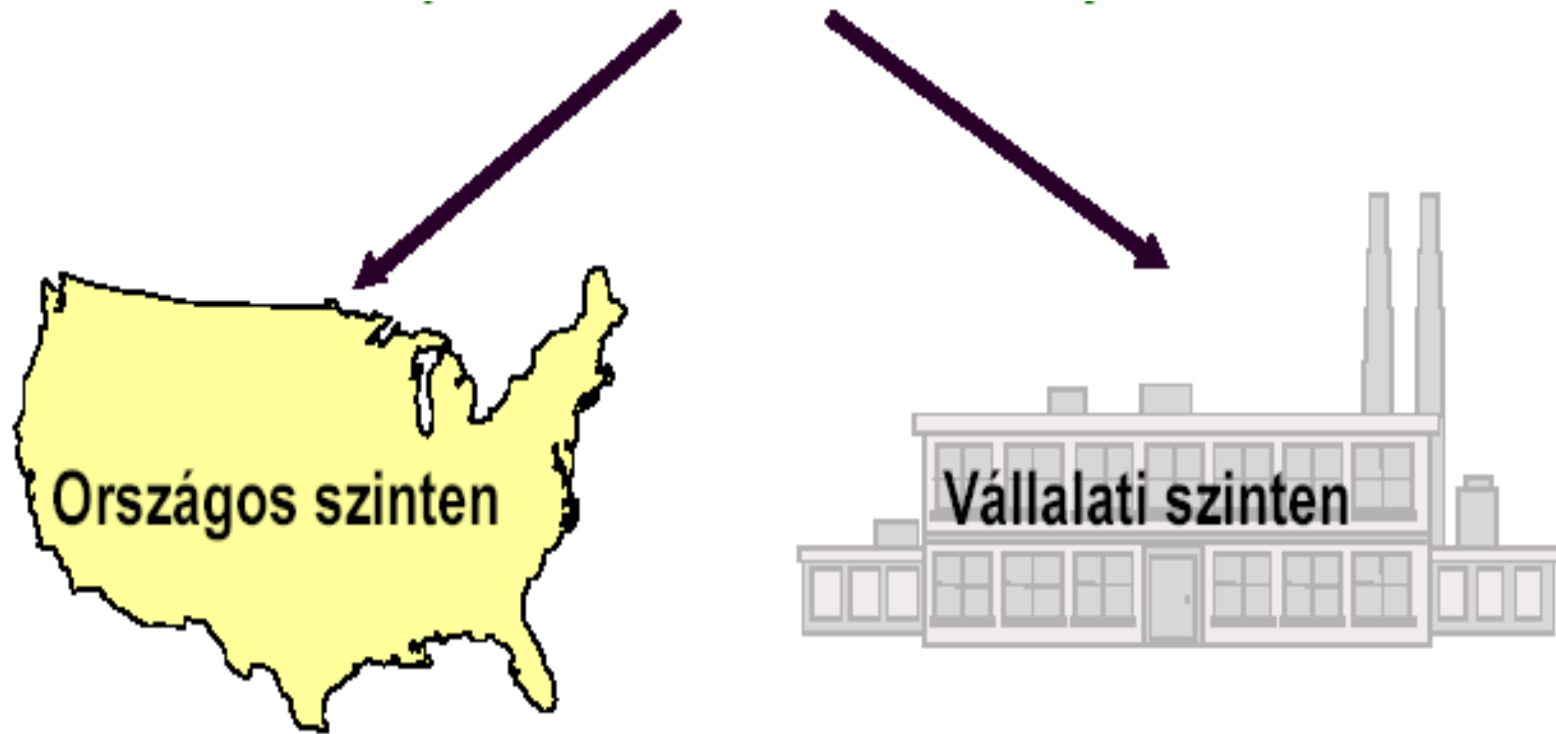

Source: Csutora, Vállalti környezetvédelmi költségek számbavétele, III.

The two main directions of EMA

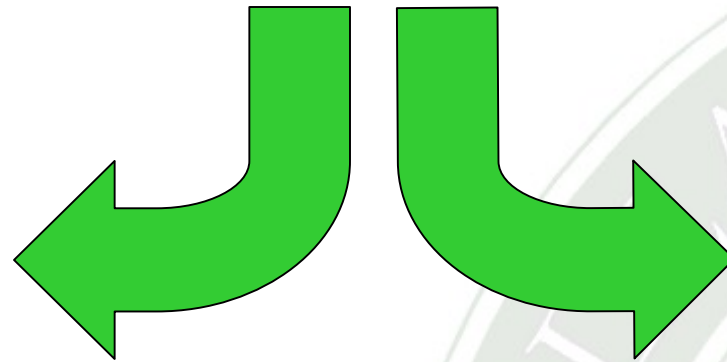

× Cost allocation

× Investment appraisal



[Http://hcpc.bke.hu](http://hcpc.bke.hu)

e-mail: cleaner@enviro.bke.hu

Why companies should use EMA?

- × many environmental costs can be significantly reduced or eliminated
- × environmental costs may be hidden in overhead costs
- × more accurate costing and pricing is possible
- × improved environmental performance
- × competitive advantage
- × can support an overall environmental management system



[Http://hcpc.bke.hu](http://hcpc.bke.hu)

e-mail: cleaner@enviro.bke.hu

Why EMA has not been used before?

- × environmental costs used to be low;
- × saving opportunities used to be low;
- × accounting itself costs money;
- × accounting is a conservative discipline.



[Http://hcpc.bke.hu](http://hcpc.bke.hu)

e-mail: cleaner@enviro.bke.hu

Different types of environmental costs

- × Conventional costs
- × Hidden costs
- × Contingent costs
- × Intangible costs
- × External costs



[Http://hcpc.bke.hu](http://hcpc.bke.hu)

e-mail: cleaner@enviro.bke.hu

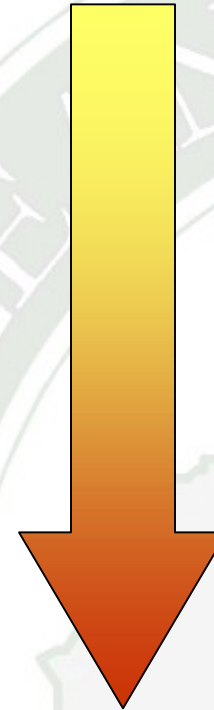

Difficulty of quantification

NATO CCMS Pilot Study, Cetraro, 2003

Characteristics of different types of environmental costs

	Conventional	Hidden	Contingent	Intangible	Social
Present costs	✓	✓			✓
Future costs			✓	✓	
The company pays for the costs	✓	✓	✓	✓	
The society or the environment bears the costs					✓
We know the exact amount	✓				
We can estimate the cost		✓	✓		
They are buried in the overhead		✓			



[Http://hcpc.bke.hu](http://hcpc.bke.hu)

e-mail: cleaner@enviro.bke.hu

Examples for the different cost types

Conventional	Hidden	Contingent	Intangible	Social
Equipment costs (buildings, equipment, site preparation); Raw materials; Direct labour cost; Utilities; General sales and administrative costs.	Cost of documentation control of environmental management systems, Compensation of workers; Environmental insurance costs; Fines; Lost workdays due to sickness and injuries, Waste disposal costs.	Future compliance costs, Penalties/fines, Response to future releases, Remediation, Property damage, Personal injury damage, Legal expenses, Natural resource damages	Corporate image, Relationship with: customers, investors, insurers, professional stuff, workers, suppliers, and regulators.	External or social costs, Medical costs of cancer patients, Damages caused in natural resources.



[Http://hcpc.bke.hu](http://hcpc.bke.hu)

e-mail: cleaner@enviro.bke.hu

NATO CCMS Pilot Study, Cetraro, 2003

Investment appraisal

Profitability indicators:

- × Payback period
- × Net present value (NPV)
- × Internal Rate of Return (IRR)
- × Etc.



[Http://hcpc.bke.hu](http://hcpc.bke.hu)

e-mail: cleaner@enviro.bke.hu

Cost Allocation



[Http://hcpc.bke.hu](http://hcpc.bke.hu)

e-mail: cleaner@enviro.bke.hu

NATO CCMS Pilot Study, Cetraro, 2003

Traditional allocation of overhead costs

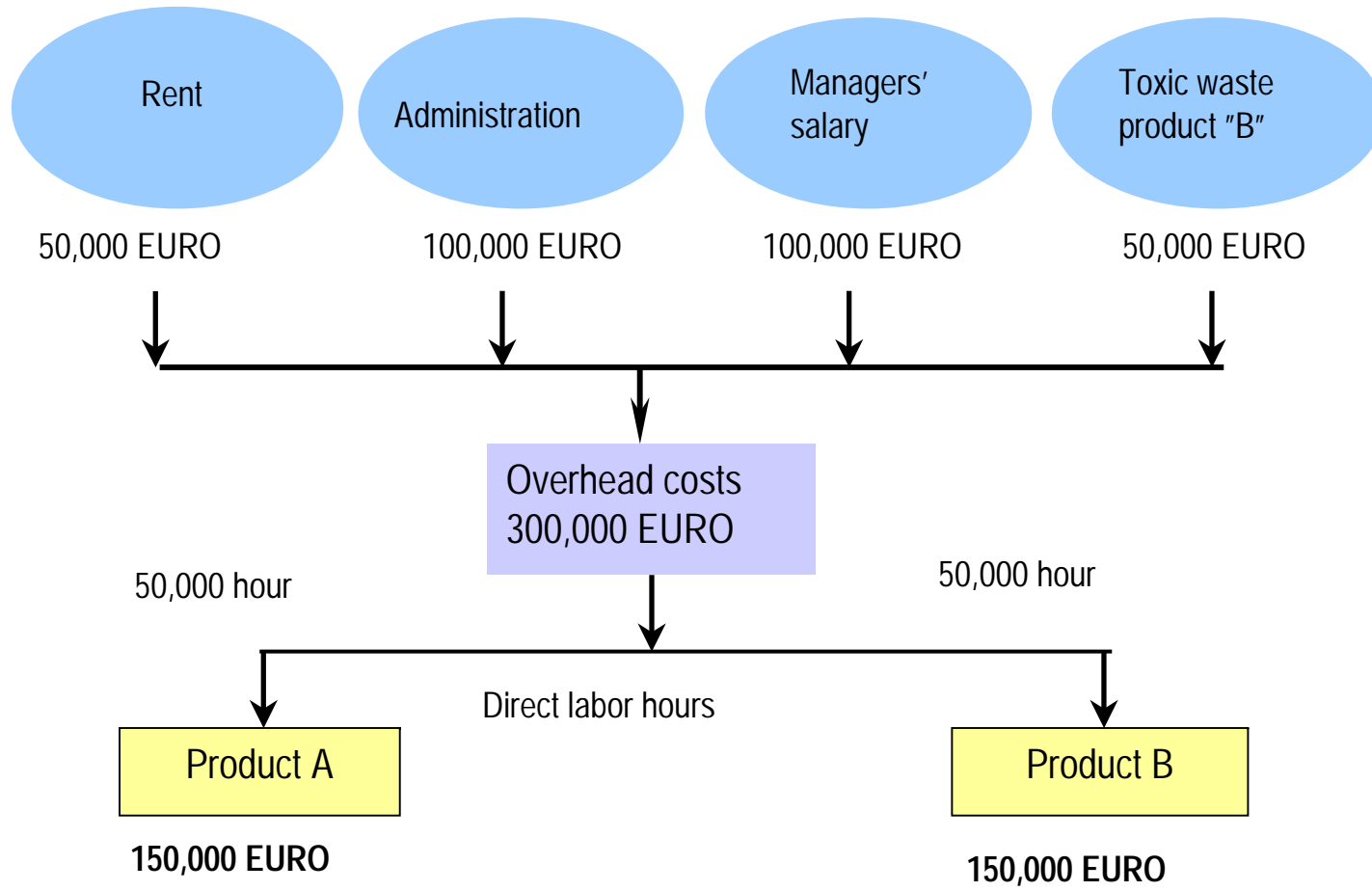

Consequences of traditional method

- × Polluting products seem more profitable;
- × Clean products seem less profitable;
- × False signals to decision makers;
- × Polluting products are favoured.



[Http://hcpc.bke.hu](http://hcpc.bke.hu)

e-mail: cleaner@enviro.bke.hu

Suggested allocation of costs

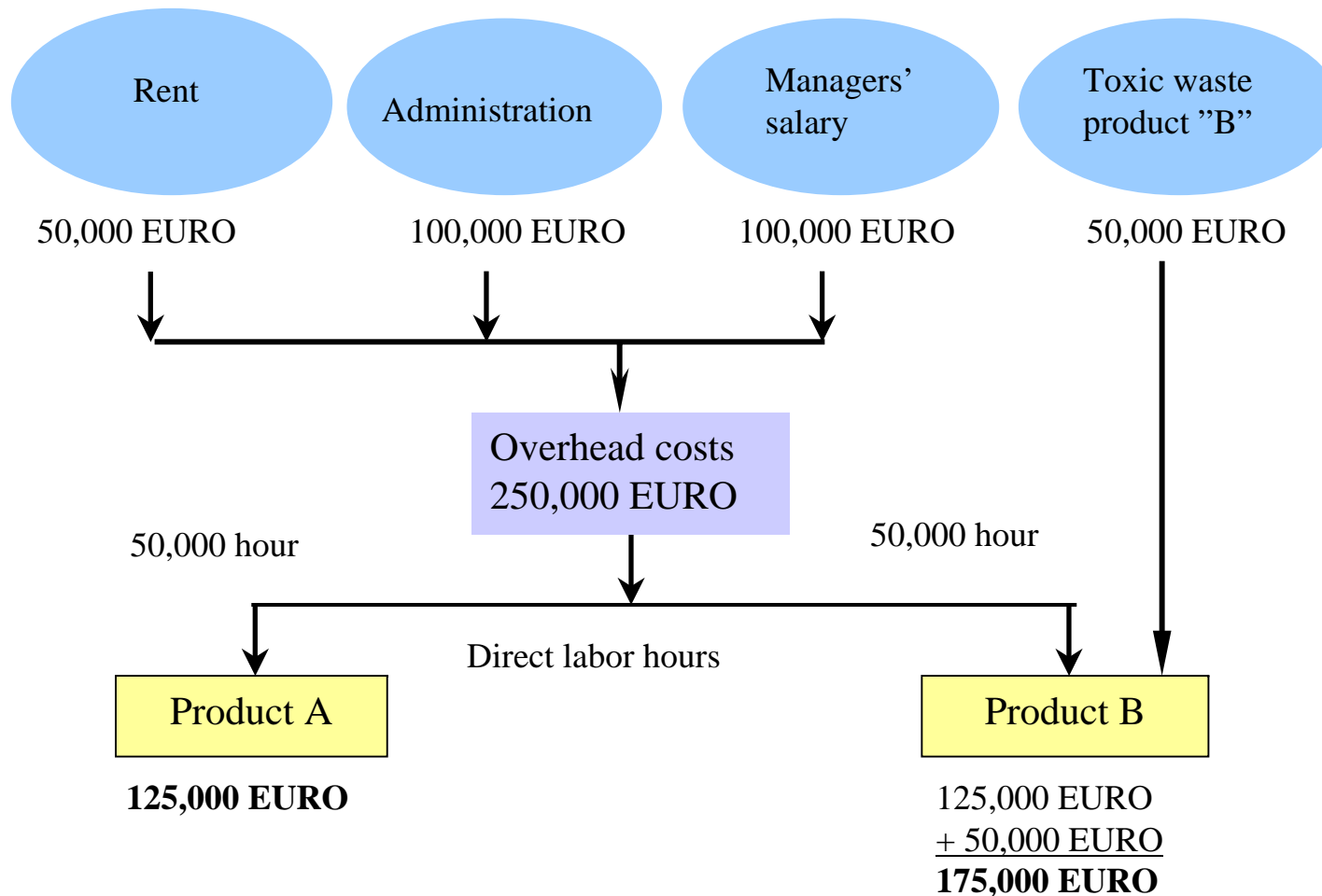

Cost Allocation: Step 1

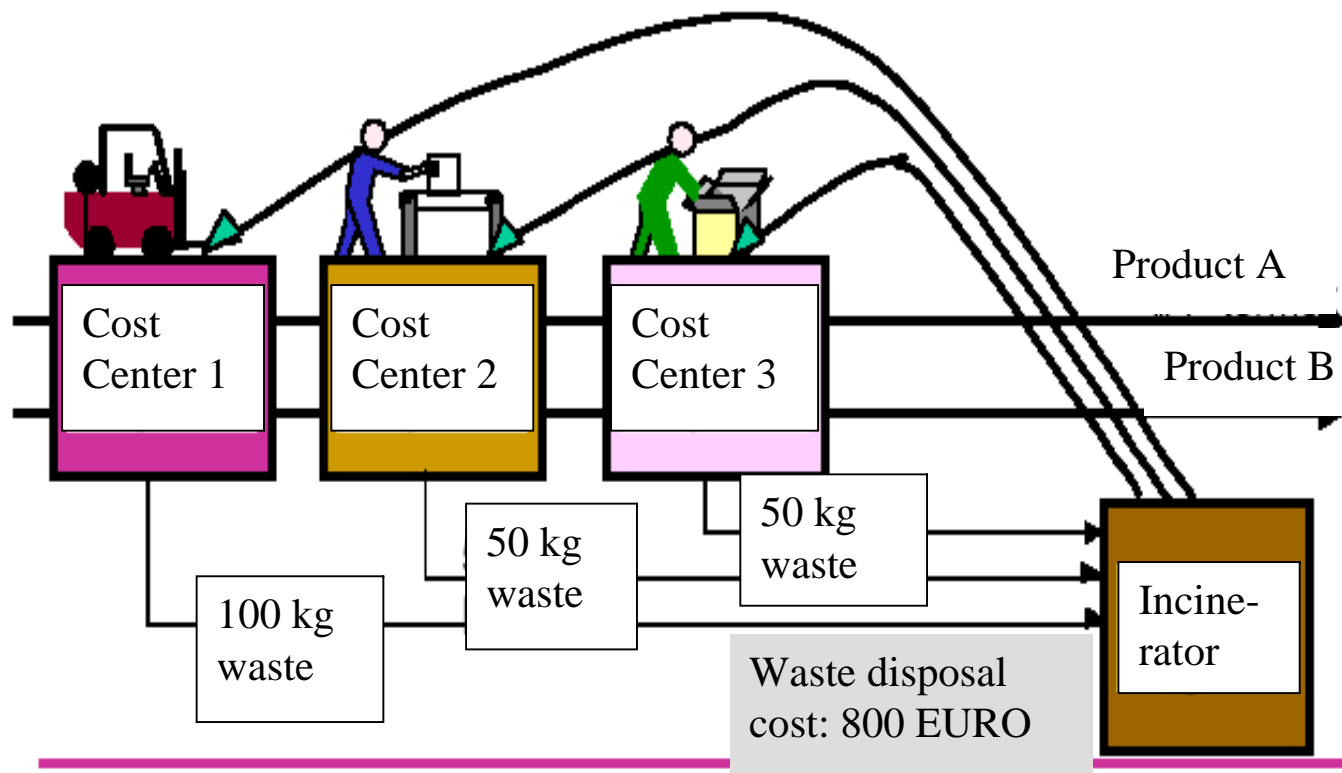

Cost Allocation: Step 1

	Waste	Cost of inceneration
Cost Center 1.	100 kg	400 EURO
Cost Center 2.	50 kg	200 EURO
Cost Center 3.	50 kg	200 EURO
Total:	200 kg	800 EURO

Cost Allocation: Step 2

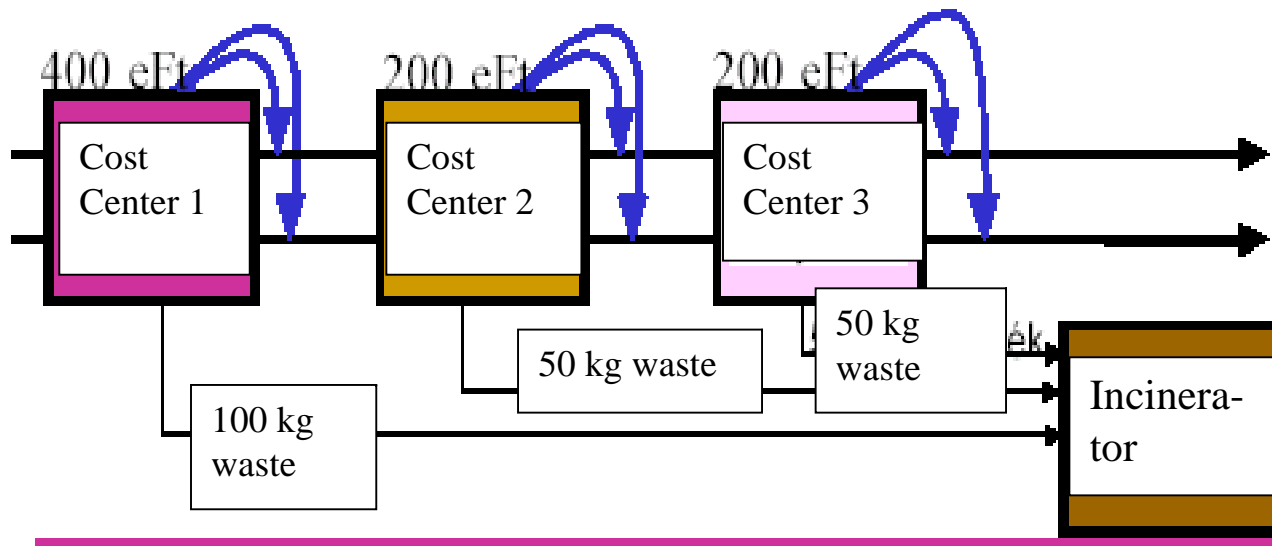

Source: Csutora, Vállalti környezetvédelmi költségek számbavétele, III.

Cost Allocation: Step 2

	Product A	Product B	Total
Cost Center 1.	50% 200	50% 200	400 EURO (100 kg)
Cost Center 2.	40% 80	60% 120	200 EURO (50 kg)
Cost Center 3.	70% 140	30% 60	200 EURO (50 kg)
Total:	420EURO	380EURO	

Results of Better Cost Allocation

- × departments will get a clear picture about their environmental costs,
- × if these costs are significant, the department manager will feel encouraged to reduce these costs, which
- × may lead to more efficient operation and less environmental pollution.



[Http://hcpc.bke.hu](http://hcpc.bke.hu)

e-mail: cleaner@enviro.bke.hu

Environmental Management Accounting

Gyula Zilahy

11th June, 2002



[Http://hcpc.bke.hu](http://hcpc.bke.hu)

e-mail: cleaner@enviro.bke.hu

NATO CCMS Pilot Study, Cetraro, 2003

Proposal for co-operation - 1

- Needs
 - × training of trainers in indicators and EMA
 - × Implementation of EMA at the company level
- Resources of the HCPC
 - × Training material in Hungarian and in English
 - × Experience in training of trainers
 - × Some experience in implementation



[Http://hcpc.bke.hu](http://hcpc.bke.hu)

e-mail: cleaner@enviro.bke.hu

Proposal for co-operation - 2

Proposed project: 2 phases

- Phase I.: train-the-trainers
 - × Trainers from NATO CCMS partners
- Phase II.: train company representatives
 - × Trainings
 - × Implementation of EMA
 - × Preparation of case studies, dissemination



[Http://hcpc.bke.hu](http://hcpc.bke.hu)

e-mail: cleaner@enviro.bke.hu

*TRACI – Tool for the
Reduction and Assessment
of Chemical and other
Environmental Impacts*

**NATO CCMS Pilot Study on
Clean Products and Processes**

Annual Meeting

May 11, 2003

TRACI - Background

- Characterize and compare the potential environmental effects of various scenarios
- Promote the use of
 - Consistent set of metrics
 - Standard and scientifically defensible impact assessment methodology

TRACI - Applications

- Process design comparisons
- Life cycle impact assessments (LCIAs)
- Sustainability metrics comparisons
- Design for environmental assessments
- Environmentally preferable products comparisons

TRACI - Metrics

Ozone depletion	Global warming
Acidification	Eutrophication
Photochemical smog	Human health – cancer
Human health – noncancer	Human health criteria
Ecotoxicity	Fossil fuel use
Land use	Water use

TRACI - Methodologies

- Consistent with previous EPA modeling assumptions
- Modeling assumptions minimized by the use of midpoint modeling
- Input parameters consistent with U.S. locations used
- Modular design allows the use of sophisticated impact assessment methods

Inventory of Stressors
Land Use
Chemical Emissions
Water Use
Fossil Fuel Use



Impact Categories
Ozone Depletion
Global Warming
Acidification
Cancer
Noncancer
Criteria
Eutrophication
Smog Formation
Ecotoxicity
Fossil Fuel Use
Land Use
Water Use

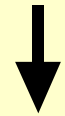
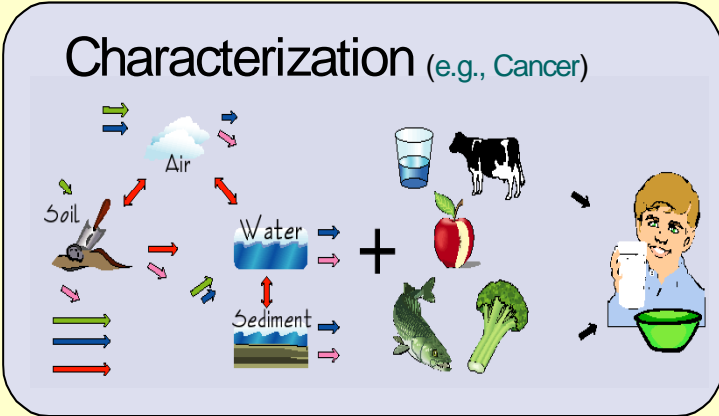

TRACI
Tool for the Reduction and Assessment Of Chemical and Other Environmental Impacts

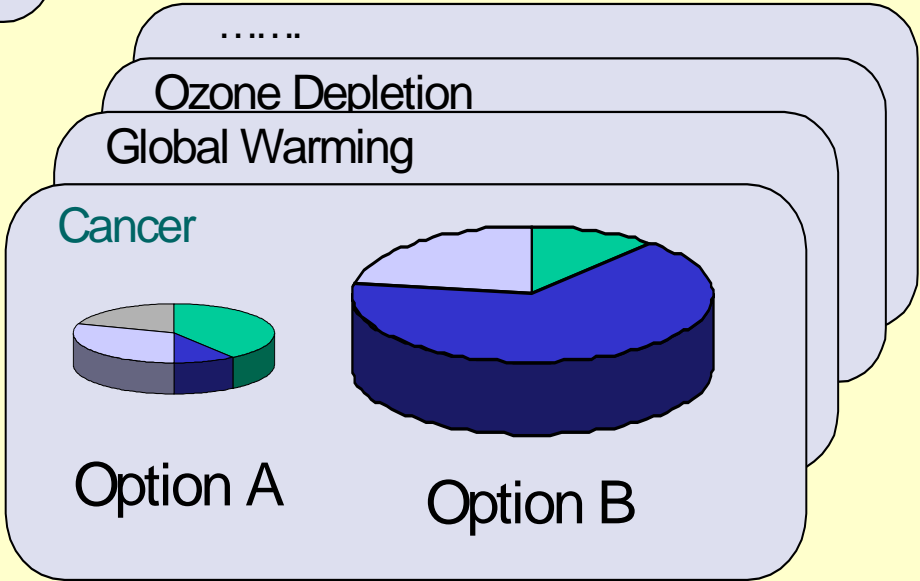

Q: How did we minimize assumptions in modeling?

A: Model at the midpoint level.

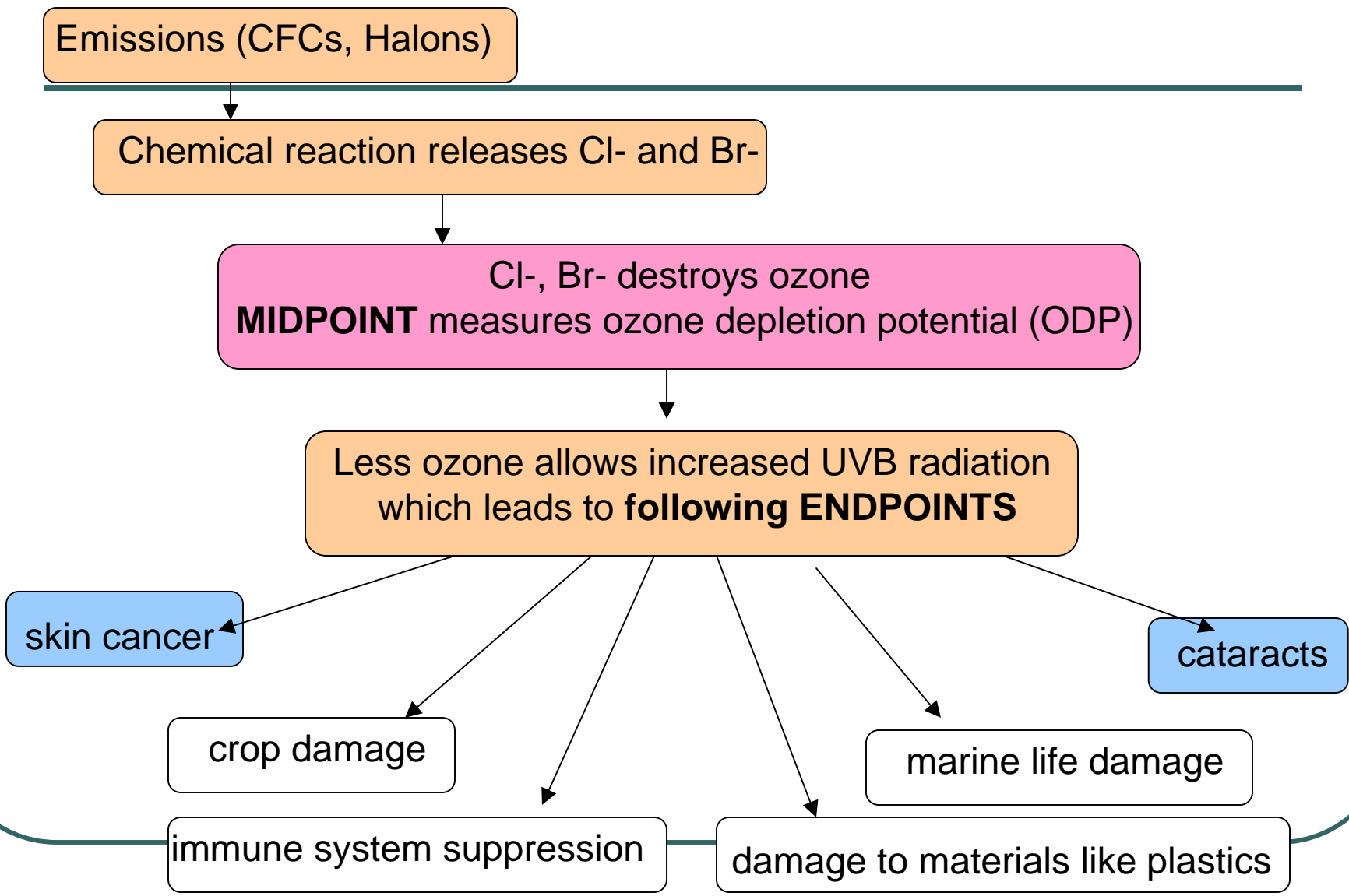

TRACI – Software, User’s Guide, and Background Paper

- Download software from:
www.epa.gov/ORD/NRMRL/std/sab/iam_traci.htm
- User’s Guide and AIChE technical paper also available
- For more information contact:
Jane Bare (bare.jane@epa.gov)

**NATO/CCMS Pilot Project
on Clean Products and Processes**

Cetraro / Italy, 11 to 15 May 2003

**Design and Simulation of
Environmental Conscious
Chemical Processes**

Teresa Mata, Raymond Smith, Douglas Young, Carlos Costa



Laboratory of Processes, Environment and Energy Engineering

FEUP - Faculty of Engineering of the University of Porto



Presentation Overview

Presentation of two case studies:

✓ 1st case study

**Fugitive emissions versus operating conditions
in the catalytic reforming process**

✓ 2nd case study

**Heat integration and process economics
in the hydrodealkylation (HDA) of toluene to benzene**

1st case study

**Fugitive Emissions versus
Operating Conditions:
Catalytic Reforming Process**

Study Objectives

- ✓ to examine different process operating conditions for the reforming process
- ✓ to estimate the reformat RON
- ✓ to estimate the process fugitive emissions
- ✓ to evaluate the PEI's

Evaluation of the PEI's

➔ U. S. EPA “Waste reduction (WAR) algorithm” (8 PEI's categories):

- **Human toxicity by ingestion and inhalation**
- **Human toxicity by dermal exposure**
- **Aquatic toxicity**
- **Terrestrial toxicity**
- **Global warming**
- **Ozone depletion**
- **Acid rain and**
- **Smog formation**

Note: These categories are combined in order to obtain a total PEI index using weighting factors currently all set equal to 1.0.

Diagram of the Reforming Process

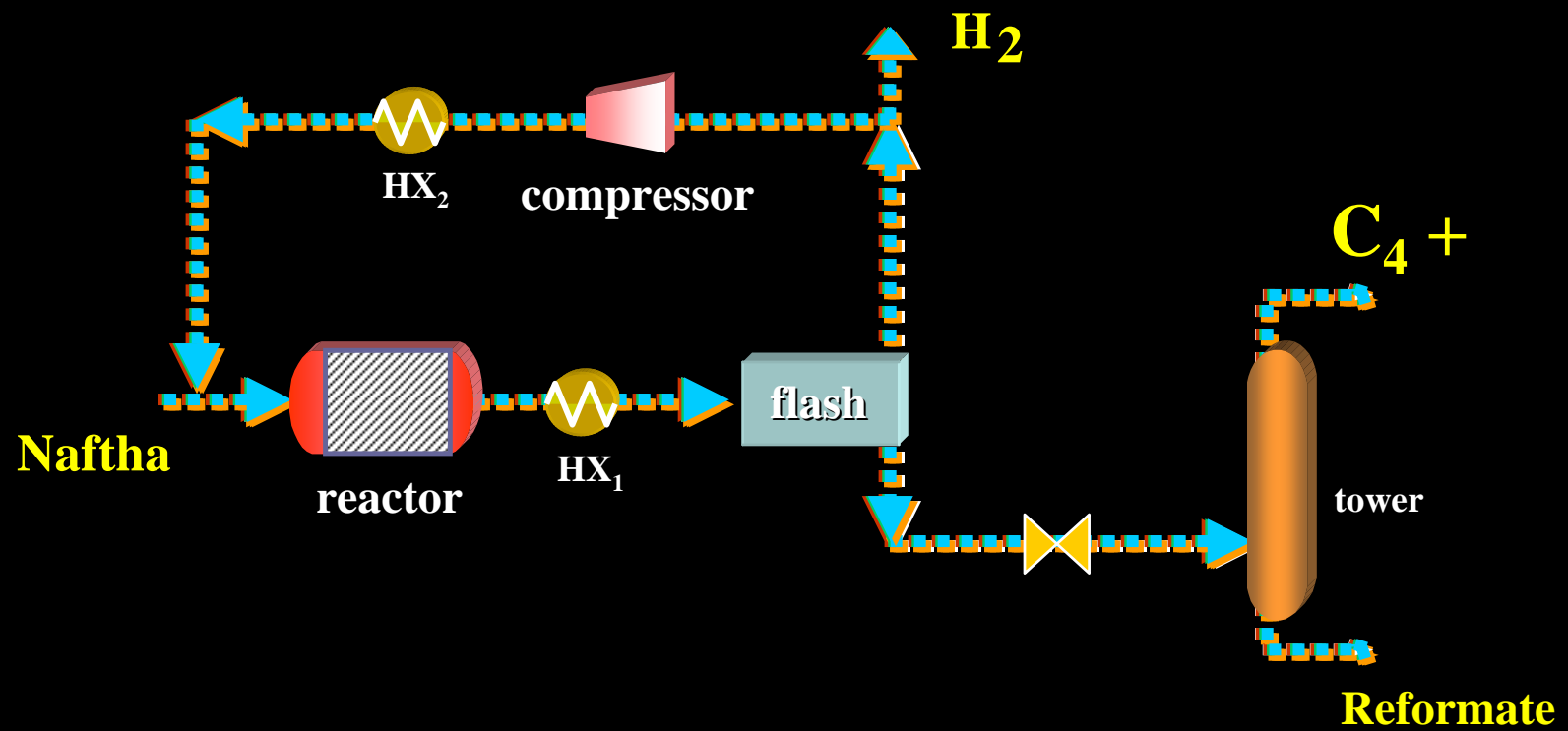

Reforming: chemical reactions

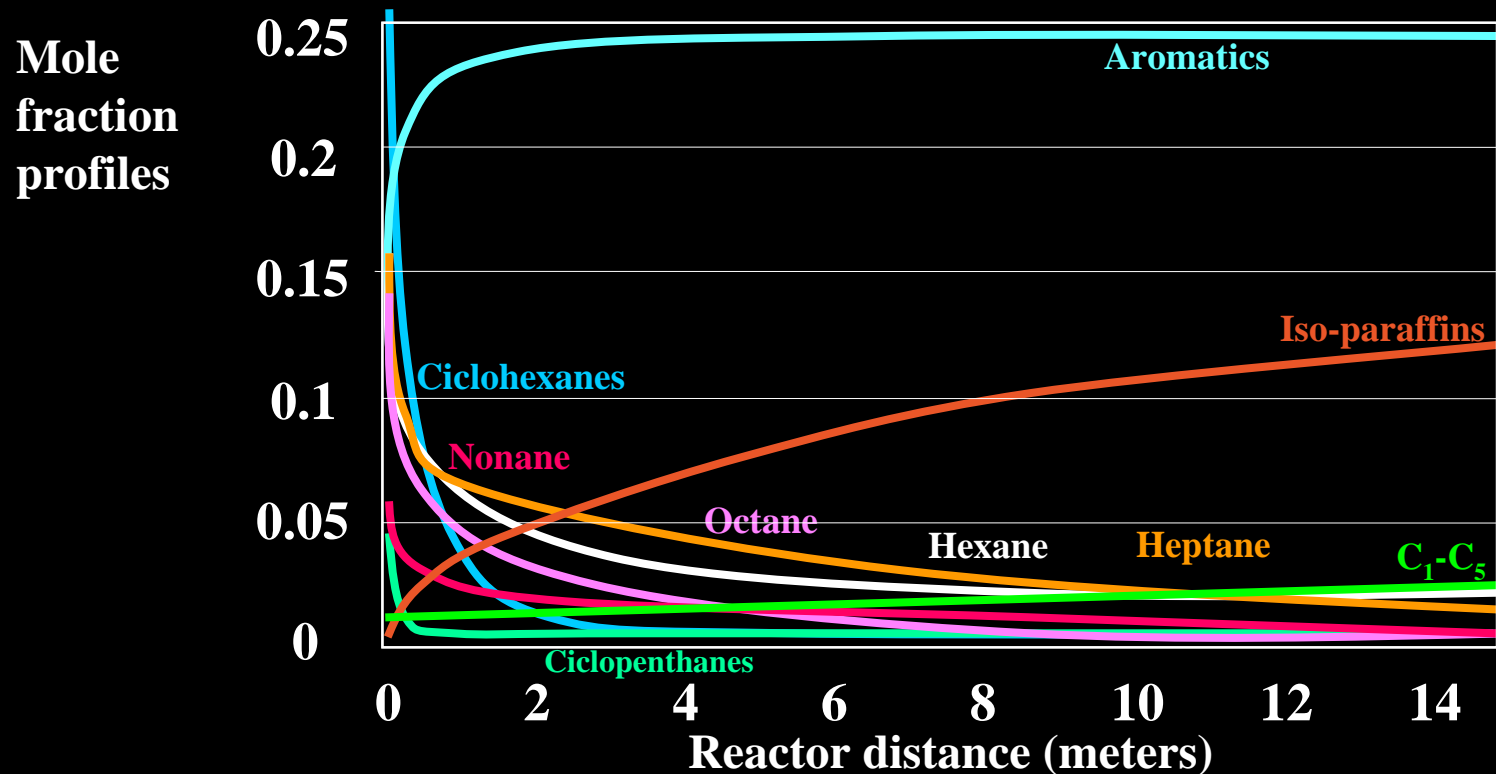

Catalytic reforming consists of diverse reactions:

- dehydrogenation of naphthenes to aromatics
- dehydrocyclization of paraffins to naphthenes
- isomerization of paraffins and naphthenes
- dealkylation of alkylaromatics and
- hydrocracking of paraffins and naphthenes

Reforming: design & simulation

- ➔ **For the simulations of Reforming:**
 - ↪ **Reactor type: adiabatic**
 - ↪ **Reactor length : 15 meters**
 - ↪ **Reactor diameter: 0.8 meters**
 - ↪ **Total volume : 7.5 m³**
 - ↪ **Mass of catalyst: 6818 kg**
 - ↪ **Bulk density : 1000 kg/m³**
- ➔ **Kinetics of 107 chemical reactions and 43 components**
- ➔ **Pressure = 500, 1500 e 3000 kPa**
- ➔ **Temperature = 733.15 K, 773.15K e 813.15K**
- ➔ **Flash overhead recycling: 0, 20, 50 e 80%**

RON of reformatate

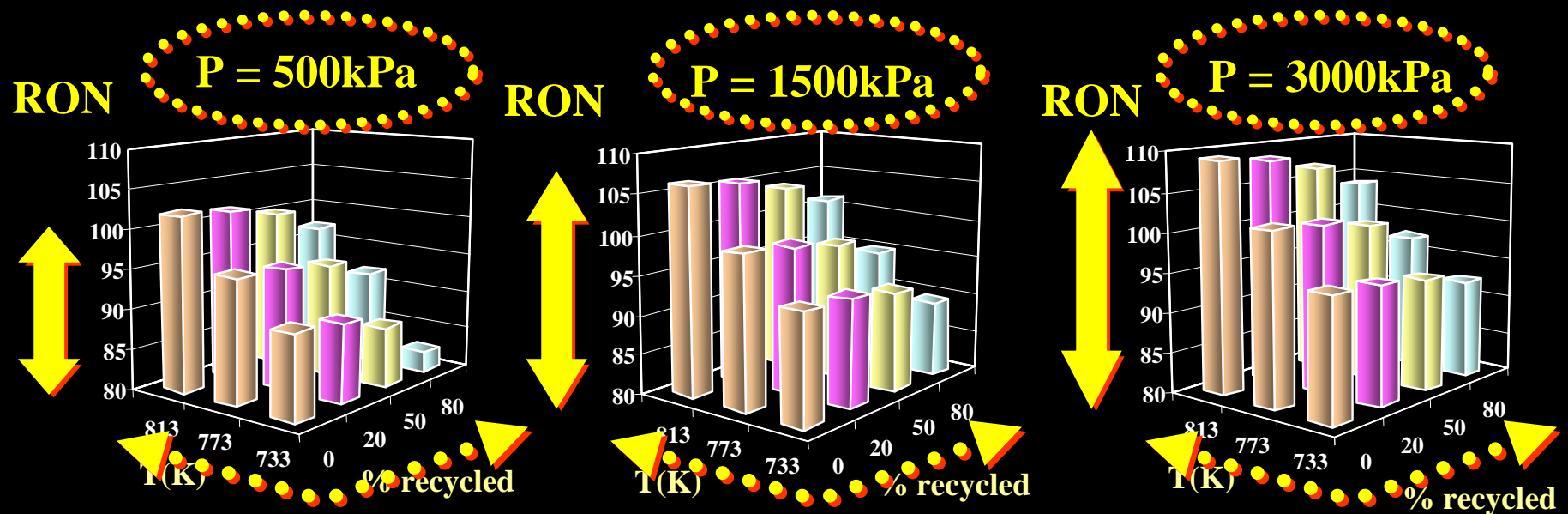

Fugitive Emissions

P = 500kPa

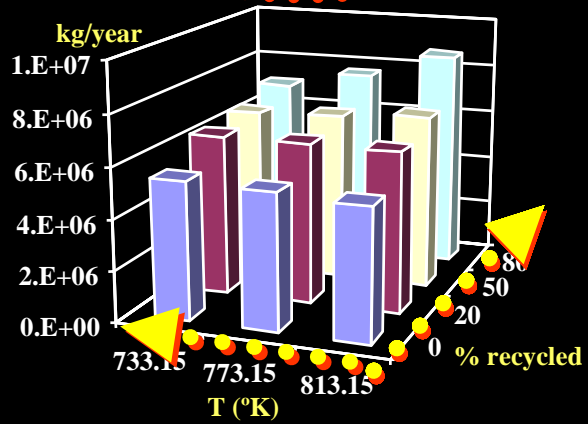

P = 1500kPa

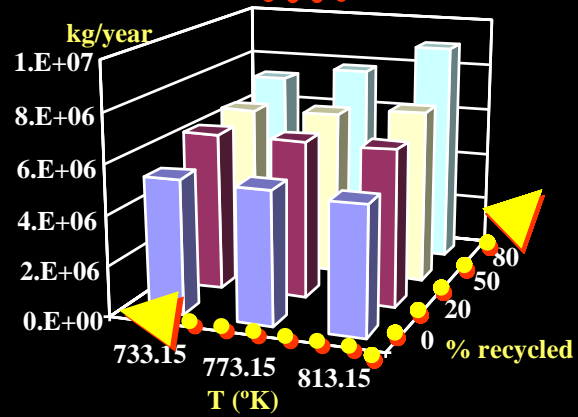

P = 3000kPa

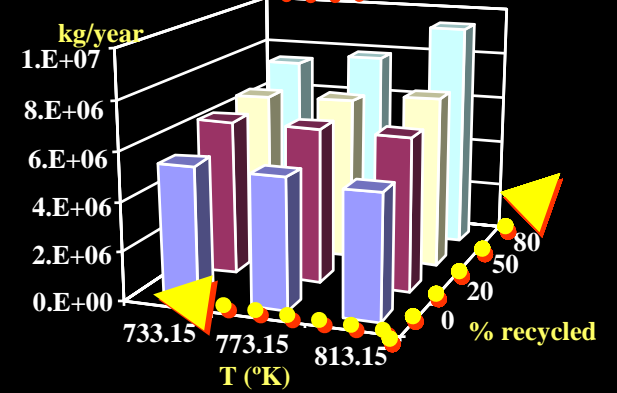

Potential Environmental Impacts

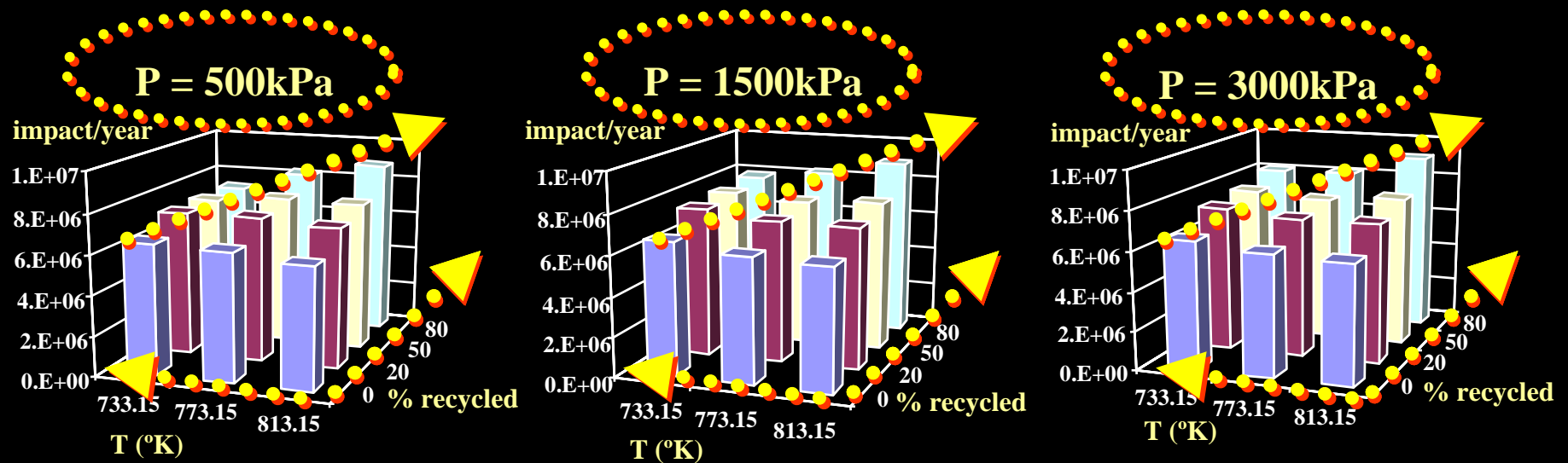

Potential Environmental Impacts

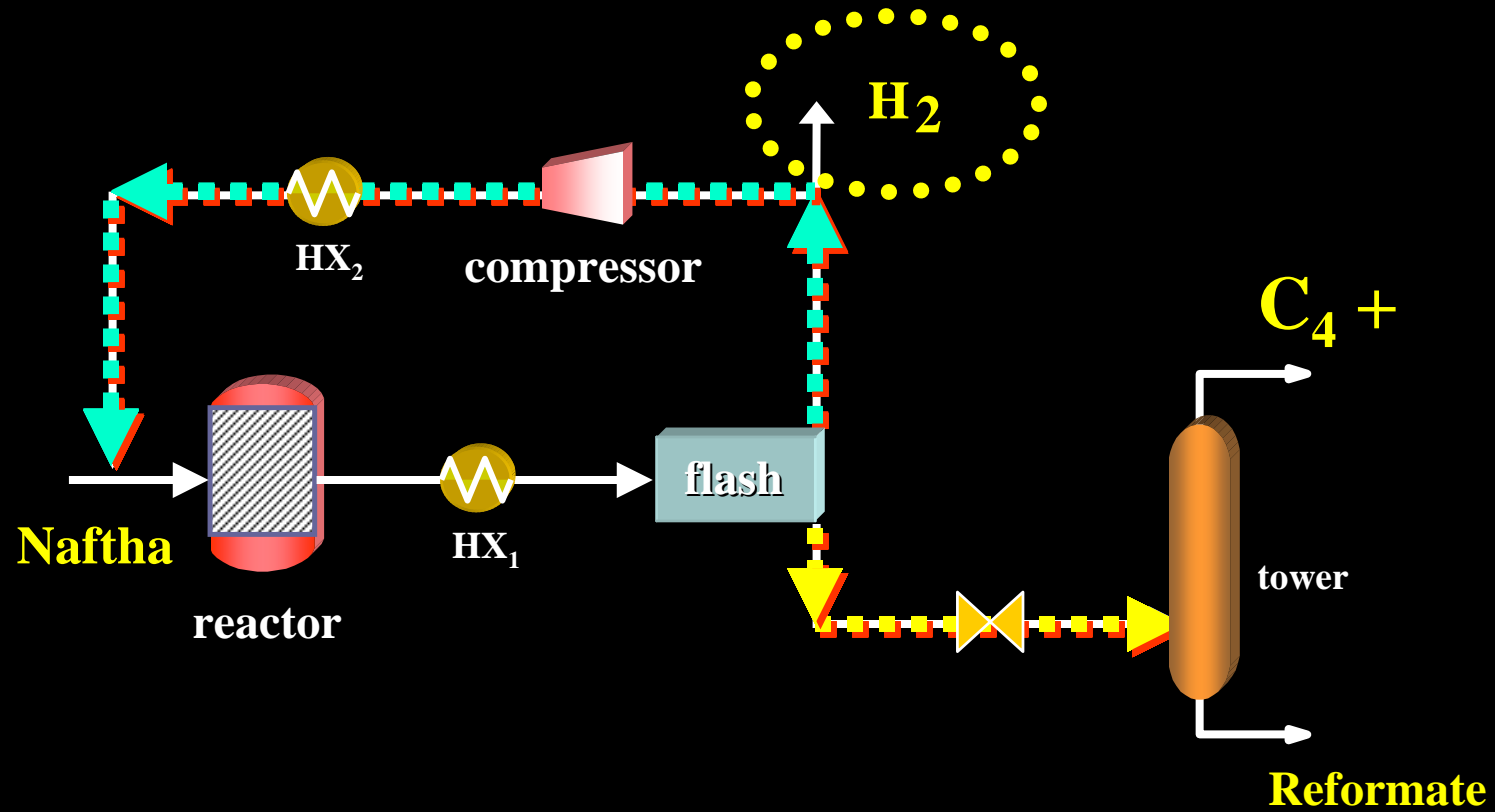

Conclusions

- ➔ **The amount of fugitive emissions and PEIs depend:**
 - **on the magnitude of the stream flowrates through the process,**
 - **on the stream chemical content and**
 - **on the process details:**
 - ◆ **number of streams and**
 - ◆ **type of process equipment (e.g. valves, flanges, compressors, etc.)**

Conclusions

- ➔ **This study indicates that more recycling is not always a better solution for waste minimization.**
- ➔ **In this case study to recycle means larger stream flowrates through almost the entire process and more equipment, which increase the fugitive emissions and their PEIs.**
- ➔ **Also, if recycle is increased and more pieces of equipment need to be added the capital and operating costs of the process will also increase.**

Conclusions

- ➔ **The RON of the reformat increases with T and P, however it decreases as the % of the flash overhead recycling increases.**
- ➔ **With this study information on research octane numbers and fugitive emissions an engineer could devise an operating policy that obtains desired products while minimizing PEIs.**
- ➔ **In particular, there are tradeoffs between higher octane numbers and potential environmental impacts at higher temperatures and pressures, while increased recycling reduces octane number and increases potential environmental impacts.**

2nd case study

Heat Integration and Process

Economics:

Hydrodealkylation (HDA) of Toluene to Benzene

Study Objectives

- ✓ **Design and simulation of the HDA process considering different design alternatives with increasing level of energy integration**
- ✓ **Estimation of fugitive and open emissions**
- ✓ **Evaluation of the PEI of the process and of the energy generation process**
- ✓ **Economic evaluation of the different design alternatives**

Diagram of the HDA Process

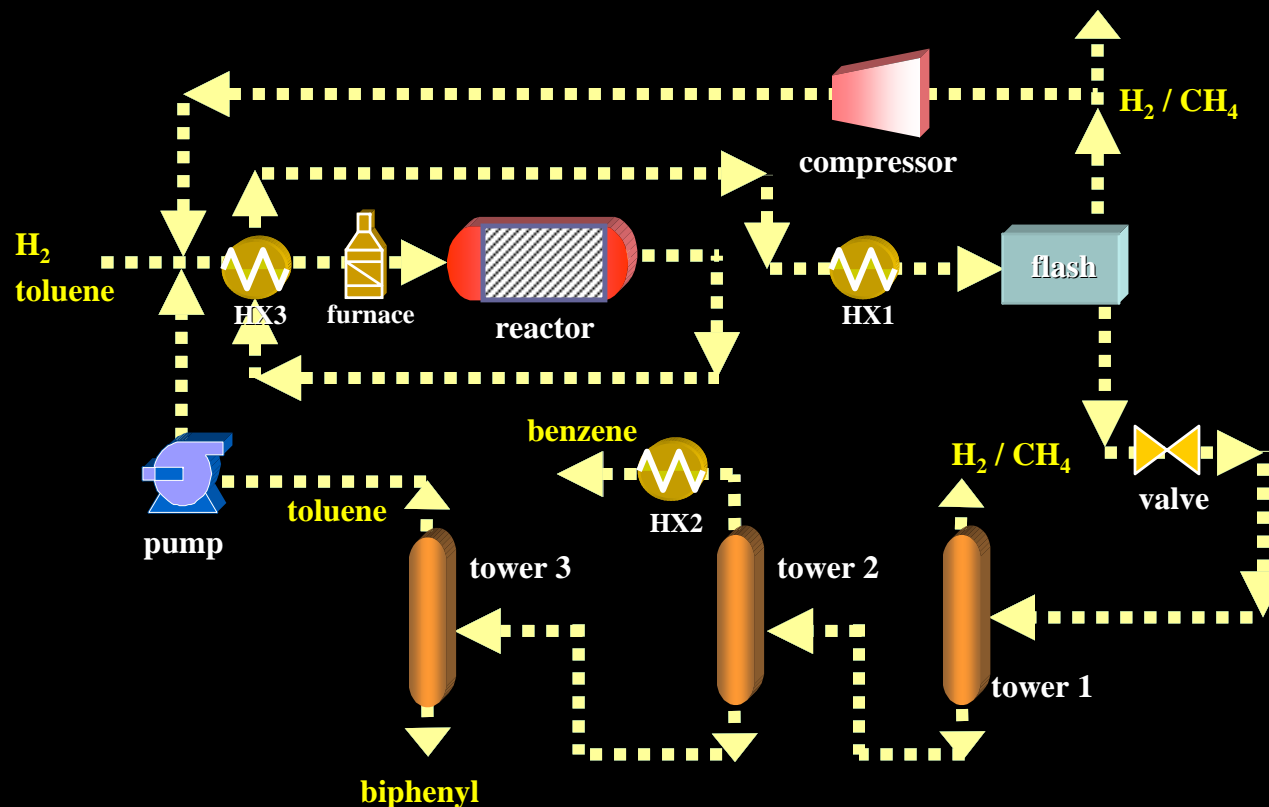

HDA: chemical reactions

The main reaction of the HDA process involves the conversion of approximately 75.4% by mass of toluene to benzene



approximately 1.5% by mass of the benzene is converted to biphenyl.



The HDA Process

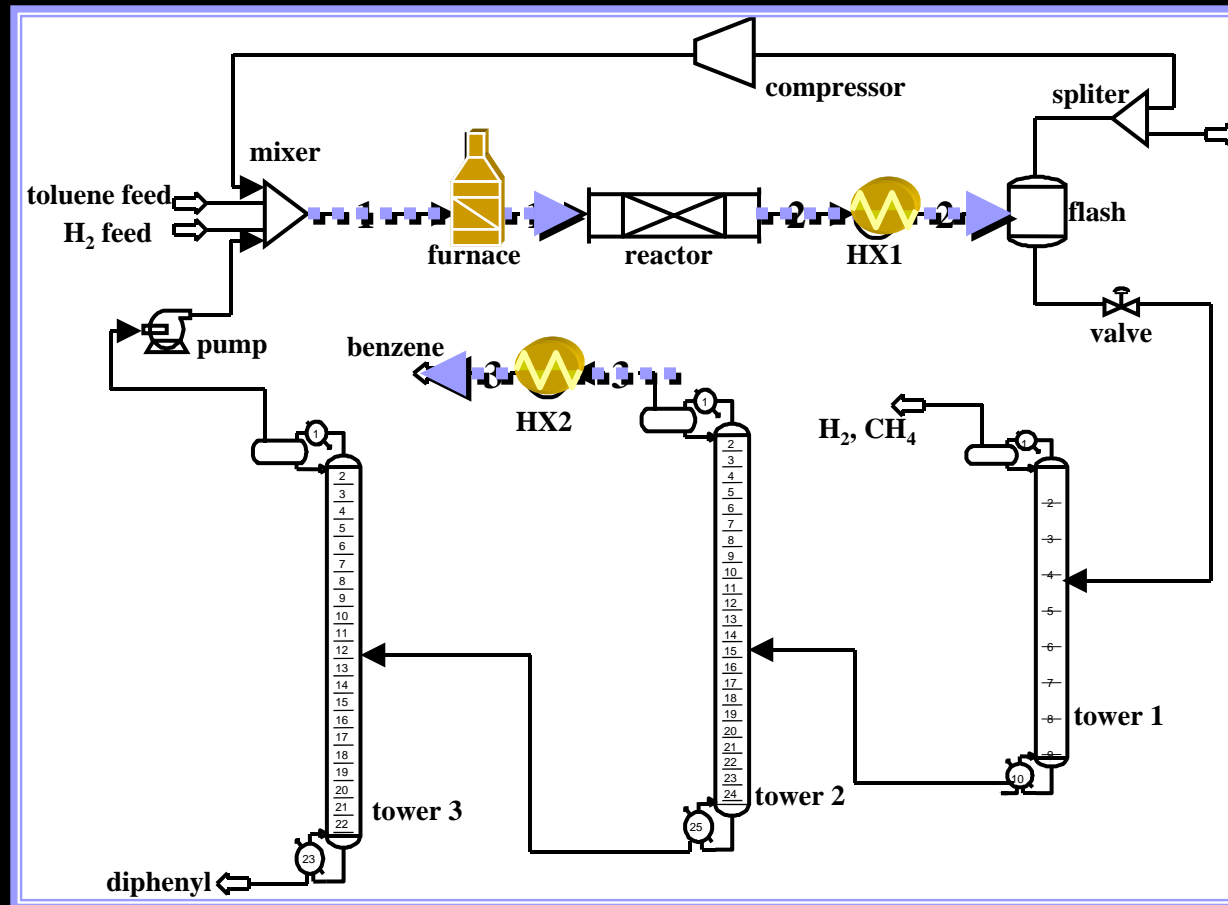

a)

The HDA Process

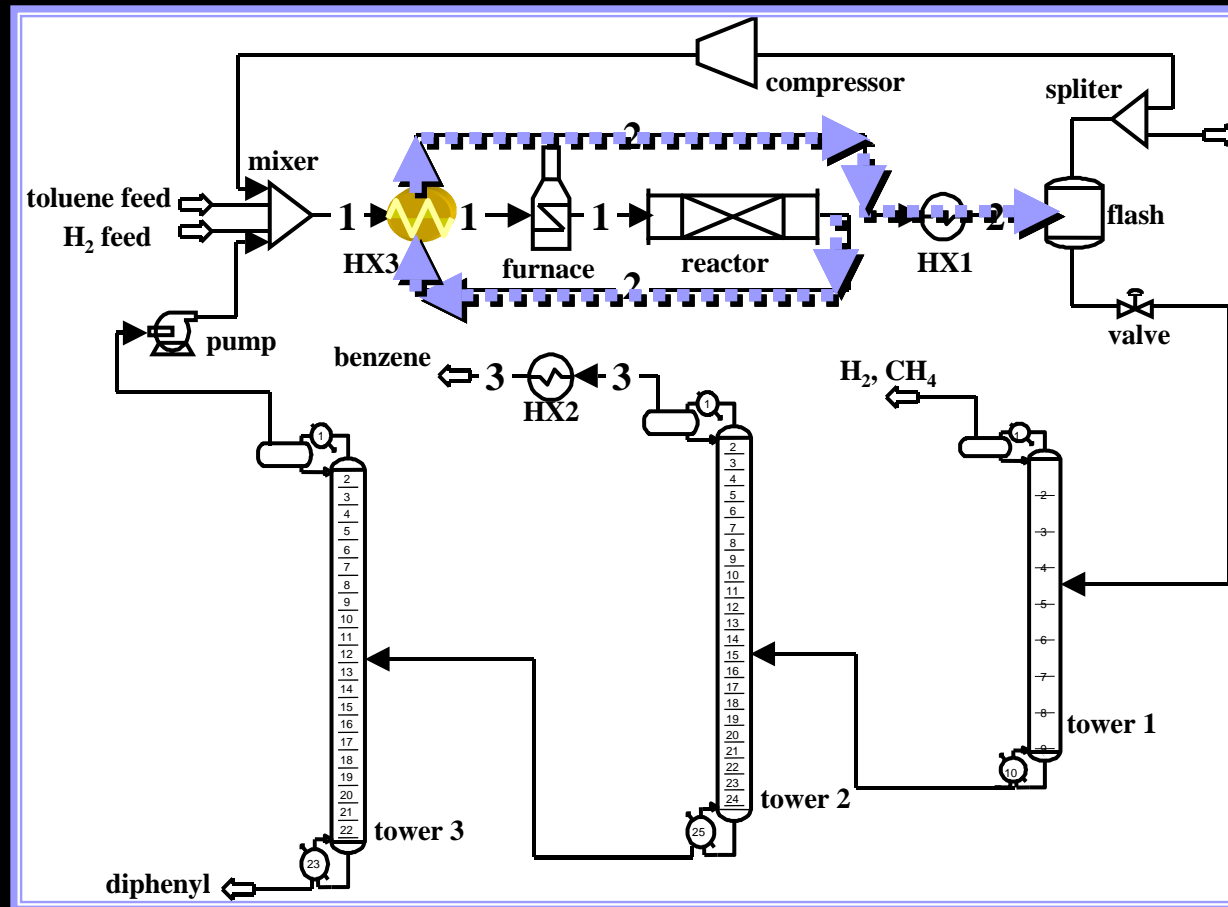

b)

The HDA Process

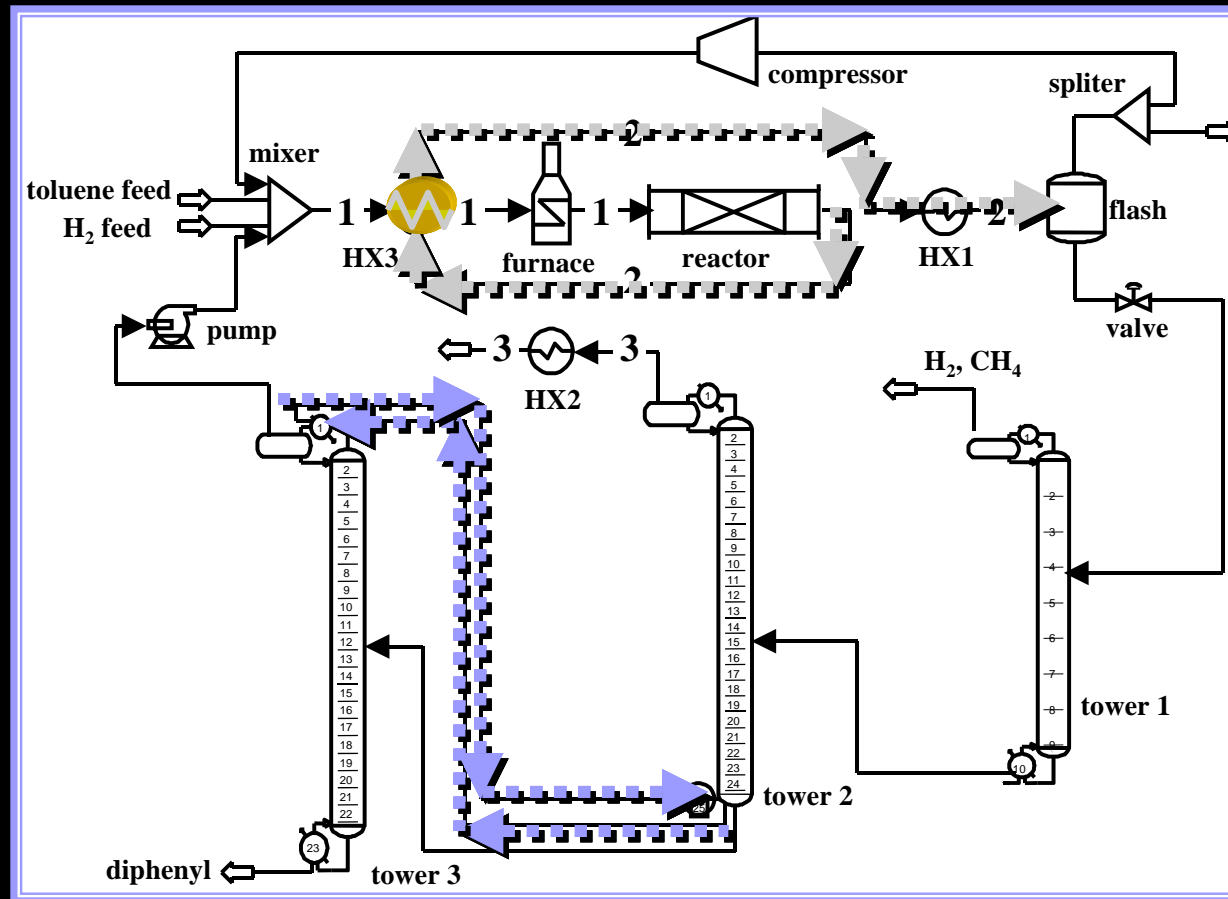

c)

The HDA Process

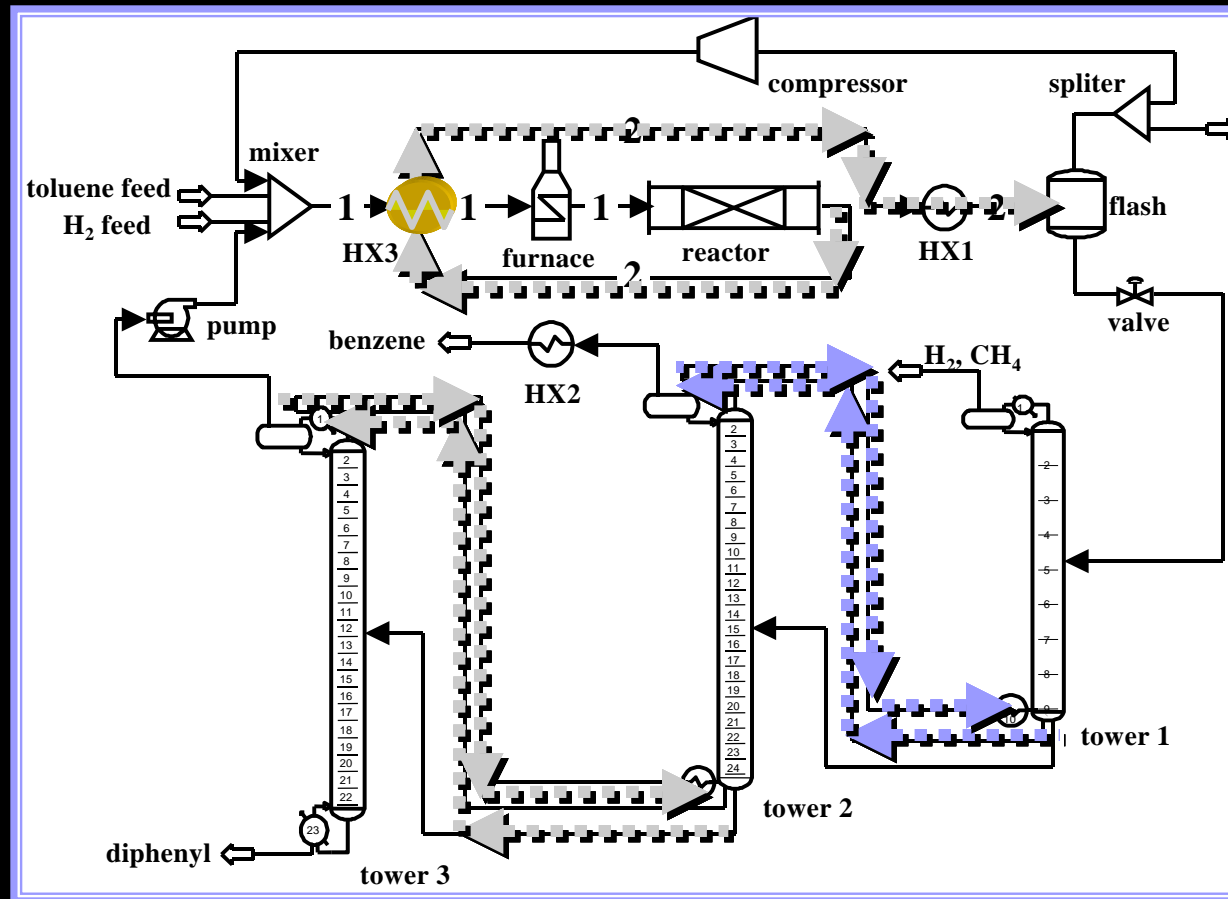

d)

PEI's of the Process

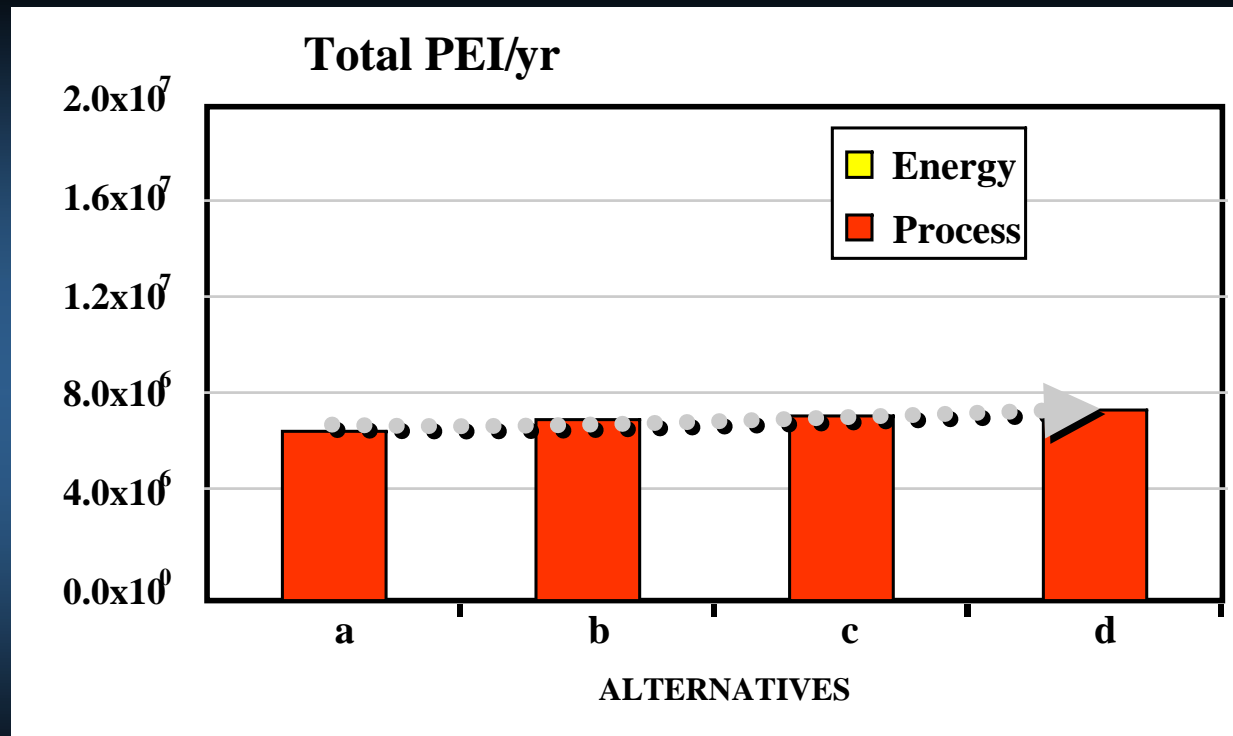

The effect of heat integration on total PEI is relatively small between these alternatives.

PEI's of the Process

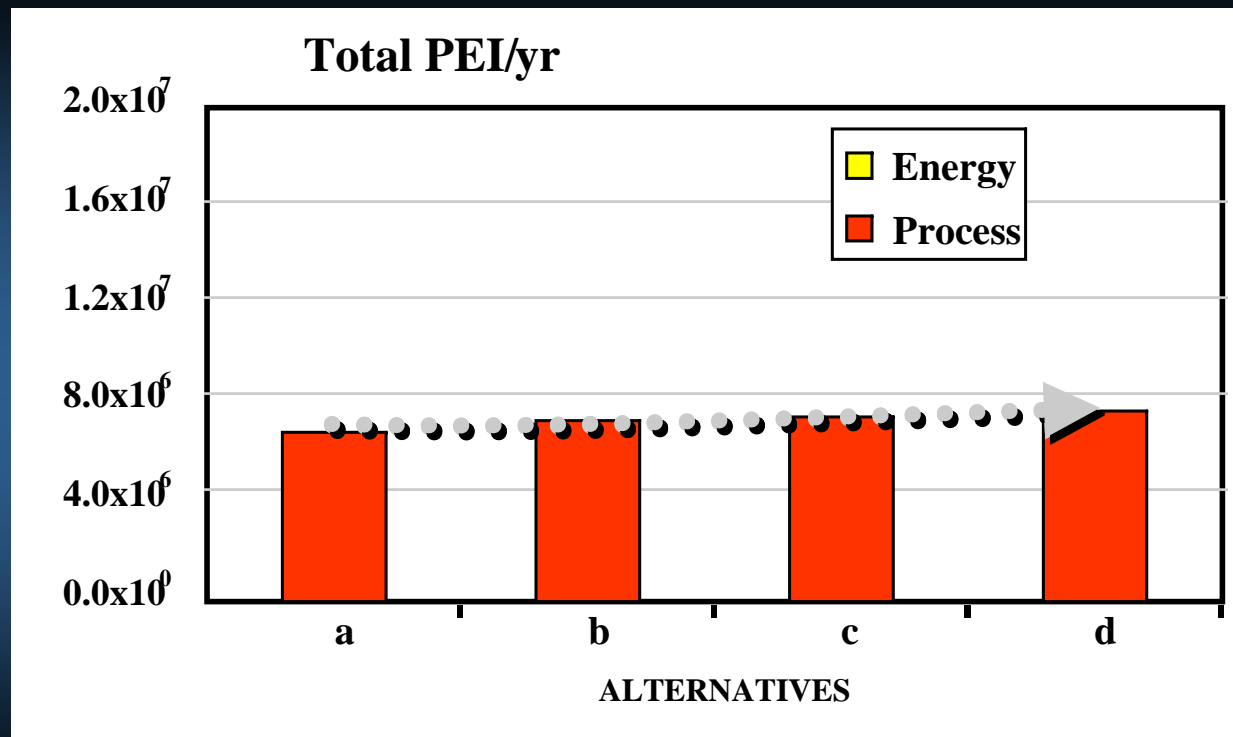

Fugitive emissions increase when more integrated the process is.

The HDA Process

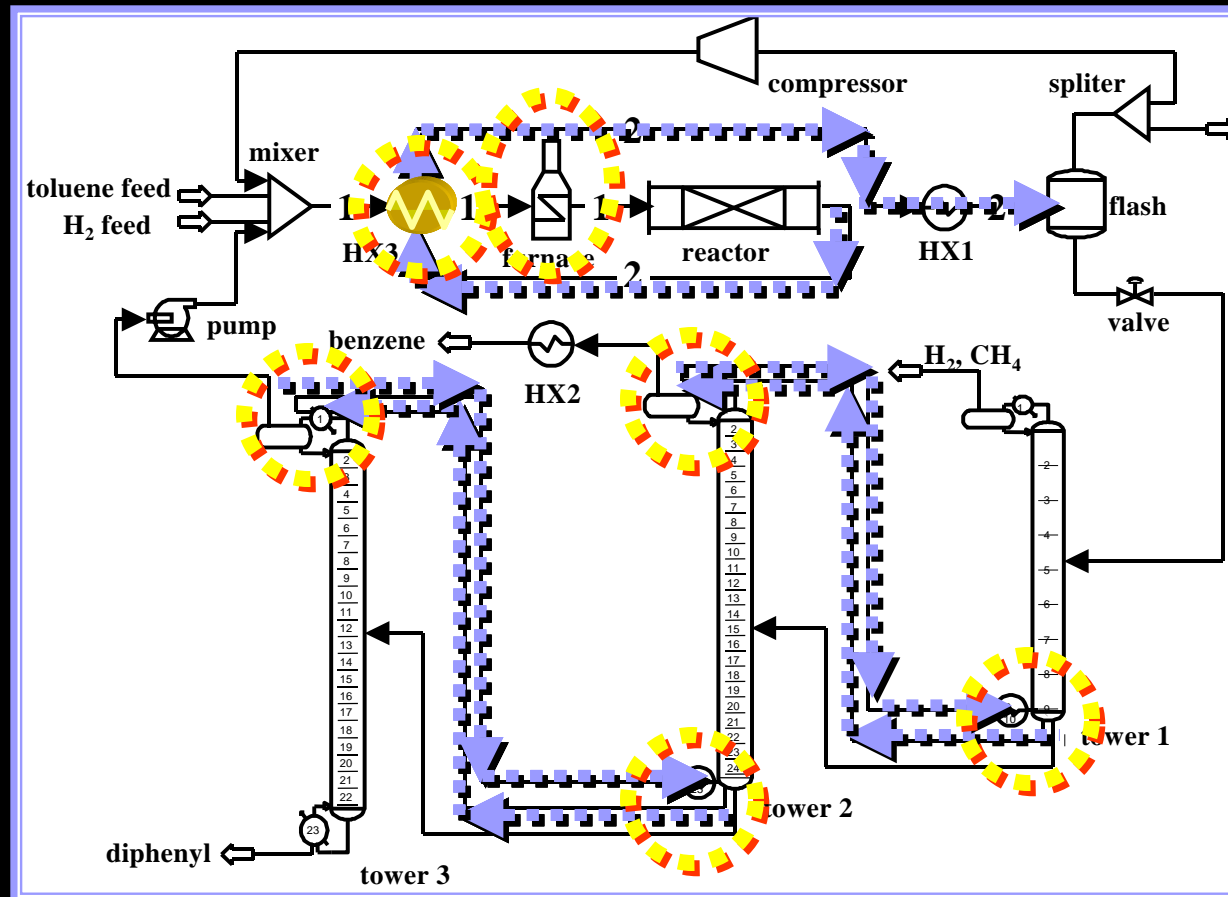

One more heat exchanger and process streams added without replacing others.

PEI's of the Energy Generation

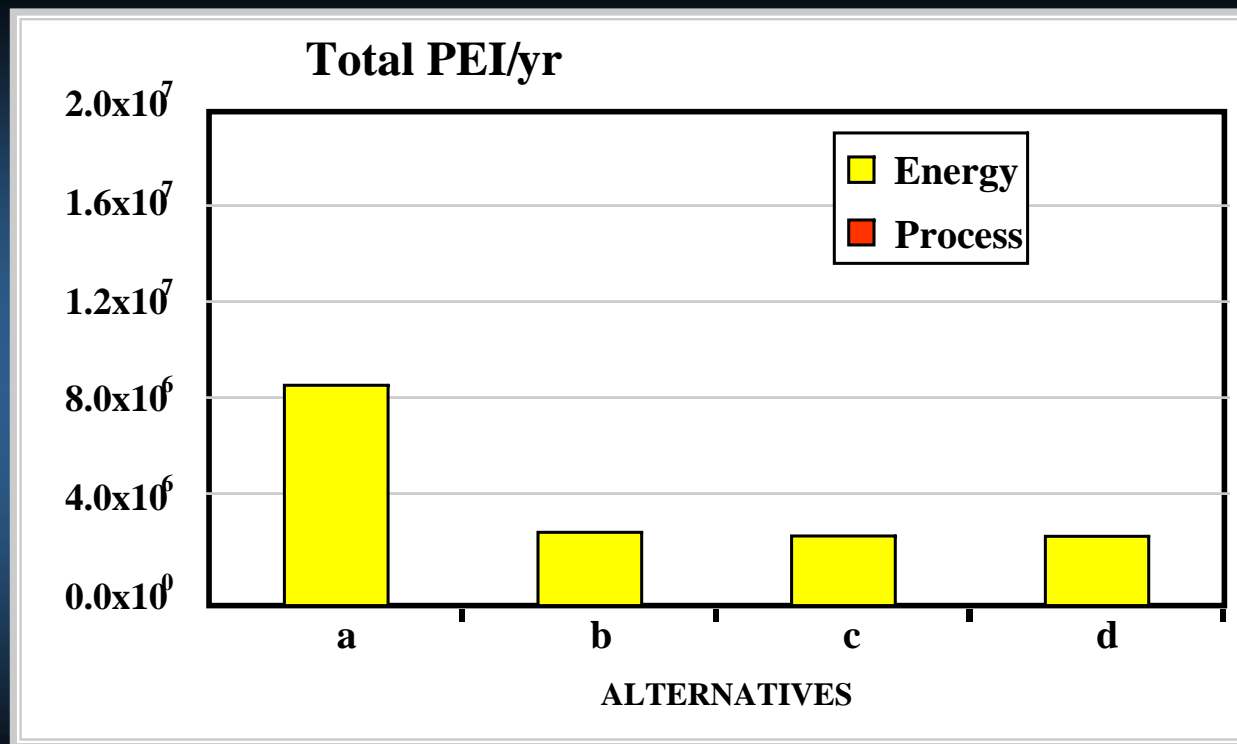

PEI's of the Energy Generation

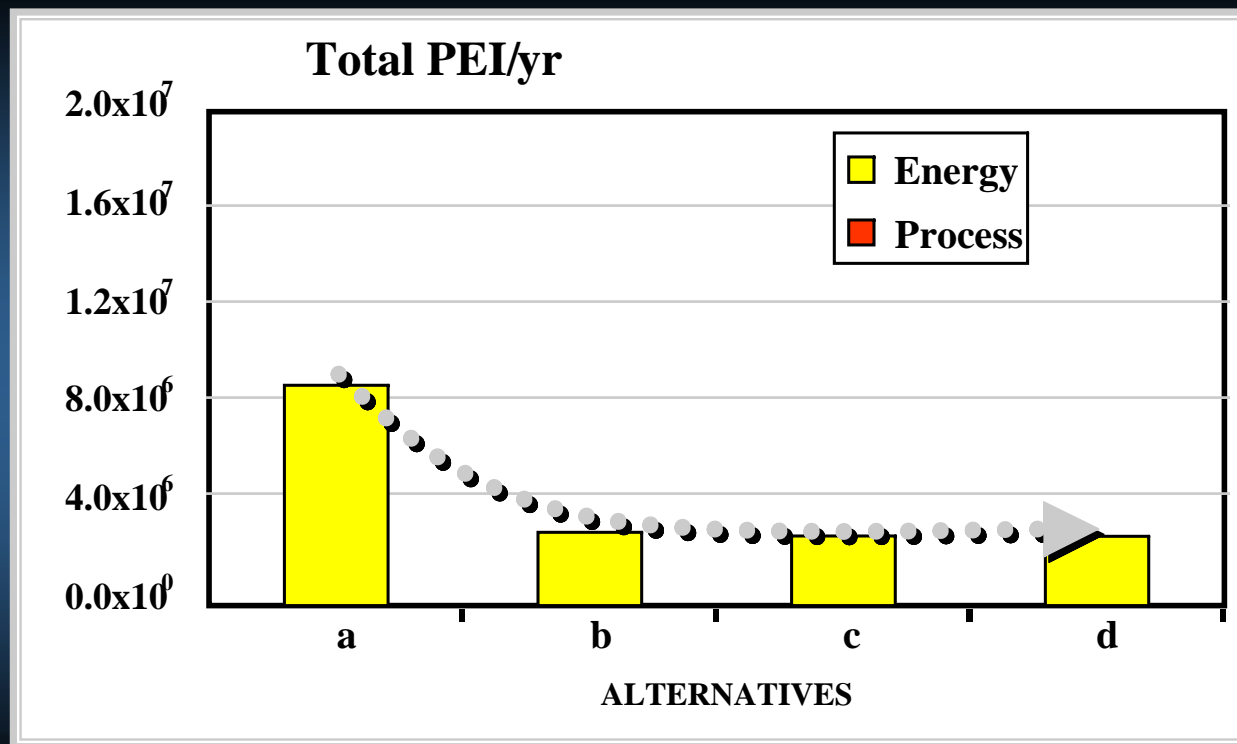

Contribution to the PEI's due to energy generation decreases as the level of energy integration increases since energy consumption decreases.

Total PEI's of the Process and Energy Generation

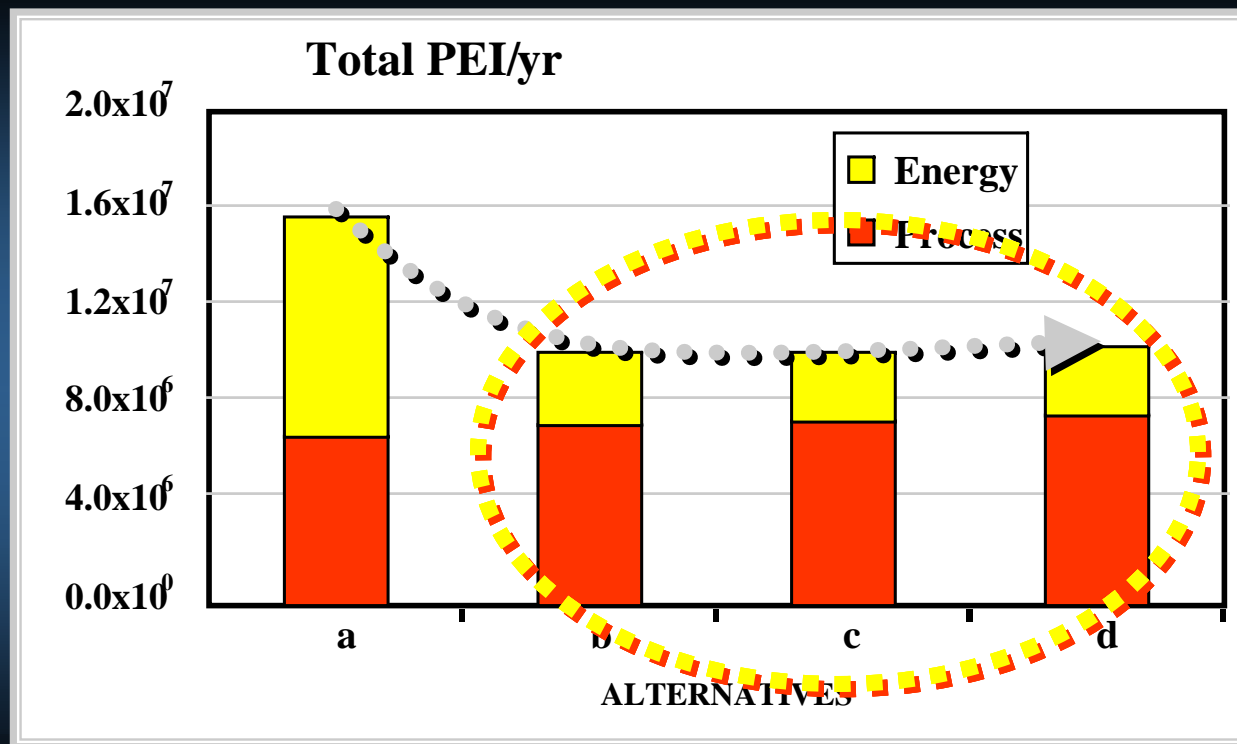

For the combined PEI of the process and of the energy generation, alternatives *b*, *c* and *d* are superior to alternative *a*.

Operating Costs

Operating costs of utilities
(million /year)

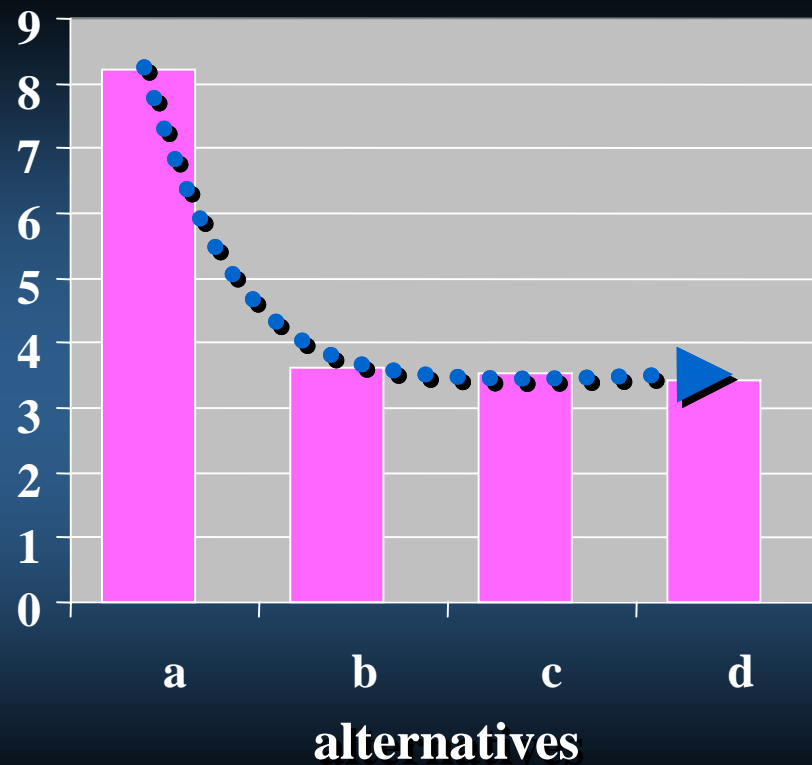

The operating costs decrease because the consumption of utilities is reduced when the process is heat integrated.

Capital Investment

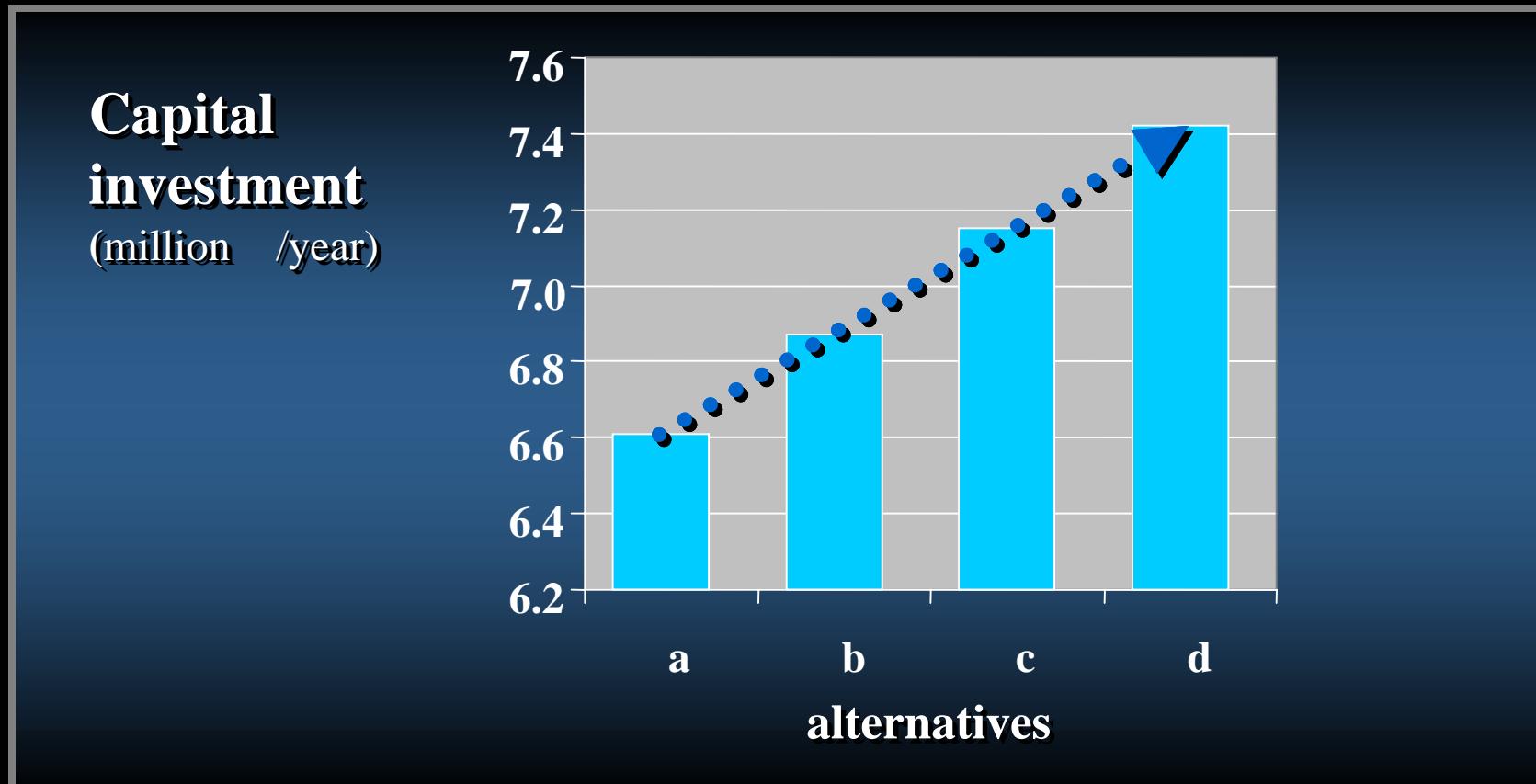

The capital investment increases when the process is more heat integrated due to additional piping system and heat exchangers.

Economic Potential

Economic potential
(million /year)

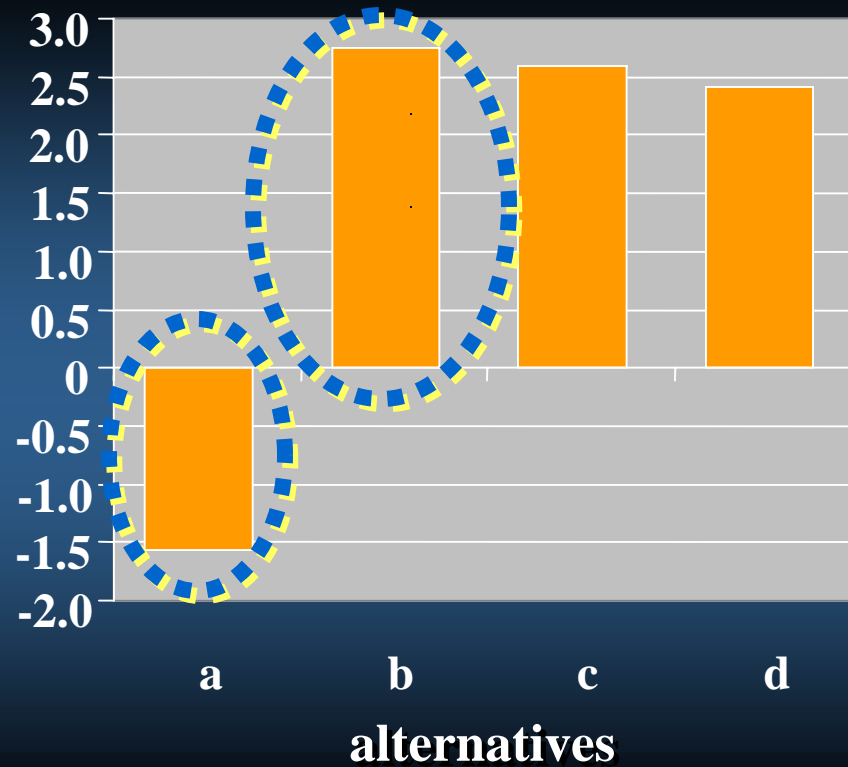

For the EP alternative *b* has the largest economic potential and alternative *a* has the lowest economic potential.

Conclusions

- ➔ There were a number of tradeoffs found in this study.
- ➔ The process fugitive emissions increase as the level of energy integration increases, and subsequently the potential environmental impacts increase.
- ➔ However, the potential environmental impacts due to energy generation decrease as the level of energy integration increases.

Conclusions

- ➔ **As for the economics, the operating costs decrease as the level of energy integration increases.**
- ➔ **However, the capital costs increase with an increase in energy integration, so that with these trade-offs an intermediate amount of energy integration produces the most economically beneficial process for the example designs considered.**
- ➔ **The design option which exchanges a large amount of heat between the reactor effluent and feed is superior to other designs in both analyses because of large energy savings that reduce operating costs and potential environmental impacts.**

Beyond the Molecular Frontier:
Challenges for Chemistry and
Chemical Engineering ---
An Overview of the Recent NRC
Report

Thomas W. Chapman, Ph.D.
National Science Foundation
Arlington, VA, USA

- The U.S. National Research Council has just published a detailed study that summarizes the current status of the chemical sciences. The report assesses current trends and identifies key opportunities and challenges for the 21st Century. In particular, the report lists a number of Grand Challenges for the chemical-science enterprise and deals explicitly with a number of issues of great relevance and concern to modern society.
- This report was supported in part by the National Science Foundation. This presentation will provide a brief summary of the report and comment on some of the Grand Challenges as they relate to the Pilot Project objectives.



PROGRAMME ON SUSTAINABLE INDUSTRIAL DEVELOPMENT IN LITHUANIA

Prof. hab. dr. Jurgis Staniškis

Institute of Environmental Engineering

Kaunas University of Technology

K. Donelaičio 20, Kaunas, tel: 300760, fax: 209372

e-mail: Jurgis.Staniskis@ktu.lt





MAIN SUSTAINABLE INDUSTRIAL DEVELOPMENT MEASURES

- Cleaner production
 - Quality and environmental management systems
 - Product related measures
 - Sustainability reporting
-



OBJECTIVES OF THE PROGRAMME

- To increase competitiveness of Lithuanian industry
 - To reduce negative process and product impact to the environment
 - To use energy and natural resources more rationally
 - To improve working conditions and promote establishment of new working places
-



SHORT-TERM TARGETS

- # To achieve that at least 200 companies implement certified environmental management systems and at least 500 companies implement certified quality management systems (until the end of 2006)
 - # To achieve that more than 30% of Lithuanian companies systematically apply cleaner production approach (until the end of 2006)
 - # To build capacity and infrastructure in the areas of eco-design and life cycle assessment (until the end of 2005)
 - # To build capacity and infrastructure in the area of sustainability reporting (until the end of 2005)
 - # To achieve that more than 10% major Lithuanian companies start development of sustainability reports in accordance to developed methodology (until the end of 2006)
-



LONG-TERM TARGETS

- # To achieve that majority of Lithuanian companies systematically apply principles of sustainable industrial development (until 2015)
 - # To achieve performance level of industry, set after analysis of performance of enterprises in Lithuania and more developed countries (until 2015)
-



KEY ELEMENTS OF THE PROGRAMME (1)

1. Establishment of framework conditions promoting implementation of sustainable industrial development measures in industrial enterprises:
 - Regulatory measures
 - Economic measures
 - Informational measures and strengthening co-operation among different stakeholders
-



KEY ELEMENTS OF THE PROGRAMME (2)

2. Capacity building and support to enterprises in implementing sustainable industrial development measures:
 - Training programmes and development of training materials
 - Financing of investments in cleaner technologies
 - Technical assistance to enterprises

 3. Research and Development:
 - Effective co-operation between enterprises and research organisations
 - Governmental support for applied research activities
-

NATO CCMS Pilot Study on Clean Products and Processes

Clean Products & Processes Update

University of Natal

Chris Buckley
Pollution Research Group
University of Natal
Durban, 4041
South Africa

Group Vision

The support of sustainable development through the promotion of Cleaner Production using process engineering tools.

Mission Statement

To promote the effective use of water through research, education and development

Partners

Industry, regulators and the community

Outline

- process impacts and improvements
- waste minimisation
- process integration
- optimisation and control
- demonstration projects
- concentrates and residues
- sustainable water and sanitation
- policy
- community issues

Process Impacts and Improvements

- LCA comparison of membrane and conventional processes for the production of potable water
- LCA of pulp and paper manufacture
- LCA of a secondary water recycling system
- development of a salinity LCA category
- fate modelling of oxygenates in South Africa
- eco-labelling of textile products
- *Score System* for the selection of chemicals

Overall Materials and Energy Used (per Kilolitre of Water)

Stage	Mass (kg)		Energy (MJ)	
	conventional	membrane	conventional	membrane
construction	0.0515	0.0329	0.0873	0.0557
operation	2.7000	2.5000	2.0670	2.5900
decommissioning	0.0002	0.0004	0.0015	0.0003

Electricity Consumption

Process	Consumption (kWh/day)
ozonation	4 900
sedimentation	2 300
filtration	1 400
sedimentation	1 400
chemical addn	960

Scope of Recycled Water LCA

The human modified terrestrial water pathway

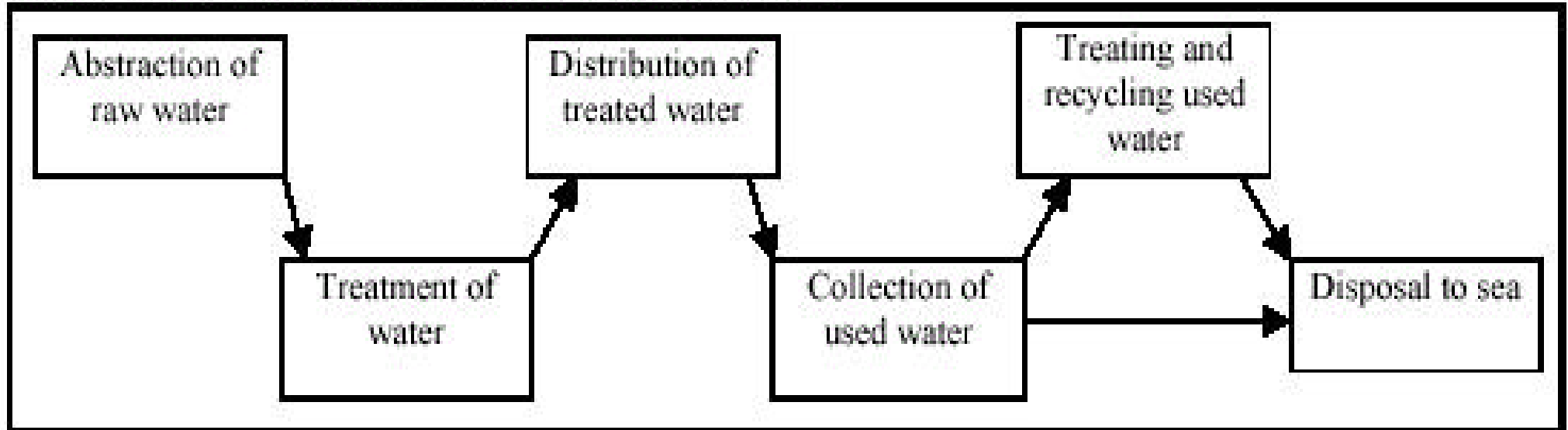

Related water quality issues

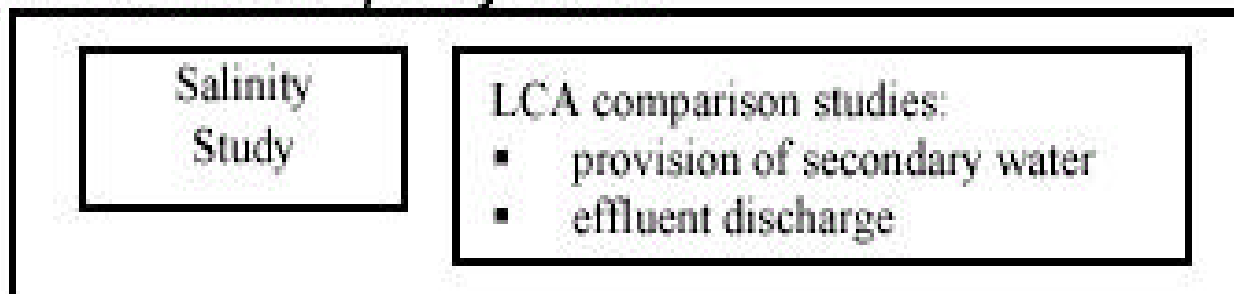

Score System

Purpose

- grading of organic textile chemicals and dyestuffs from an environmental perspective

Reason

- many products of unknown composition
- difficult to analyse the effluent

Co-regulatory approach

Basis of the Score System

* exposure (A x B x C)

- mass to drain (A)

- biodegradability (B)

- bioaccumulation (C)

- toxicity (D)

* score range from 1 to 4 on a log scale

Typical Score Report

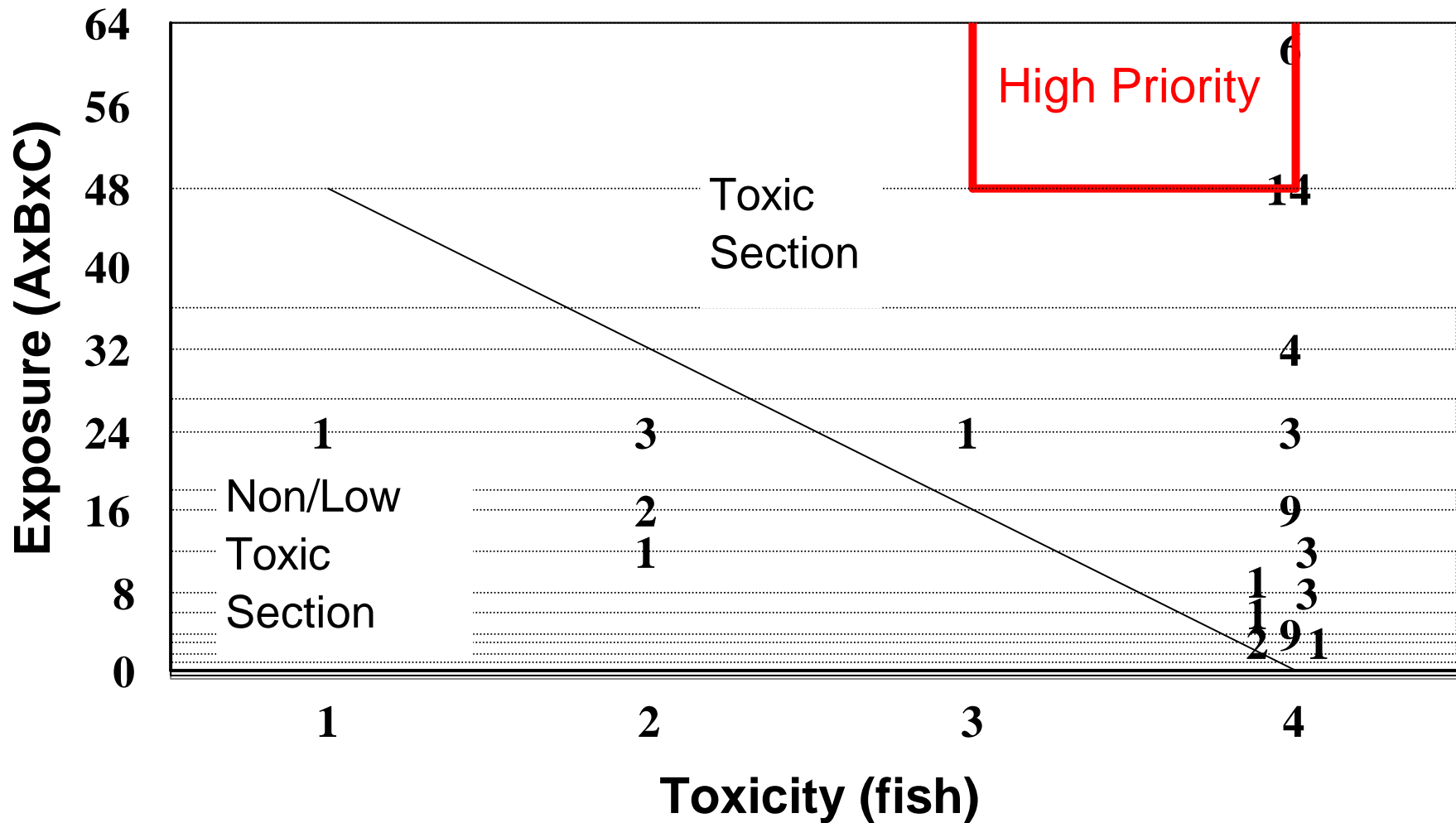

Waste Minimisation Clubs

- group of enterprises (5 to 20)
- subscriptions
- regular facilitated meetings
- training
- group learning
- member to member support
- environmental and economic focus

Waste Minimisation Clubs - Savings

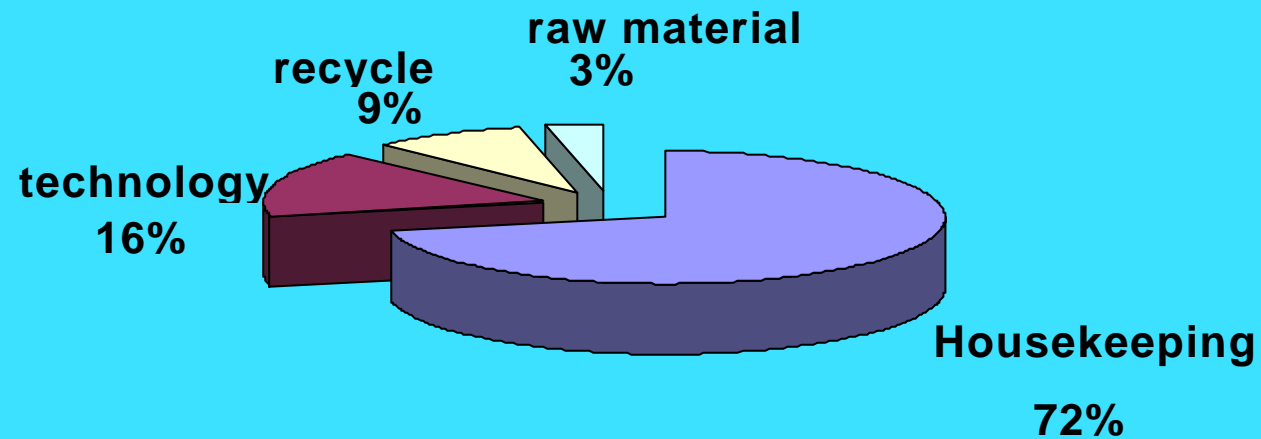

Metal Finishing Club

- 29 members - 15 active
- More than 50% had <50 employees
- Over 60% were jobbing shops
- Bimonthly meetings
- Site visits
- Training for Project Champions

Results - MF Club

Item	Cost Saving in US\$/ year	Environmental Saving / year
Water and effluent	58 954	149 000 kl
Chemicals and metals	194 355	112 tons (for 5 companies)
Energy	45 775	16 000 MWh
Carbon dioxide	N/a	1 400 tons
Sulphur dioxide	N/a	13 tons
Nitrous oxide	N/a	6 tons
Total	298 724	N/a

Note: N/a = not applicable

A conversion rate of US\$ 1 to R 7 was used in this table.

Process Integration - *Pinch*

- a **systematic** method of **optimising** the allocation of water to the **hierarchy of uses** that typically occur in an industrial system
- Accounts for all technological, economic and environmental **constraints** that apply to the processes involved
- Properly carried out, it will provide an **impartial and transparent** assessment of water and effluent requirements

Typical Water Use Circuit

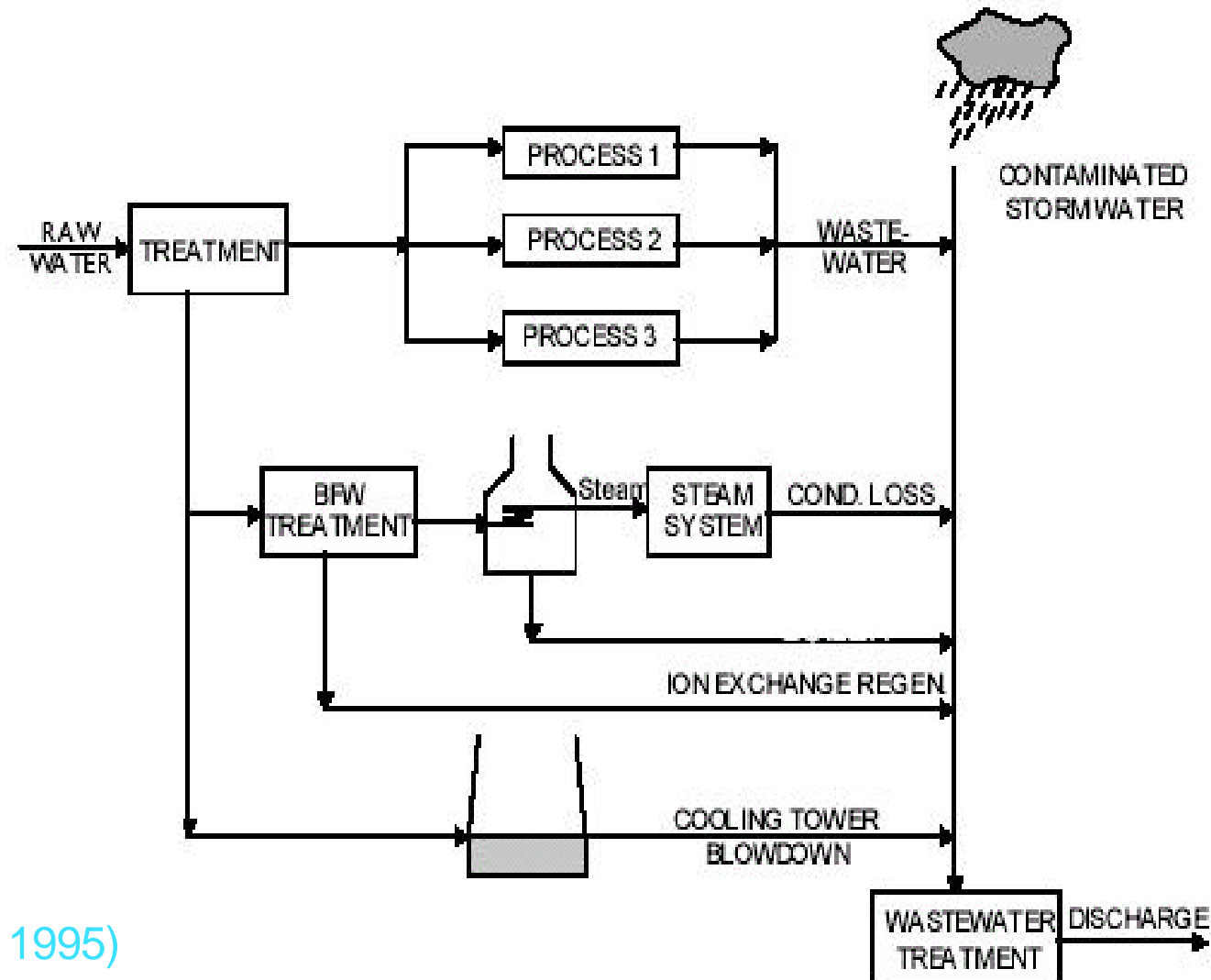

(Smith, 1995)

Pinch Applications

- water cooled thermal power station (Mathlab)
- chlor-alkali plant (hand, WaterPinch, GAMS)
- amino acid plant (WaterPinch)
- pesticide manufacturer (hand)
- pulp mill A (WaterPinch)
- pulp mill B (WaterPinch)
- pulp mill C (WaterPinch)
- oil refinery (Aspen)
- textile mill (hand)
- food and beverage plants (hand)

Modelling, Control and Optimisation

- chlorine dose of conditioning reservoir (CFD/MINLP)
- ozone contactor (CFD - Fluent)
- aquaduct energy (MINLP - GAMS)
- cooling system chemistry (Minteqa2)
- cooling system control (WEST)
- aerobic systems (WEST)
- anaerobic systems (WEST)

CP Demonstration Projects

- textiles (Danced / Danida)
- metal finishing (Danced / Danida)

Concentrates and Residues

- dye concentrates - anaerobic digestion
- toxicity and biodegradability assays
- landfill leachates
- acid mine drainage
- high value (inorganic + hydrocarbon) products
- barium process
- electrochemical processes
- sonochemistry

Water and Sanitation

- anaerobic membrane bioreactor
- sustainable engineering of free basic water

Policy

- receiving water quality standards (industry)
- National Waste Management Strategy (waste minimisation)
- National Innovation Strategy (cleaner production)
- UNEP (WSSD Regional Industrial Report - Africa)
- UNIDO (Environment and Industrialisation in Sub-Saharan Africa)
- Minister's Water Advisory Council

Staffing

- 8 researchers
- 8 PhD students
- 25 masters students

Community Issues

- refinery comparison
- CP foresight proposal
- energy integration

Process Water Reuse in Textile Processing

Application: Textile Processing

Water Using Operations (recipe dependent):

- Scour, Bleach, Dye, Rinse, Soap, Soften;
- Cooling water;
- Printer belt washing;
- Machine cleaning

Water Using Operations (recipe independent):

- Treatment operations (backwash, reagent mixing);
- Cooling tower makeup;
- Factory cleaning;
- Ash / coal wetting;
- Boiler makeup

Application: Polyester

In operation in Denmark for 2 years

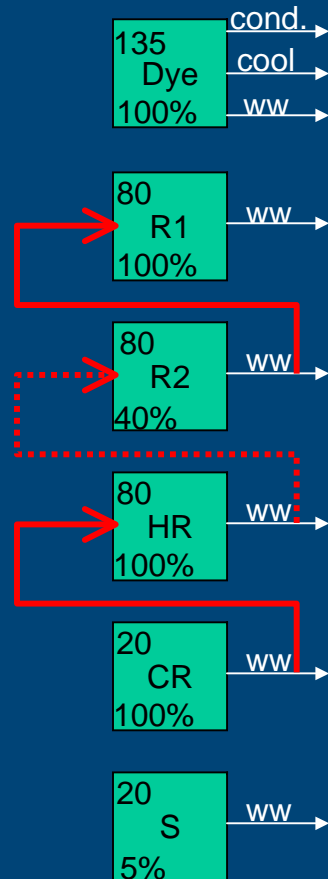

Savings:

- **Water:** 40 – 80 litres per kg fabric
25% - 50%
- **Steam:** 4 – 6 kg steam per kg fabric
20% - 30%
- **Chemicals:** negligible

Application: Cotton Knitwear

Pre-dyebath:

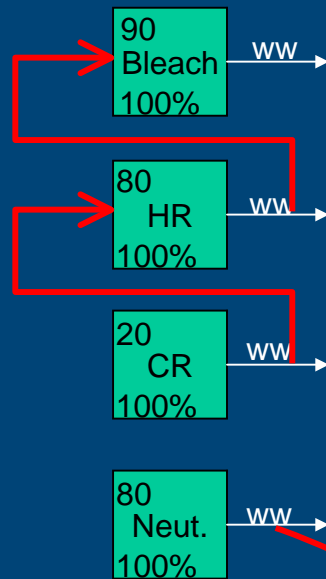

Post-dyebath:

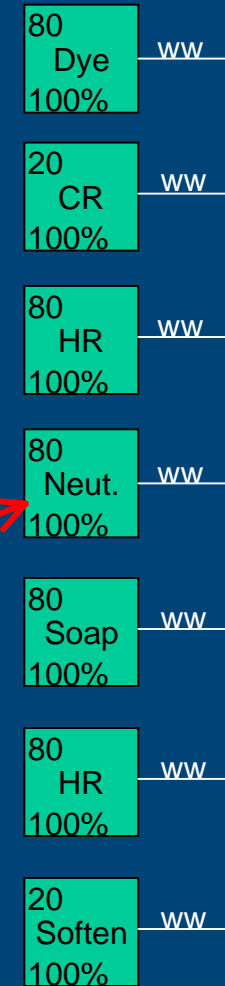

- **Water:** 20 - 40 litres per kg fabric
up to 30%
- **Steam:** 1 - 2 kg steam per kg fabric
10% - 15%

Application: Acrylic

- Cascade Overflow Rinse (OR)

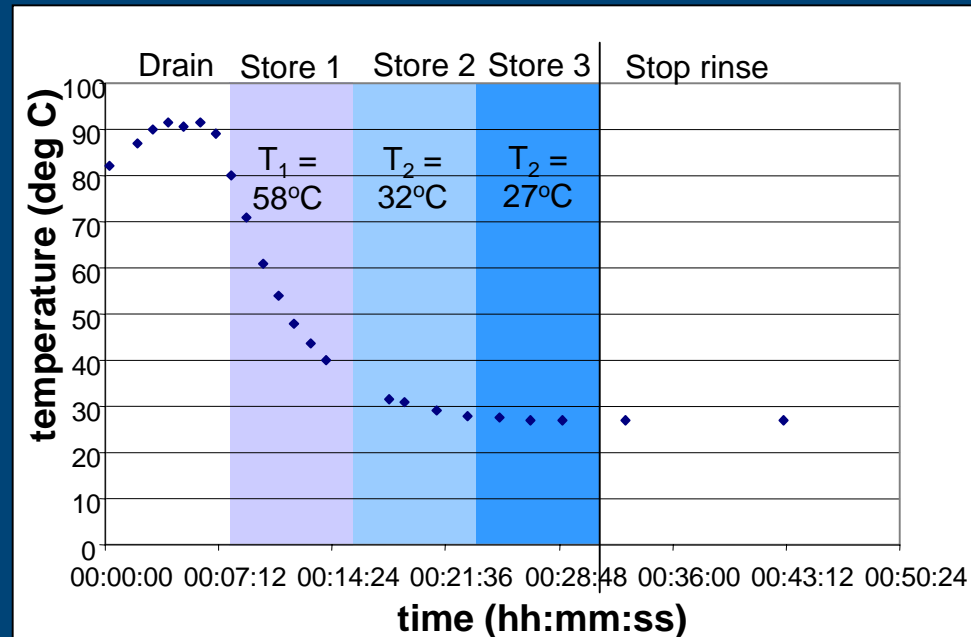
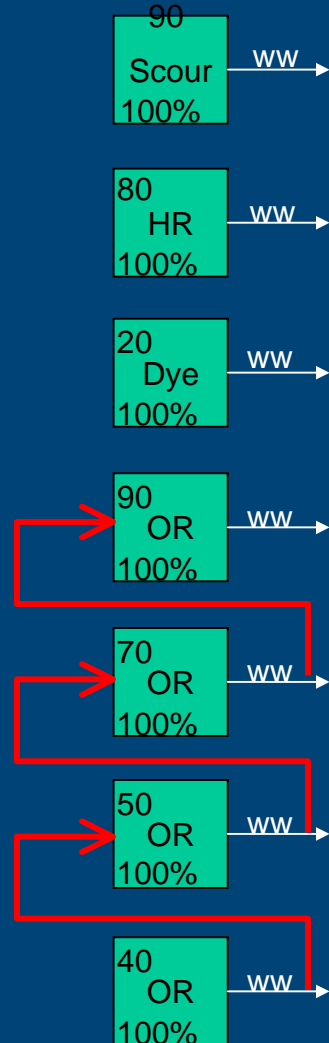

- **Water:** 30 - 50 litres per kg fabric
30% - 40%
- **Steam:** negligible
- **Chemicals:** 10% of softener

Proposed Design: Central

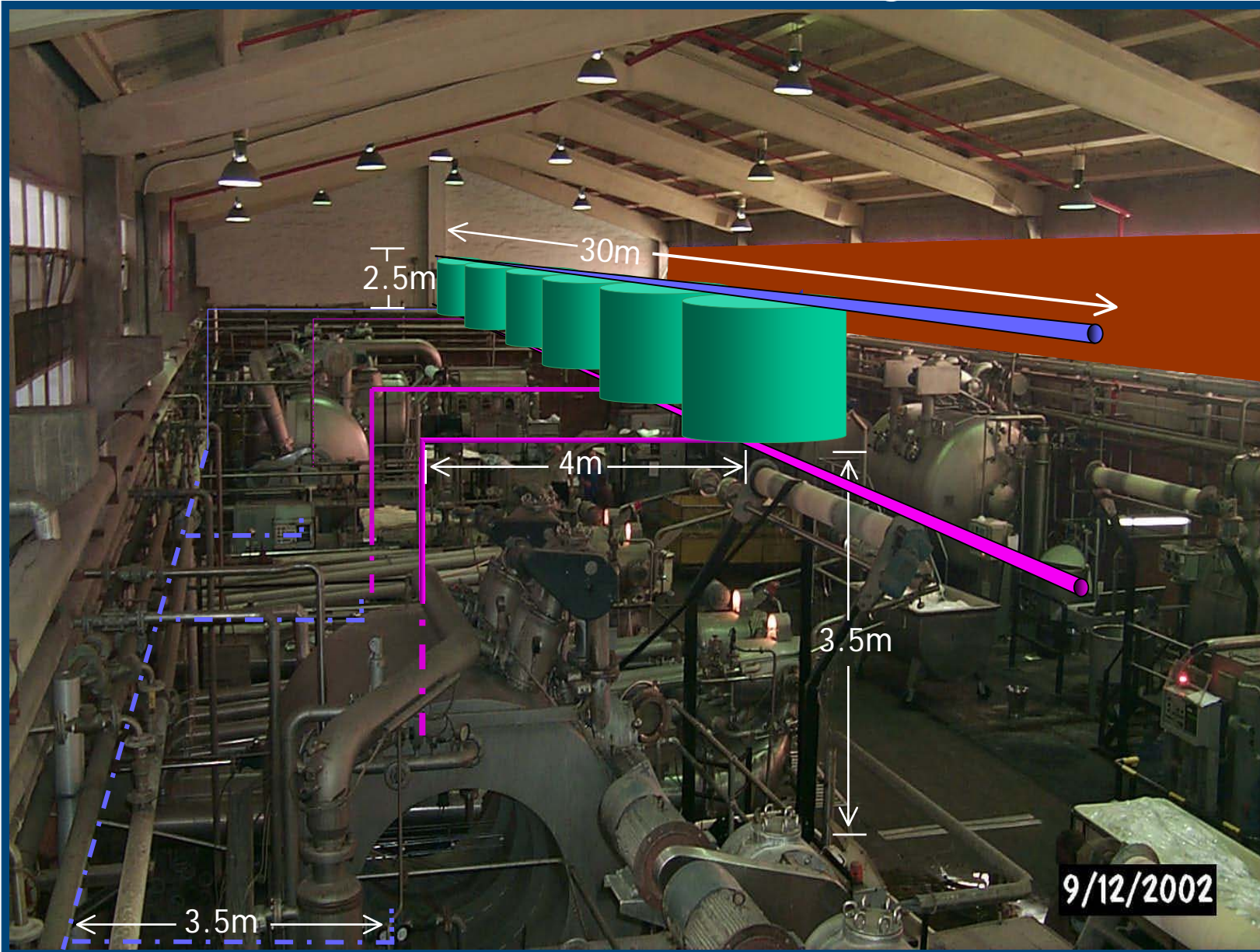

Proposed Design: Central

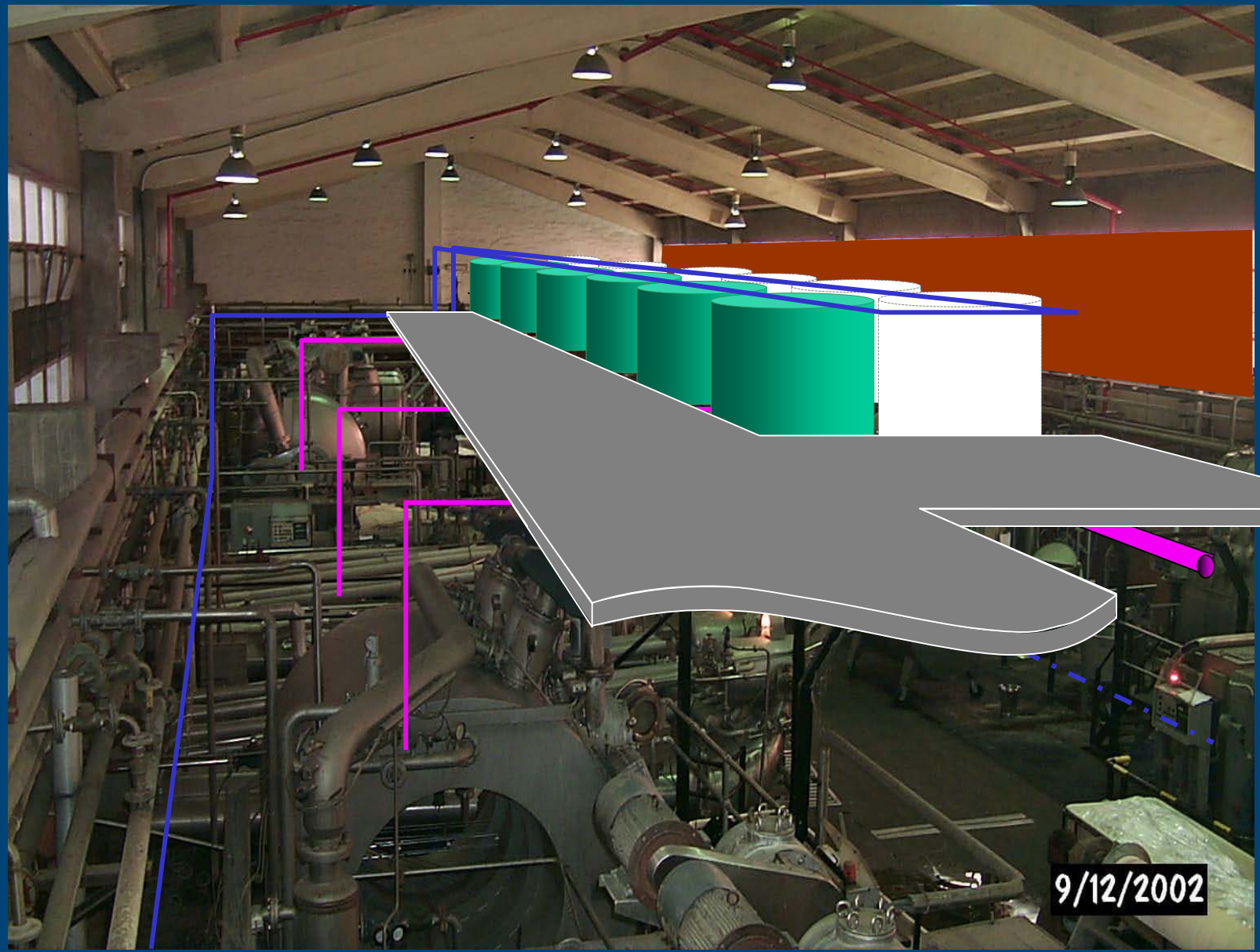

Design: Local

Tanks for local process effluent reuse:

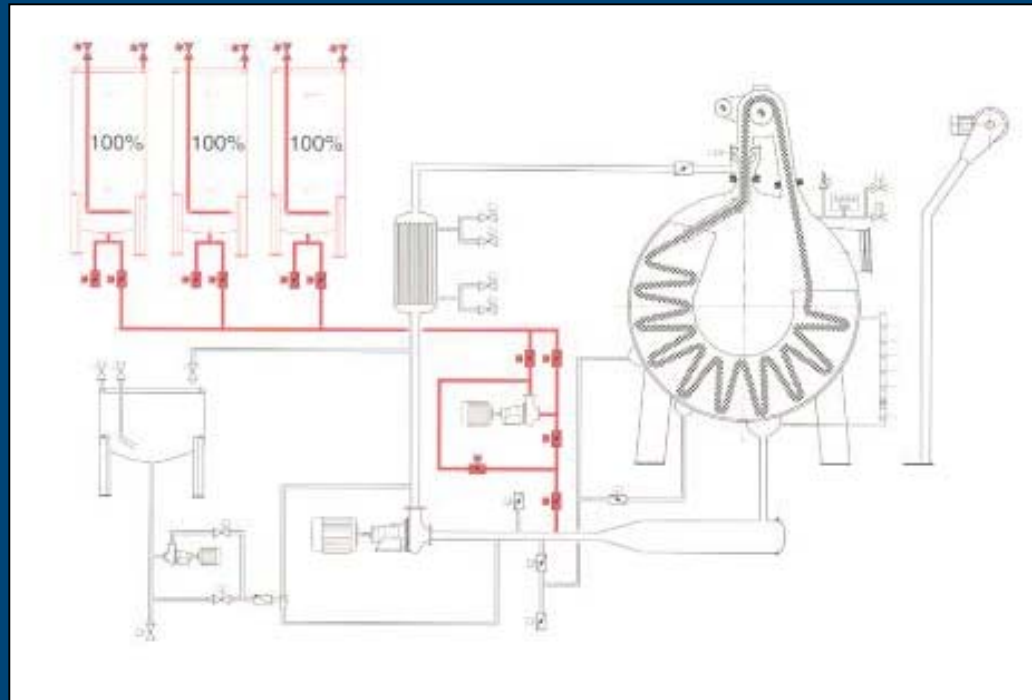

(Source: Thies Brochure)

Capital Costs

- Economic considerations:
 - a. 17% POR, 1 year ammortisation
 - b. piping, valves, monitoring equipment, tanks.
- Capital cost: R 0.5 mil – 1.2 mil
- Payback period: 6 - 18 months

Sixth NATO CCMS Pilot Study on Clean Products and Processes

“Ionic Liquids; Research and Application”

Jim Swindall

Cetraro, Italy 11 – 15th May 2003



Which Industry is the Dirtiest?

By-products as a proportion of production for the chemical industry

Industry	Production / tons p.a.	E-factor
Oil refining	$10^6 - 10^8$	0.1
Bulk chemicals	$10^4 - 10^6$	1-5
Fine chemicals	$10^2 - 10^4$	5-50
Pharmaceuticals	$10 - 10^3$	25-100

R.A. Sheldon, in "Precision Process Technology" (eds. M.P.C. Weijen and A.A.H. Drinkenburg), Kluwer, Dordrecht, 1993, p. 125



Some of the Major Problems

- Old, inefficient processes
- Solid waste
- Heavy metals
- Unnecessary process steps
- Solvent waste



Alternative Solvents

- ❖ No solvent (Heterogeneous catalysis)
- ❖ Water
- ❖ Supercritical Fluids
- ❖ Ionic Liquids



Neoteric (New) Solvents

Breaking new ground!

▶▶ **Supercritical fluids**

▶▶ **Ionic liquids**



What are ionic liquids ?

- They are salts (composed only of ions)
- They are molten at or near ambient temperatures (m.pt. $< 100\text{ }^{\circ}\text{C}$)

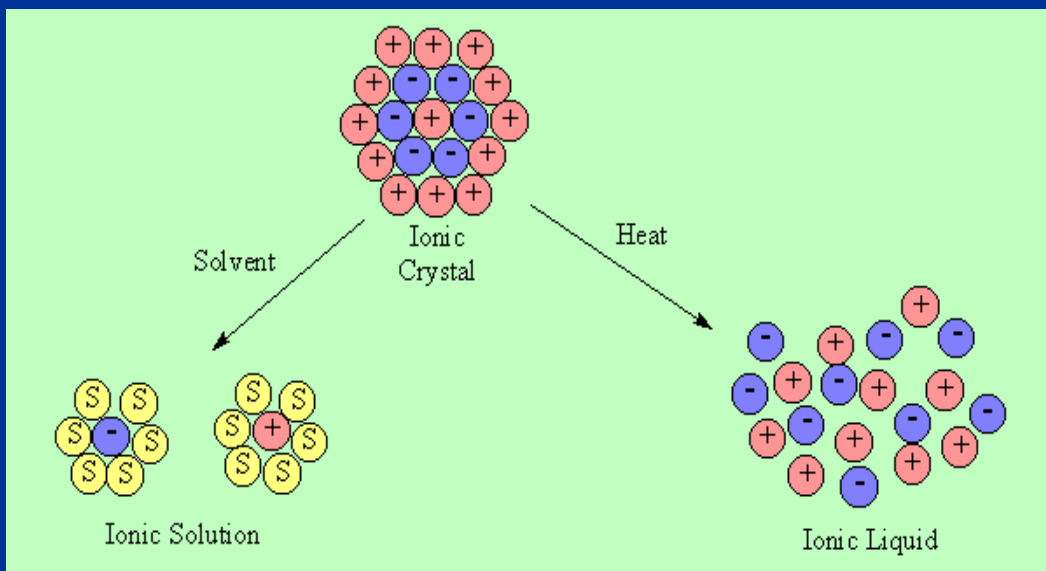

Room-Temperature Ionic Liquids

Important Properties

- Liquid range of 300 °C (-96 - +200 °C)
- Excellent solvents for organic, inorganic and polymeric materials
- Acidic compositions are superacids ($pK_a \approx -20$)
- Some are very water sensitive and must be used in a dry box; others are hydrophobic and air stable
- Thermally stable under conditions up to 200 °C
- **NOW** - easy to buy and simple to prepare



Room-Temperature Ionic Liquids

Why solvents for GREEN synthesis?

- ❖ **NO** measurable vapour pressure
- ❖ Exhibit Brønsted, Lewis, Franklin and “super” acidity
- ❖ **HIGHLY** solvating - therefore low volumes used
- ❖ Catalysts as well as solvents
- ❖ Highly selective reactions
- ❖ **NEW CHEMISTRY**



Ionic Liquids

- ❖ **Designer Solvents**
(10^{18} ionic liquids are feasible)
- ❖ **New paradigm**
- ❖ **New chemistry**
- ❖ **No VOCs**
- ❖ **Recyclable**
- ❖ **Cost effective**
- ❖ **Scale-up**



Are Ionic Liquids Toxic ?

- The University of Bremen have an extensive programme on ionic liquid toxicity
- Initial studies (*Green Chemistry, April 2003*) are very encouraging, as results indicate low toxicity, reasonable biodegradability and low eco-toxicity
- Long aromatic side chains should be avoided



SOURCES OF IONIC LIQUIDS



or



Other Sources



CYTEC



SACHEM

These, too, are primary sources of supply





Now Published

32 Chapters

State of the Art in 2000

Green Industrial
Applications of
Ionic Liquids

Edited by

Robin D. Rogers, Kenneth R. Seddon
and Sergei Volkov

NATO Science Series

II. Mathematics, Physics and Chemistry – Vol. 92

ACS SYMPOSIUM SERIES 818

Ionic Liquids

Industrial Applications to Green Chemistry



EDITED BY
Robin D. Rogers and Kenneth R. Seddon

Now Published

33 Chapters

State of the Art in 2001

 WILEY-VCH

Ionic Liquids in Synthesis

Peter Wasserscheid, Tom Welton (Eds.)

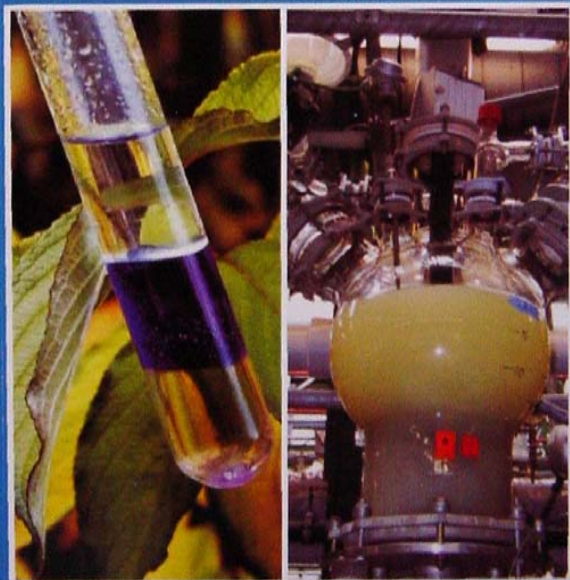

Now Published

8 Chapters

**Comprehensive
overview up to 2002**

Ionic Liquid Publications

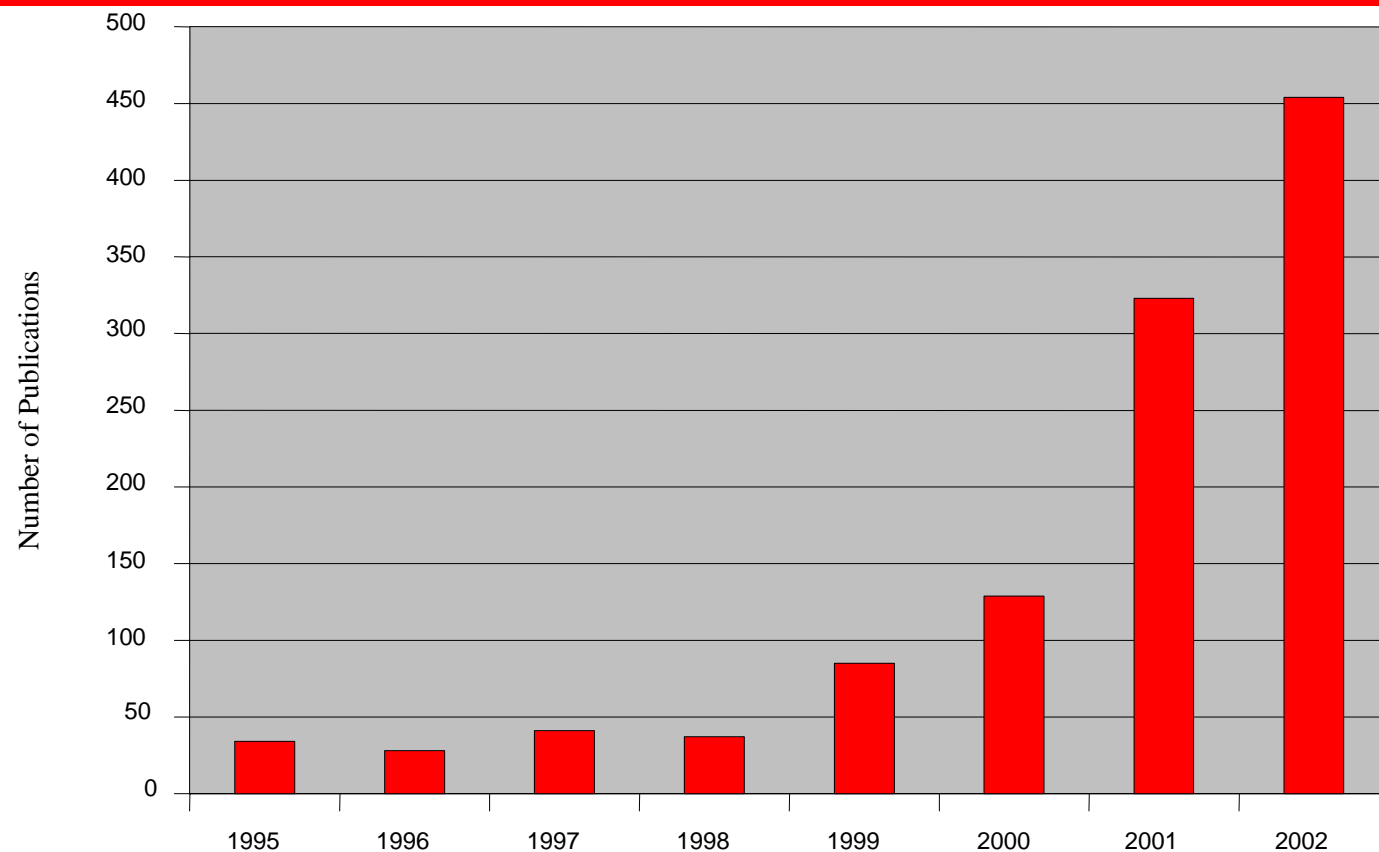

Recent IL meetings

Volume 4 Number 1
February 2002
Pages G2-G12, 1-72
ISSN 1463-9262

Green Chemistry

An International Journal and
Green Chemistry Resource
Royal Society of Chemistry

www.rsc.org/greenchem

- Boston ACS Autumn Meeting; 18th-22nd August (the sequel to San Diego) - ten sessions (more than 60 lectures) on ILs

<http://bama.ua.edu/~rdrogers/Boston/>

- Green Solvents for Catalysis (Bruchsal, Germany, 13th-16th October)

<http://www.dechema.de/gsf200>

2



Forthcoming IL meetings

- New York ACS Autumn Meeting; 7th-11th September, 2003 (the sequel to Boston) - ten sessions (more than 60 lectures) on ILs
- NATO ASI Summer School (Pisa, Italy, 18th-30th April, 2004)
- Green Solvents for Synthesis (Bruchsal, Germany, 3rd-6th October, 2004)



Industry/University Co-operation

Queen's
University
Ionic
Liquid
Laboratories



QUILL Members

- **Avecia** - UK
- **BNFL** - UK
- **ICI** - UK
- **ChemVite** - UK
- **DuPont** - UK
- **Strata** - UK
- **Merck** - D
- **SASOL** - SA
- **Cytec** - Canada



QUILL Members

- **bp** - USA
- **Chevron** - USA
- **SACHEM** - USA
- **UOP** - USA
- **Eastman** - USA
- **C-Tri** - South Korea
- **Schering Plough** - RoI
- **Shell** - NL
- **Novartis** - Switzerland

18 members from **9** countries on **4** continents



QUILL IAB with QUILL Research Team



QUILL Research Team, Oct 2002



QUILL is a Marie Curie Centre



The European Commission



Marie Curie Fellowships

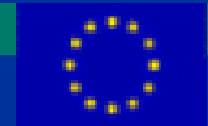

European Network of Excellence

ILIAD

Ionic Liquids: Implementation And Design

314 researchers

177 postgraduate students

77 partners

21 countries

5 major industries

7 SMEs

€23,500,000

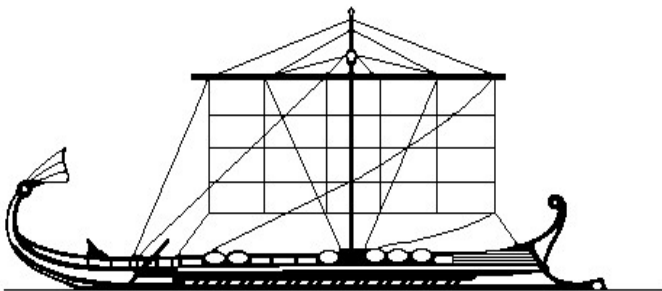

European Network of Excellence

ILIAD

Ionic Liquids: Implementation And Design

If you want to be included, it is still possible
Contact our Network Administrator at:



h.anderson@qub.ac.uk

Dr. Heather Anderson

European Network of Excellence

ILIAD

Ionic Liquids: Implementation And Design

If you want to be included, it is still possible!

Contact our Network Administrator at:

h.anderson@qub.ac.uk

Dr. Heather Anderson

Can Ionic Liquids be Used on an Industrial Scale ?

YES



Institut Francais du Petrole Process

- Biphasic catalytic process (Difasol)
- Dimerisation of butenes into a mixture of low-branched octenes
- [bmim][Al₂Et₂Cl₅] used as solvent and Lewis acid with a nickel(II) catalyst
- Pilot plant stage for some years
- Available for licensing but not commercialised
- (bmim = 1-butyl-3-methylimidazolium)



BASF Process

BASF



BASF BASIL Process

Biphasic Acid Scavenging utilizing Ionic Liquids

- The process is a multi-ton process, and has been running in Ludwigshafen (Germany) for over one year
- 1-Methylimidazole (mim) is used to scavenge produced HCl, forming liquid [Hmim]Cl (m.pt. 75 °C)
- Almost five years since the announcement in C&E News of the potential of ionic liquids



BASIL Process

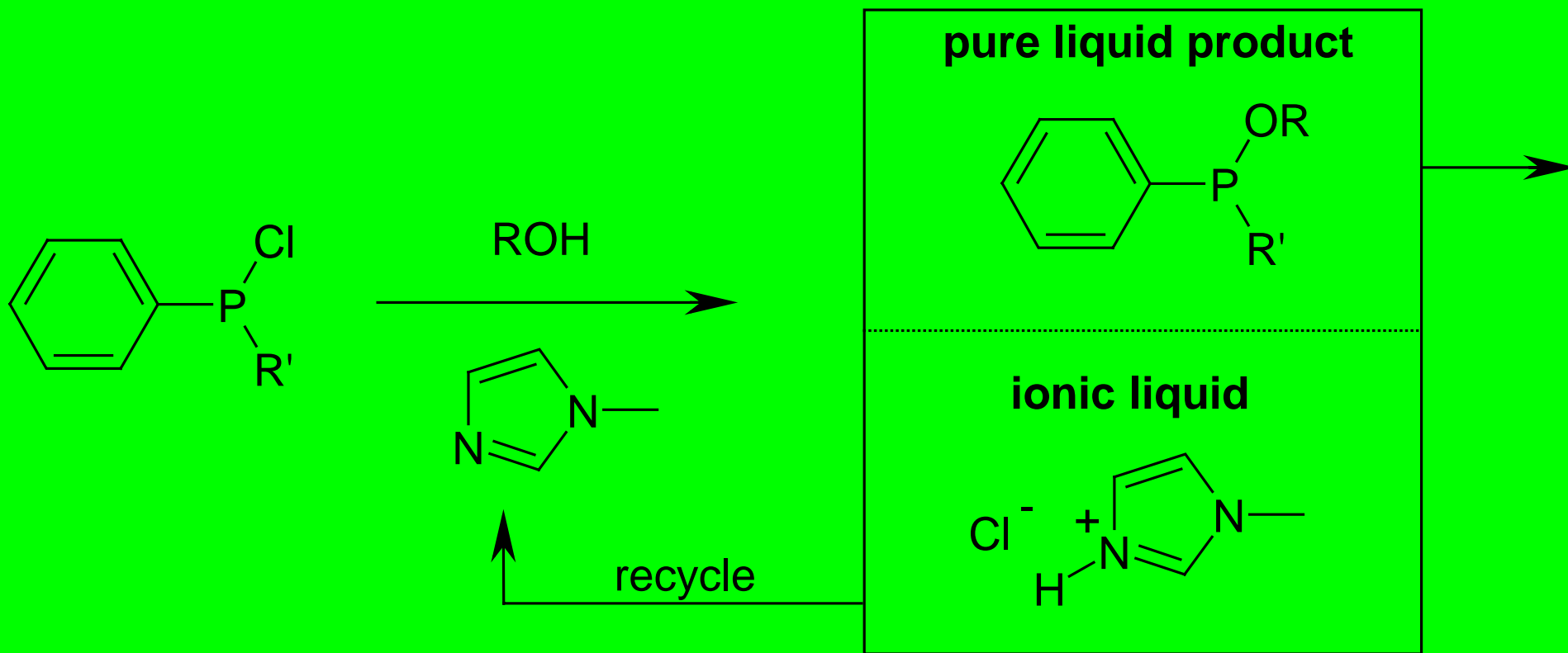

The BASF Team



The BASIL team
(from the left):
Mr. Rüdiger
Büttner, Mr.
Holger Ganz, and
Dr. Matthias
Maase



BASIL Process

- The [Hmim]Cl formed is a dense liquid, it is separated by gravity, and then the 1-methylimidazole released and recycled
- This BASIL process is used for the manufacture of alkoxyphenylphosphines, by treating chlorophenylphosphines with alcohols, liberating HCl
- The products are used as precursors for the synthesis of photoinitiators that are used in the manufacture of printing inks as well as glass fibre and wood coatings



Other reactions for the BASIL Process

- Esterifications (with acid chlorides)
- Silylations (with chlorosilanes)
- Phosphorylations
- Sulfuylations
- Eliminations (of HX)
- Deprotonations (*e.g.* to form ylids)
- And so on



Implications

This industrial application has demonstrated for the first time that ionic liquids can be handled, pumped and recycled economically, on a multi-ton scale, and with ease



SOME CASE STUDIES ON CLEAN PRODUCTS AND PROCESSES.

David Wolf* and Chaim Forgacs**

*Department of Chemical Engineering, Ben-Gurion University, Beer-Sheva, Israel and Department of Chemical Engineering and Biotechnology, The College of Judea and Samaria, Ariel, Israel.

**Department of Environmental Engineering, Ben-Gurion University, Beer-Sheva, Israel.

1. Water Desalination.

Due to the lack of sufficient water resources in Israel it was decided to rely on Sea Water Desalination as an additional source of potable water. The plants in consideration are very large in the range of 50 million cubic meter of water per year per plant.

While the technologies involved are available in Israel due to extensive R&D of these technologies, the problems that are now dealt with are related to the environmental aspects.

These refer to the effect of salty water on aquifers which has to be avoided and the effect of highly salted reject of the desalination plant on the environment of the sea area where it is introduced.

The design of the plants takes into account the above problems as well as the location of the plant which in itself is a problem to be considered.

2. Water treatment.

Recently a ministerial order of the Ministry of the Environment was issued stating that the industrial waste especially from the petrochemical industry in the Haifa Bay

Waste could not be sent to the river without pre treatment of the streams to the level that it could be released to the environment. In fact several options were considered for disposal and it was concluded that even the treated waste water could not be returned to the river and instead should be sent by a pipe deep into the sea.

Some of the companies have already spent the necessary funds in order to comply with the demand and others are in the process of implementation of the above mentioned order.

We hope that the next step will be of adaptation of the processes and indeed of changing the processes so as to take into account their environmental impact.

3. Oil spills cleaning.

The gulf of Eilat and Akaba is used by the neighboring countries Israel and Jordan for transportation of oil tankers and pumping stations of the oil to their respective Countries.

In order to preserve the environment and its rich marine life a ship was acquired in order to clean the water from oil whenever necessary.

The ship was built by a Norwegian company and is now operating in the gulf. The ship has the necessary equipment in order to fulfil the required tasks.

4. Rotem Amphert

Rotem Amphert is a large chemical industrial complex located in the Negev desert, specializing mainly in the production of phosphate fertilizers and phosphoric acid. Recently they have developed a new process to convert "green" phosphoric acid to "white" (pure) phosphoric acid.

The novelty of the process is that it has no waste stream at all, and still less expensive than the one formerly used. It is a good example to show, that it is possible to improve processes in the chemical industry which are environmentally more friendly, and at the same time economically attractive

5. Ramat Chovav

Ramat Chovav is a large industrial park in the Negev desert, about 10 kilometers from Beer-Sheva, where polluting chemical industries are concentrated. The national site for hazardous wastes is located here, too. A couple of years ago, a centralized system for industrial waste disposal was erected. In the last year a novel biological treatment plant was introduced to treat most of the industrial waste of the complex.

6. Replacement of Hg by membranes in electrolysis of NaCl.

The production of chlorine and NaOH in the electrochemical process was normally done by the electrolysis of sodium chloride with Hg electrodes. Due to the poisonous characteristics of Hg and due to fear of catastrophic accidents the electrodes are now replaced by membranes thus eliminating the environmental effects and also reducing contamination problems by traces of Hg in other products of the plants.

7. Improvements In Fuel Cells Performance.

One of the promising sources of "pollution free" electricity is the fuel cell which efficiently converts chemical energy to electrical energy. E. Korin and A. Bathelheim (Dept. of Chem. Eng., Ben-Gurion University) have studied the electrocatalysis of oxygen reduction at the cathode, the electrocatalysis of methanol at the anode and the mass transport through the electrolyte membrane. They added a special coating to the cathode that is a barrier to the methanol but is permeable to the oxygen. This they did in order to avoid the methanol crossover from the anode to the cathode which has detrimental effects on the cathode and on the efficiency of the process. The coating consists of an inner polymeric film which is a good proton conductor and an outer film which is obtained by electropolymerization of a monomeric macrocyclic compound.

This avoids almost completely the methanol from reaching the cathode.

***Process Intensification in
European Union:
Current Work and Future Plans***

G.P. Gallios

***Aristotle University of Thessaloniki
School of Chemistry,
Lab. Gen. & Inorg. Chemical Technology
Thessaloniki, Greece***

**George Gallios, Aristotle University of Thessaloniki,
Email: gallios@chem.auth.gr**

Outline

- *About Process Intensification*
 - Definition
 - Barriers
- *Current work in EU*
- *Future plans in EU*
- *Current situation in Greece*

Process Intensification (PI)

- *a highly inovative concept
(a design philosophy)*
- *refers to technologies and strategies that enable the physical sizes of conventional process engineering unit operations to be significantly reduced*

In other words

- ***a smaller compact piece of equipment takes the place of a larger one at the same given capacity or mass flowrate***

PI Benefits

- *Size reduction (factor 3 to 4)*
- *Cost reduction due to less*
 - *Support structure*
 - *Column foundations*
 - *Pipe runs*
- *Less Pollution to Environment*

PI Barriers

- High risk technique for potentially high gains
- *Concerns about the cost of additional hardware.*
- *The need for more flexible process integration design tools and cost-effective heat exchange equipment.*
- *Lack of understanding about the technique in many industries.*

PI Barriers (con.)

- *The impact of change on plant reliability, flexibility and maintenance.*
- *The risk of disturbances to production.*
- *The long payback in some applications.*
- *The (possible) need for new plant.*
- *Concerns about the scale-up from laboratory/pilot trials to full-scale production.*

PI - Operational projects

- *There are currently only **two** known Process Intensification projects operational in the European Union (**UK, Germany**) and it is too early to comment on their success.*

PI in effluent treatment (wet oxidation process)

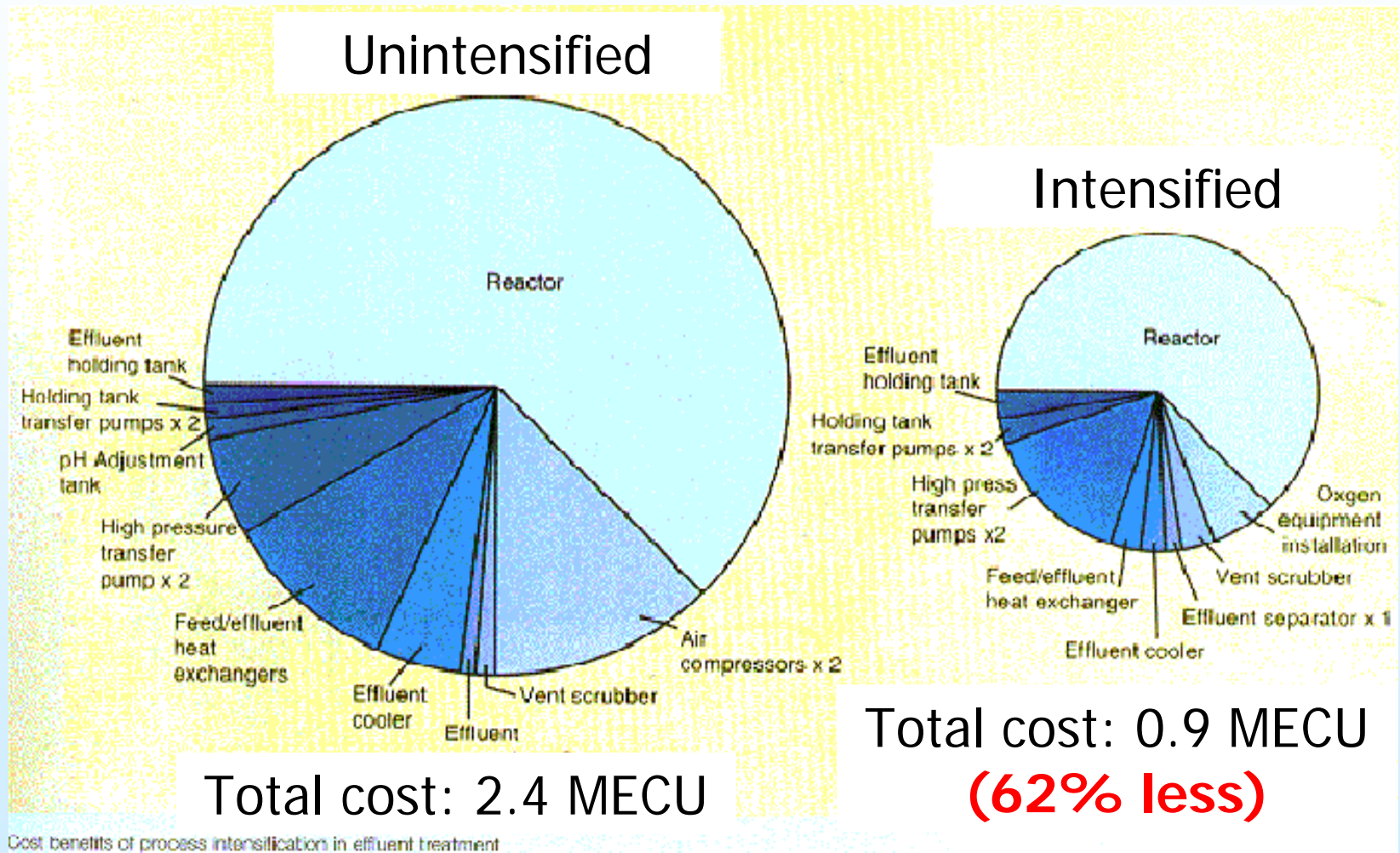

George Gallios, Aristotle University of Thessaloniki,
Email: gallios@chem.auth.gr

Process Integration - Process Intensification

RTD - Current Work in EU

- *UK*
- *Work on catalytic reactors*
 - *Modelling, design and RTD activities*
- *Funding: Government & Industry*
 - *3 years – 4.5 MECU*

- **GR**
- *Food & Dairy installations (widely)*
- *aluminium and metal installations (minor extend)*
- *Refinery (Installed Mass & heat control)*
- **Funding:** *Industry (mostly) & Government*
- *Applied RTD participants*
 - ***Industry, R&D institutes, Universities and Government***

- **NL**
- *Development of energy analysis tools.*
 - *optimisation of different tools*
 - *commercialisation of PI study tools*
 - *exchange of knowledge and experiences (Internet - workshops)*
- *Participants*
 - *process industry, consultants, RTD institutes, universities and SME organisations*
- *Funding: 0.5 MECU*

- **PT**
- *Pinch and exergy analysis*
 - *chemical industry*
 - ✓ *PRODET programme*
 - ✓ *1,5 year -33 kECU*
 - *and textile industry*
 - ✓ *Grupo Nacional de Integracao de Processos*
 - ✓ *1 year -13 kECU*

Process Integration - Process Intensification

RTD - Future Plans in EU

- *Process Integration is used successfully in certain industries*
- *Needs:*
 - *Development of robust methods in batch processes*
 - *Minimisation of water consumption and waste*

Process Integration

- *Priorities:*
 - ❑ *Improved analysis tools and data collection methods*
 - ❑ *Better recovery of waste heat, heat storage and the incorporation of heat pumps*
 - ❑ *Encourage the use of PI tools by smaller companies and by industries*
 - ❑ *Wider dissemination of existing case study material and more case studies*

- **UK**
- *Basic RTD, prototyping and component development on reactors and separators*
- *Government, industry & universities will be involved in a 5 years programme with several MECU's*
- *Potential benefits:*
 - *Better yields*
 - *Safety*
 - *Reduced environmental impact*
 - *Energy saving*

- **GR**
- *Industry, R&D Institutes, Universities and Government should work together on PI*
- *Potential benefits:*
 - *Energy saving*
 - *Improved product quality*
 - *Competitiveness and environmental protection*

- NL
- *Stimulate market penetration:*
 - *exchange of experiences (panels)*
 - *promote wider applicability of PI tools*
- *Work should be done by:*
 - *Industries, including SME and governmental agencies*
- *Budget needed: 0.5 MECU*
- *Potential benefits:*
 - *process innovations*

- *PT*
- *Promote PI in various sectors*
- *Potential benefits:*
 - *Ceramics*
 - *Petrochemical industry etc.*

Greece - Current status

- *Most of the work is on:*
 - *Membrane Processes*
 - *Reverse Osmosis (RO)*

Greece - Membrane Processes

- *EPET (National Program):*
 - *special membranes and transport processes through human skin for transdermal drug delivery systems*

Greece - Membrane Processes

- *EPET II (National Program):*
 - *Develop Vycor membranes* for juice concentration, wine filtration, desalination processes and removal of VOC's from polluted air emissions
 - *Techniques:*
 - ✓ *micro filtration*
 - ✓ *reverse osmosis*

Greece - Membrane Processes

- *Government (GR):*
 - *Fouling (by CaSO_4) of RO membranes in a desalination process*
 - *Model Production*
 - *RO plant driven by wind energy*

Greece - Membrane Processes

- *LIFE (EU) & Government (GR):*
 - *Recycling waste water from a milk collection station*
 - *Techniques:*
 - ✓ *conventional filtration*
 - ✓ *ultra filtration*
 - ✓ *reverse osmosis*

Greece - Membrane Processes

- *Brite-Eyram (EU) :*
 - *Ceramic and carbon microporous membranes for: CO₂/N₂, CH₄/C₂H₆, pollutants separation with oil refining processes and removal of VOCs from air streams*
 - *Mesoporous (e.g. Vycor) and polymer membranes, after plasma treatment formation of selective thin top layers with microporous structure*

Greece - Membrane Processes

- *JOULE (EU) :*
 - *Optimisation and evaluation of inorganic use of membranes in e.g. oil refining processes*
- *JOULE - THERMIE (EU) :*
 - *Enhanced oil recovery methods using expertise on flows through porous media*

NATO/CCMS, 11-15 May 2003, Cetraro, Italy

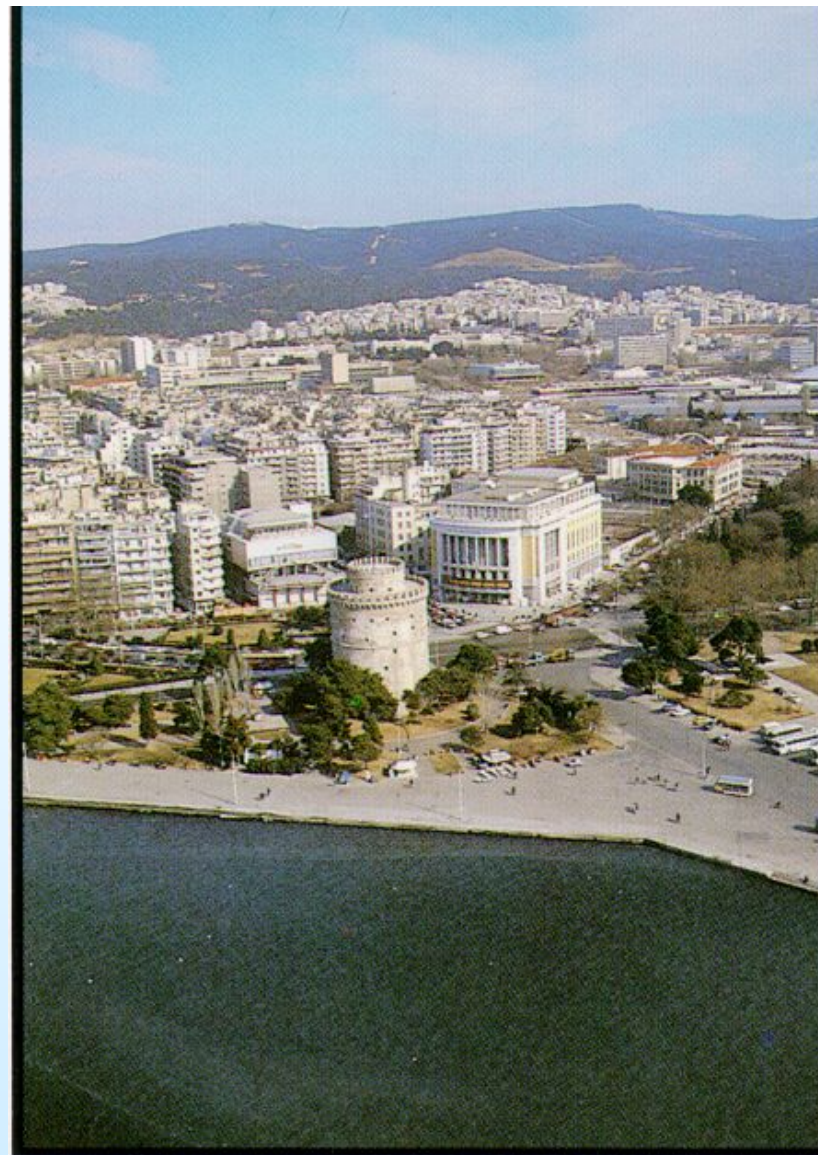

**George Gallios, Aristotle University of Thessaloniki,
Email: gallios@chem.auth.gr**

**Wettability Determination as an Important
Factor in Design and Environmental
Performance of Some Industrial Processes**

Andrzej Doniec

Pollution Prevention Center at the Technical University of
Lodz (Poland)

Wettability is a phenomenon manifesting itself within a three-phase system

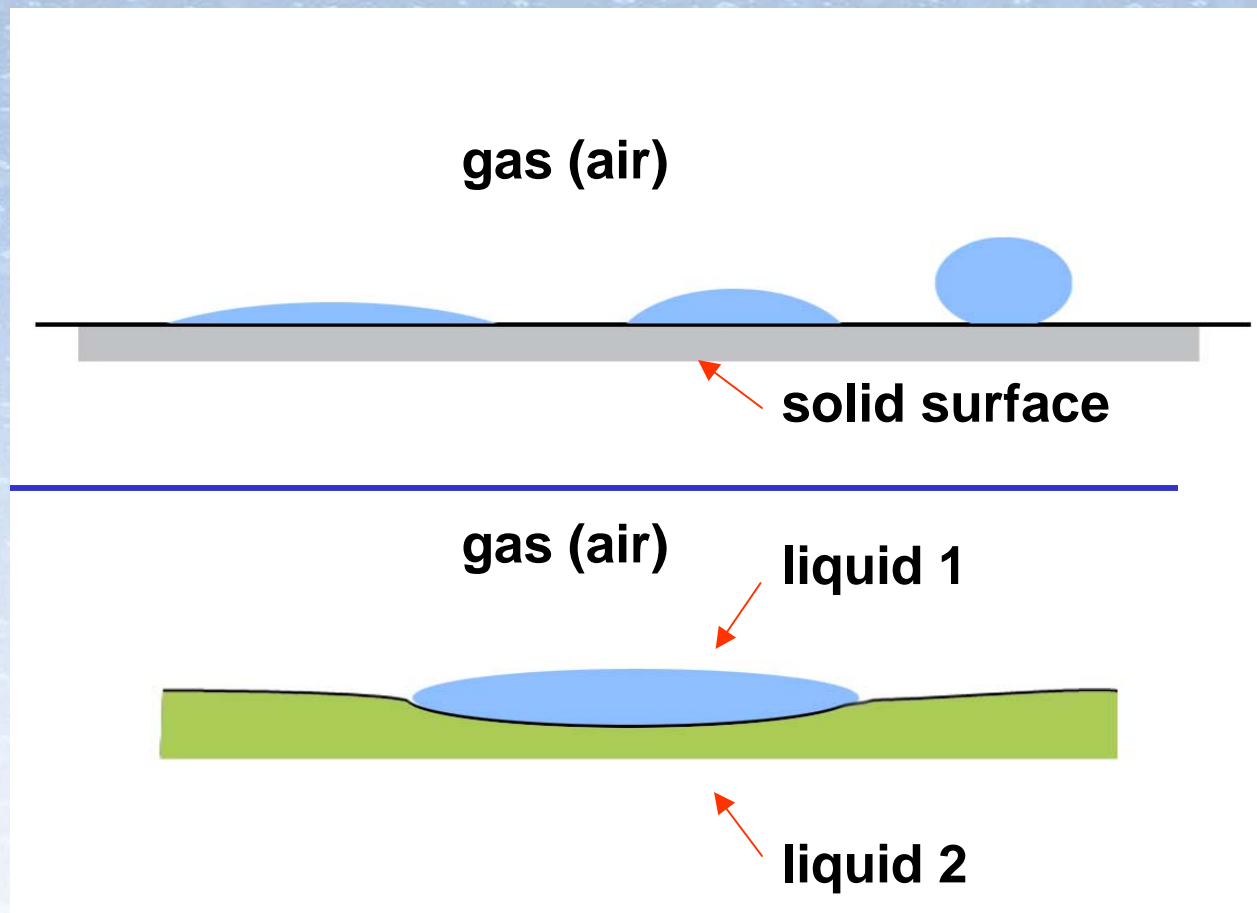

Many industrial processes are particularly associated with wetting phenomena

- heat transfer processes (heat exchange, steam condensation)
- some separation processes (absorption, distillation, floatation)
- coating processes (electroplating, painting, printing)
- specific processes of environmental technology (wet dust removal from exhausted gases, cleaning of open surface waters after oil spills etc.)

Wetting of solid surface with a liquid flowing down a vertical plane

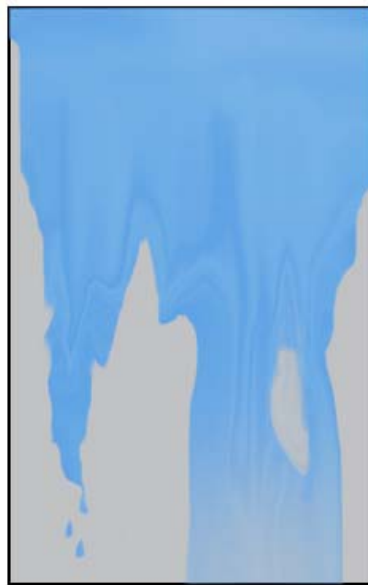

rivulets, drops, dry spots



uniform film

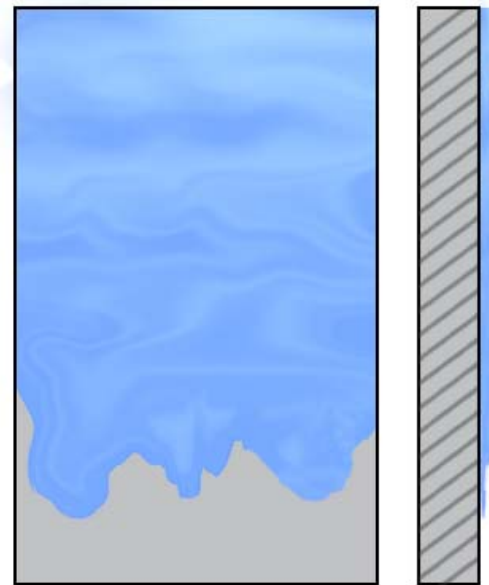

wavy film

Considering wetting action in a three-phase system one can differentiate two opposed cases:

thorough wetting and lack of it

These are resulting in

- liquid films
- ball shaped drops

Highly efficient industrial processes produce fewer emissions and waste

- Numerous industrial processes proceed with an interfacial area generation
- Generating and maintenance films or droplets dimensions (thickness and diameter) is a fundamental task for effective run of the process

Important measure of wettability is contact angle

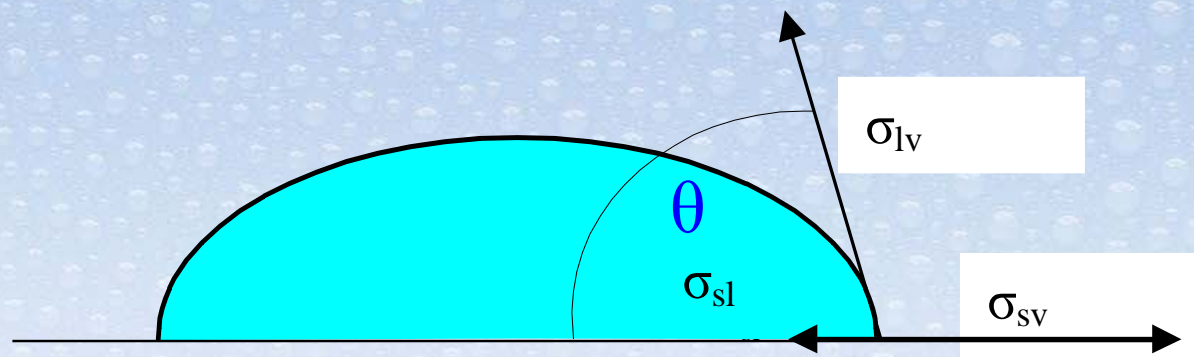

The angle θ measured at the point of contact of three phases forming the given system

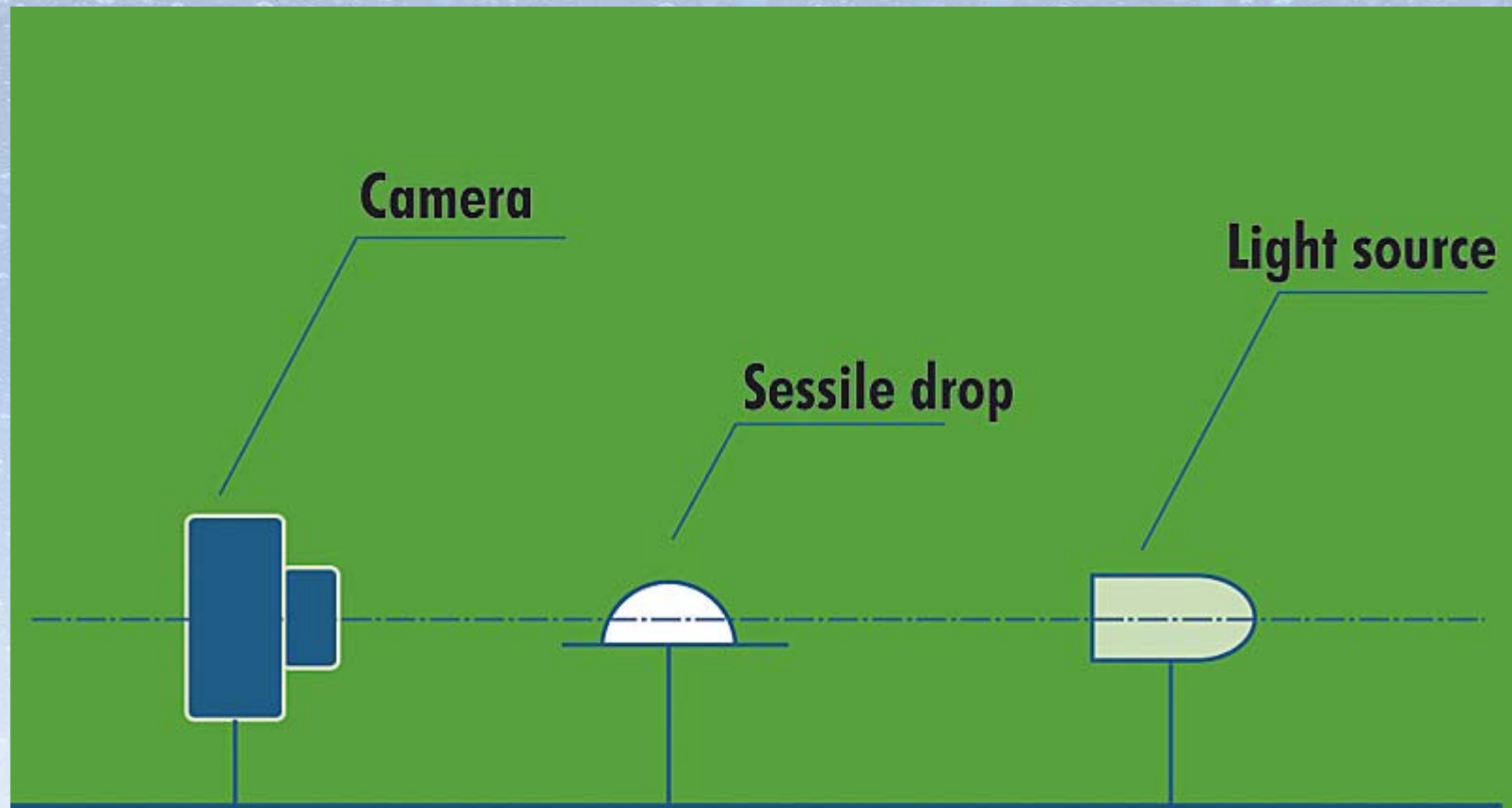

Principle of contact angle determination

Image processing



Drop shape equation



Contact angle

Input approx. (initial)
contact angle value

Compare recorded and
calculated drop profile
Successive approximations

A comparison of a recorded drop shape and a calculated one

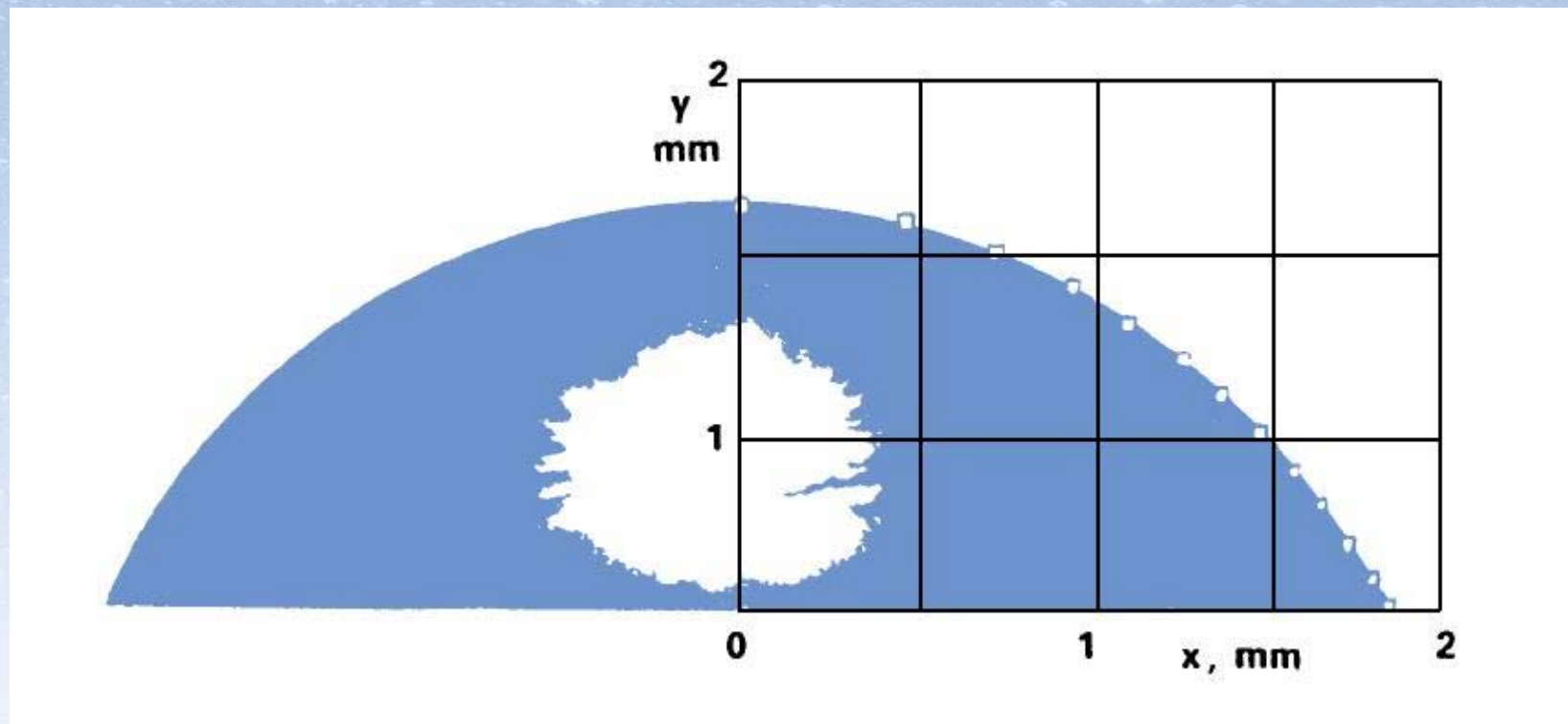

Liquid rivulet flowing down a vertical plane

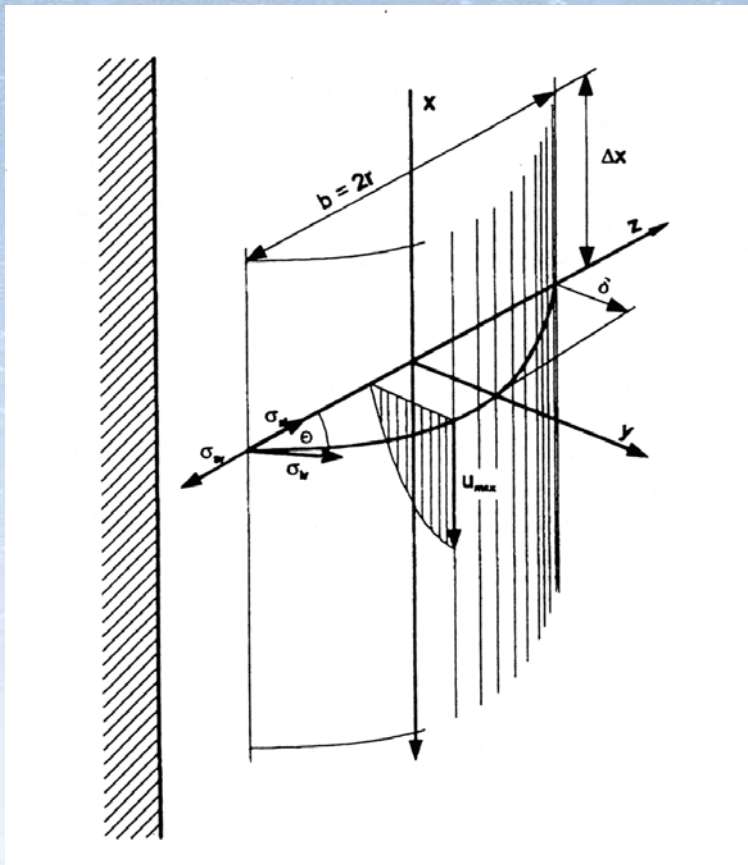

- The minimum rivulet corresponds with the liquid flow rate value below of which single drops slide down the solid surface

Liquid film and minimum rivulet thickness

$$\delta = 1,45 \left[\frac{\eta^2 \sigma}{\rho^3 g^2} \right]^{\frac{1}{5}} (1 - \cos \theta)^{\frac{1}{5}}$$

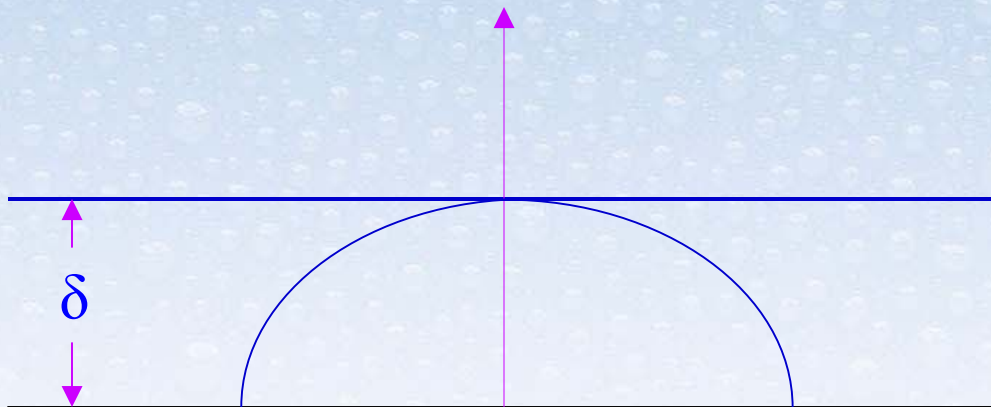

δ – film thickness
 η – viscosity
 σ – surface tension
 ρ – density
 g – acceleration of gravity
 θ – contact angle

Theoretical values of minimal rivulet dimensions

Selected liquids Temp. 20 °C

Liquid	Contact angle degree	Thickness mm	Width mm
Glycerol	5	1.78	60.7
	90	5.42	5.6
Ethylene glycol	5	0.322	11
	90	0.982	1
Water	5	0.113	3.86
	90	0.345	0.36
Ethanol	5	0.111	3.78
	90	0.337	0.345

Liquid film composed of rectangular segment
and two halves of a minimum rivulet

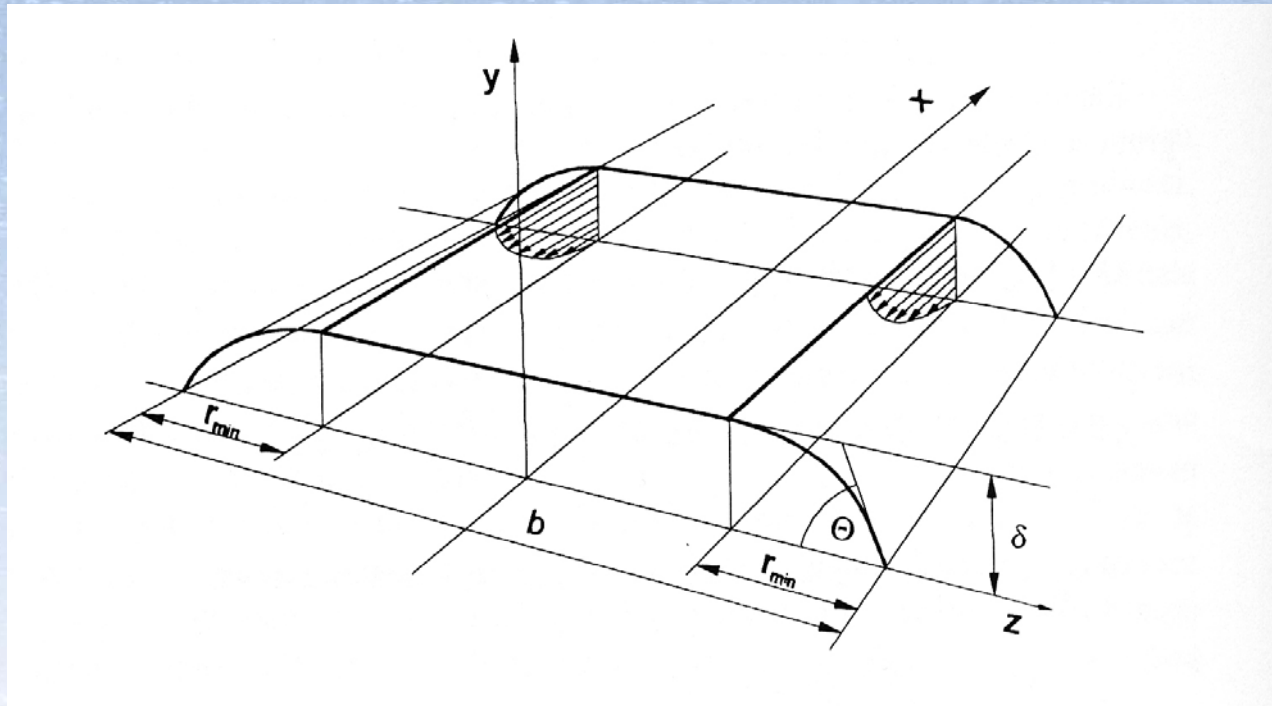

Langmuire's technique

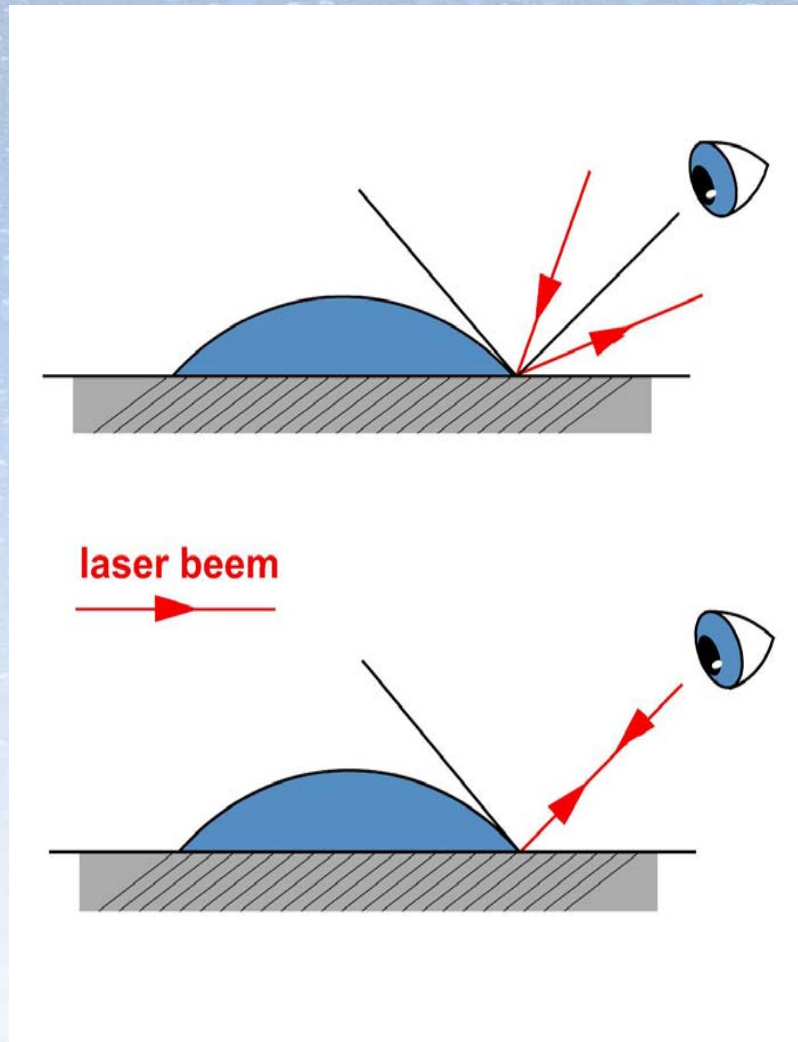

Laser beam directed to a rivulet edge

When incidence and reflection angles are equal one can determine a value of contact angle

Equilibrium and effective (minimum rivulet) contact angle values

Material	Contact angle	
	equilibrium degree	effective degree
Aluminum	69	18
Brass	80.5	46
Stainless steel	75.5	40

Liquid film stability

Liquid surface disturbance

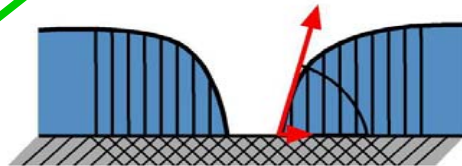
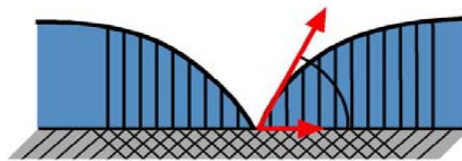
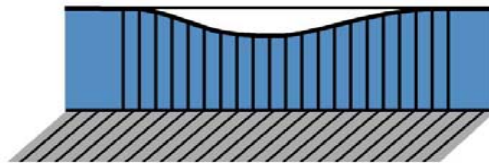

Change of solid surface energy

- Waves on the liquid surface are not the sufficient condition to break down the film
- Somewhere solid surface must be of different energy state

A hint for equipment (film evaporators,
distillation apparatus) producers:

The material used for construction must be
of the highest quality



fully energy uniform surface

Development and Integration of New Processes for Greenhouse Gases Management in Multi- Plant, Chemical Production Complexes

T. A. Hertwig, A. Xu, D. B. Ozyurt, S. Indala R.W. Pike,
F. C. Knopf, J. R. Hopper, and C. L. Yaws

A joint industry-university research effort
IMC Phosphates, Motiva Enterprises,
Louisiana State University, Lamar University

Sponsored by U. S. Environmental Protection Agency

NATO CCMS Pilot Study on Clean Products and Processes

2003 Annual Meeting, May 11 - 15, 2003

Hotel San Michele, Cetraro, Italy

LSU Mineral Processing Research Institute

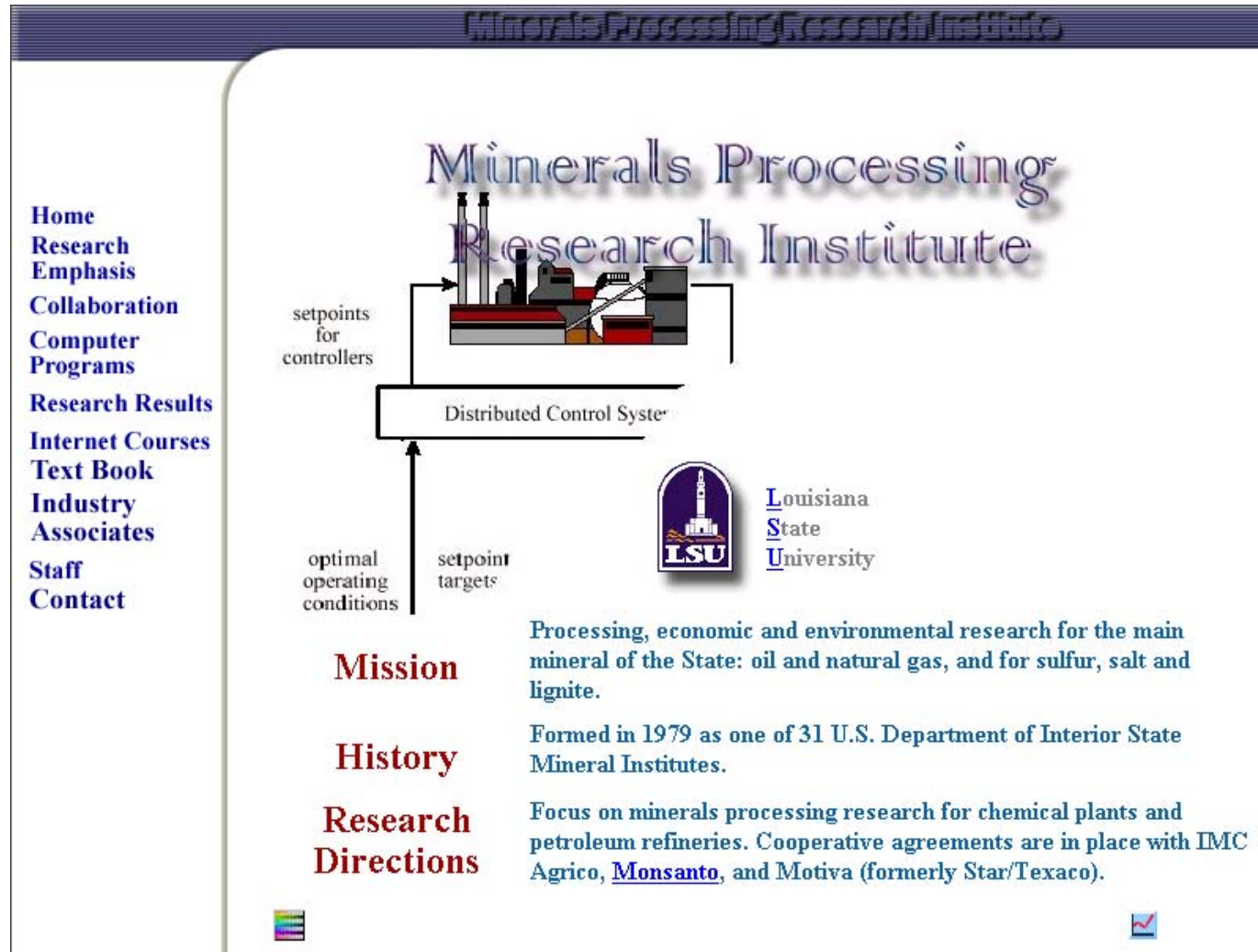

The image is a screenshot of the website for the Minerals Processing Research Institute at Louisiana State University. At the top, there is a dark blue header with the text "Minerals Processing Research Institute" in a light, semi-transparent font. Below the header, the main content area is white. On the left side, there is a vertical navigation menu with the following items: Home, Research Emphasis, Collaboration, Computer Programs, Research Results, Internet Courses, Text Book, Industry Associates, Staff, and Contact. The central part of the page features a large, stylized title "Minerals Processing Research Institute" in a purple, serif font. Below the title is a diagram of a mineral processing plant with several towers and pipes. A box labeled "Distributed Control System" is positioned below the plant. Arrows indicate the flow of information: "setpoints for controllers" points from the DCS to the plant, and "optimal operating conditions" and "setpoint targets" point from the DCS to the plant. To the right of the DCS box is the LSU logo, which consists of a purple shield with a white building and the letters "LSU" below it, followed by the text "Louisiana State University". Below the diagram, there are three sections: "Mission" with the text "Processing, economic and environmental research for the main mineral of the State: oil and natural gas, and for sulfur, salt and lignite.", "History" with the text "Formed in 1979 as one of 31 U.S. Department of Interior State Mineral Institutes.", and "Research Directions" with the text "Focus on minerals processing research for chemical plants and petroleum refineries. Cooperative agreements are in place with IMC Agrico, Monsanto, and Motiva (formerly Star/Texaco).". At the bottom left and right of the page, there are small, colorful icons.

All of the information given in this presentation is available at
www.mpri.lsu.edu

Background

Pollution prevention

- was an environmental issue
- now a critical business opportunity

Long term cost of ownership must be evaluated with short term cash flows

Companies undergoing difficult institutional transformations
Emphasis on pollution prevention has broadened to include:

Total (full) cost accounting

Life cycle assessment

Sustainable development

Eco-efficiency (economic and ecological)

Broader Assessment of Current and Future Manufacturing in the Chemical Industry

Driving forces

ISO 14000,

“the polluter pays principle”

Anticipated next round of Federal regulations associated with global warming

Sustainable development

Sustainable development

Concept that development should meet the needs of the present without sacrificing the ability of the future to meet its needs

Sustainable development costs - external costs

Costs that are not paid directly

Those borne by society

Includes deterioration of the environment by pollution within compliance regulations.

Koyoto Protocol - annual limits on greenhouse gases proposed beginning in 2008 - 7% below 1990 levels for U.S.

Overview of Presentation

Chemical Complex and Cogeneration Analysis System
for multi-plant chemical production complexes

Advanced Process Analysis System
for operating plants

Chemical Complex and Cogeneration Analysis System

Objective: To give corporate engineering groups new capability to design:

- New processes for products from greenhouse gases
- Energy efficient and environmentally acceptable plants

Introduction

- Opportunities
 - Processes for conversion of greenhouse gases to valuable products
 - Cogeneration
- Methodology
 - Chemical Complex and Cogeneration Analysis System
 - Application to chemical complex in the lower Mississippi River corridor

Related Work and Programs

- Aspen Technology
- Department of Energy (DOE)
www.oit.doe.gov/bestpractice
- Environmental Protection Agency (EPA)
www.epa.gov/opptintr/greenengineering

Chemical Complex and Cogeneration Analysis System

Chemical Complex Analysis System

Determines the best configuration of plants in a chemical complex based on the AIChE Total Cost Assessment (TCA) and incorporates EPA Pollution Index methodology (WAR) algorithm

Cogeneration Analysis System

Determines the best energy use based on economics, energy efficiency, regulatory emissions and environmental impacts from greenhouse gas emissions.

Structure of the System

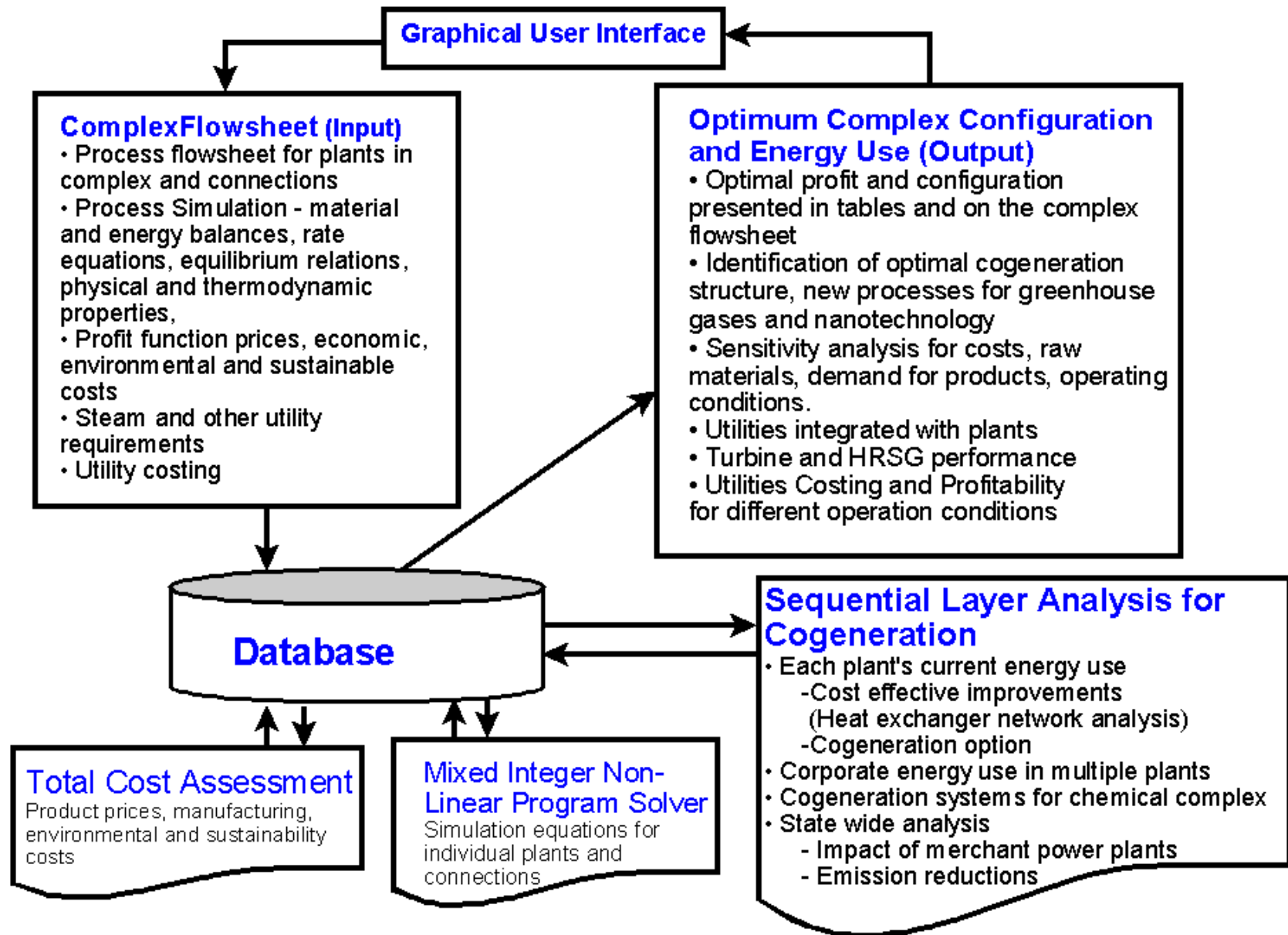

AIChE Total Cost Assessment

- Includes five types of costs: I direct, II overhead, III liability, IV internal intangible, V external (borne by society - sustainable)
- Sustainable costs are costs to society from damage to the environment caused by emissions within regulations, e.g., sulfur dioxide 4.0 lb per ton of sulfuric acid produced
- Environmental costs – compliance, fines, 20% of manufacturing costs
- Combined five TCA costs into economic, environmental and sustainable costs
 - economic – raw materials, utilities, etc
 - environmental – 67% of raw materials
 - sustainable – estimated from sources

Illustration of Input to the System for Unit Data

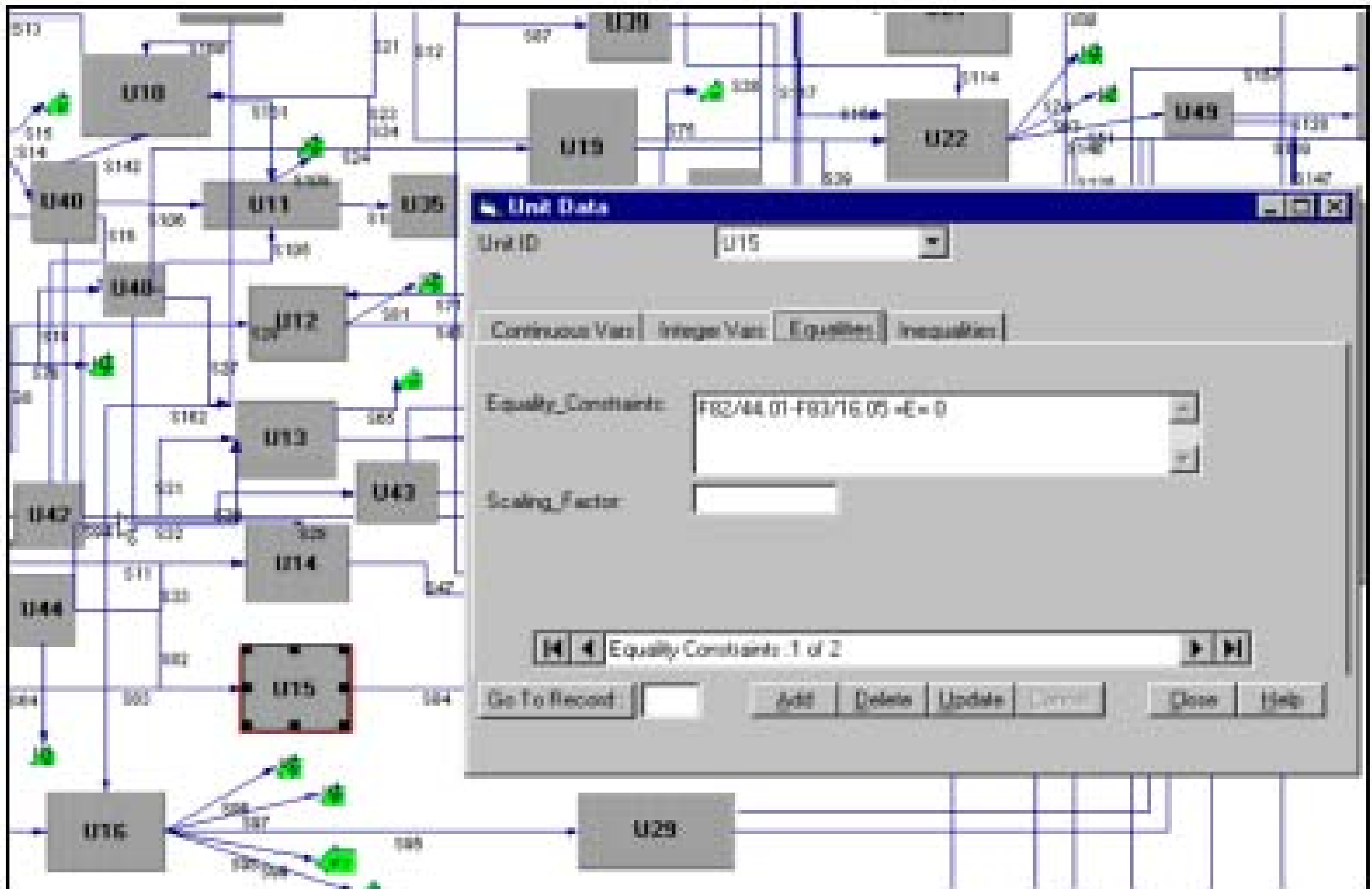

Typical Cogeneration Results on the CHP Diagram

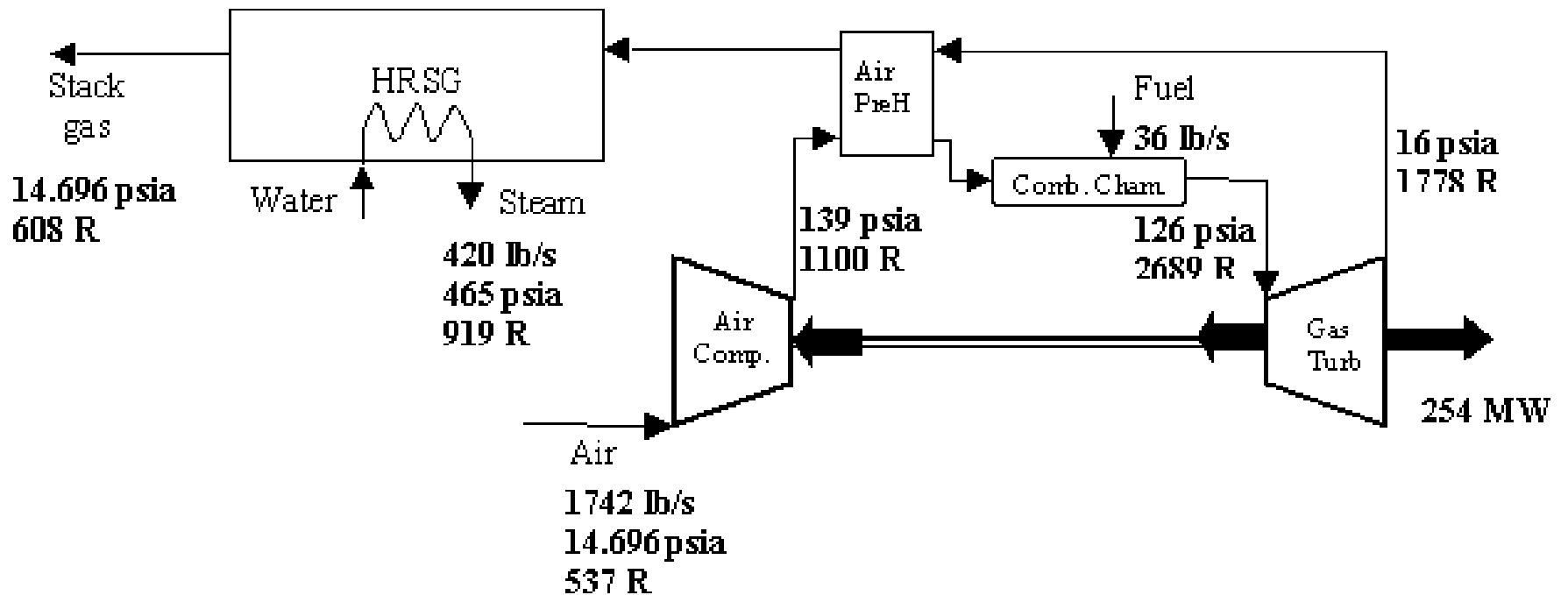
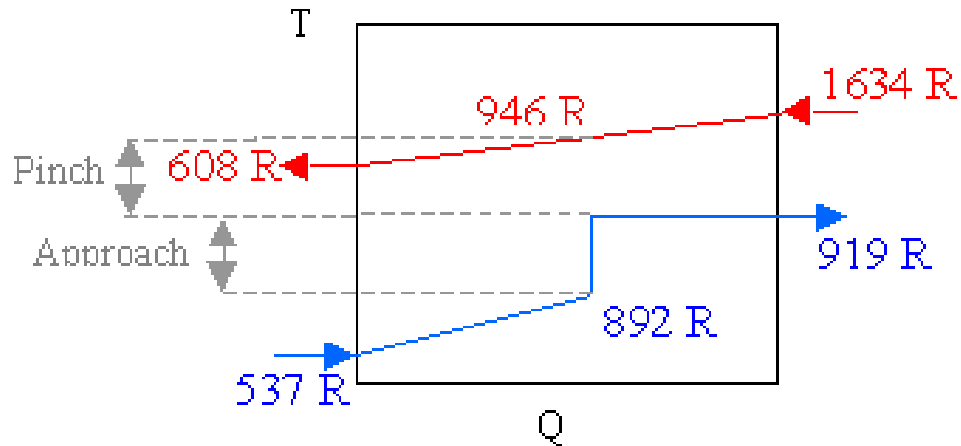

Comparison of Power Generation

	Conventional	Cogeneration
Operating efficiency	33%	77%
Heat rate (BTU/kWh)	>10,000	5,000-6,000
NO _x emission (lbs of NO _x / MWh)	4.9	0.167
CO ₂ emission (tons of CO ₂ / MWh)	1.06	0.30

Plants in the lower Mississippi River Corridor

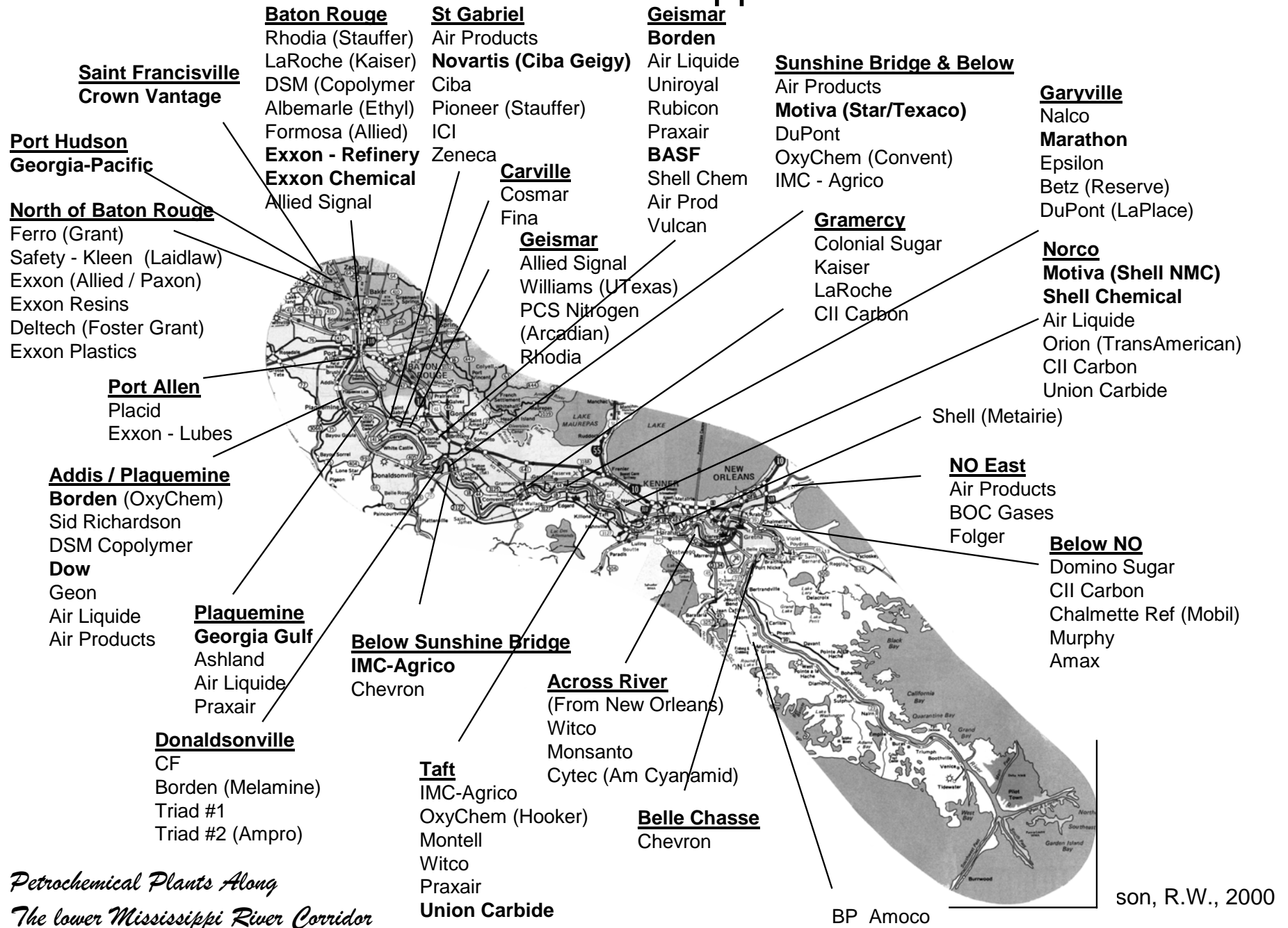

Expanded Agricultural Chemical Complex

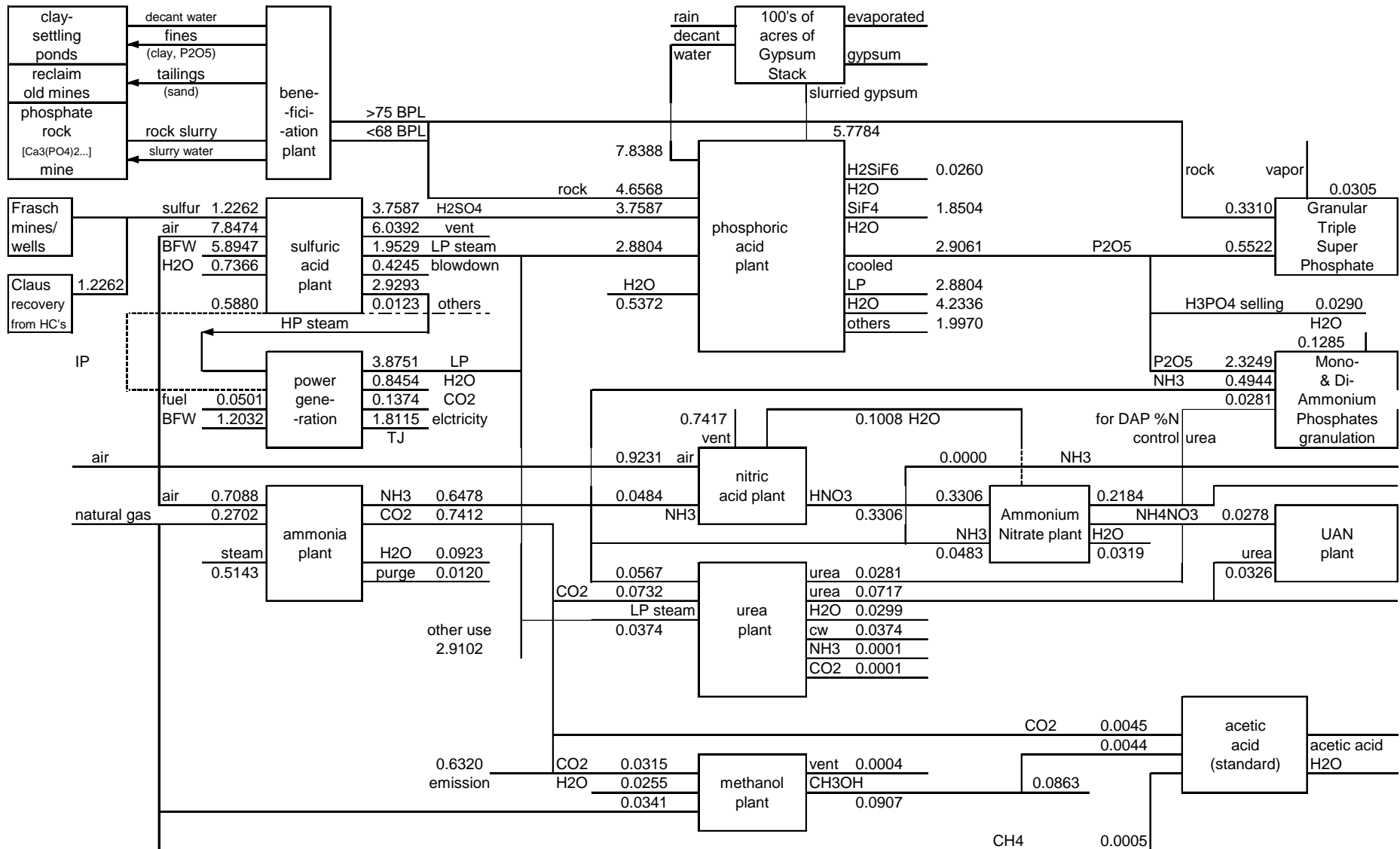

Plants in the lower Mississippi River Corridor, Base Case. Flow Rates in Million Tons Per Year

Some Chemical Complexes in the World

Continent	Name and Site	Notes
North America	<ul style="list-style-type: none"> •Gulf coast petrochemical complex in Houston area (U.S.A.) and •Chemical complex in the Baton Rouge-New Orleans Mississippi River Corridor (U.S.A.) 	<ul style="list-style-type: none"> •Largest petrochemical complex in the world, supplying nearly two-thirds of the nation's petrochemical needs
South America	<ul style="list-style-type: none"> •Petrochemical district of Camacari-Bahia (Brazil) •Petrochemical complex in Bahia Blanca (Argentina) 	<ul style="list-style-type: none"> •Largest petrochemical complex in the southern hemisphere
Europe	<ul style="list-style-type: none"> •Antwerp port area (Belgium) •BASF in Ludwigshafen (Germany) 	<ul style="list-style-type: none"> •Largest petrochemical complex in Europe and world wide second only to Houston, Texas •Europe's largest chemical factory complex
Asia	<ul style="list-style-type: none"> •The Singapore petrochemical complex in Jurong Island (Singapore) •Petrochemical complex of Daqing Oilfield Company Limited (China) •SINOPEC Shanghai Petrochemical Co. Ltd. (China) •Joint-venture of SINOPEC and BP in Shanghai under construction (2005) (China) •Jamnagar refinery and petrochemical complex (India) •Sabic company based in Jubail Industrial City (Saudi Arabia) •Petrochemical complex in Yanbu (Saudi Arabia) •Equate (Kuwait) 	<ul style="list-style-type: none"> •World's third largest oil refinery center •Largest petrochemical complex in Asia •World's largest polyethylene manufacturing site •World's largest & most modern for producing ethylene glycol and polyethylene
Oceania	<ul style="list-style-type: none"> •Petrochemical complex at Altona (Australia) •Petrochemical complex at Botany (Australia) 	
Africa	petrochemical industries complex at Ras El Anouf (Libya)	one of the largest oil complexes in Africa

CO₂ Emissions from Industries

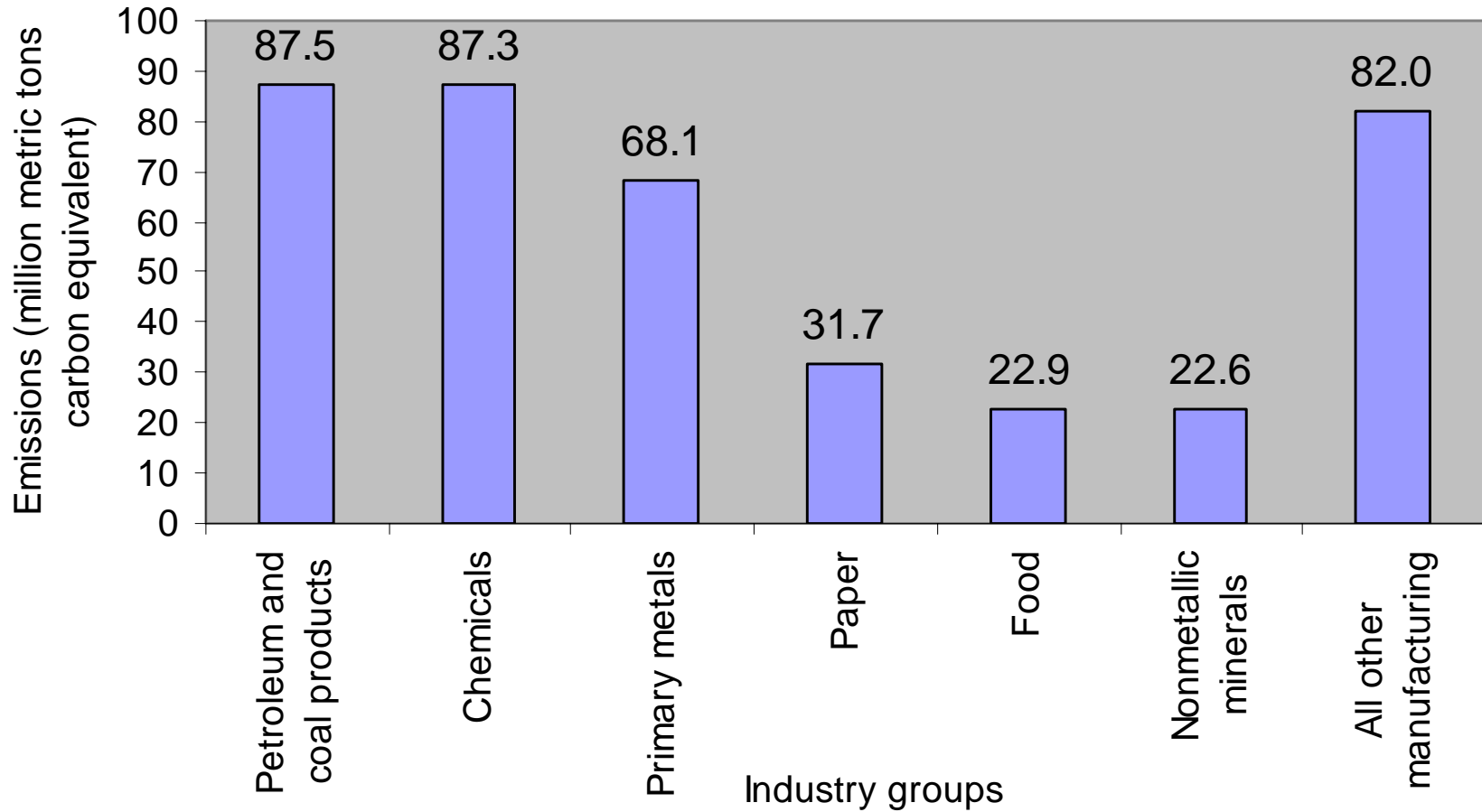

Total Energy-Related Carbon Dioxide Emissions for Selected Manufacturing Industries, 1998, from EIA, 2001

Carbon Dioxide Emissions and Utilization

(Million Metric Tons Carbon Equivalent Per Year)

CO ₂ emissions and utilization	Reference
Total CO ₂ added to atmosphere Burning fossil fuels 5,500 Deforestation 1,600	IPCC (1995)
Total worldwide CO ₂ from consumption and flaring of fossil fuels United States 1,526 China 792 Russia 440 Japan 307 All others 3,258	EIA (2002)
U.S. CO ₂ emissions Industry 630 Buildings 524 Transportation 473 Total 1,627	Stringer (2001)
U.S. industry (manufacturing) Petroleum, coal products and chemicals 175	EIA (2001)
Chemical and refinery (BP) Combustion and flaring 97% Noncombustion direct CO ₂ emission 3%	McMahon (1999)
Agricultural chemical complex in the lower Mississippi River corridor excess high purity CO ₂ 0.183	Hertwig et al. (2002)
CO ₂ used in chemical synthesis 30	Arakawa et al. (2001)

Commercial Uses of CO₂

- 110 million tons of CO₂ for chemical synthesis
 - Urea (chiefly, 90 million ton of CO₂)
 - Methanol (1.7 million tons of CO₂)
 - Polycarbonates
 - Cyclic carbonates
 - Salicylic acid
 - Metal carbonates

Surplus Carbon Dioxide

Ammonia plants produce 1.2 million tons per year in lower Mississippi River corridor

Methanol and urea plants consume 0.15 million tons per year

Surplus high-purity carbon dioxide 1.0 million tons per year vented to atmosphere

Greenhouse Gases as Raw Material

- Intermediate of fine chemicals for the chemical industry
 - C(O)O-: Acids, esters, lactones
 - O-C(O)O-: Carbonates
 - NC(O)OR-: Carbamic esters
 - NCO: Isocyanates
 - N-C(O)-N: Ureas
- Use as a solvent
- Energy rich products
CO, CH₃OH

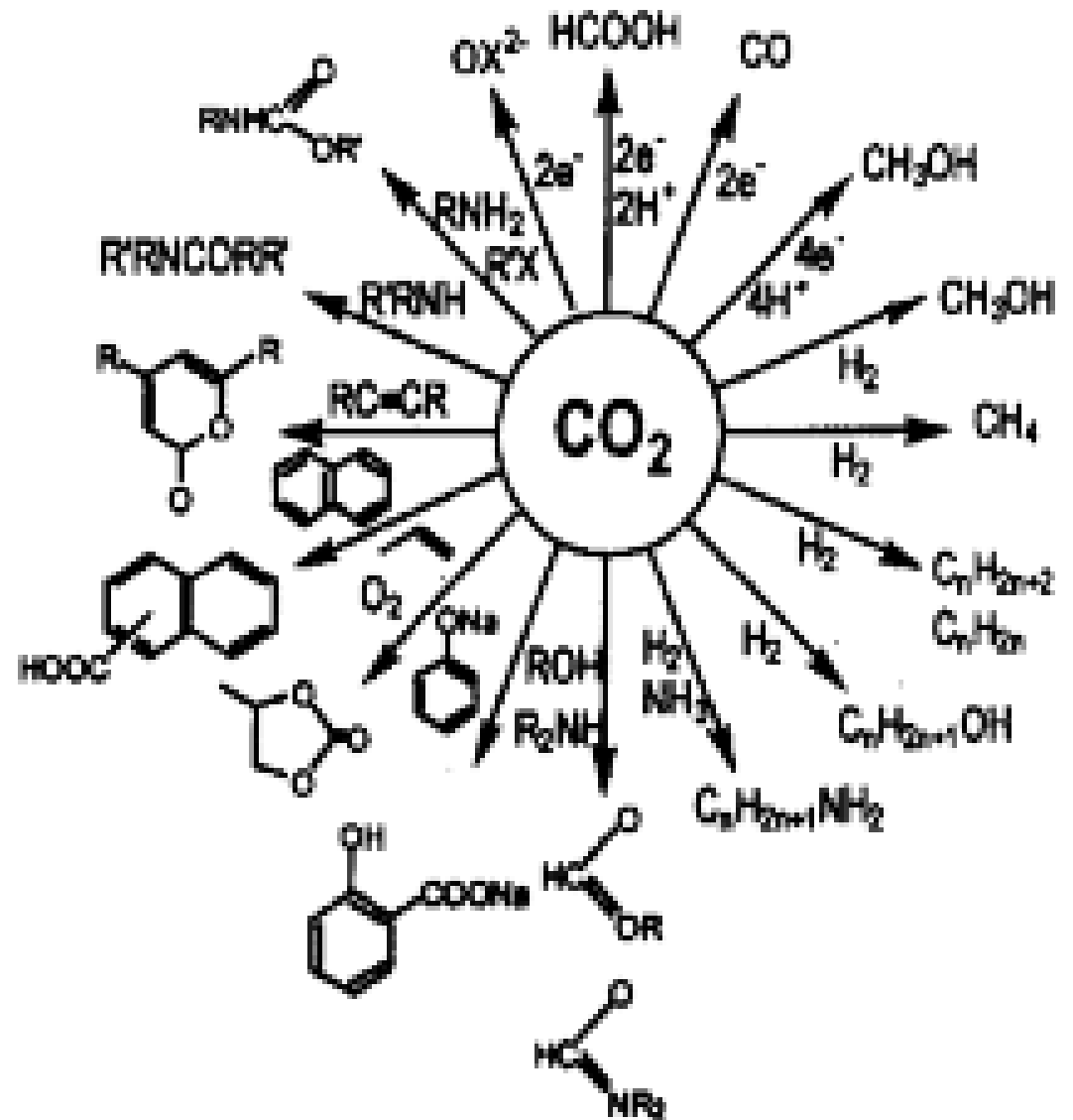

From Creutz and Fujita, 2000

Catalytic Reactions of CO₂ from Various Sources

Hydrogenation

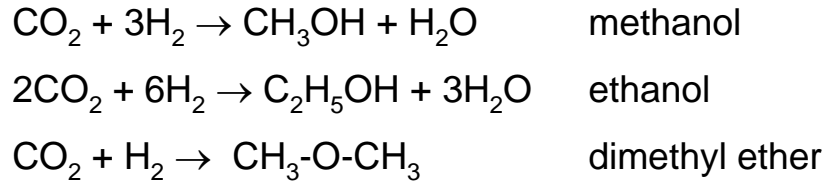

Hydrolysis and Photocatalytic Reduction

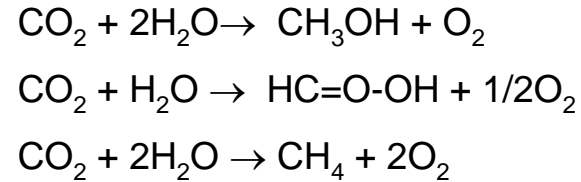

Hydrocarbon Synthesis



Carboxylic Acid Synthesis

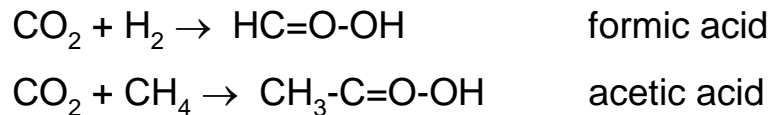

Other Reactions

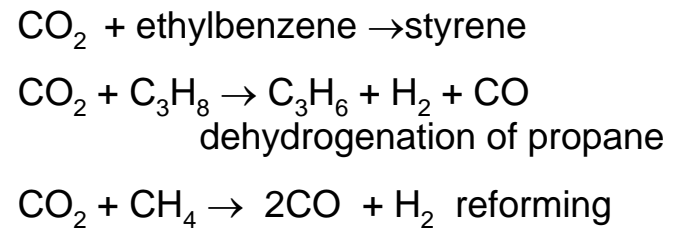

Graphite Synthesis



Amine Synthesis

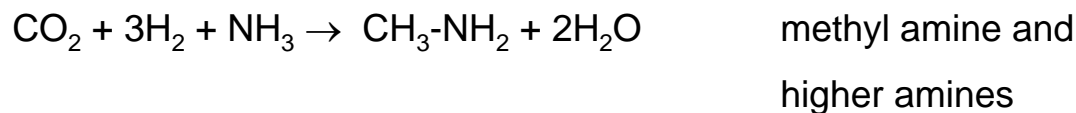

Application of the System to Chemical Complex in the Lower Mississippi River Corridor

- Base case
- Superstructure
- Optimal structure

Base Case of Actual Plants

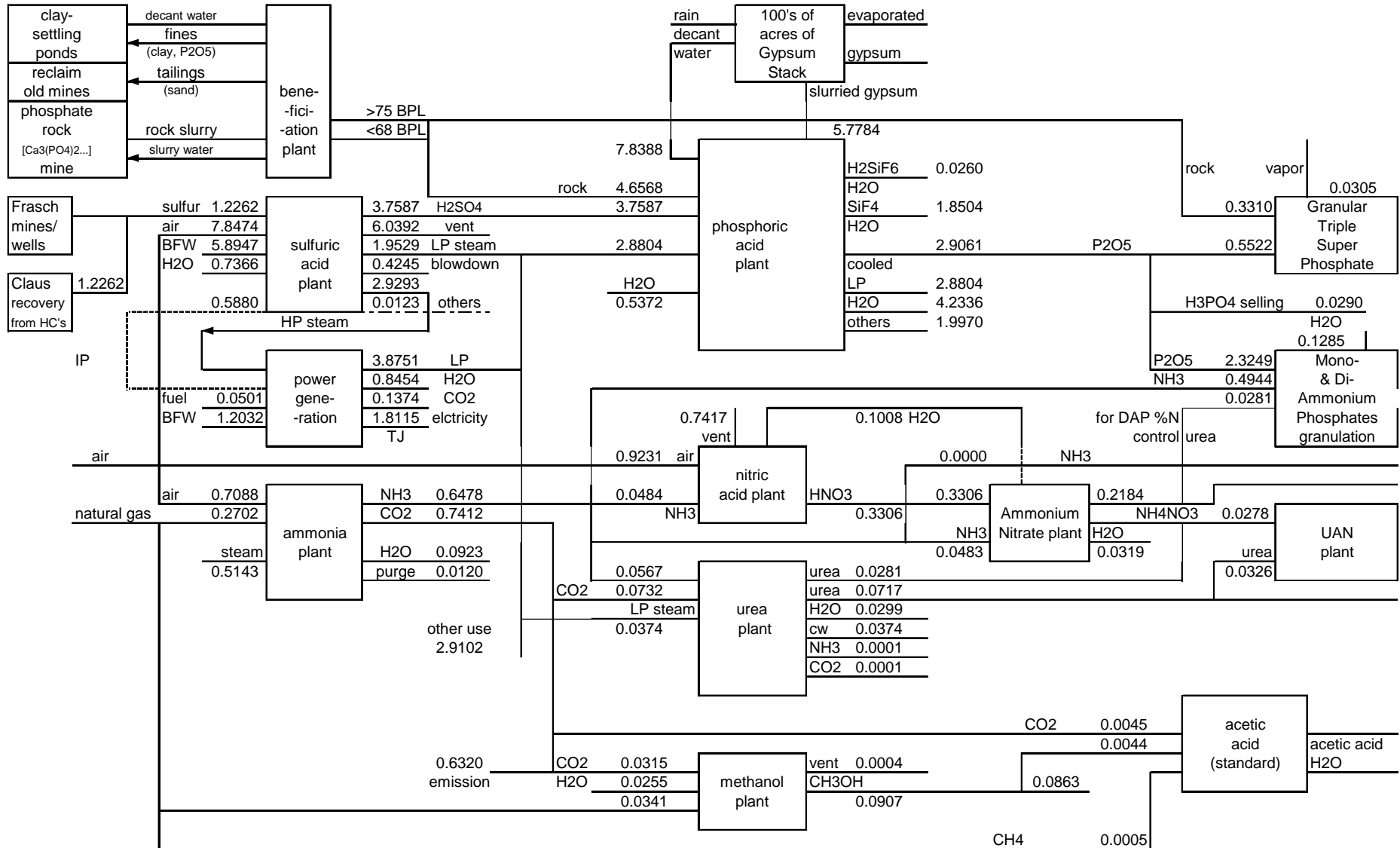

Plants in the lower Mississippi River Corridor, Base Case. Flow Rates in Million Tons Per Year

Processes in the Superstructure

Processes in Superstructure	
Processes in Base Case	Electric furnace process for phosphoric acid
Ammonia	HCl process for phosphoric acid
Nitric acid	Ammonium sulfate
Ammonium nitrate	SO ₂ recovery from gypsum process
Urea	S & SO ₂ recovery from gypsum process
UAN	Acetic acid – new CO ₂ -CH ₄ catalytic process
Methanol	
Granular triple super phosphate	
MAP & DAP	
Power generation	
Contact process for Sulfuric acid	
Wet process for phosphoric acid	
Acetic acid-conventional process	

Superstructure

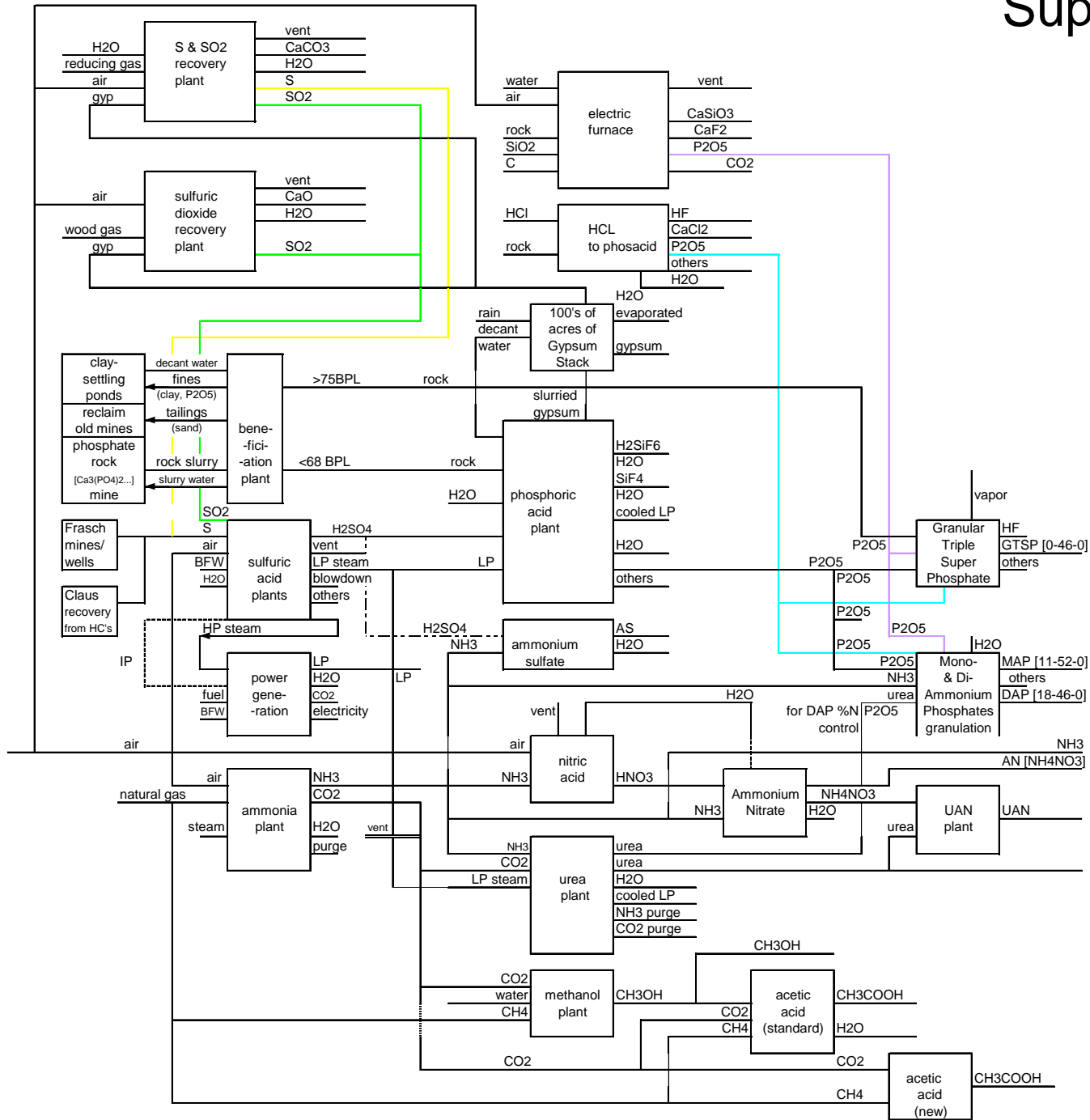

Superstructure Characteristics

Options

- Three options for producing phosphoric acid
- Two options for producing acetic acid
- One option for sulfuric acid
- Two options for recover sulfur and sulfur dioxide
- New plants for
 ammonium sulfate
 recover sulfur and sulfur dioxide

Mixed Integer Nonlinear Program

594 continuous variables

7 integer variables

505 equality constraint equations
for material and energy balances

27 inequality constraints for availability of raw materials
demand for product, capacities of the plants in the complex

Raw Material and Product Prices

<u>Raw Materials</u>	<u>Cost (\$/mt)</u>	<u>Raw Materials</u>	<u>Cost (\$/mt)</u>	<u>Products</u>	<u>Price (\$/mt)</u>
Natural Gas	245	Market cost for short term purchase		Ammonia	190
Phosphate Rock		Reducing gas	1394	Methanol	96
wet process	27	Wood gas	634	Acetic Acid	623
electrofurnace	24	<u>Sustainable Costs and Credits</u>		GTSP	142
HCl process	25	Credit for CO ₂	6.50	MAP	180
GTSP process	30	Consumption		DAP	165
HCl	50	Debit for CO ₂	3.25	NH ₄ NO ₃	153
Sulfur		Production		UAN	112
Frasch	42	Credit for HP Steam	10	Urea	154
Claus	38	Credit for IP Steam	6.4	H ₃ PO ₄	320
C electrofurnace	760	Credit for gypsum	5	(NH ₄) ₂ SO ₄	187
		Consumption			
		Debit for gypsum	2.5		
		Production			
		Debit for NO _x	1025		
		Production			

Optimal Structure

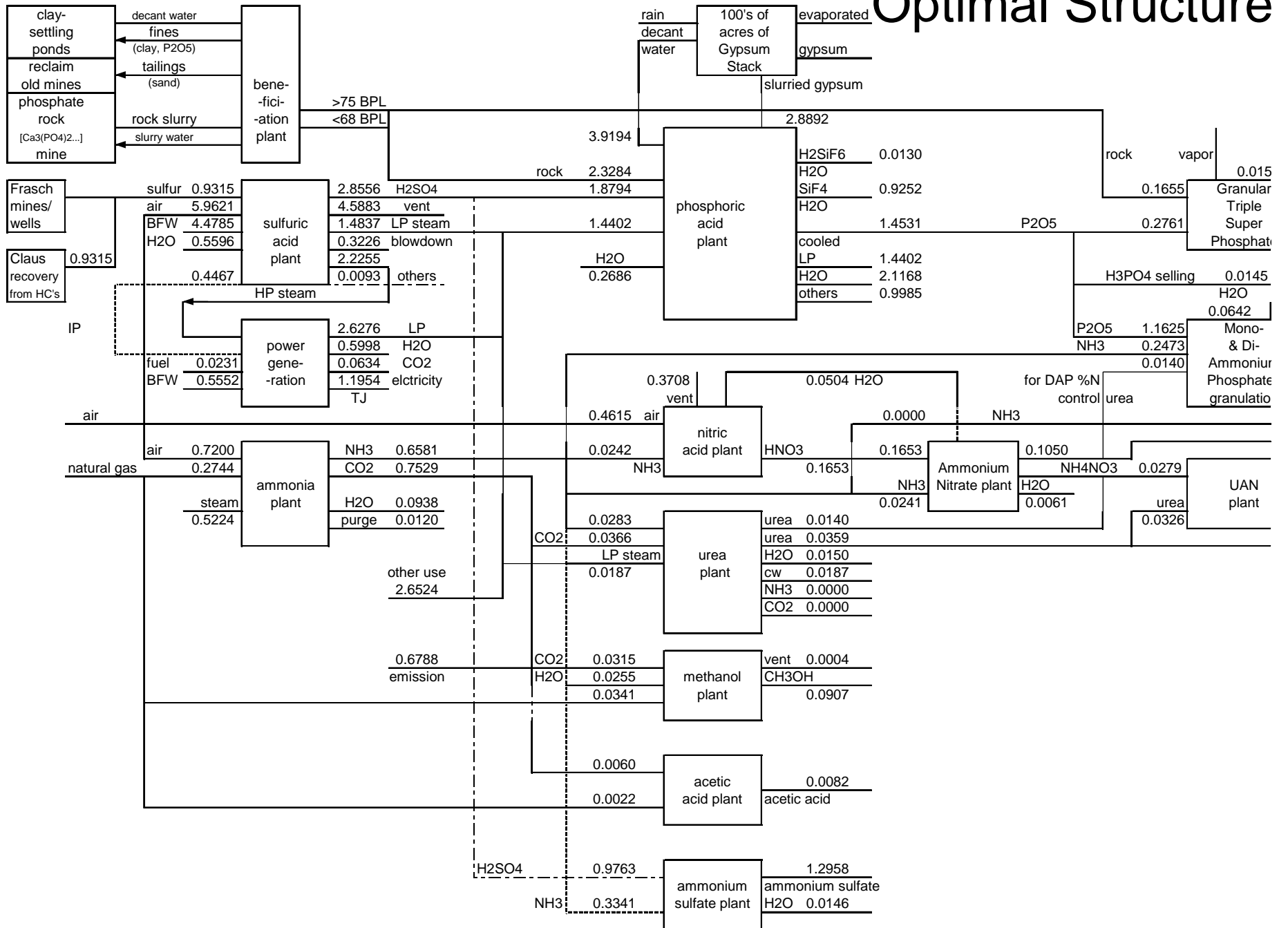

Comparison of Base Case and Optimal Structure

		Base case		Optimal structure	
Profit (U.S.\$/year)		148,087,243		246,927,825	
Environmental cost (U.S.\$/year)		179,481,000		123,352,900	
Sustainability cost (U.S.\$/year)		-17,780,800	energy	-16,148,900	energy
Plant name	Capacity (mt/year) (upper-lower bounds)	Capacity (mt/year)	requirement (TJ/year)	Capacity (mt/year)	requirement (TJ/year)
Ammonia	329,030-658,061	647,834	3,774	658,061	3,834
Nitric acid	0-178,547	178,525	-649	89,262	-324
Ammonium nitrate	113,398-226,796	226,796	116	113,398	26
Urea	49,895-99,790	99,790	127	49,895	63
Methanol	90,718-181,437	90,719	1,083	90,719	1,083
UAN	30,240-60,480	60,480	0	60,480	0
MAP	0-321,920	321,912		160,959	
DAP	0-2,062,100	2,062,100	2,127	1,031,071	1,063
GTSP	0-822,300	822,284	1,036	411,150	518
Contact process sulfuric acid	1,851,186-3,702,372	3,702,297	-14,963	2,812,817	-11,368
Wet process phosphoric acid	697,489-1,394,978	1,394,950	7,404	697,489	3,702
Electric furnace phosphoric acid	697,489-1,394,978	na	na	0	0
HCl to phosphoric acid	697,489-1,394,978	na	na	0	0
Ammonium sulfate	0-2,839,000	na	na	1,295,770	726
Acetic acid (standard)	0-8,165	8,165	268	0	0
Acetic acid (new)	0-8,165	na	na	8,165	92
SO2 recovery from gypsum	0-1,804,417	na	na	0	0
S & SO2 recovery from gypsum	0-903,053	na	na	0	0
Ammonia sale		0		0	
Ammonium Nitrate sale		218,441		105,043	
Urea sale		39,076		3,223	
Wet process phosphoric acid sale		13,950		6,975	
Methanol sale		86,361		90,719	
Total energy requirement from fuel gas			2,912		1,344

Comparison of Acetic Acid Processes

Process	Conventional Process	New Catalytic Process
Raw Materials	Methanol, Carbon Monoxide	Methane, Carbon Dioxide
Reaction Condition	450K, 30bar	350K, 25bar
Conversion of methane	100%	97%
Equipment	reactor, flash drum, four distillation columns	reactor, distillation column

Production Costs for Acetic Acid

Moulijn, et al., 2001

Plant Production Cost, (cents per kg)	Methanol Carbon Monoxide	Methane Carbon Dioxide
Raw materials	21.6	21.6
Utilities	3.3	1.7
Labor	1.2	1.2
Other (capital, catalyst)	10.1	10.1
Total Production Cost	36.2	34.6

Current market price 79 cents per kg

Catalytic Process for Acetic Acid

Capacity: 100 million pound per year of acetic acid

36,700 tons per year of carbon dioxide raw material

Potential Savings

Reduction in utilities costs for process steam \$750,000

Energy savings from not having to produce this steam

275 trillion BTUs per year

Reduction in NOx emissions base on steam and power generation
by cogeneration

3.5 tons per year

Reduction in carbon dioxide emissions

12,600 tons per year from the steam production

36,700 tons per year conversion to a useful product

Develop Process Information for the System

- Simulate process using HYSYS and Advanced Process Analysis System.
- Estimate utilities required.
- Perform economic analysis.
- Obtain process constraint equations from HYSIS and Advanced Process Analysis System.
- Maximize the profit function to find the optimum process configuration with the System.
- Incorporate into superstructure.

Advanced Process Analysis System

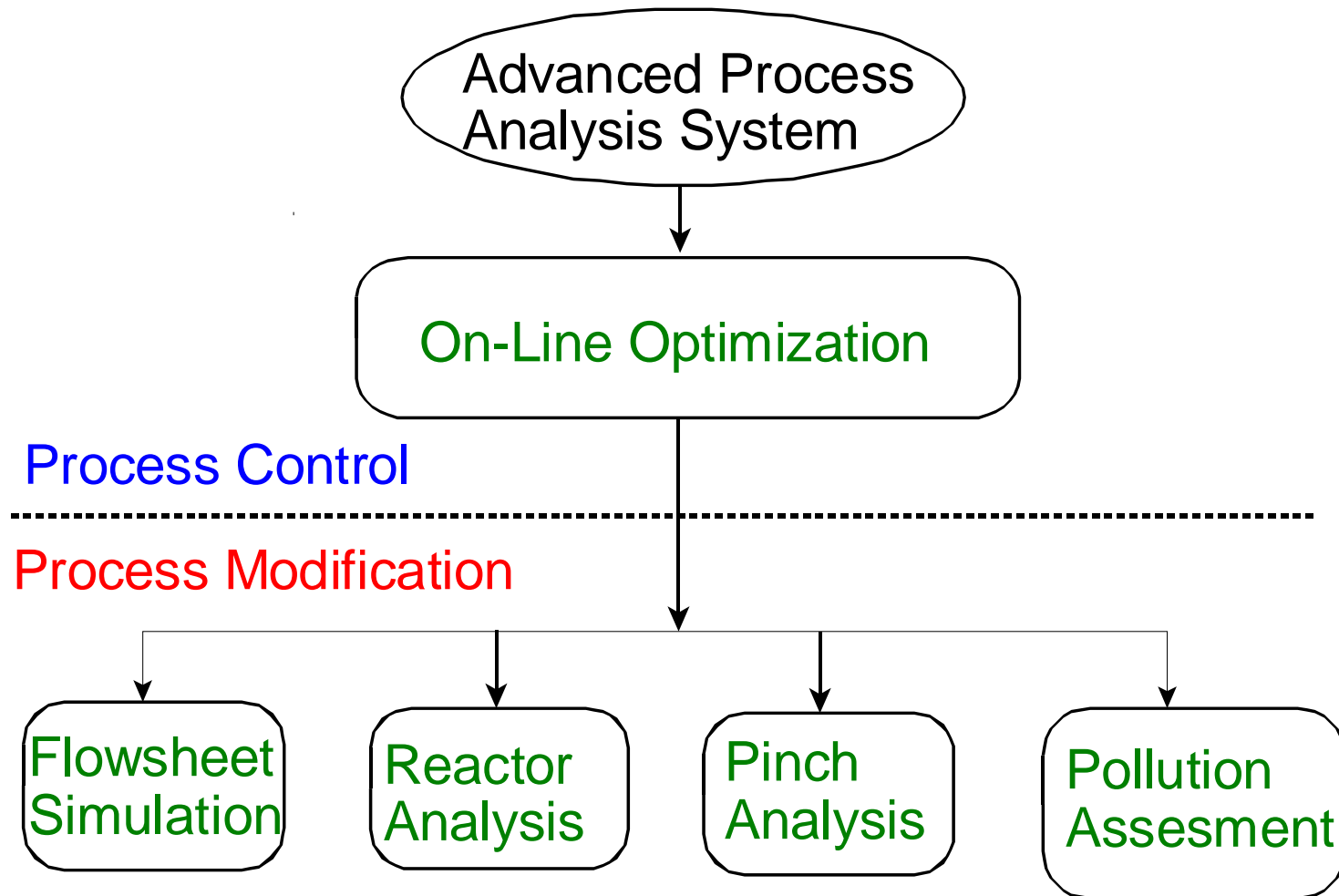
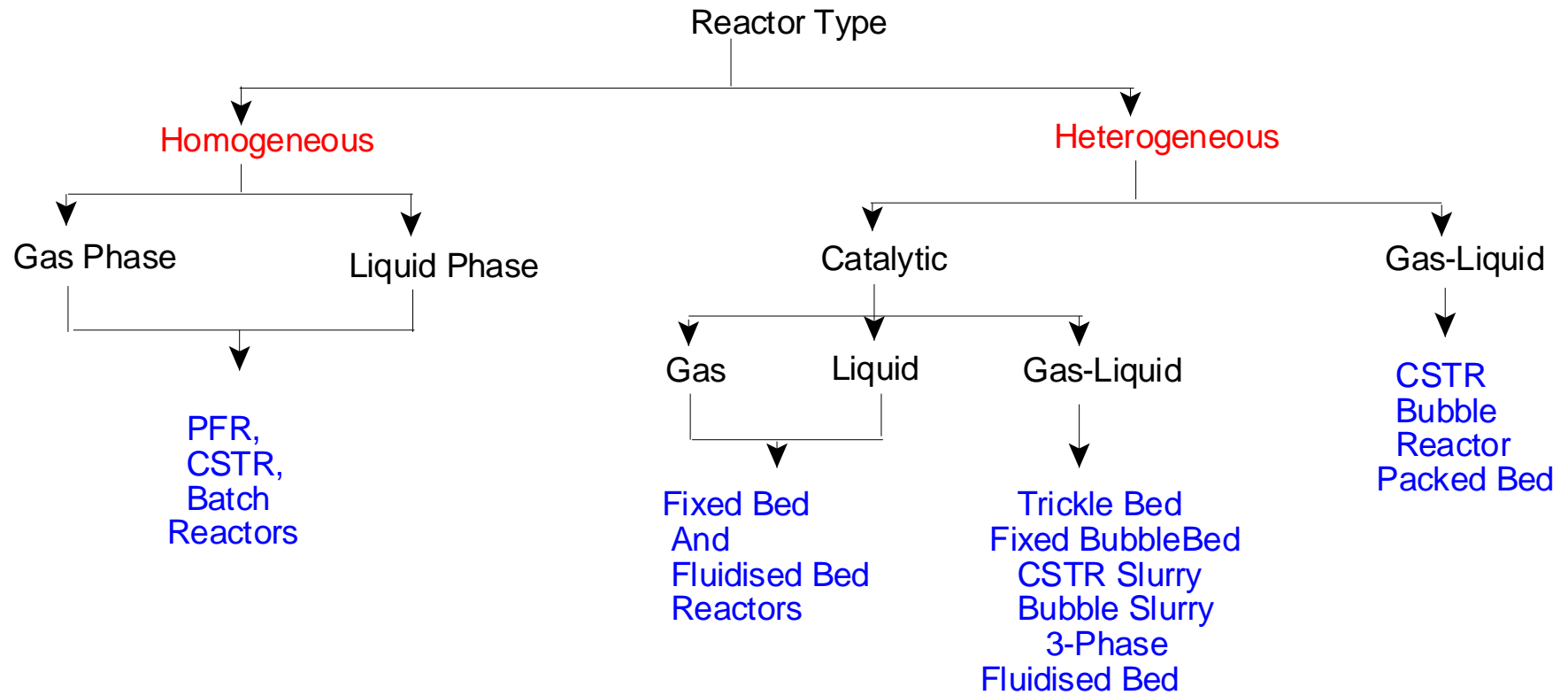
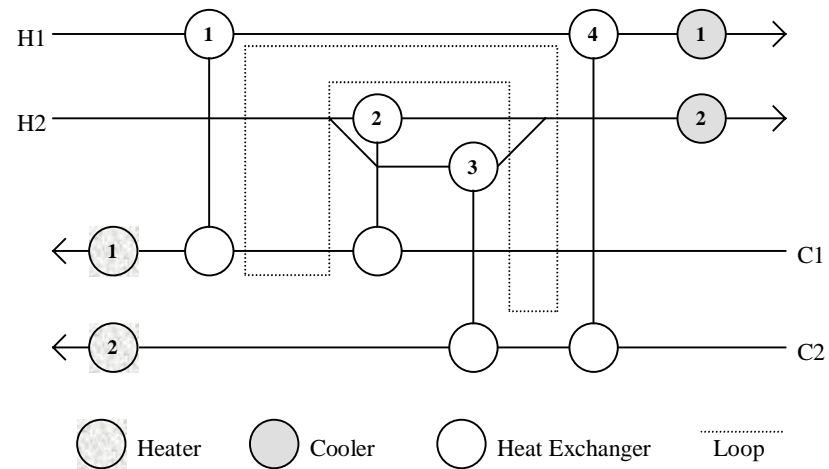
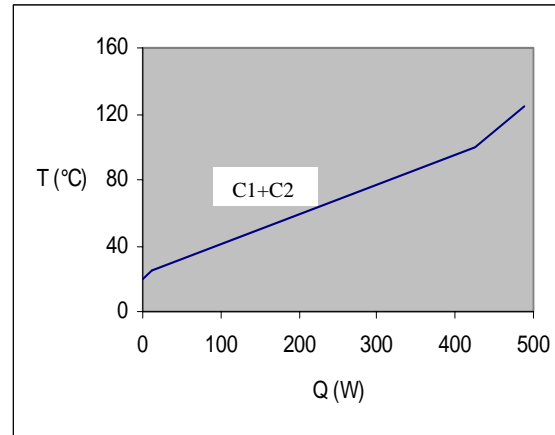
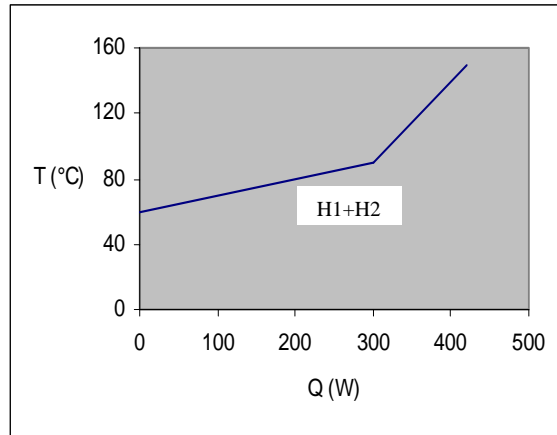

Fig. 1 Overview of Advanced Process Analysis System

Reactor Analysis



Energy Integration – Pinch Analysis



Pollution Assessment

Waste Reduction Algorithm (WAR) and Environmental Impact Theory

Pollution Index

$$I = \text{wastes/products} = - (\Sigma \text{Out} + \Sigma \text{Fugitive}) / \Sigma P_n$$

Potential Environmental Impact

$$\Psi_k = \sum_l \alpha_l \Psi_{k,l}^s$$

α_l relative weighting factor

$\Psi_{k,l}^s$ units of potential environmental impact/mass of chemical k

Conclusions

- The System has been applied to an extended agricultural chemical complex in the lower Mississippi River corridor
- Economic model incorporated economic, environmental and sustainable costs.
- An optimum configuration of plants was determined with increased profit and reduced energy and emissions
- For acetic acid production, new catalytic process is better than conventional process based on energy savings and the reduction of NO_x and CO_2 emissions.

Conclusions

- Based on these results, the methodology could be applied to other chemical complexes in the world for reduced emissions and energy savings.
- The System includes the program with users manuals and tutorials. These can be downloaded at no cost from the LSU Mineral Processing Research Institute's web site www.mpri.lsu.edu

Future Work

- Add new processes for carbon dioxide
- Expand to a petrochemical complex in the lower Mississippi River corridor
- Add processes that produce fullerenes and carbon nanotubes

Advanced Process Analysis System

On-Line Optimization and Flowsheet Simulation
accurate description of the plant
maintain optimum operating conditions

Pinch Analysis
minimum utilities, steam and cooling water

Chemical Reactor Analysis
select best chemical reactor from options

Pollution Assessment – WAR Algorithm
identify sources of pollutant generation
in the plant and process modifications

Advanced Process Analysis System

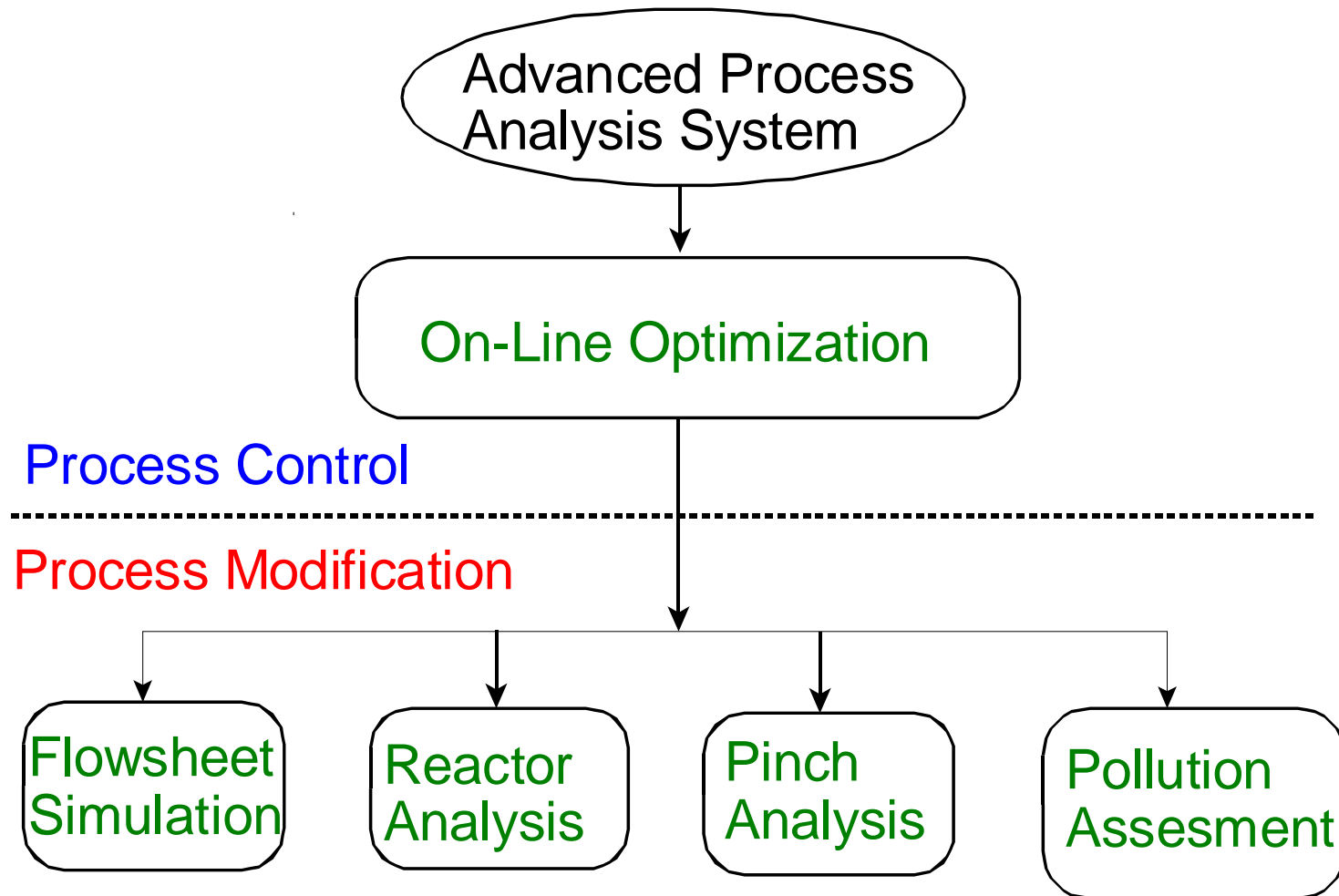

Fig. 1 Overview of Advanced Process Analysis System

Advanced Process Analysis System Structure

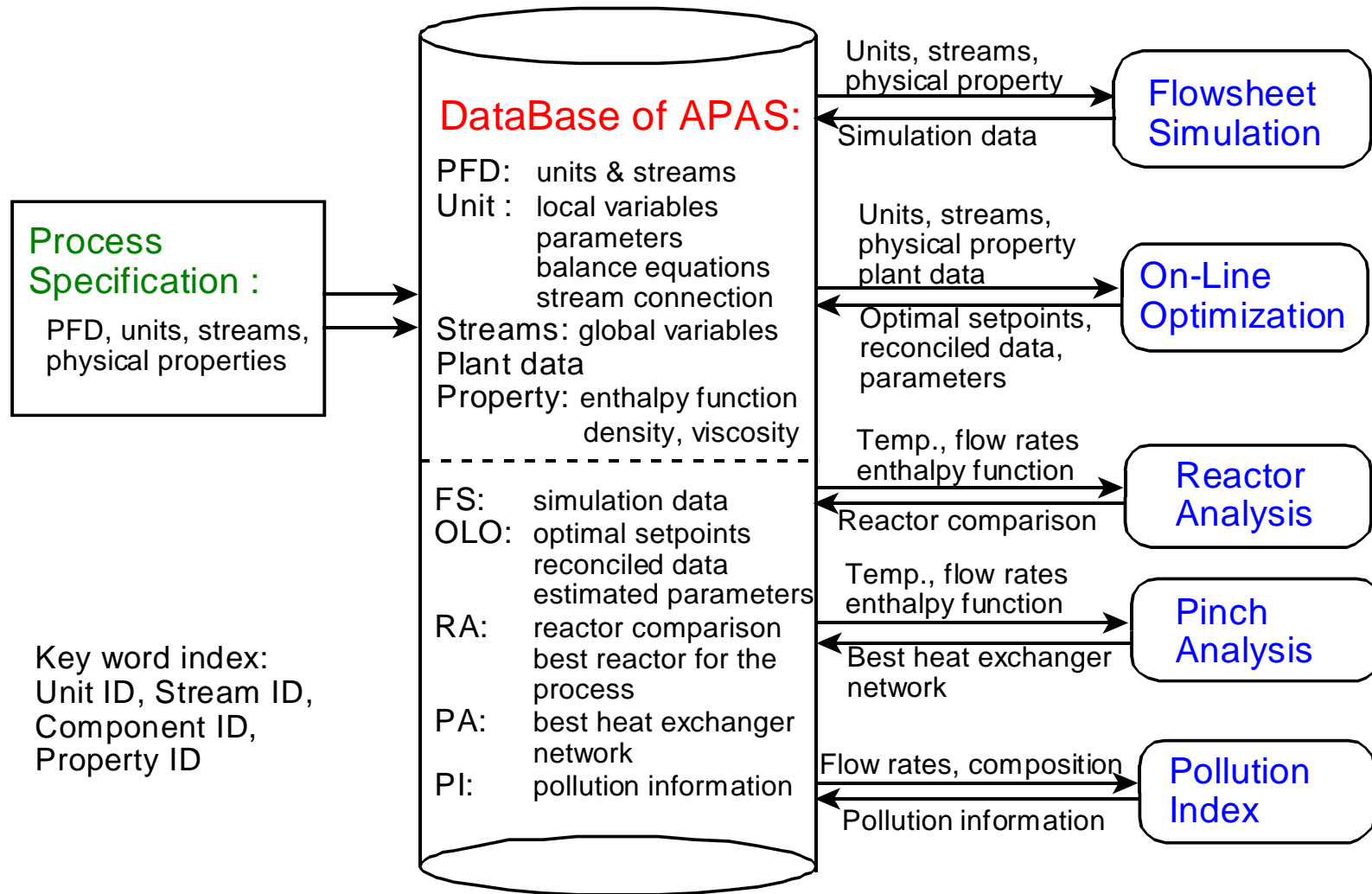

Fig. 2 Database Structure of Advanced Process Analysis System

On-Line Optimization

Automatically adjust operating conditions with the plant's distributed control system

Maintains operations at optimal set points

Requires the solution of three NLP's
gross error detection and data reconciliation
parameter estimation
economic optimization

BENEFITS

Improves plant profit by 3-5%

Waste generation and energy use are reduced

Increased understanding of plant operations

On-Line Optimization

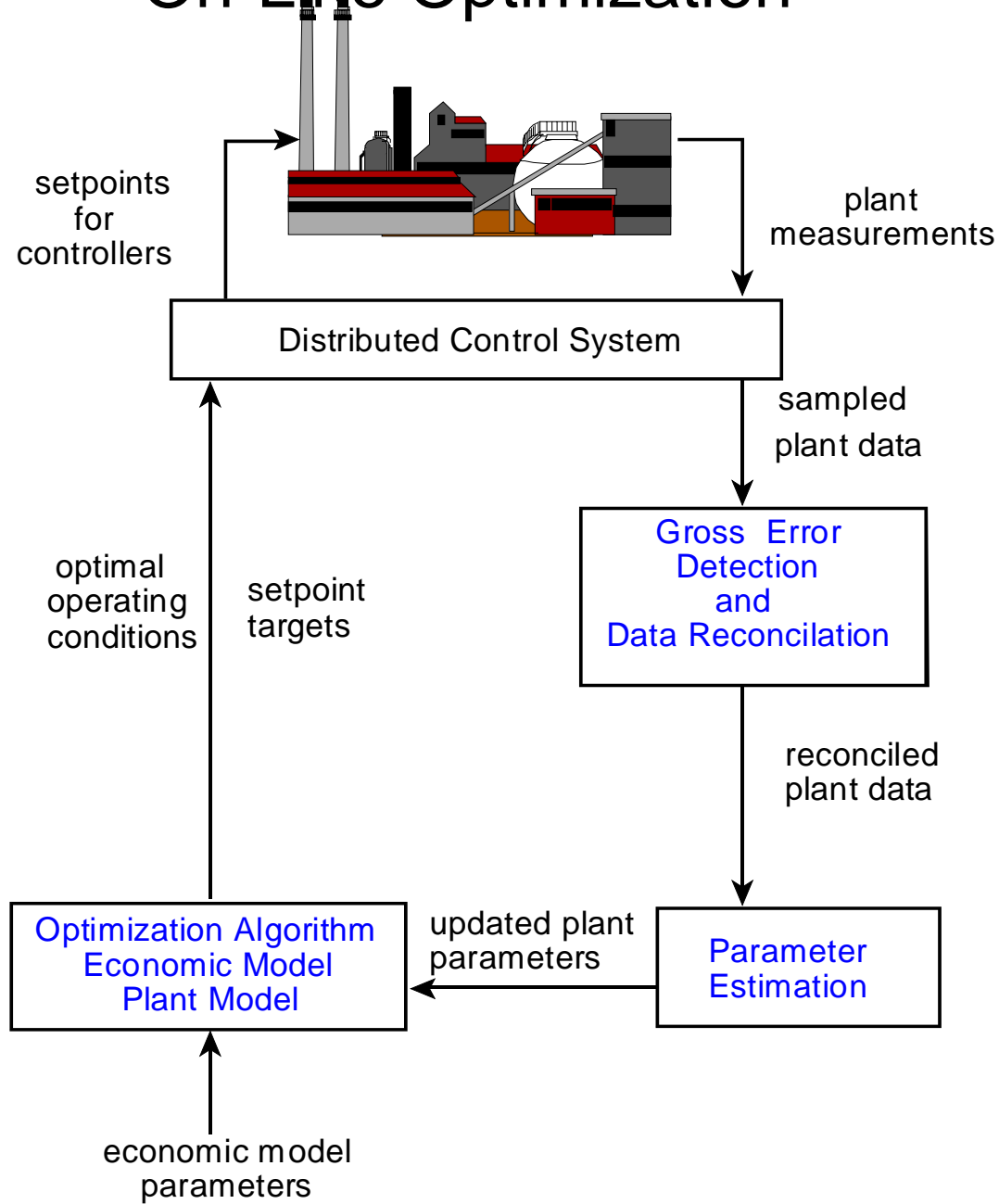

Some Companies Using On-Line Optimization

United States

Texaco

Amoco

Conoco

Lyondel

Sunoco

Phillips

Marathon

Dow

Chevron

Pyrotec/KTI

NOVA Chemicals (Canada)

British Petroleum

Europe

OMV Deutschland

Dow Benelux

Shell

OEMV

Penex

Borealis AB

DSM-Hydrocarbons

Applications

mainly crude units in refineries and ethylene plants

Companies Providing On-Line Optimization

Aspen Technology - Aspen Plus On-Line
- DMC Corporation
- Setpoint
- Hyprotech Ltd.

Simulation Science - ROM
- Shell - Romeo

Profimatics - On-Opt
- Honeywell

Litwin Process Automation - FACS

DOT Products, Inc. - NOVA

On-Line Optimization Problem Size

	Contact	Alkylation	Ethylene
Units	14	76	-
Streams	35	110	~4,000
Constraints			
Equality	761	1579	~400,000
Inequality	28	50	~10,000
Variables			
Measured	43	125	~300
Unmeasured	732	1509	~10,000
Parameters	11	64	~100

Key Elements

Gross Error Detection

Data Reconciliation

Parameter Estimation

Economic Model
(Profit Function)

Plant Model
(Process Simulation)

Optimization Algorithm

Status of Industrial Practice for On-Line Optimization

Steady state detection by time series screening

Gross error detection by time series screening

Data reconciliation by least squares

Parameter estimation by least squares

Economic optimization by standard methods

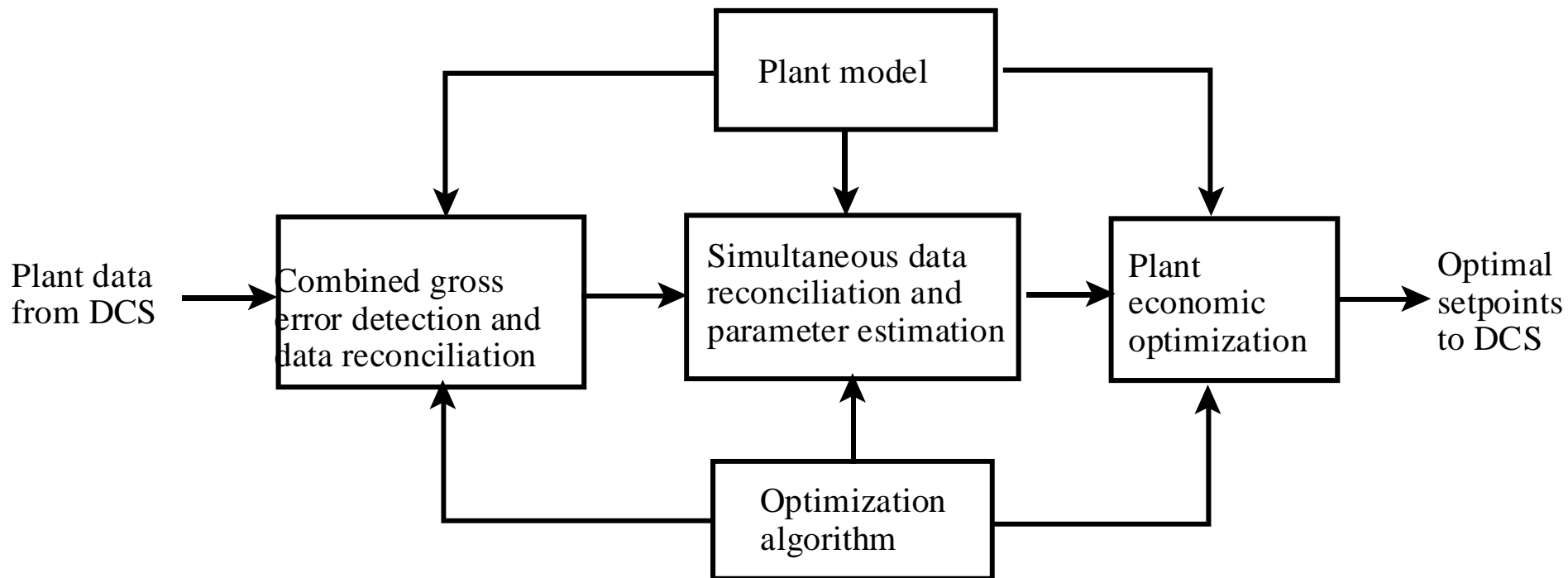

Data Reconciliation

Adjust process data to satisfy material and energy balances.

Measurement error - **e**

$$\mathbf{e} = \mathbf{y} - \mathbf{x}$$

y = measured process variables
x = true values of the measured variables

$$\mathbf{x} = \mathbf{y} + \mathbf{a}$$

a - measurement adjustment

Data Reconciliation NLP

Measurements having only random errors - least squares

$$\text{Minimize: } \sum_{i=1}^n \left(\frac{y_i - x_i}{\sigma_i} \right)^2$$

$$\text{Subject to: } f(x) = 0$$

σ_i = standard deviation of y_i

$f(x)$ - process model

- linear or nonlinear

Types of Gross Errors

Types of Gross Errors

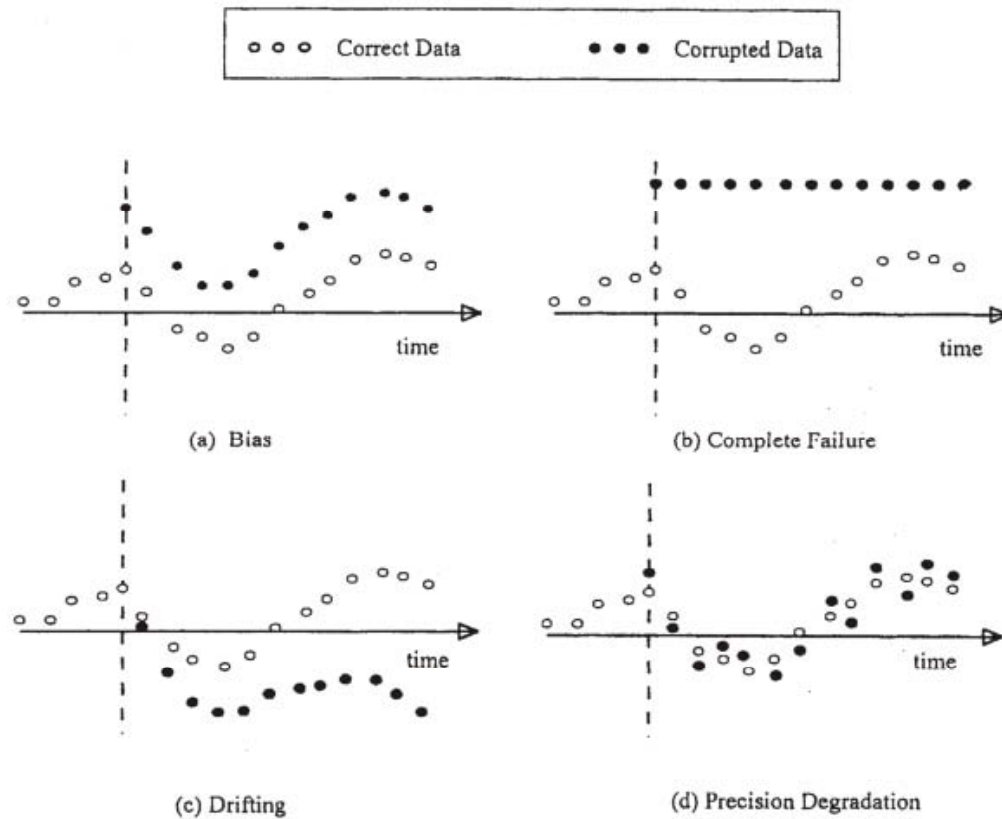

Source: S. Narasimhan and C. Jordache, *Data Reconciliation and Gross Error Detection*, Gulf Publishing Company, Houston, TX (2000)

Gross Error Detection Methods

Statistical Testing

- o many methods
- o can include data reconciliation

Others

- o principal component analysis
- o ad hoc procedures – time series screening

Combined Gross Error Detection and Data Reconciliation

Measurement Test Method - least squares

$$\text{Minimize: } (\mathbf{y} - \mathbf{x})^T \mathbf{Q}^{-1} (\mathbf{y} - \mathbf{x}) = \mathbf{e}^T \mathbf{Q}^{-1} \mathbf{e}$$

\mathbf{x}, \mathbf{z}

$$\text{Subject to: } \mathbf{f}(\mathbf{x}, \mathbf{z}, \theta) = 0$$

$$\mathbf{x}^L \leq \mathbf{x} \leq \mathbf{x}^U$$

$$\mathbf{z}^L \leq \mathbf{z} \leq \mathbf{z}^U$$

Test statistic:

if $|e_i|/\sigma_i \geq C$ measurement contains a gross error

Least squares is based on only random errors being present

Gross errors cause numerical difficulties

Need methods that are not sensitive to gross errors

Methods Insensitive to Gross Errors

Tjao-Biegler's Contaminated Gaussian Distribution

$$P(y_i | x_i) = (1-\eta)P(y_i | x_i, R) + \eta P(y_i | x_i, G)$$

$P(y_i | x_i, R)$ = probability distribution function for the random error

$P(y_i | x_i, G)$ = probability distribution function for the gross error.

$$P(y|x, G) = \frac{1}{\sqrt{2\pi}b\sigma} e^{-\frac{(y-x)^2}{2b^2\sigma^2}}$$

Results of Theoretical and Numerical Evaluation

Method based on contaminated Gaussian distribution had best performance for measurement containing random errors and gross errors in the range 3σ - 30σ .

Method based on Lorentzian distribution had best performance for measurement containing random errors and gross errors larger than 30σ .

Measurement test method had the best performance when only random errors were present. Significant error smearing (biased estimation) occurred for gross errors greater than 10σ .

Parameter Estimation

Error-in-Variables Method

Least squares

$$\text{Minimize: } (\mathbf{y} - \mathbf{x})^T \mathbf{Q}^{-1} (\mathbf{y} - \mathbf{x}) = \mathbf{e}^T \mathbf{Q}^{-1} \mathbf{e}$$

θ

$$\text{Subject to: } f(\mathbf{x}, \theta) = 0$$

θ - plant parameters

Simultaneous data reconciliation and
parameter estimation

$$\text{Minimize: } (\mathbf{y} - \mathbf{x})^T \mathbf{Q}^{-1} (\mathbf{y} - \mathbf{x}) = \mathbf{e}^T \Sigma^{-1} \mathbf{e}$$

\mathbf{x}, θ

$$\text{Subject to: } f(\mathbf{x}, \theta) = 0$$

another nonlinear programming problem

Three Similar Optimization Problems

Three Similar Optimization Problems

Optimize: **Objective function**
Subject to: **Constraints are the plant model**

Objective function

data reconciliation - distribution function
parameter estimation - least squares
economic optimization - profit function

Constraint equations

material and energy balances
chemical reaction rate equations
thermodynamic equilibrium relations
capacities of process units
demand for product
availability of raw materials

Interactive On-Line Optimization Program

1. Conduct combined gross error detection and data reconciliation to detect and rectify gross errors in plant data sampled from distributed control system using the Tjoa-Biegler's method (the contaminated Gaussian distribution) or robust method (Lorentzian distribution).

This step generates a set of measurements containing only random errors for parameter estimation.

2. Use this set of measurements for simultaneous parameter estimation and data reconciliation using the least squares method.

This step provides the updated parameters in the plant model for economic optimization.

3. Generate optimal set points for the distributed control system from the economic optimization using the updated plant and economic models.

Interactive On-Line Optimization Program

Process and economic models are entered as equations in a form similar to Fortran

The program writes and runs three GAMS programs.

Results are presented in a summary form, on a process flowsheet and in the full GAMS output

The program and users manual (120 pages) can be downloaded from the LSU Minerals Processing Research Institute web site

[URLhttp://www.mpri.lsu.edu](http://www.mpri.lsu.edu)

Opening Screen of On-Line Optimization Program

The screenshot shows a software window titled "Instructions" with a close button (X) in the top right corner. The window is divided into two main sections: a diagram on the left and a text area on the right.

Diagram: A flowchart illustrating the data flow between different components of the optimization system. At the top, a stylized industrial plant icon is shown. An arrow labeled "setpoints for controllers" points from a box labeled "Economic Optimization Economic Model Plant Model" to the plant. An arrow labeled "Plant measurements" points from the plant to a box labeled "Distributed Control System". From the "Distributed Control System", an arrow labeled "Sampled plant data" points to a box labeled "Gross Error Detection and Data Reconciliation". From this box, an arrow labeled "Reconciled plant data" points to a box labeled "Parameter Estimation". From "Parameter Estimation", an arrow labeled "updated plant parameters" points to the "Economic Optimization Economic Model Plant Model" box. From the "Economic Optimization Economic Model Plant Model" box, an arrow labeled "setpoint targets" points to the "Distributed Control System". Another arrow labeled "optimal operating conditions" points from the "Economic Optimization Economic Model Plant Model" box to the "Distributed Control System". At the bottom, an arrow labeled "economic parameters" points to the "Economic Optimization Economic Model Plant Model" box.

Text Area: Contains a blue italicized description of the program's function and a list of options.

On-line optimization adjusts the operation of a plant to maximize the profits and minimize the emissions by providing the optimal set points of the Distributed Control System (DCS).

- Create New Model. Requires:**
 - a. Plant Model
 - b. Economic Model
 - c. Parameters
 - d. DCS Data
- Open Existing Model**
Revise Plant Information

Buttons:

Do not display this window next time

Algorithm Selection in On-Line optimization Program

The screenshot displays the 'Interactive On-line Optimization' software interface. The title bar shows the file path: E:\OFFICE\PRWIN\FILES\loo\Examples\refinery.ioo. The menu bar includes 'File', 'View', and 'Help'. The toolbar contains icons for file operations and help. The main window is divided into several tabs: 'Model Description', 'Tables', 'Measured Variables', 'Unmeasured Variables', 'Plant Parameters', 'Equality Constraints', 'Inequality Constraints', 'Optimization Algorithms', and 'Constant Properties'. The 'Optimization Algorithms' tab is active, showing the following settings:

- Data Validation Algorithm: Tjoo-Biegler Method (moderate gross errors)
- Parameters Estimation Algorithm: Tjoo-Biegler Method (moderate gross errors)
- Economic Optimization Objective Function: $-33*crude+0.01965*fgad-2.5*smrf+0.01965*(grf-2.2*rdsec-2.2*rfocc+0.01965*fgcc+$
- Optimization Direction: Maximizing
- Economic Model Type: Linear

Steady State Detection for On-Line Optimization

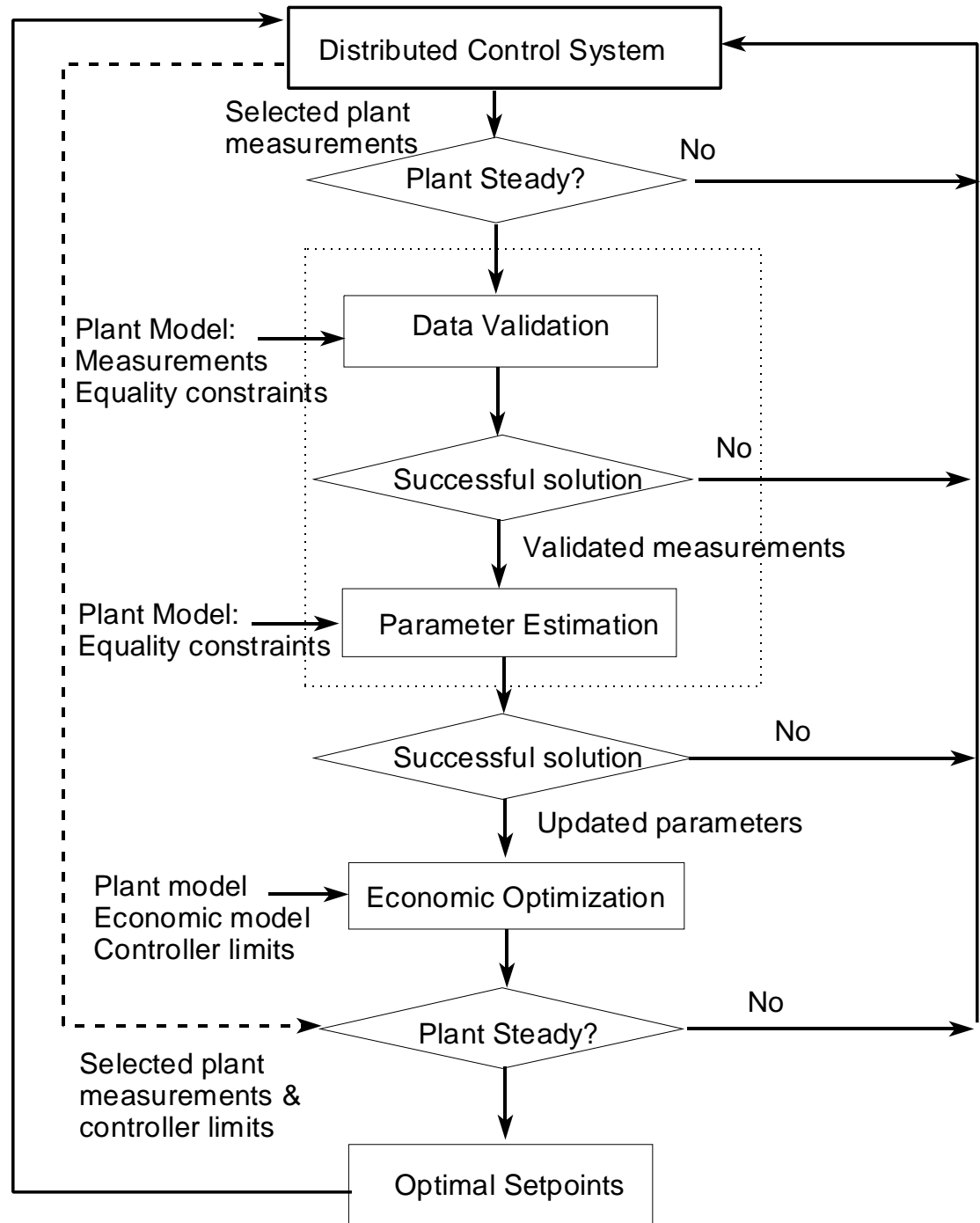

Some Other Considerations

Redundancy

Observeability

Variance estimation

Closing the loop

Dynamic data reconciliation
and parameter estimation

On-Line Optimization Summary

Summary

Most difficult part of on-line optimization is developing and validating the process and economic models.

Most valuable information obtained from on-line optimization is a more thorough understanding of the process

Process Flow Diagram for Contact Process

Air Inlet Air Dryer Main Compressor Sulfur Burner Waste Heat Boiler Super-Heater SO₂ to SO₃ Converter Hot & Cold Gas to Gas Heat EX. Heat Econo-mizers Final & Interpass Towers

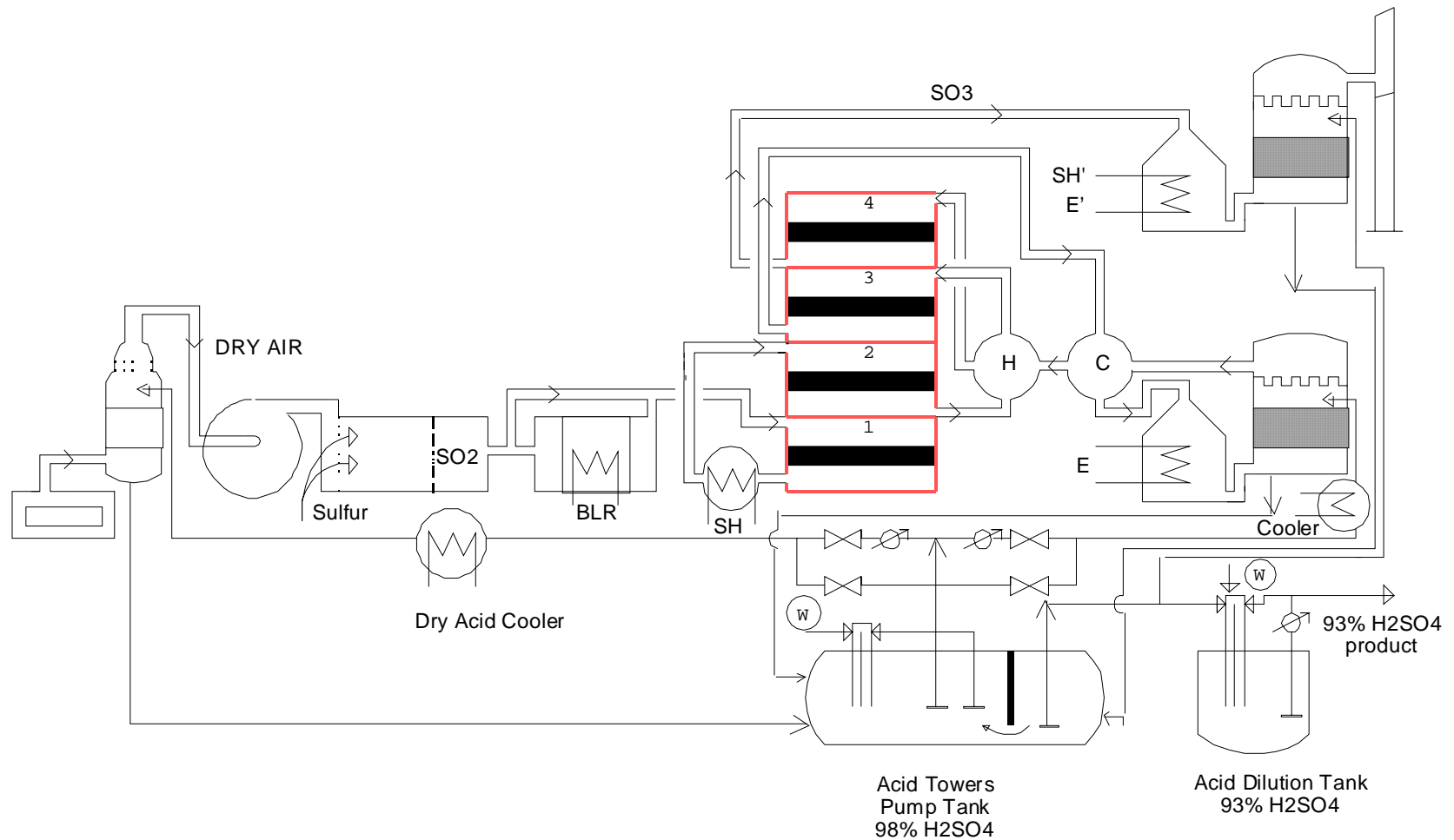

Validation of Contact Process Model

Table 4-14 The Comparison of Model Prediction and Plant Design Data for Converter I

	Design Data	Model Prediction
FSO_2 (In-Out), Kmol/sec	0.337 - 0.129	0.337 - 0.129
FSO_3 (In-Out), Kmol/sec	0.007 - 0.215	0.007 - 0.215
FO_2 (In-Out), Kmol/sec	0.280 - 0.176	0.280 - 0.176
FN_2 (In-Out), Kmol/sec	2.373 - 2.373	2.373 - 2.373
Conversion of SO_2	62.5%	62.5%
Temp. (S06 - S07), K	693.2 - 890.2	692.5 - 890.9
Effectiveness factor	-	0.241

Contact Process Economic Optimization

Economic Optimization

Value Added Profit Function

$$s_{F64}F_{64} + s_{FS8}F_{S8} + s_{FS14}F_{S14} - c_{F50}F_{50} - c_{FS1}F_{S1} - c_{F65}F_{65}$$

On-Line Optimization Results

Date	Current (\$/day)	Profit Optimal (\$/day)	Improvement
6-10-97	37,290	38,146	2.3% \$313,000/yr
6-12-97	36,988	38,111	3.1% \$410,000/yr

Contact Process Potential Improvement

On-Line Optimization

Increased profit by 3%(\$350,000/yr)

Reduction in sulfur dioxide emissions by 10%

Improved understanding of the process

Alkylation

Isoparaffin-olefin alkylation produces branched paraffins in the gasoline range

Refineries use C_3 C_4 and C_5 hydrocarbon streams

Sulfuric acid catalyst concentration maintained above 88% to prevent polymerization

Reactor temperatures in the range of 10-20 °C

Alkylation is a two-phase system

- low solubility of isobutane in the catalyst phase
- intimate contact of the reactant and the catalyst
- efficient mixing with fine subdivision

Motiva Alkylation Process

15,000 BPD STRATCO Effluent Refrigerated Alkylation Plant

STRATCO reactor contacts the reactants in a high velocity propeller stream and removes heat from the exothermic reaction

Process flow diagrams

prepared from P&ID's of the plant

reaction section

refrigeration, depropanizer and alkylate deisobutanizer sections

saturate deisobutanizer section

Reactor Section

Four reactors
and acid settlers

Three feed
streams

Olefin feed
(HC01)

Isobutane feed
(HC03)

Recycled
olefin/isobutane
(HC32)

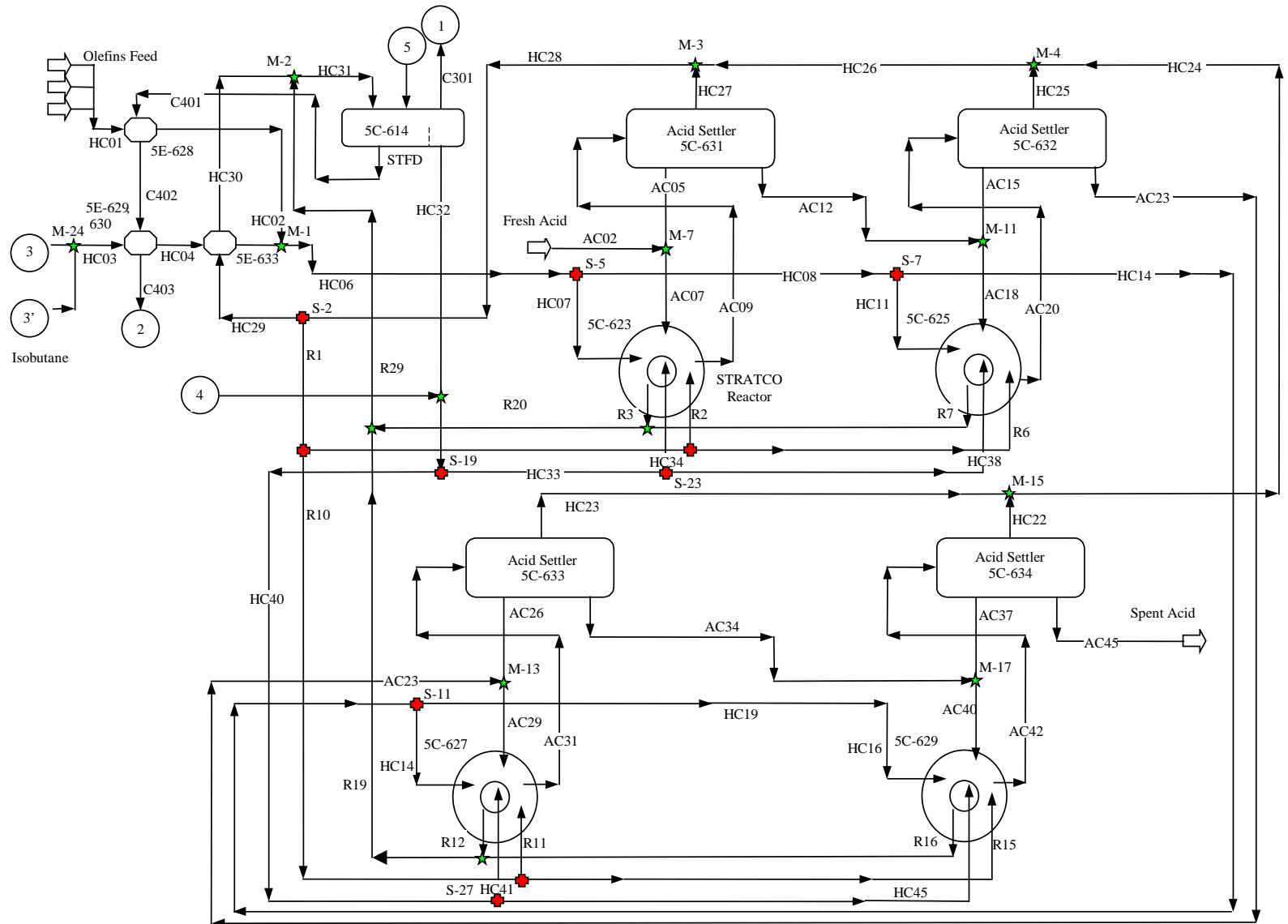

Model Summary

Table 5.1. Summary of the Alkylation Process Model

Feature	Quantity
Process Units	76
Process Streams	110
Equality Constraints	1579
Inequality Constraints	50
Measured Variables	125
Unmeasured Variables	1509
Parameters	64

Table 4.8. Plant vs. Model Data

Variable Name	Plant Data (y_i)	Reconciled Data from Data Validation (x_i)	Standard Measureme nt Error (ϵ_i)
FAC02	0.1125	0.1600	4.2235
FAC12	0.1259	0.1600	2.7085
FAC23	0.1253	0.1600	2.7653
FAC45	0.1040	0.1600	5.3846
FC308	2.1990	3.1032	4.1120
FC316	0.6581	1.8000	17.3515
FC322	0.4427	1.5619	25.2812
FC328	0.0942	0.0535	2.6399
FC403	3.8766	2.2834	4.1097
FC412	0.0324	0.0418	2.8968
FSC411	2.7287	1.3525	5.0436
FstmE612	0.1425	0.0889	3.7607
x1C417	0.0372	0.0255	3.1309
x2SC402	0.0136	0.0084	3.7929
x2SC408	0.0221	0.0002	9.9048
x3C325	0.0017	0.0000	10.0000
x3SC403	0.0103	0.0212	10.5665
x4C316	0.0580	0.0796	3.7155
x4SC408	0.0331	0.0088	7.3475
x5C316	0.0020	0.0060	19.8000
x5C417	0.0009	0.0295	286.2300
x5HC32	0.0096	0.0306	22.0134
x6SC402	0.0167	0.0666	29.8204
x6SC403	0.0250	0.0950	27.9946
x7HC32	0.0197	0.0497	15.2312
x7SC402	0.0022	0.0032	4.3956
x7SC408	0.0022	0.0000	10.0000
xx1C322	0.0027	0.1167	428.5338
xx1C414	0.0330	0.0800	14.2498
xx2HC01	0.4525	0.1291	7.1481
xx3C407	0.0003	0.0000	7.4194
xx3HC01	0.3558	0.0125	9.6498
xx4C407	0.1124	0.0853	2.4068
xx5C407	0.0803	0.1506	8.7555
xx5C412	0.0022	0.0581	255.6751
xx5C414	0.0021	0.0011	4.8325
xx7C414	0.0015	0.0080	44.4218

Model Validation

Establish accuracy of model to predict performance of plant

Used data validation

125 measured plant variables, 88 were within the accuracy of the measurements

Remaining 37 variables shown here with standard measurement error

$$\epsilon_i (\epsilon_i = |y_i - x_i| / \sigma_i)$$

Process engineers concluded that these 37 variables were within the range of possible process values

Model of the process accurately predicted its performance and can be used for on-line optimization.

Alkylation Process Economic Model

$$\text{Profit} = \text{Sales} - \text{Cost} - \text{Utilities}$$

$$\text{Sales} = \text{Alkylate (C}_3, \text{C}_4 \text{ and C}_4 \text{ Raffinate)} \\ \text{produced} * \text{Price of alkylate}$$

$$\text{Cost} = \sum \text{Input} * \text{Cost}$$

$$\text{Utilities} = \sum \text{Input} * \text{Utility Cost}$$

Raw Material/Utility Costs and Product Prices

Table 5.4. Alkylation Plant Raw Material/Utility Costs and Product Prices

Feed and Product	Stream Number	Cost and Price (\$/bbl)	
		Summer	Winter
Feeds			
Propylene	HC01	11.79	10.44
Butylene	HC01	18.00	16.56
Iso-butane	SC414	16.88	17.39
Products			
N-butane	SC405, C413	13.29	12.71
C ₃ Alkylate	C407	24.49	22.30
C ₄ Alkylate	C407	26.32	24.06
C ₄ Raffinate	C407	26.34	24.19
Alkylate			
Catalyst and Utilities		Cost	
H ₂ SO ₄ (Stream AC02)		\$110/Ton	
Electricity		\$0.04/KWH	
50# Steam		\$2.50/M-Lbs	
250# Steam		\$3.60/M-Lbs	
600# Steam		\$4.40/M-Lbs	

On-Line Optimization

Process Data from Distributed Control System

Plant measurement at 1.0 minute intervals over a two day period

Six steady state periods identified using time series with MathCAD graphics

Data Reconciliation and Gross Error Detection

Robust Lorentzian function method and CONOPT2

Optimal solution obtained in 1,200 iterations

Reconciled measurements reported and about 30 gross errors identified

Parameter Estimation and Data Reconciliation

Optimal solution obtained in 1,500 iterations

Small adjustments in values of parameters

On-Line Optimization Results Economic Optimization

Table 5.5. Calculated Profit after Data Validation (D.V.), Parameter Estimation (P.E.) and Economic Optimization (E.O.) Steps for six Different Operation Points (Steady States)

Operation points	D.V.	P.E.	E.O	% Increase
#1	11.9	12.1	29.1	144
#2	7.4	7.4	21.4	189
#3	21.4	22.1	26.9	26
#4	7.0	7.0	22.1	216
#5	10.1	23.3	26.3	160
#6	22.0	23.6	27.6	25
			Average % increase	127

Improvement in profit

8.5% reduction in costs and 2.2% increase in sales

5.5% more olefin charge

98% reduction in isobutane purchase cost (because of reduced isobutane flow rate)

7.2% reduction in saturate feed to the Saturate Deisobutanizer column

2.2% increase in the alkylate (alkylate quality did not change at optimal operation)

Average of 9.4×10^9 BTU/yr in energy savings from steam usage in the distillation columns

Reactor Analysis

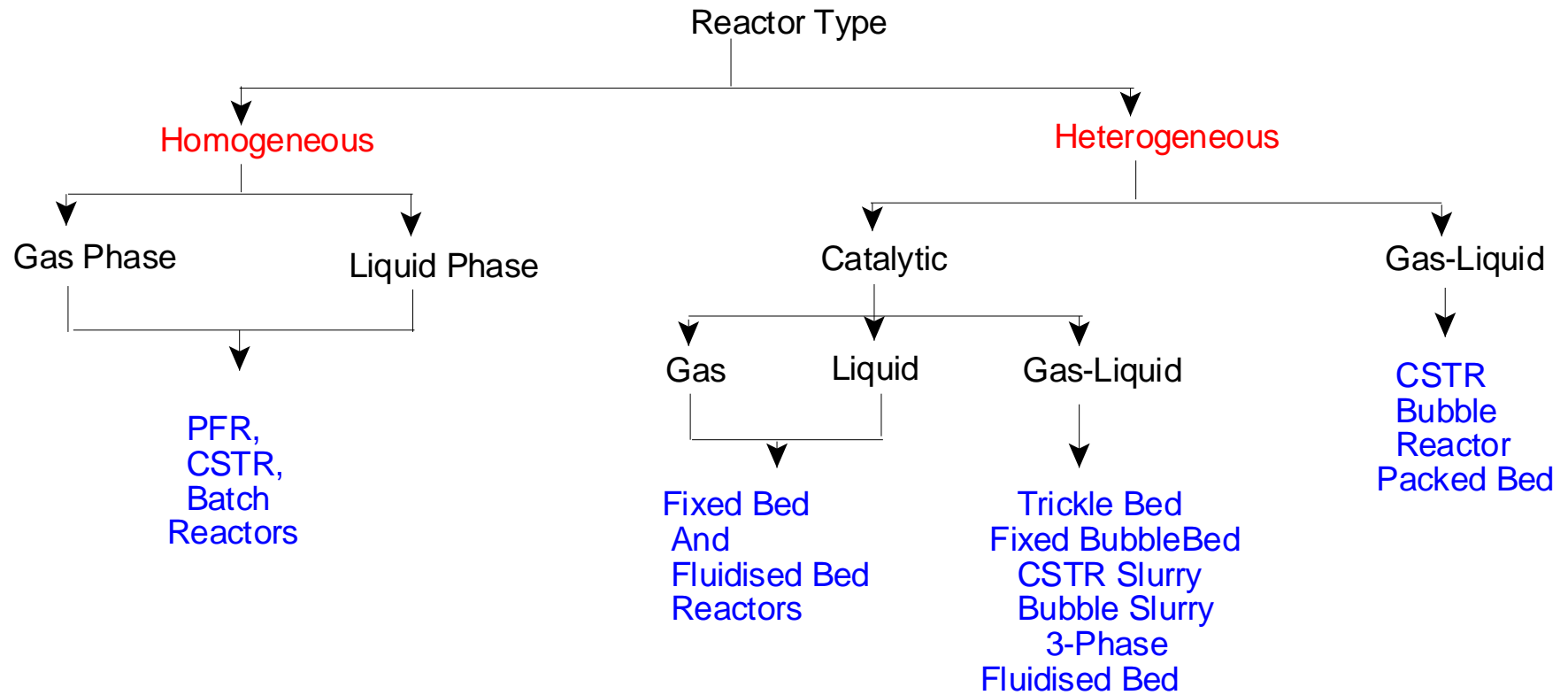

Contact Process Chemical Reactor Improvement

Chemical Reactor Analysis

Conversion could be increased by 19% in the first reactor.

Reactor volumes could be reduced by 87% by using a reactor pressure of 10.3 atms rather than current operations at 1.3 atms.

Energy Integration – Pinch Analysis

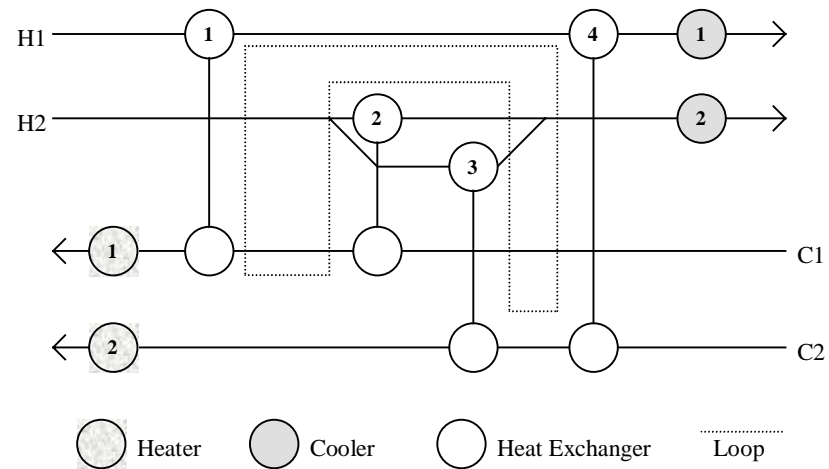
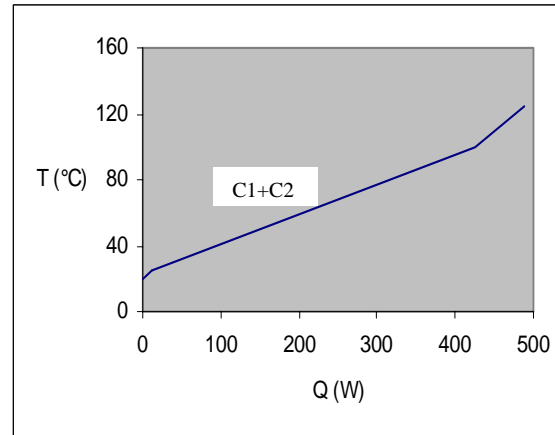
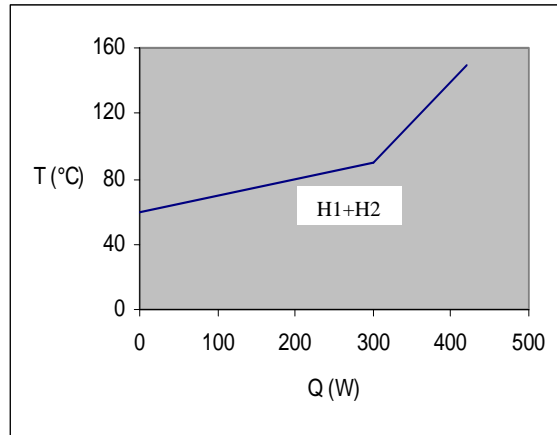

Contact Process Pinch Analysis

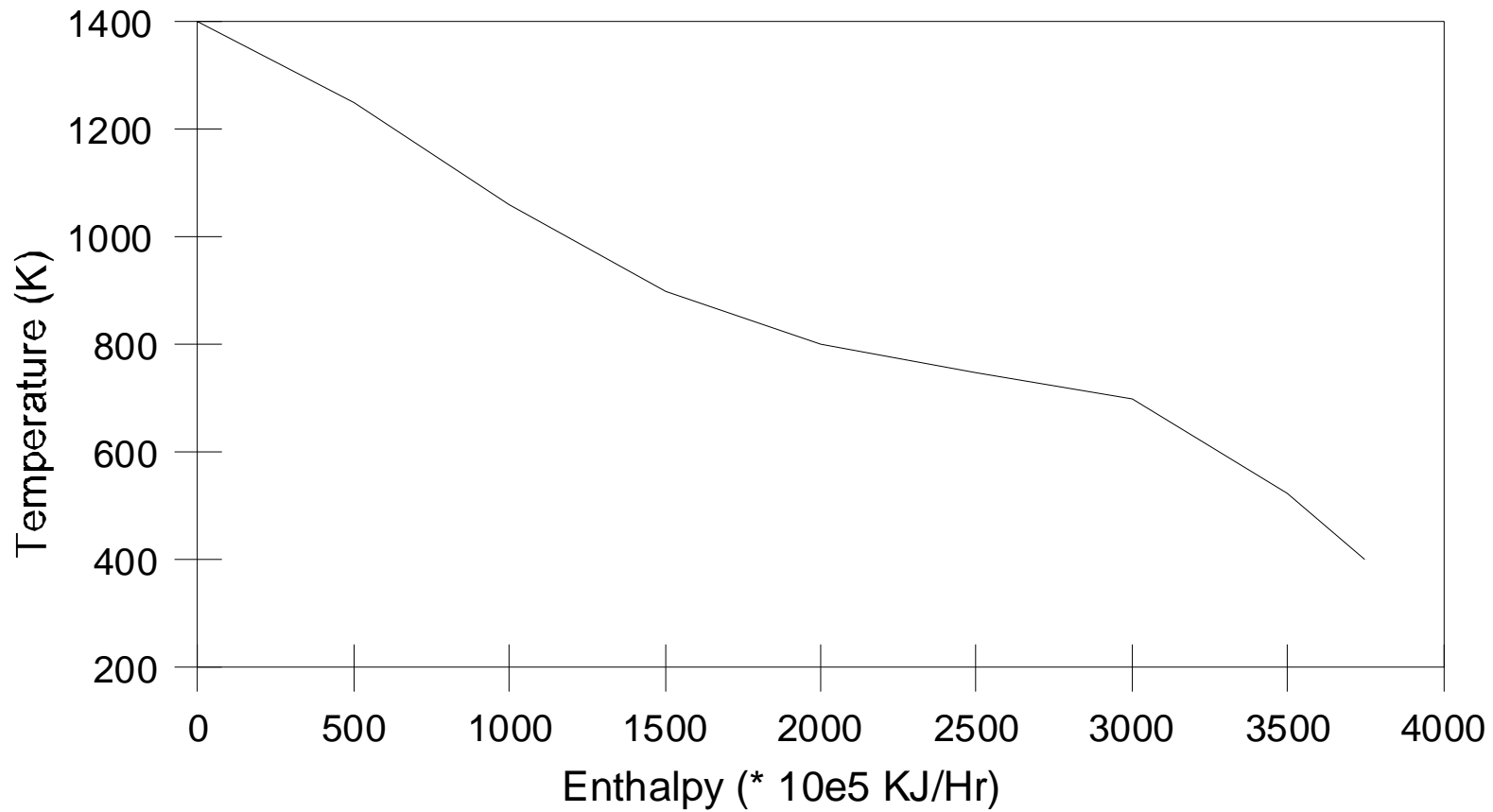

Fig. 5 Grand Composite Curve for the Contact Process

Contact Process Pinch Analysis

Process is below the pinch, and no hot utilities are required.

A proposed heat exchanger network has 25% less area than the current one.

Energy Integration – Pinch Analysis

Alkylation process is very energy intensive

Alkylation process model has 28 heat exchangers, plus four contactors. Heat exchange in contactors not included in the pinch analysis

Grand Composite Curve

End points of the curve gives the minimum values of external heating and cooling required by the process

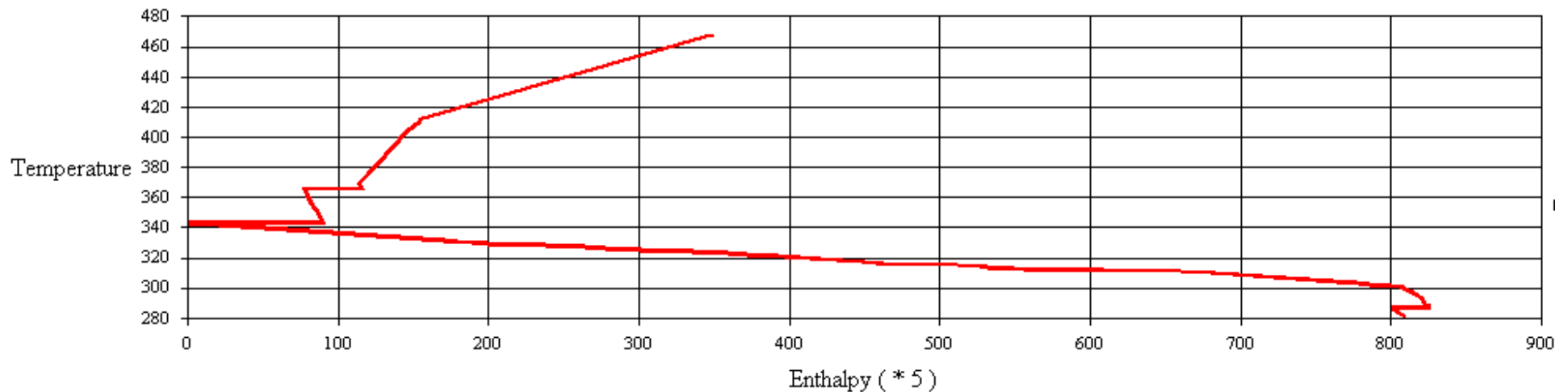

Pinch Analysis – Maximum Energy Recovery Network Diagram

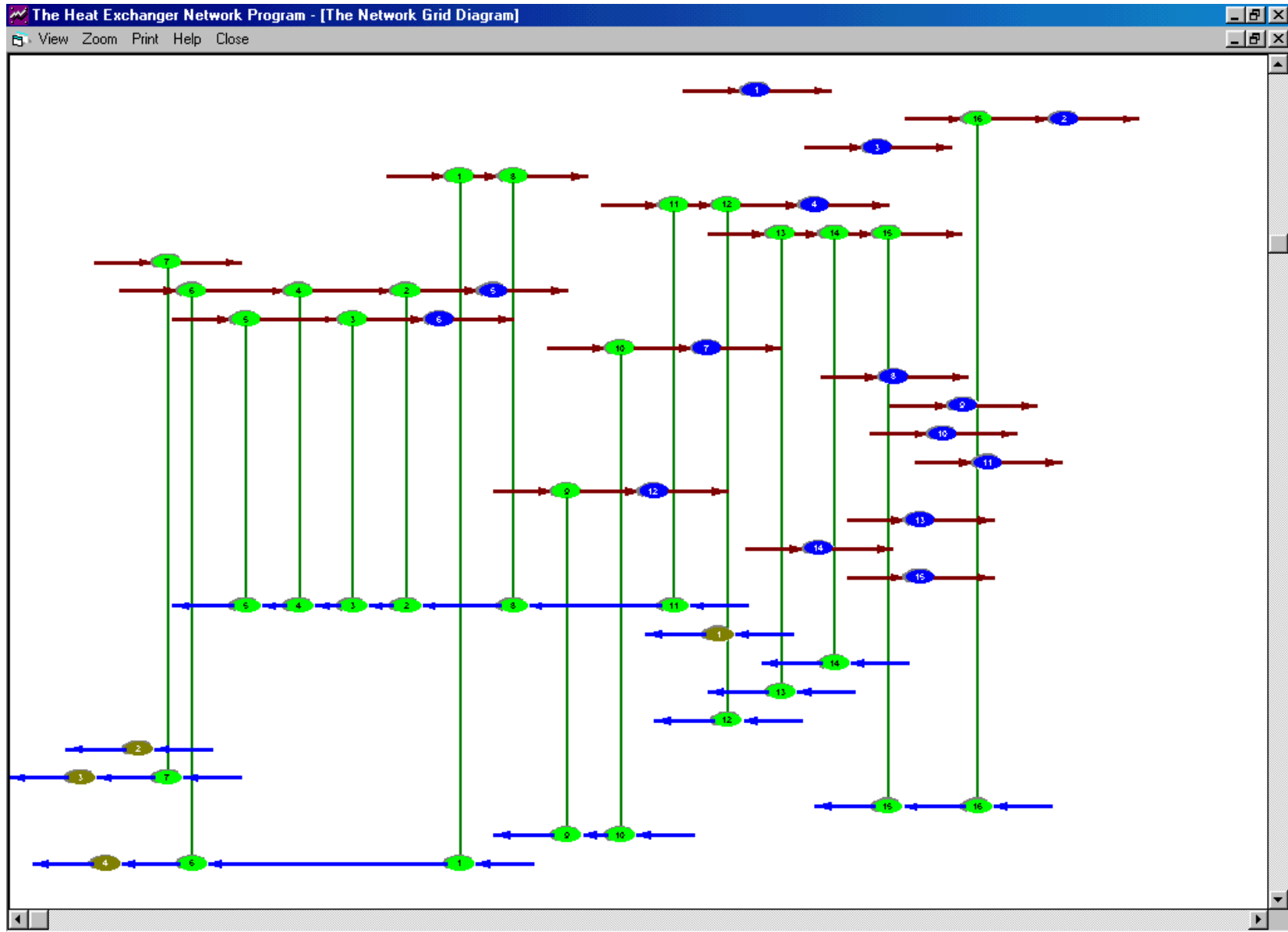

Pinch Analysis – Minimum Utilities

Minimum Utilities

1742 MJ/min steam (external heat)

4043 MJ/min of cooling water (external cooling)

Current Operations

1907 MJ/min steam (external heat)

4300 MJ/min of cooling water (external cooling)

Pinch Analysis – Optimum Heat Exchanger Configuration

Current Configuration

6 heat exchangers, 4 heaters and 12 coolers

Optimal Configuration

16 heat exchangers, 4 heaters and 15 coolers

Additional heat exchangers reduce energy requirements

May result in operational difficulties

See report for pressure shift applied to distillation columns

Pollution Assessment

Assess the pollutants generated in the process

Determine location of generation

Modify process for waste minimization

Contact Process Pollution Assessment

Process units identified for modification to reduce sulfur dioxide emissions were the sulfur furnace and the four packed bed reactors

Pollution Assessment

Waste Reduction Algorithm (WAR) and
Environmental Impact Theory

Pollution Index

$$I = \text{wastes/products} = - (\Sigma \text{Out} + \Sigma \text{Fugitive}) / \Sigma P_n$$

Potential Environmental Impact

$$\Psi_k = \sum_l \alpha_l \Psi_{k,l}^s$$

α_l relative weighting factor

$\Psi_{k,l}^s$ units of potential environmental impact/mass of chemical k

$\Psi_{k,l}^s$ Values used in Alkylation Process Model

Component	Ecotoxicity (aquatic)	Ecotoxicity (terrestrial)	Human Toxicity (air)	Human Toxicity (water)	Human Toxicity (soil)	Photochemical Oxidant Formation
C₃-	0.0305	0	9.06E-7	0	0	1.1764
C₄=	0.0412	0.3012	0	0.3012	0.3012	1.6460
iC₄	0.1566	0.2908	8.58E-7	0.2908	0.2908	0.6473
nC₄	0.1890	0.2908	8.58E-7	0.2908	0.2908	0.8425
iC₅	0.0649	0.2342	0	0.2342	0.2342	0.6082
nC₅	0.3422	0.2342	5.53E-7	0.2342	0.2342	0.8384
iC₆	0.2827	0.1611	0	0.1611	0.1611	1.022
H₂SO₄	0.0170	0.1640	0.2950	0.1640	0.1640	0

Source EPA National Laboratory for Sustainable Development

Pollution Assessment

Table 5.6. Input and Output Streams in Alkylation Process.

Stream	Description	Type	Pollution Index
AC02	Fresh Acid Feed	Input	0.808
HC01	Olefin Feed	Input	1.622
SC414	Make-up Isobutane	Input	1.611
SC401	Sat-Deisobutanizer Feed	Input	1.789
AC45	Spent Acid	Non-Product	1.034
C320	To LPG Storage	Product	0
C328	To Fuel Gas	Product	0
C407	To Alkylate Storage	Product	0
C413	To N-butane Storage	Product	0
SC405	To N-butane Storage	Product	0

Pollution Assessment before and after Economic Optimization

Program calculates pollution indices for each input, produce and non-product stream in the process

These values are used to calculate the six pollution indices for the process

Negative values mean that the input streams are actually more harmful to the environment than the non-products if they are not processed through the alkylation process

Table 5.7. Pollution Assessment Values (BEO) and after (AEO)

Index Type	Value		
	(BEO)	(AEO)	
Total rate of impact generation	-4.9120	-4.7966	impact/time
Specific impact generation	-3.2860	-3.4584	impact/product
Pollution generation per unit product	-0.9777	-0.9742	mass of pollutant/mass of product
Total rate of impact emission	1.0325	1.0337	impact/time
Specific impact emission	0.6897	0.7453	impact/product
Pollutant emission per unit product	0.1069	0.1154	mass of pollutant/mass of product

Conclusions – Flowsheeting

Demonstrated Capability of Advanced Process Analysis System

- process flowsheeting
- on-line optimization
- pinch analysis
- pollution assessment
- chemical reaction analysis determined best alkylation reaction kinetics

Process Flowsheeting

76 process units, 110 process streams

1,579 equality, 50 inequality constraints, 1,634 variables

Simulation validated using plant data and data reconciliation

Simulation predicted the performance of the plant within the accuracy of the data

Conclusions – Economic Optimization

Evaluated six operating points

25% to 215% increase in the profit

Increase of 145% included

- 8.5% reduction in costs and 2.2% increase in sales

- 5.5% more olefin charge

- 98% reduction in isobutane purchase cost

- 7.2% reduction in feed to the Sat Deisobutanizer

- 2.2% increase in the alkylate

- 2.2% reduction in the sulfuric acid consumption.

- 1.0% reduction in energy to 1888 MJ/min

Conclusions – Pinch Analysis and Pollution Assessment

Pinch Analysis

7.7% reduction in steam to 67×10^9 BTU/yr

6.0% reduction in cooling water to 106×10^9 BTU/yr

Pollution Assessment

Demonstrated ability to locate and estimate the severity pollutant emissions from the process.

Conclusions - Summary

Development and validation of process simulation
most difficult and time consuming part
of applying the System

Applicable to small plants

Typical improvements

5% for on-line optimization

5 –35% for pinch analysis

Detailed understanding of process

- most valuable result

- difficult to measure value

Program and users manual downloaded from

'www.mpri.lsu.edu - no charge

Studies on the Purification of nonwater Media by ceramic membranes

Kagramanov Gueorgui G., Choupis
Roman A.

D.I.Mendeleyev University of Chemical Technology of Russia
125047, Miuskaya Sq.9, Moscow, Russia
E-mail: sark@muctr.edu.ru ; kadri@muctr.edu.ru
tel/fax: 7-095-978-82-60; 7-095-200-42-04

- **Production and applications of the ceramic membranes (CM), modules and units, based on these membranes, demonstrate the stable rise in Russia. Due to the unique properties of the CM- chemical, microbiological and thermal stability, mechanical strength, possibility of regeneration by rigorous media (acids, alkali solutions) and back-washing, long life-time etc.- they are being employed in many branches of industry and life.**
- **These advantages of CM, compared with polymeric membranes (PM)- showed the way of their successful application– to replace the PM in the filtration systems in food, microbiological, pharmaceutical branches of industry, potable water treatment systems etc., as well as in processes with rigorous technological parameters, using aggressive, abrasive and highly-viscous media, high temperatures, i.e. in production of ‘clean products’ by ‘clean processes’.**

- The great majority of the commercialized technologies using CM deal with water media-filtration of various biomasses in production of vitamins, antibiotics, lysine, purification of enzymes, treatment of milk and corresponding milk products, syrups and wines, purification of potable, mineral and waste waters etc.
- The filtration processes and technologies dealing with nonwater systems, such as various industrial and vegetable oils, different kind of fuels (gasoline, Diesel) are developing, but not commercialized yet.

- **The application of CM in these, environmentally friendly, processes seems very promising and prospective, permitting:**
- **to regenerate and recycle industrial and motor oils, preventing pollution;**
- **to develop new technologies of natural (mostly vegetable) oils' purification instead of traditional processes, demanding high values of energy consumption and producing various kinds of wastes;**
- **to purify various types of fuels, especially Diesel one, from mechanical and colloidal particles, including raisins and sulfur compounds, in order to rise the engines degree of combustion and decreasing pollution.**

Table 1. Characteristics of MF ceramic membranes made of α -Al₂O₃ (substrate) and coated by α -Al₂O₃ or ZrO₂. Length 800-900 mm, Porosity: substrate 40-45 %, selective layer 40%.

Numbers of channels	Geometry of membrane elements		Pores diameter, mcm		Distilled water permeability, m ³ /(m ² *h*bar)
	Diameter, mm	Channel diameter, mm	Substrate	Selective layer	
1	8*6	6	3-5	0.8-1.0 0.2-0.4	4.8-5.6 2.0-2.2
1	10*6	6	4-6	1.0-1.5 0.2-0.4	4.8-6.2 1.8-2.0
7	22	4	5-10	1.0-1.5 0.2-0.4	4.4-5.4 1.8-2.0
19	29 (spanner)	3.8	10-15	1.5-2.0 0.2-0.4	4.4-5.0 1.6-1.8

Length 800-900 mm, Porosity: substrate 40-45 %, selective layer 40%.

Table 2: Characteristics of UF ceramic membranes with α -Al₂O₃ supports. Pressure difference 1 bar.

Selective layers material	Mean pores diameter, nm	Permeability coefficient, $\text{m}^3/(\text{m}^2 \cdot \text{h} \cdot \text{bar}) \cdot 10^3$			Selectivity, %	
		Distilled water	SiO ₂ sol	PVP, M=40000 g/mol	SiO ₂ sol	PVP, M=40000 g/mol
SiO ₂	70	145	40	58	98.0	98.9
	15	100	25	47	99.2	99.3
	3	50	12	32	99.9	99.6
ZrO ₂	70	400	50	110	98.9	66.0
	30	250	30	78	99.1	81.5
	15	150	15	60	99.1	83.6
TiO ₂	70	610	57	90	97.5	72.5
	25	320	35	65	99.3	83.2
	7	55	15	35	99.4	89.9

The solution tested (table 2) were:

*SiO₂ sol with solid phase particles of 30 nm diameter, concentration of SiO₂- 5% weight
Water solution of PVP (1% weight) with molecular mass of 111-360000*

The corresponding experimental parameters and data of filtration processes using CM, (some characteristics of CM used in experiments are presented in tables 1 and 2) in laboratory and pilot scales are presented and discussed.

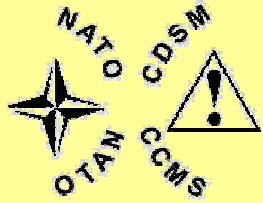

***NATO/CCMS Pilot Study on Clean
Products and Processes***



***ALTERNATIVES FOR THE SEPARATION
OF ORGANIC ACIDS AS EXAMPLES OF
PROCESS INTENSIFICATION***

José Coca Prados

Department of Chemical & Environmental Engineering

University of Oviedo

6th Meeting, Cetraro, Italy, May 14, 2003

Outline

- ↪ Introduction
- ↪ Reactive L-L extraction
- ↪ Freeze concentration
- ↪ Electrodialysis



NATO/CCMS Pilot Study on Clean Products and Processes

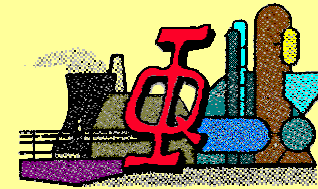

INTRODUCTION

Strategies for process development

Process integration: optimize energy resources

- ✓ Heat exchangers (Pinch analysis)
- ✓ Mass transfer networks

Process intensification

- ✓ Equipment
- ✓ Processes



NATO/CCMS Pilot Study on Clean Products and Processes

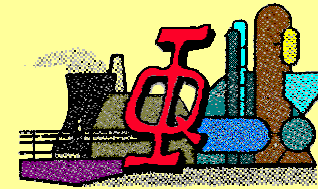

ORGANIC ACIDS

Organic acids

- ↪ Additives in food industry, chemical feedstocks
- ↪ Competition between microbiological and chemical processes
- ↪ Low concentration when electrochemical or biochemical routes are used
- ↪ Recovery from fermentation broth: precipitation as Ca^{2+} salts and treatment with sulfuric acid

Lactic acid as example of organic acid

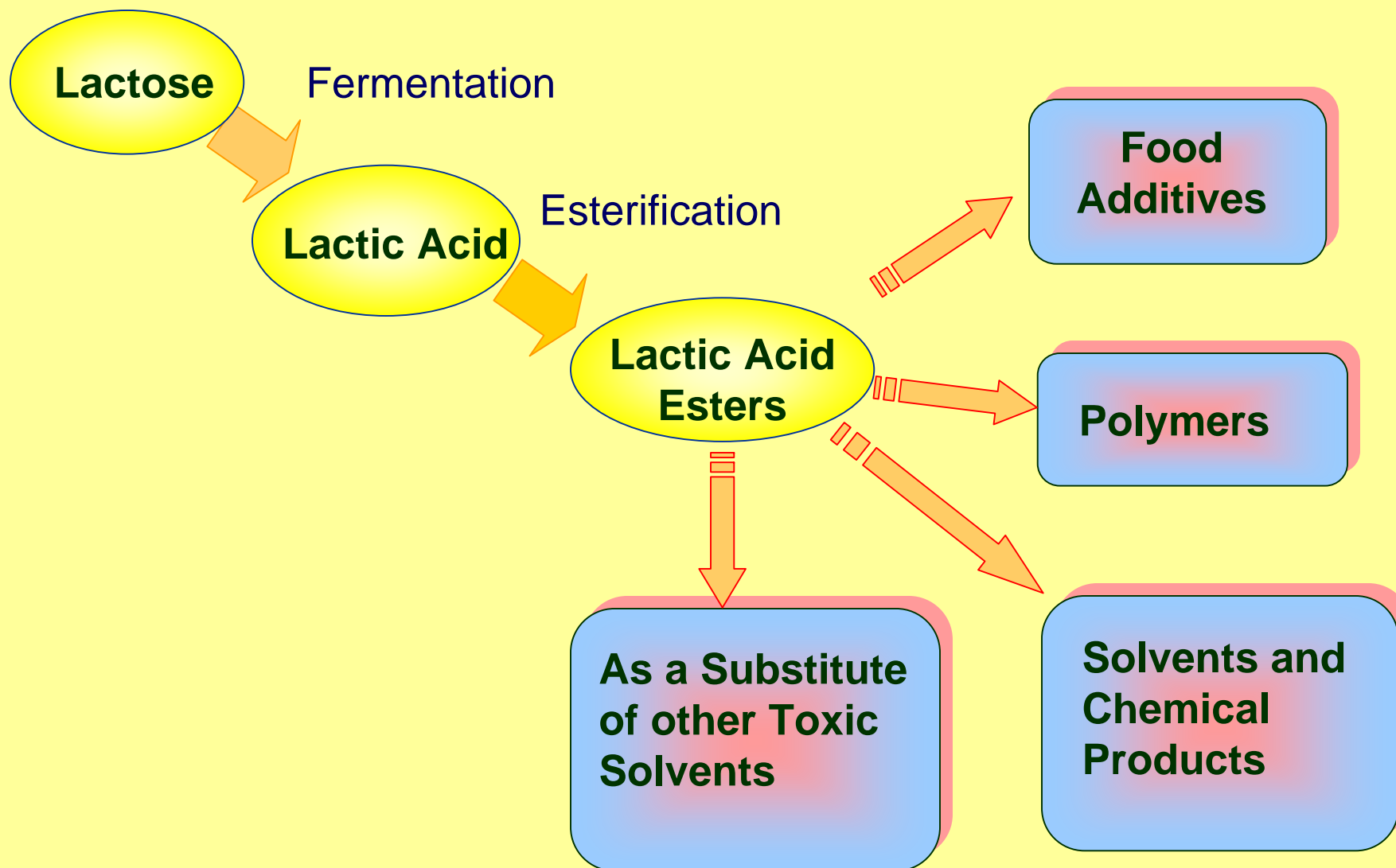



NATO/CCMS Pilot Study on Clean Products and Processes

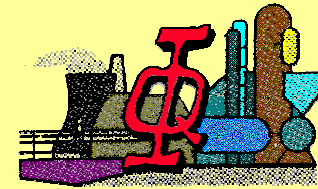

REACTIVE LIQUID LIQUID EXTRACTION

Reactive liquid-liquid extraction (RLLE)

- **Physical interaction solvent-feed:**
 - solvent easily regenerated
 - low separation selectivity
- **Chemical interaction solvent-feed:**
 - difficult regeneration → reversibility
 - high selectivity
- **Liquid-liquid extraction is suitable for:**
 - Systems with low volatility
 - Removal of low volatility components from water
 - Removal of low-volatility polar compounds from organics
 - Recovery of thermally sensitive components

Process intensification of RLLE

- Extractant impregnated resin (EIR) technique:
 - *Advantages of solid adsorbent and a reactive extractant*
 - *Fixed or a fluidized bed*
- Extractive ultrafiltration (EU)
- Pertraction

Extractive ultrafiltration

Conventional Extraction

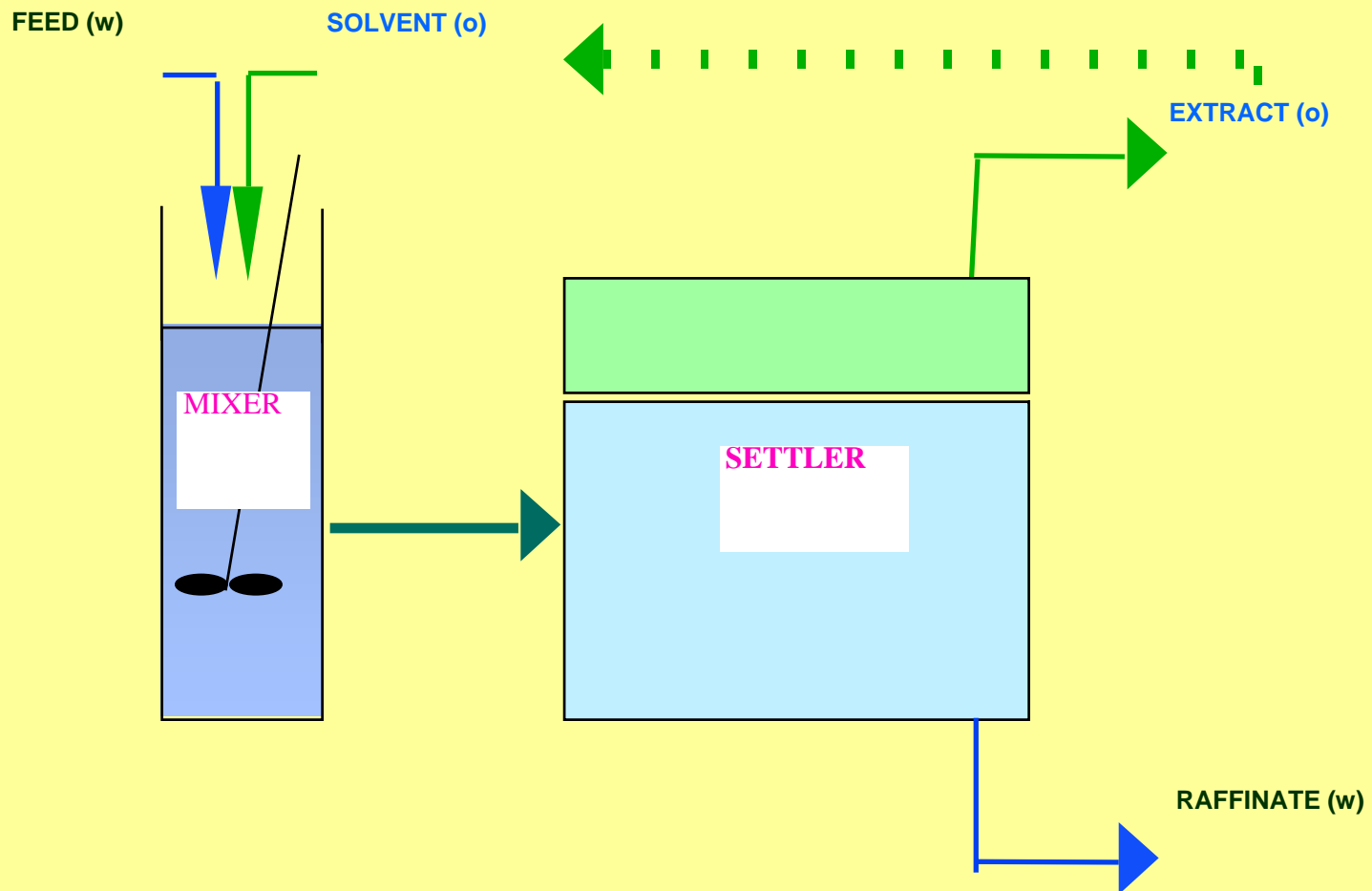

Extractive ultrafiltration

Extractive Ultrafiltration

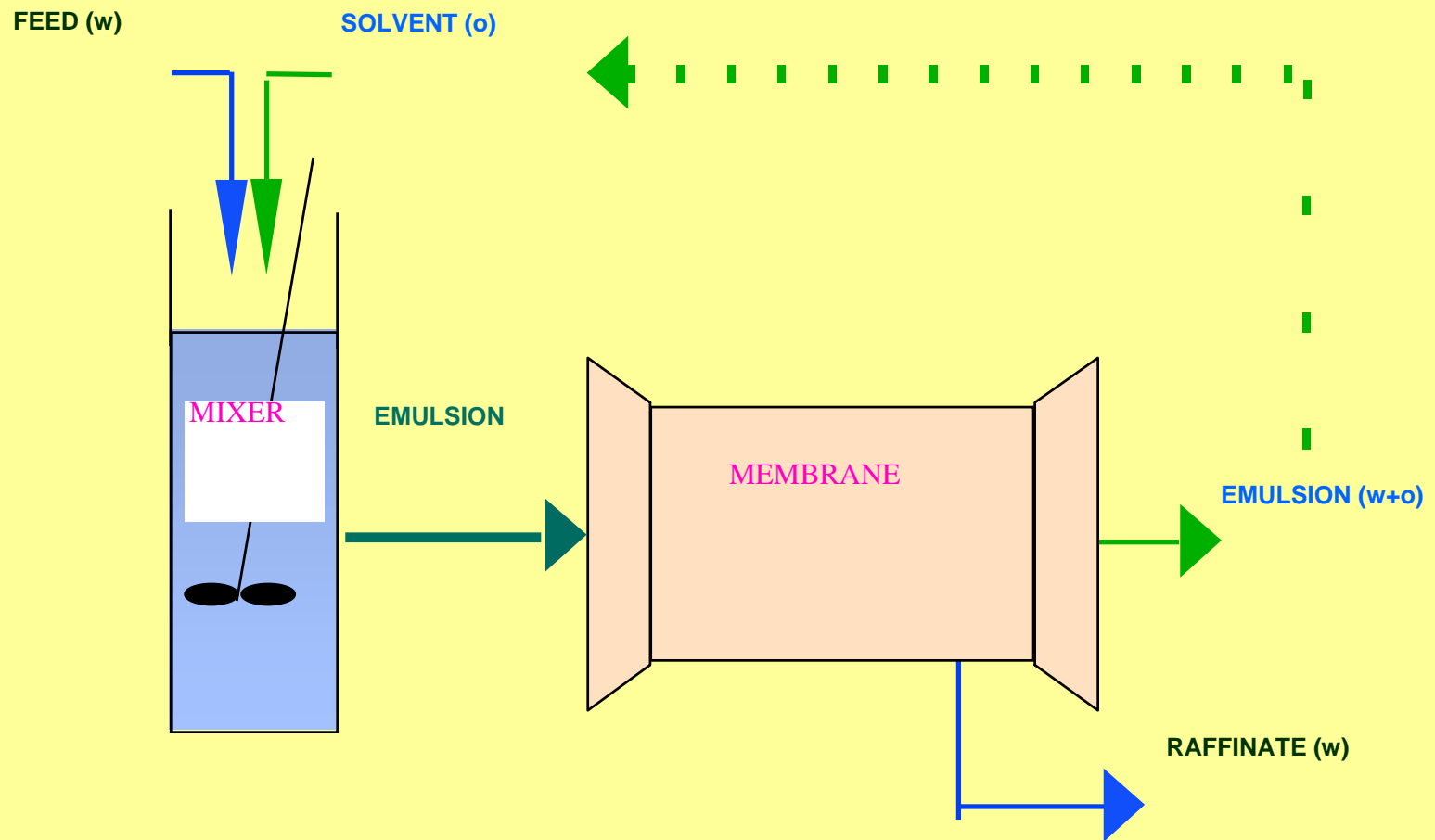

Extractive ultrafiltration

Experimental set-up

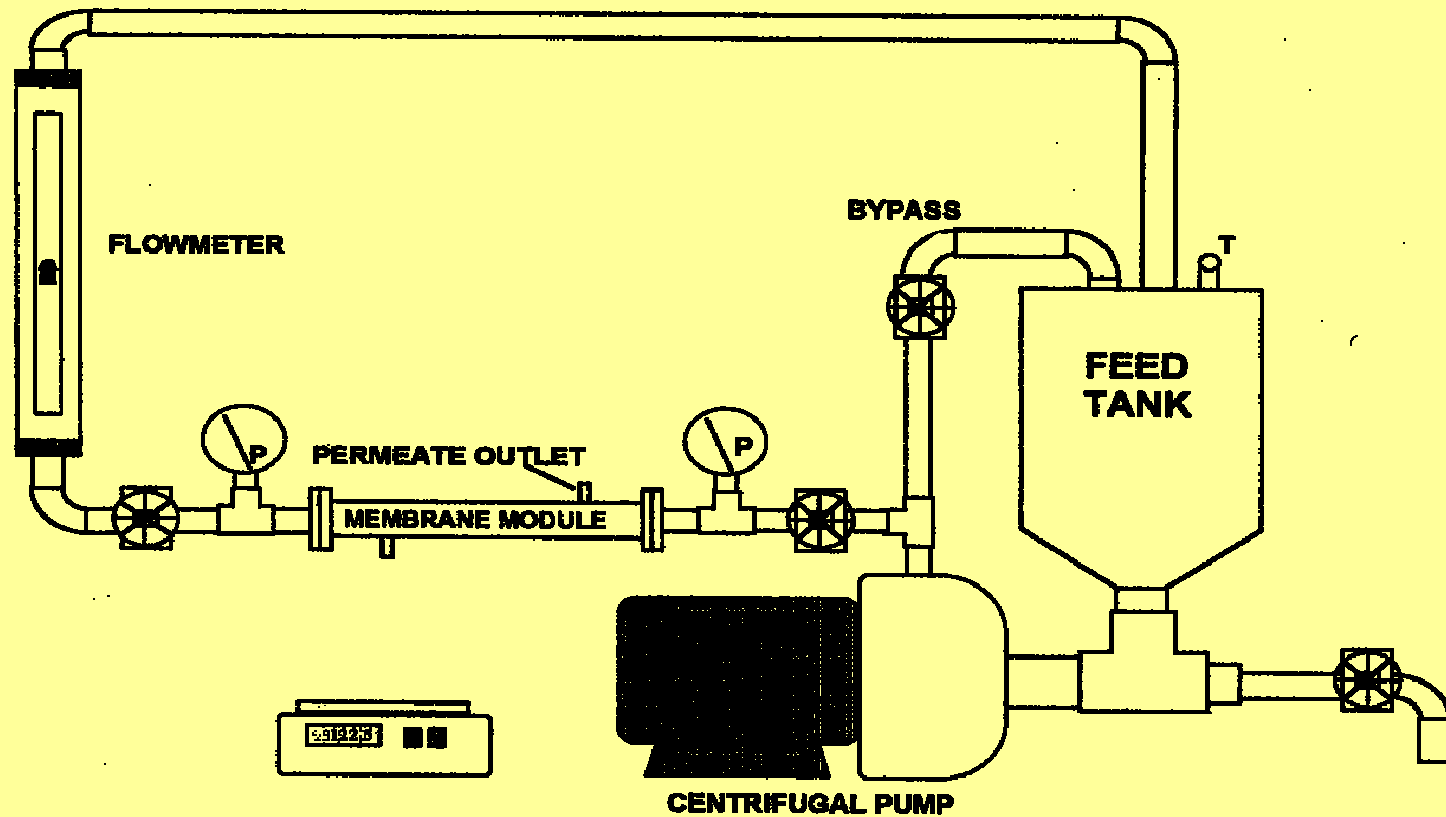

Valeric acid recovery by pertraction

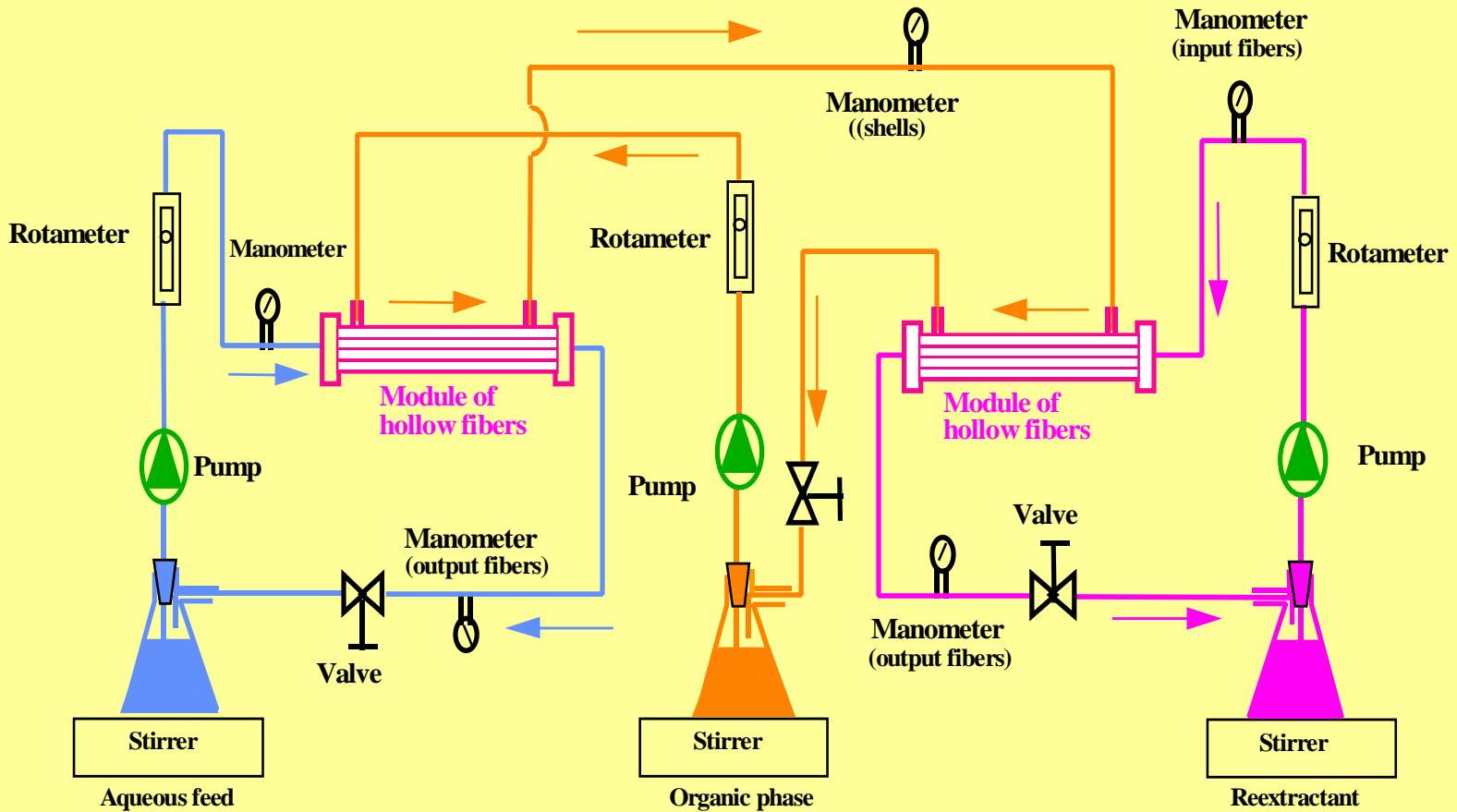



NATO/CCMS Pilot Study on Clean Products and Processes

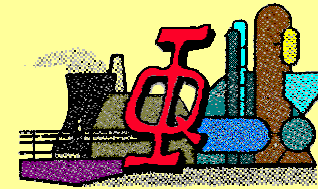

FREEZE CONCENTRATION

Freeze concentration

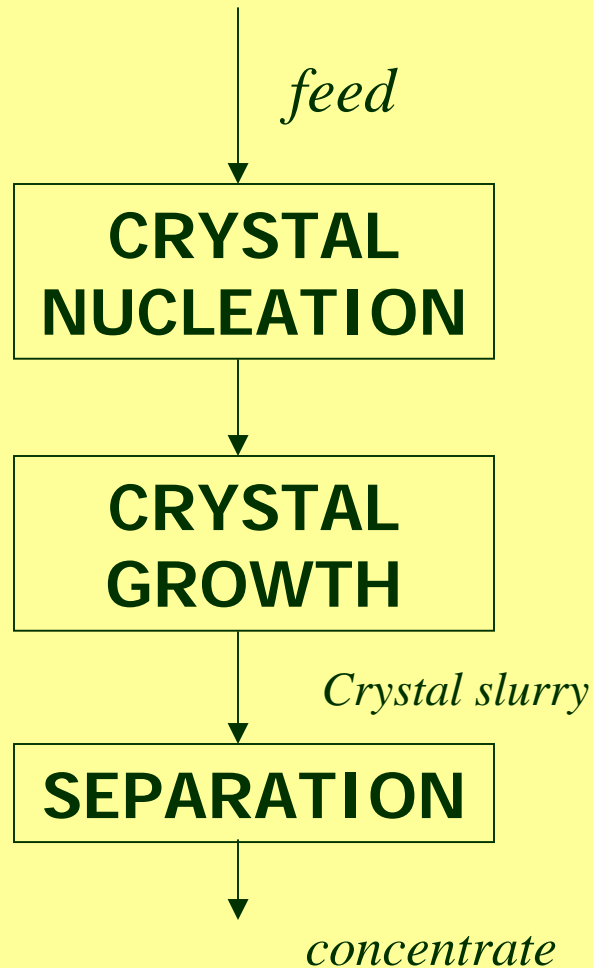

- Degree of concentration = f (amount of ice frozen in product stream)
- Mass-balance:

$$w_i = 1 - \frac{C_f}{C_i}$$

Freeze concentration

- Advantages:
 - *Low energy consumption*
 - *No scaling and fouling*
 - *Concentration of thermally sensitive products*
 - *Low corrosion*
- Disadvantages:
 - *Limited concentration can be attained. 40-55 %*
 - *Higher capital and operating costs*
 - *Loss of product during ice separation*

Freeze concentration equipment

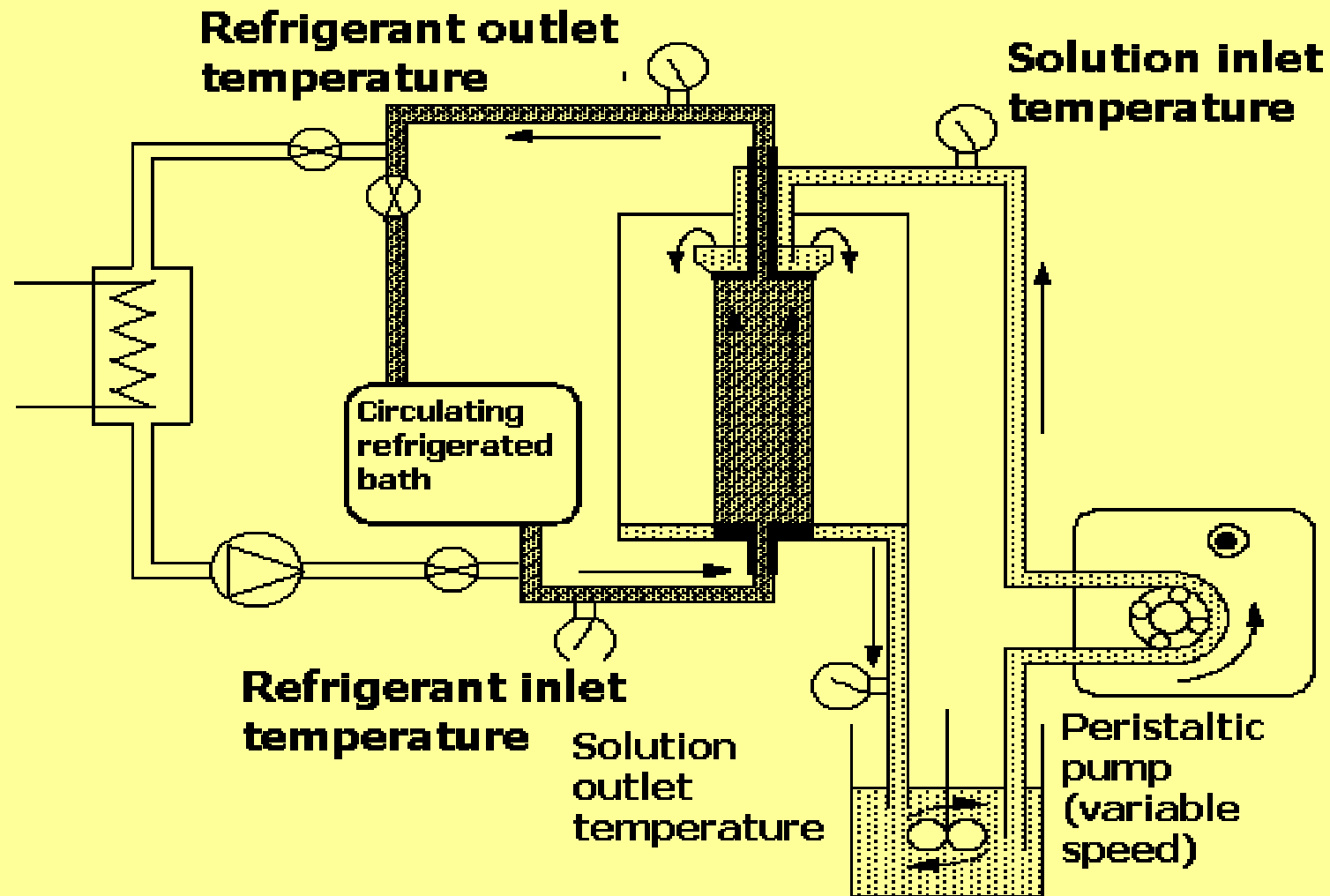

Reverse Osmosis-Freeze concentration for the Removal of Valeric Acid

Selection of alternatives

- EFFLUENT CHARACTERISTICS

- Valeric acid concentration: 6000 ppm
30000 kg/h

- Other compounds present:

- other carboxylic acids < 200 ppm

- degradation products

- toluene 50 ppm

- ALTERNATIVES

- Reverse osmosis

- Freeze concentration

- Extraction (Physical and/or reactive)

- Extractive ultrafiltration

- Adsorption

Reverse Osmosis-Freeze concentration for the Removal of Valeric Acid: Economic Analysis

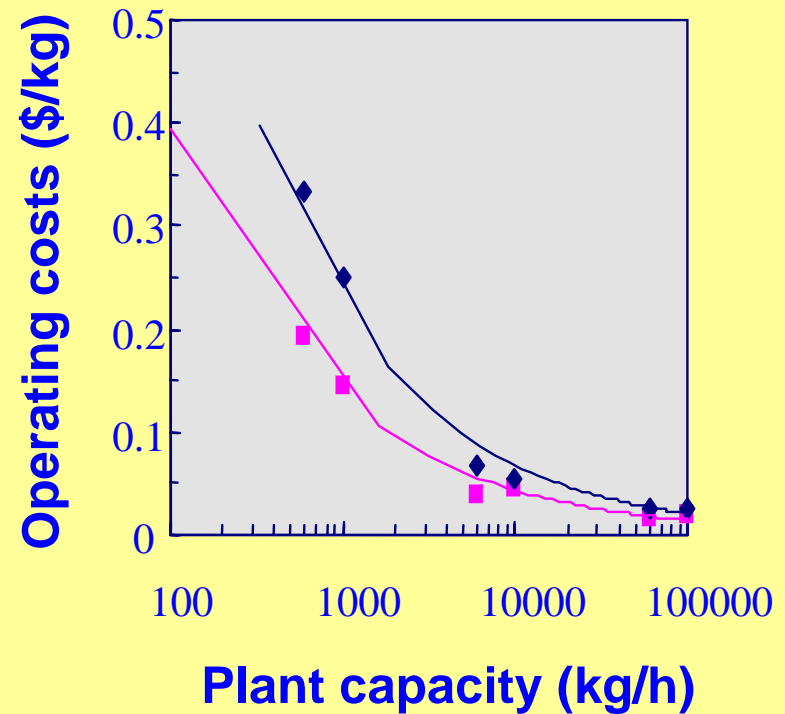
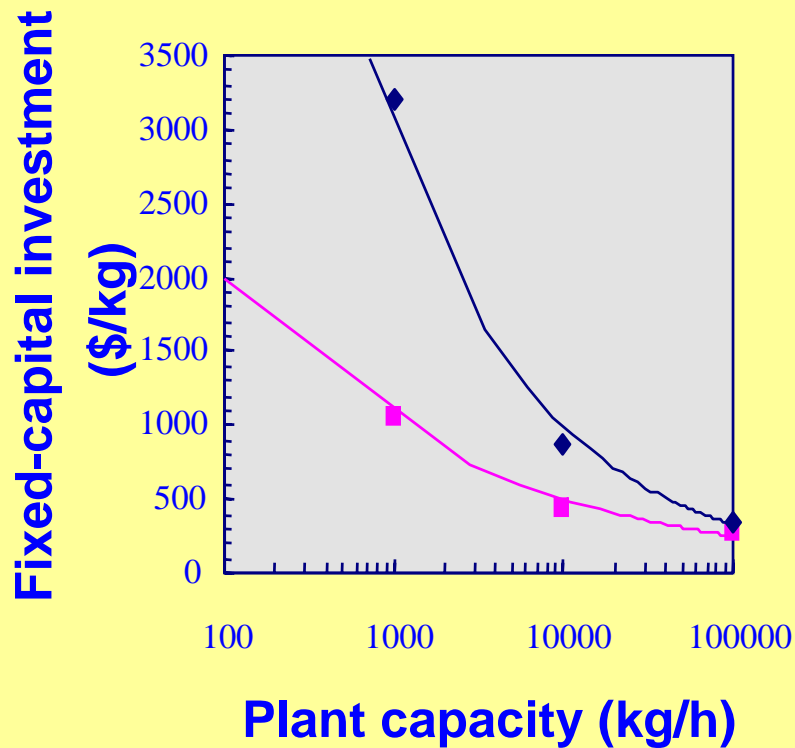

■ RO ◆ FC



NATO/CCMS Pilot Study on Clean Products and Processes

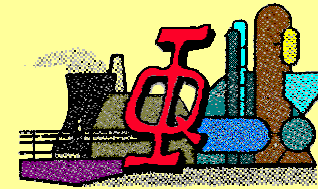

ELECTRODYALYSIS

Electrodialysis

- Reduction of the ionic content of a solution by:
 - *Potencial difference*
 - *Ion-exchange membranes*

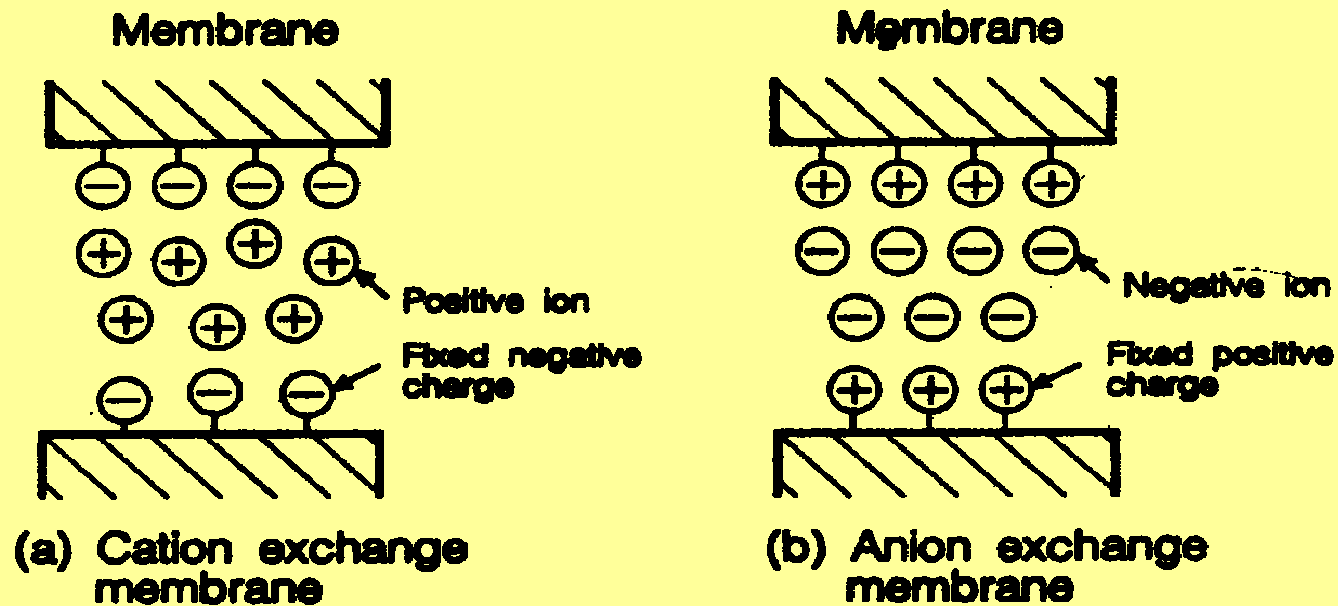

Electrodialysis cell

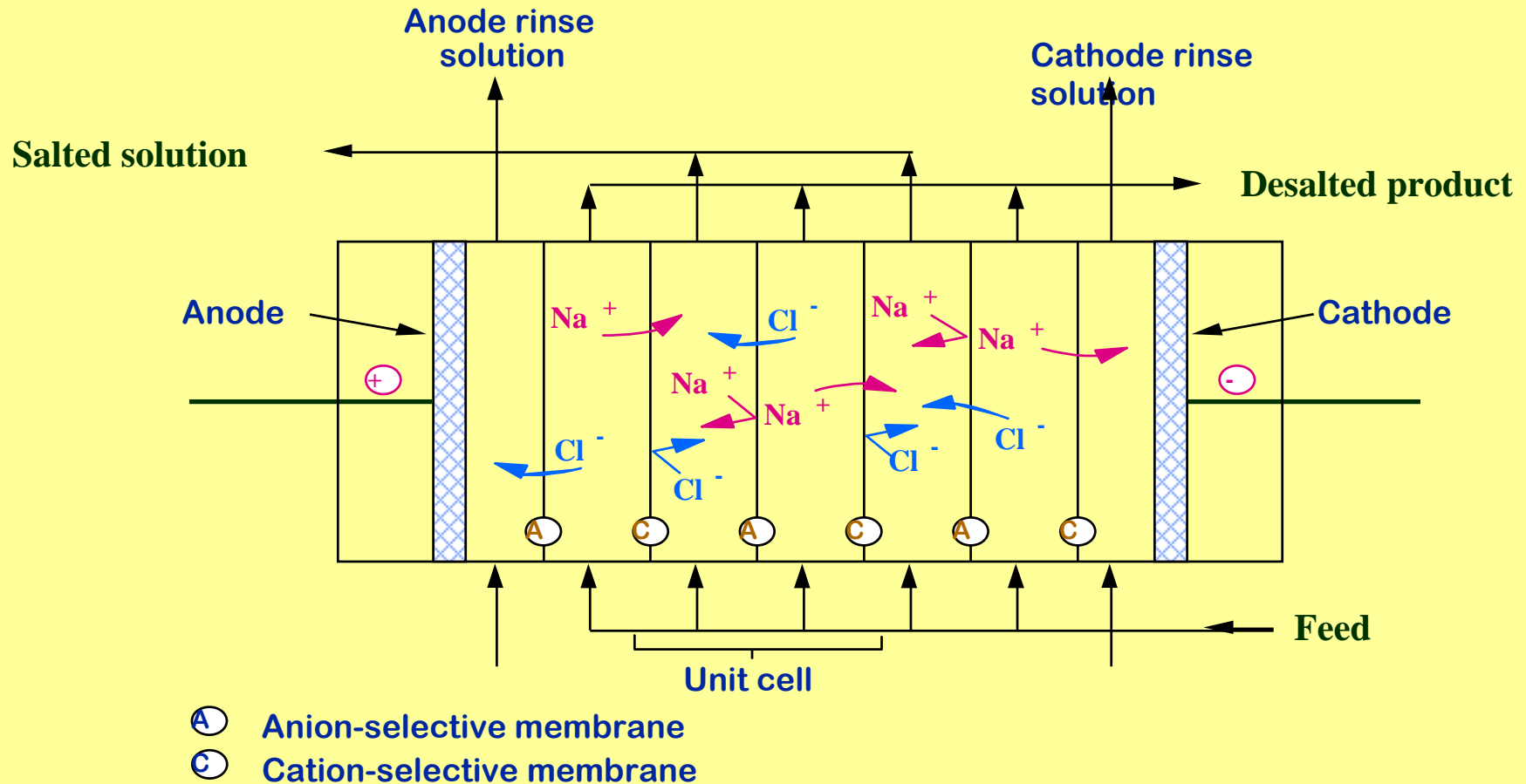

Applications of electrodyalisis

- **Production of potable water from brackish water**
- **Treatment of industrial effluents**
- **Demineralization of certain products**
 - Chemical
 - Food
 - Pharmaceutical industry

Electrolysis with bipolar membranes

- Water splits into H^+ and OH^- ions

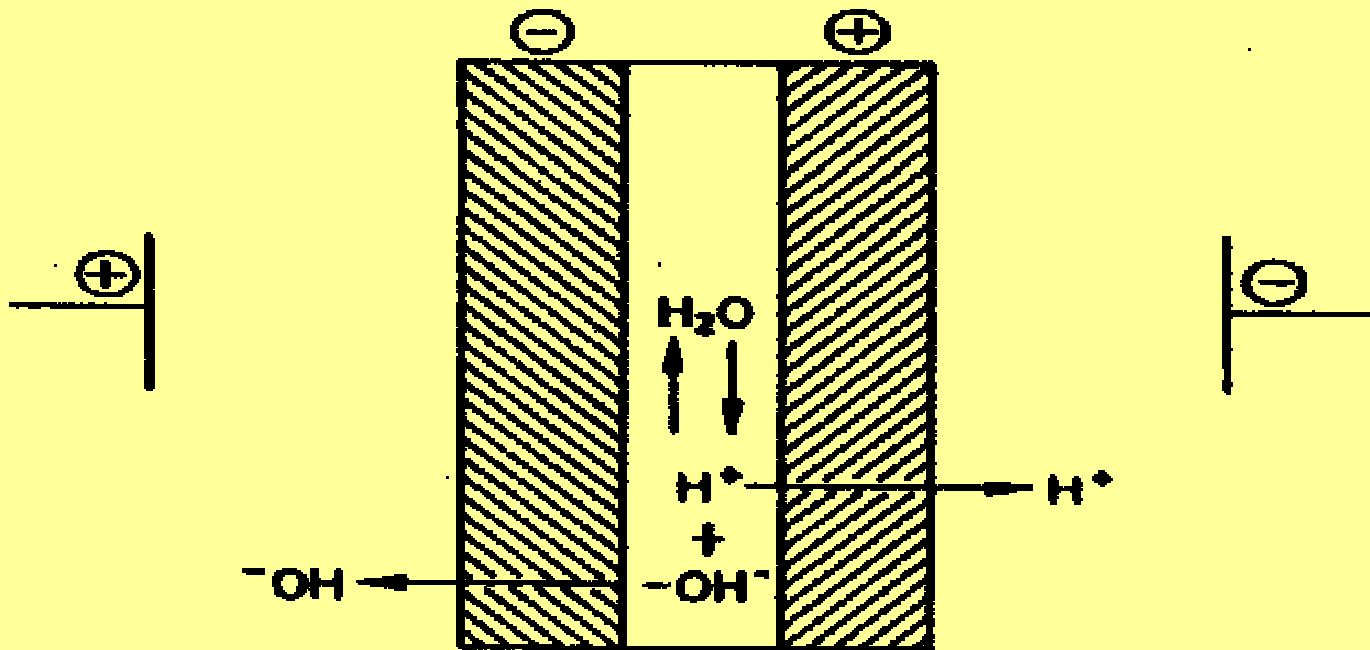

Synthesis of salicylic acid with bipolar membranes

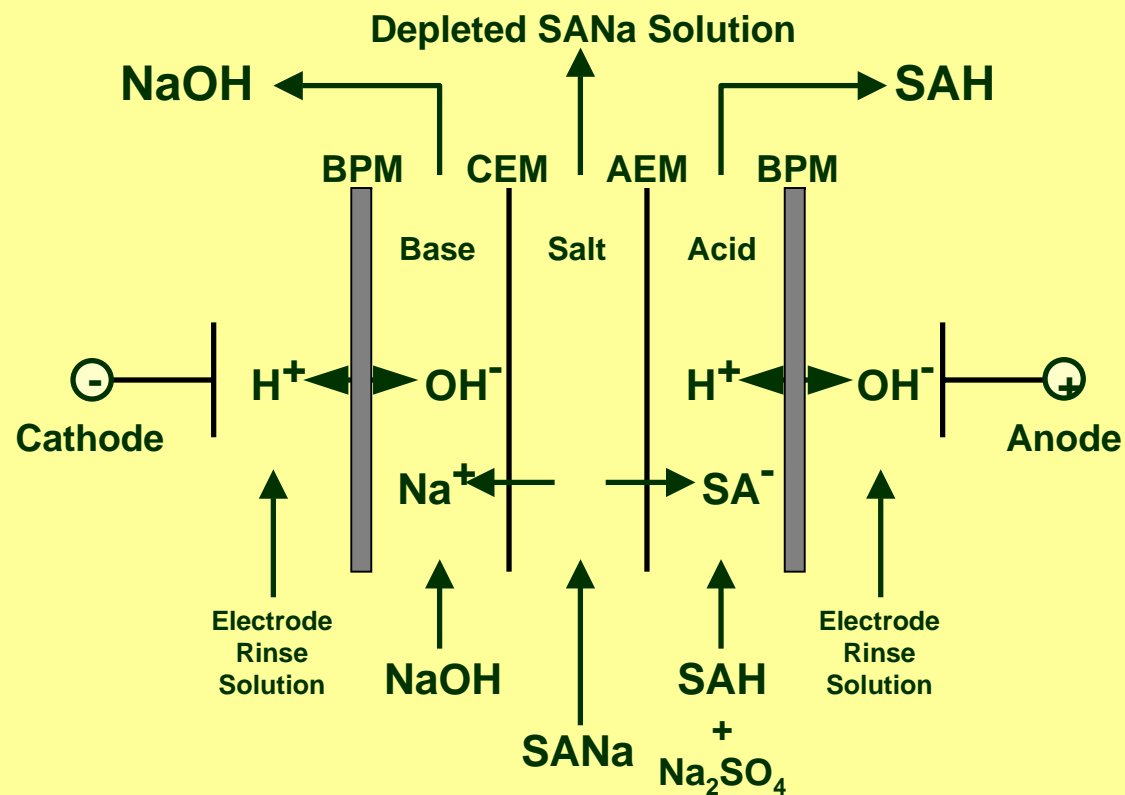
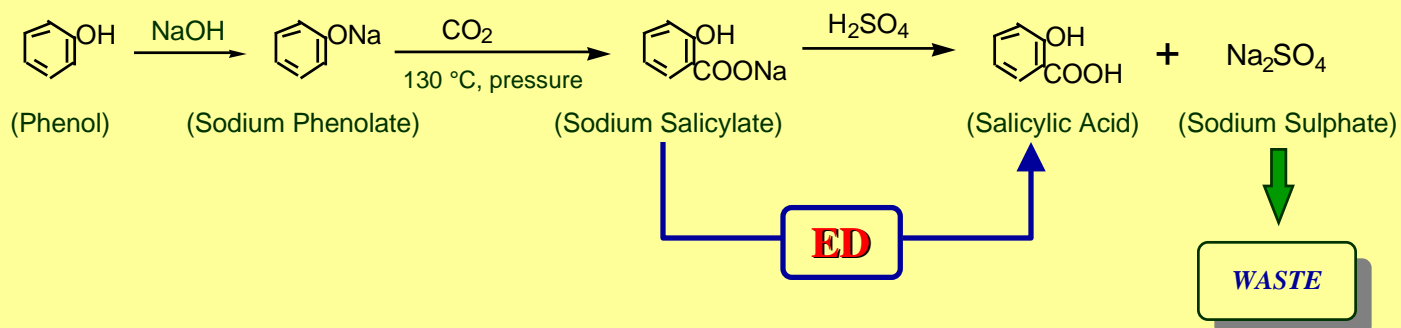

i Last visual aid !

Thank you!

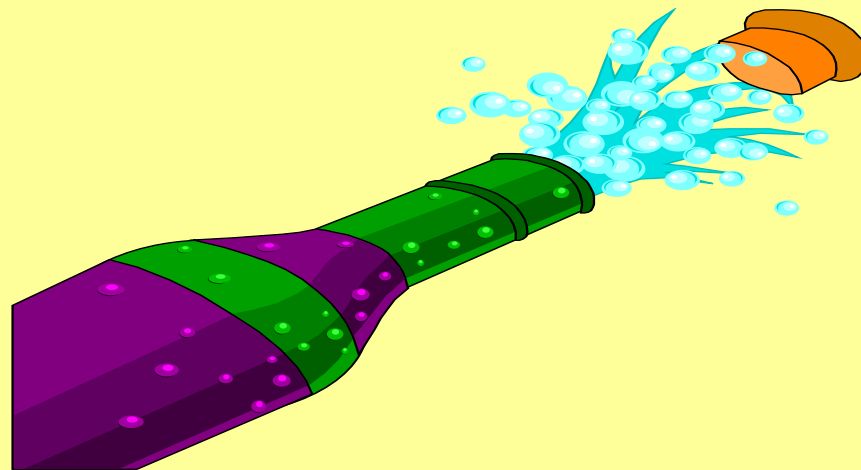

NATO CCM S Pilot Study on Clean
Products and Processes
Cetraro, Italy, 2003

Process Intensification by Modelling and Modifying Packed Bed Reactors

António Martins, Paulo Laranjeira, Madalena Dias, José Carlos Lopes



Presentation Plan

- Process Intensification: Definition and interest to packed bed reactors.
- Network and geometrical model of a packed bed.
- Flow modelling in packed beds.
- Mass transport and reaction in a packed bed reactor.
- Conclusions and possible modifications of packed bed reactors.

Process Intensification

Process Intensification is a strategy to increase the efficiency of process units, for example by reducing the raw materials or the energy consumption of the process.

This goal can be reached only by modifying existing processes or the development of new ones.

Despite the importance of process intensification, both from economical and environmental point of view, it has been applied on a limited scale.

Process Intensification

Process intensification can be implemented in different ways

- Using different types of units, e.g., membranes.
- The development of different process: different chemical pathways (Green Chemistry), multifunctional reactors, etc.
- Process integration.

Process Intensification

Process intensification must look to the all process and not only to small units, as their depend on each other.

Implementation can be hindered by the costs of new equipment and the disposal of old one.

The analysis of the benefits and tradeoffs of process intensification must be based on a detailed understanding of the physical phenomena occurring and their influence on the behaviour of the process.

Process Intensification

At the "heart" of almost any chemical process there is a reactor. Process intensification will have more impact closest to the core of process is applied.

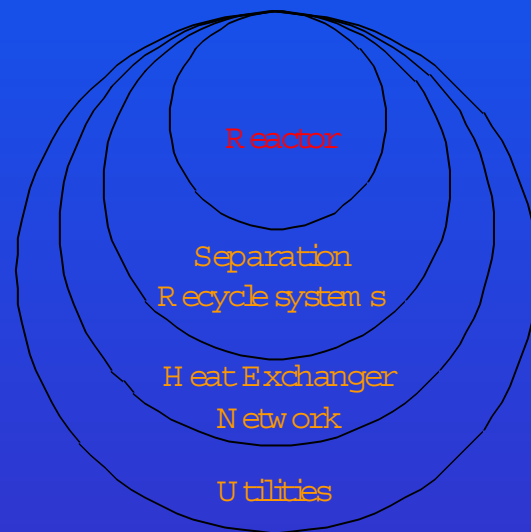

Depending on type of reactions, catalyst, chemical pathways and reactants, many types of reactors are used.

Process Intensification

Packed bed reactors are advantageous in many cases

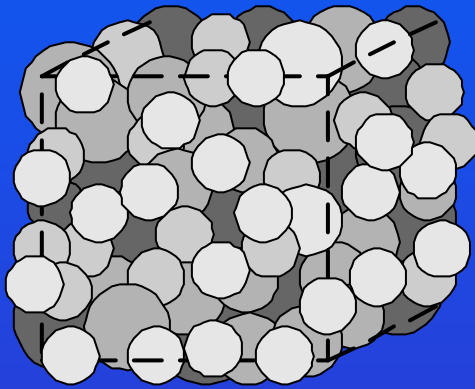

- No loss of catalyst.
- Ensure a high surface area for reaction.
- High conversion and selectivity possible.
- Wide range of operating conditions.
- Enhance mixture between reactants.

... ..

- Process Intensification: Definition and interest to packed bed reactors.
- Network and geometrical model of a packed bed.
- Flow modelling in packed beds.
- Mass transport and reaction in a packed bed reactor.
- Conclusions and possible modifications of packed bed reactors.

Network-Geometrical Model

A network model was selected to describe the void space between the particles.

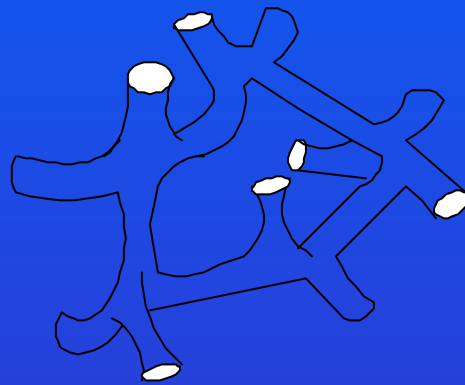

Real structure

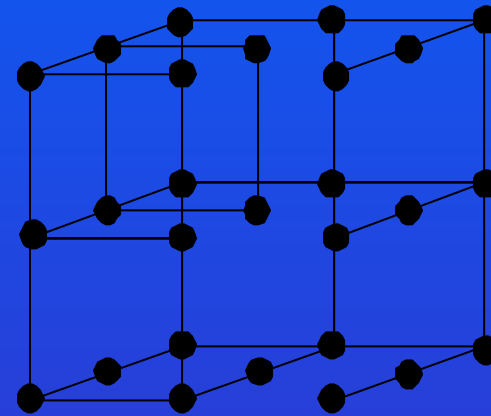

Simplified Network Structure

Network-Geometrical Model

Main assumptions

Network is two-dimensional

Two types of elements are used

- chambers/spheres, characterised by D_i
- channels/cylinders, characterised by d_i and l_i

Network-Geometrical Model

The network is generated by repetition of a fundamental unit cell.

Chamber and channel diameters follow given size distributions.

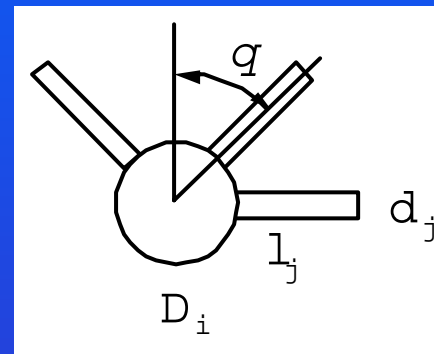

Local structure of network can be varied by removing channels and chambers or changing relative size elements.

Network-Geometrical Model

Example is shown of a typical network used to describe the packed bed local structure.

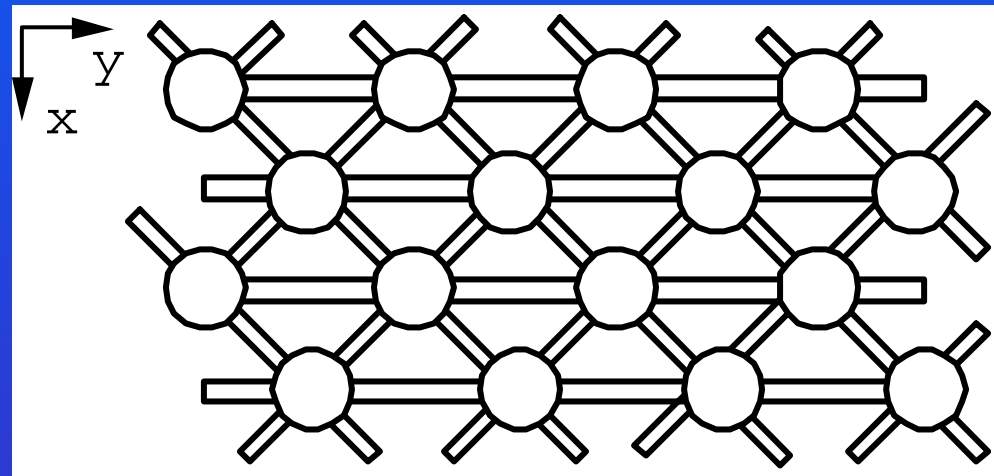

Network-Geometrical Model

Network elements size distributions are obtained from a geometrical model based on the geometrical analysis of six ideal packings of equal spheres.

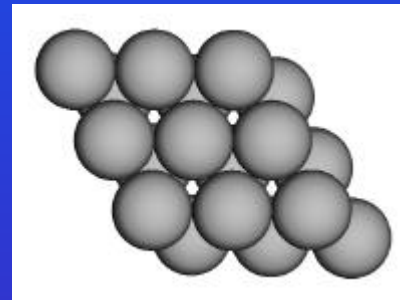
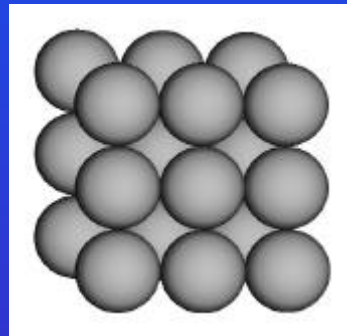
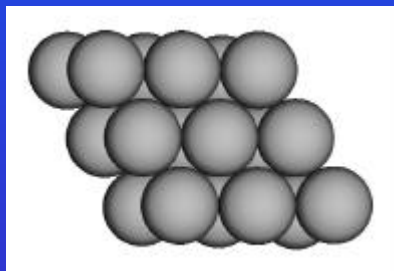
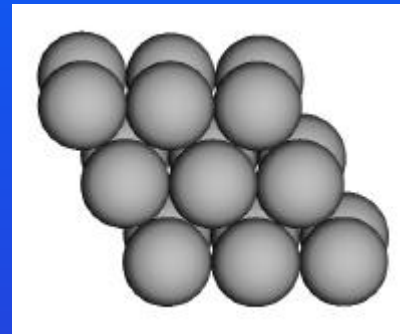
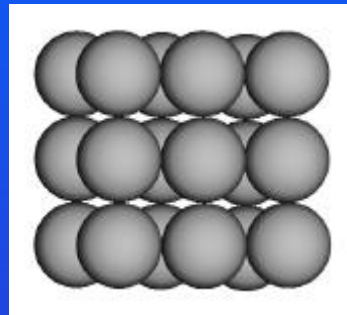
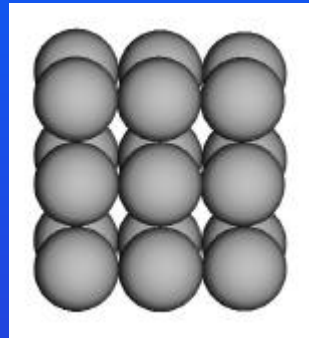

Network-Geometrical Model

The network elements size distributions are functions of porosity and particle size distribution.

$$D_i = f_D(e, D_{pj})$$

$$d_j = f_d(e, D_{pj})$$

$$l_i = f_l(e, D_{pj})$$

- Assuming
- $\langle D \rangle = f_D(e, \langle D_p \rangle)$
 - $\langle d \rangle = f_d(e, \langle D_p \rangle)$
 - $\langle l \rangle = f_l(e, \langle D_p \rangle)$

Network-Geometrical Model

Average values depends only on the porosity of the packed bed.

If the particle size distribution is known

$$f_D(D_i) = K_D(e) f_{D_p}(D_{pj})$$

$$f_d(d_i) = K_d(e) f_{D_p}(D_{pj})$$

Average size of the network elements predicted using the geometrical model compared well with experimental values obtained in packed formed with particles with a narrow particle size distribution.

... ..

- Process Intensification: Definition and interest to packed bed reactors.
- Network and geometrical model of a packed bed.
- Flow modelling in packed beds.
- Mass transport and reaction in a packed bed reactor.
- Conclusions and possible modifications of packed bed reactors.

Flow Modelling

Flow is modelled using the analogy with an electrical circuit.

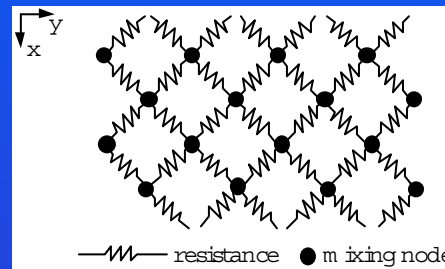

$$p_k - p_{k-1} = \Delta p_i = R_i q_i$$

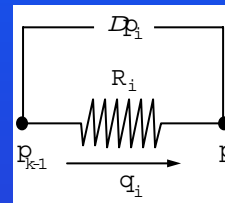

If the resistance in each channel is known, the pressure and the flow fields are obtained by solving a non-linear, sparse system of equations.

Flow Modelling

Total resistance of a channel is the sum of three terms:

$$R_i = R_i^F + R_i^{EL} + R_i^{ET}$$

R_i^F - frictional resistance, function of the Reynolds number

- Laminar flow - Poiseuille eq.
- Turbulent flow - Blasius eq.
- Transition zone - interpolation

Flow Modelling

R_i^{EL} and R_i^{ET} - additional resistance due to the connections between channels and chambers.

- R_i^{EL} - Linear flow (Koplik, 1982)
- R_i^{ET} - Nonlinear flow. Based on the usual method to calculate the pressure losses in accidents in pipe systems. Constants were given to the simulator.

Flow Modelling

Agreement with the Ergun Equation is only observed when the effects of the connections between channels and chambers are explicitly taken into account.

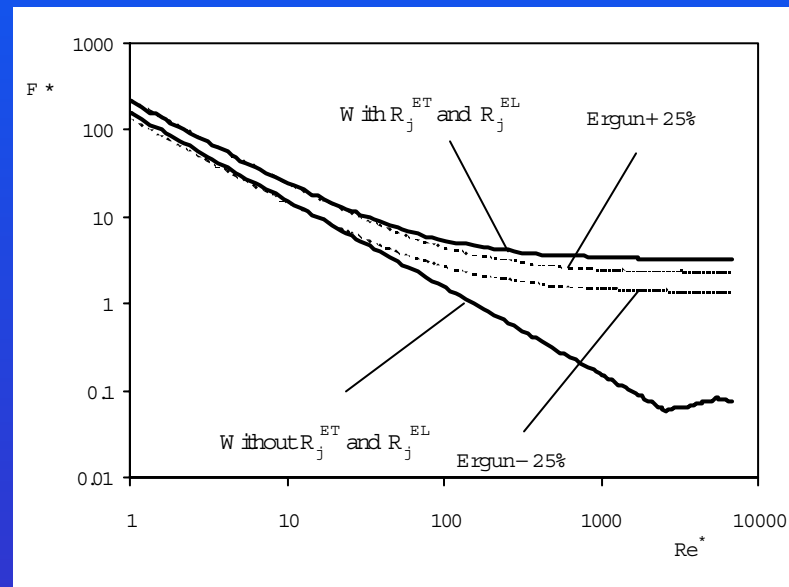

Flow Modelling

Good comparison between predicted and experimental data is obtained. Model gives a good description of the characteristics of the local flow and pressure field.

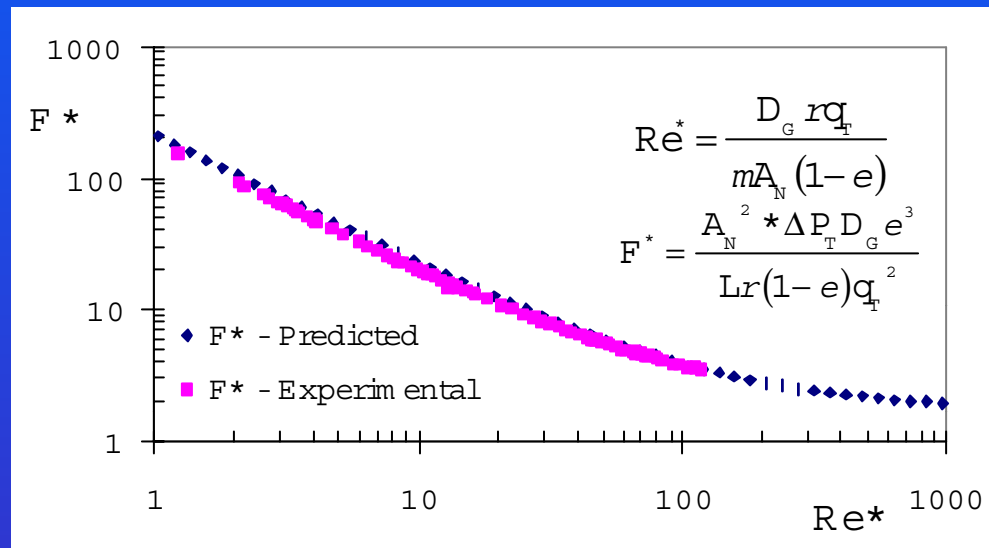

...

- Process Intensification: Definition and interest to packed bed reactors.
- Network and geometrical model of a packed bed.
- Flow modelling in packed beds.
- Mass transport and reaction in a a packed bed reactor.
- Conclusions and possible modifications of packed bed reactors.

Mass Transport and Reaction

The mass transport and reaction modelling in a packed bed reactor was done for transient and steady state conditions.

The mass balance equations were written for the network elements assuming:

- Perfect mixture in the chambers. Accounts for the dispersion of mass.
- Plug flow in the channels. Accounts for the convection of mass. Mathematically represents a pure delay.

Mass Transport and Reaction

Dimensional mass balance equations are:

$$t_i \frac{df_i(t)}{dt} + f_i(t) + R[f_i(t)] = \sum_j a_{ij}^E f_j(1,t)$$

Chambers

$$t_j \frac{\partial f_j(z,t)}{\partial t} + \frac{\partial f_j(z,t)}{\partial z} + R[f_j(z,t)] = 0$$

Channels

When solving the equations, delays were incorporated in the chamber mass balances and considered explicitly.

Mass Transport and Reaction

Proposed model has several distinct features from normal used models for describe mass transport and reaction.

- Delay due to the flow of fluid is taken in to account explicitly.
- Dispersive behaviour is modelled directly using the local structural and flow field characteristics.
- No necessity to define parameters to determine from correlations or experimental data.

Mass Transport and Reaction

Different types of perturbations can be considered, both uniform and non-uniform, in time and space. Time and spatial evolution for a local step perturbation is shown.

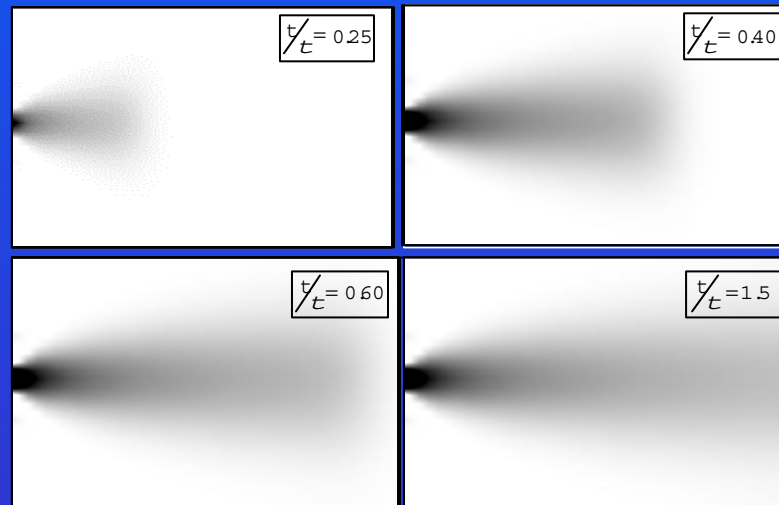

Mass Transport and Reaction

Different types of operation can be studied easily. Example represents the response to a periodic pulse perturbation with reaction.

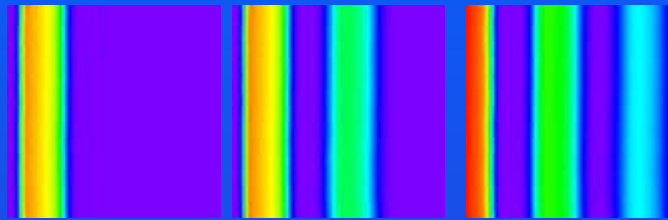

The influence of the local structure in mass transport can be visualised. Example compares a case with (bottom) and without chemical reaction.

Mass Transport and Reaction

Varying the geometrical parameters of the network elements, it is possible to control the relative importance of the two mass transport mechanisms.

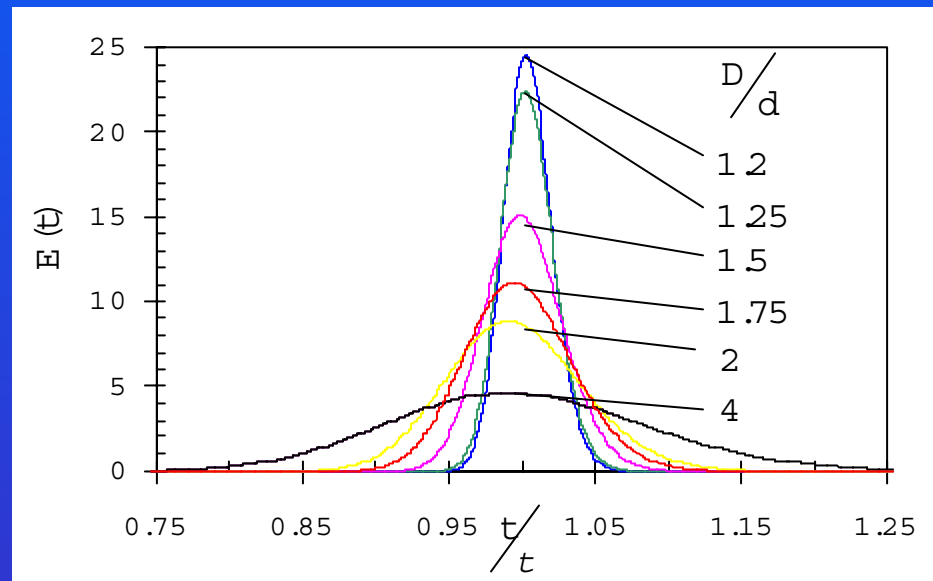

Mass Transport and Reaction

In steady state conditions the influence of the reactant feed to the reactor can be studied in detail.

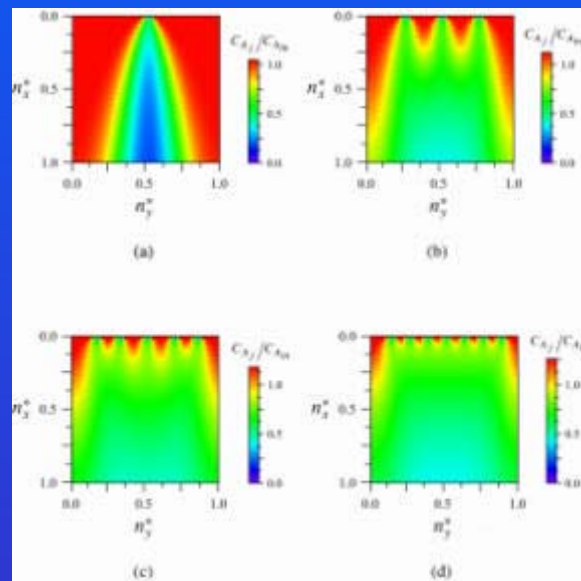

Concentration profiles shown for a second order reaction $A + B \rightarrow C$ and different feeding modes of B.

Effects of mixture and segregation can be easily studied.

Mass Transport and Reaction

Conditions to obtain optimal selectivity can be determined from simulations, avoiding costly and lengthy experiments.

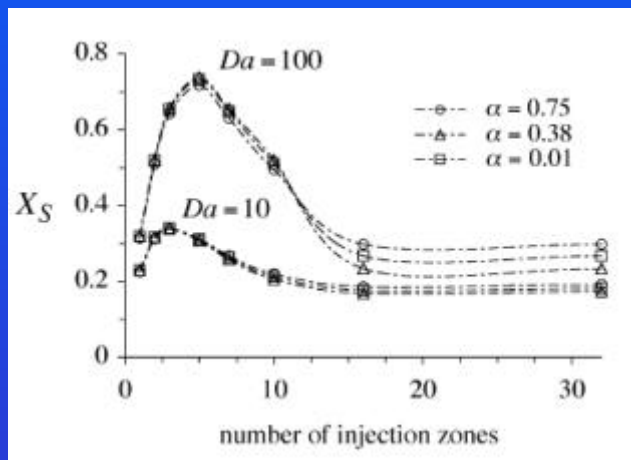

The yield of S as function of reaction, feed and local structure characteristics is presented in the figure for the kinetic scheme

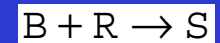

... ..

- Process Intensification: Definition and interest to packed bed reactors.
- Network and geometrical model of a packed bed.
- Flow modelling in packed beds.
- Mass transport and reaction in a packed bed reactor.
- Conclusions and possible modifications of packed bed reactors.

Conclusions

Geometrical characteristics of the packed bed are the controlling factor of its behaviour.

- Model provides a good description of the hydrodynamical behaviour.
- The influence of the local structure, flow field characteristics and operation conditions on the behaviour can be predicted.
- Data required is easily obtained and does not require experiments.

Conclusions

Proposed model is predictive and uses only information of the packed bed structure.

Advantages:

- Reduction on the design and development stage.
- Easier scale-up.
- Changes can be addressed faster.

Conclusions

Possible extensions of the model:

- Inclusion of the heat effects and its influence on the flow, mass transport and reaction in a packed bed reactor.
- Inclusion of mass transfer between phases and adsorption.
- Chemical reaction in the solid and fluid phase.

Conclusions

Modifications of packed beds rely on the control of flow and the mixture of reactants at the local level

Examples include:

- Use of packings in other types of reactors, e.g. Bubble Column Reactors.
- Structured packings
- Microfluidics systems for biochemical or chemical analysis.



New Technologies for Improving Gas-Liquid Transfer Processes and Catalytic Reactions

A. Criscuoli ¹, E. Drioli ^{1,2}

¹ *Research Institute on Membrane Technology (ITM-CNR), Via Pietro Bucci Cubo 17/C, 87030 Rende (CS) Italy*

^{1,2} *Department of Chemical Engineering and Materials, University of Calabria, Via Pietro Bucci Cubo 17/C, 87030 Rende (CS) Italy*

First meeting of the NATO/CCMS Pilot Study on Clean Products and Processes- Phase II

Cetraro (Italy) May 11-15 2003



Aim of the contribution:

To discuss the role of some membrane operations in the logic of the **Process**

Intensification



Main targets of the Process Intensification

To develop systems of production with:

- **lower equipment-size/production-capacity ratio**
- **lower energy consumption**
- **lower waste production**
- **higher efficiency**



Content

Water deoxygenation

Sparkling water production

Hydrocarbons removal from aqueous streams

Catalytic reactions



Water deoxygenation

The water deoxygenation by membrane contactors is successfully adopted by the semiconductor industry because of the **high removals achievable** (dissolved oxygen in the treated water less than 1 ppb) and **low size**.

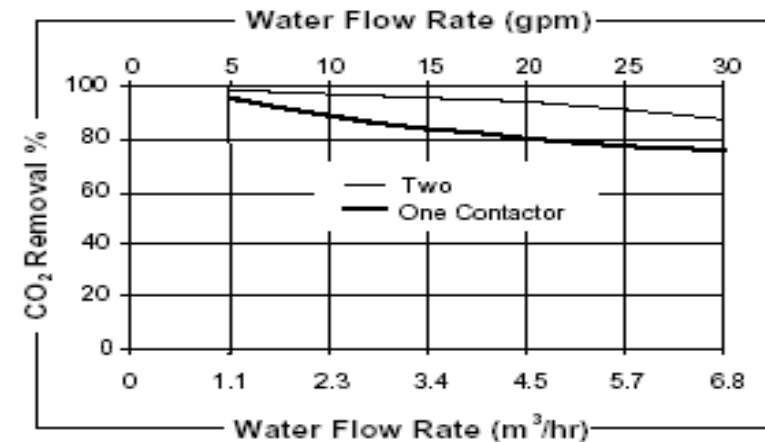
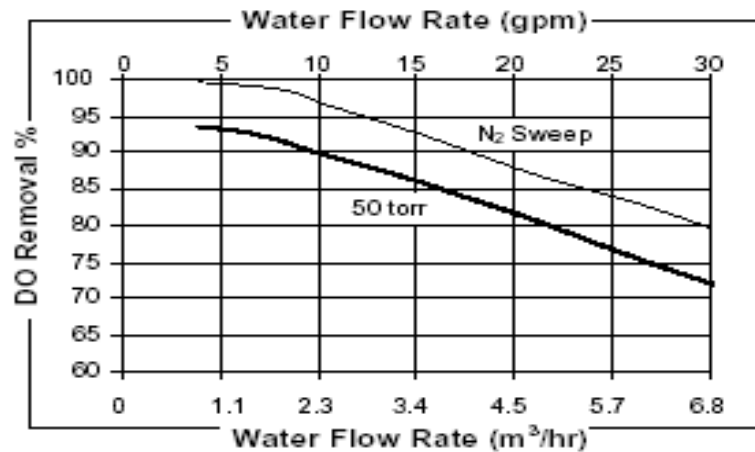

Test Conditions: Air Vacuum Combo. 150 torr at 25 °C

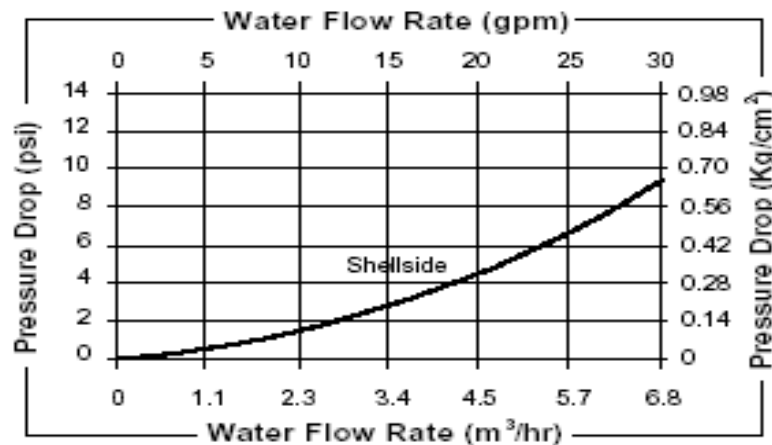

Cartridge Specifications		
Characteristics	Test Conditions	Specifications
		X50 and X40
Performance O₂ Removal	Shellside water flow: 27 gpm, 20°C (68°F). Lumenside N₂ Flow: 1 ft³/min, 1.0 atm at 20°C	78% minimum
Pressure Drop	Shellside water flow: 27 gpm, 20°C (68°F)	7.7 psi maximum

Curves represent nominal values, generated using water 20-25° C. Characteristics may change under different operating conditions.



Sparkling water production





Comparison between traditional and proposed systems

	Traditional	Proposed	Trad./Prop.
Equipment cost (Euro)	Deaeration unit: 71,013 Saturation unit: 103,291 Total: 174,304	77,800*	2.24
CO ₂ consumption (kg/h)	Deaeration unit: 60 Saturation unit: 130** Total: 190	110	1.73
CO ₂ cost (Euro/h)***	30	17	1.73
CO ₂ in the atmosphere (kg/h)	60	60	1
Membrane replacement (Euro/y)****	/	25,900	/
Volume (m ³)	3	0.25	12

* A membrane cost of 92,96 Euro/m² has been considered

** For saturating at 4.3 g/l 30 m³/h of water, 130 kg/h of CO₂ have to be used.

*** The CO₂ cost is of 0.155 Euro/kg

**** Membrane life-time: 3 years.

A. Criscuoli et al., Annals of New York Academy of Science, in press 2003



In desalination, the content of oxygen and carbon dioxide in the seawater considerably affects the performance and the material life of the desalination plants. Carbon dioxide also affects the pH and the conductivity of the water.

Removal of these gases is usually made by stripping in a **packed column** and the final water pH is adjusted by means of **caustic soda**. This operation is difficult to fine control – due to the very low dosing rates- and is not well accepted by end users who do not prefer chemically treated waters.



Membrane contactors working on the reverse osmosis permeate can efficiently lead to the desired control of the oxygen and carbon dioxide content **avoiding the final use of chemicals.**

The membrane contactor unit **does not increase the energy consumption** because it operates at atmospheric pressures and allows to **strongly reduce the environmental pollution.**



Hydrocarbons removal from aqueous streams

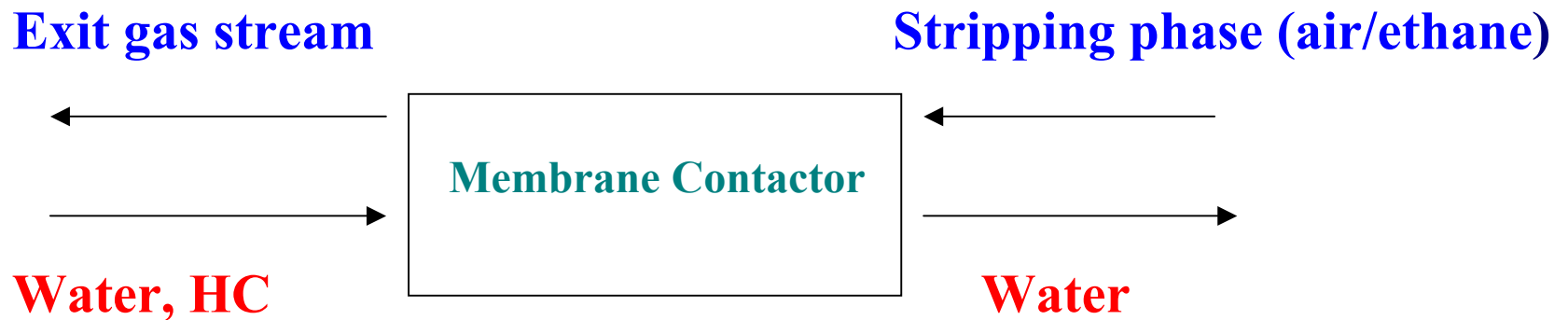

P. Bernardo et al., submitted to Clean Processes and Environmental Policy, 2003



Hydrocarbons removal from aqueous streams

Traditional process: **Stripping towers/ steam** **Removal: 90%**

Membrane contactors: **Air/ethane as strip phase** **Removal: 90% - 99%**
(35°C) – (70°C)

Main advantages of the new operation:

- **higher removals**
- **no need of high quantities of steam**
- **reduced size**

P. Bernardo et al., submitted to Clean Processes and Environmental Policy, 2003

Membrane operations can be applied also for reaction purposes, each membrane pore acting like a “micro-reactor”.

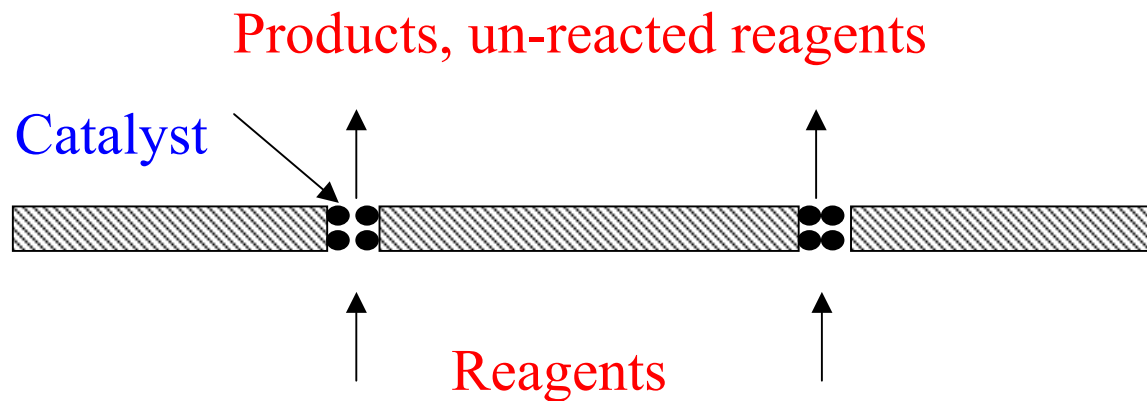

Membrane pores like “micro-reactors”



If the membrane is **high selective for the product** of interest it is possible to recover it directly at the permeate side, **without the need of separation units.**

By using membrane reactors it is possible to obtain **higher conversions or selectivities** with respect to traditional reactors and the **same performances** of conventional apparatus can be achieved with **lower energy consumption**



In catalytic membrane reactors it is possible to combine the reaction step to the separation one, performing two different operations into a single device.

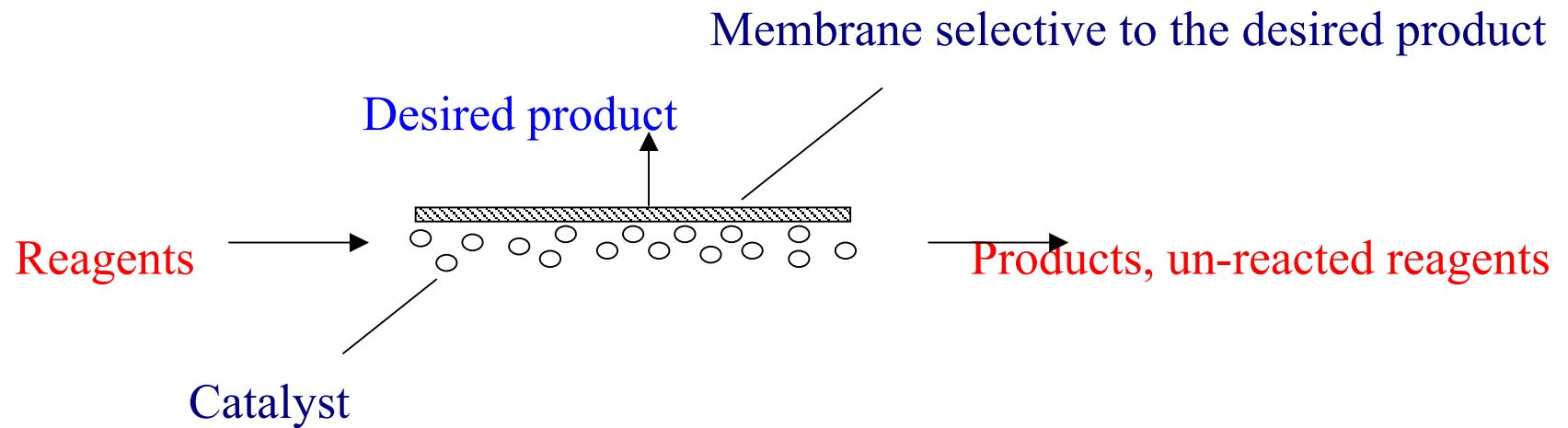

Reaction and separation in a single device



By using membrane reactors it is possible to achieve the **same conversion** of traditional devices at **lower temperatures**.

As a consequence, the **reaction selectivity** can be improved by **mimimising side reactions** and **limiting the amount of carbonaceous deposits**.



Equilibrium-limited reaction



The equilibrium constant decreases with temperature:

$$K_p = \exp[(4577.8/T) - 4.33]$$



The **water gas shift reaction** is present in several industrial processes such as the **ammonia and hydrogen production**.

Hydrogen is mainly produced by steam reforming or partial oxidation of hydrocarbons.

However both processes lead to mixtures of hydrogen and carbon monoxide that can not be directly used for industrial applications.

For example, for the ammonia production the carbon monoxide concentration has to be very low in order to avoid the deactivation of catalyst.

The water gas shift reaction is used, in this case, for reducing the CO concentration and for producing more hydrogen.



Reactors used for carrying out the water gas shift reaction are usually adiabatic.

The reaction is firstly carried out in a reactor with iron-based catalyst (High Temperature reactor-HT) and, after a cooling stage, the exit stream is fed to a reactor with copper-based catalyst (Low Temperature reactor-LT).

CASE STUDY

The WGS reaction was carried out both in a fixed bed reactor and in a tubular palladium membrane reactor.

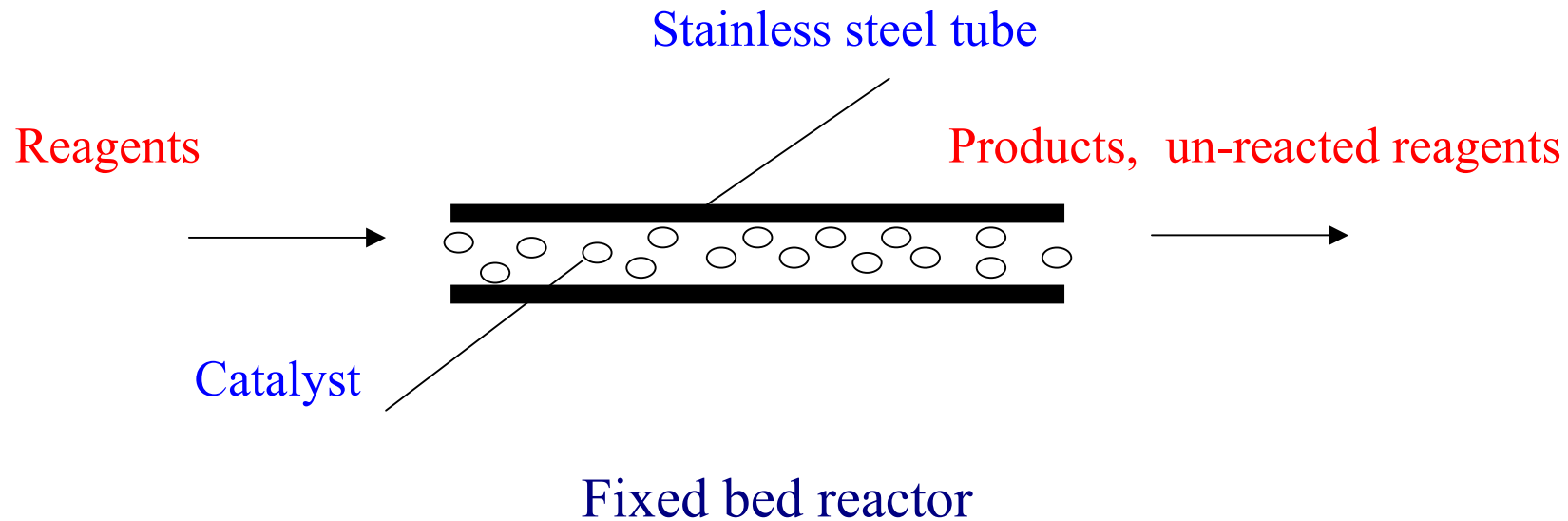

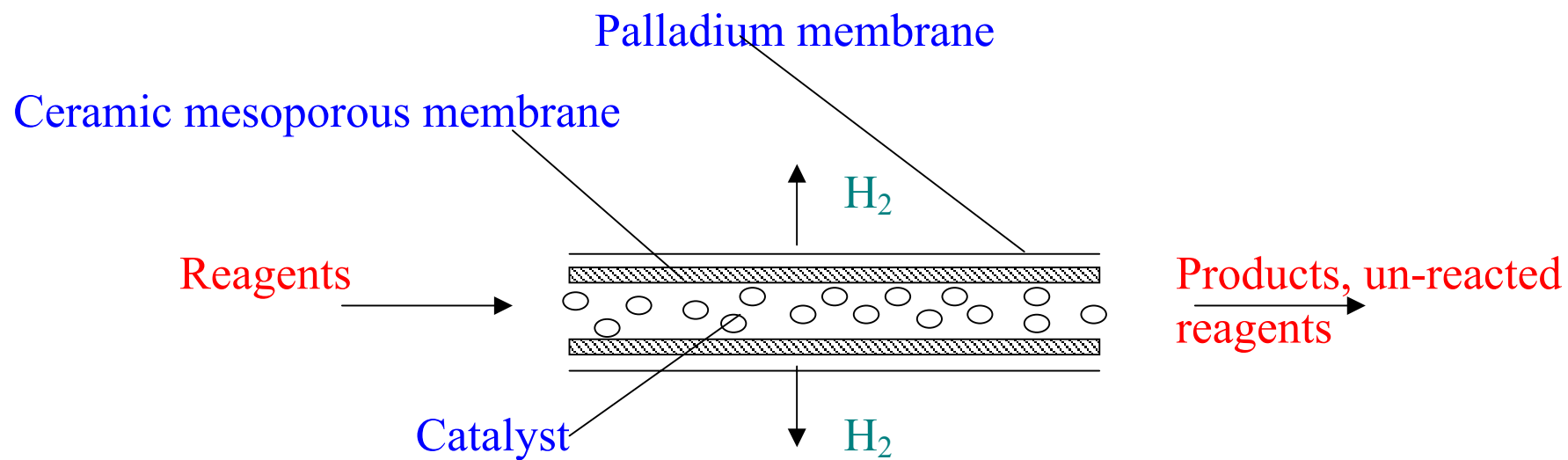

Palladium membrane reactor

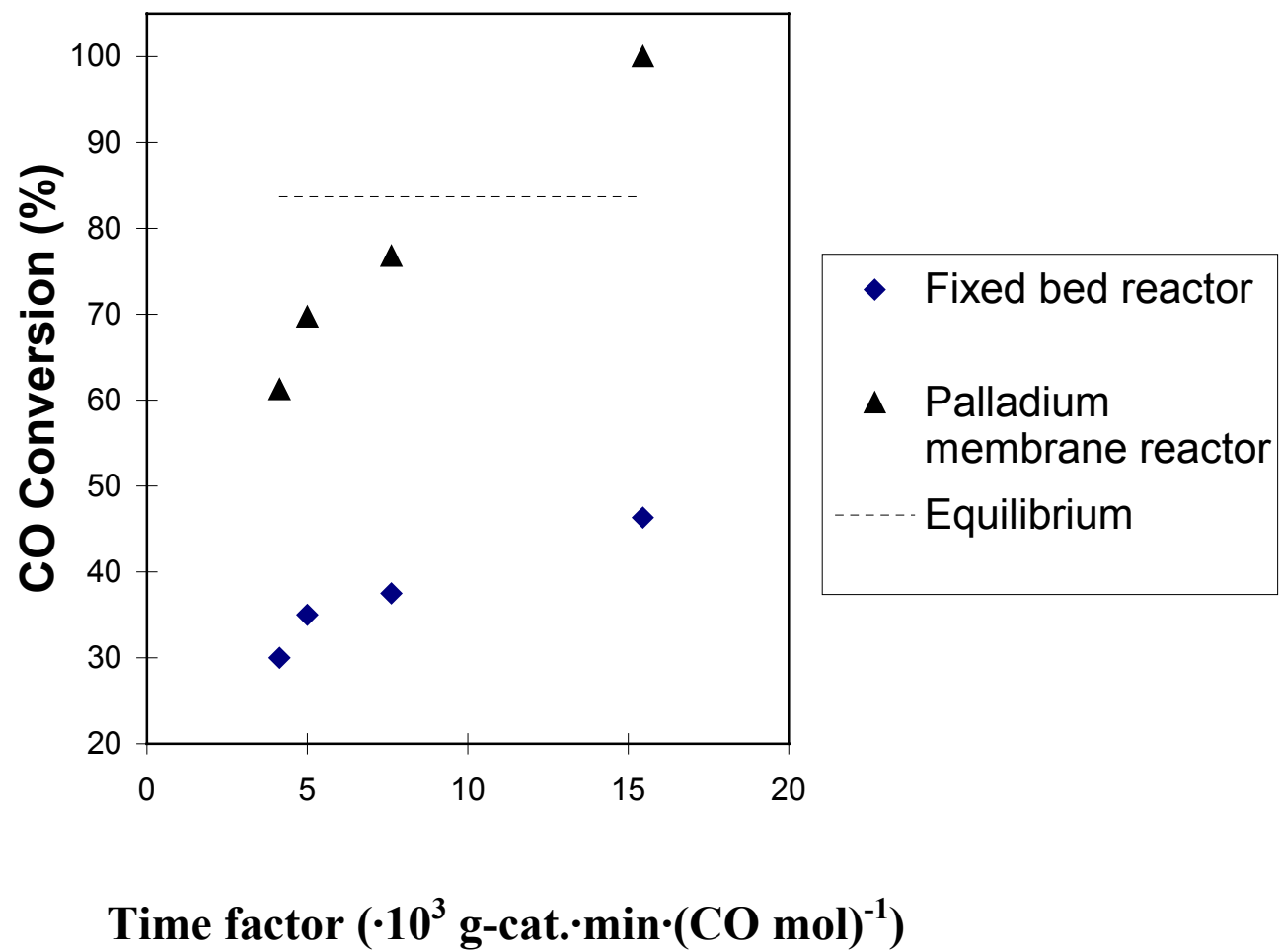



Comparison between traditional devices and the palladium membrane reactor -PM- (palladium thickness, 75 μm) [A. Criscuoli et al., *J. Mem. Sci.* 181/1 (2001) 21-27]

Reactors characteristics			
	HT	LT	PM
Volume (m^3)	6.2	4.52	5.97
Catalyst (Kg)	4,500	1,000	4,885



Capital Costs (Euro)		
	Industrial plant	PM
Reactors	77,440	$6.4 \cdot 10^6$
Catalyst	49,000	15,762
Separation unit	$1.03 \cdot 10^6$	-
Total	$1.16 \cdot 10^6$	$6.78 \cdot 10^6$
Operating Costs (MEuro per year)		
	2.43	6.97



Conclusions

The introduction of membrane operations in industrial cycles might represent an interesting way to realize the rationalization of chemical productions in the logic of the **Process Intensification.**

Membrane contactors are high efficient systems for carrying out the mass transfer between phases and achieving high removals. They also present lower size than conventional apparatus.

Membrane reactors, although not already present at industrial level, represent useful systems to improve chemical reactions yield and to enhance the performance of chemical productions.

*NATO CCMS Pilot Study on Clean Products and Processes
2003 Annual Meeting
Hotel San Michele, Cetraro*

*Rationalisation of productive cycles in the
agro-food industries by innovative processes*

A. Cassano, E. Drioli

Institute on Membrane Technology, ITM-CNR,
c/o University of Calabria, via P. Bucci, cubo 17/C
I-87030 Rende (CS), Italy
Phone: +39 0984 492011-492014
Fax: +39 0984 402103
E-mail: a.cassano@itm.cnr.it

Fruit and vegetable juices are beverages of high nutritional value since they are enriched with minerals, vitamins and other beneficial components for human health that are generally indicated as antioxidants. Unfortunately during the industrial transformation, a large part of the characteristics determining the quality of the fresh product undergoes a remarkable modification: the thermal damage and the chemical oxidation degrade more sensitive components reducing the quality of the final product.



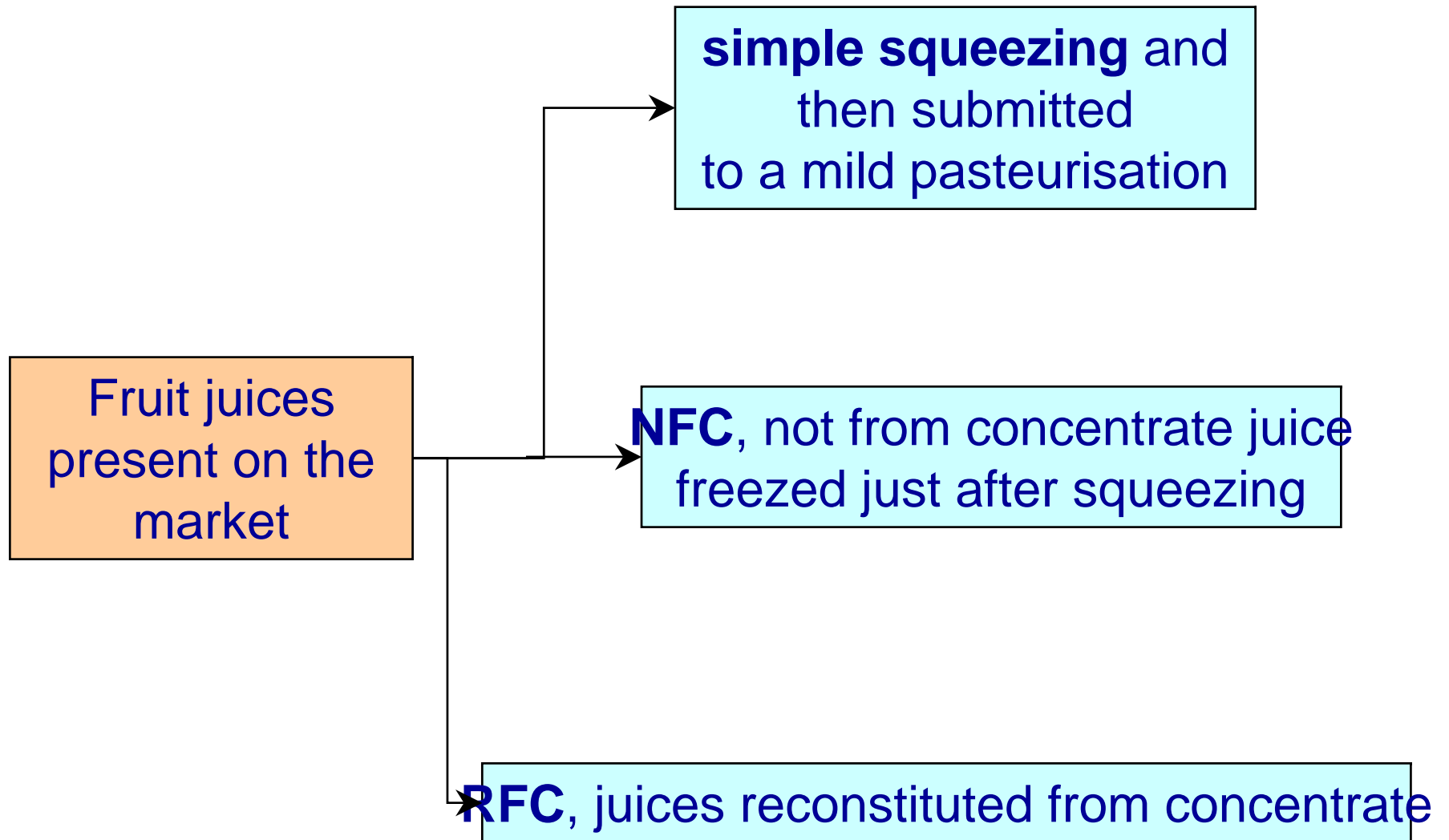

The production of concentrated fruit juices is of interest at industrial level since they can be used as ingredients in many products such ice creams, fruit syrups, jellies and fruit juices beverages. Furthermore, fruit juices concentrates, because of their low water activity, have a higher stability than single-strength juices.

In addition, package, storage and shipping costs are remarkably reduced.

When the concentration is carried out by **EVAPORATION**, most of the aroma compounds contained in the raw juice are lost and the aroma profile undergoes an irreversible change with a consequent remarkable qualitative decline. Besides, the heat required to perform the evaporation results in some “cooked” notes recognised as off-flavors.

Commercial freeze concentration systems, in which water is removed as ice and not as vapor (**CRYOCONCENTRATION**), permit to preserve the volatiles during the water removal process but, they are not able to substitute for the evaporative concentration of products with large diffusion (i.e. citrus juices) since they require a remarkable energy consumption. Besides the achievable concentration (about 40 °Brix) is lower than the values obtained by evaporation (60-65 °Brix).

MEMBRANE PROCESSES are today consolidated systems in various productive sectors, since the separation process is athermal and involves no phase change or chemical agents. The introduction of these technologies in the industrial transformation cycle of the fruit juices represents one of the technological answers to the problem of the production of juices with high quality, natural fresh taste and additive-free.

Ultrafiltration membranes retain large species such as micro-organisms, lipids, proteins and colloids while small solutes as for example vitamins, salts, sugars, flow through the membrane together with water. Therefore the possibility of microbial contamination in the permeate stream is minimised avoiding any thermal treatment and, consequently, loss of volatile aroma substances.

Clarified juice coming from the ultrafiltration process can be commercialised or submitted to a concentration process in order to obtain a product suitable for the preparation of juices and beverages.

The **Reverse Osmosis** process permits to separate principally water from the juice but it is limited by high osmotic pressures; it is used as a preconcentration technique which permits concentration values of about 30 °Brix corresponding to osmotic pressures of about 50 bar. Aroma compounds and other important chemical constituents such as anthocyanins, vitamins, sugars, acids, calcium, potassium, magnesium and phosphorus are rejected in the process.

The limitation of high osmotic pressures can be reversed by continuing juice concentration by **Membrane Distillation** or **Osmotic Distillation**.

INTEGRATED MEMBRANE OPERATIONS

The introduction of membrane operation units is studied as a fundamental step towards the rationalisation of traditional industrial processes in terms of energy consumption, of product recovery and improvement of quality in agro-food productions.

The combination among each other of different membrane operations such as enzyme membrane reactors, microfiltration, ultrafiltration, nanofiltration, reverse osmosis and osmotic distillation, is studied in order to identify their synergistic effects on the optimisation of processes for the production of fruit juices.

The possibility to realise integrated membrane systems in which all the steps of the productive cycle are based on molecular membrane separations can be considered a valid approach for a sustainable industrial growth within the **PROCESS INTENSIFICATION** strategy. The aim of this strategy is to introduce in the productive cycles new technologies characterised by low encumbrance volume, advanced levels of automation capacity, modularity, remote control, reduced energy consumption, etc..



New products from fruit and vegetables with high nutritional value (PNR- Tema 2)

Duration: 36 months

Project Coordinator: PARMALAT

Aim of the project is the development of new technologies for the production of liquid foods from fruit and vegetable as alternative to the traditional processes of the agro-food industry. An integrated membrane process for the clarification and concentration of carrot and citrus fruit juices is developed for the production of juices with high nutritional value and high organoleptic quality.

Funding Board

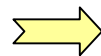

MIUR

Collaboration

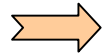

s

Istituto Mario Negri Sud; Parmalat - Centro Ricerche; San
Giorgio Flavors S.r.l.; Emmegi Agroindustriale; Stazione
Sperimentale Industria Conserve Alimentari;
Tecnoalimenti S.C.p.A.; Università di Parma



- ➔ Blood orange juice, mostly Tarocco variety, were from Sicily (1999 Production): the concentration of the raw juice was about 12.0-12.6 °Brix with a pH of 3.5. Traditionally concentrated orange juice was produced by a multiple effect TASTE (thermally accelerated short time evaporator) evaporator at a final concentration of 56.3 °Brix by Parmalat SpA.
- ➔ Lemon juice was from Sicily (1999 Production): the concentration was about 7.1 °Brix with a pH of 2.8.
- ➔ Carrot juice was produced by chemical and physical treatment and it was supplied in freezed packages at pH 4.48 and with a concentration of 6 °Brix.

Ultrafiltration process

UF is most commonly used to separate a solution that has a mixture of some desirable components and some that are not desirable. Typical rejected species include sugars, bio-molecules, polymers and colloidal particles.

The driving force for transport across the membrane is a pressure differential (UF operates at 2-10 bar).

UF processes perform feed clarification, concentration of rejected solutes and fractionation of solutes.

UF membranes are capable of retaining species in the range of **300-500,000 dalton** of molecular weight, with pore sizes ranging from **10-1000 Angstrom (10^3 - $0.1 \mu\text{m}$)**. These are mostly described by their nominal molecular weight cut-off (1000-100,000 MWCO), which means, the smallest molecular weight species for which the membranes have more than 90% rejection.

Clarification of citrus and carrot juice by ultrafiltration

Juices were submitted, without any preliminary treatment, to a clarification process by UF using a laboratory pilot plant supplied by Verind SpA (Rodano, Milan, Italy). The plant, with a 25 l feed tank, was equipped with a Koch tubular membrane module

Type	Koch Series-Cor TM HFM 251
Configuration	Tubular
Membrane polymer	PVDF
NMWCO	15 kDa
Membrane surface area	0.23 m ²
Average pores diameter	59 Å
pH operating range	2-11
Temperature operating range	0-55 °C
Pressure operating range	0.8-5.5 bar



Ultrafiltration pilot plant

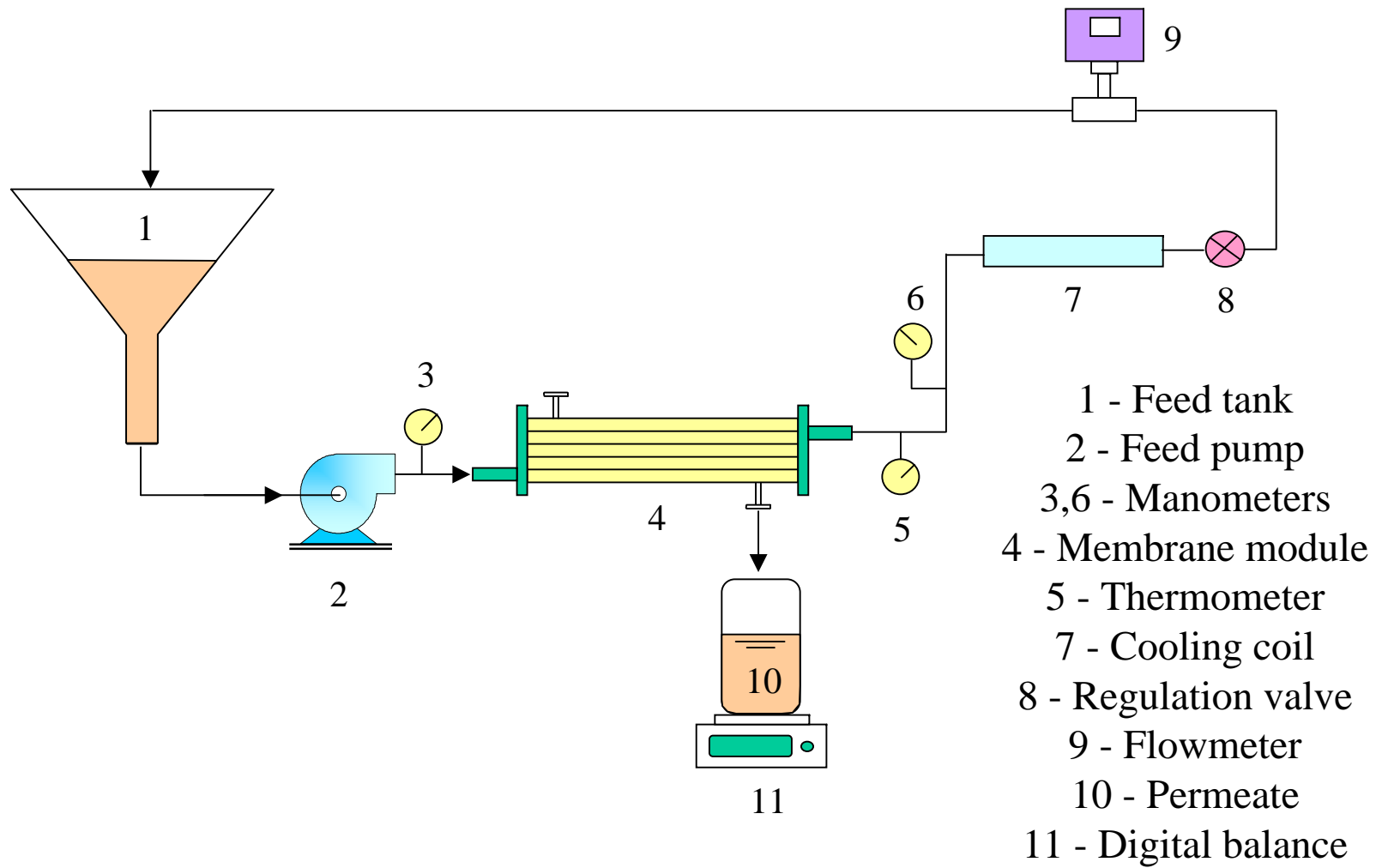

UF laboratory pilot plant

Experiments were carried out according to the **total recycle mode** (recycling both permeate and retentate stream in the feed tank) and to the **batch concentration mode** (collecting separately the permeate stream).

The total recycle mode was used in order to measure the permeate flux in different operating conditions and to identify the optimal operating conditions for the clarification process.

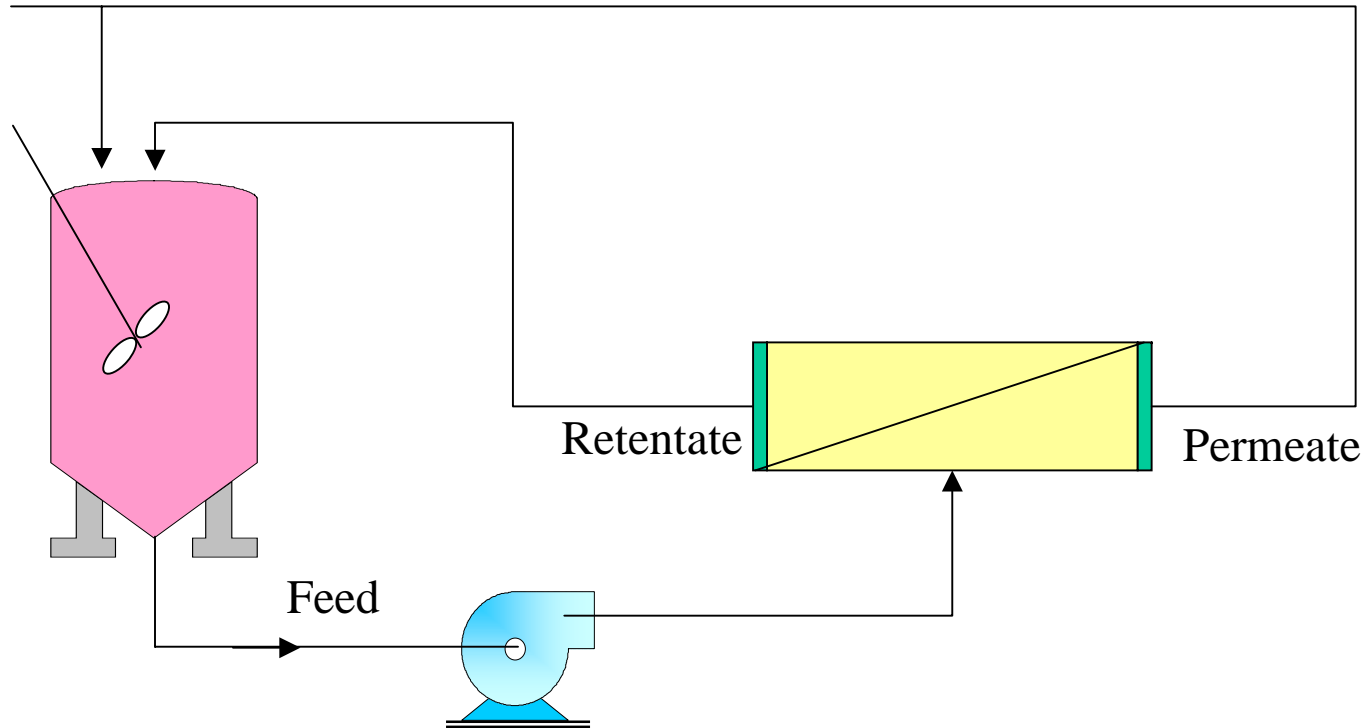

Scheme of the *total recycle* configuration

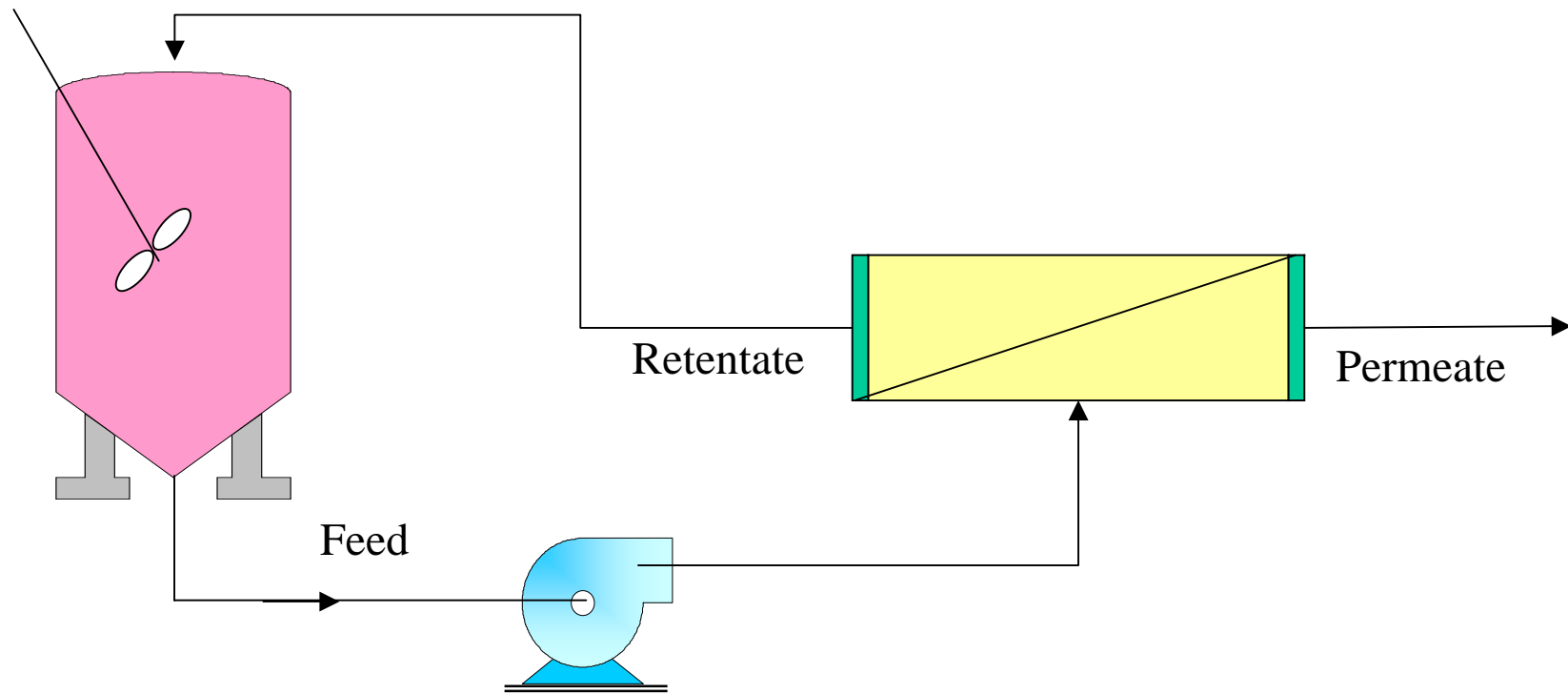

Scheme of the *batch concentration* configuration

Effect of the TMP on permeate flux

Permeate flux increases with **pressure** up to a limiting value (TMP_{lim}) which depends on the physical properties of the suspension and feed flow rate. Any increase in pressure is a source of inefficiency, because the energy input increases for no increase in production rate. Besides beyond TMP_{lim} membrane fouling becomes increasingly important and the flux decline is accelerated.

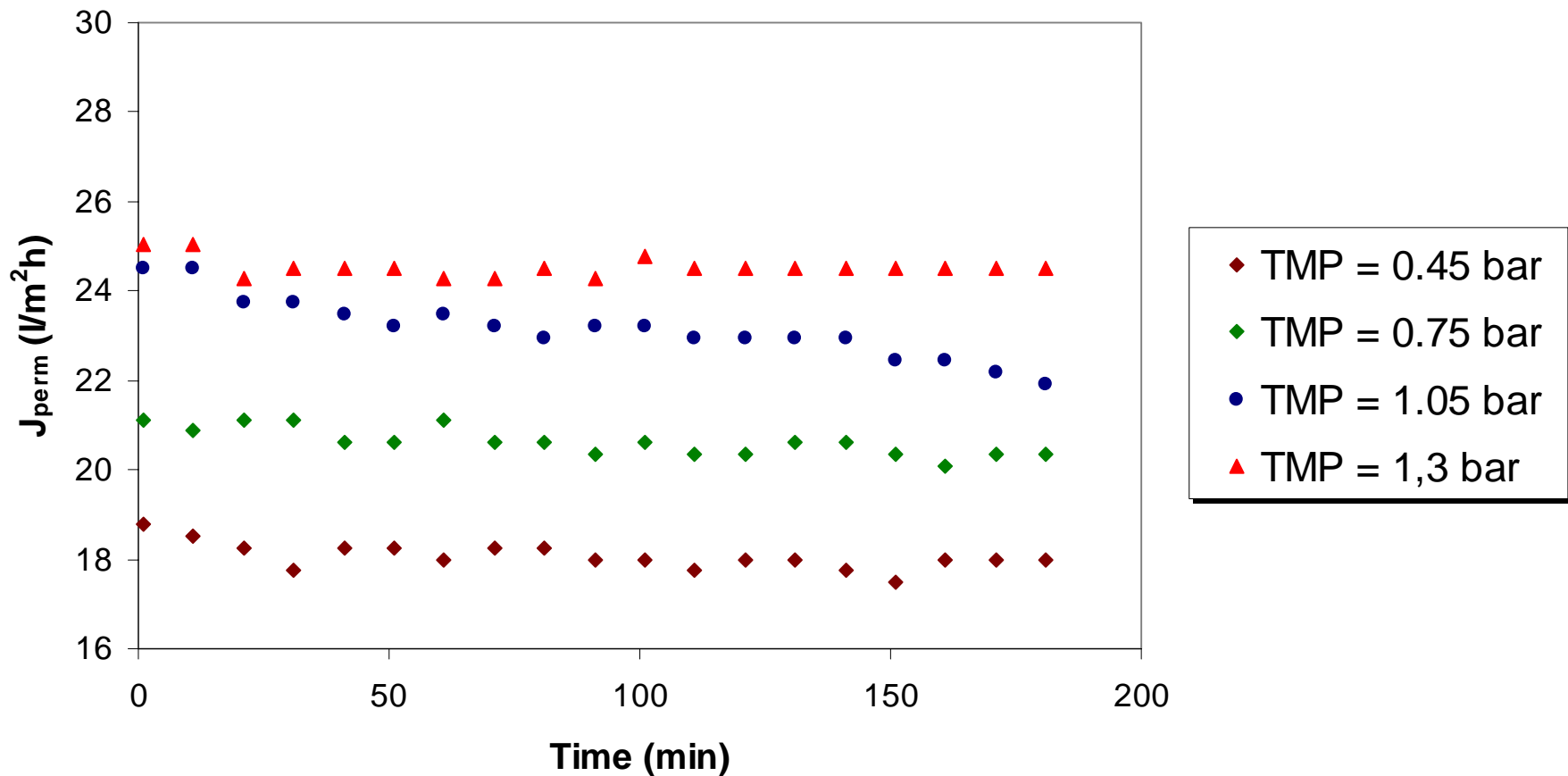

Ultrafiltration of carrot juice
Time course of permeate flux at different operating TMPs
 Operating conditions: $T = 23.5 \text{ }^\circ\text{C}$; $Q_f = 800 \text{ l/h}$

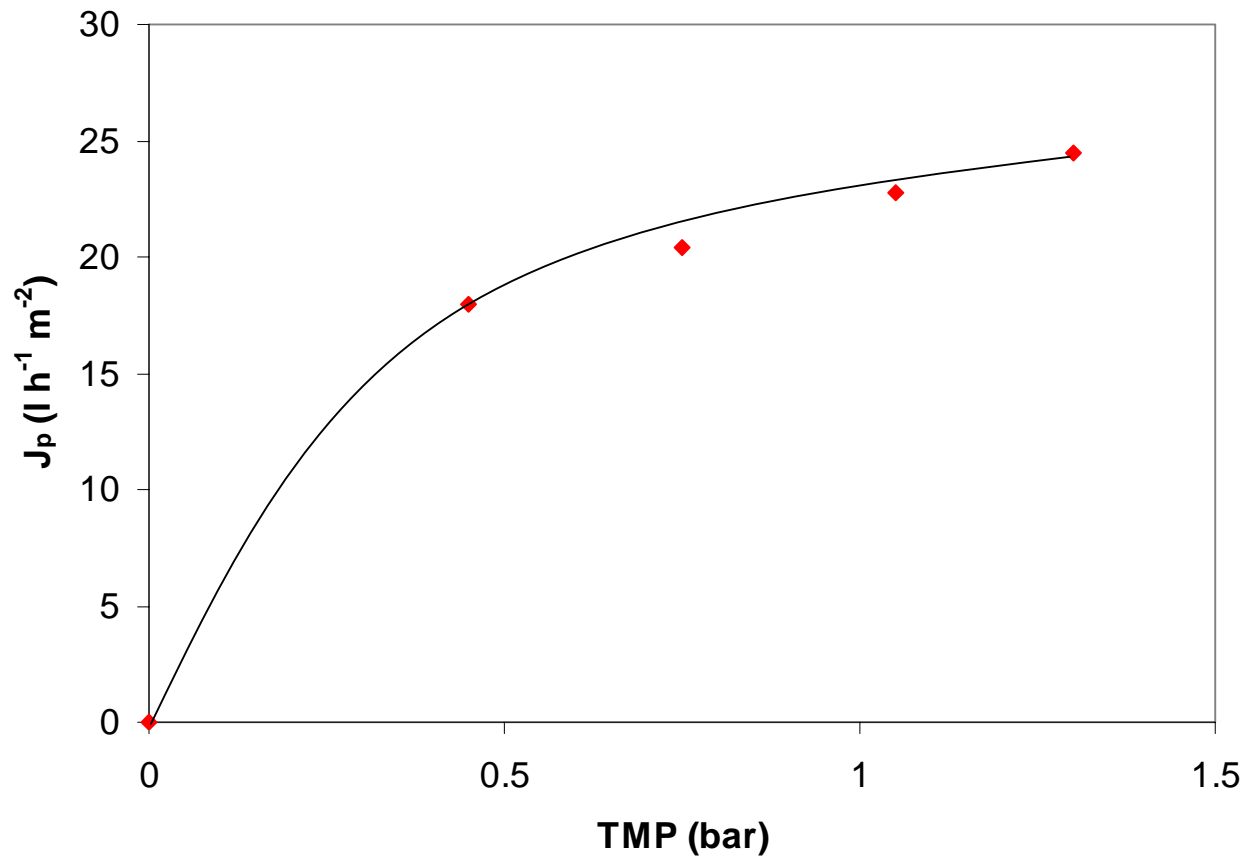

UF of carrot juice. Effect of the transmembrane pressure on the permeate flux

(Operating conditions: $T = 23.5 \text{ }^\circ\text{C}$; $Q_f = 800 \text{ l/h}$)



Effect of the feed flow rate on permeate flux

The ***feed flow rate*** is another important parameter for the performance of the ultrafiltration process. The cross-flow velocity affects the shear stress at the membrane surface and, consequently, the rate of removal of deposited particles responsible of flux decay.

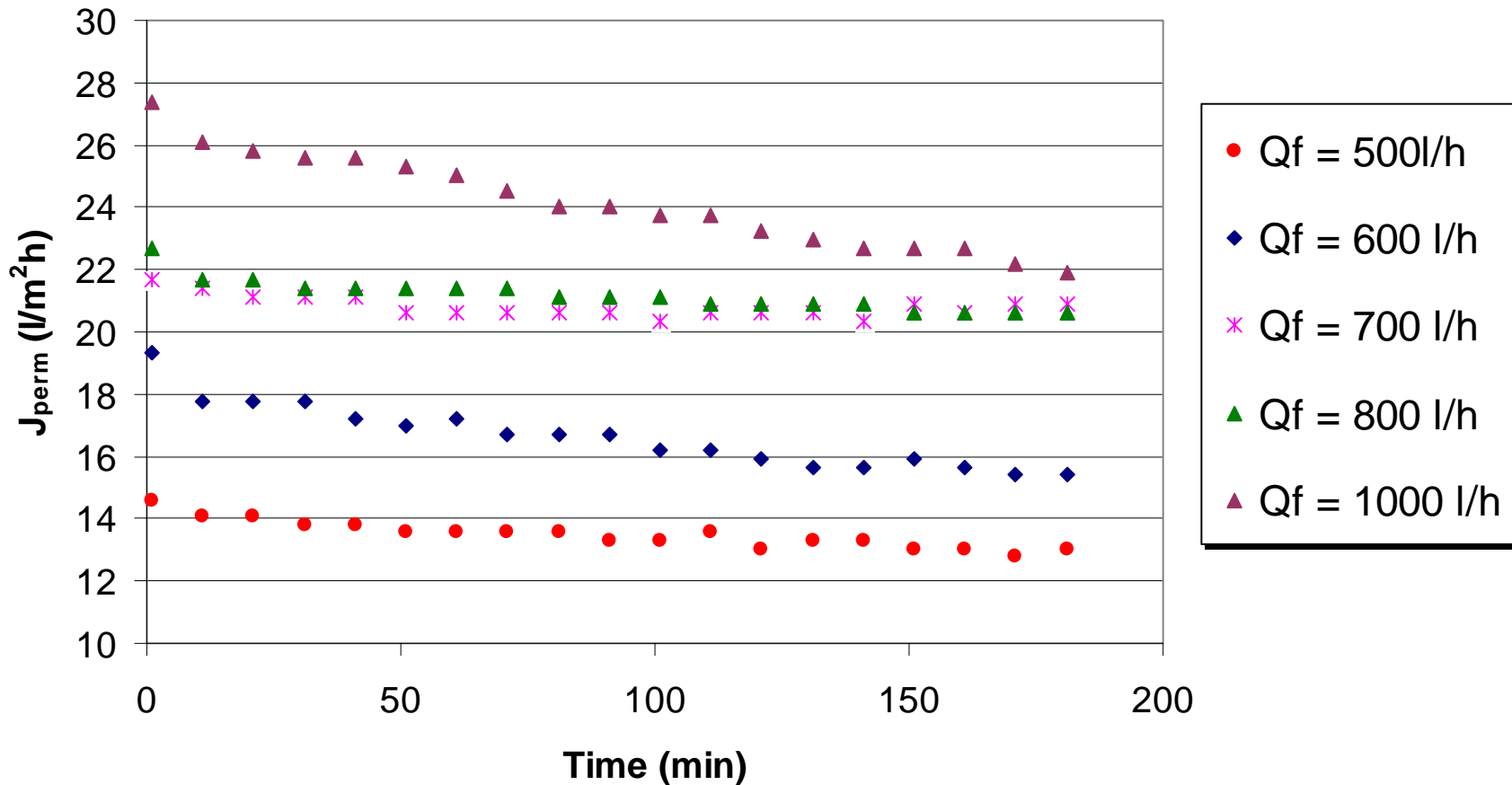

Ultrafiltration of carrot juice
Time course of permeate flux at different axial flow rates
 Operating conditions: T = 23.5 °C; TMP = 0.85 bar



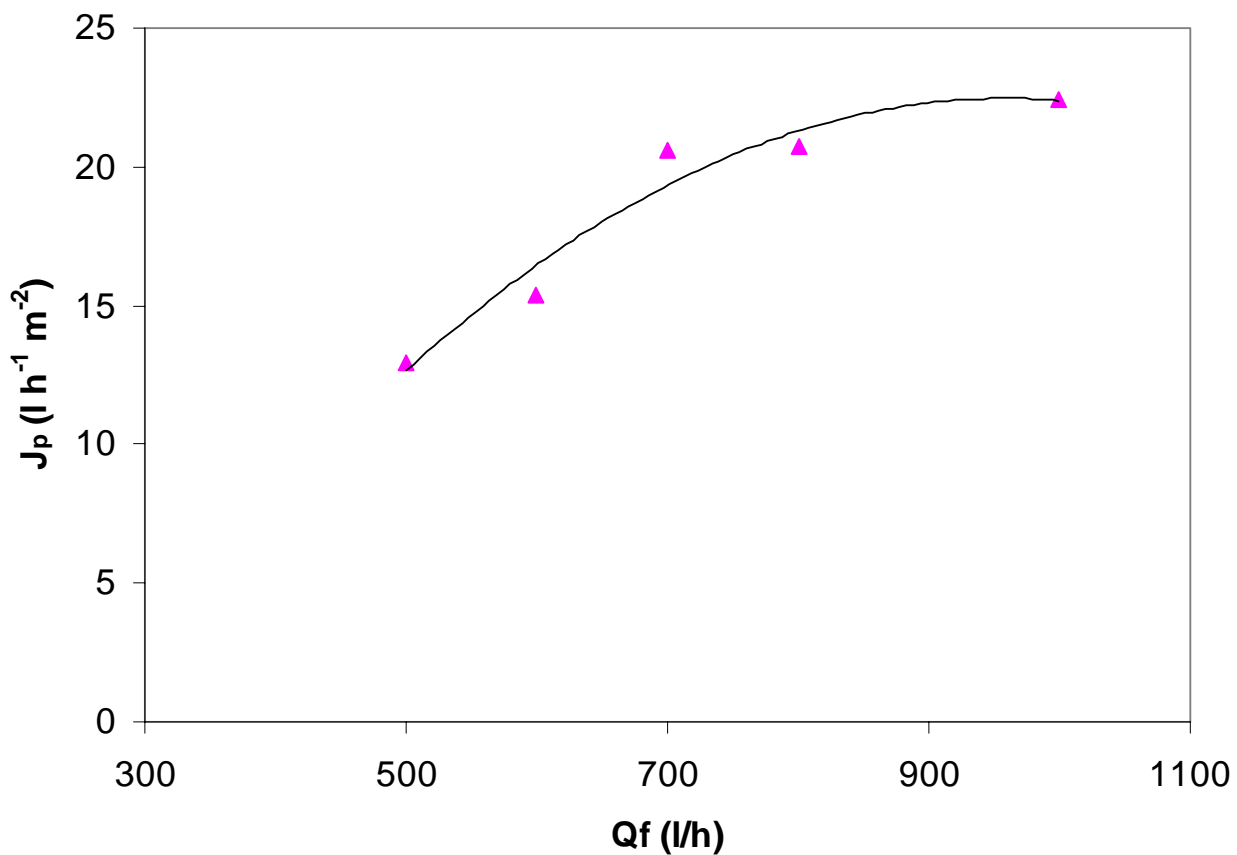

UF of carrot juice. Effect of the axial flow rate on the permeate flux
(Operating conditions: $T = 23.5$ °C; $TMP = 0.85$ bar)

Effect of the temperature on permeate flux

When the ***operating temperature*** is raised the feed viscosity is reduced and diffusion coefficients of macromolecules increase. The effect of these two factors is to enhance mass transfer and so increase the permeation rate

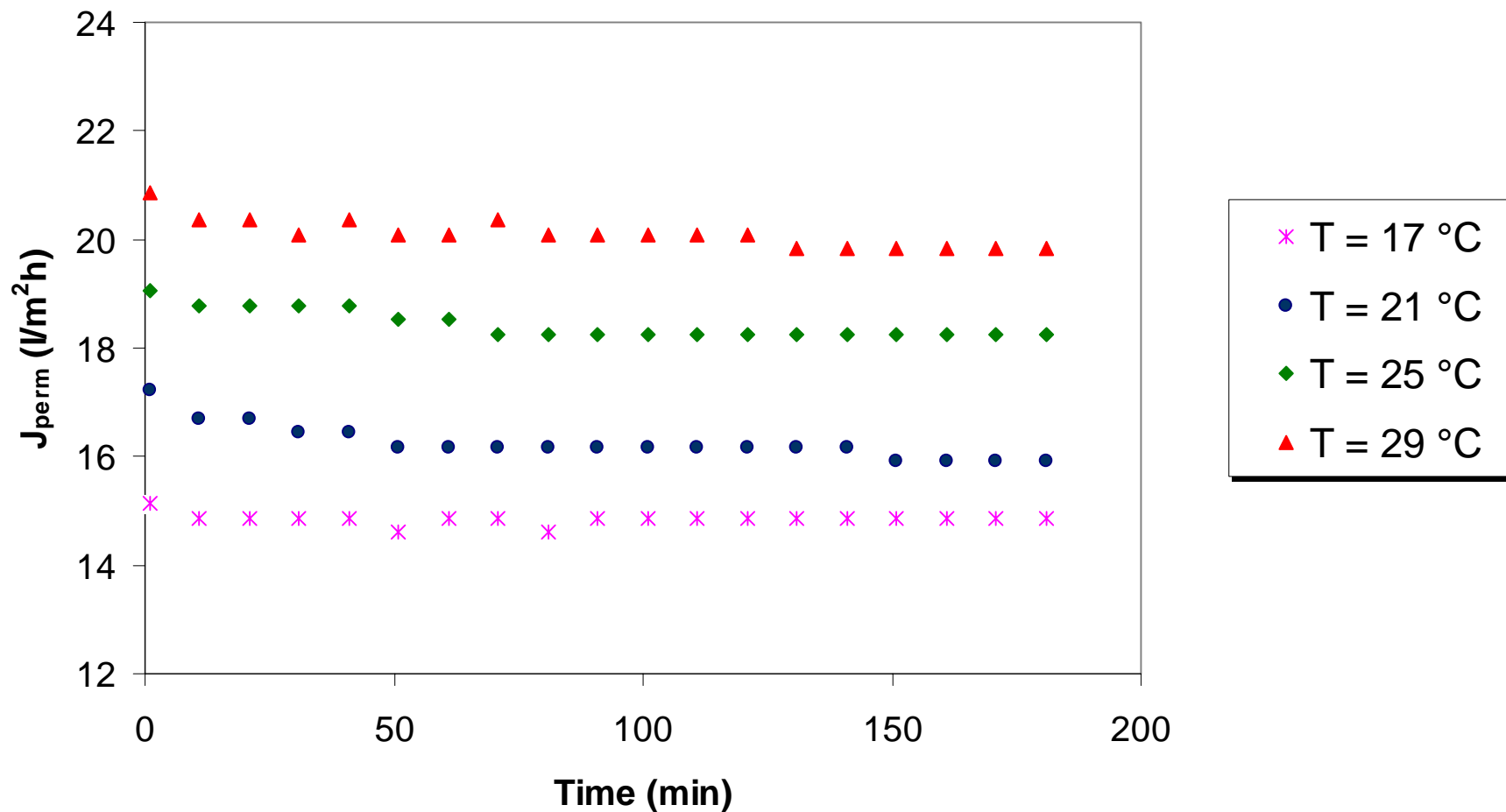

Ultrafiltration of carrot juice
Time course of permeate flux at different temperatures
Operating conditions: TMP = 0.85 bar; Q_f = 800 l/h



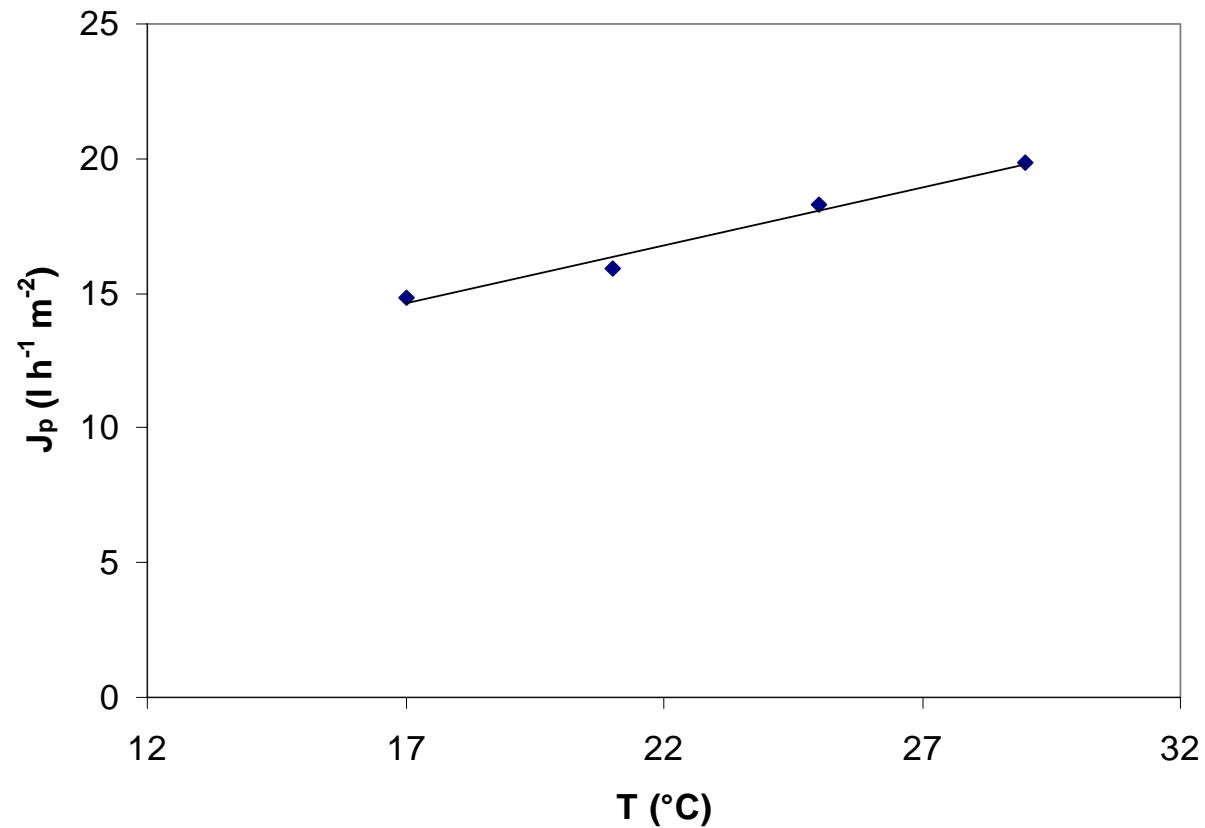

UF of carrot juice. Effect of the temperature on the permeate flux
(Operating conditions: $Q_f = 800$ l/h; $TMP = 0.85$ bar)

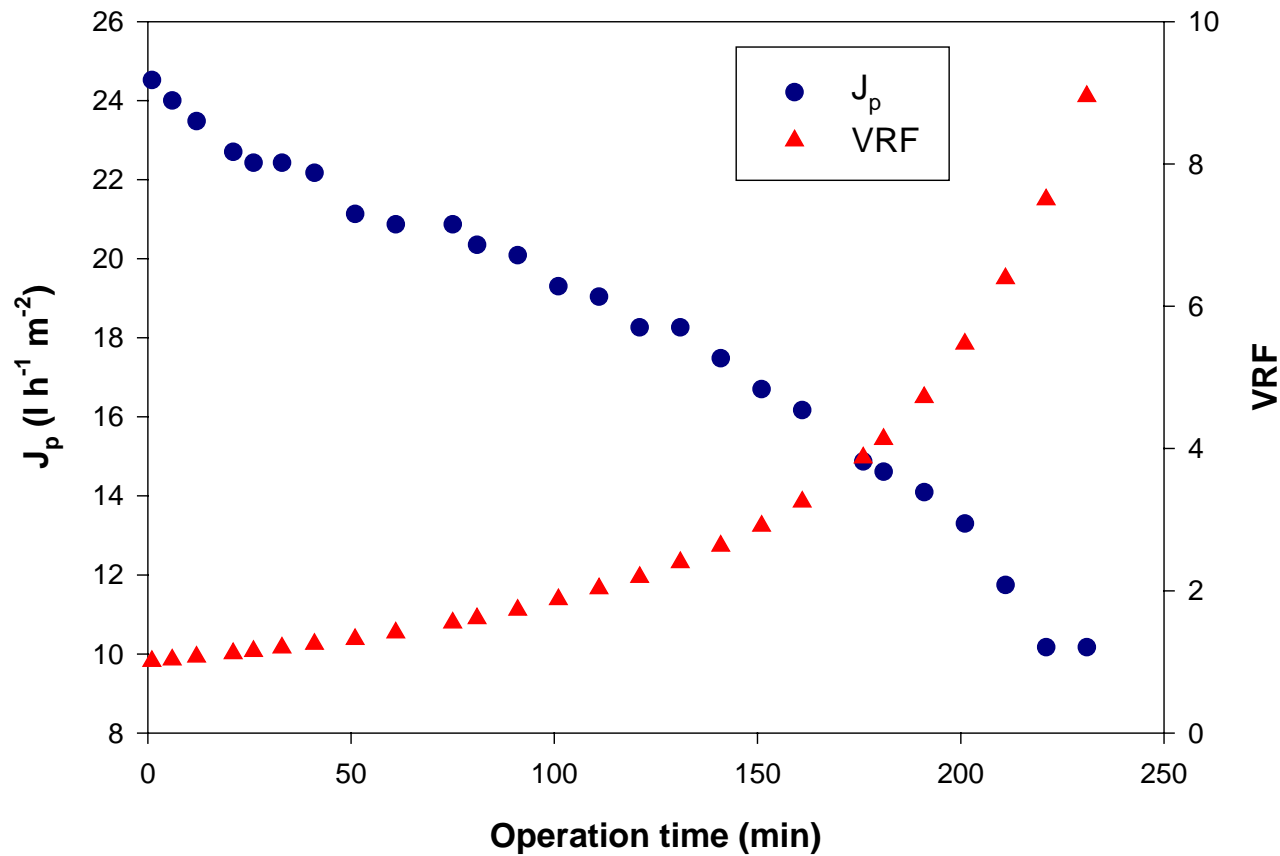

UF of carrot juice. Time course of permeate flux and VRF
(Operating conditions: $T = 23.5\ ^\circ\text{C}$; $Q_f = 800\ \text{l/h}$; $\text{TMP} = 1.03\ \text{bar}$)

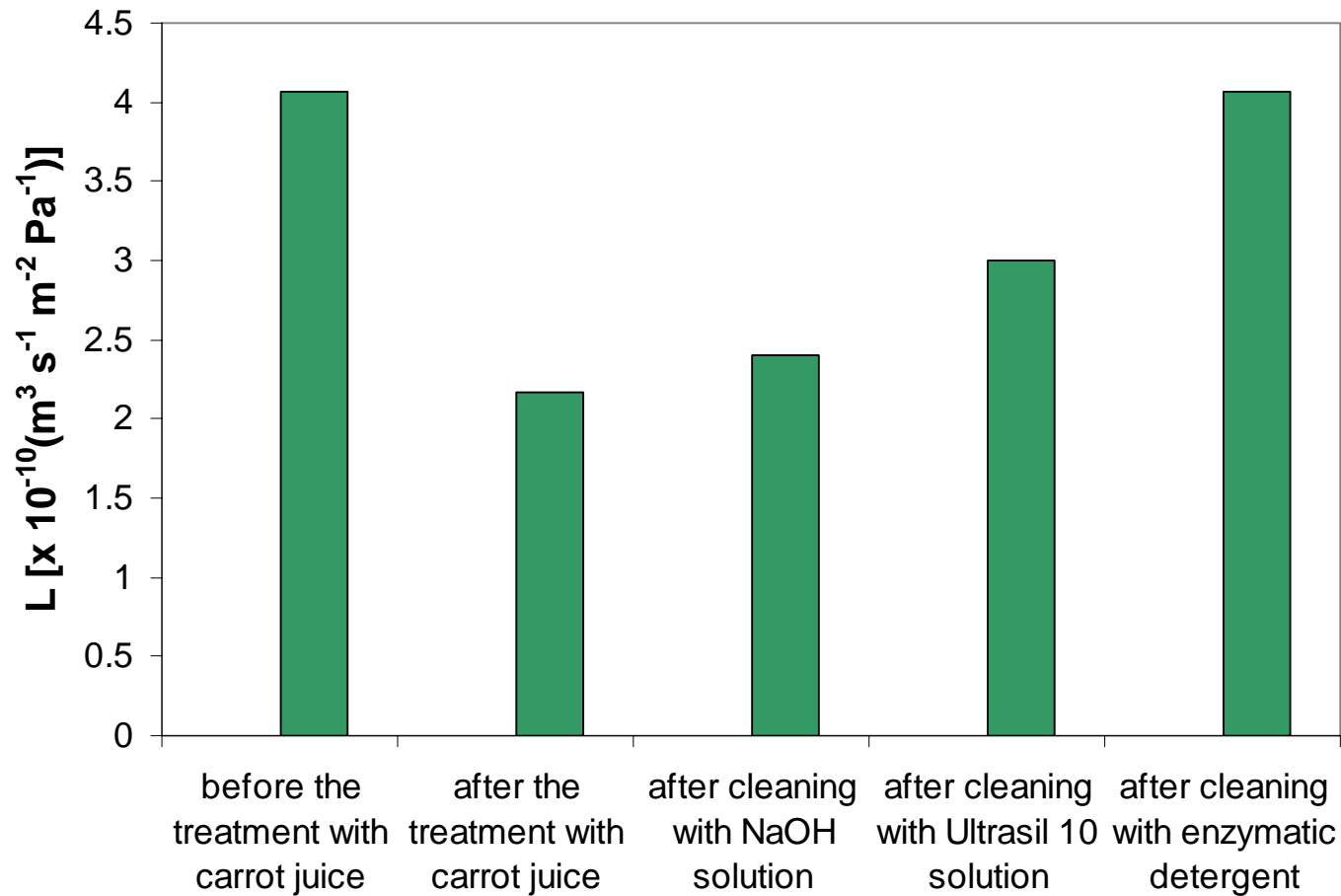

Regeneration of water permeability in UF membrane module
(Operating conditions: $T = 25 \text{ }^\circ\text{C}$; $v_f = 0.09 \text{ m s}^{-1}$)

Advantages of the UF treatment

- ⇒ reduction of clarification times
- ⇒ removal of suspended solids and turbidity
- ⇒ simplification of the clarification processes
- ⇒ increasing of clarified juice volumes
- ⇒ possibility to operate at room temperature preserving the juice's freshness, aroma and nutritional value
- ⇒ possibility to avoid gelatines, adsorbents and other filtration coadiuvant
- ⇒ improvement of the productive process

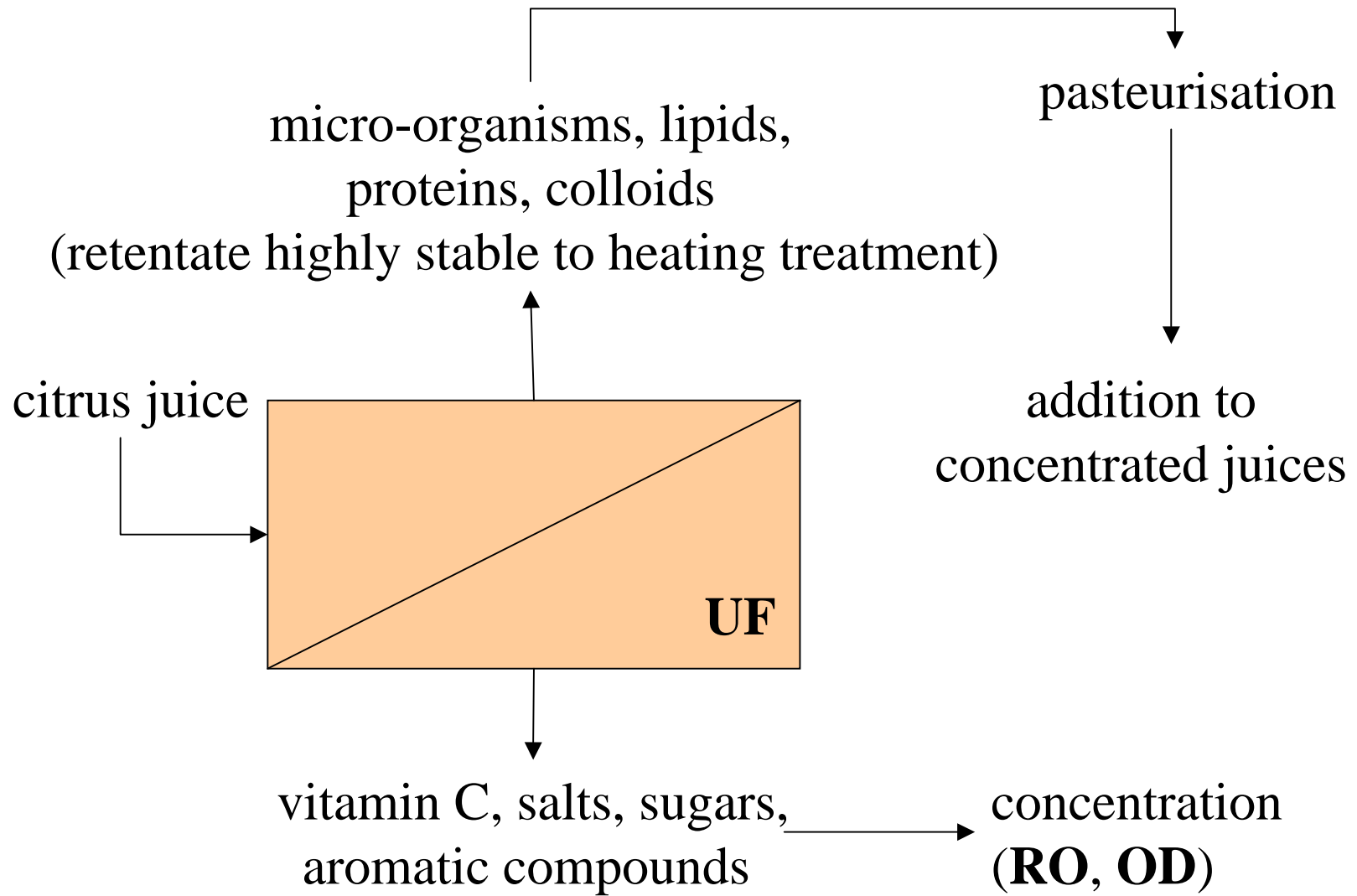

Osmotic distillation process

OD is a new membrane process also called "isothermal MD" that can be used to remove selectively water from aqueous solutions under atmospheric pressure and at room temperature, avoiding thermal degradation

It involves the use of a microporous hydrophobic membrane to separate two circulating aqueous solutions at different solute concentrations: a dilute solution and an hypertonic salt solution. The difference in solute concentrations, and consequently in water activity of both solutions, generates, at the vapour-liquid interface, a vapour pressure difference causing a vapour transfer from the dilute solution towards the stripping solution.

The water transport through the membrane can be summarised in three steps:

- evaporation of water at the dilute vapour-liquid interface
- diffusional or convective vapour transport through the membrane pore
- condensation of water vapor at the membrane/brine interface.

During the OD process the stripping solution is diluted due to the water transfer from the feed stream. It can be reconcentrated by evaporation and in this sense it can be recycled and reused in the process.



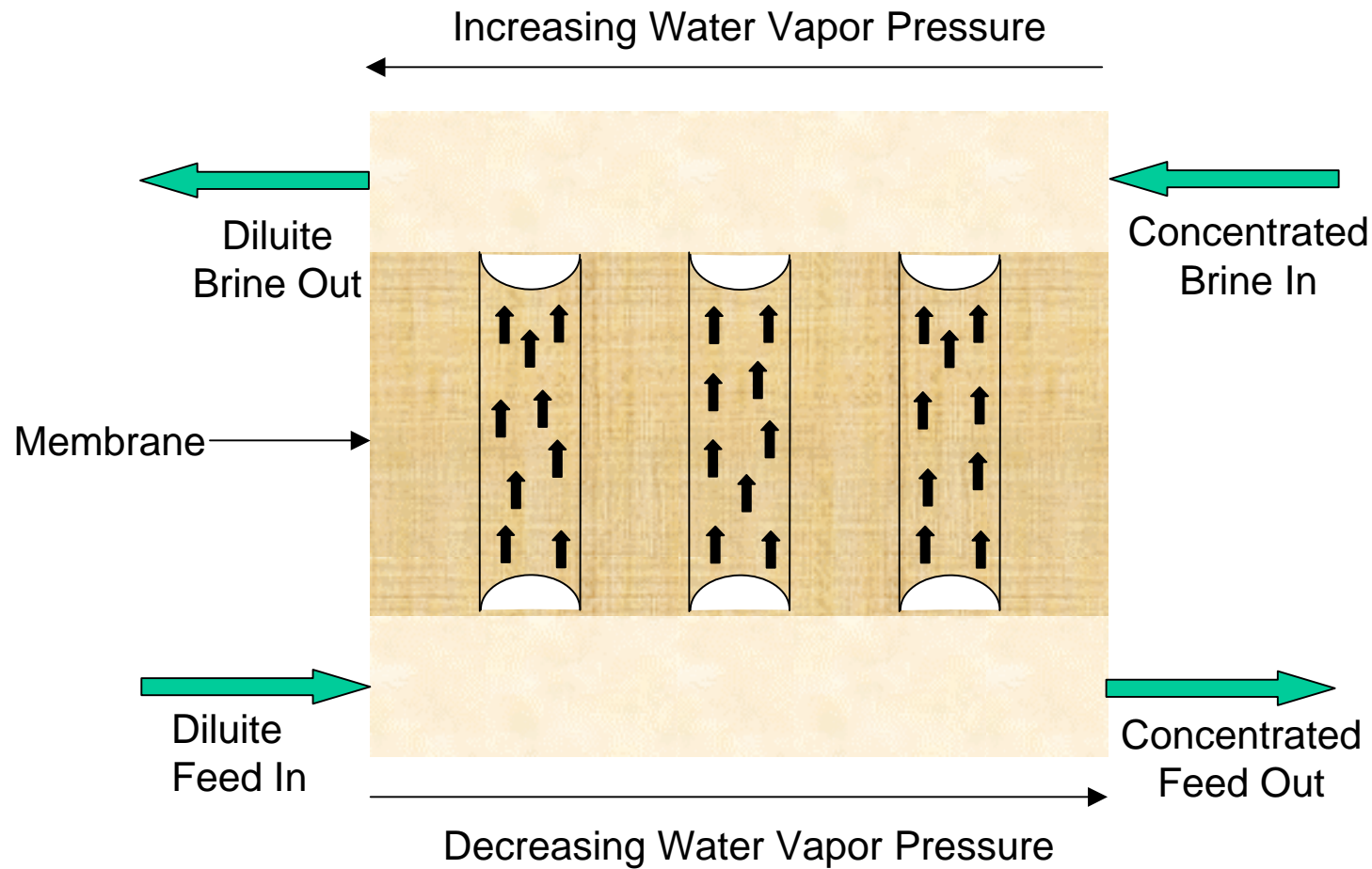

Mechanism of osmotic distillation through a microporous hydrophobic membrane (Hogan et al., 1998)

The clarified juice was submitted to OD experiments using a laboratory plant equipped with a Hoechst-Celanese Liqui-Cel membrane contactor. The juice was recirculated in the shell side of the membrane module; Calcium Chloride Dihydrate, recirculated in the tube side of the module, was used as stripping solution. It was chosen because it is not toxic, and it is readily available at low cost.

Fiber Characteristics

Fiber type

Celgard[®] Microporous
Polypropylene Hollow fiber

Cartridge Operating Limits

Maximum Transmembrane Differential Pressure

4.2 kg/cm² (60 psi)

Maximum Operating Temperature Range

40 °C (104 °F)

Cartridge Characteristics

Cartridge Dimensions (DxL)

8x28 cm (2.5x8 in)

Effective Surface Area

1.4 m² (15.2 ft²)

Effective Area/Volume

29.3 cm²/cm³

Fiber Potting Material

Polyethylene

Brine solution (Tube side)

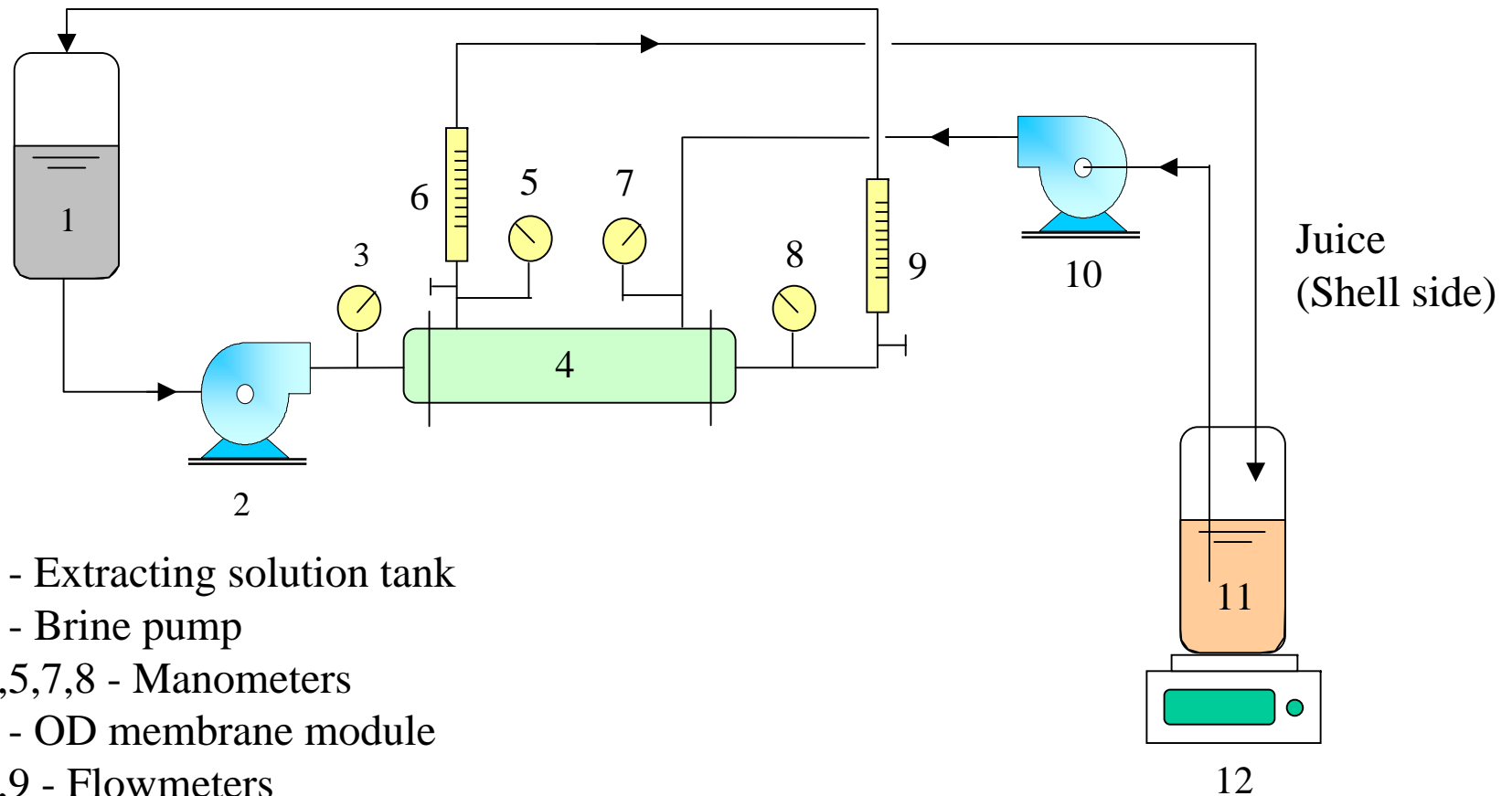

Osmotic distillation laboratory plant

2.5"x8" LiquiCel module - Hoechst Celanese

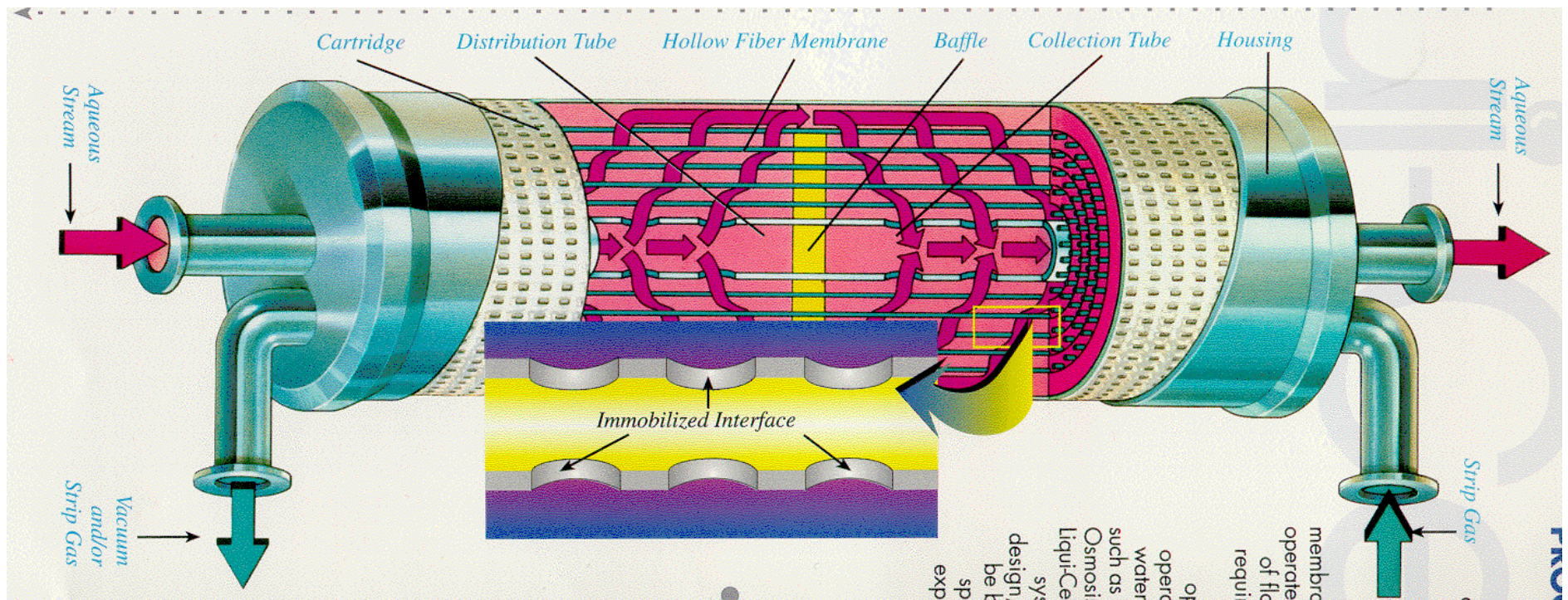

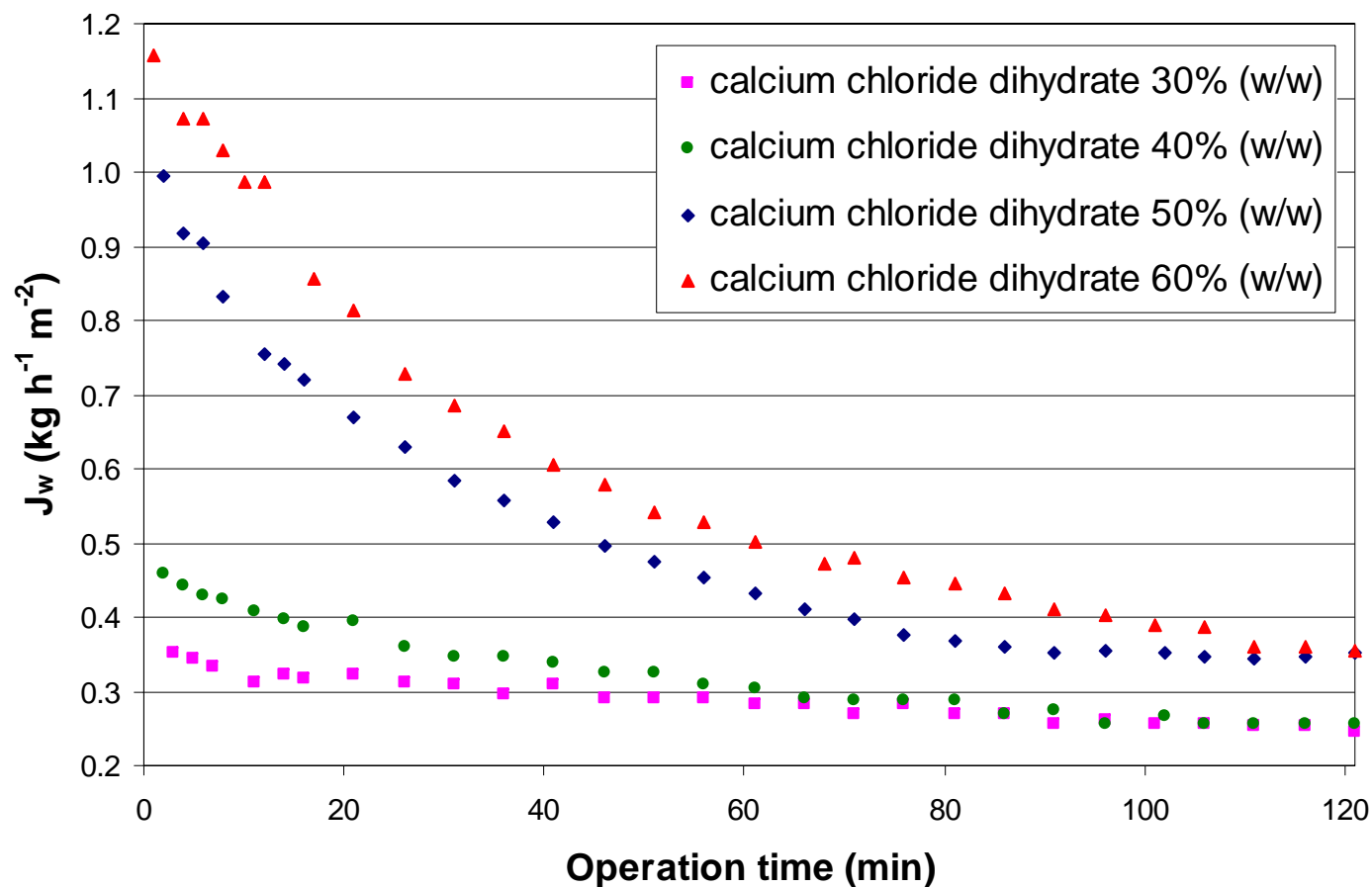

Characterisation of OD membrane module with water
(Operating conditions: $T = 25 \text{ }^\circ\text{C}$; $Q_f = 29.8 \text{ l h}^{-1}$; $Q_b = 37.8 \text{ l h}^{-1}$)



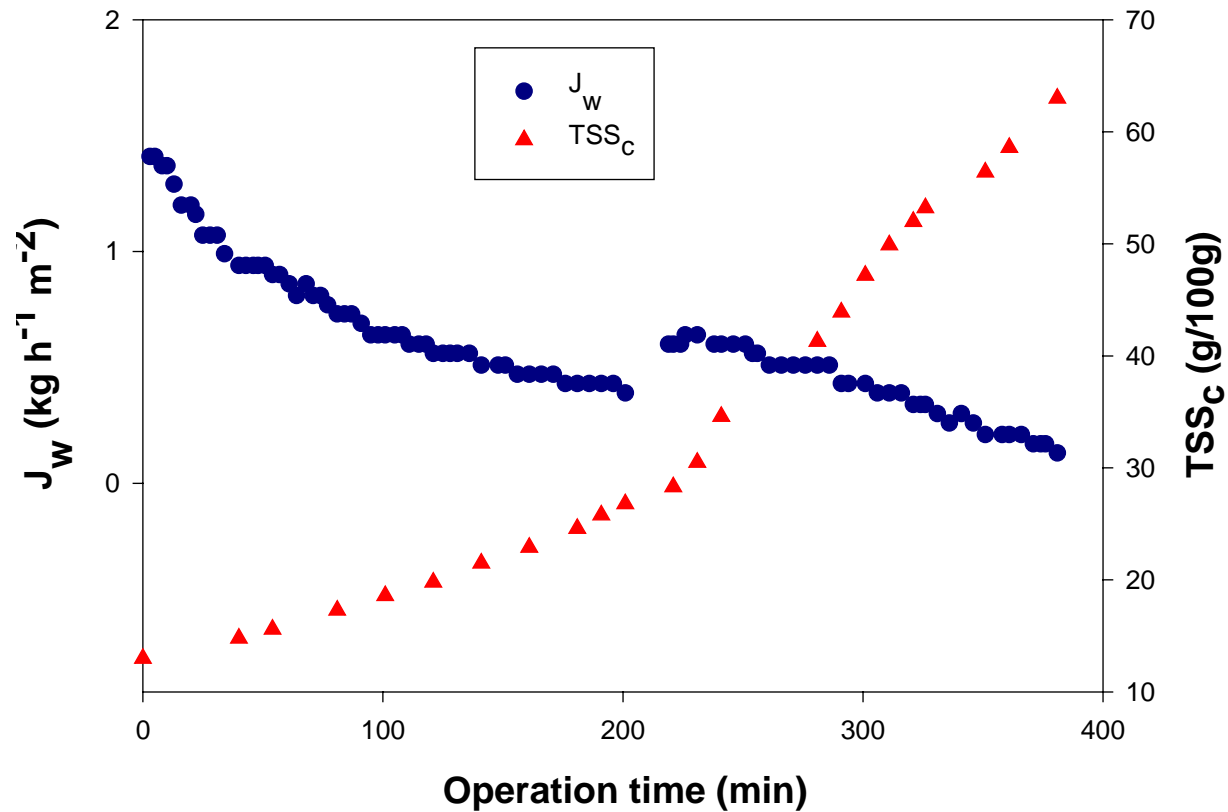

OD of carrot juice coming from a sequence UF-RO

Time course of evaporation flux and TSS concentration

(Operating conditions: $T = 26 \text{ }^\circ\text{C}$; $Q_f = 28 \text{ l h}^{-1}$; $Q_b = 69 \text{ l h}^{-1}$; $\text{TMP} = 0.13 \text{ bar}$)

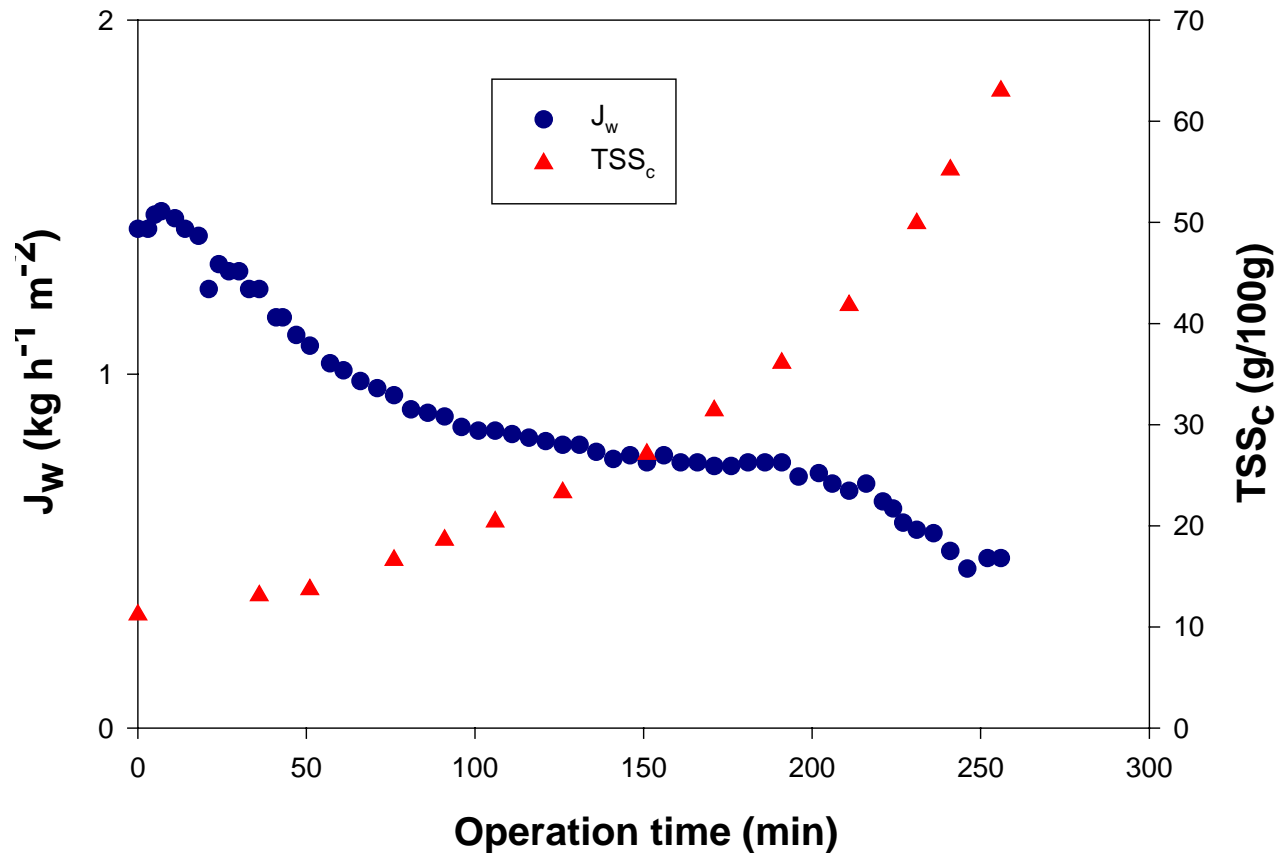

OD of blood orange juice coming from a UF treatment
Time course of evaporation flux and TSS concentration

(Operating conditions: $T = 26 \text{ }^\circ\text{C}$; $Q_f = 28 \text{ l h}^{-1}$; $Q_b = 69 \text{ l h}^{-1}$; $\text{TMP} = 0.13 \text{ bar}$)

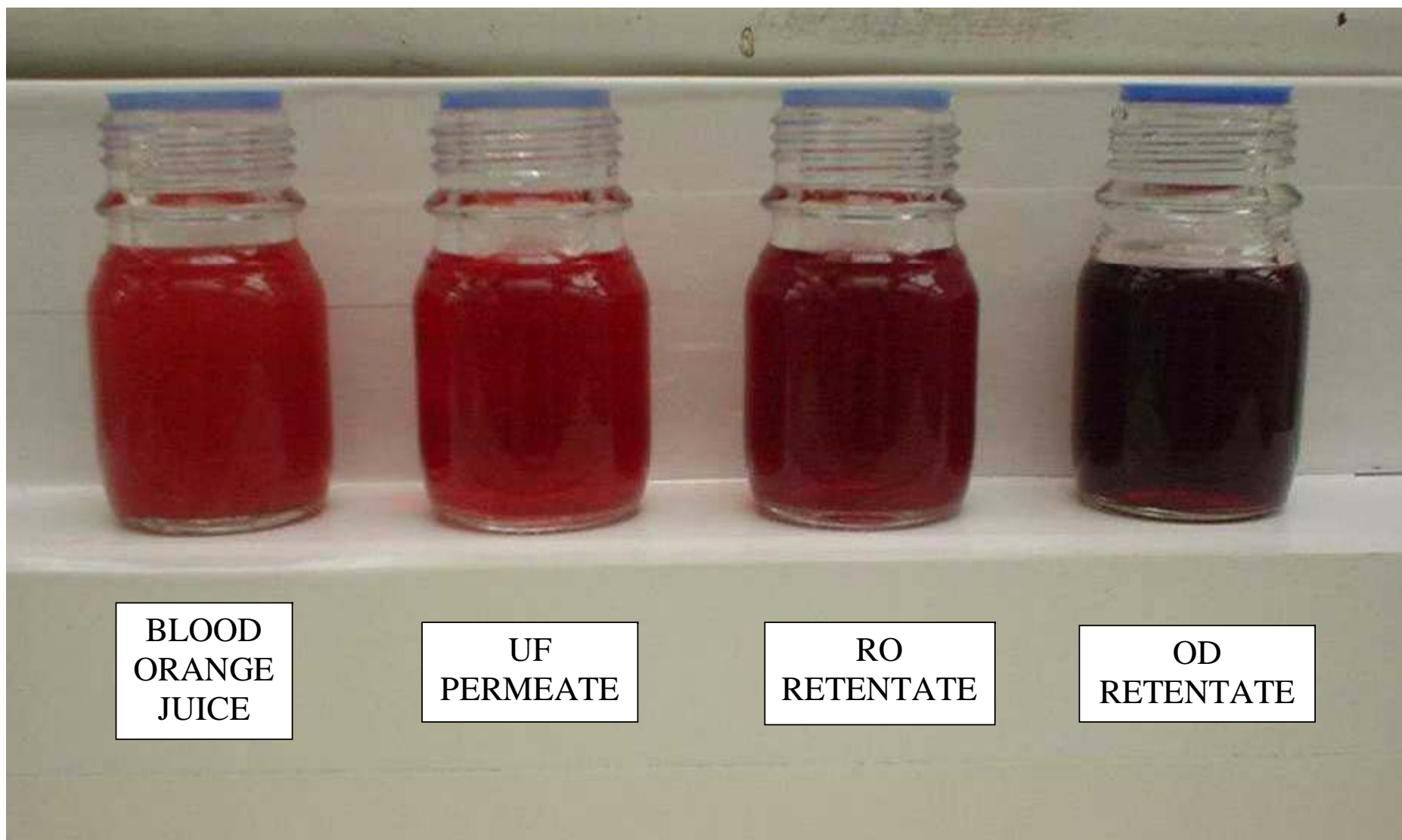

TAA measurements

In the traditional concentrated juice (TC, 56.3 °Brix) a decrease of the antioxidant activity (20-25%) was measured (6.85 ± 0.20 mM trolox), in comparison with the fresh juice (8.61 ± 0.07 mM trolox). During the ultrafiltration process TAA was maintained both for the permeate and for the retentate (UFP 8.48 mM trolox; UFR, 8.52 mM trolox). The subsequent concentration treatment by osmotic distillation did not induce other significant changes to TAA, independently from the final concentration obtained: the highly concentrated sample at 61 °Brix still showed a high value of TAA (7.66 mM trolox).

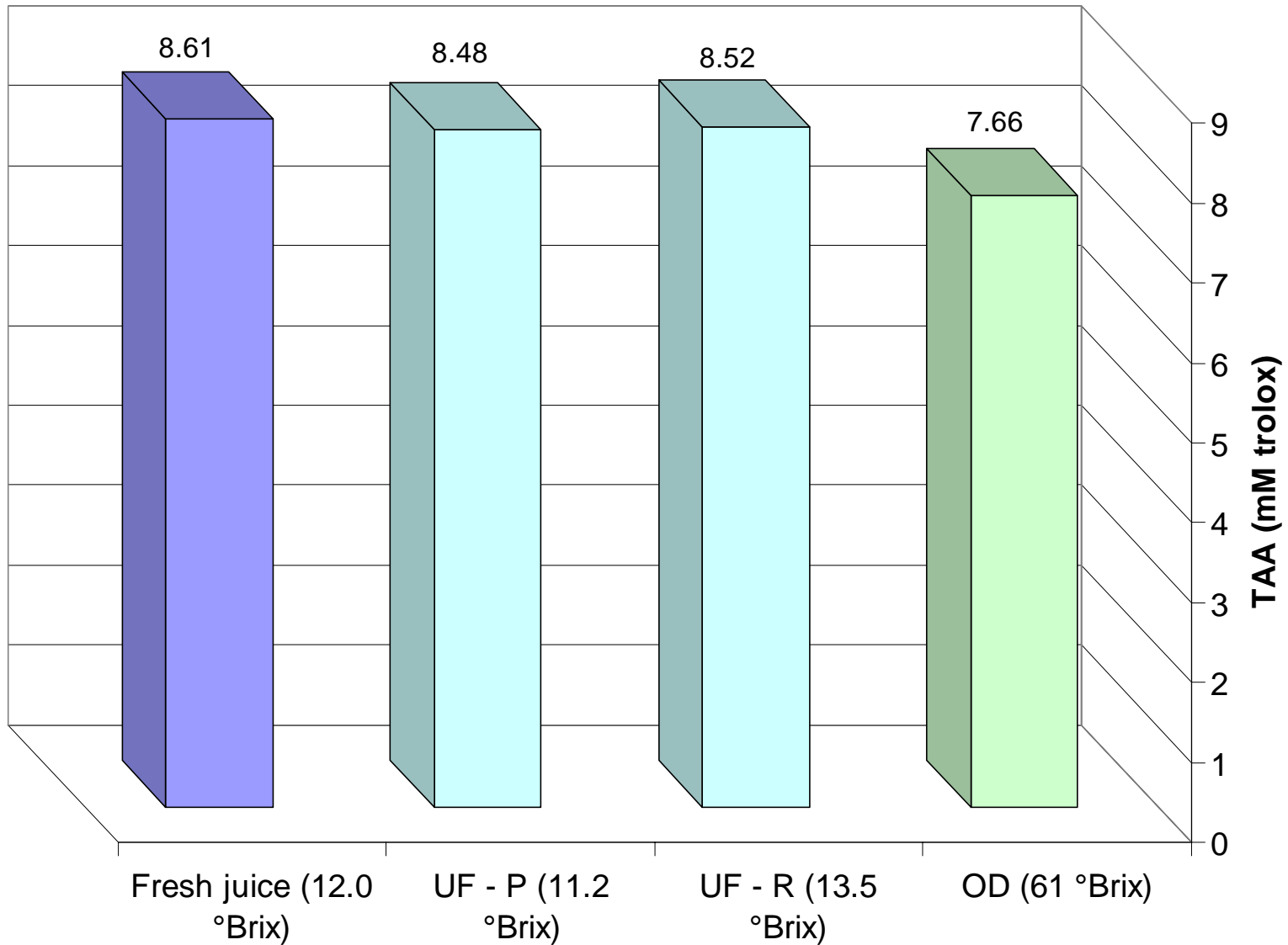

TAA variation in samples coming from a UF-OD sequence



Ascorbic acid measurements in samples of blood orange juice treated by membrane processes

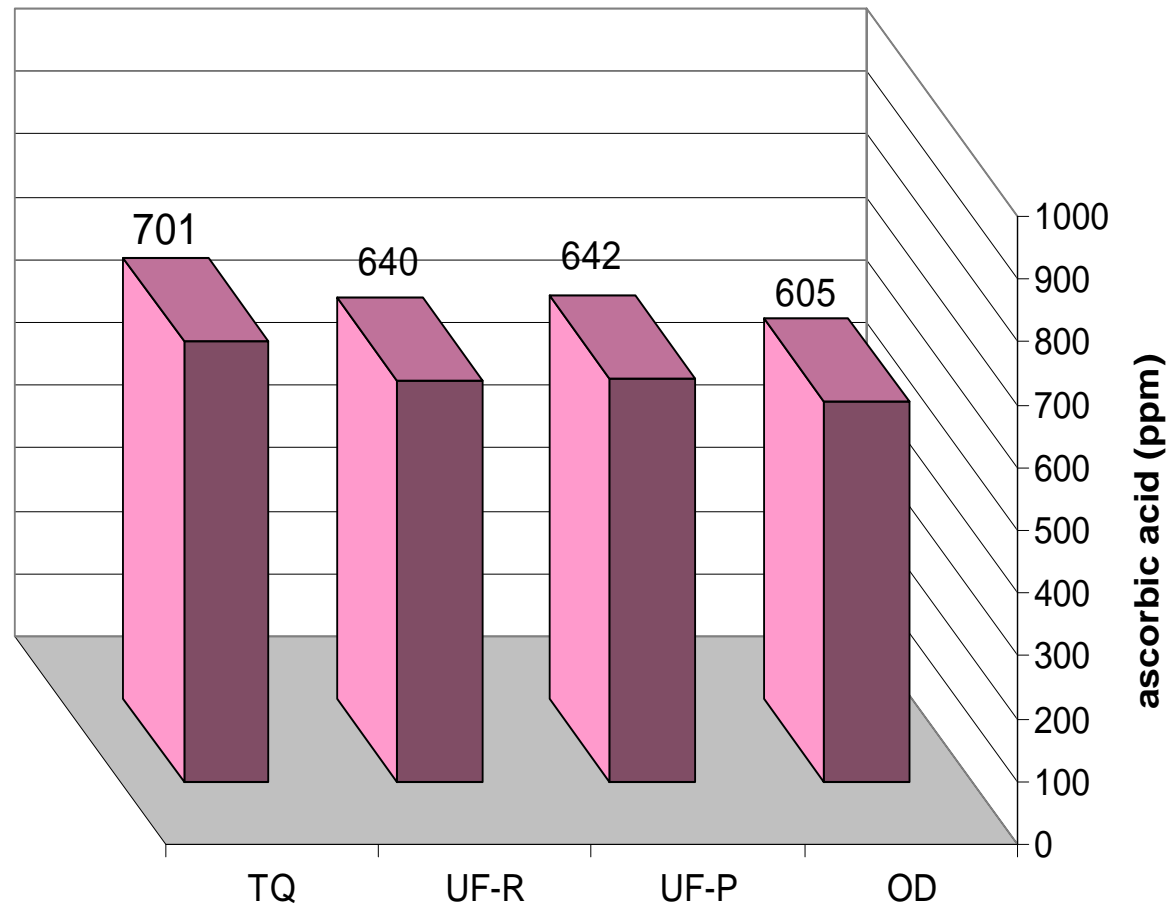

Flavonoids in samples of blood orange juice treated by membrane processes

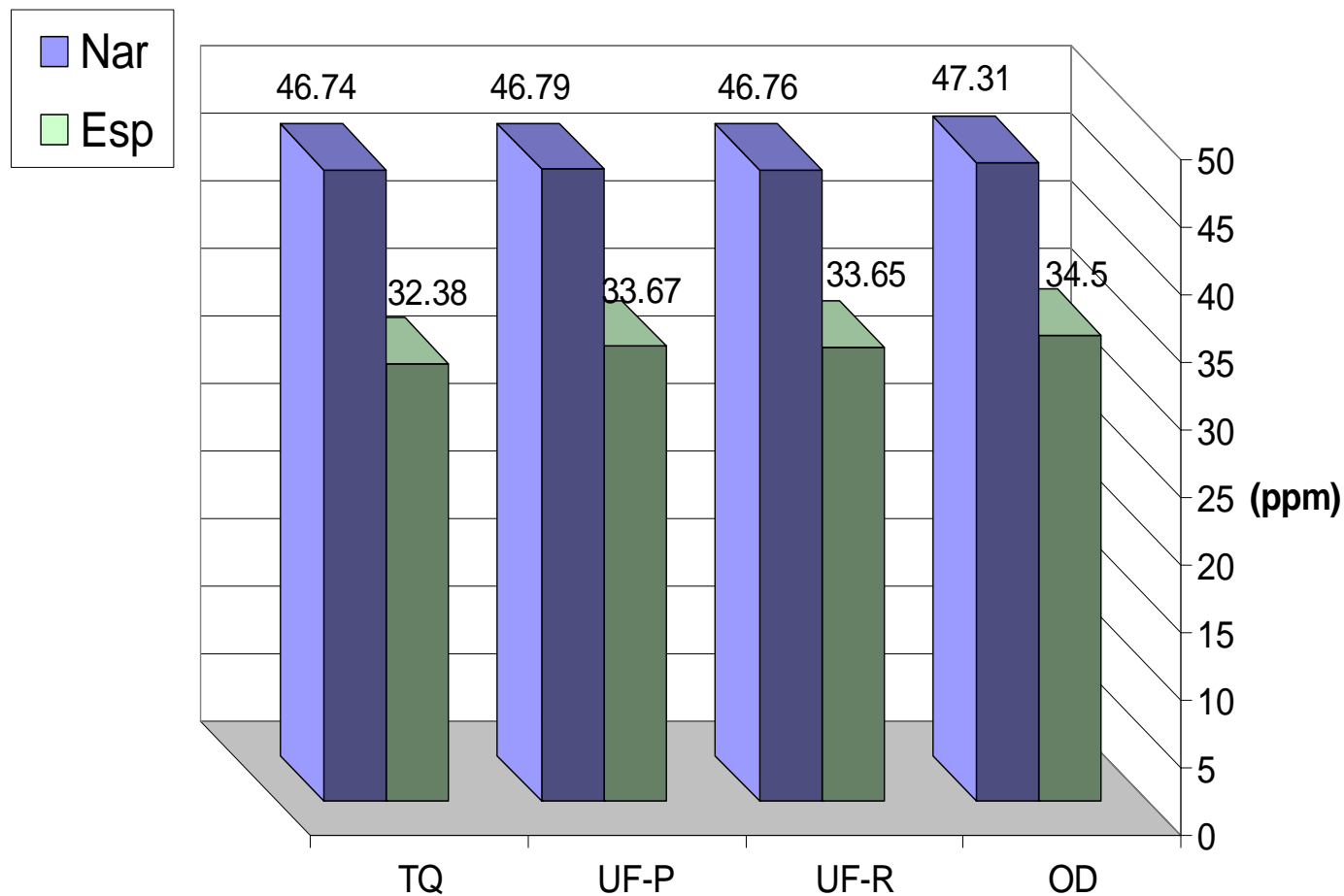

Hydroxycinnamic acids in samples of blood orange juice treated by membrane processes

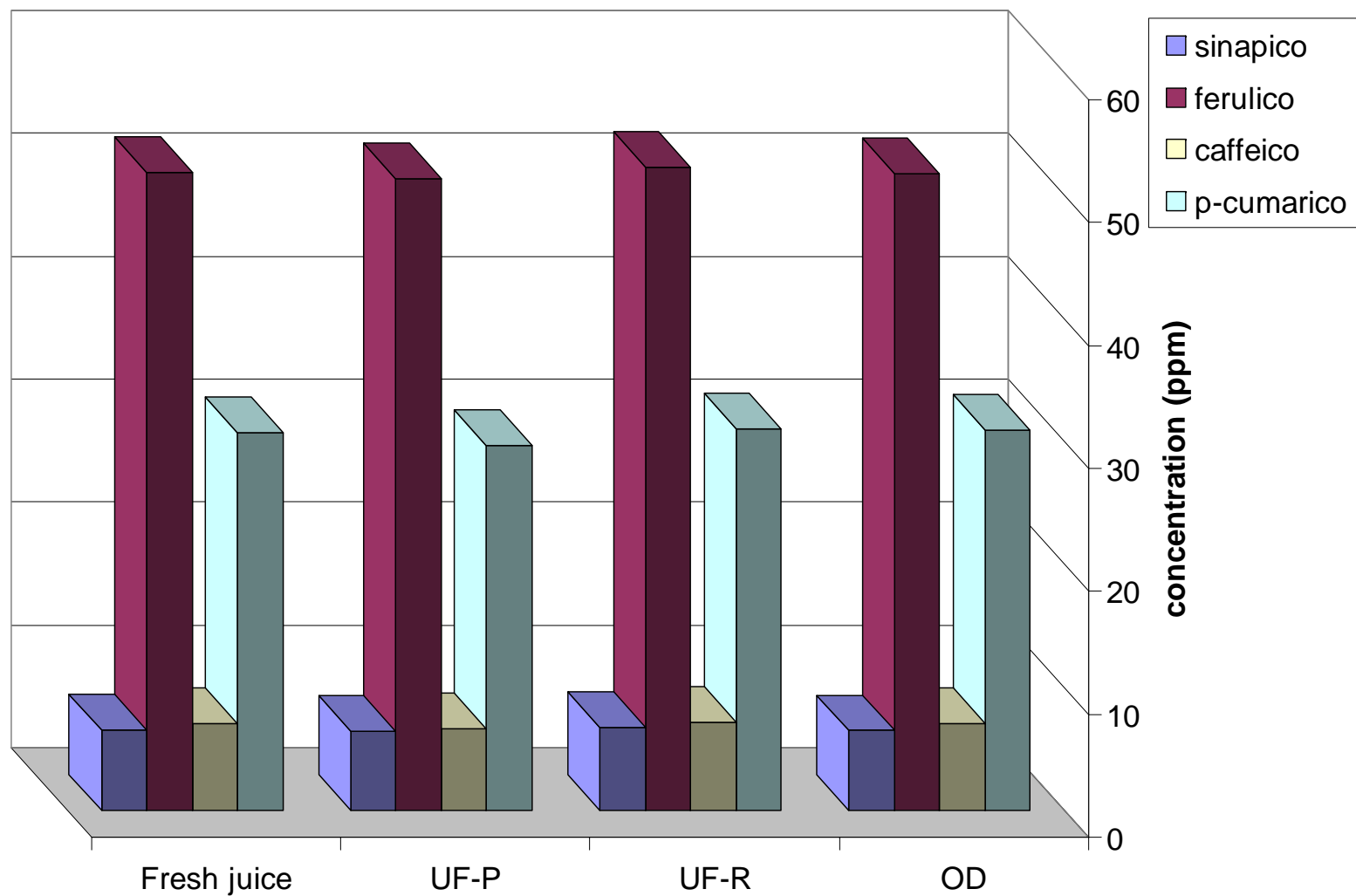

Anthocyanins in samples of blood orange juice treated by membrane processes

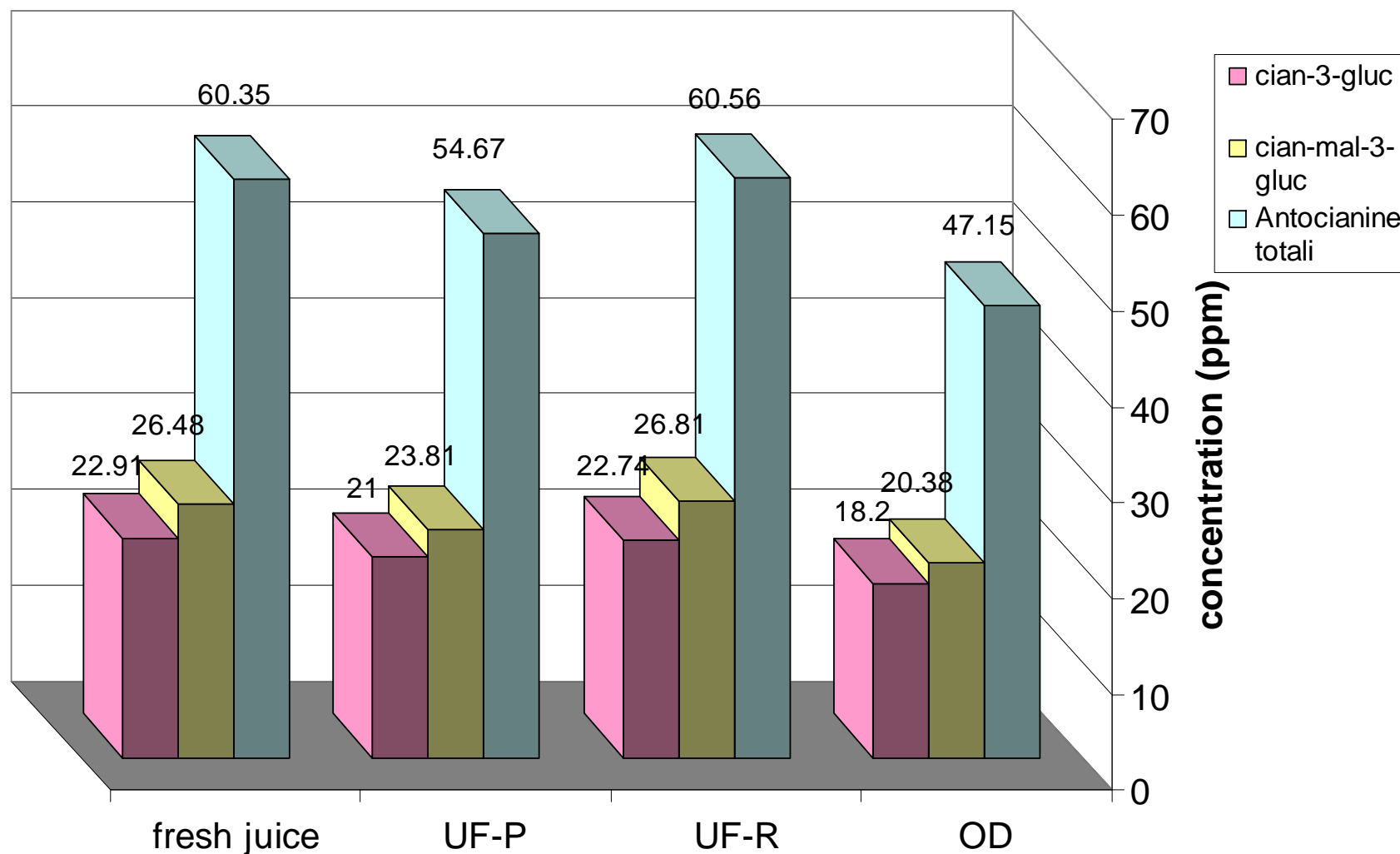

UF and OD permit to preserve the TAA of the juice also in highly concentrated samples (61 °Brix). Slight reductions were observed for the ascorbic acid and anthocyanins whereas the other components remained practically unchanged (hydroxycinnamic acids and flavonoids). On the contrary, a very high degradation of these components was observed in the thermal concentrated juice.

The juice concentrated with the proposed membrane technology retain its bright red colour and large part of its pleasant aroma, which is on the contrary completely lost during thermal concentration.

Thus, this product is more similar to a fresh orange juice, being aroma, colour and natural antioxidants better preserved during concentration.

Integrated membrane processes for clarification and concentration of kiwifruit juice

*Research activities concerning the clarification and concentration of kiwifruit juice are in progress. **Ultrafiltration** is studied for the clarification of the raw kiwifruit juice. Studies on the identification of suitable membranes, the optimal operating conditions and feed pretreatment are in progress.*

*The UF permeate is concentrated by **osmotic distillation**. In this process the optimal operating conditions and the effect of these parameters on the evaporation fluxes are under studying.*

*A **pervaporation** step for the recovery of aroma compounds from UF or OD streams is under studying. An integrated membrane process for the production of concentrated kiwifruit juice with high nutritional value will be developed.*

Collaborations

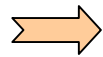

Citrus Research Institute, Chinese Academy of Agricultural Sciences, Beibei, Chongqing, China



KIWIFRUIT PROPERTIES

- ➔ Kiwifruit originates from an indigenous plant of southern China (*Actinidia Chinensis*)
- ➔ Italy is the world's largest kiwi producer with a production of about 300,000 tons/year (33% of the world-wide production) and a cultivation area of 19,000 hectares distributed mainly in 4 regions (Latium, Emilia-Romagna, Piedmont and Apulia)
- ➔ Kiwifruit is the most nutrient dense of all fruits with an index of 16 (daily value/100 grams)
- ➔ It has impressive antioxidant capacity, containing a wealth of phytonutrients (carotenoids, lutein, phenolics, flavonoids and chlorophyll)
- ➔ Content in sodium and fat is very low (kiwifruit contain no cholesterol)

Kiwifruit offers benefits for specific health conditions

- ⇒ **CANCER** (antimutagenic component helping to prevent genetic mutations)
- ⇒ **DEPRESSION** (inositol as a precursor of an intracellular second messenger system, can be beneficial in the treatment of depression)
- ⇒ **DIABETES** (inositol may play a positive role in regulating diabetes)
- ⇒ **EYE HEALTH / MACULAR DEGENERATION** (kiwifruit is rich in phytochemicals, xanthophylls and lutein that have an important role in the prevention of macular degeneration)
- ⇒ **HYPERTENSION** (the sodium-to-potassium ratio is extremely favorable in kiwifruit)
- ⇒ **IMMUNITY** (kiwifruit is considered an immune booster due to its high level of vitamin C)
- ⇒ **PHYSICAL FITNESS** (kiwifruit contains a wide range of minerals essential for replenishing)
- ⇒ **STRESS REDUCTION** (high level of serotonin)
- ⇒ **WEIGHT CONTROL** (kiwifruit contains the best balance of nutrients per calorie)

- ➔ For all the above mentioned characteristics and other important properties (resistance during preservation, sensory characteristics, etc.) *kiwifruits have a great potential for industrial exploitation*
- ➔ The production of concentrated fruit juices is of interest at industrial level since it reduces the storage volumes (reducing transport and storage costs) and facilitates preservation

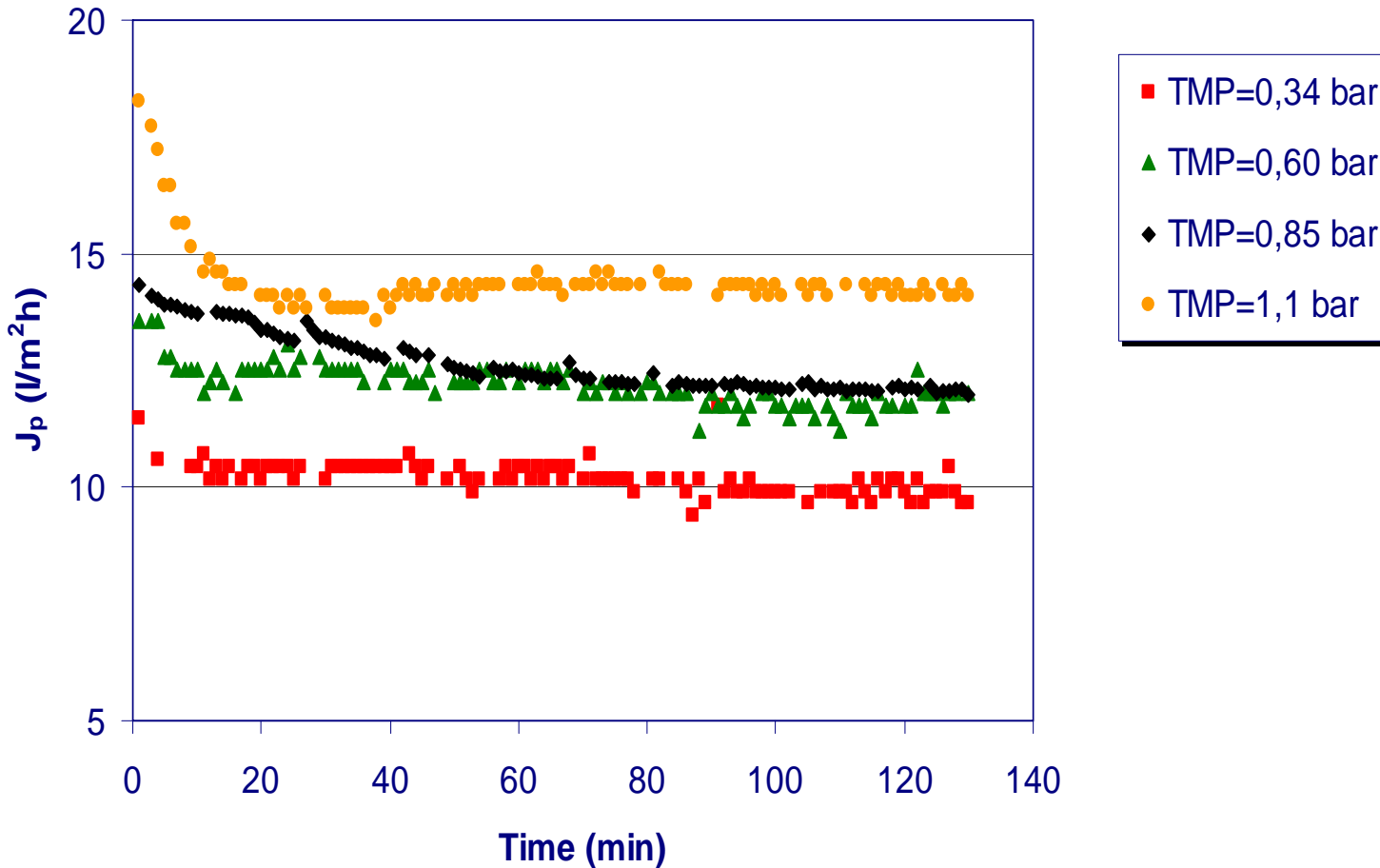

UF of kiwifruit juice. Time course of permeate flux at different TMP
($T = 25\text{ }^\circ\text{C}$; $Q_f = 800\text{ l/h}$)

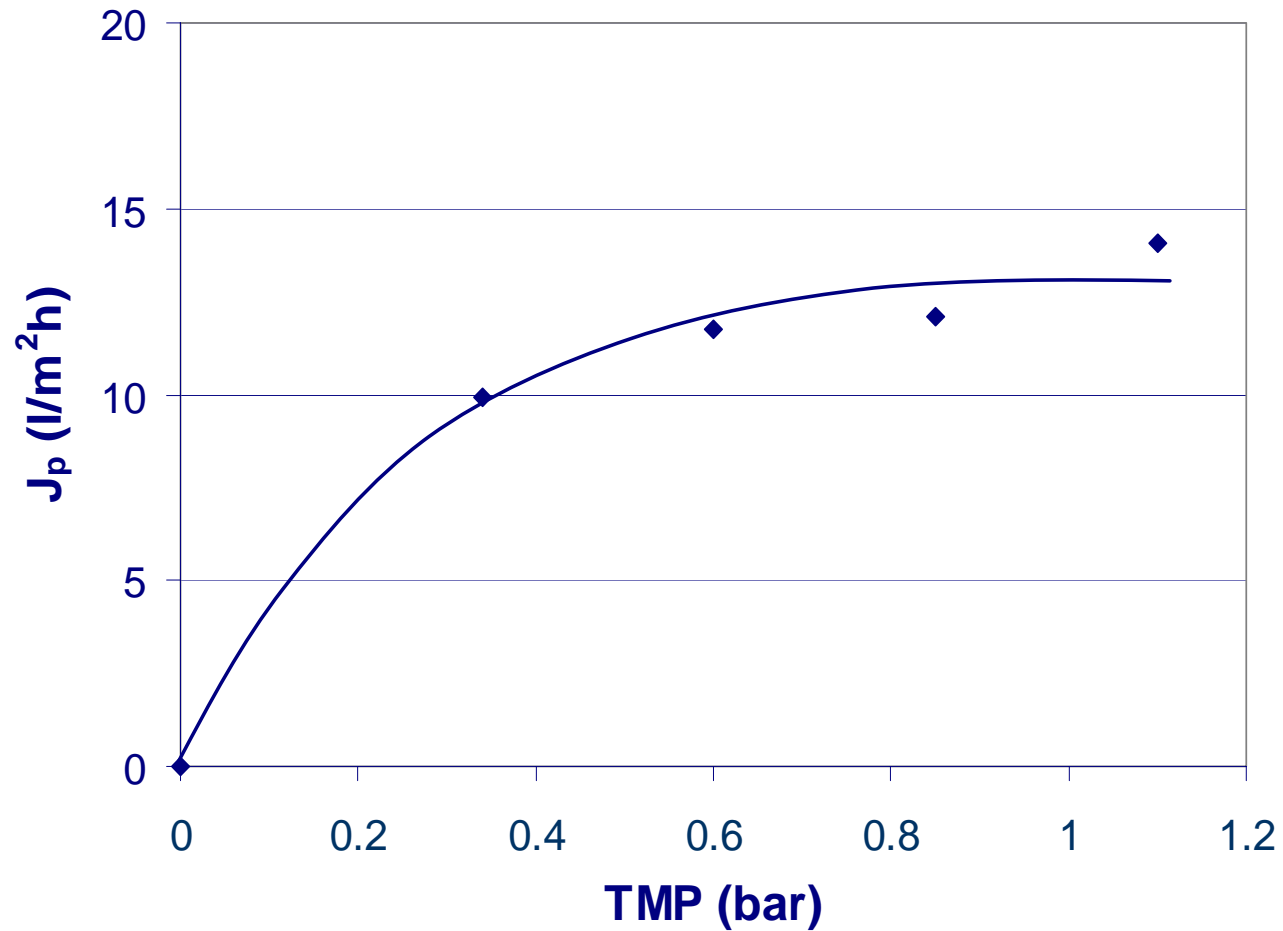

**UF of kiwifruit juice. Permeate flux vs.
TMP**

($T = 25\text{ }^\circ\text{C}$; $Q_f = 500\text{ l/h}$)



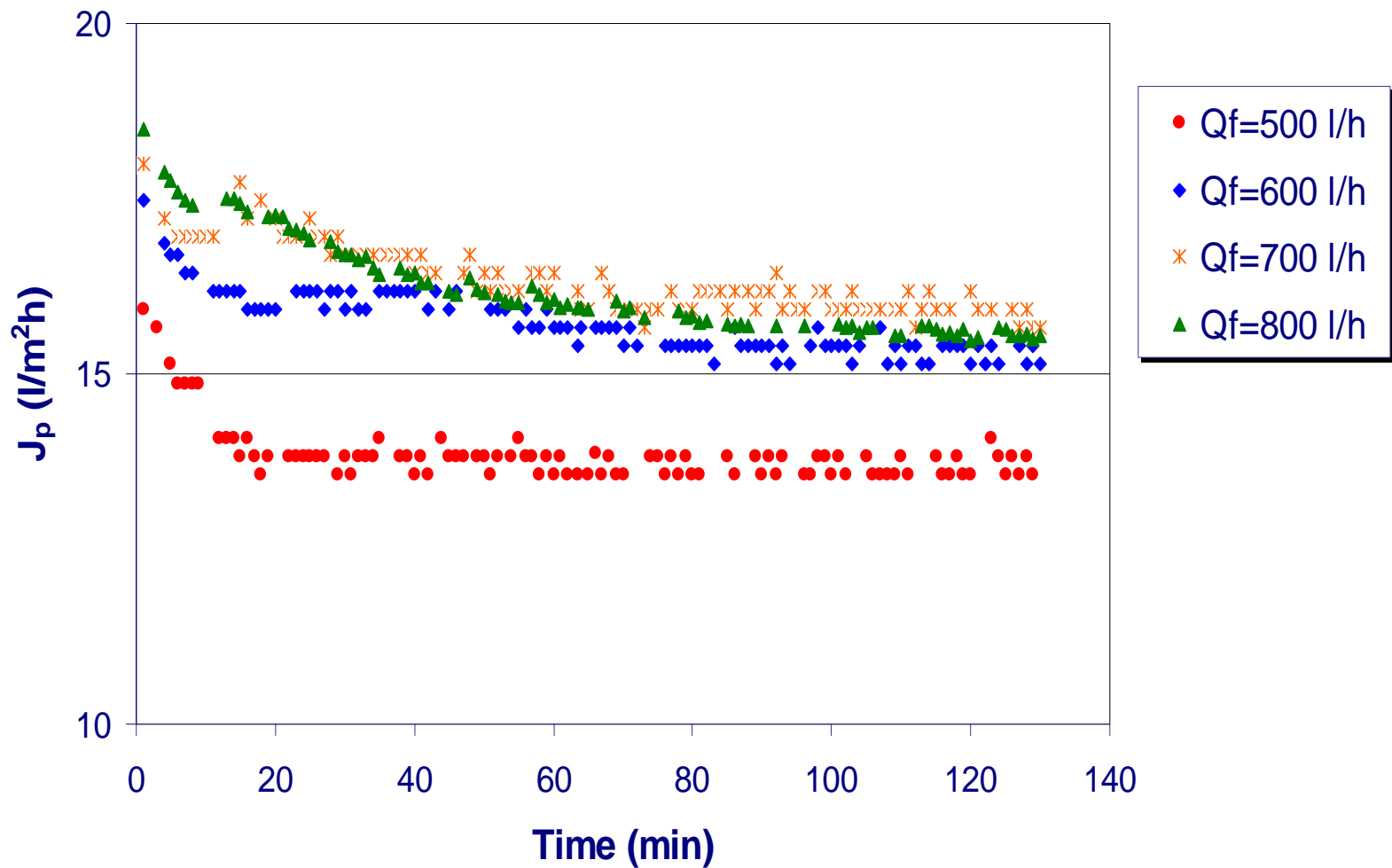

Time course of permeate flux at different axial feed flow rates
($TMP = 0.85 \text{ bar}$; $T = 25 \text{ }^\circ\text{C}$)

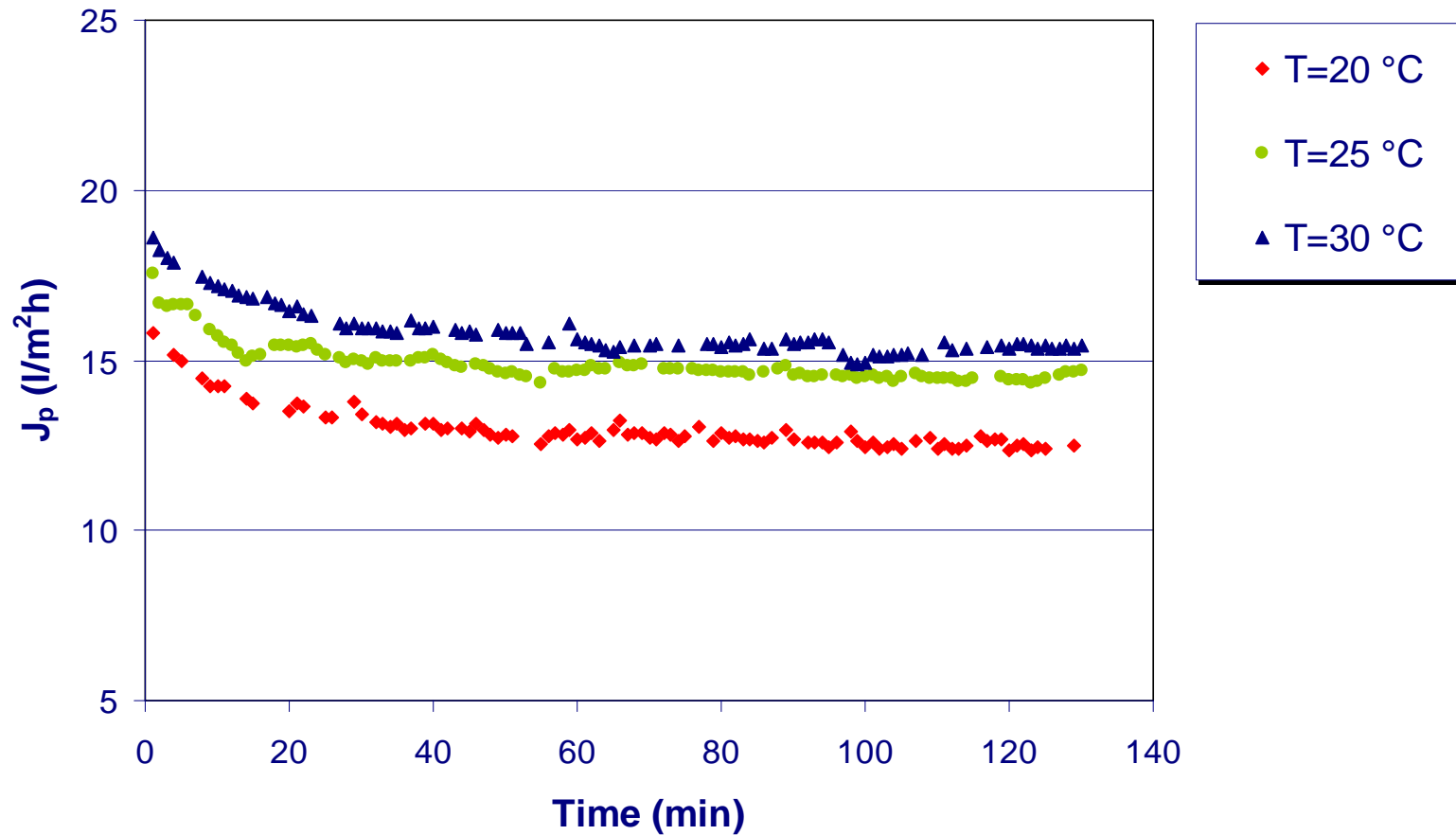

UF of kiwifruit juice. Time course of permeate flux at different temperatures
($TMP = 0.85\text{ bar}$; $Q_f = 800\text{ l/h}$)

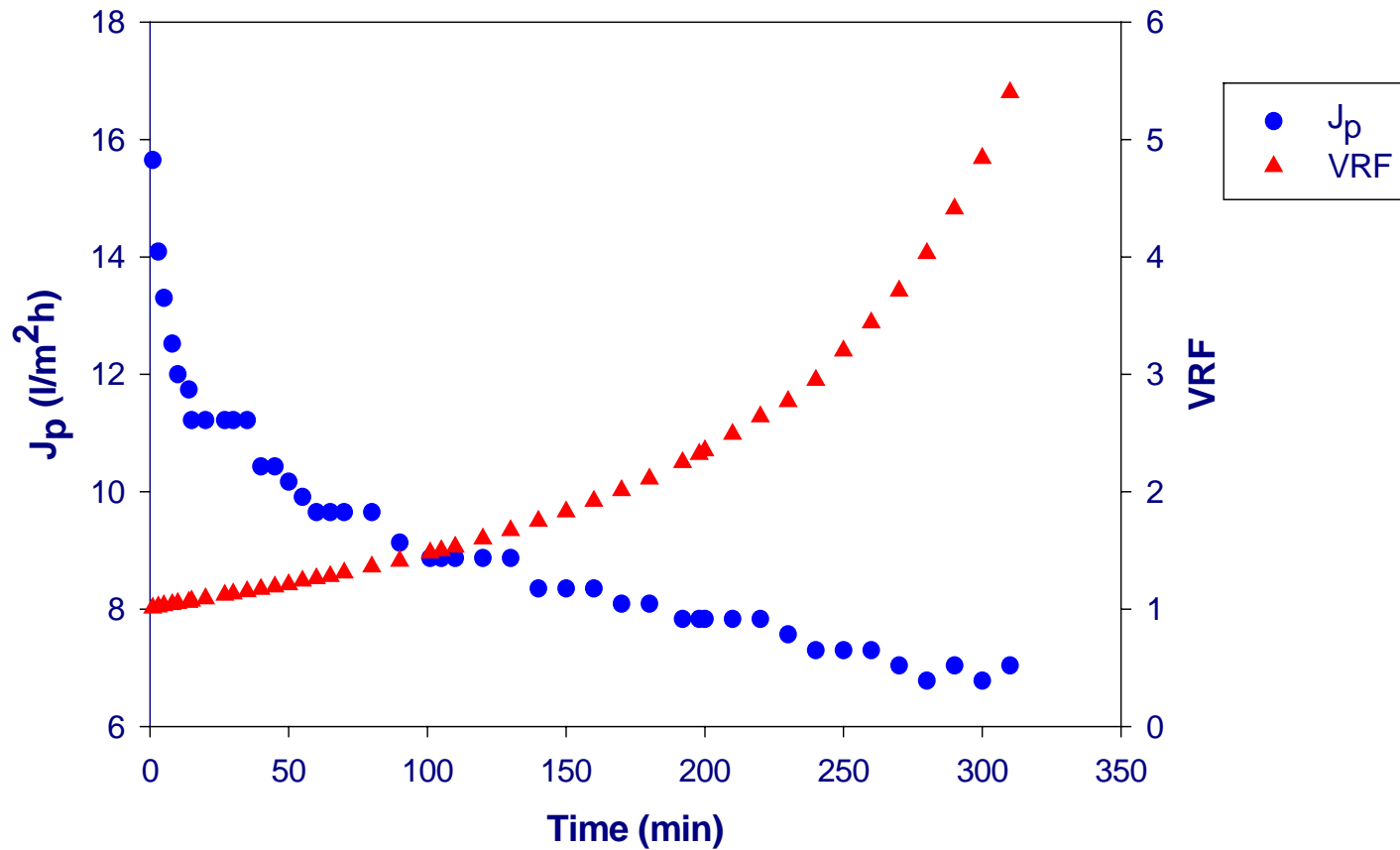

UF of kiwifruit juice. Time course of permeate flux and VRF
(batch concentration mode; $T = 25\text{ }^\circ\text{C}$; $TMP = 0.85\text{ bar}$; $Q_f = 800\text{ l/h}$)

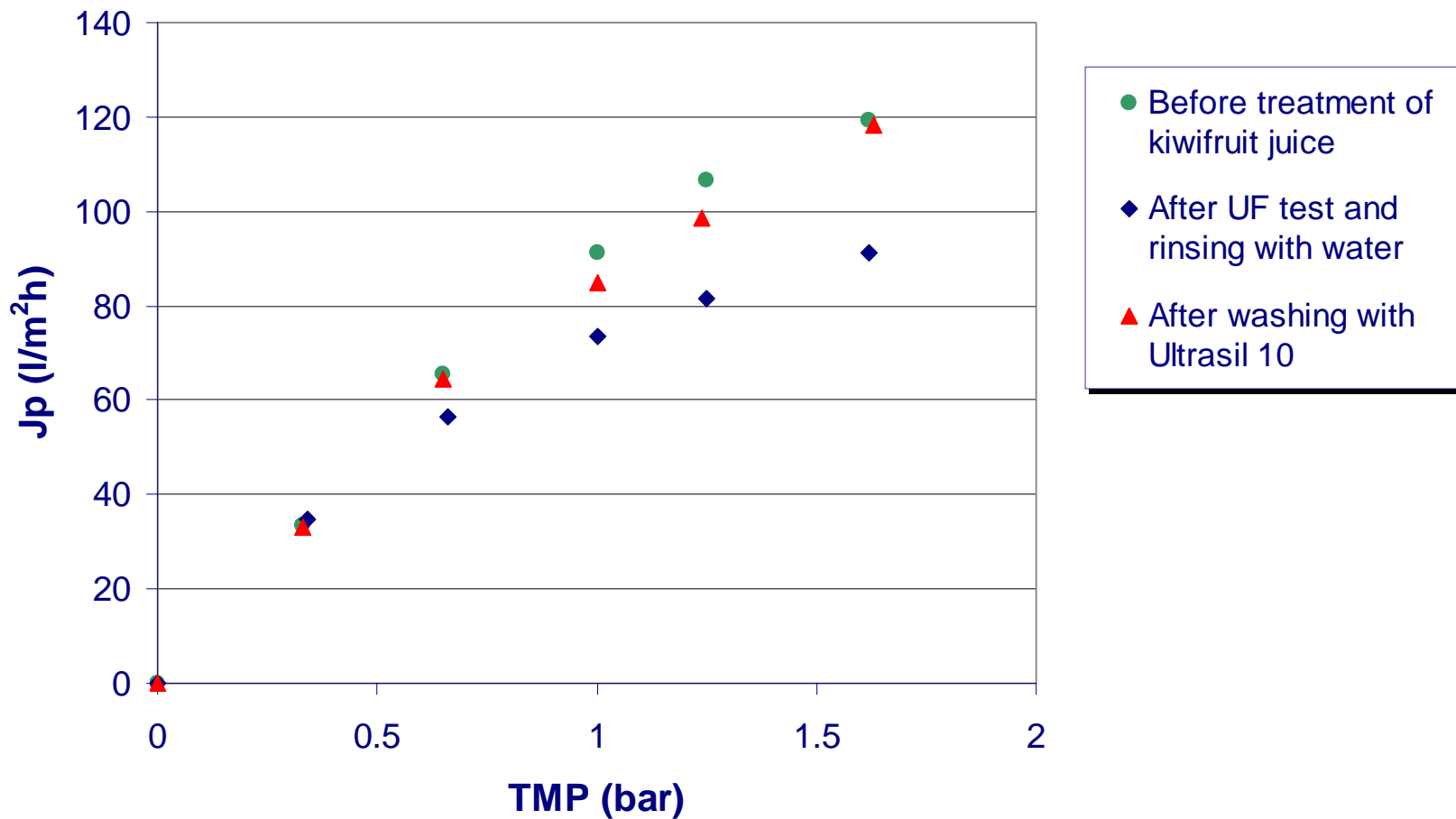

Measurement of the water flux in UF membrane module

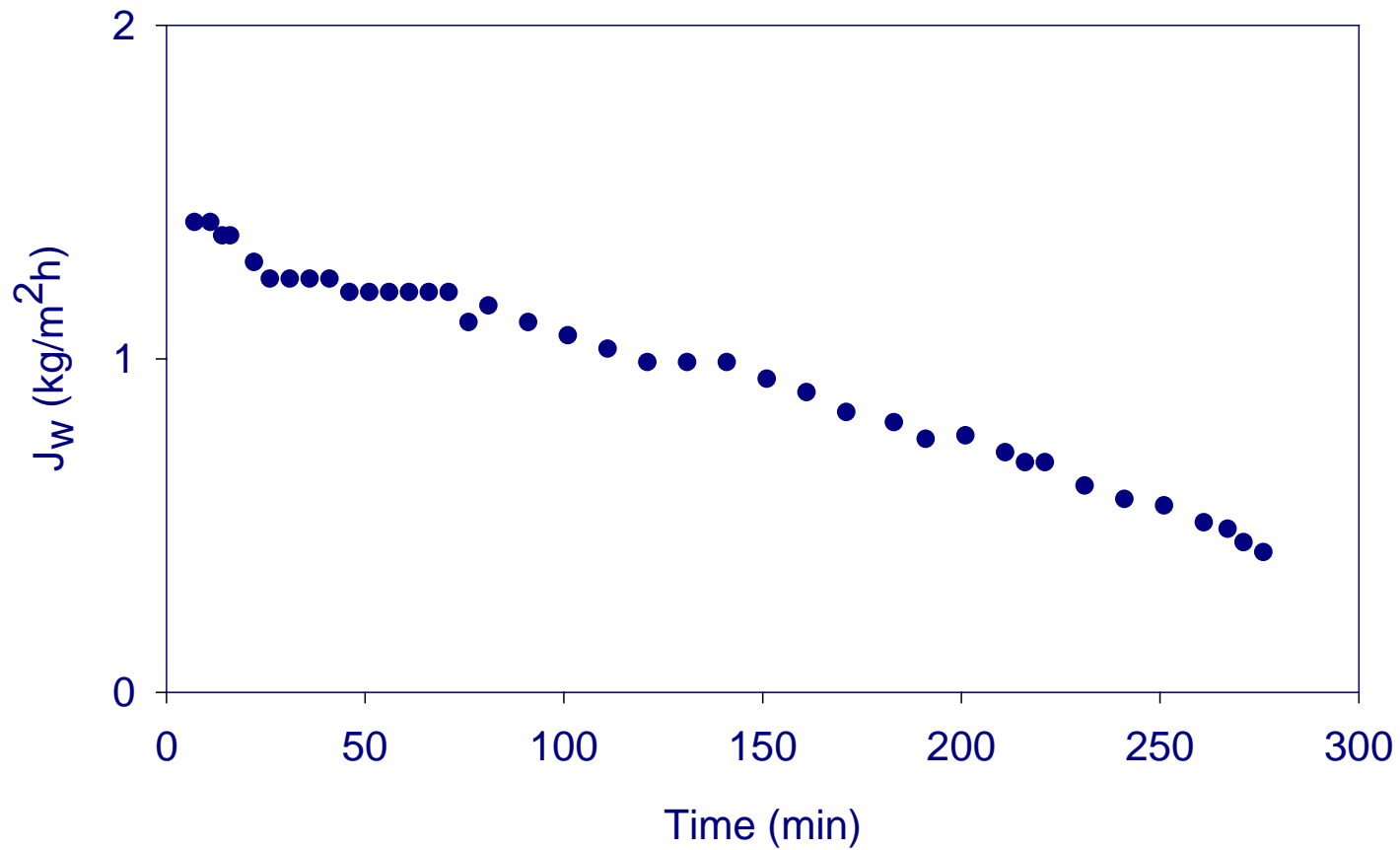

OD of clarified kiwifruit juice. Time course of evaporation flux



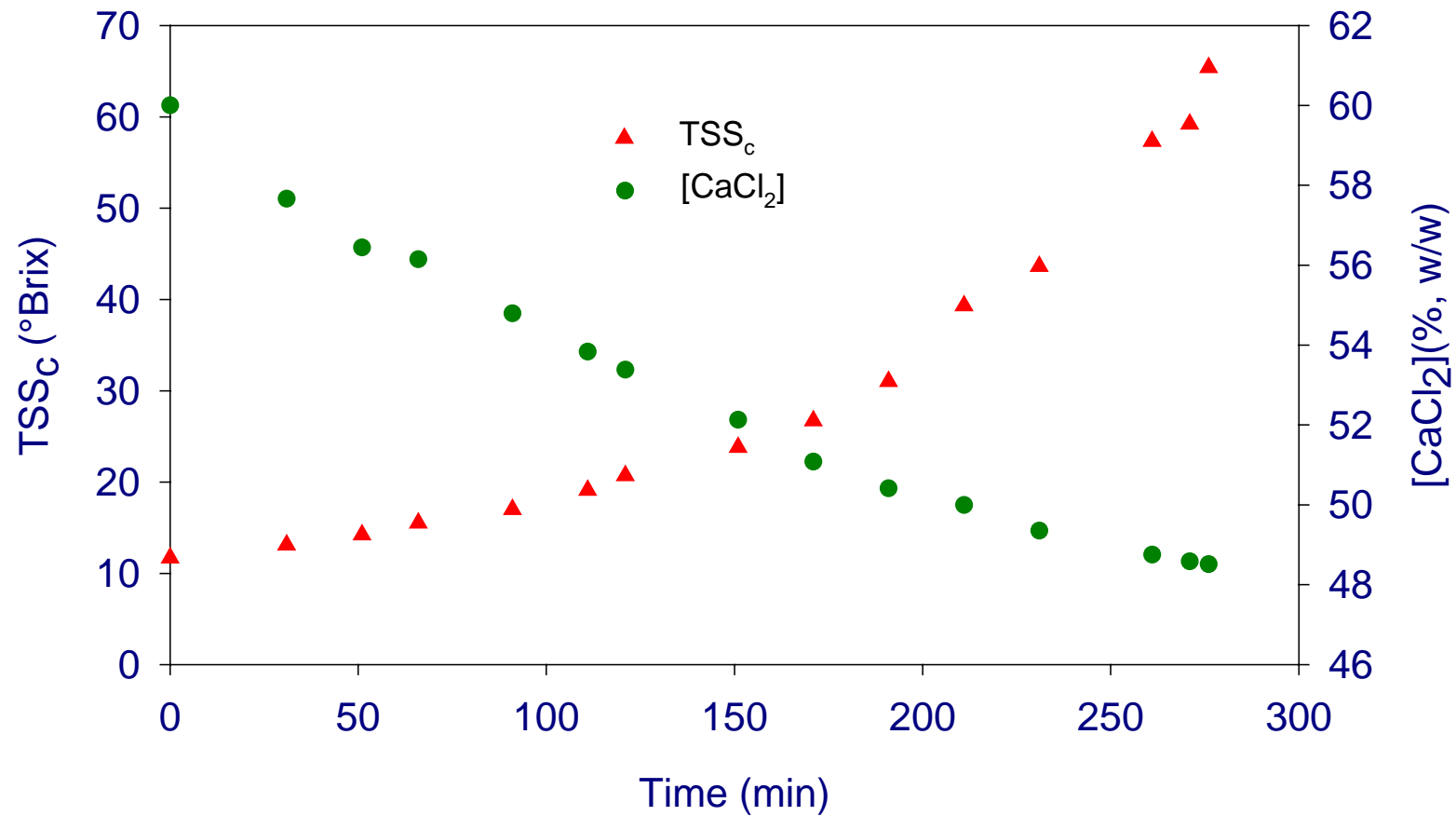

OD of clarified kiwifruit juice. Time course of TSS and brine concentration

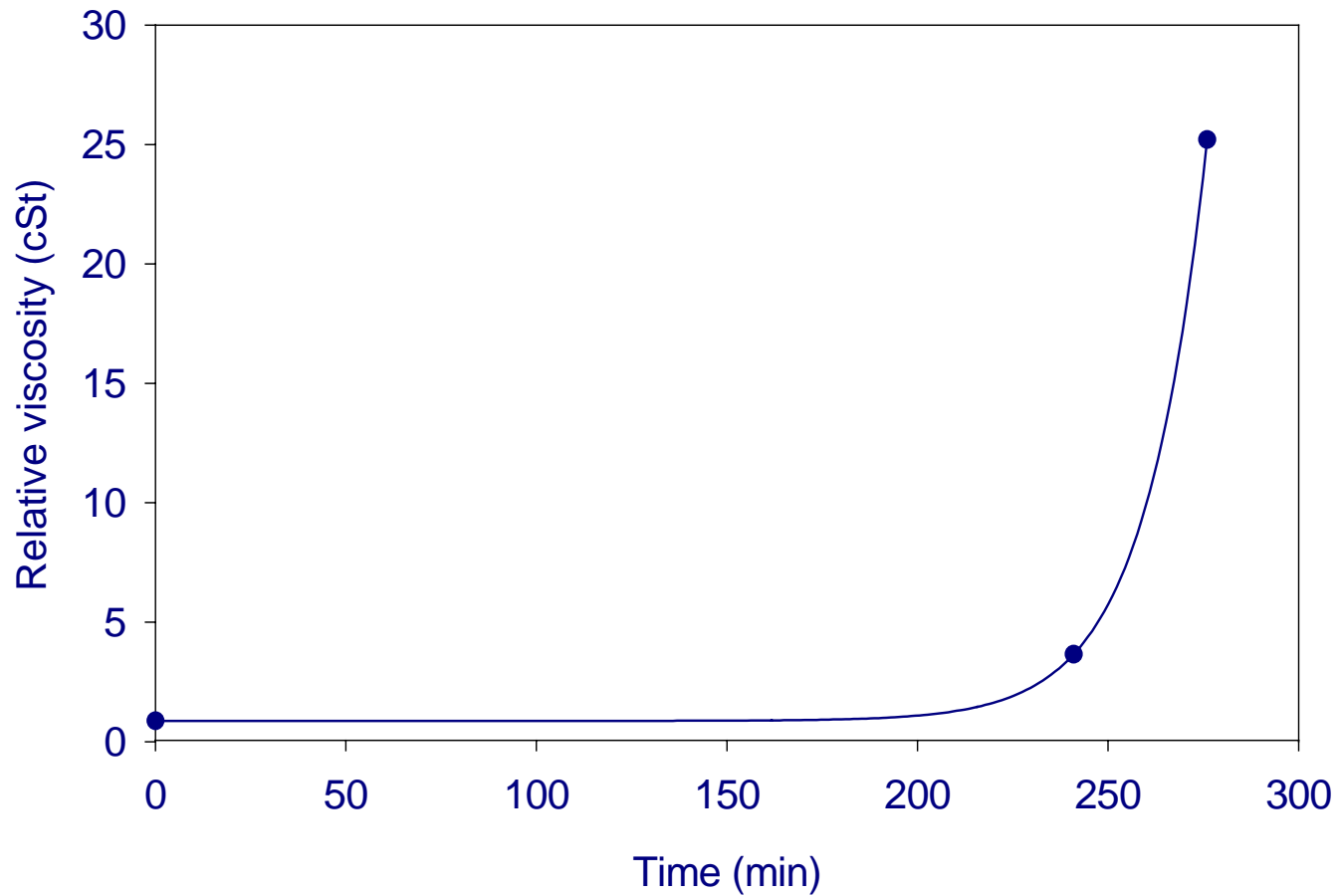

OD of clarified kiwifruit juice. Time course of the viscosity

At low TSS evaporation flux seems to depend mainly on **brine concentration**. At concentration values higher than 40 °Brix evaporation rate depends mainly on **juice viscosity** (viscous polarization) and, consequently, on juice concentration.

Analytical measurements on samples coming from treatment
of kiwifruit juice by UF and OD

<i>Sample</i>	<i>Total Soluble Solids (°Brix)</i>	<i>pH</i>	<i>Suspended Solids (%w/w)</i>	<i>Turbidity (NTU)</i>	<i>Viscosity (cSt)</i>	<i>Ascorbic acid* (mg/100 g)</i>	<i>TAA* (mm trolox)</i>
<i>Fresh juice</i>	12.5	3.58	5.16	299.5	1.30	69.6	16.0
<i>UF permeate</i>	12.1	3.60	0	0	0.87	69.3	15.3
<i>UF retentate</i>	13.5	3.58	51.5	1336.7	-	62.8	15.6
<i>OD retentate</i>	65.8	3.40	0	0	25.2	69.6	14.1

* values referred to 12.5 °Brix

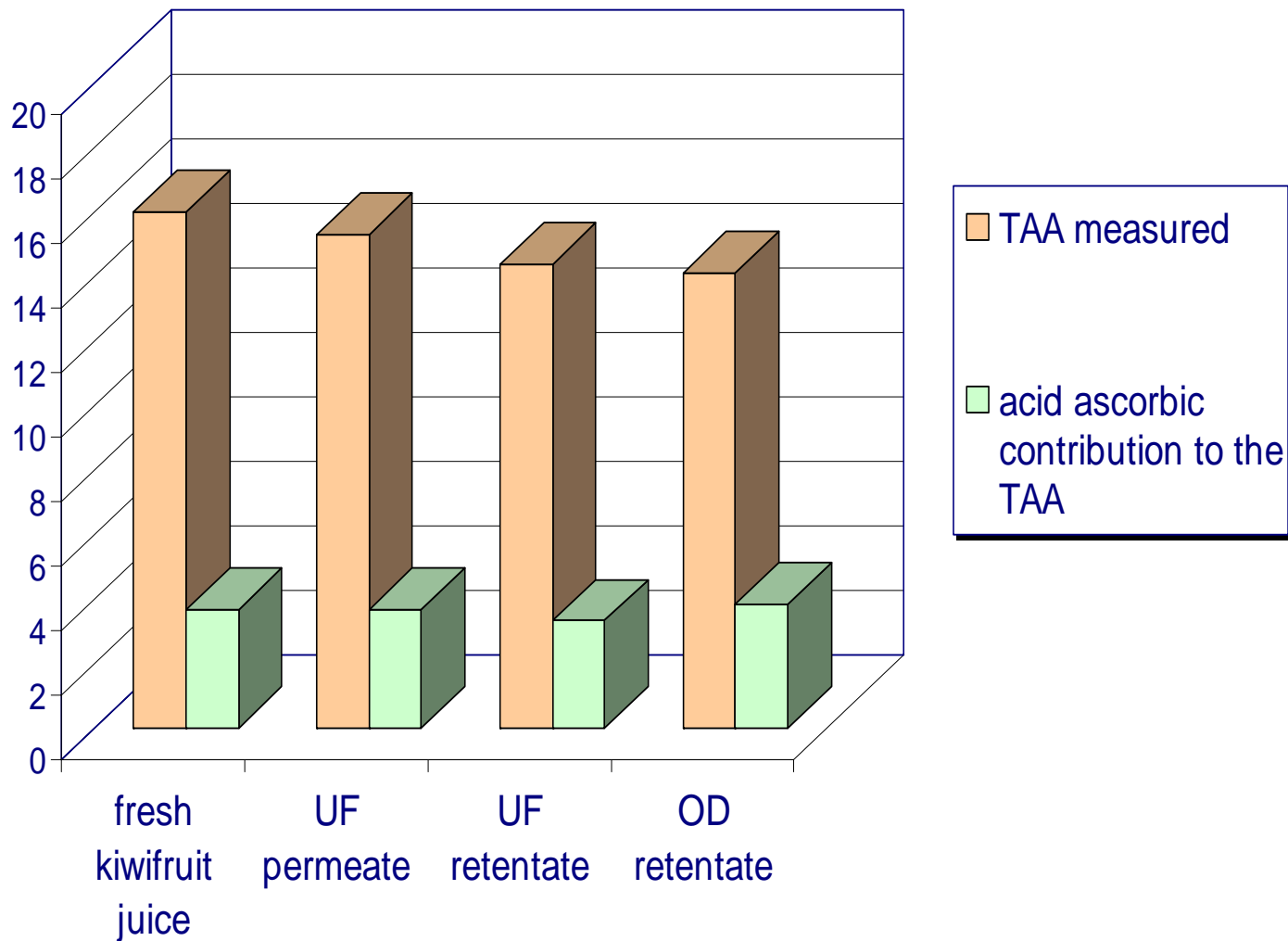

Total antioxidant activity in samples of kiwifruit juice coming from UF and OD processes

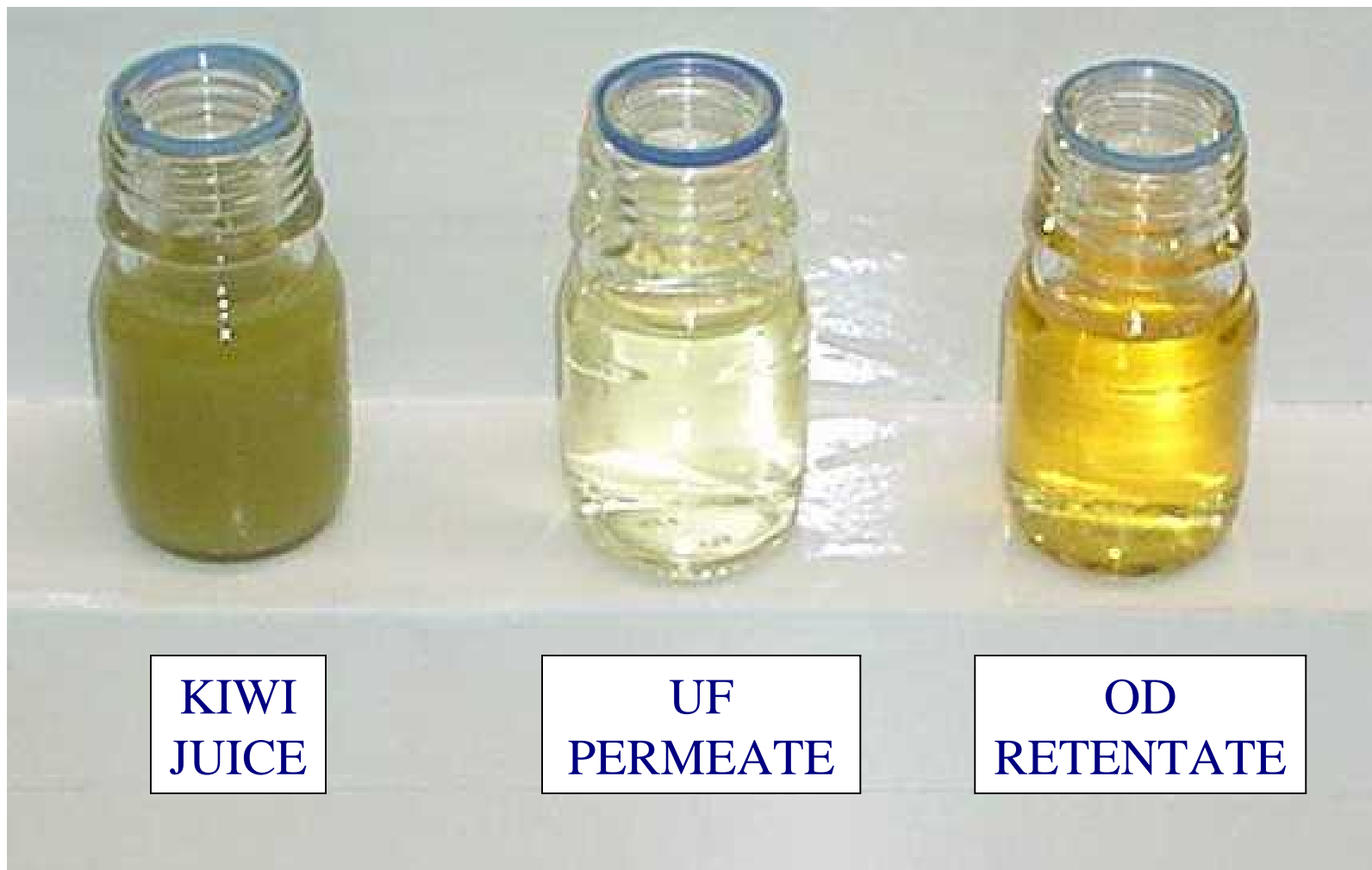

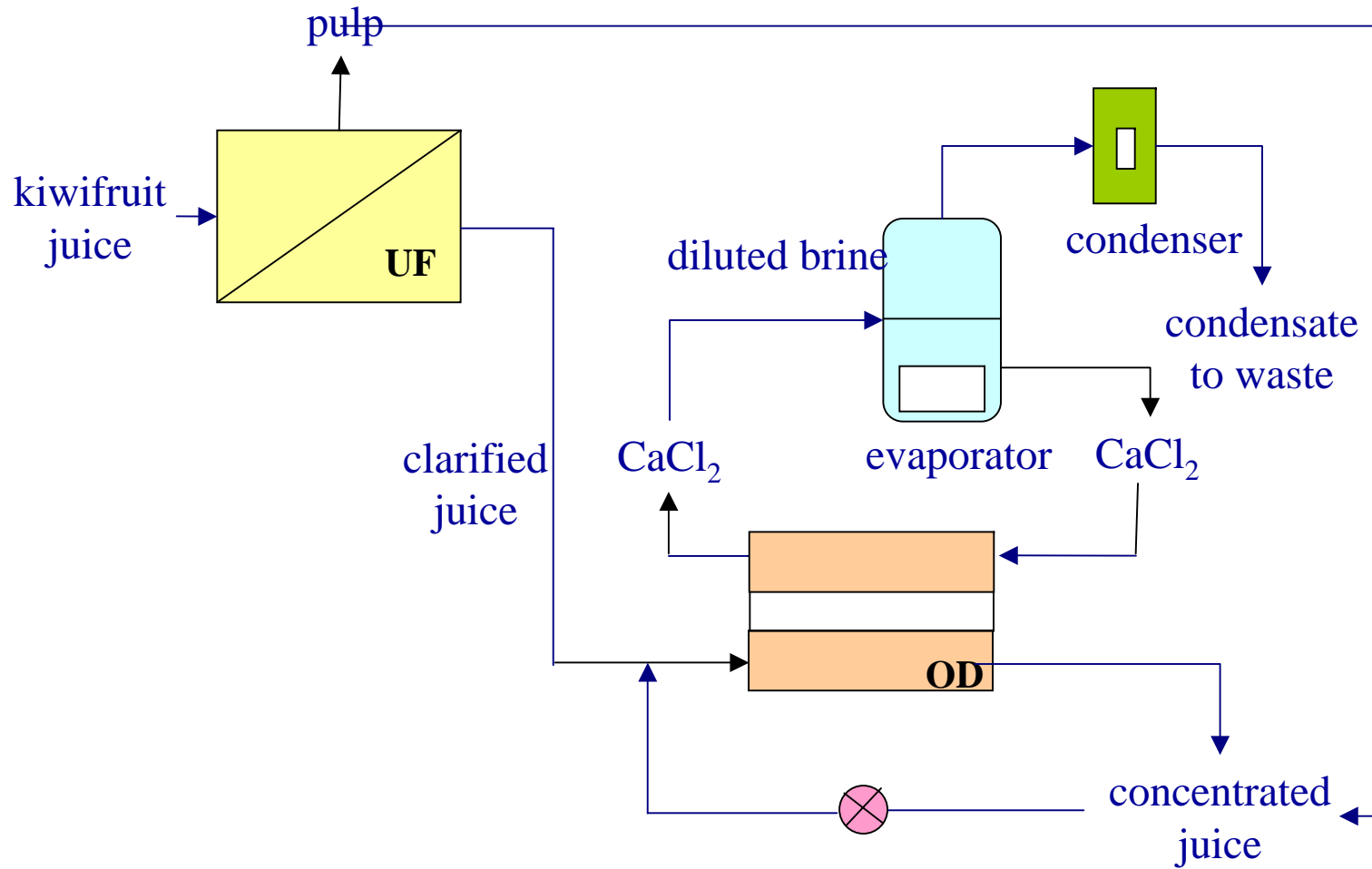

Integrated membrane process for the production of concentrated kiwifruit juice

CONCLUSIONS

- ➔ The introduction of membrane technologies in the industrial transformation cycle of the fruit juices is one of the technological answers to the problem of the **production of juices with high quality, natural fresh taste** and **additive-free**
- ➔ The possibility to realise integrated membrane systems in which all the steps of the productive cycle are based on molecular membrane separations can be considered a valid approach for a **sustainable industrial growth** within the **process intensification** strategy. The aim of this strategy is to introduce in the productive cycles new technologies characterised by **low encumbrance volume, advanced levels of automatisation capacity, modularity, remote control, reduced energy consumption**

- ➔ The new membrane-based integrated process for the concentration of blood orange juice is very efficient in **preserving the antioxidant activity** of the final product even at high concentration (60°Bx).
- ➔ The blood orange concentrated juice retains its **bright red colour** and its **pleasant aroma**, which is on the contrary completely lost during thermal concentration so this product is more similar to a fresh orange juice

- ➔ The different membrane treatments were performed on different pilot plants, with freezing and defreezing steps to preserve the juice. So that even better results could be obtained on a **fully integrated pilot plant**
- ➔ Advantages of the proposed integrated membrane system are in terms of: **reduction of clarification times, simplification of the clarification process, increasing of clarified juice volumes, possibility to operate at room temperature** preserving the juices's freshness, aroma and nutritional value, **improvement of the quality of the final product** and **improvement of the productive processes**

***SLOVAK BY-PRODUCTS IN
INTENSIFICATION OF
WASTEWATER TREATMENT
PROCESSES***



**M. VACLAVIKOVA, S. HREDZAK
AND S. JAKABSKY**

**SLOVAK ACADEMY OF SCIENCES
INSTITUTE OF GEOTECHNICS
KOSICE, SLOVAKIA**

THE PROBLEM

- *Significant hazards to the environment*



The former Sered
hydrometallurgical
plant

The Al_2O_3 production
Ziar nad Hronom

The coal-fired
power plant EVO
Vojany

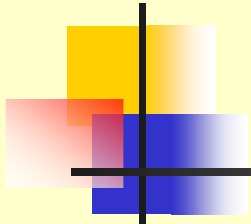

CAUSES

- ***Industry operations handle large volume of process water***
- ***Heavy metals frequently occur in industrial effluents***
- ***The solid waste dumps occupy enormous land areas***



RESEARCH OVERVIEW

- ***Material study***
 - *chemical composition*
 - *mineral composition*
 - *grain size*
 - *magnetic susceptibility*
 - *pH stability*

- ***Water treatment model experiments***

- ***Treatment experiments on real wastewater
(not started yet)***



ALBANIAN LEACHING RESIDUUM

Tab. 1: Mineral composition

<i>Phase</i>	<i>Content [%]</i>
magnetite	54.09
quartz	13.15
wustite	8.02
calcite	6.32
ferochrompicotite	5.51

Tab. 2: Chemical composition

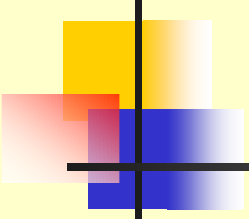

<i>Element</i>	<i>Content [%]</i>
Fe _{total}	45.89
Fe ²⁺	17.60
Fe ³⁺	26.97
Fe _{met}	1.32
SiO ₂	15.03
Al ₂ O ₃	4.80
CaO	3.54
MgO	2.21
Cr ₂ O ₃	1.06
NiO	0.17

RED MUD FROM Al_2O_3 PRODUCTION

Tab. 3: Chemical composition

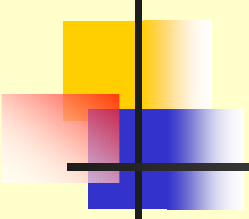

<i>Element</i>	<i>Content [%]</i>
SiO ₂	13.35
Fe _{total}	25.34
Fe ²⁺	0.56
Fe ³⁺	24.78
Ca	1.066
Mg	0.35
Al	4.43
Cr	0.039
Pb	0.011
Zn	0.014
Mn	0.42
Na	6.88

ASH FROM COAL-FIRED POWER PLANT

Tab. 4: Chemical/mineral composition

<i>Chemical formula</i>	<i>Mineral</i>	<i>Content [%]</i>
SiO ₂	quarz	4.10
3Al ₂ O ₃ .2SiO ₂	mullite	2.10
Fe ₂ O ₃	hematite	8.70
TiO ₂	anatase	0.60
C	carbon	18.32
glass phase		62.90



ASH FROM COAL-FIRED POWER PLANT

Tab. 5: Chemical composition

<i>Element</i>	<i>Content [%]</i>
Fe _{total}	6.70
SiO ₂	43.39
Al ₂ O ₃	18.16
CaO	1.55
combustible matter	21.17

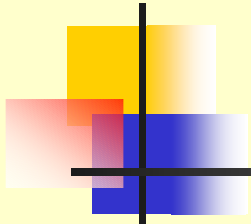

WATER TREATMENT EXPERIMENTS

➤ ***Adsorption tests***

- ***Cadmium solutions and sorbents preparation***
- ***determination of optimal pH***
- ***batch isotherm studies***
- ***results evaluation***



ADSORPTION CONDITIONS

- ***Sorbent concentration 2 g.L⁻¹***
- ***Initial Cd²⁺ concentration 20-400 mg.L⁻¹***
- ***Adsorption time 24 hours (in a rotary shaker)***
- ***Temperature ambient (about 20°C)***
- ***Initial pH :***
 - Albanian leaching residuum pH 6***
 - Red mud pH 6***
 - Magnetic fraction of ash pH 7***

ADSORPTION ISOTHERM 1

Cadmium uptake by albanian leaching residuum

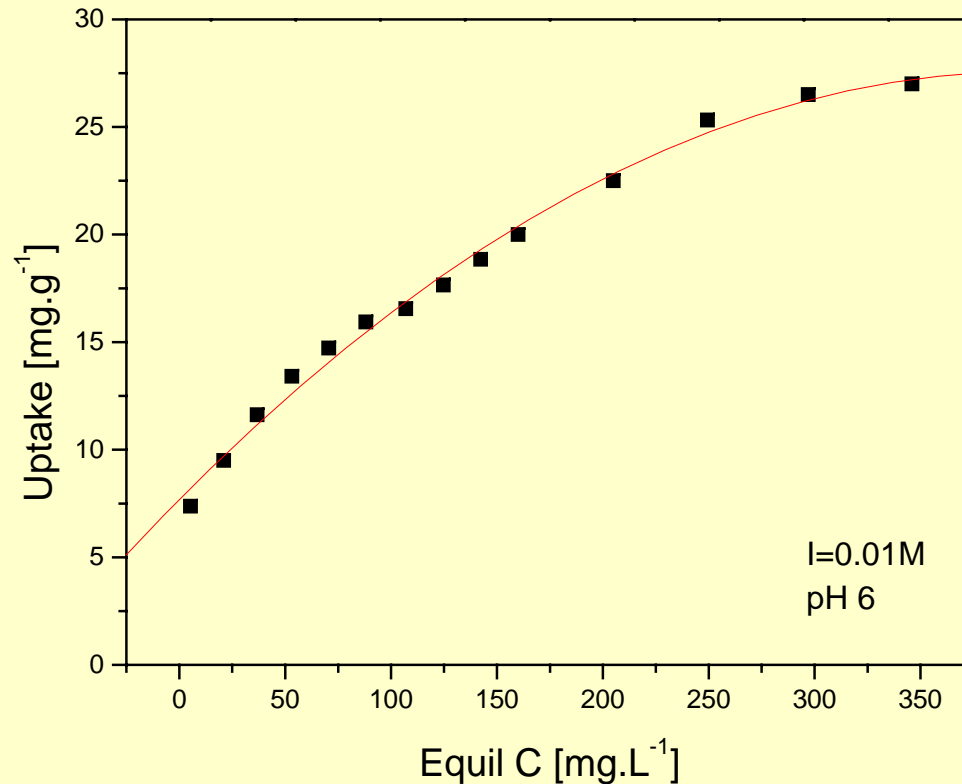

pH 6

sorption capacity:

27 mg.g^{-1}

ADSORPTION ISOTHERM 2

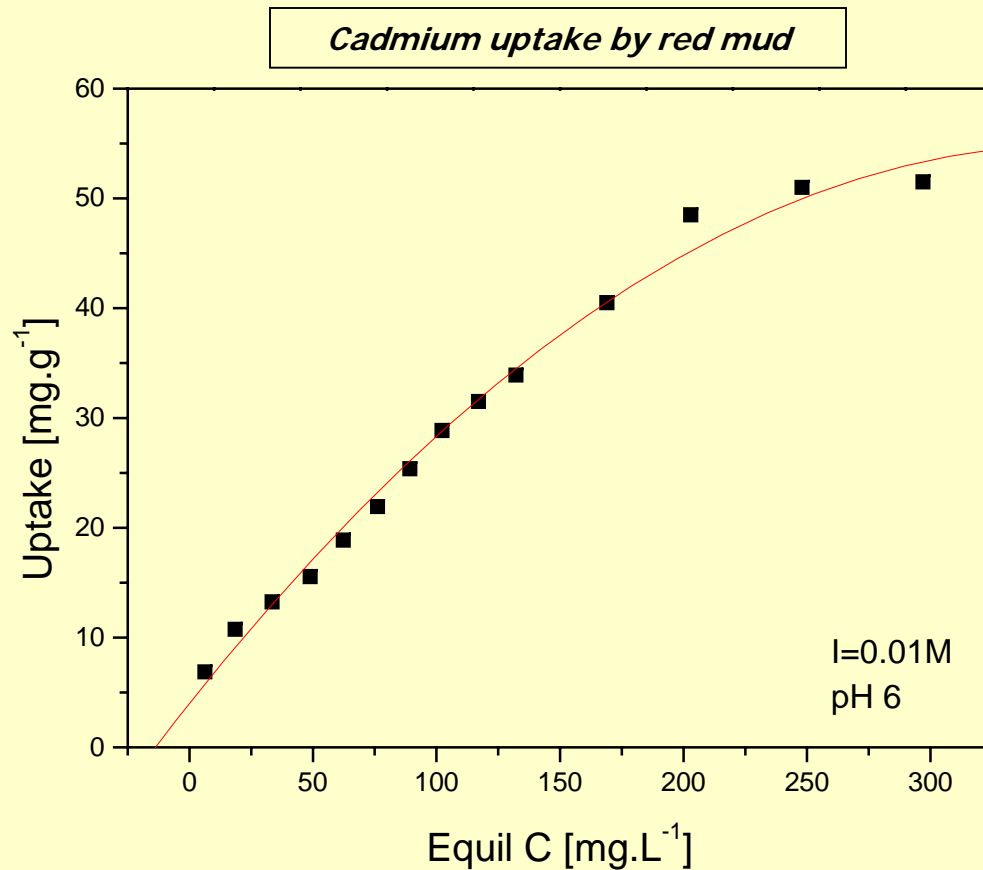

pH 6
sorption capacity:
51.5 mg.g¹

ADSORPTION ISOTHERM 3

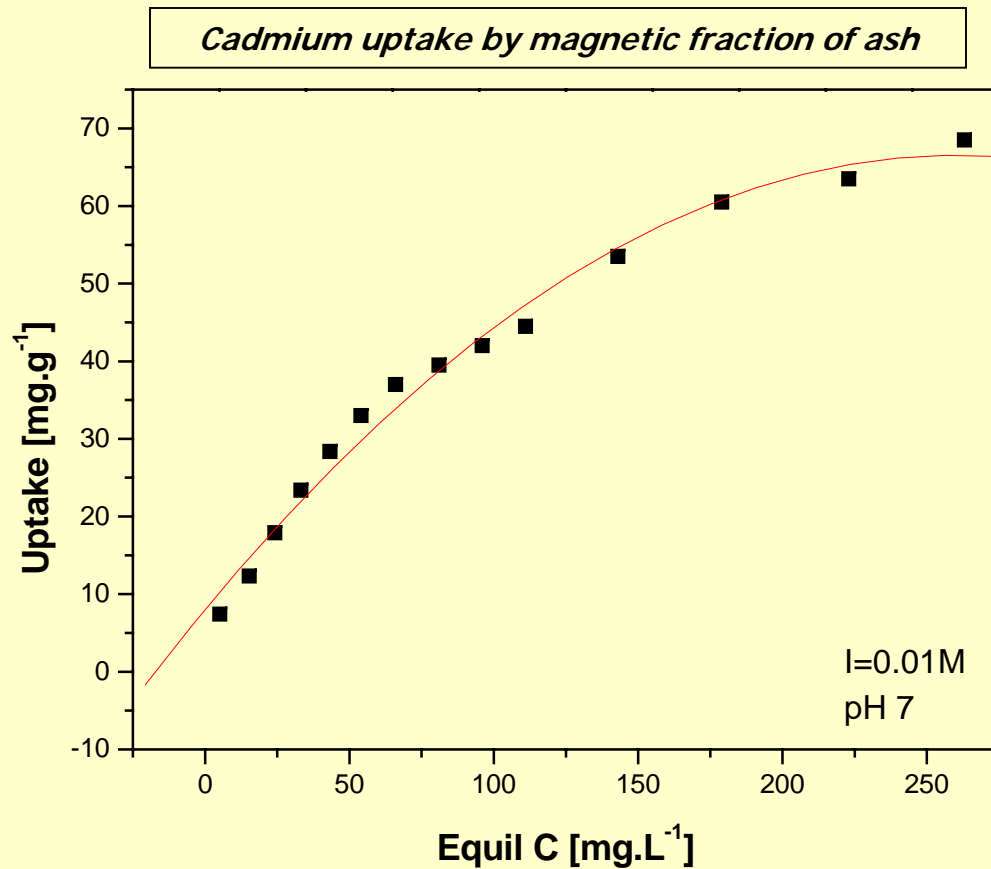

pH 7
sorption capacity:
68.5 mg.g¹



CONCLUSION

- *By-products from metallurgy and power production were tested as sorbents in wastewater treatment processes*
- *Applied materials are effective sorbents for cadmium (probably for the other heavy metal ions too)*
- *Experiments confirmed the new possibility of by-products utilisation in environmental technologies*
- *By-products application in environmental technologies will enable the reduction of material costs with regard to price of commercial produced sorbents*

REUSE OF WASTE MATERIALS FROM ZINC INDUSTRY FOR SORPTION OF HYDROGEN SULFIDE

Aysel T. Atımtay

***Middle East Technical University, Environmental Engineering
Department, 06531 ANKARA, TURKEY***

Introduction

- Zinc industry produces about 1.5-2 million tons of slag per year in Turkey. This slag is rich in metal oxide contents like FeO, ZnO, CaO, etc., however, a suitable usage area for this slag has not been found until today.
- There is a great possibility that this slag can be used in removing H₂S from waste gases from different industrial sources. Additionally, in thermal power plants based on gasification of coal (Integrated Gasification Combined Cycle-IGCC), the coal gas produced contains mainly H₂S and other sulfurous gases as polluting compounds.

- These gases need to be cleaned with a suitable and economical sorbent.
- IGCC, >50% energy efficiency and about 35% reduction in CO₂ emission thru increased efficiency.
- The waste slag from zinc industry is potential candidate for the removal of these sulfurous gases from coal gas. It is abundant and relatively cheap.

Objectives

- The objectives of this study were :
 - to study the possibility of use of waste materials from zinc industries in H₂S clean-up, and
 - to find out the conditions at which the best sorption capacity and regeneration performance are obtained

The study was carried out with the waste materials procured from CINKUR, one of the zinc processing plants in Turkey.

Experimental

- Sulfidation of the sorbent was carried out in our laboratory with 2-3 mm particles of zinc slag.
- A gas flow rate of 92 mL/min (25°C, 1 atm) was used. Reaction temperatures were 400, 500°C and 600°C.
- Inlet gas composition was 0.1% H₂S-10% H₂ in N₂ for sulfidation experiments.
- Exit H₂S concentrations were measured as a function of reaction time by a GC having a PFPD and breakthrough curves were plotted.

Schematic diagram of the packed bed reactor-furnace system

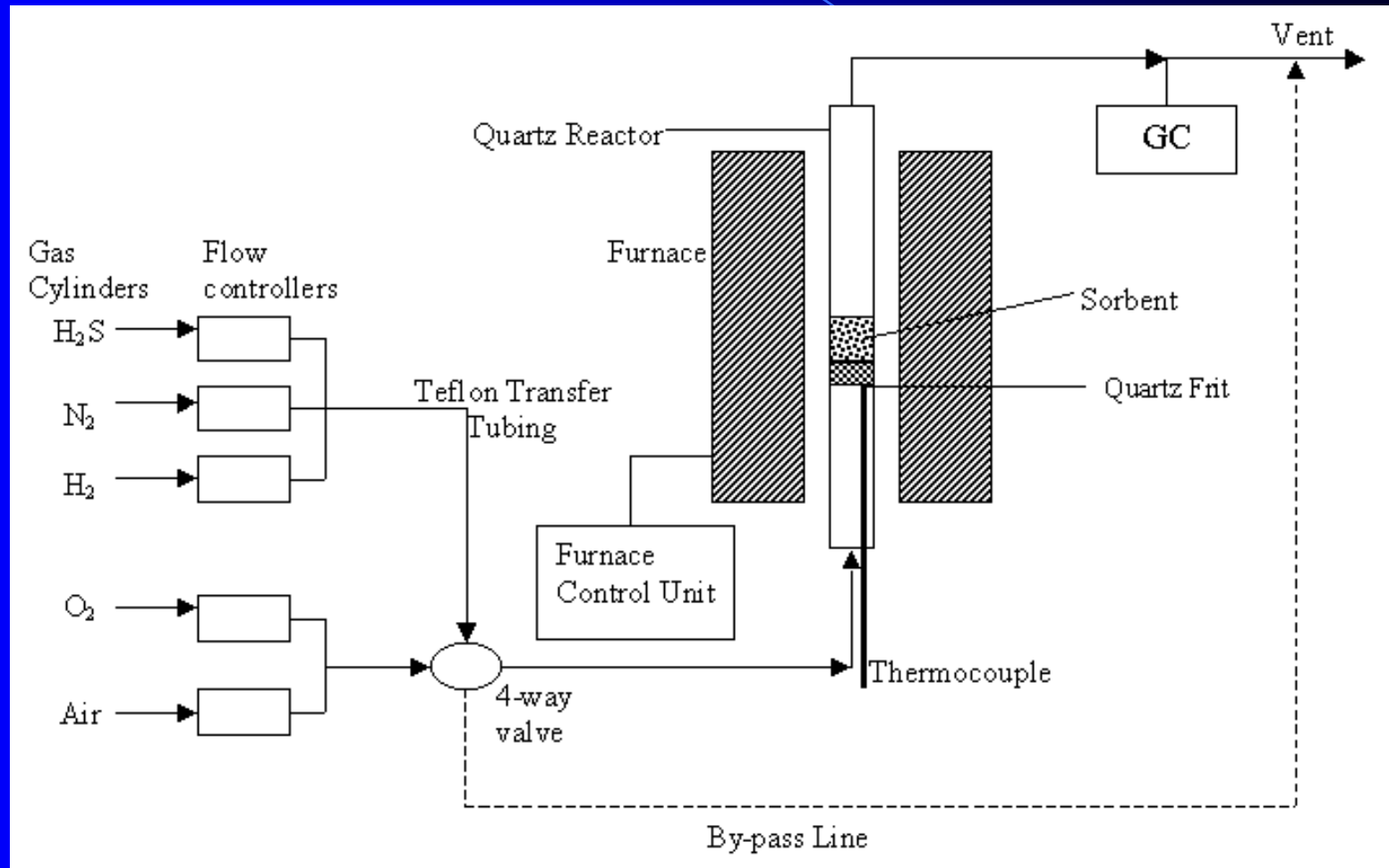

Chemical Analysis of Zinc Slag

	% by wt
Zn	1.70
Fe	8.28
Ca	11.03
Mn	0.60

BET Surface Area of Fresh Sorbent

	Sorbent Particle Size, mm	BET Surface Area (m²/g)
Zinc Slag	2-3	3.14

Mercury Porosimetry Analysis of Fresh Zinc Slag

	2-3 mm
Average pore diameter (μm)	0.2403
Total pore volume (cm^3/g)	0.6235
Total Pore Area (m^2/g)	10.3791
Bulk Density (g/cm^3)	1.3116
Porosity	0.3152

Cumulative Pore Size Distributions of 2-3 mm Zinc Slag

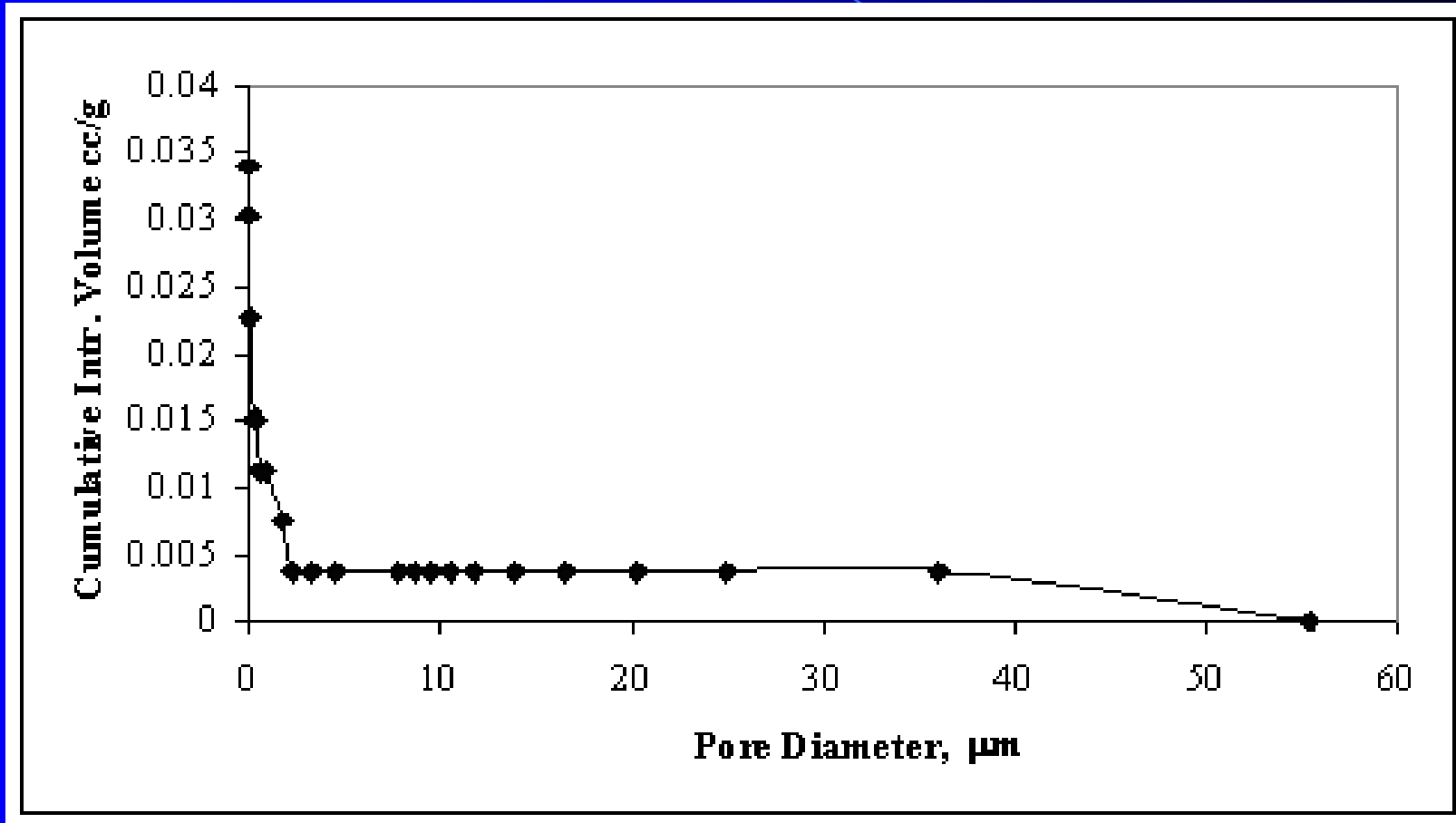

SEM Photographs of Zinc Slag



(a) 2-3 mm (x25)

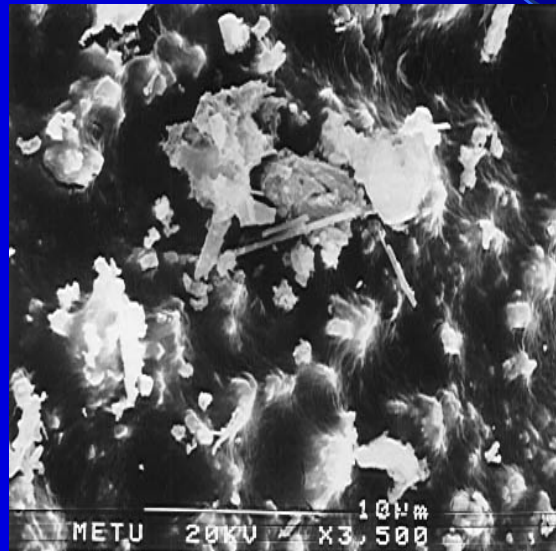

(b) 2-3 mm (x3500)

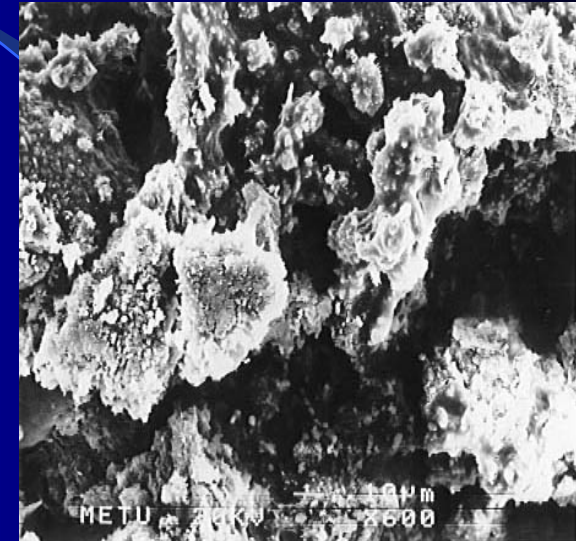

(c) 2-3 mm (x600)

XRD Analyses of 2-3 mm Zinc Slag

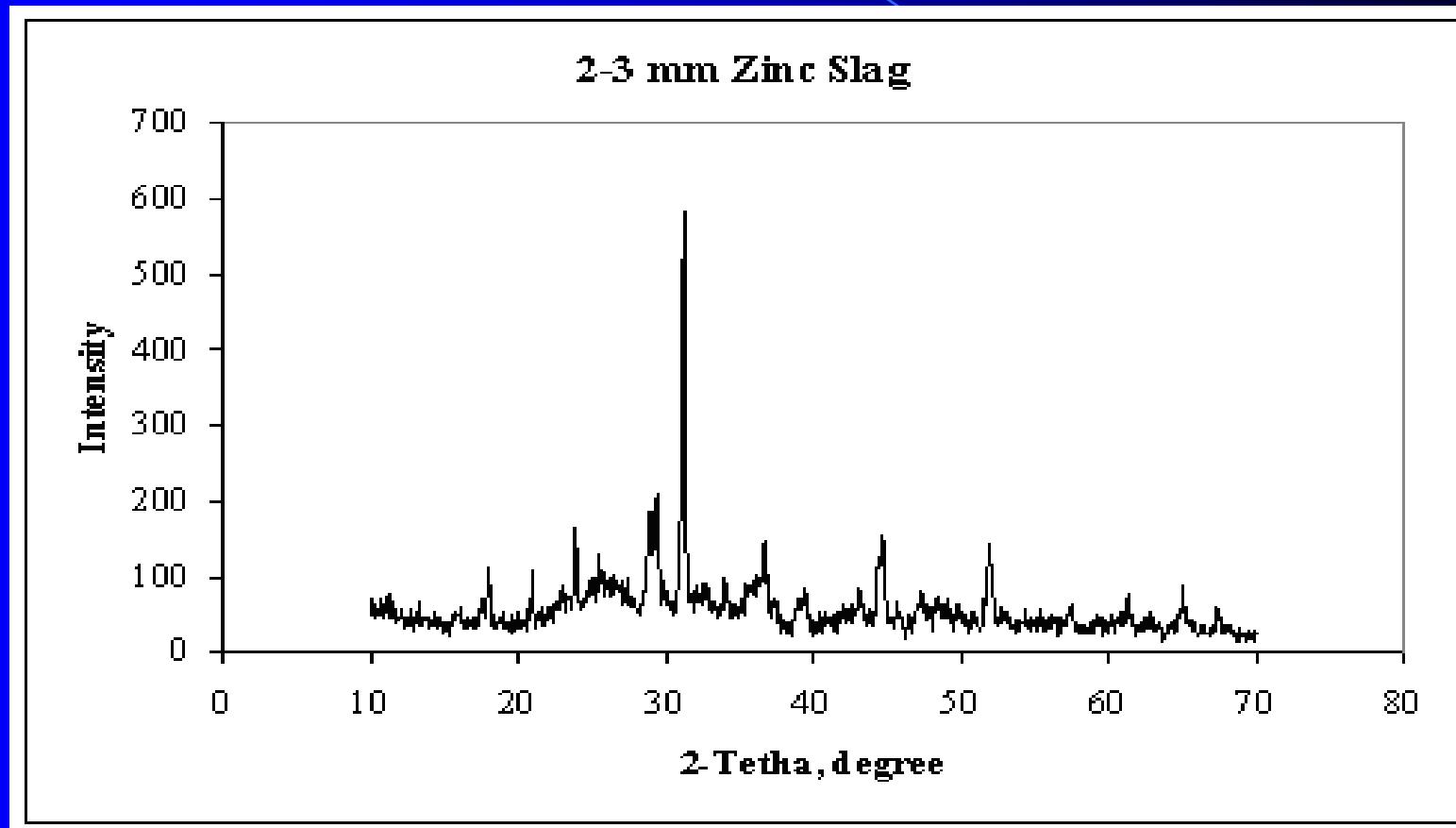

Sulfidation Runs

The background of the slide is a dark blue gradient that transitions to a lighter blue at the bottom. A thin, light blue curved line starts from the left edge and sweeps downwards and to the right, ending near the bottom right corner. The text "Sulfidation Runs" is centered in the upper half of the slide.

Breakthrough Curves for H₂S at Different Temperatures with 1000 ppmv Inlet Concentration

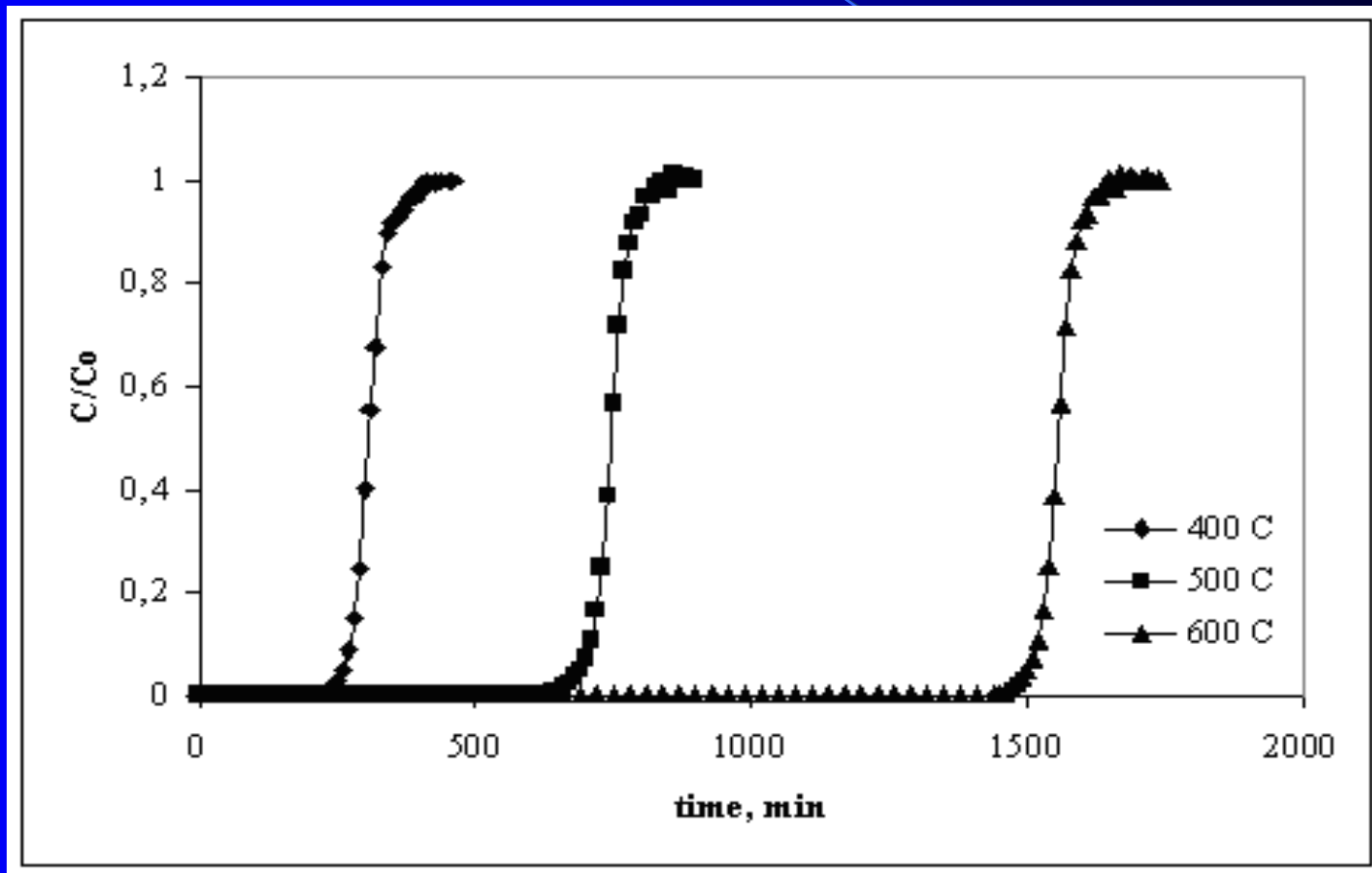

Breakthrough Curves for H₂S at Different Temperatures with 2000 ppmv Inlet Concentration

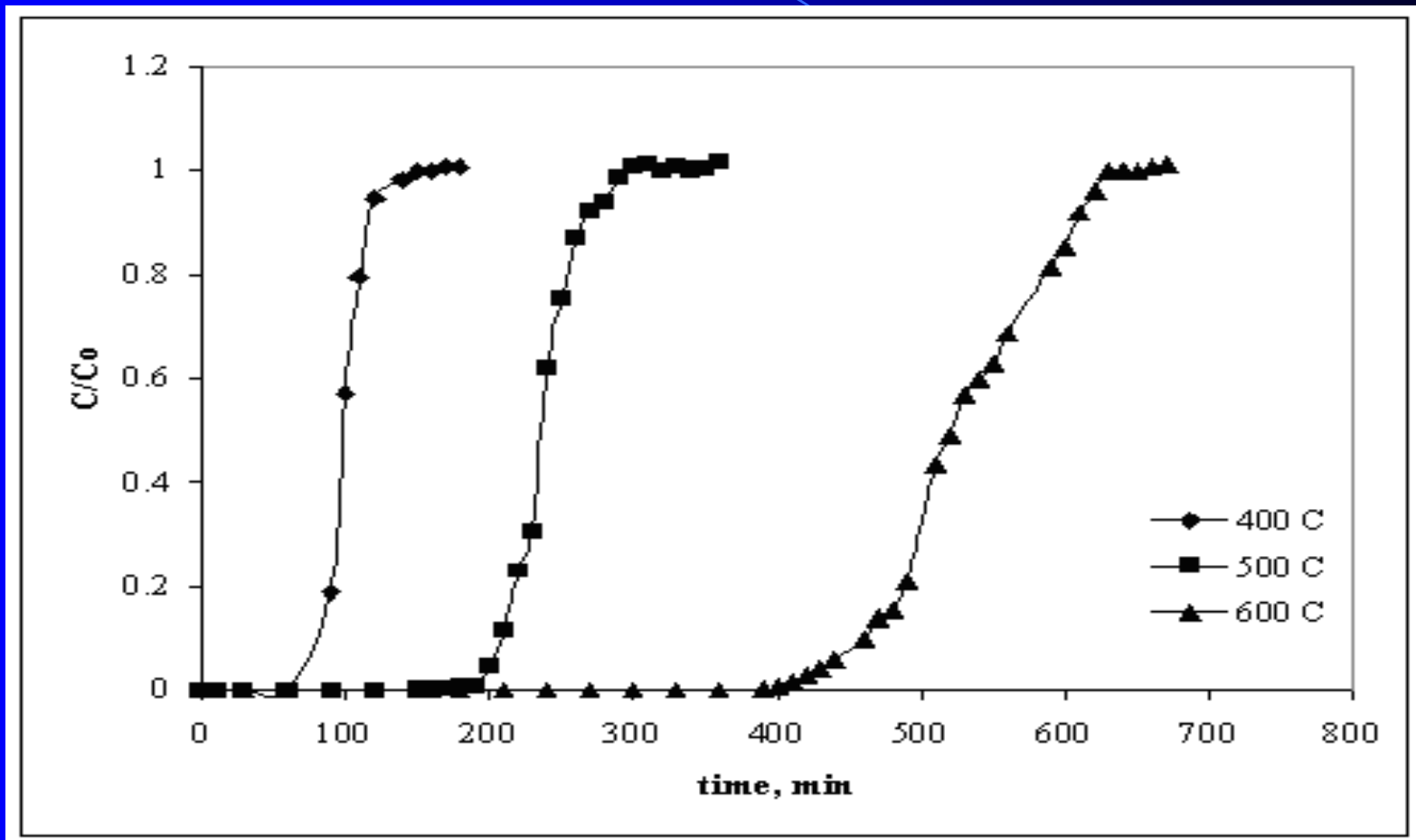

Breakthrough Curves for H₂S with Different Inlet Concentrations at 500°C

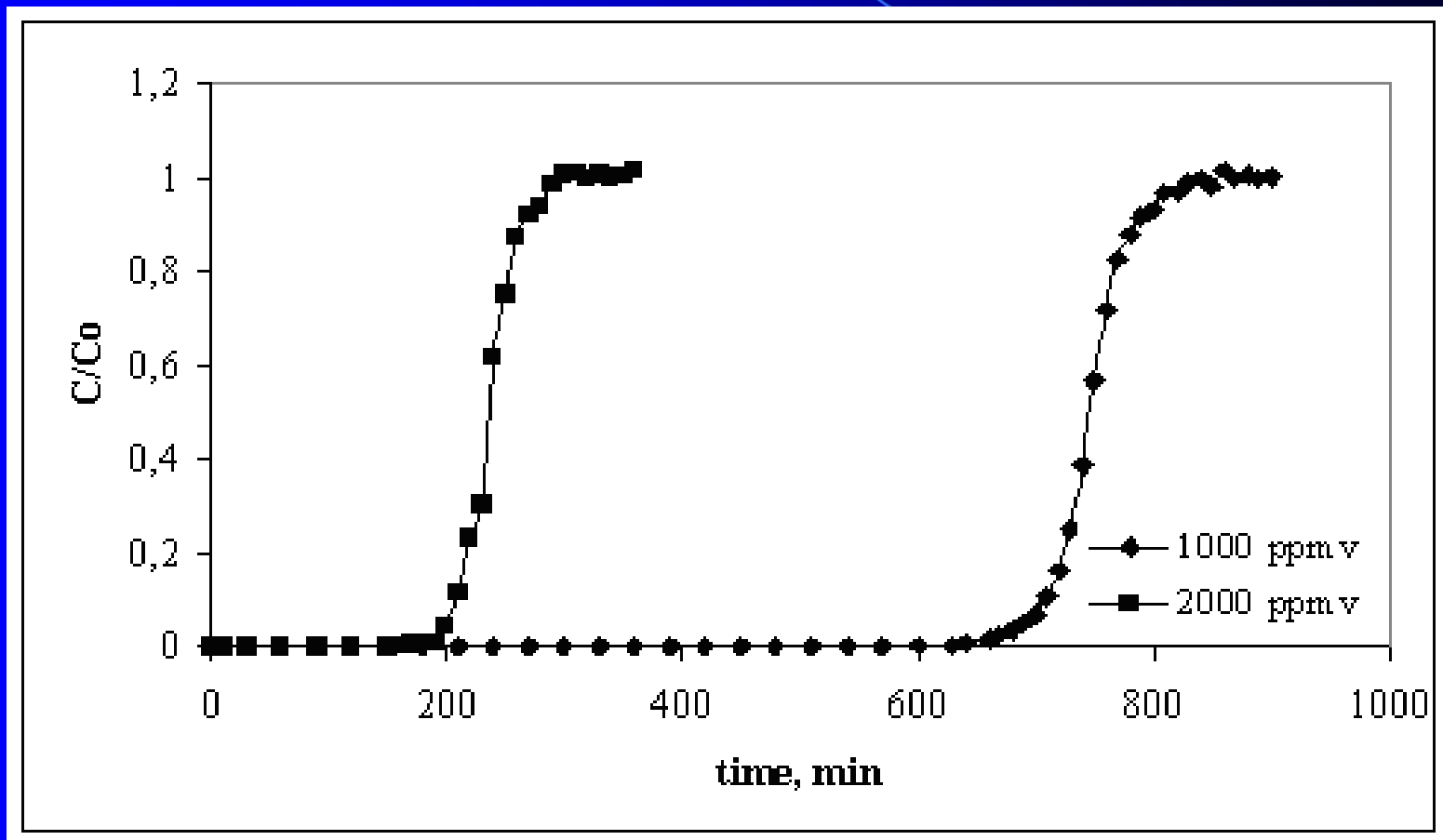

Sorption Capacities of Zinc Slag

Sulfur capacity	Inlet Concentrations and Sulfidation Temperatures					
	1000 ppmv			2000 ppmv		
	400° C	500° C	600° C	400° C	500° C	600°C
g S / 100 g Sorbent	1.17	2.78	5.78	0.78	1.87	3.88

*Sulfidation Runs Using the
Mixtures of Steel and Zinc Slag*

The background of the slide is a gradient of blue, transitioning from a darker blue at the top to a lighter blue at the bottom. A curved line, also in a light blue color, starts from the left side and curves downwards and to the right, creating a sense of movement or a path.

Weight Percentages of Waste Materials in the Sorbent Mixture

Sorbent	Weight % out of total	
	Zinc Slag	Steel Slag
Waste Mixture-1 (WM-1)	25	75
Waste Mixture-2 (WM-2)	50	50
Waste Mixture-3 (WM-3)	75	25

Breakthrough Curves for H₂S with Different Waste Mixtures at 500°C and 2000 ppmv Inlet Concentration

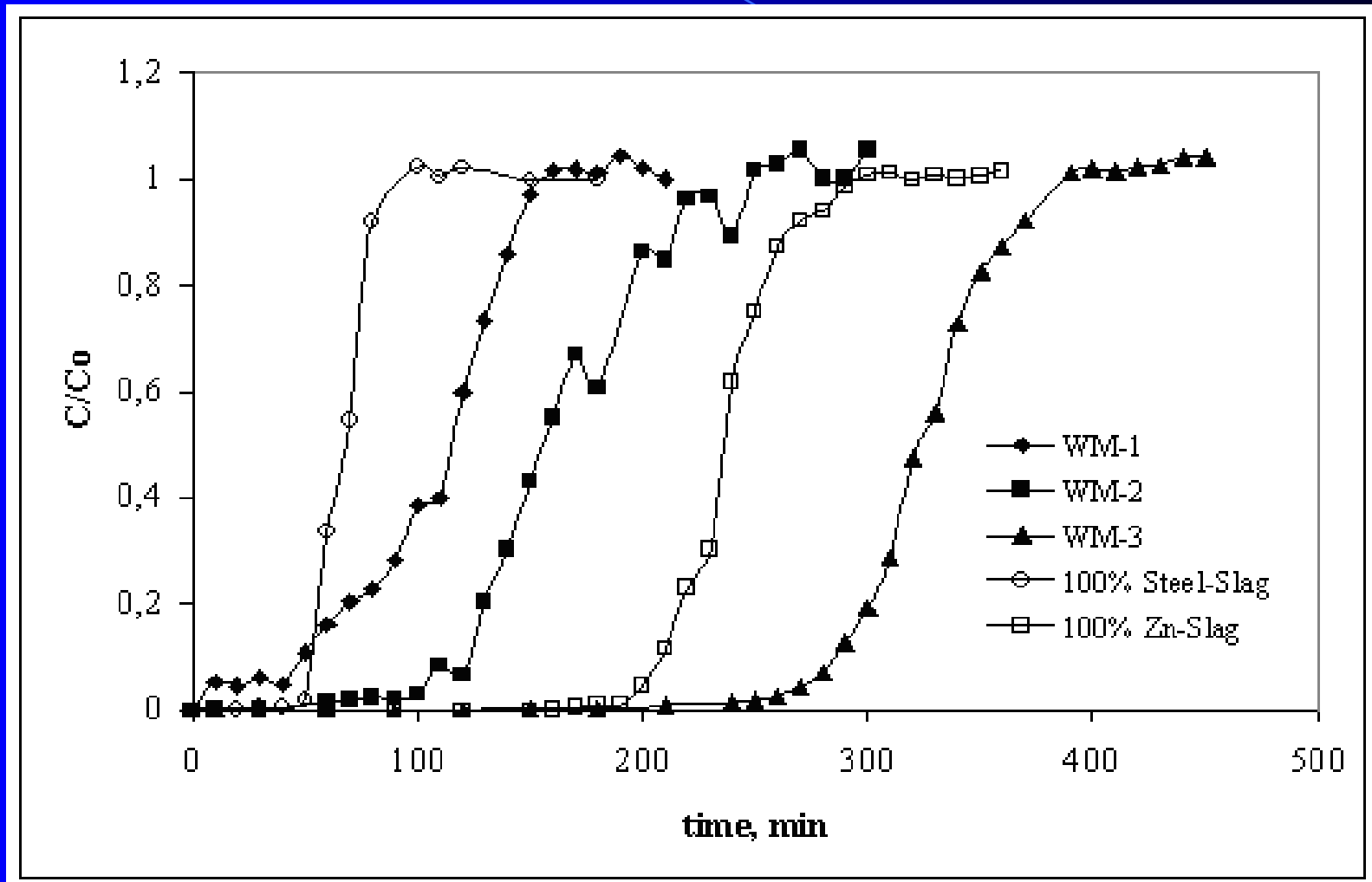

Sorbent Capacities of Tested Waste Mixtures at 500°C

Sorbents	Sorbent Capacity, g S/100 g Sorbent
100 % Steel-Slag	0.51
WM-1	0.75
WM-2	1.27
WM-3	2.55
100 % Zinc-Slag	1.87

Regeneration

The image features a dark blue to black gradient background. A prominent, curved, light blue line starts from the left edge and curves downwards and to the right, ending near the bottom right corner. This line separates the upper portion of the image, where the text is located, from the lower portion. The text 'Regeneration' is written in a bold, italicized, yellow-gold font.

Breakthrough Curves for H₂S After Four Successive Sulfidation at 500°C with 2000 ppmv Inlet Concentration (S=Sulfidation run)

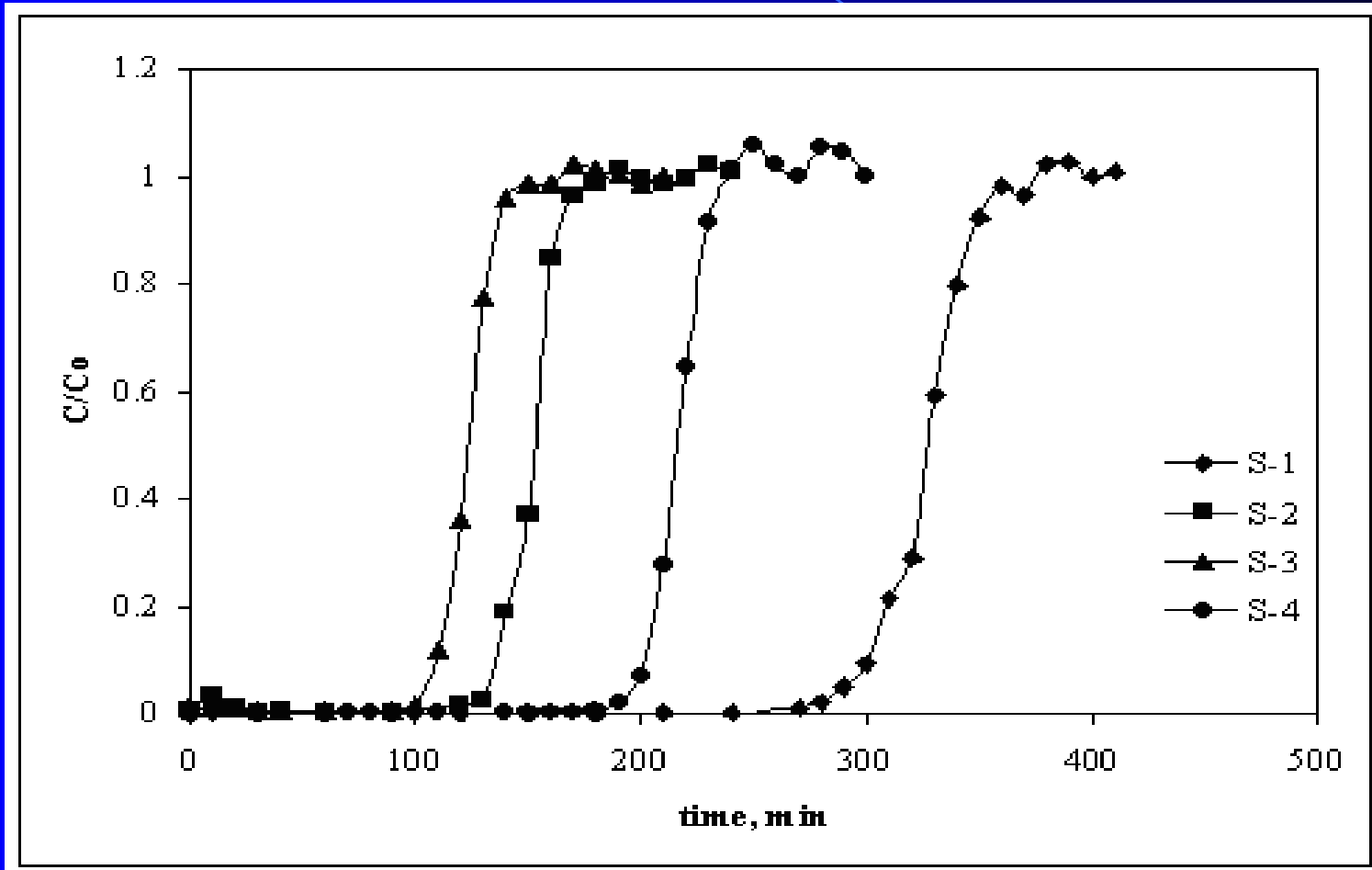

Sorbent Capacities of Zinc Slag During Cyclic Test

Sulfidation number	Sorbent capacity, g S/100 g Sorbent
S-1	2.67
S-2	1.24
S-3	0.96
S-4	1.77

Breakthrough Curves for SO₂ During Regeneration at 500°C with Dry Air, 350 ml/min (R=Regeneration run)

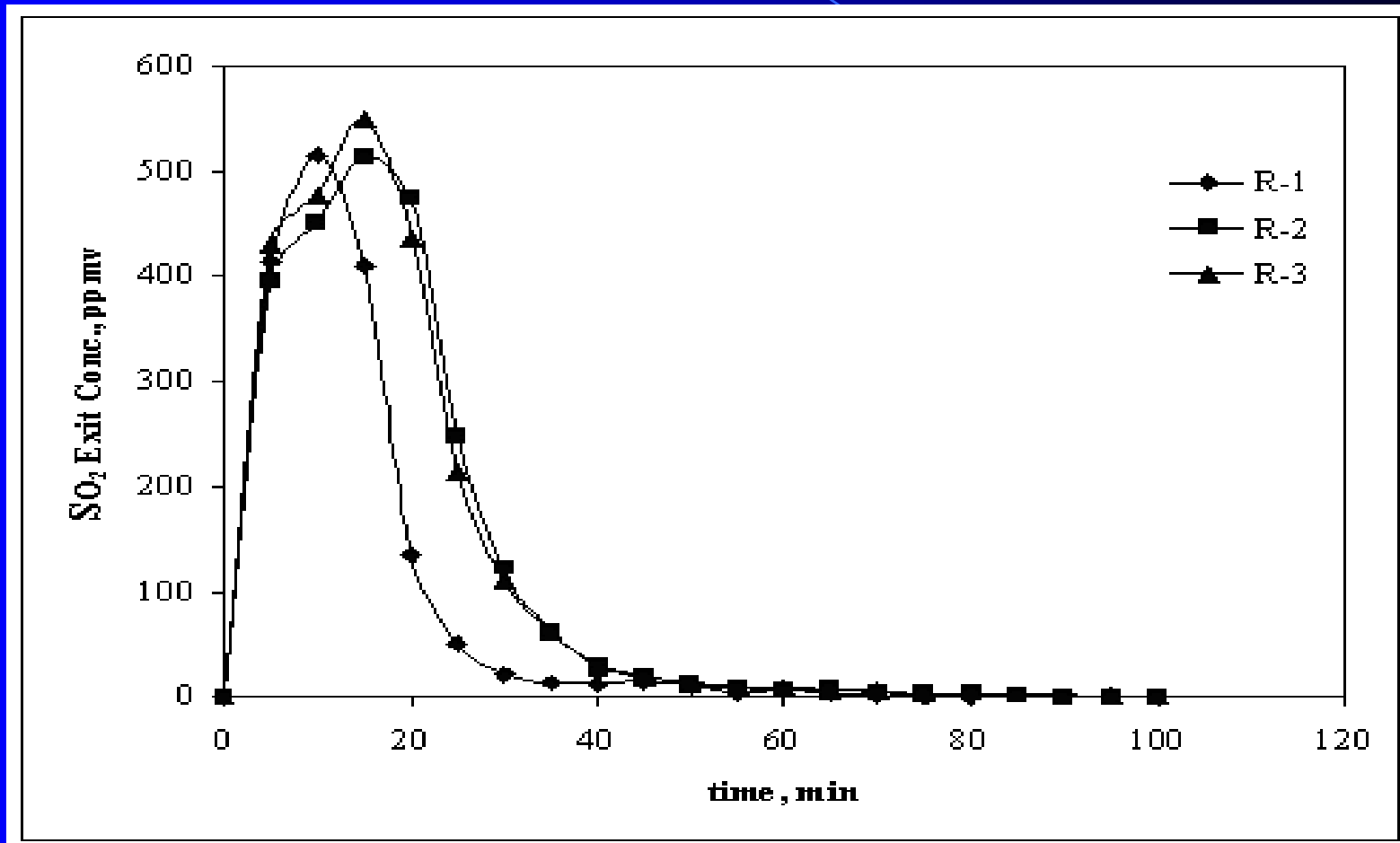

XRD Graph of Zinc Slag After Sulfidation at 600°C with 2000 ppmv

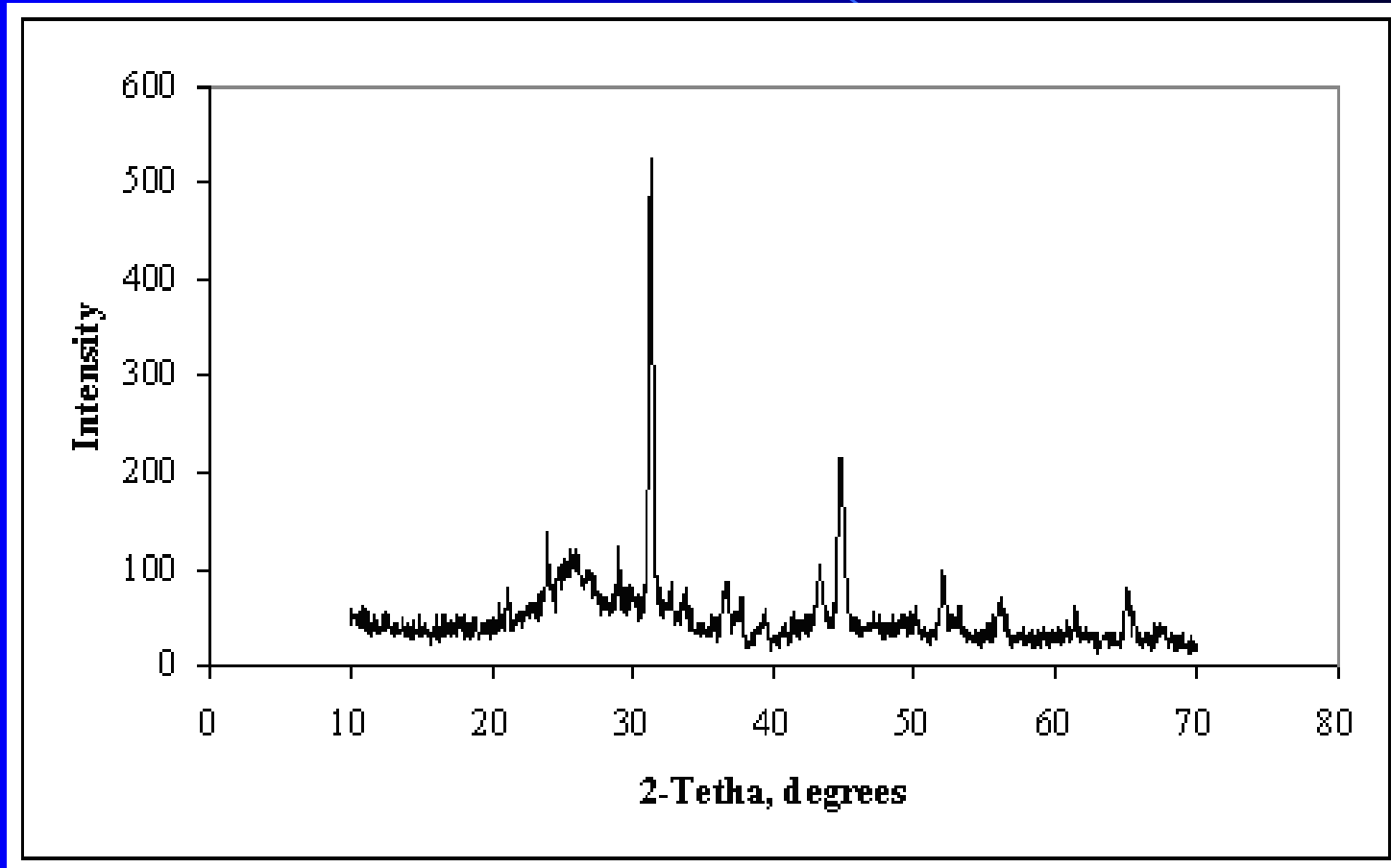

Conclusion

- Zn slag is a good candidate as a low-cost sorbent for the removal of H_2S in the temperature range of 400 – 600°C.
- H_2S sorption capacities increase with temperature. The highest efficiency is achieved at 600°C and at an inlet concentration of 1000 ppmv H_2S for the zinc slag. The corresponding breakthrough times were 1530 min. It is seen that the zinc slag can reduce the 2000-ppmv H_2S concentration down to 1-2 ppmv levels before breakthrough.

Contn'd

- The mixtures of steel and zinc slags were also tested as H₂S sorbents. It was seen that they gave good results, too. The WM-3 sorbent, which is composed of 75 % zinc slag and 25 % by wt steel slag, achieved better sorption capacity and efficiency than others including the pure zinc slag sorbent.
- The regeneration results of the sorbents showed that zinc slag can easily be regenerated. Appreciable amounts of SO₂ are released during the regeneration of the sorbents and it can be used in the production of sulfuric acid.

Changes in the sulfur content of the sorbent

	Reaction Temperature				
	200°C	300°C	400°C	500°C	600°C
% S by wt.	0.36	0.51	0.65	0.83	2.47

CONCLUSIONS

- In this study, availability of the metal oxide waste materials especially the steel slag from the iron-steel industry for the absorption of H_2S was investigated and it was found that it is a good candidate as a low-cost sorbent for the removal of H_2S in the temperature range of 500 – 600°C.
- A breakthrough time of 150 min can be reached at a reaction temperature of 700°C.
- It was observed that iron and steel industry waste can bring the H_2S concentration down from 1000 ppmv to 1 ppmv.

Conclusions Contn'd

- The XRD analysis has shown that FeS is formed in the particles and the sulfur content of the sorbent has increased about four folds as the temperature increased from 400 to 600°C.

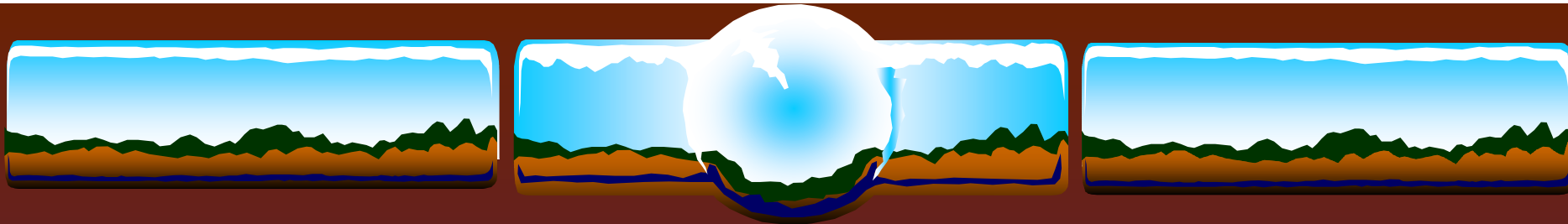

**Experience with Cleaner Production in the
Ledeko, Inc. Agricultural
Enterprise, Letovice, The Czech Republic**

**prof. František BOŽEK, Ph.D.
Military University VYSKOV
CZECH REPUBLIC**

Connection: +420 973 452 471, e-mail: bozek@feos.vvs-pv.cz

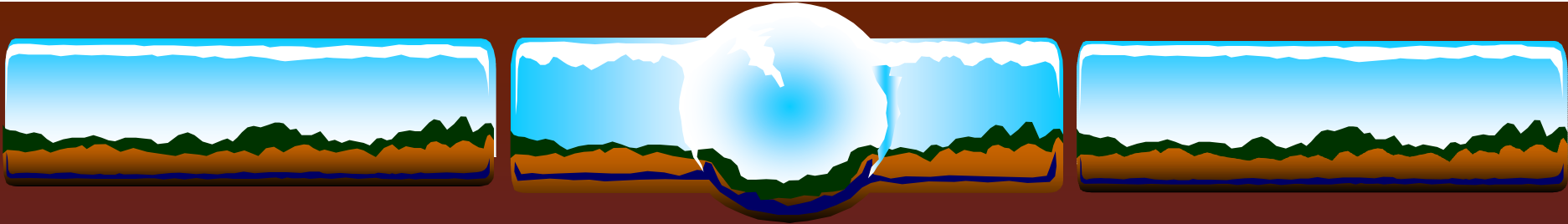

Introduction

- Present situation in the Czech agriculture
- Cleaner Production (CP) projects in 1999 - 2001

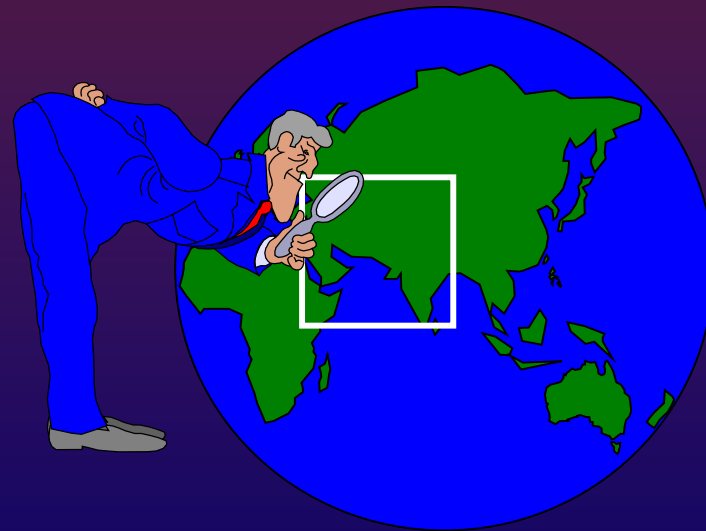

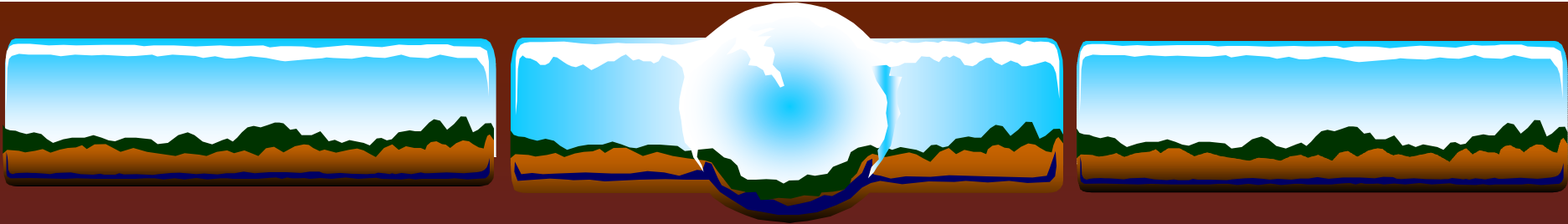

Characteristics of LEDEKO, Inc.

- **Basic information**

Animal production	46 %
Mill	25 %
Road transport	13 %
Plant production	10 %
Bakery	4 %
Wood-processing plant	2 %

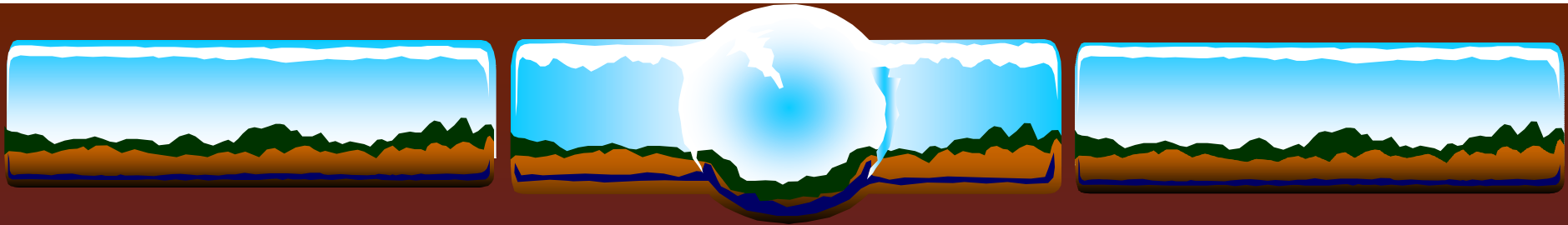

Determination of Priorities, Objectives and Choice of Indicators

The objectives:

- 1) cost reduction for milk production by 5 %**
- 2) reduction of manure losses by 10 %.**

The indicators:

- 1) reduction of costs per 1 litre of milk**
- 2) reduction of environmental impacts that are transformed into economic losses and subsequently expressed in CZK.**

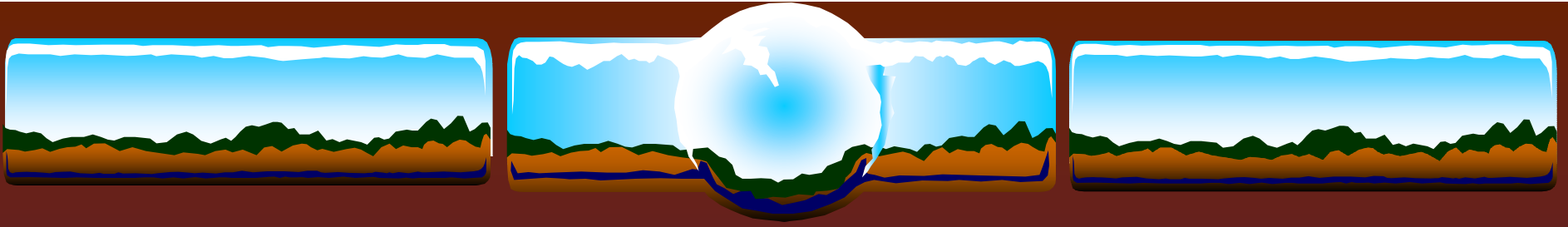

Proposed Measures

- **Reconstruction of a large-scale cowshed for 450 milk cows and removal of further 3 cowsheds.**
- **Construction of a large-capacity dung yard and removal of field dunghills.**

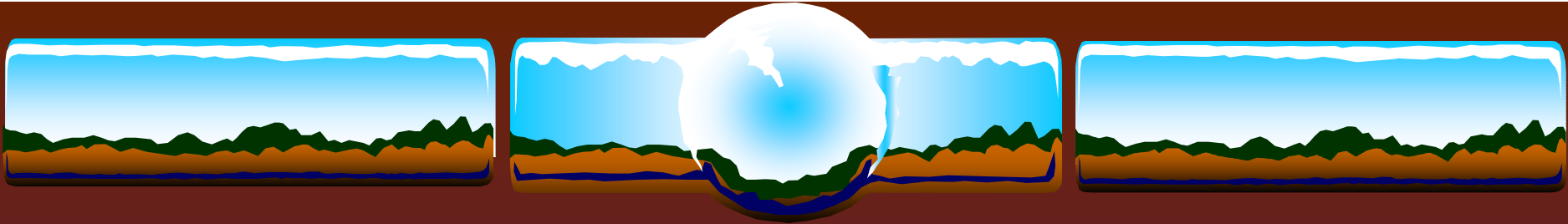

Economic Benefits and Costs

Reconstruction of a large-scale cow-shed

Burden in total: 17 000 000 CZK

burden of building: 12 952 000 CZK

burden of machine: 4 048 000 CZK

Payback period: 8 year 93 day

Economic effect: 4 274 550 CZK per year

**Costs per 1 litre of milk: 8,30 CZK → cost reduction for milk
production by 5 %**

IRR: 10,69 %

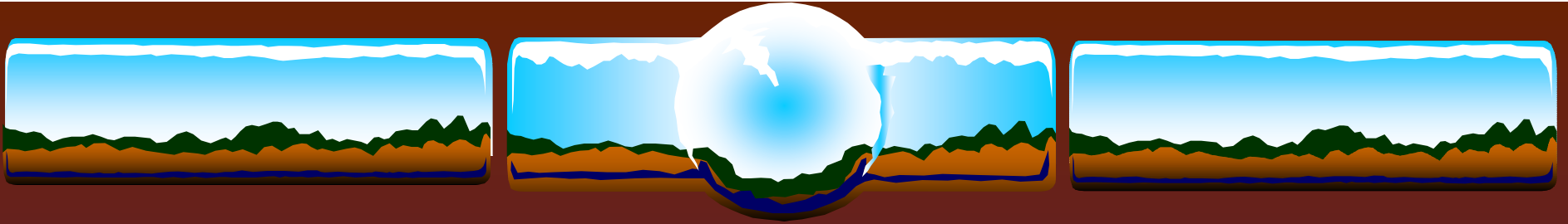

Environmental Benefits and Costs

- **removal of outdated spreading of semi-liquid manure results in smaller weed infestation of fields;**
- **lower consumption of herbicides;**
- **smaller number of passages;**
- **lower soil compaction;**
- **improvement of soil structure by means of using manure;**
- **reduction of the consumption of industrial fertilisers and diesel oil (by 1100 l), etc.**

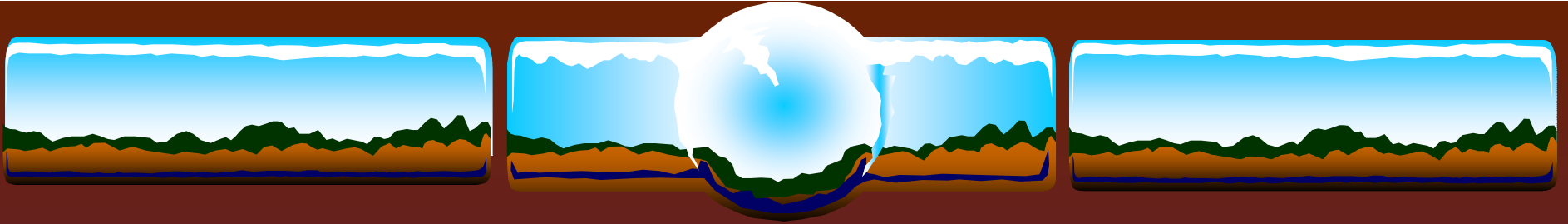

Conclusion

- **different benefits between agricultural and industry branch by using CP**
- **the CP strategy represents the change in the company management**

NATO CCMS Pilot Study on Clean Products and Processes

Establishing and Managing Waste Minimisation Clubs in South Africa

Susan Barclay and Chris Buckley

Pollution Research Group

University of Natal, Durban

Waste Minimisation Clubs

- A group of companies working together to reduce waste and save money
- Sector-specific or cross-sectional
- 7 to 15 companies
- Regular meetings

Pilot WMC in South Africa

- 2 pilot clubs formed in KwaZulu Natal
 - Metal Finishing (June 1998 to Dec 2000)
 - Hammarsdale (Nov 1998 to Dec 2000)
- Sponsored by the Water Research Commission

Results of Pilot WMC

WMC	No. members	Water and Effluent (kl/y)	Energy (MWh/y)	Financial Savings (R/y)
Metal Finishing	16	170 000	16 000	2 200 000
Hammarsdale	8	1 840 000	49 700	10 800 000

WMC in South Africa

Club	Area	Date Started
2 nd WMC for the Plastics Industry	Cape Town	Set up phase
Cape Metal Finishing	Cape Town	August 2000
WMC for Large Industries in the Western Cape	Cape Town	November 2000
Pietermaritzburg WMC	PMB	February 2001
In-house WMC	Sasol	February 2001
Nelson Mandela Metropole Metal Finishing	Port Elizabeth	March 2001
KZN Metal Finishing Club	Durban	August 2001
Gauteng Metal Finishing	Gauteng	October 2001
City of Cape Town WMC for the Blue Route Shopping Mall	Cape Town	February 2002
City of Cape Town WMC for Office Buildings	Cape Town	February 2002

WMC in South Africa (cont.)

Club	Area	Date Started
City of Cape Town WMC for Atlantis Industrial Area	Cape Town	February 2002
City of Cape Town WMC for the Plastics Industry	Cape Town	March 2002
City of Cape Town WMC for Meat Processing	Cape Town	April 2002
City of Cape Town WMC for the Car Repair Industry	Cape Town	April 2002
WMC for the Wine Farms in the Breede Valley	Robertson	April 2002
WMC at the Red Cross Children's Hospital	Cape Town	April 2002
City of Cape Town WMC for the Convention Centre	Cape Town	May 2002
WMC for the Food Industry in the Cape Metro Area	Cape Town	Set up phase
WMC for the Food and Beverage Industry in Boland	Boland	Set up phase
WMC for Medium and Large Companies in Paarl	Paarl	Set up phase
WMC for Suppliers to a Large Automotive Manufacturer	National	Set up phase
WMC for the Gauteng Plastics Industry	Gauteng	Set up phase
Eco-club for Wineries	Franschhoek	Set up phase

Facilitator's Manual

- Sponsored by the Water Research Commission
- Manual to provide guidance in forming and managing a waste minimisation club in SA
- Based on experiences of facilitator's of current WMC in SA

Stages in forming a WMC

- Raising awareness
- Recruitment
- Organisation for action
- Assessments
- Implementation
- Analysis
- Training

Funding a WMC

- Free to club members
- External subsidies
- Company contributions

Meetings

- Important aspect of a WMC
- Held at least bi-monthly
- Suitable venue
- Site visits

Barriers in Running a WMC

- Lack of attendance
- Lack of progress on-site
- Lack of *big stick*
- Competition between members

Internal Barriers

- Lack of time
- Lack of resources
- Lack of finance
- Lack of commitment

Success Factors

- Commitment from top level
- Enthusiastic project champion
- Involvement of all employees
- Training
- Success stories
- Backing from local regulators

Social Aspects

- Good interaction between club members
- Exchange of information and ideas
- Peer pressure to succeed

WMC and Local Authorities

- WMC can work as a group to discuss issues with local regulators
- Metal Finishers in KZN working towards co-regulation with eThekweni Water

Sustaining the Concept

- Keeping the awareness
- Publication of success stories
- Support of local, provincial and national government
- Centre of information
- Training

Training

- Very important in promoting waste minimisation
- Trainer's and Participant's Manuals in development stages

Acknowledgements

- Water Research Commission of Southern Africa
- Club members
- Club Facilitators

NATO/ CCMS Pilot Study
“CLEANER PRODUCTS AND PROCESSES”

Network of Excellence:

**Sustainable Remediation Concepts and Technologies for
Former Industrial Sites under consideration of
Technical -, Economical -, Legal -, Environmental -
Socio-economical Aspects (TELES)**

abc - consultants gmbh initiative

Viorel Harceag – ROMANIA

Cetraro 2003



NATO/ CCMS Pilot Study
“CLEANER PRODUCTS AND PROCESSES”

33 research organisations, companies and universities from 14 European countries have expressed their firm interest to cooperate in a consortium for the interdisciplinary development of remediation standards for former industrial sites in Europe

Cetraro 2003



NATO/ CCMS Pilot Study
“CLEANER PRODUCTS AND PROCESSES”

The core objective : dissemination of best practices, demonstration of projects with integrated and outstanding approaches on remediation strategies for former industrial sites related to the mining-, petrochemical-, energy-, chemical- and heavy industry

Cetraro 2003



**NATO/ CCMS Pilot Study
“CLEANER PRODUCTS AND PROCESSES”**

The network will access the available know-how at the Centres of Excellence as well as the implementation experience of the industry, concerned with rehabilitation and remediation of former industrial sites. An intensive training and workshop concept will help to overcome the existing barriers.

Cetraro 2003



NATO/ CCMS Pilot Study “CLEANER PRODUCTS AND PROCESSES”

The network intent to:

- ☉ **bring the basic research capacities of universities and the applied research of consulting companies and production industry together.**
- ☉ **encourage additional and supportive research in the national research centres and in the existing Centres of Excellence and Integrated Projects.**
- ☉ **bridge the differences between West and East.**
- ☉ **doing this, TELES will develop new markets**

Cetraro 2003



NATO/ CCMS Pilot Study
“CLEANER PRODUCTS AND PROCESSES”

The “networking” will be organised as follows:

- ☉ **Coordinating Workshops**
- ☉ **Applied Research Activities**
- ☉ **Basic Research Programmes**
- ☉ **Public Issues/Information Group**
- ☉ **Cooperation Forum for non-network Partners**

Cetraro 2003



**NATO/ CCMS Pilot Study
“CLEANER PRODUCTS AND PROCESSES”**

Coordinating Workshops main duties:

- ☉ **Definition of the future research projects**
- ☉ **Selection of researchers**
- ☉ **Distribution of results, including the compilation of the so called “Remediation Handbook”**

Cetraro 2003



NATO/ CCMS Pilot Study “CLEANER PRODUCTS AND PROCESSES”

Subjects for the Applied Research Activities:

- ☉ **borehole technologies,**
- ☉ **civil engineering,**
- ☉ **environmental economy,**
- ☉ **geochemistry,**
- ☉ **in-situ treatment methods,**
- ☉ **monitoring,**
- ☉ **soil cover engineering,**
- ☉ **solid waste, water treatment methods**

Cetraro 2003



NATO/ CCMS Pilot Study “CLEANER PRODUCTS AND PROCESSES”

Subjects for the Basic Research Programmes:

- ☉ acid generation,
- ☉ best available technologies,
- ☉ bio-remediation, conceptual re-mediation,
- ☉ geotechnics,
- ☉ hydrology,
- ☉ life cycle analysis,
- ☉ natural attenuation,
- ☉ risk assessment,
- ☉ rules / regulations / legal aspects

Cetraro 2003



NATO/ CCMS Pilot Study
“CLEANER PRODUCTS AND PROCESSES”

Subjects for the **Public Relation Issues and Information Group:**

- ☯ environmental policy,
- ☯ follow-up activities,
- ☯ public relation campaigning,
- ☯ socio-economic aspects

Cetraro 2003



NATO/ CCMS Pilot Study
“CLEANER PRODUCTS AND PROCESSES”

**The Cooperation Forum for
Non-network Partners** will provide
an open platform for the exchange
of technical details between the network
and non-network organisations

Cetraro 2003



Topics for Cooperation

NATO/CCMS Pilot Study on Clean
Products and Processes
2002 Annual Meeting
Cetrato, Italy

Topics for Cooperation

1. Sustainability metrics and reporting mechanisms

Leader: A. Fet (Norway)

Cooperating Nations: USA, Turkey, Greece, Slovenia, Lithuania, Germany, Hungary, Romania, UK, Portugal, and Italy

Topics for Cooperation

2. Train the trainers, implement EMA

Leader: G. Zihahy (Hungary)

Participating Nations: Slovenia,
Ukraine, Lithuania

Topics for Cooperation

3. Education and training in sustainable tradition

Leader: P. Glavic (Slovenia)

USA, Portugal, Czech Republic,
Ukraine, Germany, Poland, Spain,
Bulgaria, Israel, Denmark, Italy,
South Africa, Turkey, Lithuania

Topics for Consideration

4. Cleaner production policy in transition economy countries

Leader: W. Zadorsky (Ukraine)

Participating Nations: Germany, Hungary, Romania, Sweden, Bulgaria, Norway

Topics for Cooperation

5. Indicators for potential new sustainable technologies

Leader: E. Drioli (Italy)

Participating Nations: USA, Russia, Israel, Portugal, Slovenia, Romania, Denmark, Poland, Greece, Hungary, Turkey, Spain

Topics for Cooperation

6. Waste minimization clubs

Leader: C. Buckley (S. Africa)

Participating Nations: Ukraine,
Portugal, Israel, Slovenia, USA,
Czech Republic, Bulgaria

Sustainable Development Using Macroeconomic and Microeconomic Indicators

Prof. Dr. Peter Glavič, Damjan Krajnc

University of Maribor,

Department of Chemistry and Chemical Engineering,

Smetanova 17, P.O. Box 219, SI- 2000 Maribor, Slovenia

Strategy of development in Slovenia

Balanced development:

economic	++
social	- +
environmental	++

Indicators: GNP (p. p.) / (inhabitant)

Index of human development

Index of balanced sustainable development

Index of national competitiveness

Index of regional development

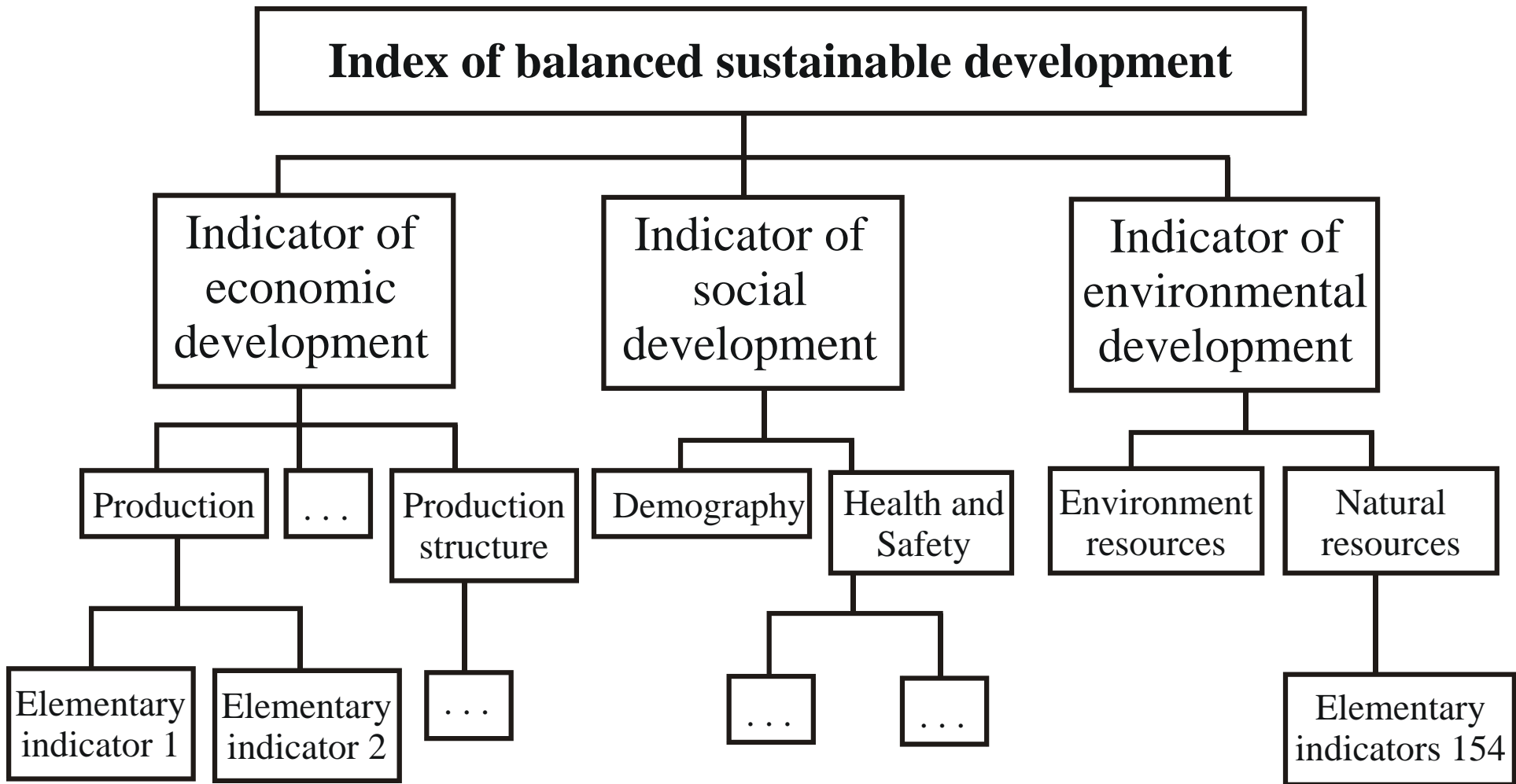

Total elementary indicators: 154

Groups of economic indicators of sustainable development:

EC 1: Production

EC 2: Macroeconomic stability and state consumption

EC 3: Factors of economic growth – capital

EC 4: -||- – human resources

EC 5: -||- – technological resources

EC 6: -||- – natural resources

EC 7: International trade

EC 8: Consumer habits

EC 9: Structure of production

Some economic indicators

Factors of economic growth:

- Technological resources:

- **Computers / inh.** (%)
- **Internet users / inh.** (%)
- **Fraction (R&R expenditure in GDP)** (%)
- **Ratio export/import** (%)

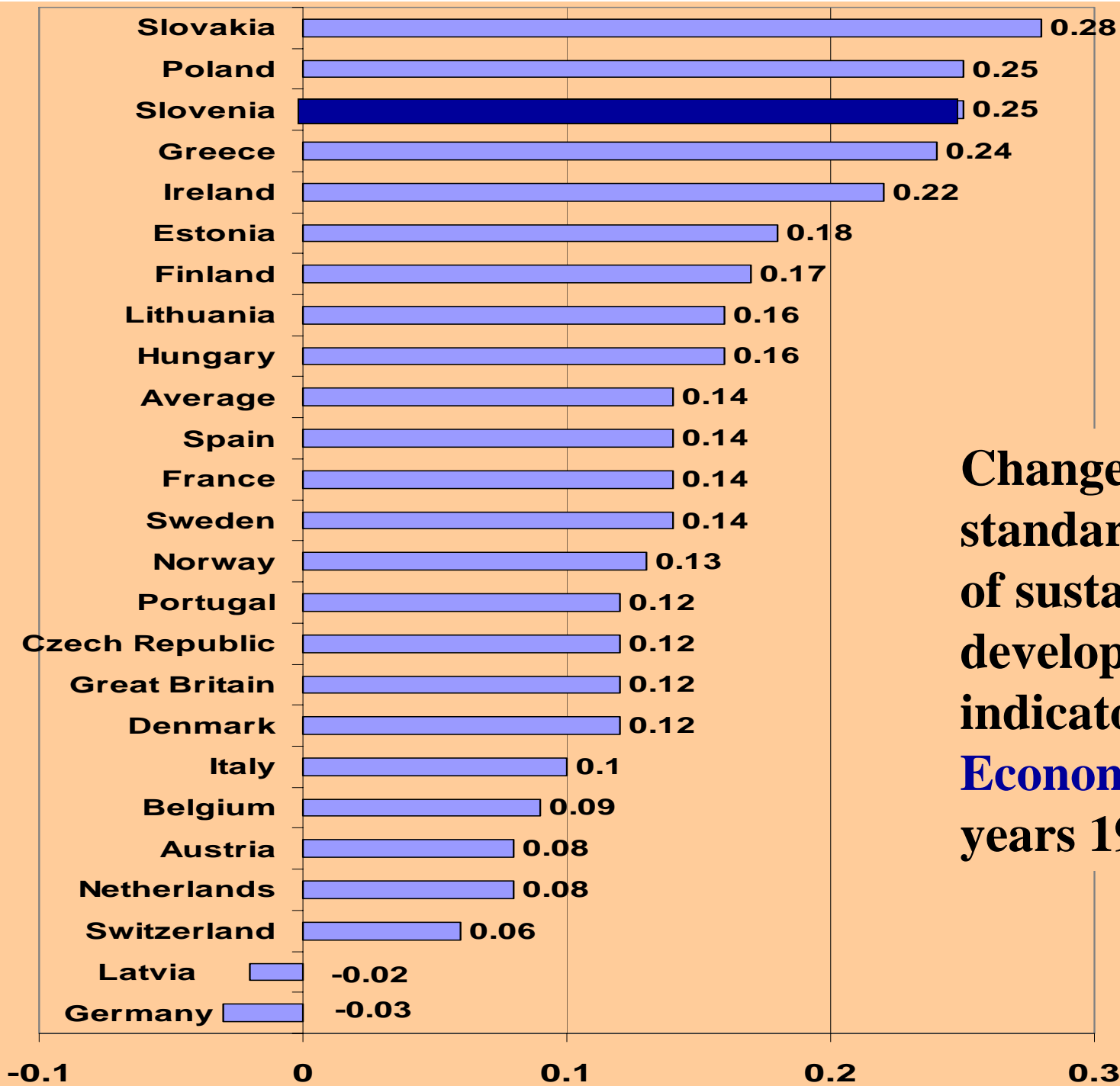

**Changes in
standardized values
of sustainable
development
indicator for
Economy field in
years 1990 - 1998**

Groups of social indicators:

- S 1: Population number and structure**
- S 2: Communities, migrations and regional structure**
- S 3: Economical inequality**
- S 4: Gender inequality**
- S 5: Expected life duration**
- S 6: Illnesses, bad habits and medical infrastructure**
- S 7: Education**
- S 8: Rights, privilege and collaboration**
- S 9: Safety**

Some social indicators

S 1: Population number and structure (S-I)

- Growth (S-1)
- Age: Over 65 years $f(\text{total population})$
Index of aging

S 2 : Communities, migrations and regional structure

- Families: marriages / inh.
 divorces / inh.
- Migrations
- Regions: $f(\text{urban population})$
 annual growth
 capital population

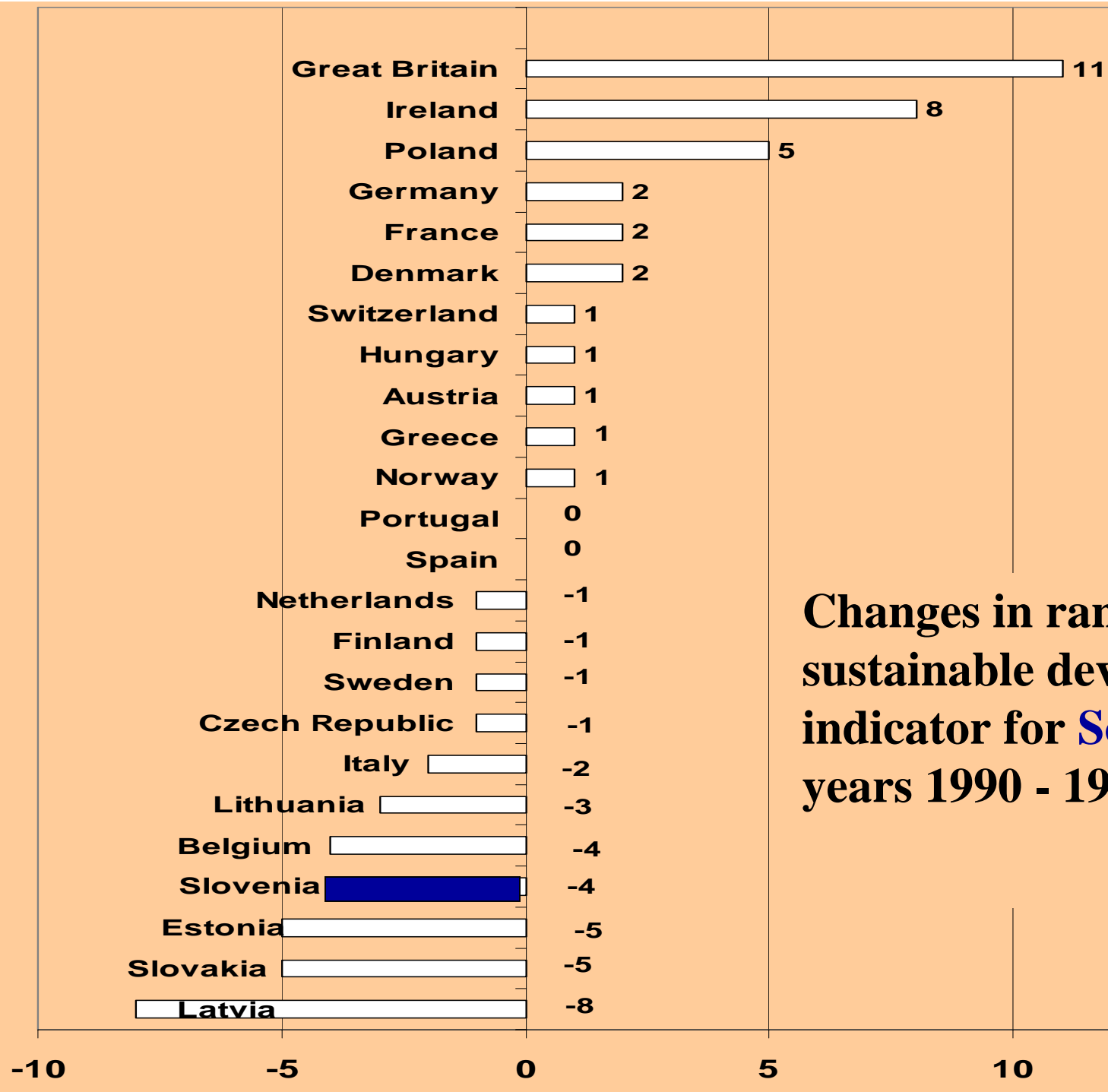

Changes in ranks of sustainable development indicator for **Social field** in years 1990 - 1998.

Groups of environmental indicators:

- | | |
|--------------|-------------------------------|
| EN 1: | Air polluting |
| EN 2: | Air pollution |
| EN 3: | Water polluting |
| EN 4: | Rivers pollution |
| EN 5: | Soil and area |
| EN 6: | Noise |
| EN 7: | Nonrenewable resources |
| EN 8: | Renewable resources |
| EN 9: | Potential resources |

Some environmental indicators

EN 1: Air polluting

SO₂ emissions per inh. (kg)

NO_x emissions per inh. (kg)

CO₂ equivalent per inh. (kg)

EN 2: Air pollution

SO₂ mass concentration in cities $\mu\text{g}/\text{m}^3$

NO_x mass concentration in cities $\mu\text{g}/\text{m}^3$

Changes in ranks of sustainable development indicator for **Environmental field** in years 1990 – 1998 for **Slovenia**

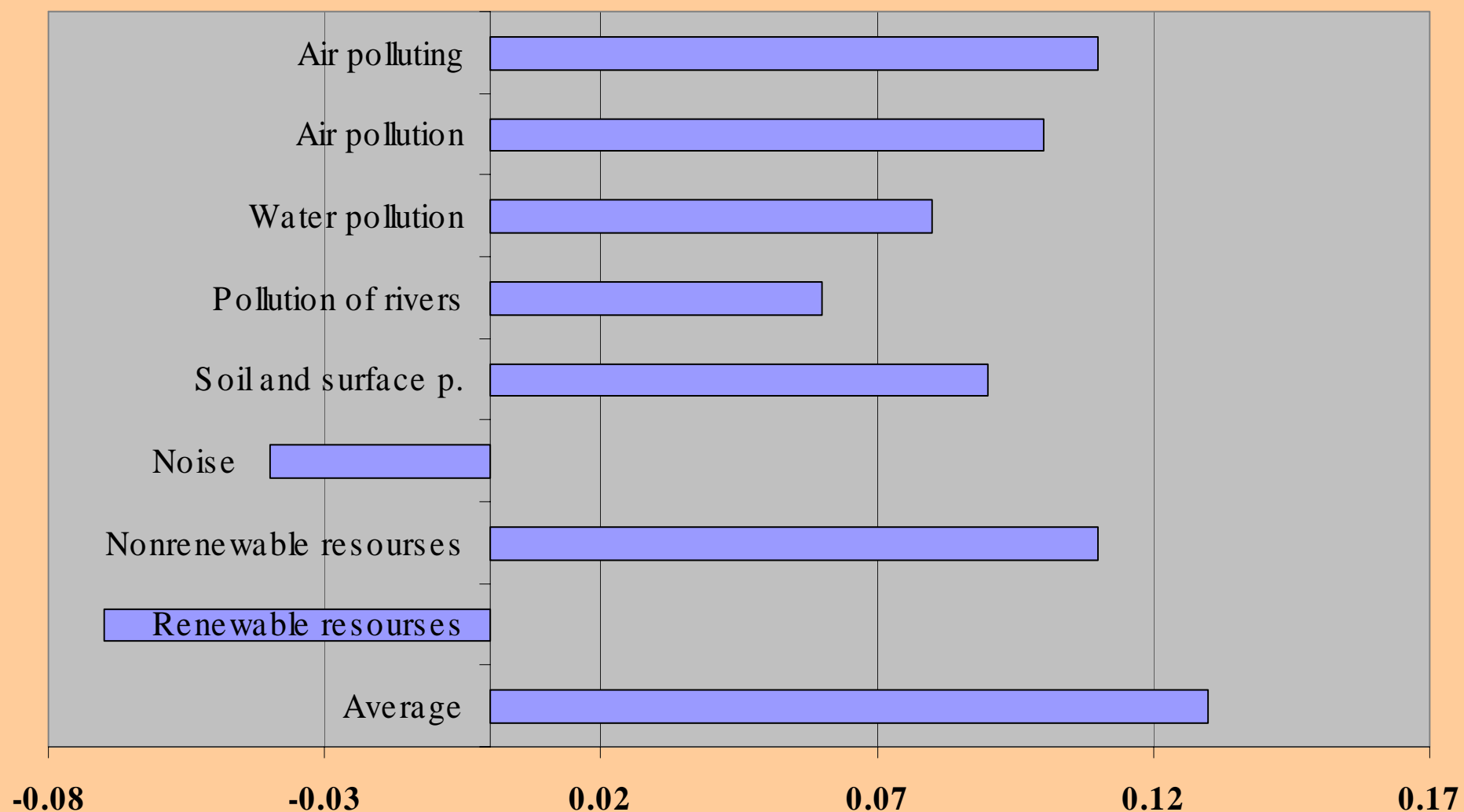

Index of balanced sustainable development in 1998

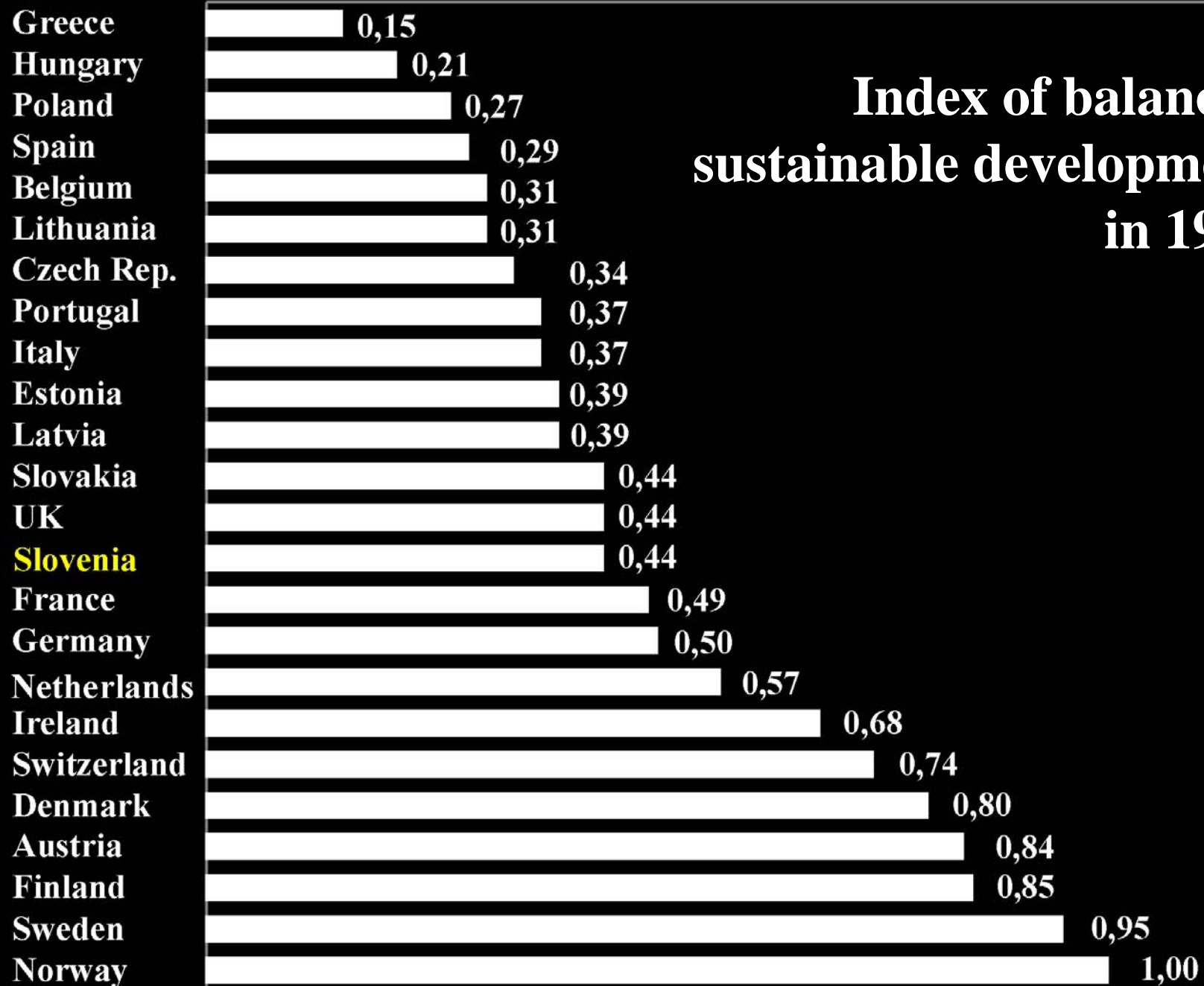

Government

National Sustainability Assessment

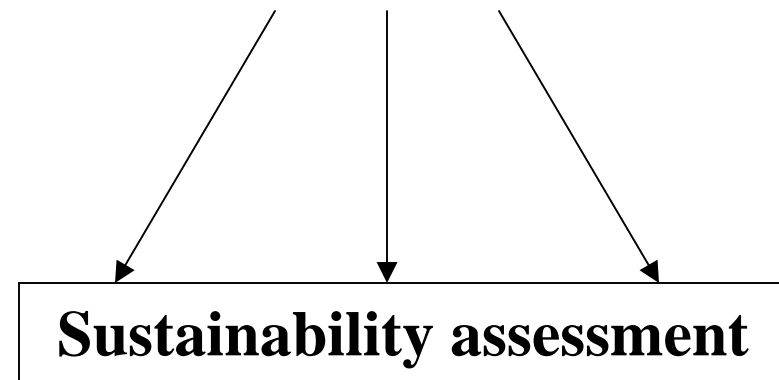

Linkage ?

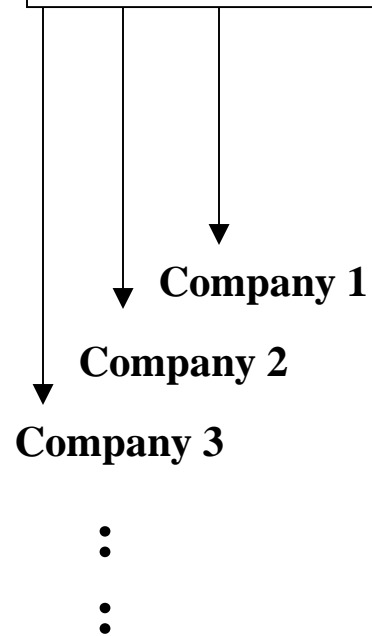

Company Sustainability Assessment



**The composite sustainable
production index – a model for
integrated assessment of
sustainability**

A model for integration of sustainable production indicators into the I_{CSP}

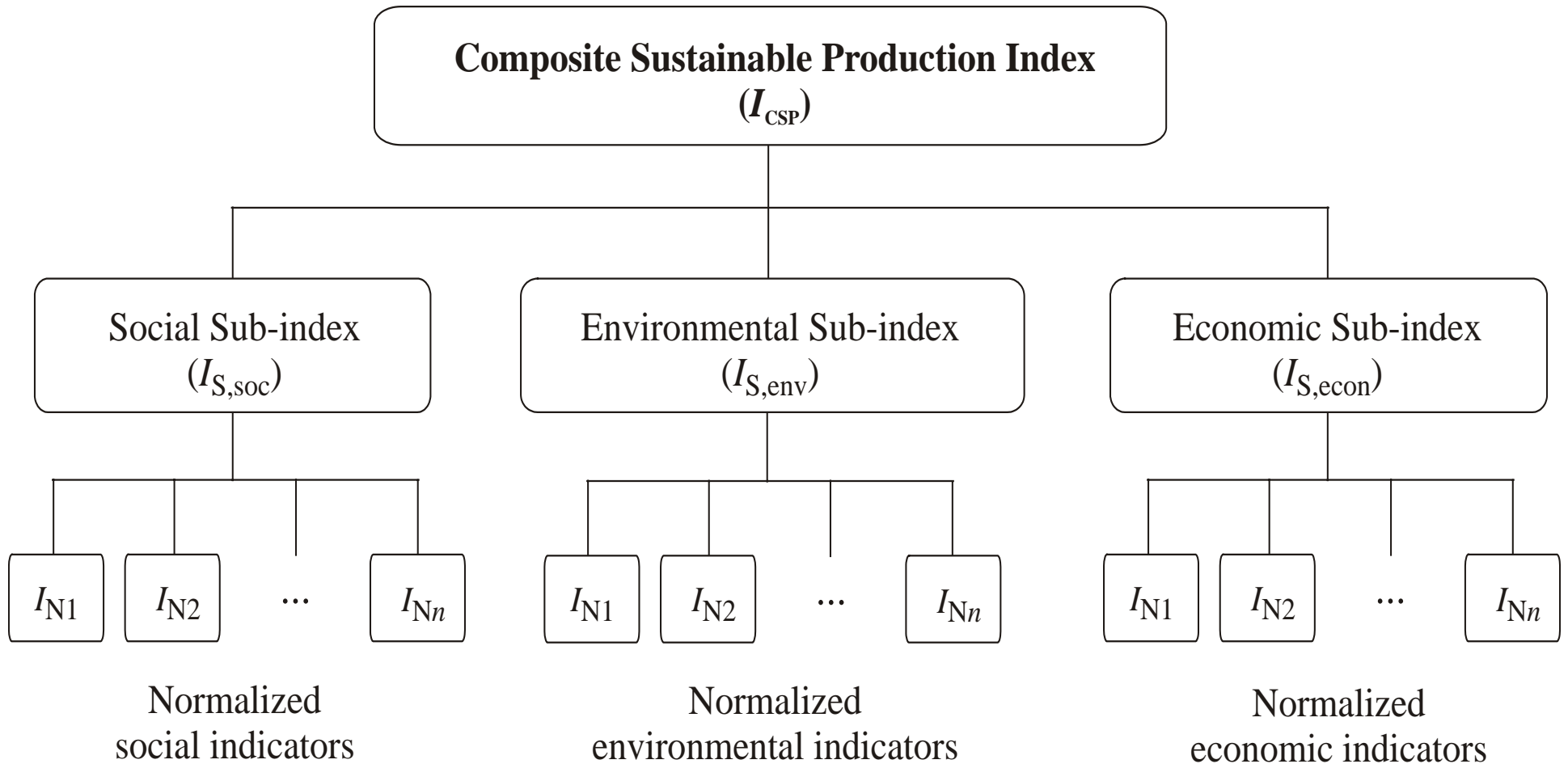

The procedure of calculating the I_{CSP} :

1. Selection of indicators

2. Grouping of indicators (social, environmental and economic group)

3. Judgment on indicator's impact (positive or negative)

4. Normalization of indicators

5. Weighting of indicators

6. Calculation of sub-indices, I_S

7. Combining sub-indices into the I_{CSP}

1. Selection of indicators

Indicators should cover main aspects of sustainable production:

- energy and material use
- natural environment
- social justice and community interaction
- economic performance
- employees satisfaction and
- products

Key dimensions of indicator:

- **Unit of measurement** (numbers, kilograms, EUR, hours etc.)
- **Type of measurement** (total or adjusted amount)
- **Period of measurement** (fiscal year, calendar year, quarter, month etc.)
- **Boundaries** (product line, facility, suppliers, distributors, life cycle etc.)

2. Grouping of indicators

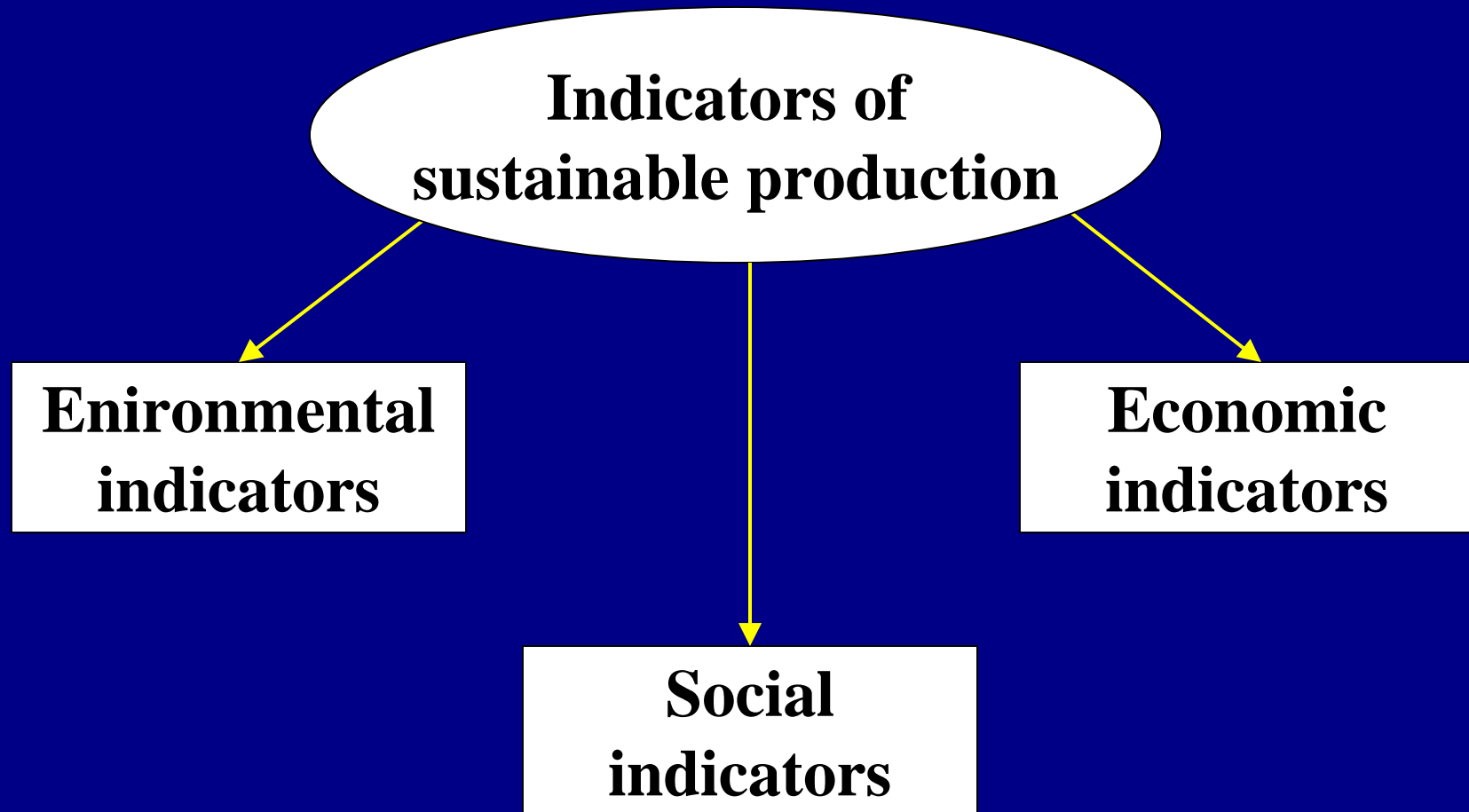

3. Judgment on indicator's impact

$I_{A,ji}^+$ increasing value has positive impact

Example: Increased operating profit

$I_{A,ji}^-$ increasing value has negative impact

Example: Increased air emissions per unit of production

Notation:

Social group $j = 1$

Environmental group $j = 2$

Economic group $j = 3$

Indicator $i = 1, \dots, n$

4. Normalization of indicators

Uncompatibility (indicators expressed in different units)

Normalization of indicators:

Compatibility (indicators lose units)

$$I_{N,ijt} = \frac{I_{A,ijt}}{I_{A,ij}}$$

← value of indicator

← average value of all years measured

normalized indicator i for group of indicators j for year t

Example:

Indicator	1998	1999	2000	2001	Average
Energy consumption (GJ/UP)	4,63	4,40	3,77	3,84	4,16

Normalized indicator for 2001: $I_{N,ijt} = \frac{I_{A,ijt}}{I_{A,ij}} = \frac{3,84}{4,16} = 0,92$

5. Weighting of indicators

The Analytic Hierarchy Process (AHP):

N indicators \longrightarrow $(N \times N)$ positive reciprocal matrix A

$a_{ii} = 1$ (i.e., on the diagonal) and
 $a_{ji} = (1/a_{ij})$, $i, j = 1, \dots, n$ (reciprocal property)

Pair-wise comparisons
(making independent judgments over each pair of indicators)

dividing an indicator relative weight by the sum of relative weights in column

Averaging the values across the rows

Normalized weight vector W containing weights (W_{ji}) of indicators

Example:

Indicator		E_{tot}	V_{water}	$m_{\text{wst., hazard}}$	
Total energy consumption	E_{tot}	1	1/3	1/4	
CO ₂ emissions	m_{CO_2}	3	1	1/5	
Hazardous waste	$m_{\text{wst., hazard}}$	4	5	1	
	Σ	8,00	6,33	1,45	Weight
	E_{tot}	0,12	0,05	0,17	0,12
	m_{CO_2}	0,38	0,16	0,14	0,22
	$m_{\text{wst., hazard}}$	0,50	0,79	0,69	0,66

6. Calculation of sub-indices, I_S

$$I_{S,jt} = \sum_{jit}^n W_{ji} \cdot I_{N,jit}^+ - \sum_{jit}^n W_{ji} \cdot I_{N,jit}^-$$

$$W_{ji} \geq 0$$

$$\sum_{ji}^n W_{ji} = 1$$

- $I_{S,jt}$ sustainability sub-index for the group of indicators j in year t
 $I_{N,jit}$ normalized indicator i for the group j in year t
 W_{ji} weight of indicator i for the group of sustainability indicators j

7. Combining sub-indices into the I_{CSP}

Composite sustainable production index (I_{CSP}):

$$I_{CSP,t} = \sum_{jt}^n W_j \cdot I_{S,jt}$$

W_j coefficient that represents a priori weight given to the group j

$I_{S,jt}$ sustainability sub-index for group of indicators j in year t

CASE STUDY

Sustainability Assessment of HENKEL

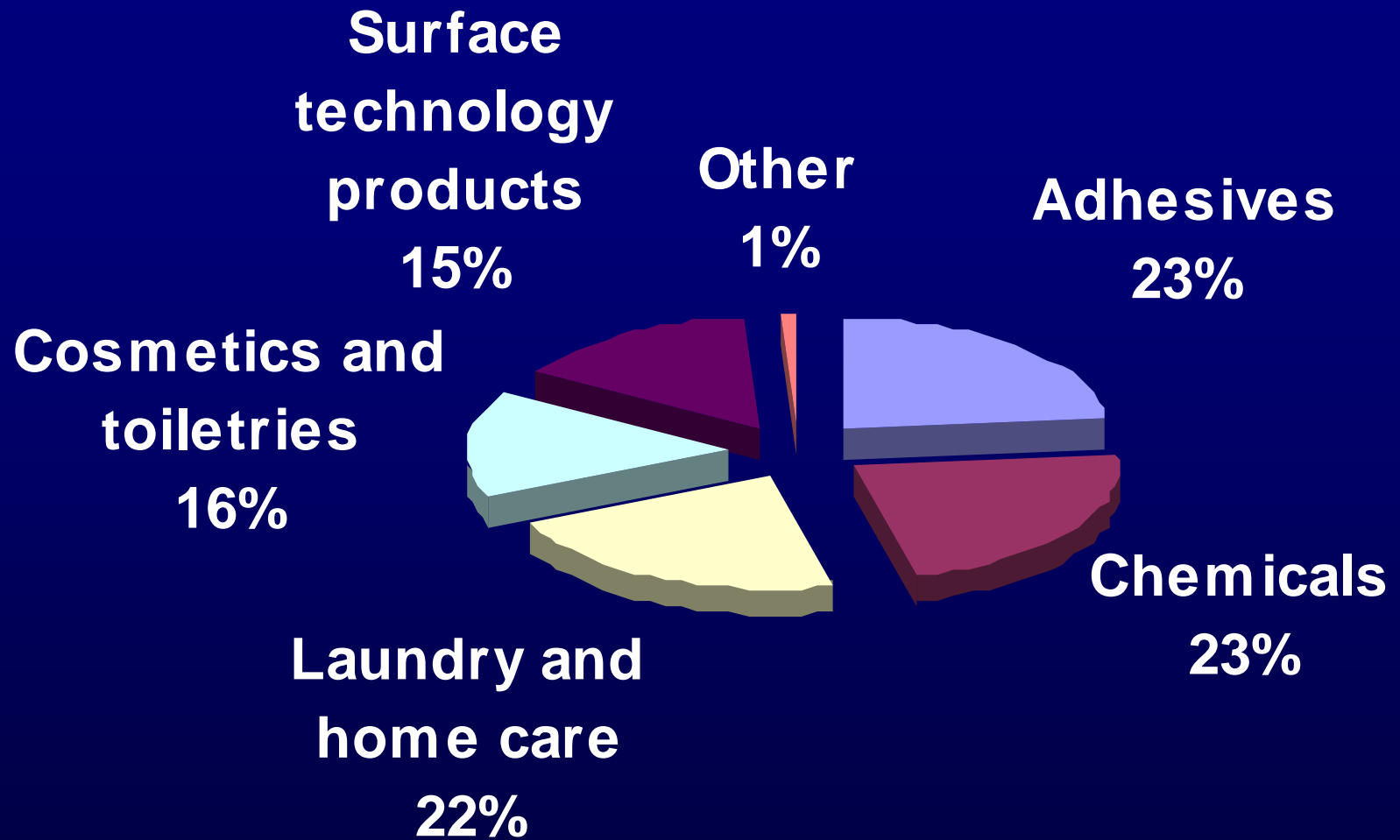

Henkel business activities

Social indicators measured by HENKEL:

Indicator	Symbol	Unit
Number of occupational accidents per 200 000 hours worked	N_{ac}	1/a
Number of serious occupational accidents*	$N_{ac, ser}$	1/a
Number of accidents during typical production activities	$N_{ac, act}$	1/a
Number of accidents while walking or moving around	$N_{ac, walk}$	1/a
Number of sites that received complaints from neighbors	$N_{c., sites}$	1/a
Number of complaints from neighbors	N_c	1/a
Number of complaints due to odor	$N_{c, odor}$	1/a
Number of complaints due to noise	$N_{c, noise}$	1/a
Number of complaints due to dust	$N_{c, dust}$	1/a
Number of improvement measures initiated	N_{impr}	1/a
Number of cause already eliminated	N_{elim}	1/a

Environmental indicators measured by HENKEL:

1. Material & Energy:

- **Energy consumption**
- **Bought-in energy consumption per UP***
- **Coal consumption per UP**
- **Fuel Oil consumption per UP**
- **Gas consumption per UP**
- **Water consumption per UP**
- **Consumption of chlorinated hydrocarbons per UP**
- **Production mass**

***UP = Unit of production (kg)**

2. Emissions:

- **Air emissions per UP**
- **CO₂ emissions per UP**
- **NO_x emissions (calculated as NO₂) per UP**
- **SO₂ emissions per UP**
- **Dust emissions per UP**
- **Emissions of VOC per UP**
- **Wastewater per UP**
- **COD emissions into surface waters per UP**

3. Metals & Waste:

- **Emissions of heavy metals into surface waters per UP**
- **Lead, chromium, copper, nickel per UP**
- **Zinc per UP**
- **Waste for recycling and disposal per UP**
- **Waste for recycling per UP**
- **Hazardous waste for disposal per UP**
- **Waste for disposal per UP**

Economic indicators measured by HENKEL:

Indicator	Symbol	Unit	1998	1999	2000	2001	Average
Sales	S	MEUR	10 909	11 361	12 779	9 410	11 115
Operating profit	P_o	MEUR	791	857	950	602	800
Capital expenditures	I_E	MEUR	979	746	1 359	664	937
Net earnings	E_N	MEUR	372	404	505	476	439
R&D costs	C_R	MEUR	250	279	320	255	276
Number of employees	N_{empl}	1	56 291	56 620	60 475	47 362	55 187

Pair-comparison of environmental indicators:

Indic.	E_{tot}	E_{bought}	E_{coal}	E_{oil}	E_{gas}	V_{water}	m_{CHC}	m_{prod}	m_{CO_2}	m_{NO_2}	m_{SO_2}	...
E_{tot}	1	1	1/2	1/2	1/2	1	1	3	1/3	1/4	1/4	...
E_{bought}	1	1	1	1	1	2	1	3	1/3	1/4	1/4	...
E_{coal}	2	1	1	1	1	2	1	3	1/2	1/4	1/4	...
E_{oil}	2	1	1	1	1	2	1	3	1/2	1/4	1/4	...
E_{gas}	2	1	1	1	1	2	1	3	1/2	1/4	1/4	...
V_{water}	1	1/2	1/2	1/2	1/2	1	1/3	1	1/5	1/7	1/9	...
m_{CHC}	1	1	1	1	1	3	1	3	1	1/2	1/2	...
m_{prod}	1/3	1/3	1/3	1/3	1/3	1	1/3	1	1/3	1/5	1/7	...
m_{CO_2}	3	3	2	2	2	5	1	3	1	1/2	1/2	...
m_{NO_2}	4	4	4	4	4	7	2	5	2	1	1/2	...
m_{SO_2}	4	4	4	4	4	9	2	7	2	2	1	...
⋮	⋮	⋮	⋮	⋮	⋮	⋮	⋮	⋮	⋮	⋮	⋮	⋮
Σ	57,3	54,8	52,3	52,3	52,3	102,0	49,7	83,0	27,7	25,9	21,6	

Comparison scale: 1 (equal importance) – 9 (extreme importance of one over another)

Sustainability sub-indices and Composite sustainable production index:

	1998	1999	2000	2001
$I_{S,1}$	0,964	0,974	1,212	0,854
$I_{S,2}$	-0,546	-0,309	-0,312	-0,273
$I_{S,3}$	-1,159	-0,849	-0,777	-0,776
I_{CSP}	-0,611	-0,376	-0,286	-0,349

The variation of sub-indices and I_{CSP} over a period 1998-2001:

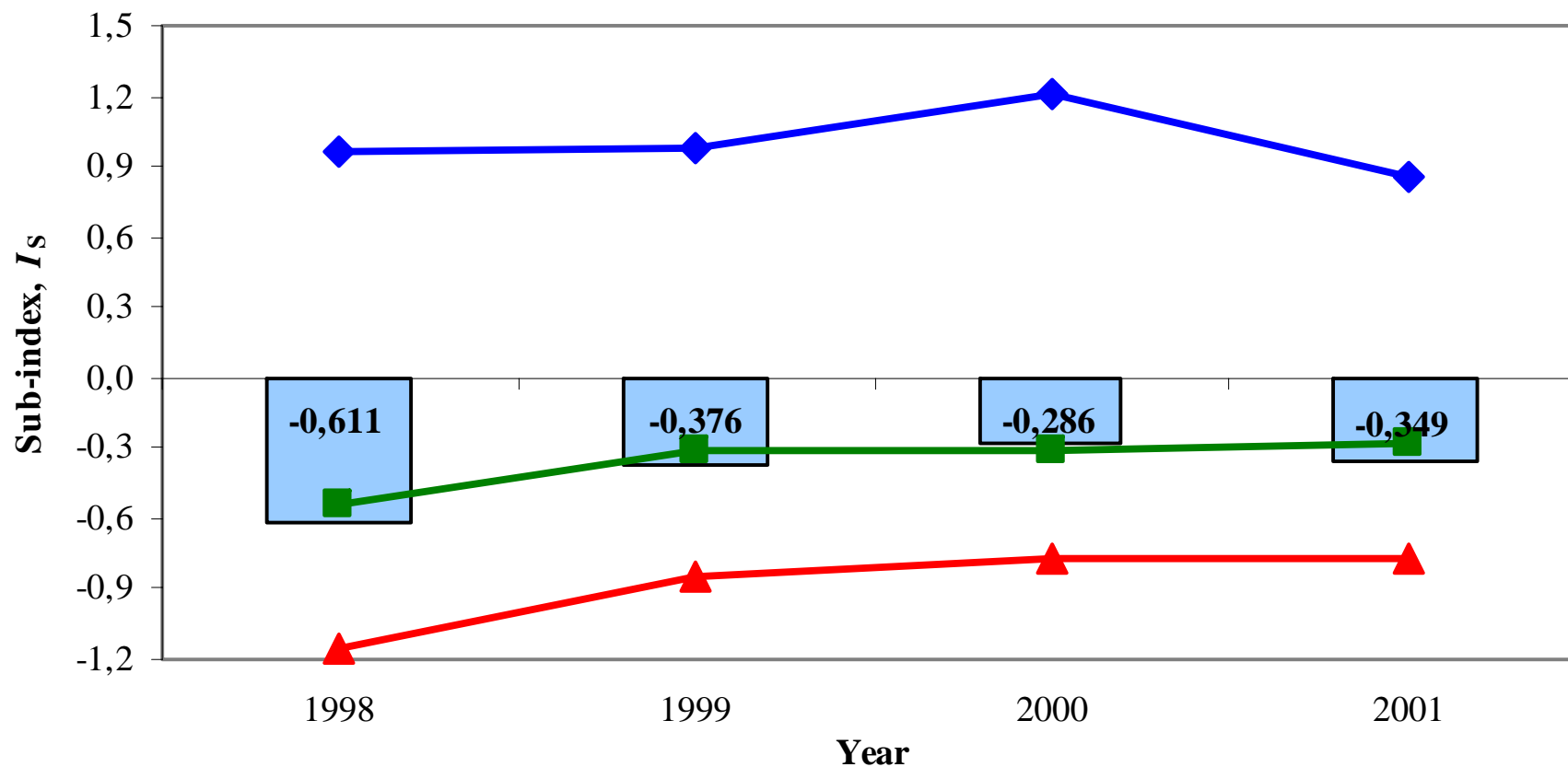

Composite Sustainable Production Index Economic sub-index Social sub-index Environmental sub-index

Conclusions:

The strengths of the proposed model:

- Uses normalized indicators, which enable incorporating various indicators having different measurement units.
- Enables integration of sustainable production indicators into sustainability sub-indices and finally into one composite measure.
- Considers indicators according to their positive/negative impact to overall sustainability of the company.
- Uses simple method for weighting indicators.
- Improves the quality of sustainability reporting and makes the information more accessible to decision makers.

Thank you

Economic Development:

Sustainability Balance

Competitiveness increase

EU Membership

Conditions:

- **Structural changes**
- **Macroeconomic stability**
- **Institutional reforms of transition**

Mechanisms:

- **Knowledge based society**
- **Competitiveness growth**
- **Effectiveness of state**
- **Regionally coherent development**

Social Development:

Goals: **life expectation**
 education and information
 access to earnings
 social security
 social incorporation

Similar $f(\text{GNP})$ as EU countries

Environmental Development:

Goals: Effective use of material resources

Economic importance of environmental capital

Environmental services: growth, multiplication, differentiation

From env. protection to env. development

24 / 122 countries

13 / 24 EU (member + candidate) countries

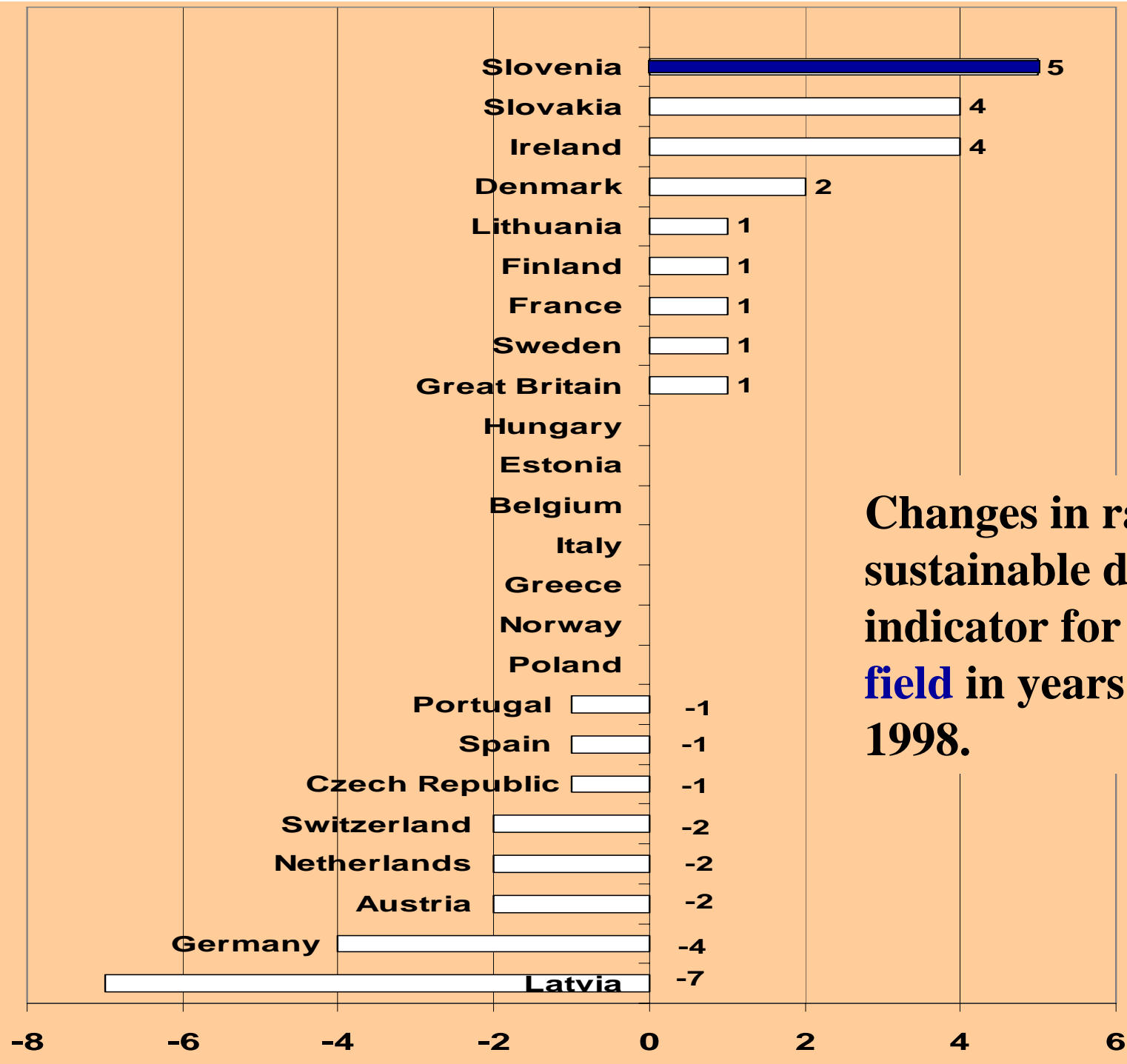

Changes in ranks of sustainable development indicator for **Economy field** in years 1990 - 1998.

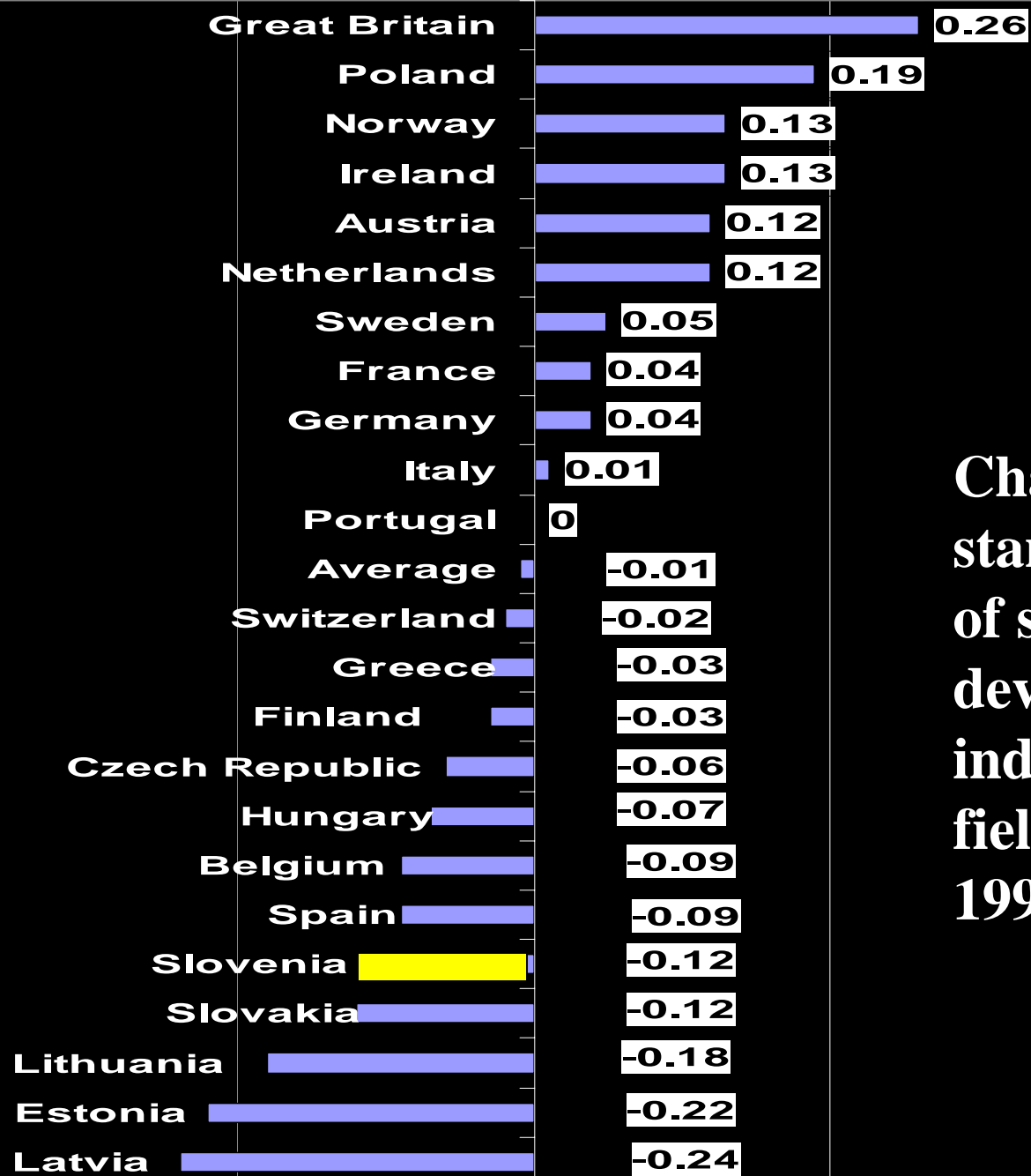

Changes in standardized values of sustainable development indicator for Social field in years 1990 - 1998

-0.4

-0.2

0

0.2

0.4

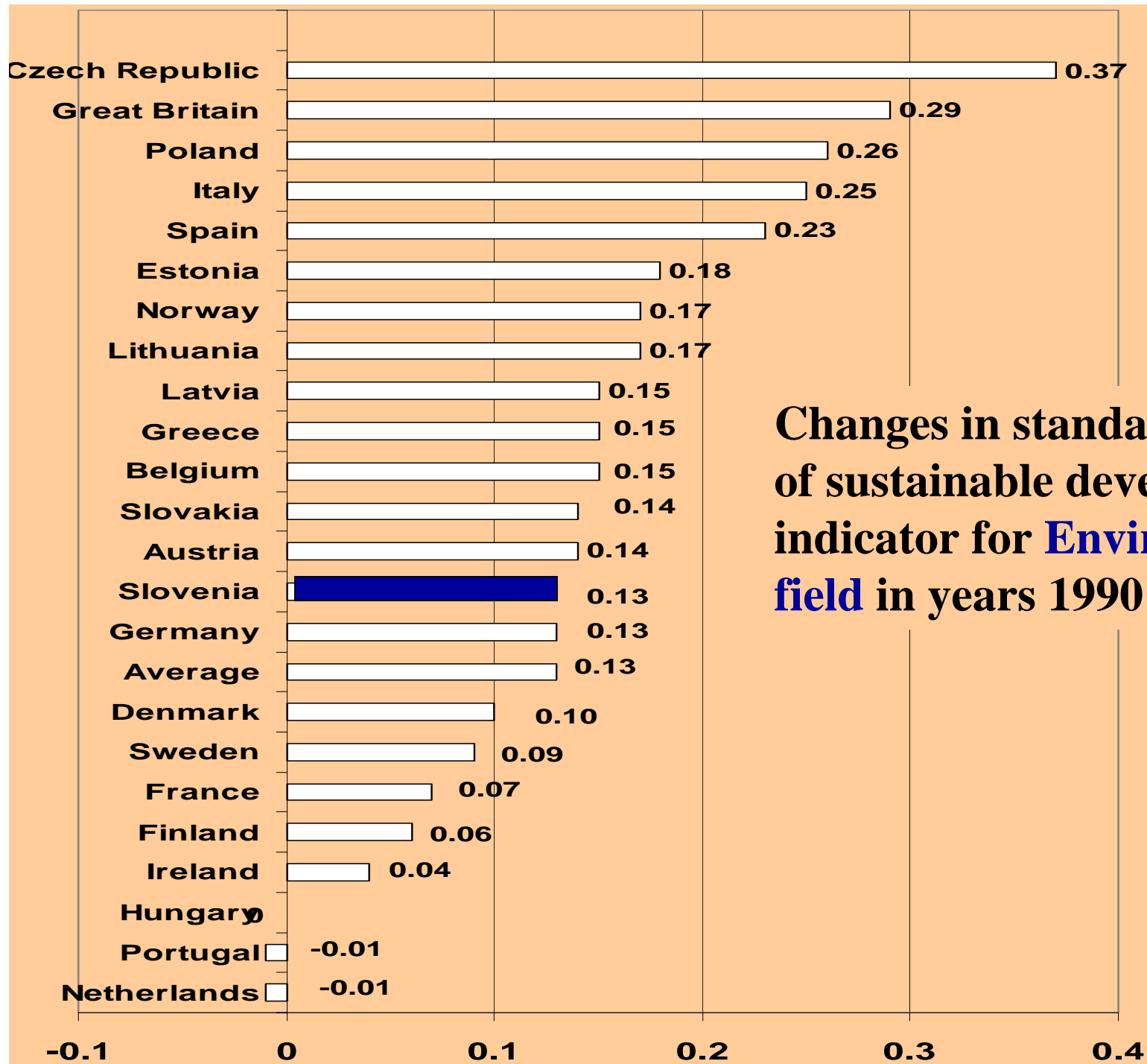

**Changes in standardized values
of sustainable development
indicator for **Environmental**
field in years 1990 - 1998**

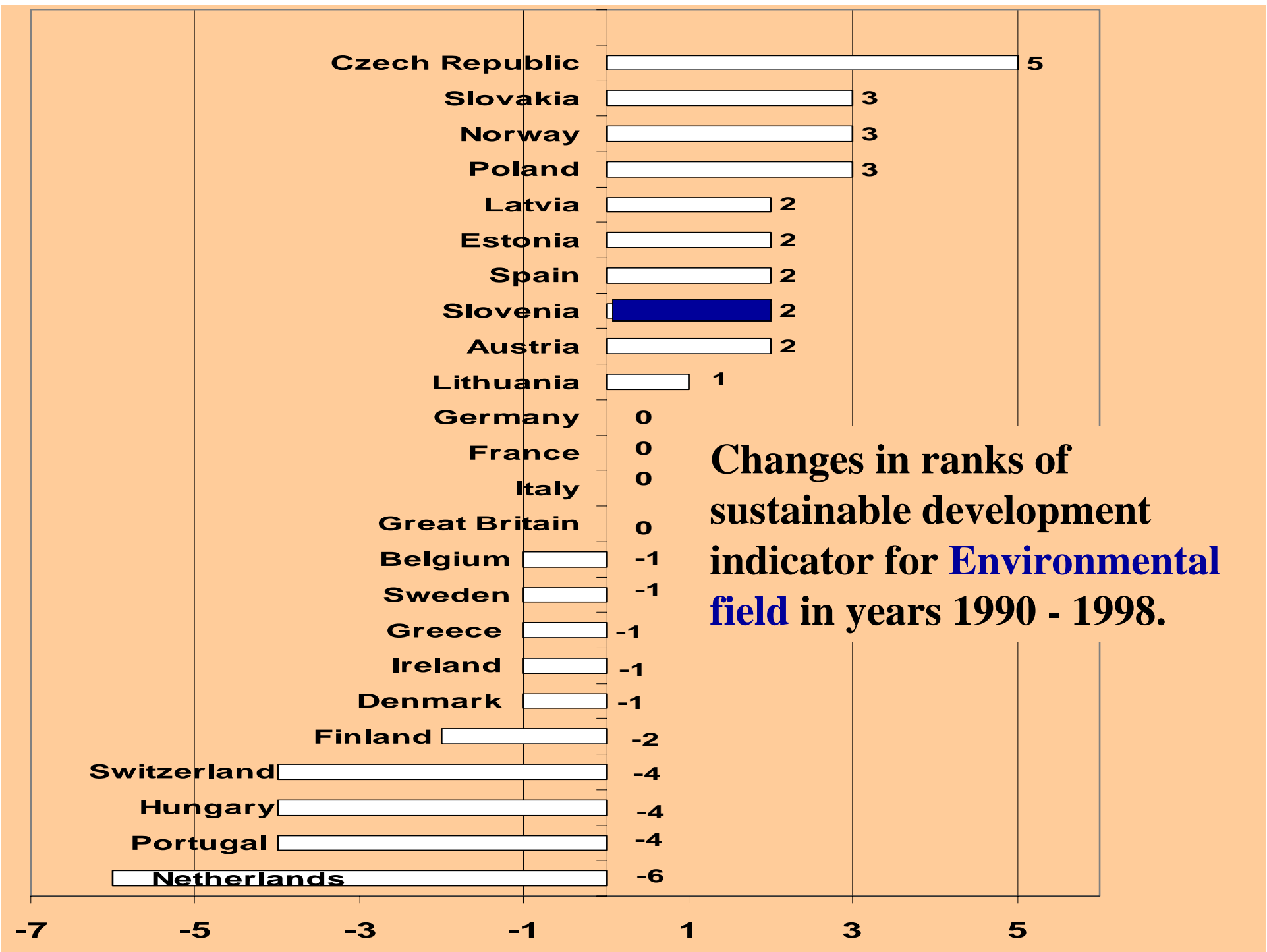

Slovenian position in sustainable development:

- **13th place among the countries presented**
- **relatively balanced development**
- **rank 14 for economic development**
- **rank 13 for social development**
- **rank 13 for environmental development**

Index of balanced sustainable development in 1998

<u>Country</u>	<u>Index of BSD</u>	<u>Country</u>	<u>Index of BSD</u>
Norway	1,00	Slovenia	0,44
Sweden	0,95	Estonia	0,39
Finland	0,85	Latvia	0,39
Austria	0,84	Portugal	0,37
Denmark	0,80	Italy	0,37
Switzerland	0,74	Czech Rep.	0,34
Ireland	0,68	Belgium	0,31
Netherlands	0,57	Lithuania	0,31
Germany	0,50	Spain	0,29
France	0,49	Poland	0,27
Slovakia	0,44	Hungary	0,21
UK	0,44	Greece	0,15

“Food grade” $\text{MgCO}_3 \cdot 3\text{H}_2\text{O}$ – clean chemical production from waste brine

Stefka Tepavitcharova and Christo Balarew

Bulgarian Academy of Sciences, Institute of General and Inorganic Chemistry,
Acad. Georgy Bonchev Str, Bl. 11, 1113 Sofia, Bulgaria, e-mail: stepav@svr.igic.bas.bg,
Tel. (359 2) 979 39 26, Fax: (359 2) 870 50 24.

Ecological and easy to handle technology for production of low-cost “food grade” $\text{MgCO}_3 \cdot 3\text{H}_2\text{O}$ from waste sea brines after the sea salt production has been developed. The main disadvantages of the available patents and methods for production of $\text{MgCO}_3 \cdot 3\text{H}_2\text{O}$ with respect to (i) *energy consumption*; (ii) *prolonged blowing through CO_2* ; and (iii) *special equipment* (ion-exchange membranes, autoclaves) have been eliminated. This technology leads to an improved and more efficient management of the solar sea-salt production, to an environmental protection of the Black Sea coastal area as well as meets the needs of Bulgarian market of $\text{MgCO}_3 \cdot 3\text{H}_2\text{O}$ as animal fodder additive and pharmaceutical product.

Pilot studies on the technological scheme for preparation of large “food grade” $\text{MgCO}_3 \cdot 3\text{H}_2\text{O}$ crystals were carried out. $\text{MgCO}_3 \cdot 3\text{H}_2\text{O}$ was precipitated by mixing nondeluted waste brine from the sea salt production with alkaline carbonate (95% Na_2CO_3 + 5% NaHCO_3) during intense stirring at 0-40°C. An important moment is the way and rate of mixing of the two solutions. Thus, conditions of complete proceeding of crystallization in the field of $\text{MgCO}_3 \cdot 3\text{H}_2\text{O}$ are created, and in this way cocrystallization of a series of carbonate double salts is avoided. The system is allowed to recrystallize for 50 min (40°C) to 5 h (0°C) in the presence of $\text{MgCO}_3 \cdot 3\text{H}_2\text{O}$ seeds under static conditions.

The theoretical yield of $\text{MgCO}_3 \cdot 3\text{H}_2\text{O}$ from 1,000 l concentrated brine at temperatures higher than 15°C is 180-185 kg, while at temperatures below 15°C it is 140-160 kg. Under the conditions of dilution, these amounts are 70-75 kg, respectively. The comparison demonstrates the advantage of working under the optimal conditions proposed by us.

At present there is no Bulgarian State Standard concerning the quality and admissible admixtures in $\text{MgCO}_3 \cdot 3\text{H}_2\text{O}$ permitting its application as fodder additive. The products obtained by us were characterized on the basis of:

- the admixtures in magnesium carbonates admissible according to the European Pharmacopoeia standard and 10th Pharmacopoeia of the Soviet Union still usable;
- the requirements with respect to phosphate content in fodder mixtures (Bulgarian State Standard 9775-85)
- Calculations of the maximum admissible amounts of microelements in fodder. The calculations are made according to the requirements of the National Research Council, USA, concerning microadmixture in food for different animals (sheep, cattle, pigs, poultry). Averaging is made having in view the universality of the product. The calculations are based on a maximum additive of 1% MgCO_3 to the food of animals, assuming that its contribution is maximum 10% of the total amount of food additives. The admissible additives in MgCO_3 should be equal to those in the whole ration, i.e. ten times lower. Since combined fodder contains 0.5% premix and the content of Mg^{2+} ions in the latter is 2%, the concentration of Mg^{2+} ions in combined fodder should be 0.01%. This means that the norms calculated by us are by almost 3 orders of magnitude lower than the needed ones.

The all our products meet the Pharmacopoeia requirements concerning As, heavy metals, sulphates, Fe, Cu and Ca. Mixtures of $\text{MgCO}_3 \cdot 3\text{H}_2\text{O}$ and NaCl with ratios varying from 1-2 % NaCl to 3-4 fold predomination of NaCl in the mixture are used for different kinds of animals. Taking into account that the norm per 1 kg fodder is 0.1 g Mg^{2+} ions, or 0.58 g $\text{MgCO}_3 \cdot 3\text{H}_2\text{O}$, the product proposed by us leads to no increase of harmful components in the food for animals. This signifies that both $\text{MgCO}_3 \cdot 3\text{H}_2\text{O}$ and its mixtures with NaCl are applicable to fodder mixtures as well as for pharmaceutical uses.

$\text{MgCO}_3 \cdot 3\text{H}_2\text{O}$ has a double action on the body – supply of the biogenic element Mg and decrease of acidity in the alimentary tract. Magnesium salts are prescribed also in the therapeutic and prophylactic treatments of tetanic animal diseases (grazing, herbal, etc). $\text{MgCO}_3 \cdot 3\text{H}_2\text{O}$ assimilation by the animals is high - 76%. The needs for $\text{MgCO}_3 \cdot 3\text{H}_2\text{O}$ in the country as additive to animal fodder is about 121 tons for 2005. Combined fodders with 0.01% magnesium are used for ruminant animals. At present, imported MgO is used. Stored in air, however, it absorbs moisture and CO_2 . $\text{MgCO}_3 \cdot 3\text{H}_2\text{O}$ is much cheaper than MgO and it is more stable under the fodder storage conditions – it is stable below 80°C and dehydrates very slowly in air.



NATO/CCMS Pilot Study on Clean Products and Processes

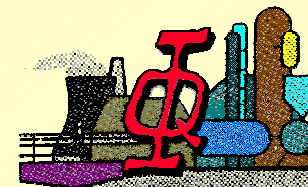

Chemical dispersants and bioremediation for the treatment of oil spills

José Coca Prados

Department of Chemical & Environmental Engineering

University of Oviedo

6th Meeting, Cetraro, Italy, May 15, 2003

OIL SPILLS

↪ **World oil consumption is roughly 11.5 M m³/day**

↪ **Accidents while oil is transported have caused:**

- **Ecological disasters, harmful for fish, marine mammals and birds**
- **Extensive damage to the local economy of communities in coastal areas, with a strong effect on their income sources (fishing and tourism)**

LARGEST AND RECENT OIL SPILLS

Date	Ship / Incident	Location	Tons
January 26, 1991	Gulf war	Sea Island, Kuwait	800 000
June 5, 1979	<i>IXTOC I</i> blowout	Gulf of Mexico, Mexico	470 000
July 19, 1979	<i>Atlantic Empress/</i> <i>Aegean Captain</i>	Caribbean Sea, off Tobago	300 000
August 6, 1983	<i>Castillo de Bellver</i>	Saldanha Bay, South Africa	260 000
March 16, 1978	<i>Amoco Cadiz</i>	Coast of Brittany, France	235 000
March 24, 1989	<i>Exxon Valdez</i>	Prince William Sound, Alaska, USA	39 000
December 5, 1992	<i>Aegean Sea</i>	La Coruña, Spain	75 000
December 12, 1999	<i>Erika</i>	Coast of Brittany, France	10 000
November 19, 2002	<i>Prestige</i>	Coast of Galicia, Spain	40 000

THE *PRESTIGE* OIL SPILL

- ↪ **Wednesday, November 13, 2002:** The single-hull oil tanker *Prestige*, transporting 77,000 tons of heavy fuel oil, sent out an S.O.S. from the Cape of Finisterre (West coast of Galicia, Spain). It was reported that the ship was in danger of sinking because of a large crack on the starboard side of the hull. The ship was towed to sea and the situation deteriorated on board, due to the extremely bad weather conditions.
- ↪ **Tuesday morning, November 19, 2002:** The ship structure collapsed and the tanker broke into two. It sank to 3,500 meters below sea level, 270 km off the Spanish coast. A large quantity of oil was released into the sea when the ship sank, with further oil spillage observed for a considerable time after the sinking.

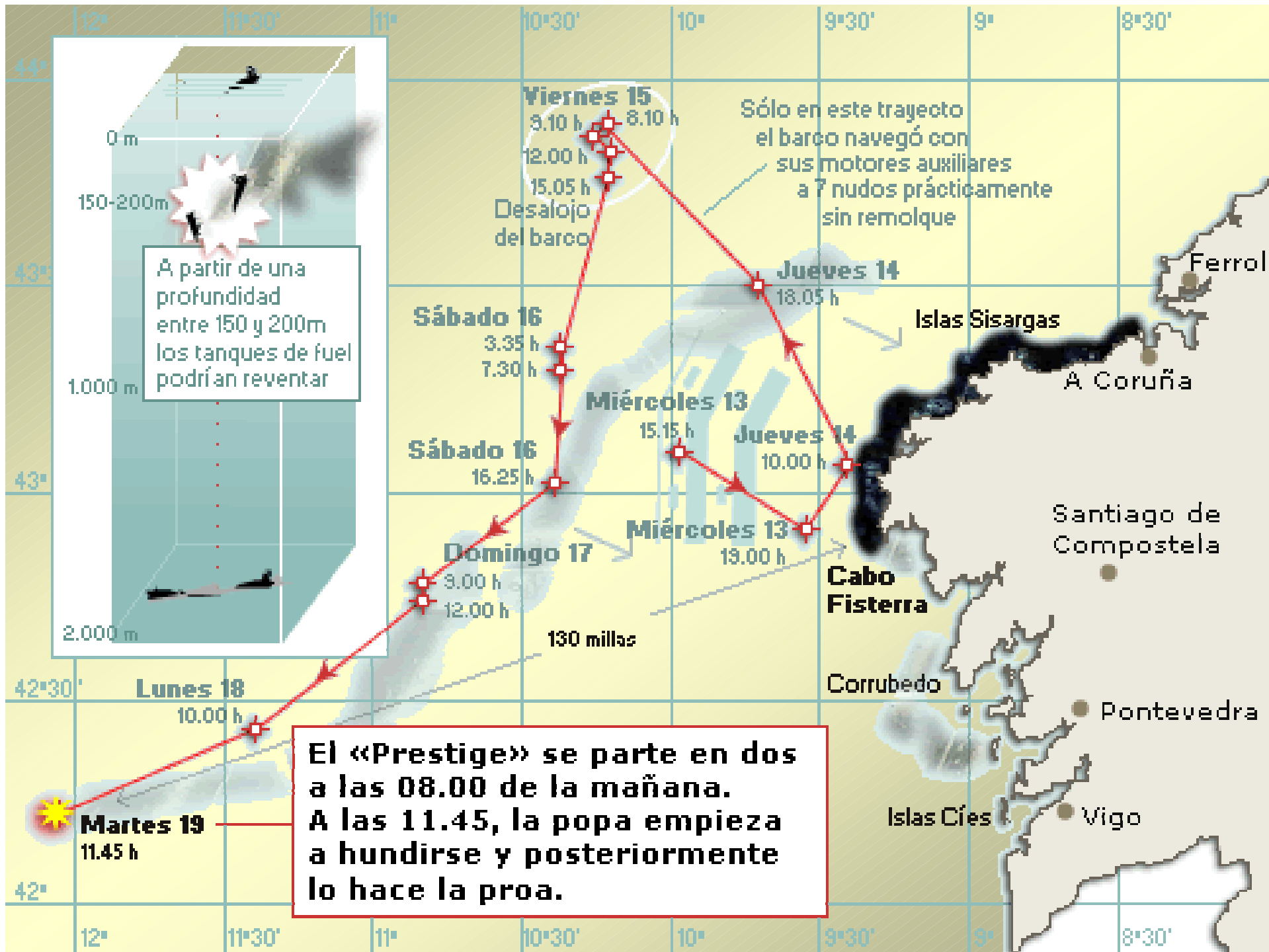















THE *PRESTIGE* OIL SPILL

- ↪ Approximately **40,000 tons** of heavy fuel oil polluted the Galician and northern Portugal coastline. The pollution then spread to the shores of northern Spain (Asturias, Cantabria and the Basque Country). On December 31, 2002, it reached the French coast.
- ↪ Analysis carried out identified the spilled oil as **fuel oil # 6**
- ↪ Fuel oil # 6 is one of the so-called *heavy fuel oils*. It is the highest boiling fraction of the heavy distillates from petroleum. The analysis gave the following composition:
 - **22 % saturated hydrocarbons**
 - **50 % aromatic hydrocarbons**
 - **28 % resins and asphaltenes**
 - **Density and viscosity (15°C): 995 kg/m³ and 30,000 cst**





















METHODS TO CLEAN UP THE SPILL OIL

- ↪ **Manual recovery**
- ↪ **Containment booms and barriers**
- ↪ **Skimmers**
- ↪ **Sorbents**
- ↪ **Burning**
- ↪ **Dispersants**
- ↪ **Washing oil using hoses**
- ↪ **Vacuum trucks**
- ↪ **Shovels and road equipment**

MANUAL RECOVERY







BOOMS

Floating barriers to collect the oil



SKIMMERS

Skimmers are mechanical devices designed to remove oil from the water surface

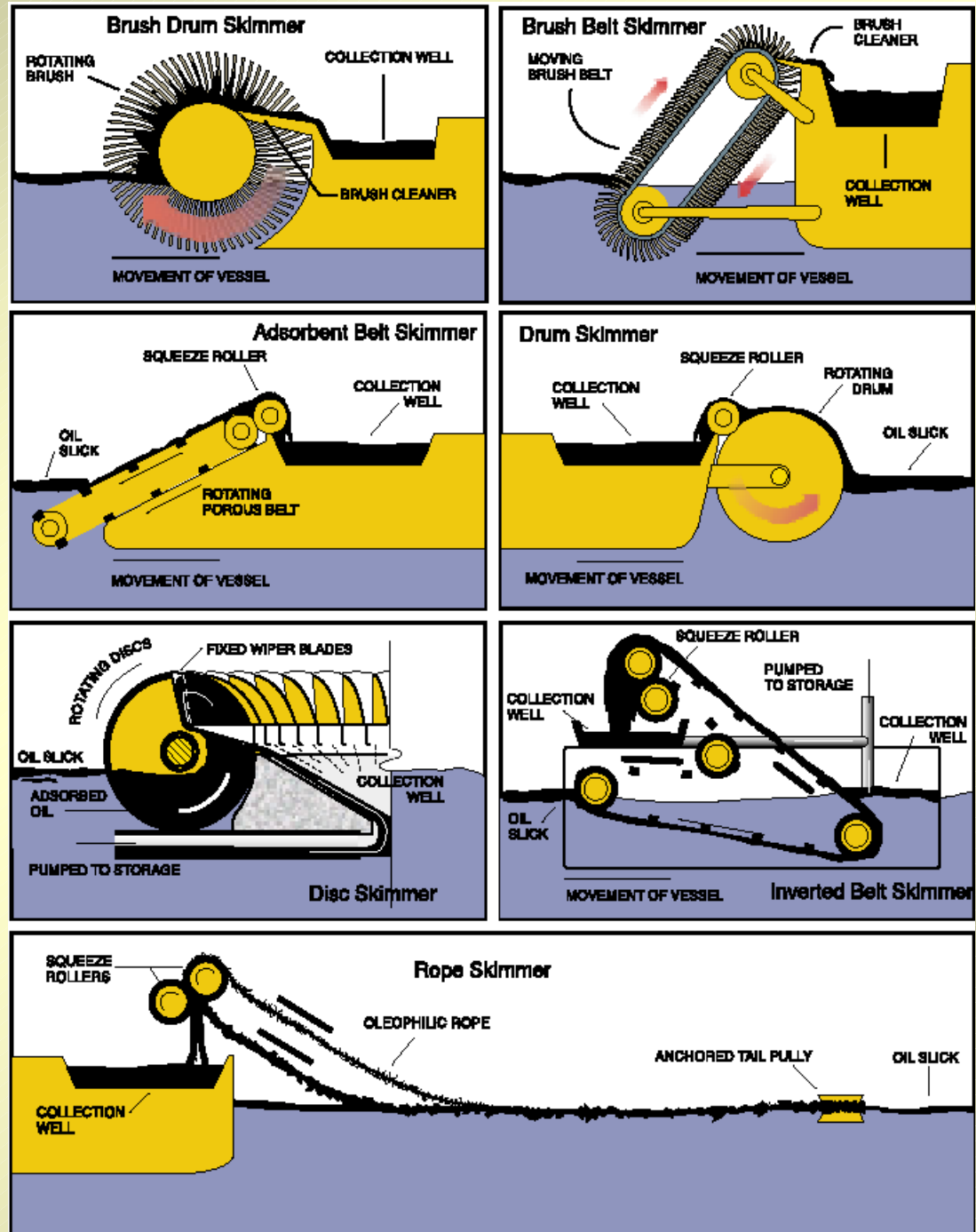

Ref.: Merv Fingas, "The Basics of Oil Spill Cleanup", 2nd Ed. Lewis Publishers, CRC Press, Boca Raton, FL (2001)

SORBENTS

↪ Sorbents are materials that recover oil by absorption/adsorption. They are used in the following ways:

- To clean up the final traces of oil spills on water or land
- As a backup to other containment means, *i.e.* sorbent booms
- As a primary recovery means for very small spills



Manual recovery of oil and oil-soaked sorbent

(Environment Canada. Ref.: Merv Fingas, "The Basics of Oil Spill Cleanup", 2nd Ed. Lewis Publishers, CRC Press, Boca Raton, FL (2001))

SORBENTS

Performance of some sorbents

Sorbent Type	Typical Oil Recovery with Oil Type (weight:weight)*				Percent Oil**
	Diesel	Light Crude	Heavy Crude	Bunker C	
Synthetic Sorbents					
polyester pads	7	9	12	20	90+
polyethylene pads	25	30	35	40	90+
polyolefin pom-poms	2	2	3	8	90+
polypropylene pads	6	8	10	13	90+
polypropylene pom-poms	3	6	6	15	90+
polyurethane pads	20	30	40	45	90+
Natural Organic Sorbents					
bark or wood fibre	1	3	3	5	70
bird feathers	1	3	3	2	80+
collagen sponge	30	40	30	10	90+
peat moss	2	3	4	5	80+
treated peat moss	5	6	8	10	80+
straw	2	2	3	4	70
vegetable fibre	9	4	4	10	80+
Natural Inorganic Sorbents					
clay (kitty litter)	3	3	3	2	70
treated perlite	8	8	8	9	70
treated vermiculite	3	3	4	8	70
vermiculite	2	2	3	5	70

* Recovery depends very much on the thickness of the oil, type of oil, surface type, and many other factors.

**This is the percentage of oil in the recovered product. The higher the value, the lower the amount of water and thus the better the sorbent's performance.

Ref.: Merv Fingas, "The Basics of Oil Spill Cleanup", 2nd Ed. Lewis Publishers, CRC Press, Boca Raton, FL (2001)

BURNING

- ↪ This technique involves controlled burning of the oil at or near the spill site
- ↪ The major advantage is its capacity to rapidly remove large amounts of oil over an extensive area
- ↪ Disadvantage: toxic emissions from the large black smoke plume produced (PAHs, VOCs, etc.).
- ↪ For oil to ignite on water, it must be at least 2 to 3 mm thick. Most oils must be contained to maintain this thickness
- ↪ Burning oil is a final, one-step solution, which requires less equipment and much less labour than other cleanup techniques
- ↪ *In-situ* burning can be applied in remote areas where other methods cannot be used because of distances and lack of infrastructure

Accidental *in-situ* burning of
oil spill from the *Aegean Sea*
1992, La Coruña, Spain



DISPERSANTS

- ↪ Dispersants are chemical formulations that are applied directly to the spilled oil in order to remove it from the water surface
- ↪ Dispersants *do not eliminate the problem of an oil spill* but are intended as a means of reducing the overall environmental impact of an oil slick at sea and on *sensitive foreshore environments*
- ↪ Oil spill dispersants are composed of three main component groups
 - Surface-active agents, also known as *surfactants*
 - Solvents (hydrocarbon and water-based)
 - Stabilizing agents

DISPERSANTS (II)

↪ Surfactants are specifically designed chemicals that have both hydrophilic (water liking) and oleophilic (oil liking) groups in the chemical compound. These chemicals reduce the interfacial tension between the oil and water and helps the creation of small oil droplets, which move into the water column facilitating quicker natural biological breakdown (biodegradation) and dispersion

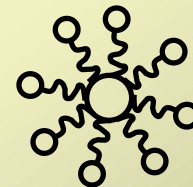
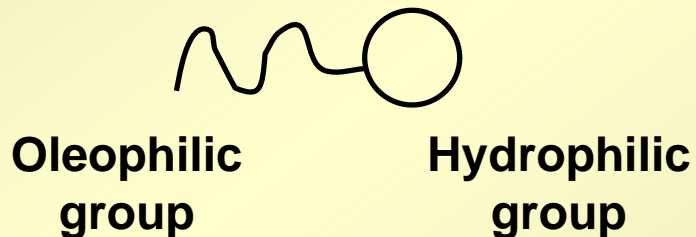

HOW DO DISPERSANTS WORK?

↪ A dispersant agent acts in the oil spill in the following ways:

- Reduce the interfacial tension between oil and water, breaking up the oil slick
- Increase the volatilization rate of the lighter components of the oil
- Decrease the surface spreading of oil on the sea
- Increase the oxygen diffusion rate to the bulk oil phase
- Increase of breaking frequency of the spill, avoiding that big oil spots arriving to the coastline

One end of each dispersant molecule 'chain' attaches to water molecules while the other end of the 'chain' attaches to the oil droplets.



A little energy from wind and waves breaks the oil slick into smaller oil droplets surrounded by dispersant molecules as shown.

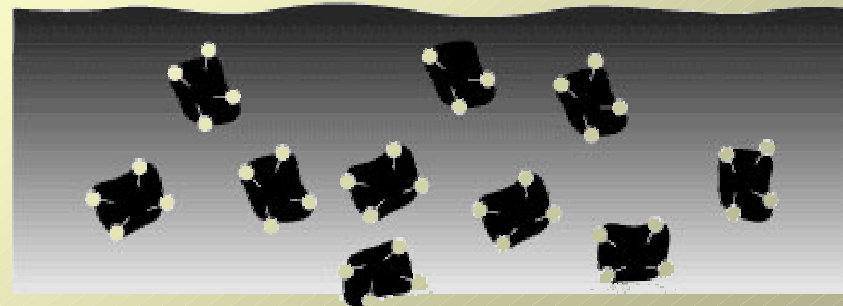
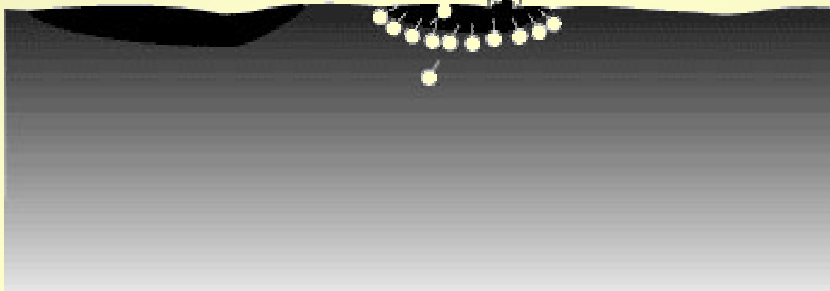

Ref.: National Oceanic and Atmospheric Association (<http://response.restoration.NOAA.gov>)

DISPERSANTS FORMULATION

↩ Key point: To ensure a very narrow window of physical properties, such as density, viscosity and ignition temperature. The salinity of seawater plays an important role

↩ “Generation” classification of oil spill dispersants:

- **First generation dispersants** (1960-1970). They are no longer used in oil spill treatment and were "industrial cleaners", "degreasers" and "detergents" with high aquatic toxicity, due to their higher content of aromatic hydrocarbons
- **Second generation dispersants**, specifically designed to treat oil spills at sea with a mixture of surfactants and solvents with much lower toxicity levels than the first generation ones. These dispersants were conventional low aromatic hydrocarbon based and applied undiluted (neat) and sprayed from vessels
- **Third generation dispersants**. They are mixtures of surfactants (fatty acid esters, ethoxylated alcohols, amines, amides, etc.) with a concentration of 50-80% on partially water miscible solvents (mainly polyglycol ethers), designed to be applied from both aircraft and vessels as either a concentrate or diluted

↩ “Type” classification of oil spill dispersants:

- **Type I** - Conventional hydrocarbon based - used neat at sea or on foreshores. (2nd generation)
- **Type II** - Water diluted concentrate - diluted prior to use (up to 1:10) with water. (3rd generation)
- **Type III** - Concentrate - used neat from aircraft and vessels or on foreshores. (3rd generation)

APPLICATION OF DISPERSANTS

- ↪ Application technology includes both the transportation (boats, aircrafts, etc.) as well as the application device (ejectors, injectors, blowers, etc.)
- ↪ Aerial spraying, which is done from small and large fixed-wing aircraft as well as from helicopters, is the most popular application method
- ↪ Dispersants must be applied as soon as possible to the thickest parts of the oil slicks and in an optimal droplet size and rate of application. A minimum sea energy is also required before dispersants function effectively - the higher the sea energy the more effective the dispersant



Ref.: National Oceanic and Atmospheric Association (<http://response.restoration.NOAA.gov>)

DEGRADATION OF DISPERSED OIL

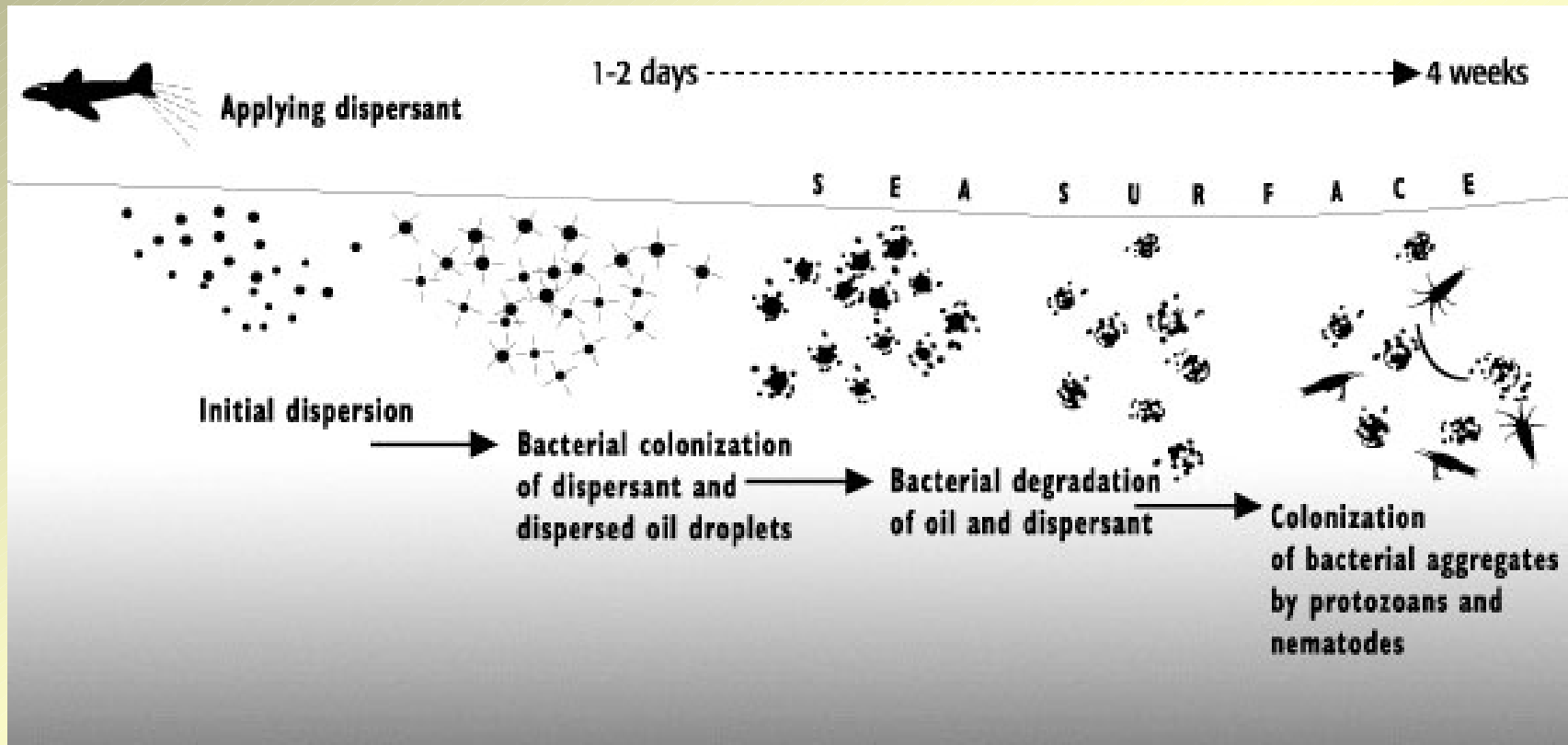

Ref.: National Oceanic and Atmospheric Association (<http://response.restoration.NOAA.gov>)

BIOREMEDIATION

- ↪ Microorganisms (added or, preferably present in the environment) use the oil as source of carbon and energy (heterotrophic microorganisms)
- ↪ The consequence is that oil components are, ideally, transformed into CO_2 and water
- ↪ Microorganisms:
 - ↪ Bacteria
 - ↪ Fungi and yeasts
 - ↪ Superior organisms => **Phytoremediation** (use trees, although promising not fully developed)
- ↪ Metabolic routes: AEROBIC. The presence of oxygen is normally enough.

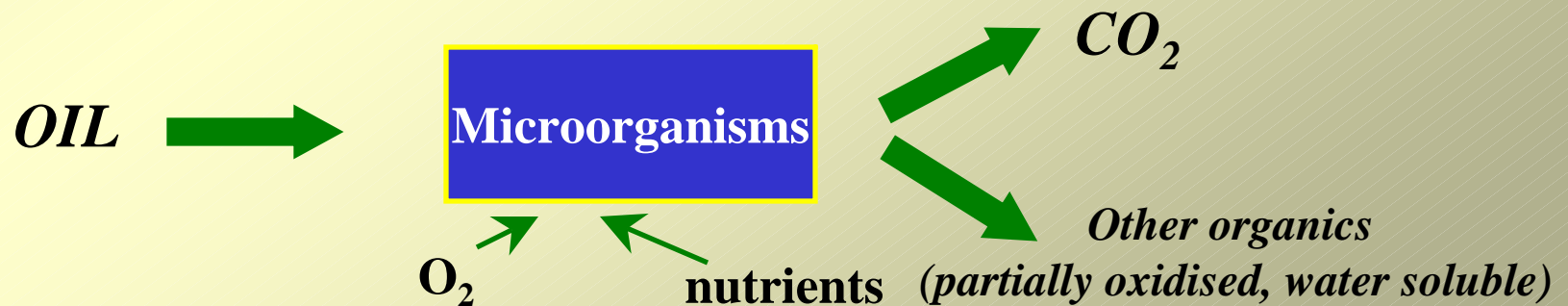

BIOREMEDIATION

Key-parameter: BIODEGRADABILITY (BDG)

↪ This parameter can not be estimated for a given organic compound

↪ Approximate rules to evaluate BDG:

↪ For a given organic family, BDG increases as molecular weight decreases

↪ For a given organic family, BDG increases as branched-character decreases (important in the spills of gasolines)

↪ As general trend the BDG decrease in this sequence:

Alkanes > Alkenes ≈ Alkynes > Poliaromatics > Aromatics

↪ The presence of heteroatoms (N, S, O) increases the BDG of the molecule except in the case of halogens

↪ Polymeric materials are low degradable (*i.e.* resins, asphaltenes)

↪ **As a result, the relative concentrations of the different components of the oil spill change as the bioremediation proceeds**

BIOREMEDIATION

ENVIRONMENTAL CONDITIONS

- ↪ Bioremediation has been successfully applied for shoreline cleaning (more than 100 km of shoreline was cleaned using this technique in Alaskan coast in 1989 after Exxon Valdez disaster).
- ↪ The **HISTORY** of the site plays an important role. Bioremediation in *dirty* coast lines (near industries or harbours) is faster because of the presence of microorganisms adapted to use synthetic organic mater as substrate.
- ↪ The **temperature, alkalinity** (rather than pH) and **salinity** of the water also plays an important role in the degradation. Unfortunately, these parameters are not easy to modify.
- ↪ The **shape and density of the spill** is also important. Big oil spots are difficult to degrade because of the hindered diffusion of oxygen to the bulk of the spot

BIOREMEDIATION: NUTRIENTS

- ↪ The presence of nutrients (specially **N** and **P**) is not enough to carry out the bioremediation at appreciable rates
- ↪ The addition of external P and/or N is needed. This aspect is a critical point in the bioremediation since the conventional fertilizers are too soluble in water (**EUTROPHICATION**)
- ↪ The development of low solubility fertilizers is a crucial point in these processes
- ↪ Different methods such as salts-organic mixtures or sintering of granulates are developed to manufacture these fertilizers
- ↪ In most cases, the main task in bioremediation is the application of the fertilizer

BIOREMEDIATION AND EMULSIFICATION

- ↪ Biodegradation of the oil components takes place in aqueous phase
- ↪ Most of the microorganisms used in bioremediation produce different bioemulsifiers:
 - ↪ **Light emulsifiers** (glycolipides and lipopeptides): efficient in reducing interfacial tension.
 - ↪ **Heavy emulsifiers** (lipopolysacharides): efficient in avoiding recalescence
- ↪ These bioemulsifiers are highly specific as well as biodegradable. For this reason, the biosynthesis of dispersants is now being developed
- ↪ In some cases (specially heavy fuels) it is necessary the addition of synthetic emulsifiers

BIOREMEDIATION vs. DISPERSION

<i>Feature</i>	<i>Bioremediation</i>	<i>Dispersion</i>
<i>Rate</i>	Slow	Fast
<i>Destructive</i>	Yes	No
<i>Flexibility</i>	Low	High
<i>Cost</i>	Low	Medium
<i>Environment</i>	Mainly shoreline	Mainly floating oil
<i>Secondary Env. Problem</i>	Eutrophication	Org. pollutants

They can be complementary!

COMPARATIVE

Cleanup Methods for Surface Land Spills

Habitat	Removal of Excess Oil	Natural Recovery	Manual Oil Removal	Mechanical Oil/Surface Removal	Enhanced Bio-degradation	<i>In-Situ</i> Burning	Hydraulic Measures
Urban	√	+	√	+	+	◇	√
Roadside	√	+	√	+	+	+	+
Agricultural land	√	+	√	+	+	+	√
Grassland	√	+	√	+	+	+	+
Forest	√	√	√	+	+	◇	√
Wetland	√	√	√	×	+	√	+
Taiga	√	√	√	×	+	+	+
Tundra	√	√	√	×	+	+	+

√— acceptable or recommended

+— can be used under certain circumstances

×— should not be used

◇— only marginally acceptable

Ref.: Merv Fingas, "The Basics of Oil Spill Cleanup", 2nd Ed. Lewis Publishers, CRC Press, Boca Raton, FL (2001)

LAST VISUAL AID!!

ANY SUGGESTIONS?

ANY QUESTIONS?

THANK YOU !!!



**2003 NATO/CCMS Annual Meeting
Clean Products and Processes Pilot Study
Cetraro , Italy, May 11 - 15, 2003**

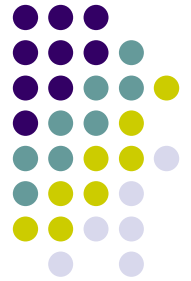

Cleaner Production Policy in context of Market Economy & Sustainable Development for Ukraine and other countries of transition economy

Prof .William Zadorsky

**Ukrainian Ecological Academy of Sciences,
Ukrainian State University of Chemical Engineering**

ecofond@ecofond.dp.ua
<http://www.zadorsky.com>

Why I proposed for collaboration the theme “CP policy for the transition economy countries” ?



What is the main problems with CP policy using in transition economy countries?

1. Corruption and criminality of officials. “Criminal production” instead of Cleaner Production. I write my last book “Ecological crimes in Ukraine”
2. Non-controlled privatization, restructuring, demilitarization (with use of the most ecologically dangerous projects)
3. Lack or ignoring of Sustainable Development Concept
4. Lack of CP legislation
5. Lack of money

Evolution of environmental protection (UNIDO)

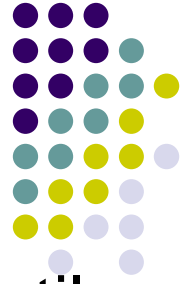

- No action / lack of recognition of the problem - until mid-20th century
- Dispersion / “solution by dilution” (the 1960’s)
- End-of-pipe treatment (the 1970’s)
- Recycling and energy recovery (the 1980’s)
- Cleaner Production and preventive measures (the 1990’s)
- In future: Dematerialisation ? Industrial ecology ?

It is (UNIDO) for advanced countries. For transitional economy countries while it is “Criminal Ecology”.

Samples of “Criminal Ecology” in Ukraine – transitional economy country

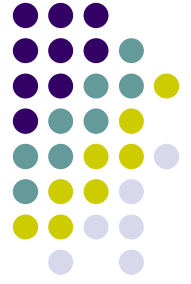

- Fuel with 30% of benzene (instead of limited in civilized countries 1%). We have now New standard on “Motor fuel” where the line “limit of benzene” is absent.
- Utilization of the rockets with “geptil” in the centre of megapolis Dnepropetrovsk, Pavlograd
- Plant “Ista” for lead (Pb) accumulator production in the centre of human settlement in Dnepropetrovsk
-

Cleaner Production is recognized as a tool that can contribute to the sustainable forms of economic development, as endorsed in Agenda 21 adopted by the United Nations Conference on Environment and Development (UNCED) (Chapters 20, 30 and 34).

CP is a strategy that protects the environment, the consumer and the worker while improving the industrial efficiency, profitability and competitiveness of enterprises.

FOR US:

CP strategy should be directed at the industrial and agricultural development with the "greening" of industry along with the implementation of the concept for adaptation and rehabilitation of the population and introduction of effective systems for life support under adverse environmental conditions.

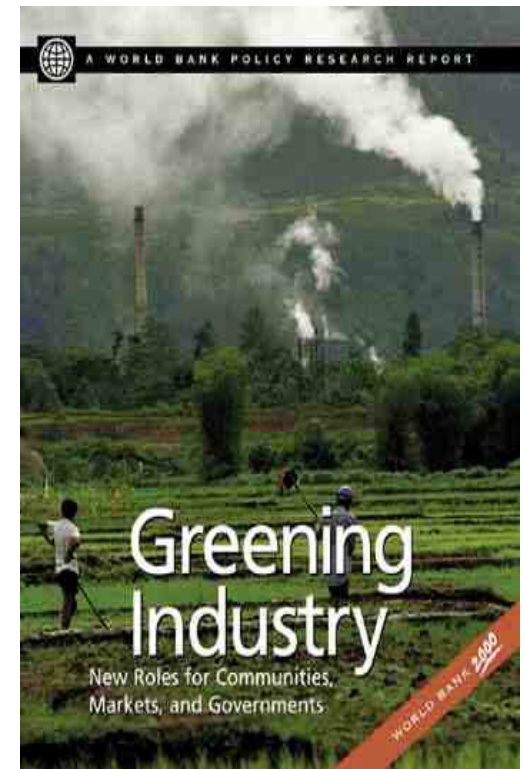

For us CP is possible not as result of scientists and experts activity but as CP 'policy' in country.

Read please the definitions (UNIDO) of "policy":



- **Everything that a Government decides to do or not to do**
- **A set of interrelated decisions**
- **A set of principles and directives that guide the decisions of an organization**
- **'Policy making' is a long-term, interactive, and multi-stakeholder process to develop a framework to implement a certain policy, and to evaluate and modify its implementation on a regular basis.**
- **Elaborating a policy document or a policy statement - such as a national CP Policy**
- **'Policy' versus 'legislation'**
- **"Policy" or "guidelines for actions and decisions" establish the setting in which an entity exists and operates .**
- **"Policy" is not equivalent to "regulations" or "a legal framework", since they represent only one of a number of possible tools for policy implementation.**
- **Other tools include economic incentives, information and education, etc.**

There is some specific for countries with transfer economy policy instruments, which fall into three general categories :

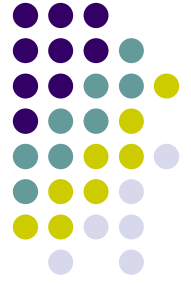

- Regulatory instruments - which require or mandate specific behaviour, e.g. determine what is prohibited, what is allowed, and how to carry out certain activities
- Economic Instruments, which create incentives or disincentives for specific behaviours, by changing related economic conditions
- Information-based strategies, which seek to change behaviour by providing information. The underlying assumption is that the actors do not take optimal or correct decisions for lack of information or know-how

Therefore for transition economy countries CP policy requires:



- Good analysis of existing sectoral policies
 - Inter-institutional and intersectoral effort
 - Strong leadership and broad support for CP
 - Typical policies of relevance to CP
 - Industrial development policy
 - Environmental policy
 - Foreign trade policy / customs policy
 - Investment promotion policy
 - CP Fiscal policy and tax regimes
 - CP Energy and transport policy
 - CP Agricultural policy
 - CP Education and science and technology policy
 - CP Health policy
- **And the main - Market-based instruments**

Samples of Market-based instruments other Countries (UNIDO):

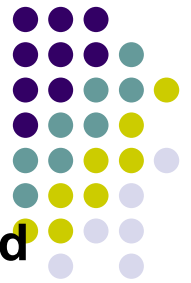

- **Emission fees and non-compliance fines (Mexico, Uruguay and Colombia)**
- **Grants, subsidies and financial assistance for CP (Colombia, Subsidy for Technological Conversion in Chile)**
- **Marketable permits (uptake of water in Chile)**
- **Deposits and product charges (batteries and tires in Hungary, bottles in Trinidad)**
- **Demand-side management (Costa Rica ICE) Uruguay and Colombia**
- **Harmful subsidy removal (energy prices in Nicaragua)**
- **Green procurement guidelines (Energy Star programme in the United States)**
- **Argentina: reduction of waste generation taxes for companies with a recycling programme**
- **Mexico: environmental taxes on gasoline depending on the lead content**
- **Argentina: favorable taxes to promote the use of natural gas instead of gasoline**
- **Lithuania: accelerated depreciation**
- **Belgium: eco-tax on beer if the producer does not use to 95% recycled bottles / packaging**

Samples of Information-based strategies:

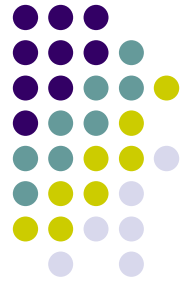

- Establishment of a national CP Programme (Chile)
- Waste prevention targets (US EPA's goal for 2005: reduction in per capita municipal waste generation by 25 per cent against the 1990 level)
- Public recognition and awards (CP award for industry in Nicaragua)
- Product labelling (eco-labels in Chile and Uruguay for CFC-free products)
- Pollutant Release and Transfer Registers (PRTR) and public access to environmental information (Chile, Argentina)
- Public environmental reporting (Brazil)
- Information clearinghouse and technical assistance (United States)
- Voluntary pollution prevention agreements (Costa Rica)
- Public education campaigns (energy efficiency and water savings campaign)
- Financial support for environmental measures tend to promote 'traditional' end-of-pipe control measures

It is necessary first of all for Ukraine and other countries of transition economy to realize the next program (see in Abstract Booklet) :

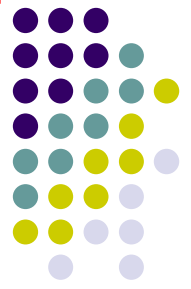

- to accelerate adoption of the **State Program for Industrial and Domestic Wastes Utilization** with the consideration of the military complex potential and capacities
- to set priorities in the state policy of sustainable development and military conversion for the design and manufacturing of products related to the environmental protection and national use of natural resources, environmental monitoring and survival of the population in critical technogenic conditions....

• See continue in Abstract Booklet





What is our future? How long shall we live in a country with the so-called "transitional economy"? What type of social and economic system will be formed finally in our country? How have we to solve our economic, social and environmental problems? How can we ensure sustainable balance between the human beings, industry and the environment? It became clear that Ukraine still has not adopted the concept of sustainable development, which today has become a basis on the solution of these problems in many other countries.

Theoretical base of every CP project is:

- Sustainable development concept
- Systematic approach
- Life cycle assessment (with logistics) and using



What is a tools and methods of its realization?
Unfortunately we pay more attention to
“assessments”, “accounting”, “indicators” and
etc.

Soon we have to be waiting for the line of “SD
modeling” work.

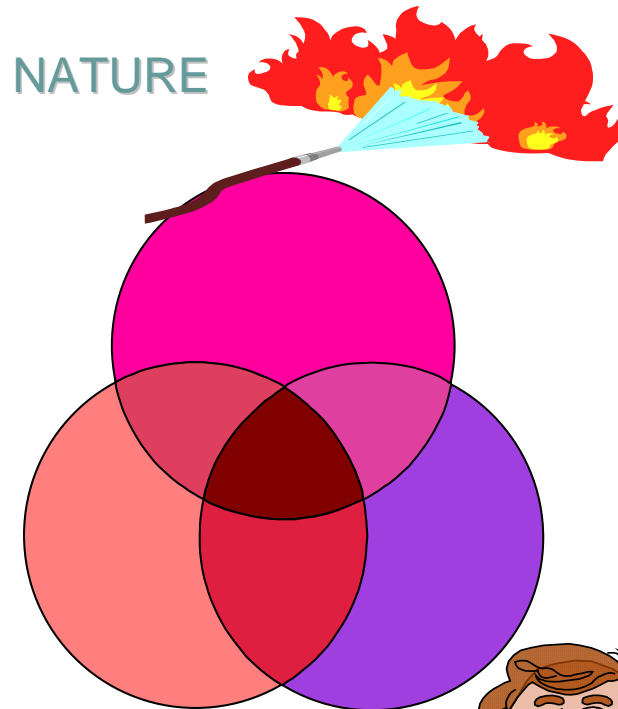

NATURE

ECONOMY

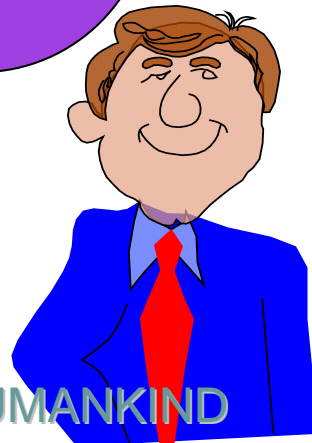

HUMANKIND

The concept of sustainable development includes the following three basic components: economic, environmental and social. Only the balanced progress in all three directions, thus the growth of economy tightly linked with simultaneous improvement of environmental conditions and solution of social problems will promote achieving the goals of sustainable development.



I showed it one year ago. Today Aheading of Development concept hypertrophied and became the element of state policy. SD is a task of State Safety Committee

Ukraine's "Aheading of Development" (similar Chinese "Large Jump")

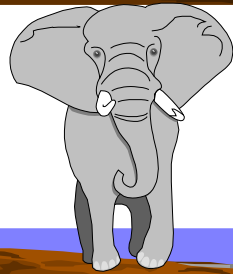
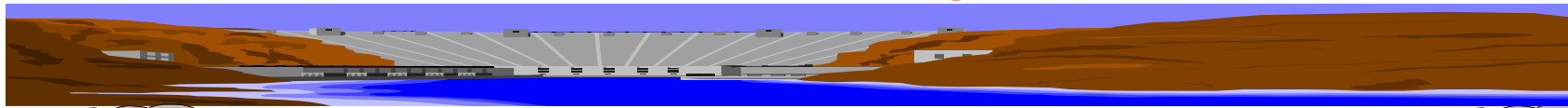

Systematic approach

Informatic

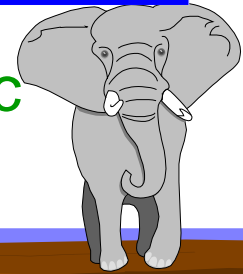

SUSTAINABLE DEVELOPMENT (on three foundation - blowers)

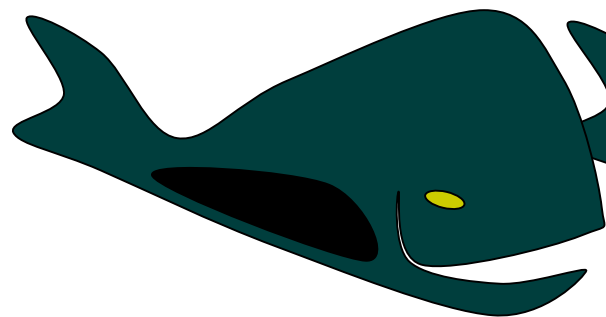

Ecology

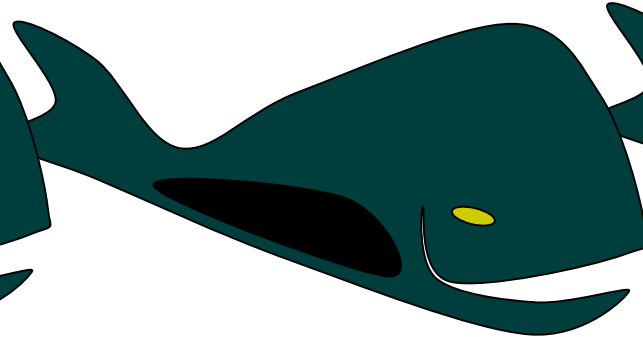

Economy

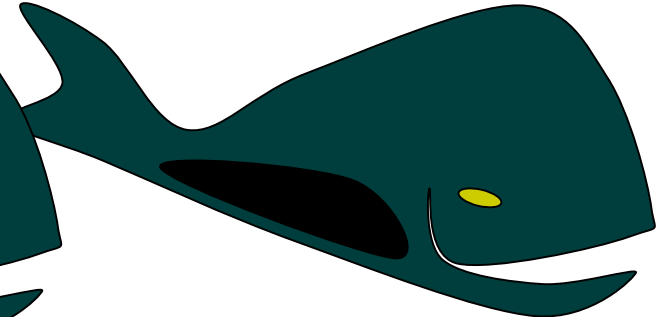

Sociality

Systematic approach. Life Cycle Assessment. Logistics (for every project/object)

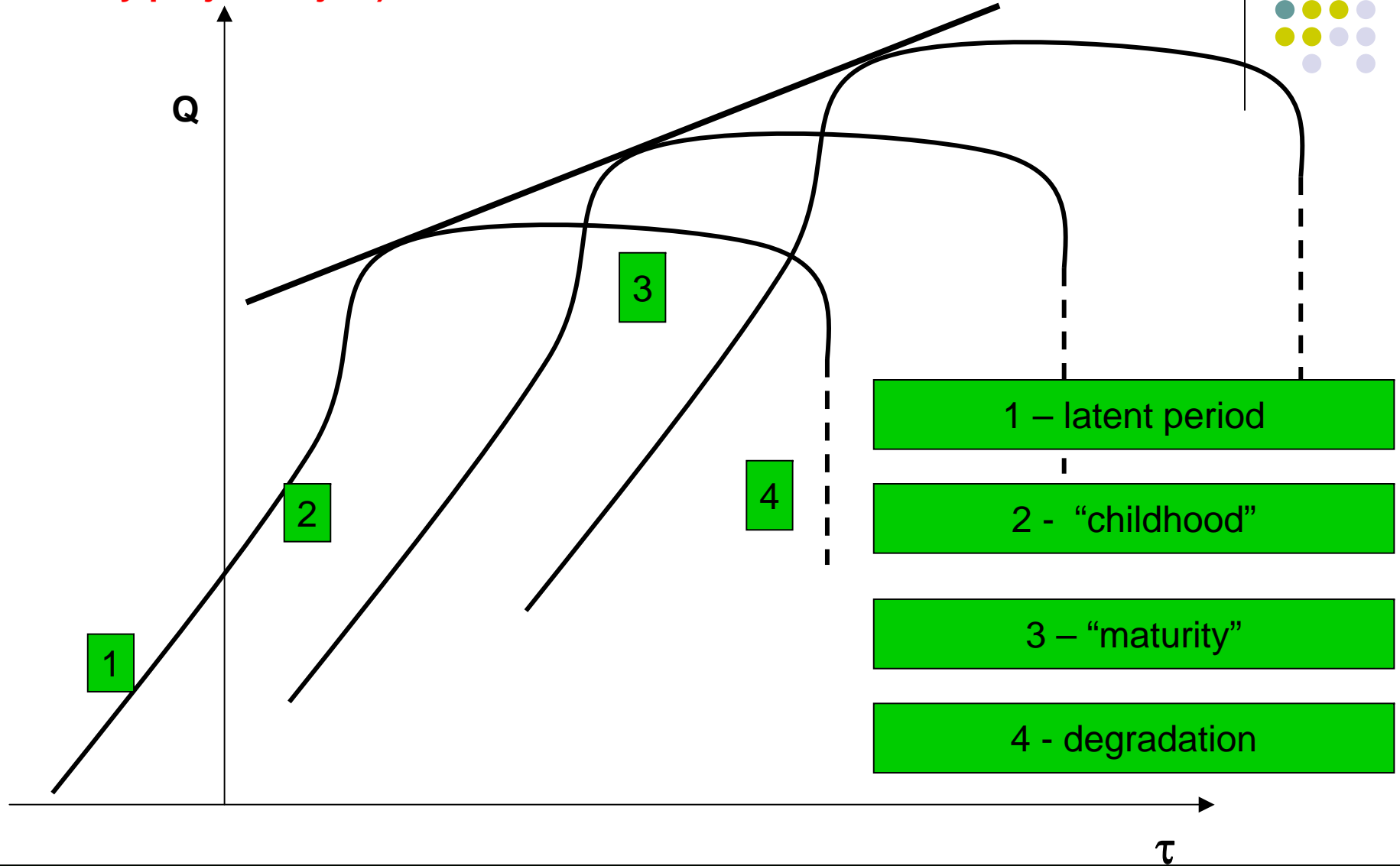

Every period requires own methods of CP/SD Management

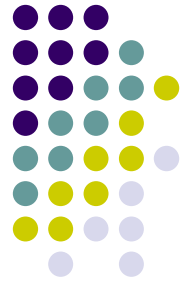

- Up to now the most countries with transitional economies have no consistent programs of their own sustainable development. Time has come to make transition from fruitless talks about some peculiar paths of development of such countries as contemporary Ukraine to realization of concepts and methods that had shown their efficiency in prosperous and stable countries.



So, concerning the peculiar problems of Ukraine and other countries with transition economies it is possible to recommend :

- To implement the concept of SD as a rule for action on legislative, administrative and economic levels. To promote wide popularization of the basic ideas of SD.
- To carry on interregional environmental and economic policies taking into account both the interests of the regions and those of the state as a whole in their mutual interrelation.
- **The next recommendations see in Abstract Booklet**

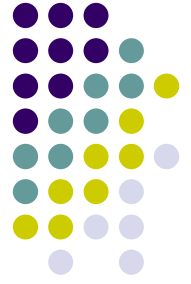

We are not waiting for help for this task solving and we started **OUR CONCRETE ACTIONS.**

First of all it is creation of:

1. Technological business-incubator
“INTELLECTUAL SERVICE” (TBI)
2. Pridneprovie Cleaner Production Center
(PCPC)
3. Innovation and Investments Internet Market

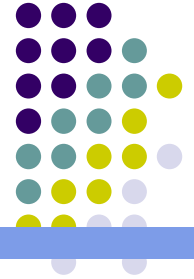

TBI (first and only in Ukraine) PROVIDES for innovators, scientists, experts elaboration commercializing on world market of intellectual production and reception of investments, search of business partners in Ukraine and abroad, business-examination, consulting, audits and management on investments objects.

The next see in Abstract Booklet

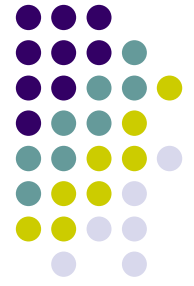

TBI works under the following scheme:

1. Preparation of information materials about development, organization, project (for web sites).
2. Search of the potential partners, preparation of the offers on cooperation and registration of the contractual attitudes.
3. Search together with the partner of the potential investors.
4. Development together with the partner both investor of the business - plans and projects.
5. Management of the project.

Technological business-incubator
"INTELLECTUAL SERVICE"

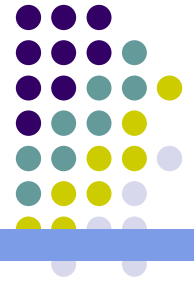

Solving of Problems Process

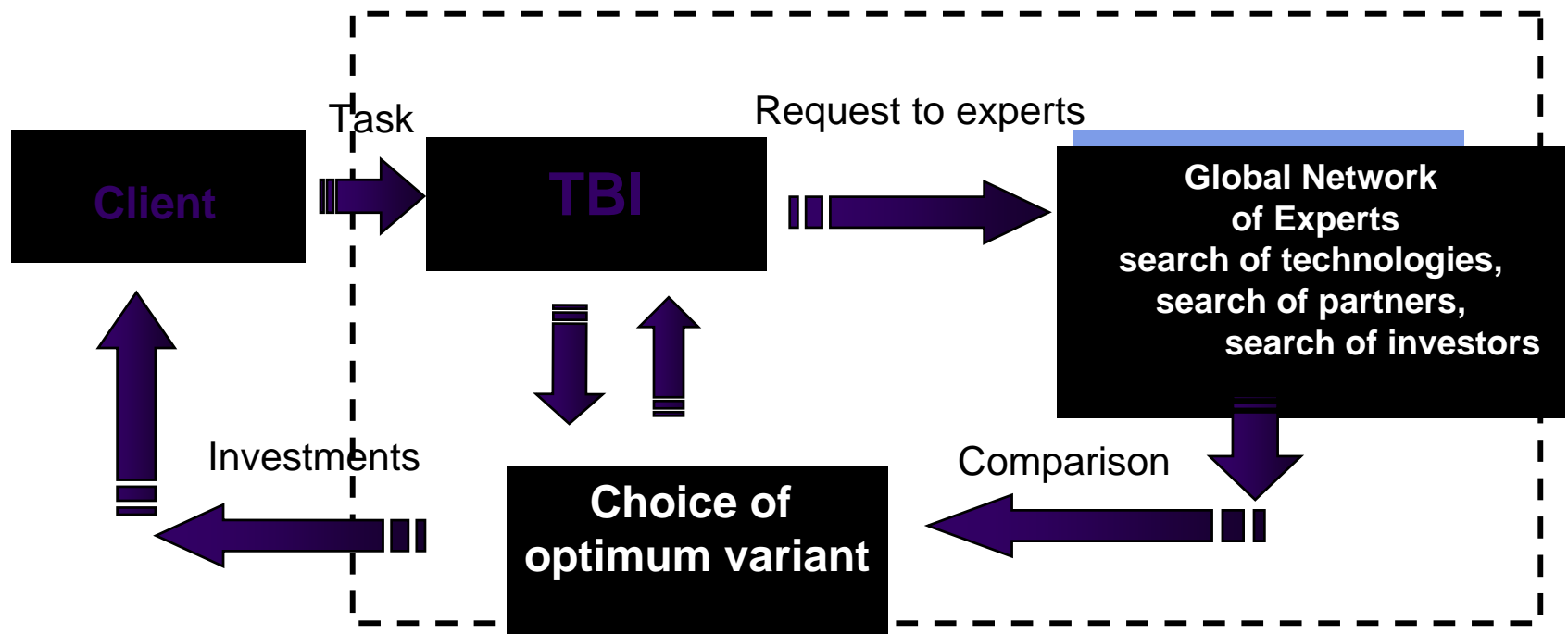

Technological business-incubator
"INTELLECTUAL SERVICE"



Marketing Process on the new technologies realization

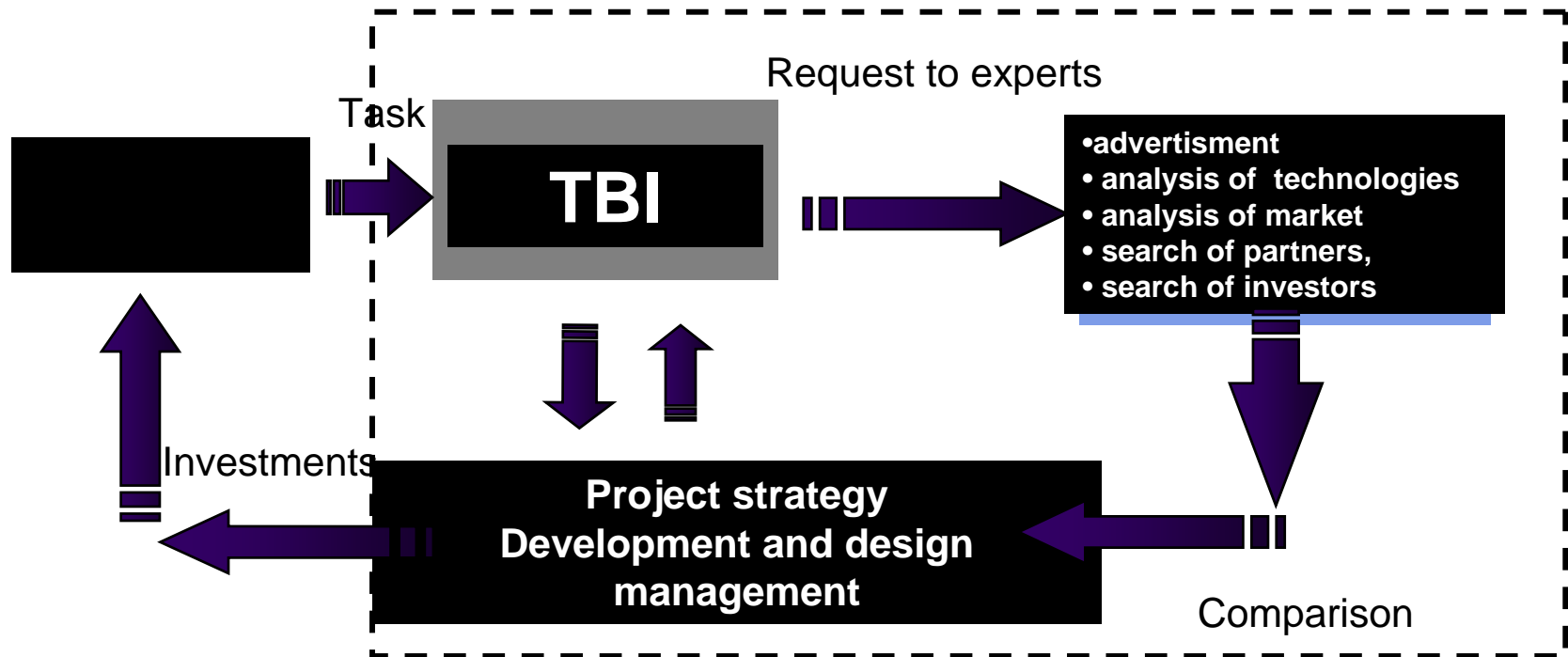



Fair Objective - Direct contact between:

1. investors

2. innovation companies and enterprises project managers

3. enterprises in order to facilitate technology transfer

4. development of technologies and materials

for the agreements on transfer technologies and attraction of foreign funds in Ukrainian economy

Principle feature/distinction of the Fair - the Fair will bring together four inter-related markets:

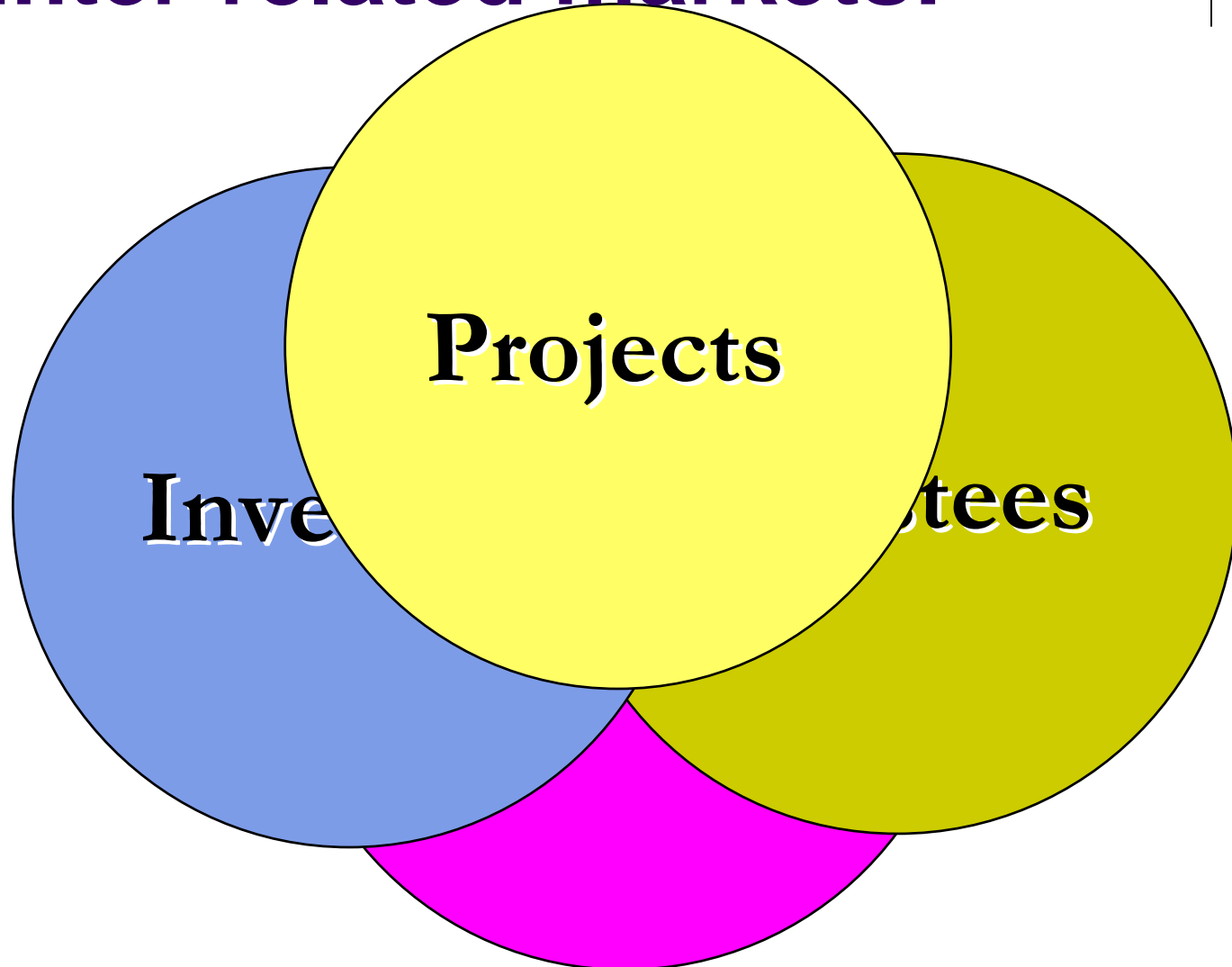

Our training programs (for subjects of market):

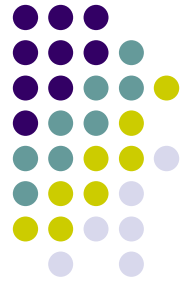

- Information technologies in the business;
- Elite education for the former high - level personnel;
- Sustainable development of enterprises and regions;
- Systematic approach and logistic concepts as theoretical base of sustainable development;
- Small and Middle Enterprises (SMEs) activity as the base of Restructuring and Military conversion;
- Pollution Prevention tools and methods;
- Cleaner Production concepts and SMEs activity;
- ISO 14000 on Ecological management for SMEs;
- Artificial Intellect and methods of technical creation;
- Navigation in Internet for business: search of partners, investors;
- Technological business; Transfer Technologies;
- Technological Business Incubation;
- Life Cycle Assessment using

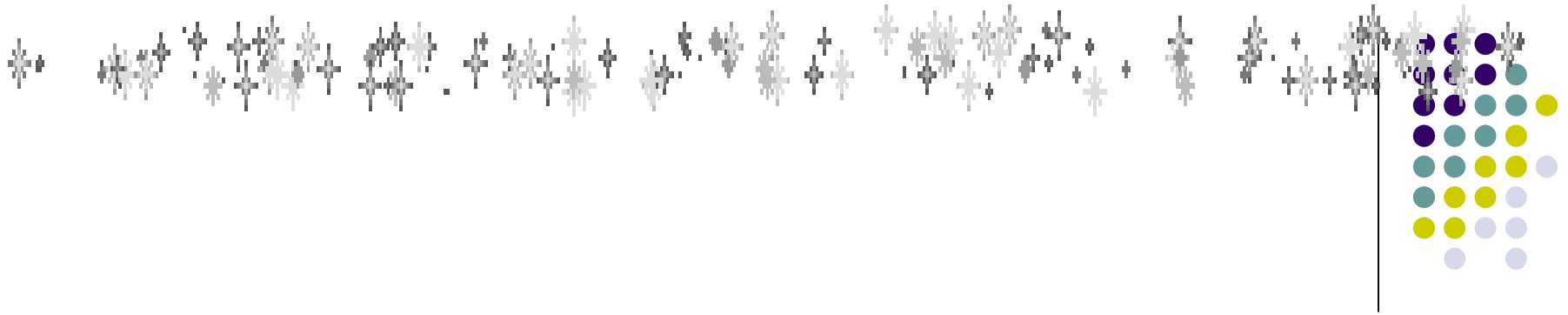

We are in realization of New
Project:

Cleaner Technology & Energy saving
Business Incubator Internet Portal
(www.arwsd.com)

Interactive “warm house”

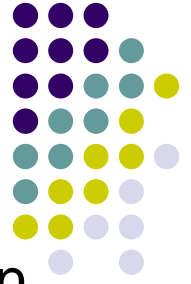

- Our task is not only to create multi-lingual information but also virtual international portal. We need more active on-line functions of our portal - expertise, consulting, training, audits, products and services. It must be connected with investment opportunities and with work within the innovative - investment markets that will support SD. Therefore the Portal aims are not only to be an essential platform for information, but also an interactive “warm house”, ‘Incubator’ for Sustainable Development, Environment and Health issues.

Architectural design of the Portal

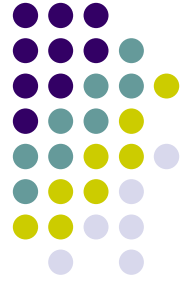

- Active on-line Data base of experts, consultants, services and organizations,
- Data base of transfer technologies with author's web-pages,
- Data base of on-line training courses,
- Data base with web pages of investment projects, and also organizations and persons who needs the investments,
- Date Base of investments and potential investors
- Date Base of Samples of Regional Programs and Concepts on Cleaner Technologies, Energy Saving, Sustainable Development, Environment and Health issues
- On-line Magazines
- On-line Shop "Goods for Surviving"

Information Databases

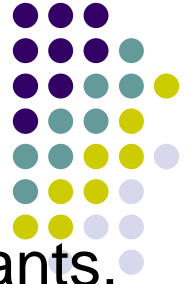

- Active on-line Databases of experts, consultants, services and organizations Partner/member directory with Net Cards and presentations
- Project search and bidding system
- Knowledge Databases
- Grant offers and search
- Available SD products and services
- Regional Programs and Concepts on Sustainable Development, Environment and Health issues

Samples of concrete recent projects:

Environmental Security: System for distant devastation of explosive devices of all types (by A.Madatov)

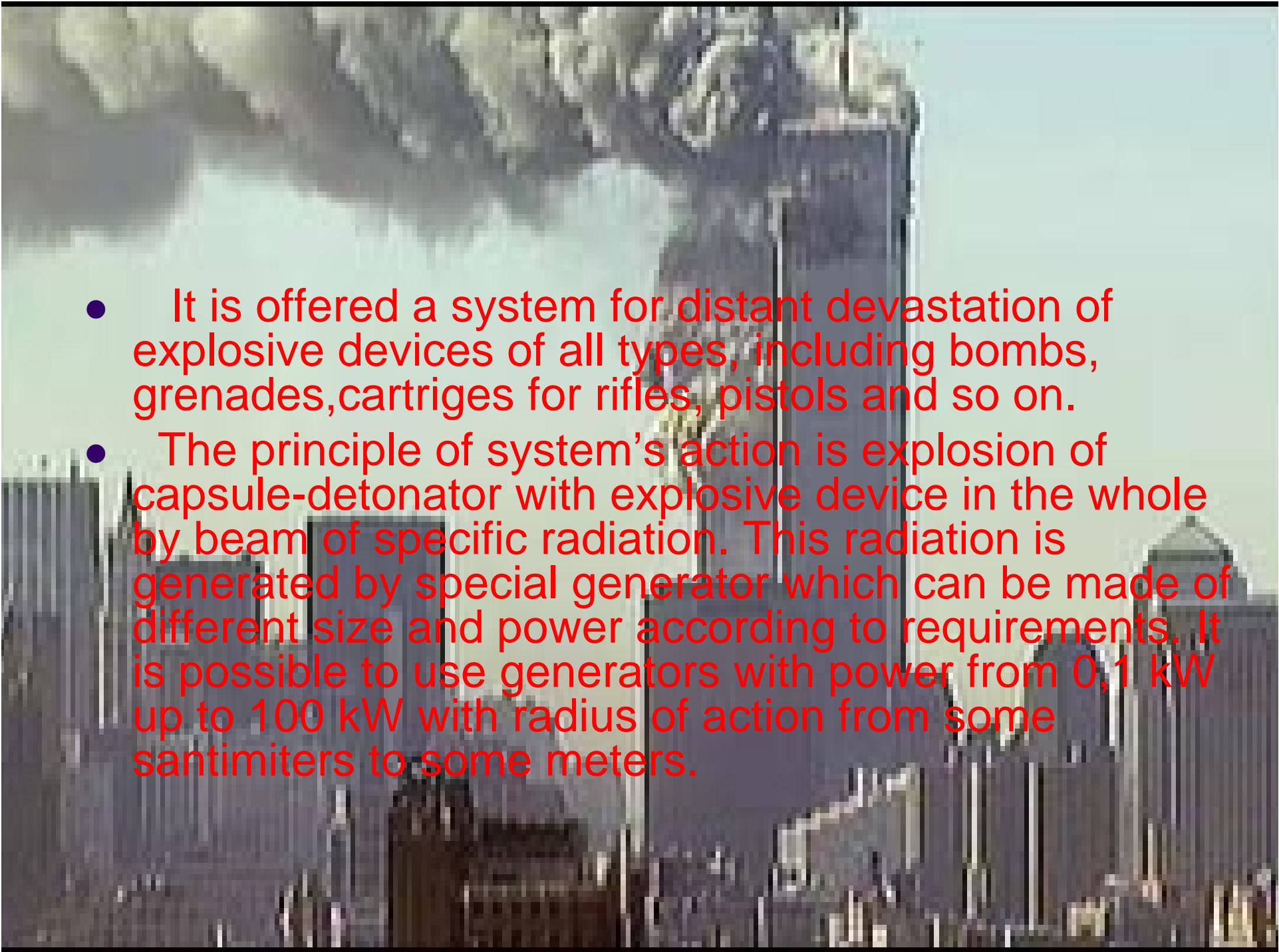

- 
- It is offered a system for distant devastation of explosive devices of all types, including bombs, grenades, cartridges for rifles, pistols and so on.
 - The principle of system's action is explosion of capsule-detonator with explosive device in the whole by beam of specific radiation. This radiation is generated by special generator which can be made of different size and power according to requirements. It is possible to use generators with power from 0,1 kW up to 100 kW with radius of action from some santimeters to some meters.

- Radiation of the generator is modulated into pulses of short impulses, so that it isn't sensitive and harmful for human at the density of power which explodes detonator.
- Radiation of the generator can't be occurred without special measurer and protection shield against this radiation can't be made portable. Therefore, the system allows to discharge 100% explosive devices that are passing through control point without visual control.





- Control points at railway stations, airports, post offices have to be equipped with explosion-proof chambers for checking that people, automobiles and goods can pass through.
- In case of discharging of plots of land and construction (perhaps under water) the generator can be located on automotive device which is directed distantly.
- Possibility of sudden getting into zone of invisible and unnoisy action of radiating generator is a real psychological threat for a terrorist which is bringing any weapon through control point.
- In the whole, the system is able to become real means of fighting against international terrorism.

2. Nature protection/conservation. Balaklava restructure project

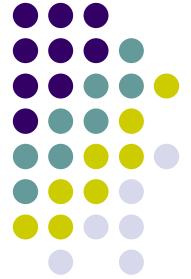

- We have in Ukraine and other NIS very important problem with former military regions which are left by army as result of demilitarization. For sample only in Crimea we have about 10 such former military towns and cities (Balaklava, Sebastopol, Feodosia, Donuzlav, Ordgonikidze and etc.).

These regions have social, environmental, economy and SD problems and nobody knows what it is necessary to do to solve its.

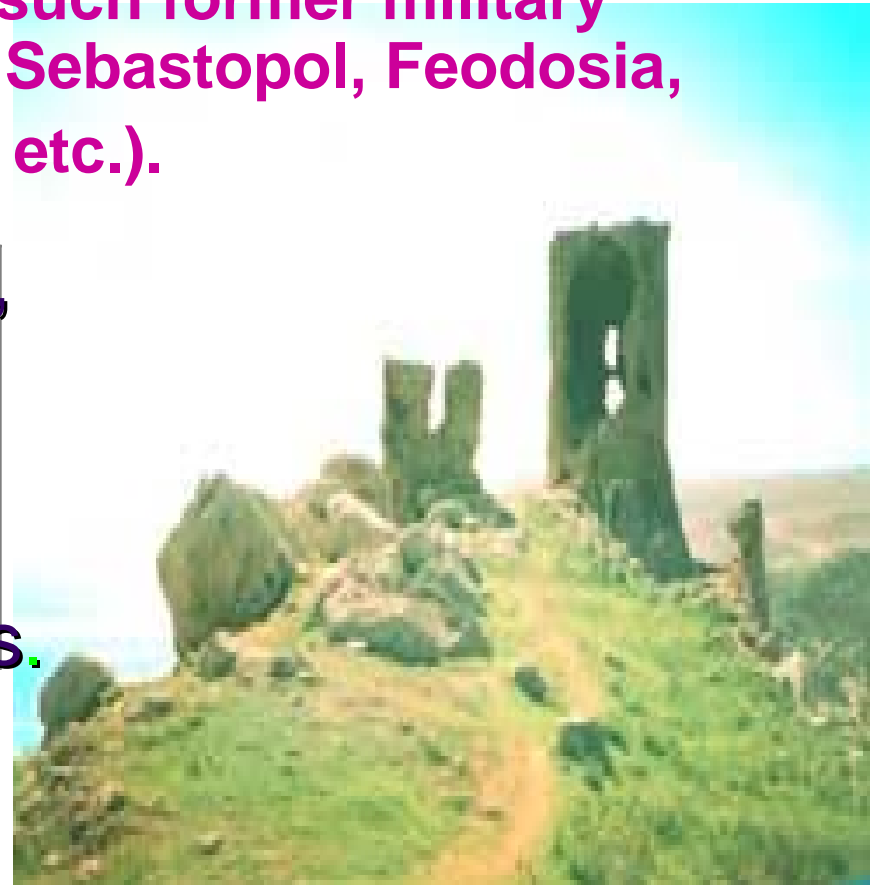

Balaklava (" the fish jack ") is located on a coast bent, picturesque bay. In opinion of some scientists the bay corresponds to the description of port, where ostensibly has got during the wanderings Odissey. Balaklava is unique monuments of a nature - capes Aya and Fiolent, and rests of a majestic Genoa fortress Chembalo, and the rests of ancient temples covered with poetic legends.

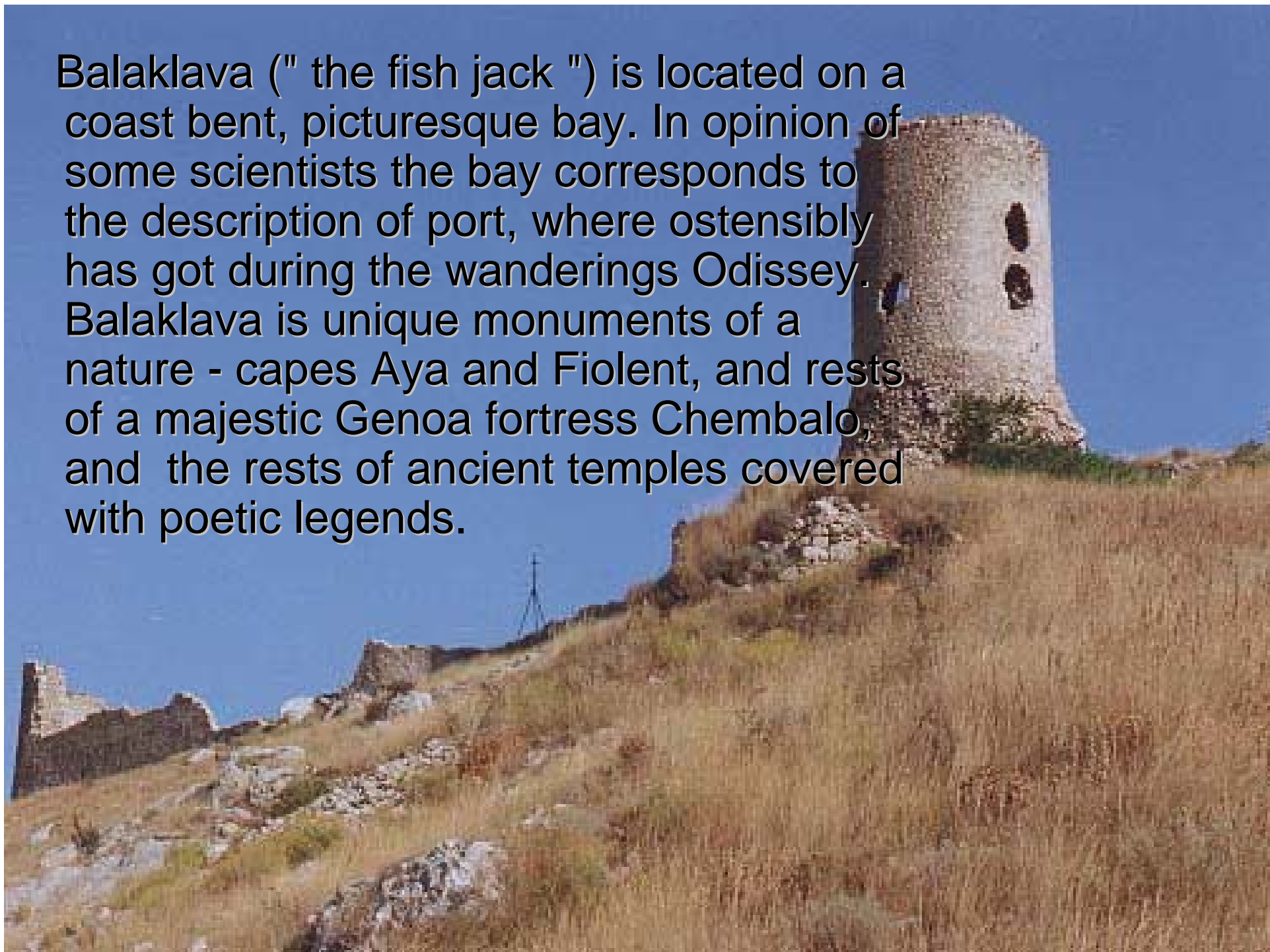

Balaklava is a corner of rare, unique beauty. Dark blue water in a bay, ancient towers and footstep from the rocks. It is places, that Asleksandr Pushkin, Valery Brusov, Adam Mitckeach were singing of.

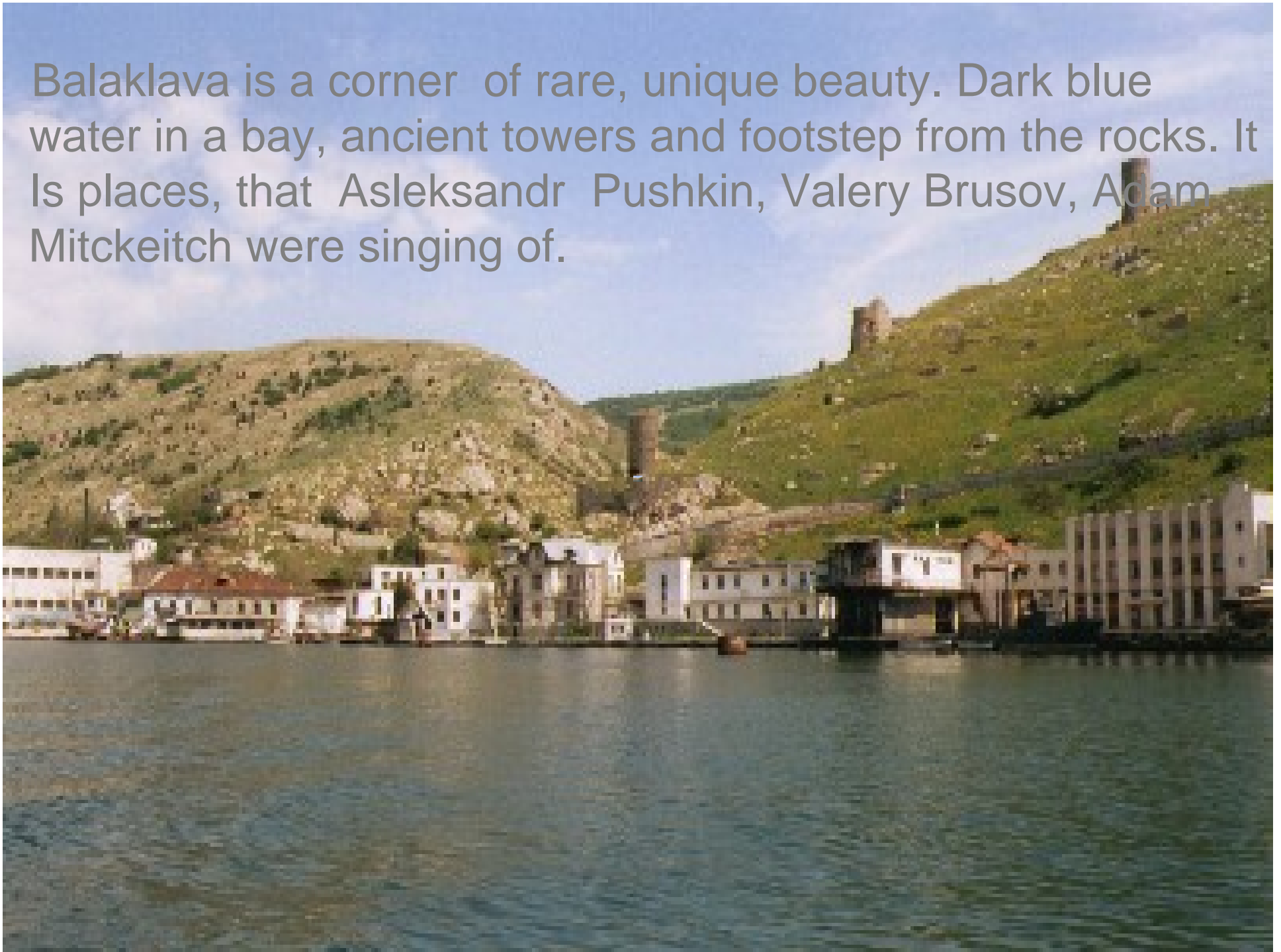



- The Ukrainian owners and businessmen proposed to create in Balaklava (Crimea region, Sebastopol district), former submarine base of FSU, international health-resort-sanitary zone (initial name "Zone of Peace") within the frameworks program of regional restructuring. Preconditions for advancement and further realization of this idea following:
 - global changes in international politics;
 - international acknowledgement of conversion projects, staging by aim to change orientation of separate peoples and world community;

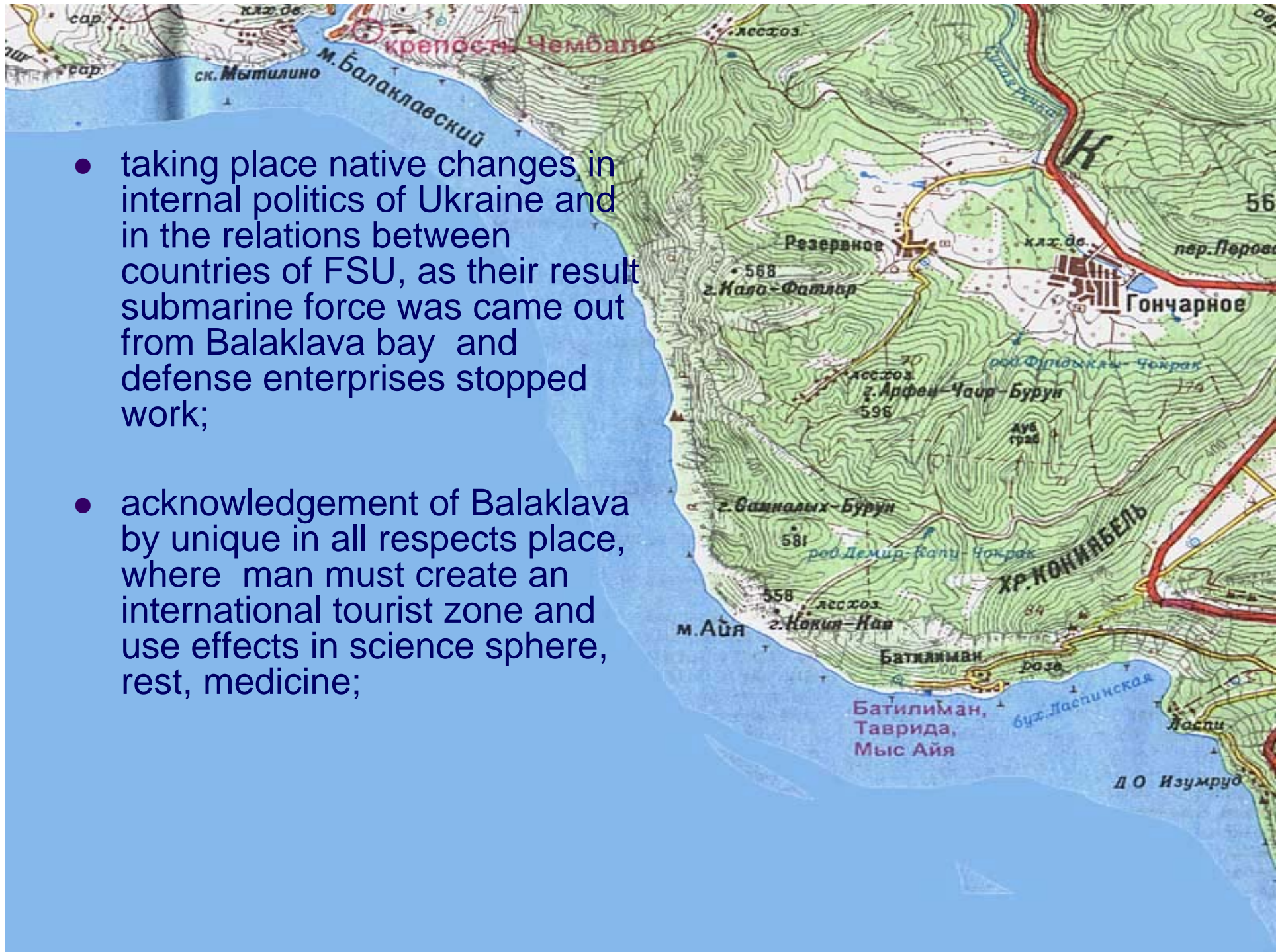

- taking place native changes in internal politics of Ukraine and in the relations between countries of FSU, as their result submarine force was came out from Balaklava bay and defense enterprises stopped work;
- acknowledgement of Balaklava by unique in all respects place, where man must create an international tourist zone and use effects in science sphere, rest, medicine;



- Word priority acknowledgements. Project idea of "Zone of Peace" timely, actual and one's base is positive, and, consequently, has a right on success;
- long-term funds enclosure in building and tourist business is absolutely advantageous business.



- On 2004 year it will be 2500 Anniversary of Balaklava. We are going to organize NATO ARW not only on creation in former military city “Zone of Peace”. With account of it may be it will be reasonable to organize in Crimea Region NATO ARW or next NATO/CCMS meeting on
“Cleaner Production Policy in context of Market Economy & Sustainable Development for transition economy countries”.
- NATO symposium will has to include also restructuring problems and sustainable development of demilitarized towns and cities in countries of transitional economy are connected with cleaner production policy.





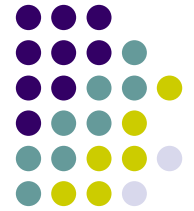

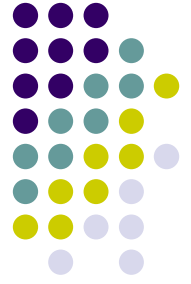

3. Communication – transfer Ecological commercialized technologies



Commercialised Environmentally Friend Technologies Virtual Market
Some commercialized technical and scientific proposals of my more 300 patents and inventions are listed here. Mutually beneficial cooperation at these projects using is possible

Recent Commercialised Technologies

- Development of competitive combined reactive- separation processes in chemical engineering
- Concurrent flow reactors for gas-liquid processes
- Production of ultra-pure substances for the semiconductor and fibre-optic industries.

Agriculture

- Electrosol spraying for agricultural applications
- New Approaches to Spraying Pesticides

Commercialized environmentally friendly technologies

- Extension of Ecologization Concept to Cleaner Production
- Adaptation and rehabilitation program of ecologically intense zones inhabitants
- Method and equipment for washing fine dispersion solid phase products

See continue in Abstract Booklet or in: www.zadorsky.com

NATO CCMS Pilot Study: Clean Products and Processes Phase II



Subhas K. Sikdar (US EPA), Director
Daniel Murray (US EPA), Co-Director
Prof. Enrico Drioli (Italy), Meeting Director



6th Annual Meeting
Cetraro, Italy - May 11 - 15, 2003

Mission of Clean Products and Processes



Promote cooperation for improving the common pollution landscape by stimulating cross-national dialogues and collaboration



Share knowledge on the methods, tools, and technologies for making cleaner products and processes possible.

Clean Products and Processes

-  Rational product design using life cycle assessment
-  Measuring pollution or wastes in processes, and minimizing them at the enterprise level
-  Green chemistry and processing
-  Material substitution
-  Improving energy efficiencies
-  Efficient separation technologies
-  Sustainability and Metrics
-  Effective dissemination of technical knowledge

Annual Meeting Activities

- 📖 Invited speakers on innovative technologies
- 📖 Topical Conference (one-day)
 - Product design (Copenhagen)
 - Process design (Oviedo)
 - Industrial ecology (Vilnius)
 - Process Intensification (Cetraro)
- 📖 Computer Café and Posters
- 📖 Updates on country-sponsored projects
- 📖 Tour de Table
- 📖 Visits to exemplary industrial sites

Clean Products and Processes



First meeting in Cincinnati, US (March 1998)

Second meeting in Belfast, Northern Ireland, UK
(March 1999)

Third meeting in Copenhagen, Denmark (May 2000)

Fourth meeting in Oviedo, Spain (May 2001)

Fifth meeting in Vilnius, Lithuania (May 2002)

Sixth meeting in Cetraro, Italy (May 2003)



Initially 14 Countries, now 27 countries





17 NATO or West European

7 Partner Countries, Israel, Egypt & Japan



CCMS Fellows from Portugal, Turkey

Products from this Pilot

-  Annual Reports (hard copies and web-based)
-  Clean Production Evaluation in member countries (metal finishing, textiles, food/agricultural, etc.)
-  Portal-site on EPA website on clean production information
-  Journal Papers from Topical Sessions

Phase I Projects in the Pilot

1. Pollution Prevention Tools (USA) – **On schedule and ongoing**
2. Water Conservation and Recycling in Semiconductor Industry: Control of Organic Contamination and Biofouling in Ultra Pure Water Systems (USA and UK) - **Complete**
3. Clean Products and Processes in Textile Industry (USA) - **Complete**
4. Clean Processes in the Turkish Textile Industry (Turkey) - **Complete**
5. Energy Efficiency in Moldova (Moldova) - **Abandoned**

Phase I Projects in the Pilot - cont'd

6. Cleaner Energy Production With Combined Cycle Systems (Turkey) - **Ongoing**
7. The Danish Center for Industrial Water Management Update. A Case on: LCA of Alternative Scenarios for Water Reuse in Molded Pulp Production (Denmark & Turkey) - **Complete**
8. International Exchange and Dissemination of Clean Products and Processes Information: Within the Pilot Study and to Industry and the Public (USA & Germany) - **Incomplete**
9. Fellow Projects (Portugal) - **Complete**
10. Use of Intelligent Systems in Pulp and Paper Industry (Canada) - **Abandoned**

Current Projects in the Pilot

-  Environmental management of industrial park by Israel, Turkey, Poland, Hungary, Denmark, and Lithuania.
-  Hybrid membrane application (milk, olive oil, chemicals) by Spain, Russia, Italy, Poland, Denmark
-  Agricultural ecology by Israel
-  Sustainability indicators benchmarking by Germany, Norway, Hungary, Lithuania, USA
-  Medical care (hospitals, diagnostic facilities that use radionuclides) by Czech Republic

Spin-off Activities

 Denmark Technological University and Solutia
(USA), DTU and U.S. EPA,
DTU and Kaunas University, Lithuania

 U.S. EPA and University of Porto, Portugal

 Jim Swindall (UK) guidance on University-Industry
Cooperative Research Centers

 Denmark Technological University hosted visiting
scientists from Turkey

 University of Oviedo, Mendeleev University in
Moscow, and U.S. EPA

Thanks to the meeting organizers and hosts of the last several years:



Steve James (USA) for Cincinnati, '98



Prof. Jim Swindall (UK) for Belfast, '99



Prof. Henrik Wenzel (Denmark) for Copenhagen, '00



Prof. José Coca (Spain) for Oviedo, '01



Prof. Jurgis Staniskis (Lithuania) for Vilnius, '02



Prof. Enrico Drioli (Italy) for Cetraro, '03



2002 Annual Report

Bridging from Phase I to
Phase II

May 15, 2003

Interactive Annual Report

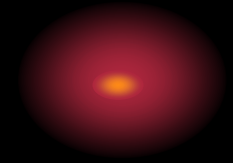

- CD-ROM based
 - PowerPoint and linked .pdf formats used
 - 29 PowerPoint presentations (28 available as .pdf)
 - Complete report (192 pages) in linked .pdf
- 

Technical Contents



- Tour de Table – 11 topics
- Pilot Project Updates – 4 topics
- University-Industry Cooperation – 5 topics
- Industrial Ecology Symposium – 11 topics
- Country Annual Reports – 9 reports

Appendices



- Appendix A – Annual Reports
- Appendix B – Phase I Summary
- Appendix C – Phase II Proposal
- Appendix D – List of 2002 Annual Meeting Participants
- Appendix E – 2002 Annual Meeting Program
- Appendix F – Presentation Links

2003 Annual Report Requirements



- Submit all meeting abstracts, presentations, and papers by June 30, 2003
- Submit midterm reports by December 15, 2003
- 2003 Annual Report published by January 31, 2004

Midterm Reports



- Update of activities related to clean production in delegate's country
- Progress on collaborative efforts resulting from pilot study
- Pilot project updates/reports
- Brief summaries
- Report 2-3 pages in length

Pilot Study Web Site and Portal



- Links to other international cleaner production resources and sites
- National web pages
 - Current delegate photo
 - Web links to organization sites, government clean production resources and reports, etc.



Annual Report Demo

Questions ?

Discussion.....



Look to 2004

New Pilot Projects
Focus and Topics
Host Country Selection
Dates for 2004 Meeting



New Pilot Projects

- Sustainability Indicators
 - Plans for 2004
- New Pilot Project Proposals
- Other Cooperative and Collaborative Ventures



2004 Annual Meeting

- Focus and Topic Areas
 - Sustainability Indicators
 - Priority industries: chemical production, energy production; food/agriculture; electronics
 - Balance between product design and production processes
 - Include service sectors



Selection of Host Country

- Delegate Proposals
- Group Discussion
- Selection



2004 Meeting Dates

- Other cleaner production and related meetings
- Suggestion from host delegate
- Open discussion
- Selection of dates





Wrap-up Discussion

Review of Recommendations for Phase II



- Address sustainability issues in the Pilot
- Increase dialogues among country delegates for ways to implement the individual projects
- Look for funding from EU, NSF International and other sources
- Pledge again for reporting on interim activities
- Keep CCMS Representatives regularly informed