

Stormwater Best Management Practice Design Guide:

Volume 1 General Considerations

EPA/600/R-04/121
September 2004

Stormwater Best Management Practice Design Guide

Volume 1 General Considerations

By

Michael L. Clar, P.E.
Ecosite, Inc.
Ellicott City, Maryland, 21042

Billy J. Barfield, P.E., Ph.D.
Professor Emeritus
Department of Agricultural Engineering
Oklahoma State University
Stillwater, Oklahoma

Thomas P. O'Connor
Urban Watershed Management Branch
Water Supply and Water Resources Division
National Risk Management Research Laboratory
Edison, NJ 08837

Order No. 1C-R059-NTSX

Project Officer
Thomas P. O'Connor
Urban Watershed Management Branch
Water Supply and Water Resources Division
National Risk Management Research Laboratory
Edison, NJ 08837

NATIONAL RISK MANAGEMENT RESEARCH LABORATORY
OFFICE OF RESEARCH AND DEVELOPMENT
U.S. ENVIRONMENTAL PROTECTION AGENCY
CINCINNATI, OH 45268

Notice

The U.S. Environmental Protection Agency through its Office of Research and Development partially funded and collaborated in the research described here under Order Number 1C-R059-NTSX to Ecosite, Inc. It has been subjected to the Agency's peer and administrative review and has been approved for publication as an EPA document. Mention of trade names or commercial products does not constitute endorsement or recommendation for use.

Foreword

The U.S. Environmental Protection Agency (EPA) is charged by Congress with protecting the Nation's land, air, and water resources. Under a mandate of national environmental laws, the Agency strives to formulate and implement actions leading to a compatible balance between human activities and the ability of natural systems to support and nurture life. To meet this mandate, EPA's research program is providing data and technical support for solving environmental problems today and building a science knowledge base necessary to manage our ecological resources wisely, understand how pollutants affect our health, and prevent or reduce environmental risks in the future.

The National Risk Management Research Laboratory (NRMRL) is the Agency's center for investigation of technological and management approaches for preventing and reducing risks from pollution that threaten human health and the environment. The focus of the Laboratory's research program is on methods and their cost-effectiveness for prevention and control of pollution to air, land, water, and subsurface resources; protection of water quality in public water systems; remediation of contaminated sites, sediments and ground water; prevention and control of indoor air pollution; and restoration of ecosystems. NRMRL collaborates with both public and private sector partners to foster technologies that reduce the cost of compliance and to anticipate emerging problems. NRMRL's research provides solutions to environmental problems by: developing and promoting technologies that protect and improve the environment; advancing scientific and engineering information to support regulatory and policy decisions; and providing the technical support and information transfer to ensure implementation of environmental regulations and strategies at the national, State, and community levels.

This publication has been produced as part of the Laboratory's strategic long-term research plan. It is published and made available by EPA's Office of Research and Development to assist the user community and to link researchers with their clients.

Lawrence W. Reiter, Acting Director.
National Risk Management Research Laboratory

Abstract

This document is Volume 1 of a three volume series that provides guidance on the selection and design of stormwater management Best Management Practices (BMPs). This first volume provides general considerations associated with the selection and design of BMPs.

Volume I provides guidance on the following elements:

- wet weather flow impacts on receiving waters
- regulations
- BMP design concepts and guidance
- BMP types and selection.

BMPs can be designed to meet a wide range of goals and objectives. These can range from a single parameter approach such as flood control or pollutant removal, which is typical in older developed watersheds, to multiple parameter ecological sustainability of receiving systems, which is more readily applied to developing watersheds. These management goals will determine the requirement for proper design and the mix of ecological and engineering principles that must be considered. These will typically include hydrology and inflow hydraulics, soil characteristics/infiltration rates, site-specific water quality and location, as well as the condition of the receiving waters. BMP control practices also vary by local regulation and standards. A brief review of currently available design goals and objectives is provided.

Hydrologic concepts and control strategies, criteria and associated standards are summarized. The hydrologic concepts that are presented include:

- rainfall frequency spectrum
- large storm hydrology
- small storm hydrology
- ground water recharge hydrology.

Control strategies for peak discharge control and water quality control are also summarized.

Currently used BMP types are described and guidance is provided on their selection and suitability for the various goals and objectives. BMPs can be classified in a number of ways, typically based on function, which include the following broad categories: pollution prevention, runoff control, end-of-pipe treatment control, source control, micro management control, regional control and structural or non structural control.

A brief summary of the suitability of the various BMP types to address the identified impact areas is provided. Also provided is BMP selection guidance with respect to the following design factors:

- watershed factors
- terrain factors
- physical site factors
- community and environmental factors
- location and permitting factors.

Contents

Notice.....	ii
Abstract.....	iii
Forward.....	v
Contents.....	ix
List of Figures.....	x
List of Tables.....	xi
Acronyms and Abbreviations.....	xii
Acknowledgements.....	xiv
EXECUTIVE SUMMARY.....	1
Section 1 Introduction.....	1-1
Section 2 Wet Weather Flow Impacts on Receiving Waters.....	2-1
Introduction.....	2-1
Background.....	2-1
Overview.....	2-2
Physical Impacts.....	2-2
Hydrologic Regime Alterations.....	2-3
Geomorphology and Stream Channel Stability.....	2-6
Flooding Impacts.....	2-8
Thermal Impacts.....	2-9
Chemical Impacts.....	2-10
Regional Data for Major Pollutants.....	2-10
Regional Differences Based Primarily on Rainfall.....	2-10
Cold Region Snowmelt Data.....	2-12
Impacts to Receiving Waters.....	2-13
Impacts of Urbanization on Biological Community.....	2-15
Overview of the Biological Impacts.....	2-15
Section 3 Regulations That Impact Stormwater BMP Design.....	3-1
Introduction.....	3-1
Federal Regulations.....	3-1
Clean Water Act.....	3-1
CWA Section 304(m).....	3-2
NPDES Phase1 and Storm Water Rules.....	3-2
Water Quality Certifications (Section 401).....	3-2
Coastal Zone Management Act (CZMA).....	3-3
Endangered Species Act.....	3-4
State and Municipal Regulations.....	3-4

Drainage Area.....	3-6
Peak Discharge Rate Requirements for Flood Control.....	3-6
Water Quality Control Requirements.....	3-7
Section 4 BMP Design Concepts and Guidance.....	4-1
Introduction	4-1
BMP Performance Goals and Objectives	4-1
Flood and Peak Discharge Control.....	4-1
Flood and Peak Discharge Control and Specified Pollutant Guideline.....	4-1
Flood, Peak Discharge and Water Quality Control	4-2
Multiple Parameter Control.....	4-2
Ecologically Sensitive Stormwater Management.....	4-3
Hydrologic Concepts	4-4
Rainfall Frequency Spectrum (RFS)	4-5
Large versus Small Storm Hydrology	4-7
Large Storm Hydrology.....	4-8
Small Storm Hydrology.....	4-8
Ground Water Recharge Hydrology.....	4-11
Design Storm vs. Continuous Flow Simulation	4-11
Assessment of Peak Discharge Control Strategies	4-14
Design Storms.....	4-15
Peak Discharge Strategies and Control of Physical Impacts	4-15
Peak Discharge Strategies and Control of Chemical Impacts	4-20
Peak Discharge Strategies and Control of Habitat and Biological Impacts.....	4-21
Assessment of Current Water Quality Control Strategies	4-21
Pollutants and Sources.....	4-22
Pollutant Concentrations and Loadings.....	4-22
Pollutant Reduction Requirements	4-22
Not-to-Exceed Concentration Requirements for New Development	4-23
Water Quality Control Strategies and Control of Physical Impacts	4-24
Water Quality Control Strategies and Control of Chemical Impacts	4-24
Water Quality Control Strategies and Control of Habitat and Biological Impacts.....	4-25
Section 5 BMP Types and Selection	5-1
BMP Types.....	5-1
Removal Processes Occurring in Treatment BMPs.....	5-2
Settling.....	5-3
Filtration	5-4
Sorption	5-4
Phytoremediation.....	5-5
Designing Using Treatment Train BMPs	5-5
BMP Selection.....	5-6
Impact Area and Design Objectives	5-6
On-Site Versus Regional Controls.....	5-7
On-Site Controls	5-9
Regional Controls	5-10
Micro-scale, Landscape Based Control	5-11
Integration of Approaches	5-12
Watershed Factors	5-12
Coldwater Streams.....	5-12
Sensitive Streams.....	5-13
Wellhead Protection	5-13
Reservoir Protection	5-13

Shellfish/Beach Protection	5-13
Other Criteria.....	5-13
Terrain Factors.....	5-14
Physical Suitability Factors	5-14
Soils	5-14
Water Table	5-14
Drainage Area.....	5-14
Drainage Area.....	5-15
Slope Restriction.....	5-15
Head.....	5-15
Urban Sites	5-15
Community and Environmental Factors.....	5-15
Community Acceptance	5-16
Construction Cost	5-16
Habitat Quality	5-16
Other Factors	5-16
Location and Permitting Factors.....	5-16
Section 6 REFERENCES	6-1
Appendix A Large Storm Hydrology.....	A-1
Appendix B Small Storm Hydrology.....	B-1
Appendix C Ground Water Recharge Hydrology for BMP Design.....	C-1
Appendix D Pollutant Loading Estimates.....	D-1
Appendix E Quantifying Pollutant Removal	E-1
Appendix F Geotechnical Methods for Karst Feasibility Testing.....	F-1
Appendix G Glossary.....	G-1

List of Figures

Figure 2-1	Goal of Ecological Integrity Under the Clean Water Act	2-2
Figure 2-2	Water Balance at a Developed and Undeveloped Site (Source: Maryland Department of the Environment [MDE], 2000)	2-4
Figure 2-3	Relationship between Impervious Cover and the Volumetric Runoff Coefficient (Schueller, 1987) `	2-5
Figure 2-4	Decline in Stream Flow Due to Diminished Groundwater Recharge (MDE, 2000).....	2-6
Figure 2-5	Depiction of Increased Frequency of Flows Greater Than the Critical Discharge Rate in a Stream after Development (modified after MDE, 2000)	2-7
Figure 2-6	An Illustration of Change in Receiving Water Hydrograph Following Development (modified after: MDE, 2000).....	2-8
Figure 2-7	An Illustration of Potential Change in Floodplain Elevations (MDE, 2000).....	2-9
Figure 4-1	Stormwater Control Points for a Storm Event along the Rainfal Frequency Spectrum for Maryland (CRC, 1996).....	4-6
Figure 4-2	Fifteen rain zones of the United States (after Driscoll et al., 1989).....	4-6
Figure 4-3	Example of Intensity-duration-frequency (IDF) Curve for New York, New York (U.S. Weather Bureau, 1955).....	4-12
Figure 4-4	Example of NRCS Runoff Curves (Source: USDA, 1986)	4-13
Figure 4-5	A watershed where the drainage from a small development site joins the flow from large watershed (Ferguson, 1998).....	4-18
Figure 4-6	Alternative hydrographs from the watershed shown in Figure 4-5 (Ferguson, 1998).....	4-18
Figure 4-7	Determining Downstream Analysis Limits (Debo and Reese, 1992)	4-19

List of Tables

Table 2-1 Categories of Impacts Attributable to Construction and Development Activities	2-3
Table 2-2 Stormwater Hotspots (MDE, 2000).....	2-5
Table 2-3 National Event Mean and Median Concentrations for Chemical Constituents of Stormwater	2-11
Table 2-4 Regional Groupings by Annual Rainfall (After Driver and Tasker, 1990)	2-11
Table 2-5 Stormwater Pollutant Event Mean Concentration for Different United States Regions (Adapted from Caraco and Schueler, 2000).....	2-12
Table 2-6 Mean and Median Nutrient and Sediment Stormwater Concentrations for Residential Land Use Based on Rainfall Regions (adapted from Tasker and Driver, 1988)	2-12
Table 2-7 Percentage of Metal Concentrations Exceeding Water Quality Standards by Rainfall Region (Driver and Tasker, 1990).....	2-12
Table 2-8 Runoff and Pollutant Characteristics of Snowmelt Stages (Oberts, 1994).....	2-13
Table 2-9 Water Quality Impacts to Receiving Waters	2-14
Table 2-10 Changes Due to Urbanization and Effects on Aquatic Organisms.....	2-16
Table 2-11 Relationship of Urbanization to Aquatic Habitat and Organisms	2-17
Table 3-1 State or Regional Planning Authority Requirements for Water Quality Protection.....	3-5
Table 3-2 Municipal or Regional Planning Authority Requirements	3-6
Table 3-3 Minimum Drainage Area Requirements for States (Tetra Tech, 2001)	3-6
Table 3-4 Minimum Area Requirements for Local Agencies (Tetra Tech, 2001).....	3-7
Table 3-5 Peak Discharge Control Criteria for States (Tetra Tech, 2001).....	3-7
Table 3-6 Peak Discharge Rate Control Requirements, Municipalities (Tetra Tech, 2001).....	3-7
Table 3-7 Water Quality Regulatory Requirements, States (Tetra Tech, 2001)	3-8
Table 3-8 Water Quality Requirements, Municipalities (Tetra Tech, 2001)	3-8
Table 4-1 Summary of Stormwater Credits (based on MDE, 2000).....	4-3
Table 4-2 BMP Performance Levels vs. Control Strategies, Criteria and Standards.....	4-4
Table 4-3 Typical Values of Individual Storm Event Statistics for 15 Zones of the United States (Driscoll et al., 1989).....	4-7
Table 4-4 Comparison of Model Attributes and Functions	4-9
Table 4-5 Design Storm Frequencies and Assumed Benefits	4-16
Table 4-6 Qualitative Assessment of Peak Discharge Control Strategies: Physical Impact Category	4-16
Table 4-7 Qualitative Assessment of Peak Discharge Control Strategies: Chemical Impact Category	4-21
Table 4-8 Qualitative Assessment of Peak Discharge Control Strategies: Habitat and Biological Impact Categories	4-21
Table 4-9 Qualitative Assessment of Water Quality Control Strategies in the Physical Impact Category.....	4-24
Table 4-10 Qualitative Assessment of Water Quality Control Strategies in the Chemical Impact Category.....	4-25
Table 4-11 Qualitative Assessment of Water Quality Control Strategies in the Habitat and Biological Impact Categories	4-25
Table 5-1 Listing of Source Control BMPs	5-1
Table 5-2 Treatment BMPs.....	5-2
Table 5-3 Removal Processes Occurring in Treatment BMPs.....	5-3

Table 5-4 Summary of Studies on Environmental Impacts for Post-Construction BMPs Category A – Stormwater Ponds	5-7
Table 5-5 Summary of Studies on Environmental Impacts for Post-Construction BMPs Category B – Stormwater Wetlands	5-8
Table 5-6 Summary of Studies on Environmental Impacts for Post-Construction BMPs Category C – Infiltration	5-8
Table 5-7 Summary of Studies on Environmental Impacts for Post-Construction BMPs Category D – Biofilters ...	5-9
Table 5-8 Summary of Studies on Environmental Impacts for Post-Construction BMPs Category E – Filters.....	5-9
Table 5-9 Treatment BMPs for Specific Watershed Factors (Modified from MDE, 2000)	5-13
Table 5-10 BMP Selection for Specific Terrain Factors (Modified from MDE, 2000).....	5-14
Table 5-11 BMP Selection for Physical Suitability Factors (Modified from MDE, 2000)	5-15
Table 5-12 BMP Selection for Community and Environmental Factors (Modified from MDE, 2000).....	5-16
Table 5-13 Permitting Checklist (Modified from MDE, 2000)	5-18

Acronyms and Abbreviations

APWA	= American Public Works Association
ASCE	= American Society of Civil Engineers
BMP	= Best Management Practice
BOD	= Biochemical Oxygen Demand
CERCLA	= Comprehensive Environmental Response, Compensation and Liability Act
COD	= Chemical Oxygen Demand
CREAMS	= A field scale model for Chemicals, Runoff, and Erosion from Agricultural Management Systems
CUHP	= Colorado Urban Hydrograph Procedure
CWA	= Clean Water Act
CZARA	= Coastal Zone Act Reauthorization Amendments
CZMA	= Coastal Zone Management Act
DCIA	= Directly Connected Impervious Area
EIS	= Environmental Impact Statement
EPA	= Environmental Protection Agency
EPT	= Ephemeroptera (mayflies), Plecoptera (stoneflies) and Trichoptera (caddisflies)
ESA	= Endangered Species Act
EMC	= Event Mean Concentration
FBI	= Family Biotic Index
FEMA	= Federal Emergency Management Agency
FIFRA	= Federal Insecticide, Fungicide and Rodenticide Act
FWPCA	= Federal Water Pollution Control Act
HPA	= Hydraulic Project Approval
HSPF	= Hydrologic Simulation Program Formulation
ILLUDAS	= The Illinois Urban Area Simulator
IPM	= Integrated Pest Management
IDF	= Intensity Duration Frequency
MDE	= Maryland Department of the Environment
MEP	= Maximum Extent Practicable
MTBE	= Methyl Tertiary Butyl Ether
MUSLE	= Modified Universal Soil Loss Equation
MS4	= Municipal Separate Storm Sewer System
MTBE	= Methyl Tertiary Butyl Ether
MUSLE	= Modified Universal Soil Loss Equation
NEPA	= National Environmental Policy Act
NGPE	= Native Growth Protection Easement
NMFS	= National Marine Fisheries Service
NOAA	= National Oceanographic and Atmospheric Administration
NPDES	= National Pollution Discharge Elimination Program
NPS	= Non Point Source

NRCS	= Natural Research Council Service
NRDC	= National Resource Defense Council, Inc.
NURP	= Nationwide Urban Runoff Program
OCZM	= Office of Coastal Zone Management
OPA	= Oil Pollution Act
PAH	= Poly Aromatic Hydrocarbons
PSRM	= Penn State Runoff Model
RCRA	= Resource Conservation and Recovery Act
RFS	= Rainfall Frequency Spectrum
RPD	= Rain Point Diagram
RVPD	= Runoff Volume Point Diagram
SBUH	= Santa Barbara Urban Hydrograph
SCS	= Soil Conservation Service
SD	= Settling Depth
SLAMM	= Source Loading and Management Model
SS	= Suspended Solids (also TSS = Total Suspended Solids)
SSP	= Stormwater Site Plan
SUBH	= Santa Barbara Urban Hydrograph
SWM	= Stormwater Management
SWMM	= Stormwater Management Model
SWPPP	= Stormwater Pollution Prevention Plan
TESC	= Temporary Erosion and Sediment Control
TIA	= Total Impervious Area
TMDL	= Total Maximum Daily Loads
TPH	= Total Petroleum Hydrocarbons
TN	= Total Nitrogen
TP	= Total Phosphorus
UDFCD	= Urban Drainage Flood Control District
USDA	= U.S. Department of Agriculture
USFWS	= U.S. Fish and Wildlife Service
USGS	= U.S. Geological Survey
WAC	= Washington Administrative Code
WEF	= Water Environment Federation
WERF	= Water and Environment Research Foundation
WEPP	= Water Erosion Prediction Model
WMS	= Watershed Modeling System
WQS	= Water Quality Standards
WSDOT	= Washington State Department of Transportation
WWF	= Wet Weather Flow

Acknowledgements

These stormwater management control practices, or best management practices (BMPs) design guidelines were prepared by Ecosite, Inc. under a contract with the Urban Watersheds Management Branch, Water Supply and Water Resources Division, National Risk Management Research Laboratory, Edison, New Jersey.

A major undertaking of this type requires the dedication and cooperation of many individuals. The technical direction and coordination for this project was provided by the technical project team of the Urban Watershed Management Branch, under the direction of Mr. Thomas P. O'Connor, the technical project officer. Many members of the branch assisted in making this product available to the public. Special recognition is also extended to the other members of the branch, which included:

Mr. Daniel Sullivan, P.E., Former Branch Chief (retired)
Mr. Richard Field, P.E., Senior Advisor
Dr. Dennis Lai, P.E., Senior Engineer
Mr. Michael Borst, P.E., Senior Engineer
Mr. Evan Fan, P.E., Senior Engineer (retired)
Dr. Ariamalar Selvakumar, P.E., Environmental Engineer

The Ecosite project team included Michael L. Clar, P.E., project manager, and Dr. Bill Barfield, P.E., Professor Emeritus, Oklahoma State University.

Thanks to the external peer reviewers Gene Driscoll, P.E. and Ben Urbonas, P.E. and Office of Water Jesse Pritts, Norbert Huang and King Boynton. Dr. Swarna Muthukrishnan checked example problem calculations. Judy Norinsky and Jatu Bracewell edited the final draft. Carolyn Esposito and Asim Ray performed QA review.

The objective of the project was to identify and build upon existing guidance documents scattered throughout the United States. A number of excellent publications were identified and have been referenced extensively throughout this document. The authors wish to acknowledge the previous work and contributions in the field of stormwater management of the following organizations:

U.S. Environmental Protection Agency
Urban Water Resources Research Council, American Society of Civil Engineers
U.S. Federal Highway Administration
Water Environment Federation
Maryland Department for the Environment
Denver Urban Drainage and Flood Control District.

EXECUTIVE SUMMARY

As this document is being published by U.S. Environmental Protection Agency's Office of Research and Development, its primary focus is not the promulgation of regulation or the enforcement of policy. Instead, this is a forward looking document that tries to develop ways to address water quality issues of best management practices (BMPs) in the absence of a complete regulatory framework. The intended audience for this document is the municipal planners, regulators and watershed managers who will be deciding how BMPs will be applied in their locality.

In the past, BMP models were purely hydrologic; now they require two components: hydrology and quality. The purpose of this document is two-fold:

- to present the state-of-the-practice for BMP design for water quality control
- to aid the end user in making better choices.

This document is the first volume of a three-volume series that provides guidance on the selection and design of stormwater management BMPs. This volume provides general considerations associated with the selection and design of BMPs.

Volume 2 provides specific design guidance for a group of onsite BMP control practices that are referred to as vegetative biofilters, and includes the following BMP control practices:

- grass swales
- filter and buffer strips
- bioretention cells.

Volume 3 provides specific guidance for basin type BMPs, which are the most widely used type of BMP. The basin types that are covered include:

- extended detention basins (dry)
- retention ponds (wet)
- constructed wetland ponds
- infiltration basins.

Volume 2 is also the only volume that contains the full storm routing which is applicable to all treatment controls detailed in Volume 2 and 3.

The purpose of this three-volume series is to guide the selection of BMPs that will be effective in preventing or mitigating the adverse impacts of urbanization either through retrofitting of existing BMPs or application of newly constructed BMPs to new development. There is sufficient evidence to indicate that urbanization is causing environmental impacts. Existing BMP technologies can resolve some of the impacts. There are continuing innovative BMP efforts such as bioretention, infiltration basins and low impact development that are being pursued at

the research level and in some actual applications, which should improve our ability to reduce or prevent impacts due to urbanization and land-use changes.

The authors have also developed a spreadsheet tool - Integrated Design and Assessment for Environmental Loadings (IDEAL) - which can aid the reader in examining the hydrology, sediment transport and water quality for BMP devices. Aspects of the capabilities of the IDEAL spreadsheet tool are demonstrated through the use of relevant equations for BMP water quality design and several examples as presented in Volume 2 and Volume 3.

Section 1 Introduction

This manual is Volume 1 of a three volume document that provides guidance on the design of best management practices (BMPs) for mitigation of the environmental impacts to receiving waters associated with urban runoff. Volume 1 presents general design considerations associated with the selection and use of BMPs. Volume 2 provides design guidelines for a group of stormwater management (SWM) best management practices (BMPs) broadly referred to as vegetative biofilters. Volume 3 presents design considerations related to the use of Pond BMPs.

Volume 1 provides guidance on the following elements:

- wet weather flow impacts on receiving waters
- regulations
- BMP design concepts and guidance
- BMP types and selection.

Wet Weather Flow Impacts on Receiving Waters

The goals and objectives of implementing BMP control practices vary by municipality, State, or watershed. Stormwater management technology and the use of BMPs have changed considerably since their introduction in the 1960's. Many stormwater controls were initially employed for flood control, i.e., to capture peak flows, provide local drainage and manage the quantity of runoff produced during wet weather flow (WWF). In response to the provisions of the Clean Water Act (CWA), a number of activities were initiated to characterize and quantify the water quality impacts of WWF such as the National Urban Runoff Program (NURP), and BMPs were adapted for pollutant removal. More recently, in response to a growing national awareness and understanding of the wide range of environmental impacts associated with land use changes, particularly urbanization, BMPs have begun to be designed for stream channel protection and restoration, groundwater infiltration, and protection of riparian habitat and biota. Collected runoff has also been used for irrigation and other non-potable purposes, such as for ponds and wetlands that also enhance urban aesthetics.

It can be observed that changes and improvements in stormwater management technology and BMPs have followed closely our increasing awareness and quantification of the impacts of land use changes on receiving waters. Section 2 of this volume provides a summary of our current knowledge of these impacts.

Regulations

Laws and regulation relating to management of WWF have also paralleled our increasing awareness of the impacts of WWF on receiving waters. These laws and regulations continue to have a significant influence in the development of stormwater management technology. Section 3 provides a brief summary of the major federal, State and local regulations that influence the design of BMPs.

The number of sources that require BMPs is expected to increase dramatically with the implementation of Phase II of the National Pollution Elimination Discharge Program (NPDES) stormwater permitting regulations. U.S. Environmental Protection Agency (EPA) promulgated Phase II in January 1998 and the Final Rule was published in the Federal Register on December 8, 1999. Phase II requires NPDES permits for stormwater discharges from

regulated small municipal separate storm sewer systems (MS4s) (primarily all those in urbanized areas) and construction activity that disturbs between one and five acres of land. The Phase I rule applies to large municipal sources (> 100,000 population), industrial sources and construction activity on areas larger than five acres.

BMP Design Concepts and Guidance

BMPs can be designed for a wide range of goals and objectives that can range from a single parameter approach such as flood control or pollutant removal – typical in older developed watersheds – to multi-parameter ecological sustainability of receiving systems, which is more common in watersheds only recently being developed. These management goals will determine the requirement for proper design and the mix of ecological and engineering principles that must be considered. These will typically include hydrology and inflow hydraulics, soil characteristics/infiltration rates, site-specific water quality and location, as well as the condition of the receiving waters.

Section 4 provides a brief review of currently available design goals and objectives. These levels of control have been identified as:

- flood and peak discharge control
- flood and peak discharge control and specified pollutant guidelines
- flood, peak discharge and water quality control
- multi-parameter (Unified Sizing Criteria) and ecologically sustainable control.

The guidance provided in these manuals focused primarily on pollutant removal and water quality control. Providing guidance for multi-parameter and ecologically sustainable control is an emerging issue beyond the scope of this document and is only addressed in these documents as a future direction of research and implementation.

Section 4 also addresses hydrologic concepts and control strategies, criteria and standards. The hydrologic concepts that are presented include:

- rainfall frequency spectrum
- large storm hydrology
- small storm hydrology
- ground water recharge hydrology.

Control strategies for peak discharge control and water quality control are also summarized.

Section 5 identifies currently used BMP types and provides guidance on their selection and suitability for the various goals and objectives. BMPs can be classified in a number of ways. These include as pollution prevention, runoff control, end-of-pipe treatment control, source control, micro management control, regional control, and structural or non-structural control.

A brief summary of the suitability of the various BMP types to address the impact areas identified in Section 1 is provided. Section 5 also provides BMP selection guidance with respect to the following design factors:

- watershed factors
- terrain factors
- physical site factors
- community and environmental factors
- location and permitting factors.

The appendices provide greater detail on some of the topics introduced in this volume. Appendix A Large Storm Hydrology covers the larger modeling schemes. Appendix B Small Storm Hydrology presents three approaches to small storm hydrology. Appendix C Ground Water Recharge Hydrology for BMP Design and Appendix F Geotechnical Methods for Karst Feasibility Testing provide methods as the titles imply. Appendix D discusses and

presents pollutant loading estimates while Appendix E provides information on the difficulties of quantifying BMP performance. A glossary is provided in Appendix G.

Section 2 Wet Weather Flow Impacts on Receiving Waters

Introduction

Historically, Best Management Practices (BMPs) were first incorporated into the urban landscape as flood and drainage controls, but increasingly BMPs are being relied on to serve multiple tasks that also include treatment of stormwater and protection of receiving waters. The purpose of this three-volume manual is to guide the selection and implementation of BMPs that will be effective in preventing or mitigating the adverse impacts to stormwater by urbanization either through retrofitting of existing BMPs or application of new BMPs to new growth. This will be done by reviewing and building upon traditional BMP design concepts that did not address quality at first, and by presenting more recent concepts like “small storm hydrology” and the treatment train approach, which intend to improve stormwater quality.

Background

For the past three decades, municipalities in the U.S. have successfully addressed pollution in the watershed by collecting and treating their wastewater. Currently, all municipalities provide secondary level treatment and in some cases tertiary treatment, while industries provide best available/best practicable treatment. This has had great benefits. More rivers are meeting water quality standards and the public health is being protected from waterborne disease. The challenge now facing us is to address pollution associated with stormwater runoff, which is now the last major threat to water quality.

It is less costly to prevent runoff than to treat it. Today, many municipalities are looking at low-cost BMPs that do so. The lowest cost BMPs, termed nonstructural or source control BMPs, include such practices as limiting pesticide use in agricultural areas or retaining rainwater on residential lots (currently termed “low impact development [LID]”). There are higher-cost BMPs that involve building a structure to store stormwater and enable sedimentation. These can be more costly, especially in areas where land costs are high. BMPs have been classified a number of different ways, including by stormwater runoff source, pollutant, land use and BMP type. For example, the Rouge River Restoration Project has six classifications in a matrix of BMPs (<http://www.rougeriver.com/pdfs/apmatrix.pdf>): public information and participation, urban source control, treatment control, construction erosion and sediment control, channel restoration/stabilization and agricultural. The American Society of Civil Engineers has nine categories (ASCE, 1998) and the State of Texas has three classes.

For the past ten years, the EPA has encouraged municipalities to approach water pollution controls on a watershed basis. A watershed approach allows tradeoffs between pollution sources, point source treatment and pollution prevention, and optimal balances between these. It requires community-level involvement and often includes the use of both hard (structural) and soft (nonstructural) engineering approaches to protect or restore watersheds from chemical, physical, or biological stressors. The watershed approach allows simultaneous pollution, flood and erosion-sedimentation control by properly siting BMPs within the watershed to maximize pollutant removals and reduce stormwater-associated stressors.

Historically, BMPs were employed to capture peak flows, provide local drainage and manage the quantity of runoff produced during WWF, i.e., flood control. While these objectives will probably remain a goal of watershed management planners, BMPs are now also considered for pollutant removal, stream restoration and groundwater recharge infiltration.

Some source control and pollution prevention are considered “good housekeeping” practices, i.e., practices that keep pollutants out of runoff such as street cleaning, product substitution and controlled application of pesticides/herbicides. Runoff source controls are used to reduce runoff generated at the source of specific activities and are

divided into two types: those used on a temporary basis (e.g., runoff control at construction activities) and those used on a permanent basis (e.g., hot spot treatment at vehicle repair sites). End-of-pipe or treatment controls are used to remove pollutants from contaminated runoff.

The three most commonly used treatment BMPs are basins or ponds (retention/detention), vegetative biofilters (swales, filter/buffer strips and bioretention cells) and constructed wetlands. Two other categories of structural treatment BMPs are filters (notably sand filters) and innovative technology options (catchbasin inserts, filters, etc). These documents concentrate on the first two most commonly used treatment BMPs: basins and vegetative biofilters. BMPs that can be applied to agricultural lands will not be covered. Constructed wetlands are covered but only as a sub-category to retention ponds. The key aquatic stressors of concern in the U.S. are nutrients, suspended solids (SS) and sediments, pathogens, toxic substances and flow. These stressors have worldwide significance.

Overview

This section presents a brief summary of the impacts that result from the interaction of WWF and land use changes on receiving waters. The summary is provided from a CWA, 33 U.S.C. 1251 et. seq.) reference point since the CWA is the legal and technical foundation for defining water quality standards. The objective of the CWA is to restore and maintain the chemical, physical and biological integrity (or ecological integrity) of the Nation's water bodies as illustrated in Figure 2-1 (CWA Section 101(a)) (EPA 1990). Consequently the impacts have been grouped into these three major impact area categories: physical, chemical and biological. Table 2-1 presents a summary of these impact areas.

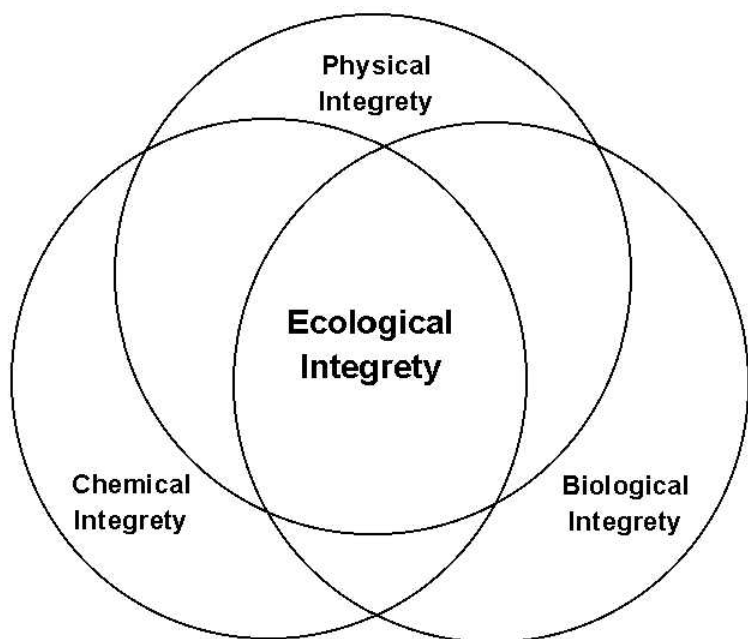

Figure 2-1 Goal of Ecological Integrity Under the Clean Water Act

Physical Impacts

The physical impacts resulting from land use changes, particularly construction and land development, can be grouped into four major categories: 1) hydrologic regime (including groundwater impacts), 2) geomorphology and channel stability, 3) flooding and 4) thermal impacts.

Table 2-1 Categories of Impacts Attributable to Construction and Development Activities

Category	Impact Type / Metric	Impairment or Change to Beneficial Use	
Physical	Hydrologic regime	Runoff volume	Flooding, groundwater recharge, hydrologic balance, etc.
		Peak discharge	Flooding, channel erosion, habitat loss
		Flow duration and frequency	Channel erosion, habitat loss
		Groundwater recharge, water table elevation and baseflows	Water table, local wells, baseflows, habitat loss
	Geomorphic	Channel geometry	Channel erosion, sediment deposition, habitat loss
		Sediment transport	Aggradations, degradation, channel capacity
	Flooding		Loss of property
Thermal		Habitat impairment	
Habitat	Attachment sites, embeddedness, fish shelter, channel alteration, sediment deposition, stream velocity and depth, channel flow status, bank vegetation protection, bank condition score, and riparian vegetation zone	Impairment or loss of habitat structure results in reduction or losses in biologic conditions and communities.	
Biological	Total taxa Ephemeroptera, Plecoptera, Tricoptera (EPT) taxa % taxa % EPT Family Biotic Index (FBI)	Biologic conditions and communities can be reduced or eliminated as a result of impairment or loss of habitat structure caused by physical impacts resulting from construction and development activities.	
Chemical (Water Quality)	Sediment, nutrients, metals, herbicides and pesticides, deicers, pathogens, petroleum, hydrocarbons, MTBE, grease, and other toxic organic carbons	Water quality degradation or impairment can have many negative consequences: drinking water violations, increased water treatment costs, beach closures, shellfish bed closures, loss of boating use, fishery loss, reduction of reservoir and lake volumes due to sediment volume.	

Hydrologic Regime Alterations

Development can have a profound influence on the quality of receiving waters. To start, land use changes, including agriculture, construction and urban development, can dramatically alter the local hydrologic regime (see Figure 2-2). The hydrology of a site changes during the initial clearing and grading that occur during construction. Trees, meadow grasses and agricultural crops that had intercepted and absorbed rainfall are removed and natural depressions that had temporarily ponded water are graded to a uniform slope. Cleared and graded sites erode, are often severely compacted, and can no longer prevent rainfall from being rapidly converted into stormwater runoff. Very large errors in soil infiltration rates can be made if published soil maps and most available models are used for typical disturbed urban soils, as these tools ignore compaction (Pitt et al., 1999). Any disturbance of a soil profile can significantly change its infiltration characteristics and with urbanization, native soil profiles may be mixed or removed, or fill material from other areas may be introduced (USDA, 1986). Some local agencies have attempted to address this issue by requiring that the predevelopment hydrologic soil group (HSG) type be downgraded for post development hydrologic analysis. For example, predevelopment HSG types A, B and C would be downgraded respectively to B, C and D.

WATER BALANCE

PRE-DEVELOPMENT

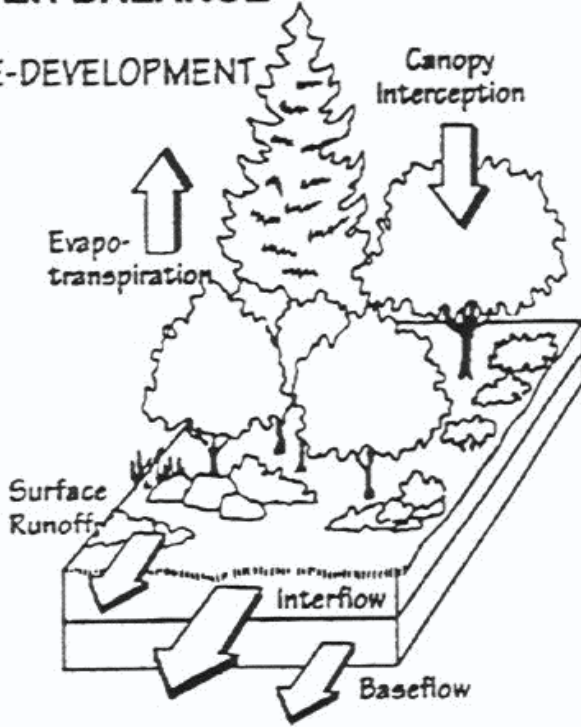

POST-DEVELOPMENT

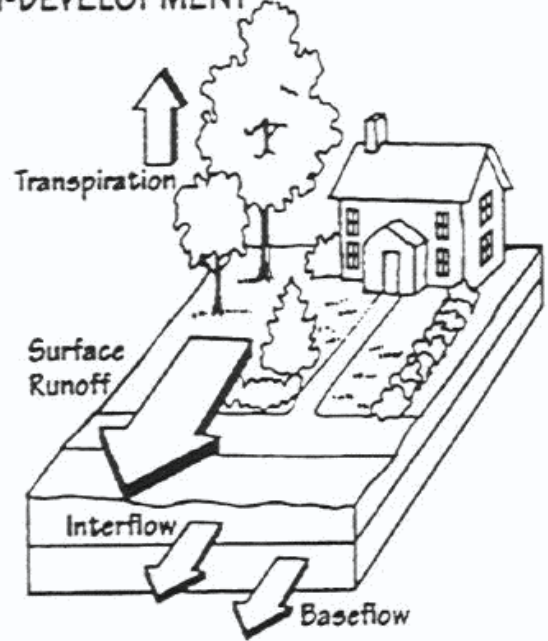

Figure 2-2 Water Balance at a Developed and Undeveloped Site (Source: Maryland Department of the Environment [MDE], 2000)

After construction, rooftops, roads, parking lots, driveways and other impervious surfaces no longer allow rainfall to soak into the ground. Consequently, most rainfall is converted directly to stormwater runoff. Increased runoff is an obvious result of increased imperviousness.

This phenomenon, first demonstrated with the National Urban Runoff Program (NURP) (EPA, 1983), is illustrated in Figure 2-3, which shows the increase in the volumetric runoff as a function of site imperviousness. The runoff coefficient expresses the amount of rainfall volume that is converted into stormwater runoff and is given by:

$$R_v = a + bI \tag{2-1}$$

where: R_v = the runoff coefficient, (alternatively defined as **C** in the Rational Method)
 I = percent impervious, and
 a, b = coefficients, values typically used are $a = 0.05$ and $b = 0.009$.

As can be seen, the volume of stormwater runoff increases sharply with impervious cover. For example, a one-acre parking lot can produce 16 times more stormwater runoff each year than a one acre meadow (Maryland Department of the Environment [MDE], 2000). This analysis did not consider any variability in the pervious area, which explains much of the scatter in Figure 2-3.

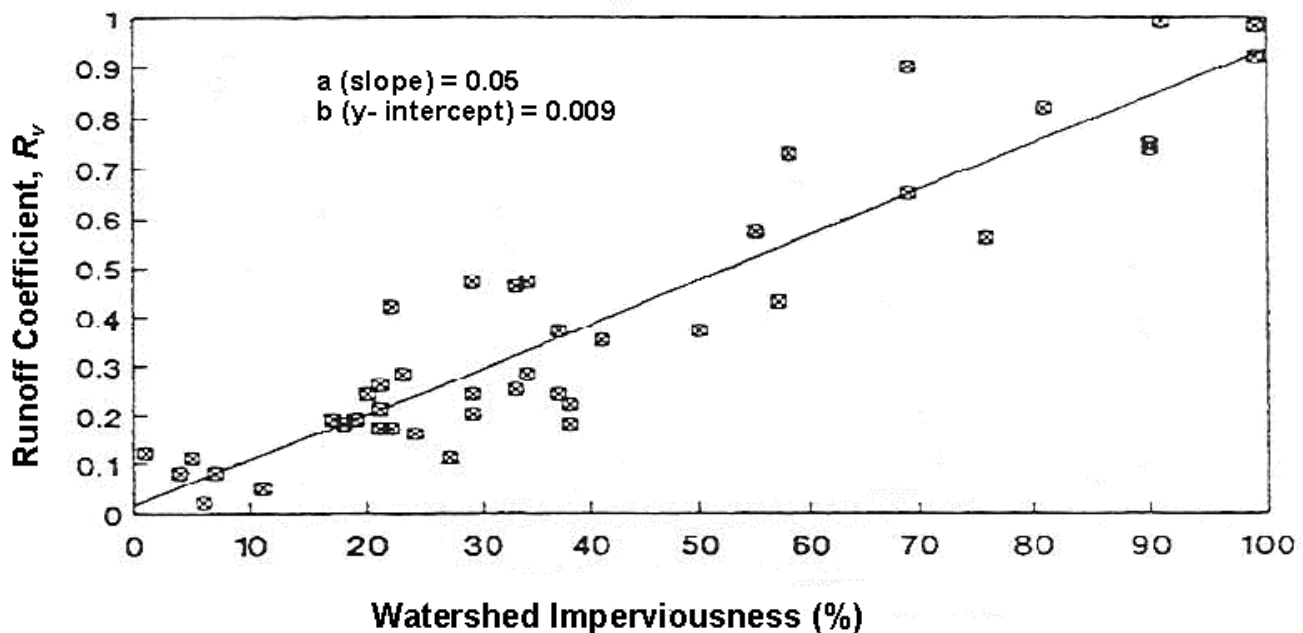

Figure 2-3 Relationship between Impervious Cover and the Volumetric Runoff Coefficient (Schueller, 1987)

Groundwater Recharge Impacts

Infiltration of rainfall through the soil layer is essential for replenishing groundwater. The infiltration rates of rainfall that recharges groundwater vary, depending on slope and other physical characteristics of soil, antecedent moisture condition, and the temperature, type and thickness of vegetation. Appendix C shows a regional estimate for the State of Maryland of the annual recharge volume based on soil type that accounts for runoff and evapotranspiration.

Groundwater is a critical water resource in many areas of the U.S. Not only do many people depend on groundwater for their drinking water, but the health of many aquatic systems is also dependent on its steady discharge. For example, during periods of dry weather, groundwater sustains flows in streams and helps to maintain the hydrology of non-tidal wetlands. Because development creates impervious surfaces that prevent natural recharge, a net decrease in groundwater recharge rates can be expected in urban watersheds (Figure 2-4). In addition, many construction and development practices disturb natural soil processes, through clearing of vegetation, grading and compaction, thereby limiting infiltration in the post development landscape. Thus, during prolonged periods of dry weather, stream flow sharply diminishes. In smaller headwater streams, the decline in stream flow can cause a perennial stream to become seasonally dry.

Urban land uses and activities can also degrade groundwater quality if stormwater runoff is directed into the soil without adequate treatment. Certain land uses and activities are known to produce higher loads of heavy metals and toxic chemicals, and are designated as stormwater hot spots. Table 2-2 provides a list of some typical hotspots.

Table 2-2 Stormwater Hotspots (MDE, 2000)

Vehicles service and maintenance facilities	Vehicle salvage yards ¹	Outdoor liquid container storage
Vehicle and equipment cleaning facilities ¹	Industrial sites	Outdoor loading/unloading facilities
Facilities that generate or store hazardous materials ¹	Public works storage areas	Fleet storage areas (bus, truck, etc.) ¹
Marinas (service and maintenance) ¹		Commercial container nursery
¹ Indicates that the land use or activity requires preparation of a stormwater pollution prevention plan under the National Pollution Elimination Discharge Program stormwater program.		

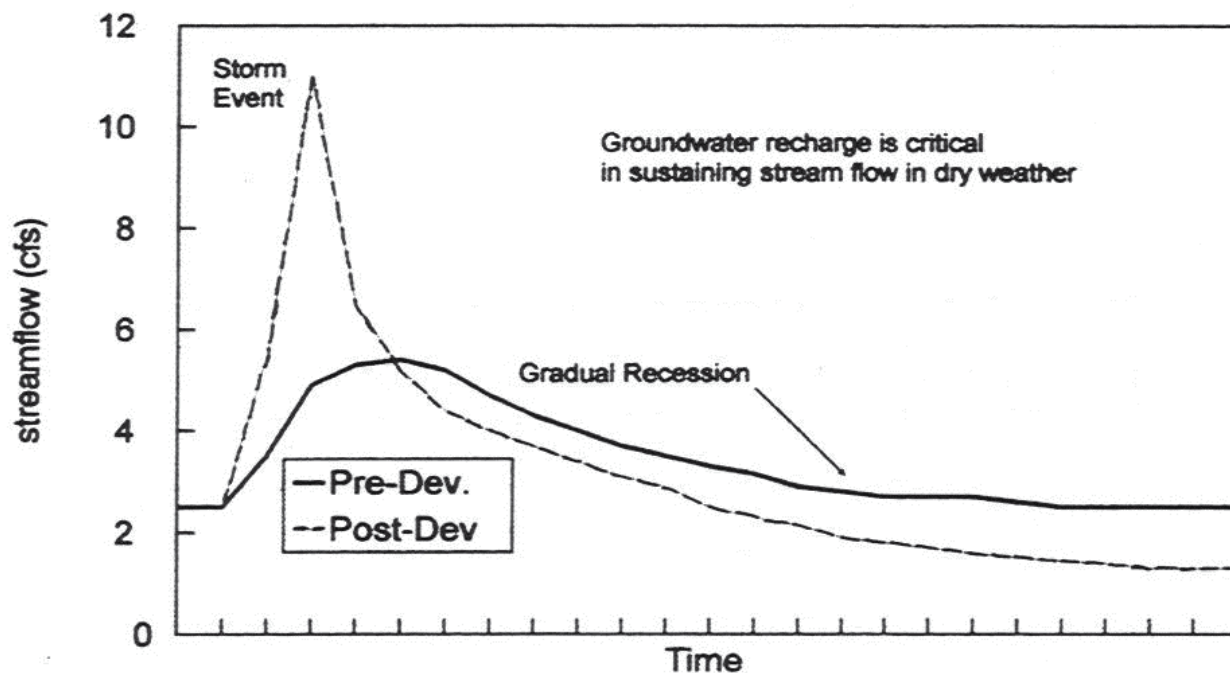

Figure 2-4 Decline in Stream Flow Due to Diminished Groundwater Recharge (MDE, 2000)

Typically, the following land uses and activities are not considered hotspots:

- residential streets and rural highways
- residential areas
- institutional areas
- commercial and office areas
- non-industrial rooftops
- pervious areas, except golf courses and nurseries (which may require integrated pest management).

Geomorphology and Stream Channel Stability

In the context of drainage design, geomorphology science defines stream characteristics through floodplain analysis, tracks stream meandering, predicts sediment scour and deposition, and defines bankfull stage. Stormwater runoff is a powerful force that influences the geometry of streams. After development, both the frequency and magnitude of storm flows increase dramatically. Consequently, urban stream channels experience more frequent out-of-bank flows, as well as intermediate flows (critical discharge rate in Figure 2-5) that have sufficient energy to erode and destabilize the stream channel than they had prior to development.

As a result, these streambeds and banks are exposed to highly erosive flows more frequently and for longer periods. Streams typically respond to this change by increasing their cross-sectional area – either by channel widening or down cutting, or both – as a means of handling the more frequent and erosive flows. This results in a highly unstable phase where the stream experiences severe bank erosion scour and habitat degradation.

In this phase, the stream often experiences some of the following changes as it adjusts to the new flow regime:

- rapid stream widening
- increased streambank and channel erosion
- decline in stream substrate quality (through sediment deposition and embedding of the substrate)
- loss of pool/riffle structure in the stream channel
- degradation of stream habitat structure.

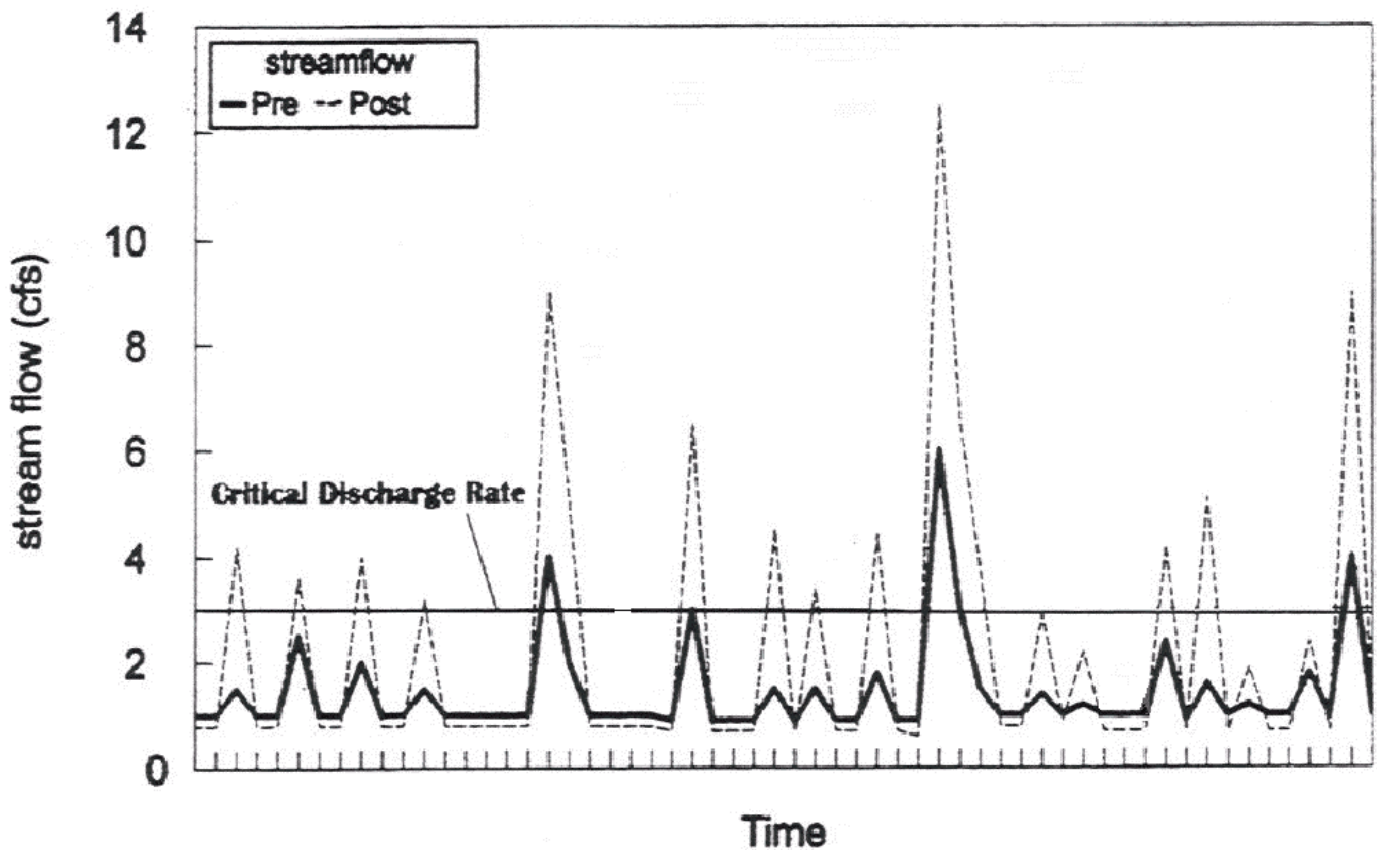

Figure 2-5 Depiction of Increased Frequency of Flows Greater Than the Critical Discharge Rate in a Stream after Development (modified after MDE, 2000)

The decline in the physical habitat of the stream, coupled with lower base flows and higher stormwater pollutant loads, has a severe impact on the aquatic community. Recent research has shown the following changes in stream ecology:

- reductions in aquatic insect and freshwater mussel populations
- decline in fish diversity
- degradation of aquatic habitat.

Traditionally, some municipalities and local agencies have attempted to provide some measure of channel protection by imposing the 2-yr storm peak discharge control requirement, which requires that the discharge from the 2-yr post development peak rates be reduced to predevelopment levels for the same storm. However, hydrologic analysis in Maryland (McCuen et al., 1987) indicated that the 2-yr peak discharge criterion is not capable of protecting downstream channels from erosion. Because urbanization leads to increased runoff volumes and runoff events even from small storms, channel erosion and erosion prevention need to be addressed even for very small storms. Surrogate geomorphic or channel protection criteria that are based on predevelopment design storms and extended detention practice may not be enough to protect all receiving waters, especially for areas with commercial, industrial or other high density land uses. Safe release rates or bankfull conditions should be determined on a site-specific basis.

Recently, Emerson et al (2002) conducted a regional survey of detention basin facilities as part of a larger watershed study for Valley Creek watershed, located in Chester County Pennsylvania. The 62 km² watershed is undergoing rapid urbanization, is covered by approximately 17% impervious surfaces and contains more than 100 detention basins. Model results showed that the detention basins, designed primarily using large hypothetical storms with typically 2-yr through 100-yr return frequencies, essentially had no attenuating effect on peak streamflow for a typical storm event, neglecting approximately 97% of the yearly precipitation volume. The storm events modeled in the study did not approach the intensity of a 2-yr storm which may explain the relatively insignificant effect the basins

had in these simulations. In urbanizing watersheds with high percentages of impervious coverage, high peak flow events happen more frequently than they would in an undeveloped watershed. These high peak flow events are caused by increasingly smaller precipitation depths as the impervious coverage of the watershed increases. It is these more frequent storms that may account for most of the sedimentation and stream bank erosion in urban watersheds. Although detention basins were designed to limit peak flow rate levels to predevelopment levels, their design objectives failed to address the increase in volume of runoff.

Flooding Impacts

Flow events that exceed the capacity of the stream channel spill out into adjacent flood plains. These are termed "overbank" floods and can damage property and downstream drainage structures. While some overbank flooding is inevitable and even desirable, the historical goal of drainage design in many jurisdictions has been to maintain predevelopment peak discharge rates for both the 2- and 10-yr frequency storms after development, thus keeping the level of overbank flooding the same over time. This prevents costly damage or maintenance for culverts, drainage structures and swales.

Overbank floods are ranked in terms of their statistical return frequency. For example, a flood that has a 50% statistical probability of occurring in any given year is termed a "2-yr" flood. The 2-yr storm is also often used as a surrogate for the "bankfull flood", as researchers have demonstrated that most natural stream channels have just enough capacity to handle a runoff event with a return frequency of 1- to 2-yr, before spilling into the floodplain (Wolman and Miller, 1960; Leopold et al., 1964; Leopold, 1968).

Similarly, a flood that has a 10% probability of occurring in any given year is termed a "10-yr flood." Under traditional engineering practice, most channels and storm drains in many jurisdictions are designed with enough capacity to safely pass the peak discharge from the 10-yr design storm.

Urban development increases the peak discharge rate associated with a given design storm because impervious surfaces generate greater runoff volumes and drainage systems deliver it more rapidly to a stream. Figure 2-6 profiles the change in the receiving water due to post-development peak discharge rates that accompany development.

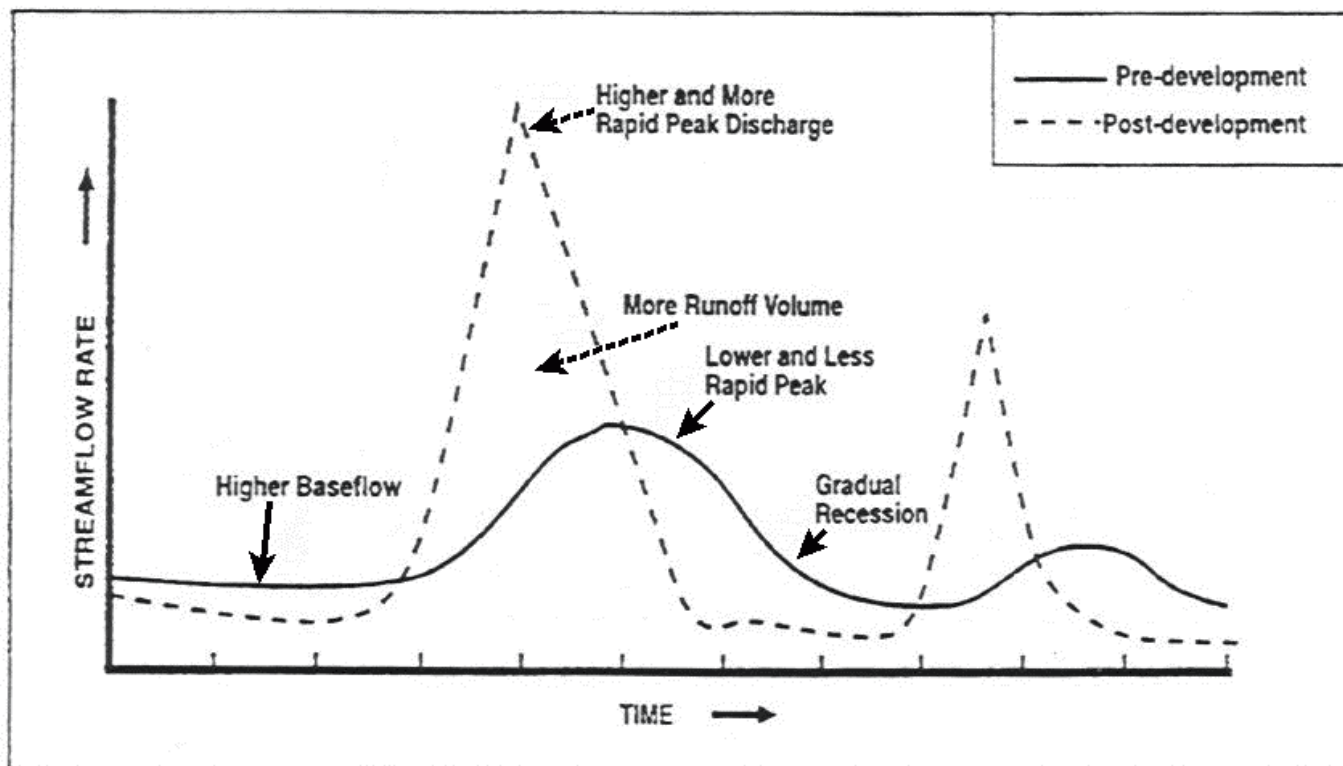

Figure 2-6 An Illustration of Change in Receiving Water Hydrograph Following Development (modified after: MDE, 2000)

Floodplain Expansion.

The level areas bordering streams and rivers are known as flood plains. Operationally, the floodplain is usually defined as the land area within the limits of the 100-yr storm flow water elevation. The 100-yr storm has a 1% statistical probability of occurring in any given year and typically serves as the basis for controlling development in many States and establishing insurance rates by the Federal Emergency Management Agency (FEMA). These floods can be very destructive and pose a threat to property and human life. Flood plains are natural flood storage areas and help to attenuate downstream flooding.

Flood plains are very important habitat areas, encompassing riparian forests, wetlands and wildlife corridors. Consequently, many local jurisdictions restrict or even prohibit new development within the 100-yr floodplain to prevent flood hazards and conserve habitat. Nevertheless, prior development that has occurred in the floodplain remains subject to periodic flooding during these storms.

As with overbank floods, development sharply increases the peak discharge rate associated with the 100-yr design storm. As a consequence, the elevation of a stream's 100-yr floodplain becomes higher and the boundaries of its floodplain expand (see Figure 2-7). In some instances, property and structures that had not previously been subject to flooding are now at risk. Additionally, such shifts in a floodplain's hydrology can degrade wetlands and forest habitats.

Thermal Impacts

Summer in-stream temperatures have been shown to increase significantly (5 to 12 F°) in urban streams due to direct solar radiation, lack of riparian buffer, runoff from heat absorbing pavement and discharges from stormwater ponds. Increased water temperatures can preclude temperature-sensitive species from being able to persist in urban streams.

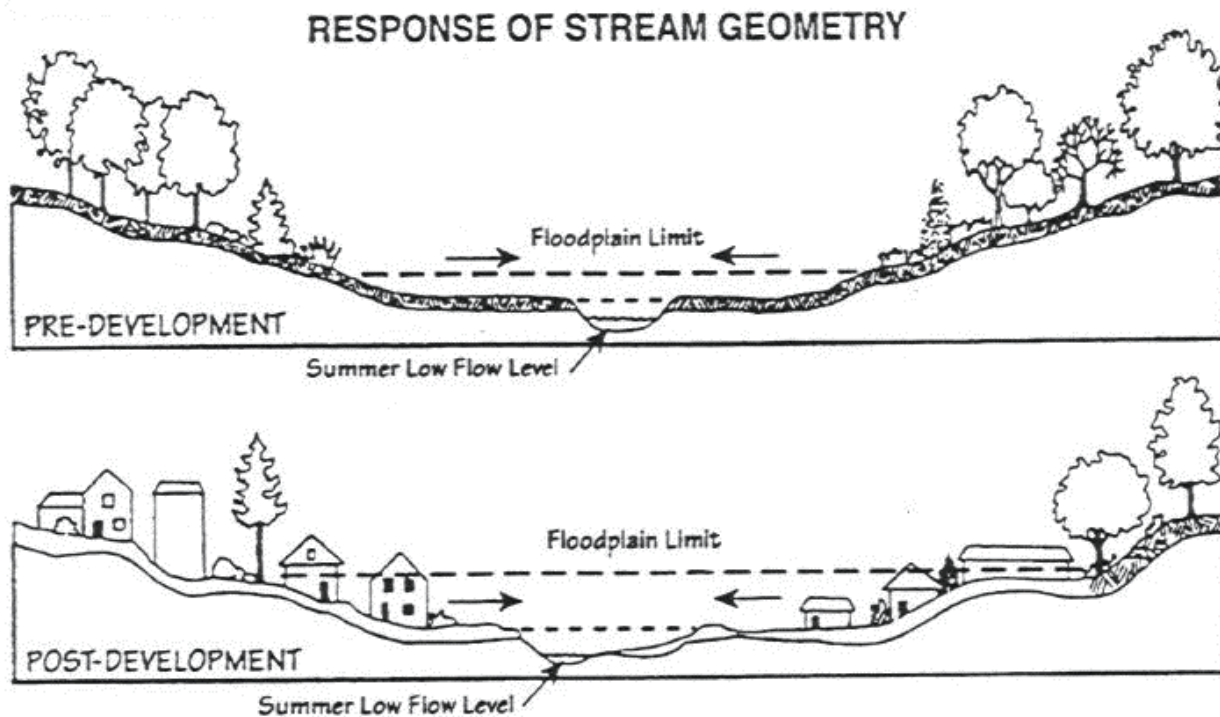

Figure 2-7 An Illustration of Potential Change in Floodplain Elevations (MDE, 2000)

Galli (1991) monitored five headwater streams in the Maryland Piedmont region over a six-month period, with each of the streams having differing levels of impervious cover. While the summer stream temperatures in the urban watersheds had mean temperatures that were consistently warmer than a forested reference stream, and other factors such as lack of riparian cover and ponds were also demonstrated to amplify stream warming, the primary contributing factor consistently appeared to be watershed impervious cover.

Chemical Impacts

Water quality impacts of urbanization encompass a broad range of parameters. Essentially, any pollutant deposited or derived from an activity on the land surface will likely end up in stormwater runoff in some concentration. However, there are certain pollutants and activities that are consistently more likely to result in degradation of a stream or receiving water. These more frequently occurring pollutants can be grouped into numerous broad categories, including nutrients, sediment, heavy metals, hydrocarbons, gasoline additives, pathogens, deicers, herbicides and pesticides.

The direct effects of these pollutants on receiving waters are often a function of the size of the receiving water and the sensitivity of the inhabiting organisms. Sensitive species such as trout and stoneflies may be more susceptible to a range of pollutants than more pollution-tolerant organisms such as the black-nosed dace or certain leeches. However, assessing a toxic response from stormwater requires analyses that consider variable concentrations with variable durations of exposure. Bioassessments may indicate that communities of organisms are responding to urbanization, but determining whether specific physical, chemical factors, or a combination of factors produce observed effects is difficult, if not impossible (Herricks, 2001).

The beneficial use of the receiving water is an important consideration when evaluating concentrations of pollutants in urban stormwater. Certain pollutants even at low levels are of greater concern when receiving waters have specific beneficial uses such as swimming or fishing. Drinking water reservoirs require more sensitive stormwater controls to lower levels of pollutants because the water is being managed for human consumption.

Data in Table 2-3 represent typical concentrations of chemical constituents discussed in this section. Concentrations for most pollutants are derived from Smullen and Cave (1998). This study represents a compilation of NURP data, combined with later data from the USGS, as well as National Pollution Elimination Discharge Program (NPDES) Phase 1 stormwater monitoring.

Regional Data for Major Pollutants

There is evidence that regional patterns exist for many of the pollutants found in urban stormwater. The amount of rainfall, temperature differences and the period between rain events are important factors causing these regional differences. Arid and semi-arid regions generally experience longer dry periods where pollutants build up from different sources and subsequently runoff in higher concentrations during storm events. In cold climates, snow accumulation in winter coincides with pollutant build up; therefore, greater concentrations of pollutants are found during snowmelt runoff events.

The USGS National Stormwater Data Base of 1123 storms for 98 stations in 20 metropolitan cities was used as the primary data source for this guide. This regional analysis of stormwater data was chosen based on the lack of standard techniques across other data sources, including NPDES, NURP and USGS. Tasker and Driver (1988) performed regression analyses to determine which factors had the greatest influence on stormwater concentrations. Their analysis determined that annual rainfall had the greatest influence on the majority of the parameters. The water quality data was then grouped based on the amount of yearly average rainfall. Table 2-4 shows the rainfall groupings and the cities and regions represented. Table 2-5 shows the distribution of rainfall and pollutant concentrations from various monitoring sources for a number of U.S. cities.

Regional Differences Based Primarily on Rainfall

Region I, the region with the lowest annual rainfall (less than 20 inches), typically had higher concentrations of a number of pollutants. Mean and median concentrations of total nitrogen (TN), total phosphorus (TP), dissolved phosphorus, SS and total ammonia plus organic nitrogen were all much higher in Region I. Additionally, a large proportion of stream flow in arid or semi-arid regions comes from turbid urban sources such as municipal wastewater effluent, return flow from irrigation and urban storm flow (Caraco, 2000). It was hypothesized that a greater amount of sediment is eroded from pervious surfaces in arid or semi-arid regions than in humid regions due to the sparsity of protective vegetative cover. In Tables 2-6 and 2-7, the higher concentrations of SS, TP and TN from the regions with less rainfall are shown, as well as the tendency to exceed chronic toxicity standards for metal.

Table 2-3 National Event Mean and Median Concentrations for Chemical Constituents of Stormwater

Constituent (Units)	Source of Data (% detection)	Concentration		Number of Events
		Mean	Median	
Suspended Solids (mg/l)	Pooled NURP/USGS ¹	78.4	54.5	3047
Total Phosphorus (mg/l)	Pooled NURP/USGS ¹	0.315	0.259	3094
Soluble Phosphorus (mg/l)	Pooled NURP/USGS ¹	0.129	0.103	1091
Total Nitrogen (mg/l)	Pooled NURP/USGS ¹	2.39	2.00	2016
Total Kjeldhal Nitrogen (mg/l)	Pooled NURP/USGS ¹	1.73	1.47	2693
Nitrite and Nitrate (mg/l)	Pooled NURP/USGS ¹	0.658	0.533	2016
Copper (: g/l)	Pooled NURP/USGS ¹	13.35	11.1	1657
Lead (: g/l)	Pooled NURP/USGS ¹	67.5	50.7	2713
Zinc (: g/l)	Pooled NURP/USGS ¹	162	129	2234
Biochemical Oxygen Demand (mg/l)	Pooled NURP/USGS ¹	14.1	11.5	1035
Chemical Oxygen Demand (mg/l)	Pooled NURP/USGS ¹	52.8	44.7	2639
Organic Carbon (mg/l)	Nationwide-Stormwater Inflow ⁵		11.9	19
Cadmium (: g/l)	NURP ⁴	0.7		150
Chromium (: g/l)	Dallas-FW NPDES ²	4		32
PAH (mg/l)	Four urban catchments ³	3.5		NA
Oil and Grease (mg/l)	NURP ⁴	3		NA
Fecal Coliform (col/100 ml)	Nationwide stormwater inflow ⁵	15,038		34
Fecal Strep (col/100 ml)	Nationwide stormwater inflow ⁵	35,351		17
Cryptosporidium (organisms)	NY ⁶	37.2	3.9	78
Giardia (organisms)	NY ⁶	41.0	6.4	78
MTBE (: g/l)	National Study 16 cities ⁷		1.6	592
Chloride (snowmelt) (mg/L)	Minnesota ⁸		116	49
Diazonon (: g/l)	Stormflow ² (92% - residential only)		0.55	76

(1) Smullen and Cave 1998, (2) Brush et al., 1995, (3) Rabanal and Grizzard 1995, (4) Crunkilton et al., 1996, (5) Schueler 1999, (6) Stern et al., 1996, (7) Delzer 1996, (8) Oberts 1999.

Table 2-4 Regional Groupings by Annual Rainfall (After Driver and Tasker, 1990)

Region	Annual Rainfall	Places Monitored	Concentration Data
Region I	<20 inches	Anchorage, AK; Fresno, CA; Denver, CO; Albuquerque, NM; Salt Lake City, UT	Highest mean and median values for TN, TP, SS, COD, total ammonia and organic nitrogen
Region II	20–40 inches	HI, IL, MI, MN, NY, OR, OH, WA, WI and Austin, TX	Higher mean and median values than Region 3 for SS, dissolved phosphorus and cadmium
Region III	>40 inches	FL; MD; Boston, MA; Durham, NC; NH; Long Island, NY; Houston, TX; Knoxville, TN; and Little Rock, AR	Lower values for many parameters likely due to the frequency of storms and the lack of build-up in pollutants

Stormwater data gathered from different regions of the country, using disparate stormwater data sources such as NPDES, USGS and local stormwater data, generally confirm the trend determined by Driver and Tasker (1990), shown in Table 2-5, that values presented as event mean concentrations (EMC) for nutrients, SS and metals tend to be higher in arid and semi-arid regions and tend to decrease for areas of increased rainfall. It is likely that arid regions do not experience build-up of pollutants such as PAHs because they are degraded rather rapidly by photo-degradation.

Cold Region Snowmelt Data

In cold regions, greater than 50% of the annual load for sediment, nutrients, PAHs and some metals can come from snowmelt runoff during late winter and early spring (Oberts, 1989). In areas where there is infrequent melting, buildup of pollutants takes place in the snowpack, contributing to high concentrations of the pollutants during snowmelt runoff. Oberts (1994) describes four types of snowmelt runoff events and the resulting pollutants (Table 2-8).

Table 2-5 Stormwater Pollutant Event Mean Concentration for Different United States Regions (Adapted from Caraco and Schueler, 2000)

Region	Annual Rainfall (in.)	Events	SS (mg/L)	BOD (mg/L)	COD (mg/L)	Total N (mg/L)	Total P (mg/L)	Soluble P (mg/L)	Copper (: g/l)	Lead (: g/l)	Zinc (: g/l)
National	--	2000-3000	78.4	14.1	52.8	2.39	0.32	0.13	14	68	162
Phoenix, AZ	7.1	40	227	109	239	3.26	0.41	0.17	47	72	204
San Diego, CA	10	36	330	21	105	4.55	0.7	0.4	25	44	180
Boise, ID	11	15	116	89	261	4.13	0.75	0.47	34	46	342
Denver, CO	15	35	242	--	227	4.06	0.65	--	60	250	350
Dalles, TX	28	32	663	112	106	2.7	0.78	--	40	330	540
Marquette, MI	32	12	159	15.4	66	1.87	0.29	0.04	22	49	111
Austin, TX	32	--	190	14	98	2.35	0.32	0.24	16	38	190
MD NPDES	41	107	67	14.4	--	1.94*	0.33	--	18	12.5	143
Louisville, KY	43	21	98	88	38	2.37	0.32	0.21	15	60	190
GA NPDES	51	81	258	14	73	2.52	0.33	0.14	32	28	148
FL NPDES	52	--	43	11	64	1.74	0.38	0.23	1.4	8.5	55
MN Snowmelt	--	49	112	--	112	4.3	0.70	0.18	--	100	--

* TKN-total Kjeldahl nitrogen.

Table 2-6 Mean and Median Nutrient and Sediment Stormwater Concentrations for Residential Land Use Based on Rainfall Regions (adapted from Tasker and Driver, 1988)

Region	TN (median) mg/l	TP (median) mg/l	SS (Mean) mg/l
Region I < 20 inches	4	0.45	320
Region II 20–40 inches	2.3	0.31	250
Region III > 40 inches	2.3	0.31	120

Table 2-7 Percentage of Metal Concentrations Exceeding Water Quality Standards by Rainfall Region (Driver and Tasker, 1990)

Rainfall Region	Rainfall	Percentage Exceeding Chronic Toxicity for Freshwater			
		10 µg/l Cadmium	12 µg/l Copper	32 µg/l Lead	47 µg/l Zinc
I	<20 inches	1.5%	89%	97%	97%
II	20-40 inches	0	78%	89%	85%
III	> 40 inches	0	75%	91%	84%

Table 2-8 Runoff and Pollutant Characteristics of Snowmelt Stages (Oberts, 1994)

Snowmelt Stage	Duration/ Frequency	Runoff Volume	Pollutant Characteristics
Pavement Melt	Short, but many times in winter	Low	Acidic, high concentrations of soluble pollutants, Chloride, nitrate, lead. Total load is minimal.
Roadside Melt	Moderate	Moderate	Moderate concentrations of both soluble and particulate pollutants.
Pervious Area Melt	Gradual, often most at end of season	High	Dilute concentrations of soluble pollutants, moderate to high concentrations of particulate pollutants, depending on flow.
Rain-on-Snow Melt	Short	Extreme	High concentrations of particulate pollutants, moderate to high concentrations of soluble pollutants. High total load.

Source areas for pollutants associated with snowmelt include snow dumps and roadside areas. Concentrations of pollutants in snow dumps can be more than five times greater than typical stormwater pollutant concentrations. These areas can build up tremendous amounts of pollutants over the winter months and much of these pollutants can be lost in just one rain or snowmelt event in the early spring. Metals, PAHs, chloride (Cl), sediment and nutrients are all parameters that build up in the snowpack.

The only significant regional differences for PAHs and oil and grease were reported for snowmelt events. These pollutants can build up in snow in urban areas and be released during significant snowmelt events. Oberts (1994) and others have reported that 90% of the load can be released during the last 10% of the runoff event.

The regional concentration data based on rainfall and the snowmelt process has implications for stormwater managers. Stormwater cannot be managed or regulated in the same manner across regional boundaries. In arid regions only a few storm events take place each year; typically, the first rainfall after a long dry spell moves higher concentrations of most pollutants. This rainstorm is, on average, a fairly small one and the stormwater management structures must be sized accordingly to treat the pollutants. In the same manner, northern climates must use different strategies to manage runoff from snowmelt conditions and utilize stormwater practices that can treat a larger amount of runoff, including PAHs moved during the last 10% of the storm.

Impacts to Receiving Waters

General impacts of pollutants on different receiving waters are reported below in Table 2-9. Impervious surfaces accumulate pollutants deposited from the atmosphere, leaked from vehicles, or windblown from adjacent areas. During storm events, these pollutants quickly wash off and are rapidly delivered to downstream waters.

Nutrients

Urban runoff has elevated concentrations of both phosphorus and nitrogen, which can enrich streams, lakes, reservoirs and estuaries. Excess nutrients, particularly nitrogen, have been documented to be a major factor in the decline of populated estuarine areas such as the Chesapeake Bay and western Long Island Sound. Excess nutrients promote algal growth that blocks sunlight from reaching underwater grasses and depletes oxygen in bottom waters. Urban runoff has been identified as a key and controllable source.

Sediment

Sources of sediment include washoff of particles that are deposited on impervious surfaces and the erosion of streambanks and construction sites. Both suspended and deposited sediments can have adverse effects on aquatic life in streams, lakes and estuaries. Importantly, sediments also transport other attached pollutants.

Table 2-9 Water Quality Impacts to Receiving Waters

Receiving Water	Sediment	Pathogens	Metal and Hydrocarbon Toxicity	Nutrients/ Eutrophication	Pesticide / Herbicide	Chloride	MTBE
Lakes	▮	▮	▮	●	▮	●	●
Reservoirs	▮	▮	▮	●	▮	●	●
Aquifers	○	○	▮	○	▮	●	●
Wetlands	▮	○	▮	○	▮	●	?
Streams	●	▮	▮	▮	●	▮	▮
Shellfish	▮	●	▮	▮	▮	○	?
Beaches	▮	●	▮	○	○	○	○
Estuaries	▮	▮	▮	●	▮	▮	●
Sea grasses	▮	○	▮	●	?	○	?

● Standard violation concerns / significant concern / loss of beneficial use
 ▮ Occasional Standard violation / site specific concerns
 ○ Rarely affects receiving area
 ? Insufficient data

Organic Carbon

Organic matter, washed from impervious surfaces during storms, can present a problem in slower moving downstream waters. As it decomposes, it can deplete dissolved oxygen in lakes and tidal waters.

Bacteria

Bacteria levels in stormwater runoff routinely exceed public health standards for water contact recreation. Stormwater runoff can also lead to the closure of adjacent shellfish beds and swimming beaches and may increase the cost of treating drinking water at water supply reservoirs.

Hydrocarbons

Vehicles leak oil and grease that contain a wide array of hydrocarbon compounds, some of which can be toxic to aquatic life at low concentrations.

Trace Heavy Metals

Cadmium, copper, lead and zinc are routinely found in stormwater runoff. These heavy metals pollutants can be toxic to aquatic life at certain concentrations and can also accumulate in the sediments of streams, lakes and estuaries.

Pesticides

A modest number of currently used and recently banned insecticides and herbicides have been detected in urban streamflow at concentrations that approach or exceed toxicity thresholds for aquatic life uses.

Chlorides

Salts applied to roads and parking lots in the winter months appear in stormwater runoff and melt water and the concentrations of salt are much higher than many freshwater organisms can tolerate.

Thermal Impacts

Impervious surfaces may increase temperature in receiving waters, adversely affecting aquatic life that requires cold and cool water conditions (e.g., trout).

Trash and Debris

Considerable quantities of trash and debris are washed through storm drain networks, accumulating in streams and lakes and detracting from their natural beauty.

Impacts of Urbanization on Biological Community

Overview of the Biological Impacts

The physical and chemical impacts identified above cause a decline in both the quantity of the aquatic biota and the quality of their habitat. This section examines some of the impacts that urbanization exerts on the aquatic community, focusing specifically on macro-invertebrates, fish, amphibians and freshwater mussels. The fundamental change in hydrology, as well as the chemical composition of runoff in urban and urbanizing streams causes both a decrease in biological diversity and a shift from more pollutant sensitive to less sensitive aquatic organisms.

Urbanization can significantly alter the land surface, soil, vegetation, water quality and stream hydrology and create adverse impacts for aquatic organisms through habitat loss or modification. Table 2-10 summarizes some of the changes to aquatic ecosystems as a result of urbanization and the effects on the biological community.

The effects of urbanization on aquatic community structure have been the subject of several recent studies that have examined the link between urbanization and its impact on aquatic organisms and habitat. These studies reveal that the onset of urbanization almost always has a negative effect on the aquatic biota of receiving waters. Degradation of the biological diversity of aquatic environments is the result of a variety of influences that added impervious cover exerts on aquatic systems. The key findings of prior research involving aquatic organisms and the problems associated with increases in impervious cover are presented in Table 2-11.

Increases in imperviousness appear to have detrimental effects on the integrity of the biological community, beginning at fairly low levels of impervious cover. Many of the studies in Table 2-11 suggest that signs of degradation are found at and above watershed imperviousness levels of 10%. Signs of this include loss of species diversity, reductions in overall species abundance, reproductive failure and juvenile mortality. Additional research is required to firmly establish the exact level of imperviousness at which the biological community of a receiving water begins to face significant impacts to its health, as well as to identify regional variations in the impervious cover levels at which aquatic diversity is affected.

Table 2-10 Changes Due to Urbanization and Effects on Aquatic Organisms

Impact	Effect on ecosystem	Effects on organisms
<i>Chemical Impacts</i>		
Heavy Metals/ Chemical Pollutants	Reduction in Water Quality	Reduced survival of eggs and alevins, toxicity to juveniles and adults, increased physiological stress, reduced biodiversity.
Sediment	Increase in Turbidity	Reduced survival of eggs, reduced plant productivity, physiological stress on aquatic organisms.
Nutrients	Algae Blooms	Oxygen depletion due to algal blooms, increased eutrophication rate of standing waters, possibly toxicity to eggs and juveniles from certain nutrients.
<i>Physical Impacts</i>		
Hydrologic	Increased Flow Volumes/ Channel Forming Storms	Alterations in habitat complexity, changes in availability of food organisms related to timing of emergence and recovery after disturbance, reduced prey diversity, scour-related mortality, long-term depletion of large woody debris, accelerated erosion of streambanks.
	Decreased Base Flows	Crowding and increased competition for foraging sites, increased vulnerability to predation, increased fine sediment deposition.
Geomorphology	Increase in Sediment Transport	Reduced survival of eggs and alevins, loss of habitat due to deposition, siltation of pool areas, reduced macro-invertebrate production.
	Loss of Pools and Riffles	Shift in the balance of species due to habitat change, loss of deep water cover and feeding areas.
	Changes in Substrate Composition	Reduced survival of eggs, loss of inter-gravel spaces used for refuge by fry, reduced macroinvertebrate production, reduced biodiversity.
	Loss of Large Wood Debris	Loss of cover from predators and high flows, reduced sediment and organic matter storage, reduced pool formation, reduced organic substrate for macro-invertebrates.
Thermal	Increase in Temperature	Changes in migration patterns, increased metabolic activity, increased disease and parasite susceptibility, higher mortality of sensitive species, reduced biodiversity in stream community.
Channel Modification	Loss of First Order Streams	Loss of valuable habitat especially for more sensitive species.
	Creation of Fish Blockages	Loss of spawning habitat for adults; inability to reach overwintering sites, loss of summer rearing habitat, increased vulnerability to predation.
	Loss of Vegetative Rooting Systems	Creates problems with decreased channel stability, increased streambank erosion, reduced streambank integrity.
	Straightening or Hardening of Channel	Increased stream flows, loss of habitat complexity.

Table 2-11 Relationship of Urbanization to Aquatic Habitat and Organisms

Indicator	Key Finding	Reference	Location
Aquatic habitat	There is a decrease in the amount of large woody debris (LWD) found in urban streams at around 10% impervious cover.	Booth et al., 1991	Washington
Aquatic insects and fish	In a comparison of three stream types, urban streams had fewer EPT {Ephemeroptera (mayflies), Plecoptera (stoneflies) and Trichoptera (caddisflies)}, (22% vs. 5% as number of all taxa, 65% vs. 10% as percent abundance), and poor index of biotic integrity (IBI) scores.	Crawford and Lenat 1989	North Carolina
Insects, fish, habitat, water quality, riparian zone	Steepest decline of biological functioning after 6% imperviousness. There was a steady decline, with approximately 50% of initial biotic integrity at 45% impervious area.	Horner et al., 1996	Puget Sound, Washington
Aquatic insects and fish	Macro-invertebrate and fish diversity decline significantly beyond 10-12% impervious area.	Klein 1979	Maryland
Fish, Aquatic insects	A study of five urban streams found that as land use shifted from rural to urban, fish and macro invertebrate diversity decreased.	Masterson and Bannerman 1994	Wisconsin
Insects, fish, habitat, water quality, riparian zone	Physical and biological stream indicators declined most rapidly during the initial phase of the urbanization process as the percentage of total impervious area exceeded the 5-10% range.	May et al., 1997	Washington
Aquatic insects and fish	There was significant decline in the diversity of aquatic insects and fish at 10% impervious cover.	MWCOG 1992	Washington, DC
Aquatic insects and fish	Evaluation of runoff effects in urban and non-urban areas found that native species dominated the non-urban portion of the watershed, but accounted for only 7% of the number of species found at the monitoring stations located in urban areas. Benthic taxa were more abundant in non-urbanized portions of the watershed.	Pitt and Bozeman 1982	California
Wetland plants, amphibians	Mean annual water fluctuation inversely correlated to plant and amphibian density in urban wetlands. Declines noted beyond 10% impervious area.	Taylor et al., 1995	Seattle, Washington
Aquatic insects and fish	Residential urban land use in Columbus watersheds caused a significant decrease in fish attainment scores at around 33%. For Cuyahoga watersheds, a significant drop in IBI scores occurred at around 8%, primarily due to certain stressors that functioned to lower the non-attainment threshold. When watersheds smaller than 100mi ² were analyzed separately, the level of urban land use causing a significant drop in IBI scores occurred at around 15%.	Yoder and Rankin 1997	Ohio
Aquatic insects and fish	All 40 urban sites sampled had fair to very poor IBI scores, compared to undeveloped reference sites.	Yoder 1991	Ohio

Section 3 Regulations That Impact Stormwater BMP Design

Introduction

The design of stormwater management BMPs is mandated and regulated by regulatory requirements at the federal, State, regional and/or local levels. This section provides a brief review of the regulatory requirements that drive the design of these BMPs.

At the federal level, the requirements of the following agencies are summarized:

- EPA
- National Oceanic and Atmospheric Administration (NOAA) of the Department of Commerce
- U.S. Fish and Wildlife Service (USFWS)

Additionally, a recent compilation of the stormwater management requirements of State, regional and local government agencies is summarized.

Federal Regulations

Clean Water Act

Originally, this act was entitled the Federal Water Pollution Control Act of 1948 (FWPCA) and prescribed a regulatory system consisting mainly of State-developed ambient water quality standards (WQS) applicable to interstate or navigable waters. In 1972, FWPCA amendments established a system of standards, permits and enforcement aimed at the "goals" of attaining "fishable and swimmable waters by 1983" and "total elimination of pollutant discharges into navigable waters by 1985." (33 U. S.C. § 1251 (a) (2)). Further amendments were passed in 1977, when the Act was officially named the "Clean Water Act." The 1987 amendments (Water Quality Act of 1987) added specific stormwater permitting requirements; section 402(p) defined municipal and industrial stormwater as point source discharges. Today, the CWA is the nation's primary mechanism for protecting and improving water quality. The broad purpose of the CWA is "to restore and maintain the chemical, physical, and biological integrity of the Nation's waters," (33 U.S.C § 1251 (a)) and its emphasis is to declare unlawful the unregulated discharge of pollutants into all waters of the U.S.

The strength of the CWA lies in its comprehensive, nationwide approach to water quality protection, which requires Federal, State and local governments to act cooperatively to achieve common goals. The CWA makes the States and the EPA jointly responsible for identifying and regulating both point and Nonpoint Sources (NPS) of pollution. Point sources, including municipal and industrial stormwater discharges, are controlled by the NPDES permits (33 U.S.C § 1342 (p)), while NPS are approached with a management strategy. The framework of the CWA thus allows for both environmental quality and technology-based (treatment processes and BMP) approaches to water pollution control. Each State is required to develop and adopt WQS that enumerate the designated uses of each water body as well as specific criteria deemed necessary to protect or achieve those designated uses. The CWA requires States to develop and implement WQS in accordance with EPA regulations and guidance.

Under current EPA regulations, the intent of water quality management planning is to focus on managing watersheds rather than geopolitical areas. This process requires the development of Total Maximum Daily Loads (TMDLs), which set the amount of pollution that may be discharged while still complying with WQS. These watershed TMDLs are implemented through the issuance of national NPDES permits that require wasteload allocations for point sources and load allocations for NPS. The EPA policy for phasing the implementation of TMDLs is described in the

memorandum “Interim Permitting Approach for Water Quality-Based Effluent Limitations in Storm Water Permits” available at <http://www.epa.gov/npdes/pubs/swpol.pdf>. In addition, State water quality programs are required to integrate three components (1) a designation of uses for all State waters, (2) criteria to meet those uses and (3) an antidegradation policy for waters that meet or exceed criteria for existing uses (40 CFR § 131.10- 131.12). State water quality management plans are also required to identify priority point and non-point problems, consider alternative solutions, and recommend control measures. In order to comply with the CWA, State WQS must, theoretically, include indicators of the health of ecological habitats and the level of biological diversity, and ambient WQS were to be supplemented by discharge standards in the form of effluent limitations applicable to all point sources.

The CWA also specifically provides that State water quality criteria must include both numeric standards for quantifiable chemical properties and "narrative criteria or criteria based upon biomonitoring." (33 U.S.C. §1313(c)(2)(a)). As defined in the CWA, the term "biological monitoring" means: determination of the effects of discharges on aquatic life measured at appropriate frequencies and locations. These includes accumulation of pollutants in tissue and receiving waters from the discharge of pollutants by techniques and procedures that include sampling of organisms representative of appropriate levels of the food chain appropriate to the volume, and the physical, chemical and biological characteristics of the effluent (33 U.S.C. § 1362).

CWA amendments, EPA regulations and State water quality programs addressing point sources/NPS have continued to evolve over the years as increased knowledge is accumulated on the impacts of urban development. Stormwater runoff from increased impervious surfaces in urban areas has emerged as a significant threat to water quality. Several sections of the CWA apply to urban runoff, both as point and NPS of pollution, as well as impacts of any activities that may result in the disturbance of natural wetlands, regulated by Section 404 of the Act. The following paragraphs describe these sections, with emphasis on their relevance to stormwater runoff and land development activities, both during the construction phase and the post construction phase.

CWA Section 304(m)

Section 304(m) of the CWA, added by the Water Quality Act of 1987, requires EPA to establish schedules for (i) reviewing and revising existing effluent limitations guidelines and standards and (ii) promulgating new effluent guidelines. On January 2, 1990, EPA published an Effluent Guidelines Plan (55 FR 80), in which schedules were established for developing new and revised effluent guidelines for several industry categories. Natural Resources Defense Council, Inc. (NRDC), challenged the Effluent Guidelines Plan in a suit filed in the U.S. District Court of the District of Columbia (NRDC et al., v. Browner, Civ. No. 89-2980). The Court entered a consent decree (the “304(m) Decree”), which established schedules for, among other things, EPA’s proposal and promulgation of effluent guidelines for a number of point source categories. The Effluent Guidelines Plan was published in the *Federal Register* on September 4, 1998 (63 FR 47285).

NPDES Phase I and Storm Water Rules

The NPDES is a permit system established under the CWA to enforce effluent limitations. Operators of construction activities, including clearing, grading and excavation, are required to apply for permit coverage under the NPDES Phase I and II stormwater rules. Under the Phase I rule (promulgated in 1990), construction sites of 5 or more acres must be covered by either a general or an individual permit. General permits covering the Phase I sites have been issued by EPA regional offices and State water quality agencies. Permittees are required to develop stormwater pollution prevention plans that include descriptions of BMPs employed, although actual BMP selection and design are at the discretion of permittees (in conformance with applicable State or local requirements). There exists considerable variability throughout the States and localities with respect to these requirements, which are summarized below.

Construction sites between 1 and 5 acres in size are subject to the NPDES Phase II stormwater rule (promulgated in 1999). The construction activities covered under Phase II are termed small construction activities and exclude routine maintenance that is performed to maintain the original line and grade, hydraulic capacity or original purpose of the facility. General construction permits are primarily focused on controlling erosion during the construction phase, not on post-construction stormwater management. Municipal permits are required to address post-construction stormwater management for existing areas and new development.

Water Quality Certifications (Section 401)

The purpose of Section 401 of the CWA is to ensure that federally permitted activities comply with the Act, State water quality laws and any other appropriate State laws. This is accomplished through a State certification process. Any applicant for a Federal permit for any activity that could result in a discharge of a pollutant to a State's waters is

required to obtain a certification from the State in which the activity is to occur (EPA, Region 2, 1993). In essence, the State certifies that the materials or pollutants discharged comply with the effluent limitation, WQS and any other applicable conditions of State law. Examples of Federal permits and licenses requiring State certification include: NPDES permits, Section 404 permits, permits for activities regulated by the Rivers and Harbors Act, and hydroelectric discharge-related activities (Doppelt et al., 1993). If the State denies the certification, the Federal permitting agency must deny the permit application. If the State imposes conditions on a certification, the conditions become part of the Federal permit (EPA, Region 2, 1993). A certification obtained for construction activities must also pertain to the subsequent operation of the structure (EPA, Region 2, 1993).

Certification processes differ from State to State, with some States participating early enough in a project's development to have an impact on determining alternatives and mitigation processes (Doppelt, et al., 1993). Typically, the process begins when the State receives the permit information from the Federal agency receiving the request from the applicant. The State regulatory agency designated with certification authority notifies the Federal permitting authority of its decisions concerning certification for the proposed activity. States must act to grant or deny certification within a reasonable time (not to exceed one year) after a request is received, or certification authority will be deemed to have been waived (Doppelt, et al., 1993).

Coastal Zone Management Act (CZMA)

The Coastal Zone Management Act of 1972 (CZMA) was passed by Congress in order to "preserve, protect, develop, and where possible, to restore or enhance, the resources of the Nation's coastal zone for this and succeeding generations." (16 U.S.C. §1452) The CZMA established a program to encourage States and territories to develop comprehensive programs to protect and manage coastal resources, including the Great Lakes (Terrene Institute 1995). Much of the CZMA is geared to managing and steering development of coastal energy resources. To encourage States to develop coastal zone management programs, Congress incorporated several major incentives in the CZMA. For example, the CZMA provides Federal grants to States for the development and administration of coastal management programs. The CZMA also provides a mechanism by which a State can allocate some of its funds to a local government or interState agency, thus encouraging the coordination of coastal management on a regional level.

The CZMA is overseen by the Secretary of Commerce, acting through the National Oceanic and Atmospheric Administration (NOAA). However, the CZMA focuses on the States as being key players in the management of coastal zone areas. The legislation emphasized the role of State leadership in the program and allowed States to participate in the Federal program by submitting their own coastal zone management proposals to the Office of Coastal Zone Management (OCZM) at NOAA for approval. To receive Federal approval and implementation funding, States and territories had to demonstrate programs and enforceable policies sufficiently comprehensive and specific to regulate land and water uses and coastal development, and to resolve conflicts between competing uses (Terrene Institute, 1995). Once the OCZM has approved a State program, Federal agency activities within a coastal zone must be consistent with the program "to the maximum extent practicable."

Areas subjected to CZMA planning include wetlands, floodplains, estuaries, beaches, dunes, barrier islands, and coral reefs, fish and wildlife and their habitat. Management plans developed by States must include an inventory and designation of coastal resources, designate those of national significance and establish standards to protect those so designated. The State plans should also include a process for assessing and controlling shoreline erosion, and a description of the organizational structure proposed to implement the program with specific references to the inter-relationships and responsibilities between various jurisdictions. States are also encouraged to prepare special area management plans that address such issues as natural resources, coastal dependent economic growth and protection of life and property in hazardous areas. These resource management and protection plans are accomplished through State laws, regulations, permits, and local plans and zoning ordinances. Section 307(c) of the CZMA requires any nonfederal applicant seeking a Federal permit to conduct activity affecting land or water uses in the State's coastal zone to furnish certification that the proposed activity will comply with the State's coastal zone management program. No Federal permit will be issued until the State has concurred with the applicant's certification of consistency (EPA, Region 2, 1993).

The Coastal Zone Act Reauthorization Amendments of 1990 (CZARA) specifically charged State coastal programs and State nonpoint source programs to address nonpoint source pollution issues affecting coastal water quality. Under CZARA, coastal States must develop appropriate management programs in order to continue to receive funding and participate in the CZMA. EPA has developed technical guidance to help States develop CZARA mandated control

programs. The guidance specifies management measures for sources of nonpoint pollution in coastal waters, including coastal stormwater control. Management measures are defined as "economically achievable measures to control the addition of pollutant to coastal waters; that is, they reflect the greatest degree of pollutant reduction available through the application of the best available nonpoint pollution control practices, technologies, processes, site criteria, operating methods or other alternatives" (Terrene Institute 1995). Coastal stormwater control programs are not intended to supplant existing coastal zone management programs or nonpoint source management programs (Camp, Dresser and McKee, et al., 1993). Rather they serve to update and expand existing programs and are to be coordinated closely with other nonpoint source management plans.

Many States have an approved coastal zone management plan that may apply to activities in specific local regions, jurisdictions or areas within the State. In these designated areas, projects affecting coastal waters, ecology or land use may require additional permitting and/or compliance with State laws or local zoning regulations and ordinances.

Endangered Species Act

The Endangered Species Act (ESA) seeks to conserve endangered and threatened species by requiring Federal agencies, in consultation with the Secretaries of the Interior and Commerce, to ensure that their actions "do not jeopardize the continued existence of endangered or threatened species or result in the destruction or adverse modifications of the critical habitat of such species" (16 U.S.C. § 1536). An endangered species is "any species which is in danger of extinction throughout all or a significant portion of its range" (16 U.S.C. § 1532). A species is threatened if it is "likely to become an endangered species within the foreseeable future through all or a significant portion of its range" (16 U.S.C. § 1532). The USFWS takes jurisdiction over listings for terrestrial and native freshwater species, and the National Marine Fisheries Service (NMFS) is responsible for listings of marine species or anadromous species (Doppelt, et al., 1993). Under the Act, the FWS and NMFS determined critical habitat for the maintenance and recovery of endangered species, and requires that the impacts of human activities on species and habitat be assessed. While States can compile their own lists of species and the degrees of protection required, species on the Federal list are under the jurisdiction and protection of the Federal Government and a violation of the act carries Federal penalties (Corbitt, 1990). Another important provision of the ESA is the establishment of an Endangered Species Committee to grant exemptions from the ESA.

When a species is listed under the ESA, the lead Federal agency is required to issue a biological assessment whenever an action in which the Federal Government is involved (as in the issuance of Department of Army permits) "may affect" a listed or threatened species (16 U.S.C § 1536). The agency must consult with the USFWS if the results of the biological assessment show that a listed species may be affected by the project. If an action will jeopardize a listed species or its habitat, the lead agency must provide mitigation measures for, or alternatives to, the proposed activity (Corbitt, 1990).

Projects that affect such areas may be subject to ESA regulation even if a "water right" exists through Federal or State compact in compliance with State water laws or the CWA. As a matter of law, the ESA supersedes most other Federal laws and policies. Given this, it is still unclear whether State water law and water rights are immune to ESA regulation. However, case law indicates that the ESA does authorize a reduction in the power of existing water rights through regulation (Doppelt et al., 1993).

The ESA applies to activities directly affecting water resources designated as "critical habitat" areas and may include receiving waters from highway or urban runoff. For example, stream quality in the Pacific Northwest has become an important issue with regard to protection of the salmon population. Highway construction, runoff quality, mitigation activities and maintenance may be subject to review under the ESA due to the identification of certain receiving waters as "critical habitat" for salmon runs. In many cases, the National Environmental Policy Act (NEPA) process required for all significant Federal activities uncovers the existence of a listed species and the subsequent Environmental Impact Statement (EIS) must deal with potential adverse impacts, project modifications or the project site relocation.

State and Municipal Regulations

States and municipalities have been regulating discharges of runoff from construction and land development industry to varying degrees for some time. A recent compilation of State and selected municipal regulatory approaches was prepared in support of EPA's ongoing effluent limitations guidelines rulemaking for the construction and land development industries (Tetra Tech, 2001) to help establish the baseline for national and regional levels of control.

Data were collected by reviewing State and municipal web sites, summary references, State and municipal regulations and stormwater guidance manuals. All States (and the selected municipalities) were contacted to confirm the data collected and to fill in data gaps; however, only 87% of the States and a much smaller percentage of municipalities responded. The State and municipal regulatory data are summarized in the tables below. This information is presented only to demonstrate that there is considerable variation in State and local regulatory requirements related to stormwater management. Many States and local agencies are currently in the process of revising and updating their requirements. Consequently the data provided in the tables is subject to constant updates and revisions.

A compilation of State and municipal regulations was conducted to determine the nature of both national and regional approaches to controlling stormwater. The data were collected by reviewing State and municipal web sites, summary references, and State and municipal regulations and stormwater guidance manuals. States and municipalities were contacted to confirm the data collected and to fill in data not available by these methods. Many months were allocated to collecting the regulatory data and repeated attempts to obtain and confirm regulatory data ceased at the end of August 2000.

A summary of criteria and standards that are implemented by States and municipalities as of August 2000 are presented in Tables 3-1 and 3-2, respectively. State requirements are generally equal to or less stringent than municipalities that are covered under the Federal CWA NPDES Storm Water Program because State requirements apply to all development within their boundaries, including single site development and low to high density developments. NPDES Storm Water Program designated municipalities generally have a population of 100,000 or more and can collect and fund the resources necessary to design, implement and monitor separate, and potentially more stringent, stormwater management programs. Table 3-1 contains responses from 47 of the 54 State controlling agencies. The total is greater than 50 because Florida has 5 regional authorities that are self-regulating. Some State data were uncertain and repeated contacts to the responsible State agencies to confirm the data were not returned. For the same reason, some of the data sought from municipal agencies also are not available for this report.

Table 3-1 State or Regional Planning Authority Requirements for Water Quality Protection

Generic Standard	States with Requirement (%)	States without Requirement (%)	No Data (%)
Solids or sediment percent reduction	24	61	15
Numeric effluent limits for SS, settleable solids or turbidity	11	76	13
Minimum design depth or volume for water quality treatment	53	28	19
Habitat/biological measures	7	80	13
Physical in-stream condition controls	17	70	13
Chemical monitoring control	6	83	11

The data collected reflect a cross section of the U.S. geography but are representative primarily of municipalities that have a population of 100,000 or greater and only a few municipalities with smaller populations. Thirty-one municipalities are included in the summary tables, which is a small data set compared to the approximately 240 municipalities with NPDES programs and nearly 3000 municipalities nationwide. Therefore, the relative use of control measures presented for the States in Table 3-1 is considered to be fairly accurate while the relative use for the municipalities presented in Table 3-2 is not considered to be accurate but does reflect the diversity of control measures used at the municipal level.

Table 3-2 Municipal or Regional Planning Authority Requirements

Generic Standard	Existing Requirement (%)	No Requirement (%)	Unknown (%)
Design storm for peak discharge control	39	45	16
Solids or sediment percent reduction	7	77	16
Numeric design depth, storm or volume for water quality treatment	–	–	--
Design storm for flood control	39	16	23
Habitat/biological measures	3	65	32
Physical in-stream condition controls	10	58	32

Tables 3-1 and 3-2 show that the following key control measures employed by States and municipal/regional authorities generally meet the intent of the federal, State and municipal regulations that address features of the CWA NPDES Storm Water Program:

- storms designed for peak discharge control; and
- storms designed for water quality control.

The State and local regulations at the State and local level can be grouped into 3 major categories:

- maximum drainage areas that can be disturbed prior to requiring an NPDES permit;
- requirements for flood control and peak discharge; and
- requirements for water quality management.

There exist considerable variation in State and local requirements throughout the U.S. that reflect local issues and concerns.

Drainage Area

The compilation of State regulations revealed that the minimum drainage area requirement among States that triggered a requirement for an NPDES permit ranged from 5000 ft² to 5 acres. The results of the compilation are summarized in Table 3-3.

Table 3-3 Minimum Drainage Area Requirements for States (Tetra Tech, 2001)

Drainage Area	Comments
5 acres	The majority of State agencies (34 of 47) have adopted the NPDES Phase 1 requirement of 5 acres. It is anticipated that most of these States will increase this requirement to one acre as the Phase II NPDES requirements go into effect.
3 acres	The State of West Virginia uses a 3-acre limit.
1 acre	Currently two States (Georgia and Washington) are already using a 1-acre limit.
5000 ft ²	Four States (DE, MD, NJ and PA) use a 5,000 ft ² limit.
No area requirement	Two States have no maximum statewide area limit that requires an NPDES permit. Only MS4 areas in these States comply with NPDES Phase I requirements.

The compilation for regional and local governments found a wider breakdown for drainage area limits for local governments especially for the smaller drainage area limits. The drainage area requirements ranged from 500 ft² to 5 acres. The results of the compilation are summarized in Table 3-4.

Peak Discharge Rate Requirements for Flood Control

The second major grouping of regulatory requirements consisted of agency requirements to control peak discharges to a predevelopment level in order to control increased flooding, channel protection or water quality. The peak discharge requirements were usually expressed as a design storm event. Design storm frequencies found in these regulations ranged from the ½-yr or six-month storm to the 100-yr storm. The results of the compilation are summarized in Table 3-5.

Table 3-4 Minimum Area Requirements for Local Agencies (Tetra Tech, 2001)

Drainage Area	Comments
5 acre	Of the 35 municipalities that were sampled, 17 use the NPDES Phase I requirement of 5 acres. It is anticipated that these municipalities will change to a one-acre requirement when Phase II is implemented.
2 acres	Two municipalities use a 2-acre limit.
1 acre	Five municipalities are currently using a one-acre limit.
10,000 ft ²	One municipality reported using a 10,000 ft ² limit.
5,000 ft ²	Three municipalities reported using a 5,000 ft ² limit.
< 5,000 ft ²	The following size limits were reported by one or more communities: 4,000; 2,500; 1,350 and 500 ft ² .

The compilation for regional and local governments found similar peak discharge requirements usually expressed as a design storm event. Design storm frequencies found in these local agency regulations closely followed the range of storms addressed by the State regulations but did not reveal as much range as the State requirements and instead appeared to focus on the 2-10 and 100-yr storms. The results of the compilation are summarized in Table 3-6.

Water Quality Control Requirements

The compilation of State regulations revealed that the States typically used one of two criteria for water quality control: 1) a specified runoff depth and/or 2) a percent removal rate. Table 3-7 summarizes the results of the compilation. It can be observed that the runoff depth required was either ½ or 1 inch. With respect to the percent removal requirement, the most frequently used requirement is 80% removal of SS. The compilation revealed a similar trend at the regional and municipal levels. The results are summarized in Table 3-8.

Table 3-5 Peak Discharge Control Criteria for States (Tetra Tech, 2001)

Peak Discharge Control Criteria	Comments
No statewide control requirements	The majority of the States (30) do not currently have any statewide requirements for peak discharge control.
2-yr, 24-hr storm	Three States (CA, ME, VT) require peak discharge control of the 2-yr, 24-hr duration.
5-yr, 24-hr storm	Pennsylvania requires peak discharge control of the 5-yr, 24-hr duration storm.
2-and 10-yr, 24-hr storms	Virginia requires peak discharge control of the 2-and 10-yr, 24-hr duration storms.
10-yr, 24-hr storms	North Carolina requires control of the 10-yr storm.
1-, 10-, 100-yr, 24-hr duration	Maryland requires control of three storms.
2-, 10- and 100-yr, 24-hr storm	Massachusetts requires control of these three storms.
2-, 25-, 100- yr, 24- hr storms	Rhode Island also requires control of three storm frequencies.
25-yr	Florida requires peak discharge control of the 25-yr storm. The southern district uses the 3-day duration storm; while the SW and St. John's River districts use the 24-hr duration storm.

Table 3-6 Peak Discharge Rate Control Requirements, Municipalities (Tetra Tech, 2001)

Peak Discharge Rate Control	Comments
No Requirement	17 of the 35 municipalities in the sample do not have peak discharge rate control requirements
2- and 10-yr, 24-hr	Four municipalities use this requirement
2-, 10- and 100-yr, 24-hr	Four municipalities use this requirement
1-yr, 24-hr	
½-yr, 24-hr	
10-yr., 24-hr duration	
10- and 25-yr, 24-hr	
10- and 100-yr, 24-hr	
25- and 100-yr, 24hr	
50- and 100-yr, 24-hr	
100-yr, 24-hr	
Not Applicable	Requirements were not identifiable for four municipalities

Table 3-7 Water Quality Regulatory Requirements, States (Tetra Tech, 2001)

Water Quality Requirements	Comments
None	38 of the 48 States in the sample currently have no requirements for water quality control in stormwater management
Runoff Depth	
None	44 of the 48 States in the sample reported no specific volume requirement for water quality control
½ in.	Two States (DE, FLA) require management of the first ½ in. of runoff
1.0 in.	Two States (MA, MD) require management of the first inch of runoff
% Removal	
None	37 of the States sampled do not have specific pollutant removal requirements
80% SS	Ten States reported this requirement which is based on CZARA
Other	One State (IN) requires 70% removal of SS; the St. John's River District of FLA requires 80% removal of all pollutants; the Chesapeake District of VA requires 10% removal of TP

Table 3-8 Water Quality Requirements, Municipalities (Tetra Tech, 2001)

Water Quality Requirements	Comments
None	28 of the 35 municipalities in the sample reported no water quality requirements for stormwater
Runoff Depth	
None	25 municipalities reported no specific volume requirements
½ in.	5 municipalities require control of the first ½ in. of runoff
¾ in.	2 municipalities require control of the first ¾ in. of runoff
1.0 in.	4 municipalities require control of the first ½ in. of runoff
% Removal	
None	28 municipalities reported no specific pollutant removal requirements
80% SS	Two municipalities reported this requirement, which is based on CZARA
Other	20% reduction in annual copper loadings by 2001 (Alameda, Co., CA) 65% TP (Washington Co., OR) 0.5 mg/L-TN, 0.1 mg/L-TP, 0.5 mg/L-Iron, 20NTU-Turbidity, 50 mg/L-SS, 2 mg/L-grease and oil (Lahontan RWQCB Lake Tahoe) 50% TP (Prince William Co., VA) 100% all pollutants (Montgomery Co., MD) 80% SS-all site; 50%TP-discharge to sensitive lake; 50% ZN-discharge to stream resource area; <10 mg/L Alkalinity, 50% TP, 40% nitrates + nitrites -discharge to sphagnum bogs (King Co., Washington)

Section 4 BMP Design Concepts and Guidance

Introduction

This section introduces and summarizes a number of important concepts and design strategies that form the foundations of BMP design. These concepts include:

- BMP performance goals and objectives
- hydrologic design concepts
- flood and peak discharge control strategies
- water quality management strategies.

BMP Performance Goals and Objectives

BMP performance goals and objectives can be developed from a number of sources that include: 1) Federal, State and local regulatory requirements, as described in the previous section; 2) State or local community goals to mitigate the environmental impacts associated with urban runoff; and 3) special local area needs such as trout or salmon fisheries protection, water supply watershed protection, ground water protection and other issues of local importance. The selection of the appropriate level of control is usually a local mandate, but can also be a federal decision, e.g. ESA or CZMA, targeted to a specific issue or to sensitive watersheds. The level of water quality management is also dependent on the type of BMP used.

A literature review related to BMP performance goals and objectives revealed that five different levels of existing BMP performance goals could be discerned (Clar et al., 2001). Implementation of the performance standards is typically accomplished by using a number of control strategies, criteria or standards. These BMP Performance goals include: 1) flood and peak discharge control; 2) specific pollutant guidelines; 3) water quality control; 4) multi-parameter controls, including groundwater recharge and channel protection; and, 5) habitat protection and ecological sustainability strategies. Each of these performance goals is described below.

Flood and Peak Discharge Control

This level of control is generally provided by the NPDES Storm Water Program regulations. General permits covering Phase I sites have been issued by EPA regional offices and State water quality agencies. Permittees are required to develop SWPPP that include descriptions of BMPs employed, although actual BMP selection and design are at the discretion of permittees (in conformance with applicable State or local requirements).

There exists considerable variability throughout the States and localities with respect to these requirements, however most States and local agencies require that the SWPPPs address two performance criteria that are closely related – flood control and peak discharge control. This requirement is generally implemented by controlling the post development peak discharges for one or more design storms to predevelopment levels. The two most frequently used storms are the 2- and 10-yr storms. Some degree of pollutant removal may be obtained with this level depending on the type of BMP used to meet the peak discharge criteria. This performance level is most frequently accomplished using dry or wet basins that are designed using peak discharge control criteria and a design storm concept. These criteria and concepts are discussed later in this section.

Flood and Peak Discharge Control and Specified Pollutant Guideline

This level of control specifies the same criteria as *Flood and Peak Discharge Control*, but in addition requires the removal of a specified pollutant, typically sediment or SS. SS removal performance has been used as a measure of

water quality management performance. Because a number of other constituents, particularly nutrients (nitrogen and phosphorus) are attached to the sediment particles, the removal SS from the water column also serves to remove many of the other constituents present in urban runoff.

An example of this level of control is the outcome of the Guidance Specifying Management Measures of Nonpoint Pollution in Coastal Waters, issued in 1993 by EPA pursuant to the CZARA of 1990, which requires 80% removal of the SS from construction sites, in addition to flood and peak discharge control. The CZARA guidance includes requirements for municipalities located in coastal States.

This performance level typically requires the use of extended detention concepts in conjunction with wet or dry basins. These concepts are described later in this section.

Flood, Peak Discharge and Water Quality Control

This level of control is frequently encountered in more environmentally active municipalities and States. It defines performance with respect to three traditional criteria: (1) pollutant removal effectiveness, (2) peak discharge control effectiveness and (3) flood control. It differs from ***Flood and Peak Discharge Control*** alone in that there is generally some mandated volume of control, typically the first ½ or 1 in. of runoff for water quality and pollutant removal. Also the water quality focus is expanded beyond ***Flood and Peak Discharge Control and Specified Pollution Guidelines*** to include all the major pollutants in the water column of urban runoff, as described earlier in Section 2. While no specific pollutant removal requirements are typically used, it is generally assumed that the pollutant removal levels reported in the literature can be achieved.

Water quality control designs are also focused more on the annual volume of runoff rather than peak storm events. Effective water quality control requires management of the smaller storm events, such as the 1-in. rainfall events and smaller storms that typically account for approximately 90% of the annual rainfall and runoff volumes. Many of the older detention facilities used for peak discharge control include low flow pilot channels that allow these frequent storm events to flow through the facilities with little or no management. Where possible, water quality control can be improved in older BMPs designed under the older peak discharge principles by retrofitting the outlet control (it is best to incorporate water quality control and peak discharge control in the same BMP for economic reasons, though this may not always be a necessary or desirable approach).

This performance level introduces some additional concepts to BMP technology that include volume control and small storm hydrology. These concepts are described later in this section.

Multiple Parameter Control

Multiple Parameter Control takes a broader definition of receiving water impacts and includes two additional criteria for BMP performance to supplement the three criteria found in ***Flood, Peak Discharge and Water Quality Control***. These additional criteria are maintenance of groundwater recharge functions and receiving channel protection criteria using extended detention control concepts. This level of control has recently been adopted by the State of Maryland where it is referred to as the “Unified Sizing Criteria.” (MDE, 2000). A similar approach was suggested by the Urban Drainage and Flood Control District (1999) to the Denver, Colorado region. Other municipalities and States are also moving in this direction.

This performance level builds upon the three previous performance levels and includes peak discharge control, extended detention, volume control and small storm hydrology. In addition, this level typically requires the use of at least two BMP types, in what is referred to as a “treatment train” approach. This level often requires the consideration of a complete array of BMPs, including ponds, wetlands, infiltration, filtration and biofilter BMPs.

Maryland’s Unified Sizing Criteria uses stormwater management credits, which emphasize better site planning techniques, that can be used to preclude, reduce and/or minimize the hydrologic and water quality impacts associated with new development activities. Table 4-1 provides a summary of the stormwater management credits included in the Maryland Design Manual (2000), which allow engineers to implement credits and reduce BMP size, i.e., more traditional pond and swales. The calculation of credits as prescribed in the Maryland Design Manual (2000), presents

a method to incorporate the broader concepts of LID, groundwater recharge and disconnected impervious areas (DCIA) within a site design (i.e., a site design where impervious areas do not flow directly to a drainage pipe, as sheets flow from impervious areas is typically directed to a vegetated area first). This new feature enables planners and engineers to address the provisions of the Pollution Prevention Act (1990), which declares it to be national policy of the U.S. that pollution should be prevented or reduced whenever feasible; pollution that cannot be prevented should be recycled in an environmentally safe manner whenever feasible; pollution that cannot be recycled should be treated in an environmentally safe manner whenever feasible; and disposal or release into the environment should be employed only as a last resort and should be conducted in an environmentally safe manner” (Section 6602; 42 U.S. C. 13101 (b)). In short, preventing pollution before it is created is preferable to trying to manage, treat or dispose of it after it is created.

Table 4-1 Summary of Stormwater Credits (based on MDE, 2000)

Stormwater Credit	Water Quality Benefits	Groundwater Recharge Benefits	Peak Discharge Benefits
Natural Area Conservation	Reduce disturbed site area	Helps maintain groundwater recharge	Reduces total impervious area (TIA) and total peak discharge (Q_p)
Disconnection of Rooftop Runoff	Reduces directly connected impervious area (DCIA) and runoff coefficient (R_v)	Provide opportunity for groundwater recharge	Reduces DCIA and R_v ; provides longer flow path, slower velocities and longer time of concentration (t_c),
Disconnection of Non-Rooftop Runoff	Reduces DCIA and R_v	Provide opportunity for groundwater recharge	Reduces DCIA and R_v ; provides longer flow path, slower velocities and longer t_c
Sheet Flow to Buffers	Subtracts contributing site area to BMP	Provide opportunity for groundwater recharge	Provide longer flow path, slower velocities and longer t_c
Open Channel Use	Provides opportunity for pollutant removal	Provide opportunity for groundwater recharge	Reduces DCIA and R_v ; provides longer flow path, slower velocities and longer t_c
Environmentally Sensitive Development	Reduces DCIA and provides opportunity for pollutant removal	Provide opportunity for groundwater recharge	Reduces DCIA and R_v ; provides longer flow path, slower velocities and longer t_c

Ecologically Sensitive Stormwater Management

This level of control is an attempt to provide an ecologically sustainable approach to stormwater management and is currently under development by a number of groups throughout the country. It includes the joint effort by Prince George’s County and the EPA (2000a, b), Yoder (1995), Yoder et al. (2000), and Snodgrass et al. (1998), among others. Land use changes can trigger physical (watershed hydrology) and chemical (pollutant loadings) changes that together with alterations of the riparian zone (stream buffers) can lead to degradation and loss of the ecological integrity of receiving waters. Ecologically-sensitive stormwater management is an ongoing experimental approach to develop control strategies that can preclude or reduce the impacts of land use activities on receiving waters.

The impetus of ecologically sensitive stormwater management is to develop an integrated approach, including biological, chemical and physical criteria to define BMP performance. A combination of water quality, bio-habitat and geomorphic criteria are used to evaluate whether a receiving stream is at a targeted goal, (e.g., “fishable and swimmable”) or the extent of its departure from the goal. A number of additional parameters are added to the **Multi-Parameter Control**: (1) stream buffer retention and thermal impact considerations, (2) volume control considerations, such as are presented in the LID concept approach, are added to the peak discharge and (3) groundwater recharge criteria to achieve maintenance of hydrologic functions at a site-specific level. Geomorphic criteria as described by Lane (1955), Leopold et al. (1964, 1968), Dunne and Leopold (1978), Rosgen (1996) and others are also incorporated to supplement or replace extended detention approaches to achieving channel stability.

Attempts at this level of performance include LID technology that introduces a number of additional concepts to BMP technology that are intended to allow replication of a site’s predevelopment hydrologic functions. LID technology includes the concepts of micro-scale BMPs, distributed management concepts, and multi-functional site and landscape

functions. Table 4-2 summarizes the control strategies, criteria and standards used by the various levels of BMP performance.

Table 4-2 BMP Performance Levels vs. Control Strategies, Criteria and Standards

CONTROL STRATEGIES	PERFORMANCE LEVELS				
	<i>NPDES Phase 1</i>	<i>Specified Pollutant Removal</i>	<i>Water Quality Control</i>	<i>Multiple Parameter</i>	<i>Ecological Sustainability</i>
<i>Flood Control</i>	X	X	X	X	X
<i>Peak Discharge Control</i>	X	X	X	X	X
<i>SS Removal</i>		X	X	X	X
<i>Volume Control</i>		X	X	X	X
<i>Water Quality Management</i>			X	X	X
<i>Ground Water Recharge</i>				X	X
<i>Channel Protection</i>				X	X
<i>Thermal Impacts Control</i>				X	X
<i>Credits</i>				X	X
<i>Pollution Prevention</i>				X	X
<i>Distributed Controls</i>					X
<i>Multi-functional Controls</i>					X

A discussion of the current stormwater control strategies that focuses on flood and peak discharge control, and water quality control concepts is provided in a subsequent subsection. Guidance for multi-parameter control and ecologically sustainable control strategies is beyond the scope of these manuals; preliminary conceptual guidance is provided elsewhere (MDE, 2000; PGC, 1997; EPA, 2000a, b). Constructed BMPs are only one part of the solution – watershed management, land use management, non-structural controls, trading strategies and other developing approaches are required to improve receiving water quality. Research is still required to develop standard methods to design and implement wet weather BMPs, as there is still a knowledge gap in understanding both the systems we are attempting to manage and the cause and effect relations that govern how these systems operate. Research to address the complexity of these issues is currently underway with funding from EPA and National Science Foundation, and should yield tools to assess the impact of varying BMPs on downstream biota and geomorphology.

Hydrologic Concepts

The hydrologic concepts of interest with respect to the design of BMPs are closely related to the design objectives of the BMP. Design of BMPs can be focused on peak discharge control, volume control, water quality management, pollutant removal, groundwater recharge, thermal control, or a combination of two or more of these objectives. Each control objective has somewhat different hydrologic parameter requirements that will need to be addressed in the design of the BMP to achieve these objectives.

The addition of water quality considerations in the design of BMPs has introduced a new dimension to the traditional hydrologic considerations for BMP design. Prior to the introduction of water quality considerations, hydrologic design methods were focused on flood event hydrology with focus on storms typically ranging from the 2-yr (bankfull), the 10-yr, (storm drainage conveyance storm) to the 100-yr (floodplain storm). Water quality considerations created a shift from flood events to annual rainfall volumes and the pollutant loads associated with

these volumes. This new focus has given rise to concepts such as the rainfall frequency spectrum and small storm hydrology. These, along with traditional concepts, are summarized below.

Rainfall Frequency Spectrum (RFS)

A rainfall frequency spectrum (RFS), defined as the distribution of all rainfall events (see example in Figure 4-1), is a useful tool placing in perspective many of the relevant hydrologic parameters. Represented in this distribution is the rainfall volume from all storm events ranging from the smallest, most frequent events in any given year to the largest most extreme events, such as the 100-yr frequency event, over a long duration.

The RFS consists of classes of frequencies often broken down by return period ranges. Four principal classes are typically targeted for control by stormwater management practices. The two smallest, or most frequent, classes are often referred to as water quality storms, for which the control objectives are groundwater recharge, pollutant load reduction and to some extent, control of channel-erosion-producing events. The two larger, or less frequent, classes are typically referred to as quantity storms, for which the control objectives are channel erosion control, overbank control and flood control. Figure 4-1 developed for the Chesapeake Research consortium (CRC, 1996) illustrates a theoretical representation of these four classes for the Maryland area (for other sections of the country, the storm event rainfall volumes would be different).

In order to establish reasonable design volumes for various BMPs, it is necessary to define the RFS for the region of application. The distribution and magnitude of the RFS varies from region to region. Driscoll et al. (1989) subdivided the U.S. into fifteen distinct rainfall regions, as shown in Figure 4-2 and summarized in Table 4-3. The runoff volume is the most important hydrologic variable for water quality protection and design because water quality is a function of the capture and treatment of the mass load of pollutants. The runoff peak rate is the most important hydrologic variable for drainage system design and flooding analysis. Water quality facilities are designed to treat a specified quantity or volume of runoff for the full duration of a storm event, as opposed to accommodating only an instantaneous peak at the most severe portion of a storm event.

To design effective BMPs and evaluate water quality impacts in urban watersheds, it is necessary to predict the following hydrologic processes:

- amount and distribution of rainfall volume; and
- amount of rainfall that contributes to runoff volume, i.e., rainfall volume minus abstractions.

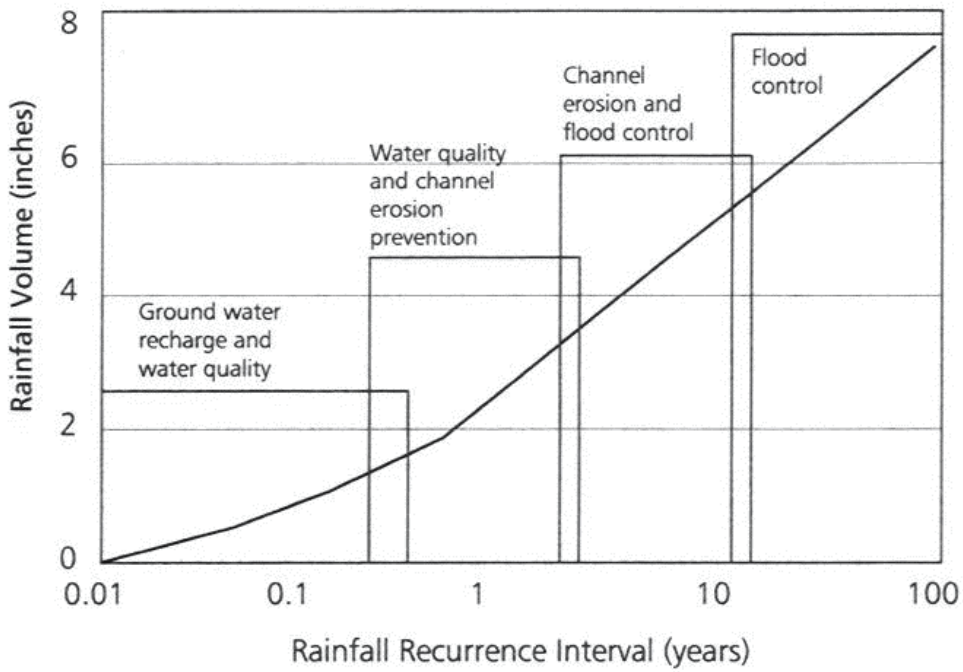

Figure 4-1 Stormwater Control Points for a Storm Event along the Rainfal Frequency Spectrum for Maryland (CRC, 1996)

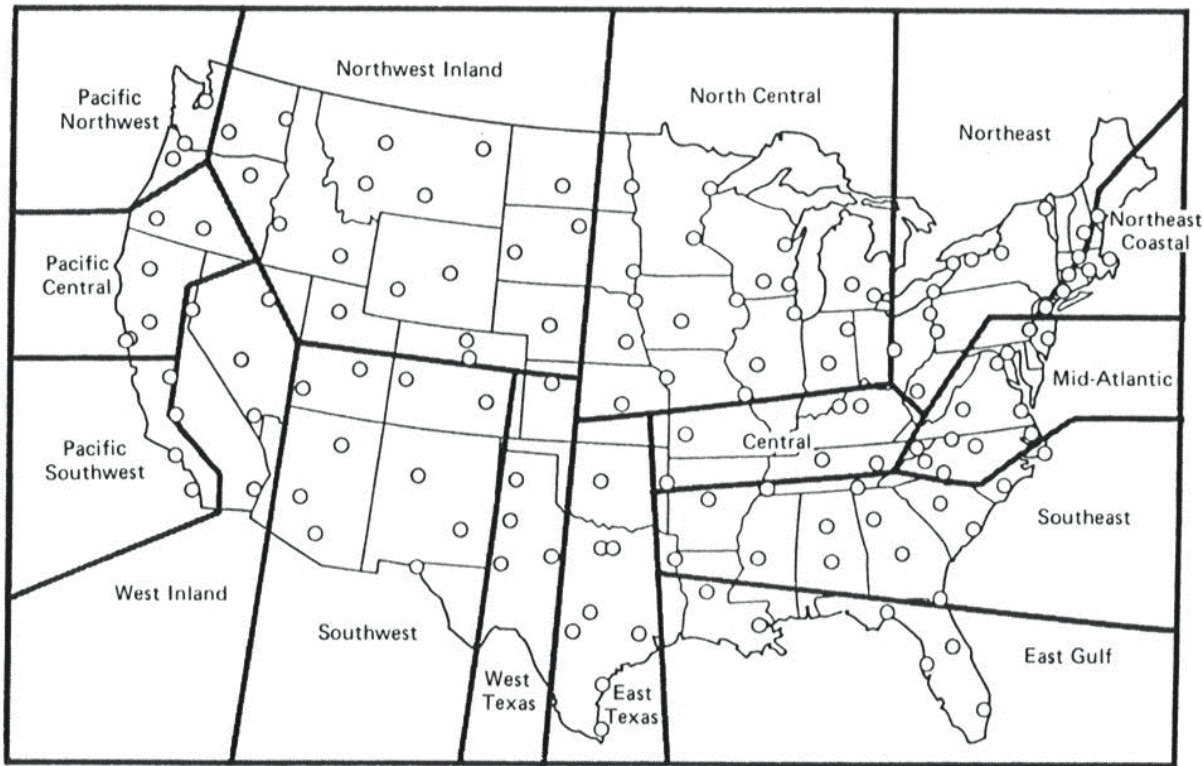

Figure 4-2 Fifteen rain zones of the United States (after Driscoll et al., 1989)

Table 4-3 Typical Values of Individual Storm Event Statistics for 15 Zones of the United States (Driscoll et.al., 1989)

Rain Zone	Annual Number of Storms		Duration (hr)		Intensity (in/hr)		Volume (in.)		Storm Separation (hr)	
	Avg.	c _v	Avg.	c _v	Avg.	c _v	Avg.	c _v	Avg.	c _v
Northeast	70	0.13	11.2	0.81	0.067	1.23	0.50	0.95	126	0.94
Northeast, coastal	63	0.12	11.7	0.77	0.071	1.05	0.66	1.03	140	0.87
Mid-Atlantic	62	0.13	10.1	0.84	0.092	1.20	0.64	1.01	143	0.97
Central	68	0.14	9.2	0.85	0.097	1.09	0.62	1.00	133	0.99
North Central	55	0.16	9.5	0.83	0.087	1.20	0.55	1.01	167	1.17
Southeast	65	0.15	8.7	0.92	0.122	1.09	0.75	1.10	136	1.03
East Gulf	68	0.17	6.4	1.05	0.178	1.03	0.80	1.19	130	1.25
East Texas	41	0.22	8	0.97	0.137	1.08	0.76	1.18	213	1.28
West Texas	30	0.27	7.4	0.98	0.121	1.13	0.57	1.07	302	1.53
Southwest	20	0.30	7.8	0.88	0.079	1.16	0.37	0.88	473	1.46
West, inland	14	0.38	9.40	0.75	0.055	1.06	0.36	0.87	786	1.54
Pacific Southwest	19	0.36	11.6	0.78	0.054	0.76	0.54	0.98	476	2.09
Northwest, inland	31	0.23	10.4	0.82	0.057	1.20	0.37	0.93	304	1.43
Pacific Central	32	0.25	13.7	0.80	0.048	0.85	0.58	1.05	265	2.00
Pacific Northwest	71	0.15	15.9	0.80	0.035	0.73	0.50	1.09	123	1.50

c_v = coefficient of variation of the observations (c_v = S/M)
 S = standard deviation of the observations, (S=[3(x_i -M)² / (N-1)]^{1/2})
 M = the mean value of the EMC observations
 X = an individual EMC observations
 N = number of observations

Large versus Small Storm Hydrology

Early efforts in stormwater management focused on flood events ranging from the 2-yr to the 100-yr storm. Increasingly stormwater professionals have come to realize that small storms (i.e. < 1 in. rainfall) dominate watershed hydrologic parameters typically associated with water quality management issues and BMP design. These small storms are responsible for most annual urban runoff and groundwater recharge. Likewise, with the exception of eroded sediment, they are responsible for most pollutant washoff from urban surfaces. Therefore, the small storms are of most concern for the stormwater management objectives of ground water recharge, water quality resource protection and thermal impacts control.

Medium storms, defined as storms with a return frequency of six months to 2-yr, are the dominant storms that determine the size and shape of the receiving streams. These storms are critical in the design of BMPs that protect stream channels from accelerated erosion and degradation. Roesner et al., (2001) believes the problem with BMPs is not the BMPs themselves but the design guidance for BMP outlet flow control that does not take into account the geomorphologic character of the receiving stream.

Large storms occur infrequently and are of primary concern for overbank flows and flooding of structures located in the floodplains of stream channels. Although these storms may contain significant pollutant loads (Chang et al., 1990), their contribution to the annual average pollutant load is really quite small due to the infrequency of their occurrence. In addition, longer periods of recovery are available to receiving waters between larger storm events. These periods allow systems to flush themselves and allow the aquatic environment to recover.

Most rainfall events are much smaller than design storms used for urban drainage models. In any given area, most frequently recurrent rainfall events are small (less than 1 in. of daily rainfall). For example, 90% of the annual rainfall

comes in storms smaller than 0.9 in/day in Cincinnati, OH (Roesner et al., 2001). For small rains, impervious areas contributed most of the runoff flows and pollutants (Pitt, 1987). The capture and treatment of these small storms would lead to improved water quality since the total pollutant load to receiving streams would be minimized.

Urban runoff models play an important role in evaluations for stormwater BMPs. Unfortunately, many commonly used models incorrectly estimate runoff flows and the washoff of particulates from impervious surfaces during small rains. Typical washoff prediction procedures used in urban runoff models greatly over-predict particulate residue washoff from impervious surfaces, especially for large particles (Pitt, 1987).

Current design, however, typically focuses on capturing large storms to minimize flooding and control drainage. These rainfall events typically range from (2 to 10 inches of daily rainfall) and occur at much longer return periods ranging from 2 to 100-yr.

Large Storm Hydrology

The computational procedures for large storm hydrology refer to procedures to estimate or model runoff hydrographs from larger storm events typically ranging from the 2-yr to the 100-yr storm. The procedures for conducting these analyses are well documented at both the national and regional level.

At the national level, a variety of models are available and well documented to simulate the rainfall-runoff processes for watersheds and the design of BMPs. Selection of an appropriate modeling technique will often depend on the level of detail and rigor required for the application and the amount of data available for setup and testing of the model results. In many instances, however, local regulatory agencies may specify which models are acceptable for design and review purposes. For example, in the State of Maryland, the State regulatory authority, the Maryland Department of the Environment, requires that BMP design be performed using the NRCS TR-55 and TR-20 models. Table 4-4 summarizes a number of national and regional level models that are frequently used for BMP large storm design.

A number of large storm models have also been developed by local and regional government. Some of these models, also summarized in Table 4-4, include:

- Penn State Runoff Model (PSRM), used widely in Pennsylvania and Virginia
- Illinois Urban Area Simulator (ILLUDAS), developed by the Illinois State Water Survey and widely used in Illinois and neighboring mid-western States
- Urban Drainage and Flood Control District model (UDFCD), developed by Denver's UDFCD (1999). This model is used widely in Colorado and adjoining States
- Santa Barbara Urban Runoff Hydrograph, developed for the City of Santa Barbara California. This model is widely used in California and other pacific coast States (Oregon and Washington).

A brief description of these large storm hydrologic models is provided in Appendix A.

Small Storm Hydrology

The addition of water quality considerations in the design of BMPs has introduced a new dimension to the traditional hydrologic considerations for BMP design. Water quality considerations created a shift from flood events to annual rainfall volumes and the pollutant loads associated with these volumes. This new focus has given rise to concepts such as the rainfall frequency spectrum and small storm hydrology. Traditional guidance for detention design was for infrequent, large storms; however, because pollutant-removal efficiency is a function of detention for all storms, using a more frequently occurring storm would be more appropriate (Newman et al., 2000). In general, small storm hydrology recognizes that detention that controls very small events with extended release rates allows for

Table 4-4 Comparison of Model Attributes and Functions

ATTRIBUTE	MODEL								
	HSPF	SWMM	NATIONAL TR-55/ TR-20	HEC-HMS	Rational Method	PSRM	REGIONAL ILLUDAS	UDFCD	Santa Barbara
Sponsoring Agency	EPA	EPA	NRCS	CORPS		PSU ¹	ISWS ²	UDFCD	
Simulation Type	Continuous	Continuous	Single Event	Single Event	Single Event	Single Event	Single Event	Single Event	Single Event
Water Quality Analysis	Yes	Yes	None	None	None	Yes	None	None	None
Rainfall/Runoff Analysis	Yes	Yes	Yes	Yes	Yes	Yes	Yes	Yes	Yes
Sewer System Flow Routing	None	Yes	None	None	None	Yes	Yes	Yes	None
Dynamic Flow Routing Equations	None	Yes	None	None	None	Yes	None	None	None
Regulators, Overflow Structures	None	Yes	None	None	None	None	None	Multiple	None
Storage Analysis	Yes	Yes	Yes	Yes	Yes	Yes	Yes	Yes	Yes
Treatment Analysis	Yes	Yes	None	None	None	Yes	None	None	None
Data and Personnel Req.	High	High	Medium	Medium	Low	Medium	Medium	Medium	Medium
Overall Model Complexity	High	High	Low	High	Low	Low	Low	Medium	Low

¹PSU = The Pennsylvania State University

²ISWS = Illinois State Water Survey

more settling to occur in the BMP and can reduce the stream power for frequently occurring runoff events to more manageable and lesser levels of impacts.

A discussion of the small storm hydrologic parameters involved in the design of BMPs is provided in Appendix B. Three different approaches to small storm hydrology computations are presented. The first approach is a Basic Procedure for Optimization of Water Quality Capture Volume and is based on the work of Urbonas et al., (1990). The second approach is from the ASCE /WEF(1998) BMP Design Manual. These approaches are well suited to the design of water quality control BMPs for larger drainage areas. The following materials are presented in the context of this computational procedure:

- long term rainfall characteristics
- capture of stormwater runoff
- an approach for estimating stormwater quality capture volume
- an example of a water quality capture volume estimate.

Also described is a third approach based largely on the work of Pitt (1994) that is tailored for very small urban sites and closely linked to the presence of impervious surfaces. This approach has been adopted by the State of Maryland (MDE, 2000) and may provide a simpler computational tool that is better suited for use by Phase II communities. The following materials are described in the context of this approach:

- small site hydrology approach
- the 90% rule-cumulative rainfall volume for water quality treatment
- short-cut method for estimating the water quality volume for small-storms
- estimating peak discharges for the water quality storm.

In urban settings, the use of the NRCS Curve number (CN) methods, whether for single or continuous simulation, may result in inappropriate rate of runoff and volume calculations, especially for smaller storms. The compositing of pervious and impervious areas in the urban watershed result in excess runoff predictions in the NRCS CN method. This concern is raised and addressed in Appendix B.

Another approach, the probabilistic method developed by the Driscoll et al. (1986) in the publication, "Methodology for Analysis of Detention Basins for Control of Urban Runoff Quality" is not specifically presented here, but is incorporated into the design procedures for basins in Volume 3. This is a well documented and referenced approach, and can be thought of as a predecessor to the small storm hydrology approaches presented in Appendix B. A copy of the report can be accessed via the web at: (<http://www.epa.gov/ednrmrl/repository/epa-440-5-87-001/>). The approach by Driscoll et al. (1986) uses rainfall statistics to determine quiescent removal between storms and dynamic settling during storms, to predict overall basin performance.

First Flush

The tendency for solids and associated constituents to be washed off of paved areas during the initial portion of the storm event is referred to as the first flush (discussed later in this sub-section). In general, the potential for first flush is determined by the storm characteristics, the size of the subwatershed and the partitioning characteristics of the pollutants of concern.

To treat the bulk of the pollutant loads from stormwater runoff, many States and municipalities specify a treatment volume that is designed to capture the first flush component of the stormwater runoff. In practice this is achieved by specifying a rainfall amount (such as the first ½-inch, 1-inch or other rainfall depth over impervious areas) or the capture of a stormwater runoff volume that correlates to a design storm (such as the 6-month, 1-yr or 2-yr frequency storm). Working with a very small (300 m²) highway segment, Sansalone, et al. (1994) found a pronounced first flush for solids, dissolved zinc and dissolved copper, but not dissolved lead. The first flush for the particulate-bound fractions of these metals was not well defined. While the first flush is commonly treated using settling technologies, filtering and cation exchange technologies may also be warranted, depending upon the subwatershed characteristics and the pollutants of concern.

Ground Water Recharge Hydrology

Historically, stormwater BMP technology has focused on surface runoff – particularly peak discharge issues and water quality management. Some exceptions to this trend have developed that involve the use of infiltration practices to address surface runoff and water quality issues, as well as groundwater recharge concerns. These exceptions include Long Island, New York which has been using infiltration recharge basins successfully since the 1930's; Fresno, CA which has been using infiltration practices successfully and exclusively for the past twenty years to address their urban runoff issues; the City of Lyon, France which has also been using infiltration practices, including both basins and trenches for the past 30 years; and the State of Maryland, which has prioritized the use of infiltration BMPs over other BMP types since 1983 and has now incorporated groundwater recharge into the updated stormwater management regulations. The focus of this guidance document is primarily peak discharge control and water quality management. However some of the BMPs described, including the infiltration basin and the vegetative biofilters can also mitigate the groundwater impacts including maintaining groundwater levels and base flows in receiving streams. Consequently a simple method for computing the ground water recharge volume hydrology for small sites is provided in Appendix C.

Design Storm vs. Continuous Flow Simulation

Design storms, primarily IDF (i.e., intensity, duration frequency, Figure 4-3) or NRCS-type curves (Figure 4-4), have been the primary tools used to predict runoff rates. These are used with a wide variety of single storm models, including HEC HMS (Feldman, 2000 and Scharffenberg, 2001), SWMM (Huber and Dickinson, 1988), Sedimot II (Wilson et al., 1982) and III (Barfield et al., 1996). The assumption made in the single storm models is that the return period of the peak discharge is the same as the return period of the design rainfall event and that watershed parameters are invariant with return period rainfall. Studies have shown that constant watershed parameters are not a good assumption. For example, Haan and Edwards (1988) evaluated predictions of peak discharge on six watersheds in Ohio, Nebraska, Arizona and Oklahoma using the NRCS curve number approach. For each storm on the watershed, they calculated the parameter **S**, the maximum potential abstraction from rainfall, for each storm event. Their results showed that:

- The value of **S**, varied widely for each storm event on each watershed due to changing soil moisture and vegetative characteristics.
- When considering the joint variability of both **S** and rainfall, the return period discharge was always greater than that predicted assuming a constant **S** and varying rainfall. This is because the probability distributions for both precipitation and **S** are skewed.

In general, considering the variability of **S** improved predictions for the rare events but increased the error for the lower return period events (probability less than 80%). As mentioned previously under ***Small Storm Hydrology***, there are limitations to NRCS CN methods whether for single or continuous simulation, especially when trying to calculate the response of smaller storms using composited pervious and impervious areas in an urban environment. If one considers only the design storm occurring solely during one antecedent moisture condition (AMC), e.g. AMC II, then the NRCS CN method will give poor results. These results demonstrate the limitation of using a design storm approach to modeling runoff.

The problem of matching single storm predictions based on rainfall with return period flow rates is hard enough to evaluate when considering runoff. The problem is amplified when considering pollutants such as sediment, toxics, nutrients and pathogens. The standard assumption is that the pollutant loading in runoff from a design storm, such as SCS-type storms, will match observed return period pollutant loadings. Because of this difficulty, the new water erosion prediction (WEPP) model of soil erosion on agricultural watersheds was developed as a continuous simulation model (Lane et al., 1989). Average and return period sediment yield values are determined by return period analyses on long records of simulated sediment yield. An attempt to circumvent this problem was made by Griffin and Beasley (1988). They developed a conceptual framework for a rainfall distribution that would allow a single storm simulation with WEPP match average annual erosion values. However evidence that their conceptual model has been completely developed to the point of application was not found.

An additional problem related to the use of return period storms to generate loadings is that some of the trapping functions of BMPs occur between storms and depends on the intervals between storms. To address the problem of variability between storms, Driscoll et al., (1986) constructed a model of sedimentation in reservoirs and developed

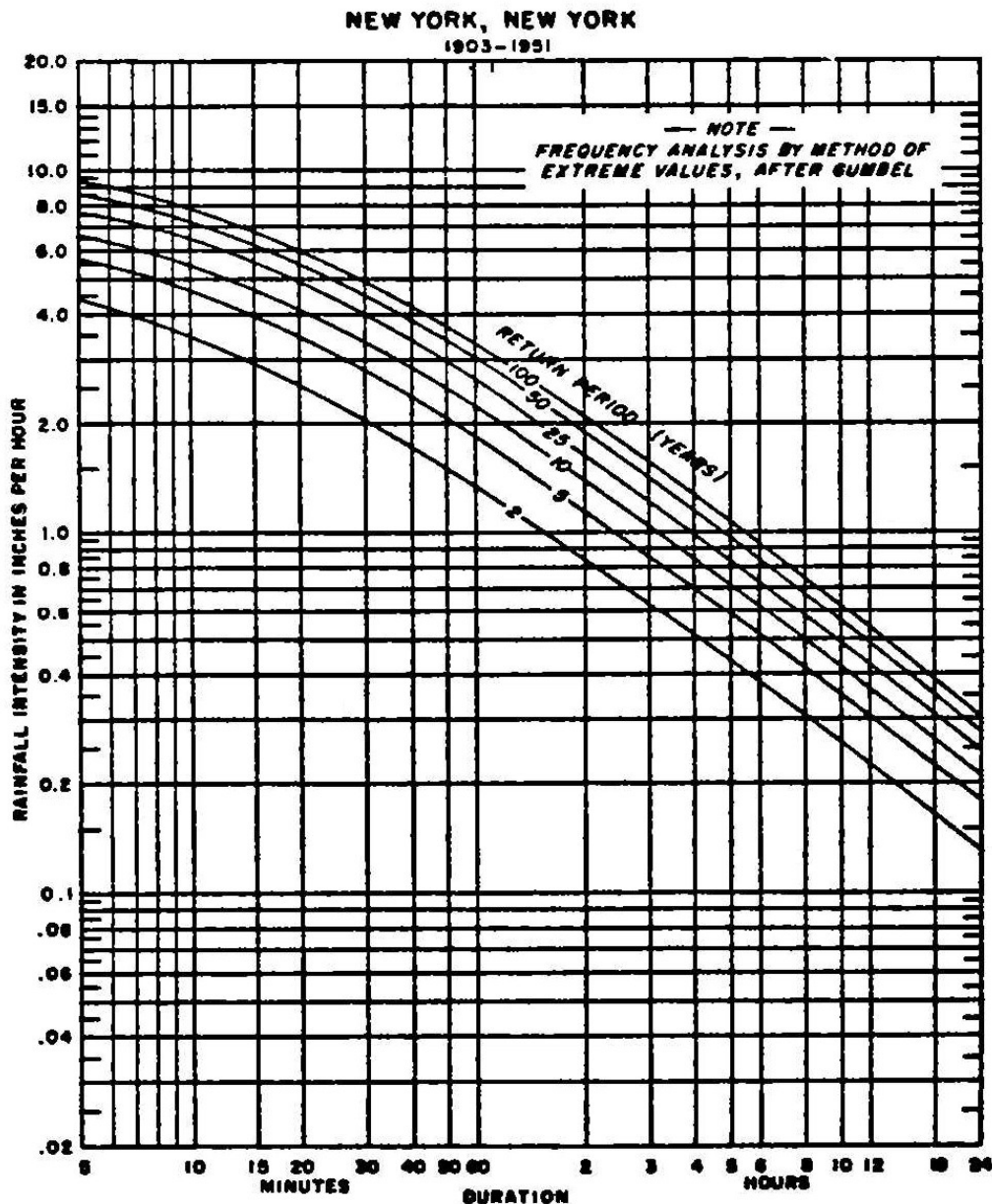

Figure 4-3 Example of Intensity-duration-frequency (IDF) Curve for New York, New York (U.S. Weather Bureau, 1955)

procedures for estimating performance under these conditions. This model has potential to be used to estimate dynamic and quiescent condition settling in reservoirs used as BMPs

An alternative to the design storm is the use of a continuous simulation model in which rainfall is typically modeled on a daily basis, and runoff and loading are predicted in response to the daily rainfall as well. Return period information is determined by conducting many years of simulation, typically 25 to 100 years, and doing a return period analysis on the predicted values. One value of using continuous simulation models is that they could capture some of the variability in input parameters that occur. Another value is that they could, assuming accurate algorithms and input data, give a good representation of lower frequency, less than 1-yr, events.

An advantage of using continuous simulation models with pollutant loadings and particular with BMPs, is that the inter-arrival time between storms can have a significant impact on trapping performance of the BMP. The WEPP model (Lane et al., 1989) is a continuous simulation model that predicts runoff and sediment yield from agricultural watersheds and routes these through sediment control structures, accounting for variations in rainfall on erosion rates in a given storm and the variations in inter-arrival times between storms in a reservoir using a continuous simulation model for reservoirs known as WEPPSIE (Lindley et al, 1998a and b). The SWMM model (Huber and Dickinson

1988) performs similar functions for urban areas. Newman et al., (2000) found that optimizing designs of extended detention ponds using long-term simulations with SWMM more realistically reflected actual performance, rather than the performance for a single, design storm condition.

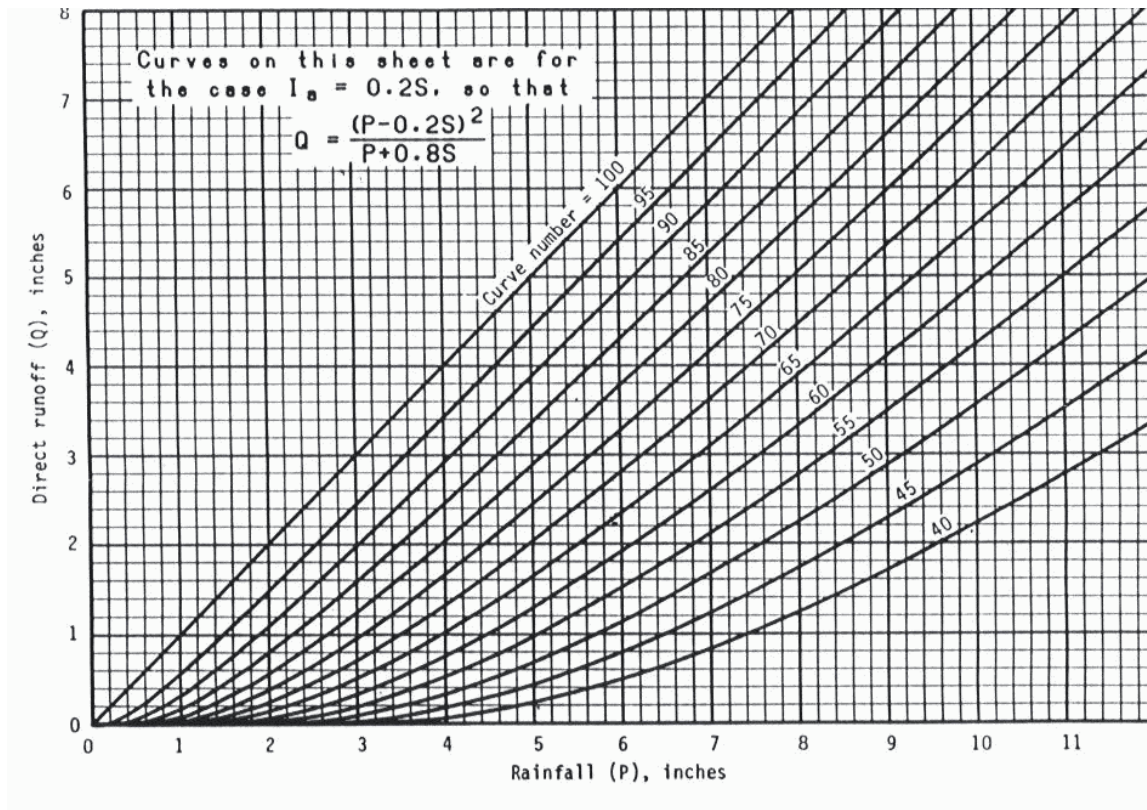

Figure 4-4 Example of NRCS Runoff Curves (Source: USDA, 1986)

The advantages of using a continuous simulation model must be weighed against the added complexity with such an approach. Specifically, these include:

- Greatly increased data set requirement for the models. The models must not only predict hydrologic and water quality responses, they must also predict changes in vegetative cover resulting from annual growth and dormancy cycles. In addition, the models must have good climatic simulators to simulate rainfall and other climatic variables. Since algorithms within models are only as good as their inputs, assuring that the models have good predictors of watershed and climatic variables is critical.
- Greatly increased complexity in setting up and executing the models, thus increasing the knowledge base requirement of the user. The validity of a model prediction is as much dependent on the skill of the user as it is on the reliability of the model algorithms. If the complexity of the model is such that an advanced degree in hydrology and water quality is required for its proper execution, the average user is not likely to generate good BMP designs from its use. Likewise, reviewers are not as likely to be competent in interpreting permit applications. It is important, therefore, that the modeling technique be selected with the skill of the average user, both in the design community as well as in the regulatory organizations.

The continuous simulation models are most appropriate for larger regional watersheds and are a necessary tool for predicting the effect of discharges from many BMPs on a watershed scale, whether the BMP response is modeled individually or in a larger watershed with many BMPs as a lumped or composite response. Continuous simulation models are better at predicting the accumulation and washoff of pollutants and the inter-arrival time between storms that can have a significant impact on the removal performance of the BMP. Continuous simulation is needed for watershed based approaches to solve habitat and water quality issues in urban streams (Strecker, 2002). Continuous

simulation offers possibilities for designing and managing BMPs on an individual site-by-site basis that are not provided by other widely used, simpler analysis methods. Therefore its application and use should be encouraged. Widespread adoption of continuous simulation in design and permit review may depend in part on the models becoming sufficiently user friendly and the continued development of input guidelines so that the user community can execute the models with confidence and competence, but also depends on acceptance by the user and regulatory communities.

Limiting water quality analysis to design storms will not sufficiently address the smaller storms that carry a majority of the annual pollutant load. On the other hand, relying solely on continuous simulation may not capture the most severe peak flow events. Therefore, a combination of approaches may be required: continuous simulation for water quality analysis and design storm approach for determining peak flows and flood analysis. Resolution of conflicting results between both approaches may require implementing more than one type of BMP. Chapter 5 discusses the use of regional, on-site and micro-scale controls.

An alternative to the above two approaches has been developed in the Integrated Design and Assessment for Environmental Loadings (IDEAL), a spreadsheet tool for hydrology, sedimentology and water quality (Hayes et al., 2001). Using probabilities of rainfall, seasons and antecedent moisture (AMC), this spreadsheet determines runoff and loadings for 12 different storm sizes with seasons and AMC nested within each rainfall class. Further, the runoff and loadings are routing through BMPs and effluent loadings calculated. Using conditional probabilities, average storm values are calculated. This approach offers a compromise between the design storm concept and the continuous simulation model. The equations used for and examples of this approach are provided in Volumes 2 and 3.

Assessment of Peak Discharge Control Strategies

Peak discharge control is the oldest and most widely used strategy for controlling the impacts of urban runoff. The strategy is relatively straightforward and consists of a general policy or requirement that post development discharge rates cannot substantially exceed existing or predevelopment discharge rates. Both post-construction runoff conditions (total volume and the peak discharge values) are usually much greater than predevelopment conditions. Therefore, the peak discharge approach generally requires that storage facilities be provided to temporarily store the additional runoff volume, which is then discharged at the allowable release rate, based on the design storm.

Peak discharge strategies represent a flood and peak discharge control approach to control or mitigation of impacts from urban runoff. This level of control is currently being provided by many States and municipalities under the NPDES stormwater regulatory approach. It provides two performance criteria that are closely related: (1) flood control and (2) peak discharge control. Some practitioners have concluded that on a watershed-wide scale, uniform detention strategies are a failure because they do not maintain base flows, do not necessarily do anything for water quality and in some cases, fail to fulfill their single explicit purpose of controlling floods (Ferguson, 1998).

A recent technology assessment for the major impact categories concluded that approaches based solely on peak discharge control are not adequate to address the range of impacts associated with urban runoff issues (Clar, et. al, 2001). Following is a summary of the assessment's findings:

- While this approach does provide some limited degree of flood control from moderate and large storms, it can in some instances actually transfer or aggravate flooding conditions downstream of the control points.
- This approach not only fails to provide protection for stream channel stability, but may actually aggravate and accelerate stream channel degradation and impacts.
- The approach does not address groundwater recharge issues, including lowering of water tables and maintenance of stream base flows.
- The approach does not address, but can actually aggravate, thermal impacts on receiving waters.
- This approach does not address or guarantee water quality management and pollutant removal, although both can be achieved if the BMPs are properly designed.
- This approach does not provide control for the degradation and loss of riparian habitat.
- This approach does not provide control for the degradation and loss of biological communities.

Peak discharge control strategies used in flood and peak discharge control with and without specified pollutant guideline management strategies appear unable to meet the objectives of the CWA, the Pollution Prevention Act, the Source Water Protection Act and the habitat protection objectives of the ESA. The peak discharge control strategies

are not capable of addressing the prevention or reduction of a number of hydrologic, hydraulic and chemical parameters that influence the ecological integrity of receiving waters, especially with respect to habitat and biological parameters. The limitations of these strategies can be supplemented with volume control techniques using control measures that include vegetated swales, infiltration trenches and bioretention cells in a treatment train approach to achieve the goals of these legal mandates. By including these supplemental measures using either distributed and /or centralized controls, control strategies based solely on peak discharge could be upgraded to water quality or multi-parameter control approaches or even ecologically sensitive approaches.

Design Storms

The peak discharge control strategy is closely tied to the use of design storms, typically referred to as synthetic storms. The selection of a specific design storm generally incorporates a number of implicit assumptions related to the stormwater runoff impacts being controlled and thus provides a good starting point for a scientific assessment relating to actual versus perceived benefits of this strategy. These storms are generated to have return periods that are consistent for every duration in the storm (i.e., a 10-yr return period storm has 15-min intensities, 30-min intensities, 45-min intensities, etc. that have a 10-yr return period). The IDF method, the NRCS type storms and the Chicago Hyetograph method are examples of procedures used to generate the design storms and can readily be found in standard texts (i.e., Haan et al., 1994). The methods generate storms that are remarkably similar, if the assumption is made that the peak discharge is centered at the half point of the storm. The Chicago Hyetograph method allows the user to develop a storm with the peak discharge in the first half, midpoint or second half.

Selection of a return period for the design storm is generally the purview of the local regulatory authority and may correspond to controlling discharge or runoff volume. In general, the return periods selected are based on a perception that controlling the design storm will result in some intended benefit such as flood control, control of downstream damage to stream geomorphology and water quality. Examples are given in Table 4-5.

As Table 4-5 documents, a number of the assumptions implicit in the selection of a design storm in conjunction with the peak discharge control strategies do not hold up under scientific scrutiny and have never been validated by field monitoring. As the table indicates, the implicit assumption that peak discharge control of the 2-yr storm as a strategy for channel protection is not supported by field monitoring data or geomorphic science. On the contrary, the geomorphic data predicts that the strategy is flawed and this is being confirmed by limited field monitoring data.

Geomorphic science also indicates that use of the 10-yr storm has no geomorphic significance within a stream valley (not defined by bankfull stage or flood plain analysis) and is simply a carryover of the cost benefit basis for the design of storm drainage systems (ASCE, 1984). Watershed-based hydrologic analysis further reveals that the downstream flood control benefits from both the 10- and 100-yr storms are very short-lived and that in fact, due to the superpositioning of hydrograph peaks, flooding problems will tend to be transferred to downstream properties (Leopold and Maddock, 1954; Skupien, 2000; Debo and Reese, 1995).

Peak Discharge Strategies and Control of Physical Impacts

With respect to the physical impact category, the major areas of impairment or change to the use of the receiving waters are:

- increased flooding
- channel instability and erosion
- frequency and duration issues
- reduction in groundwater recharge and related issues
- increased sediment transport
- thermal impacts.

Table 4-6 provides a qualitative assessment of the benefits provided by peak discharge control strategies with respect to the physical impacts category.

Table 4-5 Design Storm Frequencies and Assumed Benefits

Design Storm	Assumed Benefits	Comments	References
½ -<1 in. rainfall	Intended to capture 70-80% of annual runoff volume in an attempt to improve water quality.	Used by many municipalities. Some studies have shown that capturing the first ½ in. of runoff will control 70% of the annual runoff.	DeWiest and Livingston, 1999
1-in. rainfall	Intended to capture 90% of annual runoff volume in an attempt to improve water quality.	Replacing ½ in. as basis for water quality control. Some studies have shown that capturing the first 1 in. of runoff will control 90% of the annual runoff.	MDE, 2000
1-yr	Intended to capture sufficient runoff volume to improve water quality and provide down stream channel protection.	Used by some municipalities for water quality management and is based on the supposition that the channel-forming event is the annual storm. Maryland is now using for channel protection. Studies, particularly in humid regions, indicate that this may be insufficient to control downstream channel impacts (see next comment under 2-yr storm).	MDE, 2000
2 -yr	Intended to provide protection from accelerated channel erosion and for habitat protection.	Used by many municipalities. Limited field monitoring indicates that the strategy is flawed, as increased volume in post-development runoff results in pond discharges at flow rates near the peak discharge for much longer times than in the predevelopment state. This results in more erosion over the storm duration which subsequently result in wider and deeper channels than in the predevelopment state, even though the peak flow rates for pre- and post-development are equal.	Leopold et al., 1964; McCuen et al., 1987; MacRae, 1996; Jones, 1997; Macted and Shaver, 1997
10-yr	Intended to provide flood protection from intermediate sized storm events by matching post-disturbed peaks to pre-disturbed peaks.	When used for on-site detention, flood control benefits are provided primarily to local areas with limited protection of larger downstream channels. In some cases there is increased potential for downstream flooding due to timing of runoff events. There is no geomorphic basis for the use of this storm.	Skupien, 2000; Ferguson, 1998; Debo and Reese, 1995
100-yr	Used for flood control protection from major storms; also used to maintain 100-yr floodplain limits.	When used for on-site detention, flood control benefits are provided primarily to local areas with limited protection of larger downstream channels. In some cases there is increased potential for downstream flooding due to timing of runoff events.	Skupien, 2000; Ferguson, 1998; Debo and Reese, 1995

Table 4-6 Qualitative Assessment of Peak Discharge Control Strategies: Physical Impact Category

Physical Impact Category	Control Strategy	Assessment
Increased flooding	Peak discharge control of 10- and 100-yr storms	Peak discharge strategy provides limited downstream control. In some cases, it aggravates downstream flooding condition. Requires coordinated permitting at watershed scale (Skupien, 2000; Ferguson, 1998, Debo and Reese, 1995).
Channel instability and erosion	Peak discharge control of 2-yr storm	Geomorphic theory and limited field monitoring indicate that this strategy does not work (McCuen et al., 1987, McRae, 1996).
Reduction in groundwater recharge and related issues	Not addressed by peak discharge control	Not Applicable
Increased sediment transport	Peak discharge control of 2-yr storm	Geomorphic theory and limited field monitoring indicate that this strategy does not work (McCuen et al., 1987, McRae, 1996).
Thermal impacts	Not addressed by peak discharge control	Not Applicable

Control of Increased Flooding

Land use changes and land development activities increase runoff quantity and cause downstream flooding and erosion, as has been recognized for several decades. This recognition has led many States, counties, municipalities and other government agencies to require onsite detention of this increased runoff with the objective of maintaining peak outflows from detention basins at levels equal to the predevelopment conditions. This requirement has become popular, since it can be applied during the development design and review process on a case-by-case basis without large-scale watershed analysis. Its popularity has led to the use of onsite detention and retention basins as standard features on many land development projects.

However, the limitations of peak discharge control strategies documented by Leopold and Maddock (1954) have been largely ignored. At the exact spot where a detention basin discharges through its outlet, it reduces the peak rate of storm flow, as can be shown conclusively from the laws of physics and applied hydraulics. This provides flood protection in the channel below the structure until the flows begin combining with other tributaries. From there downstream, a basin's effect on peak rate and flooding depends partly on how its discharge combines with the flow from other tributaries. In practice, on any given site, detention should be applied with caution and should be based on an appropriate downstream analysis.

Ferguson (1998) has provided a good example of this condition, as illustrated in Figures 4-5 and 4-6. Figure 4-5 shows a small development site discharging into the main stem of a larger watershed. As shown in Figure 4-6, the storm hydrograph from the development site is short and fast compared with that from the main watershed. Because the development site's flow drains out before the main watershed's peak arrives, it does not contribute to the magnitude of a flood downstream. But if detention is added to the developed site, outflow will be delayed, so that it overlaps onto the peak flow in the main stream and contributes to a new, higher combined peak flow.

One can imagine two detention basins on different sites in the same watershed constructed by different developers at about the same time. When hydrographs from the two basins combine downstream, their delayed flows combine in a way that has never existed before development and a larger flood may be created. Despite the knowledge that this can happen, numerous local governments are requiring every developer to reduce the peak rate during a design storm to its predevelopment level. The effect of this approach has been a random proliferation of small detention basins over urbanizing watersheds, none of which is designed with regard to its specific location in the drainage network. The potential conflict between a basin and its watershed, first identified by Leopold and Maddock (1954) has been confirmed by a number of more recent studies. Independent modeling studies throughout the U.S., including the studies listed below, have all confirmed that randomly sited basins have failed to provide downstream flood and channel protection:

- McCuen (1979) for a Maryland watershed
- Ferguson and Debo (1991), Ferguson (1995), and Hess and Inman(1994) for watersheds in Colorado, Georgia and Virginia
- Debo and Reese (1992) for watersheds in North and South Carolina
- Skupien (2000) for a watershed in New Jersey.

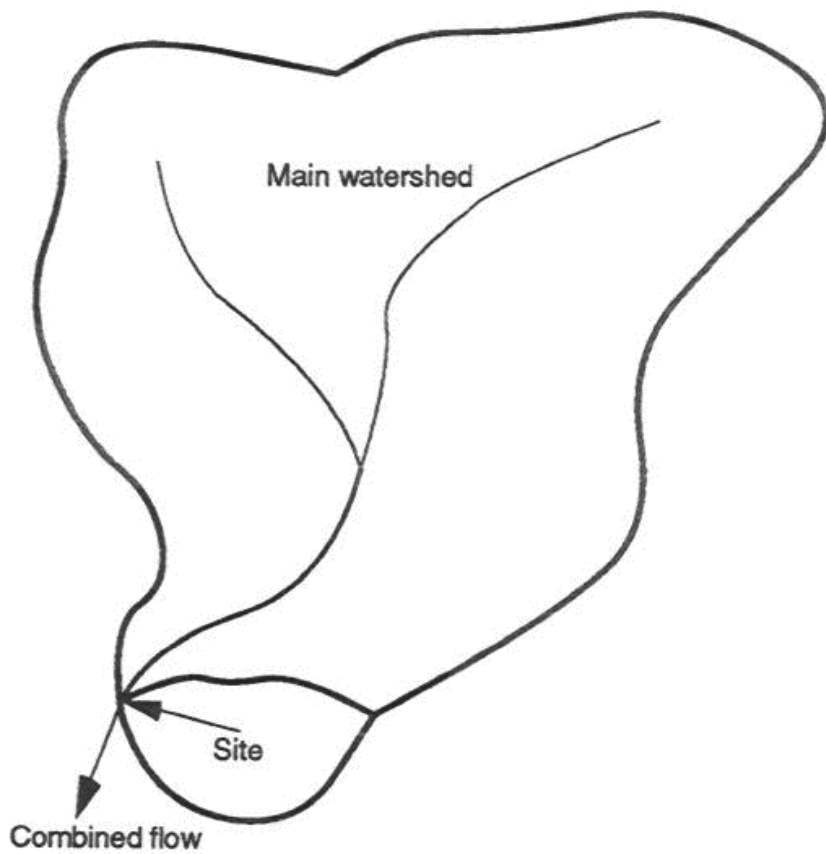

Figure 4-5 A watershed where the drainage from a small development site joins the flow from large watershed (Ferguson, 1998).
 Reprinted with permission of John Wiley & Sons, Inc.

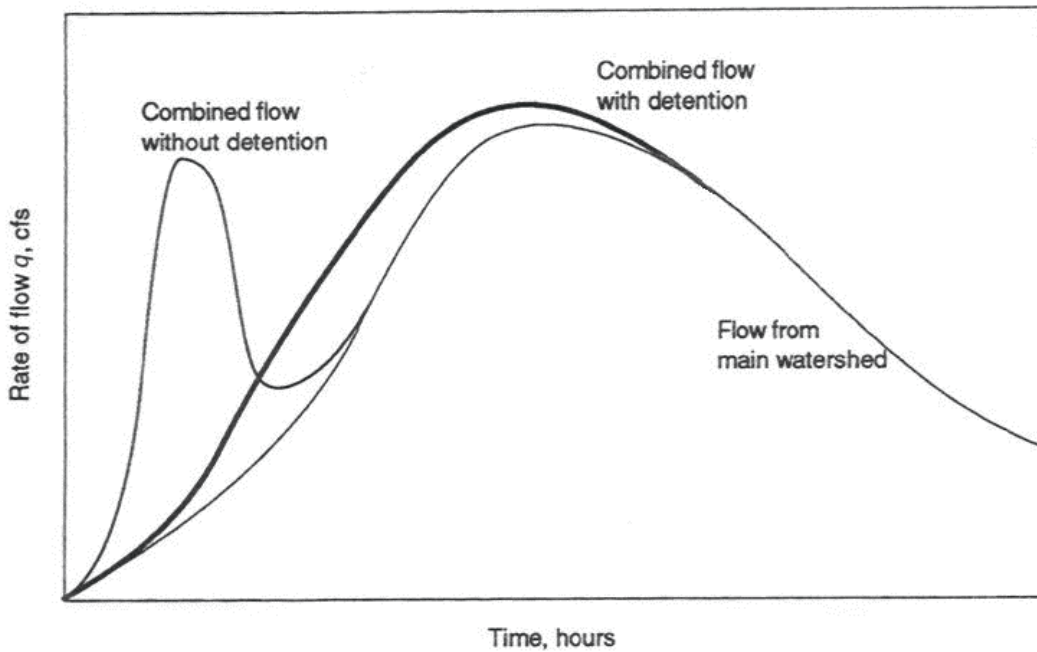

Figure 4-6 Alternative hydrographs from the watershed shown in Figure 4-5 (Ferguson, 1998)
 Reprinted with permission of John Wiley & Sons, Inc.

Enough studies have been conducted and reported that the following generalizations can be drawn from them:

- Some watershed-wide systems of detention basins help, in the sense that they keep downstream peak discharges during a given storm lower than it would be without them.
- Other individual basins do the opposite of lessening the discharge; they actually increase downstream peak discharges as a result of the overlapping of their detained volumes with mainstream peaks.
- No watershed-wide system of uniform basins works to the extent for which they were designed. If they were designed to reduce peak discharges during a given storm to predevelopment levels then their aggregate effect, although it may result in a reduction in peak discharge, is usually not a reduction to the designed degree because of the accumulation of runoff volumes downstream.

Detention basins can reduce flood peaks - when they are selectively located in their watersheds as explained by Leopold and Maddock (1954). Selective planning of publicly financed reservoirs led to the effective flood control for the Miami River in Ohio, when the Miami Conservancy District (USDA, 1951) identified specific flood hazards in Dayton and other cities; the District then located a combination of multiple-purpose reservoirs, levees and channels to work in concert to reduce flood damage at those points.

In an attempt to improve the performance of dry detention basins in the control of downstream flooding, the use of extended detention is proposed. For example, ASCE/WEF (ASCE, 1998) proposed that “mean” to the “maximized” storm volume be stored and released slowly in order to control downstream flooding and damage to the channel.

Downstream Analysis

The issue of downstream analysis is often not addressed by local stormwater management ordinances. Debo and Reese (1992) conducted studies for the City and County of Greenville, SC and Raleigh, NC to demonstrate how such a policy could be developed. This study used a hydrologic-hydraulic computer model to analyze the downstream effects of storm runoff from developments of different size, shape, physical characteristics and location within larger drainage basins. The study also examined different size flood events and different types of downstream drainage systems. The results of this study are shown in Figure 4-7, which revealed that the effects of the development process stabilizes at the point where the proposed development represents 5-10% of the total drainage area, depending on the size of the development and the amount of increased impervious area. This analysis was used as the basis for the formulation of the following policy concerning downstream impacts (Debo and Reese, 1992):

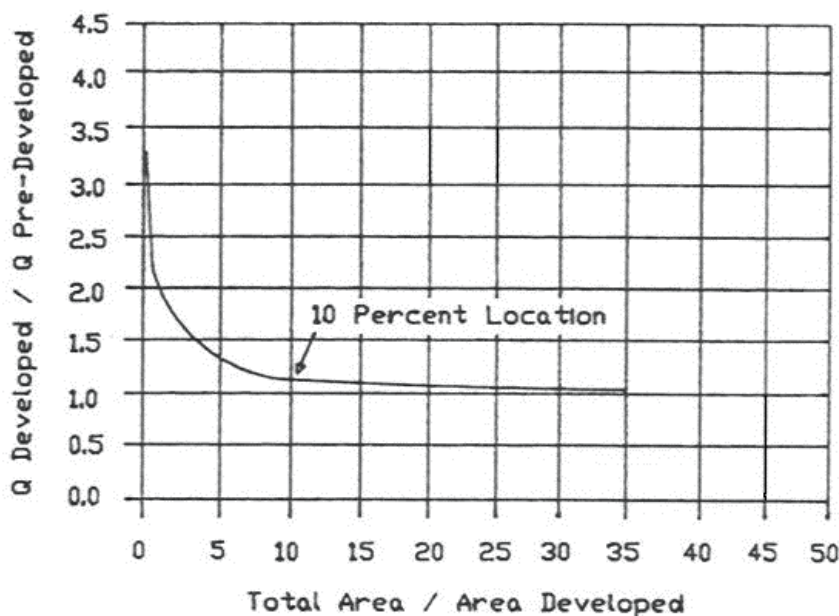

Figure 4-7 Determining Downstream Analysis Limits (Debo and Reese, 1992)

Reprinted with permission, originally presented in Novatech'1992.

“In determining downstream effects from stormwater management structures and the development, hydrologic-hydraulic engineering studies shall extend downstream to a point where the proposed development represents less than 10% of the total watershed draining to that point.”

In developing a downstream analysis, issues that need to be addressed include: determining an appropriate design storm and developing modeling efforts that could indicate whether the release rate for some BMPs should be increased above the pre-disturbed rate, or that no peak rate reduction is needed. Procedures for dealing with these controversies would need to be developed and would vary on a case-by-case basis. Obviously, this procedure cannot be a blind substitute for current policy, but will need to be approached with careful planning.

Channel Instability, Bank Erosion and Sediment Transport

A related issue associated with the peak discharge control strategy is the well-documented problem of increases in the frequency and duration of stormwater discharges. Peak discharge control strategies using detention ponds do not eliminate runoff, they simply delay it. The volume discharging from a detention basin is the same as the inflow. When the post development volumes from different tributaries join downstream, there is nothing to prevent them from combining to produce inadvertently high peak rates. In the fortunate cases in which flood peaks are consistently reduced, the receiving streams may still erode and become unstable because in accommodating the increased volume of runoff, relatively high erosive flows still pass through for longer periods (McCuen, 1987). As demonstrated by McCuen (1987), the practice of detaining the extra volume of stormwater runoff and discharging it at pre-construction peak discharge rates until the extra volume is fully dissipated has the result of creating more in-stream erosion than if no stormwater control were present. This occurs when the selected design storm focuses predominately on downstream flood control and not on in-stream erosion (channel protection) and the protection of aquatic habitat and biology.

Frequency and Duration Issues

Since land development increases the volume of stormwater runoff, impacts to the receiving waters can include increased peak discharges and volumes of runoff. The result is an increased erosion and sediment load capacity that results in erosion within streams and the prolonged flooding of higher elevations until stream geomorphology (i.e., an increase in stream cross-sectional capacity) stabilizes with the altered hydrology. These sediment loads are responsible for degraded receiving water quality. Because most regulations nationwide control water quality from land development sites but overlook impacts to receiving waters, the receiving water impacts to water quality are overlooked in land development design.

Reduction in Groundwater Recharge and Related Issues

Peak discharge control strategies are often referred to as end-of-pipe control strategies because they typically make use of small BMP ponds placed at the low topographic point on development sites. This approach does not usually address groundwater recharge and related issues, such as lowering of groundwater levels and reduction or loss of base flows in small streams. There are two exceptions to this general case. One is where infiltration ponds are used as the BMP. The other exception to this condition consists of recent initiatives in the State of Florida, where stormwater management ponds are being used as sources of gray water for lawn watering. This initiative is in part a response to the alarming lowering of water tables in many areas of Florida.

Thermal Impacts

A negative consequence of the peak discharge control strategy and the associated use of pond BMPs is the associated increase in thermal warming of runoff waters. The problem is particularly acute in regions of the country that support cold-water habitat, particularly trout and salmon fisheries.

Peak Discharge Strategies and Control of Chemical Impacts

Table 4-7 provides a brief qualitative assessment of the effectiveness of peak discharge strategies with respect to the chemical impact category. Pollutant removal is not addressed directly by peak discharge control strategies. However, BMPs designed for peak discharge reduction can have some impact on removal of nutrients and other chemicals. Water quality control designs are focused more on the annual volume of runoff rather than peak storm events. Some water quality control can be rendered by management of the smaller storm events, such as the 1-in. rainfall events and smaller storms that typically account for approximately 90% of the annual rainfall and runoff volumes. This indirect method does not give a direct indication of the effectiveness of controlling effluent loadings and concentrations, and must be calibrated on a local basis if design is being made for a specific effluent load or concentration limitation. It

should be pointed out, however, that many of the older detention facilities used for peak discharge control include low flow pilot channels that allow these frequent storm events to flow through the facilities with little or no management.

Table 4-7 Qualitative Assessment of Peak Discharge Control Strategies: Chemical Impact Category

Chemical Impact Category	Control Strategy	Assessment
Sediment	Pollutant removal not addressed directly by peak discharge control strategy, however, pond BMPs can be designed to provide pollutant removal (works better when targeting small storms, one in. of rainfall is optimum)	Peak discharge control is not required for pollutant removal. Volume control and peak discharge strategies can be combined in pond BMPs. Removal rates of 47-80% reported for ponds and wetlands. Median effluent concentrations from 17 to 28 mg/L reported.
Nutrients		TP removal rates of 19-51% and effluent concentrations of 0.11 to 0.20 mg/L reported for pond and wetland BMPs. TN removal rates of 25-33% and effluent concentrations of 0.86 to 1.7 mg/L reported for pond and wetland BMPs.
Metals		Cu removal rates of 26-57% and effluent concentrations of 5 to 9 µg/L reported for pond and wetland BMP. Zn removal rates of 26-66% and effluent concentrations of 30 to 98 µg/L reported for pond and wetland BMPs
Oil and grease		Removal rates of 3-85% reported for ponds and wetland BMPs.
Pathogens		Wetland systems controlling for peak discharge can remove some pathogens, although removal is limited.
Organic carbons		Removal rates of 44-78% reported for ponds and wetland BMPs.
MTBE		Not Applicable.
Herbicides/pesticides		Not Applicable.
Deicers		Not Applicable.

Peak Discharge Strategies and Control of Habitat and Biological Impacts

With respect to the habitat and biological impact categories, the major areas of impairment included: impairment or loss of habitat, reduction or elimination of biologic species, and proliferation of invasive species. Table 4-8 provides a brief qualitative assessment of the effectiveness of peak discharge strategies with respect to the habitat and biological impact category.

Table 4-8 Qualitative Assessment of Peak Discharge Control Strategies: Habitat and Biological Impact Categories

Habitat and Biological Impact Category	Control Strategy	Assessment
Impairment or loss of habitat	Peak discharge of design storms (100-, 10-, 2-yr)	BMP systems designed to control peak discharge are not protective of biological habitats. (Jones, 1997; Macted, 1997; Stribling, 2001)
Reduction or elimination of biological species	Peak discharge of design storms (100-, 10-, 2- yr)	BMP systems designed to control peak discharge are not protective of biological habitats. (Jones, 1997; Macted, 1997; Stribling, 2001)

Assessment of Current Water Quality Control Strategies

Water quality control of urban runoff is still a relatively new and developing technology. Section 2 documented the current status of regulatory requirements regarding water quality control. The EPA does not currently have specific concentration levels, numeric or quantitative, for water quality control for urban runoff. This situation may change in the future as effluent limitation guidelines are promulgated. In the interim, EPA leaves it up to the States and local municipalities to determine the level of protection included in the SWPPPs.

During the original drafting of this document in 2001, 38 States did not have specific requirements for water quality control in stormwater management. The States that do have water quality control requirements usually specify one of two: 1) control of a given volume of runoff (1/2 to 1.0 inch) or 2) a percentage removal rate for one or more pollutants (80% SS is the most frequently used). Typically States require that the runoff volume be computed but assume that all approved BMPs will meet the targeted removal goals.

There are certain situations, such as the conduct of watershed-wide water quality management plans or the development of water quality retrofit plans for combined sewer areas in which one would like to have a more detailed and precise approach to designing BMPs, particularly settling facilities such as large ponds, to achieve a targeted level of water quality management. Specific guidance for this type of water quality design is provided in Volume 2 for vegetative biofilters BMPs and Volume 3 for pond BMPs.

Pollutants and Sources

Land development generates pollutants from traditional point sources, such as wastewater, and from more diffuse sources, such as stormwater runoff. The CWA has had stringent controls in force for decades to control point source discharges through the NPDES program. The diffuse sources are controlled in part by NPDES stormwater programs, which involve less rigorous controls. A summary of pollutant yields on an annual basis and as EMC are given in the following subsections. Some of these pollutants are released at concentrations in excess of the woodland conditions that existed at some time prior to construction. Pollutants typically include nutrients, bacteria and heavy metals. Other pollutants are new to the receiving waters, such as forms of volatile synthetic materials. Various petroleum products and additives are also new to many receiving waters. Additional pollutants can also include trash, sediment loads, temperature, and even non-native and invasive biological species.

Except for nutrients, the summarized data show that concentration of pollutants in stormwater runoff can be comparable to treated domestic wastewater. When the concentration is multiplied by the large quantity of water in runoff, the total loading from urban areas can be greater than that in treated domestic sewage. Thus, when untreated urban runoff is discharged directly into receiving waters, the pollutant loads can be much greater than those from treated domestic sewage and are rightfully a matter of concern (EPA, 1999).

Pollutant Concentrations and Loadings

The BMP designer may find it helpful to develop an estimate of the pollutant concentrations and loadings for the constituents of concern on his project. Two general situations, or a combination of the two, may be encountered in design. The first case occurs when a designer is planning a new facility on previously undeveloped land and wishes to make an estimate of anticipated pollutant loads after the development is built. This situation will require that the designer develop estimates on anticipated pollutant concentrations from similar land uses. This can be accomplished by collecting data from similar land use or by using the available pollutant concentration data for similar land uses.

The second situation occurs when the BMP design consists of a water quality retrofit for an existing developed area. In this case one can collect actual data for the existing land uses and their runoff. Because water quality monitoring is very expensive and time consuming, the designer may choose to develop estimates based on available data for similar land uses. The designer can also use a combination of the two approaches using limited storm monitoring and sampling to verify and calibrated modeling estimates.

There are three well-documented approaches for developing pollutant loading estimates from existing data: the NURP studies use of EMC, the nationwide regression equation method developed by the USGS (Tasker and Driver, 1988) and the simple method developed by the Metropolitan Washington Council of Governments (Schueler, 1987). These three approaches are summarized in Appendix D. The use of a process-based approach, i.e., the IDEAL spreadsheet (Hayes et al., 2001) is discussed in further detail in Volumes 2 and 3.

Pollutant Reduction Requirements

A strategy for controlling the mass of pollutants released into receiving waters is to require that a specified amount of the pollutant(s) of concern be removed from the stormwater runoff before it is discharged from the point of compliance. The reduction is commonly specified as a percentage reduction of the pollutant(s) of concern, and the compliance point will usually be the municipal separate storm sewer system (MS4) or final stormwater discharge location in the regulated subwatershed. Municipal pollution reduction standards may apply to the pollutant loads from impervious areas or from the entire developed area including open space and pervious areas. The pollution reduction strategy requires a specific reduction in the average mass of pollutant(s) of concern in discharges from the specified subwatershed. An example is the federal requirement to use EPA's guidance issued pursuant to the CZARA that specifies that urban runoff from a new and stabilized development site have 80% of the SS removed before it is discharged from the site. The CZARA example is a voluntary program and applies only to new land development in municipalities not covered by the NPDES Storm Water Program in coastal States. When calculating the average mass of SS, the CZARA considers only discharges generated by the 2-yr, 23-hour frequency storm or smaller storms.

Implementing the pollution reduction strategy requires knowledge of the preconstruction and post development average mass of pollutant(s). This is usually accomplished by using pollutant loading factors from a developed site or EMCs from sites that are comparable to a proposed development site. It is possible to conduct long-term monitoring to determine the mass of preconstruction pollutants, but the post development masses need to be estimated so that stormwater management controls can be designed and permitted. Post development monitoring is not usually required or implemented as part of the permit approval process, though some municipalities are beginning to require post development monitoring. The stormwater management controls that are proposed for a site development are designed and approved by permitting agencies based on the best available knowledge. Once the design is approved by the permitting agency and constructed as designed, developers are not usually expected to retrofit stormwater controls if monitoring determines that they do not achieve the expected pollutant reduction goal.

The pollution reduction strategy is an effective means of reducing the mass of new and additional pollutants arising from land development activities. It also specifies a goal to be achieved without mandating the specific controls that to are be used. The strategy is generally considered to be effective if the regulating municipality selects an achievable pollutant reduction, and ensures that the stormwater controls are properly selected, designed, constructed, operated and maintained.

There are several limits to the effectiveness of this strategy in achieving desired water quality protections. Four of these are presented below:

1. Total pollutant loads and maximum concentrations arising from a single storm event may exceed desired levels.
2. The strategy is designed to control pollutants discharged from a development site. It does not explicitly require protections at the receiving waters, so discharges from numerous development sites could combine to exceed desired pollutant masses in receiving waters.
3. The reduction goal needs to be generic to accommodate the variety of site conditions in a municipality. Pre construction effluent characteristics and receiving water requirements will vary across a municipality as will post development characteristics. Criteria and standards developed to control water quality pollution from the broad range of environmental conditions present could be too lenient in some cases and too strict in others.
4. The pollutant removal efficiencies of stormwater technologies are not well defined. Existing guidance on the design of stormwater controls typically includes a broad range of pollutant removal efficiencies that is a result of the monitoring methods used to collect and analyze effectiveness data, site and seasonal variability, and other factors. This range in reported effectiveness leads to uncertainties in the selection and design of the treatment processes to be used to meet the pollutant reduction goals.

Some of these concerns are being addressed by ongoing investigations and innovative approaches that are being developed and tested by some municipalities. For example, evaluating compliance with the pollutant reduction strategy may entail a subjective judgment because monitoring standards and guidance generally are not well documented and implemented. A continuing study jointly funded by the ASCE and EPA seeks to provide tools that describe stormwater control monitoring and expand a database that can be used to estimate stormwater control effectiveness. This project has resulted in the development of the ASCE/EPA BMP Database web site, which can be accessed at: <http://www.bmpdatabase.com>. Some graphical results from this ongoing project are presented in Appendix E. Several municipalities and professional organizations are also studying the impacts of pollutant loads on receiving water quality and aquatic biology. These studies are expected to define and refine the understanding of and relationship between development activities, stormwater controls and receiving water responses.

Despite presently available BMP performance data that can indicate general performance levels and ranges and active programs that will in time improve our understanding, pollutant reductions that will result from any particular BMP design based on parametric models cannot be predicted with a high degree of accuracy. Emerging first principal physics-based models may be able to better predict removals, however the input data to these models is not as well developed as is needed.

Not-to-Exceed Concentration Requirements for New Development

Another strategy designed to prevent short- and long-term harm to humans and the environment is to specify that pollutants of concern in stormwater discharged at the MS4s from developed sites cannot exceed specified concentrations. A number of States and municipalities have established maximum permissible concentration criteria

and standards for pollutants such as SS or turbidity, and some have also developed criteria and standards for nutrients, oil and grease, metals and other pollutants. While these concentrations are typically specified at the MS4 discharge locations from developments, States or municipalities may require that the development activity not cause impacts to receiving waters that exceed minimum concentrations of some parameters such as dissolved oxygen.

By requiring that pollutants in stormwater effluent not exceed a predetermined concentration, municipalities can control worst-case conditions. As commonly implemented, such a requirement does not prevent the average pollutant load released from a development site from exceeding pre-construction conditions. The design of structures that achieve these controls is subject to the same degree of uncertainty as described above for the percentage reduction strategy, but the not-to-exceed concentration strategy gives the governing municipality a ready means (i.e., effluent monitoring) of ensuring that its goal is met and puts the responsibility on the developer to properly design and retrofit, if necessary, the stormwater controls needed to achieve the effluent concentration requirements. Another drawback to the strategy is that establishing concentration limits is based on the existing understanding of how water quality and aquatic biology respond to changes in pollutant loads. The current understanding is an estimate of both the ability of the receiving water to accommodate changes in pollutant loads and the impacts that aquatic biology can withstand in the short- and long-terms.

Water Quality Control Strategies and Control of Physical Impacts

In the physical impact category, the major areas of impairment or change to the use of the receiving waters are:

- increased flooding
- channel instability and erosion
- reduction in groundwater recharge and related issues
- increased sediment transport
- thermal impacts.

Table 4-9 provides a brief qualitative assessment of the effectiveness of water quality control strategies with respect to the physical impact category.

Table 4-9 Qualitative Assessment of Water Quality Control Strategies in the Physical Impact Category

Physical Impact Category	Control Strategy	Assessment
Increased flooding	Not a water quality control strategy	Not applicable
Channel instability and erosion	Not a water quality control strategy	Not applicable
Reduction in groundwater recharge and related issues	Capture and treat first flush, or 1-yr, 2-yr or larger design storm volumes using infiltration practices	Generally designed for groundwater or peak discharge control, but can be effective in removal of phosphorus, particulate matter, some pathogens and other pollutants.
Increased sediment transport	Percentage load reduction or maximum effluent limits	Effectively reduces sediment loads of overland flow, with effectiveness decreasing as finer particle loads increase.
Thermal impacts	Capture and treat first flush, or 1-yr, 2-yr or larger design storm volumes	Increased exposure to warm, impervious surfaces and solar radiation of retained stormwater increases water temperatures.

Water Quality Control Strategies and Control of Chemical Impacts

In the chemical impact category, the major areas of impairment or change to the use of the receiving waters are:

- sediment
- nutrients
- metals
- oil and grease
- pathogens
- organic carbon compounds
- MTBE.

Table 4-10 provides a brief qualitative assessment of the effectiveness of water quality control strategies in the chemical impact category.

Water Quality Control Strategies and Control of Habitat and Biological Impacts

In the habitat and biological impact category, the major areas of impairment or change to the use of the receiving waters are:

- impairment or loss of habitat
- reduction or elimination of biologic species
- invasive species.

Table 4-11 provides a brief qualitative assessment of the effectiveness of peak discharge strategies with respect to the habitat and biological impact categories.

Table 4-10 Qualitative Assessment of Water Quality Control Strategies in the Chemical Impact Category

Chemical Impact Category	Control Strategy	Assessment
Sediment	First flush, design storm volume,	Pollutant loads are reduced by these methods, though generally not to predevelopment conditions; the BMPs chosen can have a wide range of effectiveness based on treatment technology and site conditions.
Nutrients	percentage reduction and/or maximum effluent	See above. Biological processes that remove pollutants can be affected by seasonal changes. Attraction of pet and wildlife to some water control structures can increase nutrient loads.
Metals	limitations, and pollution prevention	Similar to sediment control, effective in removing particulate metals but not dissolved metals, unless cation filtering processes are employed.
Oil and grease		Structural BMP applications, such as oil/water separators, are ineffective due to lapses in maintenance and operation.
Pathogens		Not generally a focus of stormwater controls other than through pollution prevention techniques and disconnection of illicit discharges, which can effectively protect human health if consistently applied.
Organic carbon compounds		Total petroleum hydrocarbons (TPH) and hazardous material contaminants are controlled by other regulations and, except for TPH, are generally not present in stormwater runoff in large quantities. Pollution prevention techniques are effective at reducing but not eliminating this pollutant.
MTBE		Not readily removed by standard control strategies and breakdown products can be more detrimental than MTBE.
Herbicides and pesticides		See organic carbons. In high concentrations, these pollutants can degrade or remove biological processes that remove other pollutants, such as nutrients and organic carbons.
Deicers		Not effective in removing roadway deicers, which are highly soluble materials. Recovery systems such as those used at airports are effective but not applicable to most urban runoff situations.

Table 4-11 Qualitative Assessment of Water Quality Control Strategies in the Habitat and Biological Impact Categories

Habitat and Biological Impact Category	Control Strategy	Assessment
Impairment or loss of habitat	First flush, design storm volume, percent reduction and/or maximum effluent	Water quality is a component of habitat and species stress. Treatment processes are available to treat most on-site pollutants of concern (nutrients, metals and sediment). Deicers require special pollution prevention practices that are not common on highway treatment systems.
Reduction or elimination of biological species.	limitations, and pollution prevention	
Invasive species		

Section 5 BMP Types and Selection

This section provides a brief review and summary of the major BMP types and the factors that govern the selection of the appropriate BMP for a specific site. Guidance is provided on the following elements of BMP selection:

- BMP types
- removal processes occurring in treatment BMPs
- BMP selection
- impact area and design objectives
- on-site versus regional
- watershed factors
- terrain factors
- physical suitability factors
- community and environmental factors
- location and permitting factors.

BMP Types

BMPs for control of urban runoff can be generally grouped into two major categories that include; 1) source control BMPs and 2) treatment control BMPs. Source control BMPs are practices that prevent pollution by reducing potential pollutants at their sources before they come into contact with stormwater, while treatment controls, as the name implies, are methods to treat or remove pollutants from stormwater (ASCE, 1998). Table 5-1 provides a listing of source control BMPs, and Table 5-2 provides a listing of treatment control BMPs and whether or not guidelines are provided in this series of documents.

Table 5-1 Listing of Source Control BMPs

MAJOR CATEGORIES	SOURCE CONTROL PRACTICE
A - Public Education	A1 - Public Education and Outreach
B - Planning and Management	B1 - Better Site Planning
	B2 - Vegetative Controls
	B3 - Reduce Impervious Areas
C - Materials Handling	C1 - Alternative Product Substitution
D - Street / Storm Drain Maintenance	D1 - Street Cleaning
	D2 - Catch Basin Cleaning
	D3 - Storm Drain Flushing
	D4 - Road and Bridge Maintenance
E - Spill Prevention and Cleanup	E1 - Above Ground Tank Spill Control
F - Illegal Dumping Controls	F1 - Storm Drain Stenciling
	F2 - Household Hazardous Waste Collection
	F3 - Used Oil Recycling
G - Illicit Connection Control	G1 - Illicit Connection Prevention
	G2 - Illicit Connection Detection and Removal
H - Stormwater Reuse	H1 - Landscape Watering
	H2 - Toilet Flushing
	B4 - Disconnect Impervious Areas
	B5 - Greenroofs
	C2 - Housekeeping Practices
	D5 - BMP Maintenance
	D6 - Storm Channel and Creek Maintenance
	E2 - Vehicle Spill Control
	F4 - Illegal Dumping Controls
	G3 - Leaking Sanitary Sewer Control

Table 5-2 Treatment BMPs

MAJOR CATEGORIES	TREATMENT BMPs	GUIDELINES PROVIDED
A - PONDS	A1 - Extended Detention Basin (Dry)	Yes
	A2 - Retention Pond (Wet)	Yes
	A3 - Wetland Pond	Yes
	A4 - Infiltration Pond	Yes
B - WETLANDS	See A3	Yes
C - INFILTRATION	C1 - Infiltration Trench	No
	C2 - Infiltration Pond (See A4)	Yes
	C3 - Permeable Pavements	No
	C4 - Bioretention	Yes
D - VEGETATIVE BIOFILTERS	D1 - Grass Swales (Wet, Dry)	Yes
	D2 - Filter Strip / Buffer	Yes
	D3 - Bioretention	Yes
E - FILTERS	E1 - Sand Filter	No
	E2 - Perimeter Filter	No
	E3 - Media Filter	No
	E4 - Underground Filter	No
F - OTHER	F1 - Inlet Filters	No
	F2 - Others	No

A combination of source controls and one or more treatment BMPs, i.e. a treatment train approach, may be needed to meet design objectives, depending on the stormwater management goals and objectives identified for a specific site or area. The distinction between source controls and treatment controls is very clear in some cases, but less so in others. Street sweeping for pollutant removal is one BMP that could be considered either source control or treatment control. The use of vegetation to disconnect directly impervious surfaces such as rooftops, driveways, parking lots and streets, is another example of a BMP that could be a considered source or treatment control. Some of the newer concepts for urban runoff management, such as better site planning techniques (CWP, 1998) and LID technology (EPA, 2000a,b), focus on the use of planning techniques and micro scale integrated landscape based practices to prevent or reduce the impacts of urban runoff at the very point where these impacts would be generated. These approaches tend to have very close overlap between preventative source control approaches and small-scale treatment approaches that blur the distinction between these two types of BMPs.

This three-volume guidance document is focused primarily at selected treatment-type BMPs. Specifically, these guidance documents address two major groupings of treatment BMPs: 1) ponds and 2) vegetative biofilters. The ponds are clearly treatment BMPs, whereas by their nature some of the vegetative biofilters, particularly the vegetative buffer or filter strip, is one of the BMPs that bridges the definitions of source and treatment controls.

Historically stormwater management technology has focused more on the treatment type of BMPs, particularly pond BMPs. However the current trend in BMP technology, spurred by our growing awareness of the range and complexity of issues associated with our overall goals of maintaining the ecological integrity of our receiving waters, as mandated by the CWA, leans toward the use of integrated stormwater management approaches that include one or more source controls, as well as one or more treatment (i.e., treatment train) controls.

Removal Processes Occurring in Treatment BMPs

Several treatment technologies are used to treat nonhazardous stormwater runoff (runoff that is not controlled by the Comprehensive Environmental Response, Compensation and Liability Act [CERCLA], Resource Conservation and Recovery Act [RCRA], Federal Insecticide, Fungicide and Rodenticide Act [FIFRA], Oil Pollution Act [OPA] or related hazardous and controlled substances acts). The processes occurring in treatment BMPs (Table 5-3) include: settling, sorption, filtration, infiltration, biodegradation/bioassimilation, nitrification/denitrification, volatilization and phytoremediation. One or more of these treatment processes may occur in the treatment BMP systems to remove pollutants.

Table 5-3 Removal Processes Occurring in Treatment BMPs

Pollutant Constituents	Treatment BMP Type and Process Mechanism				
	Pond	Wetland	Infiltration	Biofilter	Sand Filter
Heavy Metals	Sorption Settling	Sorption Settling Phytoremediation	Sorption Filtration	Sorption Filtration Phytoremediation Settling	Sorption Filtration
Toxic Organics	Sorption Biodegradation Settling Phytovolatilization	Sorption Biodegradation Settling Phytovolatilization	Adsorption Filtration	Sorption Filtration Settling Phytovolatilization	Sorption Filtration
Nutrients	Bioassimilation	Bioassimilation Phytoremediation	Sorption	Sorption Bioassimilation Phytoremediation	Sorption
Solids	Settling	Sorption Settling	Sorption Filtration	Sorption Filtration Settling	Filtration
Oil and Grease	Sorption Settling	Sorption Settling	Sorption	Sorption Settling	Sorption
BOD ₅	Biodegradation	Biodegradation	Biodegradation	Biodegradation	Biodegradation
Pathogens	Settling UV (sunlight) Predation	UV (sunlight) Predation	Filtration	Filtration Settling	Filtration

Settling

Settling or sedimentation occurs when particles have a greater density than the surrounding liquid. The settling process in stormwater management is determined by the particle size and settling velocity, turbulence or short-circuiting, peak flow-through rate and volume of water (Stahre and Urbonas, 1990). Soil particles and SS are removed primarily through settling. In addition, because many of the other pollutants including nitrogen, phosphorus, metals and bacteria are attached or sorbed to the soil particles, these pollutants they are also removed from the water column.

Particle size directly affects the pollutant settling ability: the smaller the particle size, the longer it takes to settle. Conversely, the larger the particle, the faster its settling velocity is. Particle size, however, is not the only factor in settling ability. This relationship also depends on the difference between the density of the fluid suspending the particle and the density of the particle. Large, dense particles, such as sand, will fall through fluid at a faster rate than smaller, less dense particles, such as clay. The volume of particles suspended within the fluid also factors into this process. Stahre and Urbonas (1990) indicated that the more particles suspended within the fluid, the faster the rate of settling but at some point, the rate of settling will bottom out.

Turbulence, eddies, multilayered flows, circulation currents and diffusion at inlets and outlets affect the settling ability of particles. Each of these factors can resuspend particles into the water column. Kuo (1976) found that sedimentation would improve as flow-through rate and surface loading decreases. The difference was most significant for larger particles; however, this study did not go beyond the laboratory. Actual field conditions must take into account the particle settling velocity and surface loading rates during runoff conditions. Sediment removal under these conditions varies with storm intensity. The size of the body of water relative to stormwater runoff will also determine the settling ability of sediment. The larger the stormwater loading rate, the lower the removal of sediment by settling. Settling also occurs after stormwater is trapped and ponded between storms. Because the intervals between storm events are a random process, understanding the effective ratio of storage volume to mean runoff rate and the ratio of sediment volume removed to mean runoff rate is essential to predicting long-term averages.

The most widely used stormwater management practices that employ the sedimentation process are retention and detention structures such as ponds and constructed wetlands. These can be designed to effectively remove sediment from stormwater. Several factors are considered during the design processes: retention or detention features, detention time, storm intensity and duration, and return period of storms.

As described more fully in Volume 3, stormwater management basins with a permanent pool of water have a removal percentage of SS of about 50-90% (Wotzka and Oberts, 1988; Yousef et al., 1986; Cullum, 1985; Driscoll, 1983, Driscoll et al., 1986; MWCOG, 1983; OWML, 1983; Holler, 1989; Martin, 1988; Dorman et al., 1989; City of Austin, 1990). Extended detention ponds have a similar percentage of removal (MWCOG, 1983; City of Austin, 1990; OWML, 1987). Some researchers have found, however, that detention ponds will have lower sediment removal efficiency over the long term than retention ponds. This is because an opportunity exists for new storm flows to resuspend sediments deposited on the detention pond bed from previous storm events.

The typical detention time for detention basins in the U.S. is from 6 to 48 hours. The longer the detention time, the more time particles have to settle before the stormwater is discharged to the receiving water. The detention time must be long enough for the desired particulates to settle from the stormwater, yet the full volume of storage should also be available for the next storm event. Thus a 2-day period for the temporary storage and treatment of stormwater is the typical maximum period since this seems to balance the pollutant removal goals with the between-storm interval during the rainy season in many locations.

As mentioned earlier, the settling process can remove particulate materials and those dissolved materials that may sorb to settleable particles. However, the removal rate by settling of pollutants other than sediment particles is inconclusive. Part of the confusion is related to which removal process in a stormwater management structure is responsible for removing a pollutant. In retention ponds, for example, several processes occur simultaneously: settling, biological uptake, volatilization, infiltration to groundwater and sorption. While nitrogen, phosphorus and bacteria may be removed to some extent by sorption to larger particulates, this is not expected to be a primary mechanism for their treatment. Metals, however, are present in particulate and dissolved form and some metals species can be removed by coagulation and sedimentation.

With respect to speciation, recent runoff data from a heavily traveled highway site in Cincinnati, OH, indicate that, in general, cadmium, copper and zinc can be found substantially in dissolved form, depending on the storm event (Sansalone et al., 1994). For a series of five storm events, the event mean dissolved fraction ranged from 0.535 to 0.955 mg/L for zinc, from 0.446 to 0.964 mg/L for cadmium and from 0.310 to 0.713 mg/L for copper. In contrast, lead tends to be in the particulate form; the dissolved fraction ranged from 0.179 to 0.451 mg/L. Factors cited by Sansalone et al., (1994) that affect event-to-event variation in the dissolved fraction include rainfall pH and the average residence time of the runoff.

With respect to particle size fractions, a number of researchers have found that the smaller particles tend to be more mobilized during storm events and the concentration of metals to increase with decreasing particle size (Sartor et al., 1974). Recent highway runoff particle fraction data show that the surface area per unit of mass within different size fractions increases with decrease in particle size (Sansalone et al., 1994); thus metal concentrations would similarly increase with the smaller sized particles. On the basis of 13 monitored events from the highway runoff site in Cincinnati, the median particle diameter was about 570 Fm (Sansalone et al., 1994).

Filtration

The filtration process can remove sediment and other pollutants as stormwater passes through a filtering system. Existing media filtration practices commonly use trenches filled with sand or peat. Typically, stormwater filters remove particulates and adsorbed pollutants, such as sediment, organic carbon, phosphorus and many trace metals. Particulate pollutants are trapped by cation/anion exchange or are prevented from moving beyond the filter. In some cases, the filtration process can increase the pollutant level of stormwater. Filters that inadvertently become anaerobic and nitrify organic nitrogen can release ammonia and nitrate into stormwater. Once the treatment volume is achieved during a given storm the excess runoff bypasses the filter and is untreated.

Sorption

The clay and organic particles in soil hold negative charges. The ability of soil and organic matter to hold cations, such as phosphorus and aluminum, represent the soil's cation exchange capacity. This process is most readily used to

filter pollutants from stormwater. Organic matter, such as peat or leaf matter, in the filter media bind pollutants to the filter via cation exchange capacity. The treatment of all runoff through filter media (Stewart, 1992) and biofilters, such as the bioretention cell (Clar and Green, 1993 and Clar et al., 1993), are other examples of cation exchange processes. A shallow basin collects the runoff and gradually discharges through a filter media filled with planting soil, peat or composted leaf media. The media trap particulates (through filtration) and sorb organic chemicals, removing up to 90% of solids, 85% of oil and grease and 82-98% of heavy metals (through cation exchange from leaf decomposition) of stormwater that passes through the filter.

The extent to which a given metal is adsorbed is affected by a number of factors, including the competitive effects of other ionic metals, the presence of iron and manganese oxides, the presence of organic carbon and especially pH (Maidment, 1993). Treatment trains that include adsorptive media may provide effective treatment for dissolved metals. Such media include compost, granulated activated carbon or diatomaceous earth, all of which work on a cation exchange principle. Pilot laboratory testing of different filter media conducted by Robert Pitt at the University of Alabama/Birmingham show the following removal efficiencies (Pitt et al., 1995):

- sand filter-45% (zinc)
- composted leaves-88% (zinc), 67% (copper)
- peat moss-80% (trace metals in general).

Phytoremediation

Plants break down organic pollutants through their metabolic processes. Aquatic plants have been used to treat wastewater and constructed wetlands have been used to treat farming effluent and mining runoff. Phytoremediation refers to the use of plants to degrade, sequester and stabilize organic and metal pollutants in stormwater. Plants are able to volatilize contaminants (volatile organic compounds) from soil or water via phytovolatilization. More recently, the bacterial activity associated with the roots of grasses and other plants has been explored for its organic degradation potential. The efficiency of phytoremediation varies and depends on the depth of soil and the type and species of pollutants in water that are most available for plant uptake.

Designing Using Treatment Train BMPs

Targeted effluent quality from BMPs can usually be achieved using a series of BMPs in a treatment train. This can apply to new designs as well as to retrofit existing BMP facilities. An example of a four stage design is to have filter strips drain to swales that convey the stormwater to a retention pond that has a forebay.

A treatment train BMP process should be capable of achieving the targeted effluent quality concentration or degradation in the designed treatment system. Effectiveness may be assessed in terms of a specific stressor of concern (e.g., flow, nutrients, pathogens, sediment or toxics) or groups of pollutants. If there are no existing pollutant removal or water quality control measures currently being implemented, and the planned BMP provides a certain degree of treatment, the BMP system may be considered effective by default. Furthermore, the designed BMP treatment train (or multi-tiered approach) should achieve a minimum level of pollutant reduction to produce effluent water quality parameters that comply the regulatory requirements. Otherwise the recommended BMP treatment system should not be considered effective.

Pretreatment is recommended where the site has sufficient space to reduce incoming velocities and capture coarser sediment particles in order to extend the design life and reduce replacement maintenance of the primary BMP downstream. The pretreatment method may include a vegetative filter strip, swale or may incorporate other techniques to aid in extending the design life of the primary BMP. Historically, the primary purpose of vegetated filter strips has been to enhance the quality of stormwater runoff on small sites in a treatment system approach, or as a pretreatment device for another BMP. The dense vegetative cover facilitates conventional pollutant removal through detention, filtration by vegetation, sediment deposition, infiltration and adsorption in the soil (Yu and Kaighn, 1992). Vegetated filter strips may be used as a pretreatment BMP in conjunction with a primary BMP. Retention and detention basins should be designed to promote sediment deposition near the point of inflow. A forebay with a volume equal to approximately 10% of the total design volume can help with maintenance of the basin and extend the service life of the remainder of the basin. Pretreatment reduces the sediment and particulate pollutant load that could

reach the primary BMP, which, in turn, reduces the BMP's maintenance costs and enhances its pollutant removal capabilities.

The extended detention concept was introduced to overcome the limitations of early detention pond strategies and provide more and better control of the smaller and more frequent storm events that were unaffected and just passed through the basin. Basically, extended detention refers to designing or retrofitting the outlet so that these smaller storms that pass through ponds designed for larger storms without being detained are now detained for longer periods than they would otherwise be held. With relatively simple modifications to the outlet control structure, trapping of particles with significant settling velocities could be enhanced. The extended detention approach can provide extended detention of 6, 12, 24 or 48 hours, which provides longer holding times, increased removal for particulates with lower settling velocities, and thus higher pollutant removal performance. The ASCE/WEF design manual recommends emptying the entire volume over a 24 to 48 hour time period (ASCE/ WEF, 1998); the longer emptying time increases SS removal.

Because of the poorly documented stormwater pollutant control effectiveness of flood control detention basins, these controls cannot themselves be recommended as viable water quality control measures (Moffa et al., 2000). However, detention basins can be very effective when used in conjunction with other stormwater control practices. At a minimum, a two-stage basin is preferable for extended detention basins. The lower stage typically has a micropool that fills frequently. This reduces the periods of standing water and sediment deposition in the remainder of the basin. This recommendation does not necessarily apply to large, regional extended detention basins, and the impact of these considerations varies with climate and soil types.

BMP Selection

There are a number of factors and considerations that can help to identify the appropriate BMP or combination of BMPs to address the design objectives for a given site or watershed. These factors can be organized into a number of groupings that are listed below:

- impact area and design objectives
- onsite versus regional controls
- watershed factors
- terrain factors
- stormwater treatment suitability
- physical feasibility factors
- community and environmental factors
- locational and permitting factors.

Some general guidance for each of these major groupings is provided in Section 5.3.

Impact Area and Design Objectives

Section 1 of this volume identified and grouped the major impact areas associated with urban stormwater runoff. These major areas of impact included:

- physical impact areas
 - flooding
 - channel erosion
 - ground water recharge and base flow maintenance
 - thermal (increase in stream temperatures)
- chemical impact area
- habitat and biological impact areas.

In addition, in Section 3, the requirements of the Federal, State and local agencies were summarized. Clearly different regions of the U.S. and the local governments within these regions have differing needs and issues that lead them to adopt stormwater management goals and objectives that are appropriate for their specific needs. This

document does not attempt to define what an appropriate level of stormwater management is for any given area, or what design goals and objectives should be used. Rather, this manual recognizes that different levels of stormwater management performance goals and objectives exist and tries to provide guidance on how to address and select the BMPs that are appropriate for a given design objective. A series of tables, Table 5-4 thru 5-8, summarize the available data either qualitative or quantitative that documents the ability of major BMP groups listed in Table 5-2, to address the technical issues associated with the three major impact areas (Clar et al., 2001). It should be noted that most BMPs currently in place and evaluated were not designed to address geomorphic criteria, thermal impacts or specific habitat or biological impacts, so it should come as no surprise that the older BMPs are not accomplishing these goals.

Table 5-4 Summary of Studies on Environmental Impacts for Post-Construction BMPs Category A – Stormwater Ponds

BMP	Chemical Impacts	Physical Impacts	Habitat and Biological Impacts
Wet (Retention) Pond	Over 33 studies reporting on the effectiveness of wet ponds at reducing/removing SS, TP, TN, OP, NO ₃ , metals, bacteria (ASCE, 2000; CWP, 2000)	Implementation of BMPs has been largely ineffective in controlling the physical impacts on the stream channel resulting from urbanization. Ponds usually do not provide groundwater recharge. Ponds can provide peak discharge control, but sometimes increase downstream flooding.	Structural stormwater practices have little or no ability to mitigate the adverse impacts of urban stormwater runoff on the macro invertebrate community. Ponds pose a risk to cold water systems because of their potential for stream warming.
Extended Detention Basin	Over 24 studies reporting on the effectiveness of dry/extended detention basins at reducing/removing SS, TP, TN, OP, NO ₃ , metals, bacteria (ASCE, 2000; CWP, 2000)		

On-Site Versus Regional Controls

The decision of whether to use an on-site or a regional approach can have a strong influence on the selection of the BMP type. Some treatment BMPs, such as ponds and wetlands, can be used either as stand-alone on-site treatment controls or as part of regional controls for stormwater management. Others, including swales, filters strips, infiltration and percolation, media filters, oil and water separators, are designed only for on-site use. Within the on-site use group, there is a new subset of emerging practices referred to as micro-scale multi-functional management practices that are intended to be integrated into a site’s landscape. Many of the onsite practices such as the swale and filter strips fall within this group, as well as some new biofilter practices such as the bioretention cell.

Table 5-5 Summary of Studies on Environmental Impacts for Post-Construction BMPs Category B – Stormwater Wetlands

BMP	Chemical Impacts	Physical Impacts	Habitat and Biological
Pond-Wetland System	11 studies reporting on the effectiveness of pond/wetland system at reducing/removing SS, TP, TN, NO ₃ , metals, bacteria (ASCE, 2000; CWP, 2000)	Wetlands can be designed for flood control by providing flood storage above the level of the permanent pool, but are subject to the same limitations as ponds. Wetlands are ineffective at protecting channels. Wetlands usually do not provide groundwater.	Wetlands pose a risk to cold water systems because of their potential for stream warming.
Extended Detention Wetland	5 studies reporting on the effectiveness of pond/wetland system at reducing/removing SS, TP, TN, NO ₃ , metals, bacteria (ASCE, 2000; CWP, 2000)		
Shallow Marsh	11 Studies reporting on the effectiveness of pond/wetland system at reducing/removing SS, TN, TP, NO ₃ , metals, bacteria (ASCE, 2000; CWP, 2000)		
Submerged Gravel Wetland	1 study reporting on the effectiveness of pond/wetland system at reducing/removing SS, TP, TN, NO ₃ , metals, bacteria (ASCE, 2000; CWP, 2000)		

Table 5-6 Summary of Studies on Environmental Impacts for Post-Construction BMPs Category C – Infiltration

BMP	Chemical Impacts	Physical Impacts	Habitat and Biological
Infiltration Basin	Very little information is available; one study reported that an infiltration basin sized to treat runoff from 1-in. storm is effective at removing SS (75%), P (60 to 70%), N (55-60%), metals (85 to 90%), bacteria (90%) (Schueler 1987; ASCE, 1999; CWP, 2000).	Full infiltration basins will control post-development peak discharge rates at or below predevelopment levels. Basins are effective at recharging groundwater. Infiltration basins effectively reduce the increase in post-development runoff volume produced from small and moderate sized storms.	No information available
Infiltration Trench	Infiltration trench sized to treat runoff from 1-in. storm is effective at removing SS (75%), P (60-70%), N (55 to 60%), metals (85-90%) and bacteria (90%) (Schueler, 1987; ASCE, 1999; CWP, 2000).	Effective at recharging groundwater	No information available
Pervious and Modular Pavement	A study in Prince William VA (Schueler, 1987) recorded pollutant removal effectiveness for SS (82%), TP (65%), TN (80%). A study in Rockville, MD (Schueler, 1987) recorded pollutant removal effectiveness for SS (95%), TP (65%), TN (85%), COD (82%), metals (98-99%) (ASCE, 1999; CWP, 2000).	Effective at recharging groundwater (approximately 70-80% annual rainfall) (Gburek and Urban, 1980)	No information available

Table 5-7 Summary of Studies on Environmental Impacts for Post-Construction BMPs Category D – Biofilters

BMP	Chemical Impacts	Physical Impacts	Habitat and Biological
Bioretention	The Davis (1998) study reported the effectiveness of bioretention at removing TP (81%), TN (43%), NH4 (79%), metals (93-99%). The Yu (1999) study reported the following performance parameters; SS (86%), TP (90%), COD (97%), oil and grease (67%).	Bioretention practices are being designed to provide water quality, flood control, channel protection and groundwater recharge (Clar, 2000).	Field data information not available
Grassed Swales	Three studies have reported on the effectiveness of grassed channels at removing SS, TP, TN, NO ₃ , metals and indicator bacteria. Four studies have reported on the effectiveness of dry swales at removing SS, TP, TN, NO ₃ and metals. Two studies have reported on the effectiveness of wet swales at removing SS, TP, TN, NO ₃ and metals. Seven studies have reported on the effectiveness of drainage channels at removing SS, TP, TN, NO ₃ and metals (ASCE, 1999; CWP, 2000).	Grassed swales can be used to reduce peak discharges for small storm events and provide groundwater recharge (MDE, 2000).	Field data information not available
Grassed Filter Strips	1 study has reported on the effectiveness of 75 ft and 150 ft grassed filter strips at removing SS (54%, 84%), nitrate, nitrite (-27%, 20%), TP (-25%, 40%), lead (-16%, 50%) and zinc (47%, 55%) (ASCE, 1999; CWP, 2000).	Grassed filter strips do not have the capacity to detain large storm events, but can be designed with a bypass system that routes these flows around the toe of the slope. Grassed filter strips can provide a small amount of groundwater recharge.	Field data information not available

Table 5-8 Summary of Studies on Environmental Impacts for Post-Construction BMPs Category E – Filters

BMP	Chemical Impacts	Physical Impacts	Habitat and Biological
Sand Filters	1 study reporting on the effectiveness of sand filters at removing SS (87%), TN (44%), NO ₃ (-13%), metals (34-80%), bacteria (55%)	Some groundwater recharge is possible with the exciter design,	No field data information available.
Peat/Sand Filters	1 study reporting on the effectiveness of peat sand filters at removing SS (66%), TN (47%), NO ₃ (22%), metals (26-75%)	however, other sand filter designs cannot provide recharge.	Some systems may help prevent thermal impacts.
Compost Filter System	2 studies reporting on the effectiveness of compost filter systems at removing SS, NO ₃ and metals	These systems are not expected to have significant role in preventing channel degradation or providing peak discharge control.	These systems are not expected to have significant role in preventing habitat and biological impairment resulting from channel degradation.
Multi-chambered Treatment Train	3 studies reporting on the effectiveness of multi-chamber treatment trains at removing SS and metals		
Perimeter Sand Filter	3 studies reporting on the effectiveness of perimeter sand filter at removing SS, TP, TN NO ₃ and metals		
Surface Sand Filter	6 studies reporting on the effectiveness of surface sand filter at removing SS, TP, TN NO ₃ , indicator bacteria and metals		
Vertical Sand Filter	2 studies reporting on the effectiveness of vertical sand filter at removing SS, TP, TN NO ₃ and metals		

On-Site Controls

Three schools of thought have emerged in stormwater management technology, each of which reflects one of the three applications identified above. The most widespread approach being used nationwide is the use of on-site controls where structural treatment practices on individual sites are designed to provide peak discharge control. While this approach has many flaws, it is often selected because of the ease of application and implementation. For many jurisdictions, the use of on-site controls is perceived to be the only practical institutional and political alternative.

Any site that meets the minimum area requirements is required to provide on site controls. Many of the technical problems associated with this approach were discussed in Section 4. Some of the concerns expressed by public works practitioners include (ASCE and WEF, 1998):

- Because large numbers of on-site controls, sometimes exceeding several hundred or even several thousand, can eventually be installed within an urban watershed, it becomes difficult to reliably quantify their cumulative effects on receiving waters
- Large numbers of on-site controls complicate quality assurance during design and construction because they are typically designed by a variety of individuals and constructed by a variety of different contractors under varying degrees of quality control
- In addition, onsite BMPs may be maintained and operated in a variety of ways impossible to anticipate or control
- The major issue, however, as pointed out in Section 3, stems from the fact that unless these on-site controls are coordinated at a watershed scale, which typically they are not, they not only fail to provide downstream protection for peak discharge, but in many instances will accelerate the rate of channel degradation.

Regional Controls

The second school of thought on stormwater management takes the position that regional controls serving 32 to 240 ha (80 to 600 ac) offer a more rational approach than on-site controls (ASCE, 1998). The proponents of the regional approach cite the following advantages:

- Regional controls eliminate the uncertainty of large numbers of on-site controls
- Regional controls can use multistage outlets to “throttle” and release small runoff events in 12 to 24 hours and empty the total water quality capture volume in 24 to 48 hours
- Regional controls are perceived to be more cost effective because fewer controls are less expensive to build and maintain than a large number of on-site controls (Wiegand et al., 1986)
- Another benefit assigned to regional controls is that because they serve larger drainage areas, and the outlet works are larger and easier to design, build, operate and maintain
- Regional controls are generally under the jurisdiction of a public agency and are therefore more likely to receive ongoing maintenance
- Regional controls can provide treatment for existing and new developments, and typically will capture all runoff from public streets, which is often not addressed by on-site controls
- Because regional controls cover large land areas, this allows other compatible uses such as recreation, wildlife habitat or aesthetic open space to occur within their boundaries.

The regional approach to stormwater management is currently being successfully utilized by a number of metropolitan areas, including the Denver Metropolitan area. Some other areas of the U.S., however, have experimented with regional controls and found them to be unacceptable. Prince George’s County (PGC) in Maryland is such an example. The local jurisdiction was requested by the permitting agencies to conduct a cumulative impact assessment of its regional facilities program as a condition for continued issuance of permits. During the course of the cumulative impact assessment, PGC identified so many fatal flaws associated with its regional facilities program that it decided to abandon the regional approach and identify viable alternatives. Some of the fatal flaws associated with the regional approach identified by PGC included:

- The regional controls that are typically a peak discharge control strategy failed to provide downstream protection of stream channels.
- The regional facilities typically failed to provide significant flood relief for downstream properties, and where such relief was provided, the downstream controls were very limited. (PGC ultimately adopted a floodplain management program that includes early flood warning, flood insurance, flood proofing, and the purchase and removal of flood-prone structures).
- Maryland is in a humid region of the U.S., receiving over 40 in. of annual rainfall. Regional facilities not only did not solve the targeted problems, they exacerbated them by introducing additional environmental problems, as follows:

-
- Created fish passage blockages that were unacceptable to the permitting agencies.
 - Tended to be located in perennial streams and their construction tended to create wetland impacts that were unacceptable to the permitting agencies.
 - Resulted in increased stream temperatures that were unacceptable in cold fisheries streams.
 - Left feeder streams unprotected, which often exposed them to severe accelerated erosion. This accelerated erosion delivered large volumes of sediment to the regional facilities, which greatly accelerated the maintenance program.
 - Disposal of pond and lake sediments in urban settings became extremely expensive.

Other problems with implementing regional approaches have been identified and include (ASCE, 1998):

- The regional facility approach requires advanced planning and up-front financing.
- Lack of financing early in the watershed's land development process, before sufficient developer contributions are available, can preclude their timely installation.

Micro-scale, Landscape Based Control

The third school of thought relating to stormwater management technology, unlike the two approaches above that have been in use for over thirty years, is still in its early development and is largely unknown to most local jurisdictions. This approach, which is more commonly known as LID technology, was pioneered by Prince George's County, Maryland, after having applied both on-site and regional approaches. Its proponents cite the following benefits of the LID approach (PGC, 1997; EPA, 2000 a, b; Coffman, et al, 1998; Clar, 2000):

- Use of these techniques helps to reduce off-site runoff and ensure adequate groundwater recharge.
- Since every aspect of site development affects the hydrologic response of the site, LID control techniques focus mainly on site hydrology. Hydrologic functions such as infiltration, frequency and volume of discharges, and groundwater recharge can be maintained by utilizing reduced impervious surfaces, functional grading, open channel sections, disconnection of hydrologic flowpaths and bioretention/filtration landscape areas.
- LID also incorporates multi-functional site design elements into the stormwater management plan. Such alternative stormwater management practices as on-lot micro-storage, functional landscaping, open drainage swales, reduced imperviousness, flatter grades, increased runoff travel time and depression storage can be integrated into a multifunctional site design.
- Specific LID controls called Integrated Management Practices (IMPs) can reduce runoff by integrating stormwater controls throughout the site in many small, discrete units.
- IMPs are distributed in a small portion of each lot, near the source of impacts, virtually eliminating the need for a centralized BMP facility such as a stormwater management pond.
- LID designs can also significantly reduce development costs through smart site design by:
 - Reducing impervious surfaces (roadways), curb and gutters.
 - Decreasing the use of storm drain piping, inlet structures.
 - Eliminating or decreasing the size of large stormwater ponds.
- In some instances, greater lot yield can be obtained using LID techniques, increasing returns to developers (Clar, 2000).
- Reducing site development infrastructure can also reduce associated project bonding and maintenance costs.
- LID techniques such as bioretention cells can be used as a water quality control technique for infill development (Clar, 2000).
- LID techniques can also be used as a water quality retrofits for existing urban areas (Clar, 2000).
- The LID approach can be used as a volume control method to provide downstream peak discharge protection for major storm events (Clar, 2000).
- The LID approach can be an improvement in protecting water supply reservoirs, as demonstrated in the High Point, NC Case Study (Tetra Tech, 2001 and Clar and Coffman, 2001).
- The LID approach can be used to address total impervious area limitations (Clar, 2000).

Some practitioners have found LID's site oriented micro-scale control approach to be controversial, as it sometimes conflicts with building codes, challenges conventional stormwater management paradigms and is perceived by some to accommodate urban sprawl. Retaining the excess water from each lot on-site as policy requires that the property owner understand the engineering and policy aspects of the measure. Landscaping to solve a problem must be maintained at the design level, for instance the land owner must understand the nature and purpose of the design features i.e. that the dry lowland in his backyard is a designed dry retention pond, is supposed to flood during rain events and can not be filled in. This can be accomplished through deed restrictions. A recent critique of the LID approach questioned the use of the term "low impact" and also critiqued the adequacy of the hydrological design procedures utilized to substantiate the effectiveness of the techniques (Strecker, 2002).

Integration of Approaches

Clearly the discussion above reveals that there is no clear consensus on which school of thought is the right approach. It appears that perhaps no single approach is adequate for all cases and that the one size fits all approach is not the way to proceed. The appropriate approach for a semi-arid mountain region such as Colorado or Utah may be considerably different from the approach selected in humid climates such as are found in the Mid Atlantic or Pacific Northwest. In addition, within a specific State or region, the appropriate approach for an existing degraded urban area may be considerably different from the approach selected to protect a high quality rural area. Ultimately, each region or municipality will need to identify its watershed and water resources protection goals and objectives and select the approach or combination of approaches that are appropriate to meet these goals.

Watershed Factors

Design of urban BMPs can be strongly influenced by the nature of the downstream water body that will be receiving the stormwater discharge. Consequently, designers should determine the "use designation" of the watershed in which their project is located prior to design. In some cases, higher pollutant removal or environmental performance may be needed to fully protect aquatic resources and/or human health and safety within a particular watershed or receiving water. Therefore, a shorter list of BMPs may need to be considered for selection within these watersheds or zones. The areas of concern are summarized in Table 5-9 and include:

- coldwater streams
- sensitive streams
- wellhead protection
- shellfish/beach.

Coldwater Streams

Cold and cool water streams have habitat qualities capable of supporting trout and other sensitive aquatic organisms. Therefore, the design objective for these streams is to maintain habitat quality by preventing stream warming, maintaining natural recharge, preventing bank and channel erosion, and preserving the natural riparian corridor. Techniques for accomplishing these objectives may include:

- minimizing the creation of impervious surfaces
- minimizing surface areas of permanent pools
- preserving existing forested areas
- bypassing existing baseflow and/or springflow
- providing shade-producing landscaping.

Some BMPs can have adverse downstream impacts on cold-water streams, so their use is highly restricted.

Table 5-9 Treatment BMPs for Specific Watershed Factors (Modified from MDE, 2000)

BMPs	WATERSHED FACTORS				
	Cold Water	Sensitive Stream	Aquifer Protection	Reservoir Protection	Shellfish/Beach
Ponds and Wetlands	Restricted due to thermal impacts, offline design recommended	May be limited or require additional volume for channel erosion impacts	May require liner if HSG A soils are present, pre-treat hot spots	May be limited due to channel erosion and may require additional volume control	May require use of permanent pools to increase bacteria removal
Infiltration	Yes, if site has suitable soils	Yes, if site has suitable soils	Requires safe distance from wells and water table, pre-treat hot spots	Requires safe distance from bedrock and water table	Yes, but needs safe distance to water table
Vegetative Biofilters	OK	OK, if channel protection volume is met	OK	OK	OK, but wet swale has poor bacteria removal
Filters (Sand, Perimeter, Underground)	OK for small volumes	Ok for water quality, no channel protection	OK for water quality, no recharge	OK for water quality	OK, moderate to high bacteria removal

Sensitive Streams

Sensitive streams are defined as streams with a watershed impervious cover of less than 15%. These streams may also possess high quality cool water or warm water aquatic resources. The design objectives are to maintain habitat quality through the same techniques used for cold water streams, with the exception that stream warming is not as severe a design constraint. These streams may also be specially designated by local authorities.

Wellhead Protection

Areas that recharge existing public water supply wells present a unique management challenge. The key design constraint is to prevent possible groundwater contamination by preventing infiltration of hotspot runoff. At the same time, recharge of unpolluted stormwater is needed to maintain flow in streams and wells during dry weather.

Reservoir Protection

Watersheds that deliver surface runoff to a public water supply reservoir or impoundment are of special concern. Depending on the treatment available at the water intake, it may be necessary to achieve a greater level of pollutant removal for the pollutants of concern such as bacteria pathogens, nutrients, sediment or metals. One particular management concern for reservoirs is ensuring that stormwater hotspots are adequately treated so that they do not contaminate drinking water.

Shellfish/Beach Protection

Watersheds that drain to specific shellfish harvesting areas or public swimming beaches require a higher level of BMP treatment to prevent closings caused by bacterial contamination from stormwater runoff. In these watersheds, BMPs are explicitly designed to maximize bacteria removal.

Other Criteria

Designers should consult with the appropriate review authority to determine if their development project is subject to additional stormwater BMP criteria as a result of an adopted local watershed plan or protection zone. A summary assessment of the suitability of the treatment practices listed in Table 5-2 with respect to the watershed factors discussed above is provided below (see Table 5-11).

Terrain Factors

Three key terrain factors to consider are low-relief, karst and mountainous terrain. Special geotechnical testing requirements may be needed in karst areas (see Appendix F). Table 5-10 summarizes the key issues that need to be considered for each BMP type with respect to the three terrain factors.

Table 5-10 BMP Selection for Specific Terrain Factors (Modified from MDE, 2000)

BMPs	TERRAIN FACTOR		
	Low Relief	Karst	Mountainous
Ponds	May be limited by depth to water table	Geotechnical testing required, may require liner, ponding depth may be limited	Embankment heights restricted
Wetlands	OK		
Infiltration	Minimum distance to water table of 2 ft* depending on soil type	May be prohibited by local authority	Maximum terrain slope 15%
Vegetative Biofilter	OK	OK	Swales may be limited by steep slopes
Filter	Some designs limited by head required	Liner required	OK

* ASCE/WEF Manual (1998) recommends 4 ft. Other local guidance may vary.

The type of structure used can be affected by terrain factors. For example, in very flat areas, it is difficult to construct a basin with a dam as would be possible in a steeper watershed. In the case of the flatter areas, it may be necessary to construct the basin by excavation. Also, the type of outlet can be controlled by the terrain with drop inlets being useful in steeper slopes, but with weir and open channel outlets favored for flat terrain.

Physical Suitability Factors

The watershed and terrain factors should enable the BMP designer to reduce the BMP list to a manageable length and proceed to consideration of the physical suitability factors that characterize the physical conditions at a site. Table 5-11 cross-references testing protocols needed to confirm physical conditions at the site. The six primary physical suitability factors include:

- soils
- water table
- drainage area
- slope
- head
- urban centers

Soils

The key evaluation factors are based on an initial investigation of the USDA hydrologic soils groups at the site. Note that more detailed geotechnical tests are usually required for infiltration feasibility and during design to confirm permeability and other factors. Specific soils requirements for each BMP type are provided in Volumes 2 and 3.

Water Table

This column indicates the minimum depth to the seasonally high water table from the bottom or floor of a BMP.

Drainage Area

This column indicates the recommended minimum or maximum drainage area that is considered suitable for the practice. If the drainage area present at a site is slightly greater than the maximum allowable drainage area for a practice, some leeway is permitted or more than one practice can be installed. The minimum drainage areas indicated for ponds and wetlands are flexible, depending on water availability (baseflow or groundwater) or the mechanisms

employed to prevent clogging. Drier parts of the country may require a larger minimum tributary area. Appendix C of Volume 3 provides a shortcut method for wetland drawdown assessment.

Table 5-11 BMP Selection for Physical Suitability Factors (Modified from MDE, 2000)

BMP	SOILS	WATER TABLE¹ (ft)	DRAINAGE AREA (acre)	SLOPE	HEAD (ft)	URBAN CENTERS
Ponds - Wet - Dry	"A" soils may require liner; "B" soils may require testing	4ft if hotspot or aquifer	25 minimum ² for wet pond	None	6-8	Not practical; requires too much area to be functional
Wetlands	"A" soils may require liner	4ft if hotspot or aquifer	25 minimum ² for wet pond	None	3-5	Same as above
Infiltration - Trench - Basin	0.52 in/hr minimum	4 ft (2 ft for flatter areas)	5 maximum 10 maximum	15% maximum	1 3	Yes Not practical
Biofilters - Bioretention - Swales - Filter strip	Uses made soil	2	2 maximum 5 maximum N/A	None 4% 10%	5 4 None	OK Not practical Not practical
Filters - Sand - Perimeter - Underground	OK	2	10 maximum 2 maximum 2 maximum	None	5 2-3 5-7	OK

Notes: OK = not restricted

1 = Separation distance to the seasonally high water table elevation – local guidance may require more.

2 = Unless adequate water balance and anti-clogging device installed.

Drainage Area

This column indicates the recommended minimum or maximum drainage area that is considered suitable for the practice. If the drainage area present at a site is slightly greater than the maximum allowable drainage area for a practice, some leeway is permitted or more than one practice can be installed. The minimum drainage areas indicated for ponds and wetlands are flexible, depending on water availability (baseflow or groundwater) or the mechanisms employed to prevent clogging. Drier parts of the country may require a larger minimum tributary area. Appendix C of Volume 3 provides a shortcut method for wetland drawdown assessment.

Slope Restriction

This column evaluates the effect of slope on the practice. Specifically, the slope restrictions refer to how flat the area the practice is located in may be.

Head

This column provides an estimate of the elevation difference needed at a site (from the inflow to the outflow) to allow for gravity operation within the practice.

Urban Sites

This column identifies BMPs that work well in the highly impervious downtown urban centers, where space is limited and original soils have been disturbed. Where appropriate, these BMPs can be used at redevelopment sites.

Community and Environmental Factors

Another group of factors that should be considered by the BMP designer includes the community and environmental factors. This group of factors includes the following four factors:

- ease of maintenance
- community acceptance
- construction costs
- habitat quality

Table 5-12 employs a comparative index approach indicating whether the BMP has a high or low benefit.

Table 5-12 BMP Selection for Community and Environmental Factors (Modified from MDE, 2000)

BMP	MAINTENANCE EFFORT	COMMUNITY ACCEPTANCE	COST	HABITAT QUALITY*	OTHER FACTORS
Ponds					
Dry	Easy	Medium	Low	Low/Medium	Trash and debris can be a problem
Wet	Medium	High	High	High	
Wetlands	Medium/High	Medium	Medium/High	High	Limited depth
Infiltration					
Trench	High	High	High	Low	Avoid large stones, frequent pooling
Basin	Medium	Low	Medium	Low	
Biofilters	Low/Medium	High	Medium	Medium	Landscaping
Filters	High	Mixed	High	Low	Out of sight, traffic bearing filter media

* Habitat quality refers to ability to provide habitat quality in the BMP facility

Maintenance Effort.

This column assesses the relative maintenance effort needed for a BMP in terms of three criteria: frequency of scheduled maintenance, chronic maintenance problems (such as clogging) and reported failure rates. It should be noted that all BMPs require routine inspection and maintenance.

Community Acceptance

This column assesses community acceptance as measured by three factors: market and preference surveys, reported nuisance problems, and visual aesthetics. It should be noted that a low rank can often be improved by a better landscaping plan.

Construction Cost

The BMPs are ranked according to their relative construction cost per impervious acre treated as determined from cost surveys and local experience.

Habitat Quality

BMPs are evaluated on their ability to provide wildlife or wetland habitat, assuming that an effort is made to landscape them appropriately. Objective criteria include size, water features, wetland features and vegetative cover of the BMP and its buffer.

Other Factors

This column indicates other considerations in BMP selection.

Location and Permitting Factors

The checklist in Table 5-13 provides a condensed summary of current BMP restrictions as they relate to common site features that may be regulated under local, State or federal law. These restrictions fall into one of three general categories:

-
- Locating a BMP within an area that is expressly prohibited by law.
 - Locating a BMP within an area that is strongly discouraged and is only allowed on a case-by-case basis. Local, State and/or federal permits shall be obtained and the applicant will need to supply additional documentation to justify locating the BMP within the regulated area.
 - BMPs must be set back a fixed distance from the site feature.

This checklist is only intended as a general guide to location and permitting requirements as they relate to siting stormwater BMPs. Consultation with the appropriate regulatory agency is the best strategy.

Table 5-13 Permitting Checklist (Modified from MDE, 2000)

FEATURE	LOCATION AND PERMITTING GUIDANCE
Water Wells	<ul style="list-style-type: none"> • 100-ft setback for stormwater infiltration • 50-ft setback for all other BMPs • water appropriation permit needed if well water used for water supply to a BMP
Utilities	<ul style="list-style-type: none"> • note the location of proposed utilities to serve development • BMPs are discouraged within utility easements or rights of way (public or private)
Structures	<ul style="list-style-type: none"> • consult local review authority for BMP setbacks from structures
Stream Channels	<ul style="list-style-type: none"> • stream channels should be delineated prior to design • instream ponds may require review and permit • instream ponds may be restricted or prohibited in cold water streams • may need to implement measures that reduce downstream warming
Stream Buffer	<ul style="list-style-type: none"> • consult local authority for stormwater policy • BMPs are strongly discouraged in the stream-side zone (within 25 ft of streambank) • consider how outfall channel will cross buffer to reach stream • BMPs can be located within the outer portion of a buffer
Sinkholes	<ul style="list-style-type: none"> • infiltration or pooling of stormwater near sinkholes is prohibited • geotechnical testing may be required within karst areas
Septic Drain Fields	<ul style="list-style-type: none"> • consult local health authority • recommended setback is a minimum of 50 ft from drain field edge
Roads	<ul style="list-style-type: none"> • consult local DOT or DPW for any setback requirement from local roads • obtain approval for any discharges to local or State-owned conveyance channel
Jurisdictional Wetland	<ul style="list-style-type: none"> • wetlands should be delineated prior to siting stormwater BMPs • use of wetlands for stormwater treatment strictly discouraged and requires federal permit • BMPs require 25-ft setback from wetlands • buffers can be used as nonstructural filter strip • stormwater must be treated prior to discharge into a wetland
Forest Conservation	<ul style="list-style-type: none"> • check with local regulatory agency for applicable forest conservation requirements • BMPs are strongly discouraged within Priority 1 Forest Retention Areas • BMPs must be setback at least 25-ft from the critical root zone of specimen trees • designers should consider the effect of more frequent inundation on existing forest stands • BMP buffers are acceptable as reforestation sites if protected by conservation agreement
Critical Areas	<ul style="list-style-type: none"> • check with local regulatory agency for applicable critical area requirements • BMPs w/in the Critical Area shoreline buffer may be prohibited unless a variance is obtained from the local review authority • BMPs are acceptable within mapped buffer exemption areas
100-yr Floodplains	<ul style="list-style-type: none"> • grading and fill for BMP construction is strongly discouraged within the ultimate 100-yr floodplain, as delineated by FEMA flood insurance rate, FEMA flood boundary and floodway, or local floodplain maps • floodplain fill cannot raise floodplain water surface elevation more than a tenth of a foot

Section 6 REFERENCES

American Society of Civil Engineers (ASCE), 1984. *Final Report of the Task Committee on Stormwater Detention Outlet Structures*, ASCE, New York, NY.

American Society of Civil Engineers (ASCE) and Water Environment Federation (WEF), 1992. *Design and Construction of Urban Stormwater Management Systems*. ASCE, Manuals and Report of Engineering Practice No. 77, New York, NY and WEF, Manual of Practice No. FD-20, Alexandria, VA.

American Society of Civil Engineers (ASCE) and Water Environment Federation (WEF), 1998. *Urban Runoff Quality Management*, ASCE, Manuals and Report of Engineering Practice No. 87, Reston, VA and WEF, Manual of Practice No. 23, Alexandria, VA.

American Society of Civil Engineers (ASCE), 2000. *National Stormwater Best Management Practices (BMP) Database*, prepared by the Urban Water Resources Research Council of ASCE for the EPA, Office of Science and Technology, Washington, DC (<http://www.bmpdatabase.org/>).

Barfield, B. J., J. C. Hayes, A. W. Fogle and K. A. Kranzler, 1996. The SEDIMOT III Model of Watershed Hydrology and Sedimentology. Proceedings of *Sixth Federal Interagency Sedimentation Conference*, Las Vegas, NV, March, 1996.

Bannerman, R., A. Legg and S. Greb, 1996. *Quality of Wisconsin Stormwater 1989-1994*. USGS Open File Report 96-458. U.S. Geological Survey, Reston, VA.

Barrett, M., R. Zuber, E. Collins and J. Malina, 1995. *A review and evaluation of literature pertaining to the quantity and control of pollution from highway runoff and construction*. Center for Research in Water Resources (CRWR) Online Report 95-5. Available at: (<http://www.ce.utexas.edu/centers/crwr/reports/online.html>)

Bell, W., L. Stokes, J. Gavan and T. Nguyen, 1995. *Assessment of the pollutant removal efficiencies of the Delaware Sand filter BMPs*. Final Report. Department of Transportation and Environmental Services, Alexandria, VA.

Booth, D., 1991. *Urbanization and the natural drainage system-impacts, solutions and prognoses*. Northwest Environmental Journal. 7(1): 93-118.

Booth, D. and L. Reinelt, 1993. *Consequences of Urbanization on Aquatic Systems-Measured Effects. Degradation Thresholds and Corrective Strategies*. Proceedings Watershed Management 93: A National Conference on Watershed Management. Alexandria, VA, March 21-23, 1993, p. 545-550.

Brown, W. and T. Schueler, 1997. *National Pollutant Removal Performance Database for Stormwater BMPs. Center for Watershed Protection*. Chesapeake Research Consortium. 220 pp.

Brush, S., M. E. Jennings, P.J. Young and H.C. McWreath, 1995. "NPDES Monitoring – Dallas – Ft. Worth, Texas Area". In *Stormwater NPDES Related Monitoring Needs. Proceedings of an Engineering Foundation Conference*. Harry Torno (Ed.), ASCE, New York, NY, pp.115-143.

Burton, G.A. and R.E. Pitt, 2002, *Stormwater Effects Handbook: A Toolbox for Watershed Managers, Scientists, and Engineers*. Lewis Publishers, CRC Press Co., Boca Raton, FL.

Camp, Dresser and McKee, Inc., Larry Walker Associates, Uribe & Associates and Resources Planning Associates, 1993. *California Best Management Practices – Construction Activity Handbook*, for the California Storm Water Task Force, California State Water Resources Council Board, Alameda, CA.

Caraco D. S., 2000. Stormwater strategies for arid and semi-arid watersheds. *Watershed Protection Techniques*. 3 (3). Center for Watershed Protection, Ellicott City, MD.

Center for Watershed Protection (CWP), 1998. *Better Site Design: A Handbook for Changing Development Rules in Your Community*. Center for Watershed Protection, Ellicott City, MD.

Center for Watershed Protection (CWP), 2000. *National Pollutant Removal Database for Stormwater Treatment Practices, 2nd Edition*, prepared by the Center for Watershed Protection, Ellicott City, MD for Tetra Tech, Inc., Fairfax, VA and the EPA Office of Science and Technology, Washington, DC.

Chang, G., J. Parrish and C. Souer, 1990. *The first flush of runoff and its effect on control structure design*. Environmental Resource Management Division. Department of Environmental and Conservation Services, City of Austin, Austin, TX, pp. 18 (<http://www.ci.austin.tx.us/watershed/firstflush.pdf>).

Chesapeake Research Consortium (CRC), 1996. *Design of Stormwater Filtering Systems*, prepared by the Center for Watershed Protection, prepared for the Chesapeake Research Consortium, Solomons, MD.

City of Austin, TX, 1990. Removal efficiencies of stormwater control structures. Final report. Environmental Resource Management Division, Austin, TX, 36 pp.

City of Austin, TX, 1988. *Water Quality Management*. In Environmental Criteria Manual. Environmental and Conservation Services. Austin, TX.

Clar, M. L. and R. Green, 1993. *Design Manual for Use of Bioretention in Storm Water Management*, prepared for the Department of Environmental Resources, Watershed Protection Branch, Prince George's County, MD. Prepared by Engineering Technologies Associates, Inc. Ellicott City, MD and Biohabitats, Inc., Towson, MD.

Clar, M., L. Coffman, R. Green and S. Bitter, 1993. *Development of Bioretention Practices for Storm water Management*, paper presented at the 20th Anniversary Conference of the Water Resources Planning and Management Division of the ASCE, Seattle, WA, May, 1993.

Clar, M., 2000. *Applications of Low Impact Development Techniques in Maryland*, paper presented at the Conference on Ecological Approaches to Urban Water Resources Design, Harvard, MA.

Clar, M. and L. Coffman, 2001. “*Low Impact Development Applications for Ultra Urban Areas*,” paper presented at the World Water and Environmental Congress, sponsored by the Environmental and Water resources Institute (EWRI) of the ASCE, Orlando , Florida, May 20-24, 2001.

Claytor, R. A. and T. R. Schueler, 1996. Design of Stormwater Filtering Systems. Center for Watershed Protection, Silver Spring, MD, prepared for the Chesapeake Research Consortium, Inc. with supplemental funding of U.S. EPA Region 5.

Collins, J., M. Clar, H. Loftin, A. Butler and D. Mosso, 2001. “*Compilation of Regulatory Requirements for Stormwater Runoff*”, paper presented at the Conference on Linking Stormwater BMP Designs and Performance to Receiving Water Impacts Mitigation, Snowmass, CO, United Engineering Foundation, New York, NY.

Coffman, L. and M. Clar, 1998. *Low-Impact Development (LID) for Storm Water Management*, paper presented at

the 25th Annual Meeting of the Water Resources Planning and Management Division, ASCE, Chicago, IL, June 9-12, 1998.

Corbitt, R. A., 1990. *Standard Handbook of Environmental Engineering*, McGraw-Hill, Inc., New York, NY.

Cullum, M., 1985. *Stormwater Runoff Analysis at a Single Family Residential Site*. University of Central Florida at Orlando. Publication 85-1: 247-256.

Crawford, J. and D. Lenat, 1989. *Effects of land use on water quality and the biota of three streams in the Piedmont Province of North Carolina U.S.* Geological Survey, Water Resources Investigations Report 89-4007. Raleigh, NC, 67 pp.

Crunkilton, R., J. Kleist, J. Ramcheck, B. DeVita and D. Villeneuve, 1996. *Assessment of the response of aquatic organisms to long-term in situ exposures of urban runoff*. In: *Effects of Watershed Development and Management on Aquatic Ecosystems: Proceedings of an Engineering Foundation Conference*. Snowbird, UT.

Davis, A., M. Shokouhian, H. Sharma and C. Henderson, 1997. *Bioretention Monitoring - Preliminary Data Analysis*. Environmental Engineering Program of the University of Maryland, College Park, MD.

Debo, T. and A. J. Reese, 1992. "Downstream Impacts of Detention", Proceedings NOVATECH 92, Nov. 3-5, 1992, Lyon, France.

Debo, T. N. and A. J. Reese, 1995. *Municipal Storm Water Management*, Lewis publishers, CRC Press, LLC, Boca Raton, FL.

Delzer, G.C., 1996. *Occurrence of the gasoline oxygenate MTBE and BTEX compounds in urban stormwater in the United States, 1991-95*: U.S. Geological Survey Water-Resources Investigation Report, WRIR 96-4145.

Denver Regional Council of Governments (DRCOG), 1983. *Urban runoff quality in the Denver region*. Prepared for EPA NURP Program, Denver, CO, 240 pp.

DeWiest, D. R. and E. H. Livingston, 1999. *The Florida Stormwater, Erosion, and Sedimentation Control Inspector's Manual*. Florida Department of Environmental Protection, Stormwater/Nonpoint Source Management Section, in cooperation with Florida Department of Transportation.

Doppelt, B., M. Scurlock, C. Frissell and J. Karr, 1993. *Entering the Watershed, Pacific Rivers Council*, Island Press, Inc., Washington, DC.

Dorman, M., J. Hartigan, R. Steg and T. Quaserbarth, 1989. *Retention, detention and overland flow for pollutant removal from highway stormwater runoff*. Federal Highway Administration, Vol. 1, Research Report FHWRD 89/202 179 pp.

Driscoll, E. D., 1983. *Performance of Detention Basins for Control of Urban Runoff Quality*, Proc. International Symposium on Urban Hydrology, Hydraulics and Sediment Control, Univ. Kentucky, Lexington.

Driscoll, E. D., D. DiToro, D. Gaboury and P. Shelly, 1986. *Methodology for Analysis of Detention Basins for Control of Urban Runoff Quality*. Report No. EPA 440/5-87-01 (NTIS No. PB87-116562), U.S. EPA, Washington, DC.

Driscoll, E. D. and W. James, 1987. *Evaluation of Alternate Distributions*, in *Pollution Control Planning in Ontario*. W. James (Ed.), Computational Hydraulics, Inc., Guelph, Ontario, Canada, p. 139.

Driscoll, E. D., G. E. Palhegyi, E. W. Strecker and P. E. Shelley, 1989. *Analysis of Storm events, Characteristics for Selected Rainfall Gauges Throughout the United States*. EPA, Washington, DC.

-
- Driver, N. E. and G. D. Tasker, 1990. *Techniques for Estimation of Storm-Runoff Loads, Volumes, and Selected Constituent Concentrations in Urban Watersheds in the United States*. U.S. Geological Survey Water-Supply Paper 2363, U.S. Department of the Interior, Washington, DC.
- Dunne, T. and L. B. Leopold, 1978. *Water in Environmental Planning*, W.H. Freeman and Co., San Francisco, CA., 818p.
- Emerson, C. H., C. Welty and R. Traver, 2003. "Application of HEC-HMS to Model the Additive Effects of Multiple Detention Basins over a Range of Measured Storm Volumes." World Water and Environmental Resources Congress, ASCE, June 23-26, 2003.
- Evaldi, R., R. Burns and B. Moore, 1992. Stormwater data for Jefferson County, Kentucky, 1991-1992: U.S. Geological Survey Open File Report 92-638.
- Feldman, A. D. (Ed.), 2000. Hydrologic Modeling System HEC-HMS Technical Reference Manual. U.S. Army Corps of Engineers, Hydrologic Engineering Center, Report No. CPD-74B, March, 2000.
- Ferguson, B. K., 1998. *Introduction to Stormwater: Concept, Purpose, Design*. John Wiley & Sons, Inc., New York, NY.
- Ferguson, B. and T. Debo, 1991. On-site Stormwater management-applications for landscape and engineering. 2nd edition. Van Nostrand Reinhold, New York. 270 pp.
- Ferguson, B. K., 1995. *Downstream Hydrographic Effects of Urban Stormwater Detention and Infiltration*, in Proceedings of the 1995 Georgia Water Resources Conference. Kathryn J. Hatcher (Ed.), pp128-131, Athens, University of Georgia Institute of Government.
- Gburek W. J. and J. B. Urban, 1980. "Storm Water detention and Groundwater Recharge Using Porous Asphalt - Experimental Site", Proceedings of an International on Urban Storm Runoff, U. of Kentucky, Lexington, KY
- Galli, J., 1991. *Thermal impacts associated with urbanization and stormwater management best management practices*. Metropolitan Washington Council of Governments. Maryland Department of Environment. Washington, DC, 188 pp.
- Griffin, M. L. and Beasley, D. B., 1988. *Procedure to generate CREAMS precipitation data for average annual erosion predictions from overland area: the design storm methodology*: IN Modeling Agricultural Forest, and Rangeland Hydrology. Proceedings of 1998 International Symposium. American Society of Agricultural Engineers, St. Joseph, MI.
- Grizzard, T. J., C. W. Randall, B. L. Weand and K. L. Ellis, 1986. "Effectiveness of Extended Detention Ponds," *Urban Runoff Quality - Impacts and Quality Enhancement Technology*, B. Urbonas and L. Roesner (Ed.), ASCE, New York, NY, 1986.
- Guo, C.Y. and B. R. Urbonas, 1995. *Special Report to the Urban Drainage and Flood Control District on Stormwater BMP Capture Volume Probabilities in United States*, Denver, CO.
- Hayes, J. C., B. J. Barfield, K. F. Holbrook and B. Bates, 2001. Loading and Best Management Model for South Carolina Office of Coastal Resource Management. Report submitted to SCOCRM by Woolpert, Inc. of Charlotte, NC, December 31, 2001.
- Heaney, J.P., W. C. Huber, M. A. Medina, M. P. Murphy, S. J. Nix and S. M. Hasan, 1977. *National Evaluation of Combined-sewer Overflows and Urban Stormwater Discharges - Volume II: Cost Assessment and Impacts*. EPA Cincinnati, OH, EPA-600/2-77-064b (NTIS PB 266 005).

-
- Herricks, E. E., 2001. "Observed Stream Responses to Changes in Runoff Quality" Proceedings of an Engineering Foundation Conference Linking Stormwater BMP Designs and Performance to Receiving Water Impacts Mitigation, Snowmass Village, CO, ASCE, p. 145-157.
- Holler, J. D., 1989. *Water Quality Efficiency of an Urban Commercial Wet Detention Stormwater Management System at Boynton Beach Mall In South Palm Beach County, FL*. Florida Scientist. Winter 1989. Vol. 52(1): 48-57.
- Horner, et al., 1996. "Watershed Determinates of Ecosystem Functioning". In: *Effects of Watershed Development and Management on Aquatic Ecosystems*. L. A. Roesner (Ed.). Engineering Foundation Conference, Snowbird, UT, August 4-9, 1996.
- Huber, W. C. and R. E. Dickinson, 1988. Storm Water Management Model Version 4, User's Manual. EPA 600/3-88/001a) Environmental Protection Agency, Athens GA.
- Hydrologic Engineering Center (HEC), 1977. *Storage, treatment, overflow, runoff model, STORM, User's Manual*. U.S. Army Corps of Engineers. Davis, CA.
- Jones, J. E., 1997. *Urban Runoff Impacts on Receiving Waters*. In: *Urban Runoff Quality.-Impact and Quality*. Enhancement Technology. B. Urbonas and L. Roesner (Ed.), ASCE, New York, NY.
- Jones et al., 1996. *Bioassessment of the BMP Effectiveness in Mitigating Stormwater Impacts on Aquatic Biota*. In: *Effects of Watershed Development and Management on Aquatic Ecosystems*.
- Jones, R. and C. Clark. 1987. *Impact of Watershed Urbanization on Stream Insect Communities*. American Water Resources Association, Water Resources Bulletin, 15(4).
- Kjelstrom, L., 1995. Data for and adjusted regional regression models of volume and quality of urban stormwater runoff in Boise and Garden City, Idaho, 1993-94. United States Geological Survey Water Resources Investigations Report 95-4228.
- Klein, R., 1979. Urbanization and stream quality impairment. American Water Resources Association, Water Resources Bulletin, 15(4).
- Kuo, C., 1976. *Sedimentation Routing in an In-Stream Settling Basin*. Proceedings of the National Symposium on Urban Hydrology, Hydraulics, and Sediment Control, University of Kentucky.
- Lane, L. J. and M. A. Nearing, 1989. *Water erosion prediction project: Hillslope profile model documentation*. NSERL Report No. 2. National Soil Erosion Research Laboratory, West Lafayette, IN.
- Lane, E. W., 1955. *The importance of fluvial geomorphology in hydraulic engineering*. *Proceedings American Society of Civil Engineering*, 81: 1-17.
- Leopold, L. B. and T. Maddock, Jr., 1954. *The Flood Control Controversy*, The Ronald Press Cop., New York, 1954.
- Leopold, L. B., M. G. Wolman and J. P. Miller, 1964. *Fluvial Processes in Geomorphology*. Dover Publications, Inc., Mineola, NY.
- Leopold, L. B., 1968. *Hydrology for Urban Land Planning: - A Guide Book on the Hydrologic Effects of Urban Land Use*. U.S. Geological Survey, Water Supply Paper 1591-C.
- Lindley, M. R., B. J. Barfield, J. C. Ascough II, B. N. Wilson and E. W. Stevens, 1998a. *Hydraulic simulation techniques incorporated in the surface impoundment element of WEPP*. *Applied Engineering in Agriculture*, 14(3):249-256.

Lindley, M. R., B. J. Barfield, J. C. Ascough II, B. N. Wilson and E. W. Stevens, 1998b. *The surface impoundment element for WEPP*. Transactions of the ASAE 14(3):249-256.

Livingston, E., E. McCarron, J. Cox, P. Sanzone, 1988. "The Florida Development Manual: A Guide to Sound Land and Water Management," Florida Department of Environmental Regulation, Nonpoint Source Management Section, Tallahassee, Florida.

Livingston, E. H. et al., 1995. Use of Sediment and Biological Monitoring. In: *Stormwater, NPDES Related Monitoring, Needs*. H.C. Torno (Ed.), Engineering Foundation, ASCE, New York, NY, 375.

Lopes, T., K. Fossum, J. Phillips and J. Marical, 1995. Statistical summary of selected physical, chemical, and microbial contaminants and estimates of constituent loads in urban stormwater in Maricopa County, Arizona. U.S. Geological Survey, Water Resources Investigations Report 94-4240.

MacRae, C. R., 1996. *Experience from morphological research on Canadian streams: is control of the two year frequency runoff event the best basis for stream channel protection?* pp. 144-162 in *Effects of Watershed Development and Management on Aquatic Ecosystems*. Engineering Foundation. New York, NY.

Madison, F., J. Arts, S. Berkowicz, E. Salmon and B. Hagman, 1979. Washington County Project. EPA 905/9-80-003, U.S. Environmental Protection Agency, Chicago, IL.

Maidment, D.R., 1993, *Handbook of Hydrology*, McGraw-Hill, Inc. New York, NY.

Martin, E., 1988. *Effectiveness of an Urban Runoff Detention Pond/Wetland System*. ASCE Journal of Environmental Engineering. Vol. 114(4): 810-827.

Maryland Department of Natural Resources. 1984. Maryland standards and specifications for stormwater management infiltration practices. Annapolis, MD.

Maryland Department of the Environment (MDE), 2000. *Maryland Stormwater Design Manual: Volume 1 and 2*. Maryland Department of the Environment, Annapolis, Maryland. Available: <<http://www.mde.state.md.us/environment/wma/stormwatermanual/Introduction.pdf>> Accessed August 2000.

Masterson, J. P. and R. T. Bannerman, 1994. Impacts of stormwater runoff on urban streams in Milwaukee county, Wisconsin. National Symposium on Water Quality. American Water Resources Association.

Maxted, J. and E. Shaver, 1997. *The Use of Retention Basins to Mitigate Stormwater Impacts on Aquatic Life*. L. A. Roesner (Ed.), *Effects of Watershed Development and Management on Aquatic Ecosystems*, ASCE, New York, NY.

May, C., R. Horner, J. Karr, B. Mar and E. Welch, 1997. *Effects of Urbanization on Small Streams in the Puget Sound Lowland Ecoregion*. *Watershed Protection Techniques*, 2(4): 483-494. Center for Watershed Protection, Ellicott City, MD.

McCuen, R.H., G. Moglen, E. Kistler and P. Simpson, 1987. *Policy Guidelines for Controlling Stream Channel erosion with Detention Basins*, prepared by the Department of Civil Engineering, University of Maryland, College Park, MD, prepared for the Water Management Administration, Maryland Department of the Environment, Baltimore, MD.

McCuen, R. H., 1989 (2nd Edition 1997). *Hydrologic Analysis and Design*. Prentice Hall, Englewood Cliffs, NJ.

McPherson, M. B., 1969. *Some notes on the rational method of storm drain design*, *Technical memorandum No. 6*, ASCE Urban Water Resources Research Program. ASCE, New York (Available from NTIS PB184-701).

Metropolitan Washington Council of Governments (MWCOC), 1992. *Watershed Restoration Sourcebook*.

Department of Environmental Programs, MWCOG, Washington, DC.

Metropolitan Washington Council of Governments (MWCOG), 1983. *Urban runoff in the Washington metropolitan area, Final Report*. Washington, DC area Urban Runoff Project. Water Resources Planning Board. 168 pp.

Minton, G.R., 1998. *Stormwater Treatment Northwest*, Vol. 4, No. 3, August.

Newman, T. L., T. A. Omer and E. D. Driscoll, 2000. "SWMM Storage-Treatment for Analysis/Design of Extended-Detention Ponds." In: *Applied Modeling of Urban Water Systems*, Monograph 8 in the Series. William James (Ed.), Proceedings of the Conference on Stormwater and Urban Water Systems, Modeling, Toronto, Ontario, February, 1999.

Oberts, G., 1994. *Influence of Snowmelt Dynamics on Stormwater Runoff Quality*. Watershed Protection Techniques 1(2): 55-61.

Oberts, G. L., 1989. *Pollutants Associated with Sand and Salt Applied to Roads in Minnesota*. Water Resources Bulletin, 22, 3, 479.

Occoquan Watershed Monitoring Laboratory, 1983. *Final Report: Metropolitan Washington Urban Runoff Project*. Prepared for the Metropolitan Washington Council of Governments. Manassas, VA, 460 p.

Occoquan Watershed Monitoring Laboratory, 1987. *Final Report: London Commons Extended Detention Facility*. Urban BMP Research and Demonstration Project. Virginia Tech University. Manassas, VA, 68 p.

Pechter, R., 1978. "Design of Storm Water Retention Basins," NORDSFRSK Report (in Swedish). Seminar on Detention Basin, Marsta, November 7-8, 1978.

Pechter, R., 1978. "Dimension of Storm Water Retention Basins According to Modern Rain Evaluation," Konzept (in German), 1978.

Pennsylvania Department of Environmental Protection, 2000. Fact Sheet. Controlling Accelerated Soil Erosion and Preventing Sediment Pollution. www.dep.state.pa.us/dep/deputate/watermgt/wgp/WQPWWEC/Facts/fs1841.htmv.

Pitt, R., 1994. Small storm hydrology. University of Alabama - Birmingham. Unpublished manuscript. Presented at Design of Stormwater Quality Management Practices. Madison, WI, May 17-19, 1994.

Pitt, R. and M. Bozeman, 1982. Sources of Urban Runoff Pollution and Its Effects on an urban Creek. EPA-600/S2-82-090, EPA, Cincinnati, OH.

Pitt, R., R. Field, M. Lalor and M. Brown, 1995. Urban stormwater toxic pollutants: assessment, sources, and treatability. *Water Environment Research*, 57(3):260-275.

Pitt, R. and J. McLean, 1986. Toronto area watershed management study. Humber River Pilot Watershed Project. Ontario Ministry of Environment.

Pitt, R., S. Clark, K. Gordon, E. Schwarz and R. Field, 1995. The use of special inlet devices, filter media, and filter fabrics for the treatment of stormwater. *Stormwater NPDES Monitoring Needs*, Lewis Publishers. Conference Proceedings, ASCE, Crested Butte, CO August 7 -12, 1994.

Pitt, R. and P. Barron, 1989. Abatement of Urban and Industrial Stormwater Runoff Toxicity and the Evaluation/Development of Treatment for Runoff Toxicity Abatement-Phase I. Report for EPA. Storm and Combined Sewer Program, Edison. NJ.

Pitt, R. and J. Voorhees, 1989. Source load and management model – an urban nonpoint source water quality model:

Wisconsin Department of Natural Resources, v. I-III, PUBL-WR-218-89.

Pitt, R., J. Lantrip, R. Harrison, C. L. Henry and D. Xue, 1999. Infiltration through Disturbed Urban Soils and Compost-amended Soil Effects on Runoff Quality and Quantity. EPA, Office of Research and Development, Cincinnati, Ohio, EPA 600/R-00/020 (NTIS PB2000-102012).

Pope, L. M. and L.G. Hess, 1988. *Load-Detention Efficiencies in a Dry Pond Basin*. In: Design of Urban Runoff Quality Controls. L.A. Roesner, B. Urbonas and M. B. Sonnen (Ed.), ASCE, New York, NY, p. 258-267.

Prince George's County (PGC), Maryland, 1997. *Low-Impact Development Design Manual*, Department of Environmental Resources, Prince George's County, MD.

Rabanal, F.I. and T.J. Grizzard, 1995. "Concentrations of Selected Constituents in Runoff from Impervious Surfaces in Four Urban Catchments of Different Land Use," Proceedings of the 4th Biennial Conference on Stormwater Research, 18-20 October, 1995, Southwest Florida Water Management District, Clearwater, FL, pp. 42-52.

Randall, C. W. et al., 1982. *Comparison of Pollutant Mass Loads in Precipitation and Runoff in Urban Area*. In Urban Stormwater Quality, Management and Planning. B. C. Yen (Ed.), Water Resources Publications, Littleton, CO, 29.

Roesner, L. A., B. Urbonas and M. A. Sonnen (Ed.), 1989. Current Practices in Design of Urban Runoff Quality Facilities, Proceedings of an Engineering Foundation Conference, July, 1988 in Potosi, MO, ASCE, New York, NY, 1989.

Roesner, L.A., et al, 1991. *Hydrology of Urban Runoff Quality Management*, Proceedings 18th National Conference on Water Resources Planning and Management, Symposium on Urban Water Resources, ASCE, New Orleans, LA.

Rosgen, D. L., 1996. *Applied River Morphology*, Wildland Hydrology, Pagosa Springs, CO.

Roesner, L., B. P. Bledsoe and R. W. Brashear, 2001. Are Best-Management-Practice Criteria Really Environmentally Friendly?, *Journal of Water Resources Planning and Management*, Vol. 127, No. 3, May/June 2001, p. 150-154.

Sansalone, J. J., S. G. Buchberger and M. T. Koechling, 1994. *Correlations Between Heavy Metals and Suspended Solids in Highway runoff - Implications for Control Strategies*, Department of Civil and Engineering, University of Cincinnati, Cincinnati, OH.

Sartor, J., G. Boyd and J. Agardy, 1974. Water pollution aspects of street surface contaminants. *Journal Water Pollution Control Federation*. Part 1. 46(3): 458-467. Washington, DC.

Sauer, V. B., W. O. Thomas, Jr., V. A. Stricker and K. V. Wilson, 1983. Flood Characteristics of Urban Watersheds in the United States. U.S. Geological Survey Water-Supply Paper 2207. Prepared by the U.S. Geological Survey in cooperation with U.S. Department of Transportation, Federal Highway Administration.

Scharffenberg, W. A., 2001. *Hydrologic Modeling System HEC-HMS User's Manual Version 2.1*. U.S. Army Corps of Engineers, Hydrologic Engineering Center, Report No. CPD-74A, January, 2001.

Schiff, K., 1996. *Review of existing stormwater monitoring programs for estimating bight-wide mass emissions from urban runoff*. SCCWRP Annual Report 1996.

Schueler, T., P. Kumble and L. Herson, 1992. *A current assessment of urban best management practices*. Metropolitan Washington Council of Governments, Washington, DC, 115 pp.

Schueler, T., 1992. *Design of stormwater wetland systems*. Anacostia Restoration Team. Metropolitan Washington

Council of Governments, Washington, DC.

Schueler, T., 1987. *Controlling urban runoff: a practical manual for planning and designing urban BMPs. Appendix A*. Department of Environmental Programs. Metropolitan Washington Council of Governments, Washington, DC.

Schueler, T., 1996. Irreducible Pollutant Concentrations Discharged from Urban BMPs, *Watershed Protection Techniques*, Vol. 2, No. 2, p. 369.

Skupien, J. J., 2000. "Establishing Effective Development Site Outflow Rates," paper presented at the Delaware Sediment and Stormwater Issues for a New Millennium, Conference 2000, University of Delaware, Newark, DE.

Smullen, J. and K. Cave, 1998. *Updating the U.S. Nationwide Urban Runoff Quality Database. 3rd International Conference on Diffuse Pollution*. Scottish Environment Protection Agency, Edinburg Scotland,. August 31 - September 4, 1998.

Snodgrass, W. L., et al., 1996. *Can Environmental Impacts of Watershed Scale Development Be Measured? In Effects of Watershed Development and Management on Aquatic Ecosystems*. L. Roesner (Ed.), ASCE, New York, NY.

Snodgrass, W.J., B.W. Kilgour, L. Leon, N. Eyles, J. Parish and D.R. Barton, 1998. *Applying ecological criteria for stream biota and an impact flow model for evaluation sustainable urban water resources in southern Ontario*. In: *Sustaining Urban Water Resources in the 21st Century*. Proceedings for an Engineering Foundation Conference. A. C. Rowney, P. Stahre and L. A. Roesner (Ed.), Malmo, Sweden, September 7 - 12, 1997.

Stahre, P. and B. Urbonas, 1990. *Stormwater Detention For Drainage, Water Quality, and CSO Management*. Prentice Hall, Englewood Cliffs, NJ.

Stern, D., 1996. *Initial investigation of the sources and sinks of Cryptosporidium and Giardia within the watersheds of the New York City water supply system*. In *Proceedings of a Symposium on New York City Water Supply Studies*. McDonnell et al. (Ed.), TPS-96-2 184pp. American Water Resources Association. Herndon, VA.

Steuer, J., W. Selbig, N. Hornewer and J. Prey, 1997. *Sources of Contamination in an Urban Basin in Marquette, Michigan and an Analysis of Concentrations, Loads and Data Quality*. U.S. Geological Survey Water-Resources Investigations Report 97-4242, pp. 25.

Stewart, W., 1992. *Compost stormwater treatment system*. W&H Pacific Consultants. Draft report. Portland, OR, pp. 38.

Strecker, E., 2002. "Low-Impact Development (LID): Is it Really Low or Just Lower." *Proceedings of an Engineering Foundation Conference Linking Stormwater BMP Designs and Performance to Receiving Water Impacts Mitigation*, Snowmass Village, CO, ASCE, p. 210-222.

Strecker, E., M. M. Quigley and B. R. Urbonas, 2000. *Determining Urban Stormwater BMP Effectiveness*. National Conference on Tools for Urban Water Resources Management and Protection Proceedings. Chicago, Illinois. Feb. 7-10, 2000. EPA/625/R-00/001, July 2000.

Strecker, E., B. Urbonas, M. Quigley, J. Howell and T. Hesse, 2002. *Urban Stormwater BMP Performance Monitoring A Guidance Manual for Meeting the National Stormwater BMP Database Requirements*. OW, U.S. EPA, Washington, DC, EPA-821-B-02-001.

Stribling, J. B., 2001, "Relating Instream Biological Condition to BMP Activities in Watersheds", paper presented at the Conference on Linking Stormwater BMP Designs and Performance to Receiving Water Impacts Mitigation, Snowmass, CO, United Engineering Foundation, New York, NY.

Tasker, G. D. and N. E. Driver, 1988. *Nationwide Regression Models for Predicting Urban Runoff Water Quality at*

Unmonitored Sites, Water Resources Bulletin, vol. 24, no. 5, pp. 1091-1101.

Taylor, B., K. Ludwa and R. Horner, 1995. *Urbanization effects on wetland hydrology and water quality*. Proceedings of the Third Puget Sound Research Meeting, Puget Sound Water Quality Authority, Olympia, WA.

Terrene Institute, 1995. "Local Ordinances: A Users Guide". Terrene Institute in cooperation with EPA. Terrene Institute, 4 Herbert St., Alexandria, VA.

Terstriep, M. L. and J. P. Stall. 1974. The Illinois Urban Drainage Area Simulator, ILLUDAS. ISWS-74-Bul 58. State of Illinois Department of Registration and Education, Urbana, IL.

Tetra Tech, Inc., 2001, *Effluent Limitations Guidelines, Draft Report*, prepared by Tetra Tech, Inc., for Office of science and Technology, U.S. Environmental Protection Agency, Washington, DC.

Thomas, P. and S. McClelland, 1995. *NPDES Monitoring - Atlanta, Georgia Region*. In: Stormwater NPDES Related Monitoring Needs. Proceedings of an Engineering Foundation Conference. Harry Torno (Ed.), ASCE, New York, NY.

Urban Drainage and Flood Control District, 1999. Urban Storm Drainage Criteria Manual, Volume 3 - Best Management Practices, Urban Drainage and Flood Control District, B. Urbonas (Ed.), Denver, CO, 1992, revised and updated 1999.

Urbonas, B., 1994. *Parameters to Report with BMP Monitoring Data*. In Stormwater NPDES Monitoring Needs. H.C. Torno (Ed.), ASCE, New York, NY.

Urbonas, B. R. and L. A. Roesner, 1992. *Hydrologic Design for Urban Drainage and Flood Control*. In: Handbook of Hydrology. D. R. Maidment (Ed.). McGraw-Hill. Inc.. New York, NY.

Urbonas, B. and L. A. Roesner (Ed.), 1986. *Urban Runoff Quality - Impacts and Quality Enhancement Technology*, Proceedings of an Engineering Foundation Conference in June 1986 in Henniker, NH. ASCE, New York, NY.

Urbonas, B. R. and P. Stahre, 1993, *Stormwater - Best Management Practices Including Detention*., Prentice Hall, Englewood Cliffs, NJ.

Urbonas, B. R., C.Y. Guo and S. Tucker, 1990. Optimization of Stormwater Quality Capture Volume, In Urban Stormwater Quality Enhancement - Source Control, Retrofitting, and Combined Sewer Technology. ASCE, New York, NY.

U.S. Department of Agriculture (USDA), 1951. *Engineering Handbook, Hydraulics Section 5*, USDA, Soil Conservation Service, Washington, DC.

U.S. Department of Agriculture (USDA), 1982. *Project Formulation - Hydrology*. Soil Conservation Service, Engineering Division. Technical Release 20 (TR-20).

U.S. Department of Agriculture (USDA), 1985. *National Engineering Handbook. Section 4, Chapter 7. National Resources Conservation Service*. <http://www.wcc.nrcs.usda.gov/water/quality/common/neh630/630ch7.pdf>

U.S. Department of Agriculture (USDA), 1986. *Urban Hydrology For Small Watersheds*. Soil Conservation Service, Engineering Division. Technical Release 55 (TR-55).

U.S. Environmental Protection Agency (EPA), 1971. Stormwater Management Model. EPA 11024DOOC 07/71 to 1102DOCIO/71. Washington, DC.

U.S. Environmental Protection Agency (EPA), (1983) *Results of the Nationwide Urban Runoff Program, Volume I*,

Final Report. NTIS PB84-185552, EPA, Washington, DC.

U.S. Environmental Protection Agency (EPA), (1990). "Biological Criteria: National Program Guidance for Surface Waters," EPA, Office of Water, S.K.M. Marcy (Ed.), Report No. EPA-440/5-90-004.

U.S. Environmental Protection Agency (EPA), 2000a. Low Impact Development Design Strategies: An Integrated Design Approach. Prepared by Tetra Tech, Inc., Fairfax, VA prepared for Department of Environmental Resources, Prince George's County, MD, funding provided by the EPA, Washington, DC. Report No. EPA-841-B-00-003.

U.S. Environmental Protection Agency (EPA), 2000b. Low Impact Development Hydrologic Analysis. Prepared by Tetra Tech, Inc., Fairfax, VA prepared for Department of Environmental Resources, Prince George's County, MD, funding provided by EPA, Washington, DC. Report No. EPA-841-B-00-002.

U.S. Geological Survey (USGS), 1999. Pesticides detected in urban streams during rainstorms and relations to retail sales of pesticides in King County, Washington. USGS Fact Sheet 097-99.

U.S. Weather Bureau, 1955. Rainfall Intensity-Duration-Frequency Curves, U.S. Department of Commerce, Weather Bureau, Washington, DC, Technical Paper No. 25.

von den Herik, A. G., 1976. "Water Pollution by Storm Overflow From Mixed Sewer Systems," Berichte der ATV. No.28, Bonn, (in German).

Wiegand, C., T. Schueler, W. Chittendren and W. Jellick, 1986. *Cost of Urban Runoff Controls*. Urban Runoff Quality: Impact and Quality Enhancement Technology, B. Urbonas and L. Roessner (Ed.), ASCE, NY.

Wilson, B. N., B. J. Barfield and I. D. Moore, 1982. A Hydrology and Sedimentology Watershed Model. Part I. Modeling Technique. Department of Agricultural Engineering, University of KY, Lexington, KY.

Wolman, M.G. and J.P. Miller, 1960. *Magnitude and frequency of forces in geomorphic processes*. Journal of Geology, 68, 54-74.

Wotzka, L. and G. Oberts, 1988. *The Water Quality Performance of a Detention Basin Wetland Treatment System in an Urban Area*. In Nonpoint Source Pollution: Economy, Policy, Management and Appropriate Technology, American Water Resources Association.

Yoder C., 1991. The integrated biosurvey as a tool for evaluation of aquatic life use attainment and impairment in Ohio surface waters. In Biological Criteria: Research and Regulation.

Yoder, C.O., 1995. *Incorporating ecological concepts and biological criteria in the assessment and management of urban nonpoint source pollution*. National Conference on Urban Runoff Management: Enhancing Urban Watershed Management at the Local, County and State Levels. EPA, Office of Research and Development, Cincinnati, OH. EPA/625/R-95/003, pp.183-197.

Yoder, C and E.T. Rankin, 1997. Assessing the condition and status of aquatic life designated uses in urban and rural watersheds. In: *Effects of Watershed Development and Management on Aquatic*. L. Roesner (Ed.), ASCE, New York, NY., pp. 201-227.

Yoder, C., R. Miltner and D. White, 2000. Using biological criteria to Assess and Classify Urban Streams and Develop Improved Landscape Indicators. *National Conference on Tools for Urban Water Resource Management & Protection*. EPA, Office of Research and Development, Cincinnati, OH. Report No. EPA/625/R-00/001.

Yousef, Y. A., T. Hvitved-Jacobsen, M. Wanielista and R. Tolbert, 1986. Nutrient Transformation in Retention/Detention Ponds Receiving Highway Runoff. *Journal of the Water Pollution Control Federation*, 58, 8, pp. 838-844.

Appendix A Summary of Large Storm Hydrology

The computational procedures for large storm hydrology consist of techniques for estimating or modeling runoff hydrographs from larger storm events typically ranging from the 1-yr to the 100-yr storm. The procedures for conducting these analyses are well documented at both the national and regional levels.

Federally Funded Models

At the national level, a variety of models that simulate rainfall-runoff processes for watersheds and the design of BMPs are available and well documented. Selection of the appropriate modeling technique will often depend on the level of detail and rigor required for the application and amount of data available for setup and testing of the model results. However, in many instances local regulatory agencies may specify which models are acceptable for design and review purposes. For example, in the state of Maryland, the state regulatory authority, the Maryland Department of the Environment, requires that BMP design be performed using the NRCS TR-55 and TR-20 models.

Detailed guidance on the use of these models is beyond the scope of this manual. A brief overview of the following national models is provided here:

- HEC-1/HEC-HMS Flood Hydrograph Package
- HSPF - Hydrologic Simulation Program - FORTRAN
- SWMM - Storm Water Management Model
- TR-55/TR-20
- WMS - Watershed Modeling System

HEC-1/HEC-HMS Flood Hydrograph Package

HEC-1 was developed by the Hydrologic Engineering Center of the U.S. Army Corps of Engineers to simulate the surface runoff response of a watershed to rainfall events. Although it is a DOS-based program, it is still considered by many in the engineering and regulatory communities to be the leading model for major drainage system applications such as Flood Insurance Studies and watershed master planning. HEC-1 is accepted by the Federal Emergency Management Agency and therefore is the most widely used model for major drainage system analyses.

In HEC-1, the watershed is represented in the model as an interconnected system of hydrologic (i.e., subbasins, reservoirs, ponds) and hydraulic (i.e., channels, closed conduits, pumps) components. The model computes a runoff hydrograph at each component, combining two or more hydrographs as it moves downstream in the watershed. The model has a variety of rainfall-runoff simulation methods, including the popular NRCS Curve Number methodology. The user can define rainfall events using gage or historical data, or HEC-1 can generate synthetic storms. Hydrograph generation is performed using the unit hydrograph technique. Clark, SCS Dimensionless and Snyder Unit Hydrographs are the available methodologies. Several common channel and storage routing techniques are available as well. HEC-1 is not considered a "design tool." The program has limited hydraulic capabilities. It does not account for tailwater effects and cannot adequately simulate many urban hydraulic structures such as pipe networks, culverts and multi-stage detention pond outlet structures. However, there are other hydrologic applications developed within HEC-1 that have been utilized with much success. Multiplan-multiflood analyses allow the user to simulate a number of flood events for different watershed situations (or plans). The dam safety option enables the user to analyze the impact dam overtopping or structural failure on downstream areas. Flood damage analyses assess the economic impact of flood damage.

Because it is not a Windows-based program, HEC-1 does not have easy to use input and output report generation and graphical capabilities, and therefore is generally not considered a user-friendly program. Because of its wide acceptance, however, several software development companies have incorporated the source code into enhanced "shells" to provide a user-friendly interface and graphical input and output capabilities. Examples of these programs include Graphical HEC-1, developed by Haested Methods and WMS, developed by the Environmental Modeling Research Laboratory.

The Corps of Engineers has developed a user-friendly, Windows-based Hydrologic Modeling System (HEC-HMS) intended to replace the DOS-based HEC-1 model. The new program has all the components of HEC-1, with more

user-friendly input and output processors and graphical capabilities. HEC-1 files can be imported into HEC-HMS. Version 2 of this model has been released. Information regarding these two programs can be obtained from the U.S Army Corps of Engineers at the following address:

Corps of Engineers
Hydrologic Engineering Center
609 Second Avenue
Davis, California 95616
Tel: 530-756-1104
Website: <http://www.hec.usace.army.mil/>

Hydrologic Simulation Program - FORTRAN (HSPF).

The HSPF model was developed by the EPA for the continuous or single-event simulation of runoff quantity and quality from a watershed. The original model was developed from the Stanford Watershed Model, which simulated runoff quantity only. It was expanded to include quality components and has since become a popular model for continuous non-point source water quality simulations. Non-point source conventional and toxic organic pollutants from urban and agricultural land uses can be simulated, on pervious and impervious land surfaces and in streams and well-mixed impoundments. The various hydrologic processes are represented mathematically as flows and storages. The watershed is divided into land segments, channel reaches and reservoirs. Water, sediment and pollutants leaving a land segment move laterally to a downstream land segment, a stream or river reach or reservoir. Infiltration is considered for pervious land segments.

HSPF model output includes time series information for water quality and quantity, flow rates, sediment loads, and nutrient and pesticide concentrations. To manage the large amounts of data associated with the model, HSPF includes a database management system. To date, HSPF is still a DOS-based model and therefore does not have the useful graphical and editing options of a Windows-based program. Input data requirements for the model are extensive and the model takes some time to learn. However the EPA continues to expand and develop HSPF, and still recommends it for the continuous simulation of hydrology and water quality in watersheds.

At this time, this model can be used to develop runoff hydrographs and water quality loadings from watersheds, but currently cannot be used for BMP design.

The U.S. Geological Survey has become the point of contact for the operation, maintenance and distribution of this model. Information can be obtained at the following location:

U.S. Geological Survey
Hydrological Analysis Software Support Program
437 National Center
Reston, VA 20192
email: h2osoft@usgs.gov
website: <http://water.usgs.gov/software/>

EPA SWMM - Storm Water Management Model

EPA SWMM (Huber and Dickinson, 1988) was developed by the EPA to analyze storm water quantity and quality problems associated with runoff from urban areas. EPA SWMM has become the model of choice for simulation of minor drainage systems primarily composed of closed conduits. The model can simulate both single-event and continuous events, and has the capability to model both wet and dry weather flow. The basic output from SWMM consists of runoff hydrographs, pollutographs, storage volumes and flow stages and depths.

SWMM's hydraulic computations are link-node based and are performed in separate modules, called blocks. The EXTRAN computational block solves complete dynamic flow routing equations to simulate backwater, looped pipe connections, manhole surcharging and pressure flow. It is the most comprehensive model in its capabilities to simulate urban storm flow and many cities have used it successfully for storm water, sanitary or combined sewer

system modeling. Open channel flow can be simulated using the TRANSPORT block, which solves the kinematic wave equations for natural channel cross-sections.

SWMM has both hydrologic and water quality components. Hydrologic processes are simulated using the RUNOFF block, which computes the quantity and quality of runoff from drainage areas and routes the flow to major sewer system lines. Pollutant transport is simulated in tandem with hydrologic and hydraulic computations, and consists of calculation of pollutant buildup and washoff from land surfaces, and pollutant routing, scour and in-conduit suspension in flow conduits and channels.

EPA SWMM is a public domain model; version IV is currently available and a newer version V is to be released. For large watersheds with extensive pipe networks, input and output processing can be tedious and confusing. Because of the popularity of the model, commercial, third-party enhancements to SWMM have become more common, making the model a strong choice for minor system drainage modeling. Examples of commercially enhanced versions of EPA SWMM include MIKE SWMM, distributed by BOSS International, XPSWMM by XP-Software, and PCSWMM by Computational Hydraulics Inc. (CHI). CHI also developed PCSWMM GIS, which ties the SWMM model to a GIS platform.

General Description of SWMM

The original SWMM program consisted of the following six blocks (see Figure A-1); runoff, transport, extended transport (EXTRAN), storage/treatment, receiving water and executive.

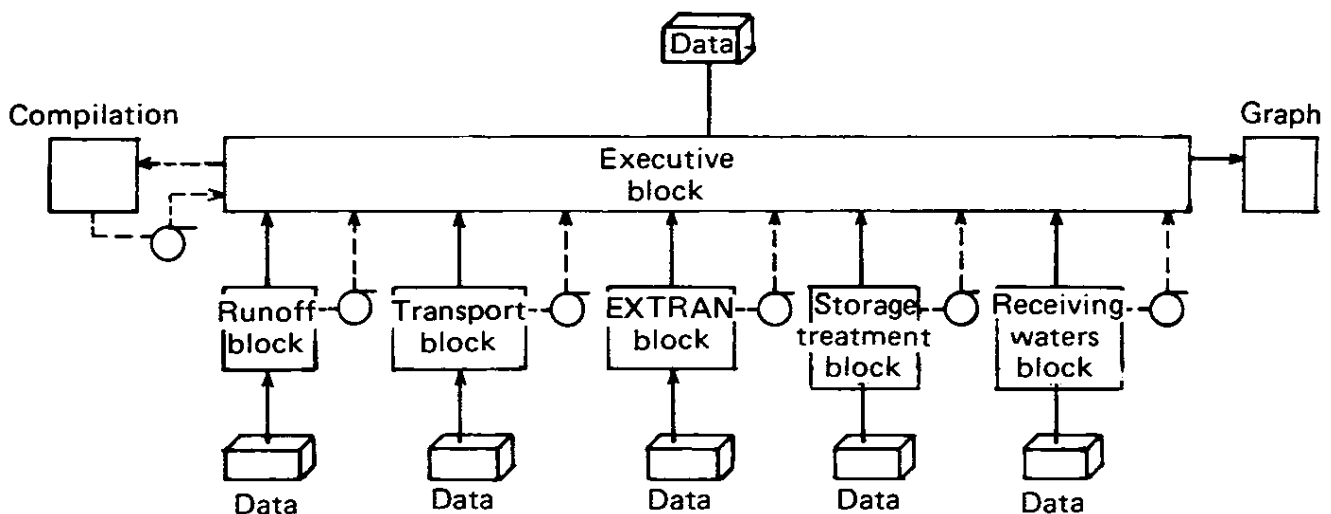

Figure A-1 SWMM Program Blocks

These blocks are not used simultaneously. Only the blocks best suited for a specific task are used at any given time. Output from one block can be used as input for another. This provides SWMM great flexibility and a staged approach to modeling complex systems.

Runoff Block. The Runoff Block is used to estimate stormwater runoff from various subwatersheds and its output can be used as input to the transport, EXTRAN, storage/treatment or receiving blocks. Initial storm runoff calculations are based on sheet flow kinematic wave principle for the water that is not lost due to infiltration and surface retention. Any temporal and spatial distribution of rainfall can be used as input. Sheet flow, including the simulated pollutant load, is intercepted by trapezoidal gutters and circular pipes, which are then combined with flow and pollutants in other gutters and pipes. All flows and pollutants are eventually routed to specified discharge points. It is not necessary, however, to simulate pollutant runoff in order to use the runoff block.

Transport Block. The Transport Block simulates the flow and pollutant transport in the major sewers of the system. Input data for the Transport Block consists of the output from the Runoff Block. This block can also simulate detention facilities at any point in the system. The calculations are based on the normal depth and continuity principle, which means they do not account for backwater effects or surcharge. If the inflow into any sewer segment

exceeds its pipe full capacity, the excess is temporarily stored at the upstream end of the pipe segment. This algorithm has a tendency to underestimate needed detention volumes.

Extended Transport Block (EXTRAN). By replacing the Transport Block by EXTRAN, it is possible to account for backwater effects in the flow conveyance system. The pressure gradient can go up to the ground surface at the nodes of the model. When the incoming flows surcharge the system so that it reaches the surface, the excess flows are not returned to the system. As a result, continuity is not maintained when a sewer system is surcharged excessively. EXTRAN also provides for the simulation of certain standard facilities such as overflows, pumping stations, detention facilities, etc.

Storage/Treatment Block. This block allows for simplified simulation of a single treatment plant in the system. The plant, however, has to be located at the downstream end of the sewer network. The treatment plant can include a single detention storage basin.

Receiving Water Block. The Receiving Water Block was originally designed to simulate the hydraulics and the fate of pollutants in the receiving bodies of water such as rivers, lakes, estuaries, etc. This block was not updated with later versions of SWMM and is typically no longer used due to the availability of other receiving water models. The loadings generated from SWMM can be imported to other receiving water models, e.g. WASP.

Executive Block. This block has the task of coordinating the information and transferring data between all of the other blocks in SWMM.

Detention Calculations in Transport Block

The Transport Block in SWMM can be used to approximate in-line and off-line detention storage in the sewer system. At most, two storage basins can be simulated by this block (see Figure A-2). If there are more than two basins, the system has to be broken up into smaller subsystems that can be simulated sequentially using the results of the upper network as input into the lower sewer network. The input data needed for storage calculations will include the following:

- Type of outlet structure. The choices provided by the model include bottom orifice outlet, constant rate pump and a spillway.
- Depth-area relationship for up to 11 different water levels. This may be simplified in the case of a storage basin having the shape of an inverted circular truncated cone, in which case the user inputs only the bottom area and the slope of the walls.
- The maximum water level.
- The water level and the discharge rate at the start of the simulation.

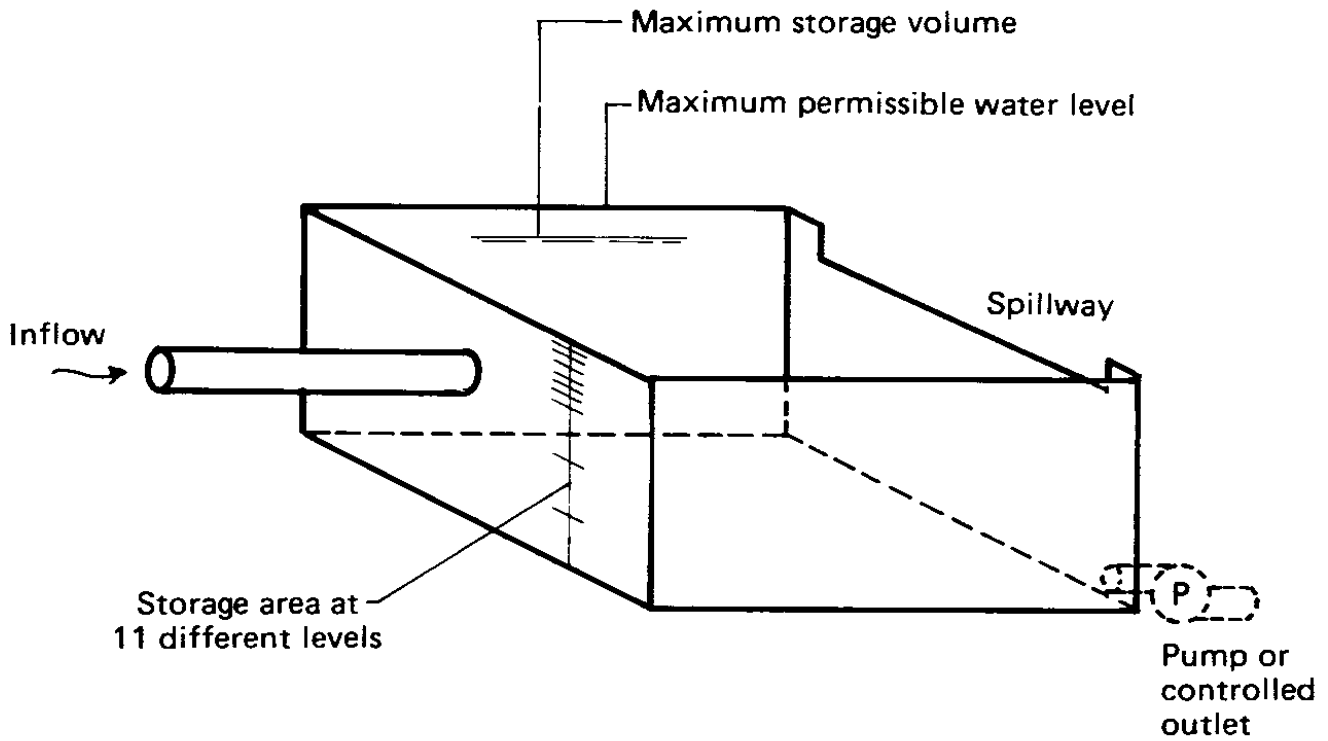

Figure A-2 Detention facility as defined in Transport Block

The following three equations are used to describe the discharge through each type of outlet:

Bottom Orifice Outlet: $Q = A \times K_1 \times H^{1/2}$ (A-1)

Spillway: $Q = L \times K_2 \times (H - h)^{3/2}$ (A-2)

Constant Rate Pump: $Q = K_3$ (A-3)

Where:

- Q = discharge rate,
- H = depth of water above basin bottom,
- A = area of the orifice outlet,
- K_1 = constant dependent on orifice configuration,
- L = length of spillway,
- K_2 = constant dependent on spillway configuration,
- h = height of spillway crest above basin bottom, and
- K_3 = constant pump capacity.

When the pump option is used, it is also necessary to input the levels at which the pump is turned on and off. If the water level in the storage basin during simulation rises above the maximum permissible level, the excess is not routed through the storage basin. Instead, it is accounted as excess volume in the printout of the simulation. This way, the modeler is aware of how much the basin may have been overloaded.

The pollutants in the system can also be routed through the storage basin. The program can estimate the removal of the settleable pollutants within the storage basin. This simulation can be performed at the user's discretion using plug flow or total mixed flow assumptions. As a result, the program provides the modeler with a simulated hydrograph and a pollutograph after they are routed through the detention basin. Also, for each time step, the output provides the water depth and storage volume. The program does not provide a hydrograph of the water that may exceed the storage capacity of the facility and may spill as uncontrolled overflow.

Detention Calculations in Storage/Treatment Block

The SWMM program permits simulation of a treatment plant located at the downstream end of the system.

Simulation of the following treatment plant components and processes is possible: gratings, swirl concentrator, sand trap, flotation, strainer, sedimentation, filtration, biological treatment and chlorination.

The modeler excludes those treatment steps that are not applicable and provides the necessary basic parameters for the processes to be used. A storage facility can be located in-line or off-line to the sewer pipe entering the plant (see Figure A-3). It is possible to use connection schemes of detention and treatment plant other than those shown in this figure. For example, when the storage is connected off-line, it is possible to route or pump the water from the storage basin to the plant.

Simulation of detention in this block is done using the same mathematic equations as used in the transport block described earlier. The only difference is that in the Storage/Treatment Block, the user has to specify the treatment efficiency for pollutant removal in the detention storage facility.

Detention Calculations in the EXTRAN Block

In the EXTRAN Block, the sewer network is represented by a series of links that are connected to each other at nodes. The modeler provides geometry, roughness and invert elevations for each pipe. The user also has to provide the ground surface elevation at each node (i.e., manhole). Detention is simulated simply by providing the geometry of a pipe that best describes the storage vs. volume relationship of the installation. If the storage facility has an unusual shape, its characteristics can be approximated using any combination of pipes connected in parallel and series. The pipe sections supplied by the program are illustrated in Figure A-4. The user may, however, describe additional pipes having any desired geometry.

It is possible to simplify the initial testing of a potential detention storage site without going into great geometric detail of the facility. This is done by defining node storage basins. All that is needed is to input the water surface area available at the node in question. EXTRAN assumes that the surface area remains constant as the water rises and falls and calculates the volume being stored at the node.

The outflow from a storage basin in EXTRAN is described by either giving the dimensions of the outlet pipe or one of the following flow regulating elements: overflows, outlet orifices, pumps and high-water gates.

When these regulation elements are used to describe the discharge characteristics between two nodes, the user has to enter their hydraulic characteristics, i.e., discharge coefficients, spillway lengths, pumping rates, etc. An example of how a detention basin can be simulated using links, nodes and flow regulating elements is illustrated in Figure A-5.

The output from the EXTRAN block can provide for each time step the flow velocities in all the pipes and water levels at all the nodes in the sewer network. At each of the detention sites, the inflow hydrograph, the outflow hydrograph and the water levels are interdependent, and are calculated simultaneously for each time step. This block is not simple to use, since all the component parts of the sewer system have to be described in detail and the calculations tend to become unstable if the element lengths are too short. It is a powerful tool for analysis of an existing system and for testing proposed designs. It is not, however, the block that one would use for the general screening of many alternatives during planning.

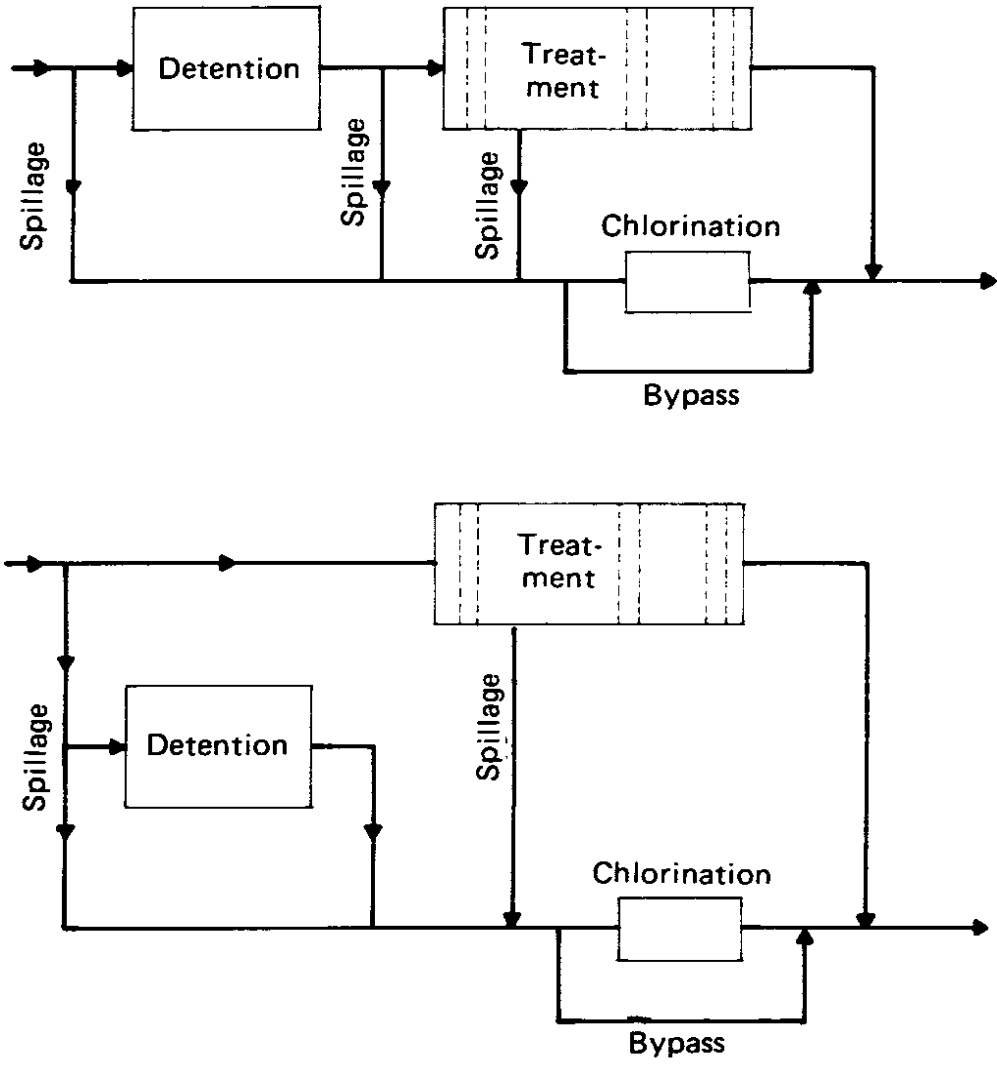

Figure A-3 Treatment processes simulated by Storage Treatment Block of SWMM

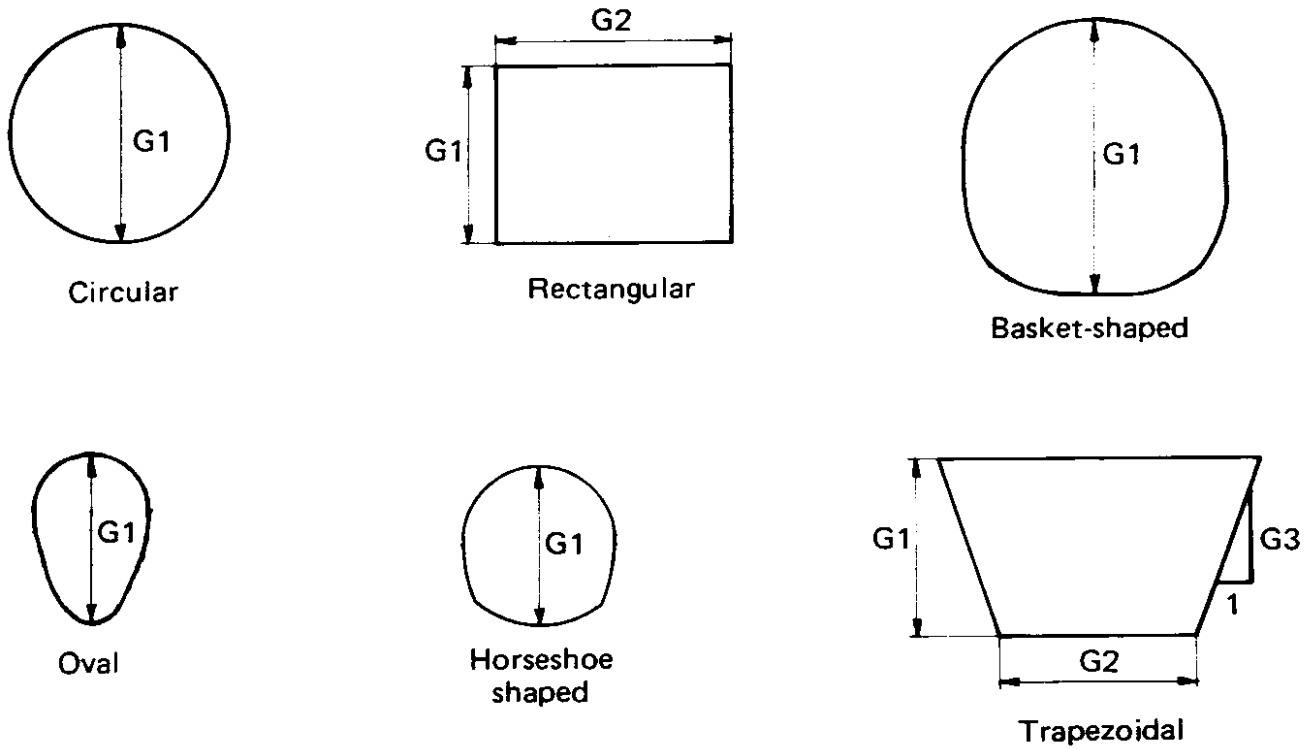

Figure A-4 Standard pipe sections provided in EXTRAN Block.

Summary of SWMM Model Description

Detention calculations can be performed by the SWMM program in the following blocks: Transport Block, Extended Transport Block (EXTRAN) and Storage/Treatment Block.

The same mathematical equations are used in detention calculations in the Transport Block and the Storage/Treatment Block. The latter block only permits the simulation of detention at a treatment facility. Backwater effects are not considered in the Transport Block. If backwater effects are of significant concern, the Transport Block can be replaced by EXTRAN, which accounts for water surface levels in the entire system.

Using SWMM, one can simulate most of the urban storm runoff and routing processes. SWMM is a comprehensive and powerful model and can be an extremely valuable tool in experienced hands. However, the model is complicated and imposes many requirements on the user. It is not a model of choice for casual investigation of what detention requirements may be needed at a single site. It is the model of choice for analyzing the performance of complete storm sewer systems, which may include detention facilities within such systems.

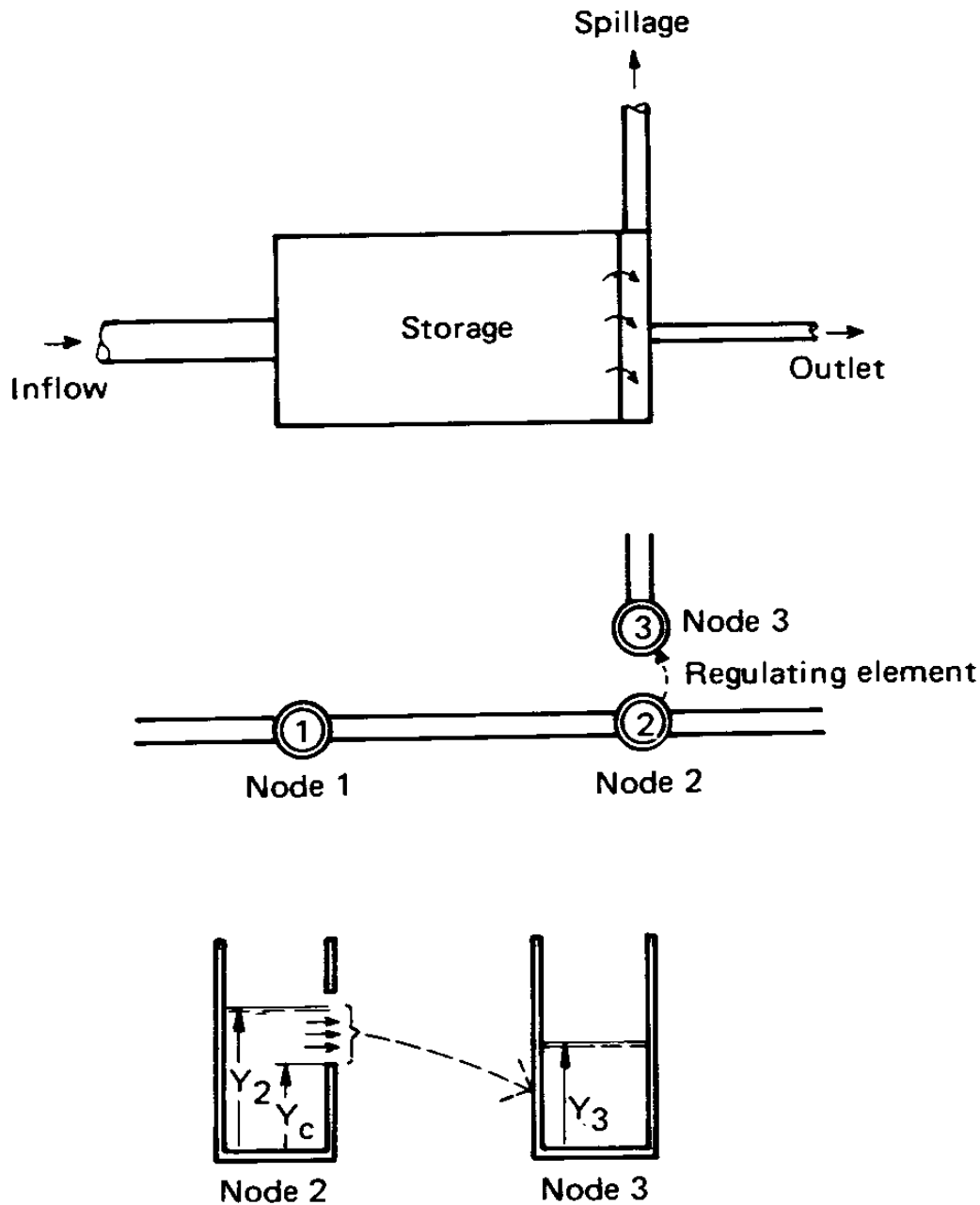

Figure A-5 Example of how detention can be described using links, nodes and flow regulators in EXTRAN Block

TR-55/TR-20

TR-55 - Technical Release 55

The TR-55 model is a DOS-based software package used for estimating runoff hydrographs and peak discharges for small urban watersheds. The model was developed by the NRCS (formally SCS) and therefore uses SCS hydrograph methodology to estimate runoff. No other methodology is available in the program. Four 24-hr regional rainfall distributions are available for use. Rainfall durations less than 24-hr cannot be simulated. Using detailed input data entered by the user, the TR-55 model can calculate the area-weighted CN, time of concentration and travel time. Detention pond (i.e., storage) analysis is also available in the TR-55 model and is intended for initial pond sizing. Final design requires a more detailed analysis.

TR-55 is easy-to-use, however because it is DOS-based it does not have the useful editing and graphical capabilities of a Windows-based program. Haestad Methods, Inc., included most of the TR-55 capabilities in its PondPack, which is available commercially.

TR-20 Watershed Hydrology Model

TR-20 (Technical Release Number 20, Computer program for Project Formulation - Hydrology) had existed for 16 years in draft status. In the fall of 1997, the newly formed TR-20 work group made the momentous decision to revise, modernize and finalize the program. The TR-20 Watershed Hydrology model is a rewritten and expanded version of the older TR-20.

TR-20 Watershed Hydrology Model is a USDA Natural Resources Conservation Service system of computer models developed to predict the runoff resulting from rainfall over a watershed. The model is also part of the TR-20 User System, an umbrella that includes pre- and post processing functions in addition to the actual model. The TR-20 model is written in ANSI standard Fortran 90 and developed in a WindowsNT programming environment using the DEC Visual Fortran 6.0 compiler. This programming effort also includes changing the philosophy of data input, developing a Windows input interface and output post-processor and adding GIS capability to the program. A converter program will reformat old input data sets so they can be run in the new program version.

The system of TR-20 computer programs consist of: (1) input generation and editing, (2) GIS based data generator, (3) old data set converter, (4) TR-20 HEC-RAS rating, (5) main program, (6) output files and (7) post processing programs.

The system of TR-20 and TR-55 computer programs is available from the National Water and Climate Center website (<http://www.wcc.nrcs.usda.gov>).

WMS - Watershed Modeling System

WMS was developed by the Engineer Computer Graphics Laboratory of Brigham Young University.

WMS is a Windows-based user interface that provides a link between terrain models and GIS software, with industry standard lumped parameter hydrologic models, including HEC-1, TR-55, TR-20 and others. The hydrologic models can be run from the WMS interface. The link between the spatial terrain data and the hydrologic model(s) gives the user the ability to develop hydrologic data that is typically gathered using manual methods from within the program. For example, when using NRCS methodologies, the user can delineate watersheds and subbasins, determine areas and curve numbers, and calculate the time of concentration at the computer. Typically, these computations are done manually, and are laborious and time-consuming. WMS attempts to utilize digital spatial data to make these tasks more efficient.

Watershed Modeling

The Watershed Modeling program was developed to compute runoff and design flood control. The program can run inside the MicroStation CAD system. Like WMS, this feature enables the program to delineate and analyze the drainage area of interest. Area, curve number, land use and other hydrologic parameters can be computed and/or catalogued for the user, removing much of the manual calculation typically performed by the hydrologic modeler.

Watershed Modeling contains a variety of methods to calculate flood hydrographs, including NRCS, Snyder and Rational methods. Rainfall can be synthetic or user-defined, with any duration and return period. Rainfall maps for the entire U.S. are provided to help the user calculate IDF relationships. Several techniques are available for channel and storage routing. The user also has a wide variety of outlet structure options for detention pond analysis and design.

Regional Models

A number of large storm models have also been developed by local and regional government. Some of these models include:

- PSRM - The Penn State Runoff Model (Aron et al., 1992), which is used widely in Pennsylvania and Virginia
- ILLUDAS - The Illinois Urban Area Simulator, which was developed by the Illinois State Water Survey and is widely used in Illinois and neighboring mid-western states.
- UDFCD - The Urban Drainage and Flood Control District model, developed by the Denver Urban Drainage Flood Control District (UDFCD, 1999). This model is used widely in Colorado and adjoining states.
- The Santa Barbara Urban Runoff Hydrograph, developed for the City of Santa Barbara California. This model is widely used in California and other pacific coast states (Oregon and Washington).

A brief description of these large storm regional hydrologic models is provided below.

PSRM - The Penn State Runoff Model

The Penn State Runoff Model (PSRM) and PSRM-QUAL are the most recent modifications of the Penn State Runoff Model (Aron et al., 1992) and is available from the Pennsylvania State University Department of Civil and Environmental Engineering (telephone: 814-865-8391). This model incorporates both runoff quantity and water quality routines, and is widely used in Pennsylvania and Virginia for the design of SWM BMPs.

Components of the quantity model include overland runoff, stream/pipe flow, surcharging, routing through channels and reservoirs, and multiple storm considerations. The quality modeling routine includes methods for determining contaminants in urban runoff and their effects.

The quantity algorithm simulates the runoff and pollutant transport as a cascade of sheet flows from consecutive terraces along the flow path. The model includes overland, tributary and reservoir routing techniques, as well as surcharging (excess runoff beyond the capacity of the main channel or drain pipe) and observed hydrograph input.

The quality algorithm calculates the buildup and washoff of sediments from the land surface. Various sediment sizes are simulated, with expected percentages of pollutants associated with the sediment sizes (a high percentage of these are associated with smaller sediment sizes). The model simulates toxicants, nutrients and sediments.

PSRM and PSRM-QUAL is an easy to use, menu-driven program written in QUICK-BASIC. Data entered by the user is written to a file and may be edited. Help screens are available to the user.

Once an input file is created, the run option executes the program. Output may be displayed on the monitor or printed out in summary form. Sensitivity runs can easily be performed by modifying input parameters through the use of a multiplier. Output from PSRM-QUAL may be plotted for both the quantity and quality routines.

ILLUDAS - The Illinois Urban Drainage Area Simulator

ILLUDAS stands for Illinois Urban Drainage Area Simulator. It has an option for sizing storm sewers given the basin runoff characteristics, design rainstorm and layout of the sewer network. If the sewer sizes are already known, such as in an existing system, the program will calculate the flows within the entire sewer network. This model was first developed during the 1960s at the Road Research Laboratory in England and was referred to as the RRL method. It was further developed and enhanced by the Illinois State Water Survey and, since it was in public domain, it was made available by the state of Illinois to anyone upon request. In recent years, this model was converted to a PC version by two individuals working for the Illinois Water Survey and is being distributed as a proprietary model outside of Illinois.

ILLUDAS includes routines for estimating detention storage volumes. One of these routines is a simplification of the flood routing process occurring at a stormwater detention facility. This simplified routing option in ILLUDAS should only be considered for preliminary pre sizing of volumes before serious and more detailed studies are initiated. We refer to this preliminary routing procedure whenever ILLUDAS is discussed. For more information on the model and its capabilities, contact the Illinois State Water Survey.

Detention design using ILLUDAS is performed using certain simplifying assumptions. Of these, the most significant is that the outflow from the detention facility is held constant during the entire detention process, namely, during filling and emptying. This simplification limits the use of ILLUDAS to preliminary systems planning. Figure A-6 illustrates a hypothetical installation that approximates the detention model used by ILLUDAS.

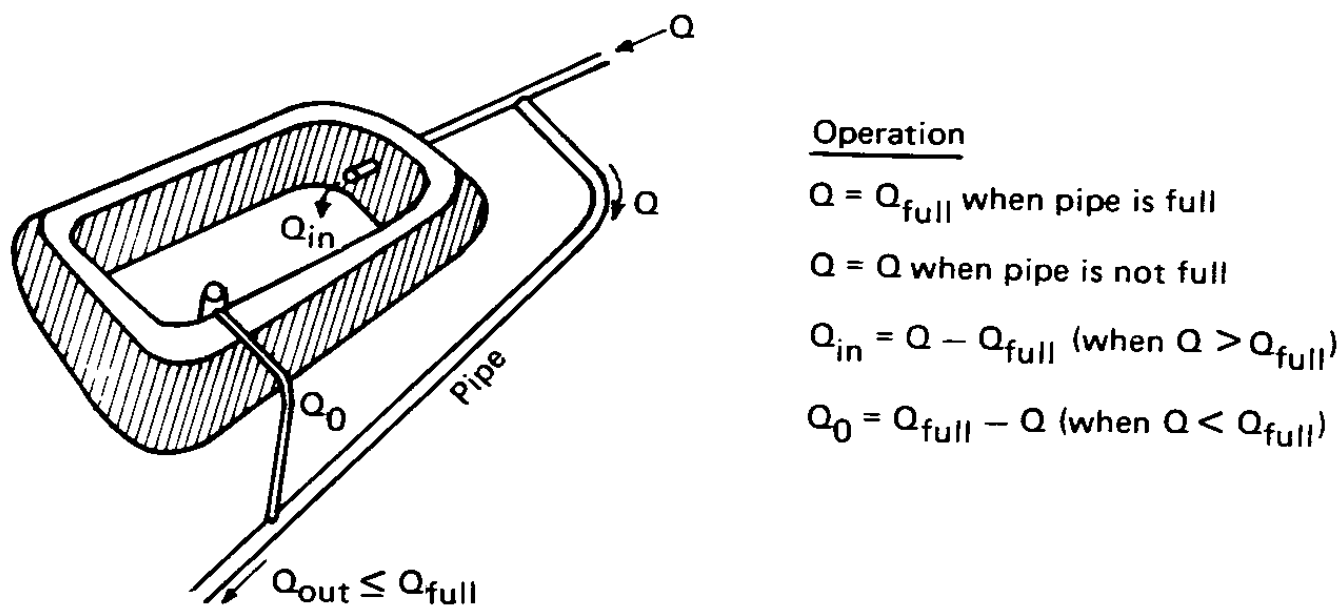

Figure A-6 Example of hypothetical detention as modeled by ILLUDAS (After Terstriep and Stall, 1974)

UDFCD - The Urban Drainage and Flood Control District Model

The Denver Urban Drainage and Flood Control District has developed a model for the computation of runoff hydrographs from urban areas that is known as the Colorado Urban Hydrograph procedure (CUHP).

The Runoff Block of SWMM was substantially modified by the Missouri Division of the Army Corps of Engineers (MRD). This version was further modified to run on a PC for the Urban Drainage and Flood Control District (UDFCD) in Denver, Colorado by the Boyle Engineering Company. In rewriting it for the UDFCD, the surface runoff calculations from tributary subbasins were decoupled from the gutter, pipe, detention and other flow routing calculations. As a result, the user needs to generate the subbasin runoff hydrographs only once and then use them as input in subsequent runs. Various flow routing options can thus be studied at considerable savings in computer run time. Description of both models and the software can be obtained free of charge from the Urban Drainage and Flood Control District Denver, Colorado on their web site at www.udfcd.org.

The user may also choose to generate storm runoff hydrographs using the UDFCD's Colorado Urban Hydrograph Procedure (CUHP) program. The output hydrographs from the CUHP program are then read by UDSWM, which routes these hydrographs through the conveyance system, detention facilities, diversions, etc. This program has many of the routing options normally found in the Transport Block of SWMM. It also has some features not found in the Transport Block. Like the MRD Version of the Runoff Block, UDSWM provides the following flow routing elements:

- trapezoidal channels
- circular pipes
- direct flow links (i.e., no flow routing)
- trapezoidal channels with an overflow channel
- circular pipes with an overflow channel
- detention facilities (based on Storage vs. Outflow rating table)

- diversion facilities (based on Flow in Main Flow Element vs. Diverted Flow rating table) and
- out-of-basin inflow hydrographs (based on Time vs. Flow table).

Also, like the MRD version of the Runoff Block, UDSWM offers a single program block with many of the options frequently used in urban stormwater hydrology. In its current version, it has no capability to estimate the runoff and transport of urban runoff pollutants. If storm runoff water quality needs to be modeled, the EPA version of SWMM, despite its shortcomings in simulating pollutant loads, is the model of choice at this time. A feature was recently added to the new version of UDSWM that can automatically design the size of circular storm sewers.

Detention calculations can be performed in two ways using UDSWM. The first option is an informal one and is similar to the methodology in the ILLUDAS model. The user can obtain preliminary detention volume requirements by merely specifying a circular pipe of known flow capacity. The model will route the flows through the pipe until its pipe-full capacity is reached. Any excess flow is then held back in storage until the flows decrease and capacity in the pipe again becomes available to carry off the stored excess. The volume held back this way is reported along with the flow hydrograph and as the maximum volume stored in a summary table. Backwater effects and surcharge in the pipes are not considered in the calculations. As with ILLUDAS, the informal option produces estimated volumes that tend to be on the low side.

The second and formal detention option of UDSWM permits the user to define the outflow vs. storage characteristics for up to 25 detention facilities. The outflow vs. storage input data are used by the program only after the outlet pipe capacity is exceeded. In other words, the program will satisfy the normal depth capacity of the pipe element first before utilizing the outflow vs. storage tables provided by the user. This option permits an experienced user considerable flexibility in testing storage scenarios.

To simulate a surcharged outlet, the user enters the Storage-Outflow table and the characteristics for a very small pipe element that has virtually no flow capacity to satisfy. To approximate an off-line detention facility, the user specifies the pipe size equal to the bypass pipe and then enters the volume outflow table for the flows that exceed its pipe full capacity. UDSWM2- PC is a single event model and will handle one storm event a time. Continuous modeling is not a currently available option.

The formal detention option calculates the storage in the basin using a Modified Pulse flood routing procedure. The time increment used is the user specified time increment of integration for all flow routing calculations in the model. The output consists of a printout that lists all the storage and discharge values throughout the run and the maximum discharge rate and volume stored throughout the storm. Full hydrograph values are printed only for the user specified flow routing elements. A summary table of peak discharge rates and volumes stored, along with their respective times of occurrence, are printed for all routing elements within the model.

UDSWM is a modified version of the SWMM Runoff Block that will run on a PC. The modifications allow the user a variety of flow routing options, including detention facilities. Detention calculations can either be performed informally in a manner similar to how ILLUDAS handles them or formally using the Modified Pulse flood routing procedure. In the latter case, the user can specify up to 500 separate detention facilities anywhere in the flow routing network.

The Santa Barbara Urban Runoff Hydrograph

The Santa Barbara Urban Hydrograph (SBUH) method was developed by the Santa Barbara County Flood Control and Water Conservation District to determine a runoff hydrograph for an urbanized area. It is a simpler method than some other approaches, as it computes a hydrograph directly without going through intermediate steps (i.e., a unit hydrograph) to determine the runoff hydrograph.

The SBUH method is a popular method for calculating runoff, since it can be done with a spreadsheet or by hand relatively easily. The SBUH method depends on several variables:

- Pervious and impervious land areas
- Time of concentration calculations
- Runoff curve numbers applicable to the site
- Design storm,

Other Models

SLAMM - Source Loading and Management Model

The SLAMM model (Pitt and Voorhees, 1989) was originally developed as a planning tool to model runoff water quality changes resulting from urban runoff pollutants. The model has been expanded to include simulation of common water quality BMPs such as infiltration, wet detention ponds, porous pavement, street cleaning, catchbasin cleaning and grass swales.

Unlike other water quality models, SLAMM focuses on small storm hydrology and pollutant washoff, which is a large contributor to urban stream water quality problems. SLAMM computations are based on field observations, as opposed to theoretical processes. SLAMM can be used in conjunction with more commonly used hydrologic models to predict pollutant sources and flows.

P8 - Urban Catchment Model Program for Predicting Polluting Particle Passage thru Pits, Puddles, & Ponds

This model was prepared for IEP, Inc. & Narragansett Bay Project EPA/RIDEM by William W. Walker, Jr. in 1990 and there have been several versions since, the latest being 2.4 in February, 2000.

P8 is a model for predicting the generation and transport of stormwater runoff pollutants in urban watersheds. Continuous water-balance and mass-balance calculations are performed on a user-defined system consisting of the following elements:

- Watersheds (nonpoint source areas, up to 192 in Version 2.4)
- Devices (runoff storage/treatment areas or BMP's, up to 48 in Version 2.4)
- Particle Classes (up to 5)
- Water Quality Components (up to 10).

Simulations are driven by continuous hourly rainfall and daily air temperature time series. The model was developed for use by engineers and planners in designing and evaluating runoff treatment schemes for existing or proposed urban developments. The model is initially calibrated to predict runoff quality typical of that measured under the EPA's NURP for Rhode Island rainfall patterns. Predicted water quality components include SS (five size fractions), total phosphorus, total Kjeldahl nitrogen, copper, lead, zinc and total hydrocarbons.

Primary applications include site BMP design to achieve SS removal efficiencies (70% or 85%) recommended by the Rhode Island Department of Environmental Management. Simulated BMP types include detention ponds (wet, dry, extended), infiltration basins, swales and buffer strips. Hydrologic components of the program are calibrated and tested against six years of daily streamflow data from the 15,000-acre Hunt-Potowomut watershed, Rhode Island. The model is used to examine the water quality implications of alternative treatment objectives.

Inputs are structured in terms that should be familiar to planners and engineers involved in hydrologic evaluation. Several tabular and graphic output formats are provided. The computer program runs on IBM-PC compatible microcomputers. A companion report (P8 Urban Catchment Model - User's Manual, IEP Inc., 1990) provides an overview and several example applications. Information obtained from: <http://www.wwwalker.net/p8/index.html>.

Appendix B Small Storm Hydrology

Water quality control designs are focused more on the annual runoff volume rather than peak storm events. Typically smaller storm events account for the majority of annual rainfall and runoff volumes. The following describes three approaches based on varying assumptions and subsequently varying levels of complexity to calculate water quality volumes, V_{WQ} , capture for small storm hydrology. These methods use storage volume as a surrogate for water quality, which is strictly a hydraulic issue and is the limitation of these methods. If the objective is to improve water quality and receiving water quality that may require more complex methods of analysis that include pollutant removal mechanisms, and not throughput detention volume alone.

Basic Procedure for Optimization of Water Quality Capture Volume

Urbonas, et al., (1990) reported that an investigation of sizing stormwater quality facilities for maximized capture of stormwater runoff events and their performance in removing settleable pollutants revealed that simplified design guidelines are possible. These guidelines can be developed using local or regional rain gauge records.

The procedure for developing these simplified guidelines uses a runoff volume point diagram (RVPD) method to approximate a continuous simulation process in combination with an optimization routine. This procedure was converted by the authors into a computer software.

Using the Denver rain gauge for testing this procedure, a figure was prepared that relates a watershed's runoff coefficient, required capture volume and the drain time for this volume. The authors described a procedure that consists of the following five steps:

1. Reduce the recorded rain gauge record (preferably hourly or 15-minute record) to a rain point diagrams (RPD) using several storm separation periods.
2. Transform these RPD into a RVPD by multiplying the individual rainfall depths by the watershed's runoff coefficient (C). This can be done for three or more values of C , such as $C = 0.1, 0.5$ and 1.0 to provide several points on the final design curves.
3. Process the RVPD through the optimization procedure described earlier using several capture volumes and brim-full storage volume drain times. A RVPD that was prepared using a time of storm separation equal to one-half of the desired brim-full drain time is suggested.
4. Plot all of the results on a figure similar to Figure B-4 (described below) for the specific precipitation gauge being used.
5. Perform sensitivity analysis and if appropriate offer options for sizing capture volume for several levels of capture probability and/or TSS removal.

The procedure described by Urbonas et al. (1990) is reproduced below.

Background

The size of runoff event to be captured and treated is a critical factor in the design of stormwater quality BMP facilities. For example, if the design runoff event is too small, the effectiveness will be reduced because too many storms will exceed the capacity of the facility. Or if the design event is too large, the smaller runoff events will tend to empty faster than desired for adequate settling of pollutants. Thus the larger basins may not provide the needed retention time for the predominant number of smaller events. A balance between the storage size and water quality treatment effectiveness is needed. Grizzard et al. (1986) reported results from a field study of basins with extended detention times in the Washington, DC area. Based on their observations they suggested that these basins provide good levels of treatment when they are sized to have an average drain time of 24 hr, which equates to a 40-hr drain time for a brim-full basin.

EPA (Driscoll et al., 1986) suggested an analytical methodology for estimating the removal efficiencies of sediments in ponds that have surcharge storage above a permanent pool. Subsequently, Schueler (1987) suggested that the surcharge volume be equivalent to the average runoff event volume. Analysis by the authors in Denver using the EPA

analysis technique indicates that wet ponds can be very effective in removing settleable pollutants (i.e., annual TSS removal rates in excess of 80%). However, this analysis was limited to ponds that have brim-full surcharge volume equal to one-half inch of runoff from the tributary impervious surfaces, with this volume being drained in 12 hr. Nevertheless, there remains little rationale for sizing the capture volume that results in reasonable pollutant load removal while providing reasonably sized cost effective facilities.

Until recently, the primary interest was in drainage and flood control. As a result, the focus was on larger storm events such as the 2- to 100-yr floods. Although drainage and flood control engineers traditionally consider the 2-yr event as small, at least in the Denver area it is larger than 95% of all the runoff events that typically occur in an urban watershed. Also, experience and monitoring data have revealed that a detention facility designed to control a 100-yr, or even a 2-yr flood has little, if any, effect on water quality. Thus, focusing on the traditional drainage design storms is not practical or desirable when considering stormwater quality.

The method described below can be used to find a point of diminishing returns for sizing water quality detention facilities. It utilizes rainstorm records as its base instead of synthesized design storms. An example based on the National Weather Service long-term precipitation record in Denver is used to illustrate the suggested methodology.

Rain Point Diagram

In 1976, von den Herik (1976) suggested in Holland a rainfall data-based method for estimating runoff volumes. This method is based on a long-term record of total rainfall and duration of storms. Subsequently, Pecher (1978 & 1979) suggested modifications to von den Herik's work to use in sizing detention facilities through the use of a RPD. Urbonas et al., (1990) modified the original method to transform the RPD to a RVPD by multiplying the individual rainstorm depths on the RPD by the runoff coefficient of the tributary watershed.

The RVPD method approximates continuous modeling without setting up a continuous model. The method requires combining individual recorded hourly or 15 minute rainfall increments in a given period of record into separate storm depth totals. Separate storms are identified by a period of time when no rainfall occurs. Very small storms that are not likely to produce runoff can then be purged from the record. Rainfall storm totals are then converted to runoff depths (i.e., volumes) by multiplying the rainfall depth by the watersheds' **C**.

The RVPD assumes an empty basin for each event. Because the RVPD procedure does not take into account the effects of several successive rainstorms, it would have a tendency to underestimate the capture effectiveness of detention facilities that have very low release rates. This is because the volume captured during one storm may not be fully drained before the next storm occurs.

The procedures used to develop the RVPD method and a case study using the Denver rain gage data will be discussed subsequently. However, to illustrate the use of the RVPD, a plot of 63 storms is shown in Figure B-1, where the individual storm runoff depth in inches is plotted against storm duration. A runoff capture envelope is also plotted on this same figure. This captured storage envelope is based on the "brim-full" volume of the detention facility and its emptying time. In Figure B-1 the runoff capture envelope is based on a detention basin that has a brim-full capacity of 0.3 watershed in., which can be emptied through the outlet in 12 hr (sometimes called draw down time).

All the points above the capture volume envelope line represent individual storms that have sufficient runoff to exceed the available storage volume (i.e., brim-full volume) of the detention facility. A software package was developed to perform this task.

While this procedure is a simplification of a continuous modeling process, the results are considered sufficiently accurate for general planning purposes. This conclusion is supported by the fact that the true accuracy of hydrologic calculations is significantly less than the precision implied by stormwater hydrology models (ASCE, 1984) that are commonly used.

To compensate for storms that may be closely spaced, Urbonas et al. (1990) used a storm separation interval equal to one-half of the emptying time of the brim-full volume. In other words, a storm was defined as separate from a previous storm when this separation condition was satisfied between the end of the last recorded rainfall increment and the beginning of the next one.

The sensitivity of the storm separation period was tested using a storm separation period equal to the brimfull volume emptying time. Virtually no difference was found in the capture volume effectiveness between the separation set at

brim-full and one-half of the brim-full emptying time. Such sensitivity tests are suggested whenever other precipitation data are used for this procedure

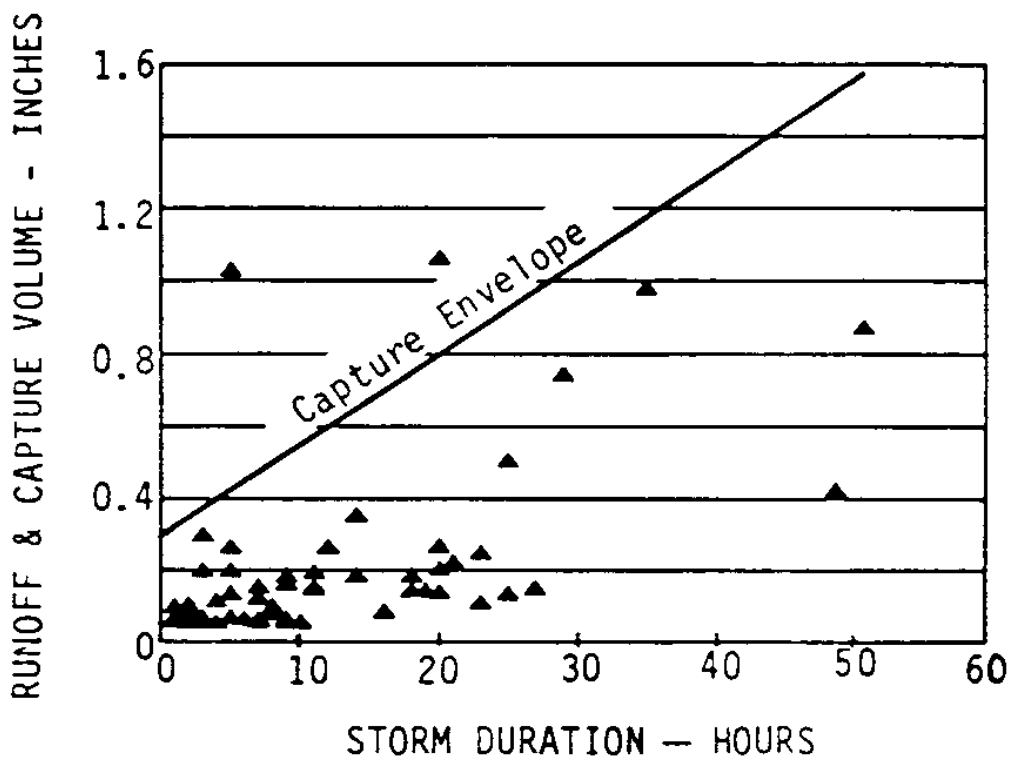

Figure B-1 Runoff Volume Point Diagram and Capture Volume Envelope (Urbonas et al., 1990) (Reprinted with permission from ASCE)

Storage Volume Optimization Procedure

After the total rainfall record is separated into individual storm events, the runoff volume for each storm can be estimated with equation B-1:

$$V_r = CP_t \tag{B-1}$$

where: V_r = total runoff volume for a storm, in watershed in. or m,
 C = runoff coefficient, and
 P_t = total precipitation over the watershed for the storm in in. or m.

For a given detention pond or basin that has a brimfull volume V_p with an emptying time T_e , its average release rate, q , is described by equation B-2.

$$q = V_p / T_e \tag{B-2}$$

The runoff volume capture capacity, V_m , of the detention basin for any storm may be estimated using equation B-3:

$$V_m = V_p + qT_L \tag{B-3}$$

where: T_L = storm length.

The product, qT_L , represents the storage beyond the brim-full volume that becomes available during the storm as the result of releases from the basin during the storm's duration.

The actual runoff volume captured and processed for quality improvement through the basin for a given storm is equal to V_r , namely storm runoff volume, when V_r is less than V_m ; otherwise it is equal to V_m with the excess runoff volume assumed to overflow without any treatment. Adding the volumes captured for all the storms occurring during the record period gives the total volume captured and treated, V_T , within the period. Thus, the volume capture ratio for the period of rainfall record is defined by equation B-4:

$$R_C = V_T / V_R \quad (B-4)$$

where: R_C = volume capture ratio for the record period,
 V_T = total volume captured during the period, and
 V_R = total runoff volume during the same period.

Similarly, the runoff event capture ratio is defined by equation B-5:

$$R_e = N_r / N \quad (B-5)$$

where: R_e = runoff event capture ratio for the period,
 N_r = number of runoff events that are less than or equal to V_m in runoff volume, and
 N = total number of runoff events.

For the total set of runoff events in the record there is a detention volume that will capture all of the runoff events of record. For practical reasons this maximum pond volume, P_m , was defined to be equal to the 99.9% probability runoff event volume for the record period. For the Denver raingage period of record studied (1944-1984) this is equal to the runoff from 3.04 in. (77.2 mm) of precipitation or 6.9 times the precipitation of an average runoff producing storm for this period of record. This 99.9% value, namely P_m , was then used to normalize all pond sizes being tested using the equation B-6:

$$P_r = P / P_m \quad (B-6)$$

where: P_r = relative pond size normalized to P_m ,
 P = pond size being tested, and
 P_m = maximum runoff volume (i.e., 99.9% probability).

The maximization procedure incrementally increases the relative (i.e., normalized) pond size and calculates the runoff volume and event capture ratios (i.e., R_v and R_e) using the RVPD method. Figure B-2 illustrates an example of the results of such an analysis using the precipitation record at the Denver gage between 1944 and 1984. In this example, the capture volume was maximized using storms defined by a 6-hr period of separation, 12-hr emptying time for the brim-full basin and $C = 0.5$ for the watershed.

The maximized pond size occurs where the 1:1 slope is tangent to the runoff capture rate function. Before this point is reached the capture rate increases faster than the relative capture volume size. After this point is reached, the increases in the capture rate become less than the corresponding increases in relative capture volume size. In other words, when the point of maximization is passed, diminishing returns are experienced if the capture volume is increased any further. In Figure B-2 example, the maximized point occurs when the relative detention volume is equal to 0.18. At this point approximately 82% of the entire runoff depth that has occurred during the 40 year study period is captured in total and released slowly. This relative capture volume is then converted to actual volume using Equation B-6, in which, 0.5 is the watershed's runoff coefficient and $P_t = 3.04$ in. (77.2 mm), namely the depth of rain during the 99.9% probability storm:

$$P = P_r P_m = P_r (C \times P_t) = (0.18)(0.5 \times 3.04) = 0.27 \text{ in.} (7.0 \text{ mm})$$

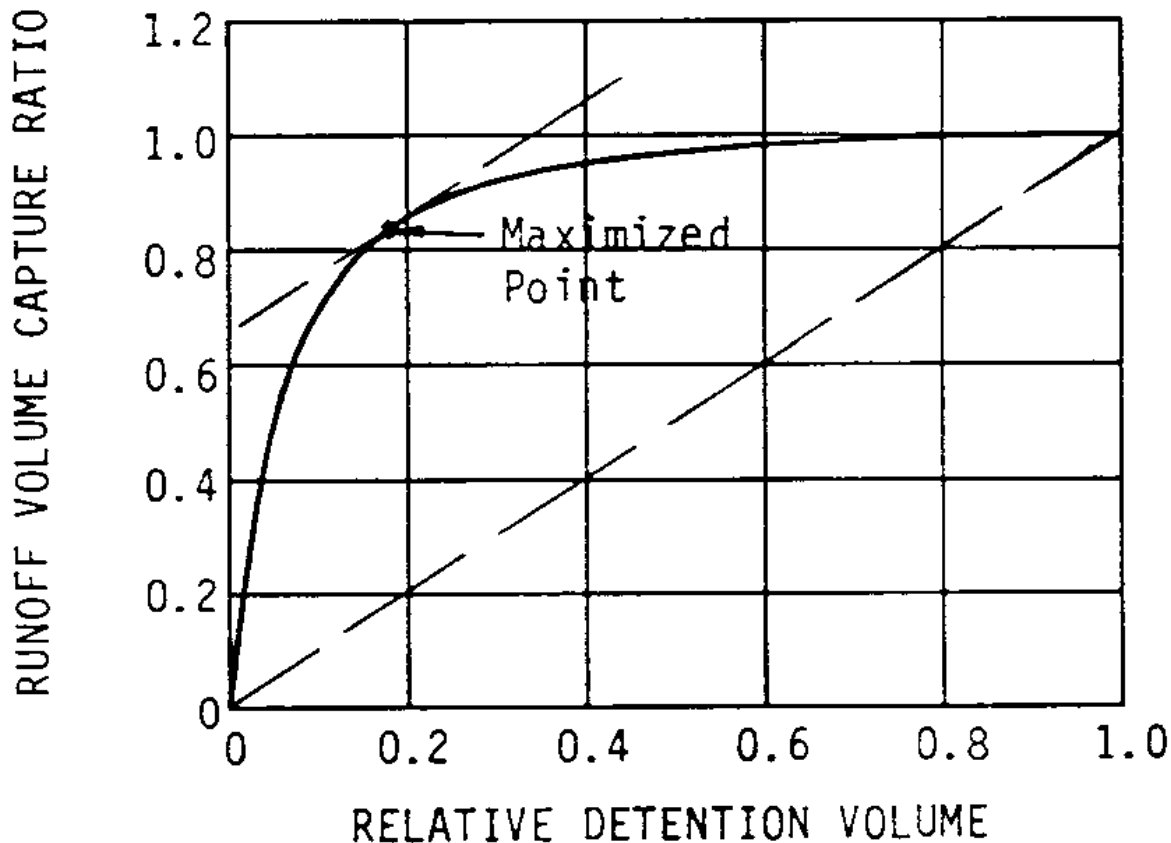

Figure B-2 Maximizing Capture Volume (Urbonas et al., 1990) (Reprinted with permission from ASCE)

Case Study Using Denver Rain Gauge Data

Urbonas et al. (1990) investigated the Denver gauge precipitation data using several storm separation periods, which has been defined as the time between the end of one storm and the beginning of the next. A statistical summary of rainfall characteristics for all storms that exceeded a total of 0.1 in. is given in Table B-1. A 0.1 in. "filter" was used to eliminate from the record the very small storms, of which most are likely not to produce runoff. The urban rainfall and runoff data in the Denver area indicate that approximately 0.08 to 0.15 in. of rainfall depth is the point of incipient runoff.

Table B-1 Denver rain gauge hourly data summary 1944 - 1984, storms larger than 0.1 in.

Separation Basis for New Storm (hr)	Number of Storms	Average Depth (in.)	Average Storm Duration (hr)	Average Time Between Storms (hr)	Number of Storms Smaller Than Average	Percent of Storms Smaller Than Average
1	1131	0.39	7	267	802	70.9
3	1091	0.42	9	275	782	71.7
6	1084	0.44	11	275	766	70.7
12	1056	0.46	14	280	748	70.8
24	983	0.51	23	293	686	69.8
48	876	0.58	43	310	613	70.0

A skewed statistical distribution exists with more than two-thirds of the storms having less precipitation than the 40-yr average storm depths. Apparently in the Denver area the average runoff producing rainstorm depth is a relatively large event.

The distribution of all (i.e., unfiltered) storms vs. total storm precipitation depth when individual storms are defined by a six hour separation period is shown in Figure B-3. Note that 60% of the precipitation events produced 0.1-in or

less of rainfall depth. Over 90% of all recorded storms had 0.5-in. or less of rainfall depth. This indicates that the focus, at least in the Denver area should be on the smaller, more frequently occurring storms whenever water quality is being considered.

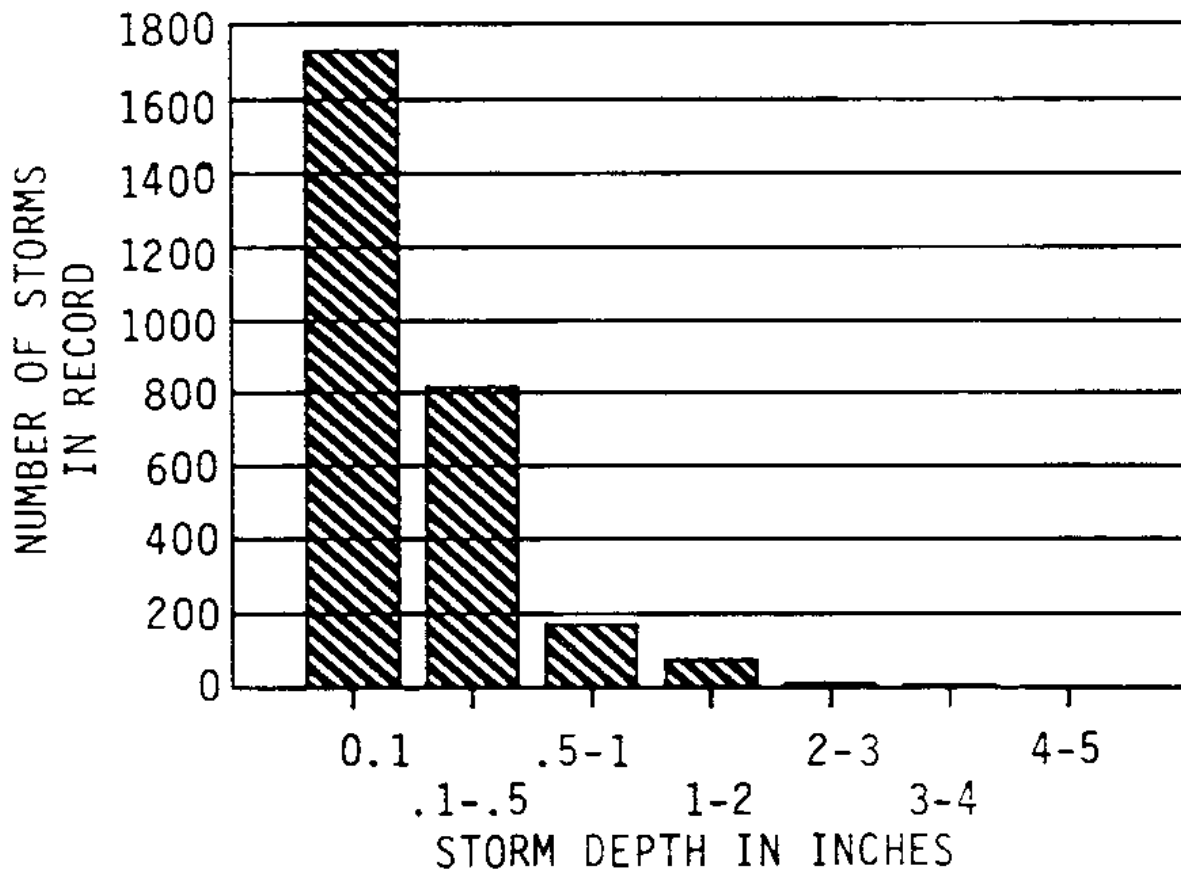

Figure B-3 Number of Storms in Denver vs. Storm Depth (Urbonas et al., 1990) (Reprinted with permission from ASCE)

Once the precipitation and runoff probabilities were understood, an attempt was made to find a simple yet reasonably accurate relationship for approximating the maximized capture volume of water quality detention basins. As described earlier, the maximized point was defined when additional storage resulted in rapidly diminishing numbers of storms or in the storm runoff volume being totally captured. The final result of this analysis is illustrated in Figure B-4, which relates the maximized capture volume to the watershed's runoff coefficient. Separate relationships are shown for the brim-full storage volume emptying time of 12-, 24- and 40-hr.

The captured volume ratio for this relationship exceeds 80% and the storm event capture ratio exceeds 86%. The storm event capture ratio is of greater importance to the receiving waters because it is the frequency of the shock loads that has the greatest negative effect on the aquatic life in the receiving streams. On the other hand, examination of the precipitation records (i.e., Figure B-3) indicates that the volume capture ratio is influenced significantly by the very few very large storms. During these very large runoff events catastrophic flooding rather than stormwater quality is likely to be of primary concern. It should also be noted that even in these larger events some degree of capture and treatment occurs, although at somewhat reduced efficiency since the detention capacity is exceeded.

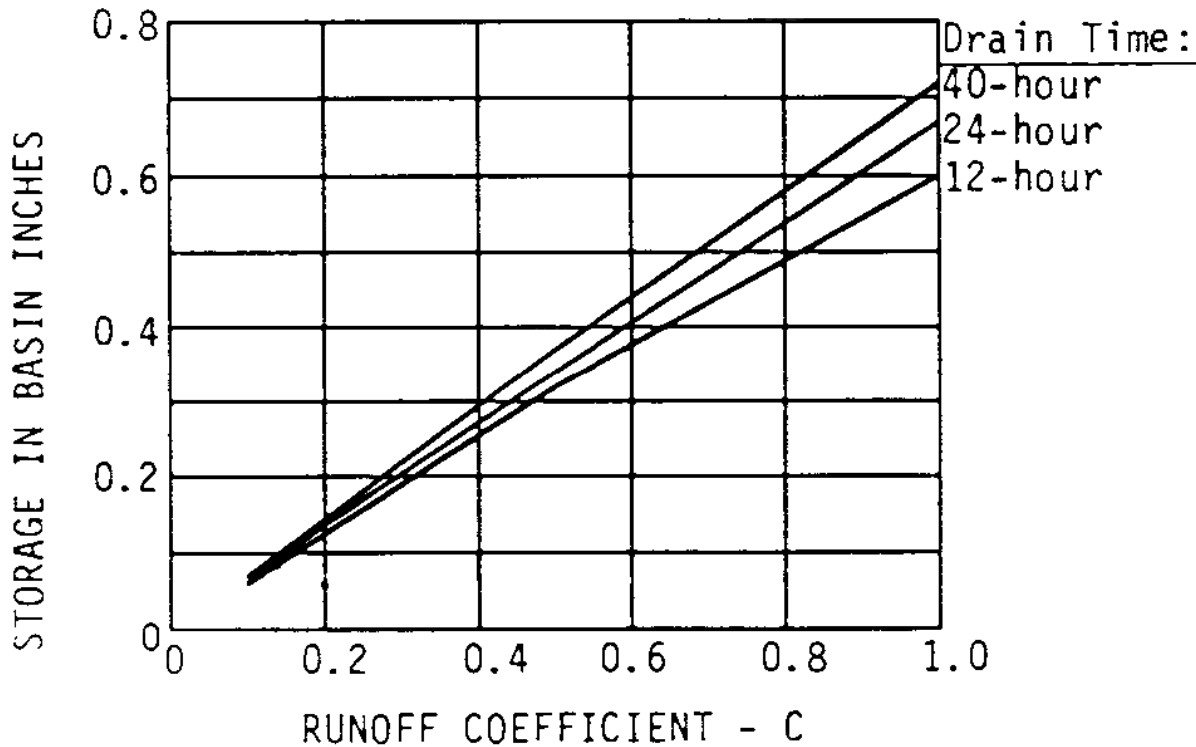

Figure B-4 Maximized Capture Volume for Water Quality, Denver Rain Gauge 1944-84 Period (Urbonas et al., 1990) (Reprinted with permission from ASCE)

Sensitivity of Procedure

Capture Volume

Understanding the sensitivity of the event capture ratios to a change in the design capture volume (i.e. brim-full volume) helps to rationally size water quality facilities. To help define this sensitivity a watershed having **C** of 1.0 and a storage basin having the maximized volume draining in 12 hrs was analyzed. The design capture volume of the basin was increased and decreased in increments and the results were normalized around the maximized volume point. Figure B-5 illustrates the findings for this particular case. Although the results varied somewhat between similar tests, the trend was virtually the same for each test that was made using the Denver rain gauge data.

At the ratio of 1.0 on the abscissa, the capture volume has to be almost doubled to capture an additional 10% of the runoff events in the record. On the other hand, reducing the capture volume by 25% results in the reduction of only 8% in the runoff events that are not captured in total. It needs to be understood that failure to capture a runoff event in total does not mean that the facility will not remove SS. SS will be removed, but at a somewhat diminished efficiency. The sensitivity of the facility's solids capture efficiency will be discussed next.

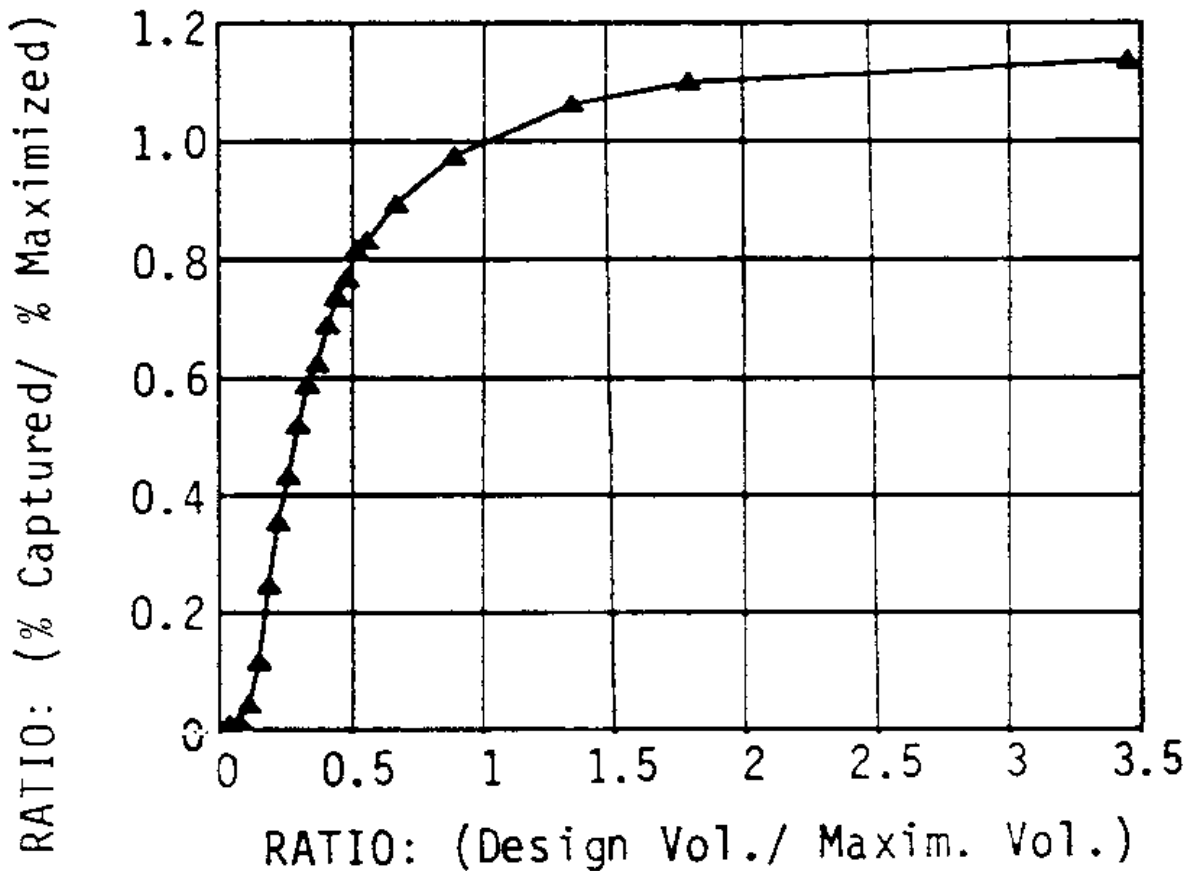

Figure B-5 Sensitivity of Capture Volume Size (Urbanas et al., 1990) (Reprinted with permission from ASCE)

Removal of Suspended Sediments

An attempt was made to test the sensitivity of the surcharge detention volume above the permanent pool level on the annual removal rates of total suspended solids in stormwater. For lack of local data on sediment settling velocities, the data given by EPA (Driscoll et al., 1986) was used for several capture volume sizes. Estimates were made of the dynamic removals during the runoff events and the quiescent removals in the pond between storms. When using a surcharge capture volume equal to 70% of the maximized volume, the annual removal of TSS by the pond is estimated at 86%. This compares to an estimated rate of 88% annual removal of TSS when using the maximized capture volume and only a 90% removal rate when using twice the maximized volume.

It appears from the preliminary estimates made using the Denver rain gauge records that it is possible to reduce the capture volume for a wet detention pond and see virtually no effect on the annual removal efficiency of the facility. Figure B-5 suggests that the design volume could be set 25 to 35% less than the maximized capture volume. Obviously this suggestion needs more testing. If verified, savings in the construction of water quality enhancement facilities should be possible. Continuous modeling and field testing are suggested as possible methods to test this premise.

Extending the Design Procedure

It is clear from the sensitivity analysis that the capture volume may be reduced somewhat from the maximized point without a significant loss in effectiveness. The designer or the water quality administrator may want to target the capture volume size to serve a runoff event of a desired recurrence probability such as the 85%, 80% or lesser runoff event. Figure B-6 illustrates the type of relationships that can be developed if such a goal is desired. Obviously economics and practicality of the capture volume size should be considered when selecting the stormwater quality sizing criteria.

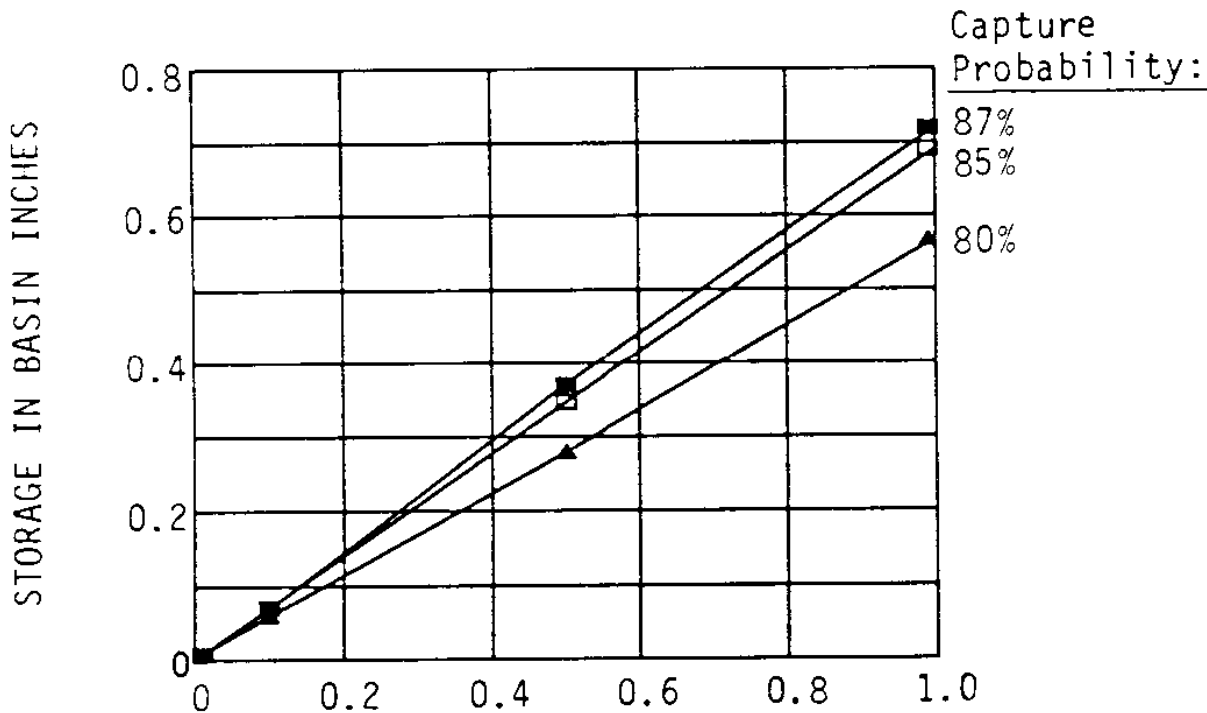

Figure B-6 Capture Volumes for a 40-hour Drain Time and Several Runoff Event Capture Probabilities (Urbonas et al., 1990) (Reprinted with permission from ASCE)

From the analysis of the Denver rain gauge data, it determined to be reasonable, logical and prudent to target the capture of approximately the 80th percentile runoff event. This means that the detention facility can be reduced by about 25 to 30% in size to make it more affordable, while still capturing in total 92% of the storm events. When the reduced detention facility is analyzed for impact on the average annual removal in total suspended solids, the difference from the maximized size in water quality being released to the receiving waters is practically not measurable. In other words, the 80th percentile capture volume should provide very good long-term TSS removal rates. Also, basins of this size should fit easily within either on-site detention facilities designed for control of runoff peaks or within most landscaping areas of new developments.

At the same time, the removal of dissolved nutrients, such as phosphorous or nitrates, is primarily the function of residence time within the permanent water pool of the "wet pond" between storms. Increasing the capture volume above this pool should have little effect on the removal efficiencies of these compounds. Similarly, "dry ponds" have limited removal efficiencies of dissolved nutrients since their primary removal mechanism is sedimentation (Grizzard et al., 1986; Schueler, 1987; Roesner et al., 1988; Stahre and Urbonas, 1988).

Determination of Runoff Coefficient

Using Figure B-4 or Figure B-6 it is possible to quickly estimate an effective size of a stormwater quality detention basin. Since the engineer has to address smaller runoff events when dealing with stormwater quality, an appropriate runoff coefficient needs to be used. In 1982, EPA published data as part of the NURP study on rainfall depth vs. runoff volume. Although EPA did acknowledge some regional differences, much of the United States was found to be well represented by the data plotted in Figure B-7. The curve in this figure is a third order regressed polynomial with the regression coefficient $R^2 = 0.79$. This value of R^2 implies a reasonably strong correlation between the watershed imperviousness, *I*, in percent and *C*, for the range of data collected by EPA.

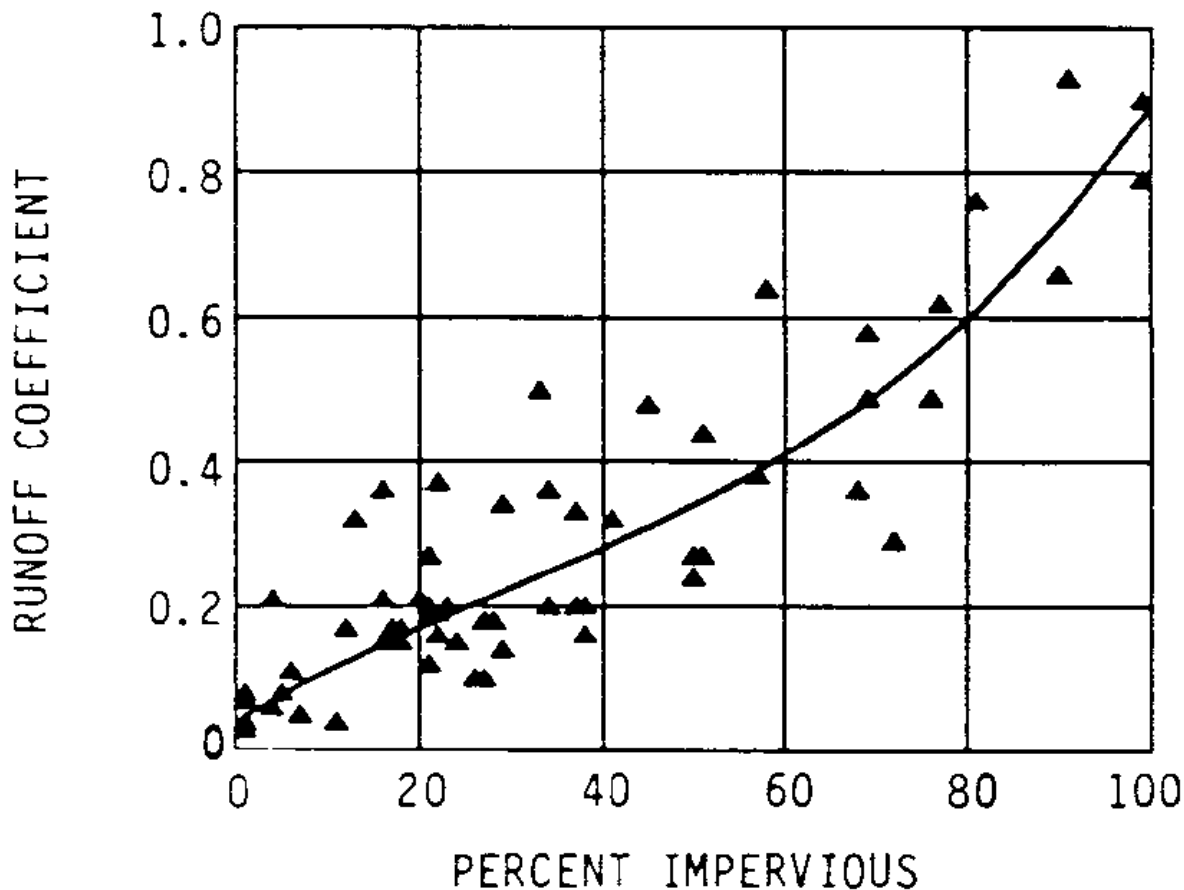

Figure B-7 Runoff Coefficient Based on NURP Data (Urbonas et al., 1990) (Reprinted with permission from ASCE)

Example of Basin Sizing

An example is used next to demonstrate how to determine a "maximized" capture volume for an extended detention basin. A 100-acre (40.5 hectares) multi-family residential tributary watershed that has 60% of its area covered by impervious surfaces is used as the example conditions.

Using Figure B-7 the runoff coefficient for the watershed, $C = 0.4$, is estimated. A well performing extended detention basin, according to Grizzard et al. (1986), needs to capture approximately the mean seasonal runoff and release it over a 24 hr period, which they suggested could be accomplished if the brim-full volume is drained in 40 to 48 hr. Thus, using the 80th percentile curve on Figure B-6 and a brim-full drain time of 40 hr a design volume of 0.22 watershed in. is obtained. This is the runoff from a 0.55 in. storm and equates to 1.8 acre ft of storage.

ASCE/WEF Regression Equation for Maximized Water Quality Capture Volume

The American Society of Civil Engineers (ASCE) and the Water and Environment Federation (WEF) (1998). have provided a regression equation to maximize the water capture volume that builds upon the earlier work by Urbonas et al. (1990). The procedure is summarized below.

Long Term Rainfall Characteristics.

Figure B-8 presents the cumulative probability distribution of daily precipitation data for 40 years in Orlando, FL and Cincinnati, OH. These data were screened to include only precipitation events 2.5 mm (0.1 in.) or greater in Cincinnati and 1.5 mm (0.06 in.) or greater in Orlando. Cumulative occurrence probabilities were computed for values ranging from 2.5 to 51mm (0.1 to 2.0 in.).

Examination of Figure B-8 reveals most of the daily values to be less than 25 mm (1 in.) in total depths. In Orlando, which averages 1,270 mm (52 in.) of rainfall per yr, 90% of these events produce less than 36 mm (1.4 in.) of rainfall. In Cincinnati, which has 1016 mm (40 in.) per yr of precipitation, 90% of the events produce less than 20 mm (0.8 in.) of rainfall. By contrast, the 2-yr, 24-hr storm produces precipitation of 127 mm (5.0 in.) in Orlando and 74 mm (2.9 in.) in Cincinnati. This suggests that capturing and treating runoff from "smaller" storms should capture a large percentage of the runoff events and runoff volume that occur in the urban landscape. Also, a water quality facility capable of capturing these smaller storms would also capture the "first flush" portion of the larger, infrequently occurring runoff events.

Capture of Stormwater Runoff.

Long-term simulations of runoff were examined for six U.S. cities by Roesner et al. (1991) using the Storage, Treatment, Overflow, Runoff Model (STORM). The six cities were Butte, MT; Chattanooga, TE; Cincinnati, OH; Detroit, MI; San Francisco, CA; and Tucson, AZ. STORM is a simplified hydrologic model that translates a time series of hourly rainfall to runoff then routes the runoff through detention storage.

Hourly precipitation records of 40 to 60 years were processed by Roesner et al. (1991) for a variety of detention basin sizes for the six cities. These simulations were performed using the characteristics of the most typically occurring urban developments found in each city. Table B-2 lists the average annual rainfall and the area-weighted runoff coefficient at each of the study watersheds. Runoff capture efficiencies of detention basins were tested using an outflow discharge rate that emptied or drained the design storage volume in 24 hours based on field study findings by Grizzard et al. (1986). The findings by Roesner et al. (1991) are illustrated in Figure B-9.

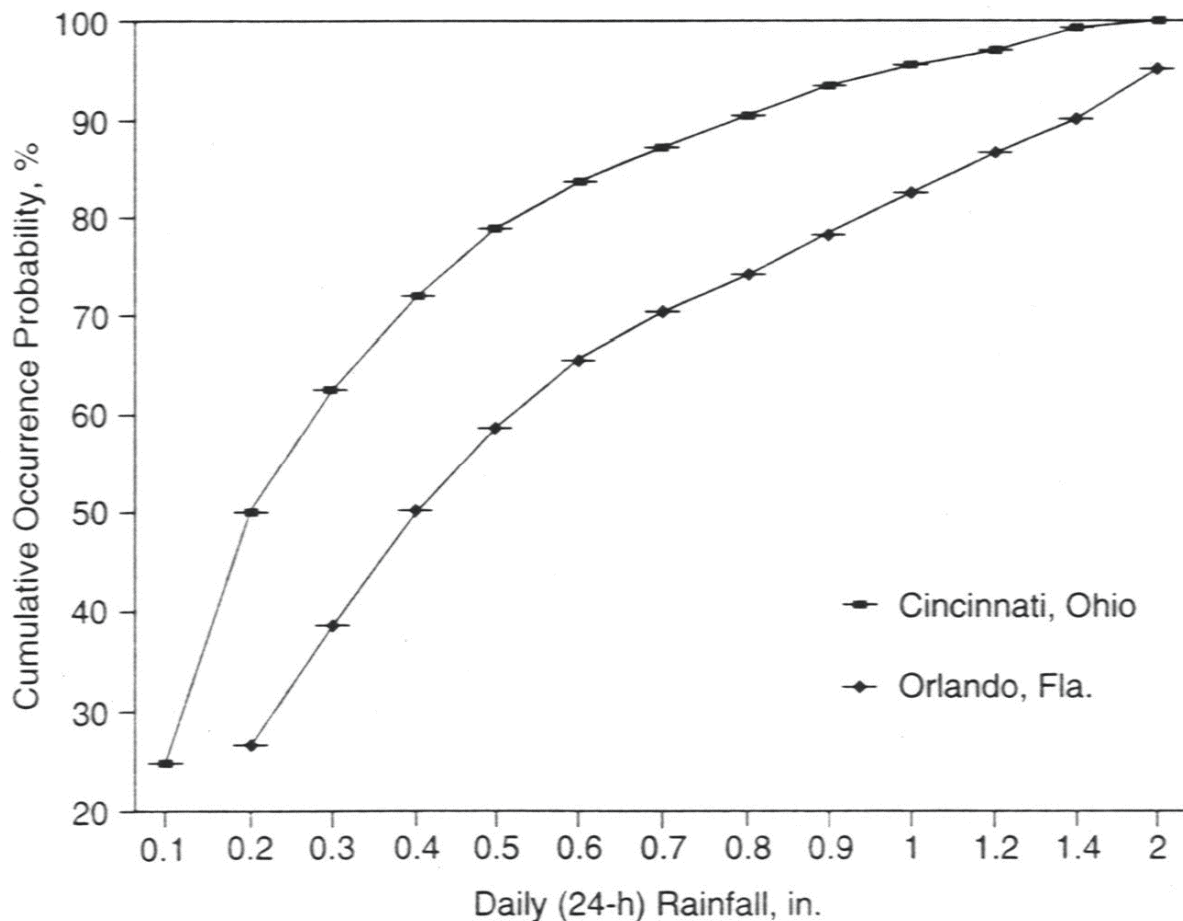

Figure B-8 Cumulative probability distribution of daily precipitation for two cities in the U.S. (in. X 25.4 = mm) (Roesner et al., 1991) (Reprinted with permission from ASCE)

Table B-2 Hydrologic parameters used at six study watersheds (Roesner et al., 1991)

City	Average annual rainfall, in. (mm)	Watershed runoff coefficient , C
Butte, MT	14.6 (371)	0.44
Chattanooga, TN	29.5 (749)	0.63
Cincinnati, OH	39.9 (1,013)	0.50
Detroit, MI	35.0 (889)	0.47
San Francisco, CA	19.3 (490)	0.65
Tucson, AZ	11.6 (295)	0.50

One way to define a cost-effective basin size is to represent it as that which is located on the "knee of the curve" for capture efficiency. This "knee" is evident on the six curves in Figure B-9 (Roesner et al., 1991) defined this "knee" as the "optimized" capture volume and reported on a sensitivity study they performed relative to this volume for the Denver, Colorado, area. Later, Urbonas and Stahre (1993) redefined this "knee" as the "maximized" volume because it is the point at which rapidly diminishing returns in the number of runoff events captured begin to occur. For each of the six study watersheds previously described, the maximized storage volume values are listed in Table B-3. The sensitivity investigation by Urbonas et al. (1990) also estimated the average annual stormwater removal rates of total suspended sediments using the maximized volume as the surcharge storage above a permanent pool of a retention pond. Estimates of total suspended sediment removals were performed using the procedure reported by Driscoll (1983). Similarly, the runoff capture and total suspended sediment removal efficiencies were estimated for capture volumes equal to 70% and 200% of the maximized volume. These findings are summarized in Table B-4.

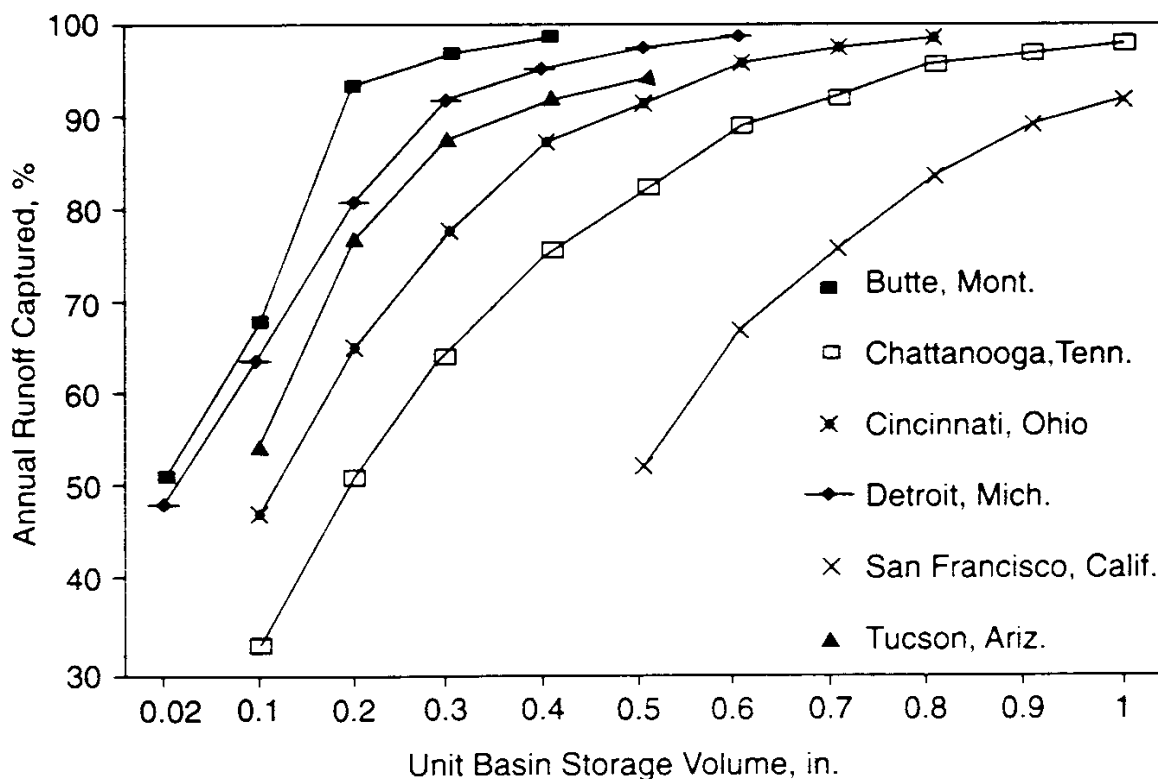

Figure B-9 Runoff capture rates versus unit storage volume at six study sites (Roesner et al., 1991) (Reprinted with permission from ASCE)

Review of Table B-4 shows that a doubling of the maximized capture volume results in a very small increase in the total annual runoff volume captured and an insignificant increase in the average annual removal of total suspended sediments. When 70% of the maximized volume is used, only a moderate decrease occurs in the volume of runoff captured and an insignificant decrease in the annual total suspended sediment load removed. Based on these findings, the Denver, Colorado, municipal area adopted an 80th percentile runoff event (that is, 95% of the maximized event) as the basis for sizing stormwater quality BMPs. This 80th percentile runoff event is viewed as the design event that

achieves maximum extent practicable (MEP) definition under the CWA, but is not considered by the municipalities in this semiarid region of the U.S. as cost effective for stormwater quality management.

Although the MEP event is not clearly defined by the regulations, insight into to the appropriate MEP design event can be gained by performing an analysis of local long-term hourly rainfall data similar to those reported in Tables B-2 through B-4. These analyses form a basis for making a rational decision in defining sizing criteria for various BMPs. As an example, the maximized unit runoff volume for a watershed in Denver, Colorado, with $C = 0.5$ is 0.28 watershed in. (7.0 mm) or 0.023 ac-ft/ac (70 m³/ha). This compares well with the maximized storage volumes listed in Table B-3 for Butte, MT and Tucson, AZ, namely, the two semiarid communities on that list.

Table B-3 Maximized unit storage volume at six study watersheds (Roesner et al., 1991) (Reprinted with permission from ASCE)

CITY	MAXIMIZED STORAGE VOLUME ^a	
	in. (mm)	Ac-ft / ac (m ³ /ha)
Butte, MT	0.25 (5.4)	0.021 (63.5)
Chattanooga, TN	0.50 (12.7)	0.042 (127)
Cincinnati, OH	0.40 (10.2)	0.033 (102)
Detroit, MI	0.30 (7.6)	0.025 (76.2)
San Francisco, CA	0.30 (7.6)	0.025 (76.2)
Tucson, AZ	0.30 (7.6)	0.025 (76.2)

^a Based on the ratio of runoff volume captured from all storms

Table B-4 Sensitivity of the best management practice capture volume in Denver, Colorado (Urbonas et al., 1990).

Capture volume to maximized volume ratio	Annual runoff volume captured (%)	No. of storms completely captured	Average annual TSS removed (%)
0.7	75	27	86
0.7	85	30	88
2.0	94	33	90

As can be seen from Figure B-9 and Tables B-3 and B-4, most runoff-producing events occur as a result of the predominant population of smaller storms, namely, less than 0.5 to 1.0 in. (13 to 25 mm) of precipitation. To be effective, stormwater quality management should be designed based on these smaller events. As a result, detention facilities, wetland basins, infiltration facilities, media filters, grass swales and other treatment BMPs should be sized to accommodate runoff volumes and flows from such storm events to maximize pollution control benefits in a cost-effective manner.

Estimating a Maximized Water Quality Capture Volume

Whenever local resources permit, the stormwater quality capture volume may best be found using continuous hydrologic simulation and local long-term hourly (or lesser time increment) precipitation records. However, it is possible to obtain a first-order estimate of the needed capture volume using simplified procedures that target the most typically occurring population of runoff events.

Figure B-10 contains a map of the contiguous 48 states of the U.S. with the mean annual runoff-producing rainfall depths superimposed (Driscoll et al., 1989a). These mean depths are based on a 6-hr interevent time to define a new storm event and a minimum depth of 0.10 in. (2.5 mm) of precipitation for a storm to produce incipient runoff. After an extensive analysis of a number of long term precipitation records from different meteorological regions of the U.S., Guo and Urbonas (1995) found simple regression equations to relate the mean precipitation depths in Figure B-10 to "maximized" water quality runoff capture volumes (that is, the knee of the cumulative probability curve).

The analytical procedure was based on a simple transformation of each storm's volume of precipitation to a runoff volume using **C**. To help with this transformation, a third-order regression equation, Equation B-7 (Urbonas et al., 1990) was derived using data from more than 60 urban watersheds over a 2-yr period (EPA, 1983).

$$C = 0.858i^3 - 0.78i^2 + 0.774i + 0.04 \quad (B-7)$$

Where: **C** = runoff coefficient, and

i = watershed imperviousness ratio; namely, percent total imperviousness divided by 100.

Equation B-8 relates mean precipitation depth taken from Figure B-10 to the "maximized" detention volume. The coefficients listed in Table B-5 are based on an analysis of long-term data from seven precipitation gauging sites

located in different meteorological regions of the U.S. The correlation of determination coefficient, R^2 , has a range of 0.80 to 0.97.

$$P_o = a \times C \times P_6 \tag{B-8}$$

where: P_o = maximized detention volume watershed in. (mm),
 a = regression constant from least-squares analysis,
 C = watershed runoff coefficient; and
 P_6 = mean storm precipitation volume, watershed in. (mm).

The maximized detention volume, P_o , can determined using either the event capture ratio or the volume capture ratio as its basis.

Table B-5 Values of coefficient a in Equation B.8 for finding the maximized detention storage volume (Guo and Urbonas, 1995).

		Drain time of capture volume		
		12 hr	24 hr	48 hr
Event capture ratio	a	1.109	1.299	1.545
	r^2	0.97	0.91	0.85
Volume capture ratio	a	1.312	1.582	1.963
	r^2	0.80	0.93	0.85

^a Approximately 85th percentile runoff event (range 82 to 88%).

Table B-5 lists the maximized detention volume/mean precipitation ratios based on either the ratio of the total number of storm runoff events captured or the fraction of the total stormwater runoff volume from a catchment. These can be used to estimate the annual average maximized detention volume at any given site. All that is needed is the watershed's C and its mean annual precipitation.

The actual size of the runoff event to target for water quality enhancement should be based on the evaluation of local hydrology and water quality needs. However, examination of Table B-5 indicates that the use of larger detention volumes does not significantly improve the average annual removal of total suspended sediments or other settleable constituents. It is likely that an extended detention volume equal to a volume between the runoff from a mean precipitation event taken from Figure B-10 and the maximized event obtained using Equation B-8 will provide the optimum-sized and most cost-effective BMP facility. A BMP sized to capture such a volume will also capture the leading edge (that is, first flush) of the runoff hydrograph resulting from larger storms. Runoff volumes that exceed the design detention volume either bypass the facility or receive less efficient treatment than do the smaller volume storms and have only a minimal net effect on the detention basin's performance. If, however, the design volume is larger and has an outlet to drain it in the same amount of time as the smaller basin, the smallest runoff events will be detained only for a brief interval by the larger outlet. Analysis of long-term precipitation records in the U.S. shows that small events always seem to have the greatest preponderance.

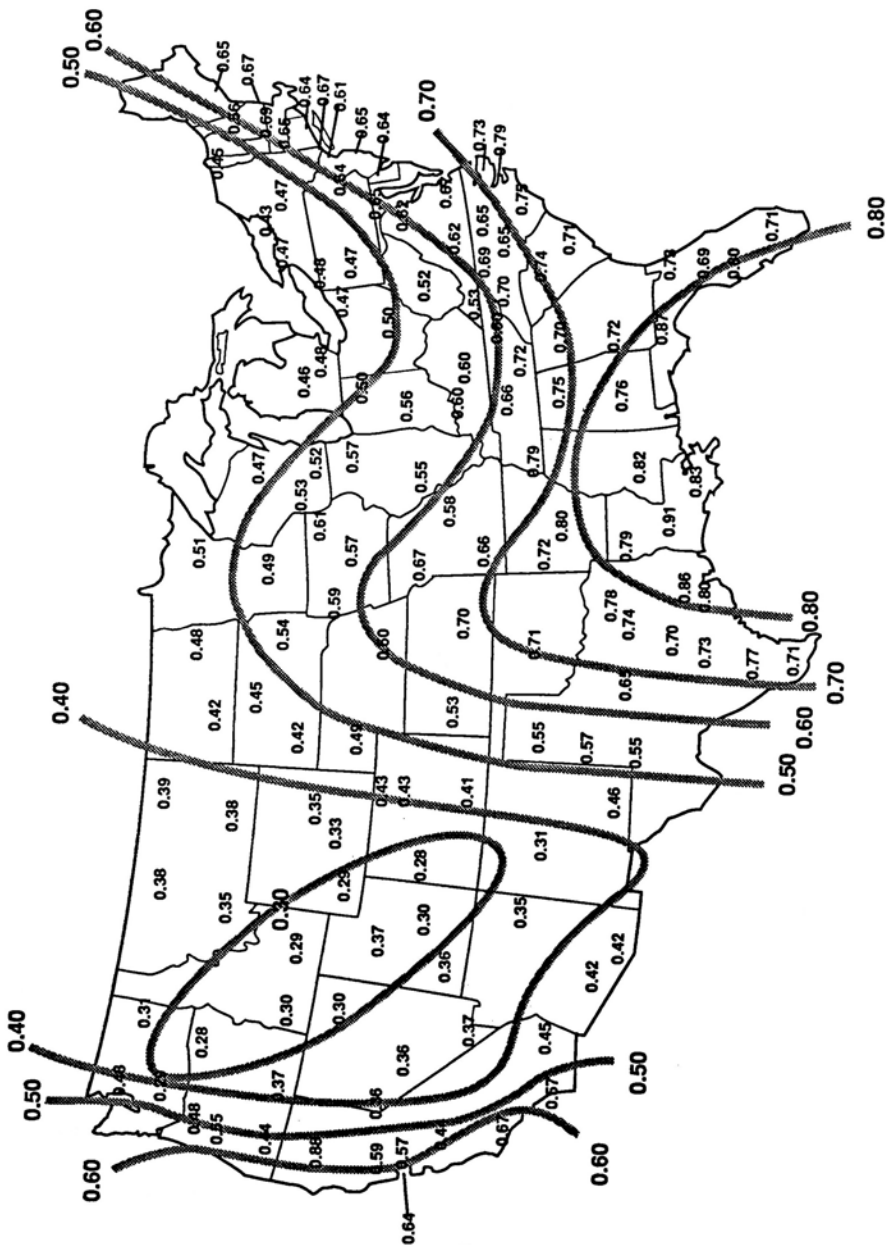

Figure B-10 Mean storm precipitation depth in the U.S. (in.) (Driscoll et al., 1989)

Example of a Water Quality Capture Volume Estimate

It is desired to estimate the maximized storage volume for a 223-ha (550-ac) watershed that has 40 % of its area covered by impervious surfaces. Assume that this-site is located in Houston, Texas (i.e., the largest storm region of the U.S.). The detention basin needs to be sized and designed to drain its water quality capture volume in 24 hr. Substituting a value of 0.40 (that is 40/100) for the variable "*i*" in Equation B-7 yields a **C** = 0.28. Using Figure B-10 we find the mean storm precipitation depth in Houston: **P₆** = 20.3 mm (0.8 in.). From Table B-5 we find the coefficient **a** = 1.299 for the 24-hr drain time. Thus, the maximized detention volume is calculated as follows:

$$P_o = a \times C \times P_6 = 1.299 \times 0.28 \times 0.8 = 0.31 \text{ in. (79 mm)}$$

This is equivalent to 0.026 ac-ft/ac (79 m³/ha). The volume of an extended detention basin for this 223-ha (550-ac) watershed needs to be 17,600 m³ (14.3 ac-ft). It is recommended that this volume be increased by at least 20% to account for the loss in volume from sediment accumulation. The final design then can show a total volume for the basin of 21,200 m³ (17.2 ac-ft) with an outlet designed to empty out the bottom 17,600 m³ (14.3 ac-ft) of this volume in approximately 24 hr.

Impervious Area Approach to Small Storm Hydrology for Small Urban Sites.

Urban surfaces can be broken down into two main categories, pervious and impervious surfaces. Impervious surfaces are traditionally thought to convert almost all rainfall into runoff, with pervious surfaces contributing much less runoff. The amount of runoff generated by pervious surfaces is related to the size of the pervious area, the relationship to impervious surfaces, the permeability of the underlying soils and the condition and type of vegetative cover. In urban areas this may not always be the case as pervious surfaces can be heavily compacted and can have a surprisingly high runoff potential while impervious surfaces, with minor cracks and expansion joints can have a remarkably high infiltration capability.

Impervious surfaces have five main components that contribute to rainfall losses:

- interception of rainfall by overhanging vegetation
- flash evaporation
- depression storage
- sorption by soil particles
- infiltration through cracks and seams.

The first four processes predominately occur immediately after the start of a rainfall event and dissipate within a relatively short time period, and are therefore often referred to as initial abstractions. Infiltration through cracks and seams continues throughout the storm event and depending on the amount of rainfall, can account for significant losses. Many runoff models incorrectly estimate initial abstractions by holding them constant and few consider infiltration through impervious surfaces for the duration of the storm event (Pitt, 1994).

Many jurisdictions throughout the U.S. use the NRCS Curve Number (CN) approach to predicting runoff volumes. One of the principal shortcomings of the methodology is an assumption of a constant CN for a large range of rainfall events. While this assumption does not significantly affect the accuracy of the model for larger storm events (> 2 in.), smaller rainfall events produce more runoff than are predicted by the NRCS procedure (Pitt, 1994). Standard NRCS methods should only be used by designers for computing volumes and peak discharges for larger storm events (i.e., 10- and 100-yr storms).

Principles of Small Storm Hydrology

Pitt and colleagues conducted several years of research on small storm hydrology, in several diverse geographic regions, over a wide range of land uses with remarkable consistency between simulated and observed results. The results (Pitt, 1994) are as follows:

- Larger rainfall events correspond reasonably well with NRCS CN procedures.

- Smaller rainfall events produce more runoff than is predicted by NRCS CN procedures.
- For strictly pervious surfaces, published CN values are much lower than observed CN values for small storm events. Therefore, less runoff is predicted from pervious areas during small storm events and NRCS method incorrectly attributes more flow to impervious surfaces. This translates into inaccurate pollutant loading estimates from both pervious and impervious surfaces.
- For impervious surfaces, the type of surface (i.e., rooftop, large paved surface, narrow street) has a significant impact on the amount of runoff for small storm events. The infiltration characteristics and depression storage of these surfaces vary greatly.
- Disconnecting impervious surfaces can significantly reduce the volume of runoff. The relative amount of reduction is a function of the pervious area flow path, the amount of impervious area draining to pervious areas and the infiltration capacity of the pervious surfaces. Substantial reductions in runoff are observed for a wide range of land uses when impervious surfaces are disconnected and drained through permeable soils (NRCS, HSG A and B). Reductions are only slight for relatively low-density land uses when impervious surfaces are disconnected and drained through relatively impermeable soils (NRCS, HSG C and D). Not surprisingly, disconnecting paved surfaces and rooftops for commercial areas does not result in significant reductions in runoff.

The “90% Rule”-Cumulative Rainfall Volume for Water Quality Treatment

Table B-6 outlines the RFS for the Washington, DC metropolitan area and illustrates that the vast majority of all annual runoff is produced from the small frequent storm events. Schueler (1987 and 1992) conducted a detailed evaluation of 50 years of hourly rainfall data in the Washington, DC area. The recorded precipitation data from Washington National Airport consisted of all storm events separated by at least 3 hr from the next event. The base data collected at National Airport included minor storm events that normally do not produce measurable runoff. These minor events make up approximately 10% of all annual rainfall, are usually less than 0.1 in. and are therefore excluded from the RFS analysis. These small storms seldom produce measurable stormwater runoff, yet are numerically the most common rainfall event.

Table B-6 Rain Frequency Spectrum Washington, DC Area (Schueler, 1992)

Percent of All Storm Events ^a	Return Interval	Rainfall Volume ^b
30	7 days	0.25
50	14 days	0.40
70	Monthly	0.75
85	Bi-monthly	1.05
90	Quarterly	1.25
95	Semi-annually	1.65
98	Annually	2.40
99	2-yr	2.90

a. Equal to or less than given rainfall volume
b. Watershed in.

A careful examination of Table B-6 suggests that a BMP that is sized to capture and treat the three month frequency storm (or 1.25" rainfall) will effectively treat 90% of the annual average rainfall. Such a practice will also capture and at least partially treat the first 1.25" of larger rainfall events. Therefore treating the 1.25" rainfall should result in a capture efficiency exceeding 90%.

To balance the desire to capture and treat as much cumulative rainfall as possible while avoiding an overly burdensome sizing criteria, additional rainfall data was evaluated throughout Chesapeake Bay watershed. In addition to Washington, DC, three other locations were selected to evaluate longer-term rainfall characteristics. Daily precipitation data was analyzed for an 11-year period (January 1980 through December 1990) at four locations within the Chesapeake Bay Watershed. Norfolk VA, Washington, DC, Frederick MD and Harrisburg, PA were selected as representative of the bay-wide watershed where new development activity is occurring. In addition, locations are separated by 100 to 150 miles and represent a distribution from coastal to inland and south to north.

The 1-in. rainfall was evaluated to assess whether this value could be used to effectively capture 90% of the annual runoff. The average capture percentage using the 1.0" rainfall ranges from approximately 85% to 91% for the four

locations. The analysis included the first one-inch of larger rainfall events that will be captured, but probably not completely treated. It is recognized that during these large events treatment conditions may be less than ideal. But it is safe to say that approximately 90% of the annual average rainfall events will be captured and treated using a 1-in. rainfall criteria.

The results presented in Table B-7 provide justification for using the 1.0 in. rainfall event for sizing stormwater filtering practices throughout the Chesapeake Bay Watershed. It must be emphasized that regional rainfall characteristics will differ from specific location to location. Additional rainfall frequency analysis is required for more complete reliance on this value. If a particular jurisdiction has the resources and long-term data, a complete RFS should be conducted and the 90% Rule applied to establish a local water quality precipitation value. Long-term data-sets (e.g. 50 yr) minimize the statistical significance of extreme rainfall events or drought periods.

Table B-7 Comparison of Precipitation Data for Four Locations Within the Chesapeake Bay Watershed, 1980 - 1991, Daily Analysis (Claytor and Schueler, 1996)

Annual Precipitation Data	Norfolk, VA	Washington, DC	Harrisburg, PA	Frederick, MD
Average Precipitation (in.)	43.4	37.9	39.6	37.0
Average snowfall (in.)	7.7	17.2	31.3	Not Obtained
Average number of precipitation days*	76	67	71	68
Average number of precipitation days >1.0 in.	10.5	9.5	9.5	7.7
Average number of precipitation days < 0.1 in.	39.0	45.4	55.1	Not Obtained
Percent of annual average rainfall # 1.0 in.*	85.5	91.4	86.8	89.9
Percent of annual precipitation days # 1.0 in.*	86.2	85.9	86.7	88.6

* excludes rainfall events, 0.1 in. (assumed to produce no runoff)

Other studies have found similar results, as exemplified the previous discussion of Figure B-9 (Roesner et al., 1991). Heany et al. (1977) found similar knee-of-the-curve results for effective stormwater control in a nationwide study.

Many jurisdictions require storage of the first ½ in. of runoff from impervious surfaces. While this volume appears to have gained widespread acceptance, there has been little research on the cumulative pollutant load bypassing facilities sized on this principle. A study conducted in Texas by Chang et al. (1990), where the annual total solids load captured using the ad-hoc half-inch rule showed significant drop-off when imperviousness approached 70%. Bell et al. (1995) investigated the effectiveness of treatment criteria for smaller storm events given the economic considerations of capturing and storing a reasonably large water quality volume, and the realization that stormwater filters tend to lose efficiency as pollutant load input concentrations decrease.

Estimating Water Quality Volume for Small Storm BMP Design

Two methods can be utilized to estimate the V_{wq} for BMP design. Both rely on computing a volumetric runoff coefficient (R_v) and multiplying this by the precipitation amount (P) to obtain a runoff volume in watershed inches. As the heading for this sub section suggest, these methods are for small urban sites.

The Short Cut Method

The first method, the Short Cut Method, utilizes equation 2-1, the volumetric runoff coefficient R_v , (Schueler, 1987) to estimate runoff volume, or:

$$R_v = 0.05 + 0.009I$$

where, I is the percent imperviousness of the site. The required treatment volume for a site will be equal to:

$$V_{wq} = PR_v \tag{B-9}$$

The Short Cut Method is used where the site consists of predominately one type of land surface or for quick calculations to obtain a reasonably accurate estimate of treatment volume. The method does not account for variability in the pervious area, which is a limitation.

Small Storm Hydrology Method

The second, or Small Storm Hydrology Method, utilizes the work done by Pitt (1994), Pitt and Voorhees (1989) and others, to compute a volumetric runoff coefficient, R_v , based on the specific characteristics of the pervious and impervious surfaces of the drainage catchment. This method presents a relatively simple relationship between rainfall amount, land surface and runoff volume. The R_v used to compute the volume of runoff are identified in Table B-8. The Small Storm Hydrology method involves the following:

- R_v for land surfaces present on the subject site are selected for a given rainfall depth.
- If a portion of the site has disconnected impervious surfaces, reduction factors are applied to those impervious R_v . The reduction factors (from Table B-9) are multiplied by the R_v for disconnected impervious areas to obtain the corrected value.
- A weighted R_v for the entire site is computed.
- For the given rainfall, the water quality runoff volume, V_{WQ} (in watershed in.) is computed (same as equation B-9 above).

In order to use the reduction factors for disconnected impervious surfaces as general guidance, the impervious area above the pervious surface area should be less than one-half of the pervious surface and the flow path through the pervious area should be at least twice the impervious surface flow path.

Table B-8 Volumetric Runoff Coefficient, R_v , for Urban Runoff for directly Connected Impervious Areas (Pitt, 1994)

Impervious Area	Precipitation (in.)			
	0.75	1.00	1.25	1.50
Flat roofs and large unpaved parking lots	0.82	0.84	0.86	0.88
Pitched roofs and large impervious areas (large parking lots)	0.97	0.97	0.98	0.98
Small impervious areas and narrow streets	0.66	0.70	0.74	0.77
Sandy Soils (HSG -A)	0.02	0.02	0.03	0.05
Silty Soils (HSG -B)	0.11	0.11	0.13	0.15
Clayey Soils (HSG C and D)	0.20	0.21	0.22	0.24

Table B-9 Reduction Factors to Volumetric Runoff Coefficients, R_v , for Disconnected Impervious Surfaces (Pitt, 1994)

Impervious Surface	Precipitation (in.)			
	0.75	1.00	1.25	1.50
Strip commercial shopping center	0.99	0.99	0.99	0.99
Medium to high density residential with paved alleys	0.27	0.38	0.48	0.59
Medium to high residential without alleys	0.21	0.22	0.22	0.24
Low density residential	0.20	0.21	0.22	0.24

The Small Storm Hydrology method has the advantage of evaluating the precise elements of a particular site and can be utilized for most design applications to estimate accurate runoff volumes. The method requires somewhat more effort to identify the specific land surface area ratios and additional effort is needed to assess the disconnections of impervious areas. The method rewards site designs that utilize disconnections of impervious surfaces by lowering the computed R_v and the required V_{WQ}

The following procedure was adopted from the 2000 Maryland Stormwater Design Manual¹ (MDE, 2000) and can be used to estimate peak discharges for small storm events.

The peak rate of discharge is needed for the design of basins or vegetative biofilters. As mentioned, earlier conventional NRCS methods underestimate the volume and rate of runoff for rainfall events less than 2" (Pitt, 1994;

¹ Method for Computing Peak Discharge for Water Quality Storm (MDE, 2000 – Appendix D.10) originally adapted from Claytor and Schueler, 1996. It relies on the volume of runoff computed using the Small Storm Hydrology Method (Pitt, 1994) and utilizes the NRCS, TR-55 Graphical Peak Discharge Method (USDA, 1986).

Pitt and Voorhees, 1989). This discrepancy in estimating runoff and discharge rates can lead to situations where a significant amount of runoff can by-pass a treatment practice due to inadequately sizing diversion or swales and filter strips are undersized swales.

The NRCS Runoff Curve Number method described in detail in National Engineering Handbook, Chapter 4, Hydrology (USDA, 1985) and TR-55 Chapter 2: Estimating Runoff (USDA, 1986).

A Curve Number (CN) can be obtained through the use of Figure B-11 or the following equations (USDA, 1985, 1986):

$$Q = \frac{(P - I_a)^2}{(P - I_a) + S} \quad (B-10)$$

where: **Q** = runoff volume, watershed in.,
P = rainfall, in.,
S = potential maximum retention after runoff begins, in., and
I_a = initial abstraction (rainfall losses before runoff begins), in.

It is assumed that the following empirical approximation is valid:

$$I_a = 0.2S \quad (B-11)$$

Equation B-10 can be rewritten as:

$$Q = \frac{(P - 0.2S)^2}{(P - 0.8S)} \quad (B-12)$$

Equation B-12 is then solved concurrently with the following equation:

$$S = \frac{1000}{CN} - 10 \text{ or } CN = \frac{1000}{S + 10} \quad (B-13)$$

An alternative approximation based on the equations above is:

$$CN = \frac{1000}{\left[10 + 5P + 10Q - 10\sqrt{Q^2 + 1.25QP} \right]} \quad (B-14)$$

Once a **CN** is computed, the time of concentration, **t_c** is computed (TR-55, Chapter , USDA, 1985). The **t_c** for small sites is often small based on relatively short flow paths, however, a minimum value of 0.1 hr should be used.

Using the computed **CN**, **t_c** and drainage area **A**, in acres, the peak discharge **Q_p** for the **V_{WQ}** is computed (based on TR-55, Chapter 4, USDA, 1986).

The peak discharge Q_p is computed using:

$$Q_p = q_a \times A \times V_{WQ} \quad (B-15)$$

where: Q_p = the peak discharge, in cfs
 q_a = the unit peak discharge, in cfs/mi²/in. (csm/in.)
 A = drainage area, mi²
 V_{WQ} = water quality volume, in watershed in.

The unit peak discharge, q_a (csm/in.), is obtained from one of the four exhibits in TR-55 Chapter 4 (USDA, 1985) based on the appropriate rainfall distribution curve (Type I, I-a, II or III) for the part of the country, the appropriate time of concentration, t_c and also requires calculation of the value of I_a/P . Alternatively, the Rational Formula may be used to compute peak discharges associated with the V_{WQ} but the designer must have available reliable intensity, duration, frequency (IDF) tables or curves for the storm and region of interest. As this information may not be available for many locations, the TR-55 method is recommended (MDE, 2000). The example below runs through the procedures outlined above.

Example Calculation of Peak Discharge for Water Quality Storm

Given:

A 3.0 acre small shopping center has a 1.0 acre flat roof, 1.6 acres of parking and 0.4 acres of open space. Use $P = 1.0$ in., $t_c = 10$ minutes (0.17 hour) and Type II rainfall distribution.

The runoff coefficient R_v , where $I = 86.7\%$ (2.6 acres/ 3 acres), is:

$$R_v = 0.05 + 0.009(87\%)$$

$$R_v = 0.83$$

The runoff volume, V_{WQ} is:

$$Q = P \times R_v = 1 \text{ in.} \times 0.83 = 0.83 \text{ in.}$$

$$V_{WQ} = Q \times A = 0.83 \text{ in.} \times 3 \text{ acres} (1/12 \times 43,560) = 9,039 \text{ ft}^3$$

Using Equation B-14, computed CN is:

$$CN = \frac{1000}{\left[10 + 5(1.0) + 10(0.83) - 10\sqrt{(0.83)^2 + 1.25(0.83)(1.0)} \right]} = 98$$

Substituting Equation B-11 into Equation B-13

$$I_a = \frac{200}{CN} - 2 = \frac{200}{98} - 2 = 0.041$$

$$I_a/P = 0.041 \times 1.0 = 0.041$$

Then (from TR-55 Exhibit 4-II) $q_a = 950$ csm/in. and $A = 3.0$ acres $\times 1.640$ mi² per acre = 0.0047 mi²

$$Q_p = q_a \times A \times V_{WQ} = (950 \text{ csm/in.})(0.0047 \text{ mi}^2)(0.83 \text{ in.}) = 3.7 \text{ cfs}$$

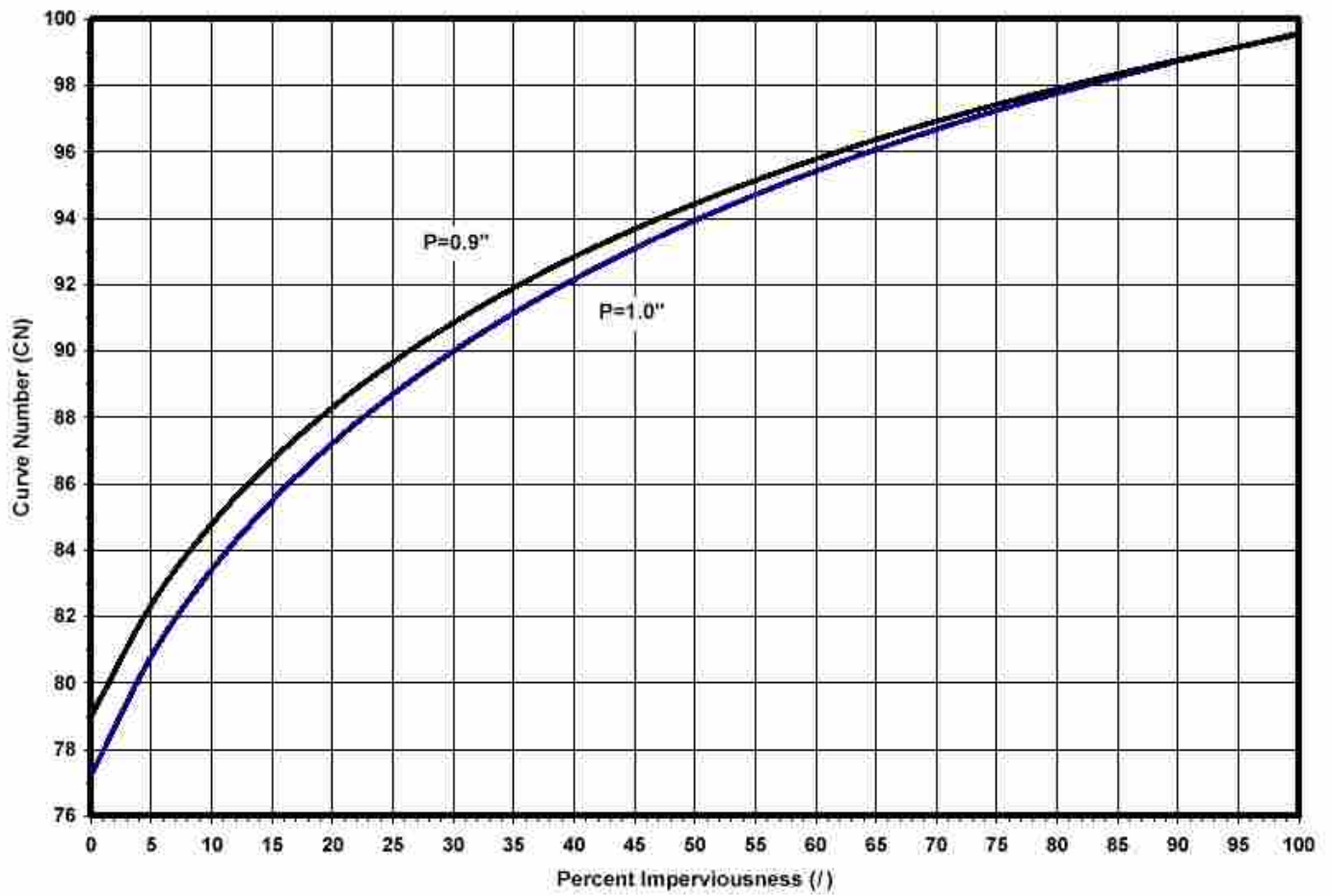

Figure B-11 Curve Number (CN) for Water Quality Storm Rainfall (P) =1.0" & 0.9"

Appendix C Ground Water Recharge Hydrology for BMP Design

Introduction

The state of Maryland has recently developed design guidance for the design of BMPs to address the impacts on ground water recharge and base flow levels associated with land use changes, and in particular urban development (MDE, 2000). This design guidance is summarized below.

Recharge Volume Requirements (V_{Re}) for BMP Design

The intent of the recharge criteria is to maintain existing groundwater recharge rates at developed sites. This helps to preserve existing water table elevations thereby maintaining the hydrology of streams and wetlands during dry weather. The volume of recharge that occurs on a site depends on slope, soil type, vegetative cover, precipitation and evapo-transpiration.

Criteria for maintaining groundwater recharge volumes based on the average annual recharge rate of the HSG present at a site as determined from USDA, NRCS Soil Surveys have been proposed for the State of Maryland (MDE, 2000). More specifically, each specific recharge factor (S) is based on the USDA average annual recharge volume per soil type divided by the annual rainfall (42 in/yr in Maryland) and multiplied by 90%. This keeps the recharge calculation consistent with the water quality volume (V_{WQ}) methodology Maryland has adopted that uses control of the first inch of runoff computed using the simple method described in Appendix D. Table C-1 presents the soil specific recharge factors that have been developed for the state of Maryland (MDE, 2000).

Table C-1 Soil Specific Recharge Factor

Hydrologic Soil Group ¹	Soil-Specific Recharge Factor (S)	Average Annual Recharge Volume ² (in/yr)
A	0.38	18
B	0.26	12
C	0.13	6
D	0.07	3

¹ USDA Soil types are described in Chapter 7, Hydrology, of National Engineering Handbook (USDA, 1985) <http://www.wcc.nrcs.usda.gov/water/quality/common/neh630/630ch7.pdf>

² Data is presented for state of Maryland based on average annual rainfall of 42 in. (MDE, 2000); www.mde.com

Sites with natural ground cover, such as forest and meadow, have higher recharge rates, less runoff and greater transpiration losses under most conditions. Because development increases impervious surfaces, a net decrease in recharge rates is inevitable. The relationship between V_{Re} and site imperviousness is shown in graphical form in Figure C-1.

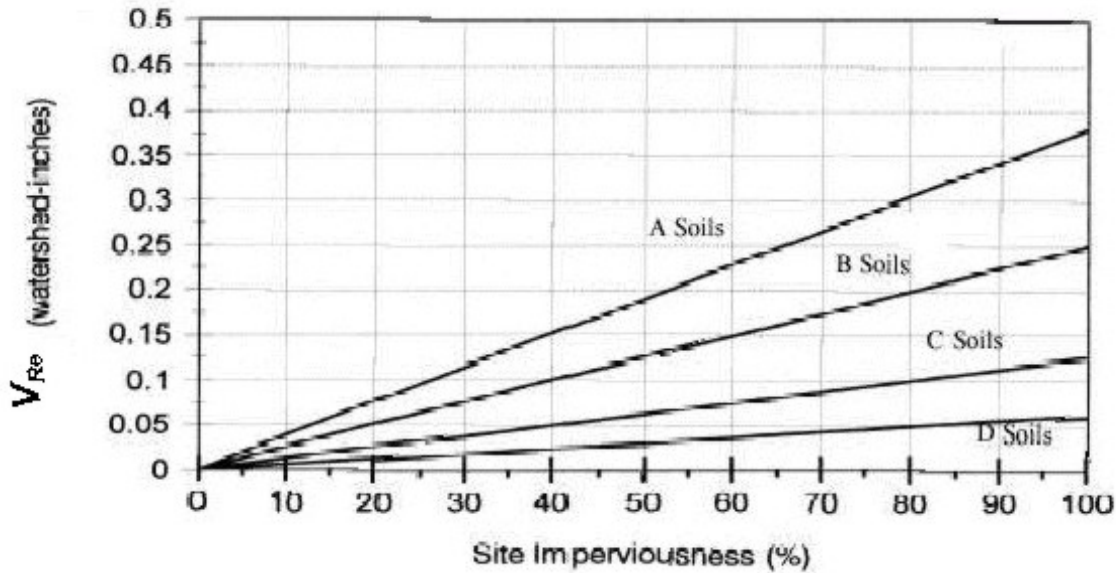

Figure C-1 Relationship between Groundwater Recharge, V_{Re} , and Site Impervious Cover (MDE, 2000)

Thus, an annual recharge volume requirement can be specified for a site using a volume or area method as follows:

$$V_{Re} = SR_v A / 12 \text{ (Percent Volume Method)} \quad (C-1)$$

where: V_R = runoff fractions, which is a function of percent impervious as defined in equation 2-1,
 A = site area in acres.

$$V_{Re} = SA_i \text{ (Percent Impervious Area Method)} \quad (C-2)$$

where: A_i is the measured impervious cover.

V_{Re} is considered part of the total V_{WQ} that must be provided at a site and can be achieved either by a structural practice (e.g., infiltration, bioretention), a nonstructural practice (e.g., buffers, disconnection of rooftops, vegetated swales, filter strips) or a combination of both. Drainage areas having no impervious cover and no proposed disturbance during development may be excluded from the V_{Re} calculations. Designers are encouraged to use these areas as non-structural practices for V_{Re} treatment. V_{Re} and V_{WQ} are inclusive. When treated separately the V_{Re} may be subtracted from the V_{WQ} when sizing the water quality BMP (MDE 2000).

Procedures for Determining Recharge Volume.

If more than one HSG is present at a site, a composite soil specific recharge factor must be computed based on the proportion of total site area within each HSG. The recharge volume provided at the site should be directed to the most permeable HSG available.

The "percent volume" method is used to determine the V_{Re} treatment requirement when structural practices are used to provide recharge. These practices include infiltration and exfiltration structures (i.e., infiltration, bioretention, dry swales or sand filters with storage below the underdrain). In this method, the volume of runoff treated by structural practices must meet or exceed the computed V_{Re} .

The "percent area " method is used to determine the V_{Re} treatment requirements when non-structural practices are used. Under this method, the recharge requirement is evaluated by mapping the percent of impervious area that is effectively treated by an acceptable non-structural practice and comparing it to the minimum recharge requirements. Acceptable non-structural practices include filter strips that treat rooftop or parking lot runoff, sheet flow discharge to stream buffers and grass channels that treat roadway runoff.

The recharge volume criteria do not apply to any portion of a site designated as a stormwater hotspot nor any project considered as redevelopment. In addition, the appropriate local review authority may alter or eliminate the V_{Re} requirement if the site is situated on unsuitable soils (e.g., marine clays), karst or in an urban redevelopment area.

If V_{Re} is treated by structural or non-structural practices separate and upstream of the V_{WQ} treatment, the V_{WQ} is adjusted accordingly.

Appendix D Pollutant Loading Estimates

There are many methods to estimate the concentration and loading of pollutants to surface waters. Physically based models attempt to mimic the accumulation and removal of pollutants as well as the chemical reactions within the receiving streams. More empirical models rely on general data and information on pollution concentrations in surface runoff and then predict pollution through an estimation of surface runoff volumes. Regression equations use significant variables to predict loadings of various constituents based on data sets. This type of model can be used with little or no data, but the models yield very rough estimates. The models are less effective for "what if" analyses that may extend the situation beyond the limits of data bases, nor are they very accurate in predicting acute or shock loadings. Physically based models require substantial and site-specific data for calibration over the range of expected conditions, but can be very effective when data exists and can simulate the most important physical, biological and/or chemical aspects of the problem.

The methods presented below are not definitive and all have been criticized in one manner or another. The methods are presented as a means to generate estimates. More than one method can be used for comparative purposes. Local ordinances may require alternative methods or specific inputs. For site specific results, users of these manuals are advised to collect their own data to calculate more precise estimates of loads.

Pollutants and Sources

Land development generates pollutants from traditional point sources, such as wastewater, and from more diffuse sources, such as storm water runoff. The CWA has had stringent controls in force for decades to control point source discharges through the NPDES program. The diffuse sources are controlled in part by NPDES stormwater programs, which involve less rigorous controls. Table D-1 presents typical urban areas and pollutant yields on an annual basis, while Table D-2 provides median EMC values (Burton and Pitt, 2002). Some of these pollutants are released at concentrations in excess of the woodland conditions that existed at some time prior to construction. These pollutants include nutrients, bacteria and metals. Other pollutants, such as forms of volatile synthetic materials, are new to the receiving waters. Various petroleum products and additives are also new to many receiving waters. Additional pollutants can also include trash, sediment loads, temperature, and even non-native and invasive biological species.

Table D-3 indicates that, except for nutrients, the concentration of pollutants in storm water runoff can be comparable to treated domestic wastewater. Untreated urban runoff that is discharged directly into receiving waters can have a higher concentration for certain contaminants than can be attributed to treated domestic wastewater. However, care should be taken in making direct comparisons between domestic wastewater discharges and separate stormwater discharges as the constituents of stormwater will be different. The SS loading of the storm water will contain a much higher inorganic fraction and the COD load is expected to contain a higher refractory content. Fecal coliform in stormwater may not necessarily indicate the presence of sewage, the original intent of this indicator bacteria, and will require further testing to eliminate the possibility of leaking septic systems or illicit connections. Also, while the concentrations in treated wastewater and those in urban runoff may be similar, the daily loadings from wastewater will be small compared to the loading from a single storm event due to the great difference in the magnitude of volume discharged to the receiving waters. Table D-3 is presented for comparative purposes only.

Table D-1 Typical Urban Areas and Pollutant Yields (Burton & Pitt, 2002)

POLLUTANT	LAND USE (lb/acre/yr) ^a								
	Com-mercial	Parking Lot	Residential - Density			High-ways	Ind-ustry	Parks	Shop-ping Center
			High	Medim	Low ^b				
Total Solids	2100	1300	670	450	65	1700	670	NA ^c	720
SS	1000	400	420	250	10	880	500	3	440
Cl	420	300	54	30	9	470	25	NA	36
TP	1.5	0.7	1	0.3	0	0.9	1.3	0.03	0.5
TKN	6.7	5.1	4.2	2.5	0.3	7.9	3.4	NA	3.1
NH ₃	1.9	2	0.8	0.5	0	1.5	0.2	NA	0.5
NO ₃ + NO ₂	3.1	2.9	2	1.4	0.1	4.2	1.3	NA	0.5
BOD ₅	62	47	27	13	1	NA	NA	NA	NA
COD	420	270	170	50	7	NA	200	NA	NA
Pb	2.7	0.8	0.8	0.1	0	4.5	0.2	0	1.1
Zn	2.1	0.8	0.7	0.1	0	2.1	0.4	NA	0.6
Cr	0.15	NA	NA	0	0	0.09	0.6	NA	0.04
Cd	0.03	0.01	0	0	0	0.02	0	NA	0.01
As	0.02	NA	NA	0	0	0.02	0	NA	0.02

^a The difference between lb/acre/yr and kg/ha/yr is less than 15%, and the accuracy of the values shown in this table cannot differentiate between such close values

^b The monitored low-density residential areas were drained by grass swales

^c NA = Not available

Table D-2 Median Event Mean Concentrations for All Sites by Land Use Category (EPA, 1983)

Constituents	Land Uses							
	Residential		Mixed Land Use		Commercial		Open/ Non-urban	
	Median	COV ^a	Median	COV	Median	COV	Median	COV
BOD5, mg/L	10	0.41	7.8	0.52	9.3	0.3	--	--
COD, mg/L	73	0.55	65	0.58	57	0.4	40	0.78
TSS, mg/L	101	0.96	67	1.14	69	0.9	70	2.92
Total Pb, µg/L	144	0.75	114	1.35	104	0.7	30	1.52
Total Cu, µg/L	33	0.99	27	1.32	29	0.8	--	--
Total Zn, µg/L	135	0.84	154	0.78	226	1.1	195	0.66
TKN, µg/L	1900	0.73	1289	0.5	1179	0.4	965	1
NO ₂ +NO ₃ (as N), µg/L	736	0.83	558	0.67	572	0.5	543	0.91
TP, µg/L	383	0.69	263	0.75	201	0.7	121	1.66
Soluble P, µg/L	143	0.46	56	0.75	80	0.7	26	2.11

^a COV: coefficient of variation = standard deviation/mean

Table D-3 Comparison of Water Quality Parameters in Urban Runoff With Domestic Wastewater (mg/L)

Constituent	Urban Runoff		Domestic Wastewater		
	Separate Sewers		Before Treatment		After Secondary Treatment
	Range	Typical	Range	Typical	Typical
COD (mg/l)	10-275	75	250-1,000	500	80
TSS (mg/l)	20-2,890	150	100-350	200	20
Total P (mg/l)	0.02-4.30	0.36	36630	8	2
Total N (mg/l)	0.4-20.0	2	20-85	40	30
Lead (mg/l)	0.01-1.20	0.18	0.02-0.94	0.1	0.05
Copper (mg/l)	0.01-0.40	0.05	0.03-1.19	0.22	0.03
Zinc (mg/l)	0.01-2.90	0.02	0.02-7.68	0.28	0.08
Fecal Coliform per 100 ml	400-50,000		10^6 - 10^8		200

Source: Bastian, 1997; EPA, 1999.

Pollutant Loads

EPA (1983) determined that, based on the sampling done during the NURP, there are certain pollutants that may be typically found in urban stormwater. Some of the conventional pollutants show up in significant concentrations in most samples, notably the metals, but most others were present in measurable quantities in less than 15% of the samples. Many of these constituents are related to automotive traffic or industrial activities, while others are characteristic of fertilizing and insect control practices. Automotive sources and street locations are generally the two key factors for other than illicit connections and dumping pollutant sources. Common pollutants addressed in studies include: coliform bacteria; total suspended sediment (TSS), total phosphorus (TP), total nitrogen, (TN), 5-day biochemical oxygen demand (BOD₅), chemical oxygen demand (COD), total copper (TCu), total lead (TPb), total zinc (TZn), and oil and grease.

Event Mean Concentrations

NURP was designed and executed under the auspices of EPA in the late 1970's and early 1980's. Its main goal was to provide reliable data and information characterizing runoff from urban sites (EPA, 1983). Twenty-eight sites were monitored from across the United States. While there were some differences in the objectives and procedures of the sites, a common base of information emerged. Later sampling data from municipalities with NPDES permits confirm NURP's findings. Because of the variability of measurements within storms, among different storms at one site and among sites it was desirable to use a measure that tended to reduce this variability somewhat. The measure of the magnitude of urban runoff pollution chosen is termed the Event Mean Concentration (EMC). EMC is defined as the total constituent mass discharge divided by the total runoff volume for a given storm event. With few exceptions EMC's were found to not vary significantly for similar land uses from site to site for the same constituent and were found to have a log normal distribution. Therefore, measures of central tendency (median and mean) and scatter (standard deviation, coefficient of variation), as well as expected values at any frequency of occurrence, could be calculated by using the logarithmic transformation of the raw data. Standard statistical tests and sampling theory can also be used on the log normally distributed data.

In selecting a method for estimation of potential washoff loads for a particular site, it is often decided to use methods that estimate washoff loads by land use type. Total loadings are then determined based on event mean concentrations of pollutants and runoff volumes. Table D-2 presented typical EMCs for various land uses and percent imperviousness based on the NURP data and other sources. This information should be compared to local information, when available. Initial data from a number of municipalities throughout the east and midwest indicate that, other than lead, most constituents did not vary significantly from the NURP information. Lead concentrations have plummeted since the use of lead-free gasoline was mandated, which was instituted after the NURP data were collected.

USGS Regression Equations Method

Reconnaissance studies of urban storm-runoff loads commonly require preliminary estimates of mean seasonal or mean annual loads of chemical constituents at sites where little or no storm runoff or concentration data are available. To make preliminary estimates, a regional regression analysis can be used to relate observed mean seasonal or mean annual loads at sites where data are available for physical, land use or climate characteristics. The result of a major study by the USGS and the EPA resulted in the development of regression equations that can be used to estimate mean loads for COD, SS, dissolved solids, TN, total ammonia plus nitrogen, TP, dissolved phosphorous, total copper, total lead and total zinc (Tasker and Driver, 1988). The data represent 1,144 storms at 97 stations in 21 metropolitan areas. Storm loads of 18 constituents and 15 characteristics of rainfall, runoff and antecedent conditions are reported. Twenty-eight selected basin characteristics are also reported, including 11 categories of land use.

USGS developed equations for determining pollutant loading rates based on regression analyses of data from sites throughout the country (Driver and Tasker, 1990). This method consists of three sets of equations for analysis of runoff pollutant load. The first set of equations allows for calculation of storm pollutant constituent loads and storm runoff volumes. The second set of equations is used to calculate the storm runoff mean concentrations. The third set of equations is used to calculate mean seasonal and annual pollutant loads. Eleven water quality constituents, listed in Table D-4 are modeled.

Table D-4 List of modeled water quality constituents

Chemical Oxygen Demand (COD)	Dissolved Phosphorus (DP)
Suspended Solids (SS)	Total Recoverable Cadmium (Cd)
Dissolved Solids (DS)	Total Recoverable Copper (Cu)
Total Nitrogen (TN)	Total Recoverable Lead (Pb)
Total Kjeldahl Nitrogen (TKN)	Total Recoverable Zinc (Zm)
Total Phosphorus (TP)	

The country is divided into three regions based on mean annual rainfall to increase the precision of the regression equations. Region I consists of states with a mean annual rainfall of less than 51 mm (2 in) and includes the Western States, excluding Hawaii, Oregon and Washington. Region II consists of States with a mean annual rainfall between 510 mm (20 in.) and 1,020 mm (40 in.), and includes the Midwestern and Great Lakes States, the Pacific Northwest, and Hawaii. Region III consists of states with a mean annual rainfall of more than 1,020 mm (40 in.) and includes the Southern States and the coastal Northeastern States. All of the constituents are modeled for regions I and II; dissolved solids and cadmium are not modeled for Region III due to a lack of data.

Estimating Storm Runoff Loads and Storm Runoff Volumes

Regression analyses of USGS and EPA data were performed using a variety of variables to generate equations for storm runoff load and storm runoff volume. The same basic regression formula was originally used for pollutant load and runoff volume. Equation D-1 is applicable for loads. When applying the equation for volume, multiply by 0.02832 to convert from ft³ to m³ in lieu of 0.4536. The variables used in the regression analysis include physical and land use parameters, and climatic variables. The physical and land use parameters include drainage area, percent imperviousness, population density, and percentage of industrial, commercial, residential and non-urban land use. The climatic parameters included in the model include total rainfall, storm duration, maximum 24-h intensity that has a 2-yr recurrence interval, mean annual rainfall, nitrogen load in precipitation and mean minimum January temperature. Table D-5 lists the parameters, their units and their symbols.

Table D-5 Parameters and Symbols Used in USGS Equations

Physical and Land Use Parameters		Climatic Parameters	
A	Total contributing drainage area, km ²	Hr	Total storm rainfall, mm
I	Impervious area, as a percentage of A	Tr	Storm duration, min
LUI	Industrial land use, as a percentage of A	INT	Maximum 24-h precipitation INTensity that has a 2-yr recurrence interval, mm
LUC	Commercial land use, as a percentage of A		
LUR	Residential land use, percentage of A	Hmar	Mean annual rainfall, mm
LUN	Non-urban land use, percentage of A	MNL	Mean annual nitrogen load in precipitation in kg/km ²
PD	Population density, people per km ²	Tj	Mean minimum January temperature, degree Celsius

The parameters listed in Table D-5 were used to develop equations of the general form:

$$L_p = \left[\beta_0 \times (X_1)^{\beta_1} \times (X_2)^{\beta_2} \dots (X_n)^{\beta_n} \times BCF \right] \times 0.4536 \quad (D-1)$$

where: L_p = Estimated storm runoff load or volume in kg or m³ (multiply by 0.02832 in lieu of 0.4536 to obtain m³)
 $\beta_0, \beta_1, \beta_2, \dots, \beta_n$ = Regression coefficients.
 X_1, X_2, \dots, X_n = Physical, land use or climatic characteristics in the model.
 n = Number of physical, land use and climatic characteristics in the model.
 BCF = Bias correction factors which corrects for bias towards the median response and for underestimation of the mean response.

The parameters that are used for the equations vary by region and constituent. Table D-6 lists the regression coefficients for the developed load and runoff models. All constituents are listed, followed by RUN or runoff volume. The β coefficient is listed in the table. The value for the variable X is listed in parentheses at the top of the table. Note that the original study was done entirely in English units; therefore, all values obtained in metric must be converted to English before entering the equation. Appropriate metric units, with the conversion factor, are shown at the top of the table. For example, if the watershed is 2 km², X is then equal to 2 km² divided by 2.59 or 0.772.

A simplified, three-variable model was also developed for the 11 constituents. The only variables used in this model are total rainfall, drainage area and impervious area. Table D-7 lists the coefficients for the simplified model. This method may be used in place of the more detailed model when a quick estimate of loading is desired. For more accurate estimates, the models shown in table D-6 must be applied.

Table D-6 Summary of regression coefficients for storm-runoff loads and volumes, \$₀, \$₁, \$₂... \$_n (Adapted from Driver and Tasker 1990)

Response Variable/ Region	\$ ₀	Characteristics X _n =													BCF
		Hr (mm/ 25.4)	A (km ² / 2.59)	I+1 (%)	LUI+1 (%)	LUC+1 (%)	LUR+1 (%)	LUN+2 (%)	PD (people/ km ³ x2.59)	tg (minutes)	INT (mm/ 25.4)	Hmar (mm/ 25.4)	MNL (kgN per km2 x(2.59/0.4536)	T _j °C(5/a +32	
		Regression coefficients \$ _n													
COD I	7111	0.671	0.617	--	0.415	0.267	--	-0.156	--	--	--	-0.683	--	--	1.304
COD II	36.6	0.878	0.696	--	0.072	0.261	--	-0.056	--	--	--	0.866	--	--	1.389
COD III	479	0.857	0.634	--	0.321	0.217	--	-0.111	--	--	--	--	--	--	1.865
SS I	1518	1.211	0.735	--	--	--	--	--	--	-0.463	--	--	--	--	2.112
SS II	2032	1.233	0.439	0.274	--	--	--	--	0.041	--	--	--	--	-0.590	1.841
SS III	1990	1.017	0.984	--	0.226	0.228	--	-0.286	--	--	--	--	--	--	2.477
DS I	54.8	0.585	1.356	1.383	--	--	--	--	--	--	--	-0.718	--	--	1.239
DS II	2308	1.076	1.285	1.348	--	--	--	--	--	--	--	--	--	-1.395	1.208
TN I	1132	0.798	0.960	--	0.462	0.260	--	-0.194	--	--	--	-0.951	--	--	1.139
TN II	3.173	0.935	0.939	0.672	--	--	--	--	--	--	--	--	0.196	--	1.372
TN III	0.361	0.776	0.474	0.611	--	--	--	--	--	--	--	--	0.863	--	1.709
TKN I	18.9	0.670	0.831	--	0.378	0.258	--	-0.219	--	--	--	--	1.35	--	1.206
TKN II	2.890	0.906	0.768	0.545	--	--	--	--	--	--	--	--	0.225	--	1.512
TKN III	199572	0.875	0.393	--	--	--	--	0.082	--	--	--	-2.643	--	--	1.736
TP I	262	0.828	0.645	--	0.583	0.181	--	-0.235	--	--	--	-1.376	--	--	1.548
TP II	0.153	0.986	0.649	0.479	--	--	--	--	--	--	1.543	--	--	--	1.486
TP III	53.2	1.019	0.846	--	--	0.189	0.103	-0.160	--	--	--	--	--	-0.754	2.059
DP I	588	0.808	0.726	--	0.642	0.096	--	-0.238	--	--	--	-1.899	--	--	1.407
DP II	0.025	0.914	0.699	0.649	--	--	--	--	--	--	1.024	--	--	--	1.591
DP III	0.369	0.955	0.471	--	--	--	--	0.364	--	--	--	--	--	--	2.027
CD I	0.039	0.845	0.753	--	0.138	0.248	--	-0.374	--	--	--	--	--	--	1.244
CD II	0.005	1.168	1.265	--	--	--	--	--	--	--	--	--	--	0.965	1.212
CU I	0.141	0.807	0.590	--	0.424	0.274	--	-0.061	--	--	0.928	--	--	--	1.502
CU II	0.013	0.504	0.585	0.816	--	--	--	--	--	--	--	--	--	--	1.534
CU III	4.508	0.896	0.609	--	0.648	0.253	--	-0.328	--	--	-2.071	--	--	--	2.149
PB I	478	0.764	0.918	--	-0.161	0.276	--	-0.282	--	--	--	-1.829	--	--	1.588
PB II	0.076	0.833	0.381	--	--	0.243	0.087	-0.181	--	--	--	0.574	--	--	1.587
PB III	0.081	0.852	0.857	0.999	--	--	--	--	--	--	--	--	--	--	2.314
ZN I	224	0.745	0.792	--	--	0.172	-0.195	-0.142	--	--	--	-1.355	--	--	1.444
ZN II	0.002	0.796	0.667	1.009	--	--	--	--	--	--	--	--	--	1.148	1.754
ZN III	4.355	0.830	0.555	--	0.402	0.287	-0.191	--	--	--	--	--	--	-0.500	1.942
RUN I	112305 2	1.016	0.916	0.677	--	--	--	--	--	--	--	-1.312	--	--	1.299
RUN II	62951	1.127	0.809	0.522	--	--	--	--	--	--	--	--	--	--	1.212
RUN III	32196	1.042	0.826	0.669	--	--	--	--	--	--	--	--	--	--	1.525

Table D-7 Summary of three-variable regression coefficients for storm-runoff loads (Adapted from Driver and Tasker, 1990)

Response Variable and Region	Xs				Bias Correction Factor (BCF)
	Regression Constant $\$_0$ (mm/25.4)	Hr	A (km ² /2.59)	I + 1 (%)	
COD I	407	0.626	0.710	0.379	1.518
COD II	151	0.823	0.726	0.654	1.451
COD III	102	0.851	0.601	0.528	1.978
SS I	1778	0.867	0.728	0.157	2.367
SS II	812	1.236	0.436	0.202	1.938
SS III	97.7	1.002	1.009	0.837	2.818
DS I	20.7	0.637	1.311	1.180	1.249
DS II	3.26	1.251	1.218	1.964	1.434
TN I	20.2	0.825	1.070	0.479	1.258
TN II	4.04	0.936	0.937	0.692	1.373
TN III	1.66	0.703	0.465	0.521	1.845
TKN I	13.9	0.722	0.781	0.328	1.722
TKN II	3.89	0.944	0.765	0.556	1.524
TKN III	3.56	0.808	0.415	0.199	1.841
TP I	1.725	0.884	0.826	0.467	2.130
TP II	0.697	1.008	0.628	0.469	1.790
TP III	1.618	0.954	0.789	0.289	2.247
DP I	0.540	0.976	0.795	0.573	2.464
DP II	0.060	0.991	0.718	0.701	1.757
DP III	2.176	1.003	0.280	-0.448	2.254
CD I	0.00001	0.886	0.821	2.033	1.425
CD II	0.021	1.367	1.062	0.328	1.469
CU I	0.072	0.746	0.797	0.514	1.675
CU II	0.013	0.504	0.585	0.816	1.548
CU III	0.026	0.715	0.609	0.642	2.819
PB I	0.162	0.939	0.808	0.744	1.791
PB II	0.150	0.791	0.426	0.522	1.665
PB III	0.080	0.852	0.857	0.999	2.826
ZN I	0.320	0.811	0.798	0.627	1.639
ZN II	0.046	0.880	0.808	1.108	1.813
ZN III	0.024	0.793	0.628	1.104	2.533

Example of Estimating Storm Runoff Loads

Given that a 2-km² (0.77 mi²) watershed located in North Carolina (region III) has 20% industrial land use (LUI), 20% commercial land use (LUC) and 60% residential land use (LUR) with an average storm (TRN) of 18 mm (0.7 in), determine the storm runoff load of zinc from the watershed.

From table D-6, the zinc load for region III (ZNIII) values needed for equation D-1:

$$\begin{array}{ll} X_1 = Hr = 18\text{mm}/25.4 = 0.71 & \$_0 = 4.355 \\ X_2 = A = 2\text{-km}^2 / 2.59 = 0.77 & \$_1 = 0.830 \\ X_3 = LUI + 1 = 20 + 1 = 21 & \$_2 = 0.555 \\ X_4 = LUC + 1 = 20 + 1 = 21 & \$_3 = 0.402 \\ X_5 = LUR + 1 = 60 + 1 = 61 & \$_4 = 0.287 \\ & \$_5 = -0.191 \end{array}$$

Note that no other parameters are required, as illustrated by the dashes (-) in table D-6. The parameters are then applied in equation D-1.

$$\begin{aligned} L_p &= 4.355 \times 0.71^{(0.830)} \times 0.77^{(0.555)} \times 21^{(0.402)} \times 21^{(0.287)} \times 61^{(-0.191)} \times 0.4536 \\ L_p &= 4.8 \text{ kg.} \end{aligned}$$

Estimating Procedures for Storm-Runoff Mean Concentrations

USGS also developed a set of regressions for use with equation D-1 to determine the mean pollutant concentration in stormwater runoff. The same physical, land use and climatic parameters cited in table D-4 are used in the equation to determine runoff concentration. As with the loading calculations, all eleven constituents may be determined for regions I and II, while all but cadmium and zinc can be determined for region III. Table D-8 lists the regression coefficients for determining mean storm-runoff concentration. These coefficients are used in equation (I). All of the water quality constituent concentrations, except for the metals (Cd, Cu, Pb and Zn) are expressed in mg/L. The metals concentrations are expressed in : g/L.

Example of Estimating Storm Runoff Mean Concentration

Given that a 2-km² (0.77 mi²) watershed located in Washington, DC (region III) is 30% impervious with average rainstorm of 20 mm, determine the storm runoff mean concentration of lead. First obtain the parameter values to be used in equation D-1 from table D-5.

$$\begin{array}{ll} X_1 = H_r = 20 \text{ mm} / 25.4 = 0.79 & \$_0 = 39.8 \\ X_2 = A = 2 \text{ km}^2 / 2.59 = 0.77 & \$_1 = -0.196 \\ X_3 = I + 1 = 30 + 1 = 31 & \$_2 = 0.123 \\ & \$_3 = 0.404 \end{array}$$

The concentration is then calculated using equation D-1

$$\begin{aligned} C &= 39.8 \times 0.79^{(-0.196)} \times 0.77^{(0.123)} \times 31^{(0.404)} \times 1.510 \\ C &= 244 : \text{g/L.} \end{aligned}$$

Table D-8 Summary of regression coefficients for storm-runoff mean concentrations, $\$_0, \$_1, \$_2, \dots, \$_n$ (adapted from Driver and Tasker, 1990)

Response Variable/ Region	$\$_0$	Characteristics $X_n =$													BCF
		Hr (mm/25.4)	A (km ² /2.59)	I+1 (%)	LUI+1 (%)	LUC+1 (%)	LUR+1 (%)	LUN+2 (%)	PD (people/ km ³ x2.59)	tg (minutes)	INT (mm/25.4)	Hmar (mm/25.4)	MNL (kgN per km2 x(2.59/0.4536))	T _J °C(5/a +32)	
		Regression coefficients $\$_n$													
COD I	5.035	-0.473	-0.087	--	0.388	0.012	--	-0.048	--	--	--	0.855	--	--	1.163
COD II	0.254	-0.259	-0.054	--	0.0003	0.025	--	-0.033	--	--	--	1.556	--	--	1.299
COD III	46.9	-0.179	-0.047	--	0.320	0.031	--	-0.169	--	--	--	--	--	--	1.270
SS I	2041	0.143	0.108	--	--	--	--	--	--	-0.370	--	--	--	--	1.543
SS II	734	0.132	-0.342	-0.329	--	--	--	--	0.041	--	--	--	--	-0.519	1.650
SS III	176	0.054	0.286	--	0.168	0.072	--	-0.295	--	--	--	--	--	--	1.928
DS I	0.333	-0.402	0.469	0.445	--	--	--	--	--	--	--	1.497	--	--	1.352
DS II	2398	-0.112	0.519	0.468	--	--	--	--	--	--	--	--	--	-1.373	1.179
TN I	3.52	-0.285	0.033	--	0.512	0.017	--	0.012	--	--	--	-0.129	--	--	1.096
TN II	1.65	-0.204	0.065	0.176	--	--	--	--	--	--	--	--	-0.296	--	1.256
TN III	26915	-0.253	-0.169	0.057	--	--	--	--	--	--	--	-2.737-	--	--	1.308
TKN I	1.282	-0.449	0.222	--	0.426	-0.016	--	-0.012	--	--	--	--	0.347	--	1.167
TKN II	0.830	-0.224	-0.066	0.039	--	--	--	--	--	--	--	--	0.106	--	1.321
TKN III	9549	-0.157	-0.159	--	--	--	--	-0.086	--	--	--	-2.447	--	--	1.326
TP I	0.085	-0.232	-0.012	--	0.552	-0.080	--	0.038	--	--	--	0.530	--	--	1.261
TP II	0.022	-0.177	-0.133	0.006	--	--	--	--	--	--	2.019	--	--	--	1.521
TP III	2.630	-0.016	-0.107	--	--	0.053	0.184	-0.168	--	--	--	--	--	-0.710	1.363
DP I	0.352	-0.294	-0.013	--	0.629	-0.136	--	-0.046	--	--	--	-0.297	--	--	1.266
DP II	0.003	-0.209	-0.174	0.245	--	--	--	--	--	--	1.514	--	--	--	1.567
DP III	0.060	0.189	-0.076	--	--	--	--	0.358	--	--	--	--	--	--	1.341
CD I	0.338	-0.256	0.025	--	0.090	0.033	--	-0.110	--	--	--	0.481	--	--	1.166
CD II	0.851	0.223	0.189	--	--	--	--	--	--	--	--	--	--	0.394	1.284
CU I	11.3	-0.327	0.066	--	0.237	0.048	--	0.155	--	--	0.406	--	--	--	1.297
CU II	9.683	-0.298	-0.151	0.157	--	--	--	--	--	--	--	--	--	--	1.473
CU III	1774	-0.104	-0.077	--	0.446	0.078	--	-0.204	--	--	-3.247	--	--	--	1.348
PB I	141	-0.347	0.145	--	-0.109	0.034	--	-0.086	--	--	--	-0.046	--	--	1.304
PB II	0.487	-0.268	-0.359	--	--	0.099	0.152	-0.008	--	--	--	1.088	--	--	1.433
PB III	39.8	-0.196	0.123	0.404	--	--	--	--	--	--	--	--	--	--	1.510
ZN I	199	-0.338	0.070	--	--	-0.029	0.144	0.068	--	--	--	-0.004	--	--	1.242
ZN II	0.149	-0.238	-0.201	0.278	--	--	--	--	--	--	--	--	--	1.961	1.650
ZN III	1879	-0.149	-0.061	--	0.285	0.146	-0.078	--	--	--	--	--	--	-0.916	1.322

Estimating Procedures for Mean Seasonal or Annual Loads

USGS applies separate equations for calculation of the mean seasonal and annual loading. The annual or seasonal load is determined by first determining the mean load for a storm. In this case, a storm is defined as an event in which the total rainfall is at least 1.3 mm (0.05 in.). At least six consecutive hours without rainfall separate defined storms. Coefficients that were applied during the regression analysis include drainage area, percent imperviousness, mean annual rainfall, mean minimum January temperature and an indicator variable, X_2 . The variable X_2 equals 1, if the sum of commercial and industrial land use exceeds 75% of the drainage area, and 0 if it is less than 75%. The mean annual load is then multiplied by the mean number of storms per yr to obtain the mean annual load. The formula used for the model of annual load is:

$$L_m = 10^{[Exponent]} \times BCF \times 0.4536 \text{ kg / lb} \quad (D-2)$$

where: **Exponent** = $\$0 + \$1 (A/(2.59 \text{ km}^2/\text{mi}^2))^{0.5} + \$2 A_1 + \$3 Hmar/(25.4 \text{ mm/in}) + \$4 (Tj (9/5)+32) + \$5 X_2$

L_m = Estimated load for a storm (kg)

$\$0$ = Regression Constant

$\$1$ = Coefficient for drainage area

$\$2$ = Coefficient for impervious area

$\$3$ = Coefficient for mean annual rainfall

$\$4$ = Coefficient for mean minimum January temperature

$\$5$ = Coefficient for X_2

A = Drainage area in km^2

A_1 = Impervious area

$Hmar$ = Mean annual rainfall in mm.

Tj = Mean minimum January temperature in degrees Celsius

X_2 = Indicator coefficient: 1 if industrial land use plus commercial land use is > 75%; 0 if < 75%

BCF = Bias correction factor

Table D-9 lists the coefficients for calculating the mean load of a storm for the water quality constituents. Coefficients developed from two regression models are shown, for the ordinary least squares (OLS) and for the generalized least squares (GLS) models. The generalized least squares model is more accurate because this study accounts for cross correlations between the monitoring stations in the study and allows for heterogeneous errors. The regression analysis is limited to drainage areas between 0.017 km^2 (0.01 mi^2) and 1.37 km^2 (0.85 mi^2). It is necessary to use another method for drainage areas much beyond these limits.

Example of USGS Method for Determining Annual Load

Given that a 0.8 km^2 watershed is 40% industrial and 40% commercial, 20% residential and 75% impervious with an average annual rainfall of 750 mm, determine the mean annual load of SS. Use equation D-2 to determine the mean storm load. The total industrial and commercial percentage is greater than 75%, so $X_2 = 1$. The minimum temperature in January is -5°C . Referring to table D-9, $\$0 = 1.5430$, $\$1 = 1.5906$, $\$2$ and $\$3$ are not applicable, $\$4 = 0.0264$, $\$5 = -0.0297$, and $BCF = 1.521$.

$$\text{Exponent} = 1.5430 + 1.5906(0.8/2.59)^{0.5} + 0.0264(750/25.4) - 0.0297(-5(9/5) + 32) = 2.523435$$

$$L_m = 10^{2.523435} \times 1.521 \times 0.4536$$

$$L_m = 230 \text{ kg}$$

Table D-9 Regression coefficients of mean loads of a storm for indicated constituents based on physical, land use or climatic characteristics of the watershed

Response Variable	Method	Regression Constant \$ ₀	Variables					Bias Correction Factor (BCF)
			A ^{0.5} (km ² /2.59)	I (%)	Hmar (mm/25.4)	T _J °C(5/a)+32	X ₂ (0 or 1)	
			Regression Coefficients					
			\$ ₁	\$ ₂	\$ ₃	\$ ₄	\$ ₅	
COD	OLS	1.1262	2.0004	0.0049	--	--	--	1.301
	GLS	1.1174	2.0069	0.0051	--	--	--	1.298
SS	OLS	1.4627	1.6021	--	0.0299	-0.0342	--	1.670
	GLS	1.5430	1.5906	--	0.0264	-0.0297	--	1.521
DS	OLS	1.8656	2.5501	--	--	-0.0244	--	1.278
	GLS	1.8449	2.5468	--	--	-0.0232	--	1.251
TN	OLS	-0.2398	1.6039	0.0065	--	--	-0.4832	1.332
	GLS	-0.2433	1.6383	0.0061	--	--	-0.4442	1.345
AN	OLS	-0.7326	1.5991	0.0067	0.0219	-0.0199	-0.4553	1.264
	GLS	-0.7282	1.6123	0.0064	0.0226	-0.0210	-0.4345	1.277
TP	OLS	-1.4443	2.0918	--	0.0246	-0.0211	--	1.330
	GLS	-1.3884	2.0825	--	0.0234	-0.0213	--	1.314
DP	OLS	-1.3898	1.4316	--	--	--	--	1.508
	GLS	-1.3661	1.3955	--	--	--	--	1.469
Cu	OLS	-1.4861	1.7646	--	--	-0.0136	--	1.457
	GLS	-1.4824	1.8281	--	--	-0.0141	--	1.403
Pb	OLS	-2.0676	1.9880	0.0081	0.0121	--	--	1.477
	GLS	-1.9679	1.9037	0.0070	0.0128	--	--	1.365
Zn	OLS	-1.6504	2.0267	0.0073	--	--	--	1.356
	GLS	-1.6302	2.0392	0.0072	--	--	--	1.322

The Simple Method

The Simple method, as its name implies, is an easy-to-use empirical equation for estimating pollutant loadings of an urban watershed (Schueler, 1987). The method is applicable to watersheds less than 2.5 km² (1 mi²) in area and can be used for analysis of smaller watersheds or site planning. The method was developed using the database generated during a NURP study in the Washington, DC area and the national NURP data analysis. The equations, however, may be applied anywhere in the country. Some precision is lost as a result of the effort to make the equation general and simple. The method is adequate to be used in decision making at the site-planning level.

The pollutant load from a watershed, in kilograms over a specified interval is:

$$L_p = H_r P_j R_v C A / 98.6 \quad (D-3)$$

Where: L_p = Pollutant load during interval, kg.

H_r = Rainfall amount over the specified time interval, mm.

P_j = Percentage of rainfall during the interval which produces runoff.

R_v = Runoff coefficient.

C = Flow-weighted mean concentration of the pollutant in urban runoff, mg/L.

A = Area of the development site, ha.

98.6 = Unit conversion factor.

In the above equation, the rainfall amount H_r is the total depth of rain that has fallen during the time interval of interest. For example, if the pollutant load for an average year in the Washington, DC area is desired, the average annual total rainfall, 1,000 mm (40 in), is used for an H_r value. If the pollutant load for a dry or wet year is to be calculated, this rainfall amount is adjusted appropriately.

P_j is the percentage of rain during the interval that produces runoff. This parameter is used to account for the rainfall events during the interval that are so minor they do not produce appreciable runoff. Rainfall from these minor events is either intercepted or stored before it creates runoff, and eventually evaporates. If the equation is being used for a single storm event, P_j should be set equal to 1.0.

The runoff coefficient, R_v , is a function of imperviousness and can be estimated using the equation 2-1:

$$R_v = 0.05 + 0.009(I)$$

The C value used in the pollutant load equation varies according to general land uses, including suburban, urban, business, forest and highway areas. C values were determined through statistical analysis of data cited previously. The appropriate C value can be obtained from table D-10:

Table D-10 Urban C values for use with the Simple method (mg/L) (Schueler, 1987).

Pollutant	National Urban Highway Runoff	New Suburban NURP Sites (Washington, DC)	Older Urban Areas (Baltimore)	Central Business District (Washington, DC)	National NURP Study Average	Hardwood Forest (Northern Virginia)
Phosphorus						
Total	-	0.26	1.08	-	0.46	0.15
Ortho	-	0.12	0.26	1.01	-	0.02
Soluble	0.59	0.16	-	-	0.16	0.04
Organic	-	0.10	0.82	-	0.13	0.11
Nitrogen						
Total	-	2.00	13.6	2.17	3.31	0.78
Nitrate	-	0.48	8.9	0.84	0.96	0.17
Ammonia	-	0.26	1.1	-	-	0.07
Organic	-	1.25	-	-	-	0.54
TKN	2.72	1.51	7.2	1.49	2.35	0.61
COD	124.0	35.6	163	-	90.8	>40.0
BOD ₅	-	5.1	-	36	11.9	-
Metals						
Zinc	0.380	0.037	0.397	0.250	0.176	-
Lead	0.550	0.018	0.389	0.370	0.180	-
Copper	-	-	0.105	-	0.047	-

TKN = total Kjeldahl nitrogen; COD = chemical oxygen demand; BOD₅ = biochemical oxygen demand.

Example for Zinc and Total Kjeldahl Nitrogen Load

The first step is to determine the preconstruction pollutant load. The forested area corresponds to 2% imperviousness. As shown in table D-10, the C value for TKN in a forested area is 0.61, while there is no contribution from zinc. For the pre-construction conditions, using equation 2-1:

$$R_v = 0.05 + 0.009(2) = 0.068$$

Thus, the pollutant load of TKN (kg) for pre-construction conditions

$$L_p = (1000\text{mm})(0.9)(0.068)(0.61)(50)/98.6 = 18.9 \text{ kg}$$

Next, determine the pollutant load resulting from construction of the highway. The **C** values for TKN and zinc for urban highway runoff are 2.72 and 0.38, respectively. Assume the highway area is 80% impervious.

$$R_v = 0.05 + 0.009(80) = 0.77$$

Thus, the pollutant load of TKN (kg) for post-construction conditions is:

$$L_p = (1000\text{mm})(0.9)(0.77)(2.72)(50 \text{ ha})/98.6 = 956 \text{ kg}$$

and the pollutant load of zinc (kg) for post-construction conditions is:

$$L_p = [(1000 \text{ mm})(0.9)(0.77)][0.38][50]/98.6 = 134 \text{ kg}$$

The increase in TKN loading as a result of the road is 937 kg/yr (i.e., 956 kg/yr - 18.9 kg/yr). The amount of zinc added to the runoff resulting from the road is 134 kg/yr.

Data and Measurement Needs

While use of literature values is helpful in a first cut analysis or preliminary design work, it is important to characterize SS on a site-specific basis, because the transport of settleable solids is a function of local conditions that include topography, geology and antecedent dry period. Topography influences slope or gradient, with milder slopes causing greater solid amounts to be deposited; subsequently, these solids are resuspended during intensive storm flows. The surrounding geology, or more specifically the soil, affects the SS and settleable solids concentration and particle-settling-velocity distribution. Seasonal effects may also be considered.

The monitoring and analyses needed prior to installation for proper assessment, design and application of BMPs may increase expenses in the short term; however, reliable data collection may save even more expensive construction costs and may help designs improve water quality. Sampling devices must be able to capture the heavier sediments or settleable solids and not manifest biased results due to stratification of the heavier solids.

Site-specific solids characterization is necessary for the satisfactory design of physical treatment, i.e., sedimentation. Sedimentation in BMPs is dependent upon the (1) fraction of settleable solids and SS, (2) SS-settling-velocity distribution and (3) hydraulic loading. Common sieve analysis or more advanced light scattering techniques can be used for particle-size-distribution analyses. These analyses will enable a site-specific estimate of the percent of solids and their associated pollutants that the intended BMP may be capable of removing. The settling characteristic analyses (settleable solids) should be the gravimetric type with data presented in mg/L to determine the fraction of settleable solids in the storm flow. Indicator organism and pathogenic analyses may also require some special procedures before analysis.

Technological advances and improvements in real-time monitors can also allow continuous measurements of certain parameters, e.g., pH and turbidity; however, even modern probe-type-monitoring devices must remain wet (submerged), which can be a limitation.

Appendix E Quantifying Pollutant Removal

Background

In order to better clarify the terminology used to describe the level of performance achieved and how well a device, system or practice meets its identified design goals, definitions of some terms, often used loosely in the literature, are provided here. These terms help to better specify the scope of monitoring studies and related analyses:

- Best Management Practice (BMP) - A device, practice or method for removing, reducing, retarding or preventing targeted stormwater runoff constituents, pollutants and contaminants from reaching receiving waters.
- BMP System - A BMP system includes the BMP and any related bypass or overflow. For example, the efficiency (see below) can be determined for a offline retention (wet) pond either by itself (as a BMP) or for the BMP system (BMP including bypass)
- Performance - measure of how well a BMP meets its goals for storm water that the BMP is designed to treat.
- Effectiveness - measure of how well a BMP system meets its goals in relation to all storm water flows
- Efficiency - measure of how well a BMP or BMP system removes pollutants.

The quantification of efficiency of BMPs has often centered on examinations and comparisons of “percent removal” defined in a variety of ways. BMPs do not typically function with a uniform percent removal across a wide range of influent water quality concentrations. For example, a BMP that demonstrates a large percent removal under heavily polluted influent conditions may demonstrate poor percent removal where low influent concentrations exist. The decreased efficiency of BMPs receiving influent with low pollutant concentrations has been demonstrated. It has been demonstrated that there is a minimum effluent concentration achievable through implementation of BMPs for many constituents (Schueler, 1996 and Minton, 1998). Percent removal alone, even where the results are statistically significant, often does not provide a useful assessment of BMP performance.

Percent Removal Databases

Existing databases on pollutant removal by BMPs may or may not identify the design method used. Many of the BMPs monitored will have been designed using water quality measures such as control of first flush, extended detention or retention; however some of the data are representative of peak discharge control strategies. The levels reported in databases such as the National Pollutant Removal Performance Database for Stormwater Treatment Practice 2nd Edition (CWP, 2000) are presented in Table E-1 and Table E-2.

These databases and their associated summary tables at the very best should be used only to very roughly provide information on BMP effectiveness. These tables are also presented without stating the “margin of safety” or uncertainty.

Other sources of information include:

- U.S. EPA National Menu of Best Management Practices for NPDES Stormwater Phase II (<http://cfpub.epa.gov/npdes/stormwater/menuofbmps/menu.cfm>)
- ASCE/U.S. EPA BMP Database (<http://www.bmpdatabase.org>)
- Texas Sourcebook (<http://www.txnpsbook.org/>)

Table E-1 Median Pollutant Removal of Stormwater Treatment Practices (CWP 2000)

Median Pollutant Removal Efficiency (%)

Treatment BMP	TSS	TP	Sol P	TN	NOx	Cu	Zn
Stormwater Detention Ponds	47	19	-6.0	25	4	26 ⁽¹⁾	26
Stormwater Retention Ponds	80 (67)	51(48)	66 (52)	33 (31)	43 (24)	57 (57)	66 (51)
Stormwater Wetlands	76 (78)	49 (51)	35 (39)	30 (21)	67 (67)	40 (39)	44 (54)
Filtering Practices ⁽²⁾	86 (87)	59 (51)	3 (-31)	38 (44)	-14 (-13)	49 (39)	88 (80)
Infiltration Practices	95 ⁽¹⁾	70	85 ⁽¹⁾	51	82 ⁽¹⁾	N/A	99 ⁽¹⁾
Water Quality Swales ⁽³⁾	81 (81)	34 (29)	38 (34)	8 ⁽⁴¹⁾	31	51 (51)	71 (71)

1. Data based on fewer than five data points
2. Excludes vertical sand filters and filter strips
3. Refers to open channel practices designed for water quality

Notes: Data in parentheses represent values from the First Edition; N/A = data are not available, TSS = Total Suspended Solids; TP = Total Phosphorus; Sol P = Soluble Phosphorus; TN = Total Nitrogen; NOx = Nitrate and Nitrite Nitrogen; Cu = Copper; Zn = Zinc.

Table E-2 Median Effluent Concentration of Stormwater Treatment Practice Groups (CWP, 2000)

Treatment BMP	Median Effluent Concentration (mg/L)						
	TSS	TP	OP	TN	NOx	Cu ⁽¹⁾	Zn ⁽¹⁾
Stormwater Detention Ponds	28 ⁽²⁾	0.18 ⁽²⁾	0.13 ⁽²⁾	0.86 ⁽²⁾	N/A ⁽³⁾	9.0 ⁽²⁾	98 ⁽²⁾
Stormwater Retention Ponds	17	0.11	0.03	1.3	0.26	5	30
Stormwater Wetlands	22	0.2	0.09	1.7	0.36	7	31
Filtering Practices ⁽²⁾	11	0.1	0.08	1.1 ⁽²⁾	0.55 ⁽²⁾	10	21
Infiltration Practices	17 ⁽²⁾	0.05 ⁽²⁾	0.003 ⁽²⁾	3.8 ⁽²⁾	0.09 ⁽²⁾	4.8 ⁽²⁾	39 ⁽²⁾
Water Quality Swales ⁽⁴⁾	14	0.19	0.08	1.1 2	0.35	10	53

1. Units for Zn and Cu are micrograms per liter.
2. Data based on fewer than five data points
3. Excludes vertical sand filters and filter strips.
4. Refers to open channel practices designed for water quality

Notes: N/A = data is not available, TSS = Total Suspended Solids; TP = Total Phosphorus; OP = Ortho-Phosphorus; TN = Total Nitrogen; NOx = Nitrate and Nitrite Nitrogen; Cu = Copper; Zn = Zinc

Percent Removal of Pollutant is a Poor Measure of BMP Performance

The quantification of efficiency of BMPs has often centered on examinations and comparisons of “percent removal” defined in a variety of ways. BMPs do not typically function with a uniform percent removal across a wide range of influent water quality concentrations. For example, a BMP that demonstrates a good percent removal under heavily polluted influent conditions may demonstrate poor percent removal when low influent concentrations exist. The decreased efficiency of BMPs receiving influent with low contaminant concentration has been demonstrated. For many constituents, there is a minimum concentration necessary to achieve any reduction. Percent removal alone, even where the results are statistically significant, often does not provide a useful assessment of BMP performance.

The goal in watershed management is to reduce the pollutant load either through source control (the most effective way to do it) or through multi-stage treatment (treatment trains). Although individual BMPs may be less effective on a percent basis, if they cumulatively still result in a lower effluent concentration (or load), they benefit the watershed. BMPs should therefore not be designed for percent removal but for pollutant removal to achieve a given effluent level.

Other recommended parameters for measuring BMP efficiency include measurements of how performance varies from pollutant to pollutant, with large or small storm events, with rainfall intensity, and whether the BMP reduces toxicity and whether it can cause an improvement in downstream biotic communities (Strecker *et al*, July 2000).

Irreducible Concentration and Quantifying BMP Efficiency

There is no single value for percent pollutant removal for a particular BMP. The processes of BMPs as addressed in Section 4, subsection “Removal Processes Occurring in Treatment BMPs.” These processes should not change systematically from site to site e.g. settling in retention ponds of a similar particle (i.e. specific gravity, shape factor, etc.) should occur at the same rate at different parts of the country (not withstanding minor variations due to water temperature or conductivity) and evapotranspiration will occur in biofilters with some regional differences (e.g. southern states may have a longer growing season while northern states have longer summer days). However, assuming routing and design volumes are properly designed, specific pollutant removal results are site specific and BMP performance will vary with influent loadings and characteristics. The other limit to BMP effectiveness is the limit to the reduction of effluent concentration which has been termed “irreducible concentration” (Schuller, 1996) and is described in greater detail below and elsewhere. The system of equations developed in volumes 2 and 3 and summarized in a spreadsheet as the IDEAL model can assist the reader in determining the effluent concentration discharging from BMPs.

A treatment train approach, i.e. by performing multiple treatments, and source controls, i.e. by potentially limiting influent concentrations, can increase pollutant removals from a drainage area, which is a benefit for the receiving stream and is more important than achieving targeted percent removals in any specific BMP.

The following discussion is taken (minor editing) with from the U.S. EPA report “Urban Stormwater Performance Monitoring” (Strecker et al., 2002):

As treatment occurs and pollutants in stormwater become less concentrated, they become increasingly hard to remove. There appears to be a practical limit to the effluent quality that any BMP can be observed to achieve for the stormwater it treats. This limit is dictated by the chemical and physical nature of the pollutant of concern, the treatment mechanisms and processes within the BMP, and the sensitivity of laboratory analysis techniques to measure the pollutant. This concept of “irreducible concentration” (Schueler, 1996) has significant implications for how BMP efficiency estimates are interpreted. However, it is possible to get concentrations as low as desired, but in most cases achieving extremely low effluent concentrations may not be practical (i.e., would require treatment trains that may not be practical in urban areas that require treatments with small footprints or exotic methods). For example, colloids are typically viewed as “never” being able to be removed in a pond (settling is the primary mechanism for treatment in ponds), despite the fact that they could be further removed through chemical addition. The term “irreducible concentration” represents the lowest effluent concentration for a given parameter that can be achieved by a specific type of stormwater management practice.

Recent research indicates that achievable effluent concentrations vary appreciably between BMP types. For example, in many cases, well-designed sand filters can achieve lower effluent concentrations of TSS than well-designed detention facilities or grassed swales. However, sand filters have problems with long-term maintenance of flow treatment volumes. The typical approach to reporting the ability of a BMP to remove pollutants from stormwater entails comparing the amount of pollutants removed by the BMP to the total quantity of that pollutant. The concept of irreducible concentration, however, suggests that in some cases it may be more useful to report the efficiency of the BMP relative to some achievable level of treatment (i.e., express efficiency as the ability of the BMP to remove the fraction of pollutant that is able to be removed by a particular practice.

The most useful approach to quantifying BMP efficiency is to determine first if the BMP is providing treatment (that the influent and effluent event mean concentrations (EMCs) are statistically different from one another) and then examine either a cumulative distribution function of influent and effluent quality or a standard parallel probability plot. Before any efficiency plots are generated, appropriate non-parametric (or if applicable parametric) statistical tests should be conducted to indicate if any perceived differences in influent and effluent event mean concentrations are statistically significant (the level of significance should be provided, instead of just noting if the result was significant, assume a 95% confidence level). Effluent probability method is straightforward and directly provides a clear picture of the ultimate measure of BMP effectiveness, effluent water quality. Curves of this type are the single most instructive piece of information that can result from a BMP evaluation study.

The most useful approach for examining these curves is to plot the results on a standard parallel probability plot (see Figures E 1-3). A normal probability plot should be generated showing the log transform of both inflow and outflow EMCs for all storms for the BMP. If the log transformed data deviates significantly from normality, other transformations can be explored to determine if a better distributional fit exists. Figures E 1-3 show three types of results that can be observed when plotting pollutant reduction observations on probability plots. Figure E-1 shows that SS are highly removed over influent concentrations ranging from 20 to over 1,000 mg/L. A simple calculation of “percent removal” would not show this consistent removal over the full range of observations. In contrast, Figure E-2 shows poor removal of total dissolved solids (TDS) (filtered residue) for all concentration conditions, as expected for this wet detention pond. The “percent removal” for TDS would be close to zero and no additional surprises are indicated on this plot. Figure E-3, however, shows a wealth of information that would not be available from simple statistical numerical summaries, including the historical analysis approaches described in this manual. In this plot, filtered chemical oxygen demand (COD) is seen to be poorly removed for low concentrations (less than about 20 mg/L), but the removal increases substantially for higher concentrations.

Water quality observations do not generally form a straight line on normal probability paper, but do (at least from about the 10th to 90th percentile level) on log-normal probability plots. This indicates that the samples generally have a log-normal distribution as described previously in this document. Many parametric statistical tests can often be used (e.g., analysis of variance), but only after the data is log-transformed. These plots indicate the central tendency (median) of the data, along with their possible distribution type and variance (the steeper the plot, the smaller the CV and the flatter the slope of the plot, the larger the CV for the data). Multiple data sets can also be plotted on the same plot (such as for different sites, different seasons, different habitats, etc.) to indicate obvious similarities (or differences) in the data sets.

Probability plots should be supplemented with standard statistical tests that determine if the data is normally distributed. These tests, at least some available in most software packages, include the Kolmogorov-Smirnov one-sample test, the chi-square goodness of fit test, and the Lilliefors variation of the Kolmogorov-Smirnov test. They are paired tests comparing data points from the best-fitted normal curve to the observed data. The statistical tests may be visualized by imagining the best-fit normal curve data (a straight line) and the observed data plotted on normal probability paper. If the observed data crosses the fitted curve data numerous times, it is much more likely to be normally distributed than if it only crosses the fitted curve a small number of times (Burton and Pitt, 2002).

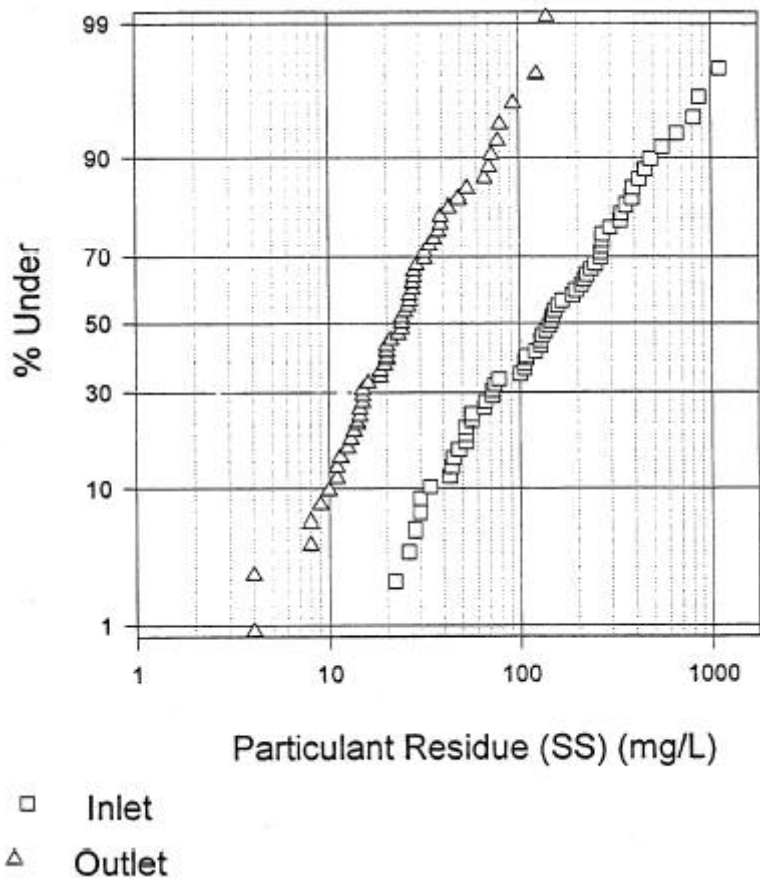

Figure E-1 Probability Plot for Suspended Solids

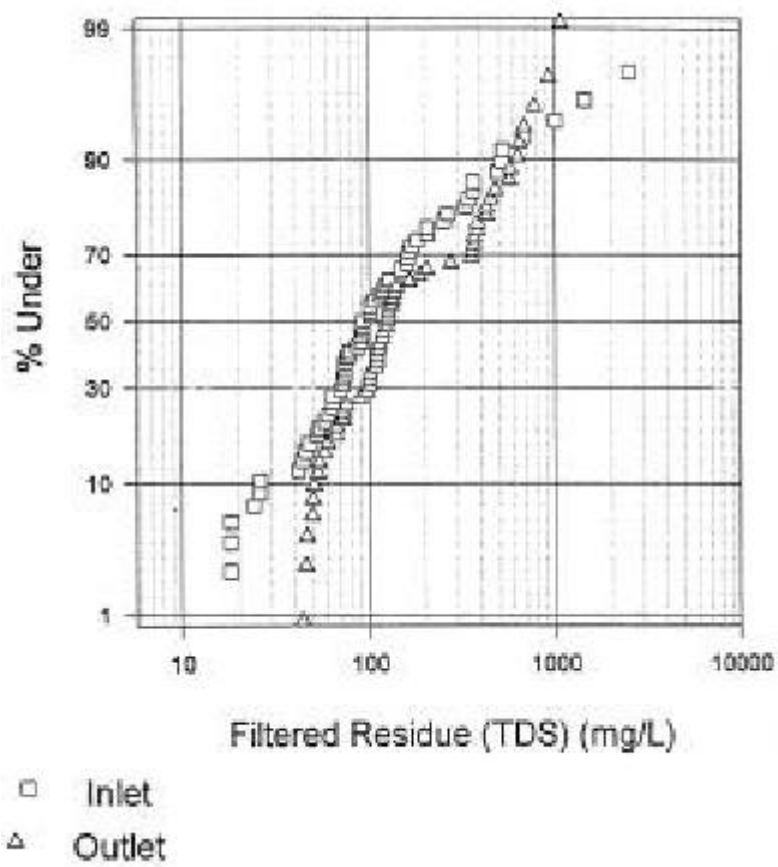

Figure E-2 Probability Plot for Total Dissolved Solids

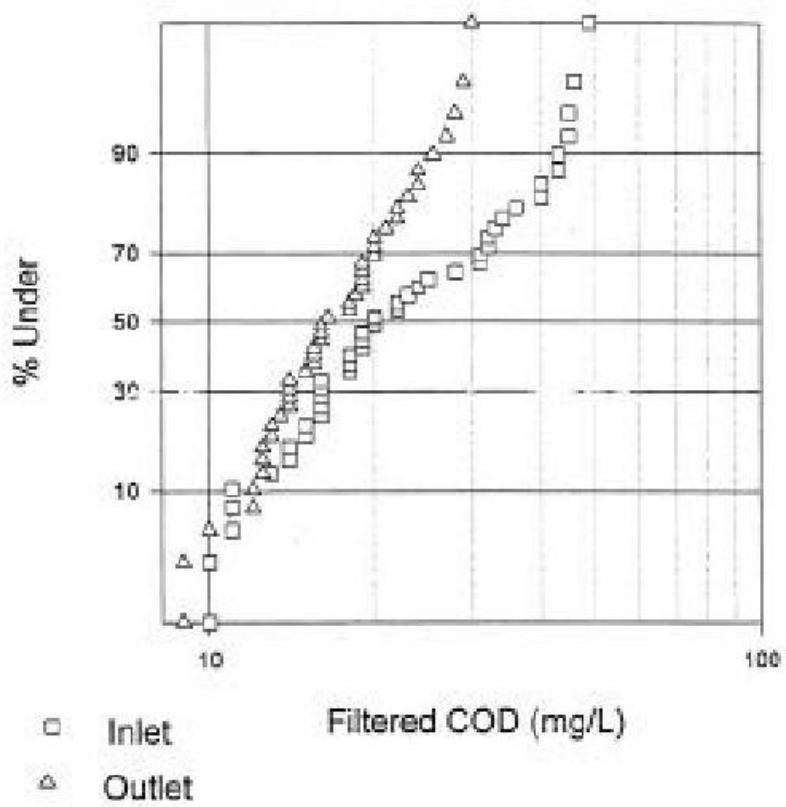

Figure E-3 Probability Plot for Chemical Oxygen Demand

Appendix F Geotechnical Methods for Karst Feasibility Testing

The following information on BMP design and SWM geotechnical testing in Karst areas has been reproduced from the Maryland Stormwater design manual (MDE, 2000). The materials are adapted from the *Carroll County, Maryland, Water Resource Management Manual and Ordinance (CCWRM)* dated July 2, 1996. For a complete discussion of these items, please refer to the Carroll County document.

Stormwater Management in Karst Terrain

In general, stormwater runoff should not be concentrated and should be conveyed through vegetated areas; in addition, the facilities should be designed in accordance with the following standards:

1. Detention/retention ponds should be designed and constructed with a synthetic or clay liner approved by the local plan approval authority.
2. Discharges from SWM facilities or directly from impervious surfaces should not be routed within 1,000 ft of the edge of any existing unremediated sinkhole. The flow should then be directed to an area not underlain by carbonate rock. Alternatively, these discharges may be routed to a stable watercourse via a pipe or lined channel.
3. Sinkholes occurring within stormwater management structures should be repaired within 72 hr of first observation of occurrence.
4. Liners: Where natural soil permeabilities are greater than 10^{-6} cm/sec or 1.4×10^{-3} in. per hr for the two-foot interval below the depth of the proposed facility, a stable, low permeability liner shall be installed as follows:
 1. One foot of clay with a permeability less than 10^{-7} cm/sec,
 2. Two ft of clay with a permeability less than 10^{-6} cm/sec,
 3. Two ft of compacted soil with a permeability less than 10^{-5} cm/sec with a 30 mil thick artificial liner with a permeability less than 10^{-7} cm/sec, or
 4. A very low permeability base constructed of concrete.

Soils Investigation for Karst Terrain

The purpose of a karst investigation is to identify subsurface voids, cavities, fractures or other discontinuities that could pose an environmental concern or a construction hazard to an existing or proposed stormwater management facility. By definition, karst investigations are required only in areas suspected of containing carbonate rocks. The requirements outlined below should not be interpreted as all-inclusive. The design of any subsurface investigation should reflect the size and complexity of the proposed project.

The investigation should determine the nature and thickness of subsurface materials, including depth to bedrock and to the water table. Subsurface data may be acquired by backhoe excavation and/or soil boring. These field data should be supplemented by geophysical investigation techniques, deemed appropriate by a qualified professional. The data listed herein should be acquired under the direct supervision of a qualified geologist, geotechnical engineer or soil scientist who is experienced in conducting such studies. Pertinent site information shall be collected and should include the following:

- Bedrock characteristics (type, geologic contacts, faults, geologic structure, rock surface configuration).
- Soil characteristics (type, thickness, mapped unit).
- Photogeologic fracture traces.
- Bedrock outcrop areas.

- Sinkholes and/or other closed depressions.
- Perennial and/or intermittent streams.

Location of Borings

Borings should be located to provide representative area coverage of the proposed facilities. The exact location of borings will be based on the following conditions or features:

- In each geologic unit present, as mapped by the U.S. Geological Surveys, state and local county records.
- Placed near on-site geologic or geomorphic indications of the presence of carbonate rock.
- On photogeologic fracture traces.
- Next to bedrock outcrop areas (i.e., 10 ft from).
- As near to identified sinkholes and/or closed depressions as possible.
- Near the edges and center of the proposed facility, and spaced at equal distances from one another.
- Near any areas identified as anomalies from any geophysical studies.

Number of Borings

The density shall be dependent upon the type and size of the proposed facility such that a representative sampling is obtained, as follows:

- Ponds/wetlands - a minimum of three per facility, or three per acre, whichever is greater with at least one along the centerline of the proposed embankment and the remainder within the proposed impoundment area.
- Infiltration trenches - a minimum of 2 per facility.
- Additional borings - to define lateral extent of limiting horizons or site-specific conditions, where applicable.

Depth of Borings

Borings shall be extended to depths dependent upon bedrock type as follows:

- Non-carbonate rocks - a minimum depth of 5 ft below the lowest proposed grade, within the facility unless auger/backhoe refusal is encountered.
- Carbonate rocks - a minimum of 20 ft below ground surface or proposed grade; where refusal is encountered, the boring may either be extended by rock coring or moving to an adjacent location within 10 linear ft of the original site, in order that the 20 ft minimum depth be reached.

Identification of Material

All material penetrated by the boring shall be identified, as follows:

- Description, logging and sampling for the entire depth of the boring.
- Any stains, odors or other indications of environmental degradation.
- A minimum laboratory analysis of 2 soil samples, representative of the material penetrated including potential limiting horizons, with the results compared to the field descriptions.
- Identified characteristics shall include, as a minimum: color; mineral composition; grain size, shape and sorting; and saturation.
- Any indications of water saturation shall be carefully logged, to include both perched and groundwater table levels, and descriptions of soils that are mottled or gley should be provided. Water levels in all borings shall be taken at the time of completion and again 24 hr after completion. The boring must remain fully open to the total depth of these measurements.
- When conducting a standard penetration test (SPT), estimation of soil engineering characteristics, including “N” or estimated unconfined compressive strength.

Geophysical Investigation

An electromagnetic terrain conductivity survey may be conducted over the entire area of the facility and extending outward to 200 ft beyond the boundaries of the proposed facility. This survey may be performed to provide a qualitative evaluation of the area to be utilized. The survey results may be used to identify “suspect areas” that will be further evaluated using borings. The use of this technique may reduce the total number of borings for a site by better defining “suspect areas.” This survey shall include appropriate techniques such that representative data are collected from a minimum depth of 20 ft below ground surface or the final proposed grade, whichever is deeper. These data shall then be correlated with boring data in the site area.

Evaluation

At least one subsurface cross section shall be provided. It should extend through a central portion of the proposed facility, using the actual or projected boring data and the geophysical data. In addition, an iso-conductivity map should be constructed. Finally, a bedrock contour map should be developed to include all of the geophysical and boring data. A sketch map or formal construction plan indicating the location and dimension of the proposed facility and line of cross section should be included for reference, or as a base map for presentation of subsurface data.

Sinkhole Remediation

Proper sinkhole remediation involves investigation, stabilization and final grading. For more information, please see the CCWRM, Section 4.2.

Sinkhole Stabilization

Sinkholes should be repaired by (1) reverse-graded backfilling, (2) concrete plugging or (3) an engineered subsurface structure. For more information on these methodologies, seek local guidance.

Monitoring of BMPs in Karst Regions

A water quality monitoring system installed, operated and maintained by the owner/operator may be required in a karst region. For areas requiring monitoring, at least one monitoring well shall be placed at a point hydraulically up gradient from the BMP and two (2) down gradient monitoring wells shall be provided within 200' of the facility. The wells shall be fitted with locking caps. Bi-annual sampling should take place and an annual report should be filed with the plan approval authority.

Appendix G Glossary

Acute: A stimulus severe enough to rapidly induce an effect; in aquatic toxicity tests, an effect observed in 96 hr or less is typically considered acute. When referring to aquatic toxicology or human health, an acute effect is not always measured in terms of lethality.

Adjacent Steep Slope: A slope with a gradient of 15% or steeper within 500 feet of the site.

Adsorption: The adhesion of a substance to the surface of a solid or liquid; often used to extract pollutants by causing them to be attached to such adsorbents as activated carbon or silica gel. Hydrophobic or water repulsing adsorbents are used to extract oil from waterways when oil spills occur. Heavy metals such as zinc and lead often adsorb onto sediment particles.

Antidegradation: Policies that ensure protection of water quality for a particular water body where the water quality exceeds levels necessary to protect fish and wildlife propagation and recreation on and in the water. This also includes special protection of waters designated as outstanding natural resource waters. Anti-degradation plans are adopted by each state to minimize adverse effects on water.

Anti-seep Collar: A device constructed around a pipe or other conduit and placed through a dam, levee or dike for the purpose of reducing seepage losses and piping failures.

Anti-vortex Device: A device designed and placed on the top of a riser or the entrance of a pipe to prevent the formation of a vortex in the water at the entrance.

Aquatic Bench: A bench that is located around the inside perimeter of a permanent pool and is normally vegetated with aquatic plants; the goal is to provide pollutant removal and enhance safety in areas using stormwater pond BMP's.

Aquifer: A porous water bearing geologic formation generally restricted to materials capable of yielding an appreciable supply of water

"As-Built": Drawing or certification of conditions as they were actually constructed.

Baffles: Guides, grids, grating or similar devices placed in a pond to deflect or regulate flow and create a longer flow path.

Bankfull Discharge: A flow condition where streamflow completely fills the stream channel up to the top of the bank. In undisturbed watersheds, the discharge conditions occurs on average every 1.5 to 2 years and controls the shape and form of natural channels.

Barrel: The closed conduit used to convey water under or through an embankment; part of the principal spillway.

Baseflow: The stream discharge from groundwater.

Berm: A shelf that breaks the continuity of a slope; a linear embankment or dike.

Best Available Technology Economically Achievable (BAT): Technology-based standard established by the Clean Water Act (CWA) as the most appropriate means available on a national basis for controlling the direct discharge of toxic and non-conventional pollutants to navigable waters. BAT effluent limitations guidelines, in general, represent the best existing performance of treatment technologies that are economically achievable within an industrial point source category or subcategory.

Best Conventional Pollutant Control Technology (BCT): Technology-based standard for the discharge from existing industrial point sources of conventional pollutants including BOD, TSS, fecal coliform, pH, oil and grease. The BCT is established in light of a two-part "cost reasonableness" test that compares the cost for an industry to reduce its pollutant discharge with the cost to a POTW for similar levels of reduction of a pollutant loading. The second test examines the cost-effectiveness of additional industrial treatment beyond BPT. EPA must find limits that are reasonable under both tests before establishing them as BCT.

Best Management Practice (BMP): Permit condition used in place of or in conjunction with effluent limitations to prevent or control the discharge of pollutants. May include schedule of activities, prohibition of practices, maintenance procedure or other management practice. BMPs may include, but are not limited to, treatment requirements, operating procedures or practices to control plant site runoff, spillage, leaks, sludge or waste disposal, or drainage from raw material storage. Physical, structural and/or managerial practices that, when used singly or in combination, reduce the downstream quality and quantity impacts of stormwater.

Best Practicable Control Technology Currently Available (BPT): The first level of technology-based standards established by the CWA to control pollutants discharged to waters of the U.S. BPT effluent limitations guidelines are generally based on the average of the best existing performance by plants within an industrial category or subcategory.

Bioassay: A test used to evaluate the relative potency of a chemical or a mixture of chemicals by comparing its effect on a living organism with the effect of a standard preparation on the same type of organism.

Biochemical Oxygen Demand (BOD): A measurement of the amount of oxygen utilized by the decomposition of organic material, over a specified time period (usually 5 days) in a wastewater sample; it is used as a measurement of the readily decomposable organic content of a wastewater.

Biofiltration: The simultaneous process of filtration, infiltration, adsorption and biological uptake of pollutants in stormwater that takes place when runoff flows over and through vegetated areas.

Biofiltration Swale: A sloped, vegetated channel or ditch that provides both conveyance and water quality treatment to stormwater runoff. It does not provide stormwater quantity control but can convey runoff to BMPs designed for that purpose.

Biological Control: A method of controlling pest organisms by means of introduced or naturally occurring predatory organisms, sterilization, the use of inhibiting hormones, or other means, rather than by mechanical or chemical means.

Bioretention: A stormwater management practice that utilizes shallow storage, landscaping and soils to control and treat urban stormwater runoff by collecting it in shallow depressions before filtering it through a fabricated planting soil media.

Buffer: The zone contiguous with a sensitive area that is required for the continued maintenance, function and structural stability of the sensitive area. The critical functions of a riparian buffer (those associated with an aquatic system) include shading, input of organic debris and coarse sediments, uptake of nutrients, stabilization of banks, interception of fine sediments, overflow during high water events, protection from disturbance by humans and domestic animals, maintenance of wildlife habitat, and room for variation of aquatic system boundaries over time due to hydrologic or climatic effects. The critical functions of terrestrial buffers include protection of slope stability, attenuation of surface water flows from stormwater runoff and precipitation, and erosion control.

Catchbasin: A chamber or well, usually built at the curb line of a street, for the admission of surface water to a sewer or subdrain, having at its base a sediment sump designed to retain grit and detritus below the point of overflow.

Catchment: Surface drainage area.

Channel: A natural stream that conveys water; a ditch or channel excavated for the flow of water and open to the air.

Channelization: Alteration of a stream channel by widening, deepening, straightening, cleaning or paving certain areas to change flow characteristics.

Channel Stabilization: Erosion prevention and stabilization of velocity distribution in a channel using jetties, drops, revetments, structural linings, vegetation and other measures.

Check Dam: A small dam constructed in a gully or other small watercourse to decrease flow velocity (by reducing the channel gradient), minimize scour and promote deposition of sediment.

Chemical Oxygen Demand (COD): A measure of the oxygen-consuming capacity of inorganic and organic matter present in wastewater. COD is expressed as the amount of oxygen consumed in mg/l. Results do not necessarily correlate to the biochemical oxygen demand (BOD) because the chemical oxidant may react with substances that bacteria do not stabilize.

Chronic: A stimulus that lingers or continues for a relatively long period of time, often one-tenth of the life span or more. “Chronic” should be considered a relative term depending on the life span of an organism. The measurement of a chronic effect can be reduced growth or reproduction, etc., in addition to lethality.

Chute: A high velocity, open channel for conveying water to a lower level without erosion.

Clay Lens: A naturally occurring, localized area of clay that acts as an impermeable layer to runoff infiltration.

Clay (Soils): 1. A mineral soil separate consisting of particles less than 0.002 millimeter in equivalent diameter. 2. A soil texture class. 3. (Engineering) A fine grained soil (more than 50% passing the No. 200 sieve) that has a high plasticity index in relation to the liquid limit (Unified Soil Classification System)

Clean Water Act (CWA): The Clean Water Act is an act passed by the U.S. Congress to control water pollution. It was formerly referred to as the Federal Water Pollution Control Act of 1972 or Federal Water Pollution Control Act Amendments of 1972 (Public Law 92-500), 33 U.S.C. 1251 et. seq., as amended by: Public Law 96-483; Public Law 97-117; Public Laws 95-217, 97-117, 97-440 and 100-04.

Closed Depression: An area that is low-lying and either has no, or such a limited, surface water outlet that during storm events the area acts as a retention basin.

Coconut Rolls: Also known as coir rolls, these are rolls of natural coconut fiber designed to be used for streambank stabilization.

Cohesion: The capacity of a soil to resist shearing stress, exclusive of functional resistance.

Combined Sewer Overflow (CSO): A discharge of untreated wastewater from a combined sewer system at a point prior to the headworks of a publicly owned treatment works. CSOs generally occur during wet weather (rainfall or snowmelt). During periods of wet weather, these systems become overloaded, bypass treatment works and discharge directly to receiving waters.

Combined Sewer System (CSS): A wastewater collection system that conveys sanitary wastewaters (domestic, commercial and industrial wastewaters) and stormwater through a single pipe to a publicly owned treatment works for treatment prior to discharge to surface waters.

Compaction (Soils): Any process by which the soil grains are rearranged to decrease void space and bring them in closer contact with one another, thereby increasing the weight of solid material per unit of volume, increasing the shear and bearing strength and reducing permeability.

Composite Sample: Sample composed of two or more discrete samples. The aggregate sample will reflect the average water quality covering the compositing or sample period.

Conduit: Any channel intended for the conveyance of water, whether open or closed.

Constructed Wetland: A wetland that is created on a site that previously was not a wetland. This wetland is designed specifically to remove pollutants from stormwater runoff.

Contour: 1. An imaginary line *on the surface of the earth* connecting points at the same elevation. 2. A line drawn *on a map* connecting points at the same elevation.

Core Trench: A trench, filled with relatively impervious material intended to reduce seepage of water through porous strata.

Conventional Pollutants: Pollutants typical of municipal sewage and for which municipal secondary treatment plants are typically designed; defined by Federal Regulation [40 CFR 401.16] as BOD, TSS, fecal coliform bacteria, oil and grease, and pH.

Conveyance: A mechanism for transporting water from one point to another, including pipes, ditches and channels.

Conveyance System: The drainage facilities, both natural and manmade, that collect, contain and provide for the flow of surface and stormwater from the highest points on the land down to a receiving water. The natural elements of the conveyance system include swales and small drainage courses, streams, rivers, lakes, and wetlands. The human-made elements of the conveyance system include gutters, ditches, pipes, channels and most retention/detention facilities.

Cradle: A structure usually of concrete shaped to fit around the bottom and sides of a conduit to support the conduit, increase its strength and, in dams, to fill all voids between the underside of the conduit and the soil.

Created Wetland: A wetland that is created on a site not previously a wetland. Such a wetland is created to replace wetlands that were unavoidably destroyed during design and construction of a project, and cannot be used for treatment of stormwater runoff.

Crest: 1. The top of a dam, dike, spillway or weir, frequently restricted to the overflow portion. 2. The summit of a wave or peak of a flood volume.

Criteria: The numeric values and the narrative standards representing contaminant concentrations that are not to be exceeded in the receiving environmental media (surface water, ground water, sediment) to protect beneficial uses.

Curve Number (CN): A numerical representation of a given area's hydrologic soil group, plant cover, impervious cover, interception and surface storage derived in accordance with Natural Resources Conservation Service methods. This number is used to convert rainfall depth into runoff

Cut: Portion of land surface or area from which earth has been removed or will be removed by excavation; the depth below original ground surface to excavated surface.

Cut-and-Fill: Process of earth moving by excavating part of an area and using the excavated material for adjacent embankments or fill areas.

Cutoff: A wall or other structure, such as a trench, filled with relatively impervious material intended to reduce seepage of water through porous strata.

CZARA: Acronym used for the Coastal Zone Act Reauthorization Amendments of 1990. These amendments sought to address the non-point source pollution issue by requiring states to develop coastal non-point pollution control programs in order to receive federal funds.

Dam: A barrier to confine or raise water for storage or diversion, to create a hydraulic head, to prevent gully erosion, or for retention of soil, sediment or other debris.

Dead Storage: The permanent pool volume located below the out structure of a storage device. Dead storage provides water *quality* treatment but does not provide water *quantity* treatment.

Depression Storage: The amount of precipitation trapped in depressions on the surface of the ground.

Design Storm: A prescribed hyetograph and total precipitation amount (for a specific duration recurrence frequency) used to estimate runoff for a hypothetical storm of interest or concern for the purposes of analyzing existing drainage, designing new drainage facilities or assessing other impacts of a proposed project on the flow of surface water.

Detention: The temporary storage of stormwater runoff in a BMP with the goals of controlling peak discharge rates and providing gravity settling of pollutants.

Detention Facility/Structure: An above or below ground facility, such as a pond or tank, that temporarily stores stormwater runoff and subsequently releases it at a slower rate than it is collected by the drainage facility system. There is little or no infiltration of stored stormwater. The facility is designed not to create a permanent pool of water.

Detention Time: The theoretical time required to displace the contents of a stormwater treatment facility at a given rate of discharge (volume divided by rate of discharge).

Dike: An embankment to confine or control water, for example, one built along the banks of a river to prevent overflow to lowlands; a levee.

Discharge: Outflow; the flow of a stream, canal or aquifer. One may also speak of the discharge of a canal or stream into a lake, river or ocean. (Hydraulics) Rate of flow, specifically fluid flow; a volume of fluid passing a point per unit of time, commonly expressed as cubic feet per second, cubic meters per second, gallons per minute, gallons per day or millions of gallons per day.

Disturbed Area: An area in which the natural vegetative soil cover has been removed or altered and, therefore, is susceptible to erosion.

Diversion: A channel with a supporting ridge on the lower side constructed across the slope to divert water to areas where it can be used or disposed of safely. Diversions differ from terraces in that they are individually designed.

Drainage: Refers to the collection, conveyance, containment and/or discharge of surface and storm water runoff.

Drainage Area (Watershed): That area contributing runoff to a single point measured in a horizontal plane that is enclosed by a ridge line.

Drainage Basin: A geographic and hydrologic sub-unit of a watershed.

Drainage Channel: A drainage pathway with a well-defined bed and banks indicating frequent conveyance of surface and stormwater

Drainage Course: A pathway for watershed drainage characterized by wet soil vegetation; often intermittent in flow.

Drainage Divide: The boundary between one drainage basin and another.

Drain: A buried pipe or other conduit (closed drain). A ditch (open drain) for carrying off surplus surface water or ground water.

Drainage Easement: A legal encumbrance that is placed against a property's title to reserve specified privileges for the users and beneficiaries of the drainage facilities contained within the boundaries of the easement.

Drainage, Soil: The removal of water from a soil.

Drop Structure: A structure for dropping water to a lower level and dissipating surplus energy; a fall.

Dry Pond: A facility that provides stormwater quantity control by containing excess runoff in a detention basin, then releasing the runoff at allowable levels.

Dry Swale: An open drainage channel explicitly designed to detain and promote the filtration of stormwater runoff through an underlying fabricated soil media.

Dry Vault/Tank: A facility that treats stormwater for water quantity control by detaining runoff in underground storage units and then releases reduced flows at established standards.

Effluent Limitation: Any restriction imposed on quantities, discharge rates and concentrations of pollutants that are discharged from point sources into waters of the United States, the waters of the contiguous zone or the ocean.

Effluent Limitations Guidelines (ELG): A regulation published by the Administrator under Section 304(b) of CWA that establishes national technology-based effluent requirements for a specific industrial category.

Emergency Spillway: A dam spillway, constructed in natural ground, that is to discharge flow in excess of the principal spillway design discharge.

Energy Dissipator: Any means by which the total energy of flowing water is reduced. In stormwater design, these are usually mechanisms that reduce velocity prior to or at discharge from an outfall in order to prevent erosion. They include rock splash pads, drop manholes, concrete stilling basins or baffles and check dams.

Enhancement: To raise ecological value, desirability or attractiveness of an environment associated with surface water.

Erosive Velocities: Velocities of water that are high enough to wear away the land surface. Exposed soil will generally erode faster than stabilized soils. Erosive velocities will vary according to the soil type, slope, and structural or vegetative stabilization used to protect the soil.

Erosion: 1. The process by which the land surface is worn away by the action of water, wind, ice or gravity. 2. Detachment and movement of soil or rock fragments by water, wind, ice or gravity. The following terms are used to describe different types of water erosion:

Accelerated erosion - Erosion much more rapid than normal, natural or geologic erosion, primarily as a result of the influence of the activities of man or, in some cases, of other animals or natural catastrophes that expose base surfaces.

Gully erosion - The erosion process whereby water accumulates in narrow channels and removes the soil from this narrow area to considerable depths ranging from 1 or 2 feet to as much as 75 to 100 feet.

Rill erosion - An erosion process in which numerous small channels only several inches deep are formed. See rill.

Sheet erosion - The spattering of small soil particles caused by the impact of raindrops on wet soils. The loosened and spattered particles may or may not subsequently be removed by surface runoff.

Erosion and Sediment Control: Any temporary or permanent measures taken to reduce erosion, control siltation and sedimentation, and ensure that sediment-laden water does not leave a site.

Erosion and Sediment Control Facility: Type of drainage facility designed to hold water for a period of time to allow sediment contained in the surface and stormwater runoff directed to the facility to settle out so as to improve the quality of the runoff.

Event Mean Concentration (EMC): The EMC is a statistical parameter used to represent the flow-proportional average concentration of a given parameter during a storm event. It is defined as the total constituent mass divided by the total runoff volume. When combined with flow measurement data, the EMC can be used to estimate the pollutant loading from a given storm.

Exfiltration: The downward movement of water through the soil; the downward flow of runoff from the bottom of an infiltration BMP into the soil.

Existing Site Conditions: The conditions (ground cover, slope, drainage patterns) of a site as they existed on the first day that the project entered the design phase. Projects that drain into a sensitive area designated by a federal, state or local agency may be required to use undisturbed forest conditions for the purposes of calculating runoff characteristics instead of using existing site conditions.

Experimental Best Management Practice (BMP): A BMP that has not been tested and evaluated by the Department of Ecology in collaboration with local governments and technical experts.

Extended Detention: A stormwater design feature that provides for the gradual release of a volume of water in order to increase settling of pollutants and protect downstream channels from frequent storm events.

Filter Bed: The section of a constructed filtration device that houses the filter media and the outflow pipe.

Filter Fence: A geotextile fabric designed to trap sediment and filter runoff.

Filter Media: The sand, soil or other organic material in a filtration device used to provide a permeable surface for pollutant and sediment removal.

Filter Strip: A strip of permanent vegetation above ponds, diversions and other structures to retard the flow of runoff, causing deposition of transported material, thereby reducing sedimentation.

Fines (Soil): Generally refers to the silt and clay size particles in soil.

Floodplain: Areas adjacent to a stream or river that are subject to flooding or inundation during a storm event that occurs, on average, once every 100 years (or has a likelihood of occurrence of 1/100 in any given year).

Flood Frequency: The frequency with which the flood of interest may be expected to occur at a site in any average interval of years. Frequency analysis defines the “n-yr flood” as being the flood that will, over a long period of time, be equaled or exceeded on the average once every “n” years.

Flood Fringe: That portion of the floodplain outside of the floodway that is covered by floodwaters during the base flood. It is generally associated with standing water rather than rapidly flowing water.

Flood Peak: The highest value of the stage or discharge attained by a flood; thus, peak stage or peak discharge.

Flood Routing: An analytical technique used to compute the effects of system storage dynamics on the shape and movement of flow represented by a hydrograph.

Flood Stage: The stage at which overflow of the natural banks of a stream begins.

Floodway: The channel of the river or stream and those portions of the adjoining flood plains that are reasonably required to carry and discharge the base flood flow. The portions of the adjoining flood plains that are considered to be “reasonably required” are defined by flood hazard regulations.

Flow Splitter: An engineered, hydraulic structure designed to divert a percentage of storm flow to a BMP located out of the primary channel, or to direct stormwater to a parallel pipe system or to bypass a portion of baseflow around a BMP.

Forebay: An easily maintained, extra storage area provided near an inlet of a BMP to trap incoming sediments before they accumulate in a pond or wetland BMP.

Freeboard (Hydraulics): The distance between the maximum water surface elevation anticipated in design and the top of retaining banks or structures. Freeboard is provided to prevent overtopping due to unforeseen conditions.

French Drain: A type of drain consisting of an excavated trench filled with pervious material, such as coarse sand, gravel or crushed stone; water percolates through the voids in this material and flows to an outlet.

Frost-Heave: The upward movement of soil surface due to the expansion of water stored between particles in the first few feet of the soil profile as it freezes. May cause surface fracturing of asphalt or concrete.

Frequency of Storm (Design Storm Frequency): The anticipated period in years that will elapse, based on average probability of storms in the design region, before a storm of a given intensity and/or total volume will recur; thus a 10-yr storm can be expected to occur on the average once every 10 years. Sewers designed to handle flows that occur under such storm conditions would be expected to be surcharged by any storms of greater amount or intensity.

Functions (wetlands): The ecological (physical, chemical and biological) processes or attributes of a wetland without regard for their importance to society (see also Values). Wetland functions include food chain support, provision of ecosystem diversity and fish and wildlife habitat, flood flow alteration, ground water recharge and discharge, water quality improvement, and soil stabilization.

Gabion: A rectangular or cylindrical wire mesh cage filled with rock and used as a protecting agent, revetment, etc., against erosion. Soft gabions, often used in stream bank stabilization, are made of geotextiles filled with dirt, in between which cuttings are placed.

Gabion Mattress: A thin gabion, usually six or nine inches thick, used to line channels for erosion control.

Gage: Device for registering precipitation, water level, discharge, velocity, pressure, temperature, etc.

Gaging Station: A selected section of a stream channel equipped with a gage, recorder or other facilities for determining stream discharge.

Gauge: A measure of the thickness of metal; e.g., diameter of wire, wall thickness of steel pipe.

Grab Sample: A sample taken from a waste stream on a one-time basis without consideration of the flow rate of the waste stream and without consideration of time.

Grade: 1. The slope or finished surface of a road, channel, canal bed, roadbed, top of embankment, bottom of excavation or natural ground; any surface prepared for the support of construction, like paving or laying a conduit. 2. To finish the surface of a canal bed, roadbed, top of embankment or bottom of excavation.

Grass Channel: An open vegetated channel used to convey runoff and to provide treatment by filtering pollutants and sediments.

Gravel: 1. Aggregate consisting of mixed sizes of 1/4 inch to 3 inches that normally occur in or near old streambeds and have been worn smooth by the action of water. 2. A soil having particle sizes, according to the Unified Soil Classification System, ranging from the No. 4 sieve size to 3 in., with more than 50% of coarse fraction larger than No. 4 sieve size.

Gravel Diaphragm: A stone trench filled with small, river-run gravel used as pretreatment and inflow regulation in stormwater filtering systems.

Gravel Filter: Washed and graded sand and gravel aggregate placed around a drain or well screen to prevent the movement of fine materials from the aquifer into the drain or well.

Gravel Trench: A shallow excavated channel backfilled with gravel and designed to provide temporary storage and permit percolation of runoff into the soil substrate.

Ground Water Table: The free surface of the ground water, that surface subject to atmospheric pressure under the ground, generally rising and falling with the season, the rate of withdrawal, the rate of restoration, and other conditions. It is seldom static.

Gully: A channel or miniature valley cut by concentrated runoff through which water commonly flows during and immediately after heavy rains or snow melt. The distinction between gully and rill is one of depth. A gully is sufficiently deep such that it would not be obliterated by normal tillage operations, whereas a rill is of lesser depth and would be smoothed by ordinary farm tillage or grading activities.

Harmful Pollutant: A substance that has adverse effects on an organism, including immediate death, chronic poisoning, impaired reproduction, cancer or other effects.

Heavy Metals: Metals of high specific gravity that are present in municipal and industrial wastes and pose long-term environmental hazards; such metals include: cadmium, chromium, cobalt, copper, lead, mercury, nickel and zinc.

Head (Hydraulics): 1. The height of water above any plane of reference. 2. The energy, either kinetic or potential, possessed by each unit weight of a liquid expressed as the vertical height through which a unit weight would have to fall to release the average energy possessed. Used in various terms such as pressure head, velocity head and head loss.

High Marsh: A pondscaping zone within a stormwater wetland that exists from the surface of the normal pool to a six-inch depth and typically contains the greatest density and diversity of emergent wetland plants.

Hotspot: Area where land use or activities generate highly contaminated runoff, with concentrations of pollutants in excess of those typically found in stormwater.

Hydraulic Gradient: The slope of the hydraulic grade line, which includes static and potential head.

Hydrodynamic Structure: An engineered structure to separate sediments and oils from stormwater runoff using gravitational separation and/or hydraulic flow.

Hydrograph: A graph of runoff rate, inflow rate or discharge rate past a specific point over time.

Hydrologic Soil Groups (HSG): A soil characteristic classification system defined by the U.S. Soil Conservation Service in which a soil may be categorized into one of four soil groups (A, B, C or D) based upon infiltration rate and other properties.

Hydrology: The science of the behavior of water in the atmosphere, on the surface of the earth and underground.

Hydroperiod: A seasonal occurrence of flooding and/or soil saturation that encompasses depth, frequency, duration and seasonal pattern of inundation.

Hydroseed: An application of seed or other material applied with forced water in order to revegetate.

Hyetograph: A graph of precipitation versus time.

Impervious Surface/Cover (I): A hard surface area that either prevents or retards the entry of water into the soil. Common impervious surfaces include roof tops, walkways, patios, driveways, parking lots or storage areas, concrete or asphalt paving, gravel roads, packed earthen materials, and oiled surfaces.

Industrial Stormwater Permit: An NPDES permit issued to an identified land use that regulates the pollutant levels associated with industrial stormwater discharges or specifies onsite pollution control strategies.

Infiltration: The downward movement of water from the surface to the subsoil.

Infiltration Facility (or system): A drainage facility designed to use the hydrologic process of surface and stormwater runoff soaking into the ground, commonly referred to as a percolation, to dispose of surface and stormwater runoff.

Infiltration Pond: A facility that provides stormwater quantity control by containing excess runoff in a detention facility, then percolating that runoff into the surrounding soil.

Infiltration Rate (f): The rate at which stormwater percolates into the subsoil measured in inches per hour.

Inflow Protection: A waterhandling device used to protect the transition area between any water conveyance (dike, swale or swale dike) and a sediment trapping device.

Inlet: A form of connection between surface of the ground and a drain or sewer for the admission of surface and stormwater runoff.

Invert: The lowest point on the inside of a sewer or other conduit.

Invert Elevation: The vertical elevation of a pipe or orifice in a pond that defines the water level.

Isopluvial Map: A map with lines representing constant depth of total precipitation for a given return frequency.

Karst Geology: Regions that are characterized by formations underlain by carbonate rock and typified by the presence of limestone caverns and sinkholes.

Lag Time: The interval between the center of mass of the storm precipitation and the peak flow of the resultant runoff.

Land Disturbing Activity: Any activity that results in a change in the existing soil cover (both vegetative and nonvegetative) and/or the existing soil topography. Land disturbing activities include, but are not limited to demolition, construction, clearing, grading, filling and excavation.

Leachate: Liquid that has percolated through soil and contains substances in solution or suspension.

Leaching: Removal of the more soluble materials from the soil by percolating waters.

Level Spreader: A temporary BMP used to spread stormwater runoff uniformly over the ground surface as sheet flow. The purpose of level spreaders is to prevent concentrated, erosive flows from occurring. Level spreaders will commonly be used at the upstream end of wider biofilters to ensure sheet flow into the biofilter.

Low Flow Channel: An incised or paved channel from inlet to outlet in a dry basin that is designed to carry low runoff flows and/or baseflow, directly to the outlet without detention.

Major Storm: A precipitation event that is larger than the typically largest rainfall for a year.

Mass Wasting: The movement of large volumes of earth material downslope.

Mean Depth: Average depth; cross-sectional area of a stream or channel divided by its surface or top width.

Mean Velocity: The average velocity of a stream flowing in a channel or conduit at a given cross-section or in a given reach. It is equal to the discharge divided by the cross-sectional area of the reach.

Metals: Elements such as mercury, lead, nickel, zinc and cadmium that are of environmental concern because they do not degrade over time. Although many are necessary nutrients, they sometimes accumulate in the food chain, and they can be toxic to life in high enough concentrations. They are also referred to as heavy metals.

Micropool: A smaller permanent pool that is incorporated into the design of larger stormwater ponds to avoid resuspension of particles and minimize impacts to adjacent natural features.

Million Gallons per Day (mgd): A unit of flow commonly used for wastewater discharges. One mgd is equivalent to 1.547 cubic feet per second.

Mitigation: means, in the following order of preference:

1. Avoiding the impact altogether by not taking a certain action or part of an action;
2. Minimizing impacts by limiting the degree or magnitude of the action and its implementation by using appropriate technology, or by taking affirmative steps to avoid or reduce impacts;
3. Rectifying the impact by repairing, rehabilitating or restoring the affected environment;
4. Reducing or eliminating the impact over time by preservation and maintenance operations during the life of the action; and
5. Compensation for the impact by replacing, enhancing or providing substitute resources or environments.

Monitor: To systematically and repeatedly measure something in order to track changes.

Monitoring: The collection of data by various methods for the purposes of understanding natural systems and features, evaluating the impacts of development proposals on such systems, and assessing the performance of mitigation measures imposed as conditions of development.

Municipal Stormwater Permit: An NPDES permit issued to municipalities to regulate discharges from municipal separate storm sewers for compliance with EPA regulations.

Municipal Separate Storm Sewer System (Commonly referred to as an MS4): A conveyance or system of conveyances (including roads with drainage systems, municipal streets, catch basins, curbs, gutters, ditches, manmade channels or storm drains) owned by a state, city, town or other public body that is designed or used for collecting or conveying storm water that is not a combined sewer, and that is not part of a publicly owned treatment works [40 CFR 122.26(b)(8)].

National Pollutant Discharge Elimination System (NPDES): The national program for issuing, modifying, revoking and reissuing, terminating, monitoring and enforcing permits, and imposing and enforcing pretreatment requirements, under Sections 307, 318, 402, and 405 of CWA.

NGVD: National Geodetic Vertical Datum

Native Growth Protection Easement (NGPE): An easement granted for the protection of native vegetation within a sensitive area or its associated buffer. The NGPE shall be recorded on the appropriate documents of title and filed with the County Records Division.

New Development: Includes the following activities: land disturbing activities, structural development, including construction, installation or expansion of a building or other structure; creation of impervious surfaces; Class IV — general forest practices that are conversions from timber land to other uses; and subdivision and short subdivision of land as defined in RCW 58.17.020. All other forest practices and commercial agriculture are not considered new development.

New Impervious Area: The impervious area that is being created by the project.

Nonconventional Pollutants: All pollutants that are not included in the list of conventional or toxic pollutants in 40 CFR Part 401. Includes pollutants such as chemical oxygen demand (COD), total organic carbon (TOC), nitrogen and phosphorus.

Nonpoint Source Pollution: Pollution that enters a water body from diffuse origins on the watershed and is not transported via discernible, confined or discrete conveyances.

Non-Structural BMPs: Stormwater runoff treatment techniques that use natural measures to reduce pollution levels, do not require extensive construction efforts and/or promote pollutant reduction by eliminating the pollutant source.

Normal Depth: The depth of uniform flow. This is a unique depth of flow for any combination of channel characteristics and flow conditions. Normal depth is calculated using Manning's Equation.

Nutrients: Essential chemicals needed by plants or animals for growth. Excessive amounts of nutrients can lead to degradation of water quality and algal blooms. Some nutrients can be toxic at high concentrations.

Off-Line: A management system designed to control a storm event by diverting a percentage of stormwater events from a stream or storm drainage system.

Off-site: Any area lying upstream of the site that drains onto the site and any area lying downstream of the site to which the site drains.

One-Year Storm: A stormwater event that occurs on average once every year or statistically has a 100% chance on average of occurring in a given year (abbreviated as 1-yr storm).

One Hundred Year Storm: An extreme flood event that occurs on average once every 100 years or statistically has a 1% chance on average of occurring in a given year (abbreviated as 100-yr storm).

On-Line: A management system designed to control stormwater in its original stream or drainage channel.

Orifice: An opening with a closed perimeter, usually sharp-edged, and of regular form in a plate, wall or partition through which water may flow, generally used for the purpose of measurement or control of flow.

Outlet: Point of water disposal from a stream, river, lake, tidewater or artificial drain.

Outlet Channel: A waterway constructed or altered primarily to carry water from man-made structures, such as terraces, tile lines and diversions. Also known as swale, grass channel and biofilter. This system is used for the conveyance, retention, infiltration and filtration of stormwater runoff.

Overflow: A pipeline or conduit device, together with an outlet pipe, that provides for the discharge of portions of combined sewer flows into receiving waters or other points of disposal, after a regular device has allowed the portion of the flow which can be handled by interceptor sewer lines and pumping and treatment facilities to be carried by and to such water pollution control structures.

pH: A measure of the hydrogen ion concentration of water or wastewater; expressed as the negative log of the hydrogen ion concentration in mg/L. A pH of 7 is neutral, pH less than 7 is acidic and pH greater than 7 is basic.

Peak Discharge Rate: The maximum instantaneous rate of flow during a storm, usually in reference to a specific design storm event.

Permanent Seeding: The establishment of perennial vegetation that may remain for many years.

Permeability Rate: The rate at which water will move through a saturated soil.

Permeable Soils: Soil materials with a sufficiently rapid infiltration rate so as to greatly reduce or eliminate surface and stormwater runoff. These soils are generally classified as NRCS hydrologic soil types A and B.

Permeable Cover: Those surfaces in the landscape consisting of open space, forested areas, meadows, etc. that infiltrate rainfall.

Permissible Velocity (Hydraulics): The highest average velocity at which water may be carried safely in a channel or other conduit. The highest velocity that can exist through a substantial length of a conduit and not cause channel scour. A safe, non-eroding or allowable velocity

Perviousness: Related to the size and continuity of void spaces in soils; related to a soil's infiltration rate.

Pesticide: A general term used to describe any substance, usually chemical, used to destroy or control organisms; includes herbicides, insecticides, algicides, fungicides and others. Many of these substances are manufactured and are not naturally found in the environment. Others, such as pyrethrum, are natural toxins that are extracted from plants and animals.

Piping: Removal of soil material through subsurface flow channels.

Point Source: Any discernible, confined and discrete conveyance, including but not limited to any pipe, ditch, channel, tunnel, conduit, well, discrete fixture, container, rolling stock, concentrated animal feeding operation, landfill leachate collection system, or vessel or other floating craft from which pollutants are or may be discharged.

Pollutant: Dredged spoil, solid waste, incinerator residue, filter backwash, sewage, garbage, sewage sludge, munitions, chemical wastes, biological materials, radioactive materials (except those regulated under the Atomic Energy Act of 1954, as amended (42 U.S.C. 2011 et seq.)), heat, wrecked or discarded equipment, rock, sand, cellar dirt, and industrial, municipal and agricultural waste discharged into water.

Practicable: Available and capable of being done after taking into consideration cost, existing technology and logistics in light of overall project purposes.

Pretreatment: The removal of material such as gross solids, grit, grease and scum from flows prior to physical, biological or physical treatment processes to improve treatability. Pretreatment may include screening, grit removal, and oil/water separators.

Pond Buffer: The area immediately surrounding a pond that acts as a filter to remove pollutants and provide infiltration of stormwater prior to reaching the pond. Provides a separation barrier to adjacent development.

Pond Drain: A pipe or other structure used to drain a permanent pool within a specified time period.

Pondscaping: Landscaping around stormwater ponds that emphasizes using native vegetative species to meet specific design intentions. Species are selected for up to six zones in the pond and its surrounding buffer based on their ability to tolerate inundation and/ or soil saturation.

Porosity (*n*): Ratio of pore volume to total volume.

Pretreatment: Techniques employed in stormwater BMPs to provide storage or filtering to help trap coarse materials and other pollutants before they enter the system.

Principal Spillway: The primary pipe or weir that carries baseflow and storm flow through a dam embankment.

Rare, Threatened or Endangered Species: Plant or animal species that are regionally relatively uncommon, are nearing endangered status, or whose existence is in immediate jeopardy and is usually restricted to highly specific habitats. Threatened and endangered species are officially listed by federal and state authorities, whereas rare species are unofficial species of concern that fit the above definitions.

Rational Method: A means of computing storm drainage flow rates (*Q*) by use of the formula $Q = CIA$, where *C* is a coefficient describing the physical drainage area, *I* is the rainfall intensity and *A* is the area.

Reach: A length of channel with uniform characteristics.

Receiving Waters: Bodies of water or surface water systems receiving water from upstream manmade (or natural) streams.

Recharge: The flow to ground water from the infiltration of surface and stormwater runoff.

Recharge Rate: Annual amount of rainfall that contributes to groundwater as a function of hydrologic soil group.

Recharge Volume: The portion of the water quality volume (V_{WQ}) used to maintain groundwater recharge rates at development sites (V_R).

Redevelopment: Any construction, alteration or improvement exceeding five thousand square feet of land disturbance performed on sites where existing land use is commercial, industrial, institutional or multifamily residential.

Regional: An action (here, for stormwater management purposes) that involves more than one discrete property.

Regional Detention Facility: A stormwater quantity control structure designed to correct existing excess surface water runoff problems of a basin or subbasin. The area downstream has been previously identified as having existing or predicted significant and regional flooding and/or erosion problems. This term is also used when a detention facility is used to detain stormwater runoff from a number of different businesses, developments or areas within a catchment.

Release Rate: The computed peak rate of surface and stormwater runoff for a particular design storm event and drainage area conditions.

Restoration: Actions performed to reestablish wetland functional characteristics and processes that have been lost by alterations, activities or catastrophic events in an area that no longer meets the definition of a wetland.

Retention: The process of collecting and holding surface and stormwater runoff with no surface outflow. The amount of precipitation on a drainage area that does not escape as runoff. It is the difference between total precipitation and total runoff.

Retention/Detention Facility (R/D): A type of drainage facility designed either to hold water for a considerable length of time and then release it by evaporation, plant transpiration and/or infiltration into the ground; or to hold surface and stormwater runoff for a short period of time and then release it to the surface and SWM system.

Retrofitting: The renovation of an existing structure or facility to meet changed conditions or to improve performance.

Return Interval: A statistical term for the average time of expected interval that an event of some kind will equal or exceed given conditions (e.g., a stormwater flow that occurs every 2 years).

Reverse-Slope Pipe: A pipe that draws from below a permanent pool extending in a reverse angle up to the riser and determines the water elevation of the permanent pool.

Right-of-Way: Right of passage, as over another's property. A route that is lawful to use. A strip of land acquired for transport, conveyance or utility construction.

Rill: A small intermittent watercourse with steep sides, usually only a few inches deep. Often rills are caused by an increase in surface water flow when soil is cleared of vegetation.

Riprap: A facing layer or protective mound of stones placed to prevent erosion or sloughing of a structure or embankment due to flow of surface and stormwater runoff.

Riparian: Pertaining to the banks of streams, wetlands, lakes or tidewater.

Riser: A vertical pipe extending from the bottom of a pond BMP that is used to control the discharge rate from a BMP for a specified design storm.

Roughness Coefficient (Hydraulics): A factor in velocity and discharge formulas representing the effect of channel roughness on energy losses in flowing water. Manning's "n" is a commonly used roughness coefficient.

Runoff: That portion of the precipitation on a drainage area that is discharged from the area in the stream channels. Types include surface runoff, groundwater runoff or seepage.

Safety Bench: A relatively flat area above the permanent pool and surrounding a stormwater pond that is designed to provide a separation to adjacent slopes.

Sanitary Sewer: A pipe or conduit (sewer) intended to carry wastewater or water-borne wastes from homes, businesses and industries to the POTW.

Sanitary Sewer Overflows (SSO): Untreated or partially treated sewage overflows from a sanitary sewer collection system.

SBUH: Santa Barbara Urban Hydrograph Method. An event-based hydrographic method of analysis used to determine stormwater runoff from a site.

SCS: Soil Conservation Service, U.S. Department of Agriculture.

Sediment: Fragmented material that originates from weathering and erosion of rocks or unconsolidated deposits, and is transported by, suspended in or deposited by water.

Sedimentation: The depositing or formation of sediment.

Seepage: 1. Water escaping through or emerging from the ground. 2. The process by which water percolates through soil.

Seepage Length: In sediment basins or ponds, the length along the pipe and around the anti-seep collars that is within the zone of saturation through an embankment.

Setbacks: The minimum distance requirements for locating certain structures in relation to roads, wells, septic fields or other structures.

Settleable Solids: Those suspended solids in stormwater that separate by settling when the stormwater is held in a quiescent condition for a specified time.

Sheetflow: Runoff that flows over the ground surface as a thin, even layer, not concentrated in a channel.

Short Circuiting: The passage of runoff through a BMP in less than the design treatment time.

Siltation: The process by which a river, lake or other water body becomes clogged with sediment. Silt can clog gravel beds and prevent successful salmon spawning.

Soil Group: A classification of soils by the Soil Conservation Service into four runoff potential groups. The groups range from A soils, which are very permeable and produce little or no runoff, to D soils, which are not very permeable and produce much more runoff.

Soil Permeability: The ease with which gases, liquids or plant roots penetrate or pass through a layer of soil.

Soil Stabilization: The use of measures such as rock lining, vegetation or other engineering structures to prevent the movement of soil when loads are applied to the soil.

Source Control BMP: A BMP that is intended to prevent pollutants from entering stormwater. A few examples of source control BMPs are erosion control practices, maintenance of stormwater facilities, constructing roofs over storage and working areas, and directing wash water and similar discharges to the sanitary sewer or a dead end sump.

Spillway: A passage such as a paved apron or channel for surplus water over or around a dam or similar obstruction. An open or closed channel, or both, used to convey excess water from a reservoir. It may contain gates, either manually or automatically controlled, to regulate the discharge of excess water.

Stabilization: Providing vegetative and/or structural measures that will reduce or prevent erosion.

Stage (Hydraulics): The variable water surface or the water surface elevation above any chosen datum.

Steep Slope: Slopes of 25% gradient or steeper.

Stilling Basin: An open structure or excavation at the foot of an outfall, conduit, chute, drop or spillway to reduce the energy of the descending stream of water.

STORET: EPA's computerized STorage and RETrieval water quality data base that includes physical, chemical and biological data measured in waterbodies throughout the United States.

Storm Water: Storm water runoff, snow melt runoff and surface runoff and drainage [40 CFR 122.26(b)(13)].

Storm Frequency: The time interval between major storms of predetermined intensity and volumes of runoff for which storm sewers and other structures are designed and constructed to handle hydraulically without surcharging and backflooding, e.g., a 2-yr, 10-yr or 100-yr storm.

Stormwater: That portion of precipitation that does not naturally percolate into the ground or evaporate, but flows via overland flow, interflow, channels or pipes into a defined surface water channel or a constructed infiltration facility.

Stormwater Drainage System: Constructed and natural features that function together as a system to collect, convey, channel, hold, inhibit, retain, detain, infiltrate, divert, treat and/or filter stormwater.

Stormwater Facility: A constructed component of a stormwater drainage system designed or constructed to perform a particular or multiple functions. Stormwater facilities include, but are not limited to, pipes, swales, ditches, culverts, street gutters, detention basins, retention basins, constructed wetlands, infiltration devices, catchbasins, oil/water separators, sediment basins and modular pavement.

Stormwater Filtering: Stormwater treatment methods that utilize an artificial media to filter out pollutants entrained in urban runoff.

Stormwater Ponds: A land depression or impoundment created for detaining or retaining stormwater runoff.

Stormwater Quality: A term used to describe the chemical, physical and biological characteristics of stormwater.

Stormwater Quantity: A term used to describe the volume characteristics of stormwater.

Stormwater Site Plan: A plan that shows the measures that will be taken during and after project construction to provide erosion and sediment control and stormwater control.

Stormwater Wetlands: Shallow, constructed pools that capture stormwater and allow for the growth of characteristic wetland vegetation.

Stream Buffers: Zones of variable width that are located along both sides of a stream and are designed to provide a protective natural area along a stream corridor.

Stream Gaging: The quantitative determination of stream flow using gages, current meters, weirs or other measuring instruments at selected locations. See gaging station.

Streams: Those areas where surface waters flow sufficiently to produce a defined channel or bed. A defined channel or bed is indicated by hydraulically sorted sediments or the removal of vegetative litter or loosely rooted vegetation by the action of moving water. The channel or bed need not contain water year-round.

Structural BMPs: Devices constructed to provide temporary storage and treatment of stormwater runoff.

Subbasin: A drainage area that drains to a water course or waterbody and that is named and noted on common maps and contained within a basin.

Subgrade: A layer of stone or soil used as the underlying base for a BMP.

Suspended Solids: Organic or inorganic particles that are suspended in and carried by the water. The term includes sand, mud and clay particles (and associated pollutants) in stormwater.

Swale: A shallow drainage conveyance with relatively gentle side slopes and flow depths generally less than one foot.

Tailwater: Water, in a river or channel, immediately downstream from a structure.

Technical Release No. 20 (TR-20): A Soil Conservation Service (now NRCS) watershed hydrology computer model that is used to compute runoff volumes and provide routing of storm events through stream valleys and/or ponds.

Technical Release No. 55 (TR-55): A watershed hydrology model developed by the Soil Conservation Service (now NRCS) used to calculate runoff volumes and provide a simplified routing for storm events through stream valleys and/or ponds.

Ten-Year Storm: The 24 hr storm event that exceeds bankfull capacity and occurs on average once every ten years (or has a likelihood of occurrence of 1/10 in a given year) (abbreviated as 10-yr storm).

TESC: Temporary Erosion and Sediment Control (Plan).

Time of Concentration: The time period necessary for surface runoff to reach the outlet of a subbasin from the most remote point hydraulically in the tributary drainage area.

Toe of Slope: A point or line of slope in an excavation or cut where the lower surface changes to horizontal or meets the existing ground slope; or a point or line on the upper surface of a slope where it changes to horizontal or meets the original surface.

Toe Wall: Downstream wall of a structure, usually built to prevent flowing water from eroding under the structure.

Topography: General term to include characteristics of the ground surface such as plains, hills or mountains, and degree of relief, steepness of slopes and other physiographic features.

Topsoil: Fertile or desirable soil material used for the preparation of a seedbed.

Total Maximum Daily Load (TMDL): The amount of pollutant, or property of a pollutant, from point source, NPS and natural background, that may be discharged to a water quality-limited receiving water. Any pollutant loading above the TMDL results in violation of applicable WQS.

Total Phosphorus (TP): The total amount of phosphorus that is contained within the water column.

Total Solids: The solids in water, sewage or other liquids, including the dissolved, filterable and nonfilterable solids. The residue left when the moisture is evaporated and the remainder is dried at a specified temperature, usually 130°C.

Total Suspended Solids (TSS): A measure of the filterable solids present in a sample, as determined by the method specified in 40 CFR Part 136.

Toxic Pollutant: Pollutants or combinations of pollutants, including disease-causing agents that after discharge and upon exposure, ingestion, inhalation or assimilation into any organism, either directly from the environment or indirectly by ingestion through food chains, will, on the basis of information available to the Administrator of EPA, cause death, disease, behavioral abnormalities, cancer, genetic mutations, physiological malfunctions, (including malfunctions in reproduction) or physical deformations, in such organisms or their offspring. Toxic pollutants also include those pollutants listed by the Administrator under CWA Section 307(a)(1) or any pollutant listed under Section 405(d), which relates to sludge management.

Trash Rack: A grill, grate or other device installed at the intake of a channel, pipe, drain or spillway for the purpose of preventing oversized debris from entering the structure.

Travel Time: The estimated time for surface water to flow between two points of interest.

Truncated Hydrograph: A method of computing the required design infiltration storage volume utilizing the differences from post-developed and pre-developed hydrograph volumes over a specific time frame.

Two-Year Storm: The 24 hr storm event that exceeds bankfull capacity and occurs on average once every two years (or has a likelihood of occurrence of 1/2 in a given year) (abbreviated as 2-yr storm).

Underdrain: Plastic pipes with holes drilled through the top, installed on the bottom of an infiltration BMP that are used to collect and remove excess runoff.

Unstable Slopes: Those sloping areas of land that have in the past exhibited, are currently exhibiting or will likely in the future exhibit mass movement of earth.

Urbanized Area: Areas designated and identified by the U.S. Bureau of Census according to the following criteria: an incorporated place and densely settled surrounding area that together have a maximum population of 50,000.

Ultimate Condition: Full watershed build-out based on existing zoning.

Ultra-Urban: Densely developed urban areas in which little pervious surface exists.

Vector Waste: The waste material found in the bottom of a catch basin.

Values: Processes or attributes that are valuable or beneficial to society (also see Functions). For example, wetland values include support of commercial and sport fish and wildlife species, protection of life and property from flooding, recreation, education, and aesthetic enhancement of human communities.

Vegetative Filter Strip: A facility designed to provide stormwater quality treatment of conventional pollutants, but not nutrients, through the process of biofiltration.

Velocity Head: Head due to the velocity of a moving fluid, equal to the square of the mean velocity divided by twice the acceleration due to gravity (32.16 feet per second per second)[$v^2/2g$].

Volumetric Runoff Coefficient (Rv): The value applied to a given rainfall volume to yield a corresponding runoff volume based on the percent impervious cover in a drainage basin.

Water Quality BMP: A BMP specifically designed for pollutant removal.

Water Quality Criteria: Comprised of numeric and narrative criteria. Numeric criteria are scientifically derived ambient concentrations developed by EPA or states for various pollutants of concern to protect human health and aquatic life. Narrative criteria are statements that describe the desired water quality goal.

Water Quality Standard (WQS): A law or regulation that consists of the beneficial use or uses of a waterbody, the numeric and narrative water quality criteria that are necessary to protect the use or uses of that particular waterbody, and an antidegradation statement.

Water Quality Volume (V_{WQ}): The volume needed to capture and treat 90% of the average annual stormwater runoff volume equal to 1" (or 0.9" in Western Rainfall Zone) times the volumetric runoff coefficient (Rv) times the site area.

Water Quantity BMP: A BMP specifically designed to reduce the peak rate of stormwater runoff.

Water Surface Profile: The longitudinal profile assumed by the surface of a stream flowing in an open channel; the hydraulic grade line.

Wedges: Design feature in stormwater wetlands that increases flow path length to provide for extended detention and treatment of runoff.

Wetlands: Those areas that are inundated or saturated by surface or ground water at a frequency and duration sufficient to support, and that under normal circumstances do support, a prevalence of vegetation typically adapted for life in saturated soil conditions. Wetlands generally include swamps, marshes, fens, bogs and similar areas. This includes wetlands created, restored or enhanced as part of a mitigation procedure. This does not include constructed wetlands or the following surface waters of the state intentionally constructed from sites that are not wetlands: irrigation and drainage ditches, grass-lined swales, canals, agricultural detention facilities, farm ponds, and landscape amenities.

Wet Pond: A facility that treats stormwater for water quality by utilizing a permanent pool of water to remove conventional pollutants from runoff through sedimentation, biological uptake and plant filtration.

Wet Swale: An open drainage channel or depression, explicitly designed to retain water or intercept groundwater for water quality treatment.

Wetted Perimeter: The length of the wetted surface of the channel.

Wet Vaults/Tanks: Underground storage facilities that treat stormwater for water quality through the use of a permanent pool of water that acts as a settling basin.