

Prepared in cooperation with the  
New Hampshire Department of Environmental Services

# Methods for and Estimates of 2003 and Projected Water Use in the Seacoast Region, Southeastern New Hampshire

Scientific Investigations Report 2007–5157

U.S. Department of the Interior  
U.S. Geological Survey

**Cover.** Photograph shows sunrise over the Atlantic Ocean taken from the Seacoast Region, southeastern New Hampshire.  
(Photograph by Werner Horn, Photographer)

# **Methods for and Estimates of 2003 and Projected Water Use in the Seacoast Region, Southeastern New Hampshire**

By Marilee A. Horn, Richard B. Moore, Laura Hayes, and Sarah M. Flanagan

Prepared in cooperation with the  
New Hampshire Department of Environmental Services

Scientific Investigations Report 2007–5157

**U.S. Department of the Interior**  
**U.S. Geological Survey**

**U.S. Department of the Interior**  
DIRK KEMPTHORNE, Secretary

**U.S. Geological Survey**  
Mark D. Myers, Director

U.S. Geological Survey, Reston, Virginia: 2008

For product and ordering information:

World Wide Web: <http://www.usgs.gov/pubprod>

Telephone: 1-888-ASK-USGS

For more information on the USGS—the Federal source for science about the Earth, its natural and living resources, natural hazards, and the environment:

World Wide Web: <http://www.usgs.gov>

Telephone: 1-888-ASK-USGS

Any use of trade, product, or firm names is for descriptive purposes only and does not imply endorsement by the U.S. Government.

Although this report is in the public domain, permission must be secured from the individual copyright owners to reproduce any copyrighted materials contained within this report.

Suggested citation:

Horn, M.A., Moore, R.B., Hayes, Laura, and Flanagan, S.M., 2008, Methods for and estimates of 2003 and projected water use in the Seacoast region, southeastern New Hampshire: U.S. Geological Survey Scientific Investigations Report 2007–5157, 87 p., plus 2 appendixes on CD ROM.



## Acknowledgments

The authors thank the members of this project's technical advisory committee, composed of town water officials, engineering consultants, conservation group members, state environmental officials, and academics, who met regularly and provided assistance to this project. Matthew Civale of Aquarion Water Company, Thomas Fargo and Jeffrey Harrington of Dover Water Department, Gail Cunningham of Portsmouth Water Department, and Dennis McCarthy of Raymond Water Department, provided meter data for domestic and non-domestic users for the year 2003. Special appreciation is expressed to Debra Foster, U.S. Geological Survey, and Nicole Clegg, New Hampshire Department of Environmental Services, for their efforts to coordinate the domestic water-demand survey in the middle schools; the science teachers for the schools who participated in the survey; and to Schuyler Merritz and Lindsay Anderson, for their efforts to compile the results. Special thanks also are extended to Theodore Diers, New Hampshire Department of Environmental Services, in his role of coordinating the 44 towns and 3 State agencies; Frederick Chormann, New Hampshire Geological Survey, for providing information on the Water Use Registration and Reporting program; and to Thomas Falk, Rockingham Regional Planning Commission, for assistance with the Seacoast Regional Transportation Demand Model. Finally, the authors would like to thank Barbara Korzendorfer for her assistance in reorganizing this report.



# Contents

Abstract.....	1
Introduction.....	1
Purpose and Scope .....	3
Water-Use Concepts .....	3
Description of Study Area .....	4
Methods Used to Compile and Analyze Water-Use Data .....	8
Water-Use Framework.....	8
Development of Coefficients for Estimating 2003 Water Demand and Consumptive Use.....	10
Domestic Water Demand and Consumptive Use .....	10
Domestic Water-Demand Survey.....	13
Per Capita Water-Demand Model.....	13
Model Development .....	14
Model Results.....	15
Model Assumptions and Limitations .....	18
Non-Domestic Water Demand and Consumptive Use .....	22
Commercial Water Demand and Consumptive Use.....	22
Industrial Water Demand and Consumptive Use .....	22
Projecting Future Water Demand .....	27
Domestic Water Demand .....	27
Non-Domestic Water Demand .....	27
Water-Use Databases.....	28
Estimates of 2003 Water Use and Projected Water Demand .....	28
Towns, 2003.....	30
Domestic Water Use .....	30
Commercial Use.....	32
Industrial Water Use .....	37
Other Non-Domestic Water Use .....	37
Community Water Systems .....	38
Community Wastewater Systems .....	42
Subbasins.....	43
Bellamy River–Great Bay .....	43
Coastal Drainages .....	43
Cocheco River .....	48
Exeter River.....	48
Lamprey River.....	48
Oyster River–Great Bay .....	48
Salmon Falls River.....	48
Summary of Water-Use Framework for the Seacoast Region, 2003 .....	52
Towns, Projected to 2017 and 2025 .....	56
Domestic Water Demand .....	56
Non-Domestic Water Demand .....	56
Summary.....	63
References Cited.....	65

Glossary.....	69
Appendix 1. Domestic Water Demand Survey.....	73
Appendix 1A. Residential Water-Use Survey Form.....	77
Appendix 1B. Student Data-Collection Activities Form.....	83
Appendix 2. Water-Use Summaries by Town in the Seacoast Region .....	[on CD ROM]
Appendix 3. Water-Use Summaries by Subbasin in the Seacoast Region .....	[on CD ROM]

## Figures

1. Map showing location of the Seacoast region in southeastern New Hampshire .....	2
2. Diagram showing relations among water-use activities .....	5
3. Flow chart showing general approach for building the water-use framework in the Seacoast region, New Hampshire, by identifying who is using the water, assigning these users to census blocks, and determining the source of water and destination of wastewater .....	9
4. Maps showing location of (A) community water-distribution systems, and (B) community wastewater-collection systems in the Seacoast region, New Hampshire .....	11
5. Flow chart showing general approach for developing estimates for domestic, commercial, and industrial water demand.....	12
6. Graph showing relation of housing units on public supply or self supply to ranges in domestic per capita water demand .....	14
7. Diagram showing table structure of the Seacoast Census Water-Use Database.....	30
8. (A) Boxplot showing distribution of town mean annual domestic per capita water-demand coefficients in the Seacoast region, and (B) map showing town mean annual domestic per capita water-demand coefficients from the per capita water-demand model.....	33
9. Maps showing domestic water-demand and population data by town for (A) population, (B) total water demand, (C) self-supplied population, and (D) self-supplied water demand.....	34
10. Flow chart showing water-use framework in 2003 in the Seacoast region, New Hampshire .....	55
11. Pie charts showing water withdrawal and water demand (excluding non-consumptive use) in 2003 in the Seacoast region, New Hampshire.....	56
12–16. Maps showing—	
12. Water use by town (A) withdrawal, (B) demand, (C) return flow, (D) consumptive use, and (E) withdrawal minus return flow in 2003 in the Seacoast region, New Hampshire .....	57
13. Water use by subbasin (A) withdrawal, (B) demand, (C) return flow, (D) consumptive use, and (E) withdrawal minus return flow in 2003 in the Seacoast region, New Hampshire .....	58
14. Example map of town water demand by grouped water-use categories by census block in Epping, New Hampshire .....	59
15. Projected domestic water demand by Transportation Area Zone for (A) domestic water demand in 2003, (B) domestic water demand projected to the year 2017, and (C) domestic water demand projected to the year 2025 .....	61
16. Projected non-domestic water demand by Transportation Area Zone for (A) non-domestic water demand in 2003, (B) non-domestic water demand projected to the year 2017, and (C) non-domestic water demand projected to the year 2025 .....	62

## Tables

1.	Water-use activities analyzed in the Seacoast region, New Hampshire.....	4
2.	Population statistics for the 44 towns in the Seacoast region, New Hampshire .....	6
3.	Summary of data on metered deliveries to domestic users for selected community water systems and towns used to predict domestic per capita water-demand coefficients in the Seacoast region, New Hampshire, 2003.....	15
4.	Census block-group variables with number of housing units in subcategories defined by numerical ranges that were evaluated for possible inclusion in per capita water-demand model in the Seacoast region, New Hampshire .....	16
5.	Census block-group variables with number of housing units in descriptive subcategories evaluated for possible inclusion in per capita water-demand model in the Seacoast region, New Hampshire .....	17
6.	Census block variables evaluated for possible inclusion in per capita water-demand model in the Seacoast region, New Hampshire .....	18
7–9.	Regression coefficients, variable ranges and medians, standard errors, <i>t</i> -statistics, and <i>p</i> -values for the per capita water-demand model to predict coefficients per census block, 2003, Seacoast region, New Hampshire	
7.	Annual coefficients .....	19
8.	Summer coefficients.....	20
9.	Winter coefficients.....	21
10.	Summary of data on metered deliveries to commercial, industrial, irrigation, and mining users for selected community water systems and towns and data reported by businesses to NHDES by town used in developing water-demand coefficients in the Seacoast region, New Hampshire, 2003 .....	23
11.	Estimated commercial water demand by groups, 2003, in the Seacoast region, New Hampshire .....	24
12.	Coefficients for estimating industrial water demand from two-digit Standard Industrial Classification categories and number of employees .....	26
13.	Methods used to project non-domestic water demand for the years 2017 and 2025 in the Seacoast region, New Hampshire .....	29
14.	Town mean annual domestic per capita water-demand coefficients, estimated domestic demand, and domestic withdrawals in 2003 by town in the Seacoast region, New Hampshire .....	31
15.	Town mean annual, summer, and winter domestic per capita water-demand coefficients and consumptive use in 2003 by town in the Seacoast region, New Hampshire .....	35
16.	Town mean annual domestic per capita consumptive-use coefficient, estimated domestic water demand, return and sewer flow, and consumptive use in 2003 by town in the Seacoast region, New Hampshire .....	36
17.	Commercial water demand and number of facilities by group, 2003, in the Seacoast region, New Hampshire .....	37
18.	Industrial water demand and number of facilities by group, 2003, in the Seacoast region, New Hampshire .....	38
19.	Summary of water demand, withdrawal, return flow by hydroelectric, thermoelectric, irrigation, mining, and aquaculture users in 2003 by town in the Seacoast region, New Hampshire .....	39
20.	Multi-use community water system sources of supply, population served, distribution, and unaccounted-for water in 2003 in the Seacoast region, New Hampshire .....	40

21.	Summary of water demand, withdrawal, return flow by domestic, commercial, industrial, irrigation, and other users, community water systems, and community wastewater systems in 2003 by town in the Seacoast region, New Hampshire .....	44
22.	Summary of water demand, withdrawal, return flow, consumptive use, imports, and exports in 2003 by town in the Seacoast region, New Hampshire .....	46
23.	Community wastewater system population served, wastewater collection, return flow, and inflow and infiltration in 2003 in the Seacoast region, New Hampshire .....	49
24.	Summary of water demand, withdrawal, return flow by domestic, commercial, industrial, irrigation, and other users, community water systems, and community wastewater systems in 2003 by subbasin in the Seacoast region, New Hampshire .....	50
25.	Summary of water demand, withdrawal, return flow, consumptive use, imports, and exports in 2003 by subbasin in the Seacoast region, New Hampshire .....	51
26.	Projected domestic water demand for 2017 and 2025 by town in the Seacoast region, New Hampshire .....	60

## Conversion Factors and Datum

Multiply	By	To obtain
Length		
inch (in.)	2.54	centimeter (cm)
inch (in.)	25.4	millimeter (mm)
mile (mi)	1.609	kilometer (km)
Area		
square mile (mi <sup>2</sup> )	2.590	square kilometer (km <sup>2</sup> )
Volume		
gallon (gal)	3.785	liter (L)
gallon (gal)	0.003785	cubic meter (m <sup>3</sup> )
million gallons (Mgal)	3,785	cubic meter (m <sup>3</sup> )
Flow rate		
gallon per minute (gal/min)	0.06309	liter per second (L/s)
gallon per day (gal/d)	0.003785	cubic meter per day (m <sup>3</sup> /d)
gallon per day per square mile [(gal/d)/mi <sup>2</sup> ]	0.001461	cubic meter per day per square kilometer [(m <sup>3</sup> /d)/km <sup>2</sup> ]
million gallons per day (Mgal/d)	0.04381	cubic meter per second (m <sup>3</sup> /s)

Horizontal coordinate information is referenced to the North American Datum of 1983 (NAD 83).



# Methods for and Estimates of 2003 and Projected Water Use in the Seacoast Region, Southeastern New Hampshire

By Marilee A. Horn, Richard B. Moore, Laura Hayes, and Sarah M. Flanagan

## Abstract

New methods were developed to estimate water use in 2003 and future water demand in 2017 and 2025 in the Seacoast region in southeastern New Hampshire, which has experienced a 37-percent population increase during 1980 to 2000. Water-use activities for which estimates were developed include water withdrawal, delivery, demand, consumptive use, release, return flow, and transfer by registered and aggregated unregistered (less than 20,000 gallons per day (gal/d)) users at the census-block and town scales.

Estimates of water use rely on understanding what influences water demand and its associated consumptive use, because changes in demand and consumptive use affect withdrawal and return flow. Domestic water demand was estimated using a per capita water-demand model that related metered deliveries to domestic users with census block and block-group data. The model was used to predict annual, summer, and winter per capita water-demand coefficients for each census block. Significant predictors of domestic water demand include population per housing unit, median value of owner-occupied single family homes, median year of housing construction (with 1900 as the base value), population density, housing unit density, and proportion of housing units that are in urban areas. Mean annual domestic per capita water-demand coefficient in the Seacoast region was 75 gal/d; the coefficient increased to 92 gal/d during the summer and decreased to 63 gal/d during the winter. Domestic consumptive use was estimated as the difference between annual and winter domestic water demand. Estimates of commercial and industrial water demand were based on coefficients derived from reported use and metered deliveries. Projections of water demand in 2017 and 2025 were determined by using the housing and employee projections for those years developed through a Travel Demand Model and applying current domestic and non-domestic coefficients.

Water demand in 2003 was estimated as 26.3 million gallons per day (Mgal/d), 35 percent of which was during the summer months of June, July, and August. Domestic water demand was 19.0 Mgal/d (72 percent), commercial water demand was 3.7 Mgal/d (14 percent), industrial water demand was 2.9 Mgal/d (11 percent), irrigation water demand was

0.4 Mgal/d (1 percent), and thermoelectric, mining, and aquaculture water demand was 0.3 Mgal/d (1 percent). Domestic consumptive use for the Seacoast region was 16 percent of domestic water demand, which translates to a loss of 3 Mgal/d over the entire Seacoast region.

In 2003, water withdrawal was 771.3 Mgal/d, of which 742.2 Mgal/d was instream use for hydroelectric power generation and thermoelectric power cooling. The remaining 29.1 Mgal/d was withdrawn by community water systems (20.3 Mgal/d; 70 percent), domestic users (6.5 Mgal/d; 22 percent), commercial users (1.0 Mgal/d; 3 percent), industrial users (1.0 Mgal/d; 3 percent), irrigation (0.2 Mgal/d; 1 percent) and other users (less than 0.1 Mgal/d).

Return flow for 2003 was 774.0 Mgal/d, of which 742.2 Mgal/d was returned following use for hydroelectric power generation and thermoelectric plant cooling. The remaining 31.8 Mgal/d was returned by community wastewater systems (21.0 Mgal/d; 66 percent), domestic users (8.0 Mgal/d; 25 percent), commercial users (1.2 Mgal/d; 4 percent), industrial users (0.8 Mgal/d; 3 percent), and other users (0.1 Mgal/d).

Domestic water demand is projected to increase by 54 percent to 28.7 Mgal/d from 2003 to 2025 based on projection of future population growth. Non-domestic (commercial, industrial, irrigation, and mining) water demand is projected to increase by 62 percent to 11.8 Mgal/d from 2003 to 2025.

## Introduction

The Seacoast region encompasses 44 towns within 7 major subbasins in southeastern New Hampshire (fig. 1). Its proximity to metropolitan Boston has led to a 37-percent population increase from 1980 to 2000 (New Hampshire Office of Energy and Planning, 2001). This population increase, and associated urban development, has been accompanied by an estimated 50-percent increase in the use of ground- and surface-water resources for domestic, industrial, commercial, irrigation, and other purposes. Continued population and urban growth in the future will result in greater dependence on the available ground- and surface-water resources of the region. Determining the sustainability of and effectively managing

2 Methods for and Estimates of 2003 and Projected Water Use in the Seacoast Region, Southeastern New Hampshire

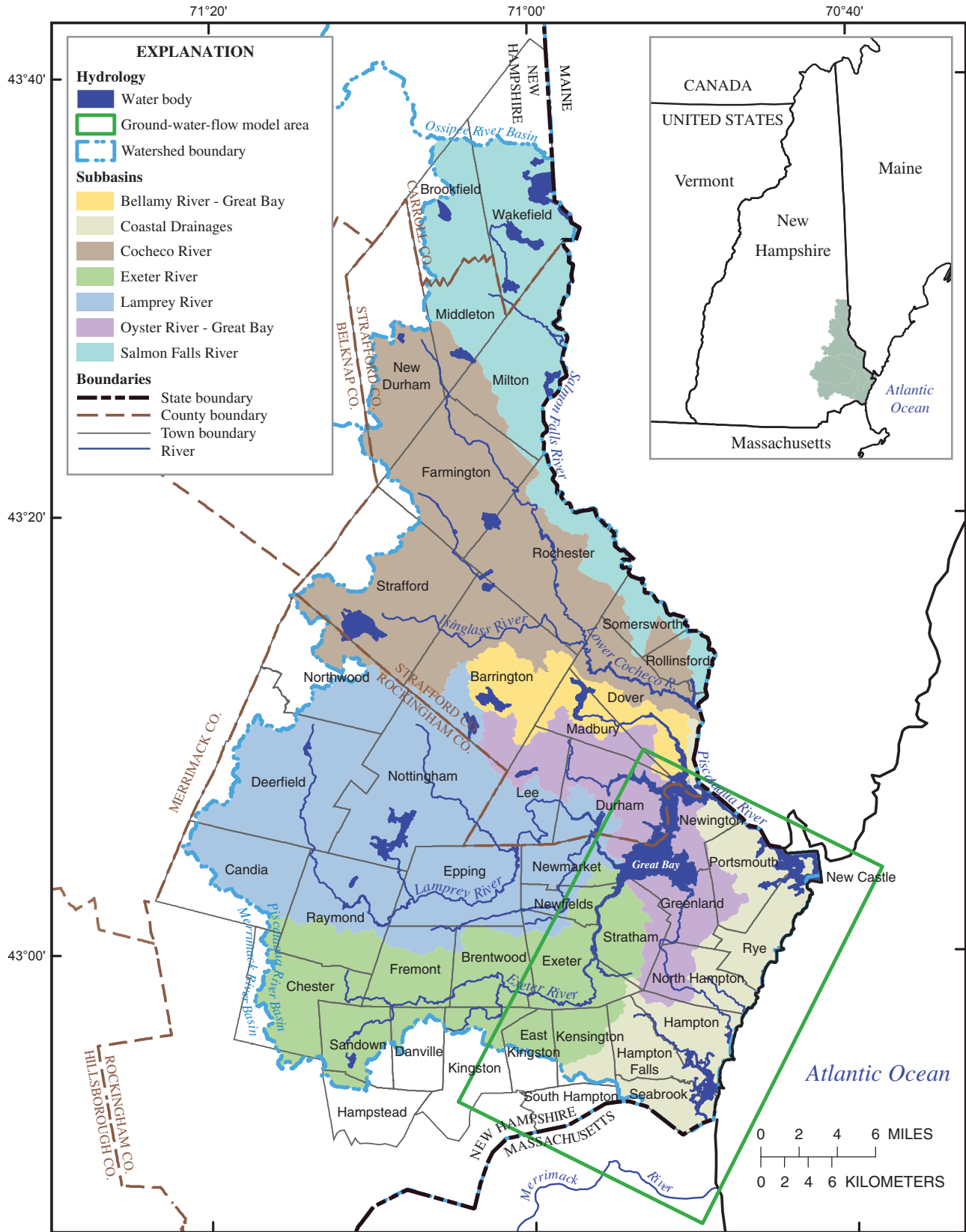

Watershed and subbasin boundaries from Natural Resource Conservation Service Watershed Boundary Dataset (WBD), 2001, 1:24,000-scale. Hydrography digitized from photoreduced 1:62,500-scale USGS quadrangles, 1985, 1:125,000-scale.

Figure 1. Location of the Seacoast region in southeastern New Hampshire.

these water resources requires a thorough understanding of the available resources, how much water is currently used, and how much water is projected to be needed in the future.

Sustainability of water resources requires that water use be balanced with available water resources. Water-use activities are defined in this report as human activities that use and transfer ground and surface water. In 1987, New Hampshire State statute RSA 482:3 established a water-use registration and reporting program, now administered by the New Hampshire Geological Survey (NHGS), under the New Hampshire Department of Environmental Services (NHDES; New Hampshire Geological Survey, 2000) in accordance with RSA 488 to gather data on the largest water users in the state. This information is used to assess demands on the state's aquifers, lakes, reservoirs, rivers, and streams. All facilities that use more than 20,000 gallons per day (gal/d) averaged over any 7-day period, or 600,000 gallons (gal) in any 30-day period, must register and report their monthly water use (withdrawal, delivery, release to sewers, and return flow), by each source and destination. Data on the registrants and their reported water use are stored in the state water-use database (WATUSE). In 2003, about 100 active registered water users were in the Seacoast region. At that time, 17 of the 44 towns in the Seacoast region had no registered water users; hence, little was known about water use in those towns. Even in towns with registered water users, only limited information was available on consumptive use, unaccounted-for use, inflow and infiltration, and transfer between watersheds and towns. In addition, there were no geographical (town or watershed) summaries of total withdrawal from and return flow to ground or surface water in the Seacoast region. Comprehensive assessments of water use in the Seacoast region of New Hampshire were needed for water-sustainability studies.

To address these concerns, the U.S. Geological Survey (USGS), in cooperation with the New Hampshire Coastal Program, now also part of the NHDES, the NHGS, and 44 towns in the Seacoast region, conducted a study to assess the availability of water in the ground- and surface-water resources and the current and future water use for the Seacoast region. The study consisted of several tasks conducted in a coordinated manner: the NHGS compiled data on wells and aquifers and estimated areas in the Seacoast region that are considered high-recharge zones; the USGS developed a surface-water monitoring program that consisted of a network of streamflow gages (online access at <http://nh.water.usgs.gov/projects/seacoast/monitor.htm>). The USGS also developed a ground-water-flow model in a 200-square mile (mi<sup>2</sup>) area adjacent to the Atlantic Ocean (fig. 1; Mack, 2003) to (1) evaluate water resources in 2004, (2) forecast effects of projected water demands in the future on streamflow and ground-water availability, and (3) evaluate alternative management practices in the Seacoast region that might mitigate stresses on the region's ground-water system. The fifth component of the Seacoast study was to study current water use and projected water demand.

## Purpose and Scope

This report describes methods used to estimate water-use in 2003 and project water demand in 2017 (approximately 10 years in the future) and in 2025 (approximately 20 years in the future) for the Seacoast region of southeastern New Hampshire. Water-use activities include water withdrawal, delivery, demand, consumptive use, release, return flow, and transfer (for an explanation of these water-use terms, see section entitled "Water-Use Concepts"). The water-use activities that were analyzed during this study are listed in table 1. Data were compiled by registered and aggregated unregistered (less than 20,000 gal/d) users at the census-block scale, by town. Estimates of water-use in 2003 and future water demand by category and type of water-use activity are summarized for the region, by town. Estimates of water use in 2003 also are summarized by subbasin. In addition, this report includes in appendix 1 the survey and data-collection forms used by middle school students to collect information on their own household domestic water demand as part of an analysis to determine if there is a difference in water demand between households that are served by community water systems and those that have private wells.

## Water-Use Concepts

Water-use activities begin when water is diverted or withdrawn from surface- or ground-water sources and conveyed to a place of use (fig. 2). A withdrawal is made by an individual user or by a community water system (CWS), which may treat the water and convey or deliver it to users through a distribution system. A CWS is defined as a public water system that delivers water for human consumption through pipes and other constructed conveyances if such a system regularly serves at least 25 year-round residents or has at least 15 service connections used by year-round residents. Community water systems (CWSs) might serve towns, cities, military bases, apartment complexes, or mobile home parks (U.S. Environmental Protection Agency, 1998). Users, who obtain their water directly from a ground- or surface-water source, and not from a CWS, are self-supplied. In this report, CWSs are divided into two groups: "domestic CWSs" that serve only domestic users in trailer parks, condominiums, and residential developments; and "multi-use CWSs" that serve a mix of domestic, commercial, industrial, and irrigation users.

Water demand by a single user, or aggregate of users (group of users in a specific geographic area), refers to water that is used for a specific purpose, such as for domestic activities in a household (such as drinking or bathing), irrigation, or industrial processing. In this study, nine categories of water use were estimated—domestic, commercial, industrial, irrigation (both golf course and agriculture), hydroelectric, thermoelectric, mining, and aquaculture. Non-domestic water demand in this report refers to all of the eight categories of use, excluding domestic, unless a specific subset is described.

**Table 1.** Water-use activities analyzed in the Seacoast region, New Hampshire.

<b>Community Water Systems</b>
Withdrawal by source and resource
Population served
<b>Domestic</b>
Population on public supply and self supplied; sewers and septic
Per capita coefficient
Withdrawal
Demand (public supply and self supply)
Consumptive use
Release to sewers
Return flow to resource through septic systems
<b>Commercial, Industrial, and Irrigation</b>
Number of facilities
Number of employees
Demand (public supply and self supply)
Withdrawal by resource and delivery from community water systems
Release to sewers and return flow to resource through septic systems
Consumptive use
<b>Community Wastewater Systems</b>
Return flow to resource
Population served
<b>Summary Values</b>
Water imported into area
Water exported from area
Unaccounted-for water (difference between withdrawal and delivery)
Inflow and infiltration (difference between release to sewers and treatment plant return flow)
Consumptive use

Consumptive use refers to water that evaporates or is incorporated into a product during use and, therefore, is removed from the immediate environment. Water in a distribution system can leak back into the hydrologic system, be used in fire fighting, or for infrastructure maintenance such as street cleaning, filter backwash at the treatment plant, or hydrant and system flushing. The combination of leakage, fire fighting, and infrastructure maintenance is called unaccounted-for use.

Wastewater is returned directly to the ground through on-lot systems for sewage disposal or is released or conveyed through sewers by a community wastewater system (CWWS) or an onsite private wastewater system to a treatment facility for treatment and discharge to a stream or the ground. This is collectively called return flow. Wastewater in a collection system can leak back to the hydrologic system, or, more commonly in New England, can be augmented by water from surface runoff or through storm drains (termed “inflow”) or ground water (termed “infiltration”) (Horn, 2002).

Water also can be transferred from one area into another—water leaving an area (political or drainage basin) is termed an “export,” and water entering an area is termed an “import.” A water-use framework is a flow chart of a series of points and pipes that show how water is used and moved throughout the anthropogenic (manmade) water system. The framework describes who uses the water and how it is conveyed from withdrawal to return flow.

### Description of Study Area

The Seacoast region encompasses approximately 830 mi<sup>2</sup> in southeastern New Hampshire and contains all or parts of 44 towns—2 in Carroll County, 29 in Rockingham County, and 13 in Strafford County, and includes surface drainages to the Piscataqua River, Great Bay, and the Atlantic Ocean (fig. 1). The Seacoast region is bordered on the north by the Ossipee River watershed, on the west by the Merrimack

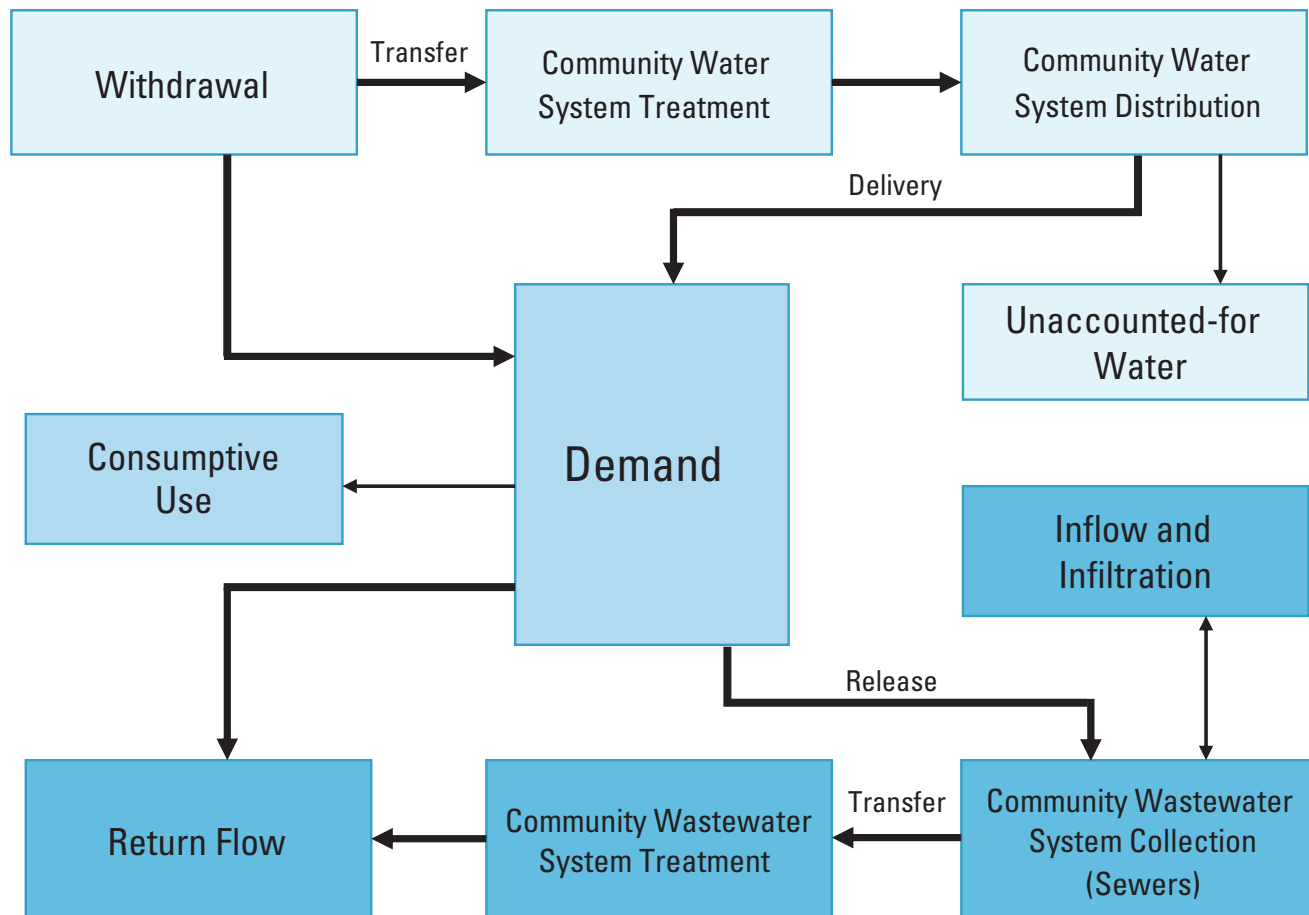

**Figure 2.** Relations among water-use activities.

River watershed, and on the east and south by the borders with Maine and Massachusetts and the Atlantic Ocean. The major surface drainages include the Bellamy, Cochecho, Exeter, Lamprey, Oyster, and Salmon Falls Rivers, and other smaller coastal drainages to the Piscataqua River, Great Bay, and the Atlantic Ocean.

The Seacoast region consists of coastal lowland hills and plains. Precipitation is evenly distributed throughout the year and averages about 42 inches (in.) annually (Flanagan and others, 1999). As of 1998, 67 percent of the Seacoast region was classified as forests and shrub lands, 11 percent as residential lands, 7 percent as water and wetlands, 7 percent as agricultural lands and recreational grasses (including golf courses), 2 percent as urban, industrial, or mixed urban, and 6 percent as roads, transportation, or barren/other lands (Complex Systems Research Center, 2003a and 2003b).

The geology of the Seacoast region consists of fractured, crystalline bedrock that is overlain by glacial materials deposited during the last glaciation, which ended between 12,000

and 5,000 years ago. The bedrock consists of metamorphic rocks composed of metasedimentary sandstones, shales, and calcareous rocks, and volcanic rocks intruded by mafic and felsic igneous rocks (Lyons and others, 1997). Glacial stratified-drift aquifers (consisting of layers of sand, gravel, clay, and silt) cover about 18 percent of the Seacoast region and are generally more productive than bedrock aquifers (Moore, 1990; Mack and Lawlor, 1992; Stekl and Flanagan, 1992; Medalie and Moore, 1995). Bedrock aquifers generally have lower yields than glacial stratified-drift aquifers, but are an important source of water for rural households and other users without access to large CWSs. In the few areas where the bedrock aquifers have unusually high yields, they are an important source of water for CWSs.

The population of the 44 towns that are partially or wholly in the Seacoast region was 275,000 people in 2000—an increase of 37 percent from 1980 population levels (table 2) (T.J. Duffy, New Hampshire Office of Energy and Planning, written commun., 2004). Parts of some towns lie



**Table 2.** Population statistics for the 44 towns in the Seacoast region, New Hampshire.

[Location of towns shown in figure 1. Data from U.S. Bureau of Census (2001a) and New Hampshire Office of Energy and Planning (2001; 2005)]

Town name	County	2000 Census data for each town										1980-2000 Census data		2000-2020 Population projections	
		Population of town	Population in the study area only	Total area, in square miles, of water and land	Persons per square mile in land area	Number of housing units	Number of seasonal housing units	Population per housing unit adjusted for seasonal housing	1980 Population	Change in population from 1980 to 2000, in percent	Projected population in 2020	Change in population from 2000 to 2020, projected, in percent			
Barrington	Strafford	7,475	7,475	48.52	161	3,147	15	2.39	4,404	70	10,050	35			
Brentwood	Rockingham	3,197	3,197	16.98	190	920	1	3.48	2,004	60	4,560	43			
Brookfield	Carroll	603	535	23.26	26	280	3	2.18	385	57	900	49			
Candia	Rockingham	3,911	2,491	30.57	129	1,384	0	2.83	2,989	31	4,830	24			
Chester	Rockingham	3,572	3,196	26.02	146	1,247	0	2.86	2,006	78	5,450	53			
Danville	Rockingham	4,023	574	11.91	344	1,479	2	2.72	1,318	205	5,250	31			
Deerfield	Rockingham	3,477	3,089	52.26	72	1,406	0	2.47	1,979	76	4,960	43			
Dover	Strafford	26,884	26,884	29.05	1,006	11,924	0	2.25	22,377	20	30,860	15			
Durham	Strafford	12,664	12,664	24.76	566	2,923	0	4.33	10,652	19	15,710	24			
East Kingston	Rockingham	1,784	1,458	10.05	179	648	1	2.76	1,135	57	2,360	32			
Epping	Rockingham	5,476	5,476	26.23	210	2,215	48	2.53	3,460	58	6,730	23			
Exeter	Rockingham	14,058	14,058	20.01	716	6,107	1	2.30	11,024	28	16,770	19			
Farmington	Strafford	5,774	5,769	37.48	155	2,337	3	2.47	4,630	25	7,760	34			
Fremont	Rockingham	3,510	3,510	17.41	205	1,201	0	2.92	1,333	163	4,690	34			
Greenland	Rockingham	3,208	3,208	13.29	306	1,244	0	2.58	2,129	51	4,190	31			
Hampstead	Rockingham	8,297	825	14.01	623	3,276	0	2.53	3,785	119	10,400	25			
Hampton	Rockingham	14,937	14,937	14.58	1,146	9,349	2,490	2.18	10,493	42	18,170	22			
Hampton Falls	Rockingham	1,880	1,880	12.52	154	729	0	2.58	1,372	37	2,450	30			
Kensington	Rockingham	1,893	1,841	11.96	158	672	0	2.82	1,322	43	2,490	32			
Kingston	Rockingham	5,862	1,344	20.88	299	2,265	0	2.59	4,111	43	7,260	24			
Lee	Strafford	4,145	4,145	20.16	208	1,534	1	2.70	2,111	96	5,400	30			
Madbury	Strafford	1,509	1,509	12.24	129	543	0	2.78	987	53	2,040	35			
Middleton	Strafford	1,440	1,440	18.51	80	706	177	2.72	734	96	2,070	44			
Milton	Strafford	3,910	3,910	34.28	118	1,815	219	2.45	2,438	60	5,340	37			
New Castle	Rockingham	1,010	1,010	2.38	1,223	488	0	2.07	936	8	1,220	21			



**Table 2.** Population statistics for the 44 towns in the Seacoast region, New Hampshire.—Continued

[Location of towns shown in figure 1. Data from U.S. Bureau of Census and New Hampshire Office of Energy and Planning]

Town name	County	2000 Census data for each town										1980-2000 Census data		2000-2020 Population projections	
		Population of town	Population in the study area only	Total area, in square miles, of water and land	Persons per square mile in land area	Number of housing units	Number of seasonal housing units	Population per housing unit adjusted for seasonal housing	1980 Population	Change in population from 1980 to 2000, in percent	Projected population in 2020	Change in population from 2000 to 2020, projected, in percent			
New Durham	Strafford	2,220	1,147	44.15	53	1,309	96	1.83	1,183	88	3,550	60			
Newfields	Rockingham	1,551	1,551	7.18	221	532	0	2.92	817	90	1,930	24			
Newington	Rockingham	775	775	12.47	93	305	0	2.54	716	8	940	21			
Newmarket	Rockingham	8,027	8,027	14.17	640	3,457	0	2.32	4,290	87	9,990	25			
North Hampton	Rockingham	4,259	4,259	14.4	306	1,782	2	2.39	3,425	24	5,330	25			
Northwood	Rockingham	3,640	1,787	30.05	130	1,905	96	2.01	2,175	67	4,530	25			
Nottingham	Rockingham	3,701	3,701	48.42	80	1,592	172	2.61	1,952	90	5,050	37			
Portsmouth	Rockingham	20,784	20,784	16.97	1,331	10,186	1	2.04	26,254	-21	24,420	18			
Raymond	Rockingham	9,674	9,674	29.57	336	3,710	2	2.61	5,453	77	12,120	25			
Rochester	Strafford	28,461	28,461	45.78	630	11,836	6	2.41	21,560	32	35,590	25			
Rollinsford	Strafford	2,648	2,648	7.54	363	1,060	0	2.50	2,319	14	3,210	21			
Rye	Rockingham	5,182	5,182	35.5	411	2,645	295	2.21	4,508	15	6,080	17			
Sandown	Rockingham	5,143	4,002	14.42	370	1,777	4	2.90	2,057	150	6,790	32			
Seabrook	Rockingham	7,934	7,893	9.62	895	4,066	409	2.17	5,917	34	9,930	25			
Somersworth	Strafford	11,477	11,477	10.01	1,173	4,841	0	2.37	10,350	11	13,050	14			
South Hampton	Rockingham	844	695	8.01	111	308	0	2.74	660	28	1,040	23			
Strafford	Strafford	3,626	3,224	51.42	74	1,564	247	2.75	1,663	118	4,890	35			
Stratham	Rockingham	6,355	6,355	15.48	421	2,371	0	2.68	2,507	154	8,180	29			
Wakefield	Carroll	4,252	2,858	44.65	108	3,331	1,560	2.40	2,237	90	6,130	44			
<b>Total or average</b>		<b>275,052</b>	<b>250,925</b>	<b>1,009</b>	<b>273</b>	<b>118,416</b>	<b>5,851</b>	<b>2.44</b>	<b>200,157</b>	<b>37</b>	<b>344,660</b>	<b>25</b>			

outside the Seacoast regional boundary (fig. 1), so the total population in the Seacoast region in 2000 is estimated to be about 250,000 (table 2). Forty-one of the 44 towns experienced population growth greater than 10 percent from 1980 to 2000; the highest growth rate was 205 percent for the town of Danville in the southern part of the Seacoast region. Portsmouth experienced a 21-percent loss in population from 1980 to 2000, the only town to have a loss in population during this period. This loss can be attributed mostly to the closure of housing at the 4,100-acre Pease Air Force Base in the late 1980s, which also affected Newington. New Castle experienced a modest population growth (8 percent) because it was already nearly fully developed.

The population of these 44 towns is projected to grow to about 345,000 in 2020, an increase of 25 percent from 2000 (New Hampshire Office of Energy and Planning, 2005). New Durham, in Strafford County, is projected to have the highest population growth rate (60 percent) from 2000 to 2020 (table 2) and Chester is second with a projected 53-percent growth. The three largest cities in the Seacoast region, Rochester, Dover, and Portsmouth, are projected to grow at 25, 15, and 18 percent, respectively. These data indicate that some of the more rural towns will grow faster in the future than the more densely populated cities. Some factors that affect population growth and associated urban development include availability of developable land and its cost, zoning restrictions, job growth, and transportation network. Although rural towns may grow faster than cities in terms of percent change, population density is likely to remain low in comparison to the population density of the cities. Rural towns with residents that rely predominantly on self-supplied water from wells and wastewater disposal through septic systems tend to have low-density residential housing because this type of housing generally requires large lot sizes; cities with water-distribution and sewer systems tend to have high-density residential housing (New Hampshire Office of State Planning, 2000).

Population per housing unit in the Seacoast region for 2000 ranged from 1.8 persons per housing unit in New Durham to 4.3 persons in Durham (includes the number of college students living in dormitories at the University of New Hampshire) and had a mean of 2.4 persons per housing unit (table 2). Population densities ranged from 26 persons per mi<sup>2</sup> in Brookfield to 1,331 persons per mi<sup>2</sup> in Portsmouth. Seaside towns, primarily Hampton, North Hampton, Rye, and Seabrook, are popular summer destinations and have substantially larger populations in the summer months than in the winter months. The U.S. Census Bureau estimated 3,508 seasonal homes in these 4 towns in 2000. Based on an mean population per housing unit in the Seacoast region of 2.4, population during the summer increased by almost 8,500 people. There are about 100 motels and hotels in the area, with an average capacity of 100 guests, which further increased the population during the summer by 10,000 people. Therefore, the summer population residing (overnight) in the four towns increased from about 30,000 to almost 50,000. The number of people spending the day in these four towns during the summer is

estimated to increase the total by an additional 10,000 to 30,000 or to about 60,000 to 80,000 people (James Barrington, Hampton Town Manager, written commun., 2006).

## Methods Used to Compile and Analyze Water-Use Data

In this study, water-use estimates were generated at the census-block scale and then combined at the town level. A census block is a geographic subdivision of a census block group and is the smallest geographic area for which the U.S. Census Bureau collects and tabulates census data (U.S. Bureau of the Census, 2001b). It is a useful scale for town and regional planning purposes because census blocks are small enough to be incorporated in town planning zones. There are 7,100 census blocks in the Seacoast region, with an average block size of 100 acres (0.15 mi<sup>2</sup>). All users were assigned to their census block.

Estimates of water use rely on understanding what influences water demand and its associated consumptive use, because changes in demand and consumptive use affect withdrawal and return flow. The methods used to estimate water use in 2003 and to project water demand in 2017 and 2025 are described in this section of the report. At the simplest level, the methods can be grouped into three basic steps: (1) identify the water users in the Seacoast region, (2) identify the source of water and disposal of wastewater for each user, and (3) estimate the amount of water use for each water-use activity. More details about each step are included below.

## Water-Use Framework

A flow chart to visualize who is using water and how water is being used and disposed of was created for each town or subbasin in the Seacoast region. A generalized approach to creating this flow chart, termed a “water-use framework,” is shown in figure 3. A water-use framework is a series of points and pipes that show how water is used and moved throughout the anthropogenic water system.

In the first step, all water users in the Seacoast region were identified through water-use and related data compiled and analyzed from state, federal, local, and private databases. These databases included WATUSE for data on registered water users; New Hampshire Drinking Water and Groundwater Bureau (NHDWGB) drinking water database for descriptions of CWSs; U.S. Bureau of the Census data in both tabular and spatial (Topologically Integrated Geographic Encoding and Referencing (TIGER); U.S. Bureau of the Census, 2001d) formats for census population and other demographic information; CWS billing record databases for metered data; and Dun & Bradstreet business information database (Dun & Bradstreet, 2000).

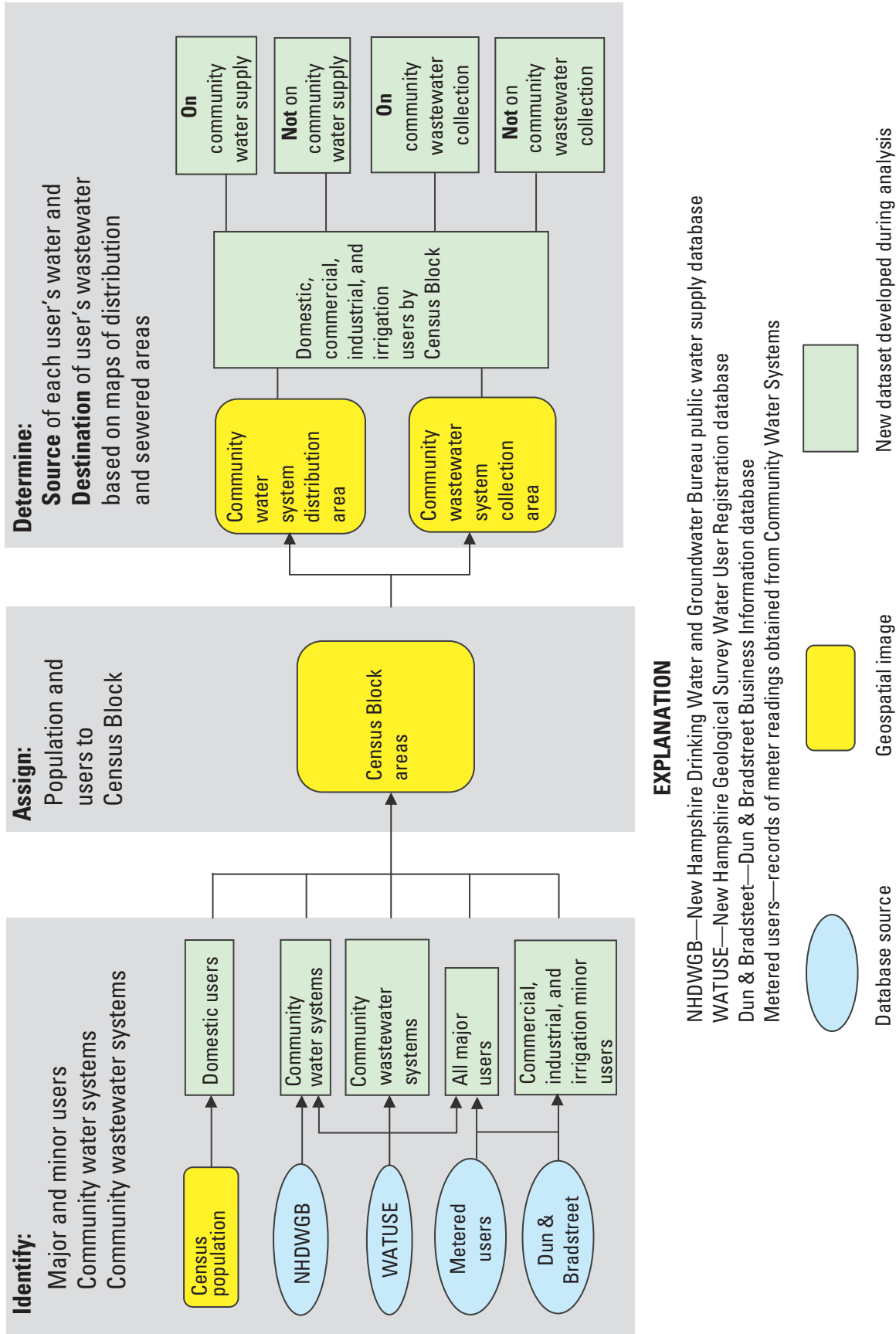

**Figure 3.** General approach for building the water-use framework in the Seacoast region, New Hampshire, by identifying who is using the water, assigning these users to census blocks, and determining the source of water and destination of wastewater.

In the second step, the source of water and disposal of wastewater were identified for each non-domestic user and census-block aggregate of domestic users. The water-use framework was georeferenced to maps of community water-distribution systems and wastewater-collection systems. These maps were from a geographic information system (GIS) dataset obtained from NHDES for community water, wastewater, and combined water and wastewater systems for the Seacoast region (Sarah Pillsbury, New Hampshire Department of Environmental Services, written commun., 2003). Two separate GIS coverages were developed—one for water-distribution systems and one for wastewater-collection systems. The U.S. Census Bureau's TIGER files were used as a base map against which the water-distribution and wastewater-collection system coverages were cross-referenced to determine the population and businesses served by these community water and (or) wastewater systems (fig. 4).

The GIS datasets were combined with the census blocks to link users to their sources of water supply and disposal of wastewater. Withdrawal from CWS wells and intakes were linked to the distribution system they supplied, which then were linked to registered users and census-block aggregates of domestic, commercial, and industrial users. All users also were linked to wastewater-collections systems, wastewater-treatment plants, and return-flow (effluent) discharge pipes. Non-domestic users and census-block aggregates of domestic users that were self-supplied and on septic systems also were identified.

In third step, the amount of water use for each water-use activity was estimated. First, estimates of water demand and associated consumptive use were made on the basis of data from registered users and CWS metered deliveries. These estimates of water demand served as the basis for estimates of withdrawal from ground and surface waters. Estimates of return flow were based on water demand minus consumptive use. Delivery to CWS were estimated from domestic, commercial, and industrial water demand. Estimating release to CWWS was equal to domestic, commercial, and industrial water demand minus consumptive use. Estimates of water transfer between towns or watersheds for a particular CWS were equal to the amount of water after delivery to the town or watershed were subtracted from CWS withdrawal. The amount of water transferred between CWSs was available from WATUSE. Estimates of wastewater transfer between towns or watersheds were equal to release to the CWWS by domestic, commercial, and industrial uses in each town or watershed that were then conveyed outside of that town or watershed.

Withdrawal and return flow by registered users, delivery to registered users, and transfer between registered users was from 2002–04 WATUSE data. The data were reviewed for completeness and accuracy, assigned to their respective census block, and stored in a Microsoft Access™ relational database and the USGS Site-Specific Water-Use Data Systems (SWUDS).

## **Development of Coefficients for Estimating 2003 Water Demand and Consumptive Use**

Coefficients for estimating water demand were developed for the domestic and commercial use categories (fig. 5), all in gal/d per unit. The industrial coefficients developed by Planning and Management Consultants, Ltd. (1995) were evaluated for use in the Seacoast region. A coefficient is an amount of water used per one unit for each category of use. The coefficient is multiplied by the number of units at the facility or in the area to obtain the total water demand for that facility or area. For example, if the domestic per capita water demand coefficient is 75 gal/d and there are 1,000 people in the census block, the total domestic water demand is 75,000 gal/d in the census block. Coefficients are developed by analyzing the relation between reported or metered water demand and ancillary data, like domestic population, number of employees at a specific facility, or per unit of product. Coefficients are then used to estimate water demand where reported or metered delivery data are not available.

### **Domestic Water Demand and Consumptive Use**

Few investigations have analyzed domestic water demand in detail because there are many individual users each using only a small amount of water. Cumulatively, however, domestic water demand generally dominates total water demand in urban areas. In previous investigations in New Hampshire, a single domestic per capita water-demand coefficient has been used for the entire state. The coefficient was usually based on observing a few systems that were assumed to represent typical systems. Using this somewhat arbitrary approach, a per capita water-demand coefficient for New Hampshire was assigned as 70 gal/d in 1995 (Solley and others, 1998) and 85 gal/d in 2000 (Hutson and others, 2004). Similarly, domestic consumptive coefficients in New England were estimated to be 15 percent (Solley and others, 1998), but these estimates were not from actual data.

The first major effort to document specific domestic activities (toilet flushing, showers, washing of clothes and dishes) that make up the total daily per capita water demand and relate this to socio-economic data was completed by the American Water Works Association Research Foundation (Mayer and others, 1999). Mayer and others (1999) developed a nationwide sampling of approximately 1,200 households to analyze domestic per capita water-demand patterns to (1) explain the variability of per capita water demand, (2) identify data sets useful in analyzing and projecting per capita water demand, and (3) present relations between public supply characteristics and per capita water demand in the form of statistical equations. The analyses by Mayer and others (1999) were based only on data for households on public supply.

Developing empirical relations between observed water demand and ancillary data used by Mayer and others (1999) was incorporated by Mullaney (2004) in a study of a coastal



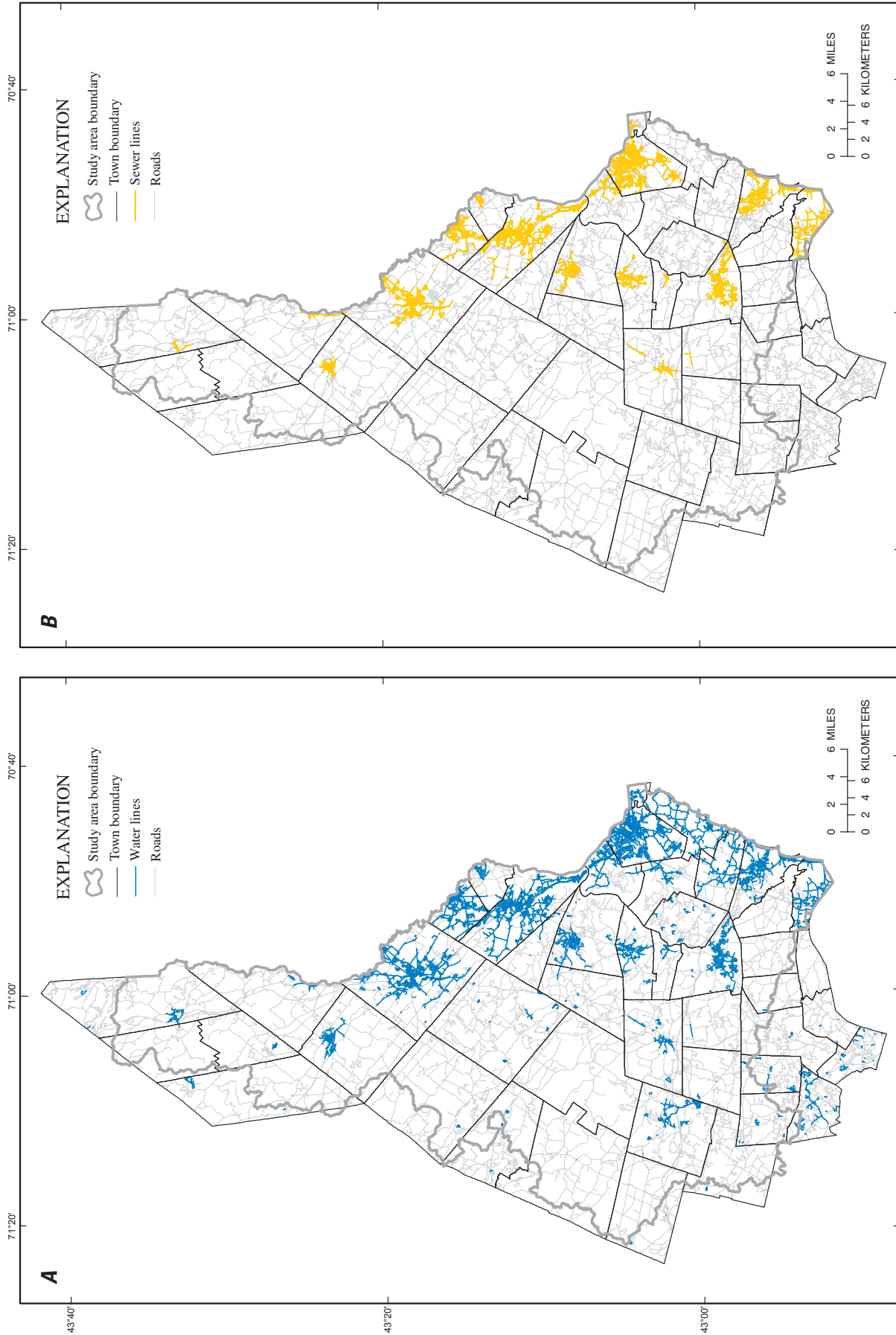
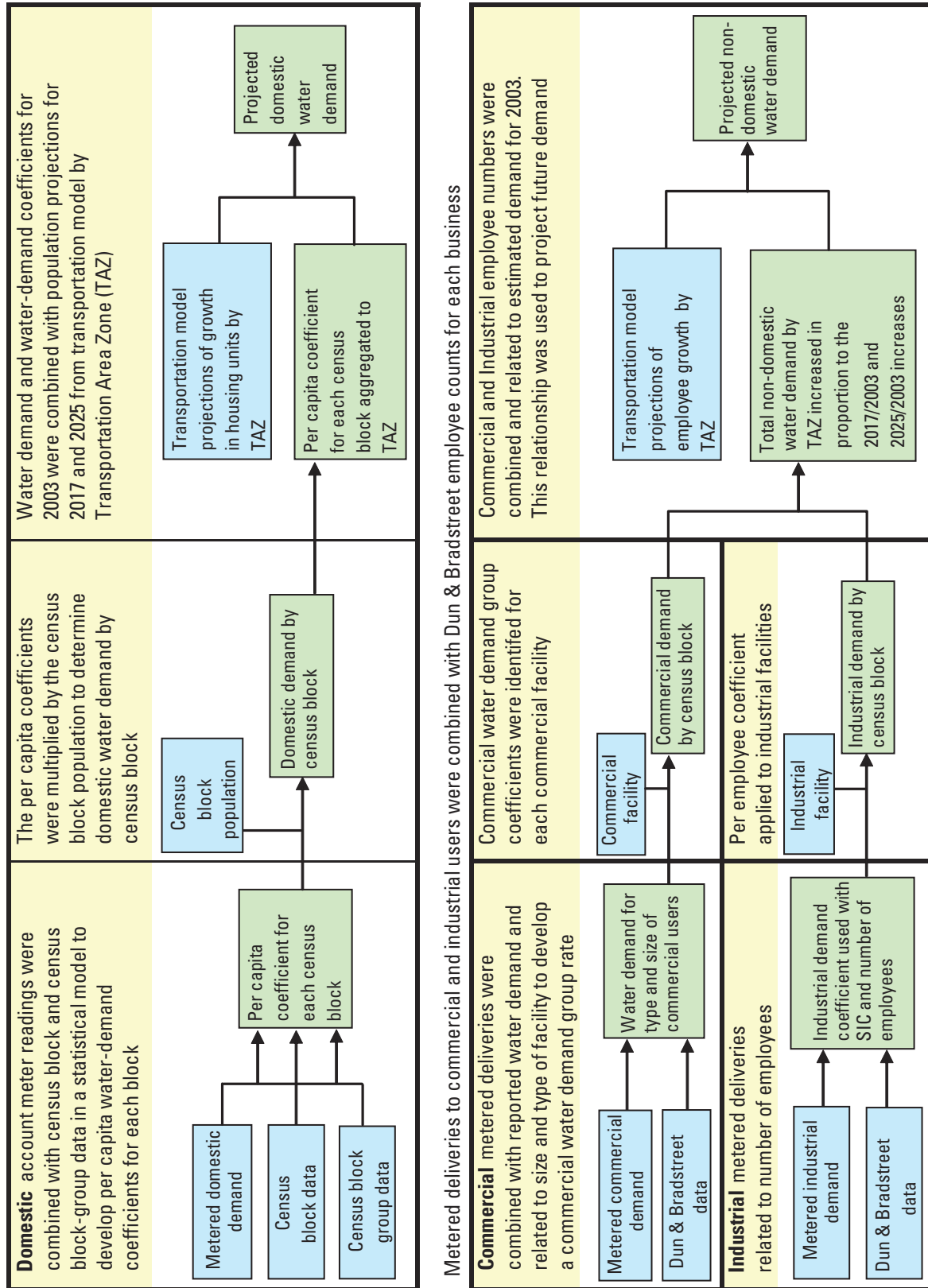

Figure 4. Location of (A) community water-distribution systems, and (B) community wastewater-collection systems in the Seacoast region, New Hampshire.



**EXPLANATION**  Raw data  Derived data  SIC = Standard Industrial Classification code

Figure 5. General approach for developing estimates for domestic, commercial, and industrial water demand.



community in Connecticut. Observation of metered deliveries to domestic households indicated that the per capita water demand coefficient ranged from 113 gal/d to 416 gal/d (Mullaney, 2004). The Connecticut data were statistically analyzed to determine the effect on per capita water demand of lot size, building footprint, outdoor swimming-pool size, and unforested area—data that were available from the town GIS database. Because the coastal areas in Connecticut and New Hampshire are similar in terms of socio-economic characteristics, the Seacoast region in New Hampshire may show a similar variability in per capita water-demand coefficients. An evaluation of the range and variability of per capita water demand coefficients by census blocks throughout the Seacoast region was needed to estimate current domestic use and future water demand.

Two methods were used to determine domestic per capita water-demand and consumptive-use coefficients. The first method involved the use of a domestic-water-demand survey to determine if there were differences in the amount of water used by households that depend on CWSs or private wells for water supply. The second method consisted of developing a statistical model that related metered water deliveries from selected CWSs to individual homes to a variety of data sets that may explain the variations in observed metered data. Per capita water-demand models were developed to determine annual, summer, and winter per capita water-demand coefficients. The per capita water-demand model also was used to estimate an annual domestic consumptive-use coefficient.

### Domestic Water-Demand Survey

Many households in the Seacoast region use their own wells and on-site systems for sewage disposal. Little is known about whether water demand in these self-supplied households is more or less than water demand in households on public water and sewer systems. To assess potential differences between domestic-well and public-water-system water demand, USGS partnered with the NHDES and 16 schools across 25 towns to implement a water-demand survey of middle school (grades 5–8) students and their families. Domestic (residential) water-demand surveys and data-collection sheets were distributed to middle school students and their families. The survey was integrated into the schools' environmental curriculums to improve the students' understanding of the importance of water resources in daily life. The USGS used the information to better understand and test the appropriateness of applying per capita water-demand coefficients to all households whether they are self- or public supplied. More information on the domestic water-demand survey is available in appendix 1.

The survey was described in several local newspapers and endorsed by the Aquarion Water Company, who made free, low-flow showerheads available to some who participated in the survey. Students and their families completed (1) a water-demand survey to document the number of household water-using appliances and outdoor water-use practices, as well as

their attitudes and habits for using water (appendix 1A); and (2) data-collection sheets to estimate the amount of indoor water used in the household for 1 to 4 weeks (appendix 1B).

There were 780 students and their families who responded from 16 middle schools participating in this survey. These responses included 431 data-collection sheets, 310 of which were accompanied by water-demand surveys (349 surveys were unaccompanied by data sheets). About 61 percent (262 households) of those who filled out the data-collection sheets were self-supplied, and 77 percent (331 households) were on septic systems. The estimated mean per capita indoor water demand for all households was 68 gal/d; self-supplied households averaged 67 gal/d, and households on public supply averaged 69 gal/d (fig. 6). Analysis of outdoor water demand from the survey is more uncertain because the data collection was during the spring when there is only minor outdoor use in New Hampshire, but the survey found little apparent difference in outdoor water use between households on public supply and those on self supply. These results indicated generally no difference in indoor domestic water demand between self- and public-supplied households; therefore, a domestic per capita water-demand model can be applied to all housing units throughout the Seacoast region regardless of the source of supply.

### Per Capita Water-Demand Model

The objectives of the per capita water-demand model are to (1) develop empirical relations between domestic water-delivery data metered by CWSs and census data at a census-block or block-group scale and (2) to predict a per capita water-demand coefficient for each census block in the Seacoast region. The predicted per capita water-demand coefficients for each census block would then be multiplied by the population in the census block to estimate domestic water demand for the census block. The per capita water-demand model is in the form of a multiple linear-regression model that relates domestic water-delivery data metered by CWSs (the dependent or predicted variable) to census data (the independent or predictor variables) to explain the variations in the metered water-delivery data. The predicted per capita water-demand coefficients for census blocks allows for the estimation of water demand for areas in the Seacoast region for which metered delivery data are unavailable.

Per capita water-demand models were developed to determine annual, summer (months of June, July, and August when outdoor water demand and its related consumptive use in the form of evaporation is high) and winter (months of December, January, and February when virtually no outdoor water demand occurs) per capita water-demand coefficients. Summer domestic water demand was estimated by multiplying the census block summer domestic per capita water-demand coefficient by the sum of the year-round and summer-only populations in the census block.

An annual domestic consumptive-use coefficient was estimated by subtracting the winter per capita water-demand

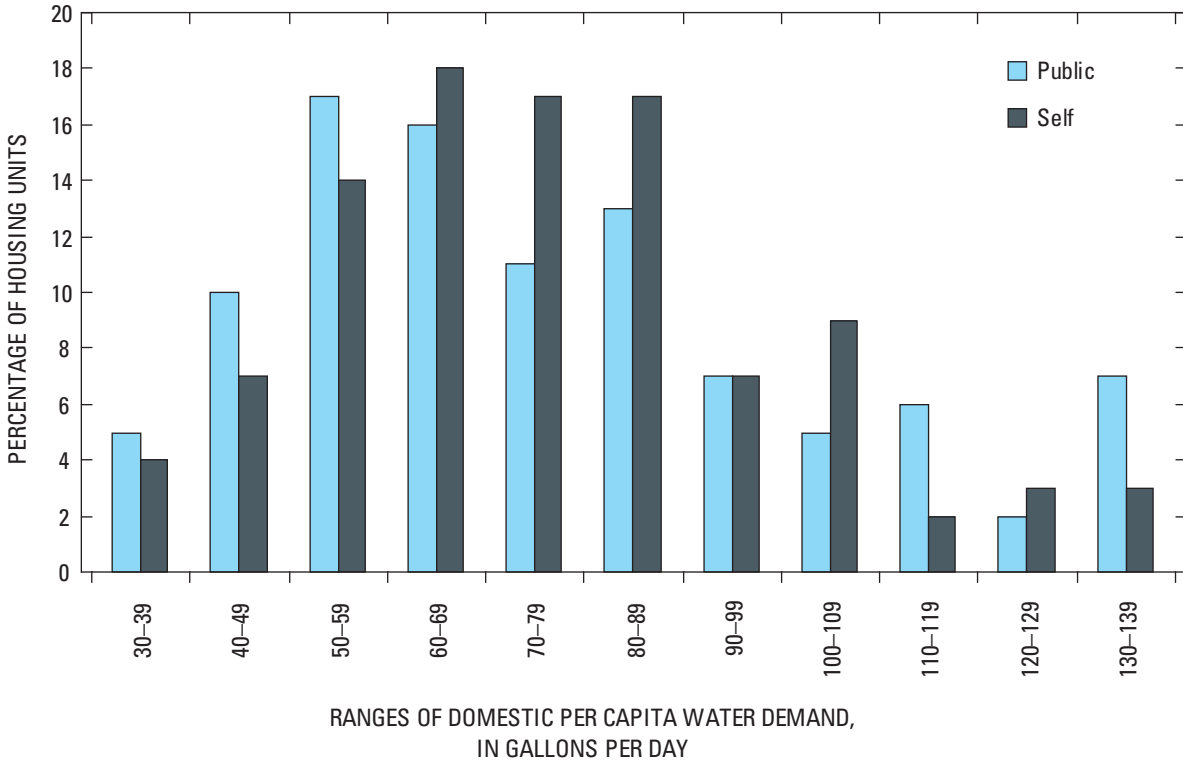

Figure 6. Relation of housing units on public supply or self supply to ranges in domestic per capita water demand.

coefficient from the annual per capita water-demand coefficient for each census block. The annual consumptive use represents the overall effect that consumptive use has on the annual water demand.

The predictions were compared to observed mean annual per capita water-demand coefficients from metered deliveries to domestic users in the census block to validate the model. The strengths and weaknesses of the model were assessed.

Model Development

The per capita water-demand model was developed from data on metered deliveries to individual domestic users in order to determine which factors influenced per capita water demand. Data sets from town tax and GIS databases and census data were evaluated to identify which sets of variables were available consistently for the entire Seacoast region, and could be readily compiled for use in the model. The only data set that met these criteria was from the U.S. Bureau of the Census.

Metered CWS deliveries to domestic users in year 2003 were compiled from Aquarion Water Company, City of Dover Water Department, Portsmouth Water Works, and Raymond Water Department CWSs. These CWSs serve the towns of

Dover, Greenland, Hampton, New Castle, Newington, North Hampton, Portsmouth, Raymond, and Rye. Approximately 69,700 meter readings representing more than 18,800 domestic accounts were compiled and assessed (table 3). Domestic meters were read three or four times a year depending on the CWS. Any account that did not have a full year of meter readings, or had values that were an order of magnitude higher than the average of the other meter readings in that year, were not used in the model because they would not represent either a complete record for the year or could represent unreliable values. The winter and summer models were based on metered delivery data for the 3- to 4-month interval that corresponded to those seasons. The address of the metered account was matched to the census block through the Census Bureau Address Search Program (U.S. Bureau of the Census, 2001b).

The meter readings were evaluated to ensure that the readings represented the range in population density found in the Seacoast region. Census block population density for the entire Seacoast region was categorized by quartile. Metered delivery data from a roughly equal number of census blocks from each quartile were selected. This resulted in using about 7,000 domestic metered accounts from 530 census blocks in the per capita water-demand model (table 3).

**Table 3.** Summary of data on metered deliveries to domestic users for selected community water systems and towns used to predict domestic per capita water-demand coefficients in the Seacoast region, New Hampshire, 2003.

[Location of towns shown in figure 1. Accounts, number of household billing accounts]

Community water supplier			Domestic users			
Water company	Town served	Total meter readings for all users	Total meter readings	Number of accounts		
				Total	With full year of readings within same order of magnitude for volume of water used	Matched to census block and used in statistical model
Dover	Dover	36,191	30,474	8,447	5,712	1,331
Portsmouth	Greenland	1,750	1,522	443	416	407
Portsmouth	New Castle	875	686	196	179	179
Portsmouth	Newington	1,459	743	237	208	208
Portsmouth	Portsmouth	29,141	20,227	5,458	4,589	2,306
Portsmouth	Rye	305	206	62	55	55
Aquarion	Hampton	7,860	4,886	1,489	926	555
Aquarion	North Hampton	5,779	4,992	1,016	1,016	998
Aquarion	Rye	2,743	2,645	575	575	488
Rye	Rye	486	399	136	133	0
Raymond	Raymond	3,464	2,884	753	738	438
<b>Total</b>		<b>90,053</b>	<b>69,664</b>	<b>18,812</b>	<b>14,547</b>	<b>6,965</b>

Census blocks with housing units identified by the U.S. Census Bureau as seasonal were removed from analysis because the seasonal housing units, all of which would be vacant during the April census, would result in population-per-housing-unit values that were too low. This affected 67 census blocks in Hampton and Rye. To further account for the seasonal variability in the population of census blocks, a new variable, population per non-seasonal housing units, was developed to ensure that the population per housing unit was in line with the April census values of population and housing units that were likely to be occupied. This variable was included in the annual, winter, and summer models.

The metered delivery data were related to U.S. Bureau of the Census block and block-group data designed to represent socio-economic conditions that may have an influence on water demand (tables 4–6). Nearly 100 possible predictor variables (tables 4–6) were tested in the development of the model. The medians of the block-group predictor variables (table 5), where available, in addition to the actual categorical values, were tested for inclusion in the per capita water-demand model. All census blocks used to develop the model were weighted on the basis of the number of metered accounts

in the census block; more metered accounts resulted in greater weight.

All statistical analyses used to build and assess model performance were done with the Statistical Analysis Software (SAS; SAS Institute, Inc., 2000). Significant predictor variables were identified if they had probability values (*p*-values) equal to or less than 0.05.

### Model Results

The annual, summer, and winter per capita water-demand models can be expressed as

$$\ln(PC) = \beta_0 + \beta_1 (X_1) + \beta_2 (X_2) + \beta_3 (X_3) \dots \beta_n (X_n) + E \quad (1)$$

where

$\ln(PC)$  = natural log of the domestic per capita water-demand coefficient, census-block value for gallons per day per person;

$\beta_0$  = intercept;

$\beta_1, \beta_2, \beta_3$  = variable coefficients;

$X$  = independent variable;

and

$E$  = random error.

**Table 4.** Census block-group variables with number of housing units in subcategories defined by numerical ranges that were evaluated for possible inclusion in per capita water-demand model in the Seacoast region, New Hampshire.

[Data from U.S. Bureau of the Census, 2000; &lt;, less than; --, not applicable; &gt;, more than]

Data category	Lowest value	Number of intermediate groupings	Highest value	Median block-group values
Total number of housing units	0	--	--	--
Household income	<\$10,000	14	>\$200,000	Yes
Number of rooms	1	7	9	Yes
Year of construction	before 1939	7	after 1999	Yes
Rental units with monthly cash rent	<\$100	19	>\$2,000	Yes
Rent as a percent of income	<10	7	>50	No
All owner-occupied housing unit value	<\$10,000	22	>\$1,000,000	Yes
Specified owner-occupied housing unit (single-family homes) value	<\$10,000	22	>\$1,000,000	Yes

The natural log of the per capita water-demand coefficient was predicted in the model to account for the heteroscedastic nature of the residuals of non-transformed predictions. The significant predictors of per capita water demand were the same for the annual, summer, and winter models (tables 7, 8 and 9) and included population per housing unit, median value of owner-occupied single family homes, median year of housing construction (with 1900 as the base value), population density, housing unit density, and proportion of housing units that are in urban areas.

The annual model had an  $R^2$  of 0.41 (an  $R^2$  value of 1 would indicate a one-to-one relation between observed and predicted values); the summer, and winter models both had an  $R^2$  of 0.38. The root mean square error of the annual model was 0.28, of the summer model was 0.33, and of the winter model was 0.27. The  $R^2$  results indicate that the per capita water-demand models were able to account for about 40 percent in the variation in the metered CWSs deliveries to domestic users. For comparison, Mullaney (2004) was able to account for 25 percent of the variation in domestic water demand in his study of water demand in the coastal area of Connecticut.

Reviewing the parameter estimation value for each of the predictor variables helps to understand the effect that variable has on the per capita water-demand coefficient. Two variables, the median value of owner-occupied housing unit and the housing unit density have a positive influence on the per capita water-demand coefficient. The higher the dollar value of the house, the less likely the cost of the water would influence water demand.

Four of the six predictor variables in the annual, summer, and winter models have negative parameter estimation values, which result in decreased per capita water-demand coefficients. Population per housing unit had a negative effect on per capita water demand; this implies that the greater number of people living in a housing unit, the less water is used per person. This observation was noted in Mayer and others (1999) and also was identified in the domestic water-demand survey.

Proportion of housing units in an urban area also had a negative influence on the per capita water demand. This may relate to outdoor water demand being greater in less urbanized areas where there are larger lawns, landscaping, and gardens. The negative influence of the variable, median year of construction (normalized to the base year 1900, which means that 1900 is subtracted from the year of construction of the housing unit in the equation), indicates that older housing units also have higher per capita water demand values because older houses are more likely to have older, less water-efficient toilets and other household appliances.

Results of the per capita water-demand model were assessed by reviewing outlier predictions and comparing them to predictions in neighboring census blocks. Model predictions were considered to be abnormally low (less than 1 gal/d to 33 gal/d) in 14 census blocks because high population per housing unit values (6 to 81) occurred in dormitories and group housing. Model predictions were considered abnormally high (251 gal/d to 825 gal/d) in 5 census blocks because very high housing densities (29,000 to 111,000 houses per square mile) occurred when a large apartment building was in a very small census block. The predicted per capita water-demand

**Table 5.** Census block-group variables with number of housing units in descriptive subcategories evaluated for possible inclusion in per capita water-demand model in the Seacoast region, New Hampshire.

[Data from U.S. Bureau of the Census, 2000; RV, Recreational Vehicle; Units in structure, A structure is a separate building that either has open spaces on all sides or is separated from other structures by dividing walls that extend from ground to roof. In determining the number of units in a structure, all housing units, both occupied and vacant, are counted; Urban area, Collective term referring to all areas that are urban. For Census 2000, there are two types of urban areas: urban clusters and urbanized areas; Urban cluster, A densely settled territory that has at least 2,500 people but fewer than 50,000. New for Census 2000; Urbanized area, (UA) An area consisting of a central place(s) and adjacent territory with a general population density of at least 1,000 people per square mile of land area that together have a minimum residential population of at least 50,000 people. The Census Bureau uses published criteria to determine the qualification and boundaries of UAs. U.S. Bureau of Census: American Fact Finder Glossary, 2006]

Data category	Number of subcategories	Name of subcategory	Descriptive groups for subcategories									
Housing unit setting	2	Urban area	Inside urbanized areas	Inside urban clusters								
		Rural area	Farm	Nonfarm								
Type of occupancy	3	Owner	None									
		Renter	None									
Number of housing units in structure	2	Vacant	For rent	For sale or rent	Rented/sold, not occupied	For seasonal use	For migrant workers					
		Occupied	1-detached	1-attached	2	3 or 4	5-9	10-19	20-49	Over 50	Mobile home	Boat/RV
		Vacant	1-detached	1-attached	2	3 or 4	5-9	10-19	20-49	Over 50	Mobile home	Boat/RV

**Table 6.** Census block variables evaluated for possible inclusion in per capita water-demand model in the Seacoast region, New Hampshire.

[Data from U.S. Bureau of the Census, 2000]

Original data variable	Formula	Derived variable
Total population	Population divided by census block area, in square miles	Population density
Total number housing units	Number of housing units divided by census block area, in square miles	Housing unit density
Total population and number of housing units	Total census block population divided by number of housing units in the census block	Population per housing unit

coefficients were changed manually to the mean per capita water-demand coefficients in neighboring census blocks.

About 1,400 metered deliveries to domestic users in 48 census blocks were used to validate the predicted domestic per capita water-demand coefficients. Each census block had 10 or more metered accounts. The mean value of the metered deliveries for each census block was compared with the predicted annual per capita water-demand coefficient. The observed mean annual per capita water-demand coefficient fell within the standard error of the predicted per capita water-demand coefficient for 71 percent of the census blocks. This was slightly better than the 68 percent expected to fall within the standard error of prediction based on the definition of standard error.

#### Model Assumptions and Limitations

The per capita water-demand model for the Seacoast region is based on assumptions that define the multiple linear-regression analysis. These assumptions are (1) the functional form of the model is correct in terms of the variables included and their role in the model; (2) the error term ( $E$ , in equation 1) is independent across the range of observations, implying that there is no correlation in the errors among the metered delivery data used to calibrate the model; (3) the residuals of the model are normally (or nearly normally) distributed; (4) the residuals are homoscedastic; that is, the distribution of the residuals are similar throughout the range of predicted values; and (5) domestic users that depend on smaller CWSs and private wells use water in a manner similar to those on large CWSs (as identified with the middle school water-demand survey). A limitation of the data used in the modeling process is that some of the predictor variables are based on block-group data, not the block-level, and this may tend to limit the range of the predicted results.

An analysis of the residuals for each of the three models was done following the transformation of the results to the inverse of the log value. This analysis indicates that the residuals appear to be randomly distributed across the Seacoast

region with no spatial grouping of over- and underpredictions. Statistically, the residuals are not skewed.

Strengths and weaknesses are associated with the model and its results. Strengths of the per capita water-demand model are relatively good precision of most parameter coefficients obtained with the three seasonal model runs. The validation of model performance using an independent data set of metered deliveries from 40 census blocks provides an indication of robustness.

Weaknesses of the per capita water-demand model include an  $R^2$  of 0.41 for the annual model and 0.38 for the winter and summer models, which indicates that additional factors are influencing variations in domestic water demand that could not be explained by the model. The annual model accounts for about 40 percent of the variance in the water-demand data, leaving 60 percent unexplained. This may lead to an oversimplification of the social, economic and policy/political variables that influence how water is used. The authors acknowledge that many factors locally and regionally affect the per capita water demand, many of which are not accounted for in the per capita water-demand model or in the census data used to develop the model. Additional analysis of parameters related to climate, cost of water, watering restrictions, and landscape development variables may provide further insight as to factors influencing domestic per capita water demand.

The validation supports the general application of the per capita water-demand models as water-demand-assessment tools. Other strengths of the per capita water-demand models include the ability to provide regionally consistent characterizations of domestic per capita water demand on an annual and seasonal basis, and to provide confidence intervals associated with these assessments. Model results also indicate the regional variation in domestic per capita water-demand coefficients. Previously in New Hampshire and many other areas of the United States, stochastically derived water-demand estimates have not been available and per capita water-demand coefficients and their derived water-demand estimates have been based on conjecture or best professional judgment.



**Table 7.** Regression coefficients, variable ranges and medians, standard errors, *t*-statistics, and *p*-values for the per capita water-demand model to predict annual coefficients per census block, 2003, Seacoast region, New Hampshire.

[Coefficient of determination ( $R^2$ ) = 0.41; <, less than; --, not applicable]

Variable	Data source	Units	Variable values		Regression coefficient	Standard error	<i>t</i> -statistic	<i>p</i> -value
			Range	Median				
Intercept	--	Dimensionless	--	--	5.059	0.125	40.52	<0.0001
Median value owner-occupied single family homes	Block group	Dollars	73,600–566,600	145,000	0.000000823	.000000011	7.58	<.0001
Housing unit density	Block	Units per square mile	2–96,982	386	.0000485	.0000129	3.76	.0002
Population density	Block	People per square mile	4–92,689	898	-.0000195	.0000069	-2.81	.0051
Median year of construction, with 1900 as the base value	Block group	Median year built minus 1900	39–95	74	-.00254	.00111	-2.29	.0226
Population per housing unit	Block	People per unit	1–5	2.4	-.258	.0278	-9.29	<.0001
Proportion of housing units that are in urban areas	Block group	Percentage	0–1	.61	-.183	.0564	-3.24	.0013

**Table 8.** Regression coefficients, variable ranges and medians, standard errors, *t*-statistics, and *p*-values for the per capita water demand-model to predict summer coefficients per census block, 2003, Seacoast region, New Hampshire.

[Coefficient of determination ( $R^2$ ) = 0.38; <, less than; --, not applicable]

Variable	Data source	Units	Regression coefficient	Variable values		Standard error	<i>t</i> -statistic	<i>p</i> -value
				Range	Median			
Intercept	--	Dimensionless	5.343	--	--	0.152	35.18	<0.0001
Median value owner-occupied single family homes	Block group	Dollars	0.00000118	73,600–566,600	145,000	.000000132	8.94	<.0001
Housing unit density	Block	Units per square mile	.0000479	2–96,982	386	.0000157	3.05	.0024
Population density	Block	People per square mile	-.000254	4–92,689	898	.0000084	-3.02	.0026
Median year of construction, with 1900 as the base value	Block group	Median year built minus 1900	-.003	39–95	74	.00135	-2.22	.027
Population per housing unit	Block	People per unit	-.263	1–5	2.4	.0338	-7.78	<.0001
Proportion of housing units that are in urban areas	Block group	Percentage	-.327	0–1	.61	.0686	-4.77	<.0001

**Table 9.** Regression coefficients, variable ranges and medians, standard errors, *t*-statistics, and *p*-values for the per capita water-demand model to predict winter coefficients per census block, 2003, Seacoast region, New Hampshire.

[Coefficient of determination ( $R^2$ ) = 0.38; <, less than; --, not applicable]

Variable	Data source	Units	Regression coefficient	Variable values		Standard error	<i>t</i> -statistic	<i>p</i> -value
				Range	Median			
Intercept	--	Dimensionless	4.967	--	--	0.124	39.96	<0.0001
Median value owner-occupied single family homes	Block group	Dollars	0.000000331	73,600–566,600	145,000	0.000000117	2.82	0.005
Housing unit density	Block	Units per square mile	0.0000464	2–96,982	386	0.0000128	3.61	0.00003
Population density	Block	People per square mile	-0.0000132	4–92,689	898	0.0000068	-1.94	0.054
Median year of construction, with 1900 as the base value	Block group	Median year built minus 1900	-0.00294	39–95	74	0.0011	-2.67	0.0079
Population per housing unit	Block	People per unit	-0.261	1–5	2.4	0.029	-9.03	<0.0001
Proportion of housing units that are in urban areas	Block group	Percentage	-0.159	0–1	0.61	0.0552	-2.87	0.0042

## Non-Domestic Water Demand and Consumptive Use

Non-domestic water demand and consumptive use in the Seacoast region were estimated for businesses involved in commercial, industrial, irrigation, and mining activities as defined by the U.S. Census Bureau's Standard Industrial Classification (SIC) Code, and its successor, the North American Industrial Classification System (NAICS). Water-demand coefficients were developed for specific types of commercial activities using a combination of metered delivery data from CWSs and withdrawal and delivery data from the WATUSE database. Industrial water-demand coefficients from the Institute for Water Resources-Municipal and Industrial Needs (IWR-MAIN) model (Planning and Management Consultants, Ltd., 1995) and from commercial and industrial consumptive-use coefficients of 10 percent were compared with metered delivery and release data from CWSs and withdrawal, delivery, and return-flow data from the WATUSE database. Estimates for irrigation and mining water demand were based on water withdrawal data from the WATUSE database.

Metered deliveries to commercial, industrial, and irrigation users in 2003 were obtained from four CWSs (Aquarion Water Company, City of Dover Water Department, Portsmouth Water Works, and Raymond Water Department) in the Seacoast region (table 10). Approximately 14,000 meter readings, representing more than 2,000 commercial-, industrial-, and irrigation-use accounts, were compiled and assessed in conjunction with data from the WATUSE database to develop or compare water-demand coefficients. Metered deliveries that did not have a full year of meter readings or had values that were an order of magnitude higher than the average of the other meter readings in that year were not used. Using this screening process, deliveries to about 700 commercial, industrial, and irrigation users were combined with data on 50 registered users to develop water-demand and consumptive-use coefficients for specific types of businesses.

### Commercial Water Demand and Consumptive Use

The category of commercial use includes offices, retail stores, hospitals, clinics, schools (non-boarding), restaurants, hotels/motels, laundromats, car washes, amusement and water parks, and aquariums. Commercial water demand is estimated by (1) identifying the type and size (usually the number of employees) of the commercial business and (2) applying the appropriate water-demand coefficient for that commercial operation. Commercial business size and type information was obtained from the Dun & Bradstreet Business Information database (Dun & Bradstreet, 2000) and included name, address, type of business (SIC code), and number of employees. The 668 commercial establishments with metered delivery data in the Seacoast region were categorized into 15 commercial group types (table 11). The 15 commercial group types were further divided into 58 subgroups based on water-demand patterns in the metered delivery and WATUSE

withdrawal and delivery data. The median water-demand coefficient for each commercial subgroup and the number of establishments included in the subgroup also are included in table 11.

The subgroups are related to the number of employees, type of establishment, and how water was used in that type of establishment. Depending primarily on the number of employees may be an unreliable way of gauging the size of a business because the definition of an employee (full-time, part-time) may vary or be outdated. Therefore, although the subgroups of very small, small, medium, large, and very large are generally linked to ranges in number of employees, the subgroups may actually indicate that additional water-demand activities occur as commercial facilities increase in size.

There are 3,463 commercial facilities identified in the Dun & Bradstreet business information database as having five or more employees in the Seacoast region, 10 percent of which had metered demand information. Each of the remaining 90 percent of the facilities was assigned to one of the 58 water-use subgroups in order to estimate commercial water demand for the Seacoast region.

An example of a commercial group where the number of employees does not completely characterize water demand is the motels and hotels group. A small motel (about 10 rooms) has a coefficient of about 500 gal/d, which includes water used by hotel guests plus water for daily cleaning of the rooms. A middle-size motel has a coefficient of about 2,300 gal/d, which includes water for guest rooms, a restaurant, onsite laundry facilities, and a pool. A very large hotel has a coefficient of about 11,600 gal/d, which includes water for guest rooms, two or more restaurants, Jacuzzis in selected rooms, indoor and outdoor pools, hot tubs, a water-using central air-conditioning system, fountains, automatic lawn-irrigation systems, on-site laundry facilities, and meeting rooms with catering. The variation in the water demand in each subgroup of motels does not change in relation to the number of employees, but instead appears to be related to the type of water-using activities. The volume of water cooled in the cooling tower for central air conditioning, or sprayed in automatic lawn-irrigation systems, generally are not related to the number of employees but substantially increase water demand.

Commercial consumptive use was estimated by reviewing meter records for commercial return flow, where available, and comparing that value with the default value of 10 percent. Although metered records for only a small number of commercial facilities were available (about 5 percent), the default value of 10 percent seemed reasonable with certain exceptions, such as when a commercial user provided water to docked ships or water was used for creating ice for skating.

### Industrial Water Demand and Consumptive Use

Industrial water use generally includes water used in fabrication, processing, washing, in-plant conveyance, and cooling for industries that include bottling, food processing, textiles, paper, chemicals, and plastics. Industrial water

**Table 10.** Summary of data on metered deliveries to commercial, industrial, irrigation, and mining users for selected community water systems and towns and data reported by businesses to NHDES by town used in developing water-demand coefficients in the Seacoast region, New Hampshire, 2003.

[Location of towns shown in figure 1. Accounts, number of commercial, industrial, and irrigation billing accounts; --, no data]

Water company	Town	Total meter readings for all users					Commercial, industrial, irrigation, and mining users				
		Total meter readings	Total number of accounts	Accounts matched to business data	Registered users	Demand data used in analysis	Commercial	Industrial	Irrigation	Mining	
--	Barrington	--	--	--	1	1	--	--	1	--	
--	Brentwood	--	--	--	4	4	1	3	--	--	
--	Durham	--	--	--	1	1	1	--	--	--	
--	East Kingston	--	--	--	1	1	--	--	1	--	
--	Exeter	--	--	--	4	4	2	1	1	--	
--	Farmington	--	--	--	3	3	--	--	1	2	
--	Kingston	--	--	--	1	1	--	1	--	--	
--	Nottingham	--	--	--	1	1	--	1	--	--	
--	Rochester	--	--	--	7	7	2	2	1	2	
--	Seabrook	--	--	--	1	1	--	1	--	--	
--	Somersworth	--	--	--	3	3	1	2	--	--	
--	Stratham	--	--	--	1	1	--	--	1	--	
Dover	Dover	36,191	3,603	113	5	118	106	11	1	--	
Portsmouth	Greenland	1,750	220	34	3	37	30	3	4	--	
Portsmouth	New Castle	875	89	17	--	17	13	--	4	--	
Portsmouth	Newington	1,459	707	55	5	60	57	3	--	--	
Portsmouth	Portsmouth	29,141	7,219	72	6	78	72	5	1	--	
Portsmouth	Rye	305	29	--	--	--	--	--	--	--	
Aquarion	Hampton	7,860	1,036	167	1	168	160	8	--	--	
Aquarion	North Hampton	5,779	516	109	1	110	109	--	1	--	
Aquarion	Rye	2,743	28	6	1	7	6	--	1	--	
Rye	Rye	486	87	16	1	17	13	--	4	--	
Raymond	Raymond	3,464	430	106	3	109	95	6	6	2	
<b>Total</b>		<b>90,053</b>	<b>13,964</b>	<b>2,066</b>	<b>54</b>	<b>749</b>	<b>668</b>	<b>47</b>	<b>28</b>	<b>6</b>	

**24 Methods for and Estimates of 2003 and Projected Water Use in the Seacoast Region, Southeastern New Hampshire**

**Table 11.** Estimated commercial water demand by groups, 2003, in the Seacoast region, New Hampshire.

[Median values from meter readings. Facility size is defined on a case-by-case basis. ~, about; --, not applicable]

<b>Water use group code</b>	<b>Description of group type</b>	<b>Subgroup based on size of facility</b>	<b>Number of facilities included in analysis</b>	<b>Median water demand, in gallons per day</b>
07820	Lawn irrigation	Small	6	108
07821		Medium	4	537
07822		Large	3	1,960
44930	Marinas	All	3	2,202
53000	Stores with minor water use	Small	61	40
53001		Medium	24	273
53002		Large	11	558
53003		Very large	13	1,129
53004		Super stores	7	2,811
53005		Part of large mall	1	0
53006		Large mall	1	36,811
54110	Stores with high water use	Medium	4	446
54111		Large	6	2,071
58120	Restaurants	Very small ~ 13 employees	21	330
58121		Small ~ 17 employees	16	724
58122		Small medium ~ 22 employees	13	1,079
58123		Large medium ~ 35 employees	18	1,410
58124		Large ~ 52 employees	13	2,390
58125		Very large ~ 69 employees	17	4,469
70110	Hotel/motel	Very small or seasonal	20	574
70111		Small	21	1,570
70112		Medium	9	2,285
70113		Large	12	4,520
70114		Very large	10	11,603
72110	Cleaners	Small	3	441
72111		Medium	4	6,179
72112		Large	1	14,058
75420	Car washes		4	3,968
76000	Business with normal water use	Very small	55	132
76001		Small	23	330
76002		Medium small	13	532
76003		Medium	12	761
76004		Large and groups	12	1,681
76005		Very large business	4	5,398
78000	Amusement facility	Small	10	186
78001		Medium	7	670
78002		Large	7	3,325

**Table 11.** Estimated commercial water demand by groups, 2003, in the Seacoast region, New Hampshire.—Continued

[Median values from meter readings. Facility size is defined on a case-by-case basis. ~, about; --, not applicable]

Water use group code	Description of group type	Subgroup based on size of facility	Number of facilities included in analysis	Median water demand, in gallons per day
79970	Golf courses		11	23,940
80590	Health care facility	Small	6	1,893
80591		Medium	4	6,200
80592		Large	6	13,008
80620	Medical facilities	Small office	34	224
80621		Small group	14	569
80622		Medium group	4	1,343
80623		Large group	2	4,432
80624		Hospitals	3	36,410
80625		Part of medical complex	--	0
82110	Schools	Very small	17	234
82111		Small	16	1,036
82112		Medium	6	1,855
82113		Large	8	6,139
82114		Very large	2	55,663
90000	Offices	Small	31	62
90001		Medium	24	454
90002		Medium large	4	787
90003		Large or group of small	14	1,680
90004		Office complexes	6	2,413
90005	Part of office complex	--	0	
<b>Total</b>			<b>668</b>	



demand is estimated by (1) identifying industrial businesses by SIC or NAICS code and (2) applying the appropriate water-use coefficient (table 12). Information on industrial businesses was obtained from the Dun & Bradstreet Business Information database (Dun & Bradstreet, 2000). Historically, coefficients for estimating industrial water-use were based on the census report Water use in manufacturing, census of manufactures, 1982 (U.S. Department of Commerce, 1986) and were subsequently updated through application of a forecasting model called the Institute for Water Resources-Municipal and Industrial Needs (IWR-MAIN) model (Planning and Management Consultants, Ltd., 1995). This model is used to forecast changes in domestic, commercial, and industrial water demand that take into account economic factors (Davis and others, 1991).

Metered industrial water-delivery coefficients were used to compare previously developed coefficients relating water demand to type of manufacturing activity and number of employees. Deliveries to industrial users metered by CWS were combined with water-use amounts reported by industrial businesses to the NHDES for a total of 47 industrial users. These were compared with results of applying the coefficients to the employee counts grouped by SIC codes. The results were comparable for the small- and medium-sized industries; however, there is too much variation in the large-sized industries due to age and conditions of plants, processes at each plant, and amount of recycled-water to use the water-demand coefficients. Industrial water demand was estimated by applying coefficients for water demand per employee to employee counts grouped by SIC codes for the small and medium-size

**Table 12.** Coefficients for estimating industrial water demand from two-digit Standard Industrial Classification categories and number of employees.

[Nonresidential employee water-demand coefficients are from Planning and Management Consultants, Ltd., 1995. --, no data available]

Two-digit Standard Industrial Classification category and [code]	Nonresidential employee water-demand coefficient (gallons per employee per day)		
	Range	Median	Mean
Industrial [20–39]	21–2,160	116	297
Food [20]	96–677	469	419
Tobacco [21]	--	--	217
Textile mill products [22]	246–1,076	315	521
Apparel [23]	6–43	13	21
Lumber and wood [24]	32–109	78	72
Furniture [25]	25–65	30	37
Paper [26]	114–8,304	863	2,160
Printing [27]	15–66	42	40
Chemicals [28]	128–653	289	363
Petroleum [29]	278–1,437	1,045	920
Rubber [30]	73–170	119	119
Leather [31]	--	--	148
Stone, clay, glass, and concrete [32]	13–224	202	147
Primary metal [33]	87–424	178	186
Fabricated metal [34]	48–585	95	189
Machinery [35]	28–153	58	70
Electrical equipment [36]	30–169	71	112
Transportation equipment [37]	14–143	63	78
Instruments [38]	40–141	66	72
Jewelry, precious metals [39]	27–61	36	39

industries. Water demand by large-size industries was based on metered or reported water-use data.

Industrial consumptive use was estimated by reviewing meter records for industrial return flow, where available, and comparing that with the default value of 10 percent. The default value of 10 percent seemed reasonable with certain exceptions, such as for bottling or sheet-rock manufacturing.

## Projecting Future Water Demand

Future water demand was projected by combining current domestic per capita water-demand coefficients, commercial group water-demand coefficients, and industrial type of manufacturing activity and employee water-demand coefficients with growth projections based on transportation models that identify areas and types of future growth. These growth projections were derived from the “Seacoast Regional Travel Demand Model” (SRTDM) developed by Resources Systems Group (RSG) for the Seacoast Metropolitan Planning Organization (MPO), an inter-jurisdictional agency comprised of the Rockingham Planning Commission and Strafford Regional Planning Commission (Resources Systems Group, written commun., 2004). The model included 39 of the 44 towns in the study area (the towns of Brookfield, Candia, Chester, Deerfield, and Raymond were not included). The model projected future growth in homes and jobs for 353 Transportation Analysis Zones (TAZs) using information on historic growth trends, existing land use, and major roadways in the modeled area. The TAZ boundaries are generally defined by and vary in size between census block and census tract areas, which are groups of census-block groups. Data sources used in the model were from the year 2000 and included land-use data compiled by the Rockingham and Strafford Regional Planning Commissions, housing data from the U.S. Census Bureau, and employment data from the New Hampshire Department of Employment Security (Resources Systems Group, written commun., 2004).

Each of the five towns that were not included in the SRTDM was treated as being equivalent to a TAZ. Population projections by the New Hampshire Office of Energy and Planning (2005) were used for the year 2025, and the rate of increase between the 2010 and 2020 was used to extrapolate a population value for 2017. Employee projections were made by using the rate of increase in employees for neighboring TAZs with similar development characteristics.

## Domestic Water Demand

Projections of domestic water demand are based on the results of the SRTDM and the domestic per capita water-demand model. The SRTDM developed projections for growth in housing units for each TAZ for the years of 2007, 2009, 2017, and 2025. The projections for 2017 and 2025 were used to estimate future water demand.

The domestic per capita water-demand coefficients for each census block were modified into domestic housing unit water-demand coefficients for each census block by aggregating census blocks into TAZs and summing the total domestic water demand divided by the total number of housing units. This new coefficient was applied to the projected number of housing units in the TAZ for the years 2017 and 2025 to estimate domestic water demand. In the five towns outside the SRTDM area, the town mean domestic per capita water-demand coefficients were applied to the town-wide population growth projections. Additional projections can be made using an assumption that (1) increased domestic water demand will result from unregulated development of housing associated with high domestic housing unit coefficients, or (2) decreased domestic water demand will result from restrictions on outdoor watering and indoor conservation practices associated with decreased domestic housing unit coefficients.

## Non-Domestic Water Demand

Projections for categories of non-domestic water demand were combined because the SIC and NAICS classifications were developed to define economic categories, such as between retail and wholesale sales, or between insurance and banking businesses. The SRTDM developed specific groupings based on frequency of vehicle trips to specific types and sizes of businesses. Because the commercial, industrial, irrigation, and mining water-demand projections were based on employee growth in the SRTDM, future water-demand projections cannot be made specifically for commercial or industrial water demand, so all businesses were combined into a group termed “non-domestic water demand.”

Projections of non-domestic water demand are based on the results of the SRTDM and the combined estimates of total commercial, industrial, irrigation, and mining water demand per census block. The SRTDM developed projections for growth in employee numbers for commercial, industrial, irrigation, and mining businesses for each TAZ for the years 2007, 2009, 2017, and 2025. The projections for the years 2017 and 2025 were used to project water demand. Growth, expressed as increases in the number of employees over the years, was projected for the following business categories: Commercial-High traffic businesses, Commercial-Lo traffic businesses, Hotels and Motels, Industrial (which included farms), Institutional, and Retail. Businesses were assigned to these categories using SIC-code information obtained from the New Hampshire State Department of Labor Statistics. An attempt was made to group the data obtained from Dun & Bradstreet into the same categories; however, the number of employees in each category from both sets of data was substantially different. The total numbers of employees from each dataset (Dun & Bradstreet and SRTDM) for the entire TAZ zone, however, were within 100 employees 58 percent of the time. The differences between the two datasets may be due to (1) different businesses included in the New Hampshire State Department of Labor Statistics than were in Dun & Bradstreet,

(2) different number of employees associated with specific businesses, and (3) different locations assigned to businesses that would place employees in a different TAZ. These differences reflect slightly different approaches used by the compilers of the basic datasets on businesses and do not imply incorrect information or results for either approach but rather are a measure of the uncertainty or different objectives of the basic datasets. All categories of water use were combined into a non-domestic category for making water-demand projections.

In general, the projections for non-domestic water demand by TAZ for 2017 and 2025 were based on the relation between (1) the number of employees in the base year (2003) with the total non-domestic water demand and (2) the increase in employees for 2017 and 2025. An index to evaluate the reasonableness of applying this approach for all TAZs was created by comparing the non-domestic water-demand employee coefficient based on the Seacoast study water-demand employee numbers with a coefficient based on the SRTDM 2003 employee numbers. This approach worked well, except when the non-domestic water-demand employee coefficient was greater than 200 gal/d or less than 7 gal/d, the employee numbers were less than 10 with a five-fold increase in the number of employees, or if there were no employees counted in the TAZ for either data set. These conditions were handled by a series of methods described in table 13; the default procedure (described above) is listed as “Method Code 5” in the table.

Projections for 2017 were based on  
 $(\text{SRTDM 2017 employees} / \text{SRTDM 2003 employees}) \times 2003 \text{ water demand}$ .

Projections for 2025 were based on  
 $(\text{SRTDM 2025 employees} / \text{SRTDM 2003 employees}) \times 2003 \text{ water demand}$ .

Projections were based on the following assumptions: (1) commercial, industrial, irrigation, and mining activities in each TAZ will be the same types for the next 20 years; and (2) although the number of employees in the TAZ in 2003 based on this study and the SRTDM area may not agree, future water demand will depend on the rate of increase in employees projected by the SRTDM. Projections for the five towns outside the SRTDM were made by associating the increase in number of employees with other similar areas in the SRTDM as follows:

- Brookfield was associated with Wakefield,
- Candia and Deerfield were associated with western Nottingham and southern Northwood,
- Chester was associated with western parts of Fremont and Sandown, and
- Raymond was associated with Exeter and western parts of Epping and Fremont.

## Water-Use Databases

Water-use data reported to NHGS from registered users is stored in the USGS Site-Specific Water-Use Data System (SWUDS), which is part of the USGS National Water Information System. Town aggregates of domestic, commercial, and industrial water withdrawal, demand, and return flow also are stored in SWUDS. The design of SWUDS provides detailed tracking and analysis of measured and unmeasured water uses. The tracking allows the sources of withdrawal by CWSs to be linked through the distribution system in each town to the registered users and town aggregates of minor users, through the wastewater-collection system to the wastewater-treatment plants, and final discharge pipe to the water resources. Ground- and surface-water-use data stored in SWUDS also can be linked, using a common identifier, with inventory data stored in the USGS Ground-Water Site Information and water-quality databases. Data in SWUDS also can be associated with GIS coverages of town boundaries, distribution and collection systems, and maps of individual water withdrawal, demand, and return flow points.

A second database (fig. 7) is used to maintain data on the census-block estimates of water withdrawal, delivery, demand, consumptive use, release, and return flow by category of use because SWUDS cannot store information on census block-level aggregates. The Microsoft Access™ database includes tables on 2000 Census Block Population and Housing Data with each block referenced by a unique identification number (STFID) by which each census block is linked to data from the (1) 2003 Dun & Bradstreet Business Information Database, (2) 2003 Registered Water Use, (3) results of the annual, summer, and winter per capita water demand model, and (4) results of the Seacoast Regional Travel Demand Model. A series of 25 queries extract data from these tables to provide water withdrawal, demand, and return flow summaries by census block that can be aggregated by watershed or town. The census-block summaries can be updated for future applications by adding in new (1) census population data; (2) business information; (3) reported withdrawal or return flow; (4) coefficients or water-demand values for domestic, commercial, industrial, or irrigation use; or (5) projections of population or commercial growth.

## Estimates of 2003 Water Use and Projected Water Demand

Estimates of water use in 2003 and future water demand by category and type of water-use activity are summarized for the Seacoast region. Categories of water use are domestic and non-domestic, which includes commercial, industrial, irrigation (crop and golf course), mining, aquaculture, and thermoelectric power and hydroelectric power generation. Estimates of water use, CWS withdrawal and distribution, and CWWS wastewater collection and return flow are discussed in

**Table 13.** Methods used to project non-domestic water demand for the years 2017 and 2025 in the Seacoast region, New Hampshire.

[SRTDM, Seacoast Region Travel Demand Model; TAZ, Transportation Analysis Zone; 2003 water-demand employee, count of employees as determined in this study; 2003 SRTDM employee, count of employees in the SRTDM; gal/d, gallons per day; \*, multiply]

Method code	Problem	Description of method used in projection of 2017 and 2025 non-domestic water demand
1	SRTDM has 0 employees for 2003, 2017, and 2025 in the TAZ.	2017 water demand = 2003 water demand 2025 water demand = 2003 water demand
2	SRTDM employee coefficient is greater than 200 gal/d per employee AND number of 2003 water-demand employees much larger than the 2017 and 2025 employees.	2017 water demand = 2003 water demand 2025 water demand = 2003 water demand
3	SRTDM employee coefficient is greater than 200 gal/d per employee AND number of 2003 water-demand employees much larger than the 2017, but close to 2025 employees.	2017 water demand = 2003 water demand 2025 water demand = (2025 employees/2017 employees) * 2003 water demand
4	2003 water-demand estimate is only part of TAZ.	New 2017 employees = (2003 water-demand employees/2003 SRTDM employees) * 2017 employees New 2025 employees = (2003 water-demand employees/2003 SRTDM employees) * 2025 employees 2017 water demand = (new 2017 employees) * (2003 water-demand employee coefficient) 2025 water demand = (new 2025 employees) * (2003 water-demand employee coefficient)
5	2003 SRTDM employee is within 10 employees of the 2003 water-demand employees.	2017 water demand = (2017 employees/2003 SRTDM employees) * 2003 water demand 2025 water demand = (2025 employees/2003 SRTDM employees) * 2003 water demand
6	2003 water demand = 0.	2017 water demand = 2017 employees * average 2003 water-demand employee coefficient for town 2025 water demand = 2025 employees * average 2003 water-demand employee coefficient for town
7	SRTDM employee coefficient is less than 7 gal/d per employee.	Adjusted 2003 water demand = ((2003 water-demand employees + 2003 SRTDM employees)/2) * 2003 water-demand employee coefficient 2017 water demand = (2017 employees/2003 SRTDM employees) * adjusted 2003 water demand 2025 water demand = (2025 employees/2003 SRTDM employees) * adjusted 2003 water demand
8	2003 SRTDM employee is less than 10 and 2017 employees is more than 5 times the number of 2003 SRTDM employees.	2017 water demand = (2017 employees/((2003 water-demand employees + 2003 SRTDM employees)/2)) * 2003 water demand 2025 water demand = (2025 employees/((2003 water-demand employees + 2003 SRTDM employees)/2)) * 2003 water demand
9	SRTDM employee coefficient is less than 7 gal/d per employee AND 2003 water-demand employee coefficient is less than 10 gal/d per employee.	2017 water demand = 2017 employees * average 2003 water-demand employee coefficient for town 2025 water demand = 2025 employees * average 2003 water-demand employee coefficient for town
11	Not in SRTDM model area.	2017 water demand = (2017 employees/2003 employees) * 2003 water demand. 2017 employees projected from 2003 employees based on projections in neighboring TAZs 2025 water demand = (2025 employees/2003 employees) * 2003 water demand. 2025 employees projected from 2003 employees based on projections in neighboring TAZs



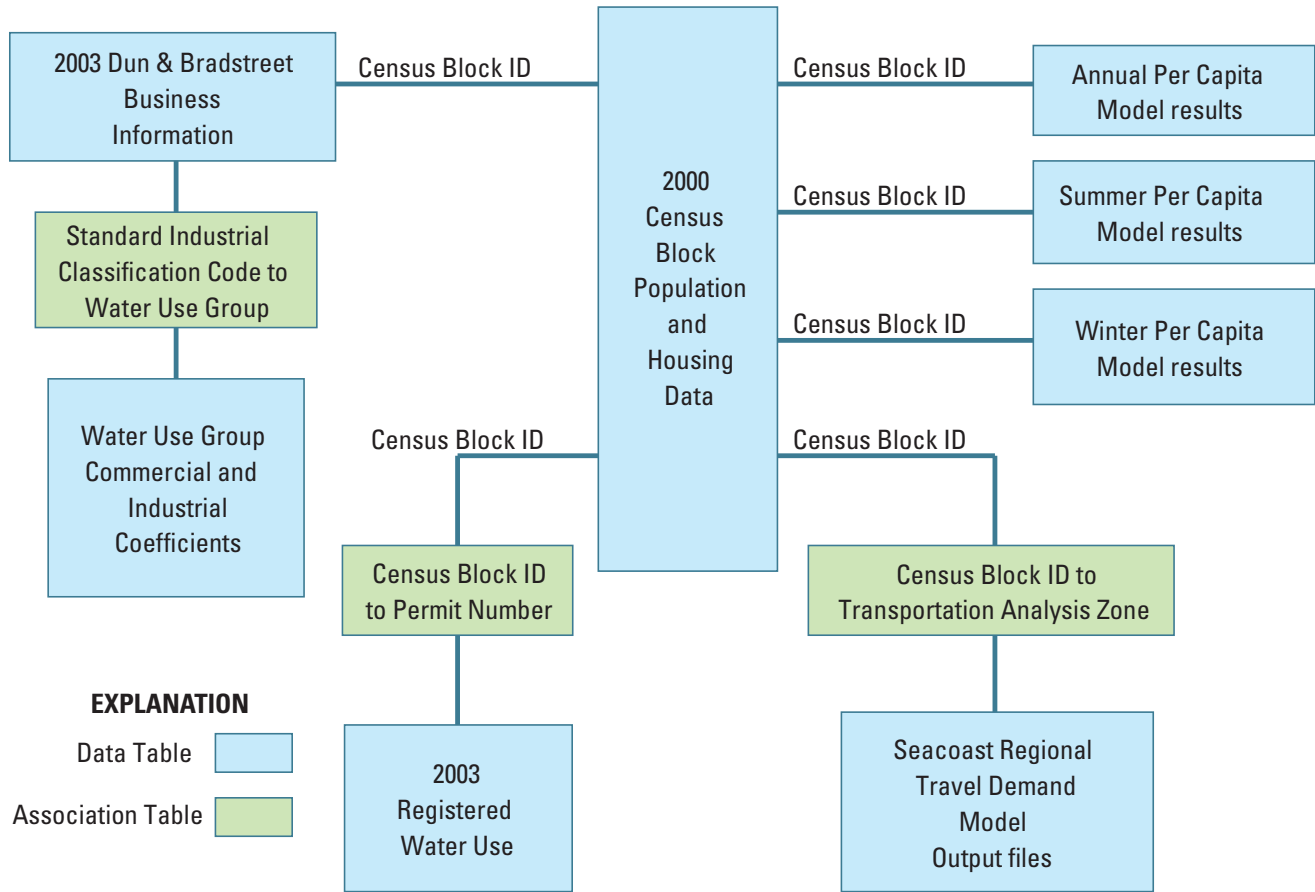

Figure 7. Table structure of the Seacoast Census Water-Use Database.

reference to towns. Estimates of water use are also discussed by subbasin. Total water use is summarized for the Seacoast region, including water withdrawal, delivery, demand, consumptive use, release, return flow, unaccounted-for use, and inflow and infiltration. Estimates of domestic and non-domestic water demand, projected approximately 10 years (2017) and 20 years (2025), are discussed, by TAZ.

**Towns, 2003**

Estimates of water use in 2003, by town, are discussed for domestic, commercial, industrial and other non-domestic water-use categories by water demand and consumptive use, proportion of public supply and self supply that meets this water demand, and the proportion of wastewater that is released to wastewater collection systems or on-site systems for return flow. Withdrawal, delivery, and unaccounted-for use by multi-use CWS are discussed, as well as release, inflow and infiltration to and return flow from CWWS. Finally, a summary of imports and exports between towns completes the description of water use in 2003 by town.

**Domestic Water Use**

Total domestic water demand for the Seacoast region in 2003 was 19.0 million gallons per day (Mgal/d) (table 14), which includes water demand by summer-only residents and added 0.4 Mgal/d. Table 14 was developed by adding the total domestic water demand for all census blocks in each town and dividing by the town population, resulting in a town mean per capita water-demand coefficient. The range of predicted census block mean per capita water-demand coefficients from 10 percent to 90 percent (table 14) shows the variation that likely occurs in the town. The broadest ranges in per capita water-demand coefficients occurred in Newington (48 gal/d to 107 gal/d) and Rye (80 gal/d to 134 gal/d). The narrowest range in per capita water-demand coefficients occurred in Candia (66 gal/d to 90 gal/d). The lowest range in per capita water-demand coefficients occurred in Sandown (48 gal/d to 82 gal/d). The highest range in per capita water-demand coefficients occurred in New Castle (87 gal/d to 131 gal/d).

**Table 14.** Town mean annual domestic per capita water-demand coefficients, estimated domestic demand, and domestic withdrawal in 2003 by town in the Seacoast region, New Hampshire.

[Location of towns shown in figure 1. gal/d, gallons per day; %, percent; Mgal/d, million gallons per day]

Town name	Town mean annual per capita water-demand coefficient, in gal/d	Range of predicted census block per capita water demand coefficients from 10 to 90%	Population			Domestic water use, in Mgal/d	
			Total	Self-supplied	Percent self-supplied	Demand (public and self supply)	Withdrawal (self supply only)
Barrington	78.6	66–109	7,475	6,326	85	0.587	0.495
Brentwood	71.4	55–86	3,197	2,588	81	.228	.186
Brookfield	83.4	70–107	535	524	98	.044	.043
Candia	72.5	66–90	2,491	2,491	100	.181	.181
Chester	67.8	54–91	3,196	2,851	89	.217	.195
Danville	68.4	58–82	574	379	66	.039	.025
Deerfield	72.0	58–101	3,089	2,992	97	.223	.216
Dover	76.2	60–94	26,884	1,719	6	2.047	.111
Durham	62.3	49–92	12,664	2,680	21	.731	.193
East Kingston	74.1	64–89	1,458	1,339	92	.108	.098
Epping	70.5	55–94	5,476	3,731	68	.386	.257
Exeter	75.8	58–94	14,058	1,391	10	1.061	.095
Farmington	78.6	60–103	5,769	2,958	51	.453	.226
Fremont	68.8	55–85	3,510	3,274	93	.241	.225
Greenland	73.3	60–93	3,208	1,842	57	.235	.130
Hampstead	62.3	55–89	825	550	67	.051	.034
Hampton <sup>1</sup>	80.0	63–114	14,937	1,652	11	1.363	.128
Hampton Falls	83.0	58–98	1,880	1,859	99	.156	.154
Kensington	75.6	57–95	1,841	1,841	100	.139	.139
Kingston	72.6	58–89	1,344	1,344	100	.098	.098
Lee	74.5	57–94	4,145	3,702	89	.309	.273
Madbury	72.8	58–85	1,509	1,498	99	.110	.109
Middleton <sup>1</sup>	71.1	61–86	1,440	1,317	91	.119	.109
Milton <sup>1</sup>	74.0	59–92	3,910	2,876	74	.304	.232
New Castle	111.4	87–131	1,010	0	0	.113	.000
New Durham <sup>1</sup>	70.8	59–88	1,147	1,147	100	.090	.090
Newfields	67.4	55–96	1,551	912	59	.105	.061
Newington	85.4	48–107	775	61	8	.066	.006
Newmarket	73.6	55–94	8,027	1,501	19	.591	.104
North Hampton	84.3	68–118	4,259	880	21	.359	.070
Northwood <sup>1</sup>	80.3	64–94	1,787	1,544	86	.152	.134
Nottingham <sup>1</sup>	75.8	62–111	3,701	3,701	100	.296	.296
Portsmouth	83.9	64–114	20,784	97	0	1.734	.006
Raymond	67.9	55–88	9,674	5,756	59	.657	.378
Rochester	69.5	55–85	28,461	4,325	15	1.972	.308
Rollinsford	70.0	54–90	2,648	812	31	.185	.053
Rye <sup>1</sup>	97.1	80–134	5,182	166	3	.533	.019
Sandown	61.0	48–82	4,002	3,556	89	.244	.213
Seabrook <sup>1</sup>	75.9	58–105	7,893	178	2	.633	.012
Somersworth	69.8	56–87	11,477	152	1	.801	.010
South Hampton	80.6	63–98	695	695	100	.056	.056
Strafford <sup>1</sup>	71.9	58–88	3,224	3,148	98	.251	.245
Stratham	71.1	54–91	6,355	4,577	72	.452	.313
Wakefield <sup>1</sup>	70.9	69–97	2,858	1,934	68	.276	.200
<b>Total or average</b>	<b>74.6</b> <sup>2</sup>	<b>58–101</b>	<b>250,925</b>	<b>88,866</b>	<b>35</b>	<b>18.996</b>	<b>6.526</b>

<sup>1</sup> Includes demand and withdrawal by summer-only residents.<sup>2</sup> Predicted mean per capita from the per capita water-demand model.

The town mean annual per capita water-demand coefficient ranged from 61 gal/d in Sandown to 111 gal/d in New Castle with a mean of 75 gal/d over the Seacoast region (table 14; fig. 8A). The range of mean annual per capita water-demand coefficients at the 95-percent confidence interval was from 70.5 gal/d to 78.8 gal/d, resulting in a Seacoast region total for domestic water demand ranging from 18.0 Mgal/d to 20.1 Mgal/d.<sup>1</sup> The highest town mean annual per capita water-demand coefficient is along the coast—8 of the 12 towns in the highest quartile (top 75th percentile) are on the coast (fig. 8B). The towns with the highest mean annual per capita water demand coefficient had (1) older housing units, (2) higher housing unit median values, (3) lower population per housing unit, and (4) lower percentage of urban housing units.

Although 65 percent of the population is on public supply, only 6.5 Mgal/d is withdrawn from private household wells throughout the Seacoast region, concentrated in areas with high development and no or limited available public supplies. Most of the withdrawal are from bedrock aquifers. The remaining 12.5 Mgal/d was from public supply from surface water and stratified-drift and bedrock aquifers.

The cities with the largest populations, Rochester, Dover, and Portsmouth, stand out on the population by town map (fig. 9A), in contrast to the southern interior of towns with very low populations. The distribution of domestic water demand by town (fig. 9B) is very similar to the map of population by town because, at the town scale, the population has a more pronounced effect on the total domestic water demand than the per capita water-demand coefficient. The distribution of population on self supply increases away from the coast (fig. 9C). The distribution of domestic self-supplied water demand (withdrawal) by town (fig. 9D) is strongly influenced by the self-supplied population.

The per capita water-demand model was used to develop a summer domestic per capita water-demand coefficient for

<sup>1</sup> The census blocks with the highest and lowest predicted per capita water-demand coefficients were reviewed to determine if the results of the per capita water-demand model were reasonable. The model predictions were abnormally low (from less than 1 gal/d to 33 gal/d) in 14 census blocks because high population per housing unit values (from 6 to 81) occurred in dormitories and group housing. The model predictions were abnormally high (from 251 gal/d to 825 gal/d) in 5 census blocks because very high housing densities (from 29,000 to 111,000 houses per square mile) occurred when a large apartment building was in a very small census block. The predicted per capita water-demand coefficients were changed to more moderate values consistent with neighboring census blocks. The adjustment in the 19 census blocks had a noticeable impact in Durham, Portsmouth, and Dover totals for domestic water demand.

The total domestic water demand without the summer-only population (18.6 Mgal/d) was calculated as the sum of the per capita water-demand coefficients for each census block multiplied by the population in that census block. It thus includes the 19 adjusted values. The mean per capita water-demand coefficient determined in this manner is 74.25 gal/d. However, the predicted mean per capita water-demand coefficient from the model, which excluded the 19 adjusted census block values, is 74.6 gal/d. The 95-percent confidence interval is calculated to range from 70.5 gal/d to 78.8 gal/d. Domestic demand in the Seacoast region is 19.0 Mgal/d, including 0.4 Mgal/d for the summer-only population, with a 95-percent confidence interval ranging from 18.0 Mgal/d to 20.1 Mgal/d.

each census block to determine the potential for increased water demand during the summer. The town mean summer per capita water-demand coefficients ranged from 75 gal/d in Sandown to 152 gal/d in New Castle and had an mean of 92 gal/d over the Seacoast region (table 15). Total domestic water demand increased from an annual mean of 19.0 Mgal/d to 26.0 Mgal/d during the summer due to a combination of increased per capita water-demand coefficients (which accounted for 23.2 Mgal/d) and increased summer population which accounted for 2.8 Mgal/d (see discussion of summer population, p. 8).

The per capita water-demand model was used to develop a winter per capita water-demand coefficient for each census block to determine an estimate for domestic consumptive use. The town mean winter per capita water-demand coefficient ranged from 51 gal/d in Sandown to 78 gal/d in New Castle with mean of 63 gal/d over the Seacoast region. Total domestic water demand decreased to 15.7 Mgal/d during the winter.

Domestic consumptive use is estimated as the difference between annual domestic water demand and winter domestic water demand. Virtually all household use during the winter is indoor during which there is little evaporation occurring, with the exception of humidifiers, which can account for up to 1 percent of per capita water demand. Summer water demand is strongly influenced by outdoor water demand, particularly lawn and garden watering; pool-water replacement; and car, driveway, patio, and sidewalk washing, which increases transpirative and evaporative losses substantially. The transitional months of March to May and September to November experience rates of consumptive use that reflect the average values between winter and summer. Town mean annual domestic consumptive use ranged from 10 percent in Durham to 30 percent in New Castle, with a Seacoast regional mean of 16 percent, which translates to a loss of 3.0 Mgal/d over the entire Seacoast region (table 16). Town mean summer domestic consumptive use ranged from 22 percent in Somersworth to 49 percent in New Castle, with a Seacoast regional mean of 39 percent (table 15), which translates to loss at a rate of 10 Mgal/d over the Seacoast region during the summer.

In 2003, about 52 percent of the domestic population (130,357) relied on septic systems and returned 8.0 Mgal/d of wastewater directly to the glacial deposits through septic systems (table 16). The remaining population (120,568) released 8.0 Mgal/d into 17 wastewater-collection systems, after which the wastewater was treated and returned primarily to surface waters. About 30,513 (12 percent) people who have water supplied through domestic CWSs relied on septic systems.

## Commercial Use

Total commercial water demand for the Seacoast region in 2003 was 3.7 Mgal/d (table 17). About 74 percent (2.8 Mgal/d) of commercial water demand was provided through the 18 multi-use CWSs. About 0.3 Mgal/d was withdrawn from the Exeter River and 0.6 Mgal/d was



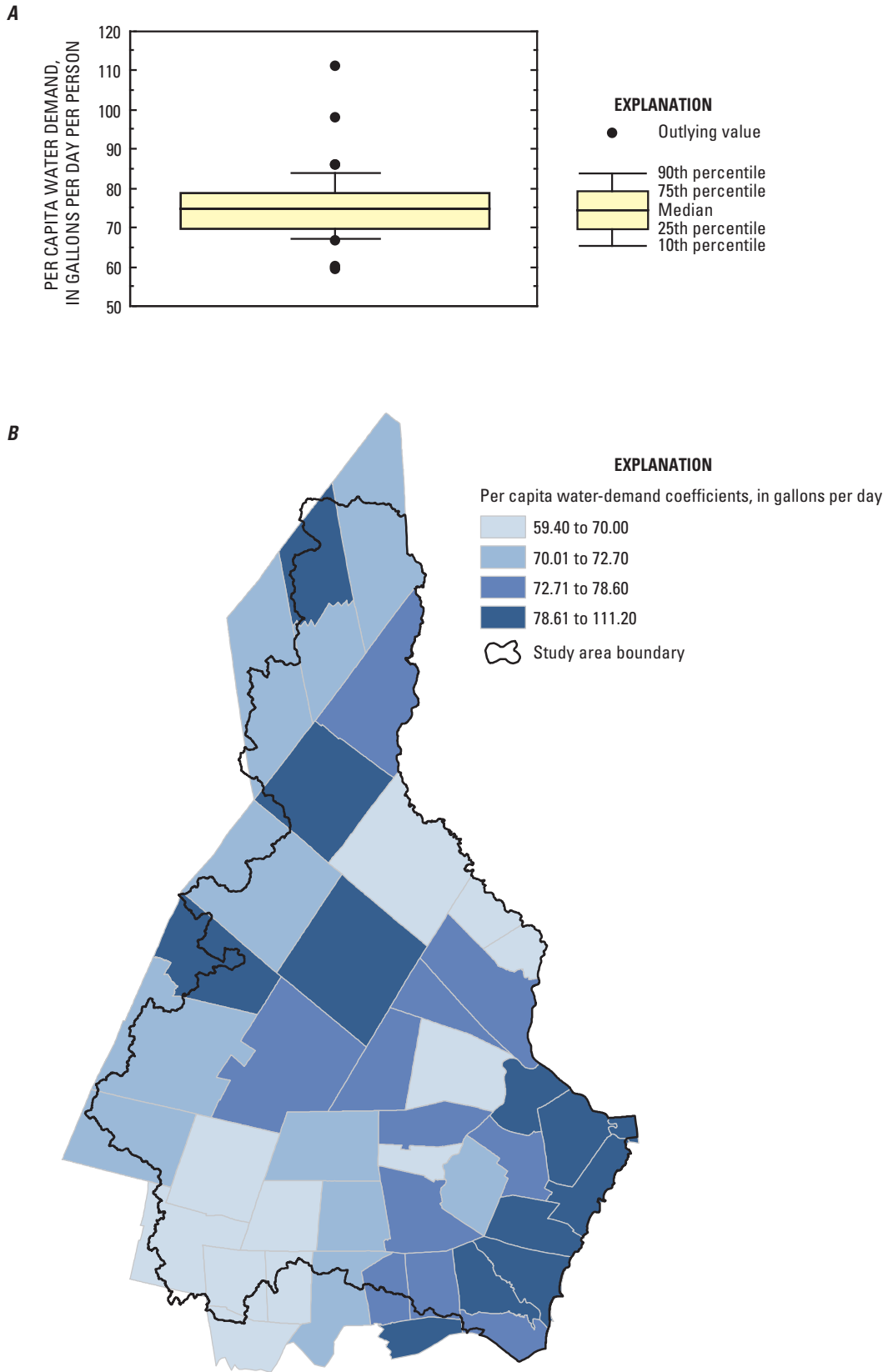

**Figure 8.** (A) Distribution of town mean annual domestic per capita water-demand coefficients in the Seacoast region, and (B) map showing town mean annual domestic per capita water-demand coefficients from the per capita water-demand model.

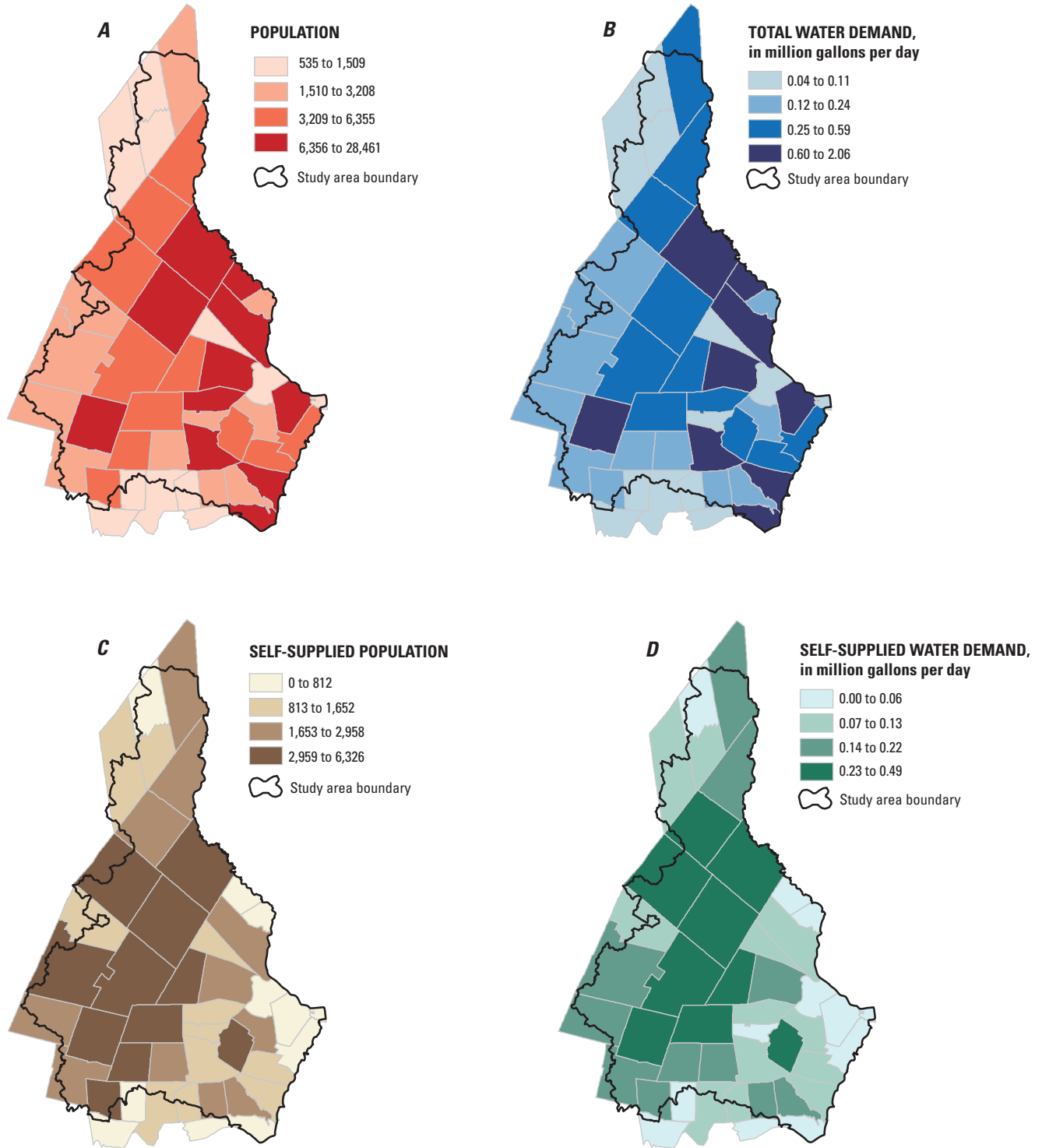

**Figure 9.** Domestic water-demand and population data by town for (A) population, (B) total water demand, (C) self-supplied population, and (D) self-supplied water demand.

**Table 15.** Town mean annual, summer, and winter domestic per capita water-demand coefficients and consumptive use in 2003 by town in the Seacoast region, New Hampshire.

[Location of towns shown in figure 1. gal/d, gallons per day; Mgal/d, million gallons per day]

Town name	Population	Annual water demand, in Mgal/d	Town mean domestic per capita water-demand coefficient, in gal/d			Percent consumptive use		Ratio summer demand to annual demand
			Annual	Summer	Winter	Annual	Summer	
Barrington	7,475	0.587	78.6	106.0	64.5	18	39	1.35
Brentwood	3,197	.228	71.4	94.7	59.5	17	37	1.33
Brookfield	535	.044	83.4	112.4	69.3	17	38	1.35
Candia	2,491	.181	72.5	98.1	59.5	18	39	1.35
Chester	3,196	.217	67.8	92.1	54.5	20	41	1.36
Danville	574	.039	68.4	86.5	55.9	18	35	1.27
Deerfield	3,089	.223	72.0	97.6	58.8	18	40	1.36
Dover	26,884	2.047	76.2	88.0	65.9	14	25	1.16
Durham	12,664	.731	62.3	81.9	56.1	10	32	1.32
East Kingston	1,458	.108	74.1	100.7	59.4	20	41	1.36
Epping	5,476	.386	70.5	89.3	58.8	17	34	1.27
Exeter	14,058	1.061	75.8	90.5	64.0	16	29	1.19
Farmington	5,769	.453	78.6	104.0	67.2	15	35	1.32
Fremont	3,510	.241	68.8	91.8	55.9	19	39	1.33
Greenland	3,208	.235	73.3	92.9	58.7	20	37	1.27
Hampstead	825	.051	62.3	73.9	50.9	18	31	1.19
Hampton <sup>1</sup>	14,937	1.363	80.0	94.3	66.9	16	29	1.18
Hampton Falls	1,880	.156	83.0	115.4	64.1	23	44	1.39
Kensington	1,841	.139	75.6	104.6	60.0	21	43	1.38
Kingston	1,344	.098	72.6	93.8	59.5	18	37	1.29
Lee	4,145	.309	74.5	101.3	60.1	19	41	1.36
Madbury	1,509	.110	72.8	97.2	59.0	19	39	1.34
Middleton <sup>1</sup>	1,440	.119	71.1	94.5	59.5	16	37	1.33
Milton <sup>1</sup>	3,910	.304	74.0	94.3	62.9	15	33	1.28
New Castle	1,010	.113	111.4	151.8	77.6	30	49	1.36
New Durham <sup>1</sup>	1,147	.090	70.8	94.9	58.7	17	38	1.34
Newfields	1,551	.105	67.4	87.6	54.1	20	38	1.30
Newington	775	.066	85.4	119.3	66.3	22	44	1.40
Newmarket	8,027	.591	73.6	87.8	63.0	14	28	1.19
North Hampton	4,259	.359	84.3	113.4	65.5	22	42	1.35
Northwood <sup>1</sup>	1,787	.152	80.3	108.1	67.1	16	38	1.35
Nottingham <sup>1</sup>	3,701	.296	75.8	102.9	61.6	19	40	1.36
Portsmouth	20,784	1.734	83.9	95.6	70.8	16	26	1.14
Raymond	9,674	.657	67.9	84.4	57.3	16	32	1.24
Rochester	28,461	1.972	69.5	81.4	60.4	13	26	1.17
Rollinsford	2,648	.185	70.0	82.1	60.4	14	26	1.17
Rye <sup>1</sup>	5,182	.533	97.1	130.5	74.9	23	43	1.34
Sandown	4,002	.244	61.0	74.7	50.5	17	32	1.23
Seabrook <sup>1</sup>	7,893	.633	75.9	89.8	62.8	17	30	1.18
Somersworth	11,477	.801	69.8	79.4	61.7	12	22	1.14
South Hampton	695	.056	80.6	112.2	63.9	21	43	1.39
Strafford <sup>1</sup>	3,224	.251	71.9	96.8	59.3	18	39	1.35
Stratham	6,355	.452	71.1	92.2	56.6	20	39	1.30
Wakefield <sup>1</sup>	2,858	.276	70.9	106.1	59.3	16	44	1.50
<b>Total or average</b>	<b>250,925</b>	<b>18.996</b>	<b>74.6</b>	<b>92.3</b>	<b>62.7</b>	<b>16</b>	<b>39</b>	<b>1.24</b>

<sup>1</sup> Includes demand by summer-only residents.

**Table 16.** Town mean annual domestic per capita consumptive-use coefficient, estimated domestic water demand, return and sewer flow, and consumptive use in 2003 by town in the Seacoast region, New Hampshire.

[Location of towns shown in figure 1. Mgal/d, million gallons per day; --, not applicable]

Town name	Town mean annual per capita consumptive use, in percent	Population			Domestic water use, in Mgal/d			
		Total	Septic	Percent on septic	Total demand	Return flow	Sewer flow	Consumptive use
Barrington	18	7,475	7,475	100	0.587	0.482	--	0.105
Brentwood	17	3,197	2,588	81	.228	.149	0.041	.038
Brookfield	17	535	535	100	.044	.037	--	.007
Candia	18	2,491	2,491	100	.181	.148	--	.032
Chester	20	3,196	3,196	100	.217	.174	--	.042
Danville	18	574	574	100	.039	.032	--	.007
Deerfield	18	3,089	3,089	100	.223	.182	--	.041
Dover	14	26,884	5,584	21	2.047	.332	1.439	.276
Durham	10	12,664	3,372	27	.731	.193	.464	.073
East Kingston	20	1,458	1,458	100	.108	.087	--	.021
Epping	17	5,476	4,602	84	.386	.267	.055	.064
Exeter	16	14,058	2,262	16	1.061	.131	.764	.166
Farmington	15	5,769	3,463	60	.453	.223	.165	.066
Fremont	19	3,510	3,510	100	.241	.196	--	.045
Greenland	20	3,208	3,208	100	.235	.188	--	.047
Hampstead	18	825	825	100	.051	.042	--	.009
Hampton <sup>1</sup>	16	14,937	2,081	14	1.363	.130	1.010	.223
Hampton Falls	23	1,880	1,880	100	.156	.119	--	.036
Kensington	21	1,841	1,841	100	.139	.110	--	.029
Kingston	18	1,344	1,344	100	.098	.080	--	.018
Lee	19	4,145	4,145	100	.309	.249	--	.060
Madbury	19	1,509	1,509	100	.110	.089	--	.021
Middleton <sup>1</sup>	16	1,440	1,440	100	.119	.099	--	.020
Milton <sup>1</sup>	15	3,910	3,385	87	.304	.226	.033	.046
New Castle	30	1,010	492	49	.113	.037	.041	.034
New Durham <sup>1</sup>	17	1,147	1,147	100	.090	.074	--	.015
Newfields	20	1,551	1,083	70	.105	.058	.026	.021
Newington	22	775	700	90	.066	.046	.005	.015
Newmarket	14	8,027	2,383	30	.591	.137	.368	.085
North Hampton	22	4,259	4,259	100	.359	.279	--	.080
Northwood <sup>1</sup>	16	1,787	1,787	100	.152	.127	--	.025
Nottingham <sup>1</sup>	19	3,701	3,701	100	.296	.241	--	.055
Portsmouth	16	20,784	1,034	5	1.734	.080	1.385	.269
Raymond	16	9,674	9,674	100	.657	.554	--	.103
Rochester	13	28,461	13,366	47	1.972	.792	.923	.258
Rollinsford	14	2,648	1,397	53	.185	.080	.080	.025
Rye <sup>1</sup>	23	5,182	4,103	79	.533	.324	.087	.123
Sandown	17	4,002	4,002	100	.244	.202	--	.042
Seabrook <sup>1</sup>	17	7,893	67	1	.633	.004	.547	.110
Somersworth	12	11,477	2,581	22	.801	.144	.564	.093
South Hampton	21	695	695	100	.056	.044	--	.012
Strafford <sup>1</sup>	18	3,224	3,224	100	.251	.206	--	.044
Stratham	20	6,355	6,355	100	.452	.360	--	.092
Wakefield <sup>1</sup>	16	2,858	2,450	86	.276	.202	.028	.045
<b>Total or average</b>	<b>16</b>	<b>250,925</b>	<b>130,357</b>	<b>52</b>	<b>18.996</b>	<b>7.956</b>	<b>8.025</b>	<b>3.038</b>

<sup>1</sup> Includes demand and return flow by summer-only residents.

withdrawn from bedrock aquifers. Water withdrawn from the Exeter River was used for an ice rink, and the same volume was estimated to be returned to the Exeter River. Estimated consumptive use accounts for about 0.4 Mgal/d. About 64 percent of the 3.3 Mgal/d of commercial wastewater (2.1 Mgal/d) was released into the 17 CWWs. Approximately 0.9 Mgal/d was returned to the surficial aquifers through septic systems.

In general, commercial water demand was relatively evenly divided among the major groups identified in table 17. Offices and businesses together accounted for about 36 percent of commercial water demand and included 55 percent of the commercial facilities (table 17). Schools accounted for 19 percent of commercial water demand, primarily due to water used for an ice rink at one school. Excluding the ice rink, schools would have accounted for 12 percent of commercial water demand. Restaurants accounted for 8 percent of commercial water demand in 7 percent of the facilities. Nursing homes accounted for 9 percent of the total commercial water demand in less than 1 percent of the facilities—most of the water demand was in the Rockingham County Home, which is also considered a CWS with a major commercial component. Motels and hotels accounted for 8 percent of commercial water demand in 2 percent of the facilities. Medical facilities, ranging from doctor offices to hospitals, accounted for 8 percent of commercial water demand in 6 percent of the commercial facilities.

## Industrial Water Use

Total annual industrial water demand for the Seacoast region in 2003 was 2.9 Mgal/d (table 18). About 64 percent (1.8 Mgal/d) of industrial water demand was provided through the 18 multi-use CWSs. About 0.2 Mgal/d was withdrawn from the Salmon Falls and North Rivers, 0.1 Mgal/d from the surficial aquifer, and 0.7 Mgal/d from bedrock aquifers. Estimated consumptive use accounts for about 0.6 Mgal/d. About 64 percent of industrial wastewater (1.5 Mgal/d) was released to the 17 CWWs, 0.2 Mgal was return directly to surface water, and 0.6 Mgal/d was returned to the surficial aquifers through leach fields/septic systems.

In the Seacoast region, three SIC-code groups accounted for 42 percent of industrial water-demand—paper; electrical equipment; and stone, clay, glass, and concrete (table 18). The paper group accounted for 0.50 Mgal/d (18 percent of industrial water demand). The electric equipment group accounted for 0.36 Mgal/d (12 percent of industrial water demand). The stone, clay, glass, and concrete group accounted for 0.34 Mgal/d (12 percent of industrial water demand).

## Other Non-Domestic Water Use

Hydroelectric, thermoelectric, irrigation, mining, and aquaculture water use were determined primarily from reported data on registered users, although some irrigation water demand was estimated through a combination of values

**Table 17.** Commercial water demand and number of facilities by group, 2003, in the Seacoast region, New Hampshire.

[Mgal/d, million gallons per day]

Commercial type	Water demand, in Mgal/d	Percentage of total commercial demand	Number of facilities
Stores	0.24	6	650
Restaurants	.29	8	249
Motel/hotel	.30	8	63
Businesses	.65	17	1,055
Nursing homes	.32	9	31
Medical facilities	.27	7	219
Schools	.69	19	223
Offices	.70	19	853
Other	.26	7	120
<b>Total</b>	<b>3.72</b>	<b>100</b>	<b>3,463</b>

derived from metered as well as reported data from registered users (table 19).

There are six hydroelectric plants in the Seacoast region—two on the Cocheco River (173 Mgal/d) and four on the Salmon Falls River (370 Mgal/d). A total of 542 Mgal/d was withdrawn from and returned immediately to the Cocheco and Salmon Falls Rivers for hydroelectric power generation in 2003. No consumptive use is assumed to have occurred.

The nuclear thermoelectric plant in Seabrook withdrew 607 Mgal/d from the Atlantic Ocean and returned approximately the same volume (return flow is not measured as precisely). The fossil-fuel thermoelectric plant in Newington withdrew 200 Mgal/d from the Piscataqua River. Both plants received about 0.23 Mgal/d from the local CWS, some of which was treated and released into the river and some of which was released to the local sewer system. The once-through cooling system has virtually no consumptive use, but the general plant operations consumptively used 0.13 Mgal/d.

Mean annual irrigation water demand was 0.35 Mgal/d during 2003. Consumptive use was estimated as 90 percent for irrigation through evaporation during application, evapotranspiration by the plants during growth, evaporation of water in the upper soil layers, or runoff evaporation. Approximately 90 percent of the irrigation water demand was for 15 golf courses and 1 recreational field in Barrington, Dover, Durham, East Kingston, Exeter, Farmington, Greenland, Newmarket, North Hampton, Portsmouth, Rochester, Rye, and Stratham, most of which report to NHGS. Plant nurseries make up the remaining 10 percent.

Mean annual mining water demand was 0.10 Mgal/d during 2003 and took place in Farmington during sand and gravel washing. Mining water use is reported to NHDES. Aquaculture water-use activities occur in Rye and Newington and account for almost 0.01 Mgal/d coming from public supply. Consumptive use was assumed to be negligible.

**Table 18.** Industrial water demand and number of facilities by group, 2003, in the Seacoast region, New Hampshire.

[Mgal/d, million gallons per day]

<b>Two-digit Standard Industrial Classification category and [code]</b>	<b>Water demand, in Mgal/d</b>	<b>Percentage of total industrial demand</b>	<b>Number of facilities</b>
Food [20], except 208	0.235	8	13
Beverage [208]	.162	6	8
Textile mill products [22]	.111	4	8
Apparel [23]	.095	3	6
Lumber and wood [24]	.012	0	10
Furniture [25]	.004	0	5
Paper [26]	.504	18	11
Printing [27]	.024	1	38
Chemicals [28]	.179	6	16
Petroleum [29]	.057	2	1
Rubber [30]	.163	6	20
Leather [31]	.228	8	8
Stone, clay, glass, and concrete [32]	.335	12	12
Primary metal [33]	.156	5	8
Fabricated metal [34]	.080	3	34
Machinery [35]	.129	5	41
Electrical equipment [36]	.356	12	34
Transportation equipment [37]	.006	0	5
Instruments [38]	.019	1	21
Jewelry, precious metals [39]	.008	0	9
<b>Total</b>	<b>2.863</b>	<b>100</b>	<b>308</b>

## Community Water Systems

There are 122 CWSs in the Seacoast region. About 84 percent (103) of these systems are domestic CWSs serving only domestic users in trailer parks, condominiums, and residential developments. The remaining 19 CWSs are multi-use CWSs serving a mix of domestic, commercial, industrial, and irrigation users. Eleven of 103 domestic CWSs and all multi-use CWSs in the Seacoast region are registered with the NHGS, with data on reported withdrawal in WATUSE; however, one multi-use system and three domestic CWS did not report withdrawal to NHGS in 2003 and had to be estimated. The remaining 92 domestic CWSs are unregistered; therefore, their water withdrawal were estimated.

Multi-use CWSs are complex and include one or more of the following components:

- Distribution systems, by town;
- Interconnections to distribution systems owned by other CWSs for imports or exports;
- Registered users; and
- Aggregates of minor domestic, commercial, industrial, and irrigation users in each town.

Population-served data are reported to the NHDWGB for each CWS and were obtained for the year 2003. These values were compared with the 2000 census data and the community water distribution system GIS coverage. Population-served values were modified as necessary to conform to the 2000 census distribution in each census block. The results of the multi-use CWS population served data are presented in table 20 and for all CWS in the town tables (appendix 2). The population served by multi-use CWSs was 149,455 (60 percent of the total population in the Seacoast region).



**Table 19.** Summary of water demand, withdrawal, return flow by hydroelectric, thermoelectric, irrigation, mining, and aquaculture users in 2003 by town in the Seacoast region, New Hampshire.

[Location of towns shown in figure 1. Units are in million gallons per day; --, rate of water withdrawal, demand, or return flow less than 49 gallons per day]

Town	Demand	Withdrawal		Return flow		Consumptive use
		Ground	Surface	Ground	Surface	
<b>Hydroelectric</b>						
Dover	0.000	--	172.937	--	172.937	0.000
Milton	.000	--	13.219	--	13.219	.000
Rollinsford	.000	--	131.181	--	131.181	.000
Somersworth	.000	--	224.880	--	224.880	.000
<b>Total</b>	<b>.000</b>	<b>--</b>	<b>542.217</b>	<b>--</b>	<b>542.217</b>	<b>.000</b>
<b>Thermoelectric</b>						
Newington	0.118	--	199.943	--	200.029	0.032
Seabrook	.108	--	--	--	--	.098
<b>Total</b>	<b>.226</b>	<b>--</b>	<b>199.943</b>	<b>--</b>	<b>200.029</b>	<b>.130</b>
<b>Golf Course and Recreational Field Irrigation</b>						
Barrington	0.027	0.013	0.013	0.003	--	0.024
Dover	.023	--	.023	.002	--	.021
Durham	.002	.002	--	.000	--	.002
East Kingston	.007	.007	--	.001	--	.007
Exeter	.008	--	.008	.001	--	.007
Farmington	.009	--	.009	.001	--	.008
Greenland	.051	.002	.022	.005	--	.046
Newmarket	.024	--	--	.002	--	.022
North Hampton	.025	.015	.009	.002	--	.022
Portsmouth	.024	--	--	.002	--	.022
Rochester	.015	--	.015	.002	--	.014
Rye	.050	--	.022	.005	--	.045
Stratham	.053	.053	--	.005	--	.047
<b>Total</b>	<b>.318</b>	<b>.092</b>	<b>.121</b>	<b>.031</b>	<b>--</b>	<b>.287</b>
<b>Nursery and Crop Irrigation</b>						
Brentwood	0.001	0.001	--	0.000	--	0.001
Deerfield	.002	.002	--	.000	--	.002
Dover	.003	.001	0.002	.000	--	.003
Epping	.002	.002	--	.000	--	.002
Exeter	.001	--	--	.000	--	.001
Greenland	.000	.000	--	.000	--	.000
Hampton	.001	.001	--	.000	--	.000
Hampton Falls	.003	.003	--	.000	--	.002
Lee	.001	.001	--	.000	--	.000
North Hampton	.001	--	--	.000	--	.001
Portsmouth	.001	--	--	.000	--	.001
Raymond	.004	.001	.002	.000	--	.003
Rochester	.003	.001	--	.000	--	.002
Rollinsford	.002	.002	--	.000	--	.002
Rye	.002	--	--	.000	--	.002
Somersworth	.001	--	--	.000	--	.000
South Hampton	.001	.001	--	.000	--	.000
Stratham	.003	.003	--	.000	--	.003
<b>Total</b>	<b>.032</b>	<b>.019</b>	<b>.004</b>	<b>.003</b>	<b>--</b>	<b>.025</b>
<b>Mining</b>						
Farmington	0.096	--	0.096	--	0.096	0.000
<b>Aquaculture</b>						
Newington	0.003	--	--	--	--	0.000
Rye	.003	--	--	.001	--	.001

**Table 20.** Multi-use community water system sources of supply, population served, distribution, and unaccounted-for water in 2003 in the Seacoast region, New Hampshire.  
 [Location of towns shown in figure 1. Mgal/d, million gallons per day; PWSID, Public Water Supply Identification; DES\_ID, New Hampshire Department of Environmental Services Water Registration Identification. Source of data on withdrawal rate: New Hampshire Geological Survey WATUSE database]

Resource	Withdrawal rate, in Mgal/d	PWSID	DES_ID	Water system and distribution area	Population served estimate	Distribution rate, in Mgal/d	Unaccounted for water, in percent
Surficial aquifer	0.073	NH0284010	20157	Rockingham County Complex	609	0.072	1
Isinglass River withdrawn and then recharged to surficial aquifer	(1.444)	NH0651010	20006	Dover Water Department - Dover	25,165	2.428	-12
Surficial aquifer	2.173			Rollinsford	209	.015	
Lamprey River	.330	NH0691010	20113	University of New Hampshire/Durham	9,770	.661	37
Oyster River	.576						
Surficial aquifer	.222						
Bedrock aquifer	.091	NH0761010	20045	Epping Water Works	944	.088	3
Dearborn Brook Reservoir	.386	NH0801010	20099	Exeter Water Works - Exeter	10,847	1.216	-11
Exeter River	.386			Hampton	58	.004	
Surficial aquifer	.318			Stratham	15	.001	
Surficial aquifer	.287	NH0811010	20329	Farmington Water Works	2,811	.243	15
Surficial aquifer	1.792	NH1051010	20020	Aquarion Water Company - Hampton	12,875	1.510	6
Bedrock aquifer	.401			North Hampton	3,221	.327	
				Rye	1,144	.197	
Surficial aquifer	.128	NH1581010	20492	Milton Water District	609	.052	59
Imported	.094	NH1661010	20269	New Castle Water Works	610	.070	26
Surficial aquifer	.036	NH1681010	20056	Newfields Water Department	639	.051	-6
Bedrock aquifer	.012						
Lamprey River	.291	NH1731010	20057	Newmarket Water Works	6,173	.526	12
Surficial aquifer	.327						

**Table 20.** Multi-use community water system sources of supply, population served, distribution, and unaccounted-for water in 2003 in the Seacoast region, New Hampshire.—Continued

[Location of towns shown in figure 1. Mgal/d, million gallons per day; PWSID, Public Water Supply Identification; DES\_ID, New Hampshire Department of Environmental Services Water Registration Identification. Source of data on withdrawal rate: New Hampshire Geological Survey WATUSE database]

Resource	Withdrawal rate, in Mgal/d	PWSID	DES_ID	Water system and distribution area	Population served estimate	Distribution rate, in Mgal/d	Unaccounted for water, in percent
Bellamy Reservoir	2.089	NH1951010	20010	Portsmouth Water Works - Portsmouth	20,687	3.060	7
Surficial aquifer	2.263			Greenland	1,366	.151	
				Madbury	11	.001	
				New Castle	400	.044	
				Newington	714	.634	
				Rye	135	.028	
Surficial aquifer	.303	NH1971010	20061	Raymond Water Department	2,409	.259	20
Berry River Rochester Reservoir	2.094	NH2001010	20011	Rochester Water Department	22,862	2.185	-4
Berry River Round Pond Reservoir							
Surficial aquifer	.037	NH2011010	20486	Rollinsford Water and Sewer District	1,490	.126	2
Bedrock aquifer	.094						
Surficial aquifer	.214	NH2041010	20038	Rye Water Works	3,579	.367	3
Bedrock aquifer	.135						
Imported	.028						
Surficial aquifer	1.026	NH2111010	20503	Seabrook Water Department - Seabrook	7,715	.903	36
Bedrock aquifer	.380			Hampton Falls	21	.002	
Salmon Falls River	1.356	NH2151010	20012	Somersworth Water Works - Somersworth	11,325	1.321	7
Surficial aquifer	.068			Rollinsford	137	.010	
Surficial aquifer	1.103	NH2391010	20692	Sanbornville Water Department - Wakefield	894	.084	17
				Brookfield	11	.001	
<b>Total or average</b>	<b>18.113</b>				<b>149,455</b>	<b>16.637</b>	<b>8</b>

<sup>1</sup> Estimated value.

The population served by domestic CWSs was about 12,604 (5 percent), and the population served by household wells was 88,866 (35 percent; table 14).

Estimates of withdrawal for domestic CWSs (2.2 Mgal/d) were based on the census block per capita water-use values from the statistical model, which were multiplied by the population served by the CWSs. The withdrawal was divided equally among the sources (usually wells). Withdrawal was assumed to equal water demand because (1) there are no data available to estimate leakage and (2) the source is close to the distribution system so most of the water leaked, if any, will recharge the aquifer from which the water was withdrawn.

Each multi-use CWS was analyzed to compare reported withdrawal with reported delivery and estimates of public-supplied domestic, commercial, industrial, and irrigation water demand. This comparison was used to (1) estimate unaccounted-for water use, (2) check that the estimated and reported delivery were in line with the reported withdrawal, and (3) estimate imported and exported water for the town (appendix 2). The estimates of unaccounted-for water use (table 20) ranged from 59 percent in Milton to -12 percent in Dover, with 8 percent for all CWS combined. High positive unaccounted-for percentages (Milton, 59 percent; Seabrook, 36 percent; and Durham, 37 percent) can reflect (1) meter errors in the reported withdrawal, (2) major leakage or fire-suppression activities, (3) unknown major users, (4) underestimation of known users, or (5) unrecorded sale of water to another CWS. Negative unaccounted-for percentages (Dover, -12 percent; Exeter, -11 percent; Rochester, -4 percent; Newfields, -6 percent) or very small unaccounted-for percentages (Rollinsford, 2 percent; Epping, 3 percent; and Rye, 3 percent) can reflect (1) meter errors in the reported withdrawal; (2) misidentification of users that are either self-supplied or served by another system; (3) overestimation of known users; (4) double-accounting of water demand, such as counting a nursing home as a commercial withdrawal and including that population under the domestic users; or (5) unrecorded purchases of water from another system. The remaining 8 CWSs had reasonable unaccounted-for water use ranging from 6 percent (Aquarion) to 20 percent (Raymond). Estimated unaccounted-for use in the Seacoast region is 2.9 Mgal/d (14 percent of CWS withdrawal).

A total of 18.1 Mgal/d (table 20) was withdrawn in 2003 by the multi-use CWSs, which accounts for 89 percent of all CWS withdrawal (20.3 Mgal/d; table 21). The largest CWS is the Portsmouth Water Department, which provides water directly to people in Portsmouth, New Castle, Greenland, Newington, Rye, and Madbury. The Portsmouth Water Department has wells in Greenland and Newington, and a reservoir in Madbury. Water is not exported to Greenland and Madbury, but the difference between the volume withdrawn and delivered locally to users is imported into the Portsmouth distribution system (table 22). The Portsmouth Water Department also sells water to the Water Departments for Rye and New Castle Water. Aquarion Water Company provides water to people in Hampton, North Hampton, and Rye.

Aquarion has wells in North Hampton, Rye, and Stratham. The town of Exeter provides water to Exeter and small neighborhoods in Stratham and Hampton Falls. The town of Raymond provides water directly to people living in Raymond and to the Pennichuck Green Acres subdivision. The town of Somersworth provides water to a small neighborhood in Rollinsford. All these systems are registered with NHDES and their reported water use is stored in WATUSE.

## Community Wastewater Systems

There were 18 CWWSs in the Seacoast region in 2003 (table 23). These systems receive wastewater from domestic, commercial, and industrial users, and treat and return effluent primarily into surface-water bodies. These systems are required to report effluent return flow to NHDES Wastewater Engineering Bureau, which are entered in WATUSE, with the exception of the Wakefield wastewater-collection system that has return flow of effluent to lagoons.

CWWSs are complex and include one or more of the following components:

- Aggregates of minor domestic, commercial, industrial, and irrigation users in each town;
- Registered users;
- Interconnections to wastewater-collection systems owned by other CWWSs for imports or exports;
- Wastewater-collection systems, by town;
- Wastewater-treatment plants; and
- Surface-water return flow and, occasionally, ground-water return flow or spray irrigation.

Population-served values were developed using a method similar to the CWS. The 2000 U.S. Census Bureau data were compared with the community wastewater-collection system GIS coverage to develop estimates of the population using sewers and using septic or other onsite disposal. The results are presented in the town tables (appendix 2). Population served by CWWSs was over 120,000 (table 23), approximately 48 percent of the Seacoast region population—20 percent less than the population served by the multi-use CWSs (150,000; table 20). The remainder of the population used leach fields or septic systems.

Each CWWS was analyzed to compare reported and estimated return flow and release for sewer domestic, commercial, industrial, and irrigation users. This comparison was used to (1) estimate inflow and infiltration, (2) check that the estimated and reported release (wastewater discharged by users into sewers) were in line with the reported return flow, and (3) estimate imported and exported wastewater for the town. Return flow from onsite (septic) disposal was estimated as equal to water demand minus consumptive use. Estimates of inflow and infiltration (table 23) ranged from 12 percent in Somersworth to 69 percent in the Pease-Portsmouth system in Newington, with a mean of 46 percent for all CWWS

combined. High inflow and infiltration percentages (Pease Development Authority Wastewater System, 69 percent; Epping, 68 percent; Rochester, 55 percent; and Portsmouth, 52 percent) can reflect (1) meter errors in the reported delivery to the wastewater-treatment plant or return flow from the plant, (2) high water-table conditions combined with many breaches in the sewer lines, (3) storm sewers combined with sanitary sewers, (4) unknown major users, (5) underestimation of known users, or (6) unrecorded delivery of wastewater from another CWS. Low inflow and infiltration percentages (Somersworth, 12 percent; Rollinsford, 19 percent; Farmington, 19 percent) can reflect (1) meter errors in the reported delivery to the wastewater-treatment plant or return flow from the plant; (2) misidentification of users that have septic systems or release wastewater to another system; (3) overestimation of known users; (4) double-accounting for water demand, such as counting a nursing home as a commercial delivery and including that population under the domestic users; or (5) unrecorded release of wastewater to another system. The remaining 8 CWSs had reasonable inflow and infiltration rates ranging from 24 percent (Seabrook) to 44 percent (Durham).

A total of 21.0 Mgal/d is returned to surface water after wastewater treatment. Portsmouth has the largest wastewater-treatment facility, treating water from the towns of Portsmouth, Newington, and New Castle, and a trailer park in Rye with return flow to the Piscataqua River (tables 22 and 23). Hampton receives wastewater from Rye with return flow to Tide Mill Creek. Wastewater in Newington is treated at three separate plants—Newington, Pease, and Portsmouth—all with return flow to the Piscataqua River. Estimated inflow and infiltration in the Seacoast region is 9.4 Mgal/d (45 percent).

## Subbasins

The seven major subbasins in the Seacoast region are the Bellamy River–Great Bay, Coastal Drainages, Cocheco River, Exeter River, Lamprey River, Oyster River–Great Bay, and the New Hampshire part of the Salmon Falls River Basin (fig. 1). The discussion of water use by subbasin in 2003 focuses on the major types of water-use categories that occur in each subbasin in terms of water withdrawal, demand, and return flow and are summarized in table 24. A summary of imports and exports in 2003 of water and wastewater between subbasins are summarized in table 25. The water-use estimates for subbasins are less precise than for towns.

### Bellamy River–Great Bay

The Bellamy River–Great Bay subbasin accounted for only 4 percent of water demand in the Seacoast region, but 15 percent of all withdrawal by CWS (table 24). Portsmouth Water Works withdrew 2.1 Mgal/d from the Bellamy Reservoir, and the water departments for Portsmouth and Dover withdrew another 0.9 Mgal/d from ground water. Most of this

water (2.4 Mgal/d) was exported to CWS distribution areas in the Coastal Drainage subbasin (table 25).

Water demand in the Bellamy River–Great Bay subbasin was about 1.0 Mgal/d, 0.9 Mgal/d (90 percent) for domestic water demand and 0.1 Mgal/d (10 percent) for commercial water demand (table 24). Water demand for industrial and irrigation use was less than 0.1 Mgal/d. One-third of domestic water demand was self-supplied from ground water (appendix 3). All wastewater return flow to this subbasin (0.3 Mgal/d) was through septic systems. Wastewater collected through the sewer systems in Dover (0.61 Mgal/d) was exported to the Cocheco River subbasin for treatment and return flow (table 25). Consumptive use was approximately 0.15 Mgal/d.

There was a net loss of 3.4 Mgal/d in the Bellamy River–Great Bay subbasin through export of freshwater to the Coastal Drainage, Cocheco River, Oyster River, and Salmon Falls subbasins (table 25) and export of wastewater to the Cocheco subbasin. There were no net imports of freshwater or wastewater into the subbasin.

### Coastal Drainages

The Coastal Drainages subbasin accounted for 26 percent (6.9 Mgal/d) of water demand in the Seacoast region (table 24), which was more water demand than any other subbasin. Domestic (4.6 Mgal/d), commercial (1.6 Mgal/d), and irrigation water demand (0.1) were all the highest in this subbasin, with industrial water demand (0.6 Mgal/d) higher in Cocheco River and Salmon Falls River subbasins. CWS withdrawal (3.5 Mgal/d) provided only 45 percent of the water demand in the basin. Imports from the Bellamy River subbasin (2.6 Mgal/d), primarily by the Portsmouth Water Works, and from the Oyster River–Great Bay subbasin (1.8 Mgal/d), primarily by the Portsmouth Water Department and Aquarion Water Company, were needed to meet the remaining 55 percent of the water demand (table 25). CWS return flow (8.6 Mgal/d) also was highest in this subbasin because of return flow by the Portsmouth, Newington, Pease, and Hampton wastewater-treatment plants. Inflow and infiltration into the sewer systems appeared to be a significant factor and contributed about 44 percent of the return flow volume (appendix 3) although wastewater imported from the Oyster River–Great Bay subbasin only added a little more than 0.2 Mgal/d.

Most (92 percent) of the water demand by domestic users were supplied by CWSs, and 65 percent of domestic wastewater was released into sewers (appendix 3). Commercial water demand accounted for 67 percent (1.6 Mgal/d) of the non-domestic water demand (2.4 Mgal/d; table 24). About 37 percent of the Seacoast region irrigation water demand was in this basin (0.1 Mgal/d), most of which was applied to golf courses. Consumptive use was approximately 1.1 Mgal/d. There also were very large withdrawal and return flow for thermoelectric power of 200 Mgal/d associated with a consumptive use of 0.03 Mgal/d.

**Table 21.** Summary of water demand, withdrawal, return flow by domestic, commercial, industrial, irrigation, and other users, community water systems, and community wastewater systems in 2003 by town in the Seacoast region, New Hampshire.

[Location of towns shown in figure 1. Units are in million gallons per day; CWS, Community water system; CWWS, Community wastewater system; --, rate of water withdrawal, demand, or return flow less than 49 gallons per day]

Town	Domestic			Commercial			Industrial			Irrigation			Other uses			CWWS			Total		
	De-mand	With-drawal	Return flow	De-mand	With-drawal	Return flow	De-mand	With-drawal	Return flow	De-mand	With-drawal	Return flow	De-mand	With-drawal	Return flow	De-mand	With-drawal	Return flow	De-mand	With-drawal	Return flow
Barrington	0.587	0.495	0.482	0.012	0.012	0.011	0.006	0.006	0.005	0.027	0.027	0.003	--	--	--	0.094	--	--	0.632	0.634	0.501
Brentwood	2.28	1.86	1.49	1.117	0.87	0.79	0.190	0.190	0.092	0.001	0.001	0.000	--	--	--	2.073	0.028	--	0.537	0.538	0.348
Brookfield	0.44	0.43	0.37	0.000	0.000	0.000	--	--	--	--	--	--	--	--	--	0.103	--	--	0.044	0.147	0.037
Candia	0.181	0.181	0.148	0.009	0.009	0.008	0.003	0.003	0.002	--	--	--	--	--	--	--	--	--	0.193	0.193	0.158
Chester	0.217	0.195	0.174	0.006	0.006	0.005	0.001	0.001	0.001	--	--	--	--	--	--	0.022	--	--	0.224	0.224	0.181
Danville	0.039	0.025	0.032	0.000	0.000	0.000	--	--	--	--	--	--	--	--	--	0.032	--	--	0.040	0.058	0.032
Deerfield	0.223	0.216	0.182	0.007	0.007	0.006	0.001	0.001	0.001	0.002	0.002	0.000	--	--	--	0.007	--	--	0.232	0.232	0.189
Dover	2.047	1.11	0.332	0.356	0.13	0.050	0.150	0.001	0.001	0.026	0.026	0.003	0.000	0.000	0.000	2.173	2.912	2.912	2.579	175.261	176.235
Durham	0.731	0.193	0.193	0.130	0.007	0.059	0.002	0.001	0.001	0.002	0.002	0.000	--	--	--	1.066	0.926	--	0.865	1.270	1.179
East Kingston	0.108	0.098	0.087	0.002	0.002	0.002	0.001	0.001	0.001	0.007	0.007	0.001	--	--	--	0.010	--	--	0.118	0.118	0.090
Epping	0.386	0.257	0.267	0.019	0.009	0.008	0.007	0.003	0.003	0.002	0.002	0.000	--	--	--	0.147	0.213	--	0.414	0.417	0.491
Exeter	1.061	0.095	0.131	0.586	0.329	0.329	0.131	0.019	0.017	0.008	0.008	0.001	--	--	--	3.205	1.811	--	1.786	1.655	2.288
Farmington	0.453	0.226	0.223	0.016	0.003	0.005	0.003	0.001	0.003	0.009	0.009	0.001	0.096	0.096	0.096	0.287	0.215	--	0.578	0.621	0.542
Frenont	0.241	0.225	0.196	0.012	0.012	0.011	0.002	0.002	0.002	--	--	--	--	--	--	0.015	--	--	0.256	0.254	0.209
Greenland	0.235	0.130	0.188	0.019	0.004	0.017	0.003	0.000	0.003	0.052	0.024	0.005	--	--	--	0.637	--	--	0.308	0.795	0.213
Hampstead	0.051	0.034	0.042	0.001	0.001	0.000	0.002	0.002	0.001	--	--	--	--	--	--	--	--	--	0.054	0.036	0.044
Hampton	1.363	1.128	1.130	0.250	0.003	0.004	0.027	0.000	0.000	0.001	0.001	0.000	--	--	--	1.063	2.816	--	1.641	1.194	2.950
Hampton Falls	0.156	0.154	0.119	0.015	0.015	0.013	0.003	0.003	0.003	0.003	0.003	0.000	--	--	--	--	--	--	0.176	0.174	0.135
Kensington	0.139	0.139	0.110	0.003	0.003	0.002	0.000	0.000	0.000	--	--	--	--	--	--	0.051	--	--	0.142	0.193	0.113
Kingston	0.098	0.098	0.080	0.006	0.006	0.005	0.001	0.001	0.000	--	--	--	--	--	--	--	--	--	0.104	0.104	0.085
Lee	0.309	0.273	0.249	0.020	0.020	0.018	0.001	0.001	0.001	0.001	0.001	0.000	--	--	--	0.258	--	--	0.331	0.553	0.268
Madbury	0.110	0.109	0.089	0.002	0.002	0.002	0.000	0.000	0.000	--	--	--	--	--	--	2.765	--	--	0.112	2.876	0.091
Middleton	0.119	0.109	0.099	0.001	0.001	0.001	--	--	--	--	--	--	--	--	--	0.009	--	--	0.120	0.119	0.100
Milton	0.304	0.232	0.226	0.006	0.004	0.004	0.017	0.017	0.016	--	--	--	0.000	0.000	0.000	13.219	13.219	--	0.328	13.623	13.464
New Castle	0.113	0.000	0.037	0.002	0.000	0.001	0.001	0.000	0.000	--	--	--	--	--	--	--	--	--	0.116	0.000	0.038
New Durham	0.090	0.090	0.074	0.002	0.002	0.002	0.001	0.001	0.001	--	--	--	--	--	--	--	--	--	0.094	0.094	0.078
Newfields	0.105	0.061	0.058	0.006	0.003	0.003	0.005	0.000	0.003	--	--	--	--	--	--	0.048	0.044	--	0.115	0.112	0.108
Newington	0.066	0.006	0.046	0.197	0.000	0.085	0.256	0.000	0.004	--	--	--	0.121	0.121	0.000	--	--	--	0.627	199.949	200.791
Newmarket	0.591	0.104	0.137	0.022	0.001	0.002	0.041	0.000	0.014	0.024	0.000	0.002	--	--	--	0.498	0.699	--	0.678	0.604	0.854
North Hampton	0.359	0.070	0.279	0.046	0.000	0.041	0.003	0.000	0.003	0.025	0.024	0.002	--	--	--	0.834	--	--	0.433	0.928	0.326
Northwood	0.152	0.134	0.127	0.007	0.007	0.006	0.005	0.005	0.004	--	--	--	--	--	--	0.019	--	--	0.164	0.164	0.138
Nottingham	0.296	0.296	0.241	0.001	0.001	0.001	0.007	0.007	0.007	--	--	--	--	--	--	--	--	--	0.304	0.304	0.248
Portsmouth	1.734	0.006	0.080	1.030	0.000	0.000	0.279	0.000	0.000	0.025	0.000	0.002	--	--	--	0.953	5.134	--	3.067	960	5.217
Raymond	0.657	0.378	0.554	0.114	0.083	0.102	0.030	0.027	0.027	0.004	0.003	0.000	--	--	--	0.375	--	--	0.804	0.867	0.684
Rochester	1.972	0.308	0.792	0.356	0.150	0.161	0.812	0.431	0.303	0.018	0.017	0.002	--	--	--	3.627	3.457	--	3.158	4.533	6.158



**Table 21.** Summary of water demand, withdrawal, return flow by domestic, commercial, industrial, irrigation, and other users, community water systems, and community wastewater systems in 2003 by town in the Seacoast region, New Hampshire.—Continued

[Location of towns shown in figure 1. Units are in million gallons per day; CWS, Community water system; CWWS, Community wastewater system; --, rate of water withdrawal, demand, or return flow less than 49 gallons per day]

Town	Domestic			Commercial			Industrial			Irrigation			Other uses			CWS			CWWS			Total		
	De-mand	With-drawal	Return flow	De-mand	With-drawal	Return flow	De-mand	With-drawal	Return flow	De-mand	With-drawal	Return flow	De-mand	With-drawal	Return flow	De-mand	With-drawal	Return flow	De-mand	With-drawal	Return flow	De-mand	With-drawal	Return flow
Rollinsford	.185	0.053	0.080	0.006	0.003	0.003	0.015	0.000	0.008	0.002	0.002	0.000	0.000	0.000	0.000	0.000	0.131	131.181	131.181	0.101	0.101	0.209	131.369	131.373
Rye	.533	.019	.324	.024	.000	.010	--	--	--	.053	.022	.005	.003	.000	.001	.467	.467	.001	--	--	.613	.508	.341	.341
Sandown	.244	.213	.202	.005	.005	.004	.003	.003	.003	--	--	--	--	--	--	.034	.034	.000	--	--	.251	.254	.209	.209
Seabrook	.633	.012	.004	.170	.108	.101	.112	.000	.000	--	--	--	.108	.000	.000	1.354	1.354	.000	7.898	7.898	1.023	1.474	.105	.105
Somersworth	.801	.010	.144	.083	.000	.014	.628	1.182	1.195	.001	.000	.000	.000	224.880	224.880	1.424	1.424	1.121	1.121	1.513	1.513	226.496	226.354	226.354
South Hampton	.056	.056	.044	.002	.002	.002	--	--	--	.001	.001	.000	--	--	--	--	--	--	--	--	.059	.059	.047	.047
Stratford	.251	.245	.206	.002	.002	.001	.001	.001	.001	--	--	--	--	--	--	.006	.006	.000	--	--	.254	.254	.208	.208
Stratham	.452	.313	.360	.041	.041	.037	.113	.113	.102	.056	.056	.006	--	--	--	.371	.371	.000	--	--	.661	.893	.504	.504
Wakefield	.276	.200	.202	.013	.002	.005	.000	.000	.000	--	--	--	--	--	--	.003	.003	.000	.036	.036	.290	.205	.244	.244
<b>Total</b>	<b>18.996</b>	<b>6.526</b>	<b>7.956</b>	<b>3.724</b>	<b>.965</b>	<b>1.220</b>	<b>2.863</b>	<b>1.023</b>	<b>.828</b>	<b>.350</b>	<b>.238</b>	<b>.033</b>	<b>.328</b>	<b>742.256</b>	<b>743.786</b>	<b>20.312</b>	<b>20.312</b>	<b>21.038</b>	<b>21.038</b>	<b>26.260</b>	<b>26.260</b>	<b>771.316</b>	<b>773.968</b>	<b>773.968</b>

<sup>1</sup> Higher consumptive use due to bottling.

<sup>2</sup> Corrected to eliminate duplicate pumpage.

<sup>3</sup> Two industrial users have both self supply and public supply.

<sup>4</sup> Commercial portion of county home.

<sup>5</sup> Metered return.

<sup>6</sup> Large commercial has both self supply and public supply.

<sup>7</sup> Discharged to the Atlantic Ocean.

**Table 22.** Summary of water demand, withdrawal, return flow, consumptive use, imports, and exports in 2003 by town in the Seacoast region, New Hampshire.

[Location of towns shown in figure 1. Units are in million gallons per day; --, rate of water withdrawal, demand, or return flow less than 49 gallons per day]

Town	Total			Freshwater				Wastewater				
	Demand	Withdrawal	Return flow	Consumptive use	Imported	From	Exported	To	Imported	From	Exported	To
Barrington	0.632	0.634	0.501	0.131	--	--	--	--	--	--	--	--
Brentwood	.537	.538	.348	.198	--	--	--	--	--	--	--	--
Brookfield	.044	.147	.037	.007	--	--	0.102	Wakefield	--	--	--	--
Candia	.193	.193	.158	.034	--	--	--	--	--	--	--	--
Chester	.224	.224	.181	.043	--	--	--	--	--	--	--	--
Danville	.040	.058	.032	.007	--	--	.018	Merrimack watershed	--	--	--	--
Deerfield	.232	.232	.189	.043	--	--	--	--	--	--	--	--
Dover	2.579	175.261	176.235	.350	--	--	.015	Rollinsford	0.003	Rollinsford	--	--
Durham	.865	1.270	1.179	.089	0.222	Lee	.146	Newmarket	--	--	--	--
East Kingston	.118	.118	.090	.028	--	--	--	--	--	--	--	--
Epping	.414	.417	.491	.068	--	--	--	--	--	--	--	--
Exeter	1.786	1.655	2.288	.213	--	--	.004	Hampton Stratham	--	--	--	--
Farmington	.578	.621	.542	.076	--	--	--	--	--	--	--	--
Fremont	.256	.254	.209	.046	.002	Sandown	--	--	--	--	--	--
Greenland	.308	.795	.213	.095	--	--	.427	Portsmouth	--	--	--	--
Hampstead	.054	.036	.044	.010	.018	Merrimack watershed	--	--	--	--	--	--
Hampton	1.641	1.194	2.950	.251	.415	North Hampton	.096	Rye	.086	Rye	--	--
					.004	Exeter	--	--	--	--	--	--
					.233	Stratham	--	--	--	--	--	--
Hampton Falls	.176	.174	.135	.040	.002	Seabrook	--	--	--	--	--	--
Kensington	.142	.193	.113	.029	--	--	.051	Seabrook	--	--	--	--
Kingston	.104	.104	.085	.019	--	--	--	--	--	--	--	--
Lee	.331	.553	.268	.062	--	--	.222	Durham	--	--	--	--
Madbury	.112	2.876	.091	.021	--	--	2.764	Portsmouth	--	--	--	--
Middleton	.120	.119	.100	.020	--	--	--	--	--	--	--	--
Milton	.328	13.623	13.464	.048	--	--	--	--	--	--	0.054	Rochester
New Castle	.116	.000	.038	.035	.094	Portsmouth-New Castle	--	--	--	--	--	--
					.044	Portsmouth	--	--	--	--	.048	Portsmouth

**Table 22.** Summary of water demand, withdrawal, return flow, consumptive use, imports, and exports in 2003 by town in the Seacoast region, New Hampshire.—Continued

[Location of towns shown in figure 1. Units are in million gallons per day; --, rate of water withdrawal, demand, or return flow less than 49 gallons per day]

Town	Total				Freshwater				Wastewater			
	Demand	Withdrawal	Return flow	Consumptive use	Imported	From	Exported	To	Imported	From	Exported	To
New Durham	0.094	0.094	0.078	0.016	--	--	--	--	--	--	--	--
Newfields	.115	.112	.108	.022	--	--	--	--	--	--	--	--
Newington	.640	199.949	200.791	.264	0.690	Portsmouth	--	--	0.495	Portsmouth	0.073	Portsmouth
Newmarket	.678	.604	.854	.113	.146	Durham	--	--	--	--	--	--
North Hampton	.433	.928	.326	.107	--	--	0.415	Hampton	--	--	--	--
Northwood	.164	.164	.138	.026	--	--	--	--	--	--	--	--
Nottingham	.304	.304	.248	.056	--	--	--	--	--	--	--	--
Portsmouth							.094	New Castle				
							.044	New Castle	.048	New Castle		
							.690	Newington	.073	Newington		
Raymond	3.067	.960	5.217	.422	.427	Greenland			.013	Rye	.495	Newington
	.804	.867	.684	.120	2.764	Madbury			--	--	--	--
Rochester	3.158	4.533	6.158	.391	--	--	--	--	.054	Milton	--	--
Rollinsford	.209	131.369	131.373	.029	.015	Dover			--	--	.003	Dover
	.613	.508	.341	.173	.010	Somersworth			--	--	.004	Somersworth
Rye					.028	Portsmouth-Rye						
					.028	Portsmouth					.086	Hampton
Sandown	.251	.254	.209	.043	.096	Hampton			--	--	.013	Portsmouth
Seabrook	1.023	1.474	.105	.236	--	--	.002	Fremont	--	--	--	--
Somersworth	1.513	226.496	226.354	.178	.051	Kensington			--	--	--	--
South Hampton	.059	.059	.047	.012	--	--	.010	Rollinsford	.004	Rollinsford	--	--
Strafford	.254	.254	.208	.044	--	--	--	--	--	--	--	--
Stratham	.661	.893	.504	.158	.001	Exeter			--	--	--	--
Wakefield	.290	.205	.244	.047	.102	Brookfield			--	--	--	--
<b>Total</b>	<b>26.260</b>	<b>771.316</b>	<b>773.968</b>	<b>4.420</b>	<b>5.392</b>		<b>5.392</b>		<b>.776</b>		<b>.776</b>	

There was a net gain of 4.6 Mgal/d in the Coastal Drainages subbasin through import of 4.4 Mgal/d of freshwater and 0.2 Mgal/d of wastewater from the Oyster River subbasin (table 25). There was only a minor export of less than 0.1 Mgal/d of wastewater into the Exeter River subbasin.

## Cocheco River

The Cocheco River subbasin accounted for 23 percent (5.9 Mgal/d) of water demand in the Seacoast region (table 24), which was second highest in water demand after the Coastal Drainages subbasin. This subbasin also had more water withdrawn by CWSs (5.2 Mgal/d), some of which (1.4 Mgal/d) was used to recharge ground water near the Rochester/Dover town line. Industrial water demand (1.0 Mgal/d) also was highest in the Cocheco River subbasin because it includes the industrial areas in Rochester and Dover. CWWS wastewater return flow also was high (6.5 Mgal/d) because of the return flow from the Dover and Rochester wastewater-treatment plants in this subbasin, plus another 0.2 Mgal/d of wastewater was exported to the Salmon Falls River subbasin.

About 70 percent of the water demand in the Cocheco River subbasin (4.1 Mgal/d) was for domestic water demand; approximately three-quarters was from public supply. Non-domestic water demand was 1.8 Mgal/d, with 16 percent of total water demand for industrial water demand, 11 percent commercial water demand, and 1 percent for irrigation water demand. A hydroelectric power generation facility in Dover withdrew and returned 173 Mgal/d. Consumptive use was 0.9 Mgal/d.

There was a net gain of 0.7 Mgal/d in the Cocheco River subbasin through import of 0.3 Mgal/d of freshwater from the Bellamy River subbasin and 0.7 Mgal/d of wastewater from the Bellamy and Oyster River subbasins (table 25). Offsetting this import was 0.1 Mgal/d of freshwater and 0.2 Mgal/d of wastewater exported into the Salmon Falls River subbasin.

## Exeter River

The Exeter River subbasin accounted for 16 percent (4.2 Mgal/d) of water demand in the Seacoast region (table 24), which was third highest in water demand. This subbasin had the least volume of water withdrawn by CWSs (1.3 Mgal/d) but the third highest return flow by wastewater systems (1.9 Mgal/d). About 69 percent of the water demand (2.9 Mgal/d) was for domestic water demand; less than half (46 percent) was from public supply. Non-domestic water demand in the Exeter River subbasin was 1.3 Mgal/d with 21 percent for commercial water demand and 10 percent for industrial water demand. Consumptive use was 0.6 Mgal/d. There was a net loss of 0.1 Mgal/d in the Exeter River subbasin through export of 0.1 Mgal/d of freshwater to the Lamprey River subbasin and less than 0.1 Mgal/d of wastewater to the Lamprey River subbasin (table 25).

Offsetting this export was less than 0.1 Mgal/d of wastewater from the Coastal Drainages subbasin.

## Lamprey River

The Lamprey River subbasin accounted for 11 percent (2.8 Mgal/d) of water demand in the Seacoast region (table 24). Ninety-one percent of the water demand was for domestic water demand (2.5 Mgal/d); about one-third was from public supply. The remaining 0.3 Mgal/d was water demand by commercial users (4 percent), industrial users (4 percent), and irrigators (1 percent). Consumptive use in this subbasin was 0.5 Mgal/d. There was a net loss of 0.2 Mgal/d in the Lamprey River subbasin through the import of 0.1 Mgal/d of freshwater and wastewater from the Exeter River subbasin and 0.3 Mgal/d of freshwater exported to the Oyster River subbasin (table 25).

## Oyster River–Great Bay

The Oyster River–Great Bay subbasin accounted for 9 percent (2.2 Mgal/d) of water demand in the Seacoast region (table 24). Domestic water demand (1.8 Mgal/d) accounted for 81 percent of the water demand, commercial water demand (0.2 Mgal/d) accounted for 11 percent, industrial water demand (0.1 Mgal/d) accounted for 5 percent, and irrigation water demand (0.1 Mgal/d) accounted for the remaining 4 percent. Consumptive use in this subbasin was 0.4 Mgal/d. There was a net loss of 1.7 Mgal/d in the Oyster River–Great Bay subbasin through the export of 1.8 Mgal/d of freshwater to the Coastal Drainages subbasin and 0.3 Mgal/d of wastewater to the Coastal Drainages and Cocheco River subbasins and import of 0.5 Mgal/d from the Bellamy River–Great Bay and Lamprey River subbasins (table 25).

## Salmon Falls River

Of the 2.5 Mgal/d of water demand in the New Hampshire part of the Salmon Falls River subbasin, 1.8 Mgal/d (70 percent) was for domestic water demand, 0.7 Mgal/d (26 percent) was for industrial water demand, and the remainder (0.1 Mgal/d or 4 percent) was for commercial water demand (table 24). Water demand for irrigation was less than 0.01 Mgal/d. Water was withdrawn and returned to the Salmon Falls River for hydroelectric power generation, at a rate of 369 Mgal/d. Consumptive use was about 0.4 Mgal/d. CWSs withdrew 1.8 Mgal/d, primarily the water departments serving Somersworth (1.42 Mgal/d), Milton (0.15 Mgal/d), Rollinsford (0.13 Mgal/d), and Brookfield (0.10 Mgal/d). Return flow from CWWSs were 1.3 Mgal/d, of which 97 percent was to the Salmon Falls River. There was a net gain of 0.3 Mgal/d in the Salmon Falls River subbasin through the imports of 0.1 Mgal/d from the Bellamy and Cocheco River subbasins and imports of wastewater from the Cocheco River subbasin (table 25).

**Table 23.** Community wastewater system population served, wastewater collection, return flow, and inflow and infiltration in 2003 in the Seacoast region, New Hampshire.

[Location of towns shown in figure 1. Mgal/d, million gallons per day; NPDES, National Pollutant Discharge Elimination System Identification; DES\_ID, Department of Environmental Services Water Registration Identification; --, no data; Annual discharge values in **bold** are estimated. Source of 2003 reported annual discharge data: New Hampshire Geological Survey WATUSE database]

Town	NPDES	DES_ID	Waterbody receiving return flow	Population served	Estimated wastewater released by users, in Mgal/d	2003 reported annual return flow, Mgal/d	Estimated inflow and infiltration, Mgal/d	Percent of wastewater treated that is inflow or infiltration
Dover	NH0100064	20442	Cochecho River	21,300	1.843	2.912	1.066	37
Rollinsford				48	0.003	--	--	--
Somersworth				--	--	--	--	--
Durham	NH0100455	20354	Oyster River	9,292	.523	0.926	.403	44
Epping	NH0100692	20389	Lamprey River	874	.067	.213	.145	68
Exeter	NH0100871	20084	Squamscott River	11,796	1.097	1.811	.714	39
Farmington	NH0100854	20317	Cochecho River	2,306	.174	.215	.041	19
Hampton	NH0100625	20087	Tide Mill Creek	12,856	1.255	2.816	1.475	52
North Hampton				--	--	--	--	--
Rye				763	0.086	--	--	--
Milton	NH0100676	20493	Salmon Falls River	525	.035	.054	.020	36
Newfields Village	NH0101192	20576	Squamscott River	468	.030	.044	.014	32
Newington	NH0101141	20328	Piscataqua River	75	.076	.126	.050	40
Newmarket	NH0100196	20323	to Lamprey River	5,644	.409	.699	.290	41
Pease-Portsmouth	NH0090000	20616	Piscataqua River	0	.147	.501	.348	69
Newington				0	.006	--	--	--
Portsmouth	NH0100234	20078	Piscataqua River	19,750	2.561	5.134	2.555	52
New Castle				518	.043	--	.005	10
Newington				0	.073	--	--	--
Greenland				--	--	--	--	--
Rye				158	.013	--	--	--
Rochester	NH0100668	20079	Cochecho River	15,095	1.509	3.403	1.894	55
Rockingham County Complex	NH0100609	20157	Ice Pond Brook	609	.064	.011	--	--
		20157	Spray irrigation	--	--	.017	--	--
Rollinsford	NH0100251	20599	Salmon Falls River	1,251	.081	.101	.020	19
Seabrook	NH0101303	20655	Atlantic Ocean	7,826	.682	.898	.216	24
Somersworth	NH0100277	20080	Salmon Falls River	8,896	.983	1.121	.135	12
Rollinsford				66	.004	--	--	--
Wakefield			Lagoons	408	.036	.036	.000	0
<b>Total or average</b>				<b>120,524</b>	<b>11.800</b>	<b>21.038</b>	<b>9.391</b>	<b>45</b>

**Table 24.** Summary of water demand, withdrawal, return flow by domestic, commercial, industrial, irrigation, and other users, community water systems, and community wastewater systems in 2003 by subbasin in the Seacoast region, New Hampshire.

[Location of subbasins shown in figure 1. Units are in million gallons per day; CWS, community water system; CWWS, community wastewater system; --, water withdrawal, demand, or return flow less than 49 gallons per day]

Subbasin name	Domestic			Commercial			Industrial		
	Demand	Withdrawal	Return flow	Demand	Withdrawal	Return flow	Demand	Withdrawal	Return flow
Bellamy River - Great Bay	0.89	0.30	0.33	0.07	0.02	0.02	0.02	0.00	0.00
Coastal drainages	4.56	.39	.88	1.64	.13	.37	.58	.00	.01
Cocheco River	4.13	1.18	1.58	.67	.16	.21	.95	.38	.08
Exeter River	2.87	1.56	1.52	.86	.57	.46	.42	.29	.20
Lamprey River	2.52	1.69	1.72	.11	.05	.07	.12	.09	.08
Oyster River - Great Bay	1.79	.66	.92	.24	.03	.08	.11	.00	.00
Salmon Falls River	1.78	.52	.81	.10	.01	.03	.66	.26	.45

Subbasin name	Irrigation			Other uses			CWS withdrawal	CWWS return flow	Total		
	Demand	Withdrawal	Return flow	Demand	Withdrawal	Return flow			Demand	Withdrawal	Return flow
Bellamy River - Great Bay	0.00	0.00	0.00	--	--	--	2.99	--	0.98	3.32	0.35
Coastal drainages	.13	.07	.01	0.12	199.94	200.03	3.54	8.58	6.92	204.07	209.60
Cocheco River	.08	.08	.01	.10	173.03	173.03	5.22	6.53	5.93	180.16	182.98
Exeter River	.02	.02	.00	.00	0.00	0.00	1.33	1.93	4.17	3.76	4.11
Lamprey River	.03	.01	.00	--	--	--	1.76	0.91	2.78	3.60	2.79
Oyster River - Great Bay	.08	.08	.01	--	--	--	3.64	0.93	2.22	4.41	1.94
Salmon Falls River	.00	.00	.00	--	369.28	369.28	1.84	1.31	2.54	371.91	371.88



**Table 25.** Summary of water demand, withdrawal, return flow, consumptive use, imports, and exports in 2003 by subbasin in the Seacoast region, New Hampshire.

[Location of subbasins shown in figure 1. Units are in million gallons per day; --, rate of water withdrawal, demand, or return flow less than 49 gallons per day]

Subbasin name	Total			Water				Wastewater				
	Demand	Withdrawal	Return flow	Consumptive use	Imported	From	Exported	To	Imported	From	Exported	To
Bellamy River - Great Bay	0.98	3.32	0.35	0.15	--	--	2.44	Coastal	--	--	0.61	Cochecho
							0.23	Cochecho				
							.12	Oyster				
							.05	Salmon Falls				
Coastal drainages	6.92	204.07	209.60	1.10	2.56	Bellamy	--	--	0.24	Oyster	.02	Exeter
					0.03	Exeter						
					1.82	Oyster						
Cochecho River	5.93	180.16	182.98	.90	.26	Bellamy	.08	Salmon Falls	.61	Bellamy	.20	Salmon Falls
									.07	Oyster		
Exeter River	4.17	3.76	4.11	.61	--	--	.03	Coastal	.02	Coastal	.04	Lamprey
							.11	Lamprey				
Lamprey River	2.78	3.60	2.79	.46	.11	Exeter	.34	Oyster	.04	Exeter	--	--
Oyster River - Great Bay	2.22	4.41	1.94	.40	.13	Bellamy	1.82	Coastal	--	--	.24	Coastal
					.34	Lamprey					.07	Cochecho
Salmon Falls River	2.54	371.91	371.86	.36	.05	Bellamy	--	--	.20	Cochecho	--	--
					.08	Cochecho						

## Summary of Water-Use Framework for the Seacoast Region, 2003

Regional water use has two aspects: (1) the water demand by category of use (domestic and non-domestic) and (2) the water-use activity that affects the hydrologic environment (withdrawal, return flow, consumptive use, and transfer). For example, the water demand for water by domestic users in a community can be met over a wide area by individual household wells, or more intensely at a point through a single well operated by a community water system. The water demand may be held as a constant, but the effect on the hydrologic environment can be adjusted by actions of the community water and wastewater systems.

The framework of water use was combined with the current amount of water use by category to illustrate how water moves through the different water-use activities (withdrawal, delivery, release, return flow, and consumptive use). Unaccounted-for use, inflow and infiltration, and import into and export from each town were estimated by comparing reported withdrawal by CWSs and return flow by CWWs with the independently derived water delivery and release rates. The resulting summary of total water-use activities provides a comprehensive understanding of the anthropogenic movement or flow of water throughout the Seacoast region. A flow chart of water use in the Seacoast region is shown in figure 10.

On the left side of figure 10, information on sources of supply is summarized; water is withdrawn from surface-water or ground-water sources and supplied directly to the user (self supply) or supplied through a CWS (public supply). In the middle section of the flow chart, information on water demand is displayed in six boxes to summarize each category of use (domestic, industrial, commercial, irrigation, hydroelectric, and thermoelectric). On the right side of the flow chart, information on wastewater is summarized; wastewater is released to sewers (public disposal) or returned by users to ground water or surface water. Surface-water withdrawal and return flow are summarized along the top of the flow chart and ground-water withdrawal and return flow are summarized along the bottom of the flow chart. The arrows represent conveyance of water from supply to demand to disposal. The arrows are color-coded to match the use category and are drawn in two widths. The thick arrows represent public supply or public disposal, and the thin arrows represent self supply or self disposal.

The four corners of the flow chart show the totals for surface- or ground-water supply source or disposal destination in gray, vertical boxes. These boxes may be connected to a water-use category directly with a thin arrow or through the public supply or public disposal box with a thick arrow.

Percentages listed on the left side of any vertical box break the total amount of water into the proportion of its supply sources, and the percentages listed on the right side break the total into the proportion of its disposal destinations. All percentages are rounded to the nearest whole number. A white box indicates that no water of that type is conveyed. A percentage of "0" indicates that the amount of water conveyed

is less than 1 percent of the total. The percentages may not total 100 due to independent rounding. Multiplication of values in million gallons per day by the rounded percentages will not result in accurate values—the accurate values are available in tables.

The public-supply box in the left middle part of the flow chart provides information on water imported into the area and exported from the area. The total volume of water for public supply is divided on the left side of the box into the percentages either withdrawn from ground water or surface water, or imported. The total volume of water for public supply is divided on the right side of the box into the percentages delivered to domestic, commercial, industrial, irrigation, and thermoelectric users; exported; and unaccounted-for.

The public-disposal box in the right middle part of the flow chart provides information on wastewater imported into the area for treatment and exported from the area for treatment and return elsewhere. The total volume of wastewater treated is divided on the left side of the box into the percentages that are released from domestic, commercial, industrial, and thermoelectric users; imported; and added to the system through inflow and infiltration. The total volume of publicly disposed water is also divided on the right side of the box into the percentages of wastewater either treated and returned to ground water or surface water, or sent to another town for treatment.

In the middle part of the flow chart, sources of supply and destinations of wastewater for six major categories of water use are summarized—domestic, commercial, industrial, irrigation, hydroelectric, and thermoelectric. Each category of use is indicated by a colored frame around its vertical box and matching colored arrows (for example, green for domestic use) showing the paths from supply and to disposal. Information on the percentage supplied by source type (surface water, ground water, or public supply) is provided in on the left side of the box. Information on the percentage released to type of wastewater destination (surface water, ground water, or sewer) is provided on the right side of the box. The flow chart also includes an estimate of consumptive use for each type of user.

Consumptive use (water that is used but not returned to the hydrologic system because it has been evaporated or incorporated in a product like bottled water or beer) is summarized in the upper middle part of the flow chart within the blue cloud. Above and to the right of each use box is the percentage that its category's consumptive use contributes to total consumptive use.

Figure 10 illustrates how the water-use framework summarizes water use and conveyance throughout the Seacoast region, providing the amount of:

- Ground water or surface water withdrawal and return flow;
- Water imported into the region;
- Water demand in the Seacoast by domestic, commercial, or industrial users;

- Water for domestic users obtained directly from ground water or from public supply;
- Water treated in the wastewater-treatment plant that was released into sewers, compared to how much enters the sewer system through storm drains, inflow, infiltration, or other means;
- Water exported from the region; and
- Water “lost” through consumptive uses.

Annual withdrawal in the Seacoast region in 2003 was estimated as 771.3 Mgal/d, of which 542.2 Mgal/d (70 percent) was withdrawn (and returned) for hydroelectric power generation (fig. 11). An additional 199.9 Mgal/d (26 percent) was withdrawn (and returned) for thermoelectric cooling. CWS withdrew 20.3 Mgal/d (3 percent) and domestic users withdrew 6.5 Mgal/d (1 percent).

Annual water demand in the Seacoast region in 2003 was estimated to be 26.3 Mgal/d (fig. 11), 35 percent of which is used during the summer months of June, July, and August. As discussed earlier, water demand does not include non-consumptive uses, such as water used for hydroelectric power generation or for cooling in thermoelectric plants. Annual domestic water demand was 19.0 Mgal/d (72 percent), commercial water demand was 3.7 Mgal/d (14 percent), industrial water demand was 2.9 Mgal/d (11 percent), irrigation water demand was 0.4 Mgal/d (1 percent), and thermoelectric, mining, and aquaculture water demand was 0.3 Mgal/d (1 percent). The mix of domestic, commercial, and industrial water demand can vary by town from as much as 99 percent domestic water demand (Strafford) to a little as 10 percent (Newington; table 21; appendix 2).

Annual water demand, withdrawal, and return flow for 2003 are summarized by town in table 21. These data will allow town planners to understand the types and magnitude of water-use activities that occur inside their town and in the surrounding towns in order to anticipate water-use activities that may expand across town lines. Estimates of water-use were based on information obtained about individual facilities or people in a block. So, if there is only one or a small number of commercial or industrial facilities in a town, the total estimated water demand may be less than 499 gal/d but still worth noting. Table 21 indicates towns where water use is less than 49 gal/d with a double dash and less than 499 gal/d with a value of 0.000 Mgal/d. Values less than 10,000 gal/d are in the table to indicate the magnitude of the coefficient-based estimate rather than to express a measured value.

Water withdrawal, demand, return flow, consumptive use, and “withdrawal minus return flow” by town (fig. 12) and subbasin (fig. 13) show the geographic variation in these water-use activities. These figures demonstrate the impact of the water and wastewater transfers between town and subbasins, particularly 12E and 13E, which display the difference between withdrawal and return flow for each geographic area. The blue areas indicate where return flow exceeds withdrawal and occur in areas where water is imported to meet water

demand and (or) for wastewater treatment and return flow. This occurs in Portsmouth, Newington, Hampton, Newmarket, Rochester, and Exeter (fig. 12E) and in the Cocheco River and Coastal Drainage subbasins (fig. 13E). The red areas indicate where withdrawal exceed return flow and occur in areas from which water is withdrawn for export or wastewater treatment and return flow, or where high consumptive use occurs, such as in water bottling or irrigation. This occurs in many towns in the Seacoast region (fig. 12E) and in the Bellamy River–Great Bay and Oyster River–Great Bay subbasins (fig. 13E). The yellow areas occur where withdrawal are about equal to return flow, which occurs in the Salmon Falls River subbasin (fig. 13E).

In 2003, annual withdrawal in the Seacoast region was 771.3 Mgal/d, of which 742.2 Mgal/d was instream uses for hydroelectric power generation and thermoelectric power cooling. The remaining 29.1 Mgal/d was withdrawn by CWSs (20.3 Mgal/d; 70 percent), domestic users (6.5 Mgal/d; 22 percent), commercial users (1.0 Mgal/d; 3 percent), industrial users (1.0 Mgal/d; 3 percent), irrigation (0.2 Mgal/d; 1 percent) and other non-domestic users less than 0.1 Mgal/d (table 21). CWSs withdrew the largest volume of water and are in 35 towns. The largest withdrawal was in Rochester (3.6 Mgal/d; for Rochester Water Department and for recharge for the Dover Water Department), Madbury (2.8 Mgal/d; for the Portsmouth Water Works) and Dover (2.2 Mgal/d). Nine towns had no CWS withdrawal in the Seacoast region, of which there were three that imported water to supply their CWS (Hampstead, New Castle, and Newington). Annual withdrawal, excluding hydroelectric power generation and thermoelectric plant cooling (29.1 Mgal/d) was larger than water demand (26.3 Mgal/d) because 2.8 Mgal/d was recharged to ground-water resources and distribution losses.

In 2003, annual return flow in the Seacoast region was 774.0 Mgal/d, of which 742.2 Mgal/d was returned after hydroelectric power generation and thermoelectric plant cooling. The remaining 31.8 Mgal/d was returned by CWSs (21.0 Mgal/d; 66 percent), domestic users (8.0 Mgal/d; 25 percent), commercial users (1.2 Mgal/d; 4 percent), industrial users (0.8 Mgal/d; 3 percent), and other non-domestic users (0.1 Mgal/d; table 21). Return flow by CWSs occurred in 16 towns, the largest of which was from Portsmouth (5.1 Mgal/d), Rochester (3.5 Mgal/d), Dover (2.9 Mgal/d); and Hampton (2.8 Mgal/d). Annual return flow, excluding return flow after hydroelectric power generation and thermoelectric plant cooling (31.8 Mgal/d), was larger than annual water demand (26.3 Mgal/d) in the Seacoast region primarily due to inflow and infiltration into the wastewater-collection system.

In 2003, consumptive use in the Seacoast region was 4.4 Mgal/d (table 22) during domestic use (3.0 Mgal/d), commercial use (0.4 Mgal/d), industrial user (0.5 Mgal/d), and other non-domestic users (0.5 Mgal/d) (fig. 10). Major consumptive use took place during bottling, irrigation, and domestic use. Areas where high rates of domestic or irrigation water demand took place were in the towns of Dover, Rochester, Portsmouth, and Exeter in figure 12D and the Cocheco River

**DISPOSAL**

**WATER USE**

**SUPPLY**

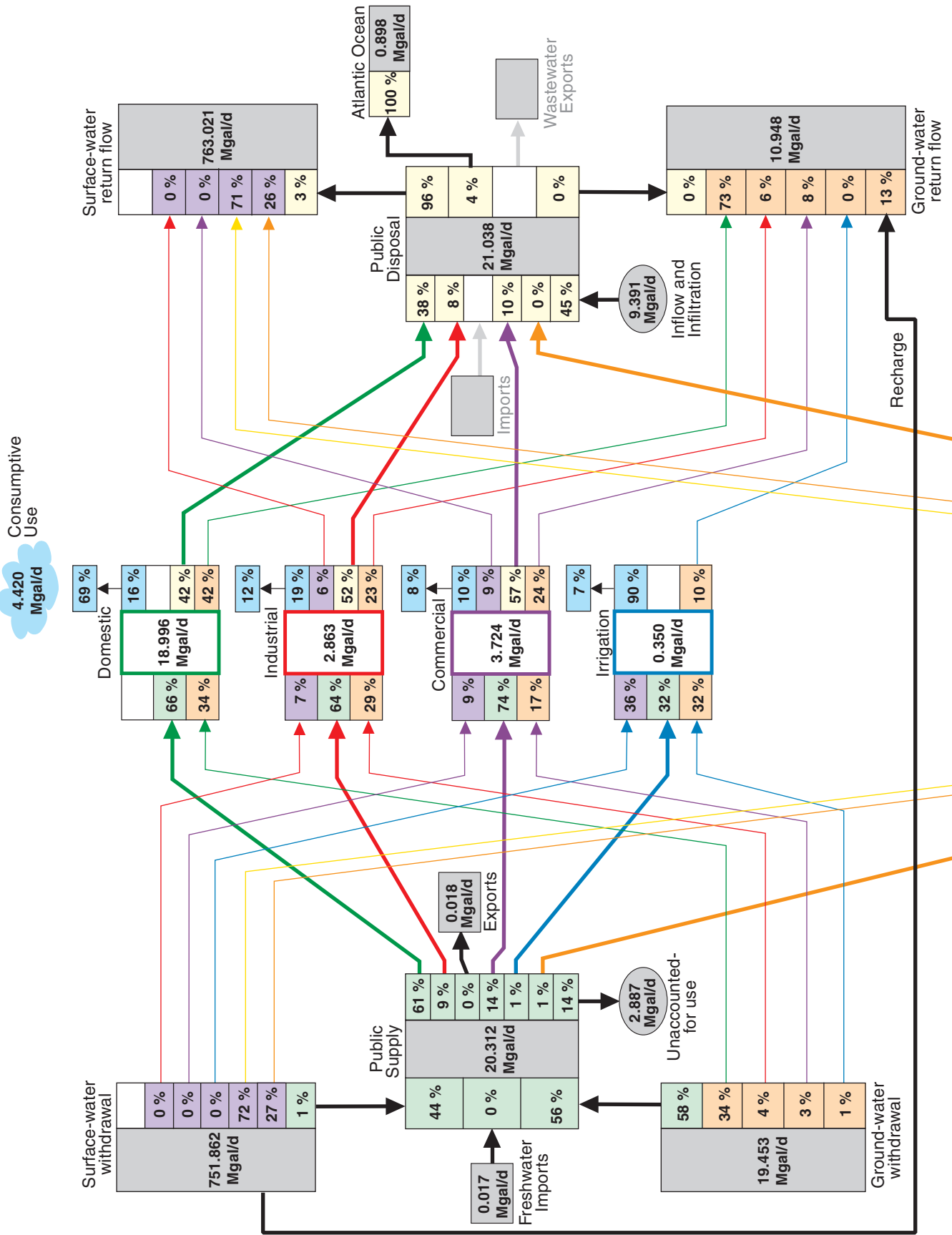

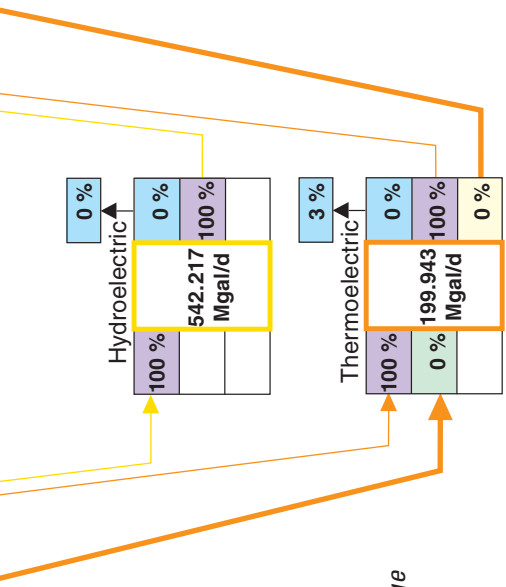

Percentages may not total 100 due to independent rounding.

Multiplication of values in million gallons per day by rounded percentage will not result in accurate values. Please consult tables for specific value.

**EXPLANATION FOR FLOW CHARTS**

**Use Box**

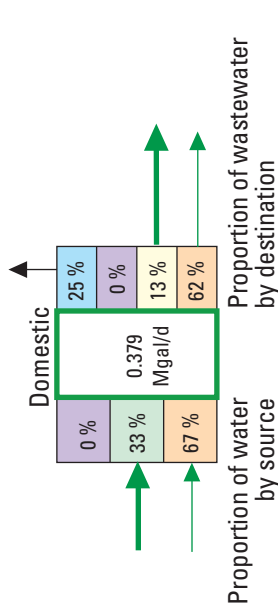

**Type of source or destination**

- Consumptive use (evaporation)
- Surface water
- Ground water
- Community water system (Public Supply)
- Community wastewater system (Public Disposal; Sewer)
- Not an active source or destination

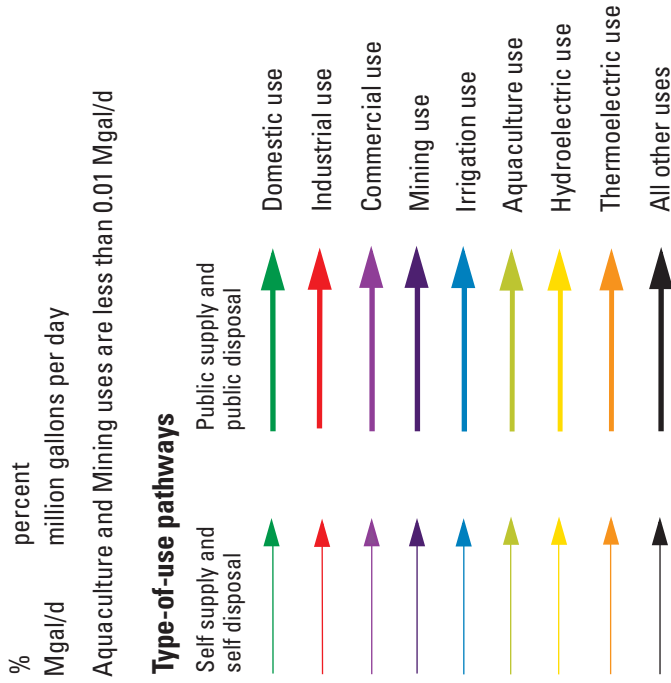

**Figure 10.** Water-use framework in 2003 in the Seacoast region, New Hampshire.

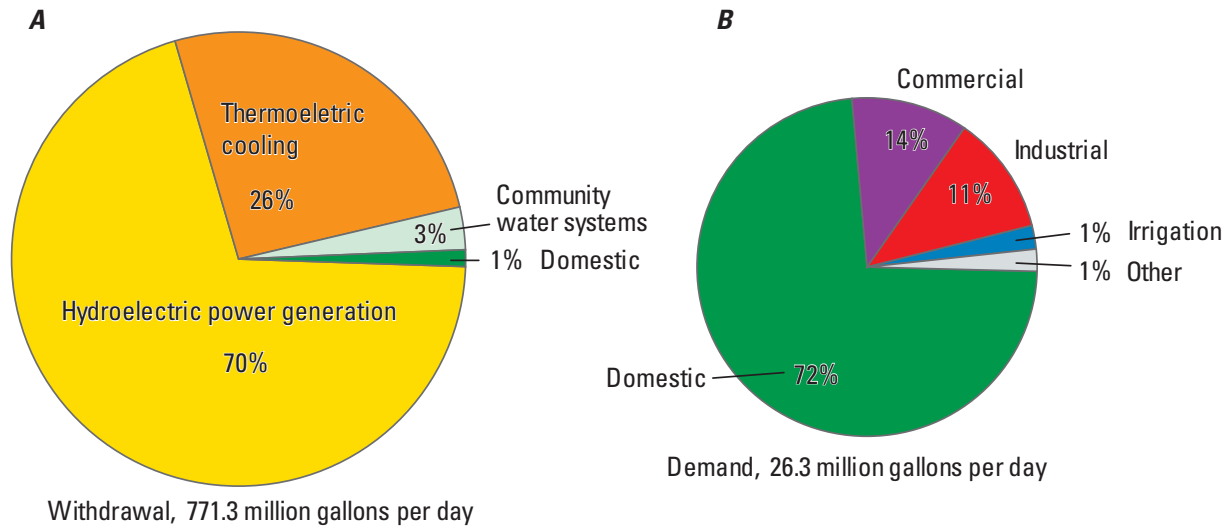

**Figure 11.** Water withdrawal and water demand (excluding non-consumptive use) in 2003 in the Seacoast region, New Hampshire.

and Coastal drainage subbasins in figure 13D. Unaccounted-for water in the Seacoast region was approximately 2.9 Mgal/d, which was primarily returned to the glacial aquifers. This represented about 14 percent of CWS withdrawal. Inflow and infiltration was approximately 9.4 Mgal/d, which was primarily removed from glacial aquifers. Inflow and infiltration was about 45 percent of return flow from wastewater-treatment plants. Although there were no import into or export from the Seacoast region as a whole, about 5.4 Mgal/d (table 22) was transferred across town boundaries, primarily into Portsmouth from Madbury (2.8 Mgal/d).

A more detailed representation of water demand by census block and grouped water-use categories provides towns an opportunity to understand which areas have more intense water demand, due to either greater withdrawal or delivery from CWS. Appendix 2 contains maps of water demand by grouped water-use categories by census block. An example for the town of Epping is provided in figure 14. The type and level of water demand is presented along with the general location of community water distribution systems and points of withdrawal or return flow by registered users and community water and wastewater systems.

### Towns, Projected to 2017 and 2025

Projections of domestic water demand are based on the results of the SRTDM and the domestic per capita water-demand model. Projections of non-domestic water demand are based on the results of the SRTDM and the combined estimates of total commercial, industrial, irrigation, and mining

water demand per census block. The SRTDM projections for 2017 and 2025 were combined with 2003 water-demand coefficients to estimate future water demand.

### Domestic Water Demand

Annual domestic water demand is projected to increase from 19.0 Mgal/d in 2003 to 26.5 Mgal/d in 2017, and to 28.7 Mgal/d by 2025 (table 26). From 2003 to 2017, the rate of projected annual domestic water demand increased and ranged from -2 percent in New Castle to 373 percent in Danville, with an average increase of 42 percent. Most of the increase in domestic water demand in 2017 is projected to be in the central and southwestern parts of the Seacoast region (fig. 15A and 15B). From 2003 to 2025, the rate of projected annual domestic water demand increased and ranged from -1 percent in New Castle to 424 percent in Danville, with an average increase of 54 percent. Most of the increase in domestic water demand in 2025 is projected to be in the central and western parts of the Seacoast region (fig. 15C).

### Non-Domestic Water Demand

Annual non-domestic water demand is projected to increase from 7.3 Mgal/d in 2003 to 10.3 Mgal/d in 2017, and to 11.8 Mgal/d by 2025. Non-domestic water demand is much less widespread than domestic water demand and, in 2003, was concentrated in the Rochester-Somersworth area, the greater Portsmouth area, the Exeter-Stratham-Brentwood



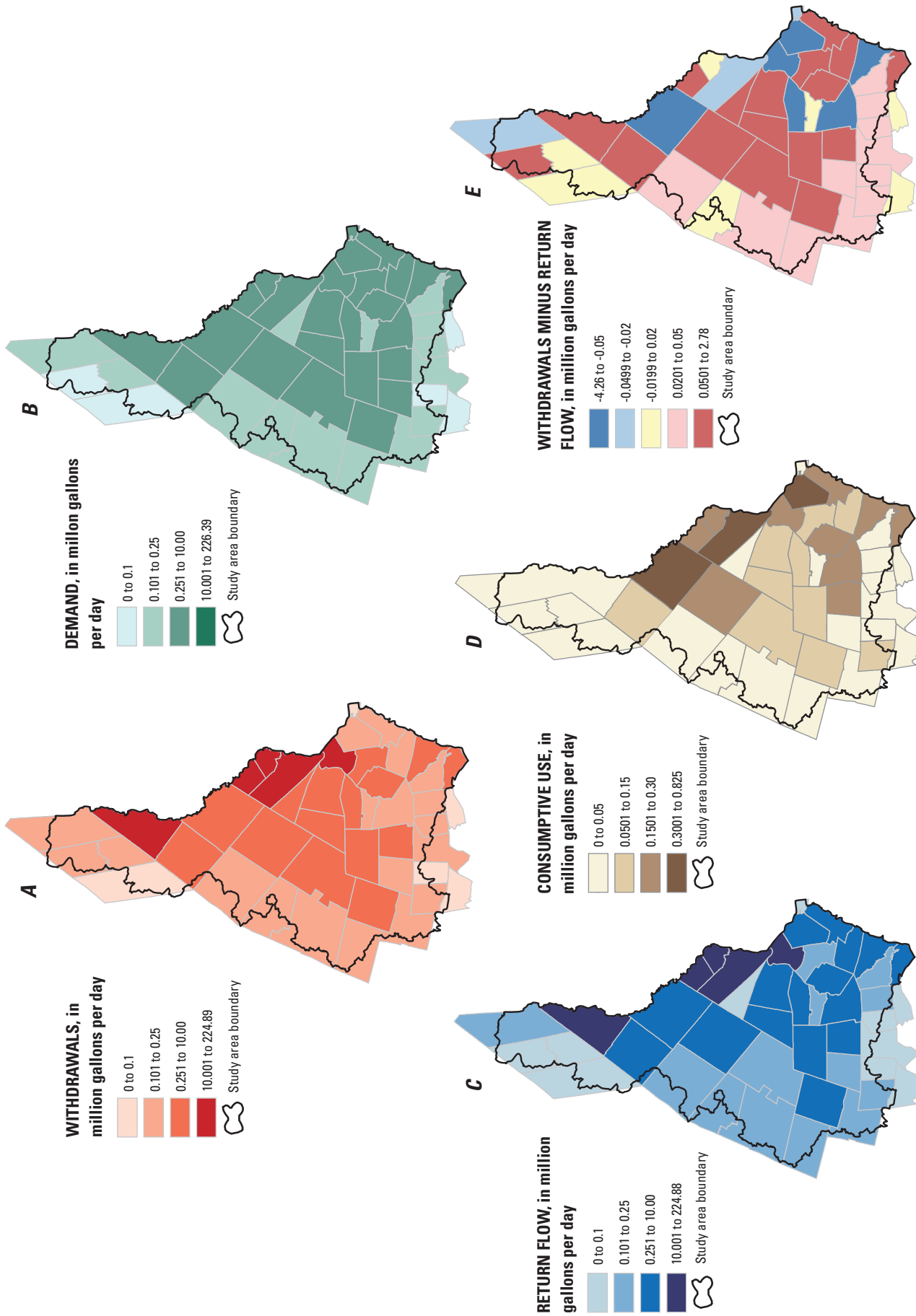

**Figure 12.** Water use by town (A) withdrawal, (B) demand, (C) return flow, (D) consumptive use, and (E) withdrawal minus return flow in 2003 in the Seacoast region, New Hampshire.

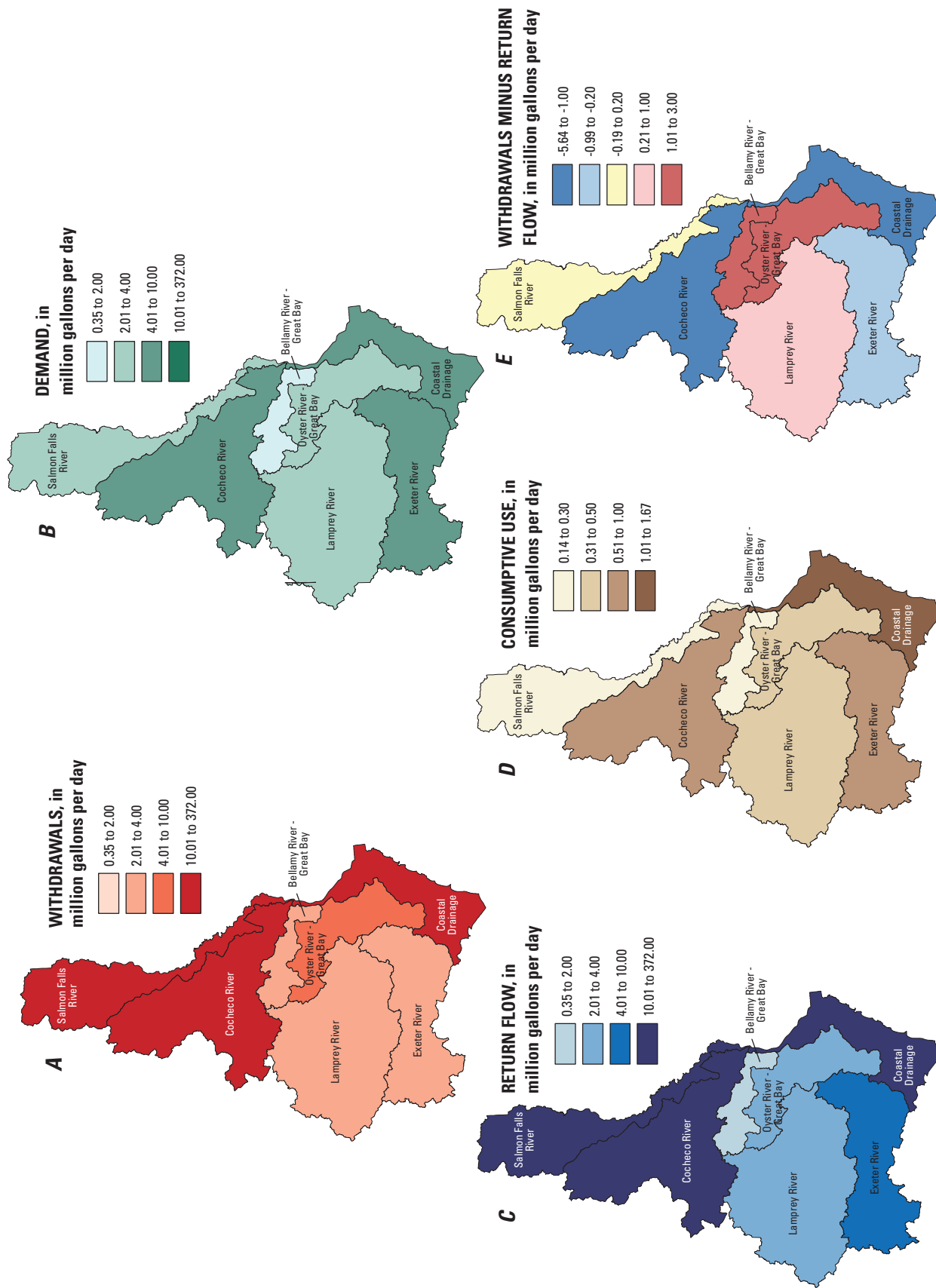
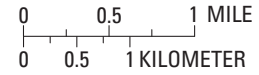
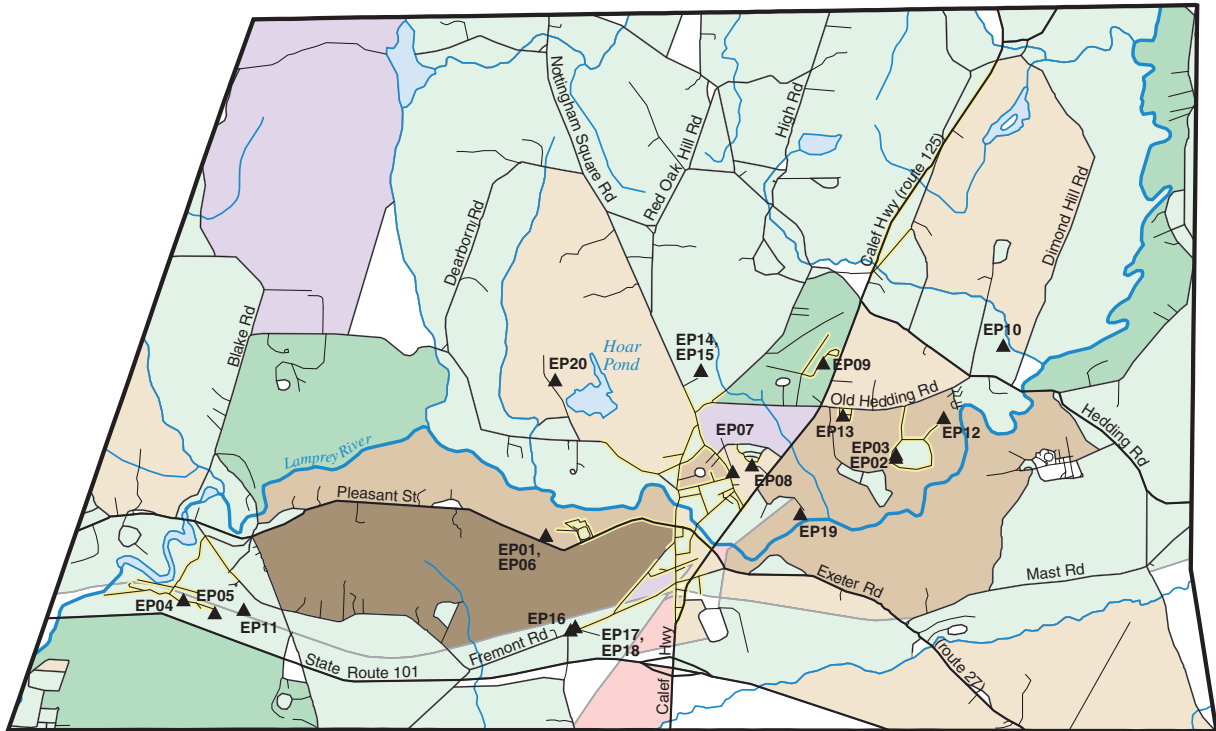

Figure 13. Water use by subbasin (A) withdrawal, (B) demand, (C) return flow, (D) consumptive use, and (E) withdrawal minus return flow in 2003 in the Seacoast region, New Hampshire.

TOWN OF EPPING



EXPLANATION

Total Census Block Water Demand by Grouped Water-Use Categories, in million gallons per day

[no water demand in white areas]

Greater than	Less than or equal to	Domestic	Domestic/Commercial	Domestic/Commercial/Industrial/Irrigation/Mining	Commercial/Industrial
0	0.01				
0.01	0.02				
0.02					

- Water body
- Major river
- Minor river
- Major road
- Minor road
- Census block boundary (other than road or stream)
- Town boundary
- Distribution system
- Major user withdrawal and (or) return point and code  
EP01

Figure 14. Example map of town water demand by grouped water-use categories by census block in Epping, New Hampshire. Maps for 44 towns in the Seacoast region are presented in appendix 2.

**Table 26.** Projected domestic water demand for 2017 and 2025 by town in the Seacoast region, New Hampshire.

[Location of towns shown in figure 1. Mgal/d, million gallons per day]

	Water demand, in Mgal/d			Growth, in percent	
	2003	2017	2025	2003–2017	2003–2025
Barrington	0.587	1.241	1.408	111	140
Brentwood	.228	0.371	0.456	63	100
Brookfield	.044	.062	.071	40	61
Candia	.181	.219	.232	21	28
Chester	.217	.319	.345	47	59
Danville	.039	.186	.206	373	424
Deerfield	.223	.310	.335	39	51
Dover	2.047	3.318	3.494	62	71
Durham	.731	.966	.972	32	33
East Kingston	.108	.226	.273	109	153
Epping	.386	.546	.594	41	54
Exeter	1.061	1.174	1.222	11	15
Farmington	.453	.596	.680	31	50
Fremont	.241	.355	.412	47	71
Greenland	.235	.295	.328	26	40
Hampstead	.051	.102	.109	98	112
Hampton <sup>1</sup>	1.363	1.313	1.400	9	17
Hampton Falls	.156	.326	.434	109	178
Kensington	.139	.235	.289	69	108
Kingston	.098	.210	.237	115	143
Lee	.309	.495	.540	60	75
Madbury	.110	.512	.539	366	391
Middleton <sup>1</sup>	.119	.134	.152	31	48
Milton <sup>1</sup>	.304	.405	.472	40	63
New Castle	.113	.111	.112	-2	-1
New Durham <sup>1</sup>	.090	.137	.159	69	96
Newfields	.105	.164	.197	57	88
Newington	.066	.077	.083	17	27
Newmarket	.591	1.103	1.161	87	97
North Hampton	.359	.428	.467	19	30
Northwood <sup>1</sup>	.152	.208	.235	45	64
Nottingham <sup>1</sup>	.296	.437	.516	56	84
Portsmouth	1.734	1.839	1.882	6	9
Raymond	.657	.794	.847	21	29
Rochester	1.972	2.758	2.978	40	51
Rollinsford	.185	.214	.230	15	24
Rye	.533	.535	.556	6	11
Sandown	.244	.447	.534	83	119
Seabrook <sup>1</sup>	.633	.865	.897	44	50
Somersworth	.801	1.047	1.089	31	36
South Hampton	.056	.151	.199	169	255
Strafford <sup>1</sup>	.251	.357	.416	54	80
Stratham	.452	.619	.708	37	57
Wakefield <sup>1</sup>	.276	.259	.278	15	23
<b>Total or average</b>	<b>18.996</b>	<b>26.466</b>	<b>28.744</b>	<b>42</b>	<b>54</b>

<sup>1</sup> Includes demand by summer-only residents for 2003 only.

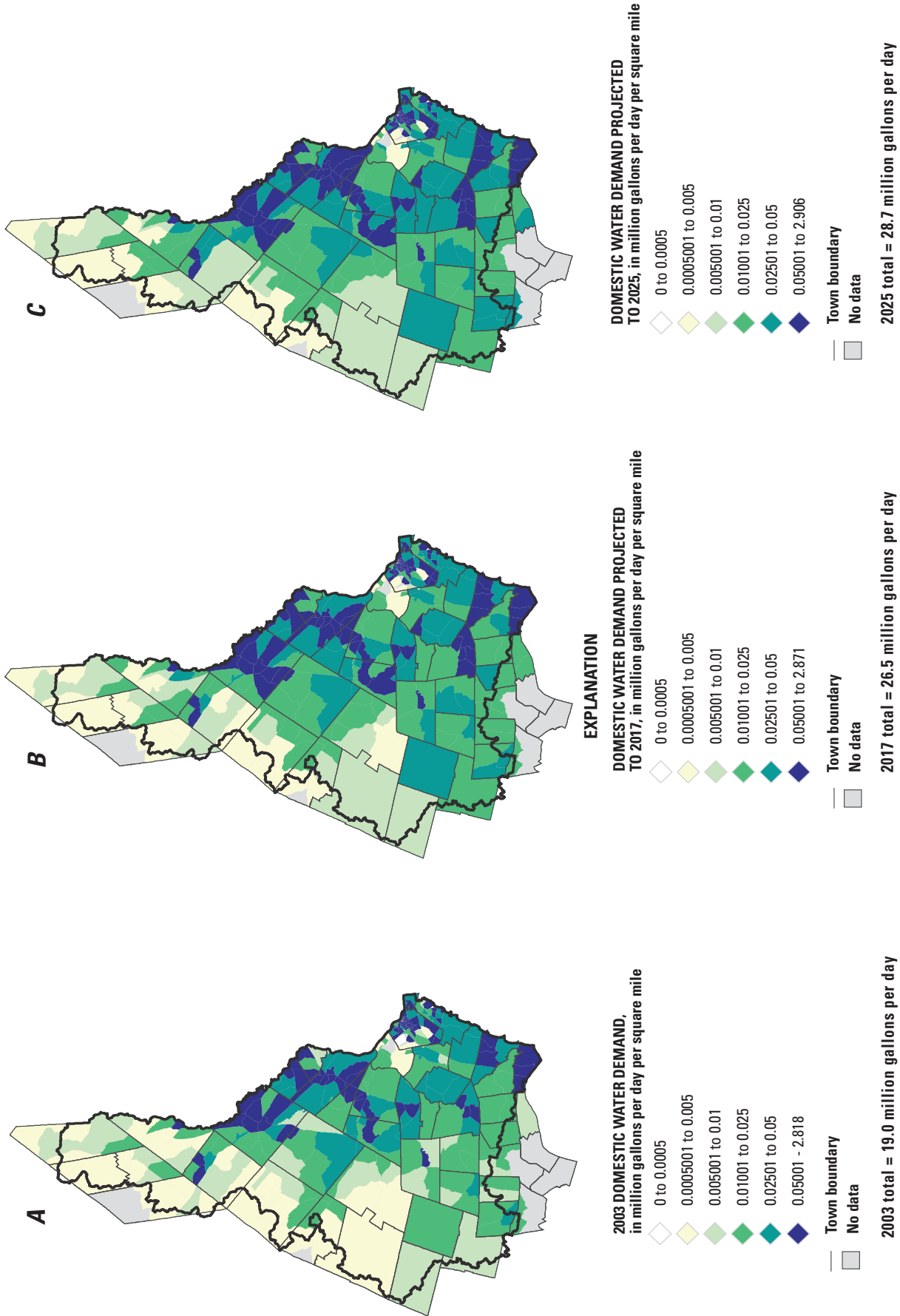

**Figure 15.** Projected domestic water demand by Transportation Area Zone for (A) domestic water demand in 2003, (B) domestic water demand projected to the year 2017, and (C) domestic water demand projected to the year 2025.

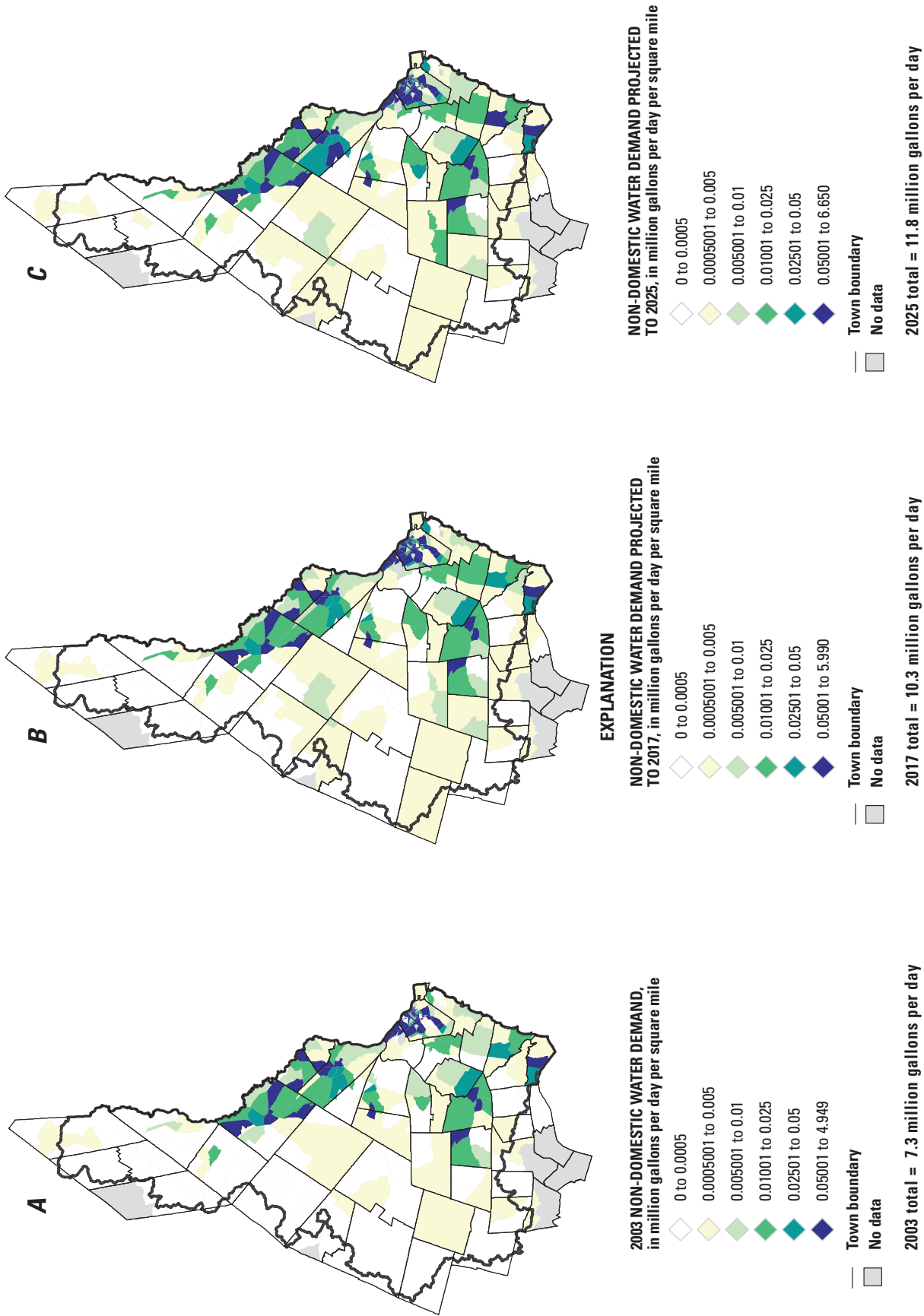

**Figure 16.** Projected non-domestic water demand by Transportation Area Zone for (A) non-domestic water demand in 2003, (B) non-domestic water demand projected to the year 2017, and (C) non-domestic water demand projected to the year 2025.



area, and the Seabrook-Hampton-North Hampton-Greenland area. Most of the increase in non-domestic water demand in 2017 and 2025 is projected to be in the Seabrook-Hampton-North Hampton-Greenland area, Barrington, and the Epping-Fremont area (fig. 16).

Domestic water demand is projected to increase in the Seacoast region from 19.0 Mgal/d in 2003 to 26.5 Mgal/d in 2017, and to 28.7 Mgal/d by 2025 (table 26). Non-domestic water demand is projected to increase from 7.3 Mgal/d in 2003, to 10.3 Mgal/d in 2017, and to 11.8 Mgal/d by 2025. The total projected water demand for 2025 is 40.5 Mgal/d, which means a total of 43.4 Mgal/d (keeping the same volume of unaccounted-for water) to 44.9 Mgal/d (keeping the same proportion of unaccounted-for water) will need to be withdrawn by 2025, an increase of 17.1 to 18.6 Mgal/d. Approximately the same increase in wastewater is anticipated. However, as more of the population is sewered, the likelihood becomes greater for an increase in total inflow and infiltration resulting in a higher volume of wastewater moving through wastewater-treatment plants. If the population on sewers increases from 48 percent of the population (yielding 8.0 Mgal/d of wastewater) to 66 percent of the increased population (yielding 13.8 Mgal/d) and the rate of inflow and infiltration remains the same at 45 percent, then an additional 18 Mgal/d will be released through wastewater-treatment plants (from 21.0 to 29.0 Mgal/d).

## Summary

The Seacoast region of New Hampshire encompasses 44 towns within 7 major subbasins in the southeastern part of the State. Its proximity to metropolitan Boston has led to a 37-percent population increase during 1980 to 2000 and an estimated 50-percent increase in the use of ground- and surface-water resources for domestic, industrial, commercial, irrigation, and other purposes. Continued population and urban growth in the future will result in greater dependence on the available ground- and surface-water resources of the region. Determining the sustainability of and effectively managing these water resources require a thorough understanding of the available resources, how much water is currently used, and how much water is projected to be needed in the future. To address these concerns, the U.S. Geological Survey (USGS), in cooperation with the New Hampshire Coastal Program, the New Hampshire Geological Survey, New Hampshire Department of Environmental Services (NHDES), and 44 towns, conducted a study to assess current water use and future water demand.

The water-use activities evaluated include withdrawal, delivery, demand, consumptive use, release, return flow, and transfer by registered and aggregated unregistered (less than 20,000 gal/d) users at the census-block and town scales in the Seacoast region. Water use for the year 2003 was estimated and water demand was projected for years 2017 and 2025.

The three basic steps followed for estimating water-use at the census-block level include (1) identifying the water users in the Seacoast region, (2) identifying the source of water and disposal of wastewater for each user, and (3) estimating the amount of water use for each water-use activity.

Estimates of water use rely on understanding what influences water demand and its associated consumptive use, because changes in water demand and consumptive use affect withdrawal and return flow. Water-demand and consumptive-use coefficients were developed for domestic and commercial categories, and an existing industrial coefficient was evaluated. A water-demand coefficient is the amount of water used per one unit for each category of use. The coefficient is multiplied by the number of units at the facility or in the area to obtain the total water demand for that facility or area.

Two approaches were used to determine domestic per capita water-demand and consumptive-use coefficients. The first approach involved the use of a domestic water-demand survey to determine if there were differences in the amount of water used by households that depend on community water systems (CWSs) or private wells for water supply. The second approach consisted of developing a statistical model that related metered water deliveries from selected CWSs to individual homes to a variety of data sets that may explain the variations in observed metered data.

To assess potential differences between domestic-well and public-water-system water demand rates, USGS partnered with the NHDES and 16 local schools in 25 towns to implement a water-demand survey of middle school (grades 5–8) students and their families. Domestic (residential) water-demand surveys were distributed to middle school students and their families as a part of the schools' environmental studies to improve the students' understanding of the importance of water resources in daily life. Results of the survey indicated generally no difference in indoor domestic water demand between self- and public-supplied households.

Domestic water demand was estimated using a per capita water-demand coefficient based on a statistical model relating metered deliveries to domestic users with census block and block-group data. This method was used to predict mean annual, summer, and winter per capita water-demand coefficients for each census block. Significant predictors of domestic water demand include population per housing unit, median value of owner-occupied single family homes, median year of housing construction (with 1900 as the base value), population density, housing unit density, and proportion of housing units that are in urban areas. The  $R^2$  of the annual model was 0.41, and the  $R^2$  of the winter and summer models was 0.38.

The mean annual domestic per capita water-demand coefficient in the Seacoast region was 75 gal/d; the coefficient increased to 92 gal/d during the summer and decreased to 63 gal/d during the winter. Domestic consumptive use was estimated as the difference between annual and winter domestic water demand, with an annual mean of 16 percent.

Estimates of commercial and industrial water demand were based on values derived from reported withdrawal and

delivery from the WATUSE database and from meter readings. Commercial water-demand coefficients were generated for 15 groups and 58 subgroups of commercial establishments in the Seacoast region. Commercial groups were based on the type of business; subgroups were defined on the basis of business size and reported water demand from WATUSE database or meter readings. Estimates of irrigation, mining, aquaculture, thermoelectric and hydroelectric water use were based on reported water use from the WATUSE database. Commercial and industrial consumptive use generally was estimated as 10 percent of water demand, but was modified for specific types of businesses, such as for bottled water or sheet rock manufacturing. Projections of water demand in 2017 and 2025 were determined by using the housing and employee projections for those years developed through a Travel Demand Model and applying current domestic and non-domestic coefficients.

The estimates of water demand served as the basis for estimates of withdrawal from ground and surface water. Estimates of return flow were based on water demand minus consumptive use. Delivery to CWSs were estimated from domestic, commercial, and industrial water demand. Estimates of release to community wastewater systems (CWWSs) were equal to domestic, commercial, and industrial water demand minus consumptive use. Estimates of water transfers between towns or watersheds for a particular CWS were equal to the amount of water after delivery to the town or watershed are subtracted from CWS withdrawal. The amount of water transferred between CWSs was available from WATUSE. Estimates of wastewater transfer between towns or watersheds were equal to release to the CWWS by domestic, commercial, and industrial uses in each town or watershed that were then conveyed outside of that town or watershed.

Water demand in the Seacoast region in 2003 was estimated as 26.3 million gallons per day (Mgal/d), 35 percent of which was during the summer months of June, July, and August. Domestic water demand was 19.0 Mgal/d (72 percent), commercial water demand was 3.7 Mgal/d (14 percent), industrial water demand was 2.9 Mgal/d (11 percent), irrigation water demand was 0.4 Mgal/d (1 percent), and thermoelectric, mining, and aquaculture water demand was 0.3 Mgal/d (1 percent). Domestic water demand increased to 26.0 Mgal/d during the summer, and decreased to 15.7 Mgal/d during the winter.

The annual per capita water demand for each town in the Seacoast region ranged from 61 gal/d to 111 gal/d, and the mean was 75 gal/d. About one-third of water supplied for domestic water demand was self-supplied, primarily from bedrock aquifers, and two-thirds was public supply from surface water, glacial aquifers, and bedrock aquifers. Water evaporated during domestic water demand ranged from 10 percent to 30 percent, with a mean value of 16 percent resulting in 3.0 Mgal/d over the Seacoast region. Fifty percent of the domestic wastewater was returned directly to the glacial aquifer system through septic systems, and 50 percent was

released into wastewater-collection systems for treatment and return flow, primarily to surface waters.

Estimated annual non-domestic water demand in the Seacoast region totaled 7.3 Mgal/d, which accounted for 28 percent of total water demand. About one-third of water supplied for non-domestic water demand was self-supplied from surface water, glacial aquifers, and bedrock aquifers, and two-thirds was public supply from the same sources. About 19 percent of non-domestic water demand, 1.4 Mgal/d, was estimated to evaporate during use. More than a third (35 percent) of the non-domestic wastewater was returned directly to the glacial aquifer system through septic systems; the remaining 65 percent was released into wastewater-collection systems for treatment and return flow, primarily to surface waters.

In 2003, annual withdrawal in the Seacoast region was 771.3 Mgal/d, of which 742.2 Mgal/d were instream uses for hydroelectric power generation and thermoelectric power cooling. The remaining 29.1 Mgal/d was withdrawn by CWSs (20.3 Mgal/d; 70 percent), domestic users (6.5 Mgal/d; 22 percent), commercial users (1.0 Mgal/d; 3 percent), industrial users (1.0 Mgal/d; 3 percent), irrigation (0.2 Mgal/d; 1 percent) and other non-domestic users less than 0.1 Mgal/d. CWSs in 35 towns withdrew the largest volume of water in the Seacoast region. Nine of the 44 towns in the Seacoast region had no CWS withdrawal. Three towns (Hampstead, New Castle, and Newington) imported water to supply their CWSs. Annual withdrawal, excluding hydroelectric power generations and thermoelectric plant cooling, totaled 29.1 Mgal/d. The annual withdrawal was 2.8 Mgal/d greater than estimated water demand (26.3 Mgal/d) due to recharge to ground-water resources (Dover) and losses from distribution systems.

In 2003, annual return flow in the Seacoast region was 774.0 Mgal/d, of which 742.2 Mgal/d was returned following hydroelectric power generation and thermoelectric plant cooling. The remaining 31.8 Mgal/d was returned by CWWSs (21.0 Mgal/d; 66 percent), domestic users through on-site disposal systems (8.0 Mgal/d; 25 percent), commercial users (1.2 Mgal/d; 4 percent), industrial users (0.8 Mgal/d; 3 percent), and other non-domestic users (0.1 Mgal/d). Annual return flow, excluding return flow after hydroelectric power generation and thermoelectric plant cooling (31.8 Mgal/d), was larger than annual water demand (26.3 Mgal/d) in the Seacoast region, primarily due to inflow and infiltration into the wastewater-collection system.

In 2003, consumptive use in the Seacoast region totaled 4.4 Mgal/d. Consumptive use from domestic households was 3.0 Mgal/d, commercial consumptive use was 0.4 Mgal/d, industrial consumptive use was 0.5 Mgal/d, and other non-domestic consumptive use was 0.5 Mgal/d. Most consumptive use took place during bottling, irrigation, and domestic water demand. Unaccounted-for water from distribution systems in the Seacoast region was approximately 2.9 Mgal/d, which was primarily returned to the glacial aquifers. This represented about 14 percent of CWS withdrawal. Inflow and infiltration into wastewater-collection systems was approximately

9.4 Mgal/d, which was primarily removed from glacial aquifers. Inflow and infiltration was about 45 percent of total amount of return flow from wastewater-treatment plants.

The Coastal Drainages subbasin, a series of small tributaries flowing directly to tidal embayments and coastal waters, accounted for 26 percent (6.9 Mgal/d) of water demand in the Seacoast region. This subbasin had the greatest water demand of all subbasins in the Seacoast region. There was a net gain of 4.6 Mgal/d in the Coastal Drainages subbasin, through import of 4.4 Mgal/d of freshwater and 0.2 Mgal/d of wastewater from the Oyster River subbasin. The Coastal Drainages subbasin includes many of the more densely population areas of the Seacoast region. The Cocheco River subbasin accounted for 23 percent (5.9 Mgal/d) of water demand in the Seacoast region. This subbasin had more water withdrawn by CWSs (5.2 Mgal/d) than any other subbasin, some of which (1.4 Mgal/d) was used to recharge ground water near the Rochester/Dover town line. There was a net gain of 0.7 Mgal/d in the Cocheco River subbasin, through import of 0.3 Mgal/d of freshwater from the Bellamy River subbasin and 0.7 Mgal/d of wastewater from the Bellamy and Oyster River subbasins. Offsetting this import was 0.1 Mgal/d of freshwater and 0.2 Mgal/d of wastewater exported into the Salmon Falls River subbasin. The Exeter River subbasin accounted for 16 percent (4.2 Mgal/d) of water demand in the Seacoast region. This subbasin had the least volume of water withdrawn by CWSs, but the third highest return flow rate by wastewater systems (1.9 Mgal/d). The Lamprey River subbasin accounted for 11 percent (2.8 Mgal/d) of water demand in the Seacoast region. The Oyster River–Great Bay subbasin accounted for 9 percent (2.2 Mgal/d) of water demand in the Seacoast region. There was a net loss of 1.7 Mgal/d in the Oyster River–Great Bay subbasin through the export of 1.8 Mgal/d of freshwater to the Coastal Drainages subbasin and 0.3 Mgal/d of wastewater to the Coastal Drainages and Cocheco River subbasins and import of 0.5 Mgal/d from the Bellamy River–Great Bay and Lamprey River subbasins. The Bellamy River–Great Bay subbasin accounted for only 4 percent of water demand in the Seacoast region, but 15 percent of all withdrawal by CWS. There was a net loss of 3.4 Mgal/d in the Bellamy River–Great Bay subbasin through export of freshwater to the Coastal Drainages, Cocheco River, and Oyster River subbasins. Of the 2.5 Mgal/d water demand in the New Hampshire part of the Salmon Falls River subbasin, 1.8 Mgal/d (70 percent) was for domestic water demand.

Water-use data for 2003 for each of the 44 towns in the Seacoast region are summarized in appendix 2 by map, flow chart, and table. The map illustrates water demand by census block. The flow chart shows all water-use activities for each town and provides an overview of water withdrawal from ground and surface water; delivery to domestic, commercial, and industrial users; how water demand is met through CWS delivery or self supply; consumptive use; the manner of wastewater disposal to on-site disposal or release to wastewater collection systems; and return flow to ground and surface water.

Tables summarize 2003 water-use data displayed in the flow chart and map. Appendix 3 contains a flow chart summarizing 2003 water use for each of the seven subbasins.

Domestic water demand is projected to increase in the Seacoast region from 19.0 Mgal/d in 2003 to 26.5 Mgal/d in 2017 and to 28.7 Mgal/d by 2025 based on changes in population. Non-domestic water demand is projected to increase from 7.3 Mgal/d in 2003 to 10.3 Mgal/d in 2017 and to 11.8 Mgal/d by 2025. The total projected water demand in the Seacoast region for 2025 is 40.5 Mgal/d, which means a total of 43.4 Mgal/d to 44.9 Mgal/d (depending on the amount estimated for unaccounted-for water) will need to be withdrawn by 2025. This is an increase of 17.1 to 18.6 Mgal/d from 2003 withdrawal amount. If the percentage of the region that is sewerred remains the same as 2003 levels, a similar increase in the amount of wastewater generated is anticipated. As more of the population is sewerred, however, the likelihood becomes greater for an increase in total inflow and infiltration resulting in a higher volume of wastewater moving through wastewater-treatment plants. Hypothetically, if the population on sewers were to increase from 48 percent of the population (yielding 8.0 Mgal/d of wastewater) to 66 percent of the population (yielding 13.8 Mgal/d) and the rate of inflow and infiltration remains the same (45 percent), then an additional 8 Mgal/d will be released through wastewater-treatment plants from domestic users (from 21.0 to 29.0 Mgal/d).

## References Cited

- Complex Systems Research Center, 2003a, Rockingham County land use—1998: Complex Systems Research Center, University of New Hampshire, 1:12,000-scale digital data, accessed April 6, 2006, at <http://www.granit.sr.unh.edu/cgi-bin/nhsearch?dset=lu98/rockingham>.
- Complex Systems Research Center, 2003b, Strafford County land use—1998: Complex Systems Research Center, University of New Hampshire, 1:12,000-scale digital data, accessed April 6, 2006, at <http://www.granit.sr.unh.edu/cgi-bin/nhsearch?dset=lu98/strafford>.
- Davis, W.Y., Rodrigo, D.M., Opitz, E.M., Dziegielewski, Benedykt, Baumann, D.D., and Boland, J.J., 1991, IWR-MAIN water use forecasting system, version 5.1—Users manual and system description, consultant report: Carbondale, Ill., U.S. Army Corps of Engineers and Planning and Management Consultants, 307 p.
- Dun & Bradstreet, 2000, Dun & Bradstreet Business Information Database: Murray Hill, N.J.
- Dziegielewski, Benedykt, Kiefer, J.C., Opitz, E.M., Porter, G.A., Lantz, G.L., DeOreo, W.B., Mayer, P.W., and Nelson, J.O., 2000, Commercial and institutional end uses of water: Denver, Colo., American Water Works Association Research Foundation, 264 p.



- Flanagan, S.M., Nielsen, K.W., Robinson, K.W., and Coles, J.F., 1999, Water-quality assessment of the New England coastal basins in Maine, Massachusetts, New Hampshire, and Rhode Island—Environmental settings and implications for water quality and aquatic biota: U.S. Geological Survey Water-Resources Investigations Report 98–4249, 78 p.
- Horn, M.A., 2002, User's manual for the New England Water-Use Data System (NEWUDS): U.S. Geological Survey Open-File Report 01–328, 377 p.
- Hutson, S.S., Barber, N.L., Kenny, J.F., Linsey, K.S., Lumia, D.S., and Maupin, M.A., 2004, Estimated use of water in the United States in 2000: U.S. Geological Survey Circular 1268, 46 p.
- Lyons, J.B., Bothner, W.A., Moench, R.H., and Thompson, J.B., Jr., 1997, Bedrock geologic map of New Hampshire: U.S. Geological Survey Special Map, 2 sheets, scale 1:250,000.
- Mack, T.J., 2003, Preliminary ground-water-flow model of a coastal bedrock-aquifer system, southeastern New Hampshire, *in* MODFLOW in More, 2003: Understanding through modeling conference, Golden, Colo., September 16–19, 2003, Abstracts with Programs: Colorado School of Mines, p. 639–643, accessed January 11, 2006, at [http://nh.water.usgs.gov/Publications/2003/tjm\\_igwmc03.pdf](http://nh.water.usgs.gov/Publications/2003/tjm_igwmc03.pdf).
- Mack, T.J., and Lawlor, S.M., 1992, Geohydrology and water quality of stratified-drift aquifers in the Bellamy, Cohecho, and Salmon Falls River Basins, southeastern New Hampshire: U.S. Geological Survey Water-Resources Investigations Report 90–4161, 65 p., 6 pls.
- Maryland Department of the Environment, 2006, Water Supply Program, Conducting a household water audit, accessed September 26, 2006, at <http://www.mde.state.md.us/assets/document/ResAudit.pdf>.
- Mayer, P.W., DeOreo, W.B., Opitz, E.M., Kiefer, J.C., Davis, W.Y., Dziegielewski, Benekykt, and Nelson, J.O., 1999, Residential end uses of water: Denver, Colo., American Water Works Association Research Foundation, 310 p.
- Medalie, Laura, and Moore, R.B., 1995, Ground-water resources in New Hampshire—Stratified-drift aquifers: U.S. Geological Survey Water-Resources Investigations Report 95–4100, 31 p.
- Moore, R.B., 1990, Geohydrology and water quality of stratified-drift aquifers in the Exeter, Lamprey, and Oyster River Basins, southeastern New Hampshire: U.S. Geological Survey Water-Resources Investigations Report 88–4128, 61 p., 8 pls.
- Mullaney, J.R., 2004, Water use, ground-water recharge and availability, and quality of water in the Greenwich area, Fairfield County, Connecticut and Westchester County, New York, 2000–2002: U.S. Geological Survey Water-Resources Investigations Report 03–4300, 64 p.
- New Hampshire Geological Survey, 2000, Water user registration and reporting in New Hampshire: New Hampshire Department of Environmental Services Environmental Fact Sheet GEO-4, 2 p., accessed online January 11, 2006, at <http://des.nh.gov/factsheets/geo/geo-4.htm>.
- New Hampshire Office of Energy and Planning, 2005, Population projections, accessed January 2006, at <http://nh.gov/oep/programs/DataCenter/Population/PopulationProjections.htm>.
- New Hampshire Office of Energy and Planning, 2001, Municipal populations 1960–2000 arranged by county: Compilation of 2000 U.S. Census Data.
- New Hampshire Office of State Planning, 2000, Managing growth in New Hampshire—Changes and challenges: The Growth Management Advisory Committee, 58 p.
- Orange Water and Sewer Authority, 2006, North Carolina, Water use calculator for OWASA's residential customers, accessed September 26, 2006, at <http://www.owasa.org/pages/WaterCalculator.html>.
- Planning and Management Consultants, Ltd., 1995, IWR-MAIN Water demand analysis software, User's manual and system description, version 6.1: Carbondale, Ill., 497 p.
- SAS Institute, Inc., 2000, SAS/STAT User's guide, version 8: Cary, N.C., SAS Institute, Inc.
- Solley, W.B., Pierce, R.R., and Perlman, H.A., 1998, Estimated use of water in the United States in 1995: U.S. Geological Survey Circular 1200, 71 p.
- Stekl, P.J., and Flanagan, S.M., 1992, Geohydrology and water quality of stratified-drift aquifers in the Lower Merrimack and Coastal River Basins, southeastern New Hampshire: U.S. Geological Survey Water-Resources Investigations Report 91–4025, 93 p., 6 pls.
- U.S. Bureau of the Census, 2001a, 2000 census of population and housing—Summary population and housing characteristic, New Hampshire: Washington, D.C., Bureau of the Census, available through Geolytics, Inc., E. Brunswick, N.J.
- U.S. Bureau of the Census, 2001b, Census 2000 Geography Glossary, accessed June 15, 2006, at <http://www.census.gov/geo/www/tiger/glossry2.pdf>.

- U.S. Bureau of the Census, 2001c, Census 2000 Summary File 1 (SF 1) 100-percent data, detailed tables: Washington, D.C., address search tool, accessed June 15, 2006, at <http://factfinder.census.gov>.
- U.S. Bureau of the Census, 2001d, Census 2000 Geography, accessed June 15, 2006, at <http://www.census.gov/geo/www/tiger/index.html>.
- U.S. Department of Commerce, 1986, Water use in manufacturing, census of manufacturers, 1982: Washington, D.C., Bureau of the Census, Special Report series MC 82-S-6, 198 p.
- U.S. Environmental Protection Agency, 1998, SDWA Section 1401(4) Public Water System Definition as amended by 1996 SDWA Amendments: Federal Register, v. 63, no. 150, Notice, p. 41939–41946, accessed January 5, 2006, at <http://www.epa.gov/safewater/pws/pwsfrn.html>.





# Glossary

## A

**Aggregate of users** A group of users defined by a geographic area, such as State, county, minor civil division, or Hydrologic Unit boundary, for which withdrawal, distribution, demand, consumptive use, wastewater collection, or return flow are collectively estimated.

## C

**Commercial water use** Water used for motels, restaurants, office buildings, ski resorts, water parks, and other commercial facilities and institutions. The water may be supplied by a community water system or be self-supplied.

**Community wastewater system** Wastewater collected from users or groups of users, conveyed to a wastewater-treatment plant and released as return flow into the hydrologic environment or sent back to users as reclaimed wastewater.

**Community water system** System for the provision to the public of water for human consumption through pipes or other constructed conveyances if such a system has 15 year-round service connections or serves more than 25 year-round residents. Community water systems provide water for a variety of uses, such as domestic, commercial, industrial, thermoelectric power, and public use.

**Consumptive use** That part of withdrawn water that is evaporated, transpired, incorporated into products or crops, consumed by humans or livestock, or otherwise removed from the immediate water environment.

**Conveyance** The systematic and intentional flow or transfer of water from one point to another primarily during distribution and wastewater collection.

**Cooling tower** A tower in which water heated during processing is cooled down for reuse, as in air conditioning systems or steam power-generating plants.

## D

**Delivery** The amount of water delivered to users.

**Discharge pipe** A pipe through which effluent is released after use into a receiving stream or infiltration bed. Also referred to as an outfall.

**Distribution** The process of conveying water from a community water system's points of withdrawal/diversion or treatment through the distribution system to the user or another water supplier. Water is "released" from the community water system into the distribution systems and "delivered" to users. *See also* delivery and release.

**Distribution system** A pipe or system of pipes conveying water from wells and intake pipes or a potable water treatment plant to users. A Local distribution system conveys water to users within a single minor civil division. A Regional distribution system conveys water to users in more than one minor civil division or to another regional distribution system.

**Diversion** Point of withdrawal from surface water.

**Domestic water use** Water for household purposes, such as drinking, food preparation, bathing, washing clothes and dishes, flushing toilets, and watering lawns and gardens. Households include single and multi-family dwellings. Also called residential water use. The water may be obtained from a community water system or be self supplied.

## E

**Export** Water that is removed from an area (watershed or town) for use in another area, or wastewater that is removed after use from an area (watershed or town) for treatment and release in another area.

## G

**Ground-water return flow** Wastewater that is returned to ground water over a geographic area by an aggregate of users or through septic systems.

**Ground-water withdrawal** Water that is withdrawn from ground water over a geographic area by an aggregate of users or by

a single user for which there is not enough information to select a more specific site type.

## I

**Import** Water that enters, or is brought into an area (watershed or town) for use, or wastewater that is conveyed after use from an outside area (watershed or town) for treatment and release in the area of interest.

**Industrial water use** Water used for industrial purposes, such as fabrication, processing, washing, in-plant conveyance, and cooling, and includes such industries as steel, chemicals, paper, and petroleum refining. The water may be supplied by a community water system or be self-supplied.

**Inflow and infiltration** Combination of inflow from surface water and infiltration from ground water into a wastewater-collection system. Infiltration will occur if the ambient ground-water pressure is greater than the internal pressure of the conveyance at a breach.

**Instream use** Water that is used, but not withdrawn/diverted, from a surface-water source, or a ground-water source, for hydroelectric-power generation, navigation, water-quality improvement or waste assimilation, fish propagation, wildlife preservation, recreation, and ecosystem maintenance, which includes freshwater circulation to the estuaries and maintenance of riparian vegetation and flood plain wetlands. Also referred to as non-withdrawal use or in-channel use.

**Intake pipe** A pipe in a surface-water body through which water is diverted to another site.

**Interbasin transfer** Conveyance of water across a drainage or river basin divide.

**Irrigation water use** The artificial application of water on lands to assist in the growth of crops or pasture including greenhouses. Irrigation water use also may include application of water to maintain vegetative growth in recreational lands such as parks and golf courses, including water used for frost and freeze protection of crops.

## L

**Land application** Disposal of wastewater over a field, for instance using wastewater to irrigate a golf course.

**Leakage** Water that moves from a conveyance system or storage area into the surrounding and underlying materials. This process will occur if the ambient ground-water pressure is less than the internal pressure of the conveyance system or storage area at a breach.

## M

**Mining water use** Water used for the extraction of naturally occurring minerals including coal, ores, petroleum, and natural gas. Includes water associated with quarrying, milling, and other onsite activities done as part of mining. Excludes water used for processing, such as smelting and refining, or slurry pipeline (industrial water use). These activities are included in SIC codes 10–14.

**Minor Civil Division** A political or administrative area of a county or county equivalent, other than an incorporated place, established by appropriate State or local government authorities and adopted as a primary county division; equivalent to a town in New England.

**Minor user** In New Hampshire, any user who withdraws, receives, or uses water, or releases or returns wastewater at a rate less than 20,000 gallons per day over any 7-day period.

## N

**NAICS Code** The North American Industry Classification System (NAICS) has replaced the U.S. Standard Industrial Classification (SIC) system. NAICS was developed jointly by the U.S., Canada, and Mexico to provide new comparability in statistics about business activity across North America.

## O

**Offstream use** Water withdrawn or diverted from a ground- or surface-water source for use.

## P

**Per capita water use** The average volume of water used per person during a standard time period, generally per day.

**Potable treatment plant** A site that prepares water to drinking water standards; may include chlorination, fluoridation, and filtration.

**Projected water demand** Water demand related to domestic, commercial, industrial, or other activities for which increases in population or employee numbers have been made. The projected water demand is based on current coefficients between water demand and population or employee number unless otherwise stated.

**Public use** Water supplied from a community-water system and used for firefighting, street washing, water-treatment plant back-flushing of filters, and municipal parks and swimming pools.

## R

**Ranney collector** A large diameter well located near a large surface-water body to induce infiltration of surface water. Screens are driven radially and approximately horizontally from this well into the sand and the gravel deposits underlying the river.

**Raw water** Untreated water.

**Recharge basin** Return of freshwater or wastewater into a specially designed basin to induce infiltration to ground-water resources.

**Recharge well** A hole in the ground that has a diameter smaller than its depth, through which water is directed/pumped back into the ground.

**Reclaimed wastewater system** System of pipes that convey wastewater from a treatment plant to users before it reaches a natural waterway or aquifer.

**Recycled water system** System of pipes that convey water from one user to another user, but generally by the same user, before it passes back into the natural hydrologic system.

**Registered user** In New Hampshire, a user who withdraws, receives, or uses water, or releases or returns wastewater at a rate of 20,000 gallons per day or more over any 7-day period.

**Release** Water discharged by a user or group of users into a wastewater-collection system.

**Resource** Aquifer or surface-water body from which water is withdrawn/diverted or returned.

**Return flow** Water that is returned to surface-water or ground-water resources after use or wastewater treatment, and thus

becomes available for reuse. Return flow can go directly to surface water, directly to ground water through an injection well or infiltration bed, or indirectly to ground water through septic systems.

**RSA** Revised Statute Annotated, legal term in the State of New Hampshire.

## S

**Self-supplied water** Water withdrawn from a ground- or surface-water source by a user and not obtained from a community water system.

**Septic system** Refers to a buried tank for the separation in the absence of oxygen of solids, grease, and liquid components of wastewater. The liquid fraction from the septic tank is discharged to a drain field and the solids remain in the tank for later disposal as septage.

**Service area (franchise area)** A group of customers who are served water through a single delivery and (or) measuring/metering device from a main distribution system.

**Single user** An individual user for which withdrawal, demand, consumptive use, or return flow are measured or estimated. This place of use can be a manufacturing plant, commercial facility, or irrigation field.

**Spring** An opening in the earth from which ground water flows without pumping.

**Standard Industrial Classification (SIC) code** Four-digit codes established by the U.S. Office of Management and Budget and used in the classification of establishments by type of activity in which they are engaged.

**Surface-water return flow** Wastewater that is returned directly to an unknown surface-water body or wetland, or occurs over an area such as from irrigation or meltwater after snow making. This does not include water discharged into ponds for holding or percolation purposes.

**Surface-water withdrawal** Water that is withdrawn from surface water over a geographic area by an aggregate of users or by a single user for which there is not enough information to select a more specific site type.

## U

**Unaccounted-for water** Water supplied from a community water system that has not been accounted for as being distributed to

domestic, commercial, industrial, or thermo-electric users. It includes public water use (fire fighting, street washing, water-treatment plant backflushing of filters, and municipal parks and swimming pools), leakage (conveyance loss), and meter errors.

**Units in structure** A structure is a separate building that either has open spaces on all sides or is separated from other structures by dividing walls that extend from ground to roof. In determining the number of units in a structure, all housing units, both occupied and vacant, are counted.

**Urban area** Collective term referring to all areas that are urban. For Census 2000, there are two types of urban areas: urban clusters and urbanized area.

**Urban cluster** A densely settled territory that has at least 2,500 people but fewer than 50,000. New for Census 2000.

**Urbanized area** An area consisting of a central place(s) and adjacent territory with a general population density of at least 1,000 people per square mile of land area that together have a minimum residential population of at least 50,000 people. The Census Bureau uses published criteria to determine the qualifications and boundaries of urbanized areas.

## **W**

**Wastewater** Water that carries wastes from homes, businesses, and industries; a mixture of water and dissolved or suspended solids.

**Wastewater collection** The process of conveying wastewater from users through a wastewater-collection system (sewer system) to a wastewater-treatment facility. May also include storm runoff. Wastewater is released by the user into the collection system and received by the treatment facility. Wastewater also can be released from a Local collection system into a Regional collection system.

**Wastewater-collection system** A pipe or system of pipes conveying wastewater from users to a wastewater-treatment plant. A Local collection system conveys wastewater from users within a single minor civil division. A Regional collection system conveys wastewater from users in more than one minor civil division or from another regional collection system.

**Wastewater-treatment plant** Plant that prepares wastewater for discharge into the hydrologic system through the removal or reduction of contained solids or other undesirable constituents.

**Water demand** (1) Water required to meet specific water-use needs, such as for domestic, commercial, or industrial purposes. The term also is used in this report in connection with projections of current use into the future. (2) Relation between water use and price, when all other factors are held constant; that is, increased prices results in decreased water use. (3) Demand is a general concept used by economists to denote the willingness of consumers or users to purchase goods, services, or inputs to production processes, because the willingness varies with the price of the thing being purchased. (4) Refers to the schedule of water quantities that consumers would use per unit of time at a particular price per unit.

**Water supply** All the processes that are involved in obtaining water for the user before use. Includes withdrawal, water treatment, and distribution.

**Water transfer** Artificial conveyance of water from one area to another.

**Water use** Water use pertains to human interaction with and influence on the hydrologic cycle, and includes activities such as water withdrawal, distribution, demand, consumptive use, treatment, wastewater collection, and return flow.

**Water-use activity** Any action related to using water, such as withdrawal, distribution, demand, consumptive use, treatment, wastewater collection or return flow. The term "Water Use" also may pertain to time and areal distribution patterns, volumes, categories, or coefficients.

**Well field** A series of wells that are joined together by a manifold metering system and are all finished in the same aquifer.

**Withdrawal** The removal of surface water or ground water from the natural hydrologic system for use, including community water systems, industry, commercial, domestic, irrigation, livestock, thermoelectric power generation, mining, and other off-channel water uses.

**Withdrawal well** A hole in the ground that has a diameter smaller than its depth and from which water is withdrawn for use.

## **Appendix 1. Domestic Water Demand Survey**

---

## **Middle School Domestic Water-Demand Survey**

The survey inventoried the number and types of toilets (high, low, and ultra-low flow), shower heads (high and low flow), faucets (high and low flow), clothes-washing machines (horizontal or vertical axis), and dishwashing machines. The survey also included a series of questions about current water-use habits, such as how and when lawns and gardens were irrigated and if faucets were kept on (1) until the water became cold or hot, (2) to keep pipes from freezing, or (3) during dishwashing. Lastly, the survey included questions about why families may limit water use, such as to keep water/electric bills down, to conserve water resources, or because of perceived insufficient capacity in the household well or septic system.

A data-collection sheet was used to document daily indoor water demand for showers, toilets, laundry, dishwashing, and kitchen and bathroom sinks for a period of 1 to 4 weeks. The data-collection activity was during the spring (part of the school year) when outdoor demand is minor. A water-demand rate table was created that listed each type of appliance with a water-use-per-minute rating (like showers) or per event (like toilet flushes) (table 1) based on information obtained from Mayer and others (1999); a website maintained by the Maryland Department of the Environment (<http://www.mde.state.md.us/assets/document/ResAudit.pdf>), last accessed September 26, 2006; and a website maintained by the Orange Water and Sewer Authority in North Carolina (<http://www.owasa.org/pages/WaterCalculator.html>), last accessed September 26, 2006. By multiplying the number of times a certain activity occurred, (such as toilet flushing, using the clothes-washing machine, or noting shower duration), the amount of water used during the day could be estimated. The daily household water demand was then divided by the number of people in the household to develop an approximate daily per capita demand. Although this approach was qualitative in nature, it was sufficient for comparing per capita demand for households on public supply to households that were self-supplied.



**Table 1.** Typical water demand by fixture or domestic appliance.

[Values obtained from the following sources: Maryland Department of the Environment, 2006; Mayer, P.W., and others, 1999; Orange Water and Sewer Authority, 2006]

<b>Fixture or appliance</b>	<b>Water-demand rate</b>
Non low-flow toilet	6 gallons per flush
Low-flow toilet	3.5 gallons per flush
Ultra-low-flow toilet	1.6 gallons per flush
Regular shower head	3.8 gallons per minute
Low-flow shower head	2.3 gallons per minute
Bathtub filling	3.0 gallons per minute
Clothes washer	40 gallons average load
Dishwasher	15 gallons average load
Faucet	3 gallons per minute



# **Appendix 1A. Residential Water-Use Survey Form**

---

Residential Water-Use Project

Survey 1

**Residential Water-Use Survey**

To help better assess current water needs and plan for the future, please answer each of the following questions. This information is being collected for **research purposes** by the U.S. Geological Survey. Results of this survey will be reported only in **anonymous summary form**. Thank you for taking time to help us compile this important information.

PLEASE CHECK (✓) OR PROVIDE YOUR MOST APPROPRIATE RESPONSE FOR EACH AND EVERY QUESTION. When you have answered all of the questions, please return to your teacher no later than May 1, 2004.

Street Address \_\_\_\_\_ Town \_\_\_\_\_

School \_\_\_\_\_ Grade \_\_\_\_\_ Teacher \_\_\_\_\_ Lot size \_\_\_\_\_ acres

**Source of water**

<input type="checkbox"/> Town water supply	<input type="checkbox"/> Housing Development supply	<input type="checkbox"/> Own Private wells
--	---	--

**Disposal of wastewater**

<input type="checkbox"/> Town sewer	<input type="checkbox"/> Housing Development septic system	<input type="checkbox"/> House septic system
-------------------------------------	--	--

Name of town water supplier or housing development \_\_\_\_\_

Number of private wells at this address \_\_\_\_\_

If you have town or development-supplied water, who pays for your water?

<input type="checkbox"/> Family	<input type="checkbox"/> Landlord
---------------------------------	-----------------------------------

**Is your water use metered?**

<input type="checkbox"/> No	<input type="checkbox"/> One meter for indoor and outdoor water use	<input type="checkbox"/> One meter for indoor use and a second meter for outdoor use
-----------------------------	---	--

**Number of people living in your household**

Over 19 years of age \_\_\_\_\_ From 4 to 12 years \_\_\_\_\_  
 From 13 to 18 years \_\_\_\_\_ Less than 4 years \_\_\_\_\_

**What type of residence do you live in?**

<input type="checkbox"/> Single family house (1-4 bedrooms)	<input type="checkbox"/> Single family house with shared walls between units (townhouse or townhouse-style condominium)	<input type="checkbox"/> Mobile home
<input type="checkbox"/> Single family house (5+ bedrooms)	<input type="checkbox"/> Two-family house	<input type="checkbox"/> Apartment or apartment-style condominium

Residential Water-Use Project

Survey 2

**INDOOR USE****In your home, how many of the following do you have?****Non-low-flow toilets? (6 gallons—pre-1980 toilets that take a long time to flush)**

<input type="checkbox"/> None	<input type="checkbox"/> One	<input type="checkbox"/> Two	<input type="checkbox"/> Three	<input type="checkbox"/> More than three
-------------------------------	------------------------------	------------------------------	--------------------------------	--

**Low-flow toilets? (3.5 gallons—manufactured during 1980's and 1990's )**

<input type="checkbox"/> None	<input type="checkbox"/> One	<input type="checkbox"/> Two	<input type="checkbox"/> Three	<input type="checkbox"/> More than three
-------------------------------	------------------------------	------------------------------	--------------------------------	--

**Ultra low-flow toilets? (1.6 gallons)**

<input type="checkbox"/> None	<input type="checkbox"/> One	<input type="checkbox"/> Two	<input type="checkbox"/> Three	<input type="checkbox"/> More than three
-------------------------------	------------------------------	------------------------------	--------------------------------	--

**Bathtubs with shower?**

<input type="checkbox"/> None	<input type="checkbox"/> One	<input type="checkbox"/> Two	<input type="checkbox"/> Three	<input type="checkbox"/> More than three
-------------------------------	------------------------------	------------------------------	--------------------------------	--

**Bathtubs only?**

<input type="checkbox"/> None	<input type="checkbox"/> One	<input type="checkbox"/> Two	<input type="checkbox"/> Three	<input type="checkbox"/> More than three
-------------------------------	------------------------------	------------------------------	--------------------------------	--

**Showers only?**

<input type="checkbox"/> None	<input type="checkbox"/> One	<input type="checkbox"/> Two	<input type="checkbox"/> Three	<input type="checkbox"/> More than three
-------------------------------	------------------------------	------------------------------	--------------------------------	--

**Whirlpool bathtubs with jets?**

<input type="checkbox"/> None	<input type="checkbox"/> One	<input type="checkbox"/> Two	<input type="checkbox"/> Three	<input type="checkbox"/> More than three
-------------------------------	------------------------------	------------------------------	--------------------------------	--

**Indoor utility/basement/garage sinks?**

<input type="checkbox"/> None	<input type="checkbox"/> One	<input type="checkbox"/> Two	<input type="checkbox"/> Three	<input type="checkbox"/> More than three
-------------------------------	------------------------------	------------------------------	--------------------------------	--

**Low-flow faucets or showerheads?**

<input type="checkbox"/> None	<input type="checkbox"/> One	<input type="checkbox"/> Two	<input type="checkbox"/> Three	<input type="checkbox"/> More than three
-------------------------------	------------------------------	------------------------------	--------------------------------	--

**How many of the following water-using appliances are used in your home?**

<input type="checkbox"/> Garbage disposal	<input type="checkbox"/> Dishwashing machine
<input type="checkbox"/> Top-loading clothes washing machine	<input type="checkbox"/> Front-loading clothes washing machine

**On average, how many times a week is a load of dishes *hand* washed in your home?**

<input type="checkbox"/> None	<input type="checkbox"/> 1-4	<input type="checkbox"/> 5-9	<input type="checkbox"/> 10-14	<input type="checkbox"/> More than 14
-------------------------------	------------------------------	------------------------------	--------------------------------	---------------------------------------

Residential Water-Use Project

Survey 3

**WATER-USE HABITS****Do you limit how much water you use for any of these reasons?** *(Please check all that apply)*

<input type="checkbox"/> Not sure well has enough water	<input type="checkbox"/> Not sure septic system can handle all wastewater
<input type="checkbox"/> Keep electrical bill down	<input type="checkbox"/> Want to conserve water to protect the resource
<input type="checkbox"/> Keep water bill down	<input type="checkbox"/> Other (Please specify) _____

**Have you done any of these actions to conserve water?** *(Please check all that apply)*

<input type="checkbox"/> Take shorter showers	<input type="checkbox"/> Water outdoors during early morning or evening
<input type="checkbox"/> Installed low-flow plumbing fixture(s)	<input type="checkbox"/> Installed a water efficient irrigation system
<input type="checkbox"/> Reduced landscape area irrigated	<input type="checkbox"/> Other (Please specify) _____

**How do you deal with running or leaky toilets and faucets?** *(Please check all that apply)*

<input type="checkbox"/> Never had the problem	<input type="checkbox"/> Fix leaks within one week
<input type="checkbox"/> Repair running toilet immediately	<input type="checkbox"/> Fix leaks eventually
<input type="checkbox"/> Call a plumber immediately	<input type="checkbox"/> Close the door and turn up the TV
<input type="checkbox"/> Try to remember to jiggle toilet handle	<input type="checkbox"/> Other (Please specify) _____

**Do you run water continuously for any of these reasons?** *(Please check all that apply)*

<input type="checkbox"/> Until it's cold	<input type="checkbox"/> While using garbage disposal
<input type="checkbox"/> Until it's hot	<input type="checkbox"/> While hand-washing dishes
<input type="checkbox"/> To keep pipes from freezing	<input type="checkbox"/> Other (Please specify) _____

**Are you concerned about the quality of your water?** *(Please check all that apply)*

<input type="checkbox"/> No	<input type="checkbox"/> Yes, we look at the water quality report sent by our water company
<input type="checkbox"/> Yes, we drink only bottled water	<input type="checkbox"/> Yes, we have our own treatment system
<input type="checkbox"/> Yes, we have had our well water tested during the past year	<input type="checkbox"/> Other (Please specify) _____



Residential Water-Use Project

Survey 4

**OUTDOOR USE****How much of your lot area is watered (irrigated)?**

<input type="checkbox"/> None	<input type="checkbox"/> One quarter	<input type="checkbox"/> Half	<input type="checkbox"/> Three quarters	<input type="checkbox"/> All
-------------------------------	--------------------------------------	-------------------------------	---	------------------------------

**During a typical summer season, how frequently do you irrigate?**

<input type="checkbox"/> Less than once a week	<input type="checkbox"/> Once a week	<input type="checkbox"/> Every other day	<input type="checkbox"/> Daily
--	--------------------------------------	--	--------------------------------

**When do you irrigate?**

<input type="checkbox"/> Early morning	<input type="checkbox"/> Late morning	<input type="checkbox"/> Afternoon	<input type="checkbox"/> Evening
--	---------------------------------------	------------------------------------	----------------------------------

**How do you irrigate? (Please check all that apply)**

<input type="checkbox"/> By hand (hose or bucket)	<input type="checkbox"/> In-ground sprinkler
<input type="checkbox"/> Manual sprinkler (one you move around)	<input type="checkbox"/> Other (please specify)

**How is the sprinkler activated?**

<input type="checkbox"/> By hand
<input type="checkbox"/> Automatic timer <b>without</b> soil moisture or rain sensor
<input type="checkbox"/> Automatic timer <b>with</b> soil moisture or rain sensor

**Do you use any additional sources for irrigation water? (Please check all that apply)**

<input type="checkbox"/> No	<input type="checkbox"/> Rain barrel
<input type="checkbox"/> Nearby surface water (stream, pond, river, lake)	<input type="checkbox"/> Purchase water

**How were you affected by last year's drought?**

<input type="checkbox"/> No problem	<input type="checkbox"/> Couldn't irrigate at all
<input type="checkbox"/> Not enough water to irrigate as much as I wanted to	<input type="checkbox"/> Well(s) went completely dry

**Do you have any of the following pools or gardens?**

<input type="checkbox"/> No	<input type="checkbox"/> Inside swimming pool	<input type="checkbox"/> Fountain
<input type="checkbox"/> Outside above-ground pool	<input type="checkbox"/> Hot tub/whirlpool	<input type="checkbox"/> Water garden
<input type="checkbox"/> Outside in-ground pool	<input type="checkbox"/> Greenhouse	<input type="checkbox"/> Other?

**Where do you get the water to fill your pool?**

<input type="checkbox"/> Well	<input type="checkbox"/> Delivered by tanker truck	<input type="checkbox"/> Public water supplier
-------------------------------	--	--

**Do you wash your**  sidewalks  driveway  vehicles  ?

**Thank you – your participation is appreciated!**

*Please return to your teacher no later than May 1, 2004.*



## **Appendix 1B. Student Data-Collection Activities Form**

---

*Residential Water-Use Project*

Student Data Collection Activities

## Student Data Collection Activity

### Directions:

1. Make a record of how much water your *family* uses each day for **4 weeks** (they do not have to be 4 consecutive weeks. One week minimum is needed for this research). To do this, make a **Data Collection Sheet** on graph paper (like the examples below) for each bathroom, kitchen, and utility room in your house. Place a new copy of the **Data Collection Sheet** in the room every day. Ask your family to write down each time they

- Task 1.** flush the toilet,
- Task 2.** run the clothes washer or dish washer,
- Task 3.** turn on and off the shower or bathtub, or
- Task 4.** turn on and off sink faucet for drinking, cooking, teeth brushing, hand dish washing, or filling containers for washing or watering plants.

2. Figure out how many minutes each shower or faucet activity took by subtracting the time-on from the time-off and enter into the **Data Collection Sheet**. At the end of each day, take down the old sheet and put up a new one. At the bottom of the sheet in the **Total for Day** row, add up the number of toilet flushes, dishwasher loads, and clothes washer loads, and the total number of minutes the showerhead, bathtub, or sink faucet was turned on. Transfer the **totals** (→) for the day from each of the columns to the **Summary Sheet**.

**Example of Bathroom Data Collection Sheet for 1 day**

	Number of toilet flushes	Showerhead			Bathtub faucet			Bathroom Sink Faucet		
		Time On	Time Off	Minutes	Time On	Time Off	Minutes	Time On	Time Off	Minutes
	x x	7:01	7:10	9						
	x	7:30	7:50	20						
→ Total for day	3			29						

**Example of Kitchen and Utility Room Data Collection Sheet for 1 day**

	Clothes washer loads	Dish washer loads	Sink Faucet			Purpose 😊
			Time On	Time Off	Number of Minutes	
			8:00	8:15	15	hand washing dishes
		x				washing load of dishes
	x					washing clothes
→ Total for day	1	1			15	

😊 **Optional, but helpful:** Fill in the purpose (like dish washing, or filling watering can). If you fill in the purpose, then send in your data collection sheets along with your Summary sheets.

**Summary Sheet**

School \_\_\_\_\_ Grade \_\_\_\_\_ Teacher \_\_\_\_\_

Your Street Address \_\_\_\_\_ Town \_\_\_\_\_

**Week 1: Begin Date \_\_\_\_\_**

Task	Total Water-use Activity	Day 1	Day 2	Day 3	Day 4	Day 5	Day 6	Day 7
1	Number of non low-flow (old) flushes							
	Number of low-flow (new) toilet flushes							
	Number of ultra low-flow toilet flushes							
2	Number of loads done in clothes washing machine							
	Number of loads done in dish washing machine							
3	Minutes used for shower with regular (old) showerhead							
	Minutes used for shower with low flow (new) showerhead							
	Minutes used in filling bathtub							
4	Number of minutes of faucet use (drinking, cooking, teeth brushing, hand dish washing, or cleaning)							

**Summary Sheet**

**Week 2: Begin Date \_\_\_\_\_**

Task	Water-use Activity	Day 1	Day 2	Day 3	Day 4	Day 5	Day 6	Day 7
1	Number of non low-flow (old) toilet flushes							
	Number of low-flow (new) toilet flushes							
	Number of ultra low-flow toilet flushes							
2	Number of loads done in clothes washing machine							
	Number of loads done in dish washing machine							
3	Minutes used for shower with regular (old) showerhead							
	Minutes used for shower with low flow (new) showerhead							
	Minutes used in filling bathtub							
4	Number of minutes of faucet use (drinking, cooking, teeth brushing, hand dish washing, or cleaning)							

**RETURN this sheet to your teacher as soon as you have completed it.**



## Summary Sheet

School \_\_\_\_\_ Grade \_\_\_\_\_ Teacher \_\_\_\_\_

Your Street Address \_\_\_\_\_ Town \_\_\_\_\_

### Week 3: Begin Date \_\_\_\_\_

Task	Water-use Activity	Day 1	Day 2	Day 3	Day 4	Day 5	Day 6	Day 7
1	Number of non low-flow (old) flushes							
	Number of low-flow (new) toilet flushes							
	Number of ultra low-flow toilet flushes							
2	Number of loads done in clothes washing machine							
	Number of loads done in dish washing machine							
3	Minutes used for shower with regular (old) showerhead							
	Minutes used for shower with low flow (new) showerhead							
	Minutes used in filling bathtub							
4	Number of minutes of faucet use (drinking, cooking, teeth brushing, hand dish washing, or cleaning)							

## Summary Sheet

### Week 4: Begin Date \_\_\_\_\_

Task	Water-use Activity	Day 1	Day 2	Day 3	Day 4	Day 5	Day 6	Day 7
1	Number of non low-flow (old) flushes							
	Number of low-flow (new) toilet flushes							
	Number of ultra low-flow toilet flushes							
2	Number of loads done in clothes washing machine							
	Number of loads done in dish washing machine							
3	Minutes used for shower with regular (old) showerhead							
	Minutes used for shower with low flow (new) showerhead							
	Minutes used in filling bathtub							
4	Number of minutes of faucet use (drinking, cooking, teeth brushing, hand dish washing, or cleaning)							

**RETURN this sheet to your teacher as soon as you have completed it.**

Prepared by the Pembroke Publishing Service Center

For more information concerning the research in this report, contact:

Keith W. Robinson, Director  
U.S. Geological Survey  
New Hampshire-Vermont Water Science Center  
361 Commerce Way  
Pembroke, NH 03275

or visit our Web site at:  
<http://nh.water.usgs.gov>

