

The Energy Correction for Calibration of Submerged Radial Gates

Tony L. Wahl¹
Albert J. Clemmens²
John A. Replogle³

ABSTRACT

The E-M (energy-momentum) method is a new technique for calibrating radial gates, using the energy equation on the upstream side of the vena contracta and the momentum equation downstream from the vena contracta when the gate is submerged. This method allows continuous calibration from free to submerged flow through the transition zone, and overcomes several limitations of energy-based submerged flow equations since it explicitly accounts for downstream channel conditions. A key parameter in the method is an energy correction factor for submerged flow. This paper uses a previously collected data set to demonstrate the dependence of the energy correction on the relative gate opening and to develop an improved model for predicting the energy correction.

INTRODUCTION

Free-flowing and submerged radial gates (Fig. 1) offer numerous opportunities for flow measurement on irrigation projects. Such gates are widely used as water control structures; the ability to accurately measure discharge at these structures would improve the capability to make timely and accurate deliveries, and would reduce the need for separate, dedicated flow measurement devices. The calibration of radial gates for flow measurement is a challenging hydraulic problem due to the variety of gate, structure, and channel configurations and the sensitivity of calibrations to such factors as gate seal type and downstream channel width. Calibration methods for gates operating in a free-flow condition are available in standard references and have reasonable accuracy and ease of use, but calibrations for submerged gates are often very inaccurate. Most of the currently available calibration procedures are based solely on the energy equation.

A procedure that uses both the energy and momentum equations for flow calibration has recently been developed (Clemmens et al. 2001). The Energy-Momentum (E-M) method uses an iterative solution of the energy and momentum equations and offers several potential advantages over previous methods:

¹ Hydraulic Engineer, U.S. Dept. of the Interior, Bureau of Reclamation, Water Resources Research Laboratory, Denver, CO; e-mail twahl@do.usbr.gov

² Laboratory Director and Supervisory Research Hydraulic Engineer, USDA-ARS, U.S. Water Conservation Laboratory (USWCL), Phoenix, AZ; e-mail bclommens@uswcl.ars.ag.gov

³ Research Hydraulic Engineer and Chief Scientist, USDA-ARS, USWCL; e-mail jreplogle@uswcl.ars.ag.gov

- Ability to account for differing upstream and downstream channel widths and differing channel invert elevations relative to the gate sill,
- Potentially better accuracy when structures include multiple gates that are not operated uniformly, and
- Accurate determination of free and submerged flow and accurate calibration through the free-flow, transition, and submerged-flow regions.

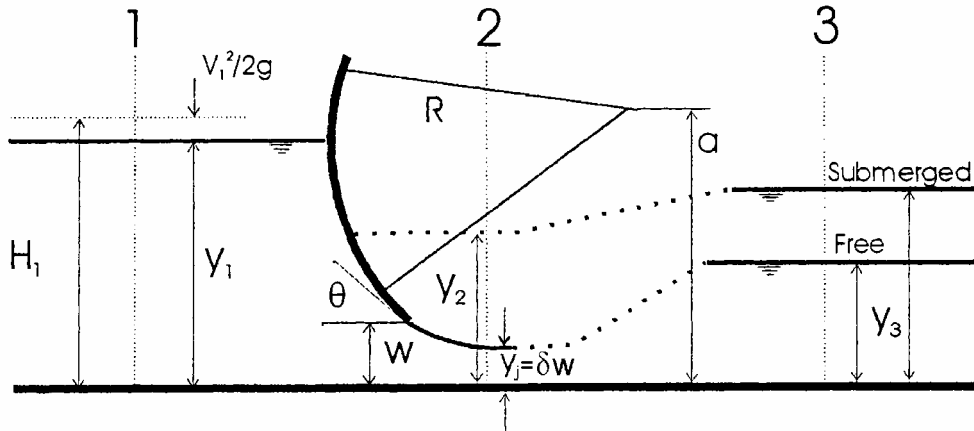

Figure 1. — Definition sketch for flow through a radial gate.

The E-M method makes use of empirical relations for:

- Determining energy losses on the upstream side of the gate,
- Computing a correction term in the energy equation when flow is in the transition zone, and
- Computing hydrostatic forces on the downstream side of the check structure for the momentum equation.

The first two issues must be addressed in any application of the method, while the last issue can be avoided by directly measuring the pressure in the vena contracta, thereby avoiding the need for the momentum equation. This paper examines the energy correction term in more detail using previously collected laboratory data.

ENERGY CORRECTION TERM

A key feature of the E-M method is the energy correction term that accounts for changes in the thickness and velocity (and thereby the energy) of the jet passing beneath the gate. The correction applies only in the transition zone; in free flow and full submergence, the correction goes to zero. The energy correction appears in a modified energy equation for submerged flow (Clemmens et al. 2001).

$$H_1 = y_2 + \frac{v_j^2}{2g} + \xi \frac{v_j^2}{2g} - E_{Corr} \quad (1)$$

H_1 is the upstream energy head, y_2 is the downstream depth above the vena contracta location, v_j is the jet velocity in the vena contracta, ξ is an upstream energy loss and velocity distribution coefficient, and E_{Corr} is the energy correction. The jet velocity, v_j , used in eq. 1 is the same jet velocity that one would determine in free flow, $v_j=Q/(\delta wb_c)$, where Q is the discharge, δ is the contraction coefficient, w is the gate opening height, and b_c is the gate width. Equation 1 can be solved for discharge.

$$Q = \delta w b_c \sqrt{\frac{2g(H_1 - y_2 + E_{Corr})}{1 + \xi}} \quad (2)$$

In the E-M method, y_2 is determined by solving the momentum equation, and $1+\xi$ and E_{Corr} are determined empirically (Clemmens et al. 2001). The value of $1+\xi$ is a function of the Reynolds number of the flow through the gate opening, and the relation for E_{Corr} is based upon the depth increase at the vena contracta relative to the free flow jet thickness, $(y_2-y_j)/y_j$. The initial relation for E_{Corr} (Fig. 2) was developed from experiments performed by the Agricultural Research Service (ARS) at the U.S. Water Conservation Laboratory, Phoenix, Arizona (Tel 2000).

$$E_{Corr}/(y_2 - y_j) = 0.52 - 0.34 \arctan(7.91((y_2 - y_j)/y_j - 0.83)) \quad (3)$$

These experiments used a single radial gate structure with a sharp-edged gate leaf. Free flow tests covered a wide range of gate openings, but submerged flow tests were performed at only one gate opening with four different flow rates and a range of tailwater conditions. The submerged flow tests covered an intermediate range of relative gate openings (the ratio of gate opening to upstream head, w/H_1).

THE BUYALSKI DATA SET

A series of tests conducted at the Bureau of Reclamation's Water Resources Research Laboratory in Denver, Colorado (Buyalski 1983) offers an opportunity to test and refine the energy correction model using data collected over a wider range of conditions. These tests were originally used to develop an energy-based calibration method, which was implemented in the RADGAT computer program. Buyalski tested 9 gate configurations consisting of 3 seal types (sharp-edged, hard rubber bar, and music note or "J" seal), and 3 different ratios of gate radius to trunnion pin height. Seven different gate openings were tested for each configuration, with gate opening to trunnion pin height ratios varying from 0.1 to 1.2. Nearly 2650 test runs were made, with more than 80 percent of the tests in submerged conditions. The tested gates were 0.711 m (2.333 ft) wide, with a gate radius of 0.702 m (2.302 ft). The gates were installed in a channel that was 0.762 m (2.5 ft) wide, with a single half-pier filling the gate bay, so that the model simulated a section from gate centerline to pier centerline.

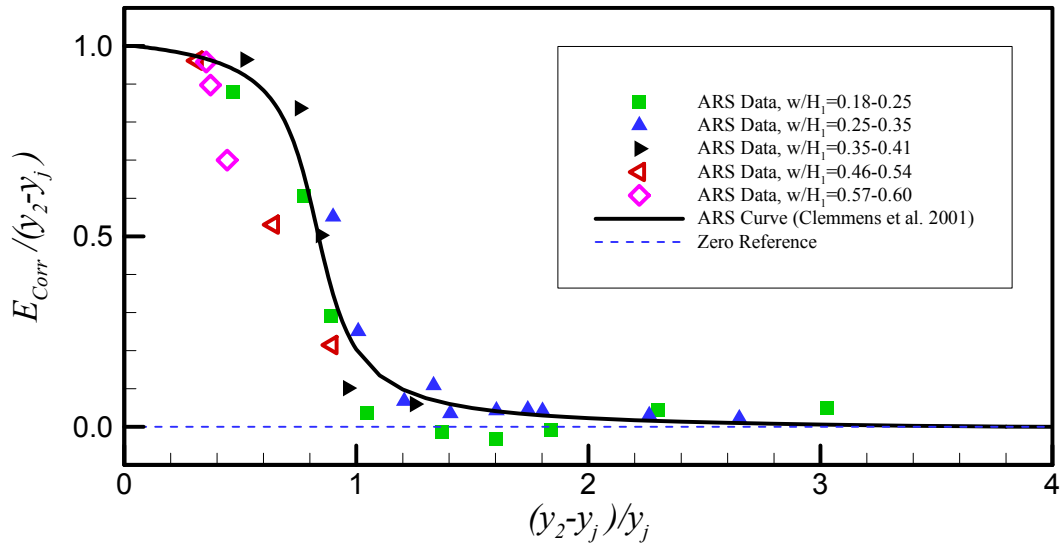

Figure 3. — Relative energy correction developed from ARS tests.

The Buyalski data set offers a means of quickly evaluating the performance of the E-M method and the original energy correction model (eq. 3). The data for the sharp-edged gates were used to test the model in free and submerged flow; free flow was modeled very accurately, but there were significant errors in submerged flow, as shown in Figure 3.

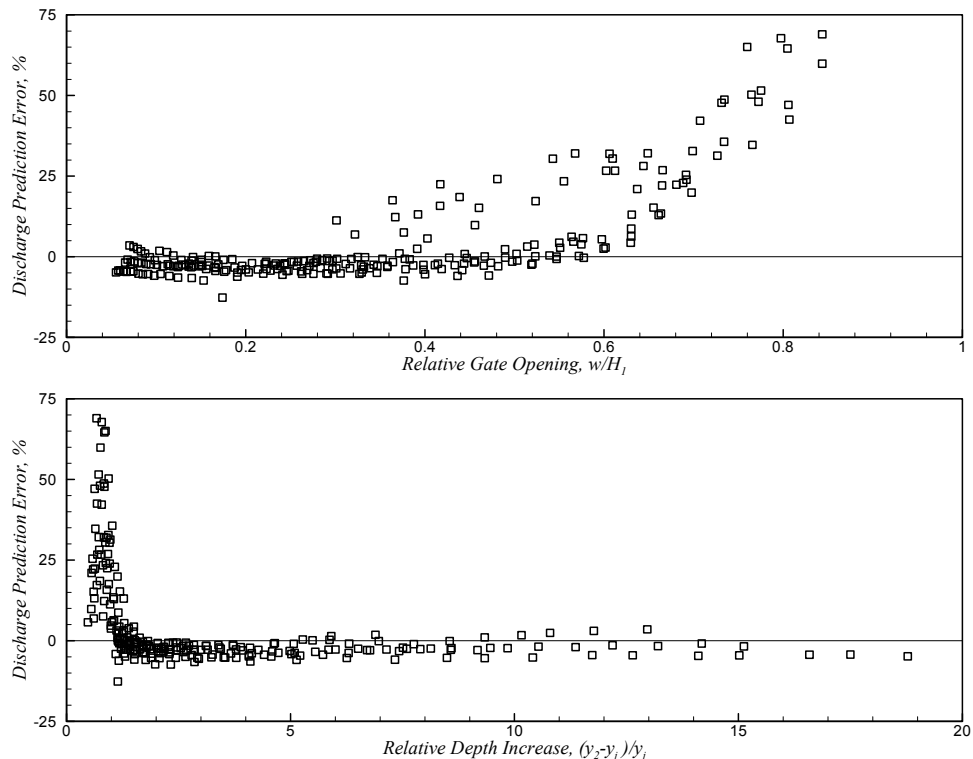

Figure 2. — Errors in prediction of submerged flow.

Discharge prediction was poor for low flows at large gate openings, where the relative depth increase is slight and the gate exerts little control on the flow. This is consistent with the observations of Clemmens who noted that data were lacking for large relative gate openings, and that the largest errors occur when the flow is in the transition zone, where the relative energy correction, $E_{Corr}/(y_2 - y_j)$, changes rapidly as a function of the relative increase in jet thickness. The largest errors occurred at relative depth increases of less than 1.5. As a function of relative gate opening, large errors began to occur at $w/H_1 > 0.3$, and the greatest errors occurred for $w/H_1 > 0.67$; it should be noted that in this latter range the contraction coefficient of the gate must be extrapolated, since it is not possible to have free flow at such large relative gate openings. Errors ranged from -13% to +70%; although there were large individual errors, 25% of the submerged flow cases were modeled with an error in the range of $\pm 2\%$, 66% had errors in the range of $\pm 5\%$, and 80% had errors in the range of $\pm 10\%$. The mean relative error was +4.80%, but this was strongly influenced by a few large positive errors; the median error was -1.48%. The standard deviation of the relative errors was 15.3%, again heavily influenced by a few large errors.

Analysis

To begin the analysis, the Buyalski free flow data were used to determine the contraction coefficients of the hard-rubber bar and music-note seals, and to verify that the contraction coefficients of the sharp-edged gates closely matched those obtained in the previous ARS tests and by other investigators. The analysis was dependent on the upstream energy loss and velocity distribution factor, $1 + \xi$, for which Clemmens et al. (2001) had established a relation applicable up to gate Reynolds numbers of 2.7×10^5 . Thus, the analysis to determine contraction coefficients used only data in this range of Reynolds numbers. The Reynolds number was based on the velocity entering the gate opening (discharge divided by gate open area) and the hydraulic radius just upstream from the gate (area divided by wetted perimeter immediately upstream from the gate, i.e., between the piers).

Next, all of the Buyalski free flow data were analyzed to verify the relation for $1 + \xi$ at higher Reynolds numbers (up to 6.5×10^5), so that it could be used in the subsequent analysis of submerged flow data. Figure 4 shows the results, along with the relation and the data obtained from the ARS tests. Overall, the Buyalski data appear to confirm the ARS relation and suggest that it could be extended to higher Reynolds numbers, but it is very important to note that the uncertainty of the Buyalski data is much greater than that of the ARS data. The reason for this is most likely differences in the uncertainty of discharge measurements associated with each series of tests. The Buyalski tests used multiple venturi meters calibrated against a volumetric tank and are believed to have a measurement uncertainty of about $\pm 0.50\%$, while the ARS tests utilized a weigh-tank for each run that has a measurement uncertainty of $\pm 0.10\%$. This additional measurement uncertainty should be expected to affect the submerged flow data as well.

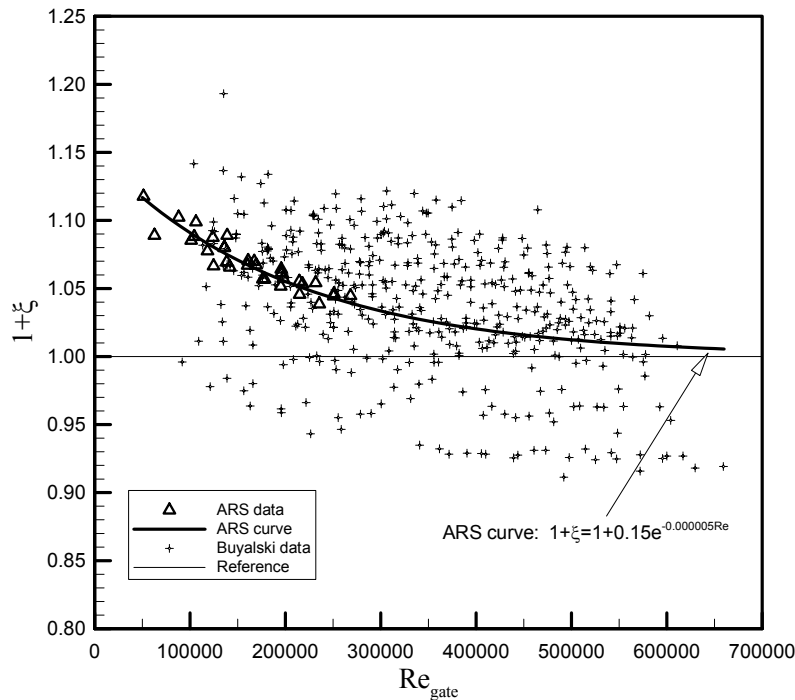

Figure 4. — Upstream energy loss and velocity distribution factor.

Once these tasks were complete, the Buyalski submerged flow tests could be used to solve for values of E_{Corr} . Only the data from the sharp-edged gates and those with hard rubber bar seals were used. The submerged flow data for the gates with music note seals were saved for verification testing. The Buyalski data set included some runs at gate openings for which the gate lip angle, θ , was greater than 90° . These tests were excluded from the analysis, because the free flow data were not sufficient to define the contraction coefficient at these gate openings.

NEW ENERGY CORRECTION MODEL

Figure 5 shows the computed relative energy corrections, $E_{Corr}/(y_2 - y_j)$, plotted against the relative depth increase at the vena contracta, $(y_2 - y_j)/y_j$, subdivided by ranges of w/H_1 values. The figure reveals a family of curves whose shape varies with w/H_1 . Other relationships were investigated, but only the relationship to w/H_1 proved to be consistent over all of the tests. The figure also shows the curve developed from the ARS data (Clemmens et al. 2001), eq. 3, which was also shown previously in Figure 2.

The trend is for the transition zone of the energy correction curve to become compressed into a narrow range of relative depth increases as w/H_1 increases. There is notable scatter in the data, including some values of $E_{Corr}/(y_2 - y_j)$ that are greater than 1.0 or less than zero (inconsistent with the physical meaning of the energy correction). These data were excluded from later curve-fitting efforts.

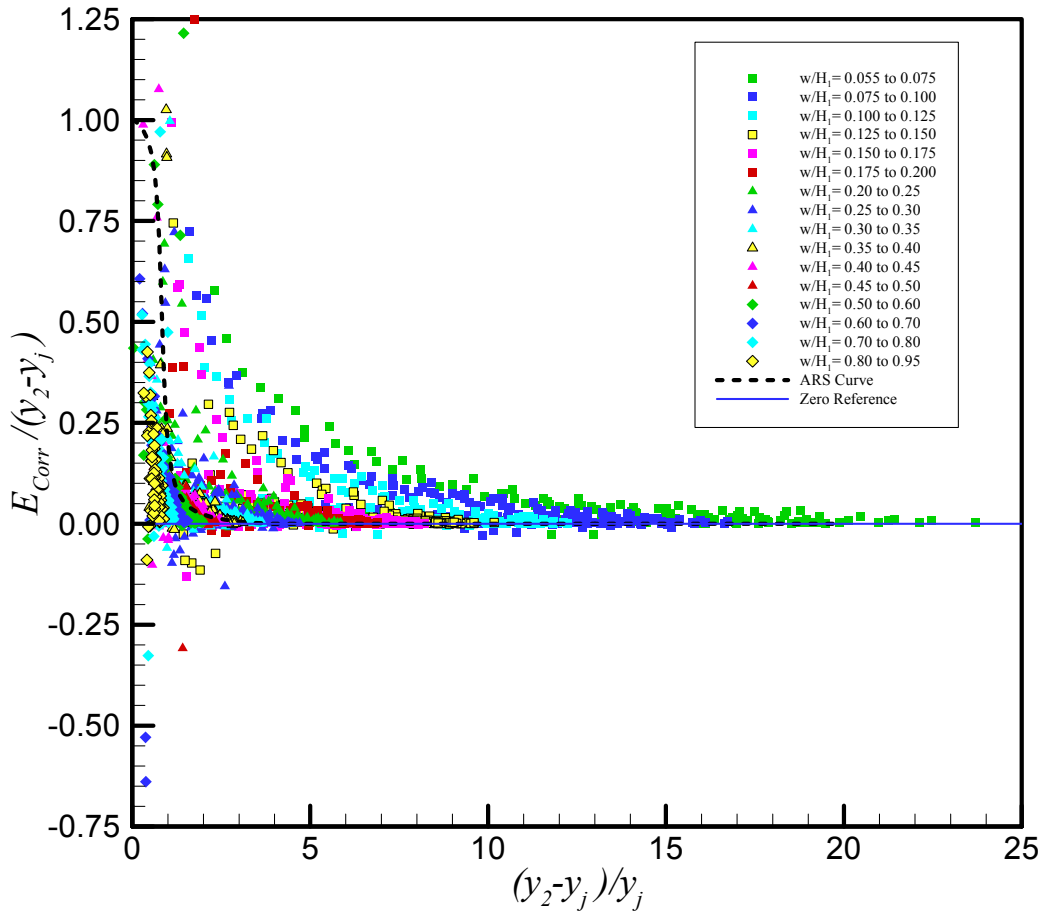

Figure 5. — Relative energy correction vs. relative depth increase at the vena contracta for different ranges of w/H_1 . (This figure is available in color at www.usbr.gov/wrrl/twahl/uscid2003.pdf)

Figure 6 shows that for some w/H_1 values (from about 0.07 to 0.18) there may be a dual relationship. The majority of the data follow a higher curve, but a significant number of points fall on a much lower curve. This may indicate a hysteresis condition in the flow, or may be due to an unknown experimental error.

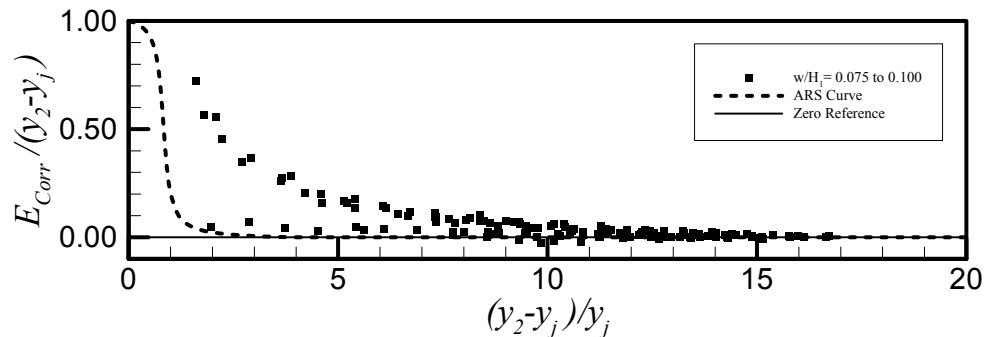

Figure 6. — Relative energy correction vs. relative depth increase for a narrow range of w/H_1 values, illustrating possible dual relationship.

Initial attempts to fit the data for each narrow band of w/H_1 values to a model of the form of eq. 3 were unsuccessful. The objective in the development of eq. 3 was to obtain a function that produced relative energy corrections of 1 and 0 at relative depth increases of zero and infinity, respectively. Equation 3 accomplished this with a relatively complex curve utilizing an inverse tangent function and having an inflection point near $E_{Corr}/(y_2-y_j)=0.5$. This functional form appeared to be somewhat compatible with the Buyalski data at large values of w/H_1 , but for small values of w/H_1 , it could not fit the data at intermediate values of $(y_2-y_j)/y_j$ and still pass through the point $(y_2-y_j)/y_j=0$ and $E_{Corr}/(y_2-y_j)=1$.

After considering several alternatives, a decision was made to model the energy correction relationship as a simple exponential power function of the form

$$\frac{E_{Corr}}{y_2 - y_j} = e^{a \left(\frac{y_2 - y_j}{y_j} \right)} \quad (4)$$

where a is an empirically determined coefficient and e is the base of natural logarithms. Curve-fitting was performed manually with the objective of minimizing a weighted sum of the Pearson residuals, $\ln[(1+|\text{residual}|^2)^{0.5}]$, with a weighting factor of $1/[(y_2-y_j)/y_j]$. This approach minimizes the influence of outliers and produces a better fit at low values of $(y_2-y_j)/y_j$. At high values of $(y_2-y_j)/y_j$ the quality of the fit is less important, since the value of $E_{Corr}/(y_2-y_j)$ will be very small and will have less influence on the computed discharge. Many of the curve fits were very good, but some were less than satisfying. Hopefully, future research can better define the shape of the curve for low values of $(y_2-y_j)/y_j$, and may also clarify the dual relationship suggested in Figure 6.

A total of 24 bands of w/H_1 values were used, and eq. 4 was fitted to the data from each range. Figure 7 shows the fitted coefficients plotted against the average w/H_1 values for each band. A linear regression between a and w/H_1 yields the following final equation for $E_{Corr}/(y_2-y_j)$, which replaces eq. (3):

$$\frac{E_{Corr}}{y_2 - y_j} = e^{-3.819 \left(\frac{w}{H_1} \right) \left(\frac{y_2 - y_j}{y_j} \right)} \quad (5)$$

Verification Testing

To test the improved energy correction model, the Buyalski data for gates with music note seals were used. Both free flow and submerged flow cases were tested, although no changes had been made to the free flow model. Results are shown in Table 1. Performance in free flow was not quite as good as for the sharp-edged gates; the difference is most likely due to additional uncertainty in the contraction coefficients for the music note seals. In submerged flow, there was significant improvement on all levels, and dramatic improvement in

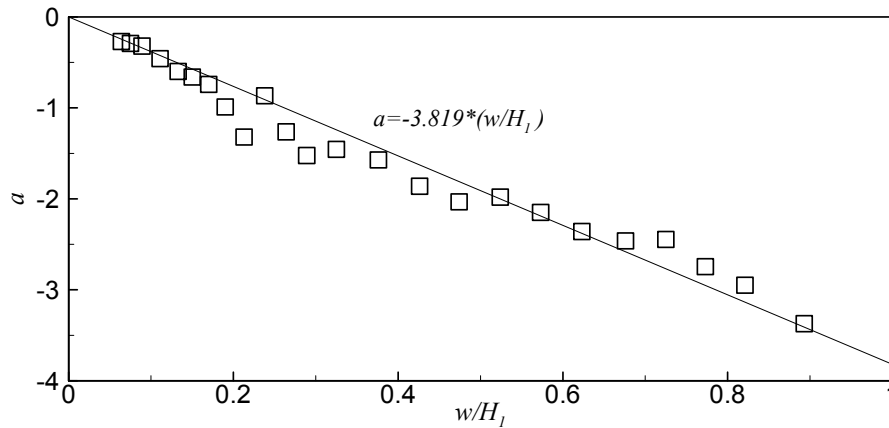

Figure 7. — Regression relation for parameter a in eq. 4, relating the relative energy correction and relative depth increase.

eliminating the very large errors that occurred in the transition zone. Still, the largest errors (and all errors beyond $\pm 10\%$) occurred in the early transition zone, at relative depth increases less than 1 (Fig. 8). This may be a zone in which accurate flow measurement will always be elusive, and operation in this zone should be avoided when flow measurement is the objective.

CONCLUSIONS

The E-M method holds significant promise as an improved calibration method for canal radial gates. The key parameter of this method is the energy correction in submerged flow, and the analysis of the Buyalski laboratory data demonstrates the dependence of this parameter on the relative gate opening. A model that accounts for this dependence has significantly improved the submerged flow calibration accuracy. Future laboratory and field testing may be able to refine the method further.

Table 1. — Comparison of errors.

Error Description	Free flow		Submerged flow	
	E-M model applied to sharp-edged gates	E-M model applied to gates with music note seals	Original E-M model applied to sharp-edged gates	Modified E-M model applied to gates with music note seals
$\pm 2\%$	78%	64%	25%	42%
$\pm 5\%$	100%	99.4%	66%	78%
$\pm 10\%$	--	0.6%*	80%	98%
$\pm 20\%$	--	--	86%	100%
+20 to +70%	--	--	14%	0%
Statistics				
Mean	0.22%	0.40%	+4.80%	+0.84%
Median	0.29%	0.69%	-1.48%	+1.04%
Standard deviation	1.48%	1.97%	15.3%	4.18%

*One run originally classified as submerged by Buyalski; due to possible data transcription error on this run, it was ignored when computing statistics.

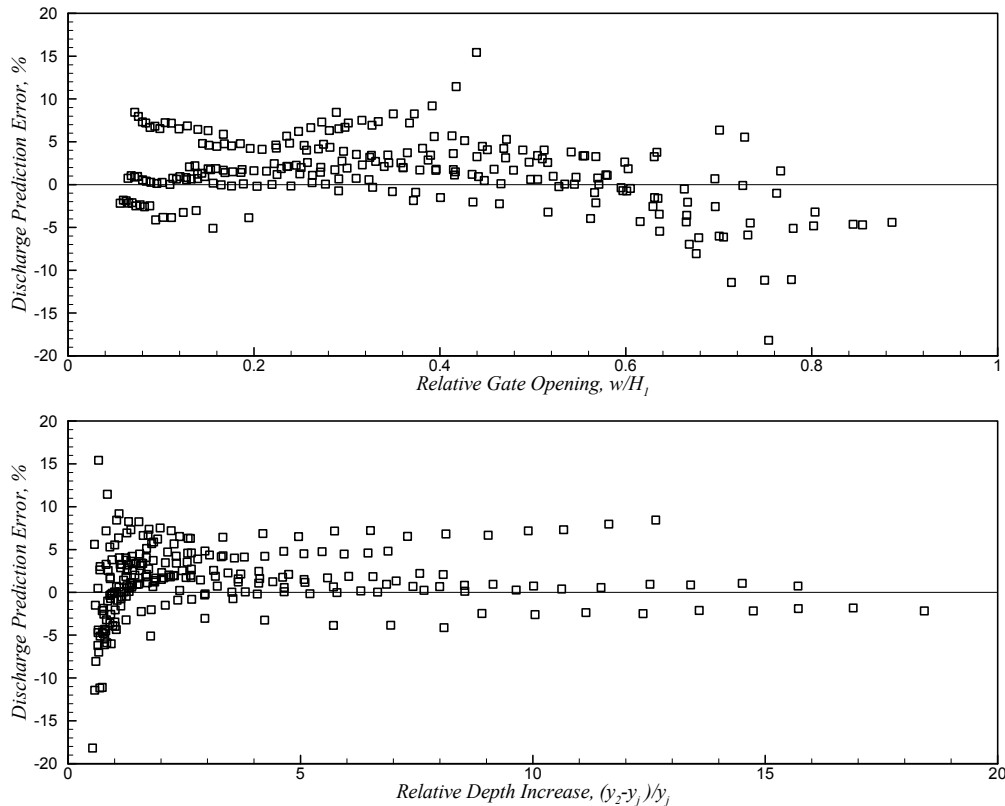

Figure 8. — Discharge prediction errors as a function of relative gate opening and relative depth increase, applying the improved energy correction model to the Buyalski data for gates with music note seals.

REFERENCES

- Buyalski, C.P., 1983. *Discharge Algorithms for Canal Radial Gates*. U.S. Department of the Interior, Bureau of Reclamation, Research Report REC-ERC-83-9, Denver, CO.
- Clemmens, A.J., Bautista, E., and Strand, R.J. 2001. *Canal Automation Pilot Project. Phase II Report* prepared for the Salt River Project. WCL Report 24, U.S. Water Conservation Laboratory, Phoenix, AZ.
- Clemmens, A.J., 2002. New calibration procedure for submerged radial gates. USCID/EWRI Conference on Energy, Climate, Environment and Water, July 10-12, 2002.
- Tel, J., 2000. Discharge relations for radial gates. MSc Thesis, Delft Technical University, Delft, The Netherlands, 86 pp. plus Appendices.