

## CHAPTER XI

### THE CIRCULATORY SYSTEM AND BLOOD

	Page
General characteristics.....	239
The pericardium.....	239
The heart.....	240
Physiology of the heart.....	242
Automatism of heart beat.....	242
The pacemaker system.....	245
Methods of study of heart beat.....	247
Frequency of beat.....	248
Extracardiac regulation.....	250
Effects of mineral salts and drugs.....	251
Blood vessels.....	253
The arterial system.....	253
The venous system.....	254
The accessory heart.....	258
The blood.....	259
Color of blood.....	261
The hyaline cells.....	261
The granular cells.....	262
Specific gravity of blood.....	265
Serology.....	265
Bibliography.....	266

A heart, arteries, veins, and open sinuses form the circulatory system of oysters and other bivalves. The sinuses, or lacunae, are irregular spaces of varying size in the tissues and have no walls of their own other than the surrounding connective tissue. They are interposed between small arteries and veins and function in place of the capillaries of vertebrates. Blood cells are not confined to the vessels; they wander throughout the tissues, aggregating in the sinuses. A large number of them accumulate on the surface of the mantle and gills and are discarded. Diapedesis, i.e., slow bleeding through the surface of the body, is a continuous and normal process which is accelerated by adverse conditions, by injuries to the tissues, and by removal of an oyster from its shell.

The open sinuses within the circulatory system present a mechanical puzzle. It is difficult to visualize how the pressure of the systolic contraction forces the blood to leave the open spaces and enter the venal system, which has no valves, go through a complex net of branchial vessels and finally enter the heart. To a great extent the mechanical deficiency of the circulatory system is compensated by the pulsating vessels of the mantle and by the contractions of two accessory hearts on the walls of the cloacal chamber. The pulsations

of these organs are independent of the beating of the principal heart, and their primary function is to oscillate the blood within the pallial sinuses.

#### THE PERICARDIUM

The heart is located in the pericardium, a thin-walled chamber between the visceral mass and the adductor muscle (fig. 71). In a live oyster the location of the heart is indicated by the throbbing of the wall of the pericardium on the left side. Here the pericardium wall lies directly under the shell. On the right side the promyal chamber extends down over the heart region and the mantle separates the pericardium wall from the shell.

The cavity in which the heart is lodged is slightly asymmetrical; on the right side it extends farther along the anterior part of the adductor muscle than on the left. The pericardium is large enough to accommodate the heart and to retain a supply of the fluid in which the heart is bathed. The volume of the pericardium can be measured by the following method. A solution of plastic or a thin mixture of plaster of paris is poured into the pericardium from which the heart has been removed; after the material has set, the plaster molds are waterproofed by immersing them in a hot mixture of beeswax, rosin, and turpentine. The volumes are measured by displacement. In an adult *Crassostrea virginica* about 12 to 14 cm. in height, the capacity of the pericardium varied from 2.4 to 2.7 ml.; approximately the same volume of blood and pericardial fluid could be withdrawn from the cavity by hypodermic syringe.

Two reno-pericardial canals open on the right and left side of the ventro-posterior wall of the pericardium and provide direct communication with the excretory system (see: ch. XII). The wall of the pericardium is formed of connective tissue similar to that in the mantle; the tissue is well supplied with blood vessels, blood sinuses (figs. 211 and 212), and branches of the cardiac nerve (fig. 213). The epithelium lining of the side



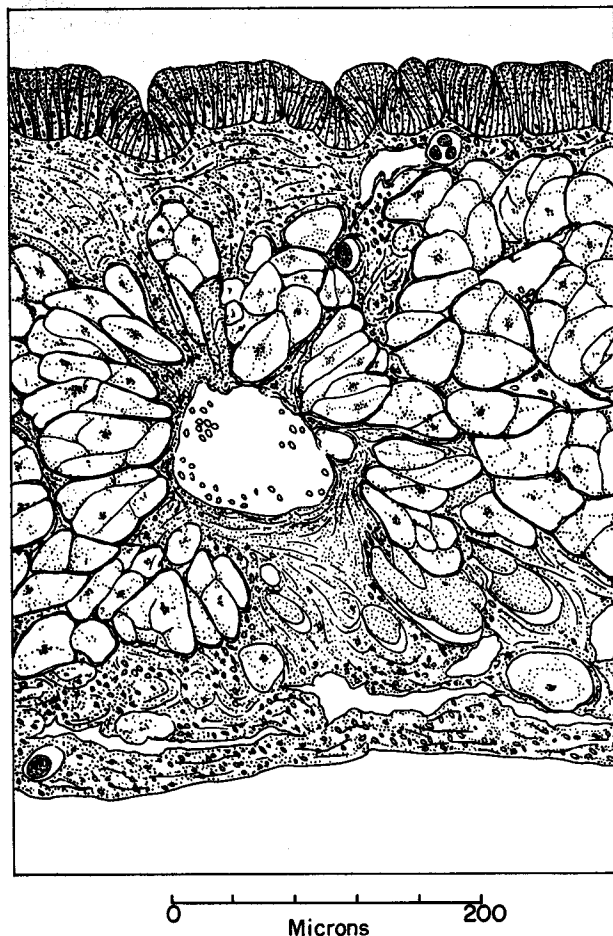

FIGURE 212.—Transverse section of a portion of the pericardium wall of *C. virginica* with an artery surrounded by large vesicular cells. NEMATOPHYSIS cysts on upper right and lower left sides. Bouin, hematoxylin-eosin.

framework of muscle fibers and connective tissue cells forming an irregular trabecular structure (fig. 216), with amoebocytes in the spaces between the fibers and in the connective tissue. The outer surface of the ventricle is covered with epithelium of a single layer of flat and thin cells with conspicuous nuclei.

The walls of the auricles, thinner and lighter than those of the ventricle, also form a trabecular framework supported by connective tissue (fig. 217). Amoebocytes are numerous between the connective tissue cells and along the muscle fibers. On the outside the auricles are covered with tall columnar epithelium which contains many glandular and dark pigment cells; this epithelium constitutes a part of the excretory system in bivalves (Franc, 1960, p. 2016). Neither the ventricle nor the auricles has an inner epithelial lining.

The movement of blood from the auricles to the ventricle is controlled by the two auriculo-ventricular valves which appear as circular bands of tissue surrounding small openings (fig. 218). In longitudinal section the auriculo-ventricular valve (fig. 219) resembles a convoluted cylindrical tube. The walls of the valves consist of several layers of muscle fibers arranged obliquely and supported by connective tissue. When the auricle (left part of fig. 219) contracts, blood is propelled into the ventricle (right portion of the figure), which in turn contracts, compressing the walls of the valves and forcing the blood forward into the aorta (not shown in fig. 219).

The heart is well supplied with ganglion cells and nerve fibers which end in the muscles. Preparations of heart tissue of *C. virginica* stained with methylene blue and examined in glycerin under oil immersion showed a great abundance of these elements (fig. 220). These observations support the findings of Suzuki (1934a, 1934b), who described the ganglion cells in the hearts of *Ostrea circumpecta* Pils., *O. gigas* Thunb., and *Pinctada martensi*. According to his data, the ganglion cells in these oysters are particularly abundant at the septum separating the auricles from the ventricle where they form a ring at the narrowest portion of the heart. Direct con-

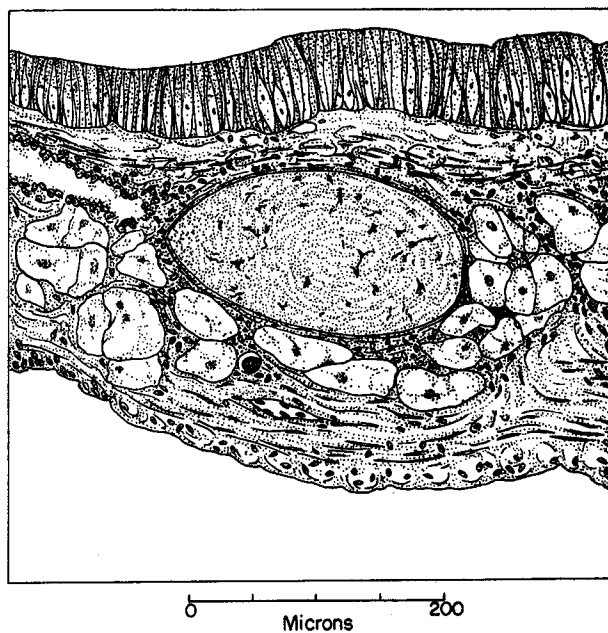

FIGURE 213.—Transverse section of the pericardium wall of *C. virginica* with the branch of the cardiac nerve (cut at a slightly slanted angle). Bouin, hematoxylin-eosin.

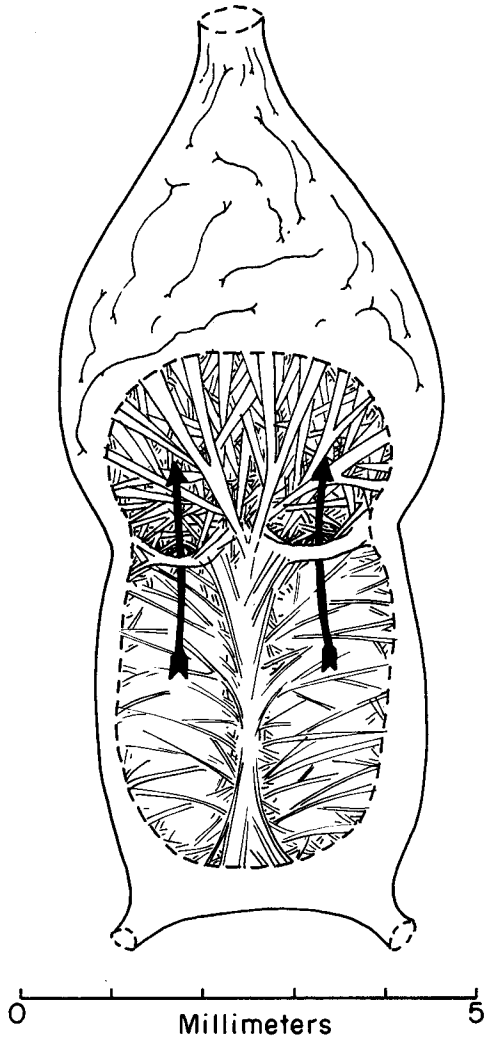

FIGURE 214.—Heart of the oyster *C. virginica* viewed from the ventro-anterior side. Part of the heart's wall was removed to show the auriculo-ventricular septum and the musculature of the heart. Upper part—ventricle and root of the aorta; lower part—two auricles and common efferent veins. Drawn from an unpreserved preparation.

nections between the nerve cells scattered in the heart muscle and nerve fibers entering the heart have not been demonstrated.

A summary of the results of many investigations of the innervation of the bivalve heart was given by Esser (1934), who denied the existence of the cardiac ganglia in the heart of *Anodonta cygnea* and stated that the so-called nerve cells of the mollusk's myocardium have none of the typical features of the nerve cells. He thought that these cells were identical with certain amoebocytes of the blood of *Anodonta*. It is true that the

amoebocytes found in the heart muscle of *C. virginica* have a certain similarity to the cells depicted by Esser. In structure and in general outline they differ, however, from the nerve cells and can be recognized in the preparations stained with methylene blue. Under high magnification the ganglia cells in the myocardium of *C. virginica* appear to be oval-shaped and bipolar (fig. 221) rather than unipolar as described by Suzuki (1934a) for *O. circumpecta*. Their cytoplasm contains granules deeply stained with methylene blue. Round granules of larger size distributed along the axis of the nerve are visible in vitally stained preparations (fig. 220). Similar structures are shown by Suzuki in his figure 4 (1934b) of the preparation of the heart muscle of the Japanese oyster (*C. gigas* and *O. circumpecta*). The nature of the granules is not known.

### PHYSIOLOGY OF THE HEART

Contributions to the study of the physiology of the heart of bivalves have been made by Carlson in a series of papers published during the years 1903-09 (Carlson, 1903, 1905a, 1905b, 1905c, 1905d, 1906a, 1906b, 1906c, 1906d, 1907, 1909); by Ten Cate (1923a, 1923b, 1923c, 1929); Jullien (1935a, 1935b, 1935c, 1935d, 1936a, 1936b, 1936c); Jullien and Morin (1930, 1931a, 1931b); Jullien and Vincent (1938); Jullien, Vincent, Bouchet, and Vuillet (1938); Jullien, Vincent, Vuillet, and Bouchet (1939); Takatsuki (1927, 1929, 1933, 1934a, 1934b); Oka (1932); Suzuki (1934a, 1934b); Prosser (1940, 1942); and many others. The literature up to 1933 is adequately reviewed by Dubuisson (1933), and more recent investigations are summarized by Krijgsman and Divaris (1955). The studies cited above were made primarily on the fresh-water mussel *Anodonta*, on *Mytilus*, *Pecten*, and *Mya*. A relatively small number of observations were made on oyster heart.

### AUTOMATISM OF HEART BEAT

Most of the experimental work on bivalve hearts has been done with excised preparations of the organ kept in a perfusion chamber supplied with the van't Hoff or Ringer solutions or with natural sea water. Few observations were made on the heart in situ.

An automatic rhythmical beating of the excised oyster heart continues for a long time if the heart is kept in an isotonic solution, preferably in sea water, at normal pH of about 8.0 or in the pericardial fluid, and the heart muscle is slightly

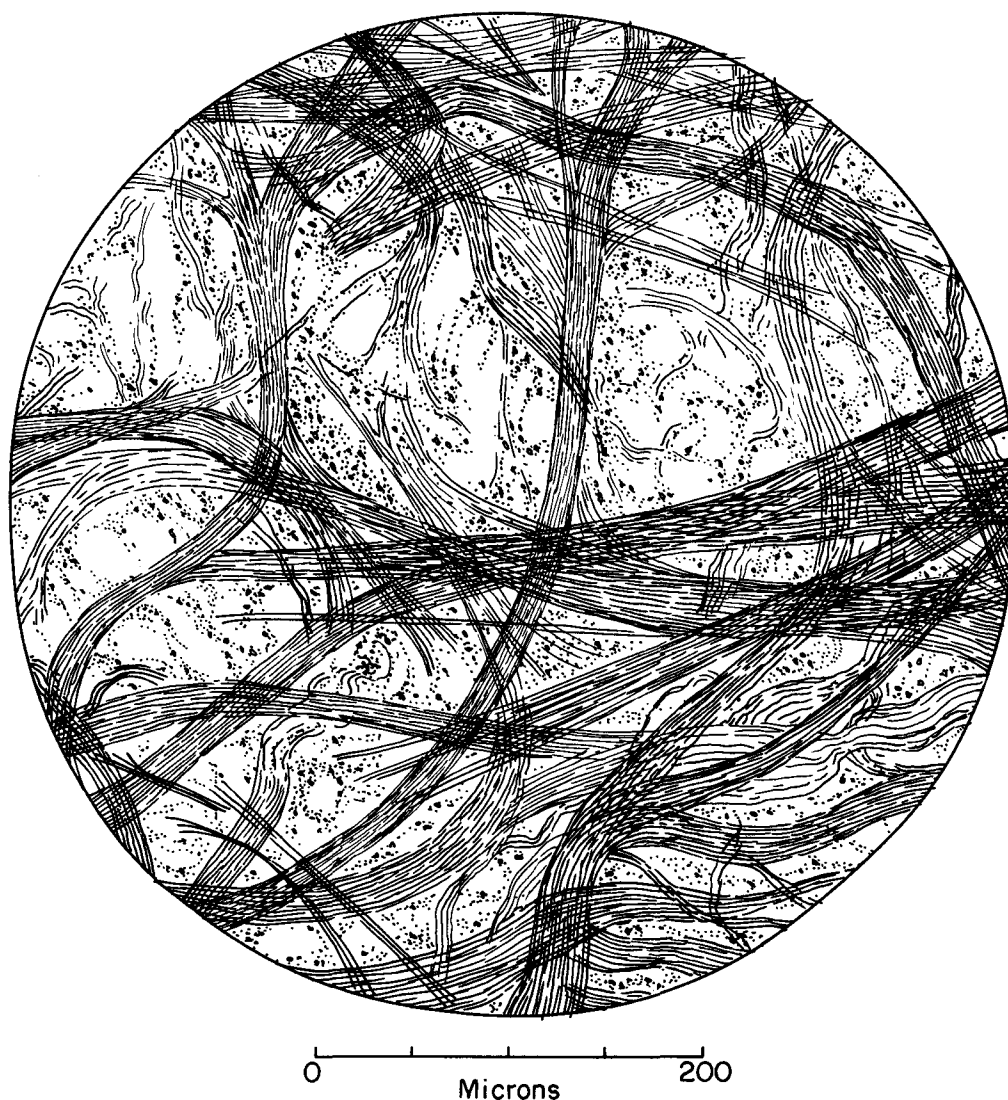

FIGURE 215.—Small piece of heart wall of *C. virginica* showing spongy appearance of muscles. Slightly compressed whole mount. Formalin, 5 percent, hematoxylin-eosin.

stretched by the pull of a light lever to which the aorta end of the ventricle is attached; the opposite end of the ventricle is tied to an immobilized glass rod. Gentle stretching is sufficient to provide the necessary stimulus. Takatsuki (1927) claimed that under these conditions the isolated heart of the Japanese oyster, *O. circumpecta*, may remain active for 16 days. Observations in the Woods Hole laboratory show that the excised hearts of *C. virginica* kept in sea water at room temperature continued to beat for 2 to 3 days, but the frequency and the amplitude of beat decreased noticeably after the first 24 hours.

The molluscan heart functions as a pressure pump which must develop considerable power

to propel the blood through the circulatory system. The mechanical force during the systole is produced by the contraction of a trabecular wall made of many anastomosing fibers. This arrangement, also present in *O. edulis* (Jullien, 1935b), is shown in figures 214 and 215.

In a number of bivalves (*Anodonta*, *Mytilus*, *Ostrea*) the peristaltic wave in the ventricle starts at the posterior end and progresses forward (DeBoer, 1929; Ten Cate, 1923a, 1923b, 1923c). The contraction of the ventricle compresses the auriculo-ventricular valves (fig. 218) and prevents the reflux of blood into the auricles. There is an interval between the contractions of the ventricle and auricles which may be noticed by visual



FIGURE 216.—Cross section through auriculo-ventricular septum of *C. virginica*. Formalin 5 percent, hematoxylin-eosin.

inspection. The electrocardiogram of the oyster heart (*O. edulis*) published by Eiger (1913) shows that the interval is about 0.5 second. A similar condition in the heart of *C. virginica* was demonstrated on an electrocardiogram (fig. 222) made in the Bureau's shellfish laboratory by removing part of one valve and placing the electrodes on the pericardium wall and on the adjacent tissues. Action currents observed by Taylor and Walzl (1941) in the ventricle of the excised heart of *C. virginica* consist, according to their interpretation, of two components, a major diphasic wave preceding the contraction, and a slow wave at the time of contraction.

The refilling of the heart during the diastolic phase is dependent on pressure mechanism in the pericardium. Krijgsman and Divaris (1955) propose the following probable explanation which requires further corroboration. The change in the hydrostatic pressure in the pericardial chamber, caused by systolic contraction, is compensated by the expansion of the auricles. At the moment the ventricle starts to contract it exerts a suction which brings in blood through the reno-pericardial canal and venous system. Thus, the contraction

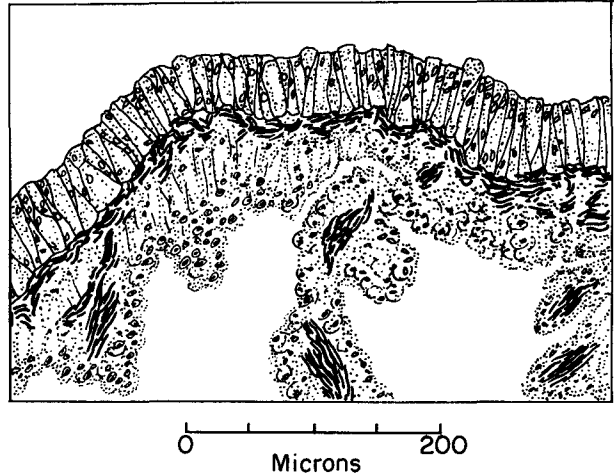

FIGURE 217.—Cross section of the wall of the auricle of *C. virginica*. Outside wall is covered with glandular epithelium. Bouin, hematoxylin-eosin.

of the ventricle automatically results in the expansion of the auricles. This interesting hypothesis may be corroborated by observations on hydrostatic pressure inside the heart and in the pericardial cavity and by motion pictures of the sequences of ventricular and auricular beat. To my knowledge these have not yet been made.

Observations on bivalve hearts in situ show that the ventricle and auricles alternately increase in size while they are being filled with blood. Both auricles of the oyster heart contract simultaneously (Skramlik, 1929).

Experimental evidence indicates that the autom-

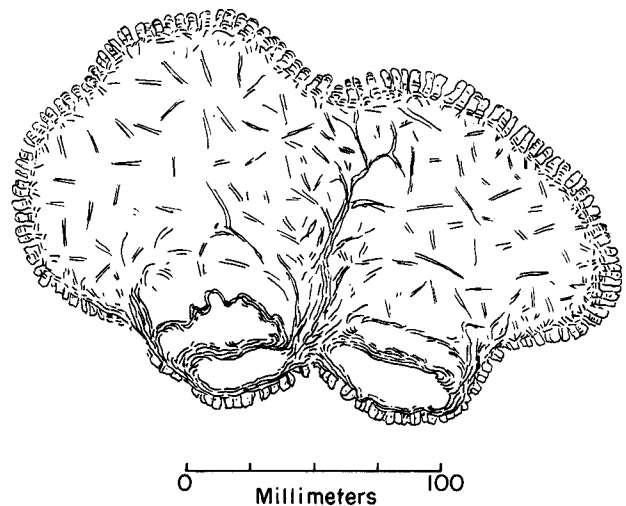

FIGURE 218.—Cross section of the heart at the auriculo-ventricular valves of *C. virginica*. Bouin, hematoxylin-eosin.

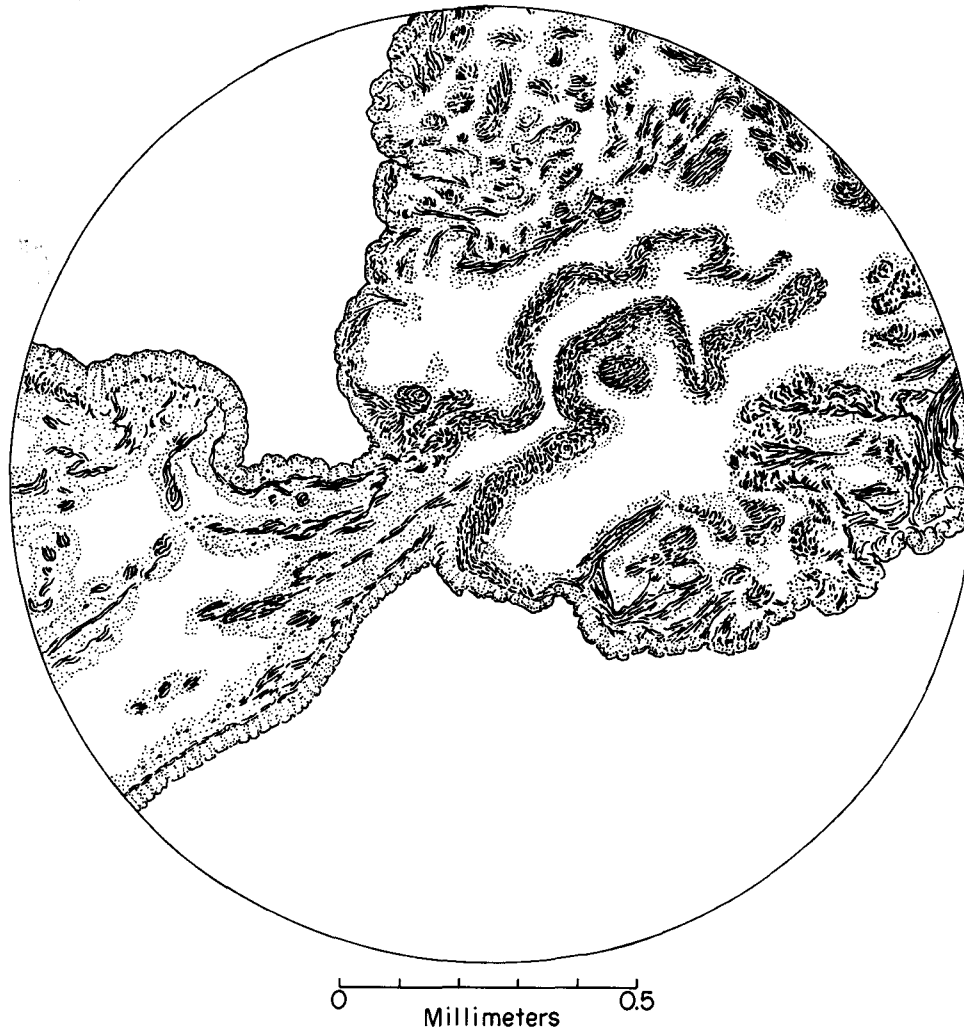

FIGURE 219.—Auriculo-ventricular valve of *C. virginica* seen in longitudinal section. Auricle on the left. Bouin, hematoxylin-eosin.

atism of the bivalve heart is of diffuse nature. Berthe and Petitfrère (1934a, 1934b) showed that contractions of the heart of *Anodonta* originate at any point of the ventricle whether it is observed in situ, or on isolated and even sectioned pieces. In these studies the authors used optical methods to record the beats of the hearts, which were fully submerged in Ringer solution or in *Anodonta* blood and were not stretched by writing levers. They found that such distension of the ventricle removed the asynchronism in automatic activity, increased the amplitude of the contraction, and diminished the rhythm. Jullien and Morin (1931a) reported that the pulsations in dissected strips of heart muscles of *O. edulis* continue for some time. One may conclude that the hearts of the oyster and other bivalve mollusks are myogenic, i.e., their

intrinsic automatism originates in the muscular tissue. In the myogenic hearts of bivalves the beat can start at any point and the contraction can be local or involve the entire organ (Berthe and Petitfrère, 1934b). This type of activity differs from that of the neurogenic hearts, such as those of arthropods, in which the excitation wave of the beat originates from the nerve cells of the ganglia.

#### THE PACEMAKER SYSTEM

We know that the rhythmic activity of the hearts of bivalves originates in the heart itself and is not provoked by impulses from the central nervous system. Whether this automatism is produced by localized pacemakers or is a general property of all muscle fibers has not been adequate-



FIGURE 220.—Nerves in the heart muscle of *C. virginica* vitally stained in methylene blue. Glycerin-jelly.

ly studied. The presence of nerve cells in the heart has been confirmed for many bivalves, gastropods, nudibranchs, and cephalopods (Dogiel, 1877; Suzuki, 1934a, 1934b; Dubuisson, 1933). On the other hand several investigators deny the presence of nerve cells in the heart of mollusks and consider that connective tissue cells were mistakenly described as nerve cells (Krijgsman and Divaris, 1955). Motley (1933), Esser (1934), and Prosser (1940, 1942) were unable to find them in *Anodonta* and *Venus*. Inconsistencies in the results are probably due to the uncertainties encountered in staining nervous elements of the heart with the usual histological technique and frequent failures in using some brands of methylene blue.

It is known that in *Anodonta* and *Mytilus* the wave of ventricular contraction starts at the

posterior end. Furthermore, by applying heating to various places of the hearts of *Anodonta*, *Unio*, and *Mytilus* DeBoer (1929) was able to show that warming the posterior part of the ventricle increases the beat frequency, whereas the heating of the anterior part has no effect (Krijgsman and Divaris, 1955). In the heart of a dying oyster (*O. edulis*), the aortic region continues to beat for a longer time than do the other parts of the organ; the isolated hearts seldom beat if the aorta is completely cut off from the preparation (Jullien and Morin, 1931a). This is also true for the longitudinal fragments of the heart, which continue to beat if they contain a piece of aorta. These observations seem to support the opinion that in most cases the bivalve heart possesses a diffuse myogenic pacemaker.



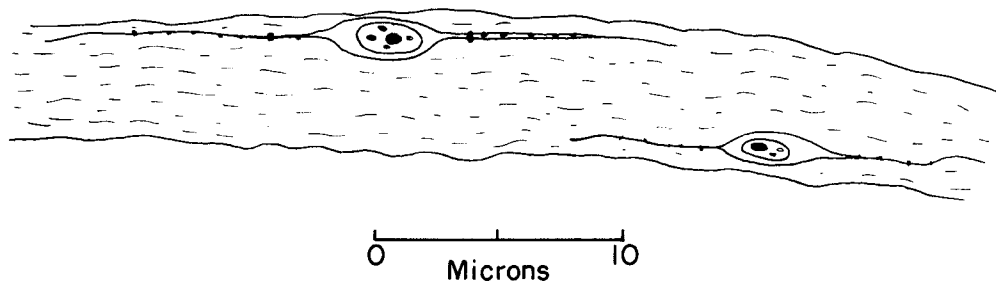

FIGURE 221.—Nerve cells in the heart muscle fiber of *C. virginica*. Methylene blue vital stain.

Pharmacological evidence of the effect of drugs on heart, described later (p. 252), and particularly the action of acetylcholine and the antagonism of curare to acetylcholine, support the view that the pacemaker system in the oyster heart is of a diffuse myogenic nature.

#### METHODS OF STUDY OF HEART BEAT

In order to count the number of beats per unit of time a portion of the left valve must be removed without injury to the adductor muscle and the underlying tissue. The oyster is then kept in sea water at constant temperature, and the number of beats is recorded. The method was used by Federighi (1929) and by Koehring (1937), who drilled a small round window in the valve and with sharp scissors dissected the pericardium to expose the heart. These oysters lived for several weeks in running sea water in the laboratory of the Bureau of Commercial Fisheries at Woods Hole without noticeable ill effects.

Stauber (1940) modified the technique by cutting windows in both valves without injury to the pericardium wall and cementing them over with pieces of glass or cellophane. For observation the operated oysters were illuminated from underneath. In a few days both were covered by new shell and had to be replaced. Shell material that covered the window of the left side, where the pericardium wall touched the valve, probably spread from the adjacent areas of the mantle.

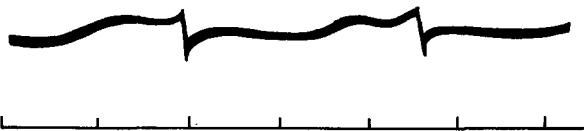

FIGURE 222.—Electrocardiogram of *C. virginica* taken in situ. A gentle wave corresponding to auricular contraction A precedes by approximately one-half second the contraction of the ventricle. Temperature 22.6 °C. Time intervals, 1 second.

Pulse records can be obtained without touching the heart itself by removing a portion of the valve, using the pericardium wall as a sphygmograph tambour, and providing a small stand made of light plastic to support one arm of the writing lever. The disadvantage of this method used in the shellfish laboratory at Woods Hole was that the heart became fatigued after several hours of recording.

There is another technique to study heart contraction in situ. The pericardium wall is exposed by cutting off the valve above the adductor muscle. A small S-shaped glass hook connecting the heart with the kymograph lever is placed under the auriculo-ventricular junction or under the ventricle. A silk thread tied to the upper part of the hook is connected to a writing lever, which is carefully balanced so that the tension on the heart does not exceed 100 mg. Care must be taken to adjust the tension so that the pull of the hook will not displace the heart from its normal position (fig. 223).

There will be a minimum of damage to the nervous system and adjacent organs if only part of the valve between the adductor muscle and the hinge is removed. This leaves the muscle itself intact, and only the pericardium wall is dissected to expose the heart. The oyster is kept in a known volume of water in a finger bowl, which is placed in a large crystallizing dish to permit the rapid change of water or of experimental solution without disturbing the setup. Temperature in the larger dish (not shown in figure 223) is thermostatically controlled at any desired degree. Under such conditions the beating of the heart continues for about 2 days.

The perfusion chamber method is frequently employed (fig. 224) in the pharmacological studies of the effects of drugs on bivalve hearts. In this method the heart is cut off at the levels of the auricles and the aorta, ligatures are applied at

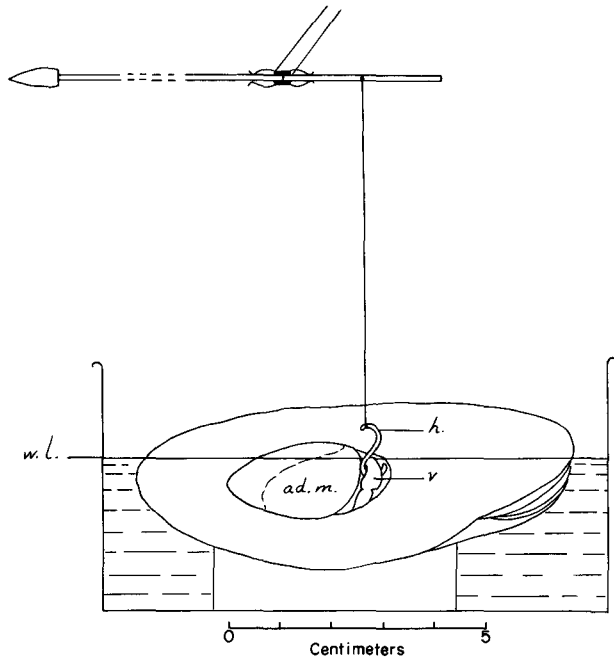

FIGURE 223.—Method of obtaining tracings of oyster heart in situ. ad.m.—adductor muscle; h.—glass hook under the ventricle, V; w.l.—water level. The upper valve has been removed, the pericardium dissected, and the oyster placed on a suitable base in a finger bowl.

both ends and the organ is placed in the perfusion chamber filled with sea water or with Ringer solution. The aorta end of the heart is connected to the writing lever, and the auricular end is attached to the base. The chamber is a glass tube about 2 cm. in diameter with an overflow arm near the top (fig. 224). The length of the tube may be adjusted to obtain the desired volume, usually 10 or 20 ml., between the bottom and the overflow. The liquid (perfusate) is delivered through an inlet A at the bottom; it fills the chamber to the level of the overflow and runs out through outlet B. The preparation may be aerated through a second glass tubing inserted in the bottom. Under this condition the heart remains alive and active for several days.

A very delicate technique to study the nerves which stimulate the oyster heart (*O. circumpecta*) was developed by Oka (1932). The preparation was made in the following manner: the shell was carefully cut off without any injury to the pericardial region and visceral ganglion; the greater part of the gills with the mantle were removed; the adductor muscle was dissected; and the oyster was fastened to a small board in the manner

shown in figure 225. In this way the visceral ganglion with its nervous connection and the heart were exposed and made accessible for stimulation. The heart was kept in water, but the ganglion was exposed to air. The rhythm was recorded for the heart in situ and separately for the ventricle and two auricles. For the latter purpose the heart was cut at the auriculo-ventricular junction and the cut end tied with a silk thread. The free end was connected to a writing lever of a kymograph (upper right part of figure 225).

#### FREQUENCY OF BEAT

The heart beat of all bivalves is so greatly affected by the environment that reports of the rates of beat are of little value unless the conditions under which the observations were made are completely and accurately described. Frequency of heart beat increases with the rise of temperature and decreases with its fall. According to Federighi (1929), the response follows Arrhenius equation from which the so-called temperature coefficient (designated as  $\mu$ ) can be calculated, using the technique developed by Crozier. Discussion of temperature characteristics of biological processes in general and the application of the Arrhenius equation of the effect of temperature on chemical reactions to heart physiology is beyond the scope of this book. The reader interested in the problem is referred to Barnes' (1937) Textbook of general physiology, chapter XIII, or to chapter I in Crozier and Hoagland's (1934) Handbook of general experimental psychology. There is, however, serious reason to question the validity of

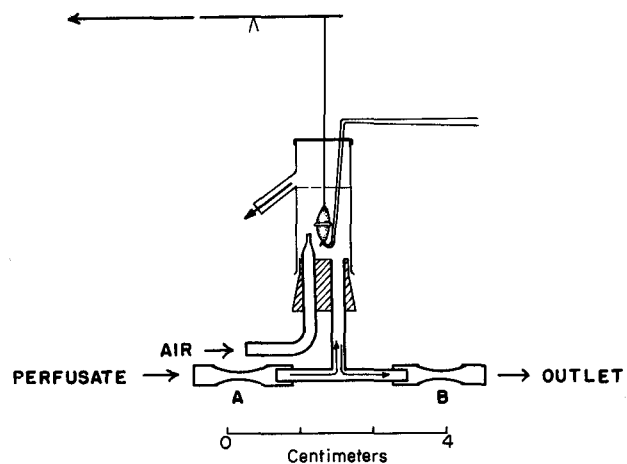

FIGURE 224.—Wait's perfusion chamber for recording the activity of an excised heart of mollusks. From Wait, 1943.

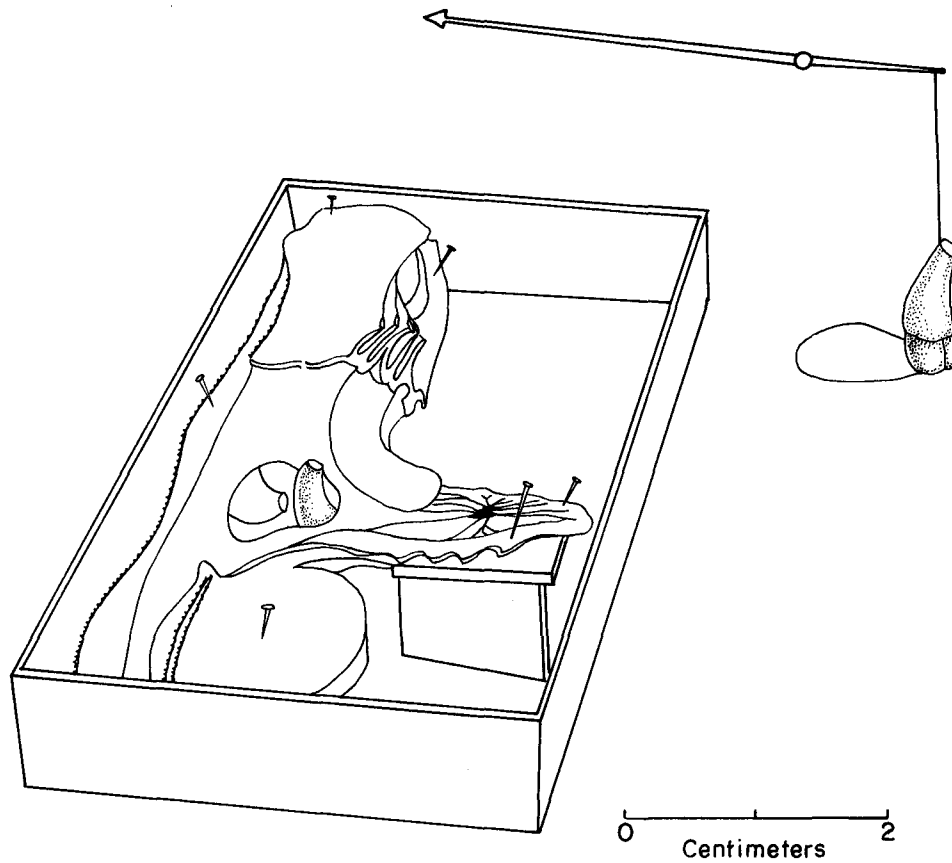

FIGURE 225.—Oka's method of exposing the visceral ganglion for study of heart stimulation in the oyster. Reproduced from Oka, 1932.

the underlying theory of temperature coefficients of biological reactions (Bělehrádek, 1935).

In experiments with *C. virginica* at the Woods Hole laboratory Federighi (1929) found the values of  $\mu$  equal to 16,000 and 13,600. It is rather difficult to convert his data into conventional terms of number of beats per minute since his experimental results are presented only as plots of logarithms of the frequencies (time required for 10 beats) multiplied by 100 against the reciprocals of absolute temperature. At my request Federighi in a personal communication supplied excerpts from his laboratory notes which show the following rates:

Temperature	Beats per minute	Temperature	Beats per minute
25°	47	16°	21
21°-22°	35	10°	11

The rates appear to be much higher than those observed by others. In Federighi's experiments

the upper critical temperature above which there was rapid decline in pulse rate was approximately 30° C.

In Koehring's (1937) observations on *C. virginica* the heart rate averaged 20 beats per minute at 20°. She found also that in the oysters with one valve completely removed the heart action was inhibited for several hours and there was no ciliary motion of the gill epithelium. Inhibition of the heart's activity when the shells are closed was reported by Stauber (1940) in oysters uninjured except for perforation of both valves. He found that the heart rhythm of *C. virginica* slowed down and became irregular when the oyster closed the valves. In some of the closed oysters the heart remained inactive for 2 to 3 minutes, then resumed beating at low frequencies of about two to three times per minute, only rarely exceeding six beats per minute at the temperature of 17.5° C. As the valves began to open, the heart beat increased to 14 to 16 times per minute. These results are in accord with observations on *Anodonta* and

*Sphaerium* (Cyclas) by Gartkiewicz (1926), who described the suppression of heart beat and of ciliary motion during the periods of shell closures. Because of the high transparency of the shell of *Sphaerium* the behavior of the heart of this mollusk could be observed under normal conditions. Gartkiewicz calls the inhibition of cardiac and ciliary activity the "sleep" of the bivalves. The cause of the heart's inhibition is not known; it is probable that in the case of *Sphaerium* the lowered pH of body fluids and the accumulation of carbon dioxide may have contributed to the suppression of cardiac activities. This, however, does not account for the observed temporary cessations of heart beats in the oysters and clams kept in sea water but with their valves partly removed. Apparently the stoppage associated with the contraction of the adductor muscle was due to inhibition originated from the nervous system.

The heart beat in *O. circumpecta* of Japan reaches a maximum of 30 beats per minute at 35° C. and slows down to three beats per minute at 5° C. and to 14 at 40° C. No heart action was recorded by Takatsuki (1927) at 0° and at 45° C. Climatic conditions apparently influence the heart rhythm since it was shown by the same author (Takatsuki, 1929) that the heart pulsation of *O. circumpecta* P. from the waters of the northern part of Japan (Anomori Prefecture) is about 14 times per minute at 20° C. In contrast, the pulse of *O. dendata* Kuster from the bay of Palau, South Sea Islands, where the temperature ranges from 28° to 29° C. throughout the year, was only eight times per minute, and the maximum rate of 22 times per minute was observed in the laboratory at 45° C. The pulsation in the northern species at temperature of 28° to 29° C. was 24 times per minute, and the critical temperature was 35° C. These observations may indicate differences in thermic adjustments of oysters inhabiting cold and warm waters. No general conclusions can be drawn at present from Takatsuki's observations because other factors such as degree of sexual maturity and general conditions of the oyster, which were not reported, may affect the heart beat.

Visual observations can be carried on for short periods of time only, and their usefulness is, therefore, rather limited although their distinct advantage is that the heart is not affected by experimental manipulations. The pulse curve of the heart beating inside the intact pericardium may be obtained by the sphygmograph tambour tech-

nique. Continuous recording may be made for several hours before the heart is fatigued by the weight of the writing lever pressing on the pericardium wall and the rhythm and amplitude decrease.

The wave-line curve shown in figure 226 represents the changes in the hydrostatic pressure inside the pericardium, the increase in pressure corresponding to systolic contraction of the ventricle which is followed by the falling of pressure during the diastole when the auricles expand and are gradually filled with blood. The method is not sensitive enough to record separately the contractions of the auricles, which beat shortly before the contraction of the ventricle. In the experiment shown in figure 226 the oyster was kept in about 3 l. of sea water at 22.5° C.; its pulse rate was 18 to 20 times per minute.

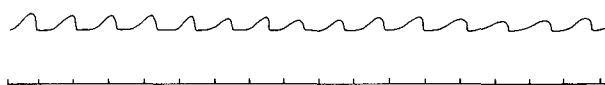

FIGURE 226.—Pulse of an adult *C. virginica* at 22.5° C. recorded by transmitting the motion of the pericardium membrane to the writing lever. Time interval: 3 seconds.

The contractions of auricles interposed between the two ventricular contractions are clearly seen on the tracings of the beats of an exposed heart with the hook connecting the writing lever placed under the auriculo-ventricular junction (fig. 227, two lower lines). In the upper line, the hook was under the ventricle near the emergence of the aorta and the auricular contractions were not registered. The increase in frequency of beat shown in the third (lowest) curve was due to an increase in the water temperature from 20.5° to 24.5° C.

Tracings obtained with the excised heart are similar to those made by the heart in situ with the hook under the ventricle since no contraction of the auricles can be registered in such preparations (fig. 228).

#### EXTRACARDIAC REGULATION

Carlson (1905a, 1905b, 1905c, 1906a, 1906b, 1906c, 1906d, 1907) has shown that stimulation of the visceral ganglion of *Cardium*, *Pecten*, *Mytilus*, and other bivalves produces an inhibitory effect on the heart. Using faradic stimulation, Diederichs (1935) demonstrated that a single shock applied to the visceral ganglion of *Mytilus* produces diastolic arrest. By separating the ganglia he obtained evidence that both the ac-

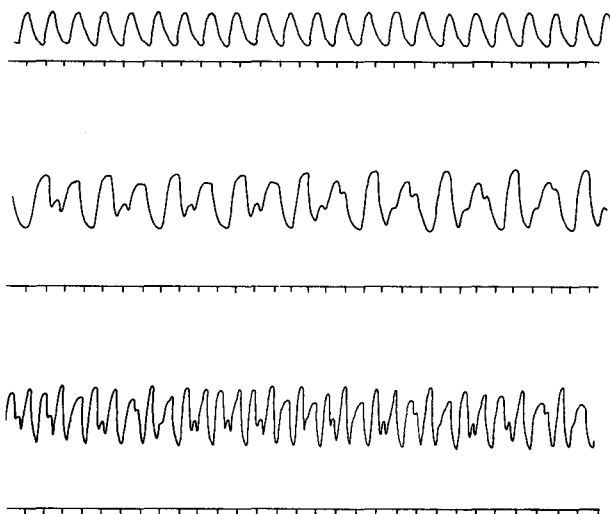

FIGURE 227.—Three records of heart beat of *C. virginica* in situ. The upper curve was obtained by placing the connecting hook of a kymograph lever under the ventricle. The two lower curves were made when the hook was placed under the auriculo-ventricular junction. Increased frequency of the lowest curve is associated with an increase of temperature of sea water from 20.5° to 24.5° C. Time interval, 2 seconds.

celerating and inhibiting nerves lead from the visceral ganglion to the heart and that the two other ganglia affect the heart by way of the visceral ganglion. Oka (1932) found that stimulation of the visceral ganglion inhibits both auricular and ventricular rhythms, and Irisawa, Kobayashi, and Matsubayashi (1961) determined the action potentials in *O. laperosi* and found that oyster heart relaxes through anodal current.

The cardiac nerve is a small branch of the visceral nerve which emerges from the cerebro-visceral connective near the visceral ganglion. Its branches enter the auricles at their base and regulate only the auricular rhythm. The ventricular rhythm, according to Oka's view, is regulated by the cardiac nerves which enter the ventricle at the aorta end. This finding is not in

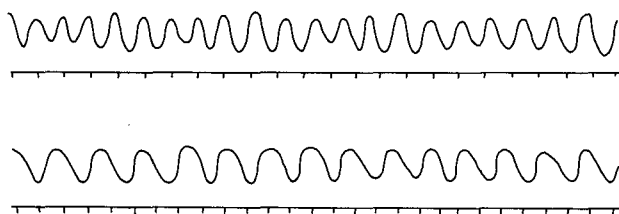

FIGURE 228.—Tracings of the beating of the excised heart of *C. virginica* at 20° C. Salinity 31.7 ‰. Time interval, 5 seconds.

agreement with Carlson's observations that the cardiac nerves enter the heart of a bivalve at the base of the auricles and not at the aortic end. Experimentation with the oyster heart is difficult because exposure of the ganglion causes profuse bleeding and collapse of the heart. Furthermore, the cardiac nerves in *C. virginica* are extremely small and difficult to observe in the living tissue.

Investigations by Carlson did not demonstrate the presence of acceleratory nerves in the hearts of bivalves. Oka (1932) thinks that possibly both kinds of nerves, the acceleratory and the inhibitory, are present in the heart of *O. circumpecta* but that the action of the inhibitory nerve predominates. The suggestion is based on the observation of old heart preparations of lowered vitality in which the beat of the auricles was slightly accelerated by stimulation of the ganglion. The evidence is not convincing and requires verification.

Krigsman and Divaris (1955) arrive at the following conclusions which appear to be applicable to the oyster heart: 1) The systolic mechanism is situated in the heart's muscle fibers; and 2) extrinsic regulatory nerves influence the pacemaker system. The inhibiting fibers are probably cholinergic, and the accelerating fibers may have adrenergic properties. The latter statement needs further verification.

#### EFFECTS OF MINERAL SALTS AND DRUGS

Bivalve hearts respond readily to changes in the chemical composition of water and to the presence of low concentrations of various drugs and poisons. Because of this sensitivity the hearts of several common species such as *Anodonta*, *Mya*, *Mercenaria*, *Ostrea*, and others often have been used in pharmacological bioassays. The test is usually made with a preparation of an excised entire heart (or ventricle) in the perfused chamber. Increased acidity slows the beat of the excised heart of *C. virginica*; a pH of 4.0 and lower causes diastolic arrest and from pH 4 to 9 the rate increases with the increase of pH values. Above pH 9 the contractions become irregular (Otis, 1942).

A change in the balance of metallic ions in the surrounding water affects cardiac activity. Small excesses of potassium stimulate the heart by increasing the frequency of beat (positive chronotropic effect) and by changing the tonus (tonotropic effect) of the myocardium (Jullien and Morin, 1930, 1931b).

The action of sodium is similar to that of the potassium, but response is less pronounced. Small excesses of calcium cause negative chronotropic and positive tonotropic effects, and magnesium acts in a way similar to that of calcium, i.e., produces negative chronotropic effect and causes diastolic arrest of the heart. Lack of magnesium results in a systolic arrest (Jullien and Morin, 1931b; Jullien, 1936a).

Among the effects of various drugs the most interesting is that of acetylcholine, a chemical agent in neuromuscular transmission which depresses heart action of oysters and other mollusks (Jullien, 1935c; Jullien and Vincent, 1938; Jullien, Vincent, Villet, and Bouchet, 1939; Prosser and Prosser, 1938; Prosser, 1940, 1942; and Wait, 1943) and is particularly effective on the heart of the clam (*Mercenaria mercenaria*). Prosser (1940) has shown that inhibition of the heart of this species can be obtained with a concentration as low as  $10^{-12}$ . Recent investigations by Pilgrim (1954) and Greenberg and Windsor (1962) showed that in the hearts of many bivalves acetylcholine produces a "combination response", depressing the cardiac activity in low concentrations and exciting it at high concentrations. The authors used ventricle strip preparations of the hearts of 40 American (in the Greenberg and Windsor experiments) and 8 New Zealand species (in Pilgrim's tests). Preparations which remained quiescent when first set up attained regular rhythm in 2 to 3 hours, a condition which was also observed in tests made in the Woods Hole laboratory on *C. virginica*. In Greenberg's and Windsor's experiments the quiescent preparations were induced to beat with  $10^{-7}$  to  $10^{-5}$  molar concentrations of 5-hydroxytryptamine.

There exists great variability in the responses of different bivalve species to acetylcholine. In some of them only the depressing effect of the drug was recorded. This group includes oysters (*C. virginica* and *C. gigas*), several clams of the family Veneridae (*Mercenaria mercenaria*, *Tapes philipinarum*, *Saxidomus giganteus*, and others), *Mya arenaria*, *Entoderma saxicola*, and *Prododesmus macrochisma*. The excitor effect was demonstrated for *Mytilus californianus* and *M. canaliculus* (in Pilgrim's tests), thus confirming previous observations on Mytilidae by Jullien and Vincent (1938). In Pectinidae, Matridae, Carditidae, and other families, both types of responses were recorded.

The following explanation of the "combina-

tion response", i.e., depression in low concentration and excitation in high concentration, was suggested by Pilgrim (1954): the low concentration tends to inhibit pacemaker activity; at high concentration, while the pacemaker is inhibited, the drug acts directly on the muscle causing a steady contraction. Further research is needed to corroborate this hypothesis.

Greenberg and Windsor (1962) remark that "a reasonable mode of acetylcholine action on bivalve hearts should involve either two separate sites of action or two modes of attachment to the same site at high and low concentrations".

Sensitivity of bivalve hearts to acetylcholine varies in different species. The most sensitive ones, reported by Pilgrim, are *Dosinia*, *Amphiderma*, and *Mercenaria mercenaria*. Oysters are less responsive to the drug. Jullien (1935c) reported that in *C. angulata* the frequency and the amplitude of heart beat are decreased in a concentration of  $10^{-5}$  with diastolic arrest following at two times  $10^{-5}$  to two times  $10^{-4}$  concentration. In New Zealand species, *Ostrea hefferdi*, the cardiac activity is depressed with a diastolic arrest at concentrations varying from  $10^{-8}$  to  $10^{-5}$  (Pilgrim, 1954). In *C. virginica* the decrease in the frequency and amplitude of isolated heart was apparent at concentration  $10^{-5}$  (fig. 229) and the effect persisted for several minutes after the preparation was flushed with fresh sea water (second line). The effect of the drug can be noticed even in extremely low concentrations of  $10^{-8}$  and  $10^{-9}$ . Under normal conditions the hearts of bivalves contain little acetylcholine (Jullien and Vincent, 1938), but the heart of the gastropod *Murex* is very rich in this compound.

Eserine causes periodical alterations in the amplitude of heart beat and slight increase in the rate of beating (fig. 230). The significance of the

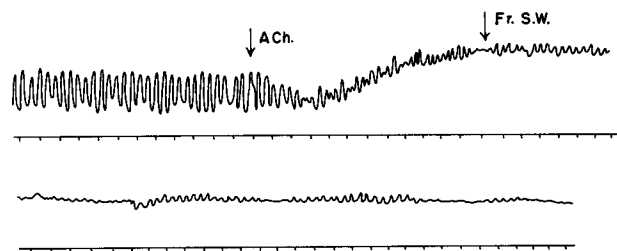

FIGURE 229.—Effect of acetylcholine in the concentration  $10^{-5}$  on the beat of isolated heart of *C. virginica*. ACh—acetylcholine added; Fr.S.W.—perfusion chamber flushed with fresh sea water. Temperature  $23.7^{\circ}$  C. Time interval, 5 seconds.

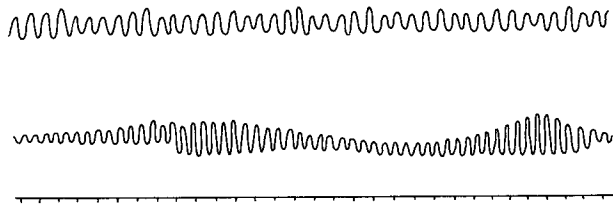

FIGURE 230.—Tracings of the heart beats (in situ) of *C. virginica* in sea water (upper line) and after the addition of eserine, (second line) in concentration of  $10^{-4}$ , to the pericardial chamber. Temperature  $21.5^{\circ}$  C. Time interval, 5 seconds.

drug in heart physiology is the fact that it prevents the destruction of acetylcholine by the enzymes of the organism.

Veratrine has a temporary stimulating effect on the heart of *O. edulis* (Jullien, 1936a). In my experiments with isolated heart of *C. virginica*, a slight stimulating effect on the frequency of ventricular contraction was recorded in the concentration of veratrine of 1:10,000. Within a few seconds the number of beats increased from 12 to 18 and 20 times per minute at  $20.5^{\circ}$  C. (fig. 231). Navez (1936) described the depressive action of pilocarpine on the heart of *Anomia*.

High concentrations of curare inhibit the heart activity of the oyster; in lower concentrations the drug has a strong positive tonotropic effect (Jullien, 1936a) and also counteracts the inhibitory effect of acetylcholine. Jullien found that heart action stopped by acetylcholine was restored by subsequent applications of curare.

Adrenaline accelerates the heart beat of *O. circumpecta*, (Takatsuki, 1933) in a concentration of about 1.8 times  $10^{-7}$ . Similar activating action has been reported for *C. virginica* (Otis, 1942) and for *O. edulis* (Jullien, 1935d, 1936a, 1936c). Stronger concentrations produce irregular beating and some times systolic arrest.

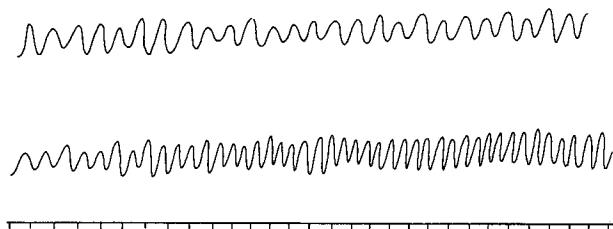

FIGURE 231.—Effect of veratrine (conc. 1:10,000) on ventricular contractions of the isolated heart of *C. virginica*. Temperature  $20.5^{\circ}$  C. Time interval, 5 sec. Upper line—in sea water; lower line—immediately after the perfusion with veratrine in sea water.

## BLOOD VESSELS

Lack of continuity between the arteries and veins due to the presence of sinuses is the characteristic feature of the open circulatory system of bivalves. The spaces which function as capillaries have no distinct walls, are of irregular shape, and appear as slits in the tissue (fig. 79). Their presence imposes difficulty in the maintenance of effective circulation of blood through the organs and tissues. The deficiency is partially overcome by the presence of pulsating vessels and accessory hearts, which assist in the moving of blood through the mantle.

All blood vessels of the oyster have very thin and delicate walls that are easily ruptured by a slight increase in pressure. In anatomical preparations of the circulatory system, it is, therefore, difficult to obtain complete penetration of arterial and venous systems by injection. Partial success may be obtained by using a warm gelatine solution stained with appropriate dyes; by injecting borax or lithium carmine and immediately placing the preparation into 95 percent alcohol in which the stain is precipitated; or by injecting vinyl resin solution diluted with acetone (Eble, 1958). For more detailed study the preparation may be dehydrated and clarified in oil of cloves or in cedarwood oil. Very small vessels may be injected through a capillary tubing using aqueous solution of methylene blue, toluidin blue, or some other suitable dye. Although no permanent preparation can be obtained in this way, the method is useful for tracing the connection between the small vessels.

Because the injection of the venous system is even more difficult than that of the arteries, knowledge of venous circulation in bivalves is less complete than that of the arterial system. Attempts to observe the movement of blood inside the veins usually are not successful because the tissues are either too contractible or contain so much glycogen that the vessels are obscured. The description of the principal blood vessels of the oyster given below is based on the examination of many specimens injected by various methods and studied under a low power of magnification.

### THE ARTERIAL SYSTEM

The arteries can be recognized in microscopic preparations by their well-developed walls lined with a single layer of flattened endothelial cells

(fig. 81). They have a distinct layer of circular and longitudinal muscles surrounded by connective tissue.

The arterial system described here is shown diagrammatically in fig. 232 from the right side, after the partial removal of the mantle and some of the visceral mass. The right wall of the pericardium is cut off to expose the heart. This diagrammatic drawing is based on examination of several specimens injected through the ventricle.

Two large arteries emerge from the posterior-dorsal side of the ventricle. The largest one is the anterior aorta (ant.ao.), which upon leaving the heart forms a short enlargement or a bulb leading to the large visceral artery (visc.a.) with its numerous branches and small pericardial artery (small unmarked vessel under the visceral artery), which supplies blood to the wall of the pericardium. The much smaller posterior aorta (post.ao.) supplies blood to the adductor muscle and rectum (r.). Near the point of emergence of the posterior aorta it gives off a small rectal artery (r.a.), which follows the wall of the rectum.

The visceral artery (visc.a.) emerges from the anterior aorta as a wide vessel that supplies blood to the organs of the visceral mass. Its upper branch reaches the level of the labial palps and of the cephalic hood. The lower branch extends along the wall of the crystalline sac and forms the reno-gonadial artery (r.g.a.); numerous small branches of this vessel supply blood to gonads and kidneys.

In its course toward the anterior part of the body, the anterior aorta (ant.ao.) passes under the intestinal loop (not shown in fig. 232) and gives off several small vessels which bring blood to the digestive diverticula (gastric arteries, g.a.), mantle, and the labial palps. At the anterior end of the body the aorta forms a common trunk of the pallial artery (co.p.a.), which divides into two short branches corresponding to the left and right side of the body, each branch giving rise to the ventral and dorsal circumpallial arteries (cr.p.a.). Each of these continues along the periphery of the mantle lobes, supplying blood to the mantle through a large number of short vessels which end in the mantle lacunae. A very small subligamental artery emerges from the end of the common pallial artery and leads to the subligamental gland (fig. 78). The cephalic artery (cph.a.) and labial artery (l.a.) supply blood to the anterior end of the body and to the right and left labial palps.

## THE VENOUS SYSTEM

Since the presence of irregular sinuses prevents the filling up of the entire venous system with one injection it is necessary to make separate injections of the principal vessels and to supplement the study with an examination of sectioned material. The course of small veins may be traced by injecting a water soluble dye and watching its penetration in the tissues of the visceral mass and gills.

The venous system comprises the sinuses, afferent and efferent veins and small vessels of the gills. It is diagrammatically shown in figure 233. Ramifications of the vessels are omitted for the sake of clarity.

The sinuses occur throughout the entire visceral mass, in the pallium, along the adductor muscle, and around the kidneys. Their outlines are highly irregular, and the area they occupy varies, depending on the degree of distension by blood. The renal sinus (r.s.) consists of several smaller sinuses which surround the main part of the kidneys and open into the efferent branchial vessel and into the sinuses between the adductor muscle and the heart at the posterior side of the body. The renal sinus spreads into the connective tissue of the adjacent area and is in communication with the inter-nephridial passages leading to the pericardium. The renal vein (r.v.) carries blood from the sinus into the common afferent vein. The visceral sinus, v.s., not definitely outlined in the diagram, spreads over the surrounding tissues and drains its blood through the gastric (g.v.), hepatic (h.v.), and other veins into the common afferent vein (c.af.v.). The muscle sinus (m.s.) is a small area below the renal sinus on the surface of the adductor muscle under the pyloric region. The system of afferent veins consists of a single common afferent vein (c.af.v.) and two lateral afferent veins, l. af. v. (fig. 233 and fig. 73). The common afferent vein runs on the ridge formed by the fusion of the two inner ascending lamellae of the gills. The blood received by this vein comes from the deeper parts of the body and is brought by a number of veins which can be identified as the cephalic veins (c.v.) from the cephalic region; the labial veins (l.v.); the gastric and hepatic veins (g.v., h.v.); the network of small reno-gonadial veins (r.g.v.); short renal vein (r.v.) and the adductor muscle vein (not shown in the diagram). In thin, watery specimens most of these veins can



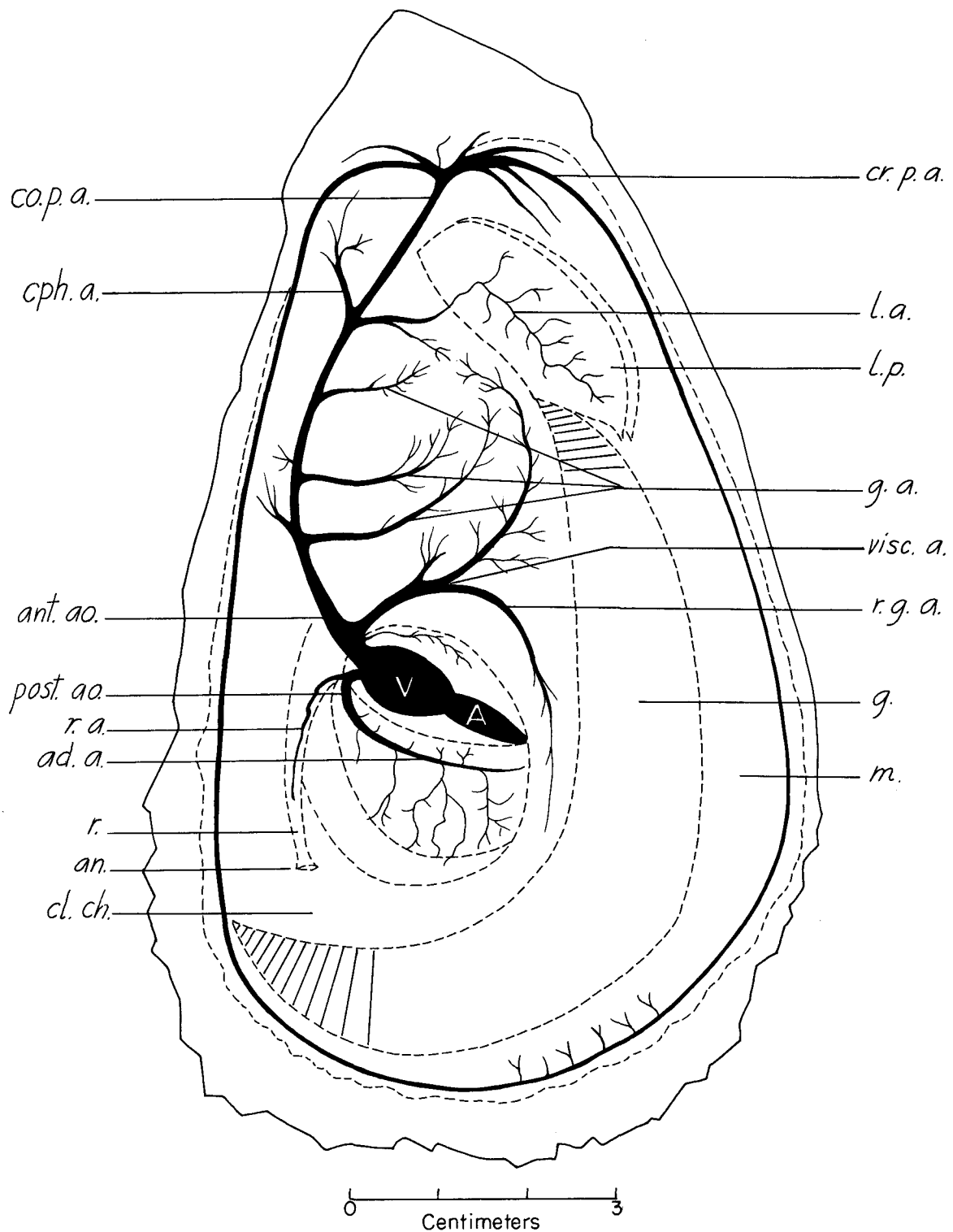

FIGURE 232.—Diagram of the arterial system of *C. virginica*. A—right auricle; ad.a.—adductor muscle artery; an.—anus; ant.ao.—anterior aorta; cl.ch.—cloacal chamber; co.p.a.—common pallial artery; cph.a.—cephalic artery; cr.p.a.—circumpallial artery; g.—gills; g.a.—gastric arteries; l.a.—labial palp artery; l.p.—labial palps; m.—mantle; post.ao.—posterior aorta; r.—rectum; r.a.—rectal artery; r.g.a.—reno-gonadal artery; visc.a.—visceral artery. For the sake of clarity profuse ramifications of the vessels are not shown.

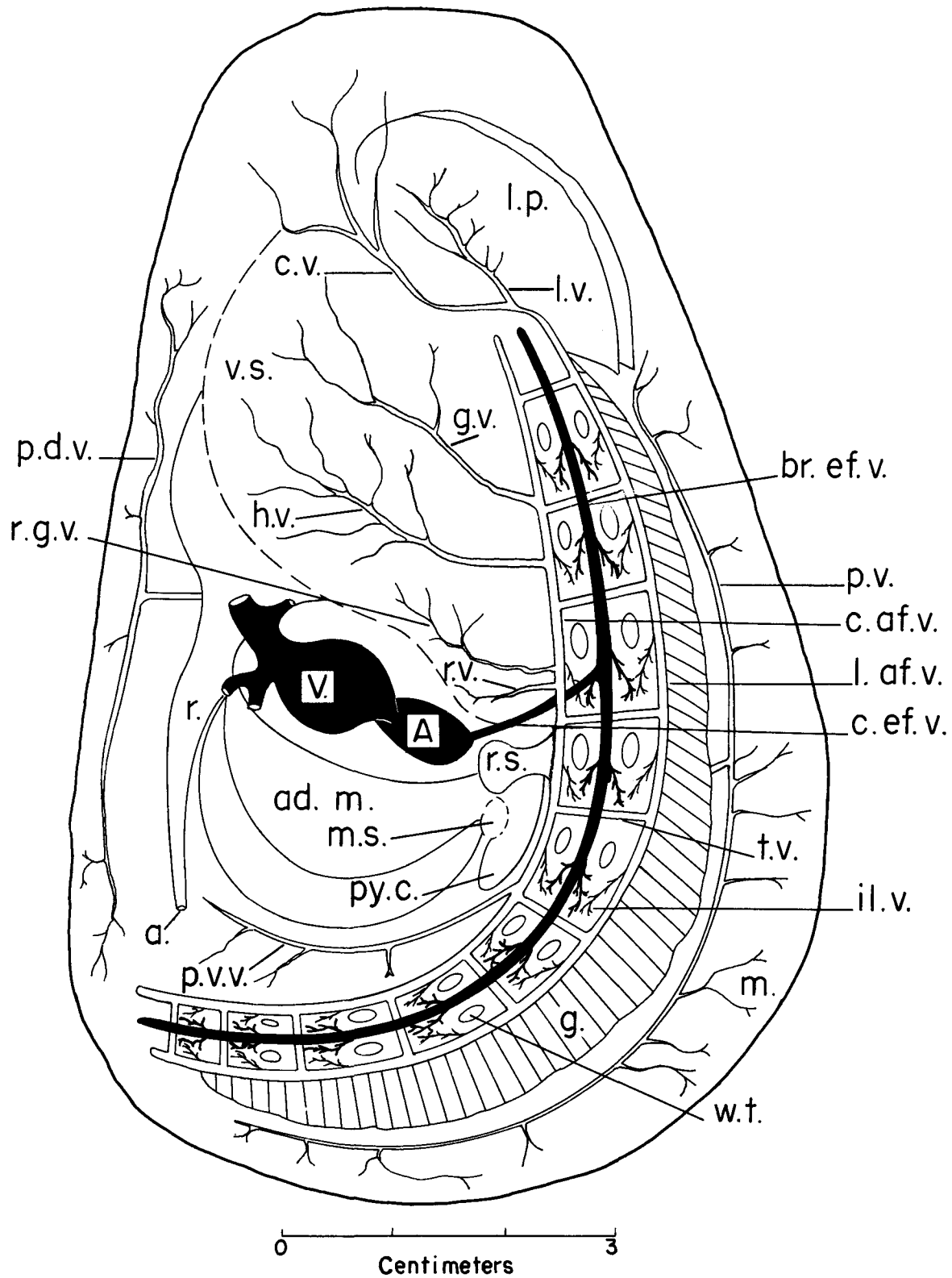

FIGURE 233.—Diagram of the venous system of *C. virginica* viewed from the right side. The right demibranch is open and pulled out to show the water tubes and the vessels of the descending and ascending lamellae. The left demibranch is not visible. Vessels carrying oxygenated blood are shown in solid black; others are open. The diagram

be seen from the surface. In sexually mature and "fat" oysters they are obscured by the deposits of glycogen and by the accumulation of sex cells. The paired lateral afferent veins (l.af.v.) are of smaller diameter than their common partner. They are located along the axis of the outer ascending lamella where the lamella fuses with the mantle lobe. The lateral afferent veins receive the blood from the mantle through the pallial veins (p.v.).

At regular intervals the common afferent vein is connected with the lateral veins by short transverse (horizontal) vessels (t.v.). These vessels can be seen in injected preparations of the gills and in sectioned material. The communication between the horizontal vessels in the gill tissues is maintained by means of vertical vessels which emerge from the walls of the three afferent veins as a series in a double row, one following the inner and the other the outer lamella of the demibranch. At each interfilamentar shelf the vertical vessels empty into a lacuna and eventually into the tubes of the gill filaments. There is no special path for the return of the blood from the interfilamentar lamellae and the tubes because the filaments end blindly. The walls of the common afferent vein contain a layer of elastic fibers arranged circularly; they are scarce in the walls of other veins. Endothelium is absent in all these vessels. The walls of the vertical vessels of the lamellae have a layer of muscular fibers which are able at intervals to constrict the lumen of the vessels along their length. In this way the flow of blood inside the gills is regulated (Elsey, 1935).

The blood channels in the interlamellar junctions are in communication with the vertical vessels and provide for the passage of blood from one lamella to the other. This rather inefficient circulation of the blood in the gill vessels is influenced by the contraction of the entire gill musculature and by contractions of the major afferent and efferent veins. The pulsations of these vessels have not

been observed in vivo, but their histological structure suggests that they are capable of constricting their lumen. A tangential section of the common afferent vein preserved in a relaxed state (fig. 234) shows a well-developed layer of circular muscles flanked on both sides by thin bands of longitudinal muscles.

The system of efferent vessels comprises two short common efferent veins (c.ef.v.) which open into the auricles, a pair of branchial efferent veins (br.ef.v.) which run along the axis of the gill lamellae (fig. 73), pallial efferent veins (not shown in fig. 233), and the interlamellar and interfilamentar vessels (il.v.) of the gills. The branchial efferent veins (br.ef.v.) run along the gill axis parallel to the branchial nerves (fig. 73) at the junctions of the ascending and descending lamellae. In their course they receive blood from the renal sinuses and empty into the common efferent vein. Blood which circulates in the mantle is carried to the heart through pallial sinuses and veins, but part of the blood from the posterior portion is drained back to the gills and to the branchial efferent vein (br.ef.v.).

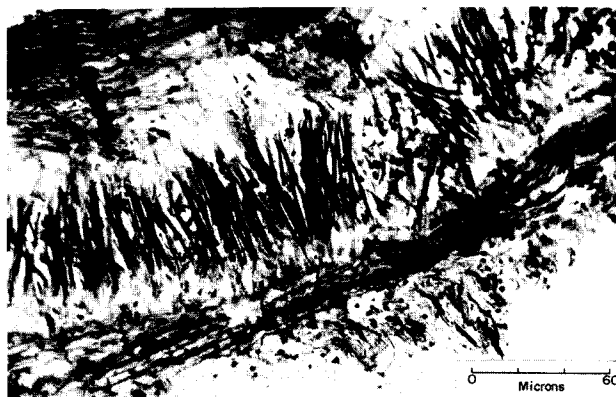

FIGURE 234.—Photomicrograph of a tangential section of the wall of the common afferent vein of *C. virginica* preserved in fully relaxed state. Narcotized in magnesium sulfate. Kahle, hematoxylin-eosin.

was drawn from a number of preparations of partially injected venous system. Only the approximate position of various vessels is indicated. The diagram does not intend to show the actual appearance and distribution of veins. A—auricle; V—ventricle; a.—anus; ad. m.—adductor muscle; br. ef. v.—branchial efferent vein; c. af. v.—common afferent vein; c. v.—cephalic vein; c. ef. v.—common efferent vein; g.—gills; g. v.—gastric veins; h. v.—hepatic veins; il. v.—interlamellar veins of the gills; l. af. v.—lateral afferent vein; l. p.—labial palps; l. v.—labial vein; m—mantle; m. s.—mantle sinus; p. v.—pallial vein; py. c.—pyloric caecum; p. d. v.—posterior dorsal vein; p. v. v.—posterior-ventral vein; t. v.—transverse veins of the gills; r.—rectum; r. s.—renal sinus; r. g. v.—reno-gonadial veins; r. v.—renal vein; v. s.—visceral mass; w. t.—water tubes of the gills.

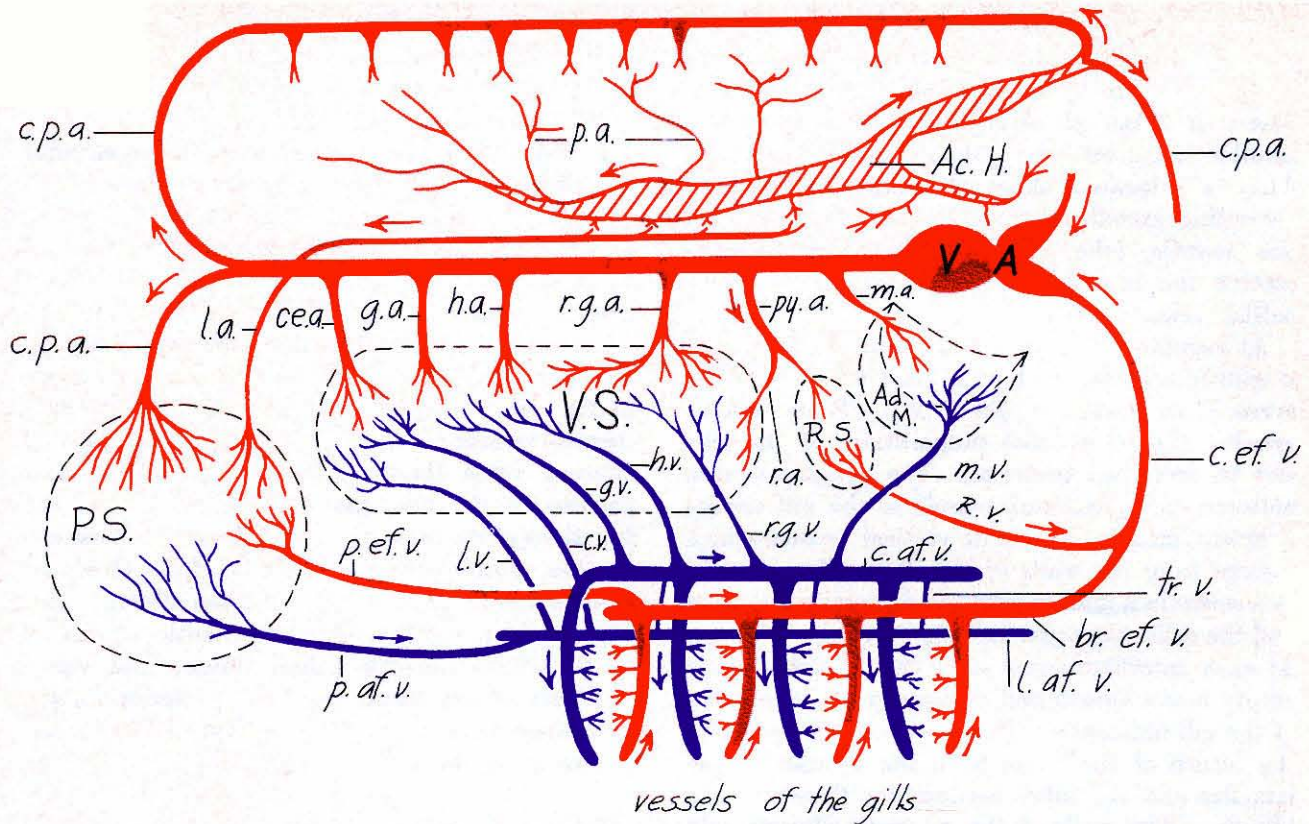

FIGURE 235.—Diagram of the circulation of blood in *C. virginica*. The position of various sinuses marked with capital letters is indicated by broken lines; only one demibranch and one accessory heart are shown. A—auricles; A.c.H.—accessory heart of one side; P.S.—pallial sinuses; R.S.—renal sinuses; V—ventricle; V.S.—visceral sinuses; br.ef.v.—branchial efferent vein; c.af.v.—common afferent vein; c.ef.v.—common efferent vein; cea.—cephalic artery; cp.a.—circumpallial artery; c.v.—cephalic veins; ga.a.—gastric artery; g.v.—gastric vein; h.a.—hepatic artery; h.v.—hepatic vein; l.a.—labial artery; l.af.v.—lateral afferent vein; l.v.—labial vein; m.a.—adductor muscle artery; m.v.—adductor muscle vein; p.a.—pallial arteries; p.af.v.—pallial afferent vein; p.ef.v.—pallial efferent vein; py.a.—pyloric artery; r.a.—renal artery; r.g.a.—reno-geonadial artery; r.g.v.—reno-gonadial vein; r.v.—renal vein; tr.v.—transverse veins of the gills.

In visualizing the circulation of blood within the gills one must keep in mind the location of the five horizontal vessels at the top of the duplicated W-shaped junctions of the gill lamellae (fig. 73).

The course of circulation presented schematically in fig. 235 shows that the arterial blood goes to the sinuses (P.S., V.S., R.S.) and then is conveyed through the afferent veins to the gills and reaches the auricles via two common efferent veins. Some of the blood from the pallial sinuses (P.S.) and from the renal sinus (R.S.) bypasses the gills and is directly delivered to the auricles through the common efferent veins.

The deficiency in circulation caused by the presence of large sinuses is counteracted by the pulsations of radial vessels of the mantle and by a pair of accessory hearts (Ac.H.), which function independently of the principal heart of the oyster.

The red and blue colors of the diagram show that only oxygenated blood fills the heart.

#### THE ACCESSORY HEART

The accessory heart is a paired tubular structure along the inner surfaces of the right and left mantle folds where they join together to form the cloacal chamber. Its position on the wall of the cloaca and its relation to the adjacent organs are shown in figure 236 drawn from life.

The accessory heart of the oyster is not the simple tubular structure described by Hopkins (1934, 1936) and Elsey (1935). It consists of three branches of almost equal size, joined together at a common center (fig. 237). The entire structure has the shape of the letter Y. The lower or ventral branch (v.br.) extends along the

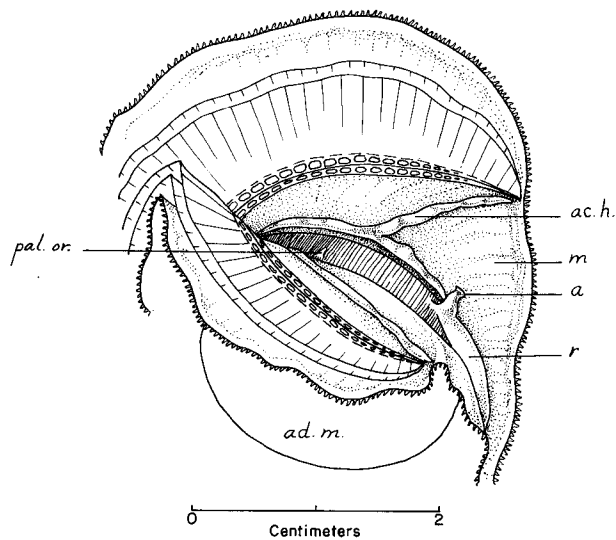

FIGURE 236.—The position of the accessory heart on the left of the cloacal wall of *C. virginica*. The epibranchial chamber was dissected, and the demibranchs of the right and left side pulled apart to expose the ventral side of the adductor muscle. The oyster was fully narcotized. The accessory hearts on both sides were fully expanded (only the part of the right accessory heart is shown). a.—anus; ac.h.—accessory heart on the left side; ad.m.—adductor muscle; m.—mantle; pal.or.—pallial organ; r.—rectum.

wall of the cloaca to the pallio-branchial junction (p.br.j.).

Under slight mechanical stimulation the delicate wall of the accessory heart collapses and the structure becomes invisible. This explains why the earlier investigators did not recognize it as an active organ and mistook it for ridges on the inner wall of the mantle (Rawitz, 1888; Kellogg, 1892).

The structure of the accessory heart of *C. virginica* (fig. 238) resembles that of the arteries of the mantle. The walls have a well-developed layer of longitudinal and circular muscles, but the endothelium lining is indistinct and is probably absent.

The pulsation of accessory hearts of *C. virginica* observed in winter at the Woods Hole laboratory was very irregular, not exceeding two to three times per minute at room temperature of 20° to 22° C., and was independent of the heart beat. During the summer the rate of contraction was six to seven times per minute. Hopkins (1934) states that in *C. gigas* the accessory heart beat at a slower rate than the average heart rhythm of this species and the frequencies for right and left organs averaged 6.0 and 7.5 times per minute respectively.

The connection of the accessory heart to other vessels was studied by the following method of injection. Live oysters were kept for 24 to 48 hours in a refrigerator, then placed overnight in cold sea water with 5 percent magnesium sulphate. About 2 ml. of lithium carmine was injected, using the finest hypodermic needle. The preparation was rapidly rinsed in fresh water and immediately immersed in 95 percent ethanol, which precipitated the dye. The injected material remained inside the vessels and was not diffused or washed away by dehydration and clarifying agents (cedar oil or xylene). In this way several permanent preparations were obtained.

Dye injected into the ventral branch (fig. 237, v.br.) penetrated some distance into the circum-pallial arteries of the right and left mantle lobes and into the small branches and capillaries of the efferent vein of the gills (ef.v.). The dorsal branch (d.br.) was found to extend along the wall of the cloaca: it does not "disappear into the excretory organs," as stated by Hopkins, but extends under the renal sinus to the dorsal part of the cloacal wall. The ramifications of the branch end in a number of capillaries which connect them with the dorsal portion of the efferent vein. The third or posterior branch (p.br.) follows the ventro-lateral border of the adductor muscle and gives many ramifications inside the cloacal wall.

Blood carried by the ventral branch of the accessory heart enters the pallial artery against the pressure produced by the principal heart. Under these conditions its penetration inside the artery must be limited, and at the end of the contraction wave some of the blood probably re-enters the branch. Movement of the blood inside the circum-pallial artery can not be seen, but through the thin wall of the accessory heart one can observe the flushing of blood cells back and forth. Ramifications of the ventral and dorsal branches form capillaries which are in direct connection with the side vessels of the efferent vein. It can be assumed from the direction of the contraction waves that blood from the accessory heart moves toward the efferent vein of the gill and that part of the blood is flushed back as the impulse wave progresses along the wall of the branch.

Oscillation of the blood in the mantle is the primary function of the accessory hearts. Their oscillatory movements facilitate the gaseous exchange and provide a means for efficient respiration. The location of the accessory hearts con-

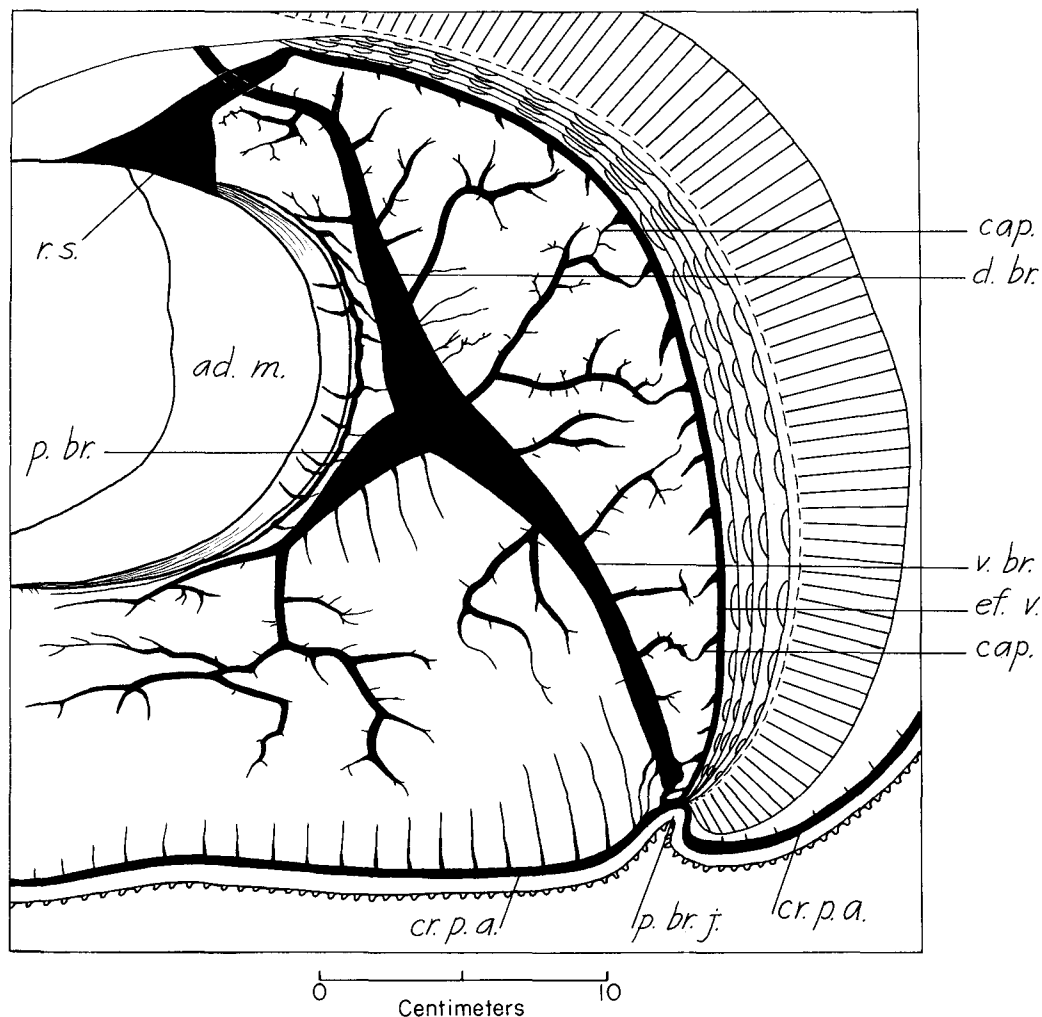

FIGURE 237.—Accessory heart of *C. virginica*. Drawing made from an injected preparation. ad.m.—adductor muscle; cap.—capillaries; cr.p.a.—circumpallial artery; d.br.—dorsal branch; ef.v.—efferent vein; p.br.—posterior branch; p.br.j.—pallio-branchial junction; r.s.—renal sinus; v.br.—ventral branch.

firms the opinion that the mantle and the wall of the cloaca play significant roles in the respiration of oysters.

The pulsation of the accessory hearts makes it possible for the blood of the pallial sinuses to enter the branchial efferent veins or to be forced into the gills through the lateral afferent veins. The pacemaker system and the nervous control of the accessory hearts have not yet been studied.

### THE BLOOD

There are two distinct groups of blood corpuscles in bivalve mollusks, the hyaline cells and the granular amoeboid cells. The latter are frequently called granulocytes because of the large number of granules in their cytoplasm, or

amoebocytes and phagocytes because of their ability for amoeboid movements and phagocytosis. The hyaline cells are not entirely devoid of granules but they are very sparse. These cells also display amoeboid movement but are much less active than the granular cells. Both types of cells are present in the oyster.

Samples of blood for examination may be obtained by puncturing the pericardial wall with a fine glass pipette and drawing the desired volume of blood. In the same manner blood may be obtained directly from the ventricle or auricles. Some blood cells are always present in the shell liquor and on the surfaces of the gills and mantle. A fair sample of cells can be obtained by scraping these tissues with cover slips or by drawing the pipette along them. For examination of live

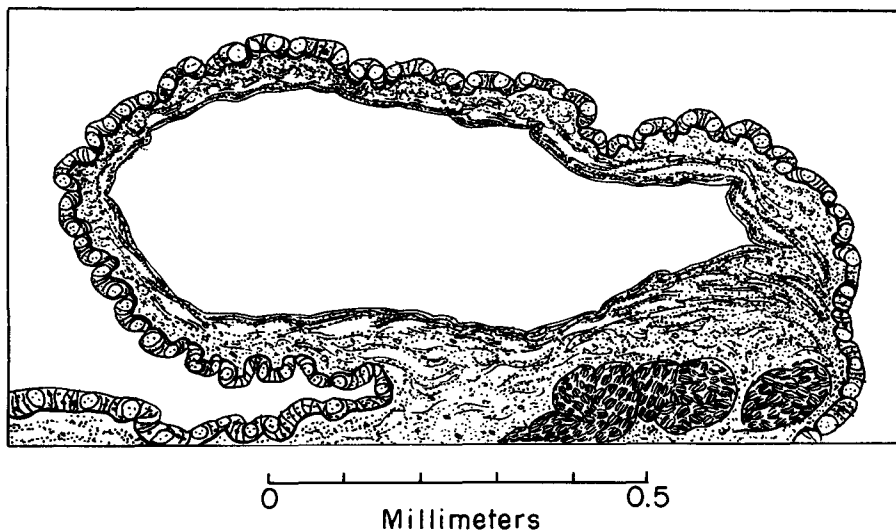

FIGURE 238.—Transverse section of the accessory heart of *C. virginica* preserved in widely expanded state. Kahle, hematoxylin-eosin.

cells the sample may be placed in a moist chamber or a small quantity of blood may be dropped in a glass dish with sea water of the same salinity from which the oysters were taken. Under these conditions the cells of *C. virginica* may remain alive for about 6 days and can be used for studies or classroom demonstration (Breder and Nigrelli, 1933).

For smear preparations drops of blood should be left on slides until the cells begin to expand. When a desired state of expansion has been attained, the preparation is fixed in Bouin III for a few minutes or in chromic or osmic acid (liquid or fumes). Satisfactory preparations may be obtained by using Romanowsky's, Leishmann's, Giemsa's, and McNeal's tetrachrome stains made in a solution of absolute methyl alcohol. These reagents fix and stain the cells in one operation.

#### COLOR OF BLOOD

The blood of the oyster is colorless and contains no respiratory pigments such as the hemoglobin in vertebrates or hemocyanin found in snails and cephalopods. In semipopular books on oysters a statement is sometimes found about the presence of hemocyanin in oyster blood. To clarify this question, a composite sample of blood and pericardial fluid was collected from six adult *C. virginica* and submitted for spectrophotometrical analysis, which was kindly performed in George Wald's laboratory at Woods Hole. The following is the report received from Wald:

"The pH (of the sample) was 7.33. The absorption spectrum showed specific absorption in the visible region corresponding to the hemocyanin band at about 570 m $\mu$ . Hemocyanin possesses also a very high, sharp absorption peak at about 340 m $\mu$ , some 20 to 30 times as intense as the absorption in the visible spectrum. This therefore constitutes a very delicate test for the molecule. This also did not appear in the spectrum though a small band was found at lower wavelengths, at about 327 m $\mu$ .

"The 570 and 340 m $\mu$ . absorptions are found in oxyhemocyanin; both are abolished in the reduced condition. As an added test therefore this sample of oyster blood was reduced with sodium hydro-sulfite. The ultraviolet absorption at about 327 m $\mu$ . instead of being depressed, rose greatly. I do not know what this substance is, but quite certainly it is not hemocyanin."

#### THE HYALINE CELLS

These cells with clear cytoplasm containing but few granules are of uniform shape, varying only in size from 5 to 15  $\mu$ . When examined alive they are usually spherical (fig. 239), have a distinct cell membrane, and are of pale yellow-green color. Because of their high refractive quality they stand out sharply in the field of view of the microscope. The slow movement of the cells can be noticed if the preparation is watched intently for 30 minutes or longer. One of these cells, under continuous observation in the Woods Hole laboratory for 45

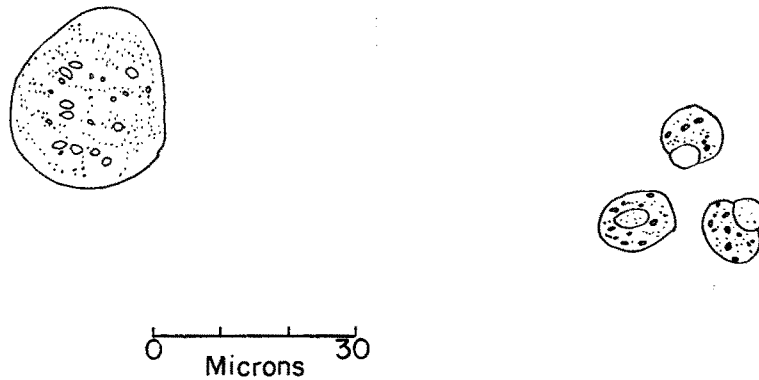

FIGURE 239.—The hyaline blood cells of *C. virginica*. Very small cells on the left; normal cells on the right. Camera lucida drawing of live cells on glass.

minutes changed its shape four times from round to oval and back again. The movement is extremely gradual and consists mainly in bulging of one side of the body. The nucleus is not visible in the live cells and rarely can be seen in stained preparations. The cells are basophilic, staining reddish-purple with Romanowsky's stain. The nucleus stains the same color as the cell.

The hyaline cells comprise about 40 percent of the total number of blood cells in a sample. This is an average of a number of samples taken from the oysters of Long Island Sound and of Chesapeake Bay in which blood was drawn from the pericardium, heart, and shell liquor. In the oysters in good, healthy condition, the proportion of hyaline cells varied from 25 to 64 percent, but the differences were not consistent and did not seem to be affected by the origin of the oysters or by the part of the body from which the sample was taken.

#### THE GRANULAR CELLS

The granular cells or the amoebocytes vary greatly in shape, size, and behavior. This undoubtedly is due to their pronounced ability for amoeboid movement. In live contracted state they measure about 6  $\mu$  in diameter, but they expand and spread to a much larger size. When fresh blood drawn from the oyster by a pipette is spread on a glass slide, many blood cells form aggregates or clumps. This aggregation or agglutination results from the adhesiveness of the cell membranes, which stick on contact with one another (Drew, 1910). In a quiescent stage the cells are usually round and motionless. In about half an hour they begin to expand and separate from the clump. By the end of the first hour

the amoeboid movement becomes active and the cells disperse themselves and form concentric rings around the clump.

The cytoplasm and the granules of a moving amoebocyte (fig. 240) flow slowly from the center of the cell out to the edge and push the cell membrane out, forming a pseudopodium. During the formation of very narrow pseudopodia the cytoplasm appears to flow out with the granules arranged in single file. Contraction seems to be affected all at once over an entire cell area, and the action can be quite sudden. In withdrawing, the cytoplasm sometimes leaves behind it a colorless and empty membrane. Fine hyaline projections called "bristle pseudopodia" (fig. 240, right) may remain extended from the membrane and some can be traced back to it. This seems to confirm the argument of Goodrich (1920) that the bristle type pseudopodium is a fold or thickening in the membrane and not a physiologically active part of the cell body.

Clots of blood cells are often observed in injured blood vessels and the connective tissue surrounding small arteries of the mantle, and can be produced by intercardiac injection of tissue extracts. Infiltration of connective tissue by amoebocytes and intravascular blood clots is usually found in watery green oysters from polluted water (fig. 241).

There is no true coagulation of the oyster blood. The coalescence and clot formation of blood cells outside of the body is the result of the entanglement of amoebocytes by the bristlelike pseudopodia or by the strands of hyaline ectoplasm (fig. 242).

The granules of live amoebocytes are usually yellowish-green, with the color much more pronounced in green oysters. The staining affinities of blood cells have been studied by several in-



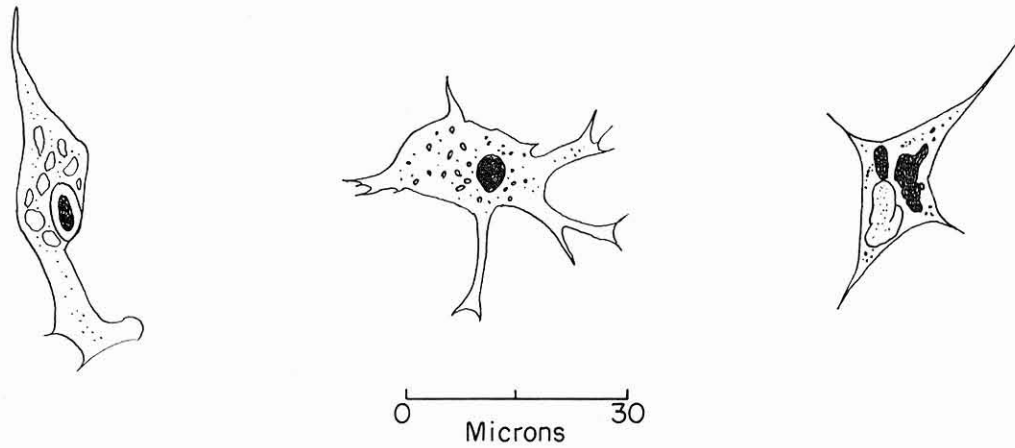

FIGURE 240.—Amoebocytes (granular cells) of *C. virginica* observed in vivo. Camera lucida drawings of live cells on glass.

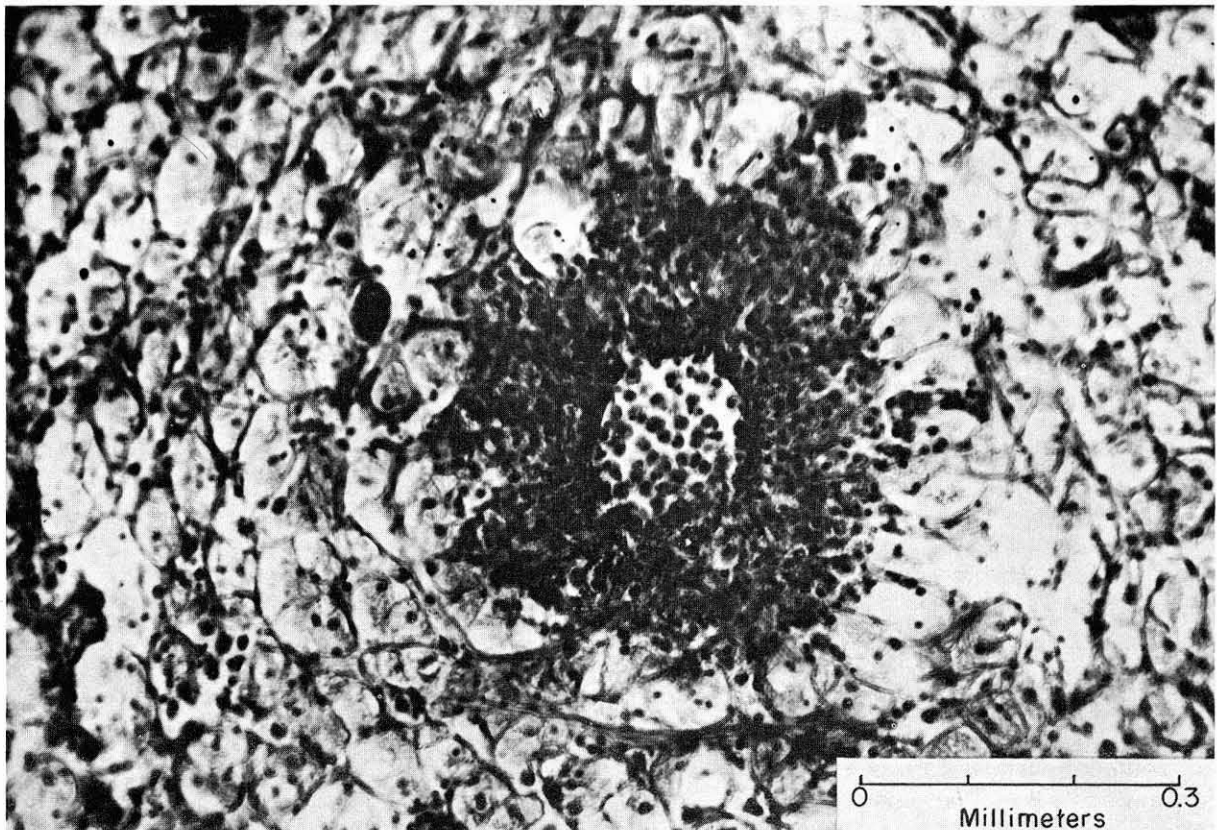

FIGURE 241.—Intervascular blood clot and infiltration of amoebocytes in the mantle of green *C. virginica*. Bouin, hematoxylin-eosin.

investigators with somewhat different results. Kollmann (1908) found that marine lamellibranchs have acidophilic granules, while those of fresh water mollusks are amphophilic. The granules of *O. edulis* (Takatsuki, 1934a) are neutrophilic with a tendency to become stained vitally by basic

dyes. The amoebocytes of *C. circumpecta* (Ohuye, 1938) have eosinophilic or amphophilic cytoplasm and basophilic granules. In a blood smear preparation of *C. virginica* examined in the Bureau's shellfish laboratory the granules stained reddish-purple to dark blue with polychrome

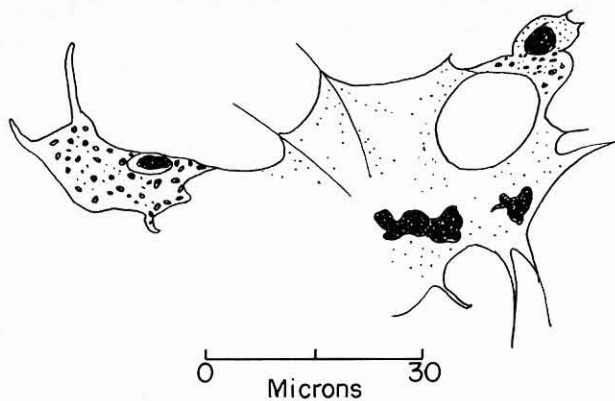

FIGURE 242.—Beginning of coalescence of blood cells of *C. virginica*. Camera lucida drawings of live preparations.

methylene blue mixture (Ramanovsky stain). Methylene blue alone stained the granules very poorly. In Ehrlich triacid stain a few granules were blue, indicating a neutrophilic reaction. In my preparations the blood cell granules never took up eosin, which is very acid stain.

The oval-shaped nuclei of the amoebocytes can be seen easily in a stained preparation. The nucleus is usually located slightly off the center of the cells in a pocket devoid of granules.

Some of the amoebocytes accumulate iron, copper, zinc, and manganese. The presence of heavy metals can be detected by treating the sectioned tissues with ammonium sulfide, which blackens the metals inside the cells (see: chapter XVII).

The following enzymes have been found in extracts of amoebocytes: amylase, glycogenase, lipase, protease, and a complete oxidase system (Yonge, 1926; Takatsuki, 1934a).

Phagocytic activity of amoebocytes is very pronounced. It can be demonstrated by injecting into the mantle or gill cavity various suspensions such as olive oil (stained with Sudan), carborundum, colloidal carbon, carmine, saccharated iron oxide, and cultures of diatoms or *Chlorella*. Some of the suspended particles may be picked up by the amoebocytes which are always present on the surface of the gills and the mantle. Ingestion of iron particles was observed in the Woods Hole laboratory by adding a suspension of iron saccharate to the shell liquor and treating the samples of tissues or smears with ferricyanide solution to produce Prussian blue reaction. Phagocytosis can also be observed in live amoebocytes placed in sea water on glass slides. Frequently under

this condition the amoebocyte approaching a bacterium reverses its movement and turns aside. The cause of this failure of phagocytosis has not been determined. According to Bang (1961), who described the phenomenon in *C. virginica*, it was impossible to assign the failure to a particular combination of bacteria and amoebocytes because repeated observations gave inconsistent results. He concluded that there was probably an undiscovered factor in phagocytosis in oyster blood which was responsible for this variation in behavior.

Tripp (1960) found that various species of living bacteria and yeast cell injected in the tissues of *C. virginica* were rapidly destroyed extracellularly and by phagocytes. Bacterial spores were removed from tissues at a much slower rate.

At the beginning of phagocytosis of a uni-flagellate bacterium, observed by Bang with the electron microscope (fig. 243), many filamentous pseudopods extend from the cell's surface and entangle the flagellum which is coiled around them while the bacterium remains outside the amoebocyte's body.

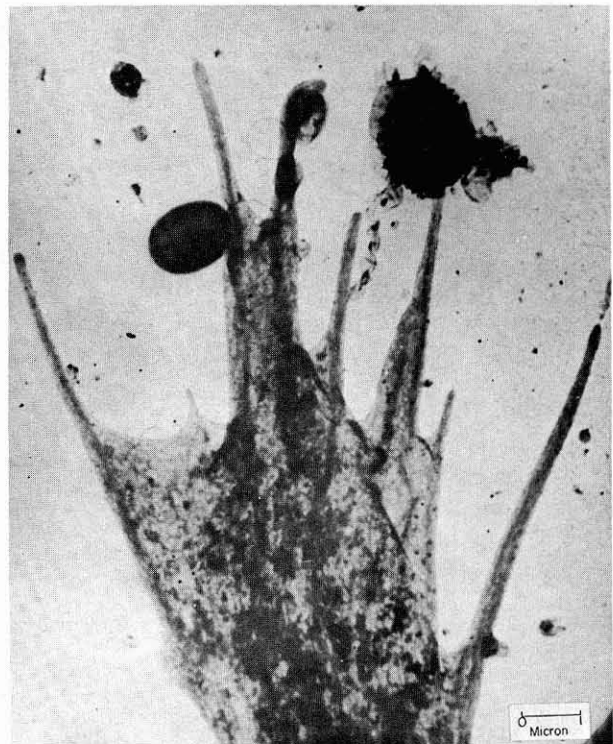

FIGURE 243.—Electron micrograph of a periphery of one amoebocyte which spread out on a collodion film and was fixed with osmium vapor. Courtesy of F. B. Bang.

## SPECIFIC GRAVITY OF BLOOD

The osmotic pressure of body fluids of bivalves is about equal to that of the surrounding water so it may be expected that the specific gravity of blood approximates that of the water. For determining the specific gravity of blood or of pericardial fluid, the falling drop method of Barbour and Hamilton (1926) has been used. The procedure consists of timing a drop of fluid of uniform size as it falls a distance of 30 cm. through a mixture of xylene and bromobenzene in a vertical glass tube of exactly 7.5 mm. in diameter. The time is recorded with a stopwatch accurate to one-tenth of a second. The speed of falling of a drop of the sample is compared with that of a drop of the same size of standard potassium sulfate ( $K_2SO_4$ ) solution of known density. By using an alignment chart (supplied with the instrument), correction is made for room temperature; the specific gravity of the sample can be calculated with an accuracy of 1 times  $10^{-4}$ . The source of error caused by variations in the size of drops is minimized by using an automatic Guthrie pipette controller. The method is simple, rapid, and gives consistent results. In this way the specific gravity of blood was determined for oysters taken from various environments.

A series of tests was also made to record changes that occurred in oysters placed in diluted sea water and in those exposed to air. The blood collected from the ventricle with a glass pipette was centrifuged for 20 minutes at 1,200 r.p.m. to separate blood cells from plasma. For brief storage the sample of plasma was kept in a paraffin coated container from which portions were taken for determination. Observations were made at the time of full sexual maturity of the oysters in the middle of July and were repeated 2 weeks later at the completion of spawning. All tests were made at 22° C. and salinity 31.0–31.5 ‰. The oysters were collected from Wellfleet Harbor, Mass., but remained in the laboratory tanks for about 3 weeks before the tests. The specific gravity of blood during the July 15 to 18 period varied from 1.0252 to 1.0262; in the tests made after spawning between July 28 and 31 the specific gravity of blood varied from 1.0258 to 1.0259. The results are close to those reported by Yazaki (1929) for *O. circumpecta* in which the specific gravity of blood in the summer specimens varied between 1.025 and 1.029.

No significant changes were found in the blood of oysters kept for 72 hours in the refrigerator at temperatures varying from 4.5° to 7.5° C. At the end of the test the specific gravity of the blood of the refrigerated mollusks was 1.0258; and in the controls which were kept in running sea water at 21° to 22° C. the blood was 1.0259.

A gradual decrease in specific gravity occurred in the oysters kept in running sea water of diminishing salinity. The results of this experiment are shown in table 31.

In highly diluted water shell movements of some of the oysters were abnormal and most of the time they remained closed. In these oysters the specific gravity of the blood after 72 hours of exposure to salinity of 9 to 12 ‰ was relatively high (1.0138 and 1.0178) compared to the specific gravity of 1.0092 in the oysters which stayed open for more than 50 percent of the total time. It may be deduced from these experiments that the oysters kept in water in which the salinity was reduced from 31–32 ‰ to 16.7–17.7 ‰ attained the osmotic equilibrium of blood in about 120 hours.

TABLE 31.—Decrease in the specific gravity of cell-free blood of the oyster, *C. virginica*, in water of lowered salinity

Salinity (‰)	Time			
	24 hours	48 hours	72 hours	120 hours
31–32, control.....	1.0259	1.0259	1.0259	1.0259
16.7–17.7.....	1.0145	1.0143	1.0143	1.0127
9–12.....	1.0199	1.0103	1.0092	(*)

\*Observations discontinued after 72 hours.

## SEROLOGY

Serological reactions between several mollusks were studied by Makino (1934), who experimented with the following species: bivalves—*Meretrix meretrix*, *Paphia philipinarum*, *Ostrea (Crassostrea) gigas*, *Arca inflata*; gastropods—*Turbo cernutum*, *Haliotis gigantea*, *Rapana thomasi*; cephalopods—*Sepiella japonica* and *Polypus variabilis*. In these tests the extracts of tissues in physiological saline solution were injected intraperitoneally or subcutaneously into rabbits to obtain the antisera. Injections were repeated for 7 days using doses which increased from 0.5 to 5 grams. One ml. of extract and 0.1 ml. of antiserum were used in performing precipitation tests, and the tube was set aside for 1 hour at 37° C. Positive reaction was obtained with all the species. *Ostrea* antiserum reacted very strongly with *Meretrix* and *Paphia* and less strongly with

*Turbo*, *Haliotis*, and *Rapana*. It is interesting to note that *Arca*, which belongs to the phylogenetically low order of Protobranchia, reacted very strongly not only with *Meretrix* and *Ostrea*, but also with the gastropods *Turbo*, *Haliotis*, and *Rapana*.

Wilhelmi (1944) applied the precipitation reaction to the problem of determining the relationship of the mollusca to other invertebrates. Using a technique similar to that employed by Makino, he made tests between two species of *Busycon*, *Pecten irradians*, *Nereis*, *Limulus*, and *Asterias forbesi* and concluded that, serologically, mollusca are more closely related to annelids than to any other group. At present this work has historical interest only, since it is obvious that no broad speculations about the relationship of various phyla should be made on the basis of a few tests made with only six species belonging to four different phyla.

The existence of serological differences in five bivalves (*Anadara inflata*, *A. lareu*, *Pecten yessoensis*, *Ostrea (Crassostrea) yessoensis*, and *O. circumpecta*) was demonstrated by Tomita and Koizumi (1951). In this work the serum was obtained by centrifuging the blood withdrawn from the auricles of the mollusk. Antisera were obtained by injecting rabbits with increased doses, starting with 1 ml. and adding 1 ml. each time until 5 ml. were given on the 5th day. Blood was taken on the 9th day after the last injection. In homologous precipitation tests with *C. gigas*, i.e. using the antiserum against the antigen of the same species, positive reaction occurred in 1:16 dilution of antiserum with 1:1280 dilution of antigen.

Finer differences between closely related species were detected by absorption tests. When a cross reaction is obtained in a test of an antiserum of one species against the serum of a related organism, it is assumed that the second organism possesses a chemical substance common with the homologous substances of the first one. If after the absorption the serum still reacts with homologous substance, it is considered that the antiserum contained antibodies to two or more chemical components including the one which is common to both. Using this method Tomita and Koizumi found that absorption with *C. gigas* antigen removed from *C. circumpecta* serum all antibodies for *gigas* but not for *circumpecta*. In another test *circumpecta* removed from *gigas* antiserum all anti-

bodies for *circumpecta* but not for *gigas*. The authors' interpretation is that there are some common antigens between *C. gigas* and *C. circumpecta* but that each also has its own specific antigen. The investigators also found that *Anadara (Arca)* has all the antigens possessed by *C. gigas* plus its own specific antigen. This is in accord with the generally accepted view that *Anadara (Arca)* is a phylogenetically primitive form. Fresh-water *Anodonta* showed no affinities with any other species tested in this work.

The application of absorption technique enabled Numachi (1962) to show that the four local races of *C. gigas*—Hokkaido, Miyagi, Hiroshima, and Kumamoto—have some antigenic differences that are in accord with their geographic isolation.

Application of serological tests is a very promising method for studies of racial differences among oysters. At present it is not known whether the observed antigenic differences are hereditary characteristics or are caused by differences in local environment and particularly in the diet of oysters from different localities.

## BIBLIOGRAPHY

- BANG, FREDERIK B.  
1961. Reaction to injury in the oyster (*Crassostrea virginica*). Biological Bulletin, vol. 121, No. 1, pp. 57-68.
- BARBOUR, HENRY G., and WILLIAM F. HAMILTON.  
1926. The falling drop method for determining specific gravity. Journal of Biological Chemistry, vol. 69, No. 2, pp. 625-640.
- BARNES, T. CUNLIFFE.  
1937. Textbook of general physiology. P. Blakiston's Son and Company, Inc., Philadelphia, Pa., 554 pp.
- BĚLEHRÁDEK, J.  
1930. Temperature coefficients in biology. Biological Reviews and Biological Proceedings of the Cambridge Philosophical Society, vol. 5, No. 1, pp. 30-58.  
1935. Temperature and living matter. Protoplasma-Monographien, vol. 8. Gebrüder Borntraeger, Berlin, 277 pp.
- BERTHE, JEANNE, and CAMILLE PETITFRÈRE.  
1934a. L'automatisme cardiaque chez l'*Anodonte*. Annales de Physiologie et de Physicochimie Biologique, tome 10, pp. 975-977.  
1934b. L'automatisme cardiaque chez l'*Anodonte*. Archives Internationales de Physiologie, vol. 39, pp. 98-111.
- BREDER, C. M., JR., and R. F. NIGRELLI.  
1933. Lamellibranch leucocytes as living material for classroom demonstration. Science, vol. 78, No. 2015, p. 128.

- CARLSON, A. J.  
 1903. The response of the hearts of certain molluscs, decapods and tunicates to electrical stimulation. (Preliminary communication). *Science*, vol. 17, No. 431, pp. 548-550.  
 1905a. The rhythm produced in the resting heart of molluscs by the stimulation of the cardio-accelerator nerves. *American Journal of Physiology*, vol. 12, No. 1, pp. 55-66.  
 1905b. Comparative physiology of the invertebrate heart. II. The function of the cardiac nerves in molluscs. *American Journal of Physiology*, vol. 13, No. 5, pp. 396-426.  
 1905c. Comparative physiology of the invertebrate heart. *Biological Bulletin*, vol. 8, No. 3, pp. 123-168.  
 1905d. Comparative physiology of the invertebrate heart. Part III. Physiology of the cardiac nerves in molluscs (continued). *American Journal of Physiology*, vol. 14, No. 1, pp. 16-53.  
 1906a. Comparative physiology of the invertebrate heart. V. The heart rhythm under normal and experimental conditions. *American Journal of Physiology*, vol. 16, No. 1, pp. 47-66.  
 1906b. Comparative physiology of the invertebrate heart. VI. The excitability of the heart during the different phases of the heart beat. *American Journal of Physiology*, vol. 16, No. 1, pp. 67-84.  
 1906c. Comparative physiology of the invertebrate heart. VII. The relation between the intensity of the stimulus and the magnitude of the contraction. *American Journal of Physiology*, vol. 16, No. 1, pp. 85-99.  
 1906d. Comparative physiology of the invertebrate heart. VIII. The inhibitory effects of the single induced shock. *American Journal of Physiology*, vol. 16, No. 1, pp. 100-109.  
 1907. Comparative physiology of the invertebrate heart. IX. The nature of the inhibition on direct stimulation with the tetanizing current. *Zeitschrift für allgemeine Physiologie*, Band 6, pp. 287-314.  
 1909. Vergleichende Physiologie der Herznerven und der Herzganglien bei den Wirbellosen. *Ergebnisse der Physiologie*, Achter Jahrgang, pp. 371-462.
- CROZIER, WILLIAM J., and HUDSON HOAGLAND.  
 1934. The study of living organisms. In C. A. Murchison (editor). *A handbook of general experimental psychology*, ch. 1, pp. 3-108. Clark University Press, Worcester, Mass.
- DEBOER, S.  
 1929. Vergleichende Physiologie des Herzens von Evertbraten. 4. Erregungsleitung des Herzens bei Lamellibranchiaten. *Zeitschrift für vergleichende Physiologie*, Band 9, pp. 67-73.
- DIEDERICH, WALDEMAR.  
 1935. Beiträge zur Physiologie des Muschelherzens. *Zoologische Jahrbücher, Abteilung für allgemeine Zoologie und Physiologie der Tiere*, Band 55, pp. 231-280.
- DOGIEL, JOH.  
 1877. Die Muskeln und Nerven des Herzens bei einigen Mollusken. *Archiv für mikroskopische Anatomie*, Band 14, pp. 59-65.
- DREW, G. H.  
 1910. Some points in the physiology of lamellibranch blood-corpuscles. *Quarterly Journal of Microscopical Science*, vol. 54, No. 216, pp. 605-621.
- DUBUISSON, M.  
 1933. L'état actuel de nos connaissances sur la physiologie du muscle cardiaque des invertébrés. Les problèmes biologiques. Collection de monographies publiées sous le patronage du Comité Technique des Sciences Naturelles des Presses Universitaires de France. Les Presses Universitaires de France, Paris, 130 pp.
- EBLE, ALBERT F.  
 1958. Some observations on blood circulation in the oyster, *Crassostrea virginica*. *Proceedings of the National Shellfisheries Association*, vol. 48, August 1957, pp. 148-151.
- EIGER, M.  
 1913. Die physiologischen Grundlagen der Elektrokardiographie. *Pflüger's Archiv für die gesamte Physiologie des Menschen und der Tiere*, Band 151, pp. 1-51.
- ELSEY, C. R.  
 1935. On the structure and function of the mantle and gill of *Ostrea gigas* (Thunberg) and *Ostrea lurida* (Carpenter). *Transactions of the Royal Society of Canada, third series, sec. 5, Biological Sciences*, Vol. 29, pp. 131-160.
- ESSER, W.  
 1934. Recherches sur la structure des fibres musculaires cardiaques et sur l'innervation intrinsèque du coeur de l'*Anodonte*. *Archives de Biologie*, tome 45, pp. 337-390.
- FEDERIGHI, H.  
 1929. Temperature characteristics for the frequency of heart beat in *Ostrea virginica* Gmelin. *Journal of Experimental Zoology*, vol. 54, No. 1, pp. 89-194.
- FRANC, ANDRÉ.  
 1960. Classe des bivalves. In Pierre-P. Grassé (editor), *Traité de Zoologie, Anatomie, Systématique, Biologie*, tome V, fascicule 2, pp. 1845-2133. Masson et Cie, Paris.
- FREDERICQ, HENRI.  
 1947. Les nerfs cardio-régulateurs des invertébrés et la théorie des médiateurs chimiques. *Biological Reviews and Biological Proceedings of the Cambridge Philosophical Society*, vol. 22, No. 4, pp. 297-314.
- GARTKIEWICZ, ST.  
 1926. Contributions a la caractéristique du "sommeil" des Lamellibranches (suite). Rythme cardiaque et mouvements de l'*Epithelium Ciliaire*. *Archives Internationales de Physiologie*, vol. 26, pp. 229-236.
- GOODRICH, EDWIN S.  
 1920. The pseudopodia of the leucocytes of invertebrates. *Quarterly Journal of Microscopical Science*, vol. 64, No. 253, pp. 19-26.

- GREENBERG, MICHAEL J., and DONALD A. WINDSOR.  
1962. Action of acetylcholine on bivalve hearts. *Science*, vol. 137, No. 3529, pp. 534-535.
- HOPKINS, A. E.  
1934. Accessory hearts in the oyster. *Science*, vol. 80, No. 2079, pp. 411-412.  
1936. Pulsation of blood vessels in oysters, *Ostrea lurida* and *O. gigas*. *Biological Bulletin*, vol. 70, No. 3, pp. 413-425.
- IRISAWA, HIROSHI, MAKOTA KOBAYASHI, and TOKIKO MATSUBAYASHI.  
1961. Action potentials of oyster myocardium. *Japanese Journal of Physiology*, vol. 11, No. 2, pp. 162-168.
- JULLIEN, A.  
1931. Action du calcium et du magnésium sur le coeur de l'huître. Antagonisme du potassium et des alcalino-terreux. *Comptes Rendus Hebdomadaires des Séances et Mémoires de la Société de Biologie et de ses Filiales*, tome 108, pp. 77-79.  
1935a. Modifications immédiates de l'activité cardiaque provoquées par le changement des solutions salines chez l'huître. *Comptes Rendus Hebdomadaires des Séances et Mémoires de la Société de Biologie et de ses Filiales et Associées*, tome 118, pp. 1449-1451.  
1935b. La distension des cavités cardiaques appliquée a la détermination de leur structure chez l'huître. *Comptes Rendus Hebdomadaires des Séances et Mémoires de la Société de Biologie et de ses Filiales et Associées*, tome 119, pp. 605-607.  
1935c. Action de l'atropine et de l'acétylcholine sur le coeur de l'huître et, plus généralement, action de ces deux substances sur le coeur des mollusques. *Comptes Rendus Hebdomadaires des Séances et Mémoires de la Société de Biologie et de ses Filiales et Associées*, tome 119, pp. 603-605.  
1935d. Action de l'adrénaline et de la Pelletièreine sur le coeur de l'huître. *Comptes Rendus Hebdomadaires des Séances et Mémoires de la Société de Biologie et de ses Filiales et Associées*, tome 120, pp. 211-213.  
1936a. Effects chronotropes, inotropes et tonotropes de la cicutine, du curare, de la véraltrine et de la digitaline sur le coeur de l'huître. *Comptes Rendus Hebdomadaires des Séances et Mémoires de la Société de Biologie et de ses Filiales et Associées*, tome 121, pp. 1002-1004.  
1936b. Contribution a l'étude de l'automatisme cardiaque chez les mollusques. Nouvelles recherches sur l'action des ions Ca, Mg, K et Na chez l'huître. *Journal de Physiologie et de Pathologie Générale*, tome 34, pp. 757-773.  
1936c. De l'action de certains poisons sur le coeur de l'huître et des mollusques en général. *Journal de Physiologie et de Pathologie Générale*, tome 34, pp. 774-789.
- JULLIEN, A., and G. MORIN.  
1930. De l'automatisme du ventricule de l'huître en fonction de la concentration moléculaire et du rapport des ions alcalins aux alcalino-terreux. *Comptes Rendus Hebdomadaires des Séances et Mémoires de la Société de Biologie et de ses Filiales*, tome 103, pp. 1132-1134.  
1931a. Observations sur l'automatisme du coeur isolé et des lambeaux cardiaques chez l'huître. *Comptes Rendus Hebdomadaires des Séances et Mémoires de la Société de Biologie et de ses Filiales*, tome 108, pp. 1242-1244.  
1931b. Influence des ions alcalins et alcalino-terreux sur l'automatisme du coeur de l'huître, action spécifique du potassium. *Journal de Physiologie et de Pathologie Générale*, tome 29, pp. 446-461.
- JULLIEN, A., and D. VINCENT.  
1938. Sur l'action de l'acétylcholine sur le coeur des mollusques. L'antagonisme curare-acétylcholine. *Comptes Rendus Hebdomadaires des Séances de l'Académie des Sciences*, tome 206, pp. 209-211.
- JULLIEN, A., D. VINCENT, M. BOUCHET, and M. VUILLET.  
1938. Observations sur l'acétylcholine et la cholinestérase du coeur des mollusques. *Annales de Physiologie et de Physicochimie Biologique*, tome 14, pp. 567-574.
- JULLIEN, A., D. VINCENT, M. VUILLET, and M. BOUCHET.  
1939. Contribution a l'étude de l'automatisme cardiaque chez les mollusques. Action de mimétiques et de drogues sur le coeur d'*Helix pomatia*. *Journal de Physiologie et de Pathologie Générale*, tome 37, pp. 562-572.
- KELLOGG, JAMES L.  
1892. A contribution to our knowledge of the morphology of lamellibranchiate mollusks. *Bulletin of the U.S. Fish Commission*, vol. 10, for 1890, pp. 389-436.
- KOEHRING, VERA.  
1937. The rate of heart beat in clams. *Bulletin of the Mount Desert Island Biological Laboratory*, 1937, Thirty-ninth season. Salsbury Cove, Maine, pp. 25-26.
- KOLLMANN, MAX.  
1908. Recherches sur les leucocytes et les tissu lymphoïde des invertébrés. *Annales des Sciences Naturelles, Zoologie*, série 9, tome 8, pp. 1-240.
- KRIJGSMAN, B. J., and G. A. DIVARIS.  
1955. Contractile and pacemaker mechanisms of the heart of molluscs. *Biological Reviews of the Cambridge Philosophical Society*, vol. 30, No. 1, pp. 1-39.
- MAKINO, KATASHI.  
1934. Beobachtungen über die Immunitätsreaktionen bei Molluskenarten. *Zeitschrift für Immunitätsforschung und experimentelle Therapie*, Band 81, pp. 316-335.
- MOTLEY, HURLEY LEE.  
1933. Histology of the fresh-water mussel heart with reference to its physiological reactions. *Journal of Morphology*, vol. 54, No. 2, pp. 415-427.

- NAVEZ, ALBERT E.  
1936. Observations sur le Rythme cardiaque d'*Anomia simplex* (D'Orbigny) (Lamellibranchiae). Mémoires du Musée Royal d'Histoire Naturelle de Belgique, série 2, fascicule 3, pp. 701-737.
- NUMACHI, KEN-ICHI.  
1962. Serological studies of species and races in oysters. American Naturalist, vol. 96, No. 889, pp. 211-217.
- OHUYE, TOSHIO.  
1938. On the coelomic corpuscles in the body fluid of some invertebrates. X. Some morphological and histological properties of the granulocytes of various invertebrates. Science Reports of the Tôhoku Imperial University, series 4, Biology, vol. 12, No. 4, pp. 593-622.
- OKA, KÔZÔ.  
1932. On the cardiac nerves in the oyster, *Ostrea circumpecta* Pils. Science Reports of the Tôhoku Imperial University, series 4, Biology, vol. 7, No. 1, pp. 133-143.
- OTIS, ARTHUR B.  
1942. Effects of certain drugs and ions on the oyster heart. Physiological Zoölogy, vol. 15, No. 4, pp. 418-435.
- PILGRIM, R. L. C.  
1953. Osmotic relations in molluscan contractile tissues. I. Isolated ventricle-strip preparations from lamellibranchs (*Mytilus edulis* L., *Ostrea edulis* L., *Anodonta cygnea* L.). Journal of Experimental Biology, vol. 30, No. 3, pp. 297-317.  
1954. The action of acetylcholine on the hearts of lamellibranch molluscs. Journal of Physiology, vol. 125, No. 1, pp. 208-214.
- PROSSER, C. LADD.  
1940. Acetylcholine and nervous inhibition in the heart of *Venus mercenaria*. Biological Bulletin, vol. 78, No. 1, pp. 92-102.  
1942. An analysis of the action of acetylcholine on hearts, particularly in arthropods. Biological Bulletin, vol. 83, No. 2, pp. 145-164.
- PROSSER, C. LADD (editor).  
1950. Comparative animal physiology. W. B. Saunders Company, Philadelphia, Pa., 888 pp.
- PROSSER, C. LADD, and HAZEL B. PROSSER.  
1938. The action of acetylcholine and of inhibitory nerves upon the heart of *Venus*. Anatomical Record, vol. 70, suppl. 1, p. 112.
- RAWITZ, BERNHARD.  
1888. Der Mantelrand der Acephalen. Erster Teil, Ostreaacea. Jenaische Zeitschrift für Naturwissenschaft, Neue Folge, Band 15, pp. 415-556.
- SKRAMLIK, EMIL V.  
1929. Über den Kreislauf bei den Weichtieren. Pflüger's Archiv für die gesamte Physiologie des Menschen und der Tiere, Band 221, pp. 503-507.
- STAUBER, LESLIE A.  
1940. Relation of valve closure to heart beat in the American oyster. National Shellfisheries Association, 1940 Convention Papers, 2 pp.
- SUZUKI, SENJI.  
1934a. On the distribution of ganglion cells in the heart of the oyster. Science Reports of the Tôhoku Imperial University, series 4, Biology, vol. 8, No. 4, pp. 335-344.  
1934b. On the ganglion cells in the heart of the pearl oyster: *Pinctada martensi* Dunker. Science Reports of the Tôhoku Imperial University, series 4, Biology, vol. 9, No. 2 and 3, pp. 111-115.
- TAKATSUKI, SHUN-ICHI.  
1927. Physiological studies on the rhythmical heart pulsation in the oyster, *Ostrea circumpecta* Pils. Science Reports of the Tôhoku Imperial University, series 4, Biology, vol. 2, No. 3, pp. 301-324.  
1929. The heart pulsation of oysters in tropical seas compared with that of those living in seas of the temperate zone. Records of Oceanographic Works in Japan, vol. 1, No. 3, pp. 102-112.  
1933. Contributions to the physiology of the heart of oyster. IV. The action of adrenaline on the isolated heart of oyster. Science Reports of the Tôhoku Imperial University, series 4, Biology, vol. 8, No. 1, pp. 21-29.  
1934a. On the nature and functions of the amoebocytes of *Ostrea edulis*. Quarterly Journal of Microscopical Science, vol. 76, No. 303, pp. 379-431.  
1934b. Beiträge zur Physiologie des Austerherzens. V. Über den Bau des Herzens unter besonderer Berücksichtigung seiner physiologischen Reaktionen. Science Reports of the Tokyo Bunrika Daigaku, sec. B, vol. 2, No. 31, pp. 55-62.
- TAYLOR, IVON R., and EDWARD M. WALZL.  
1941. The effect of direct current stimulation on the electrical and mechanical behavior of the heart of the oyster (*Ostrea virginica*). Journal of Cellular and Comparative Physiology, vol. 18, No. 2, pp. 278-281.
- TEN CATE, J.  
1923a. Contributions à la physiologie du coeur de l'*Anodonte*. II. La contraction du ventricule du coeur d'*Anodonte* isolé. Archives Néerlandaises de Physiologie de l'Homme et des Animaux, tome 8, pp. 187-195.  
1923b. Contributions à la physiologie du coeur de l'*Anodonte*. III. L'action des contractions ventriculaires sur l'intestin terminal. Archives Néerlandaises de Physiologie de l'Homme et des Animaux-tome 8, pp. 196-201.  
1923c. Contributions à la physiologie et à la pharmacologie du coeur d'*Anodonte*. Archives Néerlandaises de Physiologie de l'Homme et des Animaux, tome 8, pp. 43-84.  
1929. Beiträge zur Physiologie des Muschelherzens. Zeitschrift für vergleichende Physiologie, Band 10, pp. 309-316.
- TOMITA, GUNJI, and SADA AKI KOIZUMI.  
1951. Tests on serological differences in some bivalves. Science Reports of the Tôhoku University, series 4, Biology, vol. 19, No. 1, pp. 113-117.

TRIPP, M. R.

1960. Mechanism of removal of injected microorganisms from the American oyster, *Crassostrea virginica* (Gmelin). *Biological Bulletin*, vol. 119, No. 2, pp. 273-282.

WAIT, ROBERT B.

1943. The action of acetylcholine on the isolated heart of *Venus mercenaria*. *Biological Bulletin*, vol. 85, No. 1, pp. 79-85.

WILHELMI, RAYMOND W.

1944. Serological relationships between the Mollusca and other invertebrates. *Biological Bulletin*, vol. 87, No. 1, pp. 96-105.

YAZAKI, MASAYASU.

1929. On some physico-chemical properties of the pericardial fluid and of the blood of the Japanese oyster, *Ostrea circumpicta* Pils., with reference to the change of milieu extérieur. *Science Reports of the Tôhoku Imperial University, series 4, Biology*, vol. 4, No. 1, fasc. 2, pp. 285-314.

1934. On the osmoregulation of the blood of several marine and fresh water molluscs: I. The Japanese oyster, *Ostrea circumpicta* Pils. *Proceedings of the Fifth Pacific Science Congress*, vol. 5, pp. 4102-4110.

YONGE, C. M.

1926. Structure and physiology of the organs of feeding and digestion in *Ostrea edulis*. *Journal of the Marine Biological Association of the United Kingdom*, vol. 14, No. 2, pp. 295-386.