

Building America Best Practices Series: Volume 1

Builders and Buyers Handbook for Improving New Home Efficiency, Comfort, and Durability in the Hot and Humid Climate



By

Michael C. Baechler

Pacific Northwest National Laboratory

Pat M. Love

Oak Ridge National Laboratory



NOTICE

This report was prepared as an account of work sponsored by an agency of the United States government. Neither the United States government nor any agency thereof, nor any of their employees, makes any warranty, express or implied, or assumes any legal liability or responsibility for the accuracy, completeness, or usefulness of any information, apparatus, product, or process disclosed, or represents that its use would not infringe privately owned rights. Reference herein to any specific commercial product, process, or service by trade name, trademark, manufacturer, or otherwise does not necessarily constitute or imply its endorsement, recommendation, or favoring by the United States government or any agency thereof. The views and opinions of authors expressed herein do not necessarily state or reflect those of the United States government or any agency thereof.

Available electronically at <http://www.osti.gov/bridge>

Available for a processing fee to U.S. Department of Energy
and its contractors, in paper, from:

U.S. Department of Energy
Office of Scientific and Technical Information
P.O. Box 62
Oak Ridge, TN 37831-0062
phone: 865.576.8401
fax: 865.576.5728
email: <mailto:reports@adonis.osti.gov>

Available for sale to the public, in paper, from:

U.S. Department of Commerce
National Technical Information Service
5285 Port Royal Road
Springfield, VA 22161
phone: 800.553.6847
fax: 703.605.6900
email: orders@ntis.fedworld.gov
online ordering: <http://www.ntis.gov/ordering.htm>



CONTENTS

Introduction	INT-1
Homeowners	HOM-1
Quick Tips: Homeowners	HOM-1
You're in Good Company	HOM-1
How Quality Houses Perform	HOM-2
An Energy-Efficient Home Will Cost You Less	HOM-3
Energy-Efficient Mortgages Can Help You Get More for Your Money	HOM-3
What's the Score? (HERS)	HOM-4
Guaranteed Energy Costs and Comfort	HOM-5
And There's More - More Green for You and More Green for the Planet	HOM-5
What to Look For	HOM-6
Sources and Additional Information	HOM-6
Homebuyer's Checklist	HOM-7
Managers	MNG-1
An Invitation to Building Company Managers	MNG-1
Building America	MNG-1
Quick Tips: Managers	MNG-1
The Business Case for Building Science and Energy Efficiency	MNG-2
Properly Choosing Materials and Equipment	MNG-2
Reduced Risks, Increased Productivity, and Fewer Callbacks	MNG-3
From an Economic Standpoint, Everyone Wins	MNG-3
Customer Satisfaction and Referrals	MNG-3
Consumers Expect More	MNG-4
Competitive Advantage in the Marketplace	MNG-4
Take the Next Step	MNG-5
Case Studies	MNG-5
Sources and Additional Information	MNG-5
Marketers	MKT-1
ENERGY STAR Qualified Homes: Telling Your Story	MKT-1
Quick Tips: Marketers	MKT-1
Increase Customer Satisfaction and Let Your Customers Sell Your Product	MKT-2
Sell the Value that Home Buyers Expect	MKT-2
How Industry Leaders Sell Energy-Efficient Homes	MKT-2
Sources and Additional Information	MKT-4

INTRODUCTION

Taking action in your community



HOMEOWNERS

Shopping for value, comfort, and quality



MANAGERS

Putting building science to work for your bottom line



MARKETERS

Energy efficiency delivers the value that customers demand



SITE PLANNERS & DEVELOPERS

Properly situated houses pay big dividends



DESIGNERS

Well-crafted designs capture benefits for builders, buyers, and business



SITE SUPERVISORS

Tools to help with project management



TRADES & CRAFTS

Professional tips for fast and easy installation

CASE STUDIES

Bringing it all together

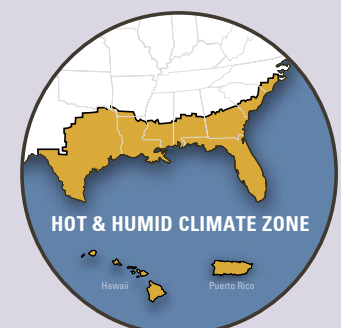

CONTENTS

Site Planners	PLN-1
Lot Orientation	PLN-1
Quick Tips: Site Planners	PLN-1
Shade Trees	PLN-3
Other Steps	PLN-4
Sources and Additional Information	PLN-6
Designers	DES-1
Quick Tips: Designers	DES-1
Building Science and the Systems Approach	DES-1
The Cost of Doing Business	DES-3
Heat and Humidity	DES-5
Hot and Humid Climate Design Best Practices	DES-5
Site - Drainage, Pest Control, and Landscaping	DES-5
Foundation Measures	DES-6
Structural Moisture Control	DES-8
Structural Air Sealing	DES-12
Structural Thermal Performance	DES-13
Heating, Ventilating, and Air Conditioning	DES-19
Mechanicals Management and Appliances	DES-28
Sources and Additional Information	DES-30
Site Supervisors	SUP-1
Managing Expectations	SUP-2
Develop a Work Plan	SUP-2
Plans - Get Them Right	SUP-2
Plans - Keep Them Right	SUP-2
Contracts - Write Them Down	SUP-3
Pre-Construction Meeting - Have One	SUP-3
Permits - Grease the Skids	SUP-4
Managing Execution	SUP-4
Training	SUP-4
Scheduling	SUP-5
Quality Assurance	SUP-6
Spot-Check Inspection Checklist	SUP-7
Pre-Drywall Inspection Checklist	SUP-8
Pre-Occupancy Inspection Checklist	SUP-9

CONTENTS

Trades & Crafts	TRD-1
Slabs	TRD-2
Housewrap	TRD-3
Window Flashing	TRD-4
Air Sealing - Plumbing	TRD-6
Electrical Air Sealing	TRD-7
Air Sealing Drywall	TRD-8
Air Sealing Glossary	TRD-9
Fiberglass Insulation	TRD-10
Masonry Construction	TRD-11
Radiant Barriers	TRD-12
Duct Sealing	TRD-13
Case Study: Habitat for Humanity	CASE A-1
Case Study: Atlantic Design & Construction	CASE B-1
Case Study: GW Robinson	CASE C-1
Case Study: Medallion Homes	CASE D-1
Appendix I: Homebuyer's Checklist	APPENDIX I-1
Appendix II: Energy & Housing Glossary	APPENDIX II-1
Appendix III: Code Official Tear-Outs	APPENDIX III-1

WELCOME

Taking action in your community

This best practices guide is the first of a series produced by Building America. The guide book is a resource to help builders large and small build high-quality, energy-efficient homes that achieve 30% energy savings in space conditioning and water heating in the hot and humid climate. The savings are in comparison with the 1993 *Model Energy Code*. The guide contains chapters for every member of the builder's team—from the manager to the site planner to the designers, site supervisors, the trades, and marketers. There is also a chapter for homeowners on how to use the book to provide help in selecting a new home or builder.

- **Homeowners** will find how energy-efficient homes package value, comfort, economy, durability, and performance. This chapter is a great introduction to energy-efficient home technologies and provides helpful checklists of what to look for when home shopping.
- **Managers** will learn why building energy-efficient homes makes business sense. They will find out how much consumers value energy efficiency and the quality that comes with it, and how their company can gain market advantage by building energy-efficient homes.
- **Marketers** will learn about great resources for selling energy-efficient homes, including getting plugged into the ENERGY STAR nationally recognized branding program.
- **Site Planners** will discover the huge impact building orientation, landscaping, and shading can have on energy costs, plus learn tips on moisture management and pest control.
- **Designers** will learn about the systems approach to home design backed up by building science. They will get guidance on key building components for designing energy-efficient homes.
- **Site Supervisors** will get guidance on contract specifications, tips on scheduling and training, and handy checklists for quality assurance and commissioning inspections.
- **Trades** will find step-by-step, easy-to-follow illustrated instructions for adding key energy efficiency technologies.

The last chapter has case studies showing real-life examples of builders who are designing and constructing energy-efficient houses in the hot and humid climate zone.

We designed this guidebook to be taken apart, passed around, and updated. Give the sections of the book to the right people in your organization. Pass on pieces to subcontractors to help them understand your objectives. Copy it as needed.

This first series of guides helps builders understand and implement the Building America process to reach 30% energy savings in space heating and cooling and water heating. Future guides will aim at even higher levels of efficiency based on the latest Building America research, giving builders the knowledge they need to build even more efficient and durable houses.

The practices in this book are intended for the hot and humid climate zone. Handbooks covering other climate regions will soon be available.

INTRODUCTION

Taking action in your community



HOMEOWNERS

Shopping for value, comfort, and quality



MANAGERS

Putting building science to work for your bottom line



MARKETERS

Energy efficiency delivers the value that customers demand



SITE PLANNERS & DEVELOPERS

Properly situated houses pay big dividends



DESIGNERS

Well-crafted designs capture benefits for builders, buyers, and business



SITE SUPERVISORS

Tools to help with project management



TRADES & CRAFTS

Professional tips for fast and easy installation

CASE STUDIES

Bringing it all together

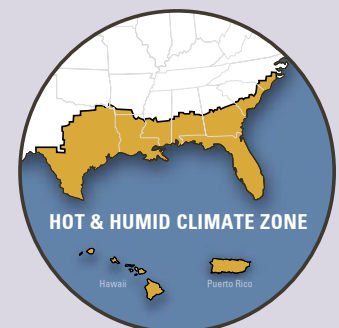

INTRODUCTION

Many builders choose to try out Building America ideas in a prototype house. After building one or a few prototypes they decide what features they will carry forward into their regular construction. This chart shows a process for working with a HERS rating professional, an engineer, or an architect to build this first house and on an ongoing basis. The person offering guidance could also be an internal designer who has become familiar with this document or has taken other Building America training. An educated staff will be the best means of selecting building science support.



**Icons correspond with chapters and company capabilities*

Building America welcomes reader feedback on this first volume of the *Best Practices Series*. Please submit your comments via e-mail to: Michael Baechler (michael.baechler@pnl.gov) or Pat Love (lovepm@ornl.gov).

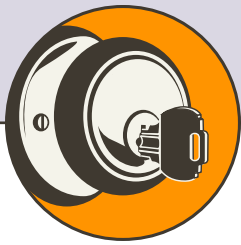

HOMEOWNERS

Shopping for value, comfort, and quality

Comfort. Economy. Durability. Performance. Some homes force you to choose. Energy-efficient homes deliver it all. And as a homebuyer, you deserve, and should demand, the whole package.

One way to know you have found an energy-efficient home is to look for the ENERGY STAR® label. ENERGY STAR has taken much of the guesswork out of buying new homes and other products. ENERGY STAR-qualified new homes are built to strict energy-efficiency guidelines using proven technologies and construction practices. Your builder also may have incorporated other building features that go beyond ENERGY STAR criteria for even more energy savings, and for greater health and comfort.

ENERGY STAR features should be included in all houses from lower cost starters to high-end customs. This chapter gives you an introduction to the technology that makes these houses work, how much they cost, how to pay for them, and a checklist of what to look for in new homes. The features described here are specifically designed for the hot and humid climate found in the Southeastern United States.

You're in Good Company

The companies that build ENERGY STAR homes are among the best and largest in the nation. Over 2,000 builders work with ENERGY STAR in the United States. And about 50% of the largest 100 builders in the nation have at least one division building ENERGY STAR qualified homes. Thousands of small companies also build ENERGY STAR homes. And many of these companies are working with Building America.

QUICK TIPS | HOMEOWNERS

- Look for the ENERGY STAR label for government-endorsed proof that a home is energy efficient.
- Learn why an energy-efficient home is usually a higher quality home all the way around.
- Use the enclosed checklist to shop for energy-efficient homes.
- Use the nationally recognized HERS rating to know just how efficient the homes you are considering really are.
- Own a home you can be proud of —energy-efficient homes are good for the environment.

In addition to discussing the minimum requirements for attaining ENERGY STAR, this packet suggests other techniques developed within the U.S. Department of Energy's Building America program. These techniques can help you avoid common construction problems that occur in the hot and humid climate. The recommendations in this chapter are based on Building America's building science research on over 25,000 homes in 34 states encompassing every climate region in the nation.

INTRODUCTION

Taking action in your community



HOMEOWNERS

Shopping for value, comfort, and quality



MANAGERS

Putting building science to work for your bottom line



MARKETERS

Energy efficiency delivers the value that customers demand



SITE PLANNERS & DEVELOPERS

Properly situated houses pay big dividends



DESIGNERS

Well-crafted designs capture benefits for builders, buyers, and business



SITE SUPERVISORS

Tools to help with project management



TRADES & CRAFTS

Professional tips for fast and easy installation

CASE STUDIES

Bringing it all together

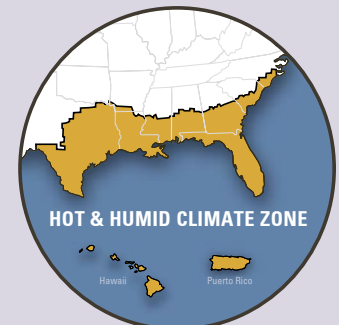

HOT & HUMID CLIMATE ZONE

Building America works with the nation's premier building scientists to conduct research and share knowledge with builders to help build better homes.

If you are looking for energy-saving features in your new home you're in good company. Recent homebuyer surveys have found that energy efficiency is the top upgrade that homebuyers choose in new homes. And homebuyers in Phoenix rated energy efficiency as the number one reason related to the house itself in determining their satisfaction with the production builder recognized by *Professional Builder* magazine as having the top customer satisfaction in the nation (2003). This same builder won the J.D. Powers and Associates top ranking for customer satisfaction in 12 of 21 markets in the United States. The winner, Pulte Homes, is a Building America Partner that brands its homes using ENERGY STAR.

How Quality Houses Perform

You don't want to spend the first several months in your new home fixing construction problems. Not long after unlocking a new home's door for the first time comes the reality of keeping the house and its inhabitants happy and comfortable. You'll save time, money, and personal energy when you buy a house that works from the start. The building materials and quality that go into an energy-efficient home help to keep temperatures even, the air clean, and the house dry, quiet, and draft-free. The checklist near the end of this chapter provides details of what to look for in quality home construction. Figure 1 provides an overview of features Building America recommends to help you avoid problems, while saving time, money, and energy.

FIGURE 1: Hot & Humid Design Features

All of these features save energy. Read the descriptions at right to see what else they do.

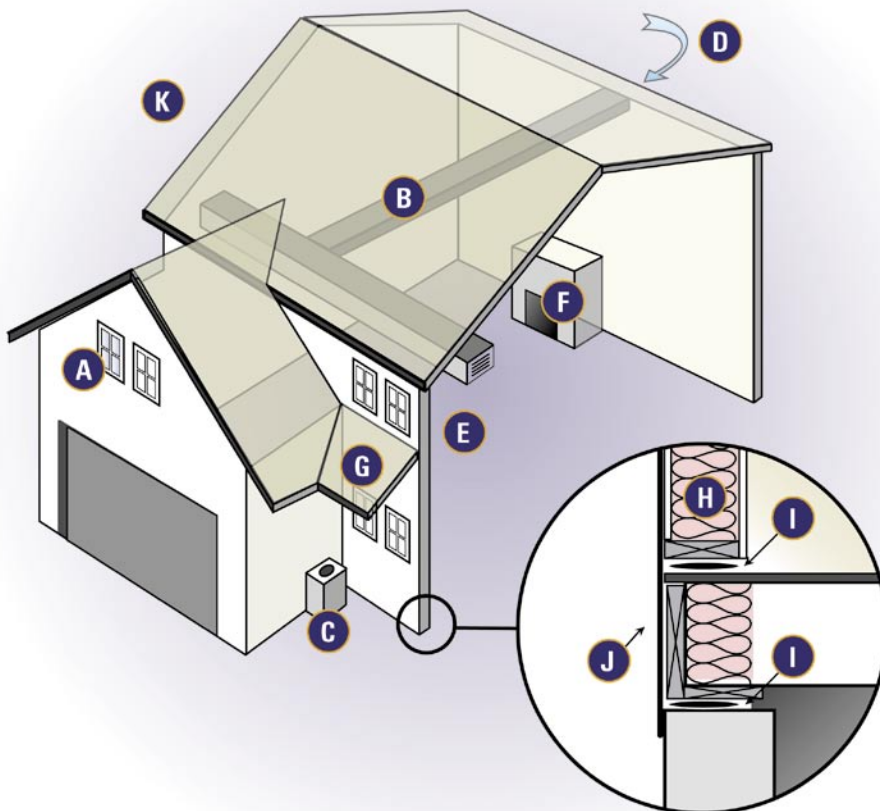

Hot & Humid Design Features

- A. Efficient Windows:** help to control and reduce ultraviolet light that can fade carpets and furniture, helping to keep your belongings looking like new and keeping window areas cooler and more comfortable to sit near. Window flashing protects against water leaks.
- B. Compact and Tightly Sealed Duct Runs:** shorter runs mean less to go wrong and fewer air leaks to put air where it is intended to go with fewer contaminants like humidity and dust from attics or crawlspaces. Leaky ducts are a major contributor to mold problems. Return air ducts in every room ensure balanced air pressure for less drafts and more balanced temperatures throughout the house. Put ducts in conditioned space, if possible.
- C. Right-Sized and High-Efficiency HVAC Equipment:** costs less to install than bigger equipment, saves energy, and is designed to comfortably handle heating and cooling loads.
- D. Ventilation:** exhaust fans remove moisture and pollutants. A controlled, filtered air intake ensures plenty of fresh air. A fresh air intake is not an ENERGY STAR requirement but it is recommended.
- E. Dehumidifier:** ensures that indoor humidity levels are kept at a comfortable level. This measure is not an ENERGY STAR requirement but is recommended by Building America.
- F. Sealed Combustion Appliances:** reduce moisture buildup and ensure the removal of combustion gases. We recommend against non-vented combustion appliances such as non-vented fireplaces or heaters.
- G. Overhangs:** provide shade and direct water away from the house. Overhangs are not required by ENERGY STAR but are a sign of thoughtful design.
- H. Insulation:** holds comfortable temperatures in conditioned spaces and helps control noise. For insulation level recommendations visit www.ornl.gov/sci/roofs+walls/insulation/ins_16.html
- I. Air Sealing:** stops drafts, helps keep humidity and garage contaminants out of the house, and creates a barrier to rodents and insects.
- J. Well-Designed Moisture Barriers:** avoid expensive structural damage and help stop humidity, mold, and mildew.
- K. Building System:** Perhaps the best thing about buying a system-designed house is that all of the parts are designed to work together. This can save you money on the purchase price, and it also means a durable and comfortable system, one that will help avoid maintenance and repair costs down the road.

An Energy-Efficient Home Will Cost You Less

As with any upgrade, precisely how much is paid for an energy-efficiency upgrade will depend on many factors. Some builders make energy-efficiency features part of their base price, so you pay no more additional cost. Others will sell you a specific upgrade package at a predetermined cost. Depending on how the builder structures his costs, the home's size and design, and the prevailing cost of building materials, the additional cost of a system-designed energy-efficient home may range from zero to \$1,500 or more.

But even if you pay more up front, the good news is you are likely pay less for an energy-efficient house on a monthly basis, if you consider the cost of energy. Here's an example showing why:

FIGURE 2: Monthly Cost Comparison

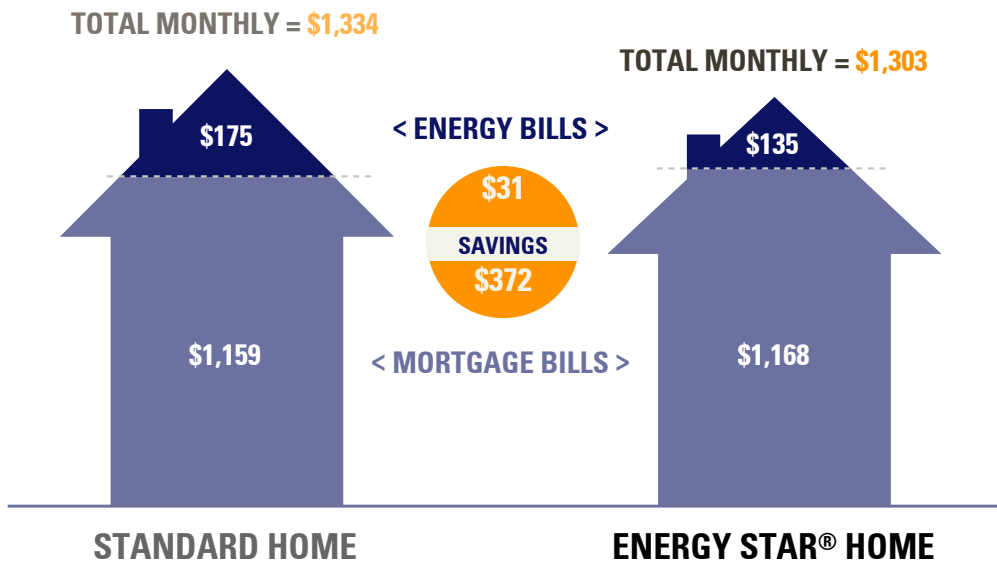

Our example assumes a base price on the house of \$200,000, an upgrade cost of \$1,500, and a 30-year mortgage at 6% interest. We also estimate that monthly energy bills will be about \$135 after energy savings of about \$40 per month in the energy-efficient home.

Your builder, realtor, or lender should be able to help you work through the savings for your house based on actual features, costs, and interest rates.

Energy-Efficient Mortgages Can Help You Get More for your Money

Lenders recognize that owning an energy-efficient home makes financial sense and they have developed energy-efficient mortgages to encourage consumers to purchase these types of homes. The loans work by allowing consumers to borrow more than they would typically qualify for.

"You don't know the quality of life you can experience until you're in one of these homes. Our quality of life has improved tremendously and we'll realize energy cost savings for years to come."

John Russo, purchased an ENERGY STAR home in 2002, as quoted in the Boston Herald, December 6, 2002.

According to the U.S. Environmental Protection Agency, which manages the Energy Star program with the U.S. Department of Energy, 100,000 new homes have now earned the Energy Star designation, saving these homeowners a total of \$26 million in energy costs every year.

HOMEOWNERS

The following features for energy-efficient loans are taken from Fannie Mae, the nation's largest source of funding for mortgages. You can learn more about Fannie Mae at www.fanniemae.com.

- Energy-efficient mortgages (EEM) are available for both purchase and refinance in conjunction with most Fannie Mae first mortgage products, including conventional fixed-rate and adjustable-rate mortgages.
- Monthly savings resulting from energy efficiency can be used to qualify borrowers for a larger mortgage. This means consumers can buy more home in the form of energy efficiency or other upgrades.
- The EEM can be used with many Fannie Mae mortgage products. The guidelines of the selected Fannie Mae mortgage apply, with the EEM allowing for the projected energy savings to provide an adjustment to the loan-to-value and qualifying ratios that favor the borrower.
- To qualify, you must obtain a Home Energy Rating System (HERS) report, which provides a rating of the energy efficiency of the home and estimates the resulting cost savings using average utility rates and usage data. See *What's the Score?* below for more information on HERS. Building America recommends that every home receive this type of rating and many ENERGY STAR homes were rated in order to qualify.

FIGURE 3: HERS Score

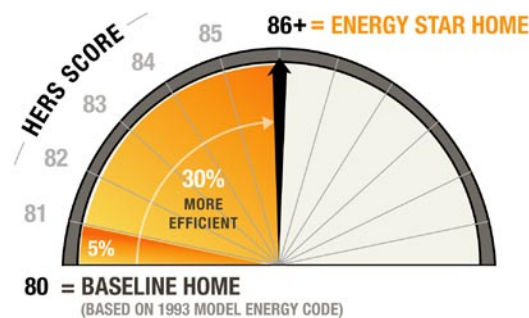

What's the Score?

The Home Energy Rating System (HERS) is a nationally recognized method of evaluating a home's energy performance. Rating professionals are people trained in preparing HERS scores and accredited by the Residential Energy Services Network, found on the web at www.natresnet.org.

A house built to the 1993 Model Energy Code has a HERS score of 80. This is considered a base house for a HERS comparison. Each one-point increase in the score equates to a 5% increase in energy efficiency in heating, cooling, and water heating. The homes described in this document are similar to ENERGY STAR homes and must be at least 30% more efficient than the base house and so would have a HERS score of at least 86. In some states, greater HERS scores are required because of stringent current building codes.

HERS scores can be used to compare across houses even if the houses differ in design, size, or type of HVAC equipment. Even if homes are not participating in labeling programs like ENERGY STAR, the HERS score can be used to gauge energy efficiency. See the *Designers* section  for more information on HERS.

HOMEOWNERS

Consumers using Federal Housing Administration (FHA) loan insurance should consider FHA's Energy Mortgage Program. This program helps borrowers to include energy-efficiency features in their home by stretching the size of the loan they may qualify for without increasing their down payment. An energy-efficient mortgage is one of many FHA programs that insure mortgage loans. FHA encourages lenders to make mortgage credit available to borrowers who would not otherwise qualify for conventional loans on affordable terms (such as first-time homebuyers) and to residents of disadvantaged neighborhoods (where mortgages may be hard to get). To learn more about FHA programs visit the web site at www.hud.gov/offices/hsg/sfh/eem/energy-r.cfm.

Some builders are working with lenders to offer special mortgage terms, such as a lower interest rate, to help buyers of energy-efficient homes. Ask your builder if they have any special programs.

Guaranteed Energy Costs and Comfort

Some builders go even further than doing a great job of constructing an energy-efficient home. Some guarantee it. Builders who guarantee their homes are willing to tell buyers how much energy the home should use, and they guarantee these levels will not be exceeded. These guarantees are backed up with payments if limits are exceeded. Builders can work with insulation companies or other partners to offer guarantees or caps on their home's energy costs, or they may develop their own programs. Some cover room comfort by guaranteeing that the temperature at the thermostat will not vary by more than 3 degrees at the center of any room served by that thermostat. A Building America team helped to develop these programs. Information on three of these programs can be found at:

- Environments for Living – www.eflhome.com/index.jsp
- Engineered for Life – www.us-gf.com/engineered.asp
- The Energy Use and Comfort Guarantee – www.artistichomessw.com/guarantee.htm

And There's More – More Green for You and More Green for the Planet

Where else can you find an investment that delivers monthly dividends, makes you more comfortable and your house more durable, comes with its own financing incentives, and may even have guaranteed energy performance? ENERGY STAR homes give you all this, plus they are good for the environment. Just one ENERGY STAR qualified new home can keep 4,500 pounds of greenhouse gases out of our air each year.

Last year, thanks to programs like Energy Star and other energy efficiency measures, Americans cut their energy bills by more than \$7 billion, along with saving enough energy to power 15 million homes. The greenhouse gas emissions saved by these steps was the equivalent of taking 14 million cars off our country's roads. Visit the ENERGY STAR web site at www.energystar.gov to learn more about how ENERGY STAR is helping the environment.

"Knowing that 100% of our homes exceed the minimum standards makes a statement to our buying public that we are confident this is the way of the future and not a fad or style."

Andrew Nevitt, Architect, Medallion Homes, San Antonio, Texas

Just one ENERGY STAR qualified new home can keep 4,500 pounds of greenhouse gases out of our air each year.

What to Look For

Take the *Homebuyer's Checklist* at the end of this chapter with you when you're shopping for a new home. Ask your builder or salesperson to help you consider each item. For a more detailed checklist, go to *Appendix I*. You may want to ask to see houses under construction to see how some measures are installed. The builder or realtor may have models and displays to help you see other features. Not all of the measures will apply to every home (for example, homes don't typically have more than one kind of heating system). Check the features that are most important to you. We've left some blank spaces at the end of the checklist in Appendix I so you can fill in features that you want to remember to check that may or may not be energy related.

If You're Building a Custom Home

A great advantage to building a custom home, or ordering your home before it is built, is that you can work with your builder or designer to get the features you want. Give your builder or designer this Best Practices Guide. It contains everything they need to design and build a durable and comfortable energy-efficient home.

Sources & Additional Information

- J.D. Power and Associates. *J.D. Power and Associates 2003 New Home Customer Satisfaction Study*. West Lake Village, California. 2003.
- Johnston, David. 2001. "Buyer Green." Housing zone.com. www.housingzone.com/topics/pb/green/survey/buyer.asp#

HOMEOWNERS

Homebuyer's Checklist

Use the following checklist to compare house features in different homes you visit.
A more detailed checklist is available in Appendix I.

MEASURE	Building America	Builder #1	Builder #2	Builder #3
BUILDER SERVICES AND RATINGS				
ENERGY STAR Rated	Yes			
HERS Score of 86 or greater	Yes			
Energy Performance Guarantee	Good Idea			
Energy Efficient Mortgage	Good Idea			
Provides Owners Manual	Yes			

If you can answer **yes** to the above questions you will have a good energy performing home.
Note that in some states, due to more aggressive energy codes, ENERGY STAR may require HERS scores greater than 86.

VENTILATION				
Controlled fresh air provided in the house	Yes			
Quiet Exhaust vents in bathrooms	Yes			
Quiet Exhaust (not recirculating) vents in the kitchen	Yes			
Supply and return air vents in each room	Yes			
WINDOWS				
Windows flashed to help repel water	Yes			
Windows rated .35 U-factor and .35 SHGC*	Yes			
COMBUSTIONS APPLIANCES				
Combustion appliance exhausts vented to the outside (except ovens)	Yes			
Hardwired carbon monoxide monitors included for every 1000 square feet of living space if combustion appliances or an attached garage are present	Yes			
DEHUMIDIFIER				
Dehumidifier present or the house has been designed so one can easily be added	Yes			
MORE TO LOOK FOR TO ENHANCE ENERGY EFFICIENCY				
ENERGY STAR qualified light fixtures	Good Idea			
ENERGY STAR qualified refrigerator	Good Idea			
ENERGY STAR qualified dishwasher	Good Idea			
ENERGY STAR qualified clothes washer	Good Idea			
ENERGY STAR qualified dehumidifier	Good Idea			

*Solar Heat Gain Coefficient



MANAGERS

Putting building science to work for your bottom line

This document tells company leaders how to use proven technologies and a successful marketing program to gain competitive market advantage and improve your company's economic and product performance. A more efficient home can mean a faster return on your investment

An Invitation to Building Company Managers

We invite you to use the information in this packet to lead your company to increased profits and greater customer satisfaction. Building America is a Department of Energy (DOE) program that has sponsored building science research on 25,000 homes nationwide. These technologies and the Building America systems approach can set your company apart, giving you a considerable competitive advantage in how you design, build, and sell homes.

"I'm very positive about Building America. We are taking an approach of wanting to build a better product in all areas—energy efficiency, indoor air quality, no moisture problems, and one that is sensitive to the environment."

GW Robinson,
President of GW Robinson

Building America

Building America works with the nation's premier building scientists to conduct research and bring knowledge to builders to help them build better homes. This knowledge has been gained from private/public partnerships involving builders all over the country. The program is sponsored by the U.S. Department of Energy. Many builders have adopted the program's principles and improved the performance of their houses and companies. Over 250 builders and vendors have partnered with Building America, including five of the largest 10 builders in the nation. This best practices guide contains results from this research in a form that your company can immediately build into your homes to increase efficiency, comfort, and durability.

QUICK TIPS | MANAGERS

- The smartest builders in the industry are working with Building America.
- Applying the Building America Process can: cut your production costs, reduce risks, improve your bottom line, help make you a market leader, and turn your customers into lead generators.
- This document gets you and your company started.
- ENERGY STAR® can help you market your new and improved product.

INTRODUCTION

Taking action in your community



HOMEOWNERS

Shopping for value, comfort, and quality



MANAGERS

Putting building science to work for your bottom line



MARKETERS

Energy efficiency delivers the value that customers demand



SITE PLANNERS & DEVELOPERS

Properly situated houses pay big dividends



DESIGNERS

Well-crafted designs capture benefits for builders, buyers, and business



SITE SUPERVISORS

Tools to help with project management



TRADES & CRAFTS

Professional tips for fast and easy installation

CASE STUDIES

Bringing it all together

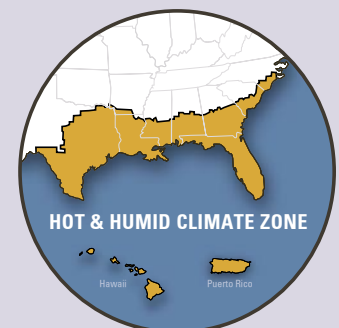

FIGURE 1: A small sampling of Building America’s 250 partners

Building America Partner	Ranking among Top 100 Builders
Pulte Homes	2
Centex Corp	4
The Ryland Group	7
Beazer Homes USA	8
K Hovnanian	9
Shea Homes	12
Habitat for Humanity International	16
Weyerhaeuser Real Estate Company	17

The Business Case for Building Science and Energy Efficiency

Why are all these builders working with Building America? The answer is simple - Working with Building America can enhance your company’s bottom line through:

- Cost savings from making the best materials and equipment choices
- Reduced risks, increased productivity, and fewer callbacks
- Greater profit margins on energy efficiency and other upgrades
- Competitive advantage in the marketplace
- Customer satisfaction and referrals.

More information on each of these points is presented below. But boosting the bottom line isn’t the only reason builders build quality, efficient homes. Builders tell us it boosts their pride in their craft, increases the morale of their workforce, and gives them a good feeling at the end of the day, knowing they’re doing their part to help the environment.

Properly Choosing Materials and Equipment

Building science offers many tools to help you pick out the right materials and size them correctly, and to help make sure you are using them to build the right product. Explanations and suggestions on building systems, designs, and trade-offs are in the *Designers*  chapter of this document. The costs of some measures can be more than what you are currently spending. The idea is to use the materials best suited to the job and to size equipment accordingly. Higher prices in one area can be at least partially offset with savings in other areas. Costs for all building materials can vary tremendously in their own right, but your level of experience and design choices have a large bearing. For comparison, some builders find they experience no overall increase in materials costs to offer an energy-efficient package, but others suggest added costs of up to \$1,500 per home. In the *Designers* chapter, we show one example of costs and savings that resulted in a total additional cost of about \$300 on average for the design used by a Building America partner in the hot and humid climate. Read on to find out how this investment can add to your bottom line.

“The biggest benefit is the sense of satisfaction of doing something good. We’re conserving the environment and providing a better product to our buyers.”

Lucian Kragiel, Co-owner of Atlantic Design and Construction

“I owned a private construction firm for 30 years before I retired and joined Habitat. I’d say, with the Building America practices we’re using, these homes are better built than what I built before—and I was building houses up to a million dollars or more and I thought I was building well.”

Walter Hendrix, Executive Director of Troupe Chambers Habitat for Humanity and Dependable Affordable Sustainable Housing for La Grange

“There is a sense of pride in knowing that Medallion Homes takes the extra effort in research and production to deliver the best product for the price.”

Andrew Nevitt, Architect, Medallion Homes, San Antonio, Texas

Reduced Risks, Increased Productivity, and Fewer Callbacks

These benefits follow closely from selecting and properly using the right materials and equipment. Making a change in your process may take extra time the first few times you try it, but once established, the payoffs can be significant.

One of the great values of using Building America approaches is that they were designed to solve construction problems, such as moisture degradation and mold growth, that plague builders. More than 10,000 mold cases are now pending nationwide, with an increase in cases of more than 300% since 1999 (Insurance Information Institute as reported in Wood and Clift, 2003).

Applying building science reduces the risk of big problems and helps to eliminate the more mundane defects that cost money to fix. If you reduce the time your crews are working on call backs, you increase the time they can be working on new product.

From an Economic Standpoint, Everyone Wins

As a manager, watching your profit margins is a full-time job. The structure of your business and emphasis you place on consistency determines how much profit you get from options packages. Some builders choose to incorporate energy efficiency and health and comfort options into their base price; others include them as options with a profit margin similar to other premium add-ons. Whichever approach you use, the experience of other builders suggest that customers place great value on energy efficiency and will pay to get it.

Profit margins vary substantially from company to company. A National Association of Homebuilders report (1999) and *Professional Builder* magazine (2003) suggest a net profit margin of about 10% on overall house construction. This number is consistent with publicly traded homebuilding companies. Six companies' annual financial reports to the Securities Exchange Commission over 2001 and 2002 reported net profit margins ranging from 4.2% to 9.6%. Gross profit margins over this same time period ranged from 7.4% to 19.2%. In comparison, builders report they have gained about a 30% profit margin on efficiency upgrade packages.

In the *Homeowners*  chapter, we offer an example showing how energy-efficient homes end up costing less for consumers on a monthly basis when both the mortgage and energy expenses are taken into account. Consumers can either pocket these lower costs or use them to buy a more expensive home. Any upgrades translate into added profit.

In short, builders can increase their profits at the same time that consumers lower their costs. From an economic standpoint, everybody wins.

Customer Satisfaction and Referrals

Customer satisfaction matters to your company's future and energy efficiency matters to your customers. Pulte is a Building America Partner that brands its homes using ENERGY STAR. J.D. Power and Associates, a market research firm, gave Pulte's various divisions top rankings in 12 of the 21 U.S. markets it surveys, including Houston, Palm Beach, and Tampa Bay, and placed it among the top 3 companies in 17 markets.

"Building America's technical assistance on building science helped us to reduce callbacks by 70% in our Chicago Division. That's a tremendous savings for our company and means our customers are happier with their homes."

Frank Beasley, V.P. of Building Science, Town and Country Homes.

"Since partnering with Building America in 2001, Artistic Homes reports that its liability for defects and damage has been reduced, as has the number and cost of warranty calls; 'meanwhile, customer satisfaction is at an all-time high,' according to Max Wade of Artistic. The production builder has produced more than 2000 Energy Star homes in Albuquerque, NM, since 2001."

As reported in Builder Magazine 11/1/03

"We offer ENERGY STAR as an upgrade, but everyone chooses it. We have 100% participation so all of our homes are ENERGY STAR."

Lucian Kragiel, Co-owner of Atlantic Design and Construction.

MANAGERS

Pulte Phoenix, which J.D. Powers ranked first in that local market, also won the Diamond Award from *Professional Builder Magazine* and NRS Corp., a market research company that works with the home building industry. Pulte had the top customer satisfaction for production builders of nearly 300 builders in the nation.

Paul Cardis of NRS, a market research expert, notes that “customer satisfaction is important for many reasons, not least is that satisfied customers refer future customers and the conversion rate for referrals is twice that of non-referred shoppers.”

Consumers Expect More

Buyers want energy efficiency and they are willing to pay for it. A 2001 *Professional Builder Magazine* survey found that energy efficiency is the number one upgrade that homebuyers seek in a new home. Nearly 90% of new homebuyers in the survey were willing to spend more for energy efficiency features (Johnston 2001). Consistent with this study, the NAHB found that consumers would be willing to spend up to \$5000 more on a new home if it saved them \$1000 on their annual utility bills (NAHB 2002). And Pulte’s customers in Phoenix rated energy efficiency as the most important product-related reason for referring their contractor to new buyers.



Atlantic Design, a Building America partner, was recognized as a 2000 EPA Builder of the Year for its quality energy-efficient construction.

Competitive Advantage in the Marketplace

One of your key goals as a manager is to gain competitive advantage in the marketplace. The technologies described in this packet can give your company a technological edge. One easy way to tell the public about your new product is to partner with ENERGY STAR. ENERGY STAR is a nationally recognized branding program sponsored by the U.S. Department of Energy and the U.S. Environmental Protection Agency. Consumers trust the ENERGY STAR logo to tell them whether their product is energy efficient. Participating in ENERGY STAR is easy and it gives you an effective way to distinguish your product from your competition’s. Over 2,000 builders work with ENERGY STAR in the United States. And half of the 100 largest builders in the nation have at least one division building ENERGY STAR qualified homes.

ENERGY STAR qualified homes are independently verified to be at least 30% more energy efficient in space conditioning and water heating than homes built to the 1993 national Model Energy Code or 15% more efficient than the state energy code, whichever is more rigorous. These savings are consistent with the practices described in this best practices manual. Heating, cooling, and hot water energy use make up about half of a household’s total utility bills.

The September 2003 issue of *Professional Builder* provides six top reasons why customers are willing to recommend a builder. **Energy efficiency is first among the reasons related to product.**

Nearly 93%

of buyers of Pulte Homes in Phoenix had made at least one positive recommendation.



Professional Builder Magazine, September 2003, p. 67

“Our attention to energy efficiency is what really makes Pulte’s homes stand out.”

**Les Woody, Pulte Phoenix
Director of Customer Service**

Take the Next Step

This information packet is designed to give your company all the information you need to start using the Building America systems approach in the hot and humid climate. The techniques described will help you avoid many of the problems plaguing all builders in hot and humid climate.

Make sure your team reviews the sections prepared for each of your company's capability areas: marketing, site planning, design, building site supervision, and the trades. This information will help your company compete in an increasingly complex and risky market. Following the design practices discussed in the *Designers*  chapter and the inspection and testing procedures outlined in the *Site Supervisors*  chapter will give you the technical information you need to build your business. Find more information on ENERGY STAR in the *Marketers*  chapter and on the web at www.energystar.gov.

Case Studies

Take a look at the case studies at the end of the book. All offer examples of how builders achieve energy efficiency. Two of the studies offer a comparison in management style. These case studies show builders that companies can either climb stairs, one step at a time, or jump on the elevator and push the button for the top floor. Both approaches will get you to your destination.

Compare *Atlantic Design and Construction's* case study with their neighboring builder, *G.W. Robinson*. Both companies build high value homes in the Gainesville, Florida area. A subtle difference between these companies is in how they got to the point of building highly efficient homes. Atlantic adopted changes to their base practices over time, first just meeting ENERGY STAR requirements (HERS 86), then taking several steps to reach HERS ratings of 89 and 90. Robinson took more of a makeover approach. Robinson also builds homes resulting in HERS ratings of 89 and 90, but made the innovations to do so all at once. Both management approaches are valid and both have resulted in profitable companies building great houses.

Sources & Additional Information

- National Association of Home Builders. *The Truth About Regulatory Barriers*. Washington, D.C. 1999.
- *Professional Builder*. "Where are the Giants Headed? Industry Consolidation is Changing the Way Even the Smallest Production Builders Do Business, but How Far it Will Go is Still Open to Debate." April 2003.
- J.D. Power and Associates. *J.D. Power and Associates 2003 New Home Customer Satisfaction Study*. West Lake Village, California. 2003.
- *Professional Builder*. "Customer Service Standard Setters." September 2003.
- Wood, C., and L. Clift. "Seven Wonders of the Construction World." *ProSales*. October 2003, pp. 28-44.



MARKETERS

Energy Efficiency Delivers the Value that Customers Demand

By selling homes you bind your company to its customers. Your work enables the company to capitalize on the benefits of its investments, including those made in energy efficiency. And you are the ones who help homeowners understand the quality, value, and economy represented by your product.

ENERGY STAR Qualified Homes: Telling Your Story

An easy way to sell energy-efficient homes is to become an ENERGY STAR® partner. Even if you build or sell great houses, if they aren't ENERGY STAR qualified, it's hard for your customers to know how much efficiency they are getting. ENERGY STAR helps you to tell your story. The ENERGY STAR logo makes it easy to tell consumers you are selling a superior product. And the ENERGY STAR program offers much in the way of advice and examples of how to use the logo. Differentiate yourself by offering a home that is certified to be more efficient—and better for the environment—than standard models.

To find out more about marketing with the ENERGY STAR logo visit the program's web site at www.energystar.gov. You'll find information about before-sales marketing, point-of-sale techniques, and building ongoing relationships with your customers. Much of the information comes from successful techniques used to sell ENERGY STAR homes across the nation. Tools on the website will help you instantly craft your message and prepare sales materials.



ENERGY STAR offers a marketing platform that home builders can use to recognize that you offer truly energy efficient homes.

QUICK TIPS | MARKETERS

- Energy efficiency, and the quality that comes with it, gives you a competitive advantage.
- ENERGY STAR can help you capitalize on your competitive advantage, produce marketing materials, and connect with buyers.
- Your customers see energy efficiency as a sign of value.
- Some of the biggest builders in the country have learned that energy efficiency can turn existing customers into new sales leads through customer satisfaction.
- Learn how industry leaders sell new energy-efficient homes.

INTRODUCTION

Taking action in your community



HOMEOWNERS

Shopping for value, comfort, and quality



MANAGERS

Putting building science to work for your bottom line



MARKETERS

Energy efficiency delivers the value that customers demand



SITE PLANNERS & DEVELOPERS

Properly situated houses pay big dividends



DESIGNERS

Well-crafted designs capture benefits for builders, buyers, and business



SITE SUPERVISORS

Tools to help with project management



TRADES & CRAFTS

Professional tips for fast and easy installation

CASE STUDIES

Bringing it all together

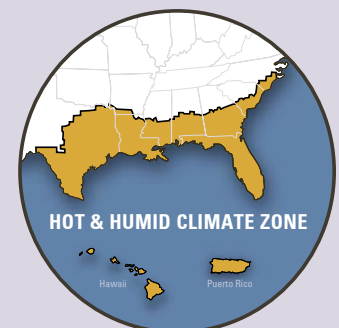

MARKETERS

Increase Customer Satisfaction and Let Your Customers Sell Your Product

Wouldn't it be great if, for every home you sold, you could add a new sales associate to your staff to sell even more?

That's what energy efficiency can do for you. Happy customers will sell your products for you. And energy-efficient homes make happy customers. Compared to standard homes, energy-efficient homes cost less to own, are more comfortable to live in, and require less maintenance.

The builder with the top customer satisfaction rating in the nation, Pulte Homes of Phoenix, is a Building America partner offering ENERGY STAR qualified homes. Pulte's Phoenix division has had one or more positive referrals from 93% of its homebuyers. The conversion rate for shoppers referred in this way is twice that of non-referred shoppers. Homeowners talk, and word of mouth is a powerful selling tool. Some experts, in fact, say word-of-mouth is the most effective selling tool because



Shoppers love to peer into the attic through this viewing window in a Building America model house by Cambridge Homes. Shoppers can see the special insulation, and the thermometer tells them how cool the attic stays.

it carries with it the credibility of a trusted third party, such as a friend or relative. Add to that the fact that many potential buyers are skeptical of traditional advertising, and it's no surprise that 10% to 30%, and sometimes more, of builders' sales come from referrals (Farnsworth 2003). The best way to sell homes is to let your customers do it for you. See the *Managers* chapter for information on the great customer satisfaction ratings received by builders selling ENERGY STAR homes.

Sell the Value that Home Buyers Expect

Market research shows:

- Energy efficiency is the number one upgrade sought by homebuyers of new homes (*Professional Builder Magazine* 2001)
- Nearly 90% of new homebuyers are willing to spend more for energy efficiency (Johnston 2001 and NAHB 2002)
- Buyers rate energy efficiency as a home builder's most important product-related reason for referring new customers (*Professional Builder Magazine* 2003)

How Industry Leaders Sell Energy-Efficient Homes

The NAHB Research Center sponsors an annual award competition called the Energy Value Housing Award. The Center has compiled the winning builder's

"If you don't tell your story, you give it away!"

Vern McKown, President Ideal Homes



"Tell other builders—it's easier to do than they think. People really want ENERGY STAR if they understand it. They (the builder) can make money doing it. They can feel better about themselves at the end of the day by making the planet healthier, by building better homes."

Lucian Kragiel, Co-owner of Atlantic Design and Construction



MARKETERS

marketing techniques into a document that can be purchased on the web at www.nahbrc.org/tertiaryR.asp?CategoryID=1705&DocumentID=3404 (Sikora 2002). Here are some of the best practices recommended by the NAHB Research Center and other sources:

- Educate customers and sales professionals. Show buyers how living in an energy-efficient home will benefit them with lower household costs. The ENERGY STAR Web site has an example as does the *Homeowners*  chapter. Vital to customer education is an informed sales staff and team of local sales professionals.
- Walk-throughs and model homes can be invaluable educational tools for both buyers and sales staff. Model homes with display cutaways of energy features such as insulated attics and wall sections help them understand the energy-efficient construction process. Use labels, flags, and banners to create a fun self-explanatory message to give buyers a focus while they drive or walk the development. Recent research suggests just how important model home, models of house features, and other educational tools are to shoppers (Farnsworth 2003).
- Training sessions can be an effective tool for educating sales staff and professionals. Use slides, sample products, and energy bills as aids.
- One way to educate consumers is to emphasize an energy-efficiency upgrade when signing the final papers. One builder has a wall of testimonials, photos, and utility billing history in his waiting room. All prospects are given an opportunity to view this “wall of fame” before the final sale is made. Another builder has the buyer meet with the building site supervisor after the sale is made. This person gives them one more chance to sign up noting, from a builders’ perspective, what a better house they will get (Rashkin 2002).
- Publications are an educational tool that customers and sales professionals can take home. Develop your own brochures or books or give away reprints of magazine articles, ENERGY STAR brochures, or Building America brochures. Don’t overlook vendors and trade associations. They can provide excellent materials, often at no charge. For example, excellent information on window performance is available at the Efficient Windows Collaborative web site at www.efficientwindows.org/index.cfm. Also, give potential buyers a checklist so they can compare the energy saving measures in your homes with those of other builders. A sample is included in the *Homeowners*  chapter.
- Advertising can be used to explain the energy-efficiency advantages and distinguish builders from their competition. The ENERGY STAR website has useful information for designing advertising.
- The Internet and compact disk formats are another forum for presenting all of your education and advertising messages. Some marketers suggest that all builders should have a web site, even if it is simple and offers only limited information. CDs with brochures or slide shows can be given to potential buyers to take home and replay your message.

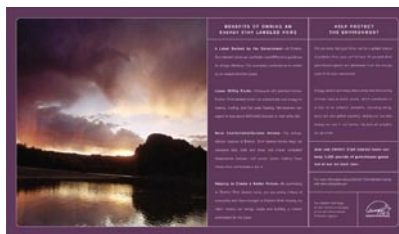

“It’s not hard to sell when you educate the buyer if you can show them (the buyer) that they will get lower utility bills. And they are also going to get a higher resale value on their house. ENERGY STAR is becoming increasingly well known. Builders who don’t do it will lag behind.”

**Lucian Kragiel, Co-owner of
Atlantic Design and Construction**

MARKETERS

- Seek out free publicity. Nothing is more cost effective than sending a news release to local media to announce business news and other company activities. News releases can cover your company's involvement in educational activities, for example, teaching school children about energy efficiency or other charitable actions.
- Offer energy-efficiency guarantees. Energy performance guarantees can help convince buyers that energy savings are real. Partnerships with outside companies can help to establish guarantees. For example, some insulation manufacturers offer home inspections, tests, and cost guarantees. The insulation company takes on the risk of covering the guarantee.
- Make buyers aware of energy-efficient mortgages.
- Take advantage of the testing data available on your homes. If your company follows the best practices in this guide, you will have blower door and duct pressure test data and a HERS score to share with buyers. Use these data to inform your customers and differentiate your houses.

Participate in ENERGY STAR and other partnerships. ENERGY STAR and Building America can provide technical guidance through publications and their Web sites. Partnering with ENERGY STAR cements your company's commitment to energy efficiency and gives you access to the ENERGY STAR brand.

Sources and Additional Information

- Farnsworth, Christina. 2003. "The Weakest Link." *Builder Magazine*, December 2003. www.builderonline.com/article-builder.asp?channelid=55&articleid=375&q=consumer+survey
- Johnston, David. 2001. "Buyer Green." Housing zone.com. www.housingzone.com/topics/pb/green/survey/buyer.asp#
- Laquatra, Joseph. 2003. "The Value of Energy Efficiency." *Home Energy*, November/December 2003. www.homeenergy.org
- National Association of Home Builders. 2002. *What 21st Century Home Buyers Want*. NAHB, Washington, D.C.
- Rashkin, Sam. 2002. "Surprise! Energy Efficiency Sells without Rebates: Results of Mainstream Builders Selling ENERGY STAR Labeled Homes" *Proceedings of the 2002 ACEEE Summer Study on Energy Efficiency in Buildings*, Washington D.C.
- Sikora, Jeannie. 2002. *Energy Value Housing Award Guide: How, Build and Profit with Energy Efficiency in New Home Construction*. National Association of Home Builders Research Center, Upper Marlboro, MD.

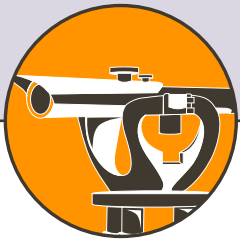

SITE PLANNERS

Properly situated homes pay big dividends

The National Association of Home Builders (NAHB) estimates that 1.6 million new homes will be built each year over the next decade (NAHB 2002a). How these new developments are designed will have a major impact on energy use, the environment, and customer satisfaction.

Developers and site planners can set the stage for efficient communities and can direct builders to protect a community's value through quality building practices.

The sun is the main source of heat in all homes. By looking at how houses receive sunlight, site planners can help optimize how much solar energy is available to heat a house, and how much heat must be removed with air conditioning.

In the hot and humid climate, planners should do all they can to avoid the entry of solar energy into houses, especially in summer. Site planners have two important tools to help avoid solar heat gain: **lot orientation** and **shade trees**.

Lot Orientation

As planners map out lots and roads, the relationship between buildings and the sun should be key. Just as you lay out roads to allow houses to take advantage of great views, or to work around hillsides and other landscape features, also consider how road design, lot lines, and orientation will influence the way that houses face the sun.

Lot lines and roads should be situated to minimize home exposure to east and west. These orientations provide the greatest solar heat gains. Plan your subdivision so that the longer sides of the houses will face north or south. Single-family homes tend to have longer fronts and backs and narrower sides, so lots facing north or south are preferred. Streets should be positioned in an east-west direction. The Florida Solar Energy Center (FSEC – see additional resources below) estimates that proper orientation can result in substantial savings of heating and cooling costs, depending on specific site conditions and house designs. Highly efficient houses, especially when good windows are used, are less dependent on orientation and shading to manage

solar gain. With proper planning, there may be no added costs to the builder for good orientation.

When the house has clear single glazing, which is not recommended, interior shades, overhangs and typical combinations of shading devices significantly reduce energy costs. Naturally, a completely shaded house has the best performance in a hot climate.

QUICK TIPS | SITE PLANNERS

- Lots facing north or south are preferred to manage heat gain from the sun, so position streets to run east and west.
- Preserve trees for shade and breezes.
- Take advantage of natural breezes from lakes, the ocean, or other geographical features.
- Properly grade your development to take water away from structures.
- Use sustainable building practices.

INTRODUCTION

Taking action in your community



HOMEOWNERS

Shopping for value, comfort, and quality



MANAGERS

Putting building science to work for your bottom line



MARKETERS

Energy efficiency delivers the value that customers demand



SITE PLANNERS & DEVELOPERS

Properly situated houses pay big dividends



DESIGNERS

Well-crafted designs capture benefits for builders, buyers, and business



SITE SUPERVISORS

Tools to help with project management



TRADES & CRAFTS

Professional tips for fast and easy installation

CASE STUDIES

Bringing it all together

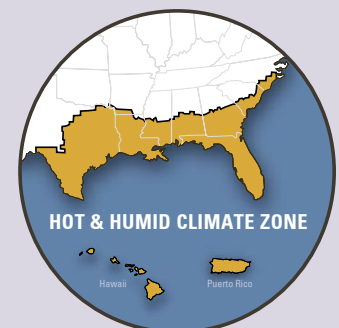

SITE PLANNERS

Shading is not nearly as important when windows with a low solar heat gain coefficient (i.e., SHGC of 0.35 or less) are used. Using a low-solar-gain low-E coating results in great energy cost reductions for all conditions even with no shading. This is because the glazing itself provides the necessary control of solar radiation, so these additional measures become less important in terms of energy use. For a description of the interactions between window performance and shading, see the Efficient Windows Collaborative Web site at:

www.efficientwindows.org.

FIGURE 1: Plan subdivision lot lines and roads for predominantly north and south orientation

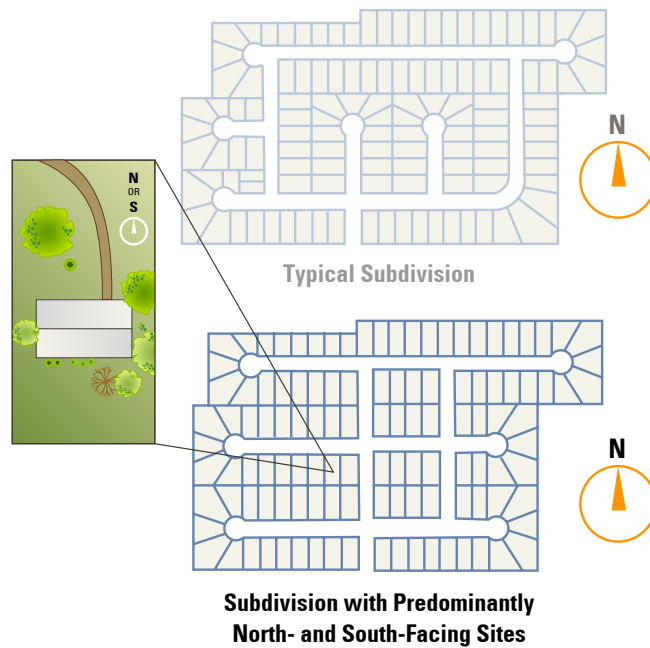

Source: Viera et al. 1992. p.3-5

Lot orientation is especially important if solar heating or electric generation systems are planned. Inexpensive tools can help assess how much solar energy will be blocked by obstacles on a particular site. Low-cost tools for solar assessments are described in the *Designers*  chapter in the section about windows.

In addition to helping manage the sun and providing a marketing advantage, proper street design can reduce the environmental impacts of runoff, encourage walking and bicycling, and discourage speeding by through-traffic.

Subdivision planning can also help to gain cooling benefits from the wind. Houses and other buildings that are tightly packed may create a wake in the wind that is four to five times the buildings' eave height.

Curved streets and staggered lots can assist in preventing wind disturbance. Trees can help to keep breezes cool as described in the next section. Taking advantage of breezes will reduce cooling costs. Wind conditions at any individual site may differ considerably from regional averages. Local geography such as ocean beaches, lakes, fields, golf courses, parks, and malls can influence local breezes.

FIGURE 2: Wind wake of a typical house

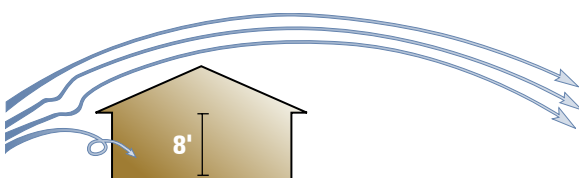

Source: Viera et al. 1992. p.3-7

Shade Trees

Tree preservation brings many benefits, one of which is increased salability. Native trees are most beneficial to the environment. The NAHB reports in its survey of buyers, *What 21st Century Homes Buyers Want*, that over 80% of respondents in the South rated trees as essential or desirable (2002b, page 61). In 1992, the Florida Solar Energy Center (FSEC) estimated that a treed lot may increase the value of a home by as much as 20%. American Forests and the NAHB (1995) found that mature trees may add from \$3,000 to \$15,000 to the value of a residential lot.

Trees also bring value by providing shade. It is far better to prevent solar energy from reaching a house than to attempt to manage it once it enters. Deciduous shade trees block summer sunlight before it strikes windows, walls, and roofs, dissipating absorbed heat to the air where it can be carried away by the breeze.

Truly cool neighborhoods have trees. A study in Florida has shown that a subdivision with mature trees had cooler outside air with less wind velocity than a nearby development without trees (Viera et al. 2000). The development with a tree canopy had peak afternoon temperatures during July that were 1.1°F to 3.1°F (± 0.7°F) cooler than the site without trees. The total effect of shading, lower summer air temperature, and reduced wind speed can reduce cooling costs by 5% to 10% (McPherson et al. 1994).

Trees are most effective when located next to windows, walls, and air conditioners, and when located on the side of the home receiving the most solar exposure. Shade to the southwest and west is especially important for blocking peak solar gain in the summer in late afternoon. Trees more than 35 feet from the structure are probably too far away for shade.

FIGURE 3: Configuration of shade trees

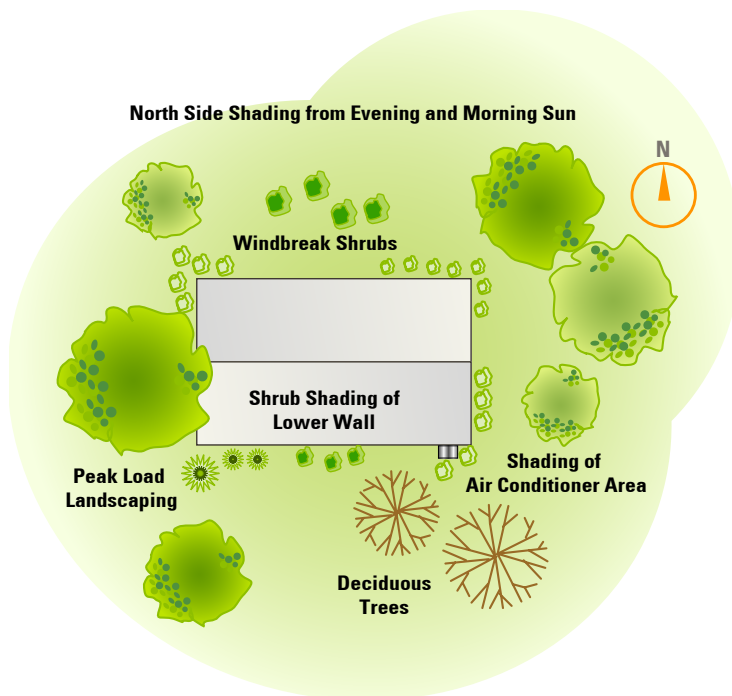

Source: Viera et al. 1992. p.3-8

Other Steps

In addition to orientation and the use of trees, many other steps can be taken during site planning to make developments user and earth friendly.

Site Grading

Proper site grading directs surface water away from building foundations and walls. The steeper the slope away from the building, the better the water will drain. Floor levels should always be above the surrounding grade. Basement floors should be higher than the surrounding drainage system. Driveways, garage slabs, patios, stoops, and walkways should all drain away from the structure. See EEBA's *Water Management Guide* (Lstiburek 2003) for more information. Additional information on moisture management is also available in the *Designers*  chapter.

FIGURE 4: Drain all water away from the structure



Source: Lstiburek, J.W. 2003. p.4

“What we tell buyers is that we sell value... it’s about high standards in every aspect of home building... The whole idea is to get builders all over the country more concerned about building this way—it’s about energy efficiency, indoor air quality, waste recycling, water recycling, better planning—it all leads to better development.”

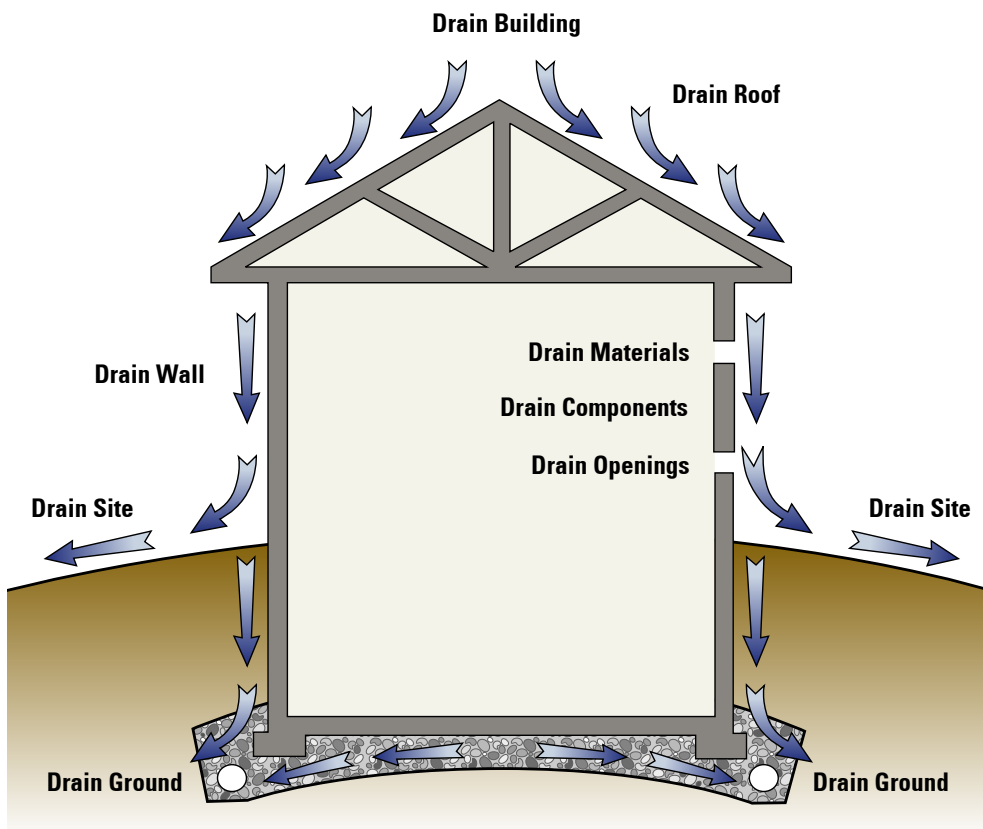
GW Robinson,
President of GW Robinson

SITE PLANNERS

Sustainable Development

Builders who choose to advertise their “green” designs have found that buyers are willing to pay for environmental features.

Features that help to conserve the natural environment can include:

- Orienting lots to best manage energy and light from the sun.
- Land planning that preserves the natural environment and minimizes land disturbance.
- Site design that minimizes erosion, paved surfaces, and runoff.
- Preserving and protecting trees and natural vegetation.
- Conserving water indoors and out.
- Designing energy efficiency into houses.
- Selecting materials that are durable and recyclable, or created from recycled products, and considering the energy that goes into making products.
- Recycling construction materials and reducing on-site waste.

Good places to start on sustainable development are found in the Southface Energy Institute’s *Sustainable Design, Construction, and Land Development: Guidelines for the Southeast* (Brown 2000), the NAHB’s *Building Greener: Building Better: The Quiet Revolution* (NAHB 2002c), and the Sustainable Building Council’s *Green Building Guidelines* (SBIC 2003).



G.W. Robinson pipes recycled irrigation water to cut water use and costs to homeowners at the Cobblefield development in Gainesville, Florida.

Sources and Additional Information

- American Forests and the National Association of Homebuilders. 1995. *Building Greener Neighborhoods: Trees as Part of the Plan*. NAHB, Washington, D.C.
- Brown, W. 2000. *Sustainable Design, Construction, and Land Development: Guidelines for the Southeast*. Southface Energy Institute and Oak Ridge National Laboratory, Oak Ridge, Tennessee. www.southface.org/home/sfpubs/large-pubs/Sustainable_community_development.pdf
- Lstiburek, J.W. 2002. *Water Management Guide*. Energy and Environmental Building Association, Minneapolis, Minnesota. www.eeba.org
- McPherson, G.E., D.J. Nowak, and R.A. Rowntree (eds). 1994. *Chicago's Urban Forest Ecosystem: Results of the Chicago Urban Forest Climate Project*. U.S. Department of Agriculture, Forest Service, Northeastern Research Station, www.f.fed.us/ne/newtown_square/publications/technical_reports/pdfs/scanned/gtr186a.pdf
- National Association of Homebuilders. 2002.a *Builder's Guide to the APA's Growing Smart Legislative Guidebook*. NAHB, Washington, D.C.
- National Association of Home Builders. 2002b. *What 21st Century Home Buyers Want: A Survey of Customer Preferences*. NAHB, Washington, D.C. www.BuilderBooks.com
- National Association of Homebuilders. 2002c. *Building Greener: Building Better: The Quiet Revolution*. NAHB, Washington, D.C.
- Sustainable Buildings Industry Council (SBIC). 2003. *Green Building Guidelines: Meeting the Demand for Low-Energy, Resource-Efficient Homes*. U.S. DOE. Washington, D.C. document available at www.SBICouncil.org.
- Sonne, J.K. and R.K. Viera, 2000. "Cool Neighborhoods: The Measurement of Small Scale Heat Islands." *Proceedings of the 2000 Summer Study on Energy Efficiency in Buildings*, American Council for an Energy-Efficient Economy, Washington, DC. www.fsec.ucf.edu/bldg/pubs/pf363/index.htm
- Viera, R.K., K.G. Sheinkopf, and J.K. Sonne. 1992. *Energy-Efficient Florida Home Building*, third printing. Florida Solar Energy Center, FSEC-GP-33-88, Cocoa Beach, Florida.



DESIGNERS

Well-crafted designs capture benefits for builders, buyers, and business

Even good builders can have bad results if they are working toward the wrong product. Designers have the job of giving builders the opportunity to do the right thing well.

“If you do the wrong things with good materials and good workmanship, it is still wrong. You must do the right thing with good materials and good workmanship.”

Joseph Lstiburek, Building Science Corporation

QUICK TIPS | DESIGNERS

- Building America brings you the results of research, real-world experience, and dialogue with builders from over 25,000 homes nationwide (as of early 2004).
- System design and building science offer you tools and techniques to improve housing performance without sacrificing style and appeal, avoid problems plaguing new homes, find cost savings to help your company’s bottom line, and give consumers satisfaction in their investment.
- Seek the help of a home energy rating professional or engineer to avoid reinventing many of the solutions that have already been found and optimize your designs.
- Review the many technologies discussed in this chapter for help in selecting the applications right for you.

Building Science and the Systems Approach

Perhaps the most important step in designing any form or function is recognizing that the design is for the entire product. No one piece can be changed without affecting all related pieces. This simple proposition applies to all systems and allows for all kinds of trade-offs. In cars, without any loss in performance, lightweight frames may be translated into smaller brakes, a smaller engine, and smaller tires. Or, that same change may be used to produce more speed.

In houses, this systems approach recognizes the interaction of windows, attics, foundations, mechanical equipment, and all other components and assemblies. Changes in one or a few components can dramatically change how other components perform. Recognizing and taking advantage of this fact, and applying appropriate advances in technology to components, can result in cost and performance payoffs, both for the builder and buyer of new homes.

Building America has embraced the systems approach and combined it with the technology development and testing that make up building science. As with other scientific disciplines, building science provides an intelligent approach to understanding complex systems and diagnosing problems. Over time, knowledge, tools, and tests are developed that make the science and the product more efficient and more powerful. *(Adapted from Florida Solar Energy Center Web site www.fsec.ucf.edu/bldg/science/basics/index.htm)*

INTRODUCTION

Taking action in your community



HOMEOWNERS

Shopping for value, comfort, and quality



MANAGERS

Putting building science to work for your bottom line



MARKETERS

Energy efficiency delivers the value that customers demand



SITE PLANNERS & DEVELOPERS

Properly situated houses pay big dividends



DESIGNERS

Well-crafted designs capture benefits for builders, buyers, and business



SITE SUPERVISORS

Tools to help with project management



TRADES & CRAFTS

Professional tips for fast and easy installation

CASE STUDIES

Bringing it all together

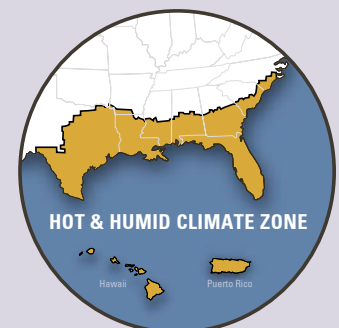

Four steps can help to manage risks and take advantage of system trade-offs.

- 1) **Give builders the right target.** Recognize you are designing a complete product—a system—and ensure the product is right for the hot and humid climate.
- 2) **Take care of the basics.** The basics are proven, cost-effective technologies that include good windows, insulation, moisture management, and ventilation. Make sure the house has adequate overhangs for shade and rain deflection. Guidelines for many of the basics are included later in this chapter.
- 3) **Take only what you need.** Size heating and cooling equipment, ducts, and fans to match the load. If equipment sizing is normally done by a subcontractor, ensure the sub uses the procedures listed in this document to properly size equipment. Proper sizing of heating and cooling equipment is a huge opportunity to save money and increase profit.
- 4) **Put everything in its place.** Be sure there is a place for everything the house requires and show it on your plans. Do not leave it to chance where ducts will be placed or even where plumbing will run. If there are places that should not be tampered with, for example a duct chase, make it clear the space is off limits to plumbers, electricians, and others who need to create routes through buildings.

Building Science and the Systems Approach: Problem Solving

Moisture, mold, and material degradation are examples of problems that building science can help solve. High temperatures create a need for cooling. High humidity adds to discomfort and is a source of moisture. Humid air and a cold surface result in condensation that can add up to discomfort, material failure, and high repair costs.

Leaky ducts located in attics or crawlspaces create air pressure differences that can draw in humid air through cracks and holes and deliver it into the house. Humid air inside a cool space encourages the occupant to turn down the thermostat for more cooling. This cycle can result in moisture forming as condensation on or in ducts, walls, and other assemblies. Accumulated moisture supports mold growth and leads to rotting, warping, and staining.

The result is that a small problem in one assembly (leaky ducts) that is inexpensive to fix during installation, can lead to big problems in framing, interior finish, and human health. Moisture problems may have causes other than leaky ducts, but many unintended problems can be avoided in a similar fashion.

Building Science and the Systems Approach: Reaping Rewards

There is more than avoiding problems to encourage you to use a systems approach. For example, trade-offs from installing energy-saving measures can help save construction costs for heating and cooling equipment. If good windows, adequate insulation, and efficient heating and cooling equipment are installed, the heating and cooling equipment capacity can also be smaller than typically used and shorter duct runs are possible. All of this can add up to reduced costs in heating and cooling equipment that offset the cost of the other measures. Using trade-offs to improve economics, durability, and comfort is essential to successful business and design.

“Understand the theory of your construction . . . then be sure to question your engineer (or subcontractor) as to whether it’s all really necessary. If you don’t get a straight, understandable answer, find an engineer who will give you one. Remember, it doesn’t cost the engineer a penny to over-design. But ultimately someone foots the bill.”

Tim Garrison, CEO of ConstructionCalc, made an important point about the cost of overdesigning structural components. He is quoted here because his point is equally valid for HVAC and other equipment (adapted from Nation’s Building News Online, 27 April 2004, www.nbnnews.com).

DESIGNERS

The challenge to designers is to carefully select new technologies, consider their cost and rewards for your overall system, and use the changes that make sense. Building America has taken this systems approach to designing energy-efficient houses. This document presents you with information that will give you a straight-forward approach to designing houses that qualify for ENERGY STAR. Design information is provided for a variety of measures and components in the remainder of this section. Put in the recommended measures and your houses should qualify. You may also qualify using other trade-offs. Suggestions from Building America's experience are also included that will improve the health and comfort of your homes.

The Cost of Doing Business

The cost of building homes is different for every builder. Technique, experience, subcontractors, suppliers, and the size of purchases can all make a difference in how much a home costs to build. Even a builder's accounting methods can influence how costs are reported. These variables all apply to energy-efficiency measures and contribute to the difficulty of providing cost estimates that apply to more than a limited example over a short period of time.

In addition to variability, other considerations apply to costs. First, the cost of higher quality housing represents an added value and holds the potential of a higher profit. Second, a tremendous benefit of the systems approach described above is that the costs of energy-efficient measures can often be offset by savings in other areas. And finally, buyers can recover any additional costs through reduced utility bills, increased resale value, and for some, better mortgage terms.

FIGURE 1: Cost Comparison of Energy Efficient Measures to Conventional Practice

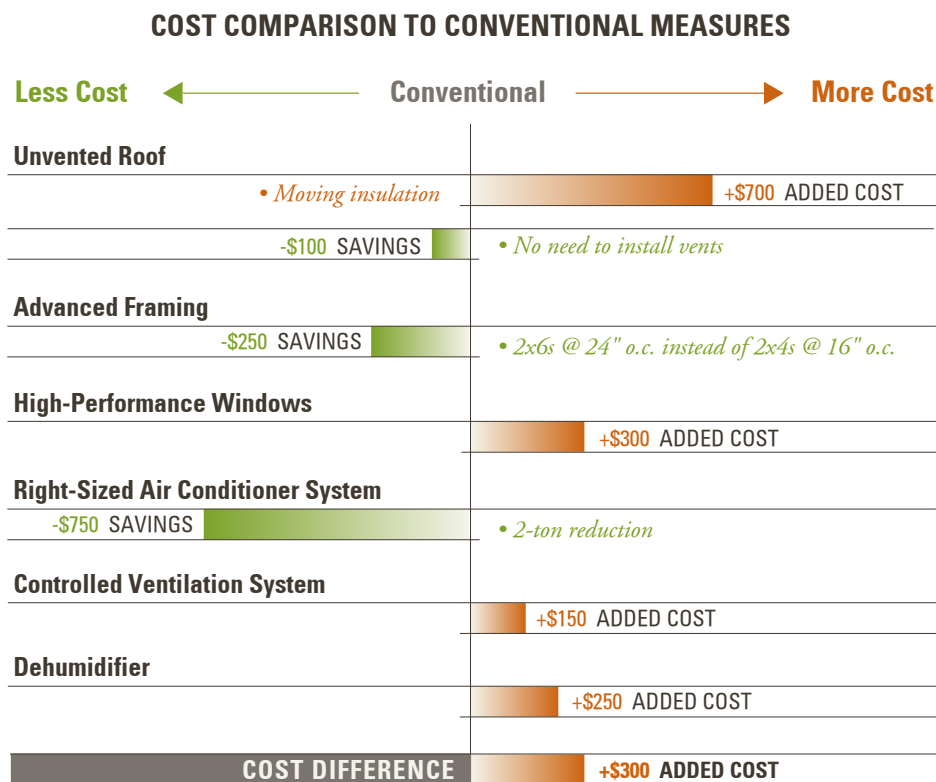

Source: Edminster, Pettit, Ueno, Menegus, and Baczek 2000.

Some builders say that meeting ENERGY STAR qualifications does not increase their costs. However, they must focus on higher quality installations. Other builders suggest additional costs up to \$1,500 to the consumer, but it's unclear if these values apply beyond their experience. The chart at left shows an estimate of costs made in the year 2000 for homes built in the hot and humid climate using a design with calculated savings of 50% for heating and 30% for cooling. The example is intended to show how costs and savings trade off, rather than to provide estimates of dollar savings.

Best Practice: Building America recommends working with a HERS rating professional, architect, or engineer early in the design process to help select and size materials and equipment. The building scientists can be especially helpful in right sizing heating and cooling equipment. By forming a relationship with a rater who later will inspect the construction site, designers can get valuable feedback about what works and what house features require more detailed information for the site supervisor and the trades.

HERS Ratings and Qualifying for ENERGY STAR

The best use of a HERS rater involves working with your rater in creating your design. When following this path, the rater analyses your construction plans, in addition to at least one on-site inspection and test of the home. The plan review allows the home energy rater to view technical information such as orientation (if known), shading area, proposed equipment ratings, and insulation levels. The on-site test involves blower door and duct testing. Results of these tests, along with inputs derived from the plan review, are entered into a computer simulation program to generate the HERS score and the home's estimated annual energy costs, based on heating, cooling, and hot water heating requirements.

A HERS rating is an evaluation of the energy efficiency of a home, compared to a computer-simulated reference house (of the identical size and shape as the rated home) that meets minimum requirements of the Model Energy Code (MEC). The HERS rating results in a score between 0 and 100, with the reference home assigned a score of 80. From the 80-point level, each 1 point increase in the HERS score results in a 5 percent reduction in heating, cooling, and hot water energy usage (compared to the reference house). An ENERGY STAR qualified new home, which is required to be 30% more efficient, must attain a HERS score of at least 86.

Your HERS rater can be a tremendous resource in the design phase. Raters who are trained in building science may help to solve construction problems. One important job your rater can help with is to work with the mechanical contractor to correctly size heating/cooling equipment, perform room-by-room calculations to determine the supply air needed for each room, and work with the mechanical contractor on duct sizes and lay out. This is likely to eliminate callbacks due to comfort complaints and can save substantial money by right-sizing the heating and cooling equipment. During the design stage, the rater can suggest alternatives to attain desired performance levels in the areas of energy, comfort, durability, and health.

Selecting a HERS rater is much like selecting any other professional services provider, such as an architect, accountant, or engineer. Be sure you are comfortable with the rater's communication skills, experience, training, and references before making a selection.

Best Practice: Building America recommends that every house receive a site inspection and diagnostic tests from a HERS rating professional. The information gained from these tests can help to isolate specific problem areas that can be solved with further training, more explicit details, better building materials, or other production changes.

HERS RATER

Building America recommends working with a HERS rater or building scientist early in the design process.

SITE INSPECTION

Building America recommends that every house receive site inspections and diagnostic tests.

Heat and Humidity

The recommendations in this *Best Practices* guide apply to the entire hot and humid climate region. If you aren't sure that your project is within the hot and humid climate region we suggest working with a HERS rater to confirm your zone. Or you can visit the Building America Web site and view the "Building America Climate Zones by Counties of the United States" document.

Hot and humid climates face several challenges for home building. The intense solar radiation in such climates imposes a large thermal load on houses that can increase cooling costs, affect comfort, and damage home furnishings. This chapter contains some of the best methods to minimize the impact of solar radiation on the building, its mechanical system, and its occupants.

Moisture is a significant problem in this climate in the form of both high humidity and high rainfall. Most of the hot and humid climate receives more than 40 inches of annual precipitation. Some areas get more than 60 inches of annual precipitation. The ambient air has significant levels of moisture most of the year. Since air conditioning is installed in most new homes, cold surfaces are present where condensation can occur. Controlling the infiltration of this moisture-laden air into the building envelope and keeping moisture away from cold surfaces are major goals of design and construction in this climate zone.

Hot and Humid Climate Design Best Practices

Housing types vary greatly throughout all of the different climate zones, but nowhere is the contrast so great as in the hot-humid climate of the southern United States. In many parts of Florida, block wall assemblies predominate, whereas wood frame is most commonly used in Texas.

In the face of this diversity, this document does not recommend a single set of measures for achieving the 30% energy savings in space conditioning, water heating, and reaching ENERGY STAR qualification. We do recommend following the principles included in these Best Practices and adjusting these practices and your designs to make them work together. We also recommend working with a building scientist such as a Home Energy Rating Professional to help with the transition.

The best practices described in this manual are intended to give builders and designers recommendations resulting from Building America's work on over 25,000 homes. Building scientists have tried and tested these measures on actual homes in the field. This does not mean that every measure will be for you. However, as builders start aiming for higher performing homes, details become more important. It may not make sense to install the best practice in every instance. Sometimes you can get away with less. But making this decision should involve an evaluation of the risks of not using the best practice, and questioning how the overall house system may be impacted.

Site – Drainage, Pest Control, and Landscaping

Additional planning information related to overall site development is presented in the *Site Planners*  chapter.

Drainage

Moving moisture away from a building is critically important to maintaining structural integrity.

FIGURE 2:
Hot and Humid Climate Zone

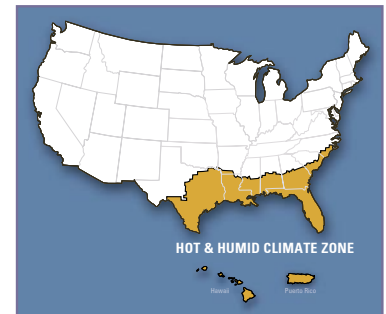
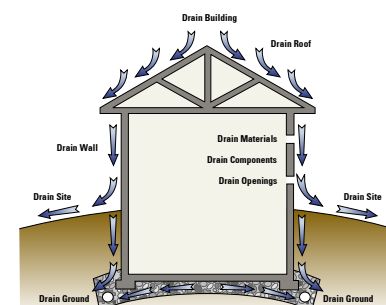



FIGURE 3: Drainage



Adapted from Lstiburek 2003

DESIGNERS

Best Practice: Grading and landscaping should be planned for movement of building run-off away from the home and its foundation, with roof drainage directed at least 3 feet beyond the building, and a surface grade of at least 5% maintained for at least 10 feet around and away from the entire structure. This topic is also discussed in the *Site Planners*  chapter.

Pest Control

Termites are a serious menace in the hot and humid climate.

Best Practice: Based on local code and Termite Infestation Probability (TIP) maps, use environmentally appropriate termite treatments, bait systems, and treated building materials for assemblies that are near soil or have ground contact (see www.uky.edu/Agriculture/Entomology/entfacts.htm).

Landscaping

Landscaping is a critical element to the marketability of a house. But plants must be placed to avoid interfering with visual inspections of termite access. Planting can also be used to shade foundations and reduce cooling loads.

Best Practice: Plantings should be held back as much as 3 feet and no less than 18 inches from the finished structure, with any supporting irrigation directed away from the finished structure. Plantings may be selected to shade the foundation edge, especially on the southwest corner of the structure. Choosing drought-tolerant plantings results in less irrigation and less chance for irrigation water to create a moisture problem in the house. Decorative ground cover—mulch or pea stone, for example—should be thinned to no more than 2 inches for the first 18 inches from the finished structure. More landscaping information can be found on DOE's Web site at www.eere.energy.gov/consumerinfo/factsheets/landscape.html.

Foundation Measures

Slabs are more cost effective and prevalent in new construction in the hot and humid climate zone than other foundation systems. Building foundations should be designed and constructed to prevent the entry of moisture and other soil gases. Moisture may cause structural decay and can contribute to human health and comfort problems. Radon that enters a home is breathed by occupants and may cause lung cancer.

Best Practice: Slabs require a 6-mil polyethylene sheeting directly beneath the concrete that accomplishes vapor control and capillary control for the slab. The vapor retarder should continuously wrap the slab as well as the grade beam. Other solutions may work for the grade beam, but a moisture retarder is needed to damp-proof the stem wall.

Best Practice: A sand layer under the slab should never be placed between a vapor retarder and a concrete slab. Cast the concrete directly on top of the vapor barrier. Differential drying and cracking is better handled with a low water-to-concrete ratio and wetted burlap covering during initial curing.

Best Practice: Sub-slab drainage should consist of a gravel capillary break directly beneath the slab vapor retarder.

In addition to other benefits, the gravel and vapor barrier are important first steps to radon control. The gravel provides a path for radon and other soil gas to escape to the

GRADING

Plan grading and landscaping to direct run-off away from the home and its foundation.

TERMITES

Use environmentally appropriate termite treatments.

PLANTINGS

Select draught-tolerant plantings and keep them at least 18 inches from the foundation.

VAPOR CONTROL

Achieve vapor and capillary control with 6 mil polyethylene sheeting directly below the slab.

CASTING CONCRETE

Cast the concrete directly on top of the vapor barrier, with no sand in between

DRAINAGE

Place a gravel capillary break directly beneath the slab vapor barrier.

DESIGNERS

atmosphere rather than being drawn into the house. And the vapor retarder helps to block soil gas entry into the house. Where gravel is scarce, such as in Florida, builders often pour slabs onto sand. When sand or other native fill is used, a 3- or 4-inch perforated and corrugated pipe loop can be use for both drainage and radon control. Or drainage matting may be installed over sand. Both approaches are described in a US EPA document described in the following list., *Building Radon Out* (2001).

Radon-resistant construction practices are described in the following documents:

- *ASTM WK2469 New Standard (Formerly E1465-92)(draft) Guide for Radon Control Options for the Design and Construction of New Low-Rise Residential Buildings*
- *Model Standards and Techniques for Control of Radon in New Residential Buildings* (U.S. EPA 1994)
- *Building Radon Out: A Step-by-Step Guide on How to Build Radon-Resistant Homes* (U.S. EPA 2001) available on the web at www.epa.gov/199/radon/images/buildradonout.pdf.

FIGURE 4: Typical Building Slab Foundation

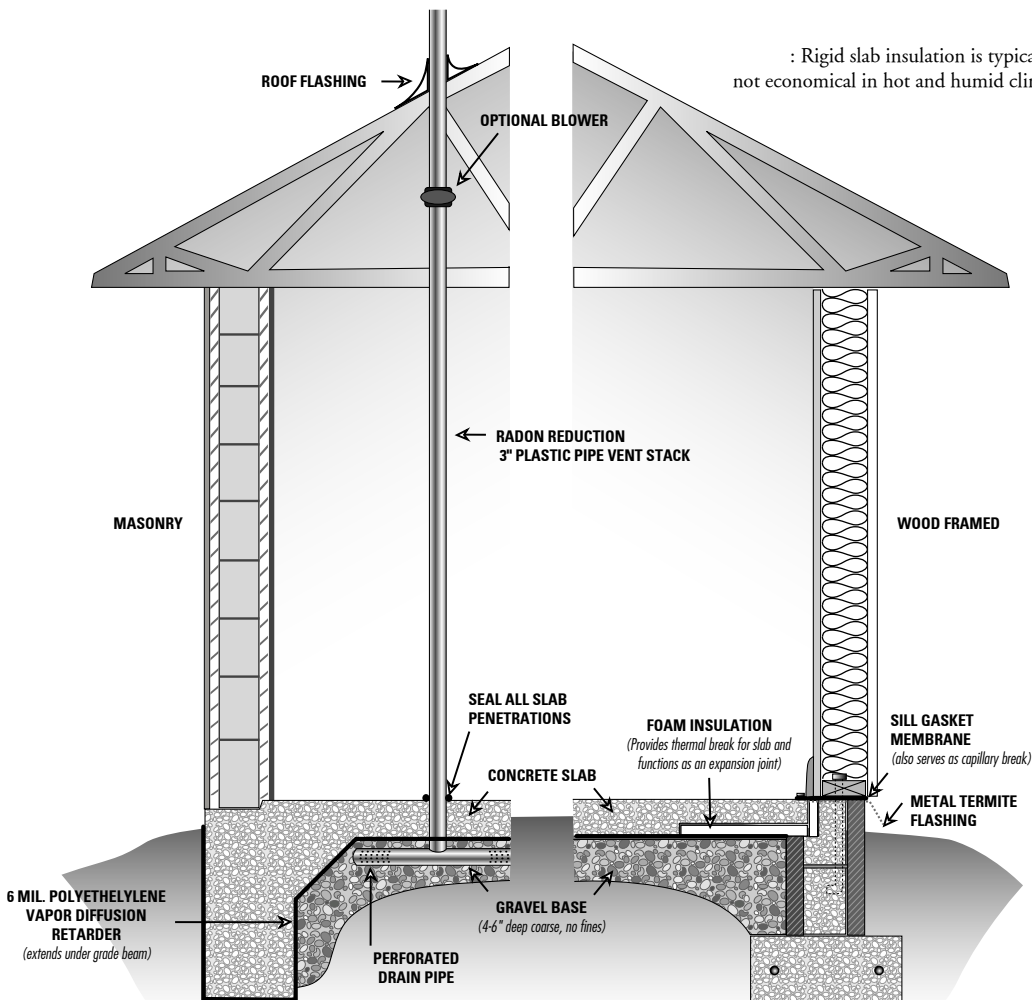

Adapted from Building Science Corporation

Best Practice: Other than identifying areas that have had radon problems, it is not possible to predict radon levels in houses prior to construction, so it is important to include inexpensive radon control measures. One measure recommended by the EPA to control potentially high radon levels and other soil gasses, is a passive soil gas stack connected to a perforated drain pipe embedded in the gravel under the slab. The stack may also be attached to a perforated pipe loop or mat. If it turns out the house has unacceptable radon levels, a fan can be added to the stack to actively draw soil gas away from the house. To determine potential radon levels in the county in which you are building, visit the EPA's radon potential map at: www.epa.gov/radon/zonemap.html.

For information about local variation in radon levels you can find local contacts at the following EPA web site: www.epa.gov/iaq/wherewelive.html. The EPA divides counties into one of three zones based on radon level potential. The EPA recommends that all homes built in Zone 1 (high radon potential) areas have radon reduction systems.

Foundation Energy Performance

Slabs in this climate are generally not insulated, even at the perimeter, because of the low overall heating load and code restrictions on below-grade use of rigid foam insulation.

Crawlspace Foundation Systems

Although not prevalent, some houses in the hot and humid climate are built with crawl spaces. Crawlspaces should be built as a conditioned space. Insulation should be applied to exterior walls and vents to the exterior should not be installed. The crawlspace should receive conditioned air from at least one supply duct, and transfer grills should allow for the transfer of air back to the living space. Other features include ground cover that is continuous and sealed to the perimeter walls and piers, air sealing of the exterior walls, and sealed air distribution ducts. If a heating system is installed in the crawlspace, use only a sealed combustion appliance. For more information see:

- The addendum to the *Site Supervisors*  chapter, look for the section entitled: *Details for Mechanically Vented Crawlspaces*.
- Yost, Nathan. May 2003. "The Case for Conditioned, Unvented Crawl Spaces." *Building Safety Journal*. Available on the BSC web site at: www.buildingscience.com/resources/articles/24-27_Yost_for_author.pdf
- The *Montgomery Building Profile* in the *Building America: Houses that Work* section of the BSC Web site: www.buildingscience.com/housethatwork/hothumid/montgomery.htm

Structural Moisture Control

Best Practice: Roof and wall assemblies must contain surfaces that will drain water in a continuous manner over the entire area of the building. Water must have a path that will take it from its point of impact, around any elements such as windows, doors, and seams, all the way to the exterior ground, sloping away from the house.

Best Practice: In areas with potentially high winds and heavy rains install four inch to six inch "peel and seal" self adhering water-proofing strips over joints in roof decking before installing the roof underlayment and cover.

RADON

Houses built in areas with potentially high radon levels can install a soil gas stack to draw soil gas away from the home.

VAPOR BARRIERS

Roof and wall assemblies must contain elements that, individually and in combination, permit drying of spaces inside of walls.

WATER-PROOFING ROOF DECKING

Install water-proofing strips over joints in roof decking.

DESIGNERS

Two types of rain management systems have been identified: barriers and screens. Barriers rely on exterior cladding to drain water and are best used with water-resistant building materials, such as masonry block or concrete. Screens have multiple lines of defense against water entry and are used with wood, brick, and gypsum-based materials. Both barriers and screens rely on lapped flashings to direct water to the exterior at critical areas such as seams, windows, and penetrations. In both systems, it is essential that materials are lapped shingle fashion to direct water down and out, away from the wall assembly.

Water Leakage

One critical point of concern is water leakage around windows. The *EEBA Water Management Guide* offers examples of many window flashing applications. The window flashing examples here are taken from the *Trades*  chapter. These examples are for homes with housewrap and plywood or OSB sheathing.

Best Practice: Specify that flashing be installed for all windows and doors. Window and door flashing details should be designed to match specific wall assemblies and claddings.

Flashing systems should be designed in accordance with the ASTM standard entitled *Standard Practice for Installation of Exterior Windows, Doors, and Skylights* (ASTM 2002). In addition to the standard and the EEBA guide, see DOE's *Technology Fact Sheet on Weather-Resistive Barriers* (DOE 2000), available on the web at www.eere.energy.gov/buildings/documents/pdfs/28600.pdf.

The hot and humid climate is especially vulnerable to catastrophic high-wind, heavy-rain events, such as hurricanes, tropical storms, and tornadoes. Proper structural fastening and impact resistant windows, doors, and skylights are critical to surviving high winds. Proper use of roofing materials can help roofs withstand high winds and protect against severe rains. This document does not provide detailed information on disaster survival but the following sources provide structural details and guidance and a listing of building materials acceptable for high wind areas.

- Federal Emergency Management Agency. *Building a Safe Room Inside Your Home*. www.fema.gov
- Florida Alliance for Safe Homes – FLASH, Inc. Building guidelines for hazardous areas in Florida. *Blueprint for Safety*. www.blueprintforsafety.org
- Institute for Business and Home Safety. The IBHS has building guidelines and public information. www.ibhs.org
- Miami-Dade County Building Code Compliance Office. This site includes a searchable database of building materials approved for high-wind locations. www.buildingcodeonline.com
- U.S. Department of Energy. A training program for home inspectors to identify hazards. www.eere.energy.gov/weatherization/hazard_workshop.html

Vapor Management Around Windows

With most areas in the hot and humid climate receiving at least 40 inches of rain per year, the source of water problems should be obvious, the rain. But water has many guises and water in its liquid state is not the only problem. Water can also cause

WINDOW FLASHING

Flashing should be installed for all windows.

FIGURE 5:
Window Flashing Building Tips

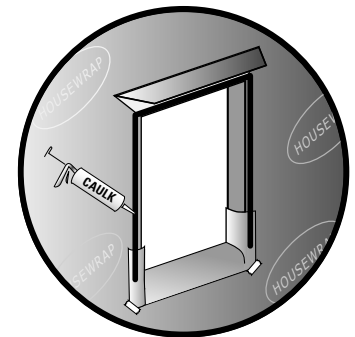

Complete instructions for window flashing are provided in the Trades and Crafts section of this handbook.

DESIGNERS

problems as vapor. The problem is especially bad when vapor gets trapped within an assembly, such as a wall; turns to its liquid form (condenses); and wets structural assemblies. Condensation can also form in and on ductwork, especially when air conditioning cools duct surfaces that come in contact with humid air, such as in an attic or crawlspace. The recommendations below are intended to control both liquid water and vapor.

Best Practice: Do not install impermeable coverings, such as vinyl wallpaper, on exterior walls and do not install vapor barriers on the framing side of gypsum board or other wall coverings. Use unfaced insulation.

Best Practice: Water soaking through wood can carry with it contaminants that interfere with the ability of housewraps and building papers and felts to resist water. One step in the solution is to backprime all wood cladding to avoid water saturation and migration. This practice also makes the wood much more durable.

Best Practice: Creating an air space between the cladding and the drainage plane effectively increases the durability of both components. With some exterior finishes, such as bricks, an air space is even more important. An air space stops the capillary movement of moisture, stops the contamination of the drainage plane via contact with the cladding, and allows for better drying. Information on housewrap and building paper performance behind brick and stucco can be found at www.buildingscience.com/resources/walls/brick_stucco_housewraps.pdf

Best Practice: If building paper or felt is used in areas prone to severe rain, install two layers. The use of two layers was once common and provides better than twice the performance of one layer. By providing a double drainage plane, they offer increased resistance to leakage at fasteners and allow for more flexible installation.

Best Practice: Installation is key for all types of housewraps. The sheets must be lapped, shingle-style, especially over and around windows, doors, and other penetrations (and their flashing systems). Use manufacturer-specified fasteners and space them closely enough to provide required support.

Additional information on moisture control can be obtained from:

- DOE's *Technology Fact Sheet on Weather-Resistive Barriers*, available on the web at www.eere.energy.gov/buildings/documents/pdfs/28600.pdf
- Building Science Consortium's web site at: www.buildingscience.com/housethatwork/buildingmaterials where you can compare wraps and other materials
- www.buildingscience.com/resources/walls/problems_with_housewraps.htm
- The following article provides an overview of house wraps and was a key source for this section: Straube, John. 2001. "Wrapping it Up," *Canadian Architect*. May, 2001. Available at: www.cdnarchitect.com.

IMPERMEABLE COVERINGS

Never install impermeable coverings inside the house.

BACKPRIMING

Backprime all wood cladding to avoid water saturation.

AIR SPACE

Creating an air space between the exterior finish and the drainage plane effectively increases the durability of both components.

TWO LAYERS OF BUILDING PAPER OR FELT

Consider installing two layers of building paper or felt to create a double drainage plane.

CAREFUL INSTALLATION

Pay close attention to lapping around windows and doors, as well as the proper use of fasteners.

Housewrap, Building Paper, or Felt – Your Choices for Wrapping it Up

Housewrap, building paper, or impregnated felt should be part of the exterior wall system that protects the building from water penetration. None of the materials are waterproof, but are intended to shed rainwater that penetrates exterior cladding. The surface formed by these materials is called a drainage plane, house membrane, or rain barrier. They are used to shed liquid water that may penetrate siding or roofing and to prevent liquid water from wicking through them, while remaining sufficiently vapor permeable (“breathable”) for outward drying (Straube 2001). By helping to keep building materials dry, these membranes improve building durability, decrease maintenance costs, and reduce the risk of moisture-related problems such as pests, mold, and rot.

Building Paper is a Kraft paper sheet impregnated with asphalt to increase its strength and resistance to water penetration. It is primarily employed as a drainage layer. It is graded according to a test of the amount of time required for a water-sensitive chemical to change color when a boat-shaped sample is floated on water. Common grades include 10, 20, 30, and 60 minutes. The larger the number, the more resistant the paper is to water.

Building Felts have been in use over a hundred years. Originally made from rags, today’s felts are made of recycled paper products and sawdust. The base felt is impregnated with asphalt. Ratings for felt harken back to the traditional weight of the material before the oil crisis of the 1970s. At that time 100 square feet of the material (1 square) weighed about 15 pounds. Modern #15 felt can weigh from 7.5 to 12.5 pounds per square depending on the manufacturer.

Housewrap typically refers to plastic sheet materials. Housewrap comes in a variety of materials and can be perforated or non-perforated. If joints and connections are sealed, housewraps can serve as air retarders to reduce air leakage. Housewraps are highly resistant to tearing, unlike building paper. Non-perforated wraps tend to have higher liquid water resistance because the holes between plastic fibers are very small.

Most building paper is UV-resistant, whereas recommended housewrap exposure limits may vary by manufacturer. Check with manufacturers if outdoor exposure will exceed a month. One person can usually install building paper, while housewrap requires two people. However, housewrap is available in wide sheets that can cover an entire one-story wall surface in a single pass.

Roof and wall assemblies must contain elements that, individually and in combination, permit drying of spaces inside of walls and other assemblies. Exterior housewraps, including building paper, will allow vapor to pass through and should be installed on the exterior of sheathing. Interior walls should be painted but not covered with plastic vapor retarders (on the framing side of gypsum board) or impervious coatings, such as vinyl wallpaper.

A more recent and graphical reference on moisture control is the EEBA *Water Management Guide* (Lstiburek 2003), available for sale from the EEBA Bookstore, on the web at: www.eeba.org/bookstore.

Structural Air Sealing

FIGURE 6: Envelope Air Sealing

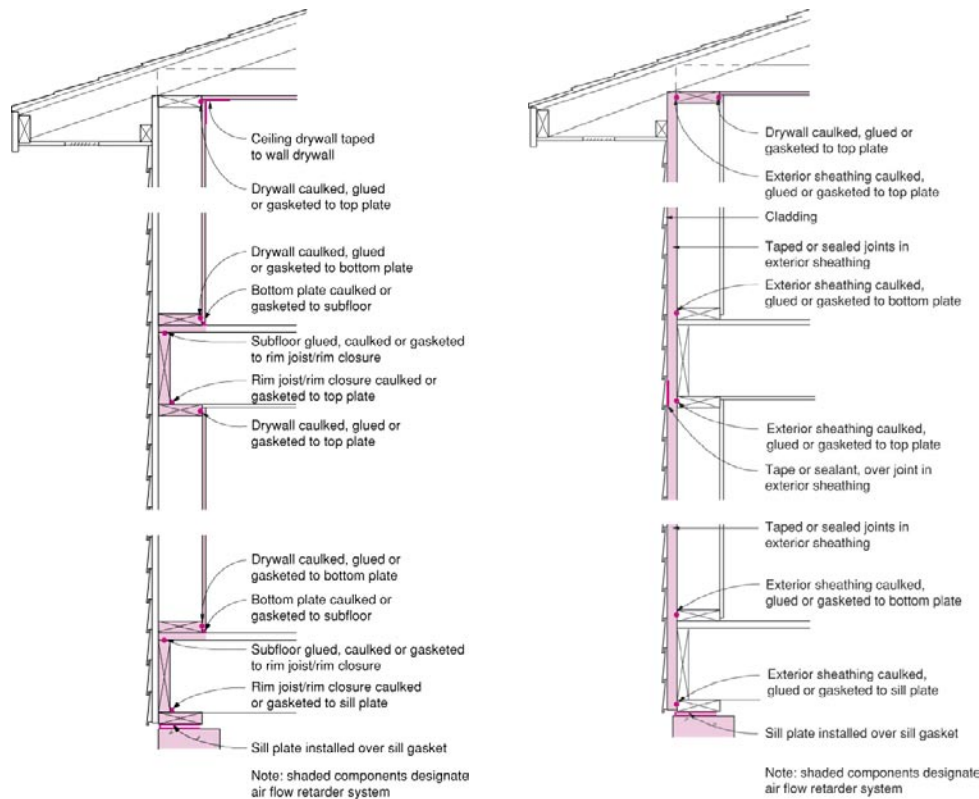

Building Science Corporation

Best Practice: Use either interior gypsum board, exterior sheathing, or both as an air flow retarder. Exterior stucco may also serve as an air barrier. Carefully seal big and little holes. Pay particular attention to sealing shared walls and attic spaces between garages and houses.

A tight building envelope is necessary to control the movement of air in and out of building assemblies. Air infiltration can contribute to problems with moisture, noise, dust, and the entry of pollutants, insects, and rodents. Using mechanical ventilation as a superior approach to supplying fresh air is discussed in the section on Mechanicals, Electrical, and Plumbing.

Moisture-laden air moving into wall or roof assemblies (particularly from the outside while cooling in hot-humid climates) may lead to condensation and result in deterioration of moisture sensitive materials. Airflow retarders can be installed on the interior or the exterior side of the envelope or on both sides. Insulation made up of batt or loose fill products does not seal against air leakage. Rigid foam board insulation can be used as both a moisture and air retarder.

Controlling air movement through the building envelope requires sealing both the “big” holes and the “little” holes. The big holes occur behind bathtubs and showers on exterior walls, behind fireplaces, and where soffits or utility walls (double wall with chase) meet exterior walls or ceilings. Recessed lights collectively can be a really big hole

AIR SEALING

Be sure to seal shared walls and attic spaces between garages and houses.

DESIGNERS

in the ceiling assembly. These big holes are responsible for wasted energy (high utility bills) and condensation that can cause mold and wood decay. These holes are easy to seal during the framing stage but only when someone has the responsibility for making sure it gets done. Only airtight recessed lights (ICAT rated) should be used in ceilings leading to unconditioned spaces.

The little holes occur between framing members (such as band joist to sill plate), around electrical boxes, and where plumbing or wiring penetrate the envelope. All penetrations leading to unconditioned spaces should be sealed with foam or caulk. See the *Trades* chapter, *Building Tips* on air sealants and the instructions for plumbers, electricians, and framers. Also see the sections later in this chapter for plumbing and electrical.

When air sealing drywall, gypsum board acts as an interior air flow retarder. The gypsum board is sealed to the framing members at the perimeter of exterior walls and around penetrations such as doors, windows, and attic hatches. The gypsum board is also sealed to electrical boxes on exterior walls. Air cannot move through the gypsum board and the taped corners.

There are many approaches and practices to sealing buildings. Many details and photographs of air sealing techniques can be found on the Building Science Corporation web site at: www.buildingscience.com/housethatwork/airsealing.htm, in the EEBA *Builders Guides*, and in the DOE *Technology Fact Sheet on Air Sealing* available on the web at: www.eere.energy.gov/buildings/documents/pdfs/26448.pdf.

Best Practice: One area to pay attention to for sealing is the intersection of the walls and roof. This area may involve an attic, cathedral ceiling, knee walls, all of the above, or other examples of complex rooflines. Figures 7 and 8 show knee wall examples. Tight sealing of this intersection may require blown-in foam.

Another area needing special attention for occupant health and safety is sealing shared walls and ceilings between attached garages and living spaces. Carefully seal any penetrations, block air pathways through the attic, and weatherstrip any doors.

Structural Thermal Performance

Properly installed insulation is like your favorite winter comforter for keeping heat where it's wanted. Any interior insulation type is acceptable that has vapor permeability. These include cellulose, fiberglass, and foam. Foam can also serve as an air retarder, but air sealing must be accomplished by a separate component or system when cellulose or fiberglass is used.

The following descriptions of insulation were adapted from DOE's Fact Sheet on Insulation available on the web at: www.ornl.gov/sci/roofs+walls/insulation/ins_08.html.

INTERSECTIONS OF WALLS & ROOF

Tight sealing of the intersection of the roof and wall may require blown-in foam.

FIGURE 7 & 8: Knee Walls

Figures 7 and 8 show possible approaches to sealing knee walls.

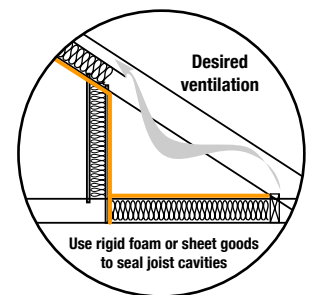

Seal knee wall to create a continuous air barrier. Knee walls can be sealed following the wall and attic floor.

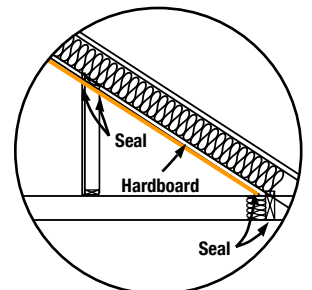

In new homes, it is preferred to seal along the sloping edge of the attic roof.

BLANKETS

Blankets in the form of batts or rolls are flexible products made from mineral fibers, typically fiberglass. They are available in widths suited to standard wall, floor, and attic framing spaces. Continuous rolls can be hand-cut and trimmed to fit. They are available with or without vapor retarder facings. High-density fiberglass batts are about 15% more effective than traditional batts. Even if you choose to use other types of insulation, such as blown or sprayed in cellulose or foam, batts can be installed in areas that may become inaccessible as construction unfolds. These areas could include behind-shower inserts, stairs, or rim joists. Batt also make good dams in attics around access points or other areas where blown-in insulation should be held back.

Best Practice: When fiberglass batt insulation is specified, use high-density, unfaced batts. Batt facing is a vapor retarder and can trap moisture inside walls.

BLOWN-IN

Blown-in, loose-fill insulation includes loose fibers or fiber pellets that are blown into building cavities or attics using special pneumatic equipment. Another form includes fibers that are co-sprayed with moisture or an adhesive that allows them to set in walls and makes them resistant to settling. The blown-in material can provide some resistance to air infiltration if the insulation is sufficiently dense.

FOAMED-IN-PLACE

Foamed-in-place polyurethane foam insulation can be applied by a professional applicator using special equipment to meter, mix, and spray into cavities. Polyurethane foam makes an excellent air seal and can be used to reach hard-to-get-at places.

RIGID INSULATION

Rigid insulation is made from fibrous materials or plastic foams that is pressed or extruded into sheets and molded pipe-coverings. These provide thermal and acoustical insulation, strength with low weight, and coverage with few heat loss paths. Such boards may be faced with a reflective foil that reduces heat flow when next to an air space. Foil facing also makes the board nearly impervious to water and vapor and so should be used with caution. Rigid foam insulation may be used in combination with other insulation types, such as on the exterior of walls that are filled with cellulose or fiberglass. Foam sheets that may be in contact with the ground should be borate-treated for termite resistance. *(See Figure 10 on page 16 for an example of rigid foam insulation)*

REFLECTIVE INSULATION SYSTEMS

Reflective insulation systems are fabricated from aluminum foils with a variety of backings such as roof sheathing, kraft paper, plastic film, polyethylene bubbles, or cardboard. The resistance to heat flow depends on the heat flow direction; this type of insulation is most effective in reducing downward heat flow and requires an air space adjacent to the reflective surface. Reflective systems are typically located between roof rafters, floor joists, or wall studs. Reflective insulation placed in walls must be perforated. If a single reflective surface is used alone and faces an open space, such as an attic, it is called a radiant barrier. Radiant barriers are sometimes used in buildings to reduce summer heat gain and winter heat loss. They can be effective in the hot and humid climate at reducing peak cooling loads, especially if ductwork or cooling

INSULATION

Use high-density batts, when fiberglass batt insulation is specified.

FIGURE 9: Insulation



Blown-in wall insulation



Batt insulation



Reflective insulation



*Soy-based foams are now available
(Photo: Building Science Corporation)*

equipment is located in the attic. All radiant barriers must have a low emittance (0.1 or less) and high reflectance (0.9 or more). Additional information on radiant barriers is available in the following sources:

- *FPC Residential Monitoring Project: New Technology Development – Radiant Barrier Pilot Project*, available at the FSEC Web site at: www.fsec.ucf.edu/bldg/pubs/rbs/index.htm.
- DOE's *Radiant Barrier Attic Fact Sheet*, available on the web at www.ornl.gov/sci/roofs+walls/radiant/rb_01.html

How Much Insulation Do You Need?

This is an excellent question to ask your Home Energy Rater. The answer depends on your location, the overall design, and the efficiency of other building features. The ENERGY STAR website contains Builder Option Packages (BOPS) that recommend insulation levels on a county by county basis. The BOPS can be found at www.energystar.gov. Examining the ENERGY STAR BOPs provides some examples of how insulation can be traded off with other features such as efficient windows and HVAC systems. DOE can also help with insulation recommendations for each zip code. Visit the web site below. Have in hand the first three digits of your zip code and the type of heating system that you are considering. The calculator will recommend an insulation level.

www.ornl.gov/sci/roofs+walls/insulation/ins_16.html

If you prefer to work with a map, the following DOE Web site will give you recommended insulation levels.

www.eere.energy.gov/consumerinfo/energy_savers/r-value_map.html

These recommendations are only guidelines and are limited in scope. The more complex or advanced your design, the more you should rely on specific calculations.

Frame Walls

Best Practice: Best practice for frame wall construction involves advanced framing techniques. However, these techniques are not required to achieve 30% space conditioning energy savings in the hot and humid climate. If you want to gain greater efficiency, more information on advanced framing can be found in the guidance provided in this document for code officials, in the *EEBA Builders Guides*, in DOE's *Fact Sheet on Wall Insulation*, and on the web at www.buildingscience.com/housesthatwork/advancedframing/default.htm. If advanced framing is to be used, a detailed plan should be developed showing framing placement.

External walls with 2 x 4 framing may achieve 30% energy space conditioning savings in the hot and humid climate and should include the following features:

- Examples of exterior finish can include stucco over paper (paper to have perm rating of <1 perm) backed with lath, vinyl siding, or cementitious board.

ADVANCED FRAMING

Consider advanced framing techniques when constructing walls.

DESIGNERS

- A housewrap should be installed as an air and water barrier.
- Insulation may be R-13 (high-density) friction-fit, unfaced fiberglass insulation or blown-in cellulose insulation.
- Frame walls between the garage and the conditioned space, including bonus rooms, should have R-13 friction-fit, unfaced batt insulation.
- Rim joists: unfaced R-13 friction-fit batt insulation cut to fit.
- Penetrations: Foam seal or caulk all top-plate penetrations and exterior wall penetrations.
- In addition to sealing all penetrations, air leakage through the walls should be controlled by sealing the gypsum board. Pay particular attention to air sealing penetrations to garages and porches.

Masonry Walls

Masonry walls are common in parts of the hot and humid environment, especially south Florida. Masonry walls may be finished with stucco, wood, or other claddings. Best practices to improve thermal efficiency include the following:

- Semi-vapor permeable rigid insulation should be installed on the interior of wall assemblies and should be unfaced. Foil facing and polypropylene skins should be avoided.
- Wood furring should be installed over rigid insulation. The rigid insulation should be continuous over the surface of the wall, except for a 2x4 furring at the intersection with the ceiling. This blocking attaches directly to the masonry block and serves as draft and fire stop. The rigid insulation abuts the blocking but does not cover it or extend behind it. Penetrations: Foam seal or caulk all top plate penetrations and exterior wall penetrations.
- Electrical boxes can be surface mounted to the masonry, avoiding chipping or chiseling. The rigid insulation, furring, and gypsum board will build up around the box for a flush finish.
- Use pressure treated lumber to frame out sub-jambs and spacers within window and door rough openings.
- As with other walls, penetrations to the exterior or through top and bottom plates should be foam sealed or caulked.
- In addition to sealing all penetrations, air leakage through the walls should be controlled by sealing the gypsum board. Pay particular attention to air sealing penetrations to garages and porches.
- When pouring the slab take care to create a seat in the concrete to accept the block and seats in the concrete to act as drain pans where exterior doors and sliding doors will be located.

More information on masonry construction can be found in the *Builders Guides* (Lstiburek 2002) and on the web at the Building America *Houses that Work* section of the Building Science Corporation Web site www.buildingscience.com/housethatwork/hothumid/orlando.htm. Look for the *Orlando Profile*. Window flashing details can be found in the ASTM standard entitled *Standard Practice for*

FIGURE10: Masonry Walls



DESIGNERS

Installation of Exterior Windows, Doors, and Skylights (ASTM 2002) and the *EEBA Water Management Guide*. The *Water Management Guide* also contains information on other approaches to draining masonry assemblies. The *Trades*  chapter contains a building tips sheet for masonry walls.

Concrete Walls

Some builders in the hot and humid climate are beginning to use poured concrete walls for residential construction. For more information on this approach see *Builder System Performance Package Targeting 30%-40% Savings in Space Conditioning Energy Use* prepared by CARB (CARB 2004).

Windows

Best Practice: Specify efficient windows to control solar energy gains and to help reduce heating and cooling loads. Some Building America experts recommend that, nationwide, windows be used with a U-factor of 0.35 or lower and a SHGC of 0.35 or less. Note that ENERGY STAR qualification can be met with windows at less stringent ratings.

Windows are a prominent feature of any wall. High-performance windows can be an easy way to achieve ENERGY STAR qualification. Efficient windows will add expense to your project, but will provide tremendous value in comfort, durability, and energy savings. High-performance windows add so much to energy efficiency that smaller cooling and heating equipment can often be specified, which may recapture much of the cost. A voluntary rating system developed by the National Fenestration Rating Council (NFRC) provides performance information for about half the windows sold. The NFRC label contains ratings for the following features. You can find more information about the NFRC on the web at: www.nfrc.org.

- U-factors take into account the entire window assembly and rate how well the window prevents heat from passing through the window. The lower the U-factor the better the window performs at stopping heat flow. U-factors are the inverse of R-values used to measure the effectiveness of insulation. U-factor values for windows generally fall between 0.20 and 1.2.
- SHGC is the solar heat gain coefficient, which measures how well the window blocks heat caused by sunlight. The lower the SHGC rating the less solar heat the window transmits. This rating is expressed as a fraction between 0 and 1.
- Visible transmittance (VT) measures how much light comes through a window. VT is expressed as a number between 0 and 1. The bigger the number the more clear the glass.
- Air leakage through a window assembly is included on most manufacturers' labels, but is not required. The AL rating is expressed as the equivalent cubic feet of air passing through a square foot of window area (cfm/sq.ft.) The lower the AL, the less the window leaks. A typical rating is 0.2.
- Another optional rating is Condensation Resistance (CR), which measures the ability of a product to resist the formation of condensation on the interior surface of that product. The higher the CR rating, the better that product is at resisting condensation formation. While this rating cannot predict condensation, it can provide a credible method of comparing the potential of various products for condensation formation. CR is expressed as a number between 1 and 100, with a higher value representing more resistance to the formation of condensation.

WINDOWS

Specify efficient windows to control solar energy gains and to help reduce heating and cooling loads.

FIGURE 11: NFRC Window Label

	World's Best Window Co. Millennium 2000+ Vinyl-Clad Wood Frame Double Glazing • Argon Fill • Low E Product Type: Vertical Slider
ENERGY PERFORMANCE RATINGS	
U-Factor (U.S./I-P) 0.35	Solar Heat Gain Coefficient 0.32
ADDITIONAL PERFORMANCE RATINGS	
Visible Transmittance 0.51	Air Leakage (U.S./I-P) 0.2
<small>Manufacturer stipulates that these ratings conform to applicable NFRC procedures for determining window product performance. NFRC ratings are determined for a fixed set of environmental conditions and a specific product size. Consult manufacturer's literature for other product performance information. www.nfrc.org</small>	



Energy efficient windows are comfortable to sit near and provide protection for furniture and window treatments.

DESIGNERS

ENERGY STAR qualifies specific windows in addition to qualifying houses. For the southern climate region all windows, doors, and skylights qualifying for the ENERGY STAR label must have a U-factor rating of 0.75 or below and a SHGC rating of 0.40 or below. You need not use ENERGY STAR-labeled windows to qualify a total house for an ENERGY STAR label.

The Efficient Windows Collaborative operates a web site that can help designers and consumers choose windows. The web site includes a tool that allows users to analyze energy costs and savings for windows with different ratings. Visit the web site at: www.efficientwindows.org/index.cfm.

The web site also has fact sheets with comparisons for each state. These fact sheets could make effective marketing tools. Also described on the Web site is a book entitled *Residential Windows: A Guide to New Technologies and Energy Performance* (Carmody et al. 2000), which offers homeowners, architects, designers, and builders a fascinating look at the state of the art in window technology. Emphasizing energy performance, the book covers every aspect of window design and technology: the basic mechanisms of heat transfer; new products and rating systems; the effects of window frame material and installation; and how to make the best decisions when purchasing windows.

Overhangs

Best Practice: Design roofs with overhangs to shade and protect windows and doors. Overhangs may take the form of eaves, porches, or other design features such as awnings, pergolas, or trellises.

Single glazing is not recommended, but when a house has clear single glazing, light-colored interior shades, overhangs, and combinations of shading devices significantly reduce energy costs. Naturally, a completely shaded house has the best performance in a hot climate.

Reliance on any form of shading is not nearly as important when windows with a low solar-heat-gain coefficient are used. Using a low-solar-gain low-E coating results in great energy cost reductions for all conditions even with no shading. This is because the glazing itself provides the necessary control of solar radiation, so shading measures become less important in terms of energy use. For a description of the interactions between window performance and shading, see the Efficient Windows Collaborative Web site at www.efficientwindows.org.

Overhangs should be sized to account for differences in sun angles, elevation, window height and width, and wall height above the window. Free and low-cost computer programs and tools are available to help. For example a free program telling you the angle of the sun for any point in the country is available at www.susdesign.com/sungangle/. Latitude, longitude, and elevation data can be obtained at www.wunderground.com. Overhang dimensions can be calculated at www.susdesign.com/overhang/index.html. For a listing of free and available-for-purchase energy models, including solar design tools, see DOE's Building Technology Program Web site at www.eere.energy.gov/buildng/index.cfm?flash=yes. Click on Software Tools on the lower right side. A low-cost sun angle calculator is available from the Society of Building Science Educators at www.sbse.org/resources/sac/index.htm.

Overhangs also provide protection from rain, hail, and the effects of overheating and ultraviolet radiation on siding and windows.

OVERHANGS

Design roofs with overhangs to shade and protect windows and doors.

FIGURE 12: Overhangs

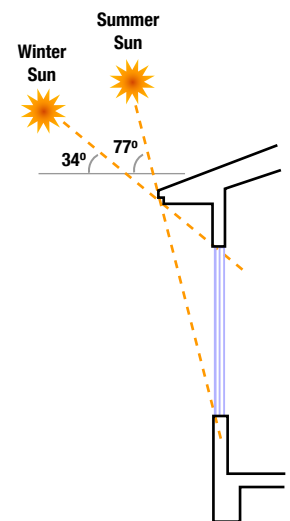

Sun angles for Charleston, South Carolina. A four foot window would need an overhang extending 18 inches with 12 inches of wall above the window.

Ceilings and Roofs

As indicated earlier, ceilings, roofs, and attics represent complex building assemblies. In addition to the sealing and insulation approaches shown in the *Air Sealing* section, here are additional insulation guidelines. These guidelines apply to traditionally ventilated attics. Unvented attics must be tightly sealed and are not described in detail in this guide.

- If attic access is provided, it must be insulated and weather-stripped.
- Use baffles to allow ventilation air to freely flow past insulation.
- Install an “energy” truss for more headroom at the eave to avoid compressing insulation and allow for consistent attic coverage.
- Use dams to hold insulation away from openings and storage areas. Thick batt insulation makes an excellent dam. Waxed cardboard, foam sheathing, and other sheet goods can also be used as dams.
- Only recessed lights rated for “insulated ceiling and air tight” (ICAT) should be installed in ceilings. See the section on electrical for more information.

Heating, Ventilating and Air Conditioning

Best Practice: For the best results in comfort, efficiency, and durability, HVAC system design for both equipment and ducts must be integrated in the overall architectural design. Work closely with your HERS rater, HVAC engineer, or HVAC contractor to properly design, size, and select your HVAC equipment. If done properly, you will save money and go a long way with this single step toward improved energy efficiency and comfort and substantial cost savings.

A well-designed house should have an HVAC system properly sized to its demands. Proper equipment sizing ensures a comfortable environment and provides opportunities to recapture some of the expense of an efficient building envelope. Rules of thumb for equipment sizing do not work in modern homes and should not be used.

Unfortunately, rules of thumb are still prevalent. A Florida survey points out some of the practices of HVAC contractors (Viera, Parker, Klonbergo, Sonn, and Cummings 1996). Although only a small percentage of Florida’s HVAC contractors responded, the survey found that about one-third of respondents size air conditioning and duct capacities based on square footage or other rules of thumb. Compounding the problem, the rules were not consistently applied. Some respondents provided twice as much capacity as others for a given square footage of floor area. Over one-third of respondents indicated intentional oversizing of HVAC equipment on some jobs, in order to avoid complaints, accommodate future expansions, enable quicker cooling down of homes, and to allow for lower cooling set points by homeowners.

Sizing Air Conditioners

Best Practice: Right size air conditioners and other HVAC equipment.

In addition to wasting energy and money, oversized air conditioning systems in a hot and humid climate may cause moisture problems. Besides cooling, air conditioners provide the valuable service of removing moisture from the air. If humidity is not removed, reducing the temperature will create condensation on cool surfaces and create cold, clammy conditions. To compensate for the clamminess, occupants are likely to

Builder GW Robinson of Gainesville, Florida, was able to go from two HVAC units - a 5-ton unit for the house and a 1.5-ton unit for the bonus room - to a 4-ton HVAC unit for the whole house, by giving extra thought to duct layout, specifying duct layout on the floor plans and using zone dampers and return air pathways in each room of his up-to 4,500.sq.ft. houses.

HVAC

Integrate HVAC system design in the overall architectural design.

“The recommended changes in our practices meant we were able to downsize our equipment by a half-ton,” explains Andrew Nevitt, Medallion’s head architect. “Our contractors were concerned that they’d experience increased callbacks because of comfort issues.” That hasn’t been the case. Medallion is building all its homes to reach Energy Star performance levels and is working with Building America to learn practices that will push the performance of its homes even further. (as reported in Professional Builder 3/1/03)

RIGHT-SIZING

Right size air conditioners and other HVAC equipment.

DESIGNERS

set the temperature much lower than would be the case if the space were drier, wasting energy and causing even more condensation and discomfort.

In addition to “right-sizing” the unit for optimum comfort, an efficient building envelope often allows for downsizing of air conditioning units, further reducing initial cost. In larger homes, downsizing may allow one unit to replace two, for additional savings in cost and maintenance. These dollar savings can help compensate for the extra cost of window and insulation improvements.

One estimate states that a Manual J calculation takes about 30 to 60 minutes for an average home, using the measurements from construction drawings. Manual S calculations require an additional 15 to 30 minutes (SBIC 2003). A single calculation can work for multiple use of the same plans.

Four Sources for HVAC Design

The Air Conditioning Contractors of America (ACCA) has published simple but effective methods for determining loads and sizing ductwork and heating and cooling equipment.

- Manual J tells you how to calculate loads.
- Manual D tells you how to size ducts.
- Manual S guides you through the selection of appropriate heating and cooling equipment to meet identified loads.
- Manual T gives you the basics for small buildings.

For more information or to purchase these documents on the web, go to: www.acca.org.

Air Conditioner and Heat Pump Ratings

Best Practice: Central air conditioners should be rated at a minimum of 13 Seasonal Energy Efficiency Ratio (SEER) for air cooling and heat pumps should be rated at a minimum of 7.6 Heating Season Performance Factor (HSPF) for heating.

In September 2006 DOE will begin enforcing a 13 SEER standard for all residential central air conditioners. For more information on this standard, visit www.eere.energy.gov/buildings/appliancestandards.

Until recently, SEER-10 air conditioning equipment has been standard across the country. But SEER-11 and SEER-12 equipment is becoming more widely used. SEER-12 equipment is nearly always cost-effective. Consider using SEER-14 air conditioning equipment to achieve performance levels greater than 30% savings. Equipment with SEER ratings up to 20 are now available. Currently, ENERGY STAR-labeled central air conditioners have a minimum rating of SEER 12.

Heat pumps are preferable to electric resistance heating in all but the mildest of climates, such as southern Florida, where there are fewer than 500 annual heating degree days. A unit with a HSPF of 7.7 or more will reduce the electric consumption during heating by more than 50% relative to electric resistance heating. The new standard will require that central heat pumps have a minimum rating of 7.7 HSPF.

FIGURE13: ACCA Manuals

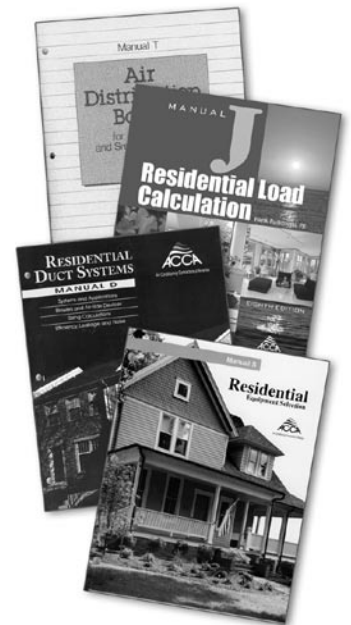

RATINGS

Central air conditioners should be rated at a minimum of 12 SEER and heat pumps should be rated at a minimum of 7.6 HSPF.

DESIGNERS

Lists of all ENERGY STAR rated appliances can be found at www.energystar.gov/index.cfm?c=appliances.pr_appliances

Central Gas-Fired Furnace

Best Practice: Sealed combustion gas furnaces should be specified for central gas-fired heating systems. ENERGY STAR labels furnaces that meet a minimum Annual Fuel Utilization Efficiency (AFUE) of 90. Lists of all ENERGY STAR-rated appliances can be found at www.energystar.gov/index.cfm?c=appliances.pr_appliances

Sealed Combustion

Sealed combustion means that an appliance acquires all air for combustion through a dedicated sealed passage from the outside, to a sealed combustion chamber, and all combustion products are vented to the outside through a separate, dedicated sealed vent.

Mechanical Ventilation

Best Practice: Building America recommends the best practice of integrating mechanical ventilation into the HVAC system. Whole house ventilation is a requirement in some state building codes.

Central fan-integrated supply ventilation can be an easy and inexpensive way to provide outside air to the HVAC system. This system provides fresh, filtered, outside air in a controlled amount using the existing HVAC delivery system for even distribution and mixing.

Most of the Building America teams have designed and field-tested these ventilation systems. The systems involve exterior air intakes, ductwork running to the return air side of the HVAC system, dampers to allow control of the air intake, and electronic controls to ensure that the HVAC fans operate frequently enough to draw in adequate fresh air. For an example of these systems, see www.buildingscience.com/resources/mechanical/air_distribution.pdf for more detailed information.

FIGURE 14: Outside Vents

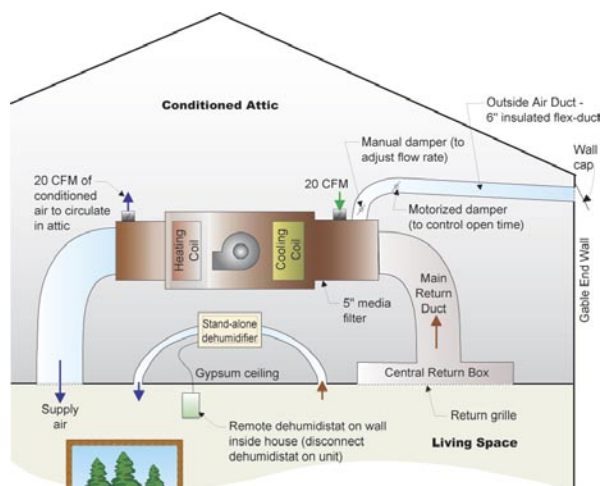

Source: Building Science Corporation

GAS FURNACES

Specify sealed combustion gas furnaces for central gas-fired systems.

VENTILATION

Integrate mechanical ventilation into the HVAC system.



Air Intake being installed in a porch overhang to provide fresh air to attic HVAC.

Efficiency Measures for Air Conditioners, Heat Pumps, and Furnaces

The Seasonal Energy Efficiency Ratio (SEER) is a measure of equipment energy efficiency over the cooling season. It represents the total cooling of a central air-conditioner or heat pump (in Btu) during the normal cooling season as compared to the total electric energy input (in watt-hours) consumed during the same period.

The Heating Season Performance Factor (HSPF) is a measure of a heat pump's energy efficiency over one heating season. It represents the total heating output of a heat pump (including supplementary electric heat) during the normal heating season (in Btu) as compared to the total electricity consumed (in Watt-hours) during the same period.

The Annual Fuel Utilization Efficiency (AFUE) measures the amount of fuel converted to heat at the furnace outlet in proportion to the amount of fuel entering the furnace. This is commonly expressed as a percentage. A furnace with an AFUE of 90 could be said to be 90% efficient.

Supplemental Dehumidification

Best Practice: Building America recommends that houses be equipped with a dehumidification system in the hot and humid climate or designed so that a dehumidifier can be easily added.

One Building America team recommends that all homes in the hot and humid climate call for supplemental dehumidification. Other teams call for these systems in homes where moisture proves to be a problem.

In an energy-efficient home, there is less demand for cooling. Air conditioners tend to run less often and humidity control may require supplemental dehumidification. In any home where oversized air conditioners lead to short cycling, the system may not provide adequate dehumidification.

Building America scientists field tested six dehumidification systems in Houston. The study identified a good supplemental dehumidification system with reasonable costs and performance. The system can be installed either during construction or after occupancy. The best performing system from the Houston study consists of the following:

- a stand-alone dehumidifier located in the attic in an insulated enclosure (if the attic is not conditioned) and ducted to the living space,
- a dehumidistat located in the living space,
- a fan cyclor and an integrated supply of fresh air (see the section on ventilation) because moisture control performance is dependent on effective and regular mixing of indoor air.

Other systems may work well in circumstances where allergy-sensitive homeowners are seeking high-performance air filtration. In all homes, spot ventilation in kitchens and bath rooms is critical to humidity control.

ENERGY STAR qualifies dehumidifiers. Energy efficiency is measured in liters of water removed per kilowatt-hour of energy consumed. To earn the ENERGY STAR label, dehumidifiers must fall within the range of greater than or equal to 1.20 to 1.50 L/kWh for standard capacity units. The requirement for high-capacity units is greater

DEHUMIDIFICATION

Equip the home with a whole-house dehumidification system.

DESIGNERS

than or equal to 2.25 L/kWh. Lists of all ENERGY STAR-certified appliances can be found at www.energystar.gov/index.cfm?c=appliances.pr_appliances.

More information on the Building Science Consortium's Houston study of dehumidifiers (BSC 2002) is available on the web at www.buildingscience.com/resources/mechanical/conditioning_air.pdf.

Compact Air Distribution System

Best Practice: Make duct runs as short as possible.

An efficient building envelope and efficient HVAC equipment allow for a compact air distribution system. Conditioned air may be discharged from inside walls (see the discussion in the next section on chase design) or from ceiling diffusers up to 12 feet from the window wall in most cases without compromising comfort. Such “inside throw” layouts cut ductwork runs, saving money and reducing the amount of ductwork that may run in unconditioned space.

Seal All Ducts and Air Handlers

Best Practice: Seal all ductwork seams and connections to air handlers with UL181-approved water-based mastic and seal drywall connections with caulk or foam sealant.

Sealing ductwork is very important. In the hot and humid climate it may be the simplest and most important step in controlling indoor humidity in some homes. Leaky ductwork in an unconditioned attic or crawspace can draw unhealthy and humid air into the air distribution system. Sealing ducts with mastic is desirable even for ducts located in conditioned spaces. Properly sealed ducts make sure air gets to the spaces intended, rather than leaking into a plenum space. It also minimizes the chances of creating pressure differentials from space to space that would induce airflow through the envelope. The process of sealing each joint reduces the chances of unconnected ductwork, a surprisingly common mistake.

FIGURE 15: Duct Run Configurations

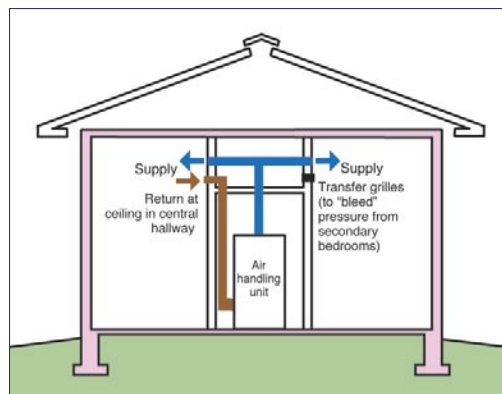
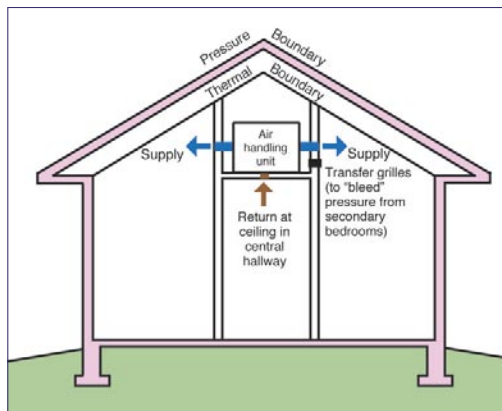
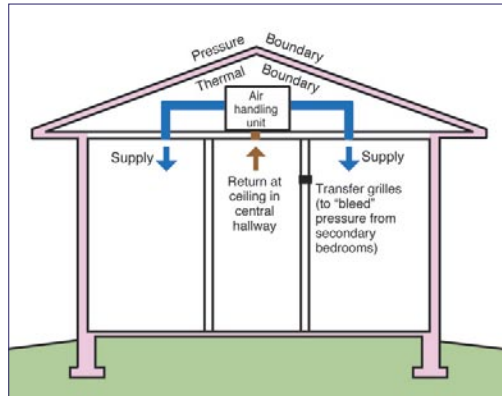

Source: Building Science Corporation

DUCT RUNS

Make duct runs as short as possible.

DUCT SEALING

Seal all ductwork and air handlers with mastic and seal duct boots to sheetrock connections.

A New Standard in Residential Ventilation

In Autumn 2003, the American Society of Heating, Refrigerating And Air-Conditioning Engineers (ASHRAE) established a new standard for indoor ventilation in residences. The standard is *ASHRAE 62.2, Ventilation and Acceptable Indoor Air Quality in Low-Rise Residential Buildings* (ASHRAE 2003). The following information is adapted from the Standard's forward:

The standard contains three main sets of requirements and a host of secondary ones. The three primary sets involve whole-house ventilation, local exhaust, and source control. Whole house ventilation is intended to dilute the unavoidable contaminant emissions from people, materials, and background processes. Local exhaust is intended to remove contaminants from specific rooms, such as kitchens and bathrooms, where pollutant sources are produced. And source control measures are included to deal with other anticipated sources. The standard's secondary requirements focus on properties of specific items, such as sound and flow ratings for fans and labeling requirements.

The standard is principally about mechanical ventilation, but its purpose is to provide acceptable indoor air quality. The most effective way for keeping exposure to pollutants low is to keep them from being released to the general indoor environment in the first place.

ASHRAE will publish guidance documents on meeting this standard in 2004.

Mastic provides the most reliable duct sealing method for new construction. All ductwork, including the air handler compartment (which typically has many leaky joints), should be mastic sealed.

DOE research has found that some tapes perform adequately for sealing ducts, particularly fiberglass duct board. However, good performing tapes may be difficult to identify and traditional duct tape (cloth-backed rubber adhesive tapes) should never be used to seal ducts, even if it meets UL ratings. Do not use sealing tapes for structural purposes. Tapes have low tensile strength and should not be used to mechanically support ducts. A technical report (Walker, Sherman, Modera, and Siegel 1998) on duct sealants can be found on the web at: <http://ducts.lbl.gov/Publications/lbl-41118.pdf> and a less technical article (Sherman and Walker 1998) on similar research can be found at: www.homeenergy.org/898ducttape.title.html.

Ducts and Air Handlers in Conditioned Space

Best Practice: Ducts and air handlers should be placed in conditioned spaces to the extent possible. High temperatures and humidity levels can be found in unconditioned spaces and create an unfavorable environment for ducts and air handlers.

Ducts and air handlers perform best when placed within conditioned space. Keeping ducts inside conditioned space may require one of several strategies, such as:

- 1) Placing ducts in a chase designed to run through a central corridor below the attic or on top of the ceiling through the attic. If the chase runs through the attic, it must fit within the roof truss design and will be covered with insulation. For more information on designing and building an interior chase see the report, *Design and Construction of Interior Duct Systems* (McIlvaine, Beal, and Fairey 2001), available on the web at: www.fsec.ucf.edu/bldg/baihp//pubs/interior_ducts.pdf.

FIGURE 16: Mastic



Mastic provides the most reliable duct sealing method for new construction.

“Sealing the ducts with mastic is I think the single most important thing that anyone should do. Sealing gets leakage rates down to about 2%. Not doing duct sealing on new construction is extremely short sighted. Mastic will last the life of the system, while conventional duct tape can fail within a year.”

Lucian Kragiel,
Co-owner of Atlantic Design
and Construction

DUCT RUNS

Ducts and air handlers should be placed in conditioned spaces to the extent possible.

DESIGNERS

- 2) Insulating and sealing the underside of the roof sheathing to create a conditioned attic. This strategy requires tightly sealing the roof structure, especially where it connects with the walls, to avoid the entry of hot moist air. This technique essentially requires building a non-vented roof assembly. For more information on this technique see www.buildingscience.com/resources/roofs/unvented_roof_summary_article.pdf
- 3) Insulating and sealing the exterior walls of the crawlspace so that it becomes a conditioned space, such as a mini basement. This strategy requires treating the crawlspace much like a living space with conditioned air supply, moisture control, and air returns to the HVAC system. More information on this approach can be found at www.buildingscience.com/housethatwork/hothumid/montgomery.htm.

Air handlers should be placed inside conditioned space. One approach is to build a conditioned closet with sealed access from the garage. In addition to improving the efficiency of the equipment, this approach adds additional square footage to the conditioned space.

Standards for Duct Sealants

Underwriters' Laboratories (UL) publishes several standards that relate to duct sealants, the most important of which is UL 181. It deals with ducts in general, with UL 181A covering field-assembled duct-board, and the three-year-old UL 181B covering flex duct systems. Each standard includes test procedures for sealants. Duct tapes and packing tapes that pass UL 181B are labeled "UL 181B-FX." Mastics can pass 181A or B and are labeled "UL 181A-M" or "UL 181B-M." Foil tapes are designated with a P.

Most tapes that are labeled 181B-FX are duct tapes. Other 181B products are just coming onto the market. UL 181A and 181B appear to do a good job of testing for safety, tensile strength, and initial adhesion. However, they may not do a good job of rating how well sealants seal typical duct leaks or how well they stay sealed under normal conditions.

Adapted from Sherman and Walker 1998

Duct Insulation

Best Practice: Ducts in unconditioned spaces must be insulated.

To the extent possible, ducts should be placed inside conditioned space. In conditioned spaces, they require minimal insulation. If the ducts are placed in unconditioned spaces, due to the extreme summer temperatures in these spaces, 10% to 30% of the energy used to cool the air can be lost to conduction through the duct surfaces. Therefore, they must be insulated. ENERGY STAR recommends the following insulation levels for ducts in unconditioned spaces in the hot and humid climate: from R-4 to R-8 in attics and R-4 in crawl spaces (EPA 2000, available on the web at: www.energystar.gov/ia/new_homes/features/DuctInsulation1-17-01.pdf).

FIGURE 17: Air Handler in Conditioned Space



INSULATING DUCTS

Ducts in unconditioned spaces must be insulated.

Transfer Grilles and Jump Ducts

Best Practice: Use jump ducts and transfer grilles and other return pathways to maintain balanced pressure in each room of the house. This practice is especially useful in rooms that are often isolated from the rest of the house by a closed door, such as a bedroom.

To maintain balanced pressure, air must be returned from each room to the central HVAC equipment. One way to do this would be to add a ducted return from each room. However, this would be expensive and consume a lot of space. A more reliable and cost-effective approach is to provide a central return and make sure that there are transfer grilles or transfer ducts, of adequate size, that allow air to pass from individual rooms to the central return even when doors are closed. Florida codes require that the differences in static pressure between any two rooms remain below 2.5 Pascals. Figure 18 illustrates different approaches to creating paths to equalize air pressure and allow air to return to HVAC equipment. When designing registers and transfer grilles, place them high on the wall in areas where furniture may block air movement.

FIGURE 18: Jump Ducts

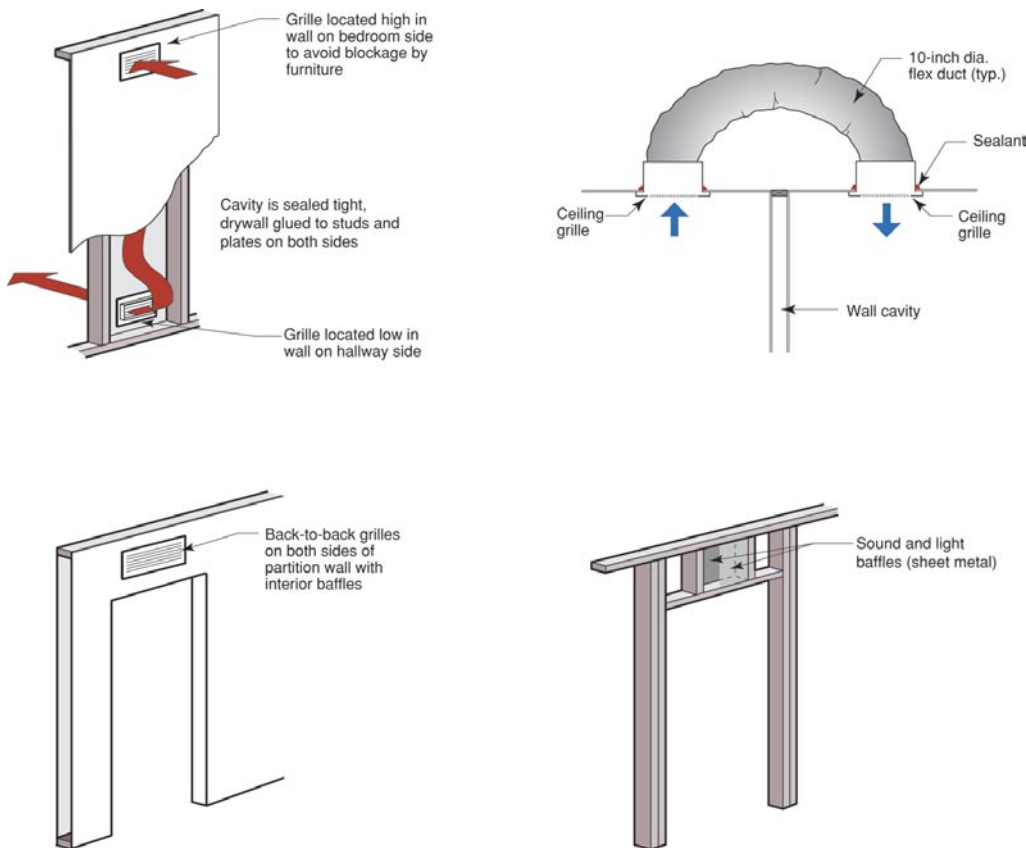

Source: Building Science Corporation

BALANCED PRESSURE

Use jump ducts and transfer grilles and other return pathways to maintain balanced pressure in each room of the house.

FIGURE 19: Jump Ducts



Source: IBACOS

DESIGNERS

Draw Duct Layouts on Plans

Best Practice: Clearly identify on plans and drawings the locations, sizes, and types for all duct work and registers, including the heating and cooling supply ducts, passive return air ducts or transfers, the locations for the mechanical ventilation air inlet (at least 8 ft away from any exhausts or condensers), and all exhaust outlets. If chases or other spaces are to be dedicated to duct runs, indicate this on the plans.

This level of detail can be referenced in contract documents so you know exactly what you will be getting. These documents can provide guidance in the field for proper installation.

Energy Performance and Commissioning

Best Practice: Air conditioners and heat pumps should be evaluated after installation with a duct pressure test and, if needed, a smoke test to identify the location of leaks. Procedures are discussed in the *Site Supervisors*  chapter.

Building Science Corporation has identified performance testing as a key reason for substantial reductions in callbacks (BSC 2003).

Occupant Health and Safety

The following best practices should be included in the house design:

- Base Rate Ventilation: controlled mechanical ventilation at a minimum base rate of 15 CFM for the master bedroom and 7.5 CFM for each additional bedroom should be provided, as listed in ASHRAE 62.2.
- Spot Ventilation: intermittent spot ventilation of 100 CFM should be provided for the kitchen; all kitchen range hoods must be vented to the outside (no recirculating hoods). Intermittent spot ventilation of 50 CFM or continuous ventilation of 20 CFM, should be provided for each washroom/ bathroom. Fans should be quiet, producing less than 1.5 sonnes.
- All combustion appliances in the conditioned space must be sealed combustion or power vented. Specifically, any furnace inside conditioned space shall be a sealed-combustion 90%+ (AFUE of 90 or greater) unit. Any water heater inside conditioned space shall be power vented or power-direct vented. Designs that incorporate passive combustion air supply openings or outdoor supply air ducts not directly connected to the appliance should be avoided. Gas cooking ranges shall follow the practices described in the second bullet.
- Use sealed-combustion gas fireplaces to eliminate the threat of harmful combustion gases from entering the house. All fuel-burning fireplaces should have sealed combustion and be properly vented to the outside. If not properly vented and sealed, the fireplace can produce harmful combustion pollutants that may be emitted into the home, such as carbon monoxide, nitrogen dioxide, and sulfur dioxide.
- Provide filtration systems for forced air systems that provide a minimum atmospheric dust spot efficiency of 30% or MERV of 6 or higher. MERV (Minimum Efficiency Reporting Value) is a measure of an air filter's efficiency at removing particles. A fiberglass panel filter may have a MERV of 4 or 5. Critical areas in hospitals may use a MERV 14 filter. Electronic air cleaners should be used with caution because the ozone they produce may affect sensitive individuals.

DUCT WORK LOCATION

Clearly identify on plans and drawings the locations, sizes, and types for all duct work and registers.

EVALUATION

Evaluate air conditioners and heat pumps after installation.

DESIGNERS

- Indoor humidity should be maintained in the range of 25% to 60% by controlled mechanical ventilation, mechanical cooling, or dehumidification. See www.buildingscience.com/resources/moisture/relative_humidity_0402.pdf.
- Carbon monoxide detectors (hard-wired units) shall be installed (at one per every approximate 1,000 square feet) in any house containing combustion appliances and/or an attached garage.
- Maximize hard surface areas (tile, vinyl, hardwood) to better manage dust for health purposes. For slab-on-grade houses, it also reduces the cooling loads.
- Information relating to the safe, healthy, comfortable operation and maintenance of the building and systems that provide control over space conditioning, hot water, or lighting energy use shall be provided to occupants.

Mechanicals Management and Appliances

Plumbing

Water heater efficiency is described by the energy factor rating. The Consumers' Directory of Certified Efficiency Ratings, Gas Appliance Manufacturers Association (GAMA) provides a concise listing of energy factors for water heaters of all fuel types at www.gamanet.org.

Best Practice: Do not install plumbing in exterior walls. Seal around plumbing penetrations in all exterior surfaces, surfaces that border on unconditioned spaces, and between floors. Use fire-resistant sealant in plates between floors.

Best Practice: Because of the dominance of warm temperatures in the hot and humid climate, water heaters are best kept out of living spaces, where heat losses could add to the cooling load. A garage location may also save money by eliminating the need for power-vented equipment. Water heaters can be located freestanding or enclosed within a closet in the garage. If enclosed, ventilation grills will be needed to provide combustion air.

Water Heaters

Water heaters come in many shapes, sizes, and efficiencies. The Oregon Department of Energy maintains a list of high-efficiency water heaters that qualify for state tax credits. The list contains high-efficiency gas combustion water heaters, instantaneous (tankless) water heaters, and water heating heat pumps. You may consider these products for your projects. The tax credits only apply to Oregon installations by Oregon taxpayers. See the list at: <http://www.energy.state.or.us/res/tax/appheat.htm>.

Electrical

Best Practice: Seal around wires penetrating all exterior surfaces, surfaces that border on unconditioned spaces, and between floors. Use fire-resistant sealants between floors. If recessed downlights are to be used they should be rated for insulated ceilings and airtight (ICAT).

PLUMBING SEALING

Seal plumbing penetrations in exterior surfaces and keep plumbing out of exterior walls.

FIGURE 20: Additional Plumbing Air Sealing Building Tips can be found in the Trades & Crafts Chapter.

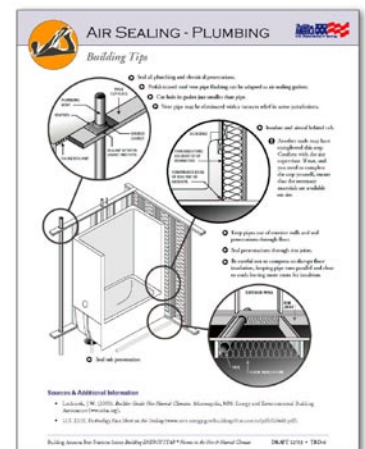

WATER HEATERS

Keep the water heater away from living spaces to avoid adding to the cooling load. If it will be located in a living space, use a power-vented water heater.

ELECTRICAL SEALING

Seal all wire penetrations.

Sources & Additional Information

- Air Conditioning Contractors of America. *Manual D: Residential Duct Systems*. ACCA, Arlington, VA. www.acca.org.
- Air Conditioning Contractors of America. *Manual J: Residential Load Calculation, Eighth Edition*. ACCA, Arlington, VA. www.acca.org.
- Air Conditioning Contractors of America. *Manual S: Residential Equipment Selection*. ACCA, Arlington, VA. www.acca.org.
- American Society of Heating, Refrigerating, and Air-Conditioning Engineers, INC (ASHRAE). 2003. *ASHRAE Standard: Ventilation and Acceptable Indoor Air Quality in Low-Rise Residential Buildings*. ASHRAE, Atlanta, GA.
- ASTM 2004. *Standard Test Method for Determining Rate of Air Leakage through Exterior Windows, Curtain Walls, and Doors Under Specified Pressure Differences across the Specimen*. ASTM E283-04.
- *ASTM 2003 WK2469 New Standard (Formerly E1465-92) Guide for Radon Control Options for the Design and Construction of New Low Rise Residential Buildings*.
- ASTM. 2002. *Standard Practice for Installation of Exterior Windows, Doors, and Skylights*. ASTM E2112-01.
- Building Science Corporation (BSC). 2002. 10. *Case Study Material: Conditioning Air in the Humid South*. National Renewable Energy Laboratory, Golden, CO.
- Building Science Corporation (BSC). 2003. 9. *BSC Final Report: Lessons Learned from Building America Participation, February 1995-December 2002*. National Renewable Energy Laboratory, Golden, CO.
- Building Science Corporation. 2003b. 1.C.2.1 *Report Expert Meeting Summary*. National Renewable Energy Laboratory, Golden, CO.
- Building Science Corporation. Undated. A. www.buildingscience.com/resources/mechanical/advanced_space_conditioning.pdf.
- CARB (Consortium for Advanced Residential Buildings). 2004. NREL/SR-550-34560. National Renewable Energy Laboratory, Golden, CO. Available at www.buildingamerica.gov
- Carmody, John, Stephen Selkowitz, Dariush Arasteh and Lisa Heschong. 2000. *Residential Windows: A Guide to New Technologies and Energy Performance*. W. W. Norton and Company, New York. www.wwnorton.com/npb/welcome.htm
- Edminster, Ann, Betsy Pettit, Kohta Ueno, Stephanie Menegus, and Steven Baczek. 2000. "Case Studies in Resource-Efficient Residential Building: The Building America Program." *2000 ACEEE Summer Study Proceedings*. ACEEE, Washington, D.C.
- DOE. 2000. *Technology Fact Sheet on Weather Resistive Barriers*. DOE/GO-102000-O769, Washington D.C. Available on the web at www.eere.energy.gov/buildings/documents/pdfs/28600.pdf.

DESIGNERS

- Lstiburek, Joseph. 2002. *EEBA Builders Guide: Hot and Humid Climates*. EEBA, Minneapolis, MN. www.eeba.org/bookstore.
- Lstiburek, Joseph. 2003. *EEBA Water Management Guide*. EEBA, Minneapolis, MN. www.eeba.org/bookstore.
- McIlvaine, Janet, David Beal, and Philip Fairey, III. 2001. *Design and Construction of Interior Duct System. Report Number FSEC-PF-365-01*, Florida Solar Energy Center, Cocoa, FL. www.fsec.ucf.edu/bldg/baihp//pubs/interior_ducts.pdf.
- Parker, D.S., J. R. Sherwin and M. T. Anello, 2001. "FPC Residential Monitoring Project: New Technology Development — Radiant Barrier Pilot Project," *Contract Report FSEC-CR-1231-01*, Florida Solar Energy Center, Cocoa, Florida. www.fsec.ucf.edu/bldg/pubs/rbs/index.htm.
- Rudd, Armund. 2003. *Refrigeration System Installation and Startup Procedures, and Air Conditioning System Efficiency*. Building Science Corporation, Westford, MA. www.buildingscience.com/resources/mechanical/air_conditioning_equipment_efficiency.pdf.
- Sherman, Max and Iain Walker. 1998. "Can Duct Tape Take the Heat?" *Home Energy*, Berkeley, CA. www.homeenergy.org/898ductape.title.html
- Straube, John. 2001. *Canadian Architect*. "Wrapping it Up". May, 2001. www.cdnarchitect.com.
- (SBIC) Sustainable Buildings Industry Council. 2003. *Green Building Guidelines: Meeting the Demand for Low-Energy, Resource-Efficient Homes*. U.S. DOE. Washington, D.C. document available at www.SBICouncil.org.
- United States Environmental Protection Agency. 1994. *Model Standards and Techniques for Control of Radon in New Residential Buildings*
- United States Environmental Protection Agency. 2000. *Duct Insulation: Air Distribution System Improvements*. EPA 430-97-028. Washington, D.C. www.energystar.gov/ia/new_homes/features/DuctInsulation1-17-01.pdf
- United States Environmental Protection Agency. 2001. *Building Radon Out: A Step by Step Guide on How to Build Radon Resistant Homes*. www.epa.gov/199/radon/images/buildradonout.pdf.
- Vieira, Robin K., Parker, Danny S., Klongerbo, Jon F., Sonne, Jeffrey K., Cummings, Jo Ellen. 1996. "How Contractors Really Size Air Conditioning Systems." Florida Solar Energy Center, Cocoa, FL. www.fsec.ucf.edu/bldg/pubs/ACsize/index.htm
- Walker, I., M. Sherman, M. Modera, and J. Siegel. 1998. *Leakage Diagnostics, Sealant Longevity, sizing and Technology Transfer in Residential Thermal Distribution Systems*. Lawrence Berkeley National Laboratory, Berkeley, CA. <http://ducts.lbl.gov/Publications/lbl-41118.pdf>
- Yost, Nathan. May 2003. "The Case for Conditioned Unvented Crawl Spaces". *Building Safety Journal*. www.buildingscience.com/resources/articles/24-27_Yost_for_author.pdf

Web Sites Not Included with Published Documents Above

- www.eere.energy.gov/buildings/index.cfm?flash=yes
- www.energystar.gov/index.cfm?c=bop.pt_bop_index
- www.epa.gov/radon/zonemap.html
- www.epa.gov/iaq/whereyoulive.html
- www.gamanet.org
- www.natresnet.org
- www.nfrc.org
- www.efficientwindows.org/index.cfm
- www.ornl.gov/sci/roofs+walls/insulation/ins_16.html
- www.fsec.ucf.edu/bldg/pubs/rbs/index.htm
- www.certainteed.com/pro/insulation
- www.susdesign.com/sunangle
- www.pnl.gov/cfldownlights/



SITE SUPERVISORS

Tools to help with project management

In the chain of events that results in a finished home, the site supervisor (or project manager) has the critical job of turning ideas into reality. The site supervisor's job is to make sure everything happens. Plans must be correct, permits must be in order, contracts must be signed, subs must be scheduled, materials must be on site, and it all must happen on schedule. Successful construction of an energy-efficient home is essentially the same as other homes, although a few details are different and can demand more careful scrutiny because of the interdependencies in a systems-designed house.

Site supervisors working to build energy-efficient homes can generally do their jobs as they already know how, with a few simple but important changes. There are three keys to constructing any quality home—managing expectations, managing the schedule, and controlling quality and costs. This section will explain how to incorporate those three keys into your construction process.

An energy-efficient home built using these Building America recommendations looks a lot like any other home. It will maintain its visual appeal and style. The key points at which it differs typically involve more efficient HVAC equipment (including ducts), an engineered HVAC system design, a supply of outside air for ventilation, humidity control, better windows, better insulation, and better air sealing. The *Designers* chapter contains best practices recommendations on the features energy-efficient homes should include. Many builders make the comment that it's not the quantity of changes that make an energy-efficient home, but the quality that is put into building the home.

"We found no significant increase in materials costs or in subcontract labor costs. It was really more in techniques," said Walter Hendrix, Executive Director of Troup Chambers Habitat for Humanity and Dependable Affordable Sustainable Housing for La Grange, Georgia.

Of course, it is not always easy for a site supervisor to control all aspects of a subcontractor's work. It may be necessary, especially while these best practices are new ideas, to prioritize activities and "pick your battles." In hot and humid climates, the top priorities are 1) window selection and installation, 2) HVAC sizing and installation, and 3) moisture control.

Managing Expectations

A project manager who can foster a set of shared expectations among the important players in his or her building team can successfully build efficient houses. Two goals should influence the project manager's actions at the start of the project:

- Make sure subcontractors and in-house workers understand what you want.
- Eliminate the need for unknowledgeable (and often unskilled) laborers to make design decisions.

The following best practices will help meet these goals.

INTRODUCTION

Taking action in your community



HOMEOWNERS

Shopping for value, comfort, and quality



MANAGERS

Putting building science to work for your bottom line



MARKETERS

Energy efficiency delivers the value that customers demand



SITE PLANNERS & DEVELOPERS

Properly situated houses pay big dividends



DESIGNERS

Well-crafted designs capture benefits for builders, buyers, and business



SITE SUPERVISORS

Tools to help with project management



TRADES & CRAFTS

Professional tips for fast and easy installation

CASE STUDIES

Bringing it all together

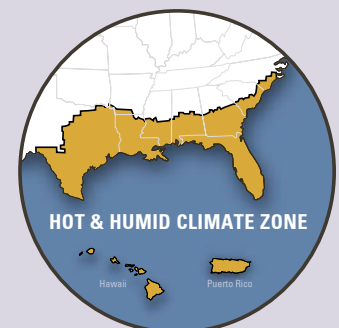

HOT & HUMID CLIMATE ZONE

Hawaii Puerto Rico

Develop a Work Plan

Decide who is going to do what. Will the plumber install insulation behind the tub or will the framer, or some other trades person? Develop a schedule for the order that activities should occur to be sure that actions are done in a reasonable order and that no actions will be forgotten. Be sure that all needed materials are on the site when the activity is scheduled to take place. More information on scheduling is included in the Managing Execution section.

Plans – Get Them Right

Best Practice: Before starting a project ensure that plans are correct and that you have everything you need to go forward. Once you have the plans you need, follow them.

Existing stock plans will likely need to be modified to both include necessary changes and to add details not commonly included in residential prints. See the Design section for a description of design best practices.

A well-designed home should have well-designed plans that include everything necessary to explain expectations to the subs. Some points that should be included are:

- HVAC design details and duct layout. The duct layout must be included on a floor plan. The duct and diffuser sizes, quantities, and locations must be installed as specified. Subcontractors should be contractually obligated to these specifications. Performance requirements (such as SEER and AFUE) for system components should be specified on the plans.
- Framing plan. If advanced framing is to be included in the design, a detailed plan is needed showing how advanced framing techniques will be applied. These should detail the placement of studs to ensure proper “stacking” in two-story homes and should show details of window and door framing. Advanced framing is not required to achieve 30% energy savings in the hot and humid climate but is an important money and time saving measure for more highly efficient homes.
- Other call-outs or specifications. Call-outs and specifications should be written to detail how particular measures will be installed, including both the techniques and the materials to be used. Of particular importance are specifications and call-outs for items that differ from local standard practice such as caulking; draft stops behind bathtubs, stairs, and dropped ceilings; duct sealing requirements; gasket materials; window schedules specifying U-factors and SHGCs; and product performance metrics. Also call out items that should not be done, such as caulking ceiling penetrations under conditioned attics.

Plans — Keep Them Right

Best Practice: Avoid plan changes. When they are required, document the changes as you would the original contract.

Numerous difficulties can be avoided with correct building plans. If the plans have been properly developed, with the proper sizing of equipment, you must be sure that changes will not undo this good work. The practice of verbally communicating changes

PLANS

Make sure they are correct and follow them closely.

AVOID CHANGES

Thoroughly document any changes to plans.

SITE SUPERVISORS

is always risky and is potentially disastrous for a systems-designed home where high-performance features interact to achieve energy efficiency, comfort, and durability. Before making any changes ask yourself these questions:

- Why are the changes being made? If there are no clear benefits from the change, don't do it.
- What effect will the change have on building performance? Will the change deviate from best practice recommendations? Will you need to change HVAC sizing or system selection? If you don't know the answer to these questions, ask your HERS rater. Be sure to adjust all the systems related to the change.
- Are new drawings or specifications needed to clearly document your expectations? Be clear in your expectations.

Contracts – Write Them Down

Best Practice: Prepare or update formal contracts with key subs that clearly show what you expect of them and what they can expect from other subs. Relevant call-outs, plans, and specifications described in the last section should be referenced in the contracts. If the sub is providing materials, list the specific materials that you want. Here are some examples of materials that a sub may supply:

- Recessed downlights, which should be air-tight and rated for insulation contact
- Mastic to seal ducts
- High-density fiberglass insulation
- Sealants and caulks to seal penetrations
- Windows are typically ordered along with other major purchases, but if the sub is supplying them, be sure they are rated as called out in the plans
- Draft-stopping sheathing.

If you have expectations for a sub, such as sealing certain types of holes, or installing insulation in some space that may become inaccessible, be sure these expectations are spelled out in the contract. The scope of work should cover things like equipment size, duct sizes, identification of who is responsible for sealing which holes, etc. Contract specifications and written assignments of responsibility can greatly simplify the ordering of materials. Duct installers, for example, will know exactly what kind of duct material will be used and how much; and with this knowledge may be able to prefabricate many of their assemblies back at the shop, rather than in the field. These pre-assembled pieces tend to be of higher quality thanks to the proximity of tools and materials and better working conditions in the shop.

Pre-Construction Meeting – Have One

A final strategy to manage expectations among the subs is to hold a pre-construction meeting that includes as many of the subs as possible. At this meeting you can emphasize the changes in workflow, shifts in responsibilities, and newly introduced building details. Tell your subs about your goals for energy-efficient houses.

WORKING WITH SUBS

Always prepare formal contracts and be clear about your expectations.

SITE SUPERVISORS

Give the subs drawings and instructions on how to accomplish their jobs. Sample instructions are included in the Trades section. This meeting will go a long way toward helping people to understand their roles and responsibilities. Make sure that your subs are aware that you will be conducting inspections and that both the ductwork and the building envelope will be tested for air tightness.

It may be necessary, especially when starting your first energy-efficient homes, to hold additional training sessions with key subs. More on this is discussed in the *Managing Quality* section below.

Permits – Grease the Skids

A home built according to the instructions contained in this document for the hot and humid climate does not violate any provisions of the national model codes or, usually, of local regulations. However, many local code officials are unfamiliar with some of the recommended construction techniques. It is well worth your while to raise these issues yourself before construction begins so that you're not surprised by a red tag later. (Ensuring that the “new” techniques are clearly delineated on the building plans can also help flag these issues during plan review rather than during inspection.)

A meeting with the building department before construction is well-advised. Should your code official need information in support of any of the new techniques used in an energy-efficient home, *Appendix III* contains several “tear-outs” that may be helpful. These cover some of the more common features that surprise many officials and should help in assuring your local official that the proposed techniques are both safe and in compliance with the model codes.

Managing Execution

If you've managed to establish clear expectations with your subs and suppliers, you're almost ready to begin construction. The final parts of the plan involve training subs as necessary, scheduling everything, and monitoring progress.

Training

Best Practice: Attend and have your key subs attend a training course on systems-designed housing.

One good way to accomplish this may be to let your Home Energy Rating System (HERS) provider (see Quality Assurance below) conduct the necessary training. Information on general training is available from:

- Building America – www.buildingamerica.gov
- Energy and Environmental Building Association – www.eeba.org
- Building Science Corporation – www.buildingscience.com/workshops/default.htm
- National Association of Home Builders Research Center – www.nahbrc.org
- Southface Energy Institute – www.southface.org
- IBACOS – www.ibacos.com

SYSTEM DESIGNED HOUSING

Be sure to attend a training on systems-designed housing.

SITE SUPERVISORS

Other sources may include regional universities or Cooperative Extension Service programs, homebuilder associations, utilities, and codes programs. More specialized training is available at the above sources, plus trade organizations, such as:



- Air Conditioning Contractors Association – offers technician certification – www.acca.org
- American Architectural Manufacturers Association – offers window installation master certification – www.aainstallationmasters.com

Scheduling

Constructing an energy-efficient home requires careful attention to scheduling. Several of the new construction techniques may require changing the order of subs; some require (or benefit from) a shifting of responsibilities from one sub to another; and some new activities will need to be added into the schedule. Here are some of the more important schedule considerations:

- Schedule HVAC rough-in before plumbing and electrical. It is far more important for the ductwork to have un-constricted access and pathways than it is for wires or pipes.
- If using a conditioned attic, schedule insulating under the roof deck before HVAC rough-in. The insulators must be able to do their job without tromping on the carefully placed ductwork.
- Don't forget to schedule for pipe insulation under the slab.
- Be sure to schedule pre-drywall insulation inspections, flashing inspections, and envelope and duct pressure tests. Inspect at key points to ensure that insulation and envelope sealing take place before areas become inaccessible. Inspections are much more likely to happen if scheduled. And subs may be a bit more conscientious if they know their work will be evaluated.
- Be sure to schedule caulking of electrical and plumbing penetrations after drywall is completed and the lines have been installed.

Some situations that may require a shifting of responsibilities include:

- If using advanced framing techniques that include two-stud corners and floating drywall corners (see the section on wall framing in the *Designers*  chapter and *Appendix III*), someone must attach drywall clips. The framer is a more likely candidate than the drywall installer.
- Some caulking work needs to be done by the HVAC subcontractor. In particular, main supply and return trunks that lead through walls need to be caulked by the person connecting them to the equipment. Don't let the drywall finisher do this with mud—it is neither a good sealant nor durable enough. Also, all duct terminations, including jump ducts, must be sealed when registers are installed.
- Some post-finish caulking can be avoided by having the electrician use pre-fabricated air-tight electrical boxes (see the *Trades*  chapter for an electrician's tip sheet).

SITE SUPERVISORS

- If installation of windows and housewrap (or other drainage planes) are done by different subs, the window installer must be careful to leave flashing unattached at the bottom so that the first row of building paper may be tucked under it (see the *Trades*  chapter tip sheets for window flashing, house wrap, and sealants).
- If you are using insulated headers, the framer will need to install insulation inside any double headers (using sandwiched foam insulation). Open headers may be left for the insulation contractor.
- Draft stops must be installed behind bathtubs and stairwells on exterior framed walls. The framer should do this, but be sure that insulation is installed before the draft-stop material goes on.

Quality Assurance

Inspections

Best Practice: Conduct several inspections during the course of construction, always conduct pressure tests of both the whole house and the HVAC ductwork, and always check AC and heat pump refrigerant charging. Have the house rated by a Certified HERS Rater.

Especially when energy-efficient systems-designed housing is new to your subs, you should conduct multiple inspections to ensure that the subs have understood what is required of them and how to implement it. After the process has become more routine, you might get by with just a couple of inspections. One key inspection should occur prior to installation of drywall.

The pre-drywall inspection allows you to ensure that insulation and draftstopping have been properly installed before they get permanently enclosed. This is also the best time to conduct a pressure test on the ductwork. The duct pressure test should be conducted with the HVAC contractor present, at least for his or her first several energy-efficient homes. If the ductwork fails to meet the pressure criteria, a smoke test will reveal the worst leaks. It is crucial that this happen while the ductwork is still visible and the HVAC contractor is present to see what the problem areas are.

Duct testing services can be most easily obtained through a Certified HERS rater. The rater can also conduct whole-house pressure tests and assist with training. And the HERS rating itself can be a valuable marketing tool for an energy-efficient house. To identify a certified rater in your area, check the registry at the Residential Energy Services Network (RESNET) web site: www.natresnet.org.

The second important inspection comes after completion of the home, including all interior and exterior finishes. This pre-occupancy inspection should check for proper sealing of electrical and plumbing (fixtures and drywall penetrations), HVAC registers, and the HVAC closet. A whole-house air leakage test (aka “blower-door” test) is crucial. Again, your HERS provider is the easiest resource for this service, and this is when he or she would be rating the home anyway. Also, if your HVAC contractor has not done it, a final check of the AC or heat pump refrigerant charge is crucial. Studies have shown that failure to check refrigerant charging results in the average system using 13% too much energy. [Ref: <http://hem.dis.anl.gov/eehem/00/001105.html>]

INSPECTIONS

Conduct inspections throughout the construction process.

SITE SUPERVISORS

Energy Efficiency Checklists

A successful energy-efficient building involves many details. It is worthwhile to maintain for each house a checklist of important features to keep track of what has been done. Although the best checklist is one you've made specific to the design(s) you are implementing, the following is a good baseline to work from and may be integrated with your existing checklists.

SPOT-CHECK INSPECTION CHECKLIST

These items should be checked if possible as they are installed because they may not be accessible at the pre-drywall inspection.

- Grading is sloped at 5% away from the house for at least 10 feet. Roof drainage is directed at least 3 feet beyond the building.
- A 6-mil polyethylene sheet is installed directly beneath the concrete slab, continuously wrapping the slab and the grade beam.
- Roof materials are installed to provide a continuous drainage plane over the entire surface of the roof. Wall/roof junctures should be appropriately flashed, including kick-out flashing at the bottom.
- HVAC system is appropriately sized and installed according to plans. No deviations should be made in the field.
- A mechanical ventilation system is installed as specified in the plans.
- Each bedroom has a separate HVAC return duct, a transfer grille, or a jump duct.

SITE SUPERVISORS

PRE-DRYWALL INSPECTION CHECKLIST

Note: Some measures in this list are unnecessary depending on whether the house is sealed on the interior (e.g., air-tight drywall) or exterior (e.g., sheathing) of the wall.

- Bathtubs on exterior walls have insulation behind them and draftstops installed.
- Dropped ceilings, dropped-soffit cabinets, and stairwells on exterior walls have draftstops installed behind them (unless drywall was installed prior to framing-in).
- Windows and doors are sealed to framing using caulks, foams, backer rod, and/or similar.
- Window flashing is properly installed to shed water.
- All electrical and plumbing penetrations between conditioned and unconditioned spaces are caulked or otherwise sealed.
- All recessed lights beneath unconditioned spaces are air-tight and rated for insulated ceiling (IC). All kitchen and bathroom fans are appropriately rated (capacity and sound) and exhausted to the outside.
- All exterior penetrations (exterior light fixtures, phone and other service cables, etc.) are sealed with caulk, gaskets, or similar.
- All housewrap seams are overlapped and taped; top and bottom edges are sealed past the plates; housewrap is appropriately lapped under window flashing.
- Building paper seams are overlapped shingle style to shed water and appropriately lapped under window flashing.
- If housewrap is used, all seams are overlapped and taped; top and bottom edges are sealed past the plates; housewrap is appropriately lapped under the bottom window flashing.
- Batt insulation is unfaced or blown-in insulation is used.
- No vapor retarder is installed on the inside of the walls.
- Ductwork is sufficiently air-sealed as verified by a duct pressure test conducted by a HERS rater. Ductwork leakage to the exterior should be not more than 5% of the total air handling unit capacity (at high speed) when tested at 25 Pa pressure.

SITE SUPERVISORS

PRE-OCCUPANCY INSPECTION CHECKLIST

- Entry of main supply/return ducts into air handling unit closet is appropriately sealed with foam, caulk, or similar materials (NOT with drywall mud).
- Plumbing penetrations through drywall are air sealed.
- Electrical switch and outlet boxes are sealed to drywall with caulk or gaskets.
- Light fixture boxes are sealed to drywall with caulk or gaskets.
- Bathroom and kitchen fans are sealed to drywall with caulk or gaskets.
- Bathroom and kitchen fans are drawing air-tested with a small piece of tissue; the fan should hold the paper against the grill.
- Duct boots/registers are sealed to floor or drywall with caulk or gaskets.
- Attic hatches and kneewall entries are weatherstripped.
- Refrigerant charge on air-conditioner/heat pump is verified in writing by installer to be within specs, using superheat method for non-Thermostatic Expansion Valve systems or subcooling method for TXV systems; this may require a return visit during warm weather.
- The whole-house envelope is sufficiently air-sealed as verified by a whole-house pressure test. Air leakage should be tested by a HERS rater and should be less than:
 - 2.5 in² per 100 ft² of envelope area (CGSB, calculated at a 10 Pa pressure differential), or
 - 1.25 in² per 100 ft² of envelope area (ASTM, calculated at a 4 Pa pressure differential), or
 - 0.25 CFM/ft² of envelope area when tested at a 50 Pa pressure differential.



TRADES & CRAFTS

Professional tips for fast and easy installation

On the following pages you will find step-by-step, easy-to-follow illustrated instructions for implementing key energy efficiency technologies.

These *Building Tips* are designed to be easily duplicated and distributed.

- Slab
- Housewrap
- Window Flashing
- Air Sealing - Plumbing
- Air Sealing - Electrical
- Air Sealing - Drywall
- Air Sealing - Glossary
- Fiberglass Insulation
- Masonry Construction
- Radiant Barriers
- Duct Sealing

INTRODUCTION

Taking action in your community



HOMEOWNERS

Shopping for value, comfort, and quality



MANAGERS

Putting building science to work for your bottom line



MARKETERS

Energy efficiency delivers the value that customers demand



SITE PLANNERS & DEVELOPERS

Properly situated houses pay big dividends



DESIGNERS

Well-crafted designs capture benefits for builders, buyers, and business



SITE SUPERVISORS

Tools to help with project management



TRADES & CRAFTS

Professional tips for fast and easy installation

CASE STUDIES

Bringing it all together

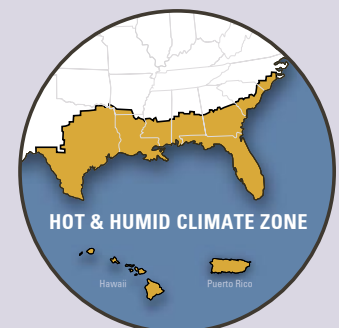



SLABS

Building Tips

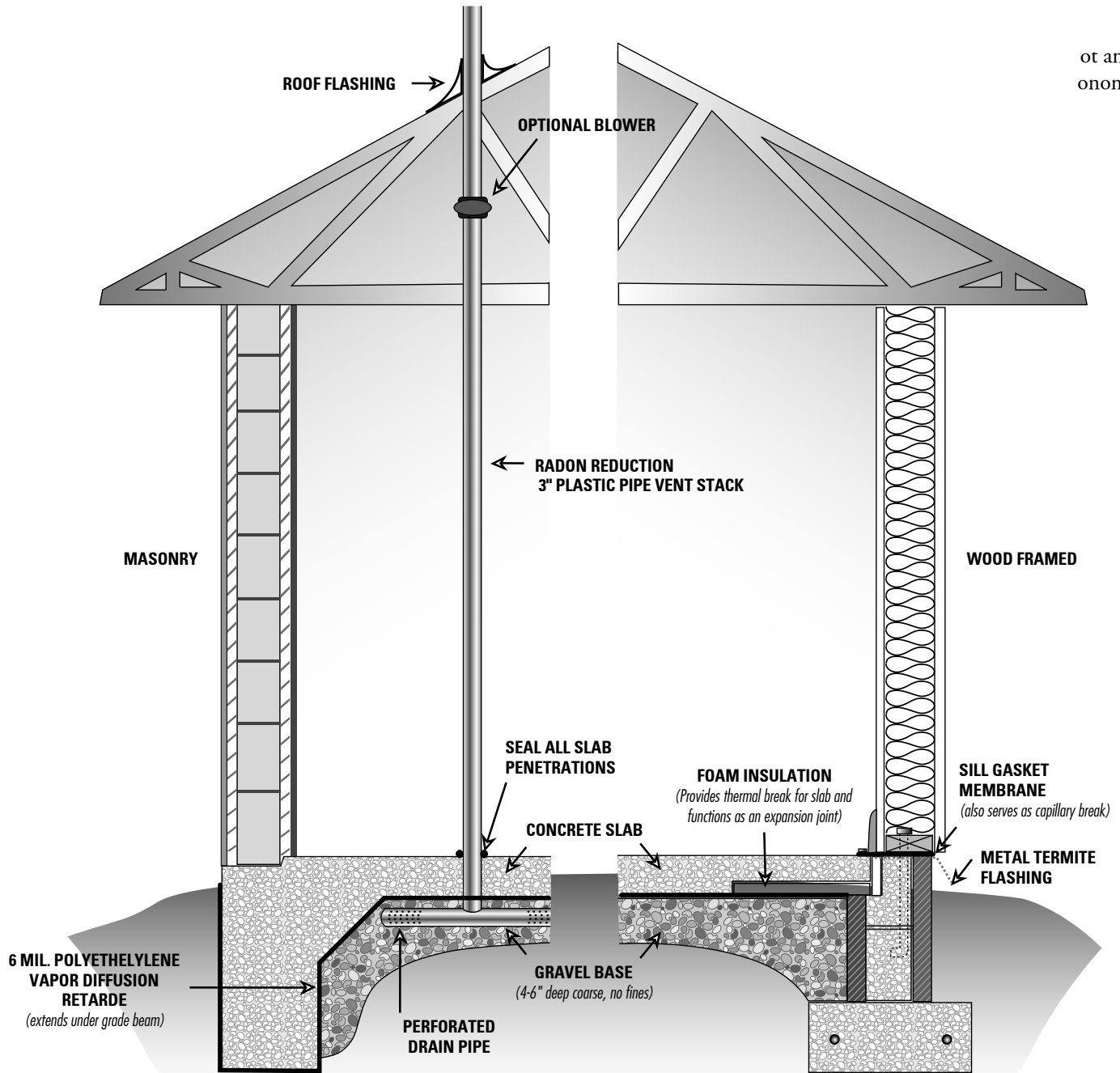

ot and
onomical.

Sources & Additional Information

- U.S. DOE *Technology Fact Sheet on Slab Insulation* (www.eere.energy.gov/buildings/documents/pdfs/29237.pdf).
- Southface Energy Institute *Fact Sheets #29: Insulating Foundation and Doors* (www.southface.org/home/sfpubs/techshts/29_insulatefloors4PDF.pdf).
- Southface Energy Institute *Fact Sheets #30: Radon-Resistant Construction for Builders* (www.southface.org/home/sfpubs/techshts/30_radonresistantconst.pdf).
- Building Science Corporation: www.buildingscience.com/housethatwork/hothumid/wood/default.htm



HOUSEWRAP

Building Tips

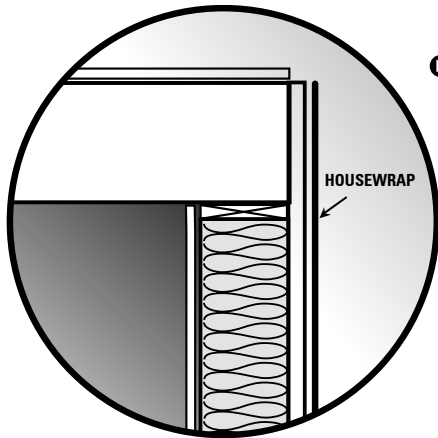

- ▶ Minimize cuts in housewrap and caulk or tape to seal all penetrations
- ▶ Tape housewrap according to manufacturers specifications at top plate, band joist, and horizontal seams, and secure with plastic-capped nails

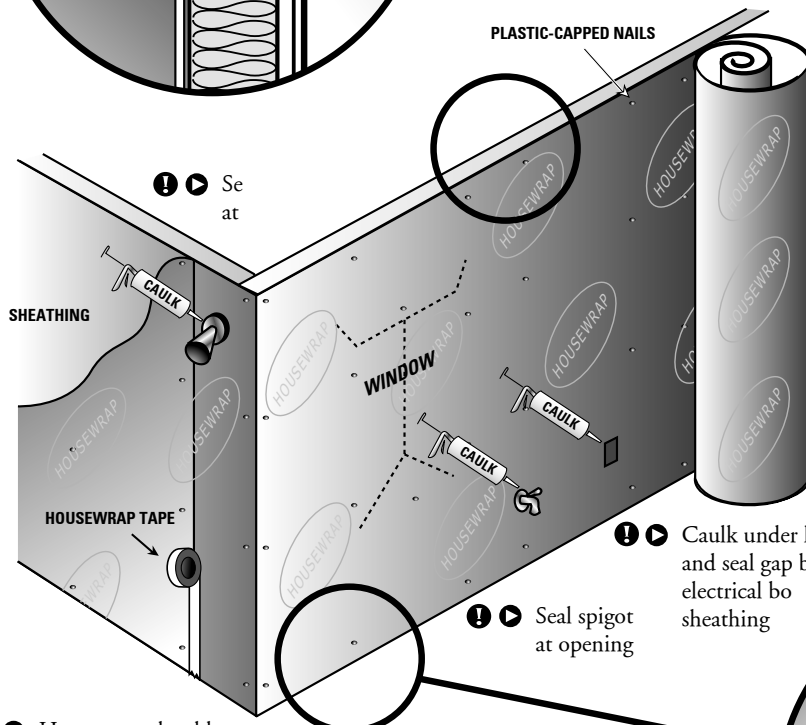

- ▶ Unroll around house
- ▶ Fasten flaps of window "T-cut" to the inside of the framing. (* See *Window Flashing Building Tips*)

- ▶ Housewrap should be overlapped shingle-style
- ▶ Seal overlap with tape

- ▶ Seal housewrap to foundation below bottom plate in basements or crawlspace.

! = Another trade may have completed this step. Confirm with the site supervisor. If not, and you need to complete the step yourself, ensure that the necessary materials are available on site.

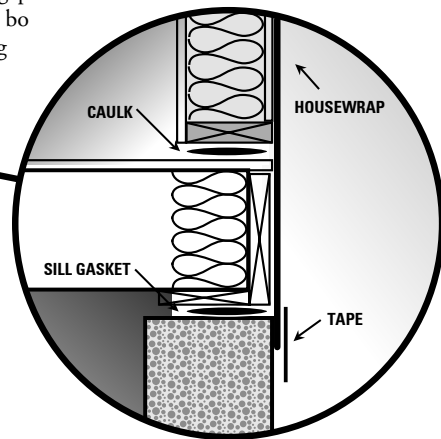

- ! ▶ Caulk under housewrap and seal gap between electrical box and sheathing
- ! ▶ Seal spigot at opening

Sources & Additional Information

- Southface Energy Institute *Fact Sheets #8 Air Sealing* (www.southface.org/home/sfpubs/techshts/8_airsealing.pdf)
- U.S. DOE *Technology Fact Sheet on Air Sealing* (www.eere.energy.gov/buildings/documents/pdfs/26448.pdf)
- See also the Building Tips on *Air Sealing* and *Window Flashing*
- See: <http://construction.tyvek.com/en/productServices/HomeWrap/index.shtml>
- Straube, John. 2001. *Canadian Architect*. "Wrapping it Up". May, 2001. www.cdnarchitect.com.



WINDOW FLASHING

Building Tips

Example of window flashing details for home with housewrap and plywood or OSB wall sheathing.

STEP 1 - IF HOUSEWRAP HAS **Not** BEEN INSTALLED

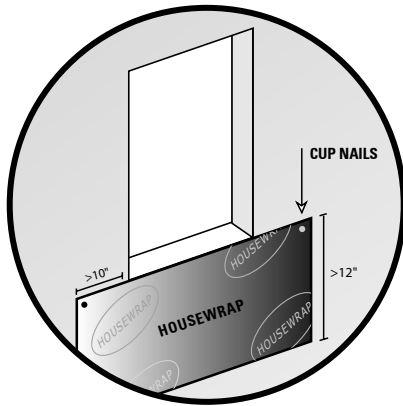

- ▶ Apply at least a 12" flap, or apron, of building paper or housewrap just below the windows sill.
- ▶ If the window sill is close to the sill plate, the apron can extend all the way to the sill plate.
- ▶ The apron should extend at least 10" past the sides of the window opening, or to the first stud in open wall construction.
- ▶ Attach only the apron's top edge with cup nails.

STEP 2 - SILL FLASHING

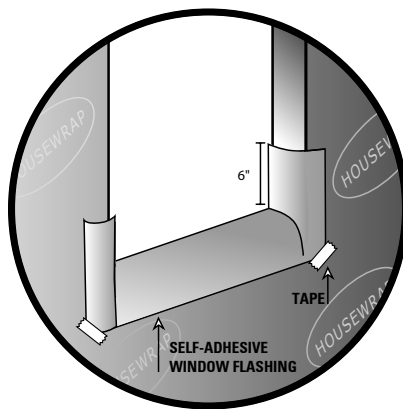

- ▶ Install self-adhesive flashing to the sill, ensuring that flashing extends up jambs at least 6".
- ▶ One commercial product comes with two removable strips over the adhesive. Remove the first strip to expose half the adhesive and apply this area to the sill. Begin pressing in the middle of the sill and work towards the sides. Remove the second strip to expose the adhesive that will be used to apply the flashing below the window to the outside wall.
- ▶ Tape down the bottom corners of the flashing

STEP 1 - IF HOUSEWRAP HAS BEEN INSTALLED

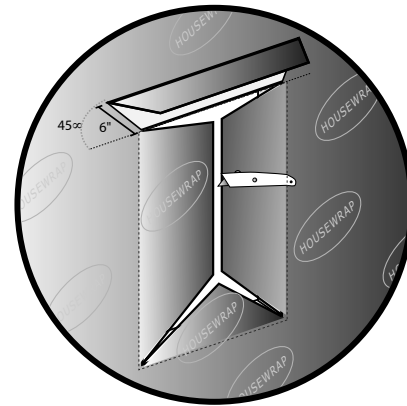

- ▶ Cut the housewrap covering the rough opening in the shape of a modified "Y".
- ▶ Fold the side and bottom flaps into the window opening and secure.
- ▶ Above the window opening, cut a head flap and flip up to expose sheathing, and loosely tape in place out of the way.

STEP 3 - JAMB CAULKING

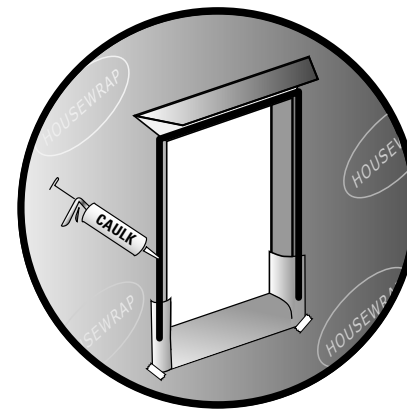

- ▶ Caulk the outside edges of the head and side jambs
- ▶ Do not caulk across the sill
- ▶ Install the window using corrosion resistant nails and following manufacturer's specifications.

BUILDING TIPS: WINDOW FLASHING

STEP 4 - JAMB AND HEAD FLASHING

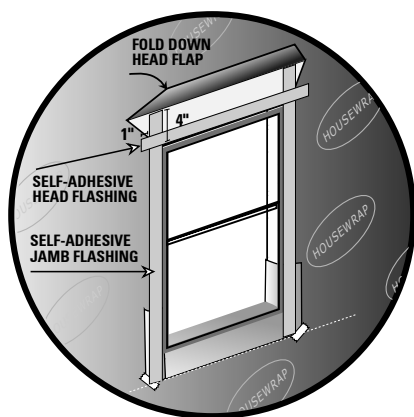

- ▶ Install self-adhesive jamb flashing extending 4" above the top of the head flange and even with the bottom of the sill flashing.
- ▶ Install self-adhesive head flashing extending 1" beyond the jamb flashing.
- ▶ If housewrap has been installed, be sure that the head flap, when it is folded down, will cover the top of the flashing.

STEP 5 - SEAL ROUGH OPENING GAP

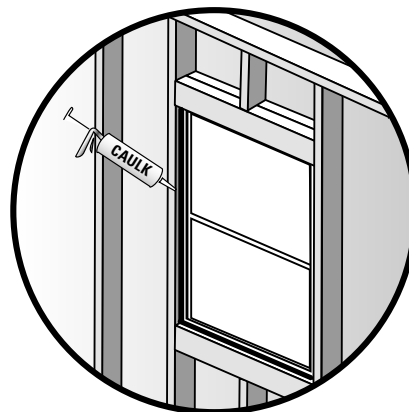

- ▶ On the interior side of the window, seal gap between the window and the rough opening with appropriate sealant.

STEP 6 - IF APRON WAS INSTALLED

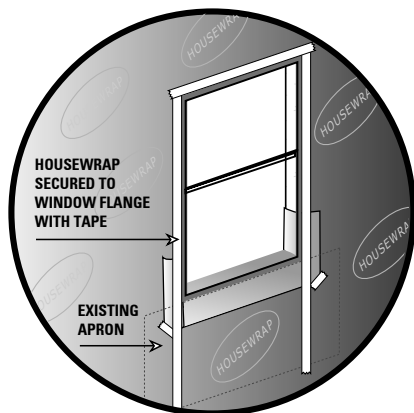

- ▶ If an apron was installed under the window, slip the housewrap or building paper under the apron.
- ▶ Tape the edges where the housewrap meets the window flange if housewrap is installed after flashing.
- ▶ If building paper is used, embed the edges in a bead of sealant where the paper meets the window flange.

STEP 6 - IF HEAD FLAP WAS CREATED

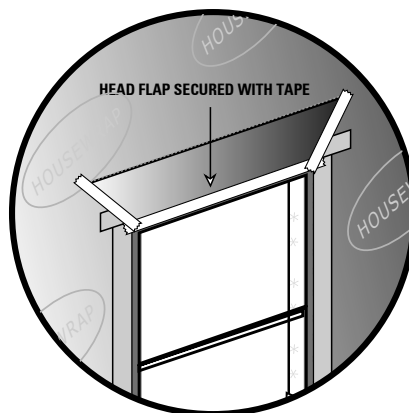

- ▶ If headflap was created, fold it over the head flashing and tape across the top window flange and the 45° angle seams.

Sources & Additional Information

- Lstiburek, J.W. (2002). *Water Management Guide*. Minneapolis, MN: Energy and Environmental Building Association (www.eeba.org).
- U.S. DOE *Technology Fact Sheet on Weather-Resistive Barriers* (www.eere.energy.gov/buildings/documents/pdfs/28600.pdf).
- *Standard Practice for Installation of Exterior Windows, Doors, and Skylights*. ASTM E2112-01, September 2002. West Conshohocken, PA.



Building Tips

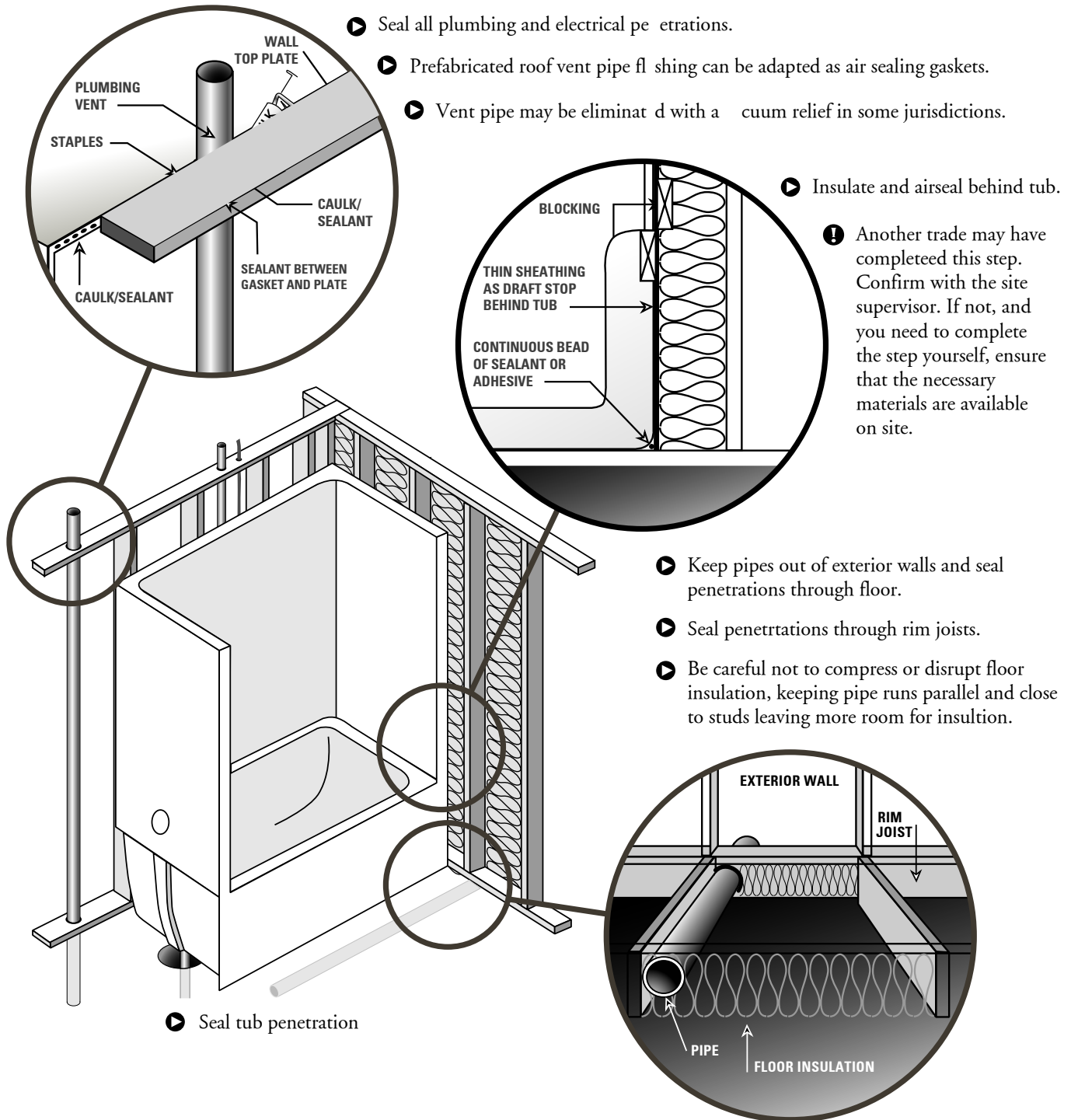

Sources & Additional Information

- Lstiburek, J.W. (2000). *Builder Guide Hot-Humid Climates*. Minneapolis, MN: Energy and Environmental Building Association (www.eeba.org).
- U.S. DOE *Technology Fact Sheet on Air Sealing* (www.eere.energy.gov/buildings/documents/pdfs/26448.pdf).



Building Tips

- ▶ Accessed light fixtures should be rated for Insulated Ceiling Air Tight (ICAT).
- ▶ Ceiling fans should be wired to a wall switch.
- ▶ Seal light fixture boxes to drywall with caulk or foam.
- ▶ Seal bath fan box to drywall with caulk or foam.
- ▶ Seal all exterior penetrations, such as porch light fixtures, phone, security, cable and electric service holes, with caulk, spray foam, or gaskets - note that foam degrades in sunlight.
- ▶ Use air tight outlet boxes or seal standard boxes.
- ▶ Run wiring along side of stud at exterior wall and along plates
- ▶ Seal standard plastic electrical box at face to drywall with joint compound or cover the plate gasket with caulked foam.
- ▶ Caulk/seal/foam all electrical wires penetrating top and bottom plates of exterior walls.
- ▶ Run wiring along bottom plate at exterior wall.
NOTE: Some codes require wires to be held up from bottom plates 6"-8" to protect from future drilling through

Sources & Additional Information

- Lstiburek, J.W. (2000). *Builder Guide Hot-Humid Climates*. Minneapolis, MN: Energy and Environmental Building Association (www.eeba.org).
- U.S. DOE *Technology Fact Sheet on Air Sealing* (www.eere.energy.gov/buildings/documents/pdfs/26448.pdf).
- See also *Air Sealing Building Tips*



AIR SEALING DRYWALL

Building Tips

MEASURE

**Actual assignments to be made by site supervisor. The supervisor may choose to work with a sealing specialist instead.*

	FRAMER	ELECTRICIAN	DRYWALLER	PLUMBER	WINDOW INSTALLER
EXTERIOR WALLS					
Install gaskets or caulk at top and bottom plates of exterior walls.	●				
Seal between the bottom plate and subflooring.	●				
Install gaskets behind coverplates.			●		
Seal large holes behind bath tubs or stairs with sheathing.		●			
PARTITION WALLS					
Seal the drywall at the intersection with the top or bottom plate.			●		
Seal penetrations through the top and bottom plates for plumbing, wiring, and ducts using fire resistant sealants.		●		●	
Knee walls can be insulated and sealed at either the roofline or along the line formed by the roof, wall, and floor. Rigid foam insulation, taped at the seams with housewrap tape, can be used to seal the backside of the knee wall and the underside of the roof. Sealing along the roofline is preferred in new construction.	●		●		
WINDOWS & DOORS					
Caulk or glue drywall edges to either framing or jambs.			●		
Fill rough opening with foam backer rod and caulk (preferred) or low-expanding foam sealant.			●		
Caulk window and door trim to drywall with clear or paintable sealant.			●		●
CEILING					
Seal the junction between the ceiling and walls.			●		
Whenever possible, use continuous drywall sheets for the ceiling and walls to minimize joints to be sealed.			●		
Seal all penetrations in the ceiling for wiring, plumbing, ducts, and attic access openings.		●	●	●	



Building Tips

Caulk

Seals gaps of less than 1/2". Select grade (interior, exterior, high temperature) based on application.

Expanding Spray Foam

Fills large cracks and small holes. Expanding foams are messy but useful for filling large holes or cracks. The material expands 2- to 3-times in volume after application. It comes in one-part cans that require no mixing or in two-part systems for larger jobs. It degrades in sunlight and users should be careful not to get the foam on their skin. **DO NOT USE** near flammable applications (e.g., flue vents). **DO NOT USE** on windows and doors. In large applications, a two-part system is used which involves mixing the sealant on site. For small jobs, one-part spray cans are used.

Low-Expanding/Non-Expanding Spray Foam

These latex-based spray foams come in one-part spray cans. They expand very little or not at all and will not pinch jambs or void window treatments.

Backer Rod

Closed-cell foam or rope caulk. Press into crack or gap with screwdriver or putty knife. Often used with caulk around window and door rough openings.

Gaskets

Apply under the bottom plate before an exterior wall is raised or use to seal drywall to framing instead of caulk or adhesive.

Housewrap

Installed over exterior sheathing. Must be sealed with housewrap tape or caulk to act as an air retarder. Resists water, but is **NOT** a vapor barrier.

Sheet Goods

(Plywood, Drywall, Rigid Foam Insulation) These materials form an air retarder. Air leaks only at unsealed seams or penetrations.

Sheet Metal

Used with high-temperature caulk for sealing high-temperature components, such as flues, chimneys, and framing.

Polyethylene Plastic

This inexpensive material for air sealing also stops vapor diffusion. All edges and penetrations must be completely sealed for an effective air retarder. Poly is fragile, and proper placement is climate specific.

Weatherstripping

Used to seal moveable components, such as doors, windows, and attic accesses.

Mastic

A thick paste which can be used on all duct materials and provides a permanent seal. Seals air handlers and all duct connections and joints. UL-181-approved water bars mastic is best.

UL-181 or Foil-Faced Tape

Temporarily seals the air handler.

Sources & Additional Information

- U.S. DOE *Technology Fact Sheet on Air Sealing* (www.eere.energy.gov/buildings/documents/pdfs/26448.pdf).



Building Tips

INSTALLING FIBERGLASS BATT INSULATION

ALWAYS:

- Avoid gaps, tight turns, and compression
 - Cut insulation to fit snugly in non-standard spaces
 - Slit batts to fit around wiring and plumbing
 - Notch out around electrical boxes and use scraps to fill in behind
- Install long runs first – then use scraps to fill in smaller spaces and gaps
- Use unfaced batts in hot and humid climates
- Even if blown in insulation is to be generally applied, use fiberglass batts to insulate areas that will be inaccessible to the blown in insulation, such as behind bath enclosures.

Walls:

- Friction fit the batts in place until covered by drywall or sheathing
- Insulate before installing stairs and tubs and other features that will block access

Knee Walls:

- Seal knee wall to create a continuous air barrier. Knee walls can be sealed following the wall itself and attic floor or along the sloping edge of the attic roof. Rigid foam insulation, taped at the seams with housewrap tape, can be used to seal the backside of the kneewall and the underside of the roof. Sealing along the roofline is preferred in new construction.
- Insulate and air seal the rafter space along the sloping ceiling of the knee wall attic space or insulate and air seal the roofline wall and floor.
- Rafters should receive [R-19 or R-30] insulation
- Cover rafters with a sealed air barrier (such as drywall or foil-faced hardboard)
- Caulk the barrier to the top plate of the wall below the attic space and to the top plate of the knee wall itself
- Seal all other cracks and holes

Ceilings:

- Insulate and seal the attic access door
- Install insulation over IC, AT rated recessed cans
- Ventilation pathways?
- Install insulation baffles

Band Joists:

- Place insulation in the cavities between joists and subfloor
- Caulk bottom plate to subfloor
- Caulk band joist to subfloor and plates and insulate
- Caulk bottom plate to subfloor

Under Floor Insulation:

- Metal stays, lathe, or stainless steel wire support insulation in joist cavities.
- In new construction it is preferred that crawlspace walls are insulated. If underfloor insulation is to be used it can be held in place with metal staves, lathe, stainless steel wire, or twine.
- If truss systems are used under floors, an approach better than batt insulation is to install netting or rigid insulation to the underside of the floor trusses and fill the joist cavity with blown-in insulation.

Sources & Additional Information

- Energy Efficient Building Association's *Builder's Guide Hot-Humid Climates*, 2000.
- U.S. DOE *Technology Fact Sheet on Attic Access*.
- U.S. DOE *Technology Fact Sheet on Crawlspace Insulation*.
- * Refer to the *Air Sealing Building Tips*



Building Tips

- ▶ Semi-vapor permeable rigid insulations used on the interior of wall assemblies should be unfaced or faced with permeable skins. Foil facings and polypropylene skins should be avoided.
- ▶ Wood furring should be installed over rigid insulation; the rigid insulation should be continuous over the surface of the wall, except for the 2x4 furring near the ceiling. This blocking attaches directly to the masonry block and is above the insulation, not behind it.

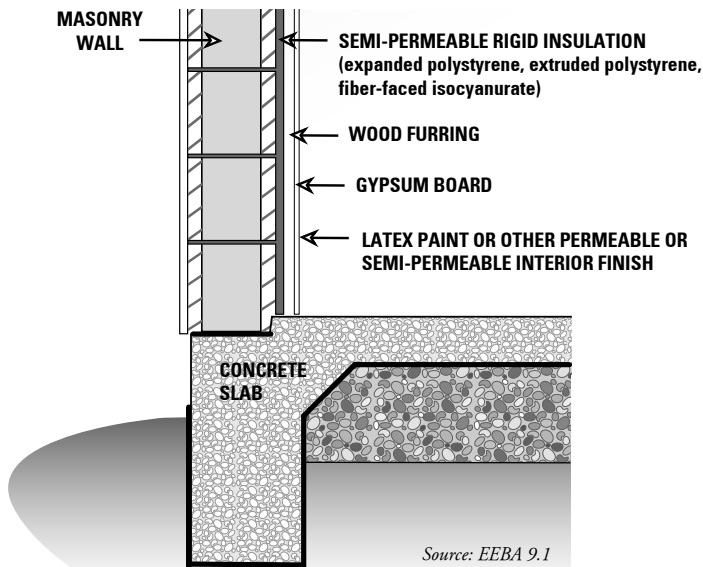
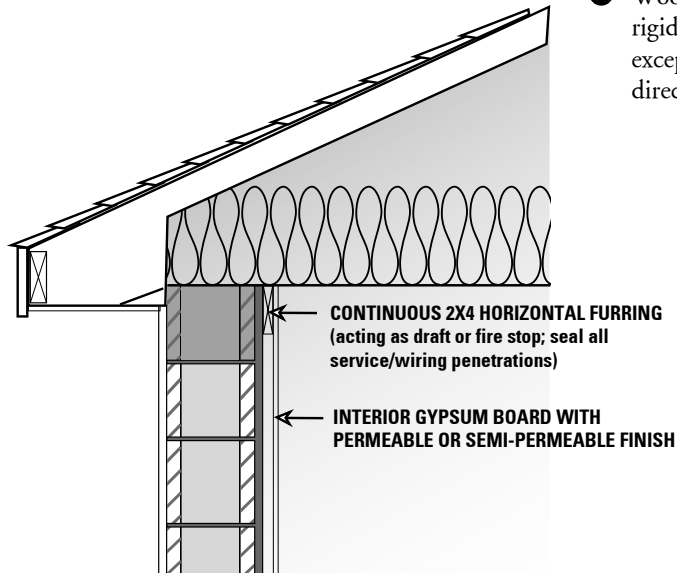

- ▶ Electrical boxes can be surface-mounted eliminating chiseling/chipping masonry

WINDOW SILL DRAINAGE

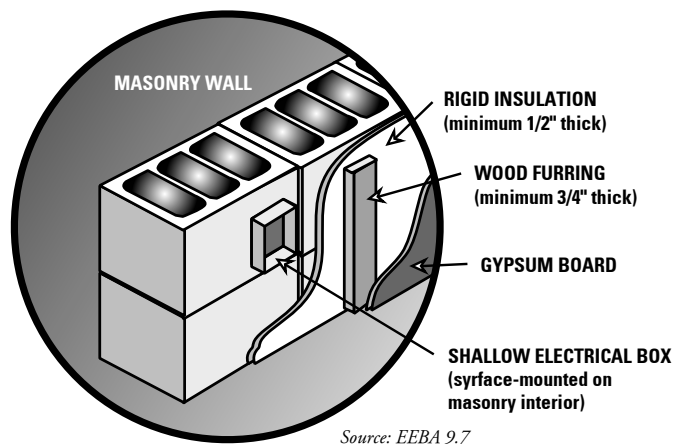
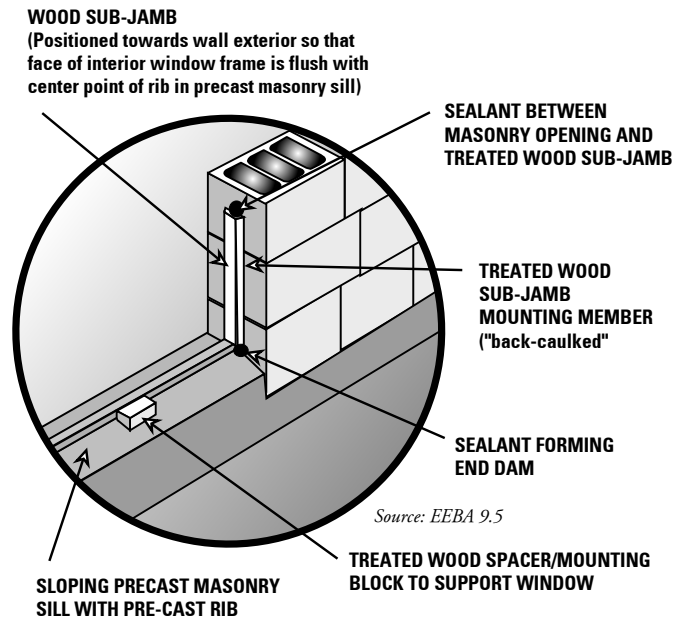

ELECTRICAL BOX

Sources & Additional Information

- *Builders Guide to Hot and Humid Climates*. 2000. Energy and Environmental Building Association (ww.eeba.org).



RADIANT BARRIERS

Building Tips

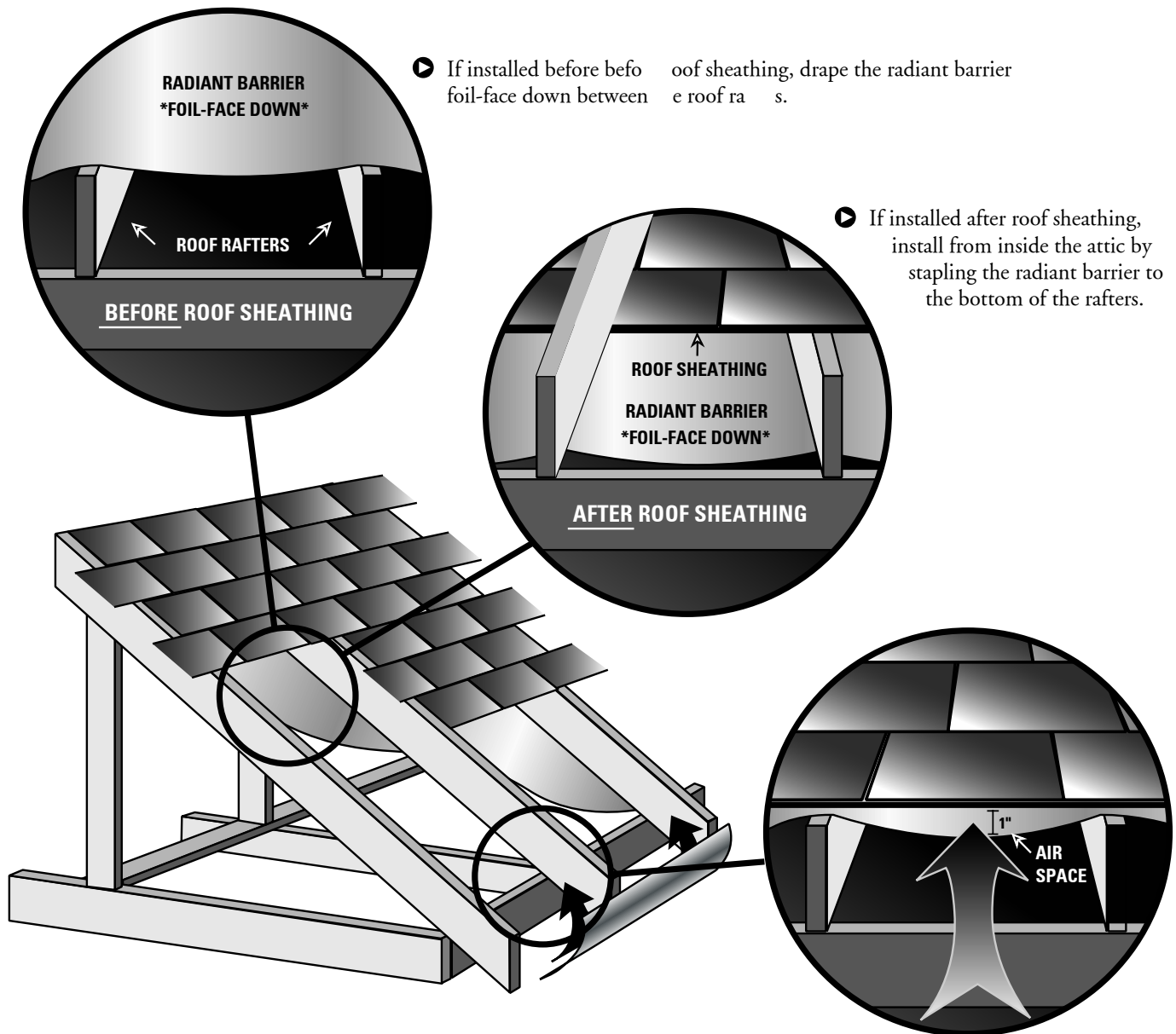

▶ If installed before roof sheathing, drape the radiant barrier foil-face down between the roof rafters.

▶ If installed after roof sheathing, install from inside the attic by stapling the radiant barrier to the bottom of the rafters.

▶ NOTE: Some roof sheathing products have a radiant barrier preinstalled; in this case, ensure the shiny side faces the attic.

▶ Allow the material to droop between attachment points to make at least a 1 inch air space between the radiant barrier and the bottom of the roof.

Sources & Additional Information

- U.S. DOE EREC Brief on Radiant Barriers (www.eere.energy.gov/consumerinfo/refbriefs/bc7.html).
- Southface Energy Institute *Fact Sheet #14 Radiant Barriers* (www.southface.org/home/sfpubs/techshts/14radiantbarriers.pdf).
- Southface Energy Institute *Fact Sheet #25 Ceiling and Attic Insulation and Ventilation* (www.southface.org/home/sfpubs/techshts/25_insulateceilings_4pdf.pdf).



Building Tips

AIR HANDLER

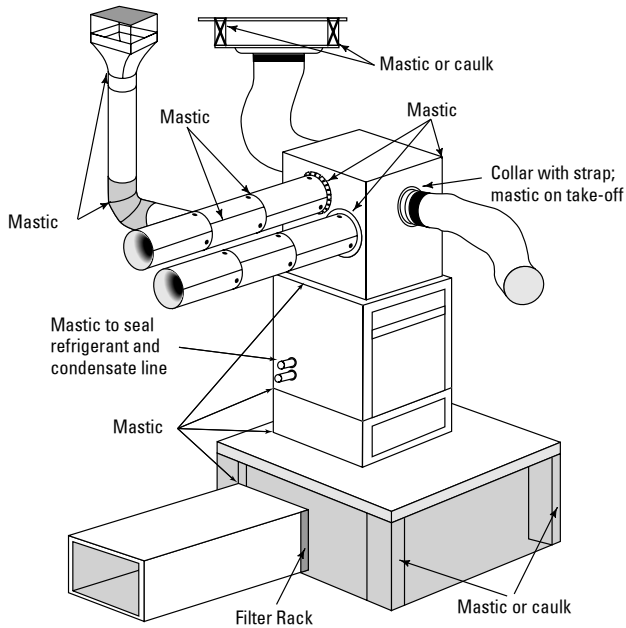

SUPPLY & RETURN PLENUMS

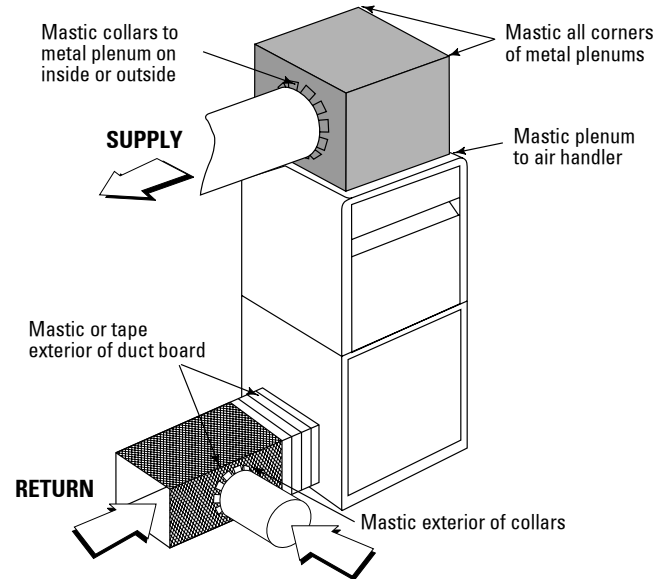

FLEX DUCT

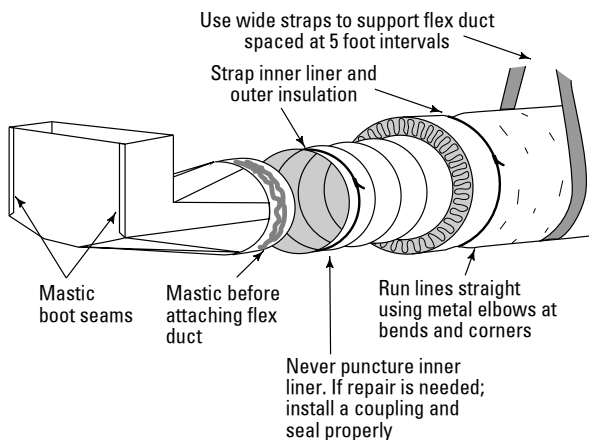

BOOTS

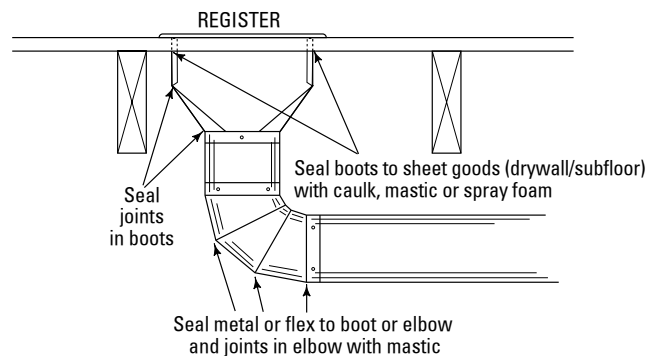

- ▶ Mastic is a goeey adhesive that is applied wet. It fills gaps and dries to a soft solid. Mastics may or may not contain reinforcing fibers, and they may be used with reinforcing mesh tape.

Sources & Additional Information

- *Energy Efficient Building Association Builder's Guide Hot and Humid Climates*, 2000.
- Southface Energy Institute *Fact Sheet #2 Ductwork Questions & Answers* (www.southface.org/home/sfpubs/techshts/2duct_q&a.pdf).
- Southface Energy Institute *Fact Sheet #18 Energy Checklist* (www.southface.org/home/sfpubs/techshts/checklist.pdf).
- * All graphics diagrams courtesy of Southface Energy Institute Fact Sheet #2 Ductwork Questions & Answers.

La Grange, Georgia

2003 Jimmy Carter Work Project

Could 1,000 volunteers using donated materials build 22 homes in just 7 days and could they build them all to ENERGY STAR standards? That's just what the Troup-Chambers Habitat for Humanity of LaGrange, Georgia, did between June 6 and 13, 2003, and every home qualified for ENERGY STAR.

These are the first ENERGY STAR homes Troup-Chambers Habitat has built and the experience was so positive, that Walter Hendrix, Executive Director of Troup Chambers Habitat for Humanity said "we are incorporating ENERGY STAR in every house we build from here on out."

Troup Chambers Habitat plans to build 38 homes this year and 30 to 40 per year over the next 20 years as part of Habitat for Humanity International's 21st Century Challenge, an initiative to eliminate substandard housing in the 21st Century. The homes range in size from 850 to 1,252 square feet, and with 2 to 5 bedrooms and 1 to 2 bathrooms. Homes range in cost from \$45,000 to \$57,000 and are sold through a special no-interest mortgage program to low-income families who invest "sweat equity" in the construction of their own and other Habitat homes. Habitat affiliates across the country built 5,400 houses last year, putting Habitat for Humanity International at number 16 on Builder's list of top 100 U.S. builders.



"The attention to detail far exceeds the standard practice."

**Walter Hendrix, Executive Director of
Troup Chambers Habitat for Humanity**

Hendrix, who took over as president of the Troup Chambers Habitat affiliate in 2002 after 34 years as a private home builder, said he felt building to ENERGY STAR standards produced a better house without a large increase in construction costs over their standard construction.

We found no significant increase in materials costs or in subcontract labor costs. It was really more in techniques, heavy caulking, ways to keep unfiltered outside air from coming in. Quite honestly when I had my own construction firm, I had concerns about making the house too airtight. The Building America team members educated us on the right way to seal a house to keep humid air out and to add mechanical ventilation for fresh air exchange. We did a lot more caulking. We used sill seal below the bottom plate, which no one was doing in LaGrange. The Building America consultants showed our volunteers how to wrap the houses, apply the insulation and foam caulk, and wrap duct joints with mastick... The attention to detail far exceeds the standard practice.

INTRODUCTION

Taking action in your community



HOMEOWNERS

Shopping for value, comfort, and quality



MANAGERS

Putting building science to work for your bottom line



MARKETERS

Energy efficiency delivers the value that customers demand



SITE PLANNERS & DEVELOPERS

Properly situated houses pay big dividends



DESIGNERS

Well-crafted designs capture benefits for builders, buyers, and business



SITE SUPERVISORS

Tools to help with project management



TRADES & CRAFTS

Professional tips for fast and easy installation

CASE STUDIES

Bringing it all together

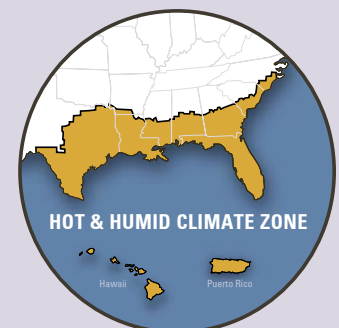

CASE STUDY: HABITAT FOR HUMANITY

Habitat for Humanity: The 16th Largest Builder in the United States

The US has 1,651 active affiliates who have built 5,400 houses in 2002 and 44,617 houses total since Habitat's founding in 1976. Habitat for Humanity International is ranked number 16 in the Builder Top 100.

Through volunteer labor and donations of money and materials, Habitat builds and rehabilitates simple, decent houses with the help of the homeowner (partner) families. Habitat houses are sold to partner families at no profit, financed with affordable, no-interest loans. The homeowners' monthly mortgage payments are used to build still more Habitat houses. Habitat has built more than 150,000 houses around the world, providing more than 750,000 people in more than 3,000 communities with safe, decent, affordable shelter. HFHI was founded in 1976 by Millard Fuller and his wife Linda.

While Troup-Chambers Habitat hires subcontractors to install the electrical, plumbing, HVAC, and flooring, Hendrix estimates their labor force is 60% volunteer, including some who have never done construction before, so construction techniques have to be simple enough for even novices to follow.

"The Building America team members from Building America's Industrialized Housing Partnership were extremely dedicated, they brought a lot of experience and intelligence to the program," said Hendrix. "They did insulation installation classes with all the house leaders and met on several occasions with HVAC contractors to go through equipment, installation, and duct sealing techniques. They were always there to give us advice on material purchases and decisions."

The importance of air sealing is stressed to the volunteers. A continuous wall air barrier is installed consisting of:

- Sill seal between the slab and exterior wall bottom plate
- Rigid insulation sheathing (over OSB) sealed at all seams and edges
- Tar paper window flashing installed shingle fashion to the sides and bottom of the rough opening then sealed to the rigid insulation and the rough opening with caulk
- Caulk between the window frame and tar paper flashing (applied to each back side of the nailing flange just before each window is set.)

Habitat receives free rigid insulation from Dow and, for this project, used 1/2" 4'x8' sheets attached with collared nails. A continuous ceiling air barrier is formed by the drywall and the top plates of all the walls.

Holes for wiring and plumbing through the rigid insulation, top plates of exterior and interior walls, and the ceiling drywall all represent breeches of the house air barrier and are sealed with either caulk or expanding foam. Common sites for this type of sealing include bathroom and kitchen plumbing and fans, the main electrical panel, outside electrical outlets and water faucets, electrical and plumbing runs through top plates, and dryer vents. Holes too large for foam sealant are first covered or filled in with appropriate materials such as drywall, OSB, or rigid insulation, then the joint

BUILDER PROFILE

Habitat for Humanity

Where:

LaGrange, Georgia

Founded:

1987

Employees:

2 part-time employees
subcontractors and volunteers

Development:

Jimmy Carter
Work Project 2003

Size:

22 homes

Square footage:

850 -1252 sq.ft.
2-5 bedrooms
1-2 bathrooms

Price range:

\$45,000 to \$57,000

Key Features:

- R-13 batt wall insulation with 1/2" rigid insulation
- Double-pane, low-e windows; U = 0.39, SHGC = 0.57
- Programmable thermostat
- Heat pump
- Interior air handler closet in two- and four-bedroom homes
- Right-sized mechanical system
- R-30 in attic
- Insulated steel doors

CASE STUDY: HABITAT FOR HUMANITY

can be sealed.

The rigid insulation serves as both the primary air barrier and the drainage plane in this wall assembly so sealing the seams and edges is critical. Tape designed for exterior air/moisture barrier applications is used because other tapes will fail over time, leaving gaps for both air and moisture intrusion.

The space between the window frame and the rough opening is insulated with strips of sill seal or wall insulation (folded length-wise, kraft face to interior, for easy placement). Where possible, this insulation is caulked to both the window frame and rough opening to back up the air seal on the exterior at the nailing flange. This is complementary to the seal at the window flange, which forms an important element of the drainage plane. Expanding foam is NOT used because it could cause deformation of the window frame and Habitat wanted to teach sealing methods that can be universally applied for volunteers' future work.

Typical wall construction is 2x4, 16" o.c. with R-13 fiberglass batt insulation, OSB, and 1/2" Dow Styrofoam blue board rigid insulation. All of the houses also have vinyl siding. The typical HVAC system in an average Habitat house is strip heating and air conditioning. In the ENERGY STAR Habitat houses, heat pumps with efficiency ratings of 10 SEER and 6.8 HSPF were installed. Programmable thermostats were also installed to provide more accurate control and performance.



Source: FSEC

"We will build 38 homes this year and intend to build 30 to 40 per year from here on out. Our goal is to make everyone of our new homes ENERGY STAR."

Walter Hendrix, Executive Director of Troup Chambers Habitat for Humanity

COMPARISON TO CONVENTIONAL MEASURES

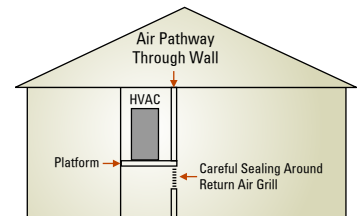
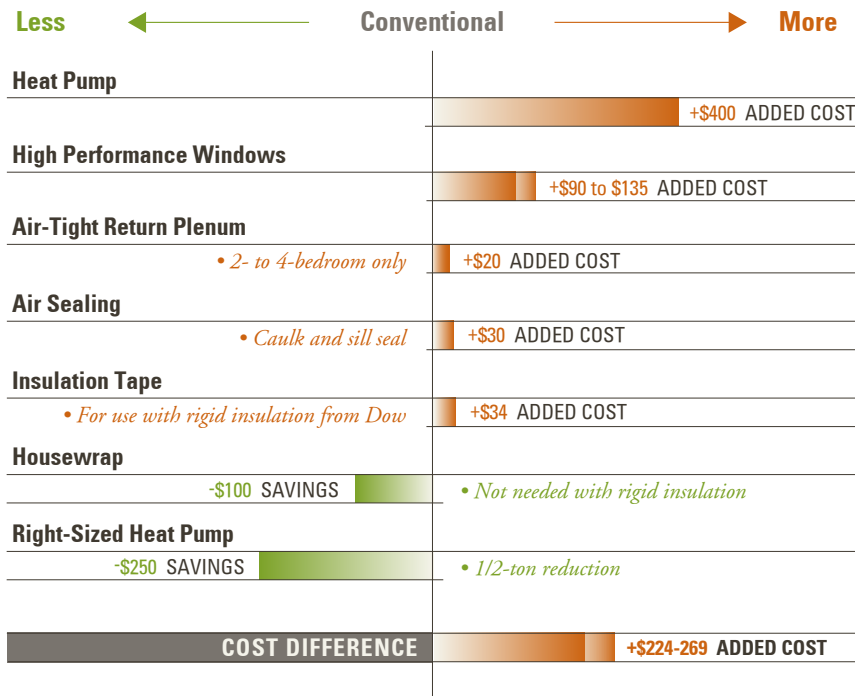

Careful sealing of the air handler closet, including framing in the return air grill, sealed leaks through open wall cavities that could pull hot and humid air from the attic.

HERS Rating

Each home was tested by a team of Building America Industrialized Housing Partnership researchers, Southface Energy Institute staff, and Habitat for Humanity International staff and volunteers. The average HERS rating exceeded 86.

CASE STUDY: HABITAT FOR HUMANITY

Innovations

The two-bedroom homes include a sealed, interior air handler closet. In the air handler closets, the space below the platform was made air tight to provide a continuous path from the return air grill to the opening in the air handling unit. The gap between the ceiling drywall and the supply duct was filled. Caulk was applied at the edges of the bottom edge of the drywall, the bottom plate, and the platform edges.

The LaGrange community was designed as a green-space community with shared greenspace available to residents and residential traffic directed behind the homes for parking.

Comfort, Durability, and Health

The attention paid to air sealing the house reduces infiltration and drafts, saves energy, and improves durability by reducing the movement of humid air through the walls. The air paths that are sealed are also the “bug paths” since cockroach dander is among the top 10 allergy and asthma triggers in the United States, these air sealing efforts are good for occupant health as well. Programmable thermostats allow more accurate control and performance. Double-pane, low-e windows reflect infrared radiation, reduce energy consumption, and prevent carpets and furniture from fading.

The Bottom Line

When asked about costs, Hendrix said “We found no significant increase in materials costs or in subcontract labor costs. It’s mainly the attention to detail, it far exceeds the standard practice. Will it cost more? On a typical 3-bedroom house you might realize \$1,000 in extra cost. The return on that is probably 2 to 3 years to the home owner.”

Gainesville, Florida

Small Changes Add Up to Big Savings

Atlantic Design and Construction of Gainesville, Florida, was already implementing some energy-efficient measures in their new home construction when they heard about ENERGY STAR in 1998. By making a handful of changes they were able to qualify for the ENERGY STAR rating. In fact, these changes were so effective Atlantic won ENERGY STAR's Small Builder of the Year award in 2000.

The firm, founded in 1985, now directly employs 15 full-time employees and sells about 50 to 60 homes per year. Since 2000, they have built more than 300 ENERGY STAR homes.

According to Atlantic president Lucian Kragiel, the biggest changes from their prior construction methods were switching to low-e windows, upgrading to a higher efficiency HVAC system and water heater, adding fresh air intake, and moving the air handler for the HVAC system from unconditioned space in the garage to conditioned space.

To get to the ENERGY STAR level, Atlantic right-sized the HVAC system, increased the efficiency of the air conditioner and the furnace, added programmable thermostats, switched to R-13 blown-in cellulose instead of R-11 fiberglass batts, and did additional air sealing around the interior where walls meet the slab. They also added filtered air intake in the eaves ducted to the HVAC to draw in fresh outside air. After winning the 2000 ENERGY STAR Small Builder award, they further increased the efficiency of the air conditioner and the furnace (and added a variable speed blower) and changed to double-pane, low-e windows with a solar heat gain coefficient (SHGC) of 0.35.



"Building America helped us by showing us how effective the measures are. Ken Fonorow (of Florida Home Energy Resources Organization, a Building America team member visited us and showed us potential energy savings, he gave us specifics on how to qualify a home in the ENERGY STAR point system. He also did the HERS testing for us," explained Kragiel.

Lucian Kragiel, President of Atlantic Design

Innovations

In Atlantic homes, the air handling unit is located in the equipment room which is completely sealed from the garage and attic. A sealed, .90+ AFUE combustion gas furnace is used. The plenum and refrigerant lines are sealed to the sheetrock with an expandable foam at all seams and penetrations. During equipment set, the supply side plenum is affixed and then completely sealed with mastic and pressure-sensitive tape. A metal tap installed in the return air plenum at ceiling height is attached to an insulated flex duct which is connected to a second tap on the furnace side. As an added bonus, the mechanical room is conditioned space, and its area (approximately 15 square feet) is added to the total square footage of the home, increasing the home's value.

INTRODUCTION

Taking action in your community



HOMEOWNERS

Shopping for value, comfort, and quality



MANAGERS

Putting building science to work for your bottom line



MARKETERS

Energy efficiency delivers the value that customers demand



SITE PLANNERS & DEVELOPERS

Properly situated houses pay big dividends



DESIGNERS

Well-crafted designs capture benefits for builders, buyers, and business



SITE SUPERVISORS

Tools to help with project management



TRADES & CRAFTS

Professional tips for fast and easy installation

CASE STUDIES

Bringing it all together

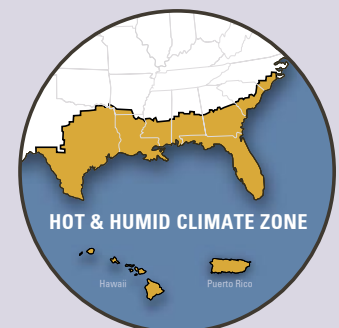

HERS Rating and Testing

A licensed, third-party contractor performs final testing and commissioning on each home. **The average HERS rating is between 89 and 90.**

To qualify as an ENERGY STAR® home the building must be at least 30% more energy efficient than a house built to the minimum requirements of the model energy codes, the HVAC system must be properly sealed and a “blower door” test must be performed. During this test the home is pressurized and air leakage is measured. To pass the blower door test a home must have an air change rate of less than 35%. That means that in the course of one hour, no more than 35% of the air in the home will be replaced by outside air through the natural leakage of the structure under average atmospheric conditions. Mentone homes have an average air change rate of 20%.

Comfort, Durability, and Health:

Atlantic installed a simple, non-mechanical fresh air system that introduces filtered, outside air to the return side of the plenum. The air handler (which circulates heated or cooled air in the home) draws approximately 25 cubic feet per minute of fresh, filtered air from a register located under the eaves on the exterior of the home. This creates a positive pressure in the home when the air handler is running and helps restrict the uncontrolled entry of hot, humid, pollen-laden air into the home. Programmable thermostats allow more accurate HVAC control and performance. Double-pane, low-emissivity windows reflect infrared radiation, reduce energy consumption, and prevent carpets and furniture from fading. All ducts are coated with an anti-microbial lining that resists mold and prevents particles of duct board from entering the air stream.

When the air handling unit (AHU) is placed in the garage in a hot and humid climate, many negative consequences can occur. Accelerated rusting in the ferrous heat exchanger and increased evaporator coil sweating are both more likely due to the humid environment and both can shorten the life expectancy of the heating and cooling system. Air leakage can introduce the home to moisture, outdoor irritants, automobile exhaust, and toxic fumes from substances stored in the garage. Ductwork creates an unfiltered pathway for hot, moist air, and/or pollen-laden outside air to enter the home. Atlantic takes care of these problems by enclosing the air handler in conditioned space in the equipment room.

The Importance of Mastic

Little changes can make a big difference. “Sealing the ducts with mastic is I think the single most important thing that anyone should do,” according to Atlantic Design’s president Lucian Kragiel. Kragiel estimated that average duct leakage in new construction in Florida is 10%, and in older homes it is closer to 30%. “Just sealing ducts on existing homes could reduce the need for new power plants. Sealing gets leakage rates down to about 2%. Not doing duct sealing on new construction is extremely short sighted. Mastic will last the life of the system, while conventional duct tape can fail within a year,” said Kragiel.

BUILDER PROFILE

Atlantic Design & Construction

Where:

Gainesville, Florida

Founded:

1985

Employees:

15 full-time employees

Development:

Mentone

Size:

342 Single-family homes

Square footage:

1500 - 2600 sq.ft.

3-5 bedrooms

2-3.5 bathrooms

Price range:

\$130,000-\$300,000

Key Features:

- Double-pane, low-e windows; SHGC = 0.35
- R-30 unfaced ceiling insulation
- R-13 blown-in cellulose insulation
- Right-sized air conditioners with SEER 13
- Natural gas heating with AFUE = 0.92+
- Natural gas water heating with 0.57 efficiency
- Sealed combustion
- Outside air with pressure balanced return air
- Duct leakage @ 25 Pa <5% of fan flow
- Programmable thermostat
- Air loc recessed lighting

CASE STUDY: ATLANTIC DESIGN & CONSTRUCTION

ENERGY STAR® as a Sales Tool

Atlantic started building ENERGY STAR homes in 1998. They offer ENERGY STAR as an upgrade, and so far they have had 100% participation—all of these homes are ENERGY STAR. “We show people the wisdom of ENERGY STAR construction and the economics of it and everyone chooses it,” said Kragiel.

Why ENERGY STAR® Makes Good Sense for Home Buyers

Atlantic cites these benefits:

- At least 30% more energy efficient than standard homes
- Lower ownership costs / higher resale value
- Mortgage rate incentives
- High return on investment
- Qualify for a larger home
- Improved indoor air quality

“It’s not hard to sell when you educate the buyer, if you can show them (the buyer) that they will get lower utility bills. And they are also going to get a higher resale value on their house,” said Kragiel. Atlantic tells buyers that the EPA has partnered with several national mortgage lenders to offer mortgage rate incentives for ENERGY STAR home buyers. Atlantic also makes buyers aware of lenders offering more liberal qualifying requirements for ENERGY STAR mortgages, which allows buyers to qualify for larger homes or additional upgrades. Atlantic made arrangements with its preferred lenders to offer a mortgage rate incentive of a 1/8 % reduction for ENERGY STAR purchases.

Atlantic tells home buyers that every home is individually HERS tested. Upon successful completion of testing, the home will receive a Certificate of Authorization from the Environmental Protection Agency that is fully transferable, which Atlantic says will give their home higher market value at resale.

Even though Atlantic has had 100% participation in ENERGY STAR, they continue to sell it as an upgrade option rather than as a standard feature. “We think it increases its value to the buyer. When it’s automatically included there may be some doubt of its value, but when it’s optional and you can tell a prospective buyer you’ve had 100% participation, that shows its value. Plus offering it as an option gives us an opportunity to talk about it,” said Kragiel.



The design calls for deep overhangs, which keep sun off windows to keep the home’s interior cooler. Double-pane, low-emissivity windows also help keep things cool by reflecting infrared radiation and reducing energy consumption. This photo shows additional building details like flashing between the wall and roof and building paper, which provides protection against moisture. Atlantic also added additional air sealing around the interior where the plate meets the slab.



Atlantic Design & Construction received the Energy Star 2000 Small Builder of the Year Award for its energy-efficient construction.

“You can make money doing it, and you can feel better about your self at the end of the day, knowing you’re making the planet healthier by building better homes.”

Lucian Kragiel, President of Atlantic Design and Construction

CASE STUDY: ATLANTIC DESIGN & CONSTRUCTION

The Bottom Line

Kragiel said Atlantic's costs to implement ENERGY STAR are about \$1700 per home and they sell the upgrade to home buyers for \$2200. "You can pick and choose from several options what features you want to add to meet the ENERGY STAR point score. We aim for a high score but just making it at all is an improvement. Our ENERGY STAR upgrade costs \$1700 but it (ENERGY STAR criteria) could be met for about half that," said Kragiel.

Kragiel advises builders to educate yourself first and then the buyer. "It (ENERGY STAR) is easier to do than you think. Buyers really do want it when they understand it. ENERGY STAR is becoming increasingly well known. Builders who don't do it, will lag behind," said Kragiel.

"Our experience with ENERGY STAR has been absolutely positive...Sales are going great."

**Lucian Kragiel, President of
Atlantic Design and Construction**

Kragiel notes that it takes a little time up-front to understand how you're going to implement ENERGY STAR and why you're doing it. Atlantic worked with consultants from the Industrialized Housing Partnership of Building America to learn about ENERGY STAR. "Ken Fonorow approached us and showed us the sense in it. We've always been concerned about the environment and making a better product," said Kragiel. "Building America's ideas fit in with our corporate philosophy. It's a good thing to do." And the rewards are concrete: 100% of their buyers purchase the \$2,200 upgrade and they've had very few callbacks on the ENERGY STAR features. According to Kragiel, the biggest benefit is the sense of satisfaction of doing something good. "You can make money doing it, and you feel better about yourself at the end of the day, knowing you're making the planet healthier by building better homes."



This outside vent located under the eaves provides filtered fresh air to the return side of the plenum, enabling the air handler to draw approximately 25 cubic feet of fresh air per minute.

Gainesville, Florida

Healthy homes for a healthy bottom line - this could be the motto for GW Robinson Builder of Gainesville, Florida. GW Robinson's efforts to build houses that are healthy for the environment and the homeowner are paying off in healthy sales as well.

CobbleField is an in-fill development of 290 single-family homes on 120 acres of woodland just west of Gainesville. The developer won over local opposition with its environmentally friendly design that includes placing homes to maintain as many existing trees as possible and landscaping with indigenous species. The homes, which range in size from 1800 to 4500 square feet, with 3 to 5 bedrooms and 2 to 5 bathrooms, have energy-saving features throughout. Every home is also equipped with water-saving features including an irrigation system using recycled water and circulating loop hot-water pipes. During building, construction debris is recycled whenever possible to reduce trips to the landfill.



Robinson uses non-toxic blown-in cellulose insulation for more even coating over uneven surfaces. Here builders have pre-insulated in an area that will be inaccessible later. The ruler will show how thick the added insulation is. The reflective layer is a radiant barrier in the roof that reflects 95% of infrared radiation and keeps the attic up to 30 degrees cooler.

While doing their part to help save the planet, CobbleField homeowners can breathe easier knowing the indoor air quality in their homes is better than most thanks to low-VOC paints; non-toxic cellulose insulation; coated ductwork to reduce mold, mildew, and fungus; arsenic- and chromium-free wood, and "Air-Loc" recessed can lights that keep moisture and microorganisms out of living areas. The high-efficiency HVAC with engineered duct system, fresh air intake, and programmable thermostats provides improved air quality, better dehumidification, quieter operation, maximum air circulation and air filtration, less drafts, and more even temperature distribution.

Innovations that Set GW Robinson Apart from the Competition

Details like these help give Robinson the edge in the competitive \$200,000 to \$600,000 price range where CobbleField homes sell. Robinson quotes Ken Fonorow of Florida Home Energy and Resources Organization, and a Building America Industrialized Housing Partnership team member, in its marketing literature saying "Homeowners are now beginning to understand the relationship between indoor air quality and their

INTRODUCTION

Taking action in your community



HOMEOWNERS

Shopping for value, comfort, and quality



MANAGERS

Putting building science to work for your bottom line



MARKETERS

Energy efficiency delivers the value that customers demand



SITE PLANNERS & DEVELOPERS

Properly situated houses pay big dividends



DESIGNERS

Well-crafted designs capture benefits for builders, buyers, and business



SITE SUPERVISORS

Tools to help with project management



TRADES & CRAFTS

Professional tips for fast and easy installation

CASE STUDIES

Bringing it all together

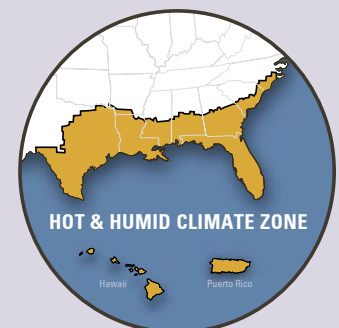

CASE STUDY: GW ROBINSON



“We are taking an approach of wanting to build a better product in all areas—energy efficiency, indoor air quality, no moisture problems, and one that is sensitive to the environment.” Building America builders like GW Robinson are coming up with creative solutions like installing irrigation systems that use recycled water. Robinson is thinking efficiency right down to the plants they choose for landscaping, selecting indigenous plants, drought resistant species, grouping plants with similar water requirements, and laying sod in continuous areas only to further minimize water use.

“When we started constructing homes to Building America standards, we realized that we were undertaking a whole new way of home building,” says company founder GW Robinson. “At first it was a challenge, but now I can’t believe we ever built any other way. You have to pay attention more, to think more about the decisions you’re making. Now that we’ve built 25 homes to this standard, I can honestly say that we’ll never go back. This systems approach just makes more sense.”

Highly Efficient Homes

CobbleField homes have many energy-saving features: high-efficiency windows, above-code insulation levels, extra attention to duct sealing, etc. But the builder has added some innovations to make significant gains in energy efficiency.

GW Robinson conducts blower door tests of every completed home to check air tightness. Robinson’s CobbleField homes have an average HERS rating of between 89 and 90, making them 50% more efficient than standard construction.

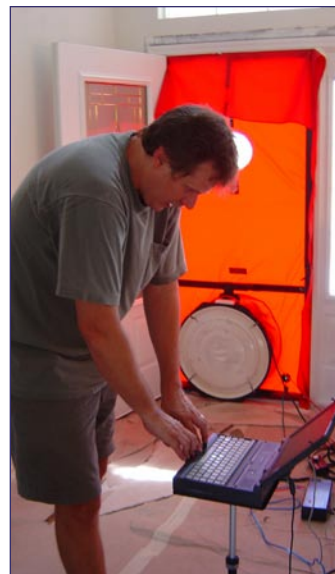

health. At CobbleField, the homes have been designed to reduce the introduction of pollen, to insure that gases, such as carbon monoxide, do not enter the home, and to reduce the growth of molds and mildews.”

Building America helps builders identify design features like these that boost a home’s energy performance and provide homeowners with the daily benefits they will notice, and mention to their friends. For example, Robinson uses a 50-gallon natural gas hot water heater that has a circulating loop which provides almost instantaneous hot water from every faucet in the house, while saving water and natural gas. (Hot water lines under the slab foundation are insulated for extra energy savings.) Double-pane, low-emissivity windows reduce energy consumption while they reflect infrared radiation, minimizing glare and heat gain inside and preventing carpets and furniture from fading. Inside walls containing plumbing are sound proofed with R-11 cellulose insulation. A radiant barrier in the roof reflects 95% of infrared radiation and keeps the attic up to 30 degrees cooler.

BUILDER PROFILE

GW Robinson

Where:

Gainesville, Florida

Founded:

1968

Employees:

22 full-time employees;
225 subcontractors and
related service workers

Development:

CobbleField

Size:

290 homes

Square footage:

1,800 - 4,500 sq.ft.
3-5 bedrooms
2-3.5 bathrooms

Price range:

\$190,000 to \$600,000
average cost at \$400,000

Key Features:

- TechShield 7/16” OSB radiant barrier roof sheathing
- Double-pane, low-e windows, SHGC = 0.21
- R-30 green fiber blown-in cellulose in the ceiling
- R-13 green fiber blown-in cellulose in the walls
- Air handling unit in conditioned space
- 13 SEER air conditioner
- Hot water recirculation loop system
- Engineered duct system
- Opposed Blade Damper registers
- Return air pathways
- Right-sized mechanical system
- Recycled water irrigation system
- Ground underslab pretreated against termites.

CASE STUDY: GW ROBINSON

Special attention was given to the HVAC and duct system with a right-sized, high-efficiency 13 SEER air conditioner and engineered ductwork system specifically designed for efficiency. All floor plans actually have the duct layout on them and no deviation from the layout is allowed by installers. HVAC registers have opposed blade dampers that put the air where it's most wanted and needed. Return air pathways are located in every room in the house. Programmable thermostats allow more accurate control and performance.

Zone dampers are used, enabling one HVAC system to heat and cool the whole house rather than adding separate systems to handle spaces such as bonus rooms. For example, instead of using a 5-ton system for the house and a 1.5-ton unit for the bonus room, a single, 4-ton unit is sufficient. The zones are generally set up with one for the master bedroom suite, one for the formal living area, one for the living area, and one for the bonus room.

In addition to meeting ENERGY STAR criteria, CobbleField also meets the Florida Green Home Standard. To be certified Green Homes, CobbleField was constructed with specific requirements within categories of protecting ecosystems and conserving natural resources, creating a green circulation system, employing green utilities practices, providing resource-driven amenities, operating under existing covenants and deed restrictions, and providing educational information to help achieve and promote green living practices.

"At first it was a challenge, but now I can't believe we ever built any other way. You have to pay attention more, to think more about the decisions you're making. Now that we've built 25 homes to this standard, I can honestly say that we'll never go back. This systems approach just makes more sense."

GW Robinson, President of GW Robinson

Building America—"The Way All Homes Should be Built"

Building America's philosophy struck a chord with Robinson. "CobbleField is our first development to implement Building America building practices. All 290 homes will be Building America. It's not an upgrade option. We are saying, 'This is a Building America development.' This is the way all homes should be built." Robinson added, "Building America will be offered in our future developments. We need to tackle every single issue, not just a few."

The Bottom Line

"Our goal is to be number one in our area in that market. If it (Building America) didn't work I wouldn't use it," said Robinson.

G.W. Robinson targets a return on investment (ROI) of 10%. The lower monthly operating costs of these homes are recognized by lenders in two ways: 1/8 point discounted mortgage rates from certain lenders and buyers qualify for higher priced homes because lower energy bills mean homeowners can afford higher mortgage payments. Overall, higher sales prices give the developer more profit headroom from which to derive ROI.



Robinson offers solar water heaters as an option on its homes.

Keeping the Bugs Out

Anybody who lives in the hot and humid climate knows bugs love it too. GW Robinson builds in features to keep bugs out. Walls and ceilings are insulated with naturally bug-resistant Green Fiber blown-in cellulose insulation – R-13 in the ceiling and R-30 in the walls. The soil underneath the slab foundation is pretreated with a boron mixture to prevent subterranean termites.

MEDALLION HOMES

San Antonio, Texas

They're Getting Better All the Time

Medallion Homes, three time winner of National Association of Home Builders' *Energy Value Housing Award* and winner of their *Builder of the Year Award* in 2000, has been building ENERGY STAR homes since 1999. The San Antonio builder incorporates ENERGY STAR features like high efficiency condensing units, low-E windows, and building airtightness measures in every home it builds as standard features.

In 2001 Medallion partnered with Building America's IBACOS (Integrated Building and Construction Solutions) to see how it could improve energy efficiency and construction quality. The result was a 2400 square foot pilot house built in Universal City, a San Antonio suburb.

Key energy-saving features of the Universal City home include the following:

- The house was designed and built with one HVAC unit inside conditioned space rather than two systems in the attic (as is the typical case for this model). This optimization took into account a detailed energy analysis of heating and cooling loads. A variable speed furnace (80% AFUE) and high-efficiency condensing unit (12 SEER) were used. Cooling capacity requirements were reduced from 5 tons to 3.5 tons.
- To improve building airtightness, a great deal of emphasis was placed on draftstopping holes to ensure air barrier continuity. With a strict airtightness goal it was important to minimize the number of penetrations in the exterior shell.
- Air distribution was optimized through a carefully detailed and engineered duct layout that focused on keeping all of the ductwork within the conditioned space of the house. Ductwork serving the second floor was located in a bulkhead constructed in the second floor ceiling space. Ductwork sealing to reduce air leakage focused on the use of UL 181 approved water based mastic.
- A supply side mechanical ventilation system ensures better indoor air quality on a continuous basis. The furnace operates continuously on low speed and draws in outdoor air through a duct connected to the return air plenum. The amount of outdoor air is fixed at 60 cfm by the constant airflow regulator installed.

The home achieved a HERS score of 90.3, exceeding the target of 90.



Award Winning

Medallion won the National Association of Home Builders and Professional Builder magazine's Best in American Living Award for "Best Affordable Home in the Nation" with its energy efficient Craftsman plan. Medallion is also three time winner of NAHB's Energy Value Housing Award and winner of their Builder of the Year award in 2000.

INTRODUCTION

Taking action in your community



HOMEOWNERS

Shopping for value, comfort, and quality



MANAGERS

Putting building science to work for your bottom line



MARKETERS

Energy efficiency delivers the value that customers demand



SITE PLANNERS & DEVELOPERS

Properly situated houses pay big dividends



DESIGNERS

Well-crafted designs capture benefits for builders, buyers, and business



SITE SUPERVISORS

Tools to help with project management



TRADES & CRAFTS

Professional tips for fast and easy installation

CASE STUDIES

Bringing it all together

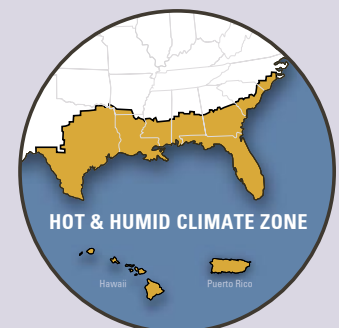

CASE STUDY: MEDALLION HOMES

Lessons Learned

HVAC Optimization

All of Medallion's homes larger than 2,300 sq.ft. typically have two mechanical systems located in the attic. One serves the second floor, the other serves the first floor and ductwork for both is located in the attic, where it is exposed to extreme outdoor conditions. Bringing the mechanical equipment and ductwork inside the home reduced the home's load and energy consumption by almost 25%. This one improvement alone can enable Medallion Homes to downsize from two mechanical systems to one system on houses in the 2,300 to 2,800 square foot floor range.

IBACOS worked closely with Medallion's design staff and mechanical contractor to develop a comprehensive duct system design. Since cooling is the priority, all supply and return diffusers throughout the home are located in the ceiling or high on the walls. For this particular design, the best location for a mechanical closet was on the first floor between the house and garage. From this location, ductwork for the first floor spaces was integrated into the floor structure for the second floor. All of the diffusers for the first floor are located in the ceiling.

A bulkhead was created above bathrooms and closets on the second floor, to create a duct distribution plenum for the second floor spaces. The second floor ceiling was raised to 9'0", while the ceiling at the bulkhead was dropped to 7'8", leaving more than 12" for duct distribution. The majority of the diffusers for the second floor are located at high sidewalls, at the edges of the bulkhead. The diffusers are accurately sized to ensure that the conditioned air is thrown across the length of the room to generate good mixing of all the air in the room.

Implementing a new design in the field proved challenging—many of the flex duct runs were severely pinched by framing members at the secondary plenum in the second floor ceiling bulkhead. The solution involved installing a ductboard supply trunk running horizontally through the bulkhead in the second floor, almost the entire length of the house. All the supply duct runs came off this trunk at locations near each diffuser. Ducts were sealed with UL181 approved water based mastic sealant.



The final duct installation incorporated a horizontal duct board trunk in the bulkhead with flex duct runs perpendicular to this main trunk.

A high efficiency condensing unit and furnace with a variable speed blower complemented the duct layout. The furnace can operate on low speed when no conditioning is called for and distribute the fresh outdoor air provided by the mechanical ventilation system. Due to cost considerations, a zone control system was not installed.

The only thermostat for the home resides in the study on the second floor. To control the high humidity of San Antonio, a Carrier programmable thermostat with dehumidification control was installed; the Thermidistat™ can vary the run-time and airflows of the cooling system to provide maximum latent load removal.

BUILDER PROFILE

Medallion Homes

Where:

San Antonio, Texas

Founded:

1995

Employees:

TBD full-time employees;
TBD contractors

Development:

TBD

Size:

250 homes annually

Square footage:

1,537 - 2,404 sq.ft.

3 bedrooms

2-2.5 bathrooms

Price range:

\$110,000 to \$200,000

Key Features:

- Radiant barrier on the roof
- Double-pane, low-e windows, SHGC = 0.41, U-Factor = 0.25
- R-30 U.S. Green Fiber blown-in cellulose in flat ceilings, R-19 in sloped ceilings
- R-13 U.S. Green Fiber blown-in cellulose in the walls
- 12 SEER HVAC
- Engineered duct system
- Right-sized mechanical system

CASE STUDY: MEDALLION HOMES

Mechanical Ventilation

Since Medallion Homes began working with IBACOS in 1998, they have installed mechanical ventilation systems in all of their homes. Initially, these were dedicated exhaust fans in the laundry/utility rooms. Exhaust ventilation is not the preferred ventilation system in a hot, humid climate and further testing revealed that many of these fans were not actually moving any air. Therefore, IBACOS recommended a new ventilation system for this pilot home, hoping to find a high performance, cost-effective solution for all of Medallion's houses.

When the furnace fan operates, fresh air will be drawn into the house through the fresh air duct, mixed with house air in the return plenum, pulled through the pleated media filter, conditioned by the central system, and then distributed throughout the house. The fan was set to run continuously at low speed whenever the thermostat is not calling for conditioning. At this low speed setting, the furnace fan moves about 500 cfm of air while using about 100 W of electrical power. This is less power than most energy recovery ventilation systems or heat recovery ventilation systems, so it is an economical option for providing ventilation air. A 5" round duct was routed from a fresh air intake at the second floor band joist and connected to the return plenum near the furnace. This fresh air duct has been equipped with a 60 cfm constant airflow regulator, which will maintain a flow of 60 cfm of fresh air whenever the furnace fan is operating, even at varying speeds.

Building Airtightness

Air sealing measures include sealing all penetrations in exterior walls and at the insulated ceiling with expanding foam sealant. All windows and doors are also sealed with low expansion foam. In addition, window frames are silicon sealed and wrapped with moisture-resistant barrier tape. The Key™ Sealing System, a polycel foam, is used to seal exterior penetrations (e.g., vents, electrical outlets and door jambs). All bottom plates are caulked to the subfloor, and the drywall functions as the main air barrier in the homes. IBACOS suggested sealing at the furnace/mechanical equipment and at the registers and specified draftstopping for the walls behind, and the lid above, the direct vent fireplace unit and behind the tub and shower surround. Draftstopping is now included in all Medallion homes.



Draftstopping applied at the top of the second floor bulkhead.

The pilot house included a programmable thermostat with dehumidification control. Medallion currently offers these features as an upgrade.



A fresh air intake duct with a Constant Airflow Regulator runs from the outside to the return plenum. The furnace operates continuously on low speed to provide whole-house ventilation.

CASE STUDY: MEDALLION HOMES

Comfort, Durability, and Health

A radiant barrier on the roof structure reflects 95% of infrared radiation and keeps the attic up to 30 degrees cooler. The radiant barrier roof decking works with the continuous soffit and ridge vents, creating air flow to reduce attic temperature. Double-pane, low-e windows reflect infrared radiation, reduce energy consumption, and prevent carpets and furniture from fading. Water-based paint and flooring adhesives don't emit volatile organic compounds, have less chemicals and odors, and lead

to better indoor air quality for the occupants. The Cocoon™ blown-in cellulose has a higher fire rating than fiberglass and is a natural, non-toxic pest control.



Front elevation of 2400 plan Pilot Home with synthetic stone cladding

Medallion homes have fiber-cement siding, which is appropriate for hot and humid climates because it is resistant to rot, fungus, and termite infestation.

The Texas Master Naturalist Alamo Area Chapter presented Medallion Homes the Naturalist Conservation Award in recognition of Mainland Square. Mainland Square was one of the first neighborhoods in Texas to be certified as a Backyard Wildlife Habitat by the Texas Parks and Wildlife Department's Texas Wildscapes Program.

Bottom Line

Medallion estimates that energy features on its Craftsman model (1,190 sq.ft.), add less than 1.5% to the cost of a home this size.

Medallion tracked most of the upgrades on the Universal City pilot project and realized significant cost savings realized by optimizing the HVAC—going from two units to one and decreasing required cooling capacity dropped from 5 tons to 3.5 tons. Medallion decided to spend these savings on the upgraded two-speed furnace, the ventilation system, draftstopping for building airtightness and duct sealing measures. As a first-time pilot study, money was spent to fix implementation problems associated with remedying the initial duct layout. In all, Medallion claims that the pilot home project cost them an additional \$300. IBACOS believes that there were enough remediation costs associated with the home that if the design was followed correctly from the start, the recommended measures would end up saving construction costs.

Homebuyer's Checklist

Below is a more detailed list of building features for those who really want to investigate their house. To really see how some of these measures are installed, visit houses that are under construction.

MEASURE	Building America	Builder #1	Builder #2	Builder #3
HEATING AND COOLING EQUIPMENT				
ENERGY STAR qualified air conditioning of SEER 13 or greater	Yes			
ENERGY STAR qualified heat pump	Yes			
ENERGY STAR qualified boiler	Yes			
ENERGY STAR qualified furnace of AFUE 90	Yes			
ENERGY STAR qualified programmable thermostat	Yes			
Ductwork sealed with mastic (no duct tape)	Yes			
5% or less duct leakage found with pressure test.	Yes			
Duct Insulation: R-4 in conditioned space, R-8 in attic, R-6 in crawlspace	Yes			
House plans show duct layouts	Yes			
Ducts located in conditioned space as much as possible	Yes			
Ducts sized according to industry standards in Manual D	Yes			
Heating and cooling equipment sized according to industry standards in Manual J	Yes			
House pressure balanced with jump ducts	Yes			
HVAC* equipment and duct work was inspected and tested after installation	Yes			
INSULATION <i>(take a look at a house under construction before sheetrock is installed)</i>				
Insulation installed behind tubs, landings, and other hard to reach places.	Yes			
Insulation fills entire cavities – no voids or compressed batts – Attic insulation level without gaps and covers entire attic floor	Yes			
High density batt insulation	Yes			
Rim joists are insulated	Yes			
WINDOWS <i>(take a look at a house under construction before exterior siding is installed)</i>				
ENERGY STAR qualified windows, doors, and skylights	Yes			
Windows flashed to help repel water	Yes			
Windows rated to .35 U-factor and SHGC	Yes			

APPENDIX I: HOMEBUYER'S CHECKLIST

MOISTURE MANAGEMENT <i>(take a look at a house under construction before exterior siding is installed)</i>				
Ground slopes away from house	Yes			
Housewrap or building paper covers exterior sheathing in wood framed houses	Yes			
Roof flashing in valleys, where walls and roofs intersect, and at other places where water may enter the house – the more complex the roof, the more flashing you should see.	Yes			
Overhangs for shade and to direct water away from walls	Yes			
AIR RETARDERS				
All penetrations through exterior walls sealed	Yes			
Careful sealing of sheetrock or exterior sheathing	Yes			
Canned lights rated as airtight and for insulated ceiling (ICAT)	Yes			
Electrical boxes on exterior walls caulked or gasketed	Yes			
Holes into attic sealed	Yes			
Air leakage determined with house depressurization test	Yes			
SLAB FOUNDATION MEASURES				
Radon vent pipe installed	Yes			
4 to 6 inch gravel base	Yes			
Polyethylene (plastic) vapor barrier below gravel	Yes			
PLUMBING				
No pipes in exterior walls	Yes			
YOUR FEATURES FOR COMPARISON				

**HVAC = heating, ventilation, and air conditioning*

If you want to know more about any of these or other house features review the other chapters of the *Best Practices* guide. Other chapters are designed to help site planners, designers, site supervisors, and crafts people design and build efficient, comfortable, and durable homes.

Energy & Housing Glossary

Accreditation

The process of certifying a Home Energy Rating System (HERS) as being compliant with the national industry standard operating procedures for Home Energy Rating System.

AFUE Annual Fuel Utilization Efficiency (AFUE)

Measures the amount of fuel converted to space heat in proportion to the amount of fuel entering the furnace. This is commonly expressed as a percentage. A furnace with an AFUE of 90 could be said to be 90% efficient. AFUE includes any input energy required by the pilot light but does not include any electrical energy for fans or pumps.

Air Flow Retarder

Sealants used to keep outside air and inside air out of the building envelope. Four common approaches to retarding air flow include careful sealing using the following building components: drywall and framing, plastic sheets (should not to be used in hot and humid climates) between drywall and framing, exterior sheathing, and building paper. Air flow retarders define the pressure boundary in a house that separates indoor and outdoor air.

Building Envelope

The outer shell, or the elements of a building, such as walls, floors, and ceilings, that enclose conditioned space. See also *Pressure Boundary* and *Thermal Boundary*.

Btu (British Thermal Unit)

A standard unit for measuring energy. One Btu is the amount of energy required to raise the temperature of one pound of water by one degree Fahrenheit from 59 to 60. An Inches-Pounds unit.

CABO (Council of American Building Officials)

A national organization of building code officials and interested parties, which, through a national consensus process, developed, adopted and promulgated the national Model Energy Code (MEC). CABO has recently become CABO International and has taken on the administrative responsibility for the development of a uniform international building code through an International Code Council (ICC).

Capacity

The rate at which a piece of equipment works. Cooling capacity is the amount of heat a cooling system can remove from the air. For air conditioners total capacity is the sum of latent capacity, the ability to remove moisture from the air, and the sensible capacity, the ability to reduce dry-bulb temperature. Heating system capacity indicates how much heat a system can provide. Heating and cooling capacities are rated in Btu per hour.

Chase

A furred out enclosure designed to hold ducts, plumbing, electric, telephone, cable, or other linear components. A chase designed for ducts should be in conditioned space and include air flow retarders and thermal barriers between it and unconditioned spaces such as attics.

Construction Documents

The drawings (plans) and written specifications that describe construction requirements for a building.

COP (Coefficient of Performance)

A measure of efficiency typically applied to heat pumps. The COP for heat pumps is the ratio, at a given point in time, of net heat output to total energy input expressed in consistent units and under designated conditions. Heat pumps result in a COP greater than 1 because the system delivers or removes more heat energy than it consumes. Other specific definitions of COP exist for refrigeration equipment. See HSPF for a description of a unit for seasonal efficiency.

APPENDIX II: ENERGY & HOUSING GLOSSARY

Debt-to-Income Ratio

The ratio, expressed as a percentage, which results when a borrower's total monthly payment obligations on long-term debt are divided by their gross monthly income. This is one of two ratios (housing expense-to-income ratio being the other) used by the mortgage industry to determine if a prospective borrower qualifies (meets the underwriting guidelines) for a specific home mortgage. Fannie Mae, Freddie Mac and FHA underwriting guidelines set an upper limit of 36% on this value for conventional loans but increase ("stretch") the ratio by 2% for qualifying energy efficient houses.

Dry-Bulb Temperature

The temperature of air indicated on an ordinary thermometer, it does not account for the affects of humidity.

ECM (Energy Conservation Measure)

An individual building component or product that directly impacts energy use in a building and has a set of differentiable energy performance factors that can be arranged into a table or list. For example, wall insulation is a measure that will impact heat transfer to and from a building, and there is some list of wall measures that are differentiated by insulation R-value that define the possible walls that can be incorporated into a building.

EEM (Energy Efficient Mortgage)

Specifically, a home mortgage for which the borrower's qualifying debt-to-income and housing expense-to-income ratios have been increased ("stretched") by 2% because the home meets or exceeds CABO's 1992 version of the Model Energy Code (MEC). This so-called "stretch" mortgage is nationally underwritten by Fannie Mae, Freddie Mac and the Federal Housing Administration (FHA). This term is often used generically to refer to any home mortgage for which the underwriting guidelines have been relaxed specifically for energy efficiency features, or for which any form of financing incentive is given for energy efficiency.

EER (Energy Efficiency Ratio)

A measurement of the instantaneous energy efficiency of cooling equipment, normally used only for electric air conditioning. EER is the ratio of net cooling capacity in Btu per hour to the total rate of electric input in watts, under designated conditions. The resulting EER value has units of Btu per Watt-hour.

EF (Energy Factor)

A standardized measurement of the annual energy efficiency of water heating systems. It is the annual hot water energy delivered to a standard hot water load divided by the total annual purchased hot water energy input in consistent units. The resultant EF value is a percentage. EF is determined by a standardized US Department of Energy procedure.

Energy (use)

The quantity of electricity, gas or other fuel required by the building equipment to satisfy the building heating, cooling, hot water, or other loads or any other service requirements (lighting, refrigeration, cooking, etc.).

Energy Audit

A site inventory and descriptive record of features impacting the energy use in a building. This includes, but is not limited to: all building component descriptions (locations, areas, orientations, construction attributes and energy transfer characteristics); all energy using equipment and appliance descriptions (use, make, model, capacity, efficiency and fuel type) and all energy features.

ENERGY STAR® Home

A home, certified by the US Environmental Protection Agency (EPA), that is at least 30% more energy efficient than the minimum national standard for home energy efficiency as specified by the 1992 MEC, or as defined for specific states or regions. ENERGY STAR is a registered trademark of the U.S. EPA.

Envelope

See Building Envelope

Fannie Mae

(FNMA - Federal National Mortgage Association)

A private, tax-paying corporation chartered by the U.S. Congress to provide financial products and services that increase the availability of housing for low-, moderate-, and middle-income Americans.

FHA (Federal Housing Administration)

A division of the Department of Housing and Urban Development (HUD). FHA's main activity is the insurance of residential mortgage loans made by private lenders.

APPENDIX II: ENERGY & HOUSING GLOSSARY

Freddie Mac

(FHLMC - Federal Home Loan Mortgage Corporation)

A stockholder-owned organization, chartered by the U.S. Congress to increase the supply of mortgage funds. Freddie Mac purchases conventional mortgages from insured depository institutions and HUD-approved mortgage bankers.

Grade Beam

A foundation wall that is poured at or just below the grade of the earth, most often associated with the deepened perimeter concrete section in slab-on-grade foundations.

HERS (Home Energy Rating System)

A standardized system for rating the energy-efficiency of residential buildings.

HERS Energy-Efficient Reference Home (EERH)

The EERH is a geometric “twin” to a home being evaluated for a HERS rating and is configured to be minimally compliant with the 1992 MEC.

HERS Provider

An individual or organization responsible for the operation and management of a Home Energy Rating System.

HERS Rater

An individual certified to perform residential Building Energy Efficiency Ratings in the Class for which the Rater is certified. There are three classes of residential Rater certification: Class 3 - requiring the certified capability to complete Ratings based on construction documents; Class 2 - requiring the certified capability to complete Ratings based on site energy audits; and Class 1 - requiring the certified capability to complete Ratings based on site energy audits and performance tests.

HERS Score

A value between 0 and 100 indicating the relative energy efficiency of a given home as compared with the HERS Energy-Efficient Reference Home as specified by the HERS Council Guidelines. The greater the score, the more efficient the home. A home with zero energy use for the rated energy uses (heating, cooling and hot water only) scores 100 and the HERS Reference Home scores 80. Every 1-point increase in the HERS score amounts to a 5% increase in energy efficiency.

Housing Expense-to-Income Ratio

The ratio, expressed as a percentage, which results when a borrower’s total monthly housing expenses (P.I.T.I.) are divided by their gross monthly income. This is one of two ratios (debt-to-income ratio being the other) used by the mortgage industry to determine if a prospective borrower qualifies (meets the underwriting guidelines) for a specific home mortgage. Fannie Mae, Freddie Mac and FHA underwriting guidelines set an upper limit of 28% on this value for conventional loans but increase (“stretch”) the ratio by 2% for qualifying Energy Efficient Mortgages.

Housewrap

Any of several spun-fiber polyolefin rolled sheet goods for wrapping the exterior of the building envelope.

HSPF (Heating Season Performance Factor)

A measurement of the seasonal efficiency of an electric heat pump using a standard heating load and outdoor climate profile over a standard heating season. It represents the total seasonal heating output in Btu divided by the total seasonal electric power input in watt-hours (Wh). Thus, the resultant value for HSPF has units of Btu/Wh.

Jump Duct

A flexible, short, U-shaped duct (typically 10-inch diameter) that connects a room to a common space as a pressure balancing mechanism. Jump ducts serve the same function as transfer grilles.

Load

The quantity of heat that must be added to or removed from the building (or the hot water tank) to satisfy specific levels of service, such as maintaining space temperature or hot water temperature at a specified thermostat setting (see also the definitions of energy and thermostat).

Low-E

Refers to a coating for high-performance windows, the “e” stands for emissivity or re-radiated heat flow. The thin metallic oxide coating increases the U-value of the window by reducing heat flow from a warm(er) air space to a cold(er) glazing surface. Low-e coatings allow short-wavelength solar radiation through windows, but reflect back longer wavelengths of heat.

APPENDIX II: ENERGY & HOUSING GLOSSARY

MEC (Model Energy Code)

A “model” national standard for residential energy efficiency. The MEC was developed through a national consensus process by the Council of American Building Officials (CABO) and is the accepted national minimum efficiency standard for residential construction. Since MEC is a model code, it does not have the “force of law” until it is adopted by a local code authority. The MEC is used as the national standard for determining Energy Efficient Mortgage (EEM) qualification, and it serves as the national “reference point” used by Home Energy Rating Systems (HERS) in the determination of energy ratings for homes.

Mechanical Ventilation

The active process of supplying or removing air to or from an indoor space by powered equipment such as motor-driven fans and blowers, but not by devices such as wind-driven turbine ventilators and mechanically operated windows.

Performance Test

An on-site measurement of the energy performance of a building energy feature or an energy using device conducted in accordance with pre-defined testing and measurement protocols and analysis and computation methods. Such protocols and methods may be defined by national consensus standards like those of the American Society of Heating, Refrigerating and Air Conditioning Engineers (ASHRAE) and the American Society for Test and Measurement (ASTM).

P.I.T.I.

An abbreviation which stands for principal, interest, taxes, and insurance. These generally represent a borrower’s total monthly payment obligations on a home loan. The taxes and insurance portion are often paid monthly to an impound or escrow account and may be adjusted annually to reflect changes in the cost of each.

Pressure Boundary

The point in a building at which inside air and outside air are separated. If a building were a balloon, the rubber skin would form the pressure boundary. Where inside and outside air freely mingle there is no pressure boundary.

Pressurization Test

A procedure in which a fan is used to place a house, duct system, or other container, under positive or negative air pressure in order to calculate air leakage.

RESNET (Residential Energy Services Network)

The national association of energy rating providers.

Rated Home

A specific residence that is evaluated by an energy rating.

R-Value

Measures a material’s ability to slow down or resist the transfer of heat energy, also called thermal resistance. The greater the R-value, the better the resistance, the better the insulation. R-values are the reciprocal of U-values. See U-values for more information.

Sealed Combustion

Sealed combustion means that a combustion appliance, such as a furnace, water heater, or fireplace, acquires all air for combustion through a dedicated sealed passage from the outside; combustion occurs in a sealed combustion chamber, and all combustion products are vented to the outside through a separate dedicated sealed vent.

SEER (Seasonal Energy Efficiency Ratio)

A measurement similar to HSPF except that it measures the seasonal cooling efficiency of an electric air conditioner or heat pump using a standard cooling load and outdoor climate profile over a standard cooling season. It represents the total seasonal cooling output in Btu divided by the total seasonal electric input in watt-hours (Wh). The SEER value are units of Btu/Wh.

Semi-Permeable

The term vapor semi-permeable describes a material with a water vapor permeance between 1 and 10 perms. Water vapor can pass through a semi-permeable material but at a slow rate.

Shading Coefficient (SC)

The ratio of the total solar heat admittance through a given glazing product relative to the solar heat admittance of “double-strength, clear glass at normal solar incidence (i.e. perpendicular to the glazing surface).

APPENDIX II: ENERGY & HOUSING GLOSSARY

Solar Heat Gain Coefficient (SHGC)

SHGC measures how well a window blocks heat caused by sunlight. The lower the SHGC rating the less solar heat the window transmits. This rating is expressed as a fraction between 0 and 1. The number is the ratio of a window's solar heat admittance compared to the total solar heat available on the exterior window surface at normal solar incidence (i.e. perpendicular to the glazing surface).

Sone

A sound rating. Fans rated 1.5 sones and below are considered very quiet.

Supply ducts

The ducts in a forced air heating or cooling system that supply heated or cooled air from the or air conditioner to conditioned spaces.

Thermal Boundary

The border between conditioned and unconditioned space where insulation should be placed.

Thermostat

A control device that measures the temperature of the air in a home or the water in a hot water tank and activates heating or cooling equipment to cause the air or water temperature to remain at a pre-specified value, normally called the set point temperature.

Ton(s) of Refrigeration

Units used to characterize the cooling capacity of air conditioning equipment. One ton equals 12,000 Btu/h.

U-Value

Measures the speed at which heat flows or conducts through a building assembly (wall, floor, ceiling, etc.). The smaller the u-value the more energy efficient an assembly and the slower the heat transfer. Window performance labels include U-values (calling them U-factors) to help in comparing across window products.

Ventilation

The controlled movement of air into and out of a house.

W (watt)

One of two (Btu/h is the other) standard units of measure (SI –or metric- System) for the rate at which energy is consumed by equipment or the rate at which energy moves from one location to another. It is also the standard unit of measure for electrical power.

Wet-Bulb Temperature

A measure of combined heat and humidity. At the same temperature, air with less relative humidity has a lower wet bulb temperature. See *Dry-Bulb Temperature*.

Wind-Washing

Air movement due to increased pressure differences that occur at the outside corners and roof eaves of buildings. Wind-washing can have significant impact on thermal and moisture movement and hence thermal and moisture performance of exterior wall assemblies.

Xeriscaping

Landscaping that minimizes outdoor water use while maintaining soil integrity and building aesthetics. Typically includes emphasis on native plantings, mulching, and no or limited drip/subsurface irrigation.

Zero Energy House

Any house that over time, averages out to net zero energy consumption. A zero energy home may supply more energy than it needs during peak demand, typically using one or more solar energy strategies, energy storage and/or net metering.

APPENDIX II: ENERGY & HOUSING GLOSSARY

Sources & Additional Information

- American Society of Heating, Refrigeration and Air Conditioning Engineers (ASHRAE). 1986. *Terminology of Heating Ventilation Air Conditioning and Refrigeration*. Atlanta, GA.
- Building News. 2001. *Construction Dictionary*. BNi Publications, Los Angeles, CA.
- Florida Solar Energy Center (FSEC). *Energy-Efficiency Economics Terms and Definitions* available on the web at www.fsec.ucf.edu/bldg/fyh/ratings/e_terms.htm
- Lstiburek, Joseph. 2002. *Builder's Guide Hot and Humid Climates*. Energy & Environmental Building Association. Minneapolis, MN www.eeba.org
- Home Energy Magazine. 1997. "No-Regrets Remodeling: Creating a Comfortable, Healthy Home That Saves Energy." Energy Auditor & Retrofitter, Inc. Berkeley, CA.

Code Official Tear-Outs

The following tear-out sheets, contained in this chapter's addendum, may help in explaining some energy-efficient design techniques to code officials unaware of them. Each topic "sheet" is designed to stand alone and includes a description of the technique and why it is useful, a discussion of the relevant code sections that permit the technique, and guidance on what the official should look for in plan reviews and inspections.

- Single Top Plates
- No Header in Non-Bearing Walls
- Floor Joists Spaced at 24" O.C.
- Studs Spaced at 24" O.C.
- Open Spaces as Return-Air Options
- Details for Mechanically-Vented Crawl Spaces
- Ventilation Requirements for Condensing Clothes Dryers
- Drywall Clips
- Rigid Board Insulation Installed as Draft Stop in Attic Kneewall

Single Top Plates

Issue

Standard practice for exterior and interior wall framing is to use a double top plate to connect wall segments and to support framing above the plates. A single top plate is allowed under the International Residential Code but is an uncommon construction practice.

Background / Description

Eliminating unnecessary wood framing within walls can increase the thermal efficiency of the wall system. Less framing allows more insulation to be installed and also eliminates hot and cold spots within the wall system. Eliminating wood framing can also reduce drywall cracking caused by the movement of wood within the walls. Using a single top plate, instead of a traditional double top plate, is allowed by code in some wood frame walls.

The single top plates must be adequately tied at joints, corners and intersecting walls by at least a 3" x 6" - 0.036-inch thick galvanized steel plate that is nailed to each wall or wall segment by six 8d nails on each side. Rafters or joists must be within 1 inch of center over the studs. The top plate may be omitted over lintels that are adequately tied to adjacent wall sections with steel plates.

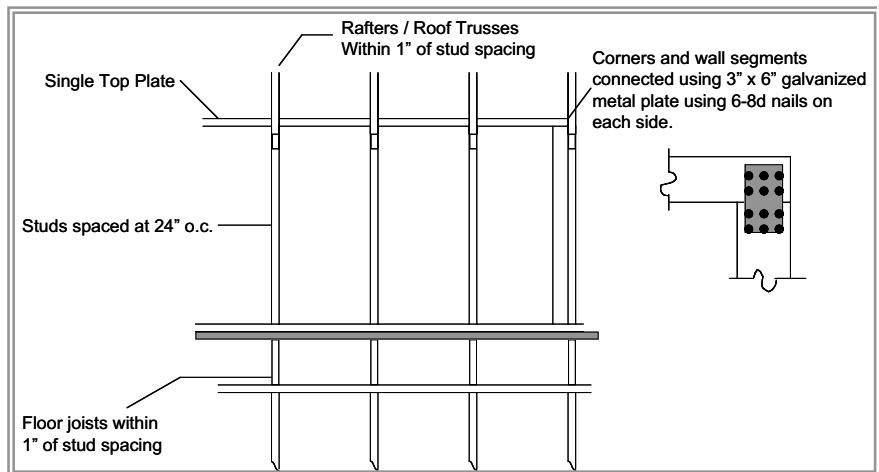

Interior nonbearing walls may be 2" x 3" inch studs spaced 24 inches (610 mm) on center or, if not part of a braced wall line, 2" x 4" inch flat studs 16 inches on center. Interior nonbearing walls must be capped with at least a single top plate and fireblocked.

Plan Review / Inspection Guidance:

Plan Review

1. Verify that the wall framing details call out a single top plate and also specify the 3" x 6" – 0.036-inch thick galvanized steel plate to be installed

at each corner and wall segment. Also verify the nailing required under IRC Section 602.3.2, Exception is specified on the building plans.

2. Verify that the spacing for the roof framing is identical to that of the wall framing. For example the roof framing must be spaced at 24" on center if the wall framing is also spaced at 24" on center. The rafter / roof trusses must be within 1" of being directly above the wall studs.
3. If the wall system supports a floor, verify that the wall floor joist spacing is identical to the wall stud spacing.

Field Inspection

1. Verify that the top plate is fastened to the studs per IRC Table R602.3(1).
2. Verify that a 3" x 6" – 0.036-inch thick galvanized steel plate is installed at each corner and wall segment and that six 8d nails are used to attach each side of the plate to the corner or wall segment.
3. Verify that the rafters or trusses used in the roof framing are within one inch of the center of each of the studs below.
4. Verify that the floor joists supported by the studs are within one inch of the center of the studs below.

Code Citations

IRC 2000 and 2003, in section R602.3.2 Top Plate

Exception: A single top plate may be installed in stud walls, provided the plate is adequately tied at joints, corners and intersecting walls by a minimum 3-inch-by-6-inch by a 0.036-inch-thick (76 mm by 152 mm by 0.914 mm) galvanized steel plate that is nailed to each wall or segment of wall by six 8d nails on each side, provided the rafters or joists are centered over the studs with a tolerance of no more than 1 inch (25.4 mm). The top plate may be omitted over lintels that are adequately tied to adjacent wall sections with steel plates or equivalent as previously described.

IRC 2000 and 2003, in Figure 602.3(2)

The figure label states "single or double top plate".

IRC 2000 and 2003, in section R602.5 Interior Nonbearing Walls

Interior nonbearing walls shall be permitted to be constructed with 2-inch-by-3-inch (51 mm by 76 mm) studs spaced 24 inches (610 mm) on center or, when not part of a braced wall line, 2-inch-by-4-inch (51 mm by 102 mm) flat studs spaced at 16 inches (406 mm) on center. Interior nonbearing walls shall be capped with at least a single top plate. Interior nonbearing walls shall be fireblocked in accordance with Section R602.8.

No Headers in Nonbearing Walls

Issue

The use of header stock over windows and doors in nonbearing walls is typical construction practice throughout the industry. But a single 2" x 4" is allowed to be used as a header in nonload bearing wall systems. This practice is unfamiliar to many in the enforcement and building industry.

Background / Description

Eliminating unnecessary wood framing within walls can increase the energy efficiency of the wall. Less framing allows more insulation to be installed and also eliminates hot and cold spots within the wall. Eliminating wood framing can also reduce drywall cracking caused by the movement of wood within the walls.

A single flat 2x4 may be used as a header in exterior, or interior, non-load bearing walls. The maximum opening may not exceed 8 feet. The vertical distance to the parallel surface above must be not more than 24 inches. No cripples or blocking are required above the header. On exterior walls, cavities above the headers must be insulated.

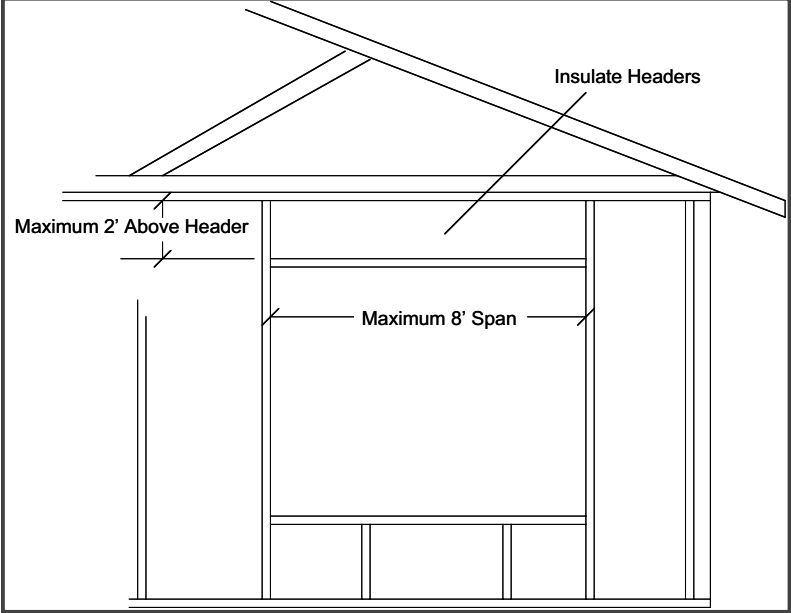

Plan Review / Inspection Guidance

Plan Review

1. Verify that the framing details call out no headers only for non-bearing interior or exterior walls.
2. Verify the horizontal span for each rough window and door opening is no greater than 8 feet.
3. Verify that the header height between the header and the next parallel framing member above the header is not greater than 2 feet. The next vertical parallel framing member will typically be the top plate.

Field Inspection

Framing Inspection:

1. Verify that the horizontal rough opening framed out in the wall assembly matches, or is less than, that called out on the approved building plans.
2. Verify that the distance between the header and the next parallel framing member (typically the top plate) is no greater than 24 inches.

Insulation Inspection

Verify that the framing cavity above the header is insulated to the required insulation R-value called out on the approved plans or documentation.

Code Citations

IRC 2000 and 2003, Section 602.7.2

Nonbearing walls. Load-bearing headers are not required in interior or exterior nonbearing walls. A single flat 2-inch-by-4-inch (51 mm by 102 mm) member may be used as a header in interior or exterior nonbearing walls for openings up to 8 feet (2438 mm) in width if the vertical distance to the parallel nailing surface above is not more than 24 inches (610 mm). For such nonbearing headers, no cripples or blocking are required above the header.

IRC 2000 and 2003 Table R702.3.5 Minimum Thickness & Application of Gypsum Board

Allows the use of 24" on center framing for fastening gypsum board with either fasters or adhesive _" thickness or greater.

IRC 2000 and 2003 Section R703 Exterior Covering

Structural sheathing and siding requirements are based on Table R703.4. Note that footnote "a" specifies that the table is based on 16" o.c. and that studs spaced 24" o.c. siding shall be applied to sheathing approved for that spacing.

Header Hangers in Bearing Walls

Issue

Headers for windows and doors are typically supported by cripples or jack studs. These studs can be eliminated using header hangers, as allowed under the International Residential Code.

Background / Description

Eliminating unnecessary wood framing within walls can increase the thermal efficiency of the wall system. Less framing allows more insulation to be installed and also eliminates hot and cold spots within the wall system. Eliminating wood framing can also reduce drywall cracking caused by the movement of wood within the walls.

Jack studs or trimmers that support headers around windows can be eliminated through the use of an approved framing anchor (“header hanger”) attached to the full-height wall stud and to the header (see Figure). 2000 IRC Table R502.5(1), Footnote “d” allows for the use of header hangers based on the following parameters:

- Ground Snow Load
- Building Width
- Number of Floors and Roof assemblies supported
- Size of the header material
- Span of the header

Wood structural panel box headers are limited to a span of no greater than 4 feet if using a header hanger.

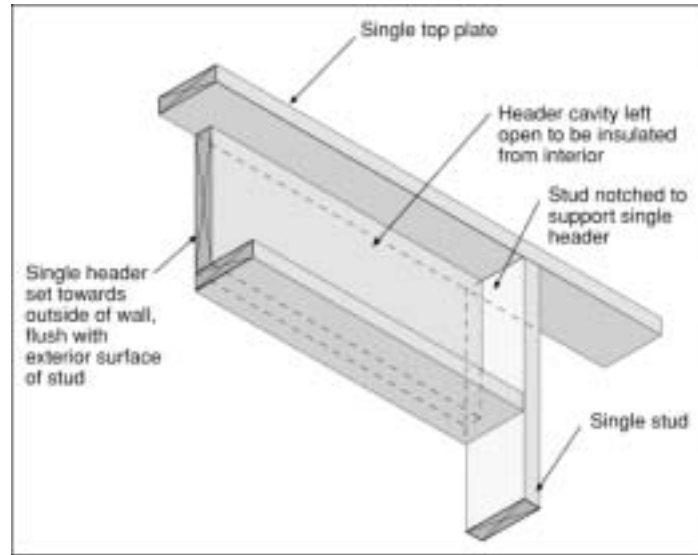

Plan Review / Inspection Guidance

Plan Review

1. Verify the number of floors and/or roof ceiling assemblies that is being supported by the header per Table R502.5(1).
2. Verify that the building width perpendicular to the ridge is not greater than that shown in Table R502.5(1).
3. Verify that the span of each window opening, where a header hanger is proposed, is not greater than the value shown in Table R502.5(1).
4. Verify that the proposed header hanger to be used in the project has an ICC Evaluation Services report.

Field Inspection

1. Verify that the span of the opening is not greater than that shown on the building plans.
2. Verify that the header material is #2 grade lumber or better.
3. Verify that the header hanger is properly nailed per the manufacturer's instructions.

Code Citations

IRC 2000 and 2003, Table R502.5(1) Girder Spans and Header Spans for Exterior Bearing Walls Footnote “d”

- d. NJ – Number of jack studs required to support each end. Where the number of required jack studs equals one, the header are permitted to be supported by an approved framing anchor attached to the full-height wall stud and to the header.*

Floor Joists Spaced at 24" O.C.

Issue

Floor joists must be spaced at 24" on center if used as part of an advanced framing strategy where the wall assemblies use a single top plate. This will allow the load to be transferred directly to the studs or foundation below.

Background / Description

Floor joists must be spaced at 24 inches on center if load bearing wood studs are spaced at 24 inches on center and a single top plate is used for the wall system.

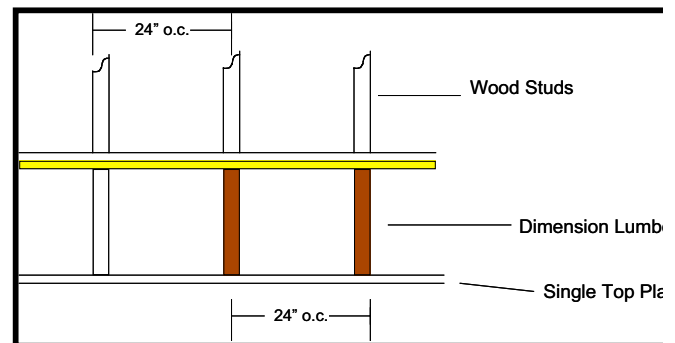
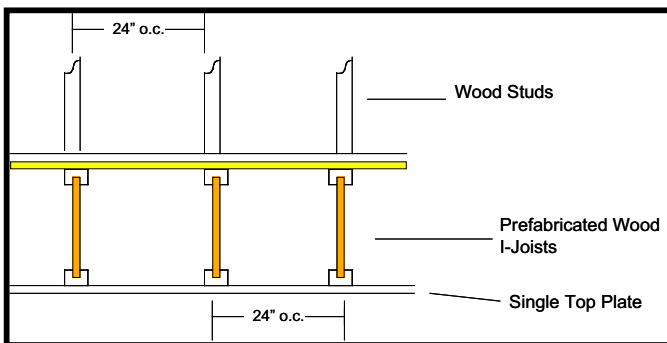

Plan Review / Inspection Guidance

Plan Review

1. If dimensional lumber is used for the floor joists, verify that the floor joist spans are consistent with Table R502.3.1(1) for 24" on center spacing for the following:
 - Dead Load,
 - Maximum floor joist span,
 - Dimension of lumber, and
 - Species and grade of lumber

2. If prefabricated wood I-joists are used for the floor joist, verify that the floor joist spacing is consistent with the manufacturer's specifications for the following:
 - Dead load
 - Maximum floor joist span
3. Verify that the floor sheathing selected for the subfloor conforms to the requirements per Table R503.1, R503.2.1.1(1) or R503.2.1.1(2).

Field Inspection

1. *Verify that the floor joists are consistent with the floor joists called out on the approved building plans.*
2. Verify that the subfloor installed on site is consistent with the subfloor type and thickness called for on the building plans.

Code Citations

IRC 2000 and 2003, Section R602.3.3 Bearing Studs

Where joists, trusses or rafters are spaced more than 16 inches on center and the bearing studs below are spaced 24 inches on center, such members shall bear within 5 inches of the studs beneath.

IRC 2000 and 2003, Section 502.3 Allowable Joist Spans

2000 and 2003 IRC Table R502.3.1(1) Floor Joist Spans for Common Lumber Species (Residential sleeping areas)

2000 and 2003 IRC Table R502.3.1(2) Floor Joist Spans for Common Lumber Species (Residential living areas)

For other grades and species and for other loading conditions, refer to AF&PA span Tables for Joists and Rafters.

IRC 2000 and 2003, Section R502.3.1 Sleeping Areas and Attic Joists

Table R502.3.1(1) shall be utilized to determine the maximum allowable span of floor joists that support sleeping areas and attics that are accessed by means of a fixed stairway provided that the live load does not exceed 30 psf and the design dead load does not exceed 10psf. The allowable span for ceiling joists that support attics utilized for limited storage or no storage shall be determined in accordance with Section R802.4.

IRC 2000 and 2003, Section R502.3.2 Other floor joists

Table R502.3.1(2) shall be utilized to determine the maximum allowable span of floor joists that support all areas of the building, other than sleeping and attics, provided that the design live load does not exceed 40 psf and the design dead does not exceed 10 psf.

IRC 2000 and 2003, Section R602.3.2 Top Plate

Exception: A single top plate may be installed in stud walls, provided the plate is adequately tied at joints, corners and intersecting walls by a minimum 3-inch-by-6-inch by a 0.036-inch-thick (76 mm by 152 mm by 0.914 mm) galvanized steel plate that is nailed to each wall or segment of wall by six 8d nails on each side, provided the rafters or joists are centered over the studs with a tolerance of no more than 1 inch (25.4 mm). The top plate may be omitted over lintels that are adequately tied to adjacent wall sections with steel plates or equivalent as previously described.

Studs Spaced at 24" o.c.

Issue

Walls are typically framed using framing spaced at 16" on center. Framing spacing can be moved to 24" on center, as allowed by the International Residential Code and the jurisdiction.

Background/Description

Eliminating unnecessary wood framing within walls can increase the thermal efficiency of the wall system. Less framing allows more insulation to be installed and also eliminates hot and cold spots within the wall system. Eliminating wood framing can also reduce drywall cracking caused by the movement of wood within the walls.

Spacing stud framing at 24 inches on center verses 16 inches on center reduces the number of framing members in exterior wall systems. This will allow more insulation to be placed in the wall system compared to standard 16 inch on center construction.

The 2000 and 2003 IRC allow for 2 x 4 and 2 x 6 studs to be spaced at 24 inches on center under certain circumstances (see Code References Allowing This Installation).

Plan Review / Inspection Guidance

Plan Review

1. Verify the stud size, spacing and height (≤ 10 ft) is consistent with the maximum stud spacing in Table R602.3(5) for bearing walls. Verify that the stud grade called out on the plans is No. 3, standard or stud grade lumber.
2. Verify that stud size, spacing and height (> 10 ft) is consistent with Table R602.3.1. Verify that the framing design in Seismic Category D meets the requirements of footnote "a", "b" and "c" of Table R602.3(5). Verify that the stud grade called out on the plans in Seismic Category D is consistent with footnote "c".

3. Verify that sheathing is called out on plans and is consistent with footnote “j” of Table R703.4 for 24” stud spacing.

Field Inspection

1. Compare the stud grade with what is called out on the framing details on the approved building plans for studs \leq 10ft and studs $>$ 10ft.
2. Verify that the sheathing type and thickness installed on site is consistent with that called out on the approved building plans.

Code Citations

IRC 2000, Section R602.3.1

In bearing walls, studs that are not more than 10 feet in length shall be spaced not more than is specified in Table R602.3(5). In bearing walls, studs that are more than 10 feet in height shall be spaced not more than specified in Table R602.3.1.

IRC 2003, Section R602.3.1.

The size, height and spacing of studs shall be in accordance with Table R602.3(5).

IRC 2000 and 2003, Table R602.3.1

Stud Spacing Based on Length of Wood in Seismic Design Categories A, B, C and D
Exposed to Wind

2 x 4 framing between $>$ 10 feet and less than 12 feet in length can support up a roof only if spaced at 24 inches on center.

2 x 6 framing can support two floors and a roof up to a length of 14 feet spaced at 24 inches on center without a design required.

IRC 2000 and 2003, Table R703.4 Weather-Resistant Siding Attachment and Minimum Thickness

Provides requirements by sheathing and siding material for framing spaced 24 inches on center.

Open Spaces as Return-Air Options

Issue

Stud cavities and floor joist spaces are often used to return air to the HVAC system's air-handler, and are specifically allowed in the I-codes. Field testing shows that these return systems are often extremely leaky. Leaks within areas that include combustion appliances break the code and present potential health risks. Open spaces in the building are often effective and inexpensive; for example, incorporating hallways as a part of a return-air system.

Background / Description

Homes with basements often use wall stud and floor joist spaces as return-air cavities. Extensive testing indicates that duct leakage in these homes is very high unless ducts have been pressure tested and sealed under some beyond code program (utility, state or local) that tests for duct tightness. In one random sample of 40 homes during 2000, over 60% of the leaks were located in the return-air ducts. In one-third of those homes, return-air leaks connected to the basement could create enough negative pressure that exhaust gases were at risk of being back-drafted down water heater flues.

Some jurisdictions want every bedroom have a return-air duct directly back to the HVAC cabinet. Yet field measurements in typical homes indicate that second-floor return-air ducts relying on building cavities for air transport are often so leaky that they returned little air to the HVAC blower. By code building cavities used for return air can only convey air from one floor level back to the HVAC blower (2000 and 2003 IRC M1601.1.1 #7).

As an inexpensive and effective alternative to seal ducts, the code specifically allows return air by “connecting rooms by permanent openings.” For example, hallways can be part of the return air path.

Two generic approaches are identified that fit the code.

Strategy #1, for single-story and multi-story homes:

1. Use either hard ducts or flex ducts for short, centralized returns that only pull air from central hallways and living zones. (Flex ducts are easy to seal tightly but are also vulnerable to flow restrictions.)
2. Any of the following is acceptable for pressure relief in bedrooms and dens with operable doors:
 - a. A pair of offset transfer-air grilles in room walls that connect to hallways or other open spaces directly linked to the central return.
 - b. Short “jump ducts” (typically located in ceilings) that allow room air to flow back to hallways.
 - c. Any method of pressure balancing that, during operation of the HVAC blower, creates no more than a 2.5-pascal pressure difference across closed doors (amendment to the Florida code in 2003). This may require a pressure test.

Strategy #2, more suitable for ranches:

One HVAC ductwork concept incorporates a dropped ceiling. In a hallway ceiling that has already been finished with drywall, ductwork and under-framing is installed to create a long dropped ceiling, typically providing a 7-foot ceiling height the length of the hallway. The supply plenum and mini-runs are suspended within the cavity; the rest of the dropped ceiling cavity carries return air from individual rooms back to the HVAC air-handler. (For more details, see “For More Information.”)

Plan Review / Inspection Guidance

The plan review guidance for *Strategy #1* assumes that mechanical plans have been submitted for permit. If no mechanical plan is submitted compliance will need to be determined in the field.

1. Verify that the mechanical plan shows the location of the return and supply duct system and the proposed cfm for each register.
2. Verify that the location of the jump ducts, offset transfer grilles or pressure balancing strategy is shown on the plan.

3. Verify that the total unobstructed area for each transfer grille is specified on the plans. The grille area should be based on the total supply cfm for the room.
4. Verify that the return duct(s) back to the system is sized per manufacturers specification. Verify that the return duct locations are in centralized hallways or living zones and not in a closet, bathroom, toilet room, kitchen, garage, mechanical room, furnace room, other dwelling unit, or a room containing a fuel burning appliance that draws its air from that exhausts air into that room..(IRC 2000 and 20003 Section M1602.3).
5. Require a construction detail to show the proposed jump ducts, offset transfer grills or pressure balancing strategy.

Plan Review for *Strategy #2* assumes that mechanical plans have been submitted for permit. If no mechanical plan is submitted compliance will need to be determined in the field.

1. Verify that a mechanical plan has been submitted that shows the location of the return and supply duct system and that proposed cfm for each register.
2. Verify that the total unobstructed area for each transfer grille is specified on the plans. The grille area should be based on the total supply cfm for the room.
3. Require a construction detail to show the dropped ceiling detail and how the supply duct will be suspended and supported in the dropped ceiling space.

Field Inspection

1. If mechanical plans have been submitted verify that that the installed system matches the system shown on the approved building plans.
2. If mechanical plans have not been submitted verify the following in the field:
 - a. For *Strategy #1*, verify that a transfer grill or jump duct is installed for each sleeping room. Also, verify that centralized returns are located in a hallway or living space.
 - b. For jump ducts verify that the duct work is sealed.
 - c. For *Strategy #2*, verify that the dropped ceiling space was framed after the sheetrock was installed and taped in the hallway. Also, verify that the sheetrock that forms the sides of the dropped return air cavity is sealed to the top plate.
 - d. Verify that the supply duct is properly sealed and supported per IRC Section M1601.3.

Code Citations

IRC 2003, Section M1601 Duct Construction, M1601.1.1 Above Ground Duct Systems

Item #7

Stud wall cavities and the spaces between solid floor joists to be utilized as air plenums shall comply with the following conditions:

7.3 Stud wall cavities shall not convey air from more than one floor level.

7.4 Stud wall cavities and joist space plenums shall be isolated from adjacent concealed spaces by tight-fitting fire blocking in accordance with Section R602.8

IRC 2000 and 2003, Section M1601.3.1

Joints of duct systems shall be made substantially airtight by means of tapes, mastics, gasketing or other approved closure systems...

IRC 2000 and 2003, Section M1602.2 Prohibited Sources

Prohibited sources, allows for permanent openings between rooms in order to connect spaces together to meet a return-air location requirement:

Item 4 prohibits return air sources as follows "A closet, bathroom, toilet room, kitchen, garage, mechanical room, furnace room or other dwelling unit" Item 5 prohibits "A room or space containing a fuel-burning appliance where such a room serves as the sole source of return air."

For more information:

--Builder's Guide: Cold Climates, Joe Lstiburek (Energy & Environmental Building Association, 2001) p. 179; available from www.eeba.org

--"Design and Construction of Interior Duct Systems," Florida Solar Energy Center (FSEC-PF-365-01), www.fsec.ucf.edu

Details for Mechanically-Vented Crawl Spaces

Issue

Codes allow conditioned crawl spaces with mechanical ventilation instead of crawl spaces with passive vents to the outdoors. However, code officials and builders are often uncertain about the design details.

Background / Description

Traditional crawl space designs include passive foundation-wall vents that are supposed to let moisture and contaminants escape outside. Yet field research shows that venting may make these potential problems worse. Eliminating crawl space vents and drawing house air in to condition the crawl space reduces moisture problems and can increase energy efficiency.

The IRC specifically allows crawl space designs with an exhaust ventilation system instead of fixed ventilation openings through the foundation walls. To comply, a mechanically-vented crawl space design must have a continuously sealed ground cover, no fixed ventilation openings to the outdoors, and must be supplied with a continuously operating exhaust fan.

Sizing the fan. *Two design options:*

A. Size to the code minimum: Eliminate the foundation vents when continuously operated mechanical ventilation is provided at a rate of 1.0 cfm for each 50 square feet of under-floor space (e.g., 20 cfm per 1000 ft²) (Section R408.2, Exception 4).

B. Size to crawl-space volume: Size for one air-change per hour--the assumed ventilation rate for crawl spaces with passive vents in foundation walls. For example, a 1000 ft² crawl space with 3.5 feet between ground and floor deck, a fan should exhaust 58 cfm.

Type of fan: Code does not specify details about fans used in crawl spaces. One possibility is to follow the Colorado amendments to the IRC. Require a fan rated for 44,000 hours (5 years) of continuous operation with flex connections or other installation detailing to reduce vibration and noise associated with the fan. The fan must be connected to a trouble light or an alarm to signal occupants when the fan fails.

Supply air for the exhaust fan: Transfer-air openings, one per 250 ft² of crawl space floor area, are installed in the decking between the crawl space and conditioned rooms above. A continuously operating exhaust fan pulls house air down through these openings. Airflow through the transfer openings is restricted (e.g., through a capped “boot” that has holes drilled in the cap) per Table.

Amount of air required	Minimum hole size	Maximum hole size
0 – 10 CFM	1.5 in ² min.	2.4 in ² max.
11-15 CFM	2.4 in ² min.	3.6 in ² max.
16 – 20 CFM	3.6 in ² min.	4.4 in ² max.

Pressure balance: the crawl-space exhaust fan, typically 30-60 cfm, will exert slight negative pressure on the house above. The resulting negative pressure will roughly equal that from a bathroom fan, but will be considerably less than the pressure generated by dryers and kitchen exhaust fans. The recommended design specification: when all exhaust appliances and any forced-air HVAC system operate simultaneously, any zone with an atmospherically-vented gas appliance should experience less than 3 pascals of negative pressure.

Plan Review / Inspection Guidance:

1. *Removal of debris:* the under-floor grade is clean of all construction materials, vegetation and (non-soil) organic material (2000 and 2003 IRC R408.4).
2. *Crawl space wall insulation:* installed in accordance with the IECC or IRC specifications.
3. *Ground cover:* “continuous vapor retarder” would be sheet material with less than 1.0 permeance (e.g., polyethylene film) that is sealed at joints as well as to the foundation wall plus to all piers and other penetrations; or a concrete slab.
4. *Fan, when using Exception 4:* sized to provide a minimum of 1 cfm per 50 ft² of under-floor space.
5. *Supply-air pathways:* Look for pathways allowing house air to be drawn, under slight negative pressure, into the crawl space (e.g., one transfer-air grille per 250 ft² of crawl space floor area). Calculations should specify transfer air sizing.

Code Citations

IRC 2000 and 2003, Section R408 Under-Floor Space

R408.1 Ventilation. The under-floor space...shall be provided with ventilation openings through foundation walls or exterior walls.

Exceptions: #4. Ventilation openings are not required where continuously operated mechanical ventilation is provided at a rate of 1.0 cfm (1.02 L/s) for each 50 square feet

(10m³) of under-floor space floor area and ground surface is covered with an approved vapor retarder material.

IMC 2000 and 2003, Section 403 Mechanical Ventilation

403.1 Ventilation system. ...The system shall not be prohibited from producing negative or positive pressure.

For additional information:

--“The Case for Conditioned, Unvented Crawl Spaces,” Peter Yost and Ann Edminster, Building Safety Journal, May 2003

--“Recommended Moisture Control Amendments to the IRC,” Colorado ICC Chapter (Sept 2003 draft); and “Guidelines for Design and Construction of New Homes with Below-Grade Underfloor Spaces,” Moisture Management Task Force, September 2003 draft (www.e-star.com)

Ventilation Requirements for Condensing Clothes Dryers

Issue

Conventional dryers require ductwork to exhaust water vapor from the appliance during operation. That exhaust can contribute to negative pressure in the home, depending on location. Some condensing dryers, relatively new products to the U.S. marketplace, don't require any ducted exhaust.

Background / Description

A fully-loaded conventional clothes dryer exhausts several pounds of water, in its vapor form, during a typical drying cycle. That water vapor is exhausted to the outdoors.

By contrast, some condensing dryers are designed to condense that water into liquid. These tend to increase energy efficiency. Some dryers draw in room air to cool the interior air and condense the water into a condensate holder. Some appliances use small blowers to circulate air across a heat-exchanger inside the dryer. Others use an internal water-cooling system to condense the water vapor. Whatever the design particular, the condensate is either pumped away to the drain or is emptied by hand at the end of the drying cycle. Some condensing dryers are actually combo washer/dryer appliances. Common in Europe for years, these appliances are becoming more widely used in the U.S.

Condensing dryers can be useful in situations where the laundry room is located a significant distance from an exterior wall that it can vent to, thereby avoiding a long dryer vent run and possible moisture condensation problems on that run.

Plan Review / Inspection Guidance

Plan Review

Verify that the building plans specify a condensing (ductless) dryer or ventless combo washer/dryer to be installed.

Verify that the proper drainage has been shown on the plumbing plans for condensing dryers using a pump to remove condensate from the dryer.

Field Inspection

Framing inspection

Verify that the proper drainage has been provided for the condensing dryer if a pump is used to remove the condensate.

Verify that the drainage that is provided is per manufacturers specifications.

Code Citations

IRC 2003, Section M1501 Clothes Dryer Exhaust

M1501.1 General. Dryer exhaust systems shall be independent of all other systems, shall convey the moisture to the outdoors and shall terminate on the outside of the building.

Exception: This section shall not apply to listed and labeled condensing (ductless) clothes dryers.

IRC 2003 Section P3001 – General.

The provisions of this chapter shall govern the materials, design, construction and installation of sanitary draining systems. Plumbing materials shall conform to the requirements of this chapter. The drainage waste and vent (DWV) system shall consist of all piping for conveying wastes from plumbing fixtures, appliances and appurtenances, including fixture traps; above grade drainage piping; below- grade drains within the building (building drain); below-and above-grade venting systems; and piping to the public sewer or private septic system.

IMC 2003, Section 504 Clothes Dryer Exhaust, Section 504.1 Installation

Clothes dryers shall be exhausted in accordance with the manufacturer's instructions.

Exception: This section shall not apply to listed and labeled condensing (ductless) clothes dryers.

For additional information:

--Web search under "condensing clothes dryers" will generate product lists and detailed product-specific functional descriptions and product specifications.

Drywall Clips

Issue

Many jurisdictions are not familiar with using drywall clips for wall gypboard.

Background / Description

Metal or plastic drywall clips can be used to replace a third stud at a corner, at a partition intersection backing stud, or in the ceiling to replace a nailer. The reduced attachment (wood to drywall) resulting from the use of dry wall clips allows small movements without drywall cracking and nail pops. Small movements are normal as wood responds to changes in temperature and moisture content over time.

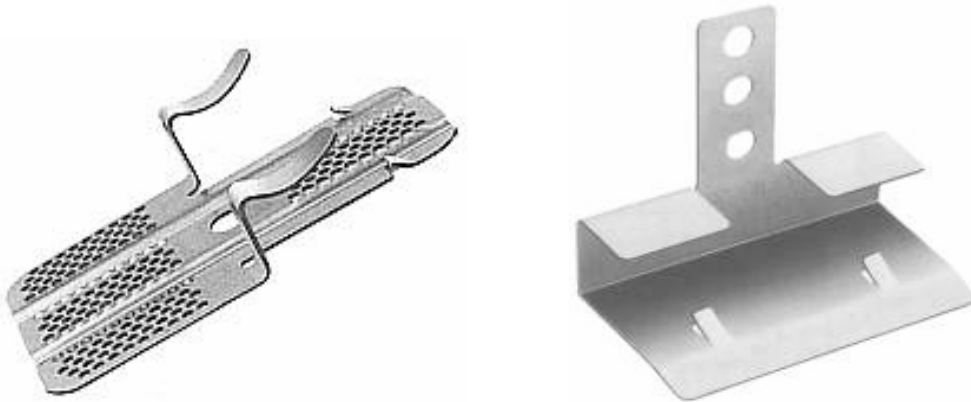

Plan Review / Inspection Guidance

Nails and screws are not used with drywall clips.

Two-stud corners and drywall clips are often used in combination with airtight drywall, where the drywall and well-sealed gypboard seams provide an effective interior air barrier.

Code Citations

IRC 2000 and 2003, Section R602.3 Design and Construction

Exterior walls of wood-frame construction shall be designed and constructed in accordance with the provisions of this chapter and Figures R602.3(1) and R602.3(2) or in accordance with AF&PA's NDS. Components of exterior walls shall be fastened in accordance with Table R602.3(1) through R602.3(4).

IRC 2000 and 2003, Figure R602.3(2)

Note: A third stud and/or partition intersection backing studs shall be permitted to be omitted through the use of wood back-up cleats, metal drywall clips or other approved devices that will serve as adequate backing for the facing materials.

Rigid Board Insulation Installed as Draft Stop in Attic Kneewall

Issue

Rigid board insulation (foam plastic) is an effective draft stop and also increases the R-value of the attic kneewall if installed on the attic side of the kneewall, replacing the need for separate draft stop and insulation products. The IRC requires foam plastic insulation to be protected against ignition by using fiberglass batt insulation, gypsum board or other products that meet the flame and smoke density requirements. Foam plastic products rated for flame and smoke density can be installed without such a protective covering.

Background / Description

Insulating attic kneewalls between a conditioned space with vaulted ceilings and the attic is important to reduce energy loss through the wall, especially in the summer months. To be effective, the insulation installed in the kneewalls must be supported so that it stays in contact with the gypsum board, and protected against air moving through the insulation.

Foam plastic insulation can be installed on the attic side of the attic kneewall (see Figure) to both act as a draft stop between the conditioned house and the unconditioned attic and to increase the insulation R-value of the attic kneewall. Installing such an insulating backing in the kneewall supports the fiberglass batt insulation between framing members, replaces an air barrier, and adds insulating value to the attic kneewall.



Plan Review / Inspection Guidance

Plan Review:

1. Verify that plastic insulation called out on the construction detail meets the ASTM E 84 requirements for flame spread and smoke development. Require manufacturer's literature or an *ICC* Evaluation Service report.
2. Verify that the insulation R-value of the foam plastic insulation called out on the building plans meets or exceeds the R-value requirements called for on the energy code compliance documentation (only if credit has been taken for the foam plastic insulation).

Field Inspection:

1. Verify that the foam plastic insulation installed in the field is consistent with that called out on the building plans.
2. Verify that the insulation R-value specified on the insulation meets or exceeds the R-value called out on the plans or documentation.
3. Verify that that sealant has been installed around the edges of the insulation and that any holes or penetrations in the foam plastic insulation are sealed.

Code Citations

IRC 2000, Section R318.2.3 and IRC 2003, Section R314.2.3

Within attics and crawlspaces, where entry is made only for service of utilities, foam plastics shall be protected against ignition by 1 -inch-thick (38 mm) mineral fiber insulation, 1/2-inch-thick (6.4 mm) wood structural panels, 3/8-inch (9.5 mm) particleboard,

1/8-inch (6.4 mm) hardboard, 3/8-inch (9.5 mm) gypsum board, or corrosion resistant steel having a base metal thickness of 0.016 inch (0.406 mm).

IRC 2000, Section R318.3

Plastic foam not meeting the requirements of Section R318.1 and R318.2 may be specifically approved on the basis of one of the following approved tests: ASTM E 84, FM 4880, UL 1040, ASTM E152, or UL 1715, or fire tests related to actual end-use configurations. The specific approval may be based on the end use, quantity, location and similar considerations where such tests would not be applicable or practical.

IRC 2003, Section R314.3

Plastic foam not meeting the requirements of Section R318.1 and R318.2 may be specifically approved on the basis of one of the following approved tests: ASTM E 84, FM 4880, UL 1040, NFPA 286, ASTM E152, or UL 1715, or fire tests related to actual end-use configurations. The specific approval may be based on the end use, quantity, location and similar considerations where such tests would not be applicable or practical.

Applicable Material Testing References

ASTM E 84 - Standard Test Method for Surface Burning Characteristics of Building Materials

UL 1715 – Fire Test of Interior Finish Material.

REPORT DOCUMENTATION PAGE

Form Approved
OMB No. 0704-0188

The public reporting burden for this collection of information is estimated to average 1 hour per response, including the time for reviewing instructions, searching existing data sources, gathering and maintaining the data needed, and completing and reviewing the collection of information. Send comments regarding this burden estimate or any other aspect of this collection of information, including suggestions for reducing the burden, to Department of Defense, Executive Services and Communications Directorate (0704-0188). Respondents should be aware that notwithstanding any other provision of law, no person shall be subject to any penalty for failing to comply with a collection of information if it does not display a currently valid OMB control number.

PLEASE DO NOT RETURN YOUR FORM TO THE ABOVE ORGANIZATION.

1. REPORT DATE (DD-MM-YYYY) December 2		2. REPORT TYPE Technical Report		3. DATES COVERED (From - To)		
4. TITLE AND SUBTITLE Building America Best Practices Series: Volume 1			5a. CONTRACT NUMBER DE-AC36-99-GO10337			
			5b. GRANT NUMBER			
			5c. PROGRAM ELEMENT NUMBER			
6. AUTHOR(S) M.C. Baechler, P.M. Love			5d. PROJECT NUMBER NREL/TP-550-36960			
			5e. TASK NUMBER BET5.8004			
			5f. WORK UNIT NUMBER			
7. PERFORMING ORGANIZATION NAME(S) AND ADDRESS(ES) National Renewable Energy Laboratory 1617 Cole Blvd. Golden, CO 80401-3393				8. PERFORMING ORGANIZATION REPORT NUMBER NREL/TP-550-36960		
9. SPONSORING/MONITORING AGENCY NAME(S) AND ADDRESS(ES)				10. SPONSOR/MONITOR'S ACRONYM(S) NREL		
				11. SPONSORING/MONITORING AGENCY REPORT NUMBER		
12. DISTRIBUTION AVAILABILITY STATEMENT National Technical Information Service U.S. Department of Commerce 5285 Port Royal Road Springfield, VA 22161						
13. SUPPLEMENTARY NOTES						
14. ABSTRACT (Maximum 200 Words) This Building America Best Practices guide book is a resource to help builders large and small build high-quality, energy-efficient homes that achieve 30% energy savings in space conditioning and water heating in the hot and humid climate. The savings are in comparison with the 1993 Model Energy Code. The guide contains chapters for every member of the builder's team. There is also a chapter for homeowners on how to use the book to provide help in selecting a new home or builder.						
15. SUBJECT TERMS Building America; U.S. Department of Energy; hot-humid climate; energy-efficient house; builder's guide; best practices; energy savings; 1993 Model Energy Code; water heating						
16. SECURITY CLASSIFICATION OF:			17. LIMITATION OF ABSTRACT UL	18. NUMBER OF PAGES	19a. NAME OF RESPONSIBLE PERSON	
a. REPORT Unclassified	b. ABSTRACT Unclassified	c. THIS PAGE Unclassified			19b. TELEPHONE NUMBER (Include area code)	

Standard Form 298 (Rev. 8/98)
Prescribed by ANSI Std. Z39.18

A Strong Energy Portfolio for a Strong America

Energy efficiency and clean, renewable energy will mean a stronger economy, a cleaner environment, and greater energy independence for America. Working with a wide array of state, community, industry, and university partners, the U.S. Department of Energy's Office of Energy Efficiency and Renewable Energy invests in a diverse portfolio of energy technologies.

Research and Development of Buildings

Our nation's buildings consume more energy than any other sector of the U.S. economy, including transportation and industry. Fortunately, the opportunities to reduce building energy use—and the associated environmental impacts—are significant.

DOE's Building Technologies Program works to improve the energy efficiency of our nation's buildings through innovative new technologies and better building practices. The program focuses on two key areas:

- **Emerging Technologies**
Research and development of the next generation of energy-efficient components, materials, and equipment
- **Technology Integration**
Integration of new technologies with innovative building methods to optimize building performance and savings

For more information contact:
EERE Information Center
1-877-EERE-INF (1-877-337-3463)
www.eere.energy.gov



U.S. Department of Energy
**Energy Efficiency
and Renewable Energy**

An electronic copy of this factsheet is available on the Building America Web site at www.buildingamerica.gov

Visit our Web sites at:

www.buildingamerica.gov

www.energystar.gov



Building America Program

George S. James • New Construction • 202-586-9472 • fax: 202-586-8134 • e-mail: George.James@ee.doe.gov
Terry Logee • Existing Homes • 202-586-1689 • fax: 202-586-4617 • e-mail: terry.logee@ee.doe.gov
Lew Pratsch • Integrated Onsite Power • 202-586-1512 • fax: 202-586-8185 • e-mail: Lew.Pratsch@hq.doe.gov
Building America Program • Office of Building Technologies, EE-2J • U.S. Department of Energy • 1000 Independence Avenue, S.W. • Washington, D.C. 20585-0121 • www.buildingamerica.gov

Building Industry Research Alliance (BIRA)

Robert Hammon • ConSol • 7407 Tam O'Shanter Drive #200 • Stockton, CA 95210-3370 • 209-473-5000 • fax: 209-474-0817 • e-mail: Rob@consol.ws • www.bira.ws

Building Science Consortium (BSC)

Betsy Pettit • Building Science Consortium (BSC) • 70 Main Street • Westford, MA 01886 • 978-589-5100 • fax: 978-589-5103 • e-mail: Betsy@buildingscience.com • www.buildingscience.com

Consortium for Advanced Residential Buildings (CARB)

Steven Winter • Steven Winter Associates, Inc. • 50 Washington Street • Norwalk, CT 06854 • 203-857-0200 • fax: 203-852-0741 • e-mail: swinter@swinter.com • www.carb-swa.com

Davis Energy Group

David Springer • Davis Energy Group • 123 C Street • Davis, CA 95616 • 530-753-1100 • fax: 530-753-4125 • e-mail: springer@davisenergy.com • deg@davisenergy.com • www.davisenergy.com/index.html

IBACOS Consortium

Brad Oberg • IBACOS Consortium • 2214 Liberty Avenue • Pittsburgh, PA 15222 • 412-765-3664 • fax: 412-765-3738 • e-mail: boberg@ibacos.com • www.ibacos.com

Industrialized Housing Partnership (IHP)

Subrato Chandra • Florida Solar Energy Center • 1679 Clearlake Road • Cocoa, FL 32922 • 321-638-1412 • fax: 321-638-1439 • e-mail: subrato@fsec.ucf.edu • www.baihp.org

National Association of Home Builders (NAHB) Research Center

Tom Kenney • National Association of Home Builders (NAHB) Research Center • 400 Prince George's Boulevard • Upper Marlboro, MD 20774 • 301-430-6246 • fax: 301-430-6180 • toll-free: 800-638-8556 • www.nahbrc.org/

National Renewable Energy Laboratory

Ren Anderson • 1617 Cole Boulevard, MS-2722 • Golden, CO 80401 • 303-384-7433 • fax: 303-384-7540 • e-mail: ren_anderson@nrel.gov • www.nrel.gov

Tim Merrigan • 1617 Cole Boulevard, MS-2722 • Golden, CO 80401 • 303-384-7349 • fax: 303-384-7540 • e-mail: tim_merrigan@nrel.gov • www.nrel.gov

Oak Ridge National Laboratory

Pat M. Love • P.O. Box 2008 • One Bethel Valley Road • Oak Ridge, TN 37831 • 865-574-4346 • fax: 865-574-9331 • e-mail: lovepm@ornl.gov • www.ornl.gov

Produced for the U.S. Department of Energy (DOE) by the National Renewable Energy Laboratory, a DOE national laboratory.

December 2004 • NREL/TP-550-36960

Printed with a renewable-source ink on paper containing at least 50% wastepaper, including 20% postconsumer waste.

Bringing you a prosperous future where energy is clean, abundant, reliable, and affordable