



AQMD

Technology Advancement Office Clean Fuels Program 2004 Annual Report and 2005 Plan Update



South Coast Air Quality Management District
Cleaning the air that we breathe...™

South Coast Air Quality Management District

Governing Board

Chairman

William A. Burke, Ed.D.*
Assembly Speaker Appointee

Vice Chairman

S. Roy Wilson, Ed.D.**
Supervisor, Riverside County

County Representatives

Michael D. Antonovich
Supervisor, Los Angeles County

James W. Silva
Supervisor, Orange County

Gary Ovitt
Supervisor, San Bernardino County

Cities Representatives

Jan Perry
Councilmember, City of Los Angeles
Los Angeles County, Western Region

Beatrice J.S. LaPisto-Kirtley
Mayor Pro Tem, City of Bradbury
Los Angeles County, Eastern Region

Miguel A. Pulido
Mayor, City of Santa Ana
Orange County Cities

Ronald O. Loveridge
Mayor, City of Riverside
Riverside County Cities

Dennis R. Yates*
Mayor, City of Chino
San Bernardino County Cities

State Representatives

Jane W. Carney
Senate Rules Committee Appointee

Cynthia Verdugo-Peralta*
Governor's Appointee

Executive Officer

Barry R. Wallerstein, D.Env.

* Technology Committee Members

** Technology Committee Chairman

*South Coast Air Quality Management District
Technology Advancement Office*

Chung S. Liu, D.Env., Deputy Executive Officer, Science & Technology Advancement
Henry Hogo, Assistant Deputy Executive Officer, Science & Technology Advancement

Gary Dixon, Special Technologies Project Manager
Larry Kolczak, Community Relations Manager
Fred Minassian, Technology Implementation Manager
Matt Miyasato, Ph.D., Technology Demonstrations Manager
Dean Saito, Fleet Rule Implementation Manager
Paul Wuebben, Clean Fuels Officer

Naveen Berry, Program Supervisor
Michael Bogdanoff, Program Supervisor
David Coel, Program Supervisor
Connie Day, Program Supervisor
Ranji George, Program Supervisor
Marty Kay, Program Supervisor
Dipankar Sarkar, Program Supervisor
Larry Watkins, Program Supervisor

Al Baez, Senior Air Quality Engineer
Howard Lange, Ph.D., Air Quality Engineer II

Phil Barroca, P.E., Air Quality Specialist
Mark Coleman, Air Quality Specialist
Larry Irwin, Air Quality Specialist
Von Loveland, Air Quality Specialist
Lisa Mirisola, Air Quality Specialist
Adewale Oshinuga, Air Quality Specialist
Shashi Singeetham, Air Quality Specialist
Vicki White, Air Quality Specialist

Geri Koerner, Staff Specialist
Phil Yenovkian, Staff Specialist

Dory Kilgour, Senior Administrative Secretary
Drue Ramirez, Senior Administrative Secretary
Penny Shaw Cedillo, Secretary
Majorie Eaton, Secretary
Donna Vernon, Secretary
Lani Montojo, Staff Assistant
Michelle White, Contracts Assistant
Flor Tumambing, Senior Office Assistant

Other Staff Contributors

Jean Ospital, Health Effects Officer, Planning, Rule Development & Area Sources

Mobile Source Air Pollution Reduction Review Committee Staff

Cynthia Ravenstein, Staff Specialist
Matt MacKenzie, Senior Office Assistant
Rachel Valenzuela, Senior Office Assistant

Table of Contents

EXECUTIVE SUMMARY	1
Clean Fuels Program	1
Introduction.....	1
The Need for Advanced Technologies & Clean Fuels.....	2
Program Funding	3
Program Review.....	4
Core Technologies	5
Program Impact.....	9
Expected Benefits of the Clean Fuels Program	9
Overcoming Barriers.....	10
Research, Development, and Demonstration (RD&D).....	11
Technology Deployment and Commercialization.....	13
2004 Project Expenditures	15
Financial Summary	15
Review of Audit Findings.....	16
Project Summaries	22
Incentive Programs-Alternative Fuels.....	22
Fuel Cell Technology.....	23
Hydrogen Technology and Infrastructure	25
Engine Technology	27
Infrastructure and Fuel Production	29
Electric/Hybrid Technologies	36
Emission Control Technologies	37
Emission Studies	39
Health Impacts Studies.....	39
VOC/Air Toxics Control Technologies	40
Outreach and Technology Transfer.....	40
Progress in 2004	47
Key Projects Completed	47
Future Technologies.....	55
Funding Priorities for 2005.....	55
Summary of Technical Priorities	56
Target Project Allocations	60
Program Plan Update	61
Incentive Programs	66
Fuel Cell Technology.....	67
Hydrogen Technology and Infrastructure.....	73
Engine Technology	81
Infrastructure and Fuel Production	89
Electric/Hybrid Technologies	94
Emission Control Technology.....	105
Emission Studies.....	118
Health Impacts Studies.....	125

Stationary Clean Fuel Technology	127
VOC/Air Toxics Control Technologies	133
Outreach and Technology Transfer	135

Appendix A

Technology Advancement Advisory Group	A-1
SB 98 Clean Fuels Advisory Group	A-2

Appendix B

Open Clean Fuels Contracts as of January 1, 2005	B-1
--	-----

Appendix C

Final Reports for 2004	C-1
------------------------------	-----

Figures

Figure 1: Major Source Contributions (2010)	2
Figure 2: Clean Fuels Program Project Types	9
Figure 3: SCAQMD Hydrogen Station Demonstrations	13
Figure 4: Natural Gas Refueling Infrastructure	14
Figure 5: Distribution of Funds for Governing Board Approved Clean Fuels Projects Calendar Year 2004 (\$15.2 million)	16
Figure 6: “Phill” Home Refueling Appliance (courtesy of FuelMaker)	48
Figure 7: Installed Particulate Trap on Heavy-Duty Construction Equipment	50
Figure 8: Fischer-Tropsch Fuel Compared to Diesel	51
Figure 9: Projected Cost Distribution for Potential SCAQMD Projects 2005 and Beyond (\$41 million)	60

Tables

Table 1: SCAQMD Funding Partners in CY 2004	12
Table 2: Clean Fuels Awards Made by the Governing Board in CY 2004	17
Table 3: Supplemental Grants & Revenues Received in CY 2004	21
Table 4: Projects Completed Between January 1 and December 31, 2004	52
Table 5: Summary of Potential Projects	62

EXECUTIVE SUMMARY

2004 Annual Report

The South Coast Air Quality Management District (SCAQMD) Governing Board approved 63 new projects, studies or amended contracts during Calendar Year (CY) 2004 to sponsor research, development, and demonstration (RD&D) and commercialization of alternative fuel and clean fuel technologies in Southern California. Table 2 (page 17) and Table 3 (page 21) list projects which are further described in this report. The SCAQMD contributed nearly \$15 million towards such projects in partnership with other government organizations, private industry, academia and research institutes, and interested parties, with total project costs of more than \$44 million. These projects addressed a wide range of issues and opportunities with a diverse mix of advanced technologies. The areas of technology advancement include the following:

- Fuel Cell Technology
- Hydrogen Technology and Infrastructure
- Engine Technology (particularly in the heavy-duty vehicle sector)
- Infrastructure and Fuel Production (compressed natural gas and liquid natural gas)
- Electric and Hybrid Vehicle Technologies
- Emission Control Technologies
- Emission Studies
- Health Effects Studies
- Stationary Clean Fuel Technology (including renewables)
- VOC and Air Toxics Control Technologies
- Outreach and Technology Transfer

During CY 2004, the SCAQMD continued the advancement of alternative fuel technologies with an emphasis on deployment of heavy-duty natural gas vehicles, expansion of the natural gas refueling infrastructure, and expanding the hydrogen refueling infrastructure for fuel cell and hydrogen internal combustion engine (ICE) vehicles. The SCAQMD advanced diesel projects to accelerate compliance with the 2010 Federal on-road heavy-duty emission standards.

Eighteen research, development, and demonstration projects and fourteen technology assessment projects or studies were completed in 2004, as listed in Table 4 (page 52). Summaries for each technical project completed in 2004 are included in Appendix C. In accordance with California Health and Safety Code section 40448.5.1(d), this report must be submitted to the state legislature by March 31, 2005, after approval by the SCAQMD Governing Board.

2005 Plan Update

The Clean Fuels Program continually seeks to support the deployment of lower emitting technologies. The design and implementation of the Program Plan must balance the needs in the various technology sectors with technology readiness, emissions reduction potential, and co-funding opportunity. The SCAQMD program is significant, especially at a time when both public and private funding available for technology research and development is limited. However, since national and international

activities affect the direction of technology trends, the real challenge for the SCAQMD is to identify project or technology opportunities in which its available funding can make a difference in making progressively cleaner technologies a reality in the Basin.

The overall strategy is based in large part on technology needs identified in the Air Quality Management Plan (AQMP) for the South Coast Air Basin and the Governing Board's directives to protect the health of residents of Southern California. The AQMP is the long-term "blueprint" that defines:

- the basin-wide emission reductions needed to achieve ambient air quality standards by 2010,
- the regulatory measures to achieve those reductions,
- the timeframes to implement these proposed measures, and
- the technologies required to meet these future proposed regulations.

The oxides of nitrogen (NO_x) and volatile organic compounds (VOC) emission sources of greatest concern are heavy-duty on-road vehicles, light-duty on-road vehicles, and off-road equipment.

In addition to specific control measures based on known technologies and control methods, the Clean Air Act has provisions for more general measures based on future, yet-to-be-developed technologies. These so-called "black box" measures are called for under Section 182(e)(5) of the Clean Air Act for regions that are extreme non-attainment areas, such as the South Coast Air Basin. The Plan Update includes projects to develop, demonstrate, and commercialize a variety of technologies, from near term to long term, that are intended to provide solutions to the emission control needs identified in the AQMP.

CLEAN FUELS PROGRAM

Introduction

The Basin, which is comprised of the Los Angeles, Orange, San Bernardino, and Riverside counties, has some of the worst air quality in the nation due to a combination of factors, including high vehicle population, high vehicle miles traveled within the Basin, and geographic and atmospheric conditions favorable for photochemical oxidant (smog) formation. Due to these challenges, the state legislature enabled the SCAQMD to implement the Clean Fuels Program to accelerate the implementation and commercialization of clean fuels and advanced technologies in the Basin. In 1999, state legislation was passed which amended and extended the Clean Fuels Program. Specifically, as stated in the California Health and Safety Code (H&SC) section 40448.5.1(d), the SCAQMD must submit, on or before March 31 of each year to the Legislature, an annual report that includes:

- A description of the core technologies that the SCAQMD considers critical to ensure attainment and maintenance of ambient air quality standards and a description of the efforts made to overcome barriers to commercialization of those technologies;
- An analysis of the impact of the SCAQMD's Clean Fuels Program on the private sector and on research, development, and commercialization efforts by major automobile and energy firms, as determined by the SCAQMD;
- A description of projects funded by the SCAQMD, including a list of recipients, subcontractors, co-funding sources, matching state or federal funds, and expected and actual results of each project advancing and implementing clean fuels technology and improving public health;
- The title and purpose of all projects undertaken pursuant to the Clean Fuels Program, the names of the contractors and subcontractors involved in each project, and the amount of money expended for each project;
- A summary of the progress made toward the goals of the Clean Fuels Program; and
- Funding priorities identified for the next year and relevant audit information for previous, current, and future years covered by the report.

This report summarizes the progress of the SCAQMD Clean Fuels Program for Calendar Year (CY) 2004. This SCAQMD program cosponsors projects to develop, demonstrate, and expedite the implementation and deployment of low-emission clean fuels and advanced technologies in Southern California. These projects are conducted through public-private partnerships with industry, technology developers, academic and research institutes, and local, state, and federal agencies.

During the period between January 1, 2004 and December 31, 2004, the SCAQMD Governing Board approved 63 projects, studies or amended contracts that support clean fuels and advanced low-emission technologies. The SCAQMD contribution for these projects was nearly \$15 million, with total project costs of nearly \$44 million. These projects address a wide range of issues with a diverse technology mix. This report highlights achievements of the SCAQMD Clean Fuels Program in this period, summarizes project costs, and outlines future plans for the Program.

The Need for Advanced Technologies & Clean Fuels

Achieving federal and state clean air standards in Southern California will require emission reductions from both mobile and stationary sources beyond those expected using current technologies. The need for advanced technologies and clean fuels is best demonstrated by considering the emissions inventory for the Basin and the future emissions levels projected in the 2003 Air Quality Management Plan (AQMP). The baseline 2010 emissions inventory is shown in Figure 1. Based on the 2003 AQMP, significant reductions are necessary to demonstrate attainment with the federal 1-hour ozone standard.

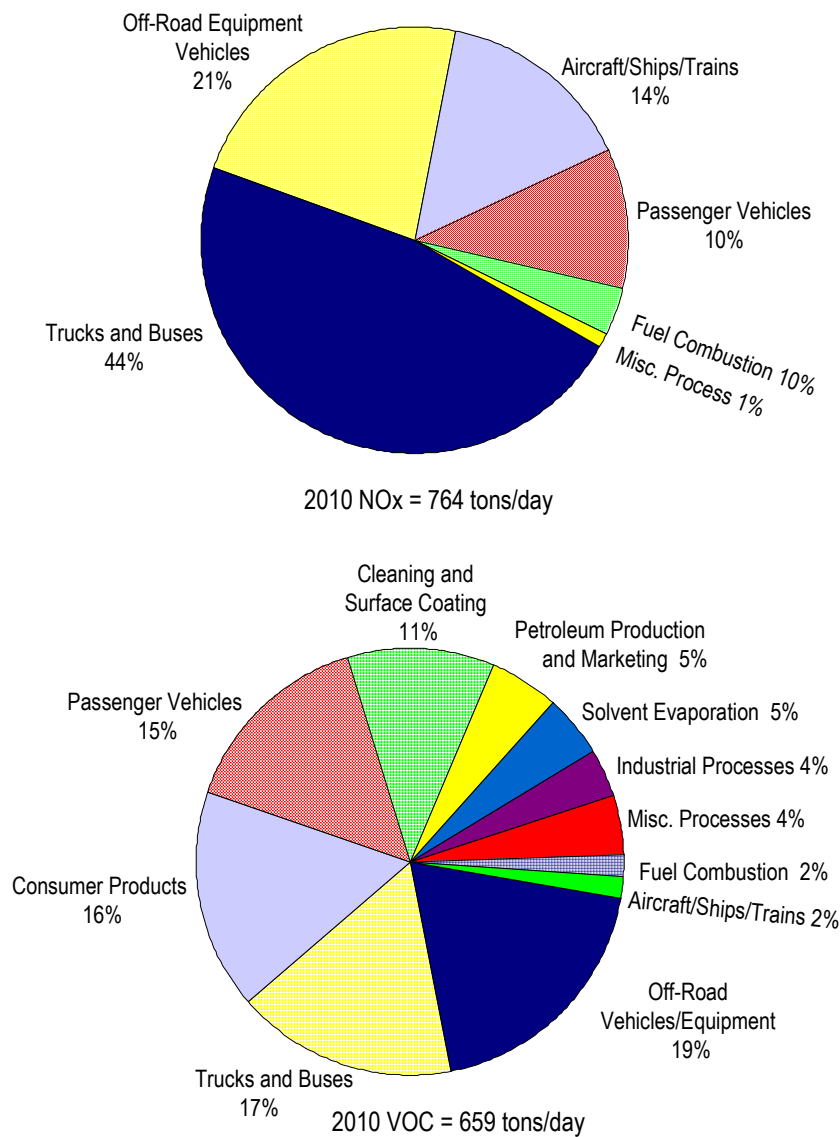

Figure 1: Major Source Contributions (2010)

To fulfill long-term emission reduction measures, the 2003 AQMP relies on advanced technologies that are not yet fully developed for commercial use. Significant reductions are anticipated from implementation of advanced control technologies for both on-road and off-road mobile sources.

In addition, new air quality standards for ozone (0.08 ppm, 8-hour average) and fine particulate matter, promulgated by the U.S. Environmental Protection Agency (U.S. EPA) in 1997, are projected to require additional long-term controls for both NO_x and VOC.

Recent health studies also indicate a greater need to reduce NO_x emissions and toxic air contaminant emissions. More importantly, the California Air Resources Board (CARB) listed diesel exhaust emissions as toxic air contaminant in 1998. Subsequently, in 1999, the SCAQMD completed the Multiple Air Toxics Exposure Study (MATES-II) and found that diesel combustion sources (primarily from heavy-duty vehicles) contribute approximately 70 percent to the estimated potential cancer risk from air toxics in the Basin. A follow-on study, (MATES-III), was initiated to evaluate air toxic exposure trends, expand the list of known air toxics, and assess local impacts from industrial, commercial and mobile sources.

In addition, there are increasing concerns over greenhouse gas emissions and petroleum dependence arising from the heavy use of conventional technologies. In recognition of these concerns, the federal government has several programs (the Hydrogen, Fuel Cells, and Infrastructure Technologies Program and the FreedomCAR and Vehicle Technologies Program) to investigate and develop increased efficiency and alternative fuel (namely hydrogen) technologies. Similarly, the state has adopted goals to reduce long-term dependence on petroleum-based fuels (AB 2076) as well as limit the amount of greenhouse gases emitted from automobiles starting in 2009 (AB 1493). The goals of the federal and state programs will be achieved, in part, through alternative fuels (petroleum displacement) and increased vehicle hybridization (improved efficiency).

It is clear then that clean, advanced, energy efficient and renewable technologies are needed not only for attainment, but also to protect the health of those who reside within the SCAQMD's jurisdiction, reduce long-term dependence on petroleum-based fuels, and support a more sustainable energy future. To help meet this need for advanced, clean technologies, the SCAQMD Governing Board continues to promote the Clean Fuels Program through the Technology Advancement Office. This program is intended to assist in the rapid development and deployment of progressively lower-emitting technologies and fuels through innovative public-private partnership. Since its inception, the SCAQMD Technology Advancement Office has co-funded projects in cooperative partnership with private industry, technology developers, academic and research institutes, and local, state, and federal agencies. This public-private partnership has enabled the SCAQMD to leverage its public funds with outside investment.

Program Funding

The Clean Fuels Program, under California Health and Safety Code (H&SC) Sections 40448.5 and 40512 and Vehicle Code Section 9250.11, establishes mechanisms to collect revenues from mobile and stationary sources to support the program's objectives, albeit with constraints on the use of the funds. In 2003 these funding mechanisms, described below, were reauthorized through January 1, 2010, under SB 288 (Sher). The objective of the Program is to support and promote projects to increase the utilization of clean-burning alternative fuels and related technologies, such as hydrogen, fuel cells, liquid petroleum gas, natural gas, combination fuels, synthetic fuels, electricity including electric and hybrid vehicles, as well as other clean alternatives yet to be developed.

The Program is funded through a \$1 fee on motor vehicles registered in the SCAQMD. Revenues collected from these motor vehicles must be used to support mobile source projects. Stationary source projects are funded by an emission fee surcharge on stationary sources emitting more than 250 tons of pollutants per year within the SCAQMD. For CY 2004 the funds available through each of these mechanisms were as follows:

- Mobile sources (DMV revenues) \$11,597,000

- Stationary sources (emission fee surcharge) \$303,500

The SCAQMD Clean Fuels Program also receives grants and cost-sharing revenue contracts from various agencies, on a project-specific basis, that supplement the SCAQMD budget. Historically, such cooperative project funding revenues have been received from CARB, the California Energy Commission (CEC), the U.S. EPA, the U.S. Department of Energy (DOE), and the U.S. Department of Transportation (DOT). These supplemental revenues depend in large part on the originating agency, its budgetary and planning cycle, and the specific project or intended use of the revenues. Table 3 lists the supplemental grants and revenues recognized in 2004.

Another limited revenue source available to fund the development and demonstration of advanced clean air technologies is the Advanced Technology, Outreach and Education Fund. This fund was established as a special revenue fund, separate from the SCAQMD budget, for revenues received as a result of penalties and settlements from violations of air pollution control rules and regulations. In some cases, the revenues from violations may be tied to specific technologies or the development of technologies to address specific industrial needs. In certain enforcement cases, for example, instead of paying a fine, a company could place the penalty amount into this fund and help develop low-emission processes in its own field of business.

The final, and perhaps most significant, funding source can best be described as an indirect source, i.e., funding not directly received by the SCAQMD. This indirect source is the cost sharing provided by private industry and other public and private organizations. Historically, the Technology Advancement Office has been successful in leveraging its available public funds with at least \$4 of outside funding for each \$1 of SCAQMD funding. Through this public-private partnership, the SCAQMD has shared the investment risk of developing new technologies along with the benefits of expedited development and commercial availability, increased end-user acceptance, reduced emissions from the demonstration projects and, ultimately, increased use of clean technologies in the Basin. The SCAQMD's Clean Fuels Program has also avoided duplicative efforts by coordinating and jointly funding projects with major funding agencies and organizations.

Program Review

In 1990, the SCAQMD initiated an annual review of its technology advancement program by an external panel of experts. That external review process has evolved, in response to SCAQMD policies and legislative mandates, into two external advisory groups. The Technology Advancement Advisory Group (one of six standing Advisory Groups that make up the SCAQMD Advisory Council) is made up of stakeholders representing industry, academia, regulatory agencies, the scientific community, and environmental interests. The Technology Advancement Advisory Group, whose members are listed in Appendix A, serves:

- To coordinate the SCAQMD program with related local, state, and national activities;
- To review and assess the overall direction of the program; and
- To identify new project areas and cost-sharing opportunities, including technologies to reduce VOC emissions from stationary and area sources

A second advisory group was formed as required by SB 98 (Alarcon). Under H&SC Section 40448.5.1(c), this advisory group must be comprised of 13 members with expertise in clean fuels technology and policy or public health, appointed from the scientific, academic, entrepreneurial, environmental, and public health communities. This legislation further specified conflict-of-interest guidelines prohibiting members from advocating expenditures towards projects in which they have professional or economic interests. The objectives of the SB 98 Clean Fuels Advisory Group are to

make recommendations regarding projects, plans, and reports, including approval of the required annual report prior to submittal to the SCAQMD Governing Board. The members of the SB 98 Clean Fuels Advisory Group are also listed in Appendix A.

The review process of the Clean Fuels Program now includes several meetings of the two Advisory Groups, review by the Technology Committee of the SCAQMD Board, public hearing of the Annual Report and Plan Update before the full SCAQMD Governing Board, and submittal of the Annual Report to the Legislature.

Core Technologies

- Fuel Cell and Hydrogen Technologies
- Engine Technology (Heavy-Duty Vehicles)
- Infrastructure and Fuel Production
- Emission Control Technologies
- Electric and Hybrid Vehicle Technology
- Stationary Clean Fuel Technology
- VOC and Air Toxics Control Technologies

The SCAQMD continually seeks to support the deployment of lower emitting technologies. The Clean Fuels Program is shaped by two basic factors:

1. Low- and zero-emission technologies needed to achieve clean air standards in the Basin.
2. Available funding to support technology development within the constraints imposed by that funding.

The SCAQMD strives to maintain a flexible program to address dynamically evolving technologies and the latest progress in the state-of-the-technology. Although the SCAQMD program is significant, especially at a time when both public and private funding available for technology research and development is limited, national and international activities affect the direction of technology trends. As a result, the SCAQMD program must be flexible to accommodate these changes in direction. The ultimate challenge for the SCAQMD is to identify project or technology opportunities in which its available funding can make a difference in achieving progressively cleaner air in the Basin.

Given the diversity of sources that contribute to the air quality problems in the Basin, there is no single technology that can solve all of the problems. Thus, the core technologies represent a variety of applications with full emissions benefit “payoffs,” i.e., perceived time to full commercialization and mass deployment, occurring at different times. Historically, mobile source projects have targeted low-emission developments in automobiles, transit buses, medium- and heavy-duty trucks, and off-road applications. These vehicle-related efforts have focused on advancements in engine design, electric power-trains and energy storage/conversion devices (e.g., fuel cells and batteries); and implementation of clean fuels (e.g., natural gas, propane, and hydrogen), including their infrastructure development. Stationary source projects have included a wide array of advanced low NO_x technologies; low VOC coatings and processes; and clean energy alternatives such as fuel cells, solar power, and other renewable energy systems.

Specific projects are selected for co-funding from competitive solicitations, cooperative agency agreements, and unsolicited proposals. Criteria considered in project selection include emissions reduction potential, technological innovation, potential to reduce costs and improve cost effectiveness, contractor experience and capabilities, overall environmental impact or benefit, commercialization and business development potential, cost sharing, and consistency with program

goals and funding constraints. The core technologies for the SCAQMD programs that meet both the funding constraints as well as AQMP needs for achieving clean air are briefly described below.

Fuel Cell and Hydrogen Technologies

Fuel cells are devices in which chemical energy is converted into electrical energy without combustion. In a proton exchange membrane (PEM) fuel cell for example, a fuel, usually hydrogen, reacts with oxygen to produce electrical power and pure water with essentially no emissions. These ultra-clean and high-efficiency electrochemical engines can provide excellent performance for vehicles and have the potential to work in virtually every mobile and stationary application currently powered by an internal combustion engine (ICE). Consequently, fuel cells are specifically identified in the AQMP as “enabling” technologies to help meet long-term control measures in the transportation sector and hold promise as near-zero emission power generators in the stationary sector.

Fuel cells are leading technology to power zero emission vehicles (ZEVs) and near-ZEVs. Despite the considerable amount of work done by nearly all of the major automotive manufacturers, a significant amount of additional development is needed to improve and demonstrate the ultimate commercial viability of fuel cells for transportation. Two of the prime challenges facing the widespread potential usage of fuel cells are the refueling infrastructure development and the relatively high cost for both mobile and stationary applications. In order to address these issues, the SCAQMD is funding the refueling infrastructure development and alternative H₂ vehicles which are lower in cost than fuel cells.

Engine Technology (Heavy-Duty Vehicles)

Heavy-duty vehicles are significant contributors to the Basin’s on-road vehicle emissions inventory, contributing over one-third of the NO_x and two-thirds of the particulate emissions. These heavy-duty vehicles are primarily powered by diesel-fueled compression ignition engines, which in addition to emitting NO_x and PM, produce exhaust pollutants that have known toxic effects. Significant long-term emission reductions will be required from mobile sources, especially from the heavy-duty sector, to attain clean air standards.

The use of alternative fuels in heavy-duty vehicles can provide significant reductions in NO_x and particulate emissions. The current NO_x emissions standard for heavy-duty engines is 2.5 g/bhp-hr (combined NO_x and VOC emissions). Natural gas fueled engines with after-controls can potentially achieve emissions as low as 0.5 g/bhp-hr and is the technology most likely to achieve the 0.2 g/bhp-hr emission levels prior to 2007. The SCAQMD, along with various local, state and federal agencies, have supported development and demonstration of alternative fueled heavy-duty engine technologies, using compressed natural gas (CNG) and liquefied natural gas (LNG), and liquefied petroleum gas for applications in transit buses, school buses, and refuse collection and delivery vehicles.

Infrastructure and Fuel Production

A key element for the widespread acceptance and resulting increased use of alternative fueled vehicles is the refueling infrastructure required to support these. The refueling infrastructure for gasoline and diesel fuel is well established and accepted by the public. Alternative, clean fuels such as natural gas, alcohol-based fuels, propane, hydrogen (as mentioned previously), hydrogen-natural gas mixtures, and even electricity, are much less available or accessible. To realize the emissions reduction benefits, the alternative fuel infrastructure must be developed in tandem with the growth in alternative fueled vehicles. The objectives of the SCAQMD are to expand the infrastructure to support zero and near-zero emission vehicles through the development, demonstration and installation of alternative fuel vehicle refueling technologies.

In 2004, the SCAQMD continued to aggressively add and upgrade natural gas fueling facilities to support the need for CNG and LNG fuel by fleet operators subject to clean-fuel fleet requirements. In addition, as mentioned previously, work continues on implementing a series of hydrogen fueling sites for use by fleets demonstrating fuel cell and hydrogen ICE vehicles.

Emission Control Technology

This broad category refers to technologies that could be deployed on existing mobile sources, especially aircraft, locomotives, marine vessels, farm and construction equipment, industrial equipment, and utility and lawn-and-garden equipment. These off-road sources represent about 35 percent of the total NO_x emission inventory and 21 percent of the total VOC inventory in the Basin. Much of the equipment in this source category is either uncontrolled and unregulated, or controlled to a much lesser extent than on-road vehicles. The authority to develop and implement regulations for these off-road mobile sources lies primarily with the U.S. EPA and CARB, and to a lesser extent with the SCAQMD.

Low-emission and clean-fuel technologies that appear promising for on-road mobile sources should also be effective at reducing emissions from a number of off-road sources. Clean fuels such as natural gas, propane, hydrogen, and hydrogen-natural gas mixtures may provide an effective option to reduce emissions from some off-road applications. Reformulated gasoline and diesel fuels in conjunction with advanced emissions controls and new engine technologies also show promise. The U.S. EPA and the SCAQMD, for example, have promulgated regulations that lower the sulfur content of diesel fuels in the future. Immediate benefits are also possible from particulate traps, fuel additives, and emulsified fuels that have been developed for diesel applications.

Electric and Hybrid Vehicle Technology

Electric Vehicles are powered by an electric motor instead of an ICE. The electrical energy is supplied from an onboard energy storage device such as a battery. Hybrid electric vehicles (HEVs) add an engine-alternator system with fuel storage for onboard recharging of the batteries to extend vehicle range, increase fuel efficiency, and minimize emissions compared to conventional vehicles. In HEVs, the engine is typically small and may be powered by gasoline, natural gas, or fuel cells. Both EVs and HEVs are usually equipped with regenerative braking that reverses the field of the electric motor during vehicle braking so that it functions as a generator to recharge the batteries and extend vehicle range.

The AQMP projects the need for significant penetration of zero and near-zero emission technologies, including EVs and HEVs, in the Basin to achieve state and federal clean air standards. Although automobile original equipment manufacturers (OEMs) are introducing HEVs such as the Prius (Toyota) and the Civic (Honda), there remains a need to support advancement of technologies to improve marketability and expedite their implementation, especially in the heavy-duty sector. For example, hybrid technologies using hydraulics (compressed gas) to assist in acceleration are being considered for heavy-duty applications, which may provide significant emissions reductions and fuel savings. The SCAQMD continues to support projects to develop and demonstrate such advancements in electric drive trains, energy storage devices, and related components.

Stationary Clean Fuel Technology

Given the limited funding available to support low emission stationary source technology development, this technical area has historically been limited in scope. To gain the maximum air quality benefits in this category, higher-polluting fossil fuel-fired electric power generation needs to be replaced with clean renewable energy resources or other advanced zero emission technologies, such as solar, wind, geo-thermal energy, and bio-mass conversion.

Although combustion sources are lumped together as stationary, the design and operating principles vary significantly. Included in the stationary category are boilers, heaters, gas turbines, and reciprocating engines. Boilers and heaters vary in size, heat input, process conditions, and operating ranges. Gas turbines vary greatly in size and application and are typically natural gas fired with add-on controls to clean up the flue gas. Stationary ICEs can be either rich-burn or lean-burn. The core technologies for this category focus on using advanced combustion processes, development of catalytic add-on controls, and alternative fuels and technologies.

VOC and Air Toxics Control Technologies

As seen from Figure 1, 40 percent of the VOC inventory comes from consumer products, cleaning and surface coating, solvent evaporation, industrial processes, and miscellaneous processes. Due to the large contribution of emissions from this sector, the Technology Advanced Office works closely with the Planning and Rule Development division at the SCAQMD to focus research efforts on developing low VOC coatings, paints, and processes. However, as with the Stationary Clean Fuel Technology category above, the funding for these types of efforts is limited.

Air toxics, on the other hand, are intimately tied to mobile sources and particulate emissions, specifically in diesel exhaust. As a result, this category includes projects in support of monitoring and analyses associated with the MATES III study.

PROGRAM IMPACT

Expected Benefits of the Clean Fuels Program

To reap the maximum emissions benefits from any technology, widespread deployment, and thus end-user acceptance, must occur. The product manufacturers must overcome technical and market barriers to ensure a competitive and sustainable business. Unfortunately, the time can be long and the costs high to address these technical and market barriers, discouraging both manufacturers and end-users from considering advanced technologies. A combination of real-world demonstrations, education, outreach, and regulatory impetus and incentives are necessary to catalyze new, clean technologies. The Clean Fuels Program addresses several of these aspects by co-funding research, development, demonstration, and deployment projects to share the risk of emerging technologies.

Figure 2 provides a conceptual diagram of the wide scope of the Clean Fuels Program. As mentioned in the *Core Technologies* section, various “stages” of technology projects are funded not only to provide a variety of emissions benefit payback timing, but also to proliferate technology choices.

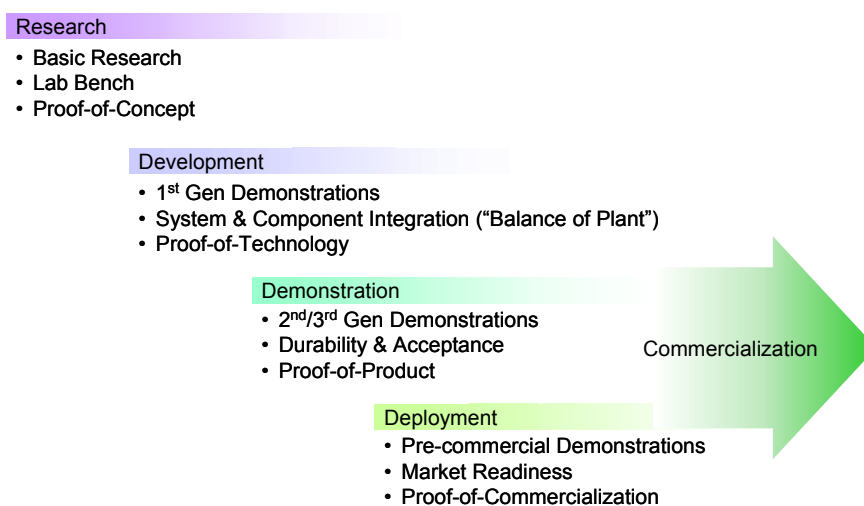

Figure 2: Clean Fuels Program Project Types

Due to the nature of these advanced technology research, development, demonstration, and deployment projects, the benefits are difficult to quantify since their full emission reduction potential may not be realized until sometime in the future, or perhaps not at all. However, a good indication of the impact and benefits of the Clean Fuels Program overall is provided by a brief list of sponsored projects which have resulted in commercialized products or helped to advance the state-of-the-technology:

- CNG Engine Development for Heavy-Duty Vehicles
 - Cummins: B5.9G (CNG), B5.9LPG (LPG), L10
 - Detroit Diesel: Series 60G (CNG/LNG), Series 50G (CNG/LNG)
 - John Deere: 6068 (CNG), 6081 (CNG)
 - Mack: E7-400G (LNG)
 - Clean Air Partners/Power Systems (Caterpillar): 3126B (Dual Fuel), C-10 (Dual Fuel), C-12 (Dual Fuel)

- Fuel Cell Bus Development and Demonstrations
 - First Ballard Fuel Cell Bus
 - ISE/ThunderPower Fuel Cell Bus
- Electric and Hybrid Electric Vehicle Development and Demonstrations
 - EPRI hybrid vehicle evaluation study
 - Hybrid electric vehicle demonstrations with SCE, UC Davis, and AC Propulsion
 - Electric vehicle demonstrations with Santa Barbara Bus Works, Toyota, and GM
- After-treatment Technologies for Heavy-Duty Vehicles
 - Johnson Matthey and Englehard trap demonstrations on buses and construction equipment
 - Lubrizol optimization and demonstration of oxidation catalysts on CNG, heavy-duty vehicles

The benefits of these technologies, however, could not have been achieved unless all stakeholders (i.e., manufacturer, end-users, and government) collectively worked to overcome the technology, market, and project-specific barriers encountered at every stage of the research, development, demonstration, and deployment process.

Overcoming Barriers

Commercialization and implementation of advanced technologies come with several real-world challenges and barriers. These include project-specific issues as well as general technology concerns.

Project-Specific Issues

- Identifying a committed demonstration site
- Overall project cost and cost-share using public monies
- Securing the fuel
- Identifying and resolving any safety issues
- Quantifying the actual emissions benefits
- Viability of Company

Technology Implementation Issues

- Viable commercialization path
- Technology price/performance parity with conventional technology
- Consumer acceptance
- Fuel availability/convenience issues
- Certification, safety, and regulatory barriers
- Quantifying emissions benefits
- Sustainability of market and technology

In order to address these barriers, the SCAQMD seeks to establish relationships with the stakeholders through unique public-private partnerships involving industry, end-users, and other government agencies. The following two subsections broadly address the SCAQMD's impact and benefits by describing specific examples of accomplishments and commercial—or near-commercial—products supported by the Clean Fuels Program in CY 2004. Such examples are provided in the following sections on Technology Advancement's Research, Development, and Demonstration projects and Technology Deployment and Commercialization efforts.

Research, Development, and Demonstration (RD&D)

The development of advanced technology faces increasing challenges in these times of reduced research budgets, infrastructure and energy uncertainties, sensitivity to multi-media environmental impacts, and the need to find balance between environmental and economic needs. Partnerships that involve all the key stakeholders have become essential to address these challenges in bringing advanced technologies from development to commercialization.

Each of these stakeholders and partners contributes more than just funding. Industry, for example, can contribute technology production expertise as well as the experience required for compatibility with process operations. Academic and research institutions bring state-of-the-technology knowledge and testing proficiency. Governmental and regulatory agencies can provide guidance in identifying sources with the greatest potential for emissions reduction, assistance in permitting and compliance issues, coordination of infrastructure needs, and facilitation of standards setting and educational outreach. There is also synergy in developing technologies that address multiple goals of public and private bodies regarding the environment, energy, and transportation.

The SCAQMD actively seeks additional partners for the program through participation in various working groups, committees, and task forces. This participation has resulted in coordinating the SCAQMD program with a number of state and federal government organizations, including CARB, CEC, U.S. EPA, and U.S. DOE and several of its national laboratories. Additionally, this list includes the AB 2766 Discretionary Fund Program administered by the Mobile Source Air Pollution Reduction Review Committee (MSRC), various local air districts, National Association of Fleet Administrators (NAFA), major local transit districts, and local gas and electric utilities. The list of organizations with which the SCAQMD coordinates research and development activities also includes the organizations specified in H&SC Section 40448.5.1(a)(2).

In addition, the SCAQMD holds periodic meetings with several organizations specifically to review and coordinate program and project plans. For example, the SCAQMD staff formally meets with CARB staff to review research and development plans, discuss project areas of mutual interest, avoid duplicative efforts, and identify potential opportunities for cost sharing. Periodic meetings are also held with industry-oriented research and development organizations, such as the Manufacturers of Emission Controls Association (MECA), California Fuel Cell Partnership, the California Stationary Fuel Cell Collaborative, and the California Natural Gas Vehicle Partnership.

The coordination efforts with these various funding organizations have resulted in a number of cosponsored projects. The descriptions of the projects awarded in CY 2004 are provided in the next section of this report. It is noteworthy that most of the projects are cosponsored by various funding organizations and include the active involvement of manufacturers. Such partnerships are essential to address commercialization barriers and help expedite the implementation of advanced low-emission technologies. Listed in Table 1 are the funding agency partners and major manufacturers actively involved in SCAQMD projects for this reporting period. It is important to note that, although not listed, there are many other technology developers, smaller manufacturers, and project participants who make important contributions critical to the success of the SCAQMD program. These partners are identified in the more detailed *Project Summaries* section.

Table 1: SCAQMD Funding Partners in CY 2004

Research Funding Organizations	Major Manufacturers/Providers
California Air Resources Board	Air Products
California Energy Commission	BAF Technologies
California Public Utilities Commission	Clean Energy Fuels Corp.
Natl. Inst. of Environmental Health Sciences	Cummins Inc.
New York State	Fuel Cell Energy
Pacific Gas & Electric	Honda America
U.S. Army/NAC	Mack Trucks
U.S. Department of Energy	Plug Power
U.S. Federal Highways Agency	Quantum Technologies
	Texaco Ovonics Hydrogen Systems
	Waste Management
	Westport Research

Important examples of the impact of SCAQMD research and development coordination efforts are: a) the continued focus of heavy-duty engine manufacturers and end-users on low-emission alternative fuel engines and b) the further expansion of the hydrogen refueling infrastructure.

Advanced Diesel Engines

The SCAQMD and others have long supported the development and demonstration of natural gas heavy-duty engine technology as the cleanest current alternative to higher-emitting diesel vehicles. In 2004, however, the Governing Board, in acknowledgement of the strides being made to reduce diesel engine emissions, awarded two contracts to accelerate the development of the cleanest diesel engines by meeting the 2010 federal on-road heavy-duty emissions standards prior to 2010. One award was made to Cummins, Inc. to develop an engine utilizing heavy exhaust gas recirculation (EGR), a NOx adsorber, and a PM trap, and the other award was made to West Virginia University and Mack Trucks to develop an engine utilizing heavy EGR, selective catalytic reduction, and a PM trap. Both projects are targeting the 0.2 g/bhp-hr NOx level required to meet the 2010 heavy-duty emission standards. Due to the potentially large impact of these projects on vehicles not only in California but also the nation, the SCAQMD has garnered the participation and co-funding of the U.S. Department of Energy (on the Cummins project) and CARB (on the West Virginia University/Mack project).

Expansion of the Hydrogen Refueling Infrastructure

As part of a larger effort to bring hydrogen vehicles into commercial fruition, the SCAQMD initiated the development of a hydrogen refueling infrastructure for the South Coast Air Basin in 2001. This effort began with initial planning and evaluation of the feasibility of constructing hydrogen refueling stations in the Basin. This was followed by SCAQMD Governing Board awards to move forward with the construction of five refueling stations located throughout the Basin: one at LAX, two in Orange County; one in Long Beach; and one in the Coachella Valley. In 2004, the SCAQMD

Governing Board approved the expansion the network with five additional refueling stations at Burbank, Ontario, Riverside, Santa Ana, and Santa Monica as part of a refueling station and hydrogen ICE vehicle demonstration program. Over the next several years, the SCAQMD will seek additional funding to strategically locate hydrogen fueling stations across the Basin in order to sustain a modest number of hydrogen and fuel cell vehicles for pre-commercial demonstration purposes. As part of this effort, various means of supplying hydrogen fuel are being evaluated including methane reforming, hydrolysis, and remote transport. The SCAQMD believes that this early expansion will provide the momentum for vehicle manufacturers to continue their research and development of hydrogen and fuel cell vehicles.



Figure 3: SCAQMD Hydrogen Station Demonstrations

In 2004, the U.S. DOE announced five large program awards to energy providers and major automobile manufacturers to demonstrate fuel cell vehicle and hydrogen fueling stations in tandem. Also in 2004, Governor Schwarzenegger signed Executive Order S-7-04, which established the California Hydrogen Highway Network effort. The SCAQMD will continue working closely with the Governor's team and the DOE to ensure that Southern California hydrogen fueling efforts leverage the state and federal programs.

Technology Deployment and Commercialization

It is the specific function of the Clean Fuels Program to help expedite the deployment and commercialization of low- and zero-emission technologies and fuels needed to meet the requirements of the AQMP control measures. This is accomplished through a unique public-private partnership where the risks and costs of developing and demonstrating promising technologies and clean-burning fuels are shared with industry. When such projects are completed, an assessment is performed to determine the feasibility of incorporating the technology into rule development. If the technology appears feasible, future rule development is recommended to realize the emission reductions associated with the corresponding long-term measure. Thus, the advanced technology projects funded are an important and necessary process towards implementation of the clean air goals of the SCAQMD.

The following describes two projects which demonstrate the impact of the SCAQMD program on technology deployment and commercialization during the CY 2004 reporting period.

Natural Gas Fueling Infrastructure

The development and demonstration of low-emission medium- and heavy-duty engines has been a priority of the SCAQMD Clean Fuels Program since its inception. These engines are used in

numerous commercial activities including local pick-up and delivery trucks, heavy-duty truck tractors for pulling trailers and shipping containers both in the Basin and for long-haul, school buses, transit buses, shuttle buses, yard tractors at shipping points, and dockside equipment at the ports. In order to fully commercialize these technologies, the fueling infrastructure must be present to support these applications. As a result, the SCAQMD continues to co-fund CNG and LNG fueling stations to support local fleet operations. To date, there are over 130 natural gas refueling stations in the Basin, some which have been recipients of Clean Fuels Program awards, demonstrating near-commercial success in the heavy-duty niche markets.

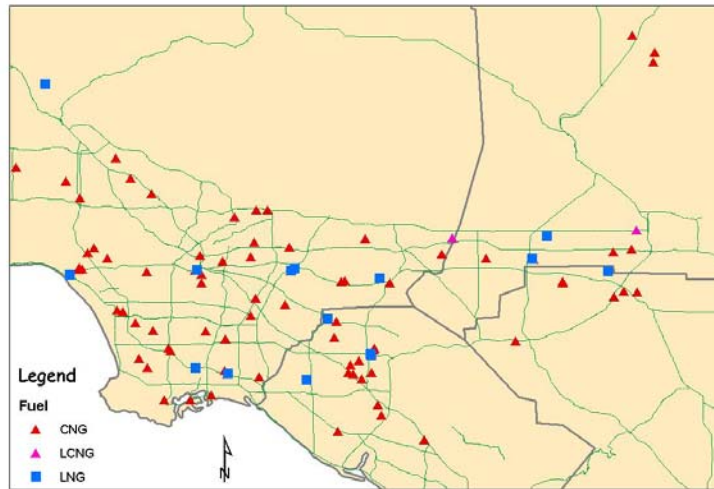

Figure 4: Natural Gas Refueling Infrastructure

Stationary Fuel Cells

The SCAQMD is part of the California Stationary Fuel Cell Collaborative, which is a government-industry consortium with goals of promoting stationary fuel cell commercialization to reduce pollutants and greenhouse gas emissions while improving efficiency and energy diversity. The main hurdle associated with stationary fuel cells has been reducing the cost of the units to a competitive level with other distributed generation (DG) technologies, e.g., microturbines, gas turbines, or ICE generators. Fuel cell manufacturers have argued that an increase in sales volume will reduce the capital cost of the systems. Until these volumes have increased sufficiently, incentives or rebates are needed to provide data and experience to demonstrate reliable, cost-effective scenarios to satisfy potential early adopters. The SCAQMD has provided this assistance for two stationary fuel cell projects in 2004, with Governing Board awards to Alliance Power and Plug Power. The Alliance Power project will install two 250kW molten carbonate Fuel Cell Energy units at a metal casting plant, located in a disproportionately impacted environmental justice area. The combined heat and power from these fuel cell units will be utilized in the industrial process to demonstrate not only the emissions benefits, but also the economic benefits of fuel cells in this type of application. The second award is to Plug Power to deploy three 5 kW proton exchange membrane units in an “as-built,” business park environment. The information collected from this project is expected to help further the utilization of fuel cells in retrofit, appliance-type applications, which could lead to displacing central plant, hot water boilers and their emissions.

2004 PROJECT EXPENDITURES

The SCAQMD Clean Fuels Program follows a “technology-driven” approach, supporting clean fuels and technologies that appear to offer the most promise in reducing emissions, promoting energy diversity, and, in the long term, providing cost-effective alternatives to current technologies. In order to address the wide variety of pollution sources in the Basin and the need for reductions now and in the future, the SCAQMD seeks to fund a wide variety of projects to establish a “diversified” technology portfolio to proliferate choices with the potential for different commercial maturity timing. Given the evolving nature of technology and changing market conditions, such a representation is only a “snapshot-in-time,” as reflected by the projects approved by the Governing Board.

As projects are approved by the Governing Board and executed into contracts every month, the finances necessarily change to reflect these projects. As such, the following represents the status of the Clean Fuels Fund as of December 31, 2004.

Financial Summary

The SCAQMD continued its successful leveraging of public funds with outside investment to support the development of advanced clean air technologies. During the period January 1, 2004 through December 31, 2004, the SCAQMD Governing Board approved 63 projects, studies or amended contracts that support clean fuels (excluding incentive projects), as shown in Table 2. The major areas of focus were: fuel cell technology, engine technology, hydrogen technology and infrastructure, electric and hybrid technologies, infrastructure and fuel production, emission studies, emission control technology, health effects studies, outreach and technology transfer, VOC and air toxics control technologies, and stationary clean fuel technology. These projects are summarized in Table 2, and the distribution of funds based on technology area is shown graphically in Figure 5, not including de-obligated funds totaling \$1,728,289. It is anticipated that the de-obligated funds will be re-committed in 2005.

Project expenditures for research, development, and demonstration (RD&D) projects that were approved or amended with dollars for the 2004 reporting period (excluding incentives and de-obligated funds) were:

Total Cost of Clean Fuels Projects	\$ 43,847,627
SCAQMD Clean Fuels Fund Contribution	15,177,440

Each year, the Governing Board approves funds to be transferred to the General Fund Budget for Clean Fuels administration. For 2004, the Board transferred \$450,000 for workshops, conferences and co-sponsorships as well as program operating costs, such as postage, supplies, and travel costs for special conferences. Only the funds committed by December 31, 2004, are included within this report. Any portion of the Clean Fuels Funds not spent during 2004 was returned to the Clean Fuels Fund.

Partially included with the SCAQMD contribution are supplemental sponsorship revenues from various organizations that supported these technology advancement projects. This supplemental revenue is listed in Table 3. Appendix B lists all Clean Fuels Fund contracts that were open and active as of January 1, 2005.

For Clean Fuels projects approved by the Governing Board in 2004, the average SCAQMD contribution was 35 percent of the total cost of the projects, identifying that each dollar from the

SCAQMD was leveraged with more than three dollars of outside investment. The historical average for leveraging dollars has been four to one.

In 2004, the SCAQMD also reallocated Clean Fuels funds to meet a portion of the local matching requirement for the Carl Moyer Program (CMP). These funds were originally designated in prior years but were reallocated because the projects were not realized or the companies returned the funding. Specifically, the Board re-approved local matching dollars of more than \$1.7 million with total project costs of more than \$101 million to fulfill requirements under the Carl Moyer Program for FYs prior to 2001-02. These local matching dollars are reflected in Table 2, "Incentive Programs - Alternative Fuels."

During 2004, the SCAQMD Governing Board approved expenditures of more than \$15.2 million for Clean Fuels projects. The distribution of funds for Board-approved projects is shown in Figure 5 below (excluding incentives and de-obligated funds).

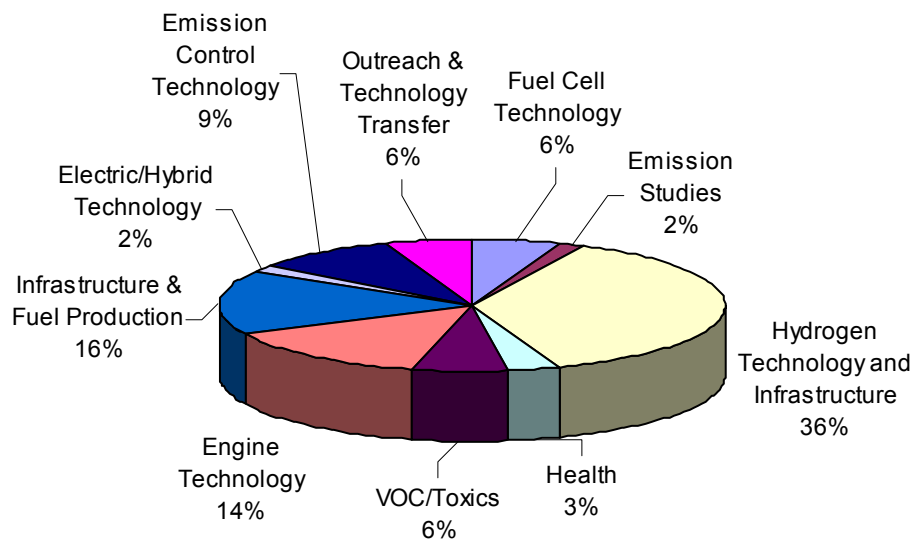

Figure 5. Distribution of Funds for Governing Board Approved Clean Fuels Projects Calendar Year 2004 (\$15.2 million)

Review of Audit Findings

State law requires the SCAQMD to undergo a standard, annual financial audit after the closing of each fiscal year. The financial audit is conducted by an independent accounting firm selected through a competitive bid process. For the fiscal year ended June 30, 2004, the firm of Simpson & Simpson conducted the financial audit. As a result of this financial audit, a Comprehensive Annual Financial Report (CAFR) was issued. The CAFR noted there were no adverse internal control weaknesses with regard to SCAQMD financial statements, which include the Clean Fuels Program revenue and expenditures. Simpson & Simpson gave the SCAQMD an "unqualified opinion," which is the highest financial rating obtainable. Notably, the SCAQMD has achieved this rating on all prior annual financial audits.

Table 2: Clean Fuels Awards Made by the Governing Board in CY 2004

Contract	Contractor	Project Title	Start Term	End Term	AQMD \$	Project Total \$
Incentive Programs - Alternative Fuels						
04167	Foothill Transit	Purchase 75 New CNG Transit Buses	TBD	TBD	\$727,000	\$25,620,675
04169	Santa Monica–Big Blue Bus	Purchase 52 New LNG Transit Buses	08/04/04	09/30/10	407,732	19,374,212
04171	Santa Clarita Transit	Purchase 12 New CNG Transit Buses	07/28/04	07/31/10	126,000	4,203,432
05000	Los Angeles County Metropolitan Transportation Authority	Purchase 100 New CNG Transit Buses	TBD	TBD	200,000	38,000,000
TBD	City of Monterey Park	Purchase Three New CNG Transit Buses	TBD	TBD	30,015	804,120
TBD	Long Beach Transit	Purchase 27 New Gasoline/Electric Hybrid Buses	TBD	TBD	241,868	13,501,863
Fuel Cell Technology						
04126	American Honda Company	Lease Two Honda Fuel Cell Electric Vehicles	06/22/04	07/14/06	25,980	25,980
05104	Alliance Power	Demonstrate Two Molten Carbonate Stationary Fuel Cell Systems in Fontana	TBD	TBD	565,000	4,176,325
05122	Plug Power, Inc.	Demonstrate Three Proton Exchange Membrane Stationary Fuel Cell Systems at UCI	TBD	TBD	257,500	572,604
Hydrogen Technology and Infrastructure						
98111	Thermo Power Corp.	Develop & Demonstrate Advanced Hydrogen Fuel Storage System Using Chemical Hydride Slurry System (Final Close-Out Payment from Clean Fuels Fund)	06/29/98	12/30/00	11,400	11,400
04012	Stuart Energy	Additional Co-Funding to Install & Demonstrate Electrolyzer-Based Hydrogen Refueling Station Integrated with Stationary Internal Combustion Engine Power Generation Unit	12/05/03	07/31/05	100,000	100,000
04185	Quantum Technologies	Develop & Demonstrate Hydrogen-Internal Combustion Engine Vehicles	10/18/04	08/31/10	2,530,000	4,050,780
TBD	University of California Riverside/CE-CERT	Develop Variable Gaseous Fueled Engine	TBD	TBD	30,000	178,786
TBD	Air Products and Chemicals, Inc.	Install & Demonstrate Three Electrolyzers (in Burbank, Riverside & Santa Monica) and Two Mobile Fuelers (in Santa Ana & Ontario), with One Year of Hydrogen Fuel Supply	TBD	TBD	2,982,000	2,982,000
*n/a	Praxair, Inc.	Install & Demonstrate Hydrogen Fueling Station at Ontario Hydrogen Production Facility	n/a	n/a	395,000	720,000

**Table 2: Clean Fuels Awards Made by the Governing Board in CY 2004
(Continued)**

Contract	Contractor	Project Title	Start Term	End Term	AQMD \$	Project Total \$
Engine Technology						
98120	Gas Research Institute	Develop Enhanced Efficiency Natural Gas Engines (Final Close-Out Payment from Clean Fuels Fund)	06/28/98	04/30/00	\$100,000	\$100,000
00170	Southern California Gas Company	Demonstrate Increased Horsepower Natural Gas Engine in On-Road Delivery Trucks (Final Close-Out Payment from Clean Fuels Fund)	10/20/00	03/01/02	55,800	55,800
05110	Westport Research, Inc.	Develop & Demonstrate Heavy, Heavy-Duty Natural Gas Engine for Class 8 Trucks	TBD	TBD	1,944,911	5,583,426
Infrastructure and Fuel Production						
02074	Clean Energy	Reduce 7/20/01 Award to Purchase & Install Natural Gas Refueling Stations to Remove 1 of 2 Stations	10/10/01	12/31/07	-106,450	0
02113	Gas Research Institute	Canceled Contract & De-Obligated 11/17/01 Award to Enhance and Upgrade L/CNG Fueling Station	n/a	n/a	-35,000	0
02157	Clean Energy	Reduce 08/17/01 Award to Upgrade Existing CNG Fueling Stations to Remove 3 of 17 Stations	01/17/02	02/28/06	-150,251	0
05109	Orange County Sanitation District	Purchase & Install New Dispenser & Credit Card Payment System in Fountain Valley	TBD	TBD	24,000	80,000
TBD	Sysco Food Services of Los Angeles, Inc.	Purchase & Install LNG Fueling System in City of Walnut	TBD	TBD	250,000	1,102,476
TBD	Burrtec, Inc.	Purchase & Install LNG Fueling Station in Santa Clarita	TBD	TBD	188,000	627,141
TBD	Clean Energy	Purchase & Install New Public Access CNG Fueling Station at Foothill Transit in Pomona	TBD	TBD	114,000	783,667
TBD	Clean Energy	Purchase & Install New Public Access CNG Fueling Station in Mission Viejo	TBD	TBD	250,000	842,050
TBD	Clean Energy	Upgrade Existing CNG Fueling Station at SoCalGas Facility in Santa Monica	TBD	TBD	190,000	634,500
TBD	Clean Energy	Purchase & Install New Public Access CNG Fueling Station at SoCalGas Facility in Canoga Park	TBD	TBD	250,000	842,050
TBD	R.F. Dickson Co., Inc.	Upgrade Existing CNG Station in Bellflower	TBD	TBD	211,148	893,828
TBD	Downs Commercial Fueling	Purchase & Install New L/CNG Fueling System in Temecula	TBD	TBD	203,137	1,033,137
TBD	Clean Energy	Upgrade Existing LNG Facility to L/CNG Fueling Station at Riverside County Waste Management Dept's Agua Mansa Facility in Riverside	TBD	TBD	120,000	400,000
TBD	Consolidated Disposal Service	Purchase & Install New LNG Fueling System in Long Beach	TBD	TBD	222,038	740,127

**Table 2: Clean Fuels Awards Made by the Governing Board in CY 2004
(Continued)**

Contract	Contractor	Project Title	Start Term	End Term	AQMD \$	Project Total \$
Infrastructure and Fuel Production (cont'd)						
TBD	Gas Equipment Systems, Inc.	Purchase & Install New CNG Fueling System at L.A. County Dept. of Beaches & Harbors Facility in Malibu	TBD	TBD	\$150,000	\$525,000
TBD	Gas Equipment Systems, Inc.	Purchase & Install New CNG Fueling System in at L.A. County Dept. of Beaches & Harbors Facility in Zuma Beach	TBD	TBD	150,000	525,000
TBD	Gas Equipment Systems, Inc.	Purchase & Install New CNG Fueling System at City of San Fernando Public Works Dept. Yard	TBD	TBD	73,200	405,000
n/a	Praxair, Inc.	De-Obligate 04/04/03 Award to Purchase & Install LNG Production Facility in Sun Valley	n/a	n/a	-750,000	0
n/a	Cryogenic Equipment Services	De-Obligate 04/04/03 Award to Purchase & Install LNG Production Facility at SoCalGas CNG Station Site	n/a	n/a	-137,264	0
n/a	SunLine Services Group	De-Obligate 04/04/03 Award to Purchase & Install LNG Production Facility in Thousand Palms	n/a	n/a	-549,054	0
Electric/Hybrid Technologies						
05003	Calstart	Develop & Demonstrate Hydraulic-Hybrid System for Heavy-Duty Vehicles	01/13/05	12/16/06	250,000	1,358,476
*05030	Waste Management, Inc.	Develop & Demonstrate Natural Gas Hydraulic-Hybrid System for Refuse Collection Trucks	n/a	n/a	250,000	1,539,000
Emission Control Technologies						
05067	Cummins Inc.	Demonstrate & Evaluate Performance, Durability and Emission-Reduction Potential of Advanced Diesel Emissions Control System (ADECS) for Low-Sulfur Diesel-Fueled Heavy-Duty Engines	TBD	TBD	750,000	4,450,000
TBD	West Virginia University	Demonstrate & Evaluate Performance, Durability and Emission Reduction Potential of ADECS for Low-Sulfur Diesel-Fueled Heavy-Duty Engines	TBD	TBD	350,000	750,000
TBD	BAF Technologies	Develop & Certify Retrofit System to Convert Gasoline-Powered Ford Crown Victoria & E-450 Cutaway Van to Compressed Natural Gas	TBD	TBD	300,000	1,227,660
Emission Studies						
05069	Automotive Testing and Development Services, Inc	Perform Evaporative Emission Testing on Gasoline Heavy-Duty Hybrid-Electric Bus	TBD	TBD	260,000	260,000

**Table 2: Clean Fuels Awards Made by the Governing Board in CY 2004
(Continued)**

Contract	Contractor	Project Title	Start Term	End Term	AQMD \$	Project Total \$
Health Impacts Studies						
05037	California Air Resources Board	Co-Fund Ultrafine Particulate Matter Health Effects Study	06/28/04	10/31/07	501,814	4,392,814
n/a	Transfer from Clean Fuels	Temporary Staffing to Support MATES III Program	n/a	n/a	425,000	425,000
Request for Quotes	Transfer from Clean Fuels	Purchase Lab Supplies & Analytical Equipment to Support MATES III Program	n/a	n/a	311,150	311,150
Outreach and Technology Transfer						
02158	College of the Desert	Development of a Natural Gas School Bus Training Curriculum	11/05/02	03/31/05	6,000	6,000
04050	Breakthrough Technologies Institute, Inc	Technical Assistance for Fuel Cells	11/21/03	12/31/05	10,000	10,000
04146	Gross, Tom	Technical Assistance for Hydrogen & Fuel Cell Technologies	06/23/04	05/31/05	25,000	25,000
04168	Regulus Associates Inc.	Technical Assistance with Contract-Related Services	06/23/04	06/22/05	40,000	40,000
04183	Energy Independence Now	Co-Sponsor Energy Independence Now's 2004 Activities & Support the California Hydrogen Highway Network	06/23/04	01/31/05	50,000	105,000
05008	Bevilaqua-Knight Inc.	CY 2004 Membership & Participation in California Fuel Cell Partnership	07/07/04	07/06/05	133,800	1,960,000
05101	Calhoun, Joseph	Technical Assistance for Development, Outreach & Commercialization of Advanced, Low-Emission Light- & Heavy-Duty Vehicle Technologies and Coordination with State Agencies	01/07/05	12/31/07	40,000	40,000
05120	Clean Fuels Connection, Inc	Technical Assistance for Technology Incentive Programs to Evaluate Proposals for Compliance with New CARB Guidelines	TBD	TBD	90,000	90,000
05121	Sullivan, Cindy	Technical Assistance to Coordinate with CARB to Develop, Analyze and Implement New Incentive Program Guidelines			75,000	75,000
05123	TIAX, LLC	Technical Assistance for Development, Outreach & Commercialization of Low-Emission and Alternative Fuels Technologies and Evaluating Project Proposals for Technology Incentive Programs			90,000	90,000

**Table 2: Clean Fuels Awards Made by the Governing Board in CY 2004
(Continued)**

Contract	Contractor	Project Title	Start Term	End Term	AQMD \$	Project Total \$
Outreach and Technology Transfer (cont'd)						
05125	Breakthrough Technologies Institute, Inc	Technical Assistance for Development, Outreach & Commercialization of Fuel Cells and Technical Coordination with Federal Energy & Transportation Departments	TBD	TBD	40,000	40,000
05126	St. Croix Research	Technical Assistance for Development, Outreach & Commercialization of LNG, CNG and Hydrogen Fuels	TBD	TBD	25,000	25,000
05127	Protium Energy Technologies	Technical Assistance for Development, Outreach & Commercialization of Hydrogen & Fuel Cell Technologies	TBD	TBD	40,000	40,000
05128	Mid-Atlantic Research Institute, LLC	Technical Assistance for Development, Outreach & Commercialization of Advanced Heavy-Duty & Off-Road Technologies	TBD	TBD	40,000	40,000
n/a	Fund Transfer from Clean Fuels	Two-Year Participation in the Natural Gas Vehicle Partnership	n/a	n/a	25,000	275,000
Various	Various Contractors	Co-Sponsorships of Conferences, Workshops and Events	Varies	Varies	121,112	360,000

*These two projects have been withdrawn by the proposer; therefore, the funding is not included in overall figures/charts.

Table 3: Supplemental Grants & Revenues Received in CY 2004

Revenue Agreement	Revenue Source	Project Title	Contractor	SCAQMD Project	Total
Grant	Dept. of Defense, National Automotive Center	Develop Five Additional Hydrogen-Internal Combustion Engine Vehicles	Quantum Technologies	Contract #04185	\$500,000
Interagency Agreement	California Air Resources Board	Demonstrate & Evaluate Performance, Durability and Emission-Reduction Potential of ADECS for Low-Sulfur Diesel-Fueled Heavy-Duty Engines	Cummins Inc.	Contract #05067	\$50,000
Interagency Agreement	California Air Resources Board	Demonstrate & Evaluate Performance, Durability and Emission-Reduction Potential of ADECS for Low-Sulfur Diesel-Fueled Heavy-Duty Engines	West Virginia University	Contract #TBD	\$50,000
Direct	DOE Clean Cities Award	Install & Demonstrate One Electrolyzer for City of Santa Monica and One Mobile Fueler and One Year of Fuel for City of Ontario	Air Products and Chemicals, Inc.	Contract #TBD	\$237,939
Direct	Sponsor/Exhibitor/Attendee Registrations	Hydrogen: Fueling the Clean Air Future Conference	n/a	Fund #26	\$78,150

Project Summaries

The following presents the summaries of the technology development and demonstration projects and studies awarded in 2004. These new and amended projects are listed in the order found in Table 2, by category and contract number (where applicable). The summaries provide the project title, contractors and subcontractors, SCAQMD cost-share, co-sponsors and their respective contributions, contract term, and a description of the projects as required by H&SC Section 40448.5.1 (d).

Incentive Programs-Alternative Fuels

04167: Purchase 75 New CNG Transit Buses

Contractor: Foothill Transit	SCAQMD Cost-share: \$	727,000
	Cosponsor:	
	Federal Transit Administration	24,893,675
Term: TBD - TBD	Total Cost: \$	25,620,675

This project is for the purchase and operation of 75 new CNG Transit Buses. Funding is for the differential cost between a new diesel bus and new CNG fueled buses minus the 80 percent portion of the purchased funded by the Federal Transit Agency.

04169: Purchase 52 New LNG Transit Buses

Contractor: Santa Monica-Big Blue Bus	SCAQMD Cost-share: \$	407,732
	Cosponsor:	
	Federal Transit Administration	18,966,480
Term: 08/04/04 – 09/30/10	Total Cost: \$	19,374,212

This project is for the purchase and operation of 52 new LNG Transit Buses. Funding is for the differential cost between a new diesel bus and new LNG fueled buses minus the 80 percent portion of the purchased funded by the Federal Transit.

04171: Purchase 12 New CNG Transit Buses

Contractor: Santa Clarita Transit	SCAQMD Cost-share: \$	126,000
	Cosponsor:	
	Federal Transit Administration	4,077,432
Term: 07/28/04 – 07/31/10	Total Cost: \$	4,203,432

This project is for the purchase and operation of 12 new CNG Transit Buses. Funding is for the differential cost between a new diesel bus and new CNG fueled buses minus the 80 percent portion of the purchased funded by the Federal Transit Agency.

05000: Purchase 100 New CNG Transit Buses

Contractor:	Los Angeles County Metropolitan Transportation Authority	SCAQMD Cost-share:	\$ 200,000
		Cosponsor:	
		Federal Transit Administration	37,800,000
Term:	TBD - TBD	Total Cost:	\$ 38,000,000

This project is for the purchase and operation of 100 new CNG Transit Buses. Funding is for the differential cost between a new diesel bus and new CNG fueled buses minus the 80 percent portion of the purchased funded by the Federal Transit Agency.

TBD: Purchase Three New CNG Transit Buses

Contractor:	City of Monterey Park	SCAQMD Cost-share:	\$ 30,015
		Cosponsor:	
		Federal Transit Administration	774,105
Term:	TBD - TBD	Total Cost:	\$ 804,120

This project is for the purchase and operation of 3 new CNG Transit Buses. Funding is for the differential cost between a new diesel bus and new CNG fueled buses minus the 80 percent portion of the purchased funded by the Federal Transit Agency.

TBD: Purchase 27 New Gasoline/Electric Hybrid Buses

Contractor:	Long Beach Transit	SCAQMD Cost-share:	\$ 241,868
		Cosponsor:	
		Federal Transit Administration	13,259,995
Term:	TBD – TBD	Total Cost:	\$ 13,501,863

This project is for the purchase and operation of 27 new gasoline/electric hybrid buses. Funding is for the differential cost between a new diesel bus and new gasoline/electric hybrid buses minus the 80 percent portion of the purchased funded by the Federal Transit Agency.

Fuel Cell Technology**04126: Lease Two Honda Fuel Cell Electric Vehicles**

Contractor:	American Honda Company	SCAQMD Cost-share:	\$ 25,980
Term:	06/22/04 – 07/14/06	Total Cost:	\$ 25,980

This item is for the lease of two 2004 Honda fuel cell electric vehicles. The vehicles are for use in Technology Advancement's Alternative Vehicle Loan Program.

05104: Demonstrate Two Molten Carbonate Stationary Fuel Cell Systems in Fontana

Contractor: Alliance Power	SCAQMD Cost-Share: \$	565,000
	Cosponsors:	
	Alliance Power (In-Kind)	1,305,000
	California Cast Metal Association (In-Kind)	56,325
	Fuel Cell Energy (In-Kind)	1,000,000
	Self-Generation Incentive Program	1,250,000
Term: TBD - TBD	Total Cost: \$	4,176,325

This is one of two-part fuel cell demonstration study to promote the development, demonstration, and commercialization of near-zero technology; the second part is awarded to Plug Power (described below). Under this project, Alliance Power will install, operate, and maintain two 250kW molten carbonate fuel cell units for combined heat and power at the TST-Timco metal foundry in Fontana, California. The waste heat recovered from the fuel cell units will be used to support the smelting operation at the foundry. These units will provide near-zero emissions and high efficiency power to a real-world, industrial process in an area of environmental justice concern and to an industry sector with high emissions. In addition, this project will demonstrate the commercial viability of fuel cells in metal foundry, but more generally, it will illustrate the validity of clean, distributed generation in industrial applications.

05122: Demonstrate Three Proton Exchange Membrane Stationary Fuel Cell Systems at UCI

Contractor: Plug Power, Inc.	SCAQMD Cost-share: \$	257,500
	Cosponsors:	
	Plug Power (In-Kind)	161,567
	UCI	80,000
	LOGAN Energy	73,537
Term: TBD - TBD	Total Cost: \$	572,604

This is the second of the two-part fuel cell demonstration study to promote the development, demonstration, and commercialization of near-zero technology. Under this project, Plug Power will install, operate, and maintain three 5kW PEM fuel cell units for combined heat and power at an industrial park building next to the University of California, Irvine (UCI) in collaboration with the National Fuel Cell Research Center (NFCRC). The waste heat generated from the fuel cell units will be used to heat steam for hot-water demands in the building. These units will establish the experience and protocol necessary for integrating fuel cells in the “as built” environment will providing near-zero emissions, reliable baseload power to the building, and critical loads in the event of a grid disruption. In addition, this project is an opportunity to accelerate the cost effectiveness and technology adoption through detailed analysis of integrated fuel cell systems and demonstration of a fuel cell system integrated into commercial and residential buildings.

Hydrogen Technology and Infrastructure

98111: Develop & Demonstrate Advanced Hydrogen Fuel Storage System Using Chemical Hydride Slurry System (Final Close-Out Payment from Clean Fuels Fund)

Contractor: Thermo Power Corp. SCAQMD Cost-share: \$ 11,400

Term: 06/29/98 – 12/30/00 Total Cost: \$ 11,400

Chemical hydride slurry offers an alternative, potentially safer way to store hydrogen as well as a way to improve range in hydrogen vehicles. Hydrogen is obtained by reacting water to the pure hydride slurry stored onboard the vehicle. Slurry is converted to oxides that is then collected and recycled in an outside processing plant back to pure hydride. This project established the technical feasibility of using hydrogen from chemical hydride slurry to drive vehicles. However, considerable more steps are needed before the concept reaches commercial feasibility. These include, but are not limited to, substantial reduction in system size, improvements in cost, improvement in handling of raw materials and spent products, recycling of spent product into pure hydride, etc. Currently, pure hydride is quite expensive. It is uncertain that the attempts to make the associated recycling process to achieve hydride in the purity desired would ever become cost-effective.

For this contract the final report and invoice were delayed due to circumstances beyond the contractor's control, and in the interim the contract was inadvertently closed out of the SCAQMD financial system. When the final invoice was eventually received, it was determined that a direct payment from Clean Fuels would have to be made. This required SCAQMD Board approval to expend funds in 2004.

04012: Additional Co-Funding to Install & Demonstrate Electrolyzer-Based Hydrogen Refueling Station Integrated with Stationary Internal Combustion Engine Power Generation Unit

Contractor: Stuart Energy SCAQMD Cost-share: \$ 100,000

Term: 12/05/03 – 02/02/05 Total Cost: \$ 100,000

This additional funding is to replace CEC co-funding that did not materialize. The funding will cover the costs associated with the hydrogen ICE power generation unit (genset) installation and commissioning.

04185: Develop & Demonstrate Hydrogen-Internal Combustion Engine Vehicles

Contractor: Quantum Technologies	SCAQMD Cost	\$ 2,030,000
	Cosponsors:	
	Dept. of Defense – National Automotive Center	500,000
	Quantum Technologies	535,780
	Texaco Ovonic Hydrogen Systems	360,000
	Five Cities (25 Prius Vehicles)	625,000
Term: 10/18/04 – 08/31/10	Total Cost:	\$ 4,050,780

The 2003 Update of the Technology Advancement Plan for the Clean Fuels Program includes Proposed Project 2003CFM6-3 – Develop and Demonstrate Light- and Medium-Duty Hybrid Electric Vehicles and Systems, which calls for significant emission reductions through the commercialization of alternative fuel hybrid-electric engines. Additionally, the Air Quality Management Plan has identified the use of alternative clean fuels in mobile sources as a key air quality attainment strategy. Hydrogen fuel cell vehicles are near zero-emission vehicles but currently have limited availability, high costs, and short warranty periods. Hydrogen-fueled internal combustion engine (ICE) vehicles show promise as a bridge technology between fuel cell vehicles and conventional vehicles and have the potential to significantly reduce VOC, NOx, CO and air toxic emissions as well as greenhouse gas emissions. Furthermore, hydrogen-fueled ICE vehicles will utilize the developing hydrogen infrastructure initiated by the SCAQMD and help to expedite the expansion of hydrogen infrastructure across the South Coast Air Basin. For this project, Quantum Technologies will convert 25 Model Year 2004 Toyota Prius gasoline hybrid-electric vehicles to operate on hydrogen fuel with an option to convert up to ten additional vehicles for an additional \$590,299. Five of the converted vehicles for the SCAQMD will be equipped with metal hydride storage. The goal of the project is to develop technology for light-duty alternative fuel vehicles, and is expected to reduce NOx, CO and PM emissions to SULEV Standards. The cities of Burbank, Ontario, Santa Monica, Riverside, and Santa Ana agreed to participate with the SCAQMD on developing infrastructure and demonstrating hydrogen ICE vehicles. Each of the five local cities and SCAQMD will each receive five of the 30 converted vehicles.

TBD: Develop Variable Gaseous Fueled Engine

Contractor: University of California Riverside/CE-CERT	SCAQMD Cost-share:	\$ 30,000
	Cosponsors:	
	University of California Riverside/CE-CERT	148,786
Term: TBD - TBD	Total Cost:	\$ 178,786

The Board has previously approved projects to develop transit buses that operate on hydrogen-CNG fuel mixtures, which have demonstrated significantly lower emissions than buses operating on CNG only. This action requests approval and award to develop a variable gaseous fueled engine for future hydrogen-natural gas blend technologies.

TBD: Install & Demonstrate Three Electrolyzers (in Santa Monica, Burbank & Riverside) and Two Mobile Fuelers (in Santa Ana & Ontario), with One Year of Hydrogen Fuel Supply

Contractor: Air Products and Chemicals, Inc.	SCAQMD Cost-share: \$	2,982,000
Term: TBD - TBD	Total Cost: \$	2,982,000

This project, called the “Five Cities” project, is designed to evaluate hydrogen internal combustion engine hydrogen-fueled vehicles at five city fleet sites. This contract is to provide hydrogen fueling stations at each of the five city sites: Santa Monica, Riverside, Burbank, Santa Ana and Ontario and to coordinate with the delivery of the converted fleet vehicles. Funding may come through from the U.S. Department of Energy and/or California Energy Commission; if so, it will be used to reimburse the SCAQMD’s expenditure from Clean Fuels.

N/A: Install & Demonstrate Hydrogen Fueling Station at Ontario Hydrogen Production Facility

Contractor: Praxair, Inc.	SCAQMD Cost-share: \$	395,000
	Cosponsor:	
	Praxair	325,000
Term: n/a	Total Cost: \$	720,000

This project has been put on hold indefinitely by Praxair. Our cost-share and the total project costs have not been included in other figures and charts referenced in the annual report.

Engine Technology

98120: Develop Enhanced Efficiency Natural Gas Engines (Final Close-Out Payment from Clean Fuels Fund)

Contractor: Gas Research Institute	SCAQMD Cost-share: \$	100,000
Term: 06/28/98 – 04/30/00	Total Cost: \$	100,000

The SCAQMD in cooperation with the U.S. DOE and Gas Research Institute (GRI) entered into a program to achieve significant energy efficiency enhancements in heavy-duty natural-gas engines while retaining low emissions characteristics. Under separate subcontracts, GRI developed enhanced, high-efficiency natural gas engines for Cummins Engine Company, John Deere Power Systems, and Mack Truck Company. Efficiency enhancements for heavy-duty natural gas engines generally involve improving combustion and air handling (“breathing”) within the engine. For each participating manufacturer, technologies were identified and investigated that are specific to that manufacturer’s natural gas engines (250 horsepower or greater).

For this contract the final report and invoice were delayed due to circumstances beyond the contractor’s control, and in the interim the contract was inadvertently closed out of the SCAQMD financial system. When the final invoice was eventually received, it was determined that a direct payment from Clean Fuels would have to be made. This required SCAQMD Board approval to expend funds in 2004.

00170: Demonstrate Increased Horsepower Natural Gas Engine in On-Road Delivery Trucks (Final Close-Out Payment from Clean Fuels Fund)

Contractor: Southern California Gas Company	SCAQMD Cost-share: \$	55,800
Term: 10/20/00 – 03/01/02	Total Cost: \$	55,800

Cummins developed a higher-horsepower (280 hp), higher-torque (850 ft-lb) version of the C8.3G engine in order to meet medium, heavy-duty trucking applications. This new engine is now called the C Gas Plus engine. Southern California Gas Company proposed to demonstrate this higher-horsepower Cummins engine in trucks operated by Viking Freight Incorporated in Whittier. Cummins provided the two pre-production engines. These engines along with CNG fuel systems were installed into two Viking trucks by NGV Ecotrans in Los Angeles. These replaced the existing diesel engines. The CNG trucks were then demonstrated in normal freight pick-up and delivery in southern California.

The emission testing yielded substantial reductions with the natural gas trucks. NOx emissions were 27-45 percent lower than the diesel trucks while PM and CO were 92-94 percent and 48-95 percent lower, respectively. Only the hydrocarbons (Total versus Non-) did not show a clear benefit (58 percent increase and 19 percent reduction).

For this contract the final report and invoice were delayed due to circumstances beyond the contractor’s control, and in the interim the contract was inadvertently closed out of the SCAQMD financial system. When the final invoice was eventually received, it was determined that a direct payment from Clean Fuels would have to be made. This required SCAQMD Board approval to expend funds in 2004.

05110: Develop & Demonstrate Heavy, Heavy-Duty Natural Gas Engine for Class 8 Trucks

Contractor: Westport Research, Inc.	SCAQMD Cost-share: \$	1,944,911
	Cosponsors:	
	Westport Research, Inc. Sustainable Technology & Development	2,320,612
	DOE/NREL	1,058,803
	Pacific Gas & Electric	259,100
Term: TBD - TBD	Total Cost: \$	5,583,426

Class 8 Trucks (Heavy, Heavy-Duty), typically used for waste transfer, bulk haul, fuel delivery, and regional distribution, are some of the highest consumers of diesel fuel, and yet currently there are currently no commercially available alternative fuel engines for this class of vehicles. This action is to award a sole-source contract to Westport Research, Inc. to develop a heavy-duty natural gas engine for Class 8 vehicles that meets 2007 emission standards at a cost not to exceed \$1,944,911 from the Clean Fuels Fund. Total funding for this project is \$5,583,426. U.S. DOE and Pacific Gas and Electric are cofunding the engine development and demonstration and the engines will be demonstrated with fleets located in Canada and Northern California. Westport Research, Inc. is currently working on identifying a fleet in the Basin that could participate in this demonstration. Staff will bring a proposal for the demonstration element of this project to the Board at a later date.

Infrastructure and Fuel Production

02074: Reduce 7/20/01 Award to Purchase & Install Natural Gas Refueling Stations to Remove 1 of 2 Stations

Contractor: Clean Energy, Inc.	SCAQMD Cost-share: \$ (106,450)
Term: 10/10/01 – 12/31/07	Total Cost: 0

At its July 2001 meeting, the Board awarded \$106,450 to Clean Energy, Inc. to install a new CNG fueling station at the Administrative Services Co-Op in Gardena (a taxicab company servicing LAX). Due to contracting issues between Clean Energy, Inc. and Administrative Services Co-Op, the station was not constructed. At its August 2004 meeting, the Board de-obligated the funds associated with this station.

02112: Canceled Contract & De-Obligated 11/17/01 Award to Enhance and Upgrade L/CNG Fueling Station

Contractor: Gas Research Institute	SCAQMD Cost-share: \$ (35,000)
Term: n/a	Total Cost: 0

At its November 2000 meeting, the Board awarded \$35,000 to the Gas Research Institute (GRI) to upgrade the existing LNG station at the UPS Ontario Airport facility. GRI was unable to secure consensus and sufficient funding through the technical partner ALT-USA to perform the upgrade; hence SCAQMD funds were not utilized. At its August 2004 meeting, the Board canceled this contract and de-obligated the funds.

02157: Reduce 08/17/01 Award to Upgrade Existing CNG Fueling Stations to Remove 3 of 17 Stations

Contractor: Clean Energy, Inc.	SCAQMD Cost-share: \$ (150,251)
Term: 01/17/02 – 02/28/06	Total Cost: 0

At its August 2001 meeting, the Board awarded \$892,615 to Pickens Fuel Corporation (now Clean Energy, Inc.) to upgrade 17 existing CNG stations throughout the Basin. Three of the 17 sites, located at John Wayne Airport, the SuperShuttle headquarters in Anaheim and the Orange County Sanitation District office, did not require funding as originally proposed. A new station was constructed at John Wayne Airport, as opposed to being upgraded, and SCAQMD funding was not required. SuperShuttle moved their headquarters from the Anaheim site to a new location and installed their fueling station at their own expense. Lastly, the Orange County Sanitation District facility will be upgraded with relatively-new equipment from Clean Energy's existing City of Industry site, as that site is being claimed by the City under eminent domain. As a result, \$150,251 remains unused. At its August 2004 meeting, the Board de-obligated the funds associated with these stations.

05109: Purchase & Install New Dispenser & Credit Card Payment System in Fountain Valley

Contractor: Orange County Sanitation District	SCAQMD Cost-share: \$	24,000
	Cosponsors:	
	Orange County Sanitation District	56,000
Term: TBD - TBD	\$	80,000

This project will provide cost-share funds for an existing station to upgrade the fueling dispenser and card reader, providing a significant improvement in the station’s ability to service increasing numbers of large fleet vehicles in a timely and convenient manner. The upgrade will enhance station reliability allow public access, improve speed of service and ensure the ability of the station to operate in an efficient manner.

TBD: Purchase & Install LNG Fueling System in City of Walnut

Contractor: SYSCO Food Services of Los Angeles, Inc.	SCAQMD Cost-share: \$	250,000
	Cosponsors:	
	SYSCO	302,476
	MSRC/AB 2766 Discretionary Fund	200,000
	Carl Moyer Program	200,000
	DOE SEP Grant	150,000
Term: TBD - TBD	Total Cost: \$	1,102,476

This project will provide cost-share funding for a new publicly accessible LNG station at 20701 Currier Road, Walnut. SYSCO has undertaken an aggressive LNG project having already received partial incremental funding for the purchase of 95 new LNG trucks and this supporting infrastructure. SYSCO is working to ultimately replace its entire fleet of 216 heavy duty trucks with LNG. It will eventually be the largest single private fleet operator of over the road LNG trucks in the United States. The station will be constructed with state of the art equipment and will fill a critical gap in the existing LNG refueling infrastructure in this region. The LNG fuel dispensers will be situated to accommodate traffic flow of several different kinds of heavy-duty trucks.

TBD: Purchase & Install LNG Fueling Station in Santa Clarita

Contractor: Burrtec, Inc.	SCAQMD Cost-share: \$	188,000
	Cosponsors:	
	Burrtec, Inc.	189,141
	MSRC/AB 2766 Discretionary Fund	250,000
Term: TBD to TBD	Total Cost: \$	627,141

This project will provide cost-share funding for a new publicly accessible LNG station at 26000 Springbrook Avenue in Santa Clarita. Burrtec has recently been awarded franchise agreements by the City of Santa Clarita to collect refuse in both residential and commercial applications. Under the agreements, Burrtec is required to use only alternative fuel powered trucks. The station will be constructed with state of the art equipment and will fill a critical gap in the existing LNG refueling infrastructure in this region. The LNG fuel dispensers will be situated to accommodate traffic flow of several different kinds of heavy-duty trucks.

TBD: Purchase & Install New Public Access CNG Fueling Station at Foothill Transit in Pomona

Contractor: Clean Energy, Inc.	SCAQMD Cost-share: \$	114,000
	Cosponsor:	
	Clean Energy, Inc.	669,667
Term: TBD - TBD	Total Cost: \$	783,667

This project will provide cost-share funding for a publicly accessible CNG station in the City of Pomona next to the Foothill Transit facility. The station address is 200 S. East End Avenue, Pomona. The new station would serve as a crucial fueling stop for the growing number of fleets traveling throughout the eastern portion of Los Angeles County as well as the Inland Empire. The existing station at Foothill Transit is not accessible to outside users. The station will benefit various fleets operating in the area including Yellow Cab Co., Inland Express Shuttle, Diversified Paratransit, Pomona Unified School District and Universal Waste Systems. The station will have three compressors to insure efficient refueling of vehicles should one compressor go down, with a total capacity of 4,200 SCFM. The CNG fuel dispensers will be situated to accommodate traffic flow of several different kinds of heavy-duty trucks. A universal card reader system will be incorporated to handle fueling and billing transactions.

TBD: Purchase & Install New Public Access CNG Fueling Station in Mission Viejo

Contractor: Clean Energy, Inc.	SCAQMD Cost-share: \$	250,000
	Cosponsor:	
	Clean Energy, Inc.	592,050
Term: TBD - TBD	Total Cost: \$	842,050

This project will provide cost-share funding for a new publicly accessible CNG station at the in the City of Mission Viejo, located at 27600 Marguerite Parkway. The new station will be constructed with state of the art equipment including a dispensing system capable of accepting Visa and MasterCard transactions plus a video screen to train new CNG users. This station would serve as a crucial fueling stop for the growing number of fleets traveling throughout the southern Orange County area. The station will benefit numerous taxi and shared ride vehicles operating out of John Wayne International Airport. The station will have two compressors to insure efficient refueling of vehicles should one compressor go down, with a total capacity of 700 SCFM. The CNG fuel dispensers will be situated to accommodate traffic flow of several different kinds of heavy-duty trucks. A universal card reader system will be incorporated to handle fueling and billing transactions.

TBD: Upgrade Existing CNG Fueling Station at SoCalGas Facility in Santa Monica

Contractor: Clean Energy, Inc.	SCAQMD Cost-share: \$	190,000
	Cosponsors:	
	Clean Energy, Inc.	444,500
Term: TBD - TBD	Total Cost: \$	634,500

This project will provide cost-share funding for a publicly accessible CNG station at the Southern California Gas Company's Santa Monica Base. The project will completely upgrade first generation equipment commissioned in 1993 and would serve as a crucial fueling stop for the growing number of fleets traveling throughout the Los Angeles Basin, specifically in the west Los Angeles area. The station will benefit numerous taxi and commercial fleets operating in the area. The station will have two compressors to insure efficient refueling of vehicles should one compressor go down, with a total

capacity of 700 SCFM. The CNG fuel dispensers will be situated to accommodate traffic flow of several different kinds of heavy-duty trucks. A universal card reader system will be incorporated to handle fueling and billing transactions.

TBD: Purchase & Install New Public Access CNG Fueling Station at SoCalGas Facility in Canoga Park

Contractor: Clean Energy, Inc.	SCAQMD Cost-share: \$	250,000
	Cosponsor:	
	Clean Energy, Inc.	592,050
Term: TBD - TBD	Total Cost: \$	842,050

This project will provide cost-share funding for a publicly accessible CNG station at the Southern California Gas Company's Canoga Park Base. The new station would serve as a crucial fueling stop for the growing number of fleets traveling throughout the Los Angeles Basin, specifically in the west San Fernando Valley. The station will benefit taxi fleets operating in the area as well as commercial fleets such as Time Warner Cable. The station will have two compressors to insure that the County will always be able to refuel their vehicles should one compressor go down, with a total capacity of 700 SCFM. The CNG fuel dispensers will be situated to accommodate traffic flow of several different kinds of heavy-duty trucks. A universal card reader system will be incorporated to handle fueling and billing transactions.

TBD: Upgrade Existing CNG Station in Bellflower

Contractor: R.F. Dickson Co., Inc.	SCAQMD Cost-share: \$	211,148
	Cosponsor:	
	R.F. Dickson Co., Inc.	682,680
Term: TBD - TBD	Total Cost: \$	893,828

This project will provide a second compressor, a second fast fill fuel dispenser and three additional storage vessels at an existing fueling station, providing a significant improvement in the station's ability to service increasing numbers of large fleet vehicles in a timely and convenient manner. The upgrade will enhance reliability by providing redundancy, improve speed of service and ensure the ability of the station to operate in an efficient manner that is not intrusive to neighbors. The added storage will minimize the need to operate the compressor at night, avoiding local area complaints regarding noise.

TBD: Purchase & Install New L/CNG Fueling System in Temecula

Contractor: Downs Commercial Fueling	SCAQMD Cost-share:	\$	203,137
	Cosponsors:		
	California Energy Commission's Alternative Fuel PON		250,000
	County of Riverside		30,000
	City of Temecula		50,000
	MSRC/AB 2766 Discretionary Fund		250,000
	AES Settlement Program		250,000
Term: TBD - TBD	Total Cost:	;	1,033,137

This project will provide a publicly accessible LNG/LCNG station in southwestern Riverside County that will fuel existing natural gas vehicles operating in the area. The station acts as a gap filler in that the nearest natural gas station is 25 miles away. Numerous fueling commitments have been received including Laidlaw Transit, Riverside County, CR&R and Camp Pendleton Marine Corps Bases.

TBD: Upgrade Existing LNG Facility to L/CNG Fueling Station at Riverside County Waste Management Dept's Agua Mansa Facility in Riverside

Contractor: Clean Energy, Inc.	SCAQMD Cost-share:	\$	120,000
	Cosponsor:		
	Clean Energy, Inc.		280,000
Term: TBD - TBD	Total Cost:	\$	400,000

This project will provide cost-share funding for a new publicly accessible CNG station at an existing LNG fueling station at 1830 Aqua Mansa Road in Riverside. The station will be constructed with state of the art equipment including a dispensing system capable of accepting Visa and MasterCard transactions plus a video screen to train new CNG users. LNG is pumped to high pressure using a cryogenic pump then passed through an ambient vaporizer where it becomes a high pressure gas. From there it is stored in storage vessels. The CNG station will benefit both light and heavy duty fleets within the Inland Empire. The CNG fuel dispensers will be situated to accommodate traffic flow of several different kinds of heavy-duty trucks. A universal card reader system will be incorporated to handle fueling and billing transactions.

TBD: Purchase & Install New LNG Fueling System in Long Beach

Contractor: Consolidated Disposal Service	SCAQMD Cost-share:	\$	222,038
	Cosponsors:		
	MSRC/AB 2766 Discretionary		250,000
	Consolidated Disposal Service		268,089
Term: TBD - TBD	Total Cost:	\$	740,127

This project will provide cost-share funding for a publicly accessible LNG station at the company's transfer station in Long Beach. This planned facility will provide convenient LNG fueling access to more than 125 LNG heavy Duty Refuse trucks to be deployed at company's facility. The LNG fuel dispensers will be situated to accommodate traffic flow of several different kinds of heavy-duty trucks. A universal card reader system will be incorporated to handle fueling and billing transactions.

TBD: Purchase & Install New CNG Fueling System at L.A. County Dept. of Beaches & Harbors Facility in Malibu

Contractor: Gas Equipment Systems, Inc. (GESI)	SCAQMD Cost-share: \$ 150,000
	Cosponsor:
	GESI 375,000
Term: TBD - TBD	Total Cost: \$ 525,000

This project will provide cost-share funding for a publicly accessible CNG station at the County of Los Angeles' Department of Beaches and Harbors' Will Rogers State Beach maintenance yard. It is the County's goal to purchase additional CNG heavy Duty vehicles and fast fill them. The station will have two compressors to insure that the County will always be able to refuel their vehicles should one compressor go down. The CNG fuel dispensers will be situated to accommodate traffic flow of several different kinds of heavy-duty trucks. A universal card reader system will be incorporated to handle fueling and billing transactions.

TBD: Purchase & Install New CNG Fueling System at L.A. County Dept. of Beaches & Harbors Facility in Zuma Beach

Contractor: Gas Equipment Systems, Inc. (GESI)	SCAQMD Cost-share: \$ 150,000
	Cosponsor:
	GESU 375,000
Term: TBD - TBD	Total Cost: \$ 525,000

This project will provide cost-share funding for a publicly accessible CNG station at the County of Los Angeles' Department of Beaches and Harbors' Zuma State Beach maintenance yard. It is the County's goal to purchase additional CNG heavy Duty vehicles and fast fill them. The station will have two compressors to ensure that the County will always be able to refuel their vehicles should one compressor go down. The CNG fuel dispensers will be situated to accommodate traffic flow of several different kinds of heavy-duty trucks. A universal card reader system will be incorporated to handle fueling and billing transactions.

TBD: Purchase & Install New CNG Fueling Station at City of San Fernando Public Works Dept. Yard

Contractor: Gas Equipment Systems, Inc. (GESI)	SCAQMD Cost-share: \$ 73,200
	Cosponsor:
	GESI 285,000
	AES Settlement Fund 46,800
Term: TBD - TBD	Total Cost: \$ 405,000

This project will provide cost-share funding for a publicly accessible CNG station at the City of San Fernando. The City has embarked on an NGV program that will eventually entail the replacement of the entire fleet. The proposed CNG station is one-half mile off the 5, 210 and 118 freeways and is within three blocks of the Los Angeles County Courthouse and police facilities. The station will have two compressors to insure that the County will always be able to refuel their vehicles should one compressor go down. The CNG fuel dispensers will be situated to accommodate traffic flow of

several different kinds of heavy-duty trucks. A universal card reader system will be incorporated to handle fueling and billing transactions.

n/a: De-Obligate 04/04/03 Award to Purchase & Install LNG Production Facility

Contractor: Praxair, Inc.	SCAQMD Cost-share: \$	(750,000)
Term: n/a	Total Cost: \$	(750,000)

At its October 2002 meeting, the Board awarded \$750,000 to Praxair, Inc. to offset the costs of purchasing and installing an LNG production facility at the Wilmington air separation facility. With the possible advent of several LNG terminals being installed on the West Coast, Praxair is discontinuing the investment until such time as they can determine that the LNG terminals may not come to fruition. At its August 2004 meeting, the Board cancelled this contract and de-obligated the funds.

n/a: De-Obligate 04/04/03 Award to Purchase & Install LNG Production Facility at SoCalGas CNG Station

Contractor: Cryogenic Equipment Services	SCAQMD Cost-share: \$	(137,264)
Term: n/a	Total Cost: \$	(137,264)

At its April 2003 meeting, the Board awarded \$137,264 to CryoEquipment Services to partially offset the installation cost of a new LNG production facility. CryoEquipment Services proposed to construct the LNG production facility on Southern California Gas Company property. However, Southern California Gas Company indicated that the property proposed originally is needed for other purposes. With the possible advent of several LNG terminals being installed on the West Coast, CryoEquipment Services is discontinuing the investment until such time as they can determine that the LNG terminals may not come to fruition. At its August 2004 meeting, the Board cancelled this contract and de-obligated the funds.

n/a: De-Obligate 04/04/03 Award to Purchase & Install LNG Production Facility in Thousand Palms

Contractor: SunLine Services Group	SCAQMD Cost-share: \$	(549,054)
Term: n/a	Total Cost: \$	(549,054)

At its April 2003 meeting, the Board awarded \$549,054 to SunLine Services Group in Thousand Palms to partially offset the installation cost of a new LNG production facility. SunLine Services Group recently indicated that, given other operational priorities as well as the possible advent of several LNG terminals being installed on the West Coast, they are discontinuing the investment until such time as they can determine that the LNG terminals may not come to fruition. At its August 2004 meeting, the Board cancelled this contract and de-obligated the funds.

Electric/Hybrid Technologies

05003: Develop & Demonstrate Hydraulic-Hybrid System for Heavy-Duty Vehicles

Contractor: CALSTART	SCAQMD Cost-share: \$	250,000
	Cosponsors:	
	Dana Systems	307,220
	U.S. Army NAC	250,000
	Permo-Drive Technologies	191,256
	Waste Management	160,000
	Mack Truck	140,000
	CALSTART	35,000
	CARB	25,000
Term: 01/13/05 to 12/16/06	Total Cost: ;	1,358,476

Hybrid technologies represent a method to reduce emissions further from existing low emission engines. Hybrid technologies use combinations of energy sources to propel vehicles, generally an internal combustion engine and another source. Both Honda and Toyota have commercialized hybrid-electric passenger cars, the Hybrid Civic, the Insight and the Prius. During braking, these hybrid-electric vehicles capture energy which is normally lost as heat in conventional braking systems. When braking, these vehicles use an electric motor/alternator to slow the vehicle and generate electricity which is stored in a battery or capacitor pack. During propulsion, the stored electricity is used to power the electric motor and help propel the vehicle. Fuel economy and emissions can be improved by up to 25 percent. Wear and tear on the braking system is also reduced further lowering operating costs.

Recently, new types of non-electric, mechanical hybrid systems have been under development. One type of these is the hydraulic-hybrid system with commercial names like Hydraulic Regenerative Drive System™ and Hydraulic Launch Assist™. In this project, a special hydraulic pump is installed in the vehicle drivetrain between the transmission and driveshaft. When braking is initiated, the pump slows the vehicle through pumping hydraulic fluid and compressing gas in a pressure tank. During propulsion, the process is reversed, pressure is released, and the hydraulic pump helps propel the vehicle. As with hybrid-electric systems, microprocessors control energy collection and release based upon the vehicle's speed, brake pedal position, throttle position and other factors.

CALSTART, in association with Permo-Drive Technologies Limited and the US Army National Automotive Center, will be conducting the development and demonstration of the Permo-Drive hydraulic-hybrid technology on a refuse collection truck.

This project has been put on hold indefinitely by Praxair. SCAQMD cost-share and the total project costs have not been included in figures and pie charts referenced in the annual report.

TBD: Develop & Demonstrate Natural Gas Hydraulic-Hybrid System for Refuse Collection Trucks

Contractor: Waste Management, Inc. SCAQMD Cost-share: \$ 250,000
Cosponsors:

Term: TBD – TBD Total Cost: \$ 1,539,000

This project has been withdrawn by Waste Management. SCAQMD cost-share and the total project costs have not been included in figures and pie charts referenced in the annual report.

Emission Control Technologies

05067: Demonstrate & Evaluate Performance, Durability and Emission-Reduction Potential of Advanced Diesel Emissions Control System for Low-Sulfur Diesel-Fueled Heavy-Duty Engines

Contractor: Cummins Inc. SCAQMD Cost-share: \$ 700,000
Cosponsors:
U.S. DOE 700,000
CARB (pass-through funding) 50,000
Cummins Inc. (In-Kind) 3,000,000
Term: TBD - TBD Total Cost: \$ 4,450,000

This project is an effort to support the implementation of advanced alternative fuel technology that could potentially reduce NOx and PM emissions from diesel-powered solid waste collection vehicles to the 2010 heavy-duty engine exhaust standards of 0.20 and 0.01 g/bhp-hr, respectively. Under this project, Cummins will use a two-step strategy to achieve the federal 2010 heavy-duty NOx and PM emissions standards. The first step involves using a high capacity exhaust gas recirculation (EGR) system, a variable geometry turbocharger, high injection pressure, and a robust controls architecture to reduce base engine-out NOx and PM emissions to 1.0 g/bhp-hr or less. In the second stage, the diesel engine will be equipped with a NOx adsorber catalyst and particulate filter to further reduce NOx and PM emissions to the desired targets of 0.2 and 0.01 g/bhp-hr, respectively. Cummins will perform engine dynamometer tests over the U.S. EPA heavy-duty Federal Test Procedure (FTP) and steady-state test cycles to optimize and assess fuel consumption, gaseous emissions, and particulate matter emissions from the ISL engines, with and without the NOx and PM emission control technologies.

TBD: Demonstrate & Evaluate Performance, Durability and Emission-Reduction Potential of ADECS for Low-Sulfur Diesel-Fueled Heavy-Duty Engines

Contractor: West Virginia University	SCAQMD Cost-share: \$	300,000
	Cosponsors:	
	CARB (pass-through agreement)	50,000
	West Virginia University/MACK	400,000
Term: TBD - TBD	Total Cost: \$	750,000

This project is an effort to support the implementation of advanced alternative fuel technology that could potentially reduce NOx and PM emissions from diesel-powered solid waste collection vehicles to the 2010 heavy-duty engine exhaust standards of 0.20 and 0.01 g/bhp-hr, respectively. Under this project, West Virginia University will work with Volvo Powertrain to modify the combustion system of a Volvo MD11 diesel engine equipped with a high-pressure, external, cooled EGR system. The modifications will include changing the original EGR system to accommodate a larger volume of EGR, retrofitting the MD11 engine with a variable geometry turbocharger, and optimizing injection system parameters to yield the lowest engine-out NOx and PM emissions. The MD11 engine will then be equipped with a selective catalytic reduction (SCR) system and diesel particulate filter to further reduce NOx and PM emissions to the desired targets of 0.20 and 0.01 g/bhp-hr, respectively. West Virginia University will perform engine dynamometer tests over the U.S. EPA heavy-duty Federal Test Procedure (FTP) and steady-state test cycles to optimize and assess fuel consumption, ammonia slip, gaseous emissions, and particulate matter emissions from the MD11 engines, with and without the NOx and PM emission control technologies.

TBD: Develop & Certify Retrofit System to Convert Gasoline-Powered Ford Crown Victoria & E-450 Cutaway Van to Compressed Natural Gas

Contractor: BAF Technologies	SCAQMD Cost-share: \$	300,000
	Cosponsors:	
	Teleflex/GFI	313,800
	BAF Technologies	213,800
	New York State	300,000
	Clean Energy	100,000
Term: TBD - TBD	Total Cost: \$	1,227,600

Two major automobile manufacturers have recently ceased production of natural gas-powered vehicles. Ford announced their entire natural gas vehicle product line will be unavailable after the 2004 model-year, and General Motors announced their full size natural gas-powered vans will be similarly unavailable. To ensure the availability of rule compliant natural gas-powered vehicles after the 2004 model-year, BAF Technologies will develop and certify CARB-compliant natural gas conversion systems for the 2005 model-year Ford Crown Victoria and E-450 Cutaway Vehicles. The total cost for this project is estimated to be \$1,227,600. SCAQMD's contribution of \$300,000 to this project will be leveraged at a ratio of approximately one to four.

Emission Studies

05069: Perform Evaporative Emission Testing on Gasoline Heavy-Duty Hybrid-Electric Bus

Contractor: Automotive Testing and Development Services, Inc.	SCAQMD Cost-share: \$ 260,000
Term: TBD - TBD	Total Cost: \$ 260,000

In 2003, CARB certified the gasoline hybrid-electric drive system manufactured by ISE Research. This drive system has exhaust emissions of 0.4 g/bhp-hr NMHC+NO_x, which makes considerable progress toward meeting the future transit bus standards of 0.2 g/bhp-hr NMHC+NO_x starting in 2007. Because such drive systems use gasoline, an evaporative control system is used on each vehicle to prevent gasoline vapors in the fuel tank and other components from escaping into the atmosphere. Due to their large size, gasoline heavy-duty vehicles are not physically tested but have their evaporative control systems designed and certified using mathematical models, which are based on light-duty vehicle systems. Without direct test data to verify compliance, however, there is concern that the evaporative emissions could be higher than expected, which would negate the extremely low exhaust emissions of the heavy-duty, gasoline hybrid-electric drive system.

SCAQMD solicited a contractor to perform evaporative emission testing on a gasoline heavy-duty hybrid-electric bus, and ATDS of Ontario, CA, was selected. Under this project, ATDS will be constructing a test vehicle with the evaporative control system of the ISE Research gasoline hybrid electric bus. The test vehicle will then undergo testing to determine the adequacy of the evaporative controls. If emissions are higher than the standards, diagnosis will be undertaken, repairs performed, and testing repeated.

Health Impacts Studies

05037: Co-Fund Ultrafine Particulate Matter Health Effects Study

Contractor: California Air Resources Board	SCAQMD Cost-share: \$ 501,814
	Cosponsors:
	NIEHS \$3,300,000
	CARB (In-Kind \$416,000) \$591,000
Term: TBD - TBD	Total Cost: \$ 4,392,814

The National Institute of Environmental Health Sciences (NIEHS) is funding a major study in Southern California to study the health effects of ultrafine particulate matter in the elderly. This project is to co-fund with CARB an enhancement that improves exposure estimates of the study participants and adds a component on the potential biological mechanism whereby particulate matter produces adverse health effects.

This project will result in important information quantifying the effects of pollutant exposures in a vulnerable population. The study will address questions of which chemical or size fractions of particulate matter are most harmful, and what biological mechanisms underlie harmful effects. The results will provide data to help determine the health benefits to residents of the Basin from reducing emissions of particulates and particulate precursors.

VOC/Air Toxics Control Technologies

05060: Laboratory Services for Analysis of Naphthlene & Other Polycyclic Aromatic Hydrocarbons (PAHs) to Support Multiple Air Toxics Exposure Study (MATES-III) Program

Contractor: Southwest Research Institute	SCAQMD Cost-share: \$ 180,450
Term: TBD – 11/01/05	Total Cost: \$ 180,450

This contract is for laboratory sample preparation and analysis for naphthalene and other selected polycyclic aromatic hydrocarbons (PAHs) for the MATES-III program. Naphthalene and other selected PAHs have been found in diesel exhaust and other combustion sources and were supported to be measured as part of MATES-III program by the MATES-III Advisory Group.

Fund Transfer: Temporary Staffing to Support MATES III Program

Contractor: n/a	SCAQMD Cost-share: \$ 425,000
Term: July 1, 2004-June 30, 2005	Total Cost: \$ 425,000

This item funds the hiring of temporary staff to perform additional field and laboratory duties related to the MATES III program. Services include field instrument set-up and operation, sample collection and delivery. Also, this item funds temporary laboratory staff that prepare sampling media and equipment as well as analyze samples once collected and returned to the laboratory.

Fund Transfer: Purchase Lab Supplies & Analytical Equipment to Support MATES III Program

Contractor: TBD (through Request for Quotes)	SCAQMD Cost-share: \$ 311,150
Term: TBD - TBD	Total Cost: \$ 311,150

This amount funded the following fixed assets to support the MATES III program: 1) one Energy Dispersive X-Ray Fluorescence Spectrometer (\$135,000); 2) two microwave digestors (\$50,000), one ion chromatograph (\$80,000); 3) three PUF samplers (\$45,000); and 4) fifty glass cartridges for the PUF samplers (\$1,150).

Outreach and Technology Transfer

02185: Development of a Natural Gas School Bus Training Curriculum

Contractor: College of the Desert	SCAQMD Cost-share: \$ 6,000
Term: 11/05/02 – 03/31/05	Total Cost: \$ 6,000

The Natural Gas School Bus Training Curriculum development has been completed. As part of the contract beta testing of the curriculum was required to be provided to working school bus mechanics. The SCAQMD offered these 48 hours of training free of charge. The response required that an additional training session beyond the original contract scope be provided. These funds were expended to provide that additional 48 hours of training commencing on January 13 and completed on January 28, 2005.

04050: Technical Assistance for Fuel Cells

Contractor: Breakthrough Technologies Institute, Inc.	SCAQMD Cost-share:	\$	10,000
Term: 11/21/03 – 12/31/05	Total Cost:	\$	10,000

Breakthrough Technologies will provide expertise in fuel cell technology and administrative coordination with the U.S. Department of Energy and U.S. Department of Transportation. Breakthrough Technologies will support the SCAQMD with expertise in commercialization of fuel cells and other low- and zero-emission technologies.

04146: Technical Assistance for Hydrogen & Fuel Cell Technologies

Contractor: Gross, Tom	SCAQMD Cost-share:	\$	25,000
Term: 06/23/04 – 05/31/05	Total Cost:	\$	25,000

Mr. Gross will provide technical assistance to SCAQMD staff in hydrogen and fuel cell technologies, and in evaluating technologies needed to meet future mobile source tailpipe emission standards. His contributions in this field span the spectrum of research and testing of these technologies for accelerating their commercialization. He has been involved in projects involving hydrogen production, delivery and storage, as well as development fuel cell systems and components for stationary and mobile applications. In addition, he possesses extensive knowledge of the U.S. Department of Energy's Hydrogen, Fuel Cells & Infrastructure Technologies Program.

04168: Technical Assistance with Contract-Related Services

Contractor: Regulus Associates Inc.	SCAQMD Cost-share:	\$	40,000
Term: 06/23/04 – 06/22/05	Total Cost:	\$	40,000

Regulus Associates, Inc. services are being retained to augment SCAQMD staff resources to provide legal counsel, negotiation and administration support with contractual matters resulting from SCAQMD programs. Regulus Associates, Inc. will also assist with the development and implementation of new programs to meet program guidelines and constraints, including development of contract terms and conditions, and advise on potential program legal issues.

04183: Co-Sponsor Energy Independence Now's 2004 Activities & Support the California Hydrogen Highway Network

Contractor: Energy Independence Now	SCAQMD Cost-share:	\$	50,000
	Cosponsors:		
	Energy Foundation		55,000
Term: 06/23/04 – 01/31/05	Total Cost:	\$	105,000

Energy Independence Now will work in coordination with the Governor's office and the office of the Secretary of California EPA to identify and convene California's leading stakeholders in the hydrogen arena to work toward the common goal of accelerating and enabling California's transition to a sustainable hydrogen economy. This non-consensus stakeholder panel will be called the California Hydrogen Highway Implementation Advisory Panel and must provide the Hydrogen Blueprint Plan to the Governor and Legislature in the first quarter of 2005.

05008: CY 2004 Membership & Participation in California Fuel Cell Partnership

Contractor: Bevilacqua-Knight Inc. SCAQMD Cost-share: \$ 133,800
Cosponsors: eight automakers, four energy companies, two technology providers, seven government agencies, and ten associate members 1,826,200
Term: 07/07/04 - 07/06/05 Total Cost: ; 1,960,000

In April 1999, the California Fuel Cell Partnership (CaFCP) was formed with eight members; SCAQMD joined and has participated since 2000. The CaFCP and its members are demonstrating fuel cell passenger cars and transit buses with associated fueling infrastructure in California. The goals of the CaFCP for 2005 include the following: a) to facilitate members placement of fuel cell vehicles and fueling stations into fleets in California, including fuel cell buses; b) to support the implementation of the California Hydrogen Highway network; c) to promote hydrogen fueling station and vehicle interoperability and accessibility; d) to train First Responder trainers in vehicle and fueling demonstration communities; e) to engage in focused community and stakeholder outreach to disseminate CaFCP learnings and distribute CaFCP Resource documents; f) to coordinate with other fuel cell vehicle programs worldwide; and g) to maintain and expand CaFCP's position as a leading information source for hydrogen and fuel cell vehicles. Since the CaFCP is a voluntary collaboration, each participant contracts with Bevilacqua-Knight, Inc. (BKI) for their portion of CaFCP administration. SCAQMD contributes \$83,800 for membership, plus up to \$50,000 and an office at SCAQMD to provide 50 percent support for the CaFCP Regional Coordinator. Subject to Governing Board annual review and approval of funding, it is expected that SCAQMD will continue its participation through 2007 under this contract.

05101: Technical Assistance for Development, Outreach & Commercialization of Advanced, Low-Emission Light- & Heavy-Duty Vehicle Technologies and Coordination with State Agencies

Contractor: Calhoun, Joseph SCAQMD Cost-share: \$ 40,000
Term: 01/07/05 – 12/31/07 Total Cost: \$ 40,000

The major light-duty vehicle manufacturers have improved the natural gas, hydrogen, and electric vehicles used in the marketplace. Due to fluctuating gasoline prices, a more available fueling infrastructure network, and vehicle reliability and durability, the public and fleet managers are now more receptive to alternative fuel technologies. Hybrid electric technologies in both light- and heavy-duty applications are developing as a major contribution to achieve federal and state ambient air quality standards in the Basin. Hybrid electric technology can be coupled with natural gas engines, microturbines, and fuel cells as well as gasoline and diesel engines. To promote, fund, manage, and expedite the development and demonstration of such advanced technology projects, Mr. Calhoun will work with SCAQMD staff to provide expertise in alternative fuels for light- and heavy-duty vehicles and outreach for dissemination and commercialization of new technologies.

05120: Technical Assistance for Technology Incentive Programs to Evaluate Proposals for Compliance with New CARB Guidelines

Contractor: Clean Fuels Connection, Inc. SCAQMD Cost-share: \$ 90,000
 Term: TBD –TBD Total Cost: \$ 90,000

The SCAQMD receives funding from state agencies to provide incentives for fleet operators to reduce emissions of construction equipment and medium- and heavy-duty vehicles. An important goal is to keep fleet operators, industry groups, and trade organizations apprised of emerging low- and zero-emissions technologies and opportunities to purchase them. Although engine technology research is required to reduce the emissions at the combustion source, combustion cleanup methods are also needed to address the current installed base of on-road and off-road technologies. Clean Fuel Connection will assist staff in project cost-effectiveness calculation and feasibility evaluation.

05121: Technical Assistance to Coordinate with CARB to Develop, Analyze and Implement New Incentive Program Guidelines

Contractor: Sullivan, Cindy SCAQMD Cost-share: \$ 75,000
 Term: TBD –TBD Total Cost: \$ 75,000

With more stringent heavy-duty engine emission standards effective as of October 2002, there is a need to develop cleaner engines. Alternative-fueled engines have inherently been cleaner than conventionally fueled engines. Most alternative-fueled engines have historically met lower optional emission standards and continue to demonstrate the capability of meeting future emission standards. As an incentive to develop new engines to meet future optional emission standards, California and SCAQMD provide incentive funds to help offset the additional costs of these engines. Ms. Cindy Sullivan will provide technical expertise on implementation of incentive program guidelines. Ms. Sullivan's in-depth experience will provide expertise with alternative fuel heavy-duty engine technology. Ms. Sullivan was the Carl Moyer Program manager for SCAQMD and CARB and is very familiar with the program requirements having drafted the original state guidelines for the Moyer Program.

05123: Technical Assistance for Development, Outreach & Commercialization of Low-Emission and Alternative Fuels Technologies and Evaluating Project Proposals for Technology Incentive Programs

Contractor: TIAX, LLC SCAQMD Cost-share: \$ 90,000
 Term: TBD –TBD Total Cost: \$ 90,000

Due to the constant and rapid changes in technologies, and the sheer breadth of the potential projects, TAO staff requires input from experts and practitioners in the field to aid in selecting and establishing projects under the Clean Fuels Program. TIAX, LLC will provide technical assistance for low-emission and alternative fuels technologies such as low- and zero-emission mobile source technologies, emissions testing, and alternative fuel vehicles. TIAX, LLC also provides staff knowledgeable in heavy-duty vehicle control technologies; off-road vehicles and equipment; and state and federal programs, policies, and regulations regarding off-road and alternative vehicles.

05128: Technical Assistance for Development, Outreach & Commercialization of Advanced Heavy-Duty & Off-Road Technologies

Contractor: Mid-Atlantic Research Institute, LLC.	SCAQMD Cost-share:	\$	40,000
Term: TBD –TBD	Total Cost:	\$	40,000

The alternative fuel refueling infrastructure has been expanding allowing for greater use of heavy-duty and off-road alternative-fueled vehicles. Mid-Atlantic Research Institute has expertise in the design and development of after-treatment, advanced heavy-duty engine design, and exhaust emission measurement and chemical speciation as these technologies apply to on-highway, off-road, portable engines, stationary engines, locomotives, and marine vessels.

Fund Transfer: Two-Year Participation in the Natural Gas Vehicle Partnership

Contractor: California Natural Gas Vehicle Partnership	SCAQMD Cost-share:	\$	25,000
	Cosponsors:		
	Other Payment Partners		250,000
Term: two years	Total Cost:	\$	275,000

The California Natural Gas Vehicle Partnership (CNGVP) was established under the Strategic Alliance Initiatives and approved by the Governing Board in February 2002. It is an alliance of state and federal air quality, transportation and energy agencies, together with vehicle and engine manufacturers, fuel and infrastructure providers, and fleet operators. The CNGVP seeks to increase and strengthen the deployment of low-emission natural gas vehicles throughout California, as a strategy transferable to many other major metropolitan areas. The CNGVP is led by a Steering Committee comprised of 11 voting and 17 associate members. The voting members, excluding an environmental representative group pay \$25,000 for a two-year membership fee, and Associate members participate without cash contribution and play a supporting role by providing specific expertise and input to the activities of the CNGVP. The SCAQMD is a voting member of the Partnership. The funds committed in 2004 represent our participation for another two years.

Varies: Co-Sponsorships of Conferences, Workshops and Events

Contractor: 14 Different Contractors	SCAQMD Cost-share:	\$	121,112
	Cosponsors:		
	Various		238,888
Term: Various	Total Cost:	\$	360,000

The SCAQMD regularly participates and sponsors conferences, workshops and events. These funds provide support for 14 such events during 2004, plus two business council memberships.

PROGRESS IN 2004

Key Projects Completed

A large number of emission sources contribute to the air quality problems in Southern California. Given the diversity of these sources, there is no single technology or “silver bullet” that can solve all of the region’s problems. Accordingly, the SCAQMD continues to support a wide range of advanced technologies addressing not only the diversity of emissions sources, but also the time frame to commercialization of these technologies. Projects co-funded by the SCAQMD’s Clean Fuels Program include emission reduction demonstrations for both mobile and stationary sources, although legislative amendments and reduced SCAQMD revenues now limit the use of available funds primarily to mobile sources.

Historically, mobile source projects have targeted low-emission technology developments in automobiles, transit buses, medium- and heavy-duty trucks, and off-road applications. These vehicle-related efforts have focused on advancements in engine design, electric power trains, energy storage/conversion devices (e.g., fuel cells and batteries); and implementation of clean fuels (e.g. natural gas, propane, and hydrogen) including their infrastructures. Stationary source projects have included a wide array of advanced low NO_x technologies; low VOC coatings and processes; and clean energy alternatives, such as fuel cells, solar power, and other renewable energy systems.

Table 4 provides a list of projects completed in 2004; summaries of these completed projects are included in Appendix C. Selected projects which represent a range of key technologies from near-term to long-term are highlighted below.

Advanced Home Refueling Appliance for CNG Vehicles

Natural Gas Vehicles (NGVs) represent some of the cleanest vehicles currently available. Despite their performance and competitive pricing, NGVs have not penetrated beyond the fleet market. One of the key barriers to consumer acceptance of NGVs as personal cars is the very limited publicly accessible refueling infrastructure. Availability of a safe and cost effective standardized home refueling appliance (HRA) for CNG is an important step in successful commercialization of non-fleet, light-duty vehicles, operating on CNG. The utilization of home refueling for private vehicles will ensure a convenient, available source for overnight refueling for these vehicles at home rather than forcing the user to rely on the existing commercial infrastructure.

The FuelMaker “Phill” HRA is unique in that it will be the smallest such system ever developed, ideally suited for small commuter vehicles, such as the Honda Civic GX which uses only natural gas as its fuel and is specifically targeted at the commuter market. Honda is supporting FuelMaker's development efforts by committing to promote the Civic GX and HRA in the consumer market. This will greatly enhance the HRA's chances for market acceptance by increasing the customers' confidence in NGVs and by creating a synergistic need for the home fueling system.

FuelMaker developed and demonstrated the Advanced HRA for CNG vehicles in two phases with the duration of 18 months for each phase. The goal of Phase A, which was completed in 2002, was to develop and produce a working Alpha-unit prototype. Initial development and limited testing was conducted in the first phase; more extensive prototype testing was carried out in Phase B. Phase B upgraded and refined the Alpha unit into a Beta unit prototype that is being used in the final product commercialization.

For the two phases, U.S. DOE allocated \$100,000; CARB allocated \$250,000 for the first phase and \$50,000 for the second phase; and Technology Partners Canada (TPC) provided \$375,000 in each of the two phases. SCAQMD funding was \$500,000 for each phase. Total project cost was \$2,150,000.

Over 30 Beta prototypes have been assembled and are being tested both in FuelMaker test cells at Honda R&D in California, and at field test sites. The next steps will be toward full commercialization of the product, with the following target features:

- home-based refueling using domestic natural gas and 110-volt power,
- inexpensive (approximately \$2,000) with little or no maintenance,
- inside or outside of garage, and
- expand alternative fuel vehicle market by making fueling accessible, through slow-fill design for overnight refueling.

FuelMaker currently plans to commercialize the HRA during the first quarter of 2005.



**Figure 6: “Phill” Home Refueling Appliance
(courtesy of American Honda and FuelMaker)**

Hydrogen-Compressed Natural Gas (HCNG) Blend Transit Buses

The fundamental goal of this project was to develop HCNG powered vehicles to serve as a commercially viable bridge for introducing hydrogen to the heavy-duty transit vehicle market, as well as to demonstrate the emissions benefits of HCNG fuel in state-of-the-art internal combustion engines. The objectives established to support this goal were:

- Optimal HCNG fuel blend
- Reviewing component compatibility
- Comparison testing (engine dynamometer & chassis dynamometer testing) for performance and emissions characteristics of HCNG
- Vehicle performance and engine wear evaluations

The project tasks consisted of conducting a literature review of previous work, the development of a Cummins Wesport Inc. B Gas Plus engine for HCNG operation, emissions and performance optimization, and finally demonstration on a transit bus in revenue service.

Key evaluation tools included 3,000 mile preventative maintenance inspections and an extensive 24,000-mile engine and vehicle inspection. In addition, fuel economy, oil consumption and operational issues were tracked throughout the demonstration.

A public outreach component was also included in the project to maximize the technology transfer of project results to other interested parties and to provide an introduction of hydrogen as a transportation fuel to the general public.

In general, the project demonstrated that HCNG blends can be successfully utilized in revenue service fleets with equal performance, and improved emissions, without costly engine or vehicle modifications. A 20 mole percent hydrogen/80 mole percent CNG blend provided the optimal NOx emissions reduction, while preserving the performance of the CNG control buses.

Up to 50 percent NOx reduction was achieved in this demonstration. A small fuel economy/range penalty was experienced in the operation of the HCNG blend. The in-use demonstration measured about a 12 percent fuel economy reduction for the HCNG relative to the CNG operation, a result that is consistent with the 10 to 14 percent reduction observed during the chassis dynamometer test cycle evaluation.

As predicted, minor engine and vehicle hardware modifications were required. Only a new fuel mass flow rate sensor and additional fuel tanks were required. The importance of reliable fueling capability was found to be a critical aspect of the project. The results of the 24,000-mile engine and vehicle inspection did not indicate any concerns or issues with the HCNG fueled buses compared to their CNG control buses.

Essentially, HCNG facilitates the early introduction of hydrogen as a transportation fuel using technology that is very near commercialization. The total project costs were \$474,481 and the four project buses continue in revenue service.

Particulate Traps in Heavy-Duty Construction Equipment

Current CARB emission models estimate that construction equipment contributes 38 percent of the total off-road PM10 emitted in California, or about 21 tons per day. This study sought to evaluate the effectiveness and durability of diesel particulate filters on heavy-duty off-road construction equipment. The project was jointly sponsored by the SCAQMD, CARB, and the Los Angeles County Sanitation District (LACSD). Additional support came for the Construction Industry Air Quality Coalition (CIAQC), and in-kind contributions from LACSD, C. W. POSS Construction, Inc. (POSS), Sukut Construction, West Virginia University, Johnson-Matthey, and Engelhard Corporation. Booz Allen Hamilton provided project management services. The total project cost was approximately \$910,000.

This project focused on the installation of 21 PM filters onto 15 engines used on 12 heavy-duty construction vehicles (some vehicles used two engines – and certain engines required two filters). Engelhard supplied 12 filters and Johnson-Matthey provided the other nine. Shepherd Machinery, the local Caterpillar dealership, installed the filters on six dozers and on six scrapers. Two construction sites, one in Newport Beach and one in Whittier, were used to demonstrate various machinery with the traps.

PM emission levels were reduced 96 percent or more with both Johnson-Matthey and Engelhard filters. Also, neither the Johnson-Matthey filter nor the Engelhard filter increased the levels of NOx significantly. HC and CO levels were also reduced with the use of the traps – about 79 percent and 65 percent respectively for the Engelhard filter, and 93 percent and 97 percent respectively for Johnson-Matthey.

The prototype traps from one manufacturer, Engelhard, completed the demonstration with one failure (out of a total of 12 traps). This single failure is believed to be largely due to poor assembly quality rather than any inherent design issues. The traps from Engelhard continue to operate successfully at LACSD, and several traps have accumulated over 1500 hours of operation. The Engelhard traps installed on the older, high PM emitting (pre-combustion chamber) engines at POSS also performed

very well with no instances of high back pressure and/or failed filter elements. These results indicate that the duty cycles and overall operating conditions of high horsepower diesel construction equipment are sufficient to support frequent regeneration – and therefore represent a reasonable application for retrofit with self-regenerating style particulate filters.



Figure 7: Installed Particulate Trap on Heavy-Duty Construction Equipment

Fischer-Tropsch Synthetic Fuel Demonstration

Gas-to-Liquid (GTL), or Fischer-Tropsch (FT), fuel is a synthetic, compression-ignitable fuel much like diesel, but without the sulphur or aromatics. FT is typically made from natural gas in stranded regions where transport of liquid fuels is more economical or in locations where diesel engines are preferred over natural gas engines. The promise of this much cleaner fuel is it offers reduced NOx and PM emissions from the in-use diesel fleet. This project was initiated to characterize the emissions from medium-duty vehicles operating on FT synthetic compression ignition fuel with catalyzed particulate filters.

This research was conducted cooperatively by West Virginia University (WVU) and the National Renewable Energy Laboratory (NREL); NREL research will continue beyond the end date of the SCAQMD contract with WVU. The total project cost was \$737,855 with the AQMD contributing \$370,000.

Three vehicles were tested running on California No. 2 diesel as a baseline. The second set of three vehicles was running on FT synthetic diesel. Each of the vehicles running on FT was tested with and without a Johnson-Matthey Continuous Regeneration Particulate Trap (CRT). The vehicles were exercised through representative dynamometer driving schedules. The six single-axle medium-duty delivery vehicles were from the Yosemite Waters fleet of Fullerton, California. The trucks had a gross vehicle weight rating of 26,000 lbs. and were powered by 195 horsepower International DT466 engines with 5-speed automatic transmissions. A simulated test weight of 20,500 lbs. would be used to evaluate the trucks. Two of the vehicles were fueled with the typical FT fuel for the baseline in the first round of research. In the second round, three vehicles were fueled with typical California diesel and were tested without exhaust aftertreatment. Also, in the second round, three vehicles were tested fueled with FT diesel with and without a Johnson-Matthey CRT on both the New York Bus (NYBUS) Cycle and the City-Suburban Heavy Vehicle Route (CSHVR). NOx emissions were reduced under the CSHVR cycle by 8.9 percent switching from CARB to FT and an additional 5.7 percent in NOx when switching to FT and an additional 4.3 percent when the FT fuel is combined with the Johnson-Matthey CRT. Particulate matter (PM) emissions were significantly reduced with

the combination of FT fuel and the Johnson-Matthey CRT by greater than 97 percent for both test schedules. PM emissions were reduced by 35.3 percent for the CSHVR cycle and 24.2 percent for the NYBUS cycle when the FT fuel is used without aftertreatment.

The combination of the Johnson-Matthey CRT and synthetic FT fuel can significantly reduce hydrocarbon (HC), CO and PM emissions while having no impact on the vehicle fuel economy. Vehicle operation, such as the difference between the CSHVR and the NYBUS cycle test cycles, can have an impact on the effectiveness of the CRT. HC emissions for the CSHVR were reduced by 59 percent and 69 percent for the NYBUS cycle when comparing CARB diesel with FT, and were eliminated below detectable limit with the addition of the Johnson-Matthey CRT to the FT fuel. Similar to the HC emission results, the CO emissions for both the CSHVR and NYBUS cycles were virtually eliminated with the addition of the Johnson-Matthey CRT. Similarly, the NYBUS cycle saw a reduction of 13.3 percent operating on FT fuel and an additional 4.3 percent when combining the Johnson-Matthey CRT with the FT fuel. PM emissions were significantly reduced with the combination of FT fuel and the Johnson-Matthey CRT by greater than 97 percent for both test cycles. PM emissions were reduced by 35.3 percent for the CSHVR cycle and 24.2 percent for the NYBUS cycle with the fuel running on FT. Switching from CARB fuel to FT fuel did not make an impact on the fuel economy for the test vehicles for either test cycle. The addition of the Johnson-Matthey CRT did not impact the fuel economy of the test vehicles.



Figure 8: Fischer-Tropsch Fuel Compared to Diesel

Table 4: Projects Completed Between January 1 and December 31, 2004

Contract	Contractor	Project Title	Date
Fuel Cell Technology			
02136 †	University of California, Irvine	Renew Participation for Three Years in National Fuel Cell Research Center at UCI	Oct-04
Hydrogen Technology and Infrastructure			
02312	SunLine Services Group, Inc.	Determine Feasibility and Steps to Design Conversion of CNG Fueling Station into a Hydrogen Fueling Station	Mar-04
03167	SunLine Services Group, Inc.	Develop & Demonstrate Hydrogen CNG-Blend Transit Buses	Oct-04
03273	SunLine Services Group, Inc.	Develop Hydrogen Fueling Station Templates	May-04
Engine Technology			
02218	Cummins Westport, Inc.	Develop Preliminary Vehicle Design for Next Generation Natural Gas Vehicle	Jun-04
Infrastructure and Fuel Production			
02320	USA Pro & Associates	Develop Odorant for Liquefied Natural Gas	Feb-04
03319	FuelMaker Corporation	Upgrade CNG Fueling Stations at Various School Districts and Municipalities	Jul-04
03232	FuelMaker Corporation	Develop & Demonstrate Advanced Home Refueling Appliance for CNG Vehicles	Dec-04
Electric/Hybrid Vehicle Technologies			
01208	Southern California Edison Company	Develop & Demonstrate Grid-Rechargeable Hybrid-Electric Utility Service Truck & Mobile Electric Power Supply	Jan-04
02326	Electric Power Research Institute	Study for Commercialization of Advanced Hybrid-Electric Vehicles	Sep-04
03275	University of California, Riverside	Develop & Evaluate Multiple Vehicle Type Expansion of Shared Electric Vehicle System	Oct-04
Emission Control Technologies			
02119 †	Booz-Allen & Hamilton Inc.	Demonstrate Particulate Trap Technologies on Existing Off-Road Heavy-Duty Construction Equipment	Jun-04
02292 †	West Virginia University Research Corporation	Demonstrate Fischer Tropsch Synthetic Fuel in Heavy-Duty Vehicles	Apr-04
Emission Studies			
02117 †	University of Southern California	Deploy & Operate Scanning Mobility Particle Sizers & Low Temperature Tapered Element Oscillating Microbalance in Children's Health Study Communities	Oct-04
02231	Coordinating Research Council Inc.	Heavy-Duty Vehicle Chassis Dynamometer Testing for Emissions Inventory	Apr-04

**Table 4. Projects Completed Between January 1 and December 31, 2004
(Continued)**

Contract	Contractor	Project Title	Date
Emission Studies (cont'd)			
03469	West Virginia University Research Corporation	Emissions Testing & Analysis of Dedicated Natural Gas and Diesel Solid Waste Collection Vehicles	Jun-04
VOC/Air Toxics Control Technologies			
02307 †	Gregg Industries, Inc.	Demonstrate Integrated Technology for Control of Odors & VOCs from Metal Casting Operations	Aug-04
Stationary Clean Fuel Technology			
02089	University of California, Irvine	Monitor Power Production by Microturbine Generators	Dec-04
Outreach and Technology Transfer			
01190	USA Pro & Associates	Technical & Management Assistance for Alternative Fuel Infrastructure	Jun-04
02240 †	Cindy Sullivan	Technical Assistance & Expert Consultation	Jun-04
02316	California Science Center Foundation	Construction & Implementation of Fuel Cell Exhibit at California Science Center	Jun-04
02334 †	Engine, Fuel & Emissions Engineering Inc.	Technical Assistance on Natural Gas Engine Technology	Jun-04
03271 †	Northwest Riverside County Clean Cities Coalition	Cosponsor 9 th Annual National Clean Cities Conference & Exposition	Jan-04
03276 †	Rose Communications Inc.	Technical Assistance for Development, Outreach & Commercialization of Fuel Cells	Mar-04
03424 †	Westart-Calstart	Cosponsor 4 th Annual Heavy-Duty Vehicle Conference	Aug-04
03466 †	Electric Drive Transportation Association	Cosponsor 20 th International Electric Vehicle Symposium & Exposition	May-04
04040 †	University of California, Irvine	Cosponsor the Transition from Fossil Fuels Conference	May-04
04080 †	National Hydrogen Association	Cosponsor 15 th Annual U.S. Hydrogen Conference & Exposition and Teacher Training Workshop	Sep-04
04096 †	Coordinating Research Council Inc.	Cosponsor 14 th Annual CRC On-Road Vehicle Emissions Workshop	Aug-04
04108 †	Western Riverside Council of Governments	Cosponsor 5 th Annual Clean Cities Stakeholder's Conference & Exposition	Mar-04
04112 †	The Partnership	Cosponsor the SCAG Clean Cities Coalition 2004 National Alternative Fuel Vehicle Odyssey Day Fair	Apr-04
04113 †	College of the Desert	Cosponsor the Coachella Valley Clean Cities Coalition "Advancing the Choice" Event	Apr-04

† Two-page summary report (as provided in Appendix C) was not required for level-of-effort contracts or unavailable at time of printing this report.

FUTURE TECHNOLOGIES

Funding Priorities for 2005

The Clean Fuels Program continually seeks to support the deployment of lower emitting technologies. Planning has been and remains an ongoing activity for the program, which must remain flexible to address evolving technologies and the latest progress in the state-of-the-art. Although the SCAQMD program is significant, especially at a time when both public and private funding available for technology research and development is limited, national and international activities affect the direction of technology trends. The real challenge for the SCAQMD is to identify project or technology opportunities in which its available funding can make a difference in making progressively cleaner technologies a reality in the Basin.

The overall strategy is based in large part on technology needs identified in the Air Quality Management Plan (AQMP) for the Basin and the Governing Board's directives to protect the health of residents of Southern California. The AQMP is the long-term "blueprint" that defines the basin-wide emission reductions needed to achieve ambient air quality standards by 2010, the regulatory measures to achieve those reductions, the timeframes to implement these proposed measures, and the technologies or types of technologies required to meet these future proposed regulations. As previously identified in Figure 1, the NO_x and VOC emission sources of greatest concern are heavy-duty on-road vehicles, light-duty on-road vehicles, and off-road equipment.

In addition to providing for specific control measures based on known technologies and control methods, the Clean Air Act has provisions for more general measures based on future, yet-to-be-developed technologies. These "black box" measures are provided under Section 182(e)(5) of the Clean Air Act for regions that are extreme non-attainment areas, such as the Basin. This Plan Update includes projects to develop, demonstrate, and commercialize a variety of technologies, from near-term to long-term, that are intended to provide solutions to the emission control measures identified in the AQMP.

Within each technical area, there exist a range of projects that represent near-term to long-term efforts. The SCAQMD Clean Fuels Program tends to support development, demonstration, and technology commercialization efforts, but not fundamental research. The general time-to-product for these efforts, from long-term to near-term, is described below.

- Technology development projects are expected to begin during 2005 with durations of about two years. Additional field demonstrations to gain long-term verification of performance, spanning up to two years, may also be needed prior to commercialization. Certification and ultimate commercialization would be expected to follow. Thus, development projects identified in this plan are expected to result in technologies ready for commercial introduction as soon as 2009. Projects are also proposed that may involve developing emerging technologies that are considered longer term and, perhaps higher risk, but with significant emission reduction potential. Commercial introduction of such long-term technologies would not be expected until 2010 or later.

- More mature technologies, that is, those ready to begin field demonstration in 2005, are expected to result in a commercial product in 2006-07. Technologies being field demonstrated generally have been certified or are in the process of being certified. The field demonstrations provide a controlled environment for manufacturers to gain real-world experience and address any end-user issues that may arise prior to the commercial introduction of the technology. Field demonstrations provide real-world evidence of a technology's performance to help allay any concerns by potential early adopters.

Summary of Technical Priorities

The SCAQMD program maintains flexibility to address dynamically evolving technologies and the latest progress. The challenge for the SCAQMD is to identify programs where the available funding can make a difference. The major technical program areas are identified below with specific project categories discussed in more detail in the following section.

Not all project areas will be funded, given the funding constraints and the availability of suitable projects. The top priority technical areas identified below are clearly appropriate within the context of the current air quality challenges and opportunities for technology advancement. Within these areas there is significant opportunity for SCAQMD to leverage its funds with other funding to expedite the implementation of cleaner alternative technologies in the Basin.

Fuel Cells

Fuel cells are emerging as a leading alternative technology to replace more polluting ICEs in vehicle, marine, and stationary distributed energy applications. There are a handful of different fuel cell technologies and fuels being considered for these applications.

On the mobile side, the first demonstration vehicles are using PEM fuel cells and compressed hydrogen as the fuel, but the long-term infrastructure requirements, stack durability, and any synergistic relationship to stationary applications remain uncertain. Considerable research, development, and demonstration efforts are already underway to address these issues by some of the largest automobile manufacturers and fuel suppliers. Yet much work is needed to improve the performance and range of these vehicles, reduce costs, develop a viable fueling infrastructure, and obtain public acceptance for a new technology in everyday applications.

On the stationary side, many of the same technology issues exist and can be potentially easier to address due to constant load applications and larger space availability for the stack and balance of plant/component integration. It is hoped that cross-cutting advances in the technology can then be transferred and applied to mobile applications. Examples are fuel cell vehicles which can put power back into the electrical grid or co-location of the fuel cell DG at fueling stations to provide power for compressors or pumping.

The SCAQMD is actively working with two state industry entities to further the commercialization of mobile and stationary fuel cells, the California Fuel Cell Partnership and the California Stationary Fuel Cell Collaborative, respectively. The 2005 Plan Update identifies key opportunities consistent with both organizations while clearly leading the way for the development and demonstration of both mobile and stationary applications. The specific future projects are expected to include the following:

- Demonstration of stationary fuel cell power production and hydrogen co-production for fueling

- Development and demonstration of cross-cutting fuel cell applications (e.g. plug-in vehicle to grid power and fuel cell auxiliary power units)
- Development and demonstration of microturbine-fuel cell hybrid technologies
- Development and demonstration of fuel cells in off-road and marine applications
- Demonstration of fuel cell vehicles in controlled fleet applications in the Basin

Hydrogen Technology and Infrastructure

In 2002, the SCAQMD initiated the groundwork for a distributed hydrogen fueling network to allow the limited number of demonstration fuel cell vehicles refueling access throughout the Basin and reduce the number of obstacles to commercialization of additional fuel cell vehicles. Despite the selection of hydrogen as the current fuel of choice for the demonstration vehicles, there are various production, storage, and dispensing strategies still under consideration for the long-term infrastructure solution. As a result, further development of these refueling technologies is planned, especially in areas where our funding can be leveraged with other state or federal programs.

The economical production of hydrogen for these vehicles and, to the extent necessary, for stationary applications, is also a key area in need of development and demonstration. In particular, the production of hydrogen from renewable sources is of interest, either using photovoltaics and electrolyzer technologies or biomass feedstocks and reformation technologies due to the potential for higher lifecycle efficiencies and lower greenhouse gas emissions compared to conventional fuels. Such renewable energy projects would provide data to help understand and benchmark critical parameters for enabling these technologies.

Furthermore, as an interim step toward full fuel cell vehicle deployment and as a means to testing and verifying the hydrogen infrastructure, hydrogen ICE and hydrogen-CNG (HCNG) blended fuel vehicles will be developed and demonstrated. Hydrogen ICE and HCNG vehicles, which utilize conventional engine technologies, represent potentially cost effective hydrogen vehicle options. The emissions, although higher than those of fuel cell vehicles, can be optimized for emissions lower than dedicated CNG vehicles. Future projects are expected to include the following:

- Development and demonstration of hydrogen ICEs for vehicle and power applications
- Development and demonstration of hydrogen HCNG vehicles for medium and heavy-duty applications
- Continued development and demonstration of distributed hydrogen production and refueling stations

Engine Technology

The use of alternative fuels can provide significant reductions in NO_x and PM emissions, especially in heavy-duty diesel engines for on-road, off-road, and marine applications. Natural gas engines have shown significant promise, with the greatest benefit coming from heavy-duty diesel truck and bus replacement with new natural gas vehicles in urban areas. Hybrid electric technologies and the use of microturbines instead of ICEs have also shown promise for replacing higher polluting diesel engines. All of these options are worth pursuing for cleaner engine technologies and immediate emission reductions.

In order for alternative fuel heavy-duty engines to achieve commercial acceptance and market penetration, their performance, durability, and cost-effectiveness, in addition to emissions reduction, must be demonstrated to the end user. Future projects will support the development, demonstration,

and certification of alternative fuel engines to broaden their application and availability. Specifically, these projects are expected to target the following:

- Demonstration of alternative fuel technologies in marine applications
- Continued development and demonstration of alternative fuel medium-duty and heavy-duty engines and vehicles
- Demonstration of low and zero-emission locomotives
- Development and demonstration of clean alternative fuel engines for off-road applications

Infrastructure and Fuel Production

The importance of refueling infrastructure cannot be overemphasized for the realization of on-road alternative fuel technologies. Significant demonstration and commercialization efforts are underway to support the deployment of natural gas vehicles. CNG and LNG refueling stations are being positioned to support public and private fleet applications today as funding for purchasing natural gas vehicles is made available to fleet operators.

Besides these technologies, some key issues that must be overcome for public acceptance involve the development of fire and safety codes and standards, cost and economics of the new fuels, public education and training, and emergency response capability. Some of the projects expected to be developed and co-funded for infrastructure development include:

- Development and demonstration of CNG as a vehicle fuel from renewable feedstocks
- Development and demonstration of advanced, cost effective CNG and LNG stations
- Deployment of natural gas home refueling appliance for light-duty vehicles
- Investigation of LNG manufacturing and distribution technologies

Electric and Hybrid Technologies

Despite the greater near-term environmental benefits of battery EVs, no major automobile manufacturer is currently producing light-duty passenger EVs. Widespread demand and deployment have also been hampered by public concerns over cost, battery lifetime, travel range, charging station infrastructure and manufacturer commitment. The SCAQMD continues to consider projects addressing these concerns as well as the use of battery EVs in fleet or niche applications.

Most of the major automobile manufacturers are now directing their efforts toward hybrid electric technologies in both light-duty and heavy-duty applications as well as off-road equipment. In particular, diesel and gasoline fueled hybrid electric vehicles, and specialty light-duty pure electric vehicles, have entered the commercial market. Such vehicles offer the benefits of higher fuel economy and range, as well as lower emissions. Hybrid electric technology is not limited to gasoline and diesel engines, and can be coupled with natural gas engines, microturbines, and fuel cells for further emission benefits. Opportunities to develop and demonstrate technologies that could enable expedited widespread use of electric and hybrid electric vehicles in the Basin include the following:

- Upgrade and demonstration of hybrid electric buses
- Demonstration of advanced commercial utility equipment
- Demonstration of advanced energy storage technologies
- Evaluation and demonstration of light and medium-duty, grid-rechargeable, hybrid electric vehicles

- Demonstration of heavy-duty hybrid vehicles

Emission Control Technologies

Although engine technology research is required to reduce the emissions at the combustion source, post-combustion cleanup methods are also needed to address the current installed base of on-road and off-road technologies. Existing diesel emissions can be greatly reduced with after-treatment controls such as Particulate Matter Traps (PM-Traps) and catalysts, as well as lowering the sulfur content or using additives with diesel fuel. Gas-to-Liquid (GTL) fuels, formed from natural gas or other gas rather than petroleum feedstock, and emulsified diesel provide low-emission fuels for use in diesel engines. And as emissions from engines become lower and lower, the lubricant contributions to VOC and PM emissions become increasingly important. The most promising of these technologies will be considered for funding, specifically:

- Evaluation and demonstration of new emerging liquid fuels, including ultra-low sulfur diesel and GTL fuels
- Development and demonstration of advanced after-treatment technologies for mobile applications (including particulate traps and catalysts)
- Development and demonstration of low VOC and PM lubricants for diesel and natural gas engines
- Development and demonstration of advanced air pollution control equipment

Emissions and Health Effects Studies

The monitoring of pollutants in the Basin is extremely important, especially when focused on a particular sector of the emissions inventory (to identify the technology responsibility) or receptor in the pollution (to assess the potential health risks). The recently published findings of the USC Children's Health Study, "The Effect of Air Pollution on Lung Development from 10 to 18 Years of Age" (New England Journal of Medicine, September 9, 2004), indicate that smoggy areas can produce irreversible damage to children's lungs. This information highlights the need for further emissions and health studies to identify the emissions from high polluting sectors as well as the health effects from these technologies:

- Emissions studies for locomotives, port, and marine vessels
- Demonstrate remote sensing to target different high emission applications
- Conduct studies to identify the health risks associated with ultrafines and ambient particulate matter

Stationary VOC/Air Toxics Control Technologies

Although progress is being made in the development and commercialization of zero VOC products and processes, the 2003 AQMP identifies further need for VOC and PM emission reductions to achieve the federal clean air standards by 2010. As such, low-VOC solvents and coatings research will continue, as well as diesel alternative technologies for stationary power applications. Air toxics monitoring and analyses may also be needed to support the MATES III study.

- Monitoring and analyses for air toxics within the Basin
- Development and demonstration of low-emission combustion technologies

- Evaluation, development, and demonstration of advanced VOC control technologies for miscellaneous stationary sources

Target Project Allocations

Figure 9 below presents the potential allocation of available funding, based on SCAQMD projected program cost of approximately \$41 million for all potential projects. The expected actual project expenditures for 2005 will be much less than the total SCAQMD projected program cost since not all projects will materialize. The target allocations are based on balancing technology priorities, technical challenges and opportunities discussed previously, and near-term versus long-term benefits with the constraints on available SCAQMD funding. Specific contract awards throughout 2005 will be based on this proposed allocation, the quality of proposals received and evaluation of projects against standardized criteria, and, ultimately, SCAQMD Governing Board approval.

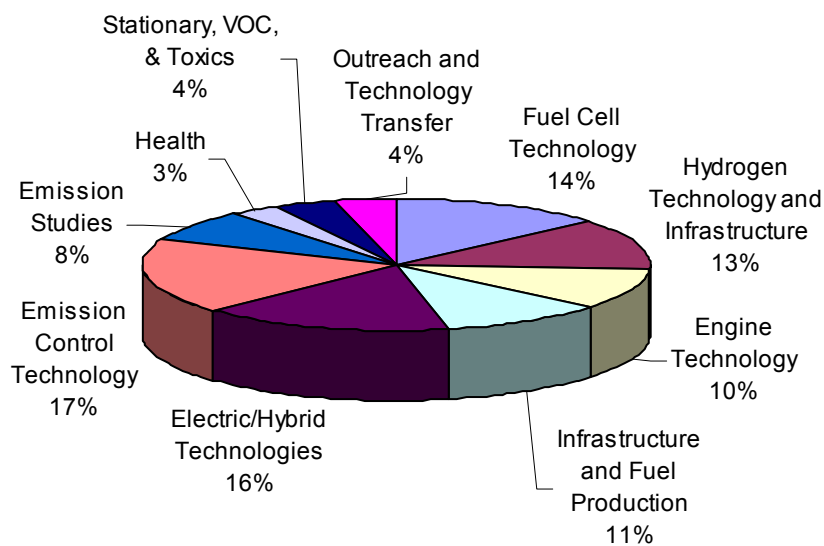

Figure 9: Projected Cost Distribution for Potential SCAQMD Projects 2005 and Beyond (\$41 million)

PROGRAM PLAN UPDATE

This section presents the Clean Fuels Program Plan Update for 2005. The proposed projects are organized by program areas and described in further detail, consistent with the SCAQMD budget, priorities, and the best available information. Although not required, this plan also includes proposed projects that may be funded by revenue sources other than the Clean Fuels Program, specifically related to VOC and incentive projects.

Each of the proposed projects described in this plan, once fully developed will be presented to the SCAQMD Governing Board for approval prior to contract initiation. This development reflects the maturity of the proposed technology, identification of contractors to perform the projects, host site participation, securing sufficient cost-sharing to complete the project, and other necessary factors. Recommendations to the Governing Board will include descriptions of the technology to be demonstrated and in what application, the proposed scope of work of the project, and the capabilities of the selected contractor and project team, in addition to the expected costs and expected benefits of the projects as required by H&SC 40448.5.1.(a)(1). Based on communications with all of the organizations specified in H&SC 40448.5.1.(a)(2) and review of their programs, the projects proposed in this plan do not appear to duplicate any past or present projects.

The remainder of this section contains the following information for each of the potential projects summarized in Table 5.

Proposed Project: A descriptive title and a designation for future reference.

Expected SCAQMD Cost: The estimated proposed SCAQMD cost share as required by H&SC 40448.5.1.(a)(1).

Expected Total Cost: The estimated total project cost, including the SCAQMD cost share and the cost share of outside organizations expected to be required to complete the proposed project. This is an indication of how much SCAQMD public funds are leveraged through its cooperative efforts.

Description of Technology and Application: A brief summary of the proposed technology to be developed and demonstrated, including the expected vehicles, equipment, fuels, or processes that could benefit.

Potential Air Quality Benefits: A brief discussion of the expected benefits of the proposed project, including the expected contribution towards meeting the goals of the AQMP, as required by H&SC 40448.5.1.(a)(1). In general, the most important benefits of any technology research, development, and demonstration program are not necessarily realized in the near-term. Demonstration projects are generally intended to be proof-of-concept for an advanced technology in a real-world application. While emission benefits, for example, will be achieved from the demonstration, the true benefits will be seen over a longer term, as a successfully demonstrated technology is eventually commercialized and implemented on a wide scale.

Table 5: Summary of Potential Projects

Proposed Project	Expected SCAQMD Cost	Expected Total Cost
------------------	----------------------	---------------------

Incentive Programs

Clean Fuels Program Match for Vehicle and Infrastructure Incentive Programs	\$1,000,000	\$4,000,000
Subtotal	\$1,000,000	\$4,000,000

Fuel Cell Technology

Demonstrate Stationary Fuel Cell with Hydrogen Co-Production	\$500,000	\$2,000,000
Demonstrate Fuel Cell Vehicle with Vehicle to Grid Power	500,000	1,500,000
Develop and Demonstrate Microturbine Fuel Cell Hybrid Technologies	200,000	800,000
Develop and Demonstrate Fuel Cells in Off-Road and Construction/Industrial Applications	250,000	1,000,000
Develop and Demonstrate Fuel Cells for Marine Vessels	100,000	1,000,000
Develop and Demonstrate Fuel Cells in Vehicle Applications	4,000,000	12,000,000
Subtotal	\$5,550,000	\$18,300,000

Hydrogen Technology and Infrastructure

Develop and Demonstrate Vehicles Utilizing Hydrogen in Internal Combustion Engines	\$1,000,000	\$5,000,000
Demonstrate 10,000 PSI Refueling	1,000,000	3,000,000
Develop and Demonstrate Hydrogen-Natural Gas Internal Combustion Engines	1,300,000	4,000,000
Demonstrate Hydrogen-CNG Compatibility	300,000	1,400,000
Perform Hydrogen Fuel Quality Development Study	5,000	500,000
Develop and Demonstrate Heavy-Duty Truck On-Board Electrolyzer	40,000	200,000
Develop and Demonstrate Distributed Hydrogen Production and Fueling Stations	1,500,000	4,000,000
Develop and Demonstrate Reformer Technology for Hydrogen Production	50,000	250,000
Subtotal	\$5,195,000	\$18,350,000

Engine Technology

Demonstrate Twin-Speed Marine Engines	250,000	500,000
Develop and Demonstrate Advanced Alternative Fuel Heavy-Duty and Medium-Duty Engines and Vehicles	2,000,000	4,000,000
Demonstrate Lower Emission Locomotives	1,500,000	7,000,000
Develop and Demonstrate Low-Emission LPG Street Sweeper	250,000	500,000
Subtotal	\$4,000,000	\$12,000,000

**Table 5. Summary of Potential Projects
(Continued)**

Proposed Project	Expected SCAQMD Cost	Expected Total Cost
Infrastructure and Fuel Production		
Demonstrate Odorized LNG	\$250,000	\$300,000
Demonstrate Conversion of Landfill Gas to LNG	1,000,000	9,000,000
Demonstrate Conversion of Bio-Fuels to Natural Gas	750,000	2,500,000
Demonstrate Equipment to Reduce Propane Fueling Emissions	53,000	348,000
Demonstrate Natural Gas Vehicle/CNG Home Refueling Appliance Buydown	600,000	800,000
Upgrade of Existing Natural Gas Infrastructure	250,000	1,000,000
Develop and Demonstrate Advanced Natural Gas Systems for Refueling Stations	750,000	4,000,000
Demonstrate LNG Manufacturing and Distribution Technologies	750,000	7,000,000
Subtotal	\$4,403,000	\$24,948,000
Electric/Hybrid Technologies		
Demonstrate Large Electric or Hybrid Off-Road Vehicles	\$150,000	\$500,000
Develop and Demonstrate Advanced Battery Technology for Commercial Utility Equipment	100,000	300,000
Demonstrate Plug-In Hybrid Electric Vehicles	600,000	13,000,000
Develop and Demonstrate Light- and Medium-Duty Hybrid Electric Vehicles and Systems	750,000	5,000,000
Demonstrate Alternative Energy Storage Systems	700,000	1,400,000
Evaluate and Demonstrate Hybrid Heavy-Duty Vehicles	2,000,000	10,000,000
Upgrade of Hybrid Electric Vehicles	500,000	3,000,000
Develop and Demonstrate High-Capacity, Alternate Fueled Hybrid Electric Transit Buses	750,000	5,000,000
Investigate and Demonstrate Small Urban Electric Vehicle Applications	150,000	500,000
Develop and Demonstrate Medium- and Heavy-Duty Grid Rechargeable Trucks	500,000	2,000,000
Demonstrate Advancements in Lithium Ion Battery Technology for Electric or Plug-In Hybrid Electric Vehicles	400,000	1,200,000
Subtotal	\$6,600,000	\$41,900,000
Emission Control Technology		
Perform Heavy-Duty Natural Gas Vehicle Transmission Optimization Study	\$150,000	\$250,000
Develop and Demonstrate Advanced Alternative Fuel Light-, Medium- and Heavy-Duty Engines and Vehicles	2,000,000	4,000,000
Demonstrate Active Diesel Particulate Filter on Construction Equipment	200,000	400,000

**Table 5. Summary of Potential Projects
(Continued)**

Proposed Project	Expected SCAQMD Cost	Expected Total Cost
------------------	----------------------------	------------------------

Emission Control Technology (cont'd)

Develop and Demonstrate Off-Road Repower with LNG On-Road Engines	250,000	600,000
Develop and Demonstrate Advanced, High Performance, Low-Emission Leaf-Blower	100,000	200,000
Develop and Demonstrate Advanced Aftertreatment Technologies for Liquid Fuels	800,000	2,600,000
Demonstrate Advanced Alternative Fuels in Off-Road Equipment	1,200,000	2,600,000
Develop and Demonstrate Advanced Aftertreatment Technologies for Natural Gas Emissions	800,000	1,600,000
Develop and Demonstrate Low-Emission Lubricants for Natural Gas Engines	250,000	1,000,000
Demonstrate NO _x and PM Control Technologies for Off-Road Equipment	750,000	1,500,000
Investigate and Demonstrate Near-Term Emissions Control Technologies	1,000,000	4,000,000
Subtotal	\$7,500,000	\$18,750,000

Emission Studies

Perform Natural Gas Quality Emissions Study	\$50,000	\$500,000
Perform Emission Studies for Locomotives, Port and Ocean-Going Vessels	300,000	300,000
Demonstrate Remote Sensing of Mobile Sources in SCAQMD	2,000,000	4,000,000
Perform Study of Comparative Emissions of Heavy-Duty Alternative Fuel and Conventional Fuel Engines	500,000	1,000,000
Develop Improved Particulate Measurement Procedures	100,000	700,000
Alternative Fuel Locomotiva Study for Alameda Corridor	250,000	750,000
Subtotal	\$3,200,000	\$7,250,000

Health Effects

Study Ultrafine Particle Emissions and Health Effects	\$1,000,000	\$4,000,000
Assess Sources and Health Impact of Ambient Particulate Matter	300,000	300,000
Subtotal	\$1,300,000	\$4,300,000

Stationary Clean Fuel Technology

Develop and Demonstrate Low-Cost Emission Monitoring Systems	\$250,000	\$500,000
Develop and Demonstrate Oscillating Combustion	25,000	75,000
Develop and Demonstrate Portable Low Emission Alternative Fuel ICE Generator	100,000	200,000

**Table 5. Summary of Potential Projects
(Continued)**

Proposed Project	Expected SCAQMD Cost	Expected Total Cost
Stationary Clean Fuel Technology (cont'd)		
Demonstrate Emulsified Diesel Fuel Use in Portable Generators	50,000	100,000
Develop and Demonstrate Renewable-Based Energy Generation Alternatives	500,000	1,000,000
Develop and Demonstrate Low Emission, High Efficiency Distributed Generation Technologies	250,000	750,000
Subtotal	\$1,175,000	\$2,625,000
VOC/Air Toxics Control Technologies		
Conduct Technology Assessments of Future VOC Limits in SCAQMD VOC Rules	\$250,000	\$250,000
Evaluate, Develop, and Demonstrate Advanced VOC Control Technologies for Miscellaneous Stationary Sources	200,000	200,000
Subtotal	\$450,000	\$450,000
Outreach and Technology Transfer		
Conduct Alternative Fuel Training	\$50,000	\$50,000
Technical Assistance in Assembling SAE Standards for LNG Fueling and Dispensing	150,000	300,000
Technical Assistance in LNG Fueling for Transit Properties	200,000	200,000
Technical Assistance for Schools' Maintenance Facilities	300,000	300,000
Assessment and Technical Support of Advanced Technologies and Information Dissemination	500,000	500,000
Support for Implementation of Various Clean Fuels Vehicle Incentive Programs	400,000	400,000
Subtotal	\$1,600,000	\$1,750,000
TOTALS FOR POTENTIAL PROJECTS	\$41,973,000	\$154,623,000

Incentive Programs

Proposed Project: Clean Fuels Program Match for Vehicle and Infrastructure Incentive Programs

Expected SCAQMD Cost: \$1,000,000

Expected Total Cost: \$4,000,000

Description of Technology and Application:

Incentive programs encourage the immediate use of commercially available, low emission on-road and off-road alternative fuel engines to replace high-polluting diesel engines and to reduce the resulting toxic exposures. In CY 2003, additional Clean Fuels funds may be used as local match funding for some of the Incentive programs as required by the specific program's guidelines. Participation in CARB ZEV Incentive Program does not require matching funds; however additional local funds may be instrumental in placing these vehicles within SCAQMD.

The incentive programs are needed to encourage use of the cleanest technologies sooner rather than later, and establish an early market penetration that would provide manufacturers justification to gear up for mass production. Projects that will be considered for funding will include the expansion of the alternative fuel infrastructure and increased alternative vehicle deployments. It is important to note that these matching funds from the Clean Fuels Program serve to assist in commercialization of alternate fuel vehicles, which is a goal of the SCAQMD Clean Fuels Program.

Potential Air Quality Benefits:

In 1998, diesel exhaust emission was identified as a toxic air contaminant based on its potential human cancer risk. The majority of heavy-duty vehicles in the Basin are powered by diesel engines, which contribute significantly to the Basin's emissions of NO_x and particulates. The use of Clean Fuels Program funds for incentivizing alternative fuel vehicles will result in the direct replacement of diesel engines with low emission engines. Potential benefits include direct NO_x emissions reductions due to introduction of cleaner engines, increased exposure to clean engine alternatives by end users, accelerated commercialization of advanced technologies due to market demand, and expansion of alternative fuel infrastructure in the Basin.

Fuel Cell Technology

Proposed Project: Demonstrate Stationary Fuel Cell with Hydrogen Co-Production

Expected SCAQMD Cost: \$500,000

Expected Total Cost: \$2,000,000

Description of Technology and Application:

High temperature, stationary fuel cells offer near-zero emissions and provide the opportunity to place power production at the demand location (distributed generation) with high efficiency in combined heat and power applications. Solid oxide and molten carbonate fuel cells internally reform natural gas to hydrogen, which is then electrochemically converted to power in the fuel cell stack. This hydrogen stream can be tapped to provide a separate stream for vehicle fueling. The proposed project is to demonstrate a stationary, high temperature fuel cell that co-produces fuel cell vehicle-grade hydrogen. The California Stationary Fuel Cell Collaborative and the California Hydrogen Highway Network effort both identified this type of technology as potentially cost-competitive with large-scale reforming. System efficiency, emissions, hydrogen throughput, hydrogen purity, and system economics will be monitored to determine the viability of this strategy for hydrogen fueling infrastructure deployment and as a means to produce power and hydrogen from renewable feedstocks (biomass, digester gas, etc.)

Potential Air Quality Benefits:

The AQMP identifies the development and implementation of non-polluting power generation as a long-term control measure goal. The SCAQMD also projects a significant increase in the use of clean electrical technologies to replace fossil fuel-fired generation. The proposed program is expected to accelerate the deployment of clean DG and hydrogen fueling by addressing the major commercialization barrier facing both fuel cells and hydrogen: cost.

Further benefits of stationary fuel cells and hydrogen co-production are reduced criteria pollutant emissions, greenhouse gases, and petroleum dependence compared to the conventional technologies for power and vehicles.

Proposed Project: Demonstrate Fuel Cell Vehicle with Vehicle to Grid Power

Expected SCAQMD Cost: \$500,000

Expected Total Cost: \$1,500,000

Description of Technology and Application:

Major automakers have begun to demonstrate their prototype fuel cell vehicles in a few controlled fleet settings in California and Japan. The vehicle designs and degree and method of electrical energy storage on-board the vehicle varies. Cost reduction, better cold start capability, increased peak power for acceleration and passing, higher system efficiency through braking energy recovery and leveling of the load on the fuel cell, and potential increases in fuel cell life are a few of the major reasons why hybrid fuel cell designs have great potential. Fuel cell vehicle designs with vehicle to grid power (VTGP) may encourage faster commercialization of fuel cell vehicles by enabling further economic value by reducing the payback period through reduced grid charges. These vehicles would allow the operator to produce power from the vehicle while parked, thereby acting as a small DG application. Having this power flexibility provides all of the fuel cell DG benefits, i.e. local, clean, reliable, efficient, and independent power.

Development, demonstration and evaluation of a VTGP fuel cell vehicle in a commercial fleet setting and comparison to other fuel cell and hybrid vehicle designs can provide a greater understanding of advanced vehicle design decisions and the market potential for hybrid fuel cell vehicles. An overall systems analysis, encompassing mobile and stationary benefits, would need to be developed to capture all of the attributes of this technology.

Potential Air Quality Benefits:

The AQMP identifies the need to implement zero emission vehicles. The proposed project has the potential to enable faster commercialization of fuel cell vehicles with greater market potential.

Demonstration of a fuel cell hybrid vehicle with VTGP prototype encourages the deployment of fuel cell vehicles by major automakers.

Proposed Project: Develop and Demonstrate Microturbine Fuel Cell Hybrid Technologies**Expected SCAQMD Cost:** \$200,000**Expected Total Cost:** \$800,000**Description of Technology and Application:**

With the price and availability of electricity supply from large power providers becoming increasingly uncertain, on-site generation of power, known as DG, is playing a larger role in the power supply infrastructure of southern California. With few exceptions, the DG technology of choice is a diesel-fueled internal combustion engine driving a generator. This technology is harmful to air quality in that diesel generators emit much larger amounts of NO_x, VOC, PM and carcinogens per unit power produced than large power plants.

Two alternative DG technologies that produce relatively low emissions of NO_x, VOC, PM and carcinogens are fuel cells and microturbine generators. These technologies are much cleaner than diesel generators mainly because they operate on clean fuels such as natural gas or propane. The electrical efficiency of these technologies, compared with diesel generators, is respectively better for fuel cells and somewhat poorer for microturbine generators. However, by combining these two technologies in a synergistic arrangement known as a hybrid fuel cell/microturbine generator (HFCMTG), a new technology is created which has a much better electrical efficiency. HFCMTG is therefore not only substantially cleaner than diesel generators in terms of air emissions but also substantially more fuel-efficient.

Development of a successful HFCMTG has been pursued for several years by researchers and commercial entities, and has been brought to the proof-of-concept stage. The next logical step in the development of this technology would be to build and demonstrate a small prototype unit, which is the principal objective of this project. Specific technical objectives include: (1) a full characterization of the emissions as a function of duty cycle; (2) performance evaluation for grid-connected operation; and (3) design and evaluation of integration into buildings to assure maximization of energy utilization and minimization of pollutant emissions.

Potential Air Quality Benefits:

A successful HFCMTG technology may constitute BACT for DG and would thus replace diesel generators in future DG installations in southern California. This technology would represent at least an order-of-magnitude reduction in NO_x, VOC, PM and carcinogens from the emissions that would otherwise have occurred from diesel generators. Furthermore, because of the far superior fuel efficiency of HFCMTG, which is expected to approach 80 percent, emissions of CO₂ would be less than half those that would be produced by diesel generators for the same amount of power produced. This has the potential to form the next generation of clean and plentiful power source for the Basin and elsewhere, while improving energy security and diversity.

Proposed Project: Develop and Demonstrate Fuel Cells for Off-Road and Construction/Industrial Applications

Expected SCAQMD Cost: \$250,000

Expected Total Cost: \$1,000,000

Description of Technology and Application:

There are many off-road applications that are potential niche markets for fuel cell systems. These applications include recreation vehicles, pleasure boats, camping equipment, lawn and garden equipment, forklifts, boom lifts, portable power units, and construction and industrial vehicles. This project would support the demonstration and deployment of limited number of promising fuel cell systems using direct hydrogen, methanol, ethanol, natural gas or gas-to-liquid fuels derived from natural gas. Among the fuel cell technologies, PEM and direct methanol systems are promising candidates for mobile applications.

Potential Air Quality Benefits:

The AQMP identifies the need to implement zero-emission vehicles. The proposed projects have the potential to accelerate the commercial viability of fuel cell in off-road equipment. Expected immediate benefits include the establishment of zero- and near-zero-emission proof-of-concept vehicles in numerous applications. Over the longer term, the proposed projects could help foster wide-scale implementation of zero-emission fuel cell vehicles in the Basin. This would also lead to significant fuel economy improvements, independence from petroleum imports, manufacturing innovations and the creation of high-tech jobs in Southern California, besides realizing the air quality benefits projected in the AQMP.

Proposed Project: Develop and Demonstrate Fuel Cells for Marine Vessels**Expected SCAQMD Cost:** \$100,000**Expected Total Cost:** \$1,000,000**Description of Technology and Application:**

The diesel engines used to power marine vessels are significant sources of NO_x, SO_x, and particulate emissions in the Basin. A previous project co-funded by the EPA and SCAQMD resulted in significant emissions reductions from a tug boat by simply replacing the old diesel engine with a new diesel engine. The proposed project would focus on replacing these conventional diesel engines with near-zero-emission, fuel cell technologies for pleasure craft and other marine applications. The demonstration would be conducted in the Port of Los Angeles, Newport Harbor, or other applicable location. The results from the proposed project will allow early insights into potential candidate technologies for emissions controls on larger ships operating in Basin waters.

Potential Air Quality Benefits:

The 2003 AQMP estimates that ships and commercial boats operating in the Basin contributes approximately than 40 tons per day of NO_x and around 30 tons per day of SO_x. Gasoline-fueled pleasure craft operating in the Basin, including recreational boats and personal water craft, contributes approximately 55 tons per day of VOC, around 300 tons per day of CO, and more than 3 tons per day of PM₁₀ emissions. These emissions clearly indicate the need for advanced technologies to reduce emissions from these types of marine vessels.

The potential benefits of the proposed project include proof-of-concept of the new technology, increased exposure and user acceptance, diversification of fuels used to power marine vessels and ships, direct emission reductions in NO_x and PM from the in-Basin demonstrations, and the potential for expedited commercialization. In addition, the successful demonstration of the dual fuel technology with a tug boat or the hybrid electric drive system could assist in developing similar controls for large freighter vessels, which are responsible for the majority of emissions from ships and commercial boats.

Proposed Project: Develop and Demonstrate Fuel Cells in Vehicle Applications

Expected SCAQMD Cost: \$4,000,000

Expected Total Cost: \$12,000,000

Description of Technology and Application:

This proposed project would support the demonstration of promising fuel cell technologies for vehicle applications using direct hydrogen in PEM fuel cell technologies. Battery fuel cell hybrids are another potential technology being mentioned by battery experts as a way of reducing costs and enhancing performance of fuel cell vehicles.

With the implementation of the California Hydrogen Highway Network, supplemented by the existing and planned hydrogen refueling stations in the Southern California area, pre-production vehicles are planned for demonstration in controlled fleets, such as local cities, transit authorities, and airports. Some of these pre-production vehicles include light-duty trucks, as well as small to full size transit and shuttle buses. Fleets are useful demonstration sites because economies of scale exist in central refueling, in training skilled personnel to operate and maintain the vehicles, in the ability to monitor and collect data on vehicle performance, and for manufacturer technical and customer support. These vehicles could include hybrid-electric vehicles powered by range-extending fuel cells equipped with batteries capable of being charged off the grid.

Relation to AQMP and Potential Benefits:

The AQMP identifies the need to implement zero-emission vehicles. SCAQMD adopted fleet regulations requiring public and some private fleets within the Basin to acquire alternatively fueled vehicles when making new purchases. In the future, such vehicles could be powered by zero-emission fuel cells operating on hydrogen fuel. The proposed projects have the potential to accelerate the commercial viability of fuel cell vehicles. Expected immediate benefits include the establishment of zero- and near-zero-emission proof-of-concept vehicles in numerous applications. Over the longer term, the proposed projects could help foster wide-scale implementation of zero-emission fuel cell vehicles in the Basin. The proposed projects would also lead to significant fuel economy improvements, manufacturing innovations and the creation of high-tech jobs in Southern California, besides realizing the air quality benefits projected in the AQMP.

Hydrogen Technology and Infrastructure

Proposed Project: Develop and Demonstrate Vehicles Utilizing Hydrogen in Internal Combustion Engines

Expected SCAQMD Cost: \$1,000,000

Expected Total Cost: \$5,000,000

Description of Technology and Application:

The SCAQMD has been involved in the development and demonstration of light-duty and heavy-duty vehicles operating on hydrogen as their primary fuel, including a full size transit bus. The proposed project is to continue developing and demonstrating additional platforms, including medium-duty shuttles that can be operated in various city and airport fleets. Some OEMs have expressed interest in developing engine technology capable of running on compressed hydrogen. The development of energy efficient systems reduces emissions associated with energy generation and is a criterion for projects funded under this category.

Relation to AQMP and Potential Benefits:

Certification of low-emission vehicles and engines, and their integration into the Basin's transportation sector is a high priority under the AQMP. This program is expected to develop hybrid technologies that could be implemented in medium- and heavy-duty trucks, buses, and other applications. Benefits will include proof of concept for the new technologies, diversification of transportation fuels, and lower emissions of criteria and toxic pollutants.

Proposed Project: Demonstrate 10,000 PSI Refueling

Expected SCAQMD Cost: \$1,000,000

Expected Total Cost: \$3,000,000

Description of Technology and Application:

Currently, most hydrogen fueled vehicles utilize the 5,000 PSI refueling option; however due to the low volumetric energy density of hydrogen gas, the 10,000 PSI refueling option will potentially allow a significant increase in on-vehicle storage capacity and vehicle range. This project will allow SCAQMD to demonstrate the 10,000 PSI refueling option and its effectiveness.

Potential Air Quality Benefits:

Potential air quality benefits are recognized by the use of hydrogen as a vehicle fuel. Vehicles using hydrogen as a fuel have demonstrated substantial reductions in tailpipe emissions and related evaporative emissions as compared to gasoline fueling. The higher pressure refueling option will also reduce the number of refueling stops and associated fuel wasted in performing these stops.

Proposed Project: Develop and Demonstrate Hydrogen-Natural Gas Internal Combustion Engines

Expected SCAQMD Cost: \$1,300,000

Expected Total Cost: \$4,000,000

Description of Technology and Application:

Over the past few years, the AQMD has initiated the development of a hydrogen refueling station network across the South Coast. Subsequently, the State of California has recently announced its intent to develop a hydrogen highway, with hydrogen refueling stations expected to be built at an average distance of 20 miles throughout the state. In recognition of these strategically-placed refueling stations, automotive OEMs have initiated limited fleet demonstrations of hydrogen-powered fuel cell vehicles in these areas. However, due to the cost and on-going technology issues, automotive OEMs plan to place a limited number in service (approximately 250 over the next four years). In parallel, there has been a significant amount of technology development for converting existing ICE vehicles to operate on hydrogen in place of gasoline. Automotive OEMs, as well as other smaller firms, have successfully developed prototypes of hydrogen ICE vehicles with near-zero emissions. These hydrogen ICE vehicles can be developed at a fraction of the cost of a fuel cell vehicle and utilize the growing hydrogen infrastructure in the near future, as the fuel cell technology is further refined.

This project is to develop, certify for emissions and safety, and demonstrate hydrogen ICE vehicles for a variety of uses. The goal of the project is to achieve a minimum of SULEV emission certification for the hydrogen ICE vehicles. The expected project partners may include auto OEMs, including small volume manufacturers, conversion firms, hydrogen fueling and certification experts, and local fleets.

The transition to hydrogen fuel will require bridging technologies to utilize the hydrogen infrastructure while fuel cell vehicles are being developed and deployed. One such bridging technology is hydrogen-natural gas mixture ICE vehicles. These vehicles will be able to use conventional engine technology and optimize the performance and emissions to operate on hydrogen and natural gas fueling blends. ICEs converted to run on hydrogen and natural gas are optimized to operate on very lean fuel mixtures, reducing peak combustion temperatures, which can result in very low exhaust emissions. Such vehicles will help in the transition to hydrogen as well as utilize the existing, well-developed natural gas infrastructure.

This project will seek to convert existing natural gas or gasoline vehicles to allow the use of hydrogen and natural gas mixtures to demonstrate the technology in a variety of applications.

Potential Air Quality Benefits:

The AQMP identifies on-road mobile sources as one of the largest contributors of air pollution in the basin, and therefore considers the development and implementation of non-polluting power generation as a long-term control measure goal. Certification of low-emission vehicles and engines, and their integration into the Basin's transportation sector is a high priority under the AQMP. This program is expected to further develop and validate new technologies, diversification of transportation fuels, and low emissions of criteria and toxic pollutants.

Proposed Project: Demonstrate Hydrogen-CNG Compatibility

Expected SCAQMD Cost: \$300,000

Expected Total Cost: \$1,000,000

Description of Technology and Application:

Natural gas promises to be a potential bridge to hydrogen fueling for vehicles. Hydrogen, however, will not replace natural gas in the near future, and it anticipated that both fuels will co-exist as pure fuels and as blends (hydrogen-CNG). This potential project is to develop and demonstrate a hydrogen-CNG refueling station that can provide hydrogen, CNG, and a blended fuel both as a new installation and as a retrofit of an existing CNG station.

Potential Air Quality Benefits:

Natural gas and hydrogen fuels offer reduced emissions compared to similar, conventional gasoline powered vehicles. Hydrogen when used in a fuel cell has near-zero emissions. Preliminary results from hydrogen-CNG blended fuels also indicate reduced emissions compared to natural gas vehicles in heavy-duty applications.

The further benefits of reduced petroleum use, greenhouse gas emissions, and energy diversity may also be realized through the use of hydrogen and natural gas.

Proposed Project: Perform Hydrogen Fuel Quality Development Study

Expected SCAQMD Cost: \$5,000

Expected Total Cost: \$500,000

Description of Technology and Application:

This study is being conducted to determine the analytical levels of various contaminants in hydrogen fuel that can be reliably measured and validated. The study will also examine the impact of these contaminants at these levels on fuel cell membranes and other related components. This funding is in support of activities being carried out by the National Fuel Cell Council (USFCC) and the American Society for Testing and Materials (ASTM).

Potential Air Quality Benefits:

The commercialization of fuel cells, particularly those using hydrogen as the fuel shows great potential to replace existing gasoline and diesel engine technology in vehicles. Fuel quality and the understanding of its impacts on fuel cells is crucial to the commercialization of fuel cells in vehicles. This is an important step in the process of making fuel cell vehicles viable commercial products.

Proposed Project: Develop and Demonstrate Heavy-Duty Truck On-Board Electrolyzer

Expected AQMD Cost: \$40,000

Expected Total Cost: \$ 200,000

Description of Technology and Application:

This proposed project is to produce and store hydrogen on-board heavy-duty vehicles by electrolyzing water. The electrolyzer can be powered through the alternator of the vehicle while the vehicle is being propelled by its engine. Heavy-duty vehicle engines have enough excess power to provide energy for such an application.

The hydrogen that is generated by this electrolysis process can be stored on-board in pressurized containers or metal hydrides, and used to power a fuel cell to provide electrical power for truck cabs (for TVs, radios, microwave ovens, computers, etc.), heating and air conditioning for truck cabs, and other auxiliary power applications without idling the main diesel ICE engine while the vehicle and the driver are at rest. Typically, a truck cab requires about 1.5 – 2kW for this purpose.

SCAQMD's truck APU project with U.C. Davis has already reached the stage where the PEM fuel cell can provide power to the cab (about 2.5 kW peak load). This fuel system can be used in conjunction with the stored on-board hydrogen in this project.

Potential Air Quality Benefits:

Main engines on trucks are idled to provide electrical power to the cab for the above mentioned purposes. These engines idle at about 5-10 percent load and diesel ICEs are extremely fuel inefficient at these low load levels. Idling also produces a lot of air pollution and noise pollution.

Currently there are over 350,000 heavy-duty vehicles in California. These vehicles generate an estimated 430 tons of PM annually. Truck idling in California wastes about 800 million gallons of diesel fuel annually. CARB is in the process of developing an air toxic control measure (ATCM) for existing heavy-duty vehicles. This ATCM, which will include limited idling times, truck stop electrification, and cleaner technologies is expected to be adopted by CARB's Board in May 2004. SCAQMD is working with CARB in developing control strategies for this ATCM.

The National Heavy-Duty Vehicle Idling committee is currently studying emission impacts from idling of trucks, locomotives, and all other heavy-duty vehicle engines. SCAQMD is a part of this committee. This committee is holding a national conference in May 2004.

SCAQMD has developed Rules 1633 and 1634, which are pilot credit generation rules, for truck stop and truck electrification which will reduce idling. The AQMP addresses heavy-duty vehicle idling issues in the on-road heavy-duty vehicle section.

Proposed Project: Develop and Demonstrate Distributed Hydrogen Production and Fueling Stations

Expected SCAQMD Cost: \$1,500,000

Expected Total Cost: \$4,000,000

Description of Technology and Application:

Alternative fuels such as hydrogen and the use of advanced technologies such as fuel cell vehicles may be necessary to meet future clean air standards. A key element in the widespread acceptance and resulting increased use of alternative fuel vehicles is the development of an infrastructure to support the refueling of vehicles, cost-effective production and distribution, and clean utilization of these new fuels.

A major challenge to the entry and acceptance of direct-hydrogen fuel cell vehicles is the limited number of hydrogen refueling sites. This program would support the development and demonstration of hydrogen refueling technologies. Proposed projects would address:

- *Fleet and Commercial Refueling Stations.* Pre-production hydrogen fuel cell vehicles are being introduced for controlled fleet demonstrations as part of the California Fuel Cell Partnership program, and other OEM programs. In 2002, the SCAQMD Governing Board approved the funding to develop five new hydrogen fueling sites in the District. The objective of this project is to continue to expand the development and demonstrate the distributed production and distribution of hydrogen to support these vehicles in the Basin. Hydrogen refueling stations will be installed at strategic locations within the Basin to enable fuel cell vehicles of various types to travel within the greater Los Angeles metro region. Several hydrogen production technologies are envisioned for these sites. Likely candidates would include electrolysis of water using grid power or renewable sources, steam reforming of methanol or natural gas, and partial oxidation of other liquid fuels such as gasoline. Multiple use energy stations, that can produce hydrogen for fuel cell vehicles or for stationary power generation, are also included in this demonstration project.
- *Home Refueling Appliances:* Home refueling/recharging is among the advantages offered by many alternative clean fuels. A project has already been initiated for demonstrating a natural gas home refueling appliance for personal vehicles. It is anticipated that the appliance will be commercially available by the end of 2003. This project would be extended for hydrogen refueling and these technologies could be evaluated for cost, compactness, performance, durability, emission characteristics, ease of assembly and disassembly, maintenance, and operations. Other issues such as building permits, building code compliance, and UL ratings for safety will also be evaluated.

Potential Air Quality Benefits:

The AQMP identifies the use of alternative clean fuels in mobile sources as a key attainment strategy. Pursuant to AQMP goals, the SCAQMD recently adopted several fleet rules that require public and certain private fleets to purchase clean-burning alternative-fueled vehicles when adding or replacing vehicles to their vehicle fleets. Fuel cell vehicles constitute the cleanest alternative-fuel vehicles today. Since hydrogen is a key fuel for fuel cell vehicles, this program would address some of the barriers faced by hydrogen as a fuel and, thus, assist in accelerating its acceptance and ultimate commercialization. In addition to supporting the immediate deployment of the demonstration fleet, expanding the hydrogen fuel infrastructure should contribute to the market acceptance of fuel cell technologies in the long run, that lead to substantial reductions in NO_x, VOC, CO, PM, and toxic compound emissions from vehicles.

Proposed Project: Develop and Demonstrate Reformer Technology for Hydrogen Production

Expected AQMD Cost: \$50,000

Expected Total Cost: \$ 250,000

Description of Technology and Application:

This proposed project is to produce and store hydrogen at existing gas stations and truck stops by reforming liquid fuels (gasoline, diesel) and propane. The infrastructure for gasoline and diesel already exists, and most truck stops in the U.S. sell propane. The hydrogen can be used to refuel ICEs in cars and future hydrogen-powered fuel cell cars. The hydrogen can also be used to provide fuel to reduce heavy-duty vehicle idling as mentioned in the above proposed project, Hydrogen Technology and Infrastructure.

This method of hydrogen production will not necessitate the development of an intricate infrastructure for this fuel. The hydrogen can be stored in pressurized tanks or in metal hydrides. For this application, the weight of metal hydrides to hydrogen absorption is not much of a concern because it is a stationary source application.

ChevronTexaco and other OEMs are currently developing reformers that can be used to produce hydrogen from propane and liquid fossil fuels. These reformers can be used for this application. The ChevronTexaco reformer can currently produce PEM fuel cell quality hydrogen from propane, and they are in the process of technology development to reform gasoline and diesel.

Potential Air Quality Benefits:

The AQMP identifies the use of alternative clean fuels in mobile sources as a key attainment strategy. The hydrogen demonstration will help address the fuel production and storage issues associated with fuel cell vehicles and, thus, assist in accelerating its acceptance and ultimate commercialization. Further, the co-location of power producing technologies offers hydrogen producers alternatives to consider while fuel cell vehicle numbers and use rise. Widespread adoption of such technologies would lead to direct reductions in NO_x, VOC, CO, PM, toxics and global warming emissions from light-duty and medium-duty vehicles as well as back up and premium power generators.

Engine Technology

Proposed Project: Demonstrate Twin-Speed Marine Engines

Expected SCAQMD Cost: \$250,000

Expected Total Cost: \$500,000

Description of Technology and Application:

Twin speed marine transmissions reduce engine speed and enhance fuel use and emissions without significantly affecting vessel speed. The technology is applicable to planing hull vessels, e.g., crew, supply, pilot, fishing, recreational boats and possibly barge towing tugs. While twin speed transmissions are commercially available for certain horsepower ranges and duty cycles, virtually all recreational and commercial vessels in the SCAQMD use single speed transmissions. Based on experience, commercial vessel operators are reluctant to use twin speed transmissions because twin speed transmissions represent a new, untested technology.

The second gear can achieve nearly the same top end vessel speed as a single speed transmission at substantially lower engine RPM and fuel consumption (25 to 30 percent). Unless the propeller speed is governed (limited), the use of twin speed transmission could result in a substantial increase in vessel fuel consumption. Experimental data indicates that if the propeller speed can be regulated in second gear, it is probable that a twin speed transmission could reduce emissions of all pollutants in the order of 25% to 30% without a significant sacrifice in vessel performance.

This project will also include vessel performance and emissions testing.

Potential Air Quality Benefits:

It is estimated that the use of a twin speed marine transmission can reduce emissions of NO_x, HC, PM and CO from marine diesel engines used in planing hulls and, possibly, barge towing applications by 25% to 30%. Assuming a planing hull vessel is powered by twin 250 hp diesel engines, that operates 1500 hours per year at a 70 percent average load, the baseline emission rate of NO_x, HC and PM (combined) is 7.5 grams/bhp-hr, and the technology has a 25 percent; emission reduction efficiency, emissions of NO_x, HC and PM would be reduced by just over one ton per year (combined).

In addition, each gallon of diesel fuel contains hidden environmental costs. A substantial amount of air pollution and energy is required to explore for, extract, transport and refine crude oil, and ship refined products to market. Any technology that reduces fuel consumption will reduce “up-stream” environmental costs as well.

Assuming a 10 year project life and the use of the CRF method at 5 percent, cost-effectiveness would be approximately \$3,200 per ton of NO_x reduced.

Proposed Project: Develop and Demonstrate Advanced Alternative Fuel Heavy-Duty and Medium-Duty Engines and Vehicles

Expected SCAQMD Cost: \$2,000,000

Expected Total Cost: \$4,000,000

Description of Technology and Application:

The objective of this proposed program is to support development and certification of near commercial prototype low emission heavy-duty alternative fuel engine technologies and demonstration of these technologies in on-road vehicles. The NO_x emissions target for this program area is 0.5 g/bhp-hr and PM emissions target is below 0.01 g/bhp-hr. This program is expected to result in several projects, including:

- Demonstration of advanced natural gas engines in medium-duty and heavy-duty vehicles
- Development of durable and reliable retrofit technologies to convert engines and vehicles from petroleum fuels to alternative fuels

The program proposes to expand field demonstration of these advanced technologies in various vehicle fleets operating with different classes of vehicles.

The use of alternative fuel in heavy-duty trucking applications has been demonstrated in certain local fleets within the Basin. These vehicles typically require 200-300 horsepower engines. Higher horsepower alternative fuel engines are beginning to be introduced. However, vehicle range, lack of experience with alternative fuel engine technologies, and limited selection of appropriate alternative fuel engine products has made it difficult for more firms to consider significant use of alternative fuel vehicles. For example, in recent years, several large trucking fleets have expressed interest in using alternative fuels. However, at this time the choice of engines over 350 HP or more is limited. Continued development of cleaner dedicated natural gas, or other alternative fuel engines such as natural gas-hydrogen blends over 350 HP would increase availability to end-users and provide additional emission reductions.

Potential Air Quality Benefits:

This proposed program supports the 2003 AQMP Mobile Sources Control Measure, On-road Heavy-Duty-3, "Pursue Approaches to Clean-up the Existing and New Truck/Bus Fleet."

This program is intended to expedite the commercialization of low emission alternative fuel heavy-duty engine technology in California, both in the Basin and in intrastate operation. By working cooperatively with other local air districts and the CARB, the SCAQMD can leverage its funds and provide a statewide air quality benefit. The emission reduction benefit of replacing one 4.0 g/bhp-hr heavy-duty engine with a 0.5 g/bhp-hr engine in a vehicle that consumes 10,000 gallons of fuel per year is about 1400 lb/yr of NO_x. Clean alternative fuels, such as natural gas, or natural gas blends with hydrogen can also reduce heavy-duty engine particulate emissions by over 90 percent compared to current diesel technology. This program is expected to lead to increased availability of low emission alternative fuel heavy-duty engines. Fleets can use the engines and vehicles emerging from this program to comply with recently adopted SCAQMD regulations.

Proposed Project: Demonstrate Lower Emission Locomotives**Expected SCAQMD Cost:** \$1,500,000**Expected Total Cost:** \$7,000,000**Description of Technology and Application:**

SCAQMD has previously supported the GasRail USA program which has successfully led to the development of LNG combustion technology capable of reducing locomotive NO_x emissions by 75 percent or more compared to conventional diesel technology. Unfortunately, the OEM involved in GasRail, GM-Electromotive Division (EMD), withdrew from the consortium and has chosen not to participate in a field demonstration. The CARB has also entered into a Memorandum of Understanding (MOU) with the Class-1 railroads who operate in the Basin (Burlington Northern Santa Fe and Union Pacific). By 2010, these railroads have agreed to meet the tightest adopted Tier-II standards, on average, with their locomotives operating in the Basin. Hybrid locomotives have been commercialized for switching applications. These units have lower emissions because they rely upon a large battery pack to supply peak locomotive power instead of a large diesel engine; the battery pack is recharged by a smaller diesel generator set.

The purpose of the proposed project is to support the demonstration of low-emission locomotives in the Basin, either utilizing LNG combustion systems, low-emission engine calibrations, exhaust after-treatment technology, zero-emission electrics or hybrid-electric technology. Both LNG spark-ignition and diesel-pilot compression ignition technology have been developed and demonstrated for certain locomotive applications. In addition, locomotive engine manufacturers and component suppliers are developing low-emission Tier-II calibrations for existing base locomotive engines. Such calibrations will allow the Class-1 railroads to meet their emission obligations under the CARB MOU using rebuilt locomotives rather than purchasing new Tier-II locomotives as they have planned. Such technology would also be applicable to Class-2 and 3 railroads and passenger locomotives which operate mainly within the Basin. On-road exhaust after-treatment technology is available for application to locomotive engines, especially for the smaller generator sets found on passenger locomotives (Head-End Power). Zero-emission electric and dual-mode (electric & diesel) locomotives are currently used at selected locations in the U.S. to match available infrastructure or to meet local environmental needs. Such locomotives could also be demonstrated for selective applications such as the Alameda Corridor or for steep rail grades within the Basin. Finally, locomotive manufacturers have investigated hybrid electric for larger locomotives. Demonstrating such retrofit technology in certain locomotive applications could significantly reduce emissions.

Potential Air Quality Benefits:

The AQMP emissions inventory shows that about 35 tons/day of NO_x emissions come from locomotives. The U.S. EPA and CARB have agreed to a program that will reduce emissions from these sources by about 65 percent by 2010. However, sooner reductions are necessary to provide additional NO_x benefits for the Basin to achieve federal PM₁₀ air quality standards by 2006. As proven in the GasRail USA program, natural gas combustion systems can meet and exceed these NO_x emission reductions while also achieving significant reductions of PM compared to conventional diesel technology. This project will continue development and demonstration of low-emission LNG technology. This has the potential to NO_x and PM emissions by more than 75 percent.

Proposed Project: Develop and Demonstrate Low-Emission LPG Street Sweeper

Expected SCAQMD Cost: \$250,000

Expected Total Cost: \$500,000

Description of Technology and Application:

SCAQMD Rule 1186.1 requires the use highly efficient street sweepers in the Basin which release limited exhaust PM. SCAQMD Rule 1196 requires that heavy-duty public fleet vehicles be fueled by alternative fuels including natural gas and liquefied petroleum gas (LPG). At present, most public fleet street sweepers use natural gas sweepers. However, some sweeping operations are unable to use natural gas because such equipment is used at many locations in the Basin where natural gas refueling is not available.

This proposed project would develop and certify an LPG-conversion of a gasoline truck engine which would meet the future heavy-duty emission standards of 0.2 g/bhp-hr NOx. This LPG engine and fuel system would then be installed into a truck chassis with a modern street sweeper body. This low-emission LPG street sweeper would then be demonstrated in regular service.

Potential Air Quality Benefits:

By developing another low-emission alternative-fuel street sweeper, the number of exemptions from compliance with Rule 1196 will be reduced. The emission benefits for the sweepers, however, will be small since only about six exemptions are granted annually. Nonetheless, this LPG engine will also be available for use in other exempted class 6 and 7 public fleet trucks. Approximately 50 exemptions for these truck classes are granted annually.

Proposed Project: Demonstrate Odorized LNG

Expected SCAQMD Cost: \$250,000

Expected Total Cost: \$300,000

Description of Technology and Application:

The AQMP identifies the use of alternative clean fuels in mobile sources as a key attainment strategy. Alternative fuel vehicles, such as NGVs, have demonstrated significantly lower VOC, NO_x, CO and toxic emissions than gasoline and diesel vehicles. LNG has become the alternative fuel of choice for some heavy-duty NGVs because of the high energy density of the stored fuel and the increased vehicle range it affords. Natural gas delivered by pipeline to commercial and residential users contains odorants to alert consumers of gas leakage. These odorants are also found in CNG which usually originates from odorized pipeline natural gas. However, LNG is a cryogenic liquid (kept at – 259° F) at which normal natural gas odorants freeze and separate and are not useful for leakage warning. Because of the lack of odorants in LNG, LNG vehicles require on-board methane detection systems. These detection systems and their associated cost are not required by CNG nor propane (LPG) vehicles because these fuels are odorized.

Under a previous SCAQMD project, various odorants for LNG were investigated, three of these compounds were found suitable, and an LNG-blending scheme for them using propane was developed. Under this proposed project, it is proposed that one LNG station would provide odorized LNG, likely for a private LNG station. The maintenance of LNG vehicles refueled at the station would then be monitored as well as the experience of the shop personnel and drivers. The purpose of such a demonstration would be to demonstrate the viability of odorized LNG (OLNG) in a small fleet of LNG vehicles.

Potential Air Quality Benefits:

The AQMP relies on the expedited implementation of advanced technologies and clean-burning fuels in southern California to achieve air quality standards. By developing and demonstrating OLNG, another safety option for LNG vehicles will be provided at lower cost. The indirect emission benefits from greater use of LNG vehicles because of the odorant technology cannot be directly estimated.

Proposed Project: Demonstrate Conversion of Landfill Gas to LNG

Expected SCAQMD Cost: \$1,000,000

Expected Total Cost: \$9,000,000

Description of Technology and Application:

Waste Management (WM) is committed to conversion of its entire trash hauling truck fleet to clean burning LNG. WM, in partnership with Vision Energy are proposing to convert landfill gas (LFG) to LNG using a combination of conventional, off-the-shelf technologies in a cost effective manner. The proposed process for the Simi Valley landfill utilizes refrigerated methanol absorption and consists of two proven steps: upgrading of landfill gas to nearly pure methane and liquefaction of the upgraded gas. LFG upgrading with refrigerated methanol has been successfully done at four locations in the eastern US during the past six years. The liquefaction module is integrated with the purification step to produce vehicle grade LNG. Liquefaction of natural gas is a mature process and has been done at over 40 locations in the US. The plant would be designed to produce approximately 12,000 gallons per day of vehicle grade LNG.

Potential Air Quality Benefits:

The LFG at Simi Valley is now being flared which wastes an in-state energy resource and contributes harmful atmospheric emissions in the South Coast Air Quality Management District. Twelve thousand gallons per day of LNG could fuel at least 100 heavy duty trucks that now operate on diesel fuel thus displacing over 7,000 GPD of diesel usage. The current LFG output at the Simi Valley facility is approximately 2,000,000 SCFD. Flaring of this gas wastes about 1,000,000 SCFD of methane and creates approximately 4.5 tons per year of NOX emissions. Upon completion and activation of the project about 85 percent of this resource would be recovered in the form of LNG fuel. The remaining 15 percent would be converted to electric power

Proposed Project: Demonstrate Conversion of Bio-Fuels to Natural Gas

Expected SCAQMD Cost: \$750,000

Expected Total Cost: \$2,500,000

Description of Technology and Application:

Kelly Space Technologies has developed a proprietary, very low emission process that uses biomass waste materials, specifically dairy manure, to synthetically generate pure methane. The Methane can be substituted for pipeline quality natural gas, for sale as a commodity at substantially lower prices than natural gas. The process provides an affordable renewable energy source generated from waste products currently disposed of in landfills or elsewhere. This process permits the production of methane in sufficient quantities to result in substantial economic benefit for U.S. energy consumers and could eventually eliminate our dependence on foreign imports of natural gas. This clean-up of existing waste piles would be very beneficial from an air quality standpoint. Partners in this venture are the Milk Producers Council, the Western United Dairymen, and individual dairy owners/operators.

Potential Air Quality Benefits:

In August of 2004, the SCAQMD adopted Rule 1127 in an effort to reduce ammonia, VOC and PM10 emissions from livestock waste. The GES system could be extremely effective in eliminating the estimated 10 million tons of dairy manure currently piled up throughout the Chino Basin. This clean-up of existing waste piles would be very beneficial from an air quality standpoint. Moreover, this system would qualify as an “Alternative Control Option” under paragraph (k) of Rule 1127. As an alternative to the centralized “manure processing operation” envisioned in the Rule, economies of scale would be an advantage.

Proposed Project: Demonstrate Equipment to Reduce Propane Fueling Emissions

Expected SCAQMD Cost: \$53,000

Expected Total Cost: \$348,000

Description of Technology and Application:

The LP Gas industry has concluded that LP gas emissions must be dramatically reduced from refueling operations. LP gas tanks of every type (e.g. BBQ, residential, forklift, automotive, commercial, industrial, etc.) are refilled everyday and leak approximately 7 tons of VOC emissions per day into the SCAB atmosphere during these fueling operations. A simple instrument and valve assembly (Maximus) would prevent such emissions from escaping into the atmosphere. Such a device has already been developed but not tested for this application. The Propane Education and Research Council, Motorola, Inc. and ASCENT will partner and participate in the demonstration and commercialization of the Maximus instrument. The total project cost is \$348K. SCAQMD is requested to contribute \$53K to this project.

Potential Air Quality Benefits:

According to the American Petroleum Institute in 2002, about 415,864,000 gallons of LP gas were sold in California. Close to half of this volume is estimated to have been sold in SCAQMD's territory. The average amount of LP gas escaping during a tank's refill is estimated to be ~0.63% of the volume filled. Thus, in SCAQMD's territory, in 2002 about 1.2M gallons of LP Gas were emitted. This amounts to ~7.1 T/day of additional VOC's pollution in SCAQMD's. The Maximus instrument will eliminate emissions, reduce health and safety risks, as well as allow for more product to be available to the end user territory.

Infrastructure and Fuel Production

Proposed Project: Demonstrate Natural Gas Vehicle/CNG Home Refueling Appliance Buydown

Expected SCAQMD Cost: \$600,000

Expected Total Cost: \$800,000

Description of Technology and Application:

Light-Duty Natural Gas Vehicles

Light-duty NGVs are spark-ignited, internal combustion vehicles less than 6,000 pounds gross vehicle weight, used primarily to transport 6 or less passengers. Light-duty NGVs have been available commercially for more than twenty years and are increasingly becoming the choice of many individuals as their personal use vehicle. NGVs are also the cleanest burning and lowest polluting internal combustion engines commercially available and their wider use can significantly contribute to the reduction of ozone forming pollutants, particularly NOx. The SCAQMD has provided significant funding to help light-duty fleet operators purchase natural gas vehicles, in particular taxicabs subject to Fleet Rule 1194 – Commercial Airport Ground Access.

Home Refueling Appliance (HRA)

The growth and expansion of NGVs in the public sector has occurred concurrently or symbiotically with the growth and expansion of the CNG fueling infrastructure. Currently more than 60 publicly accessible CNG stations, many with credit card reading equipment, operate in the SCAQMD. An additional 24 facilities will be operational by June of 2006. Although the CNG fueling infrastructure has expanded dramatically, the primary users of CNG are fleet operators. The necessary expansion of privately owned NGVs and the concurrent displacement of conventional fueled vehicles is a critical component in significantly reducing air contaminants in the SCAQMD.

Marketing research by private corporations in the NGV industry have found a significant interest among private motorists in refueling their vehicle from their own home, and home refueling would add incentive to purchasing such a vehicle. Vehicles operating on CNG have an advantage in home refueling as they can make use of the existing supply of natural gas piped into most homes.

The Home Refueling Appliance (HRA) is a small, compact, gas compressor capable of delivering 3,000 or 3,600 psig natural gas at a rate of 0.3 ft³/hour, making it a suitable overnight fueling appliance for light-duty NGVs. The unit measures 30"x14"x13" (HxWxD) and weighs approximately 85 pounds and will be wall mounted (it can fit between studs of a standard unfinished residential wall) either indoors in an unoccupied area (i.e. garage) or outdoors. The HRA uses residential piped natural gas, but its user will be charged transportation fuel rates rather than residential heating rates, thereby avoiding the significant surcharge on residential gas use above a homeowner's baseline amount. The HRA was developed with sponsorship from the SCAQMD and has recently received certification as a Natural Gas Vehicle Fueling Appliance from the Canadian Standards Association (CSA) International, a testing laboratory equivalent to Underwriters Laboratory (UL). This certification assures consumers of the product's safety and qualifies it as compatible for home installation.

Potential Air Quality Benefits:

As a source category, mobile sources contribute the greatest amounts of emissions in the SCAQMD and the authority to regulate and set emissions standards for mobile sources resides solely with the U.S. EPA and the CARB. The CARB certifies all new motor vehicles and engines for emission compliance before they are legal for sale, use, or registration in California. Natural gas vehicles are the cleanest of internal combustion vehicles. Until now the SCAQMD has primarily sponsored the

purchase or retrofitting of medium and heavy-duty fleet vehicles with CNG or LNG, furthering their advancement and development, and their use in many municipal and private fleets.

This project will focus on increasing private ownership and general public awareness of passenger class NGVs and the concept and realization of home refueling. As a leader in NGV development, marketing, and sales Honda Motor Company has said it has sold 600-1000 NGV Civics nationwide in the last 5 years, primarily in New York and California. For 2005, Honda estimates it will sell more than 400 NGV Civics to private individuals alone in Southern California.

Marketing research has shown that the concept of home refueling attracts many private motorists, and would convince many to purchase a vehicle which is capable of home refueling. The SCAQMD intends to work with the Mobile Source Emission Reduction Committee (MSRC) to provide incentive funding to private individuals, accentuating the HRA and setting a goal of 200 NGVs and 200 HRAs.

Proposed Project: Upgrade of Existing Natural Gas Infrastructure

Expected SCAQMD Cost: \$250,000

Expected Total Cost: \$1,000,000

Description of Technology and Application:

As natural gas fueling equipment begins to age or has been placed in demanding usage, components begin to age and deteriorate. This program offers an incentive to facilities to replace worn-out equipment or to upgrade existing equipment to offer increased fueling capacity to the public.

Potential Air Quality Benefits:

While having no direct impact on air emission reductions, new CNG stations will help facilitate the introduction of low emission, natural gas fueled vehicles (NGVs) initially in private and public fleets in the area. Such increased penetration of NGVs will provide direct emissions reductions of NO_x, VOC, CO, PM, and air toxic compounds throughout the Basin.

Proposed Project: Develop and Demonstrate Advanced Natural Gas Systems for Refueling Stations

Expected SCAQMD Cost: \$750,000

Expected Total Cost: \$4,000,000

Description of Technology and Application:

This program would support the development, demonstration and implementation of natural gas fueling station technologies to reduce private investment costs, increase the overall number of such fueling stations in strategic locations throughout the Basin, reduce the cost of natural gas equipment, standardize fueling station design and construction, and provide outreach in two key market segments.

Small Refueling Stations. Small private and public fleets are currently constrained in their NGV refueling choices, and do not possess in-house expertise or financial resources to design or install a fueling station. They are also unaware of governing codes or standards affecting such an installation. Providing outreach and financial incentives, reducing the cost and improving the safety, reliability and performance life of fueling station equipment could significantly increase the penetration of natural gas fueling stations.

Large Fast-Fill NGV Refueling Stations. Conventional gasoline refueling stations typically refuel between 100 to 300 vehicles per day. The perceived high costs of a fast-fill NGV refueling station that could refuel a similar number of vehicles has significantly curtailed the growth of a NGV refueling infrastructure. The project is intended to provide outreach and financial incentives, advance the technology of compressors, gas-dryers, dispensers, fuel meters, and other major subsystems of a NGV fueling station system. The proposed improvements are expected to improve the performance, and lower the capital cost and operating costs of fast-fill NGV refueling stations.

Potential Air Quality Benefits:

The AQMP identifies the use of alternative clean fuels in mobile sources as a key attainment strategy. The CARB has also passed LEV regulations that require light-duty vehicles to comply with increasingly stringent emission standards. The CARB has passed analogous standards for medium- and heavy-duty vehicles. NGVs have significantly lower emissions than gasoline vehicles and represent the cleanest internal combustion engine powered vehicles available today.

The project would significantly reduce the installation and operating costs of NGV refueling stations, besides improving the refueling time. This would lead to the expansion of the NGV fueling infrastructure and greater consumer acceptance, which in turn, should support expedited commercial implementation of NGVs. The increased exposure and fleet and consumer acceptance of NGVs would lead to significant and direct reductions in NO_x, VOC, CO, PM, and toxic compound emissions from mobile sources.

Proposed Project: Demonstrate LNG Manufacturing and Distribution Technologies**Expected SCAQMD Cost:** \$750,000**Expected Total Cost:** \$7,000,000**Description of Technology and Application:**

Lack of statewide LNG production results in increased fuel costs. The cost of transporting LNG from production facilities out-of-state increases the fuel cost anywhere from 15 to 20 cents per gallon of LNG. The capital cost to construct a large scale liquefaction facility is high. The capital cost of the distributed small-scale LNG liquefaction system is about 25 percent lower than that for conventional technology per gallon of LNG produced. Because these smaller plants can be sited near fleet customers, costs for transporting the LNG produced to the end user are much lower than those for remote larger plants. Beyond these cost reductions, the smaller plant offers the key benefit of requiring a much smaller capital investment than does a larger plant. This smaller price tag greatly reduces investment risk, and can be profitable for relatively small LNG usage. Natural gas, landfill gas and waste gases can be processed to yield LNG. These processes are typically power-intensive, due to the higher energy content of LNG.

Industry and government agree that LNG promises to capture a significant share of the heavy-duty vehicle and engine market. LNG is the preferred for long distance trucking as it provides twice the energy per unit volume as CNG. This translates to longer driving ranges and lower-weight vehicle fuel storage.

The main objectives of this project are to:

- Develop and demonstrate an economic small-scale natural gas liquefaction technology
- Develop and demonstrate LNG manufacturing plants on a small scale from various gaseous feed stocks locally available
- Commercialize incentives for fleets to site, install, and use LNG and L/CNG refueling facilities

Potential Air Quality Benefits:

The SCAQMD relies on the significant penetration of zero- and low-emission vehicles in the South Coast Basin to attain federal clean air standards by 2010. This project would help develop a number of small-scale liquefaction technologies that can reduce LNG costs to be competitive with diesel fuel. Such advances are expected to lead to greater infrastructure development. This would make LNG fueled heavy-duty vehicles more available to the commercial market leading to direct reductions in NO_x, PM, and toxic compound emissions.

Electric/Hybrid Technologies

Proposed Project: Demonstrate Large Electric or Hybrid Off-Road Vehicles

Expected SCAQMD Cost: \$150,000

Expected Total Cost: \$500,000

Description of Technology and Application:

Small electric forklifts have become the primary technology in some markets and electric ground support equipment such as air stairs, baggage tugs, and belt loaders are increasingly utilized at airports. Giant electric cranes operate at several marine terminals. However, implementation of electric vehicles is uneven, and technical, operational, and cost barriers may remain that hinder broader market acceptance.

Projects in this category will help further advance vehicle and infrastructure technologies needed to increase the product availability or decrease cost of electric vehicles designed for additional applications at airports, marine terminals, and commercial and industrial settings where electric drive technologies are uncommon. Hybrid electric vehicle applications with or without plug-in capability are of potential interest depending on the size and the duty cycle of the vehicle.

Potential Air Quality Benefits:

The AQMP identifies zero and nearly-zero emitting ventures as a key attainment strategy. This project would demonstrate the viability of zero emission technologies in innovative applications. Other benefits would include increased exposure and user acceptance of advanced technologies, direct emission reductions from in-basin demonstrations, and the potential for increased use, and resulting emission reduction of the demonstrated technologies through their expedited commercialization.

Proposed Project: Develop and Demonstrate Advanced Battery Technology for Commercial Utility Equipment

Expected SCAQMD Cost: \$100,000

Expected Total Cost: \$300,000

Description of Technology and Application:

Projects in this area would demonstrate advancements in battery technology to reduce weight, enhance performance or reduce cost of electric lawn and garden equipment.

Potential Air Quality Benefits:

The AQMP identifies zero and nearly-zero emitting ventures as a key attainment strategy. This project would increase exposure and user acceptance of advanced technologies, provide direct emission reductions from in-basin demonstrations, and the potential for increased use, and result in emission reduction of the demonstrated technologies through their expedited commercialization.

Proposed Project: Demonstrate Plug-In Hybrid Electric Vehicles

Expected SCAQMD Cost: \$600,000

Expected Total Cost: \$13,000,000

Description of Technology and Application:

Major auto makers feature nickel metal hydride batteries in their current retail gasoline fueled hybrid electric vehicles and demonstration fuel cell hybrid vehicles, plus a couple examples of ultracapacitors and automotive-sized lithium ion batteries in fuel cell hybrid vehicles.

Innovative approaches to HEV systems are also under development that could improve performance, fuel efficiency, and reduce emissions relative to the first HEVs commercially introduced. Innovations that may be considered for demonstration include: advancements in the auxiliary power unit, either ICE or other heat engine, especially using alternative fuels including natural gas and hydrogen; battery-dominant hybrid systems utilizing off-peak re-charging; and non-conventional light-duty and medium-duty HEVs including delivery vans, shuttles, and other medium-duty vehicles. Previous analysis comparing and modeling various hybrid architectures requires validation and experience with in use demonstrations and fleet applications to encourage commercialization of a variety of plug-in hybrid vehicles.

The development of energy efficient systems reduces emissions associated with energy generation and is a criterion for projects funded under this category.

Potential Air Quality Benefits:

The AQMP identifies zero- or near zero-emitting vehicles as a key attainment strategy. HEV technologies have the potential to achieve near-zero emissions but with the range of conventional gasoline-fueled vehicle, a factor expected to enhance consumer acceptance. Plug-in HEVs can increase the zero emission miles traveled in town, and also allow conventional vehicle refueling to enable long trips.

Demonstration of optimized prototypes improves the viability of electric drive vehicle technologies and encourages the deployment of near-ZEV and ZEV technologies by major automakers.

Proposed Project: Develop and Demonstrate Light- and Medium-Duty Hybrid Electric Vehicles and Systems

Expected SCAQMD Cost: \$750,000

Expected Total Cost: \$5,000,000

Description of Technology and Application:

The objective of this program is to evaluate and compare the impacts and benefits of various types of HEVs, especially plug-in or battery dominant hybrids which are also referred to as "extended range" hybrids, as compared to non plug-in hybrids. Work to be conducted will include: 1) developing various HEV architectures, and modeling their efficiency and environmental performance based on several different driving cycles; 2) determining the anticipated costs and comparing differences for each option; 3) assessing customer interest and preferences for each alternative; 4) evaluating prospective commercialization issues and strategies for various alternatives; and 5) integrating the technologies into prototype vehicles to demonstrate the viability and clean air benefits of these types of vehicles.

Innovative approaches to HEV systems are also under development that could improve performance, fuel efficiency, and reduce emissions relative to the first HEVs commercially introduced. Innovations that may be considered for demonstration include: advancements in the auxiliary power unit, either ICE or other heat engine, especially using alternative fuels including natural gas and hydrogen; battery-dominant hybrid systems utilizing off-peak re-charging; and non-conventional light-duty and medium-duty HEVs including delivery vans, shuttles, and other medium-duty vehicles.

The development of energy efficient systems reduces emissions associated with energy generation and is a criterion for projects funded under this category.

Potential Air Quality Benefits:

The AQMP identifies zero- or near zero-emitting vehicles as a key attainment strategy. HEV technologies have the potential to achieve near-zero emissions but with the range of conventional gasoline-fueled vehicle, a factor expected to enhance consumer acceptance. This proposed project will evaluate various HEV systems and their performance and identify the most appropriate protocols with which to test real-world HEVs. Given the variety of HEV systems under development, it is critical to determine the true emissions and performance of HEVs. Demonstration of optimized prototypes would improve the viability of near-ZEV HEV technologies and enhance the deployment of near-ZEV technologies.

Expected benefits include the establishment of criteria for emissions evaluations, performance requirements, customer acceptability of the technology, etc. This will help both regulatory agencies and original equipment manufacturers to expedite introduction of near-zero emitting vehicles in the South Coast Basin, which is a high priority of the AQMP.

Proposed Project: Demonstrate Alternative Energy Storage Systems

Expected SCAQMD Cost: \$700,000

Expected Total Cost: \$1,400,000

Description of Technology and Application:

The SCAQMD has been involved in the development and demonstration of energy storage systems for electric and hybrid-electric vehicles, mainly lead acid and nickel-cadmium battery packs. Over the past few years, additional technology consisting of nickel sodium chloride and lithium manganese batteries have shown robust performance, especially in heavy-duty uses. During this time period, other technology manufacturers have further developed other energy storage devices, including flywheels and hydraulic systems. Flywheel systems can draw electrical energy from internal combustion engines, microturbines, and regenerative braking systems, then store the energy in kinetic form and be capable of releasing the energy to provide electric power. Hydraulic energy storage systems are available in various forms. Typically, these systems can store retardation energy and provide this energy as a secondary source of propulsion, especially during acceleration. Both energy storage systems can be retrofitted into existing platforms to significantly increase fuel economy, especially in medium- and heavy-duty vehicles with frequent stopping in urban environments.

The long-term objective of this program is to decrease the fuel consumption without any changes in their performance compared to conventional diesel and alternative fuel engines. This program will support several projects for development and demonstration of different types of low-emission heavy-duty hybrid vehicles. The types of fuels utilized in these projects would include, but not be limited to LPG, natural gas, combined with high power energy storage systems required for the electric energy. The overall net emissions and fuel consumption of these types of vehicles are expected to be much lower than traditional diesel engine systems.

The development of energy efficient systems reduces emissions associated with energy generation and is a criterion for projects funded under this category.

Potential Air Quality Benefits:

Certification of low-emission vehicles and engines, and their integration into the Basin's transportation sector is a high priority under the AQMP. This program is expected to develop hybrid technologies that could be implemented in medium- and heavy-duty trucks, buses, and other applications. Benefits will include proof of concept for the new technologies, diversification of transportation fuels, and lower emissions of criteria and toxic pollutants.

Proposed Project: Evaluate and Demonstrate Hybrid Heavy-Duty Vehicles**Expected SCAQMD Cost:** \$2,000,000**Expected Total Cost:** \$10,000,000**Description of Technology and Application:**

The SCAQMD together with the Department of Energy are supporting the development and certification of natural gas heavy-duty engines with maximum NO_x emissions of 0.5 g/bhp-hr and 0.2 g/bhp-hr. This effort sets the stage for the development of other low-emission technologies for heavy-duty applications, including electric hybrids.

The long-term objective of this program is to achieve the emissions limits suggested by the CARB for heavy-duty trucks, without any changes in their performance compared to diesel engines. This program will support several projects for development and demonstration of different types of low-emission heavy-duty hybrid electric vehicles. The types of fuels utilized in these projects would include, but not be limited to LPG, natural gas, combined with high power energy storage systems required for the electric energy. Depending on the system design and specific operational needs of the vehicles, energy storage system of hybrid electric vehicles may be recharged off the electrical grid during non-operational periods or be self-sustaining. Either way, the overall net emissions and fuel consumption of heavy-duty hybrid electric vehicles are expected to be much lower than traditional diesel engine systems.

Potential Air Quality Benefits:

Certification of low-emission vehicles and engines, and their integration into the Basin's transportation sector is a high priority under the AQMP. This program is expected to develop hybrid electric technologies that could be implemented in heavy-duty trucks, buses, and other applications. Benefits will include proof of concept for the new technologies, diversification of transportation fuels, and lower emissions of criteria and toxic pollutants. Specifically, it is expected that heavy-duty hybrid electric technologies could achieve NO_x emissions of 0.5 g/bhp-hr or lower, compared to the 4.0 g/bhp-hr and 2.5 g/bhp-hr (combined NO_x and hydrocarbons) currently produced by heavy-duty diesel engines.

Proposed Project: Upgrade of Hybrid Electric Vehicles

Expected SCAQMD Cost: \$500,000

Expected Total Cost: \$3,000,000

Description of Technology and Application:

Over the past five years, the SCAQMD, together with the California Energy Commission (CEC) and the CARB have funded a variety of light-, medium-, and heavy-duty electric and hybrid electric vehicle projects. The technology utilized in some of those projects has since evolved and enhanced in terms of overall performance. Specifically, significant progress has been made in battery pack design and battery management systems to extend the service period. Additionally, lower-emitting APUs have successfully demonstrated in subsequent projects, including fuel cells.

This project will seek to upgrade existing electric and hybrid-electric vehicle technology with newer, better performing components, resulting in enhanced reliability and lower emissions, as well as plug-in recharging capability.

Relation to AQMP and Potential Benefits:

Certification of low-emission vehicles and engines, and their integration into the Basin's transportation sector is a high priority under the AQMP. This program is expected to upgrade existing hybrid electric vehicles from past projects. Benefits will include proof of concept for the new technologies, diversification of transportation fuels, and lower emissions of criteria and toxic pollutants. Specifically, it is expected that heavy-duty hybrid electric technologies could achieve NO_x emissions of 0.2 g/bhp-hr or lower, compared to 2.5 g/bhp-hr currently produced by heavy-duty diesel engines.

Proposed Project: Develop and Demonstrate High-Capacity, Alternate Fueled Hybrid Electric Transit Buses

Expected SCAQMD Cost: \$750,000

Expected Total Cost: \$5,000,000

Description of Technology and Application:

The SCAQMD together with the U.S. DOE are supporting the development and certification of natural gas heavy-duty engines with maximum NO_x emissions of 0.5 g/bhp-hr and 0.2 g/bhp-hr. This effort sets the stage for the development of other low-emission technologies for transit buses, including electric hybrids.

The long-term objective of this program is to achieve the emissions limits adopted by CARB for transit buses, without any changes in their performance compared to diesel engines. This program will support several projects for development and demonstration of different types of low-emission transit buses with large capacity. Over the past few years, local transit authorities have emphasized a need for higher-capacity buses in support of FTA's Bus Rapid Transit programs. Therefore, the primary focus of these projects will be the development and demonstration of 45-foot or 60-foot buses. The types of fuels utilized in these projects would include, but not be limited to LPG, hydrogen, natural gas, combined with high power energy storage systems required for the electric energy. Depending on the system design and specific operational needs of the vehicles, energy storage system of hybrid electric vehicles may be recharged off the electrical grid during non-operational periods or be self-sustaining. The overall net emissions and fuel consumption of heavy-duty hybrid electric vehicles are expected to be much lower than traditional diesel engine systems.

Potential Air Quality Benefits:

Certification of low-emission vehicles and engines, and their integration into the Basin's transportation sector is a high priority under the AQMP. This program is expected to develop hybrid electric technologies that could be implemented in heavy-duty trucks, buses, and other applications. Benefits will include proof of concept for the new technologies, diversification of transportation fuels, and lower emissions of criteria and toxic pollutants. Specifically, it is expected that heavy-duty hybrid-electric technologies could achieve NO_x emissions of 0.5 g/bhp-hr or lower, compared to 4.0 g/bhp-hr and 2.5 g/bhp-hr (combined NO_x and hydrocarbons) currently produced by heavy-duty diesel engines.

Proposed Project: Investigate and Demonstrate Small Urban Electric Vehicle Applications

Expected SCAQMD Cost: \$150,000

Expected Total Cost: \$500,000

Description of Technology and Application:

Current battery electric technology may be applicable to a number of applications beyond conventional passenger cars. For example, studies conducted by a number of different parties suggest that a high percentage of consumer/commuter driving patterns total no more than 25 miles a day. From an air quality perspective, it may be particularly advantageous to identify and implement zero-emission vehicles in conditions where low mileage and heavy stop-and-go duty cycles are prevalent.

The objective of this program area is to identify and demonstrate applications that can best utilize zero emission technologies, such as neighborhood electric vehicles and electric scooters. Applications to be included in this program include, but are not limited to station cars, shared cars, fixed route fleets, and other innovative applications, with potential linkages to transit through intelligent transportation systems.

The development of energy efficient systems reduces emissions associated with energy generation and is a criterion for projects funded under this category.

Potential Air Quality Benefits:

The AQMP identifies zero and nearly-zero emitting ventures as a key attainment strategy. This project would demonstrate the viability of zero emission technologies in innovative applications. Other benefits would include increased exposure and user acceptance of advanced technologies, direct emission reductions from in-basin demonstrations, and the potential for increased use, and resulting emission reduction of the demonstrated technologies through their expedited commercialization.

Proposed Project: Develop and Demonstrate Medium- and Heavy-Duty Grid Rechargeable Trucks

Expected SCAQMD Cost: \$500,000

Expected Total Cost: \$2,000,000

Description of Technology and Application:

The SCAQMD, in conjunction with Southern California Edison, developed a proof-of-concept grid-rechargeable hybrid utility service truck. This first-of-its-kind truck utilized a 60 kW LNG-fueled gas turbine-powered electrical generator (Capstone MicroTurbine™) as a mobile power source in conjunction with a traction battery connected to an electric power train. It featured an electro-hydraulic aerial lift and tool circuit, and a 15 kW mobile electric power distribution system. The completed truck has an all-electric drive range exceeding 10 miles, and a hybrid range of over 150 miles. It has all the hydraulic capabilities of the diesel truck it replaced, and it adds a power panel with single phase 110 V and 208 V, and 208 V three-phase power to provide power for tools without the need for engine idling. This truck has been used to develop the model specifications for the Hybrid Truck Users Forum to commercialize the concept for use by utility companies throughout the nation.

This proposed project is to develop and demonstrate additional medium- and heavy-duty hybrid electric trucks capable of all-electric driving range. The long-term objective of this program is to decrease the fuel consumption without any changes in their performance compared to conventional diesel and alternative fuel engines. This program will support several projects for development and demonstration of different types of low-emission heavy-duty hybrid vehicles. The types of fuels utilized in these projects would include, but not be limited to LPG, natural gas, combined with high power energy storage systems required for the electric energy. The overall net emissions and fuel consumption of these types of vehicles are expected to be much lower than traditional diesel engine systems.

The development of energy efficient systems reduces emissions associated with energy generation and is a criterion for projects funded under this category.

Potential Air Quality Benefits:

Certification of low-emission vehicles and engines, and their integration into the Basin's transportation sector is a high priority under the AQMP. This program is expected to develop hybrid technologies that could be implemented in medium- and heavy-duty trucks. Benefits will include development and demonstration of new technologies, diversification of transportation fuels, and lower emissions of criteria and toxic pollutants.

Proposed Project: Demonstrate Advancements in Lithium Ion Battery Technology for Electric or Plug-In Hybrid Electric Vehicles

Expected SCAQMD Cost: \$400,000

Expected Total Cost: \$1,200,000

Description of Technology and Application:

The SCAQMD has been involved in the development and demonstration of energy storage systems for electric and hybrid electric vehicles, mainly lead acid, nickel cadmium, and nickel metal hydride battery packs. Over the past few years, additional technology consisting of nickel sodium chloride and lithium manganese batteries have shown robust performance, especially in heavy-duty uses. Also, other energy storage devices are under development, including flywheels and hydraulic systems, but these storage devices have more potential in medium- and heavy-duty vehicles.

Major auto makers feature nickel metal hydride batteries in their current retail gasoline fueled hybrid electric vehicles and demonstration fuel cell hybrid vehicles, plus a couple examples of ultracapacitors and automotive-sized lithium ion batteries in fuel cell hybrid vehicles. Lithium ion batteries provide performance improvements at reduced weight compared to other battery chemistries. In the consumer electronics market the use of small lithium ion batteries has grown to be a dominant chemistry, with a large variety of competitive manufacturers producing quality product at steadily decreasing prices. Some automakers are encouraged by the continuing advancements and cost reductions in lithium ion batteries, but lithium ion automotive batteries are not in mass production, since concerns remain about battery life and other issues in automotive applications.

The development of energy efficient systems reduces emissions associated with energy generation and is a criterion for projects funded under this category.

Potential Air Quality Benefits:

The AQMP identifies zero- or near zero-emitting vehicles as a key attainment strategy. HEV technologies have the potential to achieve near-zero emissions but with the range of conventional gasoline-fueled vehicle, a factor expected to enhance consumer acceptance. HEVs can increase the zero emission miles traveled in town, and also allow conventional vehicle refueling to enable long trips.

Demonstration of optimized prototypes improves the viability of electric drive vehicle technologies and encourages the deployment of near-ZEV and ZEV technologies by major automakers.

Emission Control Technology

Proposed Project: Perform Heavy-Duty Natural Gas Vehicle Transmission Optimization Study

Expected SCAQMD Cost: \$150,000

Expected Total Cost: \$250,000

Description of Technology and Application:

Recent emission testing of natural-gas refuse trucks yielded higher-than-expected emissions. It was found that these trucks use the same identical automatic transmissions as diesel refuse trucks. While heavy-duty natural-gas engines are, generally speaking, OEM conversions of heavy-duty diesel engines, the natural-gas engines do not perform identically and have different torque performance curves than the diesel engines. By using the transmission optimized for diesel engines, the natural-gas engine has higher-than-necessary on-road emissions because the shifting points are not optimum.

In this project, emission performance of natural-gas refuse trucks will be demonstrated under more optimum transmission shifting strategies. The results of this study will be provided to industry for possible revision of transmission shifting of new and in-use natural-gas trucks and buses.

Potential Air Quality Benefits:

The proposed program support the 2003 AQMP Mobile sources Control Measure, On-Road Heavy-Duty-3, "Pursue Approaches to Clean-up the Existing and New Truck/Bus Fleet."

This project intends to maximize the low-emission performance of alternative fuel heavy-duty vehicles. Reductions of 10 to 30 percent are expected for NO_x and PM emissions.

Proposed Project: Develop and Demonstrate Advanced Alternative Fuel Light-, Medium- and Heavy-Duty Engines and Vehicles

Expected SCAQMD Cost: \$2,000,000

Expected Total Cost: \$4,000,000

Description of Technology and Application:

The objective of this proposed program is to support development and certification of near commercial prototype low emission heavy-duty alternative fuel engine technologies and demonstration of these technologies in on-road vehicles. The NO_x emissions target for this program area is 0.5 g/bhp-hr and PM emissions target is below 0.01 g/bhp-hr. This program is expected to result in several projects, including:

- Demonstration of advanced natural gas engines in medium-duty and heavy-duty vehicles
- Development of durable and reliable retrofit technologies to convert engines and vehicles from petroleum fuels to alternative fuels

The program proposes to expand field demonstration of these advanced technologies in various vehicle fleets operating with different classes of vehicles.

The use of alternative fuel in heavy-duty trucking applications has been demonstrated in certain local fleets within the Basin. These vehicles typically require 200-300 horsepower engines. Higher horsepower alternative fuel engines are beginning to be introduced. However, vehicle range, lack of experience with alternative fuel engine technologies, and limited selection of appropriate alternative fuel engine products has made it difficult for more firms to consider significant use of alternative fuel vehicles. For example, in recent years, several large trucking fleets have expressed interest in using alternative fuels. However, at this time the choice of engines over 350 HP or more is limited. Continued development of cleaner dedicated natural gas, or other alternative fuel engines such as natural gas-hydrogen blends over 350 HP would increase availability to end-users and provide additional emission reductions.

Another objective of this project is to support the near-term development and certification of alternative-fuel light- and medium- duty vehicle technologies. Recently two major automobile manufacturers ceased production of natural gas-powered vehicles. Ford announced their entire natural gas vehicle product line will be unavailable after the 2004 model-year, and General Motors announced their full size natural gas-powered vans will be similarly unavailable. This project proposes to support small volume manufacturer efforts to develop and certify advanced alternative-fuel light- and medium-duty vehicles to ensure their continued availability. A key component of this project is compliance with OBD II requirements beginning with the 2005 model year as part of light- and medium-duty engine family certification for small volume manufacturers. Alternative fuel light- and medium-duty vehicles will provide important near-term emission reductions, satisfying demand for these vehicles in applications affected by SCAQMD fleet rules.

Potential Air Quality Benefits:

This proposed program supports the 2003 AQMP Mobile Sources Control Measure, On-road Heavy-Duty-3, "Pursue Approaches to Clean-up the Existing and New Truck/Bus Fleet." It is intended to expedite the commercialization of low-emission alternative fuel heavy-duty engine technology in California, both in the Basin and in intrastate operation. By working cooperatively with other local air districts and the CARB, the SCAQMD can leverage its funds and provide a statewide air quality benefit. The emission reduction benefit of replacing one 4.0 g/bhp-hr heavy-duty engine with a 0.5 g/bhp-hr engine in a vehicle that consumes 10,000 gallons of fuel per year is about 1400 lb/yr of NO_x. Clean alternative fuels, such as natural gas, or natural gas blends with hydrogen can also reduce

heavy-duty engine particulate emissions by over 90 percent compared to current diesel technology. This program is expected to lead to increased availability of low emission alternative fuel heavy-duty engines. Fleets can use the engines and vehicles emerging from this program to comply with recently adopted SCAQMD regulations.

Emission reductions from the certification of light- and medium-duty alternative-fuel vehicles are also expected since these vehicles tend to be cleaner than corresponding gasoline-fueled vehicles. For example, the cleanest vehicle within the light-and medium duty vehicle category powered by an internal combustion engine is the CNG-fueled Honda Civic.

Proposed Project: Demonstrate Active Diesel Particulate Filter on Construction Equipment

Expected SCAQMD Cost: \$200,000

Expected Total Cost: \$400,000

Description of Technology and Application:

One of the leading technologies for controlling PM emissions from diesel engines is the diesel particulate filter (DPF). DPFs are very effective at reducing PM emissions, achieving typical PM reductions in excess of 85 percent. DPFs are generally divided into two types of systems, passive and active. Passive DPFs rely on high engine exhaust temperatures to initiate the regeneration process. When passive regeneration is not possible, the regeneration process must be "actively" performed. An active DPF uses an external source of heat to complete regeneration. Active DPFs employ a variety of approaches for regeneration, including electrical regeneration by passing a current through the filter medium, injecting fuel to provide additional heat for particulate oxidation, or adding a fuel-borne catalyst or other reagent to initiate regeneration. Some active DPFs induce regeneration automatically on-board the equipment when a specified backpressure is reached. Others use an indicator, such as a warning light, to alert the operator that regeneration is needed, and require the operator to initiate the regeneration process. For applications in which the engine-out PM is relatively high and the exhaust temperature is relatively cool, an active DPF may be more effective than a passive DPF.

The purpose of the proposed project is to assess the effectiveness of using an active DPF system to reduce PM emissions from construction equipment. This demonstration project will evaluate the emission reduction potential of the active DPF with respect to age of the equipment, exhaust temperatures, fuel sulfur content and maintenance requirements. Alternative diesel fuels, such as emulsified diesel fuel, may also be used with the active DPF system to determine the synergistic benefit for reducing emissions. Another consideration will be the equipment's operational performance. Potential applications include: grading equipment, scrapers, demolition equipment, and cranes.

Potential Air Quality Benefits:

In the AQMP, construction equipment are categorized under "Mobile Sources, Off-Road Vehicles" with commercial boats, trains, ships, aircraft, utility engines, recreational vehicles and other equipment not considered in the on-road source category. In the 2003 AQMP, off-road mobile sources contribute in the Basin 31, 29, and 52 percent of the entire 1997 mobile source VOC, NOx and PM emissions, respectively. Furthermore, it is estimated that off-road heavy-duty equipment account for 7 percent of all PM emissions in the Basin. The effectiveness of DPFs in reducing PM emissions from on-road mobile sources is well documented. CARB reports PM emission reductions of at least 85 percent for various types of catalyzed diesel particulate filters used in on-road applications. The U.S. EPA reports conservative estimates of 80 percent PM reduction for base metal catalyzed particulate filters, and more than 90 percent PM reduction for precious metal catalyzed diesel particulate filters. An active DPF system is expected to produce similar or greater PM reductions. In addition, because active DPFs are not dependent on the heat carried in the exhaust for regeneration, they potentially have a broader range of applications.

This project is expected to demonstrate the use of active DPF systems in construction equipment and assess the effectiveness of this aftertreatment technology in reducing PM emissions. An alternative diesel fuel may be used in conjunction with an active DPF system to determine the synergistic benefit in reducing emissions. Alternative diesel fuels verified by CARB are reported to reduce PM, NOx and HC emissions. Emulsified diesel fuels, for example, will reduce NOx and PM by at least 14 and 60 percent, respectively, and HC emissions that are 25 percent lower than the applicable standard. Benefits of this project will include a direct reduction in PM emissions from construction equipment,

and may also result in NO_x and HC emission reductions if a CARB-verified alternative diesel fuel is used in combination with an active DPF system. The project will also identify any issues that may need to be addressed to improve the efficiency of the active DPF system and ultimately expedite the development and commercialization of this aftertreatment emission control technology.

Proposed Project: Develop and Demonstrate Off-Road Repower with LNG On-Road Engines

Expected SCAQMD Cost: \$250,000

Expected Total Cost: \$600,000

Description of Technology and Application:

The purpose of the proposed project is to assess the effectiveness of using a certified LNG on-road heavy-duty engine to reduce NO_x+NMHC and PM emissions from off-road construction equipment. This demonstration project will evaluate the emission reduction potential of an on-road heavy-duty certified LNG engine with respect to age of the equipment, maintenance requirements operational performance, and fuel accessibility. Potential equipment applications include: grading equipment, scrapers, demolition equipment, and cranes.

Potential Air Quality Benefits:

In the AQMP, construction equipment is categorized under “Mobile Sources, Off-Road Vehicles” with commercial boats, trains, ships, aircraft, utility engines, recreational vehicles and other equipment not considered in the on-road source category. In the 2003 AQMP, off-road mobile sources are estimated to represent 31, 29, and 52 percent of the entire 1997 Basin mobile source VOC, NO_x and PM emissions, respectively. Furthermore, it is estimated that off-road heavy-duty equipment account for 7 percent of all PM emissions in the Basin. The effectiveness of certified on-road heavy-duty engines used in reducing NO_x+NMHC and PM emissions from off-road mobile sources is potentially significant.

Replacing older, uncontrolled heavy-duty diesel engines with newly certified diesel engines in construction equipment has proven to be a successful strategy for reducing NO_x and PM emissions. Recently the use of new on-road certified heavy-duty diesel engines has been considered as a potential concept to achieve additional reductions from this equipment. The difference in emission reductions from utilizing the certified on-road heavy-duty diesel engines has the potential to provide emission reductions of approximately 48% NO_x+NMHC and 63% PM over the current off-road standards. This estimate is simply based on the emissions standards for the on- and off-road engines, but does not address the fact that the two classes (on- and off-road) are evaluated using entirely different test cycles. While it is generally believed that this is a strategy that will provide additional benefits, the extent of those benefits needs to be quantified.

There is currently one Carl Moyer Program project in process to certify heavy-duty on-road dual fuel LNG/diesel engines for use in off-road construction equipment. This technology will, if certified, result in a reduction of approximately 69% NO_x+NMHC and 98% PM over the current off-road standards for heavy-duty off-road engines between 175 – 750 hp. The proposed project would be to further this trend by demonstrating a certified LNG on-road heavy-duty engine in construction equipment.

The project will identify any issues that may need to be addressed regarding real-world emission reduction benefit, fuel delivery and storage and ultimately expedite the development and commercialization of this technology.

Proposed Project: Develop and Demonstrate Advanced, High Performance, Low-Emission Leaf Blower

Expected SCAQMD Cost: \$100,000

Expected Total Cost: \$200,000

Description of Technology and Application:

There are approximately 48,804 leaf blowers used in commercial applications in the Basin. The vast majority of these leaf blowers are the backpack-style, equipped with 2-stroke gasoline engines, ranging in size from 40 to 55 cc. Exhaust emissions from leaf blowers consist of the following specific pollutants of concern: hydrocarbons from both burned and unburned fuels (which combine with other gases in the atmosphere to form ozone), oxides of nitrogen, carbon monoxide, fine particulate matter, and other toxic air contaminants in the unburned fuel, including benzene, 1,3 butadiene, acetaldehyde, and formaldehyde. Emissions from leaf blowers have only been controlled since 1995, with more stringent standards (Tier III) taking effect January 1, 2005.

The exhaust emissions from leaf blowers are consistent with other similar off-road equipment powered by small, two-stroke engines, such as string trimmers. Manufacturers have developed several different methods to comply with the standards, including engine modification and catalytic converters. There are currently no electric-powered backpack-style leaf blowers available for commercial applications. In 2004, CARB certified at least two 4-stroke models with very low NOx emission levels, however these models were never manufactured or available for sale in 2004.

The objective of this project is to develop an advanced, high performance, and low emission leaf blower for commercial applications. This project will entail the development, evaluation and demonstration of a high performance, low emission backpack-style leaf blower. Since many cities and counties in the Basin currently have ordinances banning or restricting the use of gasoline-powered leaf blowers due to noise concerns, this project will incorporate a low noise specification in the development phase.

Potential Air Quality Benefits:

In the 2003 AQMP, leaf blowers are categorized as “Lawn and Garden Equipment”. The annual average VOC emissions from lawn and garden equipment are very high relative to the other pollutants emitted by this source category. Based on the leaf blower models certified by CARB in 2004, most of the 2-stroke models meet the Tier II emission standard for HC+NOx (54 g/bhp-hr). However, the 4-stroke models were certified to a very low HC+NOx emission level, about 80 percent lower than the Tier II standard. This project will develop a high performance, low emission and low noise backpack-style leaf blower that can be used in commercial applications. The leaf blower will be demonstrated and evaluated to verify the low emission levels and ability of the equipment to meet the requirements of the commercial user. This project may ultimately expedite the development and commercialization of high performance, low emission and low noise leaf blowers for use in commercial applications.

Proposed Project: Develop and Demonstrate Advanced Aftertreatment Technologies for Liquid Fuels

Expected SCAQMD Cost: \$800,000

Expected Total Cost: \$2,600,000

Description of Technology and Application:

The Federal heavy-duty on-highway engine emission standards are 0.01 g/bhp/hr of PM, effective 2007, and 0.20 g/bhp-hr of NO_x to be phased in between 2007 and 2010. In response to these tighter emission standards, engine manufacturers are exploring many strategies including improving engine designs through electronic engine controls, changes in fuel injection systems, handling intake air, combustion chamber modification, exhaust gas recirculation systems, and reducing oil consumption. Additionally, several thermal and catalyzed technologies have been developed to control diesel NO_x and PM emissions, but many of these systems have not been tested in vehicles. Even the potentially promising technologies have development challenges, and require diesel fuel with sulfur content below 10 ppm in general for heavy-duty diesel applications.

The purpose of the proposed program is to explore alternative diesel emission control strategies, which could reduce on-road heavy-duty diesel NO_x and PM emissions by at least 60 and 90 percent and nanoparticle emissions, without significantly increasing fuel consumption on an energy equivalent basis. This involves:

- (1) Developing emissions control strategies that would include advanced alternative fuel enabling the use of advanced emission control technologies that may not otherwise be possible with conventional diesel fuel; and
- (2) Conducting a multi-year demonstration that would include participation and cost-sharing from fleet operators of heavy-duty vehicles, original equipment manufacturers, fuel suppliers, and other agencies.

Potential Air Quality Benefits:

In the 2003 AQMP, mobile sources are estimated to represent approximately 65, 89, and 14 percent of the entire 1993 Basin VOC, NO_x, and PM emissions, respectively. The on-road heavy-duty diesel trucks and urban buses contribute about 24, 35, and 41 percent of the entire 1997 on-road mobile VOC, NO_x, and PM emissions, respectively. Majority of the emissions control strategies that will be proposed under this program are already commercially available, and have been shown to reduce emissions from passenger cars, light-duty trucks, and medium-duty vehicles to very low levels, and yielded emissions reduction from buses, trucks, and heavy-duty highway vehicles. Low sulfur diesel and other advanced alternative liquid fuels, further advancements in engine design, and optimization of existing control devices (diesel oxidation catalyst/particulate filters reformulation for nanoparticles abatement) will be necessary to achieve significant reduction of ultrafine particles, and for heavy-duty vehicles to comply with future emissions standards. This program in combination with other programs could reduce NO_x and PM emissions by over 60 and 90 percent, respectively. The program will ultimately expedite the progress of heavy-duty engine and control device manufacturers to build vehicles that comply with future emissions standards.

Proposed Project: Demonstrate Advanced Alternative Fuels in Off-Road Equipment**Expected SCAQMD Cost:** \$1,200,000**Expected Total Cost:** \$2,600,000**Description of Technology and Application:**

As on-road emissions continue to be reduced through tight regulation and fleet turnover, the relative emissions contribution of off-road vehicles and equipment will increase. For many off-road equipment applications, gaseous alternative fuels, such as natural gas and LPG, may not be a viable option. However, emerging low-sulfur diesel fuels (LSDF) and additives, such as the 15-ppm sulfur content diesel fuel, Purinox, emulsified diesel fuel, natural gas derived Fischer-Tropsch (F-T) liquids, and other advanced liquid fuels, could offer some emissions benefit. Reformulated diesel fuels can facilitate the use of advanced diesel emission controls, including after-treatment devices, which are susceptible to sulfur poisoning. A comprehensive, long-term demonstration in heavy-duty equipment is an important step toward quantifying viability and emissions benefit.

The purpose of the proposed program is to evaluate the emission-reduction potential of advanced alternative liquid fuels when used in heavy-duty off-road equipment. A secondary consideration is to assess the effect of these fuels on equipment's operational performance in a demonstration study. Majority of the projects under this program will include emission control strategies for reducing engine-out emissions, and require a multi-year demonstration that would include participation and cost-sharing from owners/operators of heavy-duty off-road equipment, original equipment manufacturers, fuel suppliers, and other agencies. Potential applications include: heavy-duty construction equipment, yard hostlers, miscellaneous industrial equipment, airport ground support equipment, and port vehicles.

Potential Air Quality Benefits:

Off-road sources are classified as "Other Mobile" sources in the AQMP. These sources include off-road vehicles (i.e., construction vehicles/equipment), commercial boats, trains, ships, aircraft, utility equipment, and other equipment not considered as on-road sources. In 2003 AQMP, off-road mobile sources are estimated to represent 31, 29, and 52 percent of the entire 1997 Basin mobile source VOC, NO_x, and PM emissions, respectively. Currently, off-road heavy-duty equipment accounts for 7 percent of all PM emissions; however, its contribution to mobile source emissions inventory is projected to steadily increase over other mobile sources.

This program is expected to demonstrate LSDF, F-T, Purinox, emulsified diesel fuel, and other advanced liquid fuels that could be implemented throughout the heavy-duty off-road equipment population in the Basin thereby resulting in significant emissions reductions in NO_x, VOC, CO, PM, and toxics. Direct benefits will include proof of concept of these fuels and increased experience of end users with the cleaner fuels. In addition, the emissions control strategies that will be proposed under this program are already commercially available, and have been shown to reduce emissions from passenger cars, light-duty trucks, and medium-duty vehicles to very low levels, and yielded significant emissions reduction from buses, trucks, and heavy-duty highway vehicles. To achieve significant reduction of ultrafine particles, proponents will be required, if necessary, to optimize control devices (diesel oxidation catalyst/particulate filters reformulation for nanoparticles abatement). The program may ultimately expedite the development and commercialization of heavy-duty off-road equipment equipped with advanced diesel emission controls.

Proposed Project: Develop and Demonstrate Advanced Aftertreatment Technologies for Natural Gas Emissions

Expected SCAQMD Cost: \$800,000

Expected Total Cost: \$1,600,000

Description of Technology and Application:

Public agencies and private industry have continued to direct considerable efforts and resources to developing strategies that allow an effective use of natural gas as a cleaner-burning alternative to conventional fuel in automotive service. These efforts have resulted in many options available for improving natural gas engine technology and efficiency, and developing exhaust aftertreatment devices to achieve higher reduction of criteria and toxic pollutant emissions. However, little effort has been devoted to specifically address carbonyl (formaldehyde and acetaldehyde) and PM emissions. With tighter regulations, additional work is needed to further reduce all criteria and toxic emissions with emphasis on formaldehyde and PM emission.

The purpose of the proposed program is to develop new or optimize existing emission control strategies capable of significantly reducing engine-out PM, ultrafine particles, nanoparticles, NO_x, CO, carbonyl, and hydrocarbon emissions from CNG heavy-duty vehicles. This requires the participation and cost-sharing from fleet operators of heavy-duty vehicles, original equipment manufacturers, fuel suppliers, and other agencies.

Potential Air Quality Benefits:

The AQMP identifies the use of alternative clean fuels in mobile sources as a key attainment strategy. The CARB has also passed LEV regulations that require light-duty vehicles to comply with increasingly stringent emission standards. The CARB has passed analogous standards for medium- and heavy-duty vehicles. NGVs have significantly lower emissions than gasoline vehicles and represent the cleanest internal combustion engine powered vehicles available today. These emission levels could be reduced further by control technology enhancement or optimization. Benefits will include direct emission reductions in NO_x, VOC, CO, PM, ultrafine particles, nanoparticles, and toxics from in-Basin demonstrations, and expedited commercialization.

Proposed Project: Develop and Demonstrate Low-Emission Lubricants for Natural Gas Engines

Expected SCAQMD Cost: \$250,000

Expected Total Cost: \$1,000,000

Description of Technology and Application:

There is a body of data indicating that the formulation of engine lubrication oil affects exhaust emissions. With properly formulated lube oil, emission benefits are available from both petroleum-based and synthetic lube oils. A lube oil reformulation has recently taken place for new heavy-duty diesel engines with exhaust gas recirculation (EGR). In addition, such a reformulation process is currently underway for 2007 and newer heavy-duty diesel engines in order to improve the effectiveness of future exhaust emission controls.

It is proposed that heavy-duty lube oils be directly investigated to reduce PM (ultrafine particles, nanoparticles) emissions on both new and older (backward model-year compatible) heavy-duty natural gas and diesel engines. This will involve investigating the specific parameters that affect emissions, securing specific commercial lube oils or preparing specially formulated lube oils, conducting engine and/or vehicle emission testing, and demonstrating such oils in fleet vehicles. Further efforts may also be required to gain industry certifications of such oils for new and older engines.

Potential Air Quality Benefits:

Potentially up to 20 percent reductions in PM and toxic compounds are possible with lesser potential reductions in NOx and fuel consumption. Besides their use in new engines, such reformulated oils could be used in older diesel and natural gas engines expanding such benefits to the entire fleet in a relatively short period of time. A nominal 10 percent PM (ultrafine particles, nanoparticles) benefit and 5 percent NOx benefit to the 2007 heavy duty on-road fleet could be expected. Emission toxicity of PM, ultrafine particles and nanoparticles, and hydrocarbons can also be improved. Finally, fuel consumption is expected to be reduced potentially offsetting the increased cost of such improved lube oils. These benefits could also be expanded to off-road heavy-duty engines.

Proposed Project: Demonstrate NO_x and PM Control Technologies for Off-Road Equipment

Expected SCAQMD Cost: \$750,000

Expected Total Cost: \$1,500,000

Description of Technology and Application:

Off-road equipment, locomotives, and marine vessels contribute a significant portion of NO_x, PM, greenhouse gas and toxic emissions. These emissions contribute to on-shore air quality problems. In order to continue meeting clean air goals, emission reductions from this equipment is necessary. Currently, the California Maritime Air Quality Technical Working Group, CARB, U.S. EPA and the SCAQMD are exploring promising retrofit technologies to be used on off-road equipment.

The primary objectives of these demonstration projects are to: identify technologies that are capable of reducing NO_x, PM, and greenhouse gases, identify and demonstrate emission measurement systems capable of accurately measuring pollutant emissions in exhaust streams; and install the most promising technology(s) on an in-use for demonstration under real world conditions and establish the emission reduction potential in different modes of operation. These technologies are also being considered as control measures in the SCAQMD's AQMP. The types of technologies are listed in the following section. Alternative fuels such as emulsified diesel can also be investigated.

Potential Air Quality Benefits:

The types of technologies that can be investigated and the associated emission reductions from industrial and OEM surveys are as follows:

Type of Control Details	Emission Reductions		
	PM	NO _x	Other
Organo-metallic combustion catalysts dosed into fuel supply	40-60%		
Catalytic Vapor Injection (CVI)	25%	15%	25% CO 5% HC 7% NO ₂
CRT System: also filters reducing PM emissions	85%	90%	90% CO
MES Eco-Silencer : exhaust gas mixes with sea water solution	80%	0%	90% SO ₂
Munters H.A.M. System: humidification of air		90%	75% HC
Munters SCR Converter System		90%	75% HC
DX Systems, DXX Systems, DXXX Systems	70%	50%	23% HC
Emission Capture & Exhaust Reduction/Catalytic Separation Units			38% CO
SCR catalyst w/ urea dosing system	85%	90%	90% CO
Ceramic coatings, water-emulsified fuel oil, intake-air fumigation/temperature control, fuel injection optimization combination system	52%	26%	

Proposed Project: Investigate and Demonstrate Near-Term Emissions Control Technologies

Expected SCAQMD Cost: \$1,000,000

Expected Total Cost: \$4,000,000

Description of Technology and Application:

This category of projects includes control technologies that can be readily applied to assist in reducing emissions in the near-term. Such projects include the evaluation and demonstration of technologies, such as:

- On-Board Diagnostics (OBD) with remote notification
- Telematics for reduced congestion
- Remote Sensing
- Low cost test equipment for monitoring and identifying high emitters
- Test cycle development for different class vehicles
- Global positioning satellite (GPS) for potential high emitters
- Auxiliary power unit replacements
- Electrification where feasible

Most of these technologies have been proven in concept but not practice, so projects would need to develop these as feasible control strategies.

Potential Air Quality Benefits:

Many of the technologies identified can be applied to light-duty and heavy-duty vehicles to identify and subsequently remedy high emitting vehicles in the current fleet inventory. Estimates suggest that high emitting vehicles, 5 percent in the existing fleets account for up to 80 percent of the emissions. Identification of higher emitting vehicles would assist with demand-side strategies, where higher emitting vehicles have correspondingly higher registration charges, which is included in Chapter 4 of the AQMP as a potential control strategy.

Emission Studies

Proposed Project: Perform Natural Gas Quality Emissions Study

Expected SCAQMD Cost: \$50,000

Expected Total Cost: \$500,000

Description of Technology and Application:

Several Pacific Coast LNG projects are going through the permitting process and one or more are likely to delivering natural gas to California in the future. Depending on its source and the level of processing where it is delivered, LNG can have higher Wobbe Number and heating value than the current supplies of natural gas. Southern California Gas Co. reports that this could cause sudden changes in heating value for their customers from 1020 Btu/scf (HHV), the normal average heating value, to 1150 Btu/scf, the highest level allowed by the SoCalGas tariff, and back. With few exceptions, combustion equipment in California does not have the capability of detecting the fuel changes and adjusting air/fuel ratios.

This project would go to locations with typical industrial combustion equipment to determine the emissions and operational impacts of the high Btu natural gas, by supplementing the normal natural gas fuel with up to 8 percent LPG by volume.

Potential Air Quality Benefits:

This project would provide knowledge of the impact of high-Btu natural gas on industrial combustion equipment. It would allow regulators gas distributors to make informed decisions about gas quality requirements to be put on LNG. The research could lead to improved safety and emissions of combustion equipment burning LNG in California.

Proposed Project: Perform Emission Studies for Locomotives, Port & Ocean-Going Vessels

Expected SCAQMD Cost: \$300,000

Expected Total Cost: \$300,000

Description of Technology and Application:

From time to time, the SCAQMD sponsors studies to help upgrade the emissions inventory of various mobile sources. In 1990, a study was cosponsored with CARB to update the emission inventory from locomotives for development of the 1994 AQMP. Similarly, in 1999 a study was sponsored to update the marine vessels emissions inventories for the 2003 AQMP. Both these studies provided emissions inventories for various categories of locomotives and marine vessels (ocean-going vessels and harbor craft) for the 1994 and 1997 base years and forecast years (2000, 2010, and 2020). The emissions inventories presented a significant improvement compared to the inventories developed previously. However, current industry information indicates increases in rail and port traffic beyond that previously projected. This new information needs to be analyzed and integrated into new emission inventory projections.

Potential Air Quality Benefits:

An updated emissions inventory of locomotives and marine vessels in the Basin is necessary for the purpose of planning and development of the 2007 AQMP Revision. Further improvements to the existing emissions inventories and future growth projections are critical to accurately assess the air quality impacts from the ports as well as planning future controls necessary to demonstrate attainment of the 8-hour ozone and PM_{2.5} national ambient air quality standards.

Proposed Project: Demonstrate Remote Sensing of Mobile Sources in SCAQMD

Expected SCAQMD Cost: \$2,000,000

Expected Total Cost: \$4,000,000

Description of Technology and Application:

Remote sensing is the observation and measurement of objects from a distance, i.e. instruments or recorders are not in direct contact with objects under investigation. Remote sensing depends upon measuring some kind of energy that is emitted, transmitted, or reflected from an object in order to determine certain physical properties of the object. The method of Remote Sensing used in mobile source combustion exhaust analyses, applies the science of light absorbance, using Infrared (IR) and Ultraviolet (UV) light to identify and measure pollutants or compounds of concern. The instrument typically consists of a non-dispersive infrared component for detecting carbon monoxide (CO), carbon dioxide (CO₂), and hydrocarbons (HC), and a dispersive ultraviolet spectrometer for measuring nitric oxide (NO). The light source and detector are positioned on opposite sides of the path of the mobile source, specifically the vehicle's exhaust source. Collinear beams of IR and UV light are transmitted and focused onto a mirror, which serves to separate the beams into their IR and UV components. The IR light is subsequently spread across four infrared detectors to differentiate CO, CO₂, HC and the reference. The UV light is reflected off the surface of the beam splitter and is focused into the end of a quartz fiber-optic cable, which transmits the light to an UV spectrometer. The UV unit is then capable of quantifying NO by measuring an absorbance band at 226 nm in the UV spectrum and comparing to a calibration spectrum in the same region. The remote sensing instrument measures the exhaust medium at a rate of 100 samples per second. Each IR and UV measurement is first converted to a concentration, and ultimately to a mass emission value. Remote sensors can also be optimized for measuring opacity and correlated to particulate matter emissions.

Every major city in the world faces problems associated with emissions of air pollutants from mobile sources. In some cases these are severe and growing, with few prospects for short-term improvements. One cost-effective approach may be to target the worst offenders: often, the greatest emissions are dominated by a small number of vehicles with very high emissions. Remote Sensing of mobile emissions has been applied in a variety of mobile source studies and has been used in mobile emission monitoring and enforcement programs. The SCAQMD proposes to develop a high emitter identification and repair program for two mobile sources: light/medium duty vehicles in the urbanized areas, and Class I diesel-electric locomotive railroads in the highest emitting services, e.g. line haul, and yard service. The remote sensing program will measure CO, CO₂, HC and NO, as well as particulates.

While remote sensing for light and medium duty vehicles is more common, remote sensing for railroad locomotives is not. However, in 1999 a feasibility study was conducted by the Department of Chemistry and Biochemistry from the University of Denver, Remote Sensing of Railroad Locomotive Emissions: A Feasibility Study, and prepared for the Federal Highway Administration to assess the feasibility of measuring railroad locomotive emissions by remote sensing. The study was conducted by Peter J. Popp, Gary A. Bishop and Donald Steadman. Two of the authors, Bishop and Steadman, have authored many papers on the subject of remote sensing as can be viewed at: http://www.feac.biochem.du.edu/pub_list.shtml. The railroad study focused on CO, CO₂, HC and NO emissions and quantified mass emissions of each pollutant versus power setting. The study found that optical remote sensing is effective at measuring nitric oxide emissions from locomotive engines, but found levels of CO and HCs to be below the detection limit of the remote sensor. Additional compounds found in locomotive exhaust, such as NO₂, SO₂, and Particulates, can also be measured by adding and improving the described remote sensing instrument.

Potential Air Quality Benefits:

Authority to enact standards for mobile sources lies solely with the U.S. EPA. However, urbanized areas of the SCAQMD qualifying as Enhanced Inspection and Maintenance (I/M) areas (under the Federal Clean Air Act amendments of 1990) require a method of identifying high emitters and promoting a vehicle repair program resulting in lower vehicle exhaust emissions.

Light/Medium Duty Vehicles

The light/medium duty vehicle program will target 15 percent of the total fleet population, translating to approximately 1.5 million vehicles per year. From past remote sensing studies, 10% of the vehicles sampled will be high emitters, or 150,000 vehicles in the SCAQMD. The highest 10% of these high emitters (15,000 vehicles) would be targeted for repair, and of these an expected 25% of these vehicles owners (3,600 vehicles per year) will voluntarily repair their vehicle. The estimated emission reductions associated with repairing 3,600 vehicles per year is: 291 tons/year of HC; 23.2 tons/year NO_x; and 2,557 tons/year CO.

Railroad Locomotives

The U.S. EPA projects that railroad diesels will cause some 27 percent of total nitrogen oxides (NO_x) and particulate matter (PM) pollution coming from mobile sources. In May 2004, EPA announced its intent to propose more stringent locomotive engine emission standards that are modeled after the Clean Air Nonroad Diesel engines programs. Such standards would require the use of advanced emission-control technologies similar to those already upcoming for heavy-duty diesel trucks and buses. The availability of clean nonroad diesel fuel required under the new nonroad fuel standards will enable the use of this technology on locomotive engines. EPA estimates that nitrogen oxides and particulate matter emissions could be reduced by 90 percent by applying such advanced technology to locomotive engines (<http://www.epa.gov/cleandiesel/>).

CARB's most recent emission data (2003 Almanac Emission Projection) estimates locomotive emissions in the SCAQMD at 37.3 tons NO_x/day, and 1 ton PM₁₀/day. Of this total, diesel road hauling locomotives comprises of almost 31 tons NO_x/day and diesel Switching locomotives 3.5 tons NO_x/day. These two sources comprise over 90% of all locomotive emissions in the SCAQMD. Our current understanding is that the locomotive inventory for the South Coast is developed by the CARB and is based on a Booze, Allen and Hamilton Study published in 1990. We understand that the development of the inventory from this study took into account some in-use testing of locomotive engines.

In SCAQMD staff's attempt to estimate the potential reduction from a locomotive inspection & maintenance program similar to that for light duty vehicles, we looked at the claimed control factor for California's Inspection & Maintenance (I/M) Program anywhere between 30% and 40% from an uncontrolled baseline. Taking a conservative approach, staff believes that a locomotive I/M program would have the potential of achieving a 20% reduction from baseline or the potential to achieve a 7 tons/day NO_x reduction from road haul and switcher diesel locomotive services.

Proposed Project: Perform Study of Comparative Emissions of Heavy-Duty Alternative Fuel and Conventional Fuel Engines

Expected SCAQMD Cost: \$500,000

Expected Total Cost: \$1,000,000

Description of Technology and Application:

Various makes and models of heavy-duty engines using alternative fuels have been developed and marketed in the Basin. The certification procedure requires laboratory tests on the engine emissions performance as well as those of conventional heavy-duty diesel engines. It is important to assess the emissions performance of these engines in actual operation to determine if the engines are operating properly and the expected benefits of alternative fuels are being realized, including potential toxic emissions.

The objective of this project is to assess the on-road emission performance of heavy-duty engines using alternative fuels, including natural gas, dual fuel, and emerging liquid fuels such as Fischer-Tropsch liquids. The testing of equivalent heavy-duty engines using baseline fuels is needed to assess the relative emission performance. Diagnostic procedures will also be performed to help identify any mal-performing system.

Potential Air Quality Benefits:

This proposed program supports several 2003 AQMP On-Road Mobile Sources Control Measures, including M4, "Heavy-Duty Diesel Vehicles; Early Introduction of Low-NO_x Engines" and M5, "Heavy-Duty Diesel Vehicles; Additional NO_x Reductions in California." Certification of low-emission vehicles and engines, and their integration into the Basin's transportation sector, is a high priority under the AQMP and the SIP. In addition, the identification of diesel exhaust particulate as a toxic air contaminant by CARB and the determination that diesel exhaust contributes over 70 percent of the increased cancer risk due to air pollution in the Basin, suggest an urgency to expedite the implementation of clean alternatives to diesel engines to protect public health.

This program is intended to evaluate low emission alternative fuel heavy-duty engine technology and compare such emissions to heavy-duty diesel emissions. For example, the expected benefit of replacing one 4.0 g/bhp-hr heavy-duty diesel engine with a 2.0 g/bhp-hr natural gas engine in a vehicle that consumes 10,000 gallons of fuel per year, is about 800 lb/yr. This proposed project will also determine in-use emission performance and provide an indication of actual vs. certified performance.

Proposed Project: Develop Improved Particulate Measurement Procedures

Expected SCAQMD Cost: \$100,000

Expected Total Cost: \$700,000

Description of Technology and Application:

Reducing particulate emissions has become a high priority in the South Coast Air Basin since the CARB identified the particulate phase of diesel exhaust as a surrogate for all of the toxic air contaminant emitted from diesel exhaust. In addition, the CARB and EPA have adopted very stringent particulate standards for heavy-duty engines and vehicles. As the particulate emissions have been reduced, the specified gravimetric technique for measuring particulate mass has been approaching the limit of its sensitivity, especially with regards to natural gas engines. In addition, with the new standards, the characteristic of the particulate is changing due to various forms of particulate control.

In this program, important parameters related to assessing PM mass emissions will be performed. This includes investigating different particulate sampling techniques, simulated ambient temperatures and dilution ratios, various filter media, and particulate physical and chemical composition. In addition to developing techniques for better particulate measurement on the Federal Test Procedure, a simple alternate particulate measurement will be developed on a 1-second to 1-minute time scale rather than a multi-hour scale. This will enable engine developers to quickly assess control system changes. These improved techniques will be applicable to heavy-duty diesel, natural-gas and other alternative-fuel engines.

Potential Air Quality Benefits:

The AQMP relies on the significant penetration of low-emission vehicles in the South Coast Air Basin to attain federal clean air standards. This project would help understand and improve the characterization and measurement of particulate emissions. This will allow particulate emissions to be accurately measured and their contribution to emission inventory properly understood.

Proposed Project: Alternative Fuel Locomotive Study for Alameda Corridor

Expected SCAQMD Cost: \$250,000

Expected Total Cost: \$750,000

Description of Technology and Application:

There is a need to study alternative-fuel locomotive use for the Alameda Corridor and Alameda Corridor East in order to mitigate the emissions from increasing port and rail traffic. LNG, electric and dual-mode (electric/diesel-electric) locomotive technologies are commercially available. The use of such locomotive technology for limited, high-use routes in the SCAB maybe a cost-effective control strategy which could also accommodate the continued use of conventional locomotives upon the same tracks. The use of a local system of low-emission locomotives may require the Class 1 railroads to alter their operations. This proposed project calls for a study to compare the competing alternative-fuel locomotive technologies, required infrastructure, and potential impact on railroad operations with the use of such intra-basin freight locomotives.

Electric and dual-mode locomotives are currently used at selected locations in the U.S. to match available infrastructure or to meet local environmental needs. LNG locomotives have been demonstrated by the Burlington Northern Railroad on coal trains during the 1990's, and their low-emission capability confirmed by the GasRail USA program.

Potential Air Quality Benefits:

The AQMP emissions inventory shows that about 35 tons/day of NO_x emissions come from locomotives. The U.S. EPA and CARB have agreed to a program that will reduce emissions from these sources by about 65 percent by 2010. However, earlier reductions are necessary to provide additional NO_x benefits for the Basin to achieve federal PM₁₀ air quality standards by 2006. In addition, recent projections from the Los Angeles harbor indicate a doubling of rail traffic along the Alameda Corridor by 2020. There is an environmental effort to hold harbor-related emissions to 2004 levels. The use of zero-emission electric locomotives or low-emission LNG or dual-mode along the Alameda Corridor would be a method to help mitigate the projected increase in emissions.

Health Impacts Studies

Proposed Project: Study Ultrafine Particle Emissions and Health Effects

Expected SCAQMD Cost: \$1,000,000

Expected Total Cost: \$4,000,000

Description of Technology and Application:

Reducing diesel exhaust from vehicles has become a high priority in the South Coast Air Basin, since CARB identified the particulate phase of diesel exhaust as a surrogate for all of the toxic air contaminant emitted from diesel exhaust. Additionally, recent health studies indicate that the ultrafine portion of particulate matter may be more toxic than other fractions. Several technologies have been introduced and are under development to reduce diesel emissions. These include among others, low-sulfur diesel fuel, particulate matter traps, and heavy-duty engines operating on alternative fuel such as CNG and LNG. To have a better understanding of changes in ultrafine particulate emissions from the application of these technologies, and the health effects of these emissions, an evaluation and comparison of ultrafine particulate matter and the potential impacts on community exposures are necessary.

In this program, engine or chassis dynamometer testing will be conducted on heavy-duty vehicles to measure, evaluate, and compare ultrafine particulate matter, PAH, and other relevant toxic emissions from different types of fuels such as CNG, low-sulfur diesel, etc. These tests may also include comparisons with the application of particulate matter retrofit traps. This program needs to be closely coordinated with the development of new after-treatment technologies for alternative fuels and new engines. Additionally, epidemiologic and toxicological studies will be conducted, as well as measurements of ambient levels, to better understand the health effects and potential community exposures from ultrafine particles.

Potential Air Quality Benefits:

The AQMP relies on the significant penetration of low-emission vehicles in the South Coast Basin to attain federal clean air standards by 2010. Reduction of particulate emissions from the use of diesel fuel is a major priority in achieving these standards. This project would help to better understand the nature and amount of ultrafine particulates generated by different types of fuels and advanced control technologies, as well as provide information on potential health effects of ultrafine particles. . Such an understanding is important to assess the emission reduction potentials and health benefits of these technologies. This will in turn have a direct effect on the policy and regulatory actions for commercial implementation of alternative fuel vehicles in the Basin.

Proposed Project: Assess Sources and Health Impact of Ambient Particulate Matter

Expected SCAQMD Cost: \$300,000

Expected Total Cost: \$300,000

Description of Technology and Application:

Previous studies of ambient levels of toxic air contaminants, such as the MATES II study, have found that diesel exhaust is the major contributor to health risk from air toxics. Analyses of diesel particulate matter in ambient samples has been based on measurements of elemental carbon. While the bulk of particulate elemental carbon in the South Coast Air Basin is thought to be from combustion of diesel fuels, it is not a unique tracer for diesel exhaust.

The MATES III study is collecting a year's worth of particulate samples at ten locations in the South Coast Air Basin. Analysis of particulate bound organic compounds will be utilized as tracers to estimate levels of ambient diesel particulate matter, as well as estimate levels of particulate matter from other major sources. Other major sources that may be taken into consideration include automobile exhaust, meat charbroiling, road dust, wood smoke and fuel oil combustion. Analyzing for organic compounds and metals in conjunction with elemental carbon upon collected particulate samples can be used to determine contributing sources.

The measurements of organic compounds as tracers from specific sources is a technique that has been used in numerous source apportionment studies and published within the scientific literature. The resulting data on levels of tracers can be evaluated using Chemical Mass Balance Models and other source apportionment techniques, such as Positive Matrix Factorization, to estimate source contributions to particulate matter. The resulting estimates of ambient diesel particulate matter can then be used to assess potential health risks.

Potential Air Quality Benefits:

Results of this work will provide a more robust, scientifically sound estimate of ambient levels of diesel particulate matter, as well as levels of particulate matter from other significant combustion sources. This will allow a better estimation of potential exposures to and health effects from toxic air contaminants from diesel exhaust in the South Coast Air Basin. This information in turn can be used to determine the health benefits of promoting clean fuel technologies.

Stationary Clean Fuel Technology

Proposed Project: Develop and Demonstrate Low-Cost Emission Monitoring Systems

Expected SCAQMD Cost: \$250,000

Expected Total Cost: \$500,000

Description of Technology and Application:

Low-cost emission monitoring systems are needed for small-to-intermediate size combustion devices, including, stationary engines, boilers, heaters, furnaces and ovens, that are not large enough to justify a continuous emission monitoring system (CEMS). This class of combustion devices is permitted on the basis of a single demonstration or periodic demonstrations of NO_x and CO emissions meeting SCAQMD rule requirements or a RECLAIM concentration limit. Emission spot checks, for example SCAQMD unannounced tests, on engines and boilers have found that in many cases NO_x and/or CO levels have increased significantly above levels that have been initially or periodically demonstrated due to equipment malfunction and/or inadequate operator attention. It is suspected that the same may be true of heaters, furnaces and ovens.

Manufacturers of flue gas analyzers have, in recent years, developed low-cost multi-gas analyzers suitable for portable or stack-mounted use. Installation of stack-mounted emission monitoring systems on combustion devices would provide guidance to owners/operators in keeping the emission control features in good condition and proper adjustment and would enhance SCAQMD's ability to enforce full-time compliance.

Potential Air Quality Benefits:

The 2003 AQMP indicates that in 2010 stationary sources, i.e., stationary engines, boilers, heaters, furnaces and ovens, will account for about 11 percent of total NO_x emissions and about 6 percent of total CO emissions. As mentioned above, evidence indicates that many of these devices are operating with NO_x and/or CO emissions above levels required in their permits. Installation of stack monitors would enable continuous compliance to be more closely approximated on these devices, thus reducing a significant class of NO_x and CO emissions that is in excess of the assumptions in the AQMP.

Proposed Project: Develop and Demonstrate Oscillating Combustion

Expected SCAQMD Cost: \$25,000

Expected Total Cost: \$75,000

Description of Technology and Application:

Oscillating (or intermittent) combustion is a new low-NOx technology that has been developed by the Gas Technology Institute (GTI) and licensed for sale by Precision Q Systems, LLC. This technology is most applicable to industrial furnaces, and has the advantage that it requires modification only of the fuel system and not of the furnace or existing burner(s). NOx reductions from 30 to 70 percent are expected, depending on characteristics of individual furnaces. Intermittent combustion thus promises to be a low-cost, retrofitable and effective NOx control for industrial furnaces.

Potential Air Quality Benefits:

The district has a substantial population of metallurgical furnaces. Low-NOx burners have been retrofit to many of these furnaces, but have not been utilized in all cases. Intermittent combustion may be suitable in cases where low-NOx burners are difficult to apply and may also accomplish additional NOx reductions in cases where low-NOx burners have already been utilized. Many of these furnaces are in RECLAIM, and their owners are thus motivated to reduce NOx emissions. Intermittent combustion could provide another useful tool for them to do so and thereby lead to a significant reduction in NOx emissions in the district.

Proposed Project: Develop and Demonstrate Portable Low Emission Alternative Fuel ICE Generator

Expected SCAQMD Cost: \$100,000

Expected Total Cost: \$200,000

Description of Technology and Application:

Portable engines are commonly used for a variety of purposes, e.g., generators, compressors, tree chippers, concrete pumpers, lights, etc. Diesel engines are currently used to power portable equipment and are classified by the U.S. EPA as non-road diesels, which have emissions standards that are much less stringent than on-road diesel engines. Current standards range from NO_x levels of 6.9 g/bhp-hr and hydrocarbon (HC) levels of 1.0 g/bhp-hr to combined NO_x + HC of 4.5 g/bhp-hr.

The objective of this proposed project is to assemble and demonstrate a portable low-emission generator technology capable of operating on liquefied petroleum gas (LPG), i.e., propane that can compete with portable diesel generators over a range of useful sizes and applications. LPG-fired, spark-ignition engines could be used in their place with considerably lower emissions levels. Rich-burn engines could be equipped with a 3-way catalyst, achieving emissions levels equal to or near to stationary engines (0.15 g/bhp-hr NO_x and 0.15 g/bhp-hr of HC). Alternatively, lean-burn engines with combustion modifications and an oxidation catalyst could achieve 1.5 g/bhp-hr NO_x and 0.15 g/bhp-hr HC.

Potential Air Quality Benefits:

CARB has recently adopted regulatory standards for distributed power generation sources, based on BACT for large stationary sources and the state of available technology. A portable, low emissions LPG generator technology can be expected to become BACT for portable generators in the future. Air quality would benefit from the availability of this technology as future portable diesel generators that would otherwise have been placed in service are replaced by portable, low emissions, generators operating on propane and emitting less NO_x, VOC, PM and carcinogens per unit power produced.

Proposed Project: Demonstrate Emulsified Diesel Fuel Use in Portable Generators

Expected SCAQMD Cost: \$50,000

Expected Total Cost: \$100,000

Description of Technology and Application:

The objective of this proposed project is the development and demonstration of low-emission emulsified diesel fuel technology for portable power generators. Portable generators are used to power equipment at work sites, by film crews working on remote locations, and by highway construction companies to provide light at night, etc. The technology currently available to drive portable generators is the diesel-fueled internal combustion engine, which is a high polluting technology in terms of NO_x, VOC, PM and carcinogen compound emissions.

Emulsified diesel fuel is a blend of diesel fuel, water, and additives. This fuel has been demonstrated to reduce NO_x and PM emissions by approximately 15% and 50% respectively from on-road mobile sources. This low-emission fuel technology, which is promising for on-road mobile sources, should also be effective at reducing emissions from portable power generators.

One of the issues that will be addressed in this project is the stratification of the fuel for long term storage. It has been reported that this fuel tends to stratify when stored in tanks for a relatively long period of time without any agitation. The problem of stratification is not encountered in on-road mobile source applications due to more frequent filling of fuel tanks.

Engine durability and warranty issues will also be studied, particularly for older existing diesel engines.

Potential Air Quality Benefits:

The authority to develop and implement regulations for portable power generators lies primarily with CARB, and to a lesser extent with the SCAQMD. Some of the portable power generators require SCAQMD permits and need to comply with the Best Available Control Technology emission limits. The current AQMP does not have any control measures to reduce emissions from portable power generators; however, significant reductions in diesel toxic exposures may be expected from the reduction of emissions from such engines in urban areas.

Proposed Project: Develop and Demonstrate Renewable-Based Energy Generation Alternatives

Expected SCAQMD Cost: \$500,000

Expected Total Cost: \$1,000,000

Description of Technology and Application:

The objective of this proposed program is to support the development and demonstration of clean energy, renewable alternatives in stationary and mobile applications. The technologies to be considered include thermal, photovoltaic, and other solar energy technologies; wind energy systems; energy storage and conservation; biomass conversion; and other renewable energy and recycling technologies. Innovative solar technologies, such as solar thermal air conditioning and photovoltaic-integrated roof shingles, are of particular interest. Also, in the agricultural sections of the Basin, wind technologies could potentially be applied to drive large electric motor-driven pumps to replace highly polluting diesel fired pumps. Besides renewable technologies, using electrolyzer technology could be used to generate hydrogen, a clean fuel. Hydrogen, when used in regular engines, can substantially reduce tail-pipe emissions, while in fuel cells the emissions are reduced to zero.

The project is expected to result in pilot-scale production demonstrations, scale-up process design and cost analysis, overall environmental impact analysis, and projections for ultimate clean fuel costs and availability. This program is expected to result in several projects addressing technological advancements in these technologies that may improve performance and efficiency, potentially reduce capital and operating costs, improve reliability and user friendliness, and identify markets that could expedite the implementation of successful technologies.

Potential Air Quality Benefits:

The AQMP identifies the development and, ultimately, the implementation of non-polluting power generation. To gain the maximum air quality benefit, polluting fossil fuel-fired electric power generation needs to be replaced with clean renewable energy resources or other advanced zero emission technologies, such as hydrogen fuel cells, particularly in a distributed generation context.

The proposed program is expected to accelerate the implementation of advanced zero emission energy sources. Expected benefits include directly reducing the emissions by the displacement of fossil generation; proof-of-concept and potential viability for such zero emission power generation systems; increased exposure and user acceptance of the new technology; reduced fossil fuel usage; and the potential for increased use, once successfully demonstrated, with resulting emission benefits, through expedited implementation. These technologies would, also, have a substantial influence in reducing global warming emissions.

Proposed Project: Develop and Demonstrate Low Emission, High Efficiency Distributed Generation Technologies

Expected SCAQMD Cost: \$250,000

Expected Total Cost: \$750,000

Description of Technology and Application:

DG is the placement of small power units near the point-of-use to provide enhanced reliability and power quality. The need for such technologies is made more evident in the wake of the California energy crisis in the early 2000s and the Northeastern U.S. power blackout in 2003. Such technologies, however, need to be clean and efficient in order to be successful, especially in the South Coast Basin. Combined cooling, heat, and power DG using advanced technologies such as fuel cells, microturbines, and absorption cooling may provide the balance necessary for improved power reliability, quality, emissions benefits, and energy efficiency.

This project will investigate the integration of these various technologies including fuel cells, microturbines, and absorption cooling. The design features, load following, market acceptability, and emissions performance will be monitored, analyzed, and optimized.

Potential Air Quality Benefits:

The clean DG technologies, using fuel cells or microturbines, will result in reduced NO_x, VOCs, and PM-10 emissions. Such advanced technologies are identified in Chapter 4 of the AQMP as part of the long-term control strategy.

The need for advanced, energy efficient technologies will also satisfy the reduction of greenhouse gas emissions and reduced fossil fuel dependence, in line with the state efforts in AB 1493 and AB 2076.

VOC/Air Toxics Control Technologies

Proposed Project: Conduct Technology Assessments of Future VOC Limits in SCAQMD Rules

Expected SCAQMD Cost: \$250,000

Expected Total Cost: \$250,000

Description of Technology and Application:

Currently, SCAQMD Rule 1113 (Architectural Coatings), Rule 1122 (Solvent Degreasers), Rule 1136 (Wood Products Coatings), and Rule 1168 (Adhesive and Sealant Applications) contain technology-forcing VOC limits which will become effective in future years. These rules also contain provisions that require the Executive Officer to conduct assessment of low-VOC technologies relative to the technology-forcing limits in these rules. Specifically, the technology assessments required under various rules are as follows:

- Rule 1113: Technology Assessments for the future VOC limits for flat and nonflat coatings; lacquers; primers, sealers, and undercoaters; quick-dry primers, sealers, and undercoaters; quick-dry enamels; waterproofing wood sealers; stains floor, rust preventative, and industrial coatings.
- Rule 1122: Technology Assessment for cleaning of film resistors and the future VOC limit for cleaning satellite components.
- Rule 1136: Technology Assessment for the future VOC limits for clear sealers; clear topcoats; pigmented primers, sealers, and undercoats; pigmented topcoats, barrier coat – plastic components; composite wood edge filler; extreme performance coatings; fillers; high-solid stains; inks; mold-seal coatings; multi-colored coatings; low-solid barrier coats – plastic components; and low-solid stains, toners, and washcoats.
- Rule 1168: Technology Assessment for the future VOC limits for PVC welding, CPVC welding, plastic cement welding, and adhesive primer for plastic.

Assessments of these technologies are required to decide on a regulatory course of action to reduce the VOC emissions from these sources. If the technology is available then affected companies may be asked to utilize these new products and processes, otherwise additional work may be required to reduce such emissions.

Potential Air Quality Benefits:

VOC emission reductions are required in the Basin to attain federal Clean Air Standards and pursuant to the AQMP and SIP control measures for the sources listed above.

The future technology-forcing VOC limits in these rules were added to achieve the VOC emission reductions required under various 2003 AQMP control measures. If the future VOC limits are determined to be feasible, the application of materials complying with these limits will result in direct VOC emissions reductions in the Basin.

Proposed Project: Evaluate, Develop, and Demonstrate Advanced VOC Control Technologies for Miscellaneous Stationary Sources

Expected SCAQMD Cost: \$200,000

Expected Total Cost: \$200,000

Description of Technology and Application:

The objective of projects in this category is to evaluate, develop, and demonstrate advanced VOC control technologies for miscellaneous stationary sources. This program area will focus on the following source categories:

- Fugitive VOC emissions from organic liquid storage containers (e.g., above-ground tanks and under-ground tanks); processing and transfer (e.g., valves, pumps, compressors, etc.) of chemicals and petroleum products; and gasoline dispensing facilities. Projects in this category will focus on new technologies to detect and repair frequent and big leaks, develop leakless valves, and enhance vapor recovery devices to broaden their applications and/or to improve control efficiency.
- Manufacturing and fabrication of rubber, plastic, polystyrene foam, fiberglass and chemical products. Emissions are primarily generated from material handling, use of chemicals in different chemical processes, and storage of volatile chemicals.
- VOC emissions can be reduced by the use of control equipment such as carbon adsorption, thermal and catalytic oxidation, and bio-filtration. Projects under this category could include development and demonstration of innovative control technologies for coating, solvent, and printing industries.

Multiple projects are anticipated from this broad category. Since some of the source categories targeted by this measure are not permitted or regulated, it is necessary to first identify and refine the emission inventory, sources of emissions, and industry operations and practices. Based on the findings, appropriate control methods can then be conceptualized and developed, including technological solutions such as development of enclosures that could reduce process-related fugitive emissions.

Potential Air Quality Benefits:

Fugitive emissions are currently regulated under Rule 1173, Rule 1176, Rule 461, Rule 462, and Rule 463. The 2003 AQMP includes control measure CM#2003FUG-05: Emission Reductions from Fugitive Resources. Rubber and plastic product manufacturing operations, and fiberglass fabrication and impregnation processes are not currently regulated under a source-specific SCAQMD VOC rule. The 2003 AQMP targets VOC emission reductions from these operations in control measure CM #2003PRC-07: Industrial Process Operations. This control measure would also include bakeries, breweries, and other sources under chemical, food, and agricultural products processing sources categories. Projects in this category will target long-term technologies and processes that, if successful, will result in direct VOC emissions reductions at the demonstration sites, followed by broader applications that can deliver major VOC reductions throughout the Basin from the emission sources listed above.

Outreach and Technology Transfer

Proposed Project: Conduct Alternative Fuel Training

Expected SCAQMD Cost: \$50,000

Expected Total Cost: \$50,000

Description of Technology and Application:

As the implementation of SCAQMD's Fleet Rules continues, a need for training mechanics and other personnel involved with the operation and maintenance of alternative fuel vehicles and infrastructure have become evident. In many circumstances, public agencies such as school districts are not in a financial position to provide the necessary training needed to operate and maintain their fleet of alternative fuels. While being sensitive to the financial constraints of school districts, this project would provide classroom instruction and hands-on experience with alternative fuel engines and fuel systems for individuals responsible for the operation and maintenance of their alternative fuel fleet.

SCAQMD would work with the California Community Colleges in providing this training. The California Community Colleges has already developed a standardized instructional training program for CNG cylinder safety, fueling procedures, and heavy-duty engine maintenance and repairs. Training classes would be offered to school districts and other public agencies periodically (as needed) throughout the year.

Potential Air Quality Benefits:

The SCAQMD's Multiple Air Toxic Exposure Study (MATES-II) found that mobile source emissions are major contributors to the potential cancer risk from air pollution. In addition, recent findings from long-term epidemiological studies of school age children conducted by the University of Southern California and University of California at Los Angeles indicate that nitrogen oxides, acids, and particulate matter have much greater impacts on limiting lung growth in children than believed in the past. Mobile source emissions have become the major emission contributor to these problems. As such, the SCAQMD Governing Board has adopted clean fleet vehicle rules to reduce immediate population exposure to these pollutants. To assist in the successful implementation of these fleet rules, alternative fuel training is a necessary component.

Proposed Project: Technical Assistance in Assembling SAE Standards for LNG Fueling and Dispensing

Expected SCAQMD Cost: \$150,000

Expected Total Cost: \$300,000

Description of Technology and Application:

The alternative fuel re-fueling industry consists of numerous companies that design and install a wide variety of non-standardized, application-specific refueling systems. Virtually all hydrogen, CNG or LNG-L/CNG stations are custom built to match site parameters, often resulting in unnecessarily costly facilities. These factors all contribute to the high cost of alternative fuel re-fueling stations compared to conventional petroleum stations, and present major barriers to expansion of the NGV refueling infrastructure.

Efforts must be undertaken to reduce capital costs at alternative fuel re-fueling stations by standardizing station designs and components. For instance, dispensers are second only to compression equipment as the most expensive part of a CNG fueling station, with gas flow meters accounting for much of the high cost. Part of the problem is that CNG dispensers intended for public-access stations must meet challenging and expensive Weights and Measures regulations that are not optimized for gaseous fuels.

Card lock systems that control dispenser access and record and process NGV fueling transactions are available with many levels of sophistication. Presently, however, NGV users are unable to use a NGV credit card from one system to another unless the purveyor has an agreement in place to share credit and billing information. Very few of these types of agreements exist leading to the very real possibility of the motorist being stranded with no way to fuel their vehicle if they don't possess the right type of CNG fueling card. Software development must be done in order for the different card readers on the different CNG systems. Efforts such as the FuelNet pilot program are underway to develop a national networked system with card reader commonality among CNG stations.

The main objectives of this project are:

- Developing and implementing various code changes that will decrease unnecessary costs associated with building alternative fuel re-fueling stations.
- Demonstrate the cost, performance and safety parameters for all alternative fuel re-fueling equipment.

Potential Air Quality Benefits:

The AQMP relies on the significant penetration of zero- and low-emission vehicles in the South Coast Basin to attain federal clean air standards by 2010. This project, if successful, would help develop a uniform safety standards and codes for all types of alternative fuel re-fueling equipment. It will also help decrease the cost of alternative fuel re-fueling equipment installation and expedite the introduction of alternative fuels, including hydrogen, into the Basin. This increased convenience and lower cost equipment.

Proposed Project: Technical Assistance in LNG Fueling for Transit Properties**Expected SCAQMD Cost:** \$200,000**Expected Total Cost:** \$200,000**Description of Project:**

In the past three years, the Board has approved significant incentive funding for alternative-fueling stations in the Basin to support the fleet rules. In response to requests for technical and management assistance for developing alternative fuel vehicles and refueling infrastructure projects from fleet owners, additional alternative fuel infrastructure technical assistance was needed. The SCAQMD entered into contract agreements with contractors to increase the level of technical assistance and expertise that are offered by them to help implement alternative fuel infrastructure projects. Experts in the areas of natural gas vehicles and infrastructure with extensive experience in advanced transportation technologies and alternative fuels will provide timely consultation and assistance to clean fleet and infrastructure owners.

Potential Air Quality Benefits:

The AQMP relies on the significant penetration of zero- and low-emission vehicles in the South Coast Basin to attain federal clean air standards by 2010. This technical assistance provides the needed resources for the implementation of alternative fuel infrastructure projects and thus their wider and expedited use.

Proposed Project: Technical Assistance for Schools' Maintenance Facilities

Expected SCAQMD Cost: \$300,000

Expected Total Cost: \$300,000

Description of Project:

As school districts convert their bus fleets from diesel to natural gas, they must renovate their maintenance facilities to supply the NGVs. Cost, regulation requirements, and equipment safety are major issues during the transition. Addressing the garage modification issues will require more study and evaluation as each district is hiring architects and consultants with a host of high cost compliance solutions. These architects and consultants should be encouraged to develop options for compliance with NFPA 88 B rather than conveniently taking the worst case scenario. The approximate costs of repair garage modifications could be significant depending on the garage configuration and appurtenances, and Fire Department code interpretations.

The scope of work would include developing a California-wide school bus user group with the major school bus vendors. Formation of the user group will allow discussions of NGV performance, operational requirements, and safety standards. The process will enhance the implementation of a continuous improvement design and equipment modifications that will result in NGVs becoming more competitive and cost effective. Through this process, the user group may be able to speed up the commercialization process for NGVs. The user group will also provide complete basic standard turnkey designs, construct engineering drawings, and compile specifications packages for new NGVs stations and modifications to existing CNG stations at school districts. Areas that should be included are plans, flow schematics, fueling curves, and performance specifications, and basic construction specifications.

Potential Air Quality Benefits:

The AQMP identifies the use of alternative clean fuels in mobile sources as a key attainment strategy. The CARB has also passed standards for medium- and heavy-duty vehicles. NGVs have significantly lower emissions than gasoline vehicles and represent the cleanest internal combustion engine powered vehicles available today. This technical assistance provides the needed resources for the implementation of alternative fuel infrastructure projects and thus their wider and expedited use.

Proposed Project: Assessment and Technical Support of Advanced Technologies and Information Dissemination**Expected SCAQMD Cost:** \$500,000**Expected Total Cost:** \$500,000**Description of Project:**

This program supports the assessment of clean fuels and advanced technologies, their progress towards commercialization, and the dissemination of information on demonstrated technologies. The objective of this program is to expedite the transfer of technology developed as a result of Technology Advancement projects to the public domain, industry, regulatory agencies, and the scientific community. This program is a fundamental element in the SCAQMD's outreach efforts to expedite the implementation of low emission and clean fuels technologies and to coordinate these activities with other organizations.

This program may include the following:

- Technical review and assessment of technologies, projects, and proposals
- Alternative fuel refueling and EV charging site information support
- Advanced technology curriculum development, mentoring, and outreach to local schools
- Emissions studies and assessments of zero-emission alternatives
- Alternative Fuel Vehicle Lease Program
- Preparation of reports, presentations at conferences, improved public relations and public communications of successful demonstrations of clean technologies
- Participation in and coordination of workshops and various meetings
- Support for training programs related to fleet operation, maintenance, and refueling of alternative fuel vehicles
- Publication of technical papers, reports, and bulletins
- Production and dissemination of information, including web sites

These objectives will be achieved by consulting with industry, scientific, health, medical, and regulatory experts and co-sponsoring related conferences and organizations, resulting in multiple contracts. In addition, an ongoing outreach campaign will be conducted to encourage decision-makers to voluntarily switch to alternatively fueled vehicles, and train operators to purchase, operate and maintain these vehicles, and its associated infrastructure.

Potential Air Quality Benefits:

SCAQMD recently adopted fleet regulations requiring public and private fleets within the Basin to acquire alternatively fueled vehicles when making new purchases. Expected benefits of highlighting success stories in the use of advanced alternatively fueled vehicles could potentially expedite the acceptance and commercialization of advanced technologies by operators seeking to comply with the provisions of the recently adopted SCAQMD fleet rules. The resulting future emissions benefits will contribute to the goals of the AQMP.

Proposed Project: Support for Implementation of Various Clean Fuels Vehicle Incentive Programs

Expected SCAQMD Cost: \$400,000

Expected Total Cost: \$400,000

Description of Project:

This program supports the implementation of zero emission vehicle incentives program, the Carl Moyer incentives program, and the school bus incentives program. Implementation support includes application approval, grant allocation, documentation to the CARB, verification of vehicle registration, and other support as needed. Information dissemination is critical to successful implementation of a coordinated and comprehensive package of incentives. Outreach will be directed to vehicle dealers, individuals, and fleets.

Potential Air Quality Benefits:

As described earlier, the SCAQMD will provide matching funds to implement several key incentives programs to reduce diesel emissions in the Basin. Furthermore, the SCAQMD recently adopted fleet regulations requiring public and private fleets within the Basin to acquire alternatively fueled vehicles when making new purchases. Expected benefits of highlighting zero emission vehicle incentives could potentially expedite the acceptance and commercialization of advanced technologies by operators seeking to comply with the provisions of the recently adopted SCAQMD fleet rules. The resulting future emissions benefits will contribute to the goals of the AQMP. The school bus program and the Carl Moyer incentives program also will reduce large amounts of NO_x and PM emissions in the basin, besides reducing toxic air contaminants.

Appendix A

SCAQMD Advisory Groups

Technology Advancement Advisory Group

Tom Cackette	California Air Resources Board
Tim Carmichael	Coalition for Clean Air
Dr. Blair Folsom	GE Energy & Environmental Research Corp.
John Freel	Chevron Products Company
Dr. Henry Gong	Rancho Los Amigos Hospital
John D. Harper, Jr.	Small Business Coalition
Philip J. Hodgetts	Clean Air Now
Shang Hsiung	U.S. Department of Transportation
Pete Devlin	U.S. Department of Energy
Michael La Cavera	Westway Terminals
Scott Matthews	California Energy Commission
Dan Moran	Quality Body Works
Gary Stafford	Terra Furniture
Lee Wallace	Sempra Energy
William R. West	Southern California Edison

SB 98 Clean Fuels Advisory Group

Todd Campbell.....	Coalition for Clean Air
Dr. Blair Folsom	GE Energy and Environmental Research Corporation
Dr. John Froines.....	UCLA Center for Occupational and EnvironmentalHealth/UCLA School of Public Health
Dr. Fritz Kalhammer.....	Independent Consultant in Energy and ProcessTechnology
Jason Mark.....	Union of Concerned Scientists
Dr. Melanie Marty	Office of Environmental Health Hazard Assessment
Dr. Wayne Miller.....	Center for Environmental Research and Technology University of California - Riverside
Dr. Vernon Roan.....	Center for Advanced Studies in Engineering University of Florida
Brian Runkel.....	California Environmental Business Council, Inc.
Dr. Scott Samuelsen.....	Combustion Laboratory/National Fuel Cell Research Center/University of California - Irvine
Dr. George Sverdrup.....	National Renewable Energy Laboratory
Dr. Nicholas Vanderborgh.....	Independent Consultant in Fuel Cell Technologies
Michael Walsh	Independent Consultant in Motor Vehicle PollutionControl

Appendix B

Open Clean Fuels Contracts as of January 1, 2005

Contract	Contractor	Project Title	Start Term	End Term	AQMD \$	Project Total \$
Incentive Programs-Alternative Fuels						
00114	Alta Loma School District	Purchase Two CNG School Buses	03/22/00	06/01/05	\$ 119,608	\$ 464,000
00116	Montebello Unified School District	Purchase Two CNG School Buses	06/07/00	06/01/05	119,608	464,000
00105	Avery-Dennison Office Products North America	Purchase Nine Electric Forklifts	06/20/00	03/15/06	10,000	277,452
00107	Harbor Distributing, LLC	Purchase 32 Electric Forklifts	05/16/00	03/15/06	20,000	923,732
00113	Lowes Home Improvement Warehouse Inc.	Purchase 40 Electric Forklifts	05/24/00	03/15/06	80,000	921,595
00131	HomeBase Inc.	Purchase 20 Forklifts	06/07/00	03/15/06	40,000	700,000
01137	R.F. Dickson Company, Inc.	Repower Ten & Purchase Four PM10-Efficient CNG Street Sweepers	04/17/01	12/31/06	1,010,000	1,010,000
00143	Los Angeles Department of Water & Power	Purchase 25 Electric Buses	06/28/00	06/01/05	450,000	5,511,944
01051	Fabrica Int'l	Purchase Two Electric Forklifts w Batteries	10/11/01	12/31/05	25,598	25,598
01138	Hayward Pool Products, Inc.	Purchase Two Electric Forklifts w/Batteries	05/02/01	06/15/06	20,200	20,200
01151	Vicro Manufacturing	Purchase 30 Electric Forklifts with 2 Battery Packs	11/26/01	12/31/07	424,190	424,190
01157	Waste Management of Los Angeles	Purchase 20 Natural Gas Refuse Trucks	02/27/02	06/30/08	394,278	434,922
01159	Waste Management of San Gabriel	Purchase 20 CNG Refuse Collection Trucks	07/31/02	06/30/08	829,200	829,200
01160	Waste Management of the Desert	Repower Seven Roll-Off Refuse Trucks LNG	10/03/01	06/30/08	75,221	1,053,094
01178	CalMet Services Inc.	Repower 27 Waste Collection Trucks with CNG	09/19/01	06/30/07	343,000	1,323,000
01336	Chroma Systems	Purchase Electric Forklift w/Battery	04/11/01	06/30/06	4,734	4,734
04169	City of Santa Monica	Purchase 52 New LNG Transit Buses	08/04/04	09/30/10	407,732	407,732
04170	Mellon Grading, Inc.	Repower One Each of Diesel Water Hauler, Diesel Crawler Tractor, Diesel Crawler Tractor Loader	10/01/04	12/31/10	140,450	140,450
04171	Santa Clarita Transit	Purchase 12 New CNG Transit Buses	07/28/04	07/31/10	126,000	4,203,432

Contract	Contractor	Project Title	Start Term	End Term	AQMD \$	Project Total \$
----------	------------	---------------	------------	----------	---------	------------------

Fuel Cell Technology

03095	Fuel Cell Technologies Ltd.	Pilot Demonstration of Residential Fuel Cell	02/10/03	02/28/06	16,149	982,300
03269	University of California Davis	Develop, Demonstrate & Evaluate Truck Fuel Cell Auxiliary Power Unit	05/23/03	03/31/06	300,000	1,200,000
03287	California Air Resources Board	Develop & Demonstrate Integrated Autothermal Cyclic Reformer and Proton Exchange Membrane Fuel Cell	09/01/02	05/15/06	\$ 100,000	\$ 800,000
04120	Seaworthy Systems, Inc.	Demonstration of a Fuel Cell Water Taxi	07/13/04	09/12/06	101,000	781,000

Hydrogen Technology and Infrastructure

02189	ISE Research Corp	Develop & Demonstrate Water Electrolyzer Hydrogen Refueling Station in Coachella Valley	05/23/02	09/30/05	389,882	1,177,205
03198	Praxair Inc.	Demonstrate & Develop Electrolyzer-Based Hydrogen Fueling Station Near the LAX	10/13/03	10/16/05	351,000	1,451,000
03200	SunLine Services Group, Inc.	Develop & Demonstrate an Autothermal Reformer Hydrogen Fueling Station	02/10/03	07/31/05	350,000	1,075,000
03201	University of California, Irvine	Demonstrate & Develop Hydrogen Fueling Stations in Orange County	10/16/03	04/16/06	863,400	983,400
04009	Energy Conversion Devices Inc.	Integrate & Develop an ICE Hybrid Vehicle Utilizing Metal Hydrides for On-Board Hydrogen Storage	03/12/04	07/12/06	200,280	400,561
04012	Stuart Energy	Install & Demonstrate Electrolyzer-Based Hydrogen Refueling Station Integrated with Stationary Internal Combustion Engine Power Generation Unit	12/05/03	07/31/05	637,000	849,500
04185	Quantum Fuel Systems Technologies Worldwide Inc.	Develop & Demonstrate Hydrogen Internal Combustion Engine Vehicles	10/18/04	08/31/10	2,109,851	3,505,631

Engine Technology

03289	Cummins Engine Co. Inc.	Develop & Demonstrate Next Generation Natural Gas Vehicle (NGNGV) Engine Technology	07/07/03	08/31/05	999,769	1,999,546
03427	Mack Truck Inc.	Develop & Demo NGNGV Phase II Integration of Improved NG Engine into Commercial Chassis	07/13/04	11/30/05	583,651	2,334,998
04046	EVO Transportation Corporation	Demonstrate Program to Convert Ten Gasoline-Fueled SUVs to CNG-Fueled ULEVs	12/23/03	02/28/06	100,000	450,000

Contract	Contractor	Project Title	Start Term	End Term	AQMD \$	Project Total \$
----------	------------	---------------	------------	----------	---------	------------------

Infrastructure and Fuel Production

01154	R.F. Dickson Company, Inc.	Cost-Share Installation of CNG Fueling Facility	08/04/01	07/31/06	180,000	180,000
01165	ENRG, Inc. (formerly Pickens Fuel Corp.)	Construct & Operate One LNG & Four CNG Fueling Stations within SCAQMD Basin	05/07/01	03/30/06	288,800	1,577,600
02157	ENRG, Inc. (formerly Pickens Fuel Corp.)	Upgrade Existing CNG Fueling Stations	01/17/02	02/28/06	\$ 823,199	\$ 1,375,696
02208	Structural Composites Industries	Develop & Demonstrate Advanced Storage Tanks for Storing CNG/LNG and Compressed and Liquid Hydrogen	11/01/02	06/30/05	484,500	1,310,000
03099	Sanitation Districts of Los Angeles County	Purchase & Install LNG-L/CNG Fueling Station at Puente Hills Landfill Facility	02/10/03	07/31/08	560,000	560,000
03102	USA Waste of California, Inc.	Purchase & Install LNG-L/CNG Fueling Station at LA Metro Hauling District	06/26/03	06/30/08	400,000	400,000
03103	Waste Management Recycling & Disposal Services	Develop LNG-L/CNG Fueling Station	10/23/03	12/31/08	400,000	400,000
04015	WM Energy Solutions, Inc.	LNG Production at Bradley Landfill	11/06/03	09/30/09	300,000	5,277,000
04085	City of Banning	Construct Natural Gas Fueling Station in Banning	03/26/04	08/31/09	140,000	724,000
04121	Pas, Gas & Electric	Cost-Share Small-Scale Natural Gas Liquefaction Plant	09/24/04	06/30/05	200,000	5,600,000

Electric/Hybrid Technologies

99109	Toyota Motor Corporation	Three-Year Lease of One RAV4 Electric Vehicle	04/04/99	12/01/06	61,895	61,895
00051	Santa Barbara Electric Bus Works Inc.	Develop & Demonstrate an Electric School Bus	11/23/99	08/31/05	100,000	400,000
02116	Clean Fuels Connection	Develop Dual Inductive/Conductive Charger Bracket to Allow Reduction of EV Charging Infrastructure Costs	12/31/01	03/31/05	47,815	95,694
04019	University of California, Davis	Optimize & Demonstrate Plug-In Hybrid Electric Vehicles	04/27/04	04/26/05	150,000	458,000
04027	ISE Research Corporation	Develop & Demonstrate Hydrogen-Internal Combustion Engine for Hybrid-Electric Buses	10/29/03	05/31/05	210,000	1,075,000
04032	Electric Power Research Institute	Develop, Demonstrate & Evaluate Plug-In Hybrid Electric Vans in Fleet Use	11/14/03	08/31/05	475,000	1,525,000
04143	Clean Fuels Connection	Public EV Charging Equipment & Signage Replacement	07/09/04	07/08/05	100,000	100,000

Contract	Contractor	Project Title	Start Term	End Term	AQMD \$	Project Total \$
----------	------------	---------------	------------	----------	---------	------------------

Emission Control Technology

00139	Gas Research Institute	Develop & Demonstrate Advanced Safety Inspection Methods for Natural Gas Vehicle Tanks	07/21/00	08/31/05	325,000	2,303,000
01173	National Renewable Energy Laboratory	Demonstrate Fischer-Tropsch Synthetic Fuel in Heavy- & Medium-Duty Vehicles	06/11/01	06/25/05	178,001	737,855
02293	Automotive Testing Laboratories	Develop & Demonstrate Fischer-Tropsch Fueled Heavy-Duty Vehicles with Control Technology to Reduce Exhaust Emissions	08/23/02	03/31/05	\$ 726,850	\$ 1,670,976
03109	West Virginia University Research Corporation	Aftertreatment Technologies for PM Emissions Control of CNG-Fueled Heavy-Duty Engine	11/07/02	03/31/05	447,042	547,042
03467	Cummins Westport, Inc.	Aftertreatment Technology for PM & Hydrocarbon Emissions Control of CNG-Fueled Heavy-Duty Engines	04/08/04	01/31/05	496,785	740,000
04155	Lubrizol Engine Control Systems	Optimize & Demonstrate Oxidation Catalysts to Reduce Emissions from CNG-Fueled Heavy-Duty Vehicles	06/25/04	06/24/06	340,900	412,650

Emission Studies

00188	University of California, Riverside	Testing Support & Emissions Assessment	07/17/00	07/01/06	100,000	100,000
03468	University of California, Riverside	Reactivity & Availability Studies of VOC Species Found in Architectural Coatings and Mobile Sources	08/01/03	07/31/05	100,000	200,000

Health Impacts Studies

03225	California Air Resources Board	Quantify Health Benefits of Incremental Improvements in Air Quality in the SCAB	10/01/02	05/15/06	100,000	306,261
03358	Jurupa Unified School District	Children's Health Study	06/13/03	05/31/06	25,000	25,000
04073	University of Southern California	Study Effects of Smoke from Recent Wildfires in Cohorts of USC Children's Health Study	03/12/04	06/30/05	49,896	49,896
05037	California Air Resources Board	Co-Fund Ultrafine Particulate Matter Health Effects Study	06/28/04	10/31/07	501,814	4,392,814

Stationary Clean Fuel Technology

99046	Engelhard Corporation	Field Evaluation of PremAir Ozone Catalyst Technology on AC Units	10/06/98	12/31/10	0	0
-------	-----------------------	---	----------	----------	---	---

Contract	Contractor	Project Title	Start Term	End Term	AQMD \$	Project Total \$
Outreach and Technology Transfer						
97110	Burke, Andrew	Review & Assessment of Technical Proposal re: ATTB Ultracapacitor System	06/04/97	08/15/05	15,000	15,000
97113	JME Inc.	Review & Assessment of Technical Proposal re: ATTB Ultracapacitor	05/08/97	08/15/05	15,000	15,000
00069	Walsh Consulting	Technical Assistance Relating to the Use of Alternative Fuels in Mobile Sources	02/17/00	02/28/06	35,000	35,000
00098	Katz, Murray	Technical Assistance Pertaining to Fuel Cell Development & Commercialization	02/25/00	02/28/06	\$ 20,000	\$ 20,000
01104	Seaworthy Systems, Inc.	Evaluate Carl Moyer Marine Vessel Proposals	01/19/01	01/31/05	50,000	50,000
01169	Clean Fuels Connection	Technical & Management Assistance for Carl Moyer, School Bus and ZEV Implementation Programs and Infrastructure Scoping	04/20/01	04/19/05	225,000	225,000
02114	Gladstein & Associates	Outreach Support for Low-Emission Clean Fuel Heavy-Duty Vehicles	02/22/02	02/28/06	250,000	250,000
02158	College of the Desert	Develop Natural Gas School Bus Training Curriculum	11/05/02	03/31/05	239,609	239,609
02295	SynchroEnergies LLC	Technical Assistance on Lubricants, Fuels, Combustion, Alternative Energy Sources & High Performance Fluid Technologies	05/23/02	06/30/05	25,000	25,000
02308	Sperry Capital, Inc.	Evaluate Financial Stability of Potential Contractors	06/25/02	12/31/05	20,000	20,000
02311	Cole, Jerald A.	Technical Assistance for Development ,Outreach & Commercialization of H2 Infrastructure and Reforming Technology	08/09/02	06/30/05	30,000	30,000
02333	University of California, Riverside	Technical Assistance on Clean Fuels Technology, Hydrogen, Fuel Cell Technology and Natural Gas Technology	11/01/02	06/30/05	30,000	30,000
02334	Engine, Fuel & Emissions Engineering Inc.	Technical Assistance on Natural Gas Engine Technology	07/31/02	06/30/04	65,000	65,000
02335	Otto, Neil C.	Technical Assistance on Fuel Cell Technology	08/09/02	06/30/05	30,000	30,000
03181	Hughes Associates	Support, Training & Guidance Toward Purchase of New Fleet and On-Board LNG Fueling Systems	11/20/02	10/16/05	50,000	50,000
03450	Sawyer Associates	Technical Assistance Pertaining to 2003 Revision and Mobile Source Control Sources	06/26/03	11/30/05	15,000	15,000

Contract	Contractor	Project Title	Start Term	End Term	AQMD \$	Project Total \$
Outreach and Technology Transfer (Cont'd)						
03451	TIAX LLC	Technical Assistance Pertaining to 2003 Revision and Mobile Source Control Sources	06/23/03	11/30/05	20,000	20,000
04045	TIAX LLC	Technical Assistance for Development, Outreach & Commercialization of Low-Emission and Alternative Fuel Technologies	11/21/03	12/31/05	30,000	30,000
04048	Sullivan, Cindy	Technical Assistance for Emission Control & Alternative Fuel Technologies	11/21/03	12/31/05	30,000	30,000
04049	Engine, Fuel & Emissions Engineering Inc.	Technical Assistance for Alternative Fuels Engine Technology	11/21/03	12/31/05	\$ 40,000	\$ 40,000
04050	Breakthrough Technologies Institute	Technical Assistance for Fuel Cells	11/21/03	12/31/05	45,000	45,000
04052	Hughes Associates	Technical Assistance for Alternative Fuels Infrastructure	12/19/03	12/31/05	40,000	40,000
04053	Marathon Technical Services	Technical Assistance for Alternative Fuels Infrastructure	11/21/03	12/31/05	40,000	40,000
04097	Calstart	Ongoing Operation & Improved Functionality of Clean Car Maps Internet Website	06/15/04	01/31/07	110,000	355,000
04102	Clean Vehicle Education Foundation	Cosponsor 2004 Natural Gas Vehicle Conference & CVEF Activities	03/10/04	01/31/05	12,500	100,000
04115	Los Altos High School	Cosponsor the LAAE Ultra-Light Single Passenger Fuel Cell/Electric Power Vehicle Project	05/05/04	05/31/05	10,000	91,500
04123	Gladstein, Neandross & Associates LLC	Demonstrate Low-Emission, Alternative Fuel Heavy-Duty Vehicles within SCAB & Public Awareness Program	06/04/04	12/03/05	125,000	490,000
04146	Gross, Tom	Technical Assistance for Hydrogen & Fuel Cell Technologies	06/23/04	05/31/05	25,000	25,000
04168	Regulus Associates Inc.	Technical Assistance with Contract-Related Services	06/23/04	06/22/05	40,000	40,000
04183	Energy Independence Now	Cosponsor Energy Independence Now's 2004 Activities & Support the California Hydrogen Highway Network	06/23/04	01/31/05	50,000	105,000
04207	University High School	Cosponsor UHS Solar Racing Project	06/29/04	09/30/05	5,000	20,000
05008	Bevilacqua-Knight Inc.	CY 2004 Membership & Participation in California Fuel Cell Partnership	07/07/04	07/06/05	133,800	1,960,000
05040	Weststart-Calstart	Cosponsor 5 th Annual Clean Heavy-Duty Vehicle Conference	11/11/04	09/30/05	25,000	100,000
05053	Rand Corporation	Cosponsor Rand's Forum on Valuing the Hydrogen Economy	12/08/04	09/30/05	5,000	5,000

Appendix C

Final Reports for 2004

Determine Feasibility and Steps to Design Conversion of a CNG Station into a Hydrogen Fueling Station

Contractor

SunLine Services Group, Inc.

Cosponsors

None

Project Officer

Gary Dixon

Background

In July of 2001 the South Coast Air Quality Management District (AQMD) directed a field evaluation and assessment of natural gas fueling stations and their potential compatibility with future hydrogen fueling stations. As an outgrowth from the Hydrogen Compatibility Study Team's recommendations, AQMD directed that a study be performed to determine what is required to convert a CNG station to a hydrogen station.

Background information was collected from a variety of sources to help in understanding the position and practice of what the industry is currently doing and what the vision is for the future. Site visits were made to existing hydrogen stations to determine a preliminary set of specifications for this study.

Project Objective

The objective of this study is to provide AQMD with a detailed plan for the steps in the design phase for the conversion of a CNG fueling station to a hydrogen station. The station will be an integrated system with a design that will allow for applications to a variety of CNG station designs in existence.

The parameters of this study set a limit to the demand for hydrogen at 6 to 8 fuel cell vehicles per day. Further the quantity of fuel

to be considered was 5 kilograms at 5,000 psig. To date, demand is limited at the restricted number of hydrogen stations in existence, with excess capacity being a common denominator.

Technology Description

Design criteria for a hydrogen fueling station is discussed. Descriptions of the components of the hydrogen station were given to understand equipment availability in the industry and how the equipment can be utilized. A detailed description of the diaphragm compressor is provided to introduce the benefits of using a diaphragm compressor for hydrogen compression. Other components of the hydrogen station, in particular the cascade and dispensing system, have been developed in the last few years to meet mass production requirements. Some of these component specifications have been listed in a final specification. In addition a flow diagram of a hydrogen station, a description of a generic CNG station, and a current list of codes and standards employed by early adopters is provided.

There are five basic options to consider regarding current CNG stations and how they may be converted to hydrogen stations. These are: (1) supply from a centralized facility with liquid hydrogen; (2) supply from a centralized facility for compressed hydrogen; (3) direct connection to a hydrogen pipeline; (4) direct connection to a natural gas pipeline for a natural gas reformer for hydrogen; and (5) utilizing an electrolyzer to produce the hydrogen.

All of these station configurations have the following elements in common: planning, site layout, site design, permitting, codes and standards, electrical, mechanical, removal,

construction, demolition, transportation, reinstallation, installation, compression, storage, dispensing, detection devices, training, operations and maintenance, and policies and procedures. Discussions regarding code restrictions, electrical classifications in and around hydrogen, dispensers, fueling, venting, safety devices, maintenance safety equipment, operations and procedures, evacuation plans, repairs and leaks have been introduced. In the conversion of a CNG station to a hydrogen station, only the elements of compression, storage, and dispensing need to be considered.

Although this study presents the ideas and challenges for a CNG to hydrogen station conversion, a specific site could not be presented, as each site is unique. Further the study brings out the problems, concerns and modifications that affect the conversion which must be addressed during assessment of each station and compares a CNG station's equipment to hydrogen station requirements. Of these the compressor presents the most serious problem. Most CNG stations (if not all-current CNG stations) utilize a reciprocating compressor. Reciprocating compressors without an after-treatment system are at a high risk for hydrocarbon contamination of the storage, line distribution and dispensing equipment.

There is a summary of the conversion of a CNG Station to a hydrogen station, which requires incorporation of major modifications. The entire equipment of the station would change. As in any hydrogen station a systems design would be required. Once the desired design is complete, the footprint should accommodate almost any type of hydrogen station design. One disadvantage of this concept is the added expense of demolition of an existing station. However, some of the costs can be minimized to a certain extent if the fuel island and electrical supply are salvageable. Other than just a few items most of the station will incorporate all new equipment along with the civil and mechanical work needed to install and receive the new equipment i.e. pads, compressor, dispenser, storage, hydrogen generator and other support equipment.

An alternative consideration is the option of siting hydrogen equipment on an existing CNG site if the footprint is sufficient.

Status

This project was completed on March 31, 2004.

Results

In looking at the other options, a case can be made for conversion at minimal cost from CNG to hydrogen but at a lower pressure i.e. 3,000 to 3,600 psig. Although this has not been done before, a discussion is provided for consideration and evaluation. This could serve as a potential near term market for internal combustion engines (ICE's) running on hydrogen. Cost estimates were made for three options: (1) CNG to Low Pressure

(3,000 to 3,600 psig) Hydrogen Station: \$139,000 to \$164,000; (2) CNG to High-Pressure (5,000 psig) Hydrogen Station: \$315,000 to \$361,000; and (3) New Hydrogen Station: \$372,000 to \$421,000. All three options are discussed in detail.

Benefits

There are considerations that require the reflection of risk. If the conversion of existing CNG stations to high pressure hydrogen stations is aimed at fuel cell vehicles, in the long run it would be more economical to make the decision to develop a new high pressure hydrogen station. The difference in cost is approximately 17%. When considering the value of a fuel cell and the likelihood of affordability, it does not seem prudent to risk destruction of the fuel cell from the introduction of hydrocarbons from reciprocating compressors on the basis of approximately \$60,000 in additional costs for diaphragm compression.



CNG Compressor
Lube Reciprocating



H2 Compressor
Diaphragm

Project Costs

The cost to complete this project was \$51,680.

Commercialization and Applications

In the near term if the objective is to serve new fuel cell vehicles, then new hydrogen stations should be strategically located to become a hub for demonstrations only. More than likely liquid hydrogen or compressed gaseous hydrogen tube trailers would be the normal method of supplying hydrogen. The station would be designed to incorporate future changes on the basis of increased availability of fuel cell vehicles

Develop and Demonstrate Hydrogen-Compressed Natural Gas Blend Transit Buses

Contractor

SunLine Services Group, Inc.

Cosponsors

National Renewable Energy Laboratory

Project Officer

Gary Dixon

Background

As emission regulations continue to become more stringent, diesel engine designs are narrowing their emissions gap with natural gas fueled engine technology. Therefore, it is important to continue to improve the benefits of clean burning natural gas and ensure the existing and future investment in fueling and technology infrastructure is fully utilized. The blending of hydrogen with compressed natural gas (HCNG) has recently been investigated for its ability to further reduce emissions of CNG-fueled engines. In order to demonstrate the viability of the HCNG approach, this HCNG transit bus development and demonstration program was initiated.

Project Objective

The fundamental project goal was to develop HCNG powered vehicles to serve as a commercially viable bridge for introducing hydrogen to the heavy-duty transit vehicle market, as well as to demonstrate the emissions benefits of HCNG fuel in state of the art internal combustion engines. The objectives established to support this goal were:

- Optimal HCNG fuel blend
- Reviewing component compatibility
- Comparison testing (engine dynamometer & chassis dynamometer testing) for

performance and emissions characteristics of HCNG

- Vehicle performance and engine wear evaluations after 24,000

Technology Description

In order to determine the optimal engine calibrations and fuel blend specifications, a literature review of previous similar work was conducted, followed by the development and optimization of a CWI B gas plus engine for operation on the selected HCNG fuel blend.

A test matrix was developed to determine the optimal HCNG blend, and a new calibration was developed using the torque curve and AVL8, ESC13 cycle points. The AVL8 steady state test cycle has been used in the past as an indicator of heavy-duty engine performance and emissions over an actual federal test procedure (FTP) transient cycle, without the expense of conducting full FTP transient emissions testing.

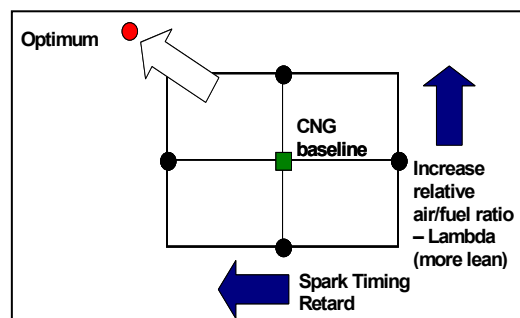

Test matrix used for HCNG blend investigation.

The optimized HCNG calibrations were then implemented in two CNG engine-equipped transit buses, which operated in revenue service against two CNG control buses, also with CWI B gas plus engines. Key evaluation tools included 3,000 mile preventative maintenance inspections and an extensive 24,000-mile engine and vehicle inspection. In addition, fuel economy, oil

consumption and operational issues were tracked throughout the demonstration.

West Virginia University (WVU) performed chassis dynamometer exhaust emissions testing on all four project buses on their Mobile Chassis Dynamometer in the city of Riverside, CA. Tests were conducted over two test cycles, the City-Suburban Heavy Vehicle Route (CSHVR) and the double length Orange County Transit Authority (OCTA2X).



Project bus on WVU mobile chassis dynamometer in Riverside, CA.

A public outreach component was included in the project to maximize the technology transfer of project results to other interested parties and to provide an introduction of hydrogen as a transportation fuel to the general public.



Status

The project is complete and all deliverables have been met. The four project buses continue in revenue service.

Results

In general, the project demonstrated that HCNG blends can be successfully utilized in revenue service fleets with equal performance, and improved emissions, without costly engine or vehicle

modifications. A 20 mole percent hydrogen/80 mole percent CNG blend provided the optimal NOx emissions reduction, while preserving the performance of the CNG control buses.

Up to 50 percent NOx reduction was achieved in this demonstration. A small fuel economy/range penalty was experienced in the operation of the HCNG blend. The in-use demonstration measured about a 12 percent fuel economy reduction for the HCNG relative to the CNG operation, a result that is consistent with the 10 to 14 percent reduction observed during the chassis dynamometer test cycle evaluation.

As predicted, minor engine and vehicle hardware modifications were required. The single required engine hardware modification was installation of a new fuel mass flow rate sensor. The single vehicle hardware modification was installation of additional fuel tanks to account for the fact that HCNG fuel requires more volume per unit of energy than CNG. The importance of reliable fueling capability was found to be a critical aspect of the project. The results of the 24,000-mile engine and vehicle inspection did not indicate any concerns or issues whatsoever with the HCNG fueled buses compared to their CNG control buses.

Benefits

Hydrogen/CNG blends have the potential to provide a fairly simple solution to the infamous “chicken-and-egg” problem, providing vehicles that could consume some amount of hydrogen, justifying CNG station “retrofits” to provide the blended fuel. But the driving benefit of this proposed technology is the potential for it to be a cost-effective “bridge” to a hydrogen future.

Project Costs

The total project costs were \$474,481.

Commercialization and Applications

Future HCNG projects should consider the design capability of the fueling station technology, and its ability to meet blend

specifications for the engine. One approach to mitigate this important concern is to eliminate the sensitivity of engine operation to blend ratios. This would be an excellent design improvement, which could operate much like the ethanol-fueled flexible fueled vehicles (FFVs) that can operate on 100 percent ethanol, 100 percent gasoline, and any blend in-between.

Essentially, HCNG facilitates the early introduction of hydrogen as a transportation fuel using technology that is very near commercialization.

AQMD Contract No. 03273

May 2004

Develop Hydrogen Fueling Station Templates

Contractor

SunLine Services Group, Inc.

Cosponsors

None

Project Officer

Gary Dixon

Background

This study was designed to develop hydrogen fueling station templates and provide an optimization study for siting future hydrogen fueling network in the South Coast Air Basin. The study is oriented toward providing economical and flexible designs with respect to different fueling formats such as liquid or gaseous hydrogen storage and dispensing, liquid or gaseous hydrogen stored on-board a vehicle, and liquid-to-gaseous hydrogen dispensing.

Project Objective

To meet SCAQMD's objectives five individual templates will be developed. These templates will provide fleet and fueling station owners/operators with the information needed to plan, develop and estimate the costs and issues associated with providing hydrogen-fueling services. Similarly an optimization study will provide a road map for the siting of a future hydrogen-fueling network within the South Coast Air Basin. An analysis of potential fleet requirements will provide insight into placing the initial stations where demand for hydrogen is expected to be most significant.

Technology Description

Sources of data that were collected in the form of literature and production methodologies that might be of assistance to

decision-makers regarding information that is currently available. This information is dated and does not necessarily reflect changes in the direction that technology is taking or preparing to take. However the most important information was developed from on site interviews with those agencies or organizations that are building hydrogen fueling stations and those manufacturing vehicles.

The strategy implemented for data collection involved there were three survey forms: Hydrogen Vehicle Study, Hydrogen Fueling Station, and Hydrogen Station Fueling Major Component List / Hydrogen Fueling Station Electrical System. The surveys were sent to 20 sites. Completed surveys were received from HyGen Industries LLC, Praxair, City of Los Angeles, City of Chula Vista and SunLine Services Group for SunLine Transit Agency. Survey forms for other sites were accomplished during the site visit.

There were a potential of 28 sites to be visited but after research and contact with each specific site the visits were reduced to 10 sites based on accessibility, availability of personnel, and security / confidentiality issues. Each site visited is presented with its site address, photographs, a description of the hydrogen facility, site information, major component list, and standards/codes employed.

Hydrogen vehicle fueling station codes and standards are presented based on the accumulation of experience over the past 10 to 20 years of fueling vehicles with compressed natural gas. There is some applicability, which can be considered, and there has been some distributed fueling experience at small commercial or private facilities over the last two years. The worldwide codes and standards for liquid and gaseous hydrogen were reviewed for this report along with industry recommendations

for a common standard delayed until the new National Fire Prevention Association Vehicular Fuels standard is published in 2005. The goal of the new NFPA VAF standard is to combine all of the existing LPG, CNG, LNG and hydrogen standards for use in the USA into one single document with independent sections which provide minimum conflicts and exceptions.

Several basic types of hydrogen fueling stations are presented as demonstrated by the 10 sites visited. Many variables affect the determination of the type of hydrogen stations such as plot area, fleet population in the long and short term, daily consumption, pressure, quality of fuel, sustainability of the station, fleet refueling windows, equipment reliability, cost competitiveness compared to other alternative fuels, availability of grants and incentives, code and standard interpretations and quality of after market maintenance.

There is a discussion on the methodology for identifying R D&D issues such as the optimistic forecasts industry and supporting agencies have followed in the past for vehicle and station planning. There is a discussion on the main strategy employed by utilities and agencies, which were focused on compression, storage and operating costs. The discussion brings forth four assumptions that from a business perspective are not realistic: (1) "build a hydrogen station and they will come", (2) that fuel cell vehicles will be available which provide double the efficiency and justify the increased price, (3) the perception that environmental rules and regulations will drive the growth of hydrogen vehicles, and (4) plans were developed without input from consumers and users of hydrogen vehicles and fueling stations.

The Optimization Study depicts the existing six stations currently in operation, the five stations currently in design and construction, and the five stations to be awarded by AQMD in June 2004.

The proposal for future network development includes 10 additional stations between 2005

and 2008. This brings the total hydrogen stations to 26 which should be sufficient to adequately fuel the 1000 hydrogen vehicles forecasted by 2010.

Status

This project was completed May 28, 2004.

Results

There are several basic types of hydrogen fueling stations as demonstrated by the 10 sites inspected. These station types include gaseous and or liquid, stationary or mobile, onsite and off site production, or in very infrequent cases, the station is directly connected to an existing hydrogen high-pressure line from a production plant. The latter is a very rare opportunity since there is only about 2000 kilometers of hydrogen pipeline in the US with very little in California except near major chemical and refinery manufacturing plants.

Hyradix Reformer

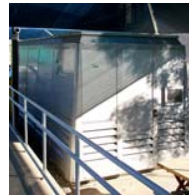

Stuart Electrolyzer



Benefits

The benefits of this study are the identification of the succinct variables that must be considered when developing plans for placing hydrogen stations in the South Coast Basin. They are:

- A. The plot area for the proposed site
- B. The short and long term hydrogen fleet population
- C. Daily fleet hydrogen fuel consumption and range requirements
- D. Hydrogen fill pressure requirements
- E. Hydrogen fuel quality
- F. Sustainable, committed long term hydrogen fuel usage commitments

- G. Fueling window for the fleet resulting in time fill and or fast fill conditions
- H. Equipment reliability and operating costs
- I. Cost competitiveness compared to CNG, clean diesel and reformulated gasoline
- J. Project budget limitations
- K. Grants and incentives to offset the capital cost
- L. Code and standards interpretations by the authority having jurisdiction (AHJ)
- M. Quality of after-market maintenance and operations services including parts and inventory

Project Costs

The cost to complete this project was \$68,554.

Commercialization and Applications

The technology available today goes a long way toward the development of the hydrogen infrastructure. However the availability of vehicles remains as a question. Fleet managers and consumers possess the rationale for success of vehicle products. They are range, affordability, convenience and quality of after market service, parts, and training at repair centers, reliability of the vehicles, perceptions of vehicle power, perceptions of inconvenience of station location and reliability of station operation and availability. These reasons whether real or imagined are voted on every time vehicle purchases are made.

Develop Preliminary Vehicle Design Development for Next Generation Natural Gas Vehicle

Contractor

Cummins Westport Inc.

Cosponsors

California Energy Commission;
National Renewable Energy Laboratory

Project Officer

Mike Bogdanoff

Background

The AQMD and California Energy Commission are cooperating with the United States Department of Energy and their National Renewable Energy Laboratory to implement the Next Generation Natural Gas Vehicle (NGNGV) program. The NGNGV program goals are to develop new Class 3 through 8 trucks that are fueled with compressed natural gas (CNG) or liquefied natural gas (LNG), incorporate advanced-technology natural gas engines, and are economically competitive with counterpart diesel trucks. Specific NGNGV exhaust emission targets are NO_x at or below 0.5 g/bhp-hr and PM at or below 0.01 g/bhp-hr.

Project Objective

The project objectives were to identify two vocation-chassis-engine combinations that are best suited to NGNGV goals, and to develop pre-liminary designs and market introduction strategies for these two CNG- or LNG-fueled trucks.

Status

All project work is complete and a final report documenting all project details is on file at the AQMD.

Methodology and Results

Cummins Westport Inc. (CWI) developed truck vocation profile data (e.g., typical

annual mileage, range, power requirement, fuel economy, refueling practices, trade cycles) for NGNGV-candidate applications including pickup and delivery, government and utility, food/beverage, package delivery, refuse collection, refuse transfer, and bulk hauling truck applications. A spectrum of truck models manufactured by PACCAR's Peterbilt and Kenworth Divisions was selected as representative NGNGV chassis candidates. Each chassis was profiled with respect to its specifications including CNG and LNG fuel system compatibility. Current and planned CWI and Westport engines (B, C, and L Gas Plus spark ignition natural gas engines, and the ISX G high pressure direct injection engine) were selected as representative NGNGV-candidate engine platforms. Applicable technologies to meet NGNGV emission goals were evaluated.

The profiled vocation-chassis-engine combinations were screened to identify the two that are best suited to NGNGV program goals. The primary screening criterion was life cycle cost (LCC). The CWI LCC model considers all incremental costs associated with natural gas truck fleet operation. Screening also considered CNG and LNG fueling infrastructure availability, truck market data consistency, and truck customer preferences. Truck market data were collected and analyzed to estimate annual sales of trucks within NGNGV-candidate vocations. CWI surveyed truck dealers and end-users to collect basic truck fleet demographic information and establish customer preference priorities. The survey shows that vehicle reliability, maintenance cost, and vehicle purchase cost are the dominant factors affecting natural gas truck purchase decisions.

Based on the LCC economic analysis and various filtering criteria, these two truck concepts were determined to be the best NGNGV candidates:

- A low cab over engine (LCOE) refuse collection truck with a chassis such as a Peterbilt 320. This truck would be powered by an L Gas engine with stoichiometric combustion, cooled exhaust gas recirculation, and a three-way catalyst (SESI). It would be LNG fueled.
- A conventional Class 8 tractor such as a Kenworth T800 used in high mileage and return-to-base refueling applications such as refuse transfer. This truck would be powered by an ISX G engine equipped with high-rate cooled exhaust gas recirculation and a catalyzed particulate filter (of the type being developed for diesel engines). It would be LNG fueled.

In actuality, the L Gas and/or ISX G engine would probably be developed to meet the EPA/CARB 2010 NO_x standard of 0.2 g/bhp-hr instead of the 0.5 g/bhp-hr NGNGV goal.

Conceptual designs for these NGNGV trucks were developed including representative summary specifications and simplified chassis layout diagrams. Market introduction plans for the NGNGV trucks were also outlined.

The sensitivity of the LCC of the two truck concepts to variations in key economic input parameters was evaluated considering two scenarios: no financial incentives, and 80% of the maximum incentive funding available through the Carl Moyer program. An example result for the refuse transfer truck with 80% Carl Moyer program funding is shown below. This analysis indicates that the differential LCC (i.e., between diesel and natural gas operation) for a Class 8 tractor vocation such as refuse transfer is most strongly affected by fuel cost and annual mileage. For refuse collection trucks, the differential LCC is most sensitive to vehicle cost and annual mileage (or annual fuel use).

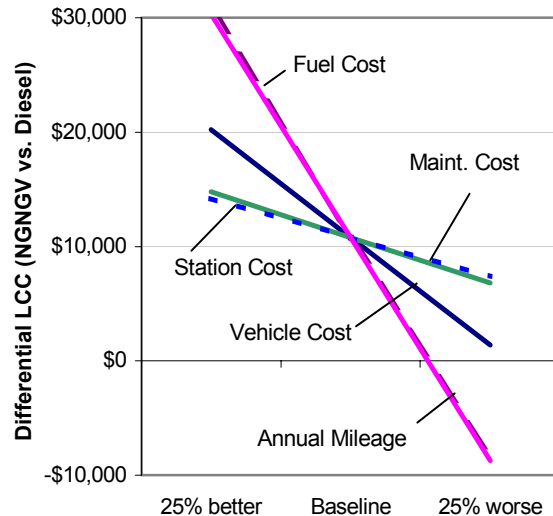

The LCC results demonstrate that, for most NGNGV-candidate vocation-chassis-engine combinations, incentive funding (such as the Carl Moyer program) to offset the incremental acquisition cost of natural gas trucks is necessary for the natural gas truck LCC to be less than the counterpart diesel truck LCC. Other incentive strategies to encourage NGNGV truck purchases are also recommended. These include reduction of Federal taxes and harmonization of state sales taxes on CNG and LNG, elimination of taxes on incremental NGNGV costs, increased NO_x and PM reduction incentives, and introduction of incentives for reducing greenhouse gas emissions and/or enhancing energy security.

Benefits

Availability of engines meeting or exceeding NGNGV emission goals will yield significant air quality benefits in the South Coast Air Basin. In particular, engines meeting EPA/CARB 2010 emission standards prior to 2010 will yield significant NO_x reductions vs. diesel engines, which are expected to utilize the EPA/CARB NO_x phase-in provisions from 2007 through 2009.

Project Costs

The project was completed on time and within budget. A summary of the costs incurred over the course of the project are as follows:

	<i>Actual</i>	<i>Budget</i>
Project expenditure	\$405,508	\$396,528
AQMD Funding	\$197,396	\$197,396
CWI Cost Share	\$108,112	\$ 99,132
CEC Funding	\$100,000	\$100,000

Commercialization and Applications

CWI is evaluating commercialization of SESI engines. Commercialization will be contingent upon successful completion of the SESI technology development project currently underway at Cummins (sponsored by SCAQMD), and availability of partial offset funding to support SESI product development.

Commercialization of an ISX G engine is contingent upon successful technology development and market demonstration activities, currently being conducted by Westport Innovations Inc.

Develop Odorant for Liquefied Natural Gas

Contractor

USA PRO & Associates LLC

Subcontractors

CryoSystems International-Quadren Cryogenics;
The Pennsylvania State University; Natural Gas
Odorizing, Inc.; NexGen Fueling

Project Officer

Mike Bogdanoff

Background

Federal and state laws require natural gas delivered to consumers to be odorized so that a person with a normal sense of smell can detect a leak when the gas concentration reaches 20% of the lower flammability limit (LFL, which is approximately 5%). Gas utilities add mercaptans, alkyl sulfides, and/or cyclic sulfides to natural gas to provide odorant concentrations of a few ppm for this purpose. Most compressed natural gas (CNG) used as an automotive fuel is derived from pipeline gas, and so it is odorized. However, odorants are removed in the pretreatment process when natural gas is liquefied, and so liquefied natural gas (LNG) used, as an automotive fuel is not normally odorized. It is not straightforward to odorize LNG because the odorants are not soluble in the -200°F to -260°F cryogenic liquid. The resulting precipitate would render the odorant ineffective and cause problems in LNG fueling stations and vehicles.

Project Objective

The general objective of this project was to assess the feasibility of an effective and economical process for odorizing LNG automotive fuel. Specific objectives were to document regulations pertinent to pipeline gas and automotive CNG and LNG fuel odorization, critically review prior LNG odorization research and carry out laboratory-scale experiments to address key questions and uncertainties.

Technology Description

In the late 1960s and early 1970s, San Diego Gas and Electric (SDG&E) developed and applied an LNG odorization technology that circumvented the precipitation problem. This was accomplished by dissolving the odorant in a propane “carrier” liquid, cooling the odorant-propane mixture in a heat exchanger, and injecting a metered quantity of this cooled mixture into LNG. This technology was reported to have been used effectively, but there are substantial ambiguities and uncertainties regarding most of the technical specifics. For example, a study by the Institute of Gas Technology (IGT) for the Gas Research Institute (GRI) in 1993 seriously questioned if SDG&E’s reported tetrahydrothiophene-in-propane concentrations could be factual (based on IGT’s solubility estimates) and if SDG&E achieved adequate odorization of the ullage vapors in LNG tanks (due to multi-component multi-phase effects). This project addressed these and other LNG odorization questions.



Figure 1. CryoSystems International LNG odorization test fixture.

Results

CryoSystems International carried out odorant-propane-LNG tests at the Quadren Cryogenics processing plant in Robbins, California. The following odorants were obtained from Natural Gas Odorizing, Inc. (NGO) as mixtures in propane with mass fractions ranging from 0.05% to 1%:

- Ethyl mercaptan (EM)
- Isopropyl mercaptan (IPM)
- Tertiary butyl mercaptan (TBM)
- Tetrahydrothiophene (THT)

CryoSystems constructed a test fixture (Figure 1), which enabled fixed quantities of the odorant-propane mixtures to be cooled and injected into LNG. Any precipitation in the LNG was observed through a viewing window, and odorant concentrations from the liquid and vapor (ullage) regions were measured using Draeger tubes. Fifteen tests were carried out, and example results are summarized in Table 1. No precipitation was observed for any tests, except when large quantities of the 1% EM- and THT-propane mixtures were injected (which would have produced theoretical concentrations of 20 and 15 ppm, respectively), in which case a quickly clearing initial cloud was observed at the point of injection. Direct comparisons of measured and theoretical odorant concentrations were difficult because most of the measurements were above or below the minimum or maximum Draeger tube scales. However, in general, odorant concentration measurements from the liquid appeared to be near or slightly higher than theoretical values, and measurements from the vapor were always less (usually much less).

Separate laboratory experiments were carried out at the Pennsylvania State University (PSU) to assess the solubility of odorants in cooled propane and to measure odorant concentrations using gas chromatography. NGO provided PSU with four odorant-propane mixtures: EM and THT in propane with mass fractions of approximately 1% and 4%. PSU tested these mixtures in a cooling and precipitation test apparatus. The PSU results showed that the EM and THT mixtures precipitated when cooled to less than approximately -200°F and -100°F, respectively, but they were clear at higher

temperatures. PSU successfully photographed the precipitate (which, in the case of THT, separated into white and brown portions). PSU found that the high odorant concentrations in the odorant-propane mixtures made gas chromatograph measurements difficult, because the sulfur from initial tests adsorbed into the sampling system and affected the results of subsequent tests.

CryoSystems and PSU results indicated that EM, IPM, TBM and THT are all acceptable odorants for LNG if they are blended with propane and the mixture is cooled before injecting it into the LNG. Acceptable conditions appear to be approximately: 1% by mass odorant-propane ratio, cooling to -50°F, and 0.5% by mass mixture-LNG ratio. However, additional testing with more precise instrumentation is required to determine optimum odorants and mixture ratios.

Odorant:	Odorant Concentrations (ppm):		
	Injected into LNG:	Measured -- vapor from LNG liquid:	Measured -- vapor from LNG ullage:
EM	0.51	<0.5	<0.5
EM	0.52	<0.5	<0.5
EM	2.70	>5	~0.5
EM	3.83	>5	<0.5
EM	20.18	>15	~1.0
IPM	0.72	~0.5	<0.5
IPM	3.96	>5	<0.5
IPM	3.97	<10	<10
TBM	0.12	~0.1	<0.1
TBM	0.66	~1.0	<0.1
TBM	0.67	~1.0	<0.1
THT	3.98	>10	~2
THT	0.76	~3	<1.0
THT	2.68	4.8	<1.0
THT	14.68	>15	8

Table 1. Example results of CryoSystems tests of various odorants mixed with propane, cooled, and injected into LNG.

Project Costs

The total cost of this project was \$418,320. This included \$170,650 contributed by USA PRO & Associates LLC and subcontractors, \$123,835 contributed by the Gas Research Institute, and \$123,835 contributed by the AQMD.

Commercialization and Applications

By demonstrating technical feasibility, this project completed the first step toward commercializing a practical and economical

LNG odorization technology. This project also generated designs for manual and automatic LNG odorization systems. The cost of odorizing LNG was estimated to be roughly \$0.015/gallon of LNG (including the odorant, propane, and equipment amortization). The next steps toward commercialization include optimization testing, assessment of LNG odorized in bulk quantities, and station/vehicle field trials.

Upgrade of CNG Fueling Stations at Various School Districts and Municipalities

Contractor

FuelMaker Corporation

Cosponsors

Southern California Gas Company

Project Officer

Gary Dixon

Background

Air quality and health impacts of diesel exhaust have led the AQMD and others to focus attention on reducing diesel exhaust emissions from medium- and heavy-duty vehicles. Rule 1195 identifies the use of low emission, alternative fueled, school buses as a viable alternative to diesel.

The CNG fueling station for the City of Monterey Park was not designed to accommodate the high water content in the natural gas supply and required an upgraded dryer and associated ancillary equipment.

Project Objective

The CNG fueling system purchased for the City of Monterey Park was designed to meet normal conditions and water content. Due to some very unusual local conditions, the natural gas supplied to this project contains an extremely high water content (about 65 pounds of water per million cubic feet of gas). Normally, natural gas contains from one-half to six pounds of water per million cubic feet of gas. The existing gas dryer is inadequate to remove the water from the supplied natural gas and must be replaced with a larger unit. As a further step to save expense, a regenerative-type dryer is being recommended to allow for the recycling of

the molecular sieve desiccant. This will extend the life of the desiccant by six to ten times. The Southern California Gas Company will be providing technical and financial assistance with this project.

Some of the deficiencies experienced at these stations are:

- Existing gas dryers unable to remove sufficient water from the natural gas stream to prevent carryover into the fueling system.
- In-line filters near the fueling posts must be manually discharged every few minutes during fueling operations, preventing overnight fueling.
- Water carryover into the bus fueling and storage systems has damaged particulate filters, required daily maintenance and removal of entrained water and resulted in fuel line freeze ups.
- Current dryer design does not include the capability to regenerate the dessicant; regeneration would allow the minimization of generated waste dessicant for disposal.
- Modifications made to the fuel tanks of the buses (removal of part of the solenoid valve) to prevent freeze up in the valve create safety and operational concerns.
- Entrained water can have serious impacts on the operational life of the fueling equipment and buses and the cost of associated maintenance and repairs.

Technology Description

The proposed replacement dryer will correct these deficiencies so that the station is reliable, efficient and user friendly. The replacement unit is a Xebec, regenerative dryer using molecular sieve as the desiccant. Water entrained in the natural gas supply is

trapped by the molecular sieve material allowing the dry natural gas to pass through to the compressor. When the water content in the molecular sieve has reached its saturation point, flow through the dryer is switched to vent, the molecular sieve is heated and the entrained water is carried out through the vent. After the water has been vented, the dryer is switched back on line to resume operation.

Status

The dryer upgrade was completed before the contract due date. In order to reduce the cost of the upgrade, a reconditioned dryer was used for the project. The equipment has been operating properly without problems.

Results

FuelMaker Corporation has provided the CNG refueling equipment for many of the smaller CNG fueling stations and they have demonstrated their ability to enhance the water removal systems if necessary. The upgraded dryer for this project has proven to be more than adequate to remove the excess water in the natural gas supply for this site. The regenerative system will minimize the need to replace the desiccant in the system and the increased size of the unit will also minimize operator maintenance.

In addition to resolving the immediate problems, FuelMaker staff have also implemented procedures for their field contractors to follow to ensure that inadequate system will not be installed on future projects. These include: the requirement to have a SoCal Gas moisture analysis conducted on the gas supply prior to installation of any CNG fueling system; work with dryer manufacturers to utilize the best available dryer options; work with SoCal Gas representative to attain better knowledge of possible variations in the water content of the natural gas supplied to CNG sites.

Benefits

The Clean Fuels Program has been active in funding the development and demonstration

of low emission, alternative fuel technologies. While not providing any direct emission reductions, the proposed station enhancements will resolve a problem that exists in the natural gas supplied to the sites. This natural gas contains extremely high levels of water and, as such, could seriously damage the fueling compressor, fuel delivery system or the storage and fueling systems in the buses. In addition, water that is carried with the fuel into the CNG vehicles presents a safety hazard for the drivers since the water could freeze and plug the fuel line thereby resulting in a stalled vehicle on a freeway or highway. The enhancements will include larger, regenerative-type dryers capable of removing the high levels of water found at this site from the gas stream. The proper operation of existing stations must be ensured, and those designing future stations must have access to information that will facilitate their design, construction and operation. The primary benefit of this project will be to help resolve refueling station challenges.

Project Costs

The costs for the dryer upgrade (including the costs for replacement charges of the molecular sieve desiccant) were \$38,769 (including freight and additional desiccant). The SCAQMD and Southern California Gas Company will equally cost-share a portion of the costs, specifically \$12,923 each.

Commercialization and Applications

These dryers are commercial products and are normally used in small-scale CNG fueling stations.

Develop & Demonstrate Advanced Home Refueling Appliance for CNG Vehicles

Contractor

FuelMaker Corporation

Cosponsors

Technology Partnerships Canada; California Air Resources Board

Project Officer

Gary Dixon

Background

Natural Gas Vehicles (NGVs) represent some of the cleanest vehicles available. Despite their performance and competitive pricing, NGVs have not penetrated beyond the fleet market. One of the key barriers to consumer acceptance of NGVs as personal cars is the very limited publicly accessible refueling infrastructure. Availability of a safe and cost effective standardized home refueling appliance for compressed natural gas (CNG) is an important step in successful commercialization of non-fleet, light-duty vehicles, operating on CNG.

Project Objective

The main objectives of this project are:

- developing and demonstrating a small sized in-home CNG vehicle refueling device with no maintenance or installation requirements,
- providing the convenience of incremental fueling with the small dryer equipped device operating from a 110 volt electric outlet,
- commercializing the in-home refueling system with an expected cost of under \$1,000, and an intended life equal to or longer than the vehicle's.

Technology Description

The overall project consists of two phases with the duration of 18 months for each phase. The goal of Phase A, which was completed in 2002, was to develop and produce a working Alpha-unit prototype. Phase B upgraded and refined the Alpha unit into a Beta unit prototype that is being used in the final product commercialization.

Some of the features of this device are:

- home-based refueling using domestic natural gas and 110-volt power,
- inexpensive (\$1,000) and designed to be maintenance free,
- installation can be either inside (the garage) or outside,
- provide AFV (1/10 ULEV emissions) within reach of retail market with reliable, accessible fueling,
- 32% reduction in greenhouse gas emissions, 38% reduction in CO₂ emissions,
- slow-fill design allows refueling to be done overnight when the vehicle is not in use.

Status

Over 30 Beta prototypes have been assembled and are being tested both in FuelMaker test cells, at Honda R&D in California, and at field test sites. The individual component status is as follows:

Compression Module and Controls Module - The design is complete -- all components have been tested for functionality and performance.

Electronics Module – The design of the electronics is nearly complete – final adjustments are being made to achieve the EMI (Electromagnetic Interference) profiles

required by certification standards in North America and Europe.

Dryer - The second generation single column regenerative Dryer design was prototyped and its functionality verified (dries and regenerates within specifications).

Housing Design - Considerable effort is being expended to incorporate a larger cooling air fan and optimize the air flow providing better cooling and longer life for the Compression Module.

Field test certification has been provided by the CSA to permit field testing in the USA and Canada. Full certification testing will be completed in 2004.

FuelMaker has completed an FMEA (Failure Modes and Effects Analysis) and is using it as a tool in confirming the safety of the design. A DOE sponsored safety study is nearing completion by TIAX. It includes Fault Tree Analysis and simulation of worst case leakage scenarios (though not yet complete, it is apparent that the technology has an inherent high level of safety).



Results

Over 30 Beta prototypes have been built and are currently being tested – 4 are shown in the picture above, undergoing durability testing. The prototypes demonstrate that the project objectives and design specifications for the HRA have been met. The next steps will be the full commercialization of the product.

prototype testing was carried out in the second phase. For the two phases, DOE

The possibility of increasing the flowrate from about .33 GGE per hour up to .42 GGE per hour is being evaluated. It is felt that this will better meet the expectations of owners of small commuter vehicles.

Benefits

The AQMD relies on the significant penetration of zero and low emission vehicles in the South Coast Basin to attain federal clean air standards by 2010. While not providing any direct emission reductions, the proposed station enhancements will assist in the commercialization of natural gas light-duty private vehicles by providing a reliable source of fuel. For the Carl Moyer Program and other programs to be successful, fleets and other vehicle users must be able to rely on reliable and efficient refueling facilities. The utilization of home refueling for private vehicles will ensure a convenient, available source for overnight refueling for these vehicles at home rather than forcing the user to rely on the existing commercial infrastructure.

The HRA is unique in that it will be the smallest VRA ever developed, ideally suited for a small commuter vehicle, such as the Honda Civic GX which uses only natural gas as its fuel and is specifically targeted at the commuter market. Honda is supporting FuelMaker's development efforts by committing to promote the Civic GX and HRA in the consumer market. This will greatly enhance the HRA's chances for market acceptance by increasing the customers' confidence in natural gas vehicles and by creating a synergistic need for the home fueling system.

Project Costs

FuelMaker Corporation developed and demonstrated the Advanced Home Refueling Appliance for CNG Vehicles in two phases. Initial development and limited testing was conducted in the first phase; more extensive

allocated \$100,000; ARB allocated \$250,000, for the first phase and \$50,000 for the second

phase; and Technology Partners Canada (TPC) provided \$375,000 in each of the 2 phases. AQMD funding was \$500,000 for each phase. Total project cost is \$2,150,000 for both phases.

Commercialization and Applications

FuelMaker has designed, developed, manufactured, sold, distributed and serviced over 8000 VRAs in NGV service since it began operations in 1989. With the HRA, FuelMaker will transfer the design into commercial production, during the last quarter of 2004, following the completion of the Beta Testing Phase.

Develop & Demonstrate Grid-Rechargeable Hybrid-Electric Utility Service Truck & Mobile Electric Power Supply

Contractor

Southern California Edison

Cosponsors

Capstone Turbine Corporation;
Enova Systems, Inc.

Project Officer

Naveen Berry



Background

Utility service trucks with aerial lifts are widely used by telephone, cable, and electric companies for service of elevated wiring. These trucks, typically powered by diesel engines, may log thousands of miles per year on the road and spend hundreds of hours parked at service sites with engines idling in order to power the lift or auxiliary power take-off. Nationwide, idling trucks are a major source of air pollution. Also, utility operations frequently occur in neighborhood areas where the noise of diesel engines causes a disturbance. Southern California Edison (SCE), the nation's second largest investor-owned utility, as a fleet operator, uses many trucks of this configuration, and has concerns about energy, pollution and compliance with clean

air regulations. A possible substitute for the diesel engine, which could be more efficient and less polluting, is the hybrid electric system of the truck presented in this report.

Project Objective

The project objective was to demonstrate a grid-rechargeable ("plug-in") hybrid-electric utility service truck with partners Capstone Turbine Corporation, and Enova Systems, Inc. The first-of-its-kind truck to utilize a 60 kW LNG-fueled gas turbine-powered electrical generator (Capstone MicroTurbine™) as a mobile power source in conjunction with a traction battery connected to an electric power train. It was to feature an electro-hydraulic aerial lift and tool circuit, and a 15 kW mobile electric power distribution system. An all-electric drive range exceeding 10 miles, and a hybrid range of over 150 miles was sought. The hydraulic capabilities of the diesel truck it replaced was required, with the addition of a power panel with single phase 110 V and 208 V, and 208 V three-phase power.

Technology Description

The vehicle platform is a two-wheel-drive, 128-inch wheelbase, 26 000-pound gross-vehicle weight rating (GVWR) "troubleman's truck", based on the International Navistar 4700 chassis. The drive system for the truck is the Panther™ 120 kW Electric Propulsion System from Enova Systems, utilizing a Capstone MicroTurbine™ LNG-fueled 60 kW power unit and liquid-cooled NiMH battery pack. An on-board inverter provides AC power for the mobile power supply panel. Supplied is 110-volt AC power for workers' tools and lights; 208 V single phase and 208 V 3-phase power is also provided to power an

EV charger, welder, or other higher power equipment; peak power capability of the panel is 15 kW. The energy for the panel can be provided quietly and cleanly by the battery pack, and in supplement if necessary for extended operating time, the turbine. The vehicle was fitted with a 10-hp electrically-powered hydraulic pump to supply the power needed to operate the aerial lift and power take-off.

Status

The project is complete with the exception of dynamometer emissions and performance testing (tentatively scheduled for February 2004). Emissions testing was delayed due to refurbishment of the CARB facility. The final report, less these test results, was published January 30, 2004.

Results

Emissions test results will be published when the tests are completed. Performance of the hybrid truck was comparable to the diesel version in many areas. Average all-electric range was nearly 12 miles. Acceleration from 0-30 mph was within 9%. Braking from 25-0 mph was almost 13% shorter. Noise from the diesel truck was twice as loud during idle PTO operations. Charger system impact was acceptable. Fuel economy was lower than the diesel truck, but further optimization could be conducted.

Benefits

Emissions testing must still to be conducted.

Project Costs

AQMD costs were as specified in the original contract.

	PARTICIPANT	COST
Base Truck	SCE	\$100,000
Battery Pack	SCE	\$12,000
Micro Turbine	Capstone	\$50,000
HEV Components	Enova Systems	<u>\$120,447</u>
Total Hardware		\$ 282,447
Truck Integration	SCE	\$159,493
Micro Turbine	Capstone	\$41,667
HEV Integration	Enova Systems	<u>\$49,088</u>
Total Labor		\$ 250,248
Total Project Cost		\$ 532,695
AQMD		\$266,348

Commercialization and Applications

SCE has in its fleet several hundred aerial lift trucks. SCE, along with most other major electric utilities in the U.S., have an interest in heavy-duty hybrid electric vehicles. Therefore, the opportunity to place a significant number of these vehicles in fleets nationwide exists. Costs of such vehicles will depend on the final specification and the numbers involved in a production run, but the interests of the parties involved seem to assure that the vehicles would be purchased if made available. The Hybrid Truck Users' Forum, managed by Calstart, is currently working with its members to produce a consensus specification for such a truck in hopes of pooling resources to submit a large enough order to influence manufacturers to build and sell them.

Study for Commercialization of Advanced Hybrid-Electric Vehicles

Contractor

Electric Power Research Institute

Cosponsors

Electric Power Research Institute
California Air Resources Board
U.S. Department of Transportation

Project Officer

Lisa Mirisola

Background

Plug-in hybrid electric vehicles (PHEVs) combine many of the benefits of both pure electric vehicles and power assist hybrid vehicles to provide significant reductions in criteria pollutants, greenhouse gases, and petroleum consumption. Plug-in HEVs can qualify as Advanced Technology Partial Zero Emission Vehicles under the ARB ZEV Program and are also listed as a compliance technology under AB1493 (Climate Change Emission Regulations for Light-Duty Vehicles).

Project Objective

This project is the second phase of collaboration between AQMD and EPRI to study the benefits of and develop technologies for plug-in hybrid electric vehicles. The first phase consisted of a broad, multi-client study of benefits and impacts of different hybrid vehicle configurations.

This project will focus on the development and evaluation of technologies important to the commercialization of plug-in hybrid vehicles and fuel cell electric vehicles. The scope of work includes (1) Technical-economic assessment and optimization; (2) Market assessment and strategy development; (3) Analysis of long-term opportunities, and

(4) Development of technical demonstrations and validation of benefits. The ultimate objective of this work is to establish a commercial path for plug-in HEV technologies.

Technology Description

Plug-in hybrid electric vehicles combine the functional powertrain attributes of a hybrid electric vehicle with a somewhat larger energy storage system that utilizes grid electricity for a portion of the vehicle's daily operation. This project has shown that PHEVs can significantly reduce petroleum consumption, criteria pollutants, and greenhouse gas emissions over hybrid vehicles that are not grid-recharged.

PHEVs achieve these benefits by combining the advantages of a hybrid system—regenerative braking, elimination of engine idle, and improvements to engine operating efficiency—with additional capabilities of a higher energy, higher power battery system. PHEVs are capable of traveling significant distances (10-60 miles) as electric vehicles. This operating mode is zero-emitting and highly efficient. By optimizing the use of the battery energy to eliminate the most inefficient periods of combustion engine operation, a PHEV can realize additional gains in efficiency.

Power assist hybrid vehicles depend in part upon engine-assisted recharging of the battery pack. This charge-sustaining operation is typically the least efficient operating mode for the vehicle due to engine, generating, and charging losses in the drivetrain. While PHEVs are capable of charge-sustaining operation—this provides full vehicle utility and range—they rely primarily upon off-peak grid recharging of the battery. A PHEV operator plugs the vehicle in at the end of the day to recharge the battery. This behavior

dramatically reduces petroleum consumption and vehicle operating costs while effectively utilizing surplus off-peak electric generating capacity.

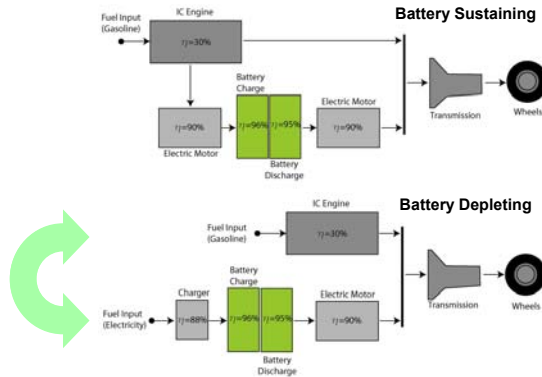

Figure 1. Schematic of a plug-in HEV system with battery depleting (included electric-only zero emitting mode) and battery sustaining (hybrid charge-sustaining) modes.

Status

This project was completed on September 30th, 2004. The final report documents are on file with AQMD.

Results

Major milestones of the project include: (1) Development of an economic and lifecycle cost model for electric-drive vehicles, including hybrid, plug-in hybrid, and battery electric vehicles; (2) Technical and economic review of advanced battery availability; (3) Development of PHEV control systems, energy management algorithms, and energy optimization techniques; (4) Development of a physical fuel cell model for fuel cell hybrid electric vehicles; (5) Initial tradeoff study for fuel cell vehicles including level of hybridization and energy storage system; (6) Fuel cycle energy and emissions comparison for hybrid electric vehicles; (7) Analysis of PHEV architectures for production vehicle platforms; (8) Development of vehicle and battery test protocols for PHEVs; (9) Research, development, and analysis of future and long-term technologies for plug-in hybrid and fuel cell vehicles, and (10) Development of a market introduction strategy for PHEVs.

Benefits

Based on project results, PHEVs can cost-effectively deliver a number of environmental benefits. Significant operating costs reductions from higher efficiency and the low cost of electricity as a transportation fuel can offset higher initial vehicle cost—resulting in total lifecycle ownership cost of PHEVs competitive conventional vehicles, providing the environmental benefits at an extremely low societal cost.

This project has also led a greater understanding of the PHEV operating cycle and developed specific techniques for vehicle and energy management that will maximize efficiency while providing the greatest possible battery durability.

Project Costs

The original Board letter stipulated a minimum EPRI cost share of \$650,000 and a minimum project cost of \$1,300,000. As shown in the table, below, these requirements were met during the course of the project. EPRI contributed a total of \$967,413 to the project. Several of EPRI’s utility

Project Participant	2002	2003	2004	Total
SCAQMD	250,000	-	-	250,000
CARB	250,000	-	-	250,000
U.S. DOT	150,000	-	-	150,000
EPRI	508,000	391,413	68,000	967,413
Total				1,617,413

customers contributed to this co-funding, including Southern California Edison, Alabama Power, New York Power Authority, Long Island Power Authority, Tennessee Valley Authority, Los Angeles Department of Water and Power, and Sacramento Municipal Utilities District.

Commercialization and Applications

Much of the technology required to commercialize PHEVs is already featured in the current generation of “full” hybrid vehicles available from leading automakers. Commercialization of PHEVs will be facilitated by continued adoption of hybrid

technologies throughout the industry, lowering the cost of system components, particularly for advanced batteries.

The results of this project have directly led to the initiation of the third phase of work on PHEVs—a demonstration project with a major vehicle manufacturer. EPRI, AQMD, ARB, and the Federal Transit Administration have joined with DaimlerChrysler to design, build, and test a plug-in hybrid electric van with 20 miles of electric mode range. The first two prototype vehicles will be tested in fleet use by AQMD and Southern California Edison in 2005. The data from this demonstration project will be used to determine the real-world benefits and operation of PHEVs.

Develop and Evaluate Multiple Vehicle Type Expansion of Shared Electric Vehicle System

Contractor

University of California - Riverside College of Engineering-Center for Environmental Research and Technology (CE-CERT)

Cosponsors

Honda Motor Company; University of California Discovery Grant; Global Electric Motorcars

Project Officer

Lisa Mirasola

Background

As an innovative transportation paradigm, shared-use vehicle systems (SUVS) can potentially help alleviate traffic congestion, improve air quality, and make surface transportation more efficient. In general, a shared-use vehicle system consists of a fleet of vehicles that are used several times each day by different users. These shared vehicles are not necessarily owned privately, but are rather owned by a group or organization. The key advantage of shared-use vehicle systems is that they reduce the number of (private) vehicles required to meet total travel demand. To better understand the multi-faceted issues and benefits associated with shared-use vehicle systems, CE-CERT has embarked on an aggressive research program focusing on shared vehicle system architectures, operations, intelligent transportation system techniques, user behavior, and environmental/energy analysis. CE-CERT has developed and implemented an intelligent shared electric vehicle system “testbed” called UCR IntelliShare. This testbed has been designed and implemented on the UC Riverside campus. The system testbed has been designed to be flexible and can be used to evaluate many different variations of shared vehicle system operation. By having such a testbed, it is possible to implement and evaluate various operating

methods and technologies that make shared-use vehicle systems successful.

Project Objective

The objective of this project was to expand UCR IntelliShare by introducing multiple vehicle types to maximize its overall effectiveness. Specifically, UCR IntelliShare’s vehicle fleet of 25 homogenous full-size electric vehicles was expanded with the integration of 11 neighborhood electric vehicles (NEVs). With these additional vehicle types, the overall UCR IntelliShare operation was evaluated.

Technology Description

CE-CERT has developed the hardware and software technology to operate an intelligent shared-used vehicle system. Specific on-board hardware was developed to enable carsharing on several vehicle types. The on-board hardware performs functions such as vehicle access control, vehicle tracking, and operation parameter management. In addition, CE-CERT has developed system operational software that is flexible for many different types of shared-use vehicle system applications. The management software monitors the vehicle fleet in real time, processes user requests for vehicles, manages reservations, and performs secondary applications such as vehicle fleet health monitoring. By using this advanced technology, shared-use vehicle systems are made much more efficient. In the case of UCR IntelliShare, because it is a multi-station carsharing model, it requires such technology.

Status

UCR IntelliShare has been in operation since 1999 and it continues to operate as a research testbed on the UC Riverside campus. The project of introducing multiple vehicle types supported by this SCAQMD contract was completed in the Fall of 2004 and the final report has been

submitted to the District. The project consisted of three major tasks: 1) development and integration of the on-board hardware for the new vehicle types; 2) modifying previous system management software to include the operation of multiple vehicles; and 3) operate and evaluate the system with the new vehicle introduced.

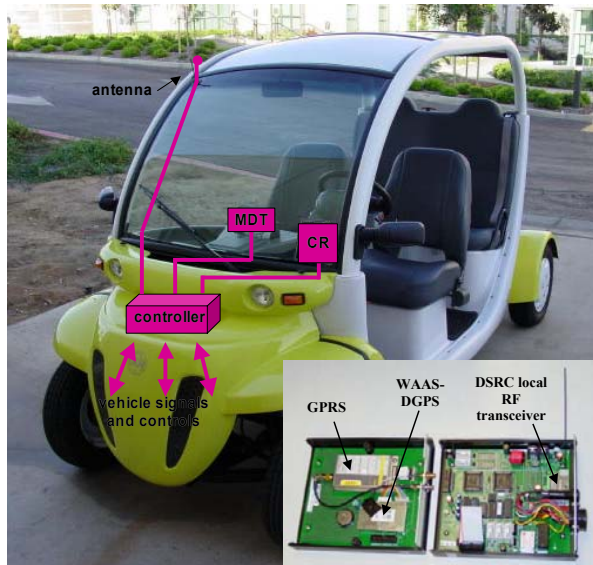

Results

The NEV integration into UCR IntelliShare has been successfully completed. Since that time, valuable operation data (e.g., vehicle, user, and operational data) on the system has been collected. Results have shown that NEVs can play an important role in a multi-station shared-use vehicle system, particularly in high-density locations that have low-speed roadways and scarcity of parking. They are very well suited for university campuses. To date, NEVs in UCR IntelliShare have only been moderately utilized, with expanded use planned for the future.

Results from this project have provided information that can be used for wide-scale commercialization of large-scale shared-use vehicle systems. These types of systems have been shown to reduce mobile-source emissions and increase the overall efficiency of public transportation.

Benefits

UCR IntelliShare and other shared-use vehicle systems can have a significant air quality benefit. The primary air quality benefit comes from

replacing trips that would be done with standard vehicles with vehicles that are clean. UCR IntelliShare exclusively uses electric vehicles, the cleanest vehicles available. As of September 2004, this limited demonstration system had generated nearly 66,500 trips and over 331,000 miles of driving since beginning operation. It is important to note that all of these miles are local, and our analysis of diurnal patterns indicates that most of the travel takes place in the early part of the day. Therefore, UCR IntelliShare is displacing the “dirtiest” kind of driving – start emissions as well as stop-and-go urban travel – at the times of day when ozone formation is most likely as a result of vehicle emissions. Also, greenhouse gas emissions are also greatly reduced.

Nearly all shared-use vehicle system implementations (i.e., carsharing) use clean vehicles to acquire this air quality benefit. Further, several studies have shown that shared-use vehicle systems in general reduce overall travel demand. By putting vehicle operational costs up front, people tend to reduce their travel compared to already owning a vehicle and feeling the need to use it to justify its capital cost.

Project Costs

The AQMD has contributed \$95,336 to this \$522,094 project. UCR IntelliShare has received significant funding over the years from Honda Motor Company, the City of Riverside, the University of California Discovery Grant Program, Riverside County Transportation Commission (RCTC), Ford Motor Company, and Global Electric Motorcars, Inc. During the period of performance for this project, contributions were made specifically from: 1) RCTC - \$110,000; 2) Global Electric Motorcars - \$90,000; 3) American Honda Motor Company - \$146,270; and 4) University of California - \$80,488.

Commercialization and Applications

The number of shared-use vehicle systems is growing across the U.S., in terms of number of vehicles as well as membership. In 2003, there were major shared-use vehicle systems in place in nearly 30 U.S. cities with approximately 20,000 members total (three service providers serve over 90 percent of users). All trends indicated that this number will increase for several years to come.

With this new shared-use vehicle systems market, there should be significant jobs growth. For example, Flexcar, one of the largest shared-use vehicle system companies, is constantly adding new employees to expand their operations. The technology developed in this research program is now ready for commercialization and can be used in many multiple station shared-use vehicle system models.

Another major product of this research project are the students that have graduated from our research program. Over the years, approximately 16 graduate students and 29 undergraduate students have participated in the UCR IntelliShare research program. They carry this research knowledge and can help develop new systems in the future.

Heavy-Duty Vehicle Chassis Dynamometer Testing for Emissions Inventory

Contractor

Coordinating Research Council Inc.

Cosponsors

Coordinating Research Council, Inc.; California Air Resources Board; U. S. Environmental Protection Agency; U.S. Department of Energy Office of FreedomCAR & Vehicle Technologies through the National Renewable Energy Laboratory; Engine Manufacturers Association

Project Officer

Lisa Mirisola

vehicles were the so-called “overlap” vehicles and were evaluated both under the USDOE “Gasoline/Diesel PM Split Study” and the CRC E-55/E-59 study.

The overlap vehicles were sampled for both regulated and unregulated emissions samples, and the unregulated emissions samples were analyzed. The following ten vehicles underwent testing for regulated emissions but the extent of sampling for chemical characterization was reduced and these samples were archived for possible chemical analysis at a later stage. The remaining 12 vehicles in Phase 1 were tested for regulated emissions and the PM10 fraction.

Background

Heavy-duty diesel vehicles are known to be substantial contributors to the inventory of oxides of nitrogen (NO_x) and particulate matter (PM), but the quantification of their real world emissions may be imprecise. As a result, emissions inventory predictions may err.

Project Objective

The objective of this project was to quantify regulated and certain unregulated gaseous and PM emissions for heavy-duty (primarily diesel) vehicles in the South Coast Air Basin to support emissions inventory development. Another objective was to quantify the influence of tampering and mal-maintenance on heavy-duty emissions.

Technology Description

To help remedy uncertainty in the heavy-duty truck emission inventory, West Virginia University (WVU) characterized exhaust emissions from a total of 25 Heavy Heavy-Duty Diesel Trucks (HHDDT) in the South Coast Air Basin of California in Phase 1 of this CRC E-55/E-59 study. The first three

Status

This project was completed a year early in April 2003. The final report is on file at AQMD and at the Coordinating Research Council, Inc.

Results

Details of vehicle procurement and vehicle inspections are discussed in WVU’s Vehicle Procurement Plan, and the Tampering and Malmaintenance (T&M) Plan. The emissions data were initially checked by the field engineer. The information was uploaded to WVU servers on the same day and the emissions data were checked by the QA/QC engineer at WVU. Any anomaly in the data was closely inspected by checking files for flow rates, gaseous concentrations, temperatures and other relevant raw data files.

The emissions data were then checked by the QA/QC Officer.

Field data were processed to yield emissions values in units of g/cycle, g/mile, g/ahp-hr, g/minute, and g/gallon. The regulated emission data showed that PM declined with

vehicle model year for all test schedules and both test weights. For the data in g/mile, although data scatter was present, the best fit lines for NO_x for the unladen transient and Cruise modes, and for the laden Cruise and Transient modes, and the UDDS showed an increase in NO_x with model year. The effect of test weight on NO_x (g/mile) was small for the transient and cruise modes. PM (g/mile) data scatter was high when plotted against model year, but it is clear that PM increased by more than a factor of two for the laden cruise versus the unladen cruise. Data analysis presented in the WVU final report is considered preliminary. A more detailed analysis of the data was performed by R. Gunst (CRC 2002).

The study also sought to identify high emitters, or vehicles that showed evidence of tampering and mal-maintenance. Several such vehicles were identified, and four were subjected to repairs and retesting.

Extensive chemical analyses of the exhaust included complete speciation of particulate and semi-volatile organic compounds as well as gas-phase volatile organic compounds, nitrosamines, and carbonyls. Detailed results of the chemical analyses are presented in the final report.

Figure 1: NO_{xI} vs. model year for the UDDS

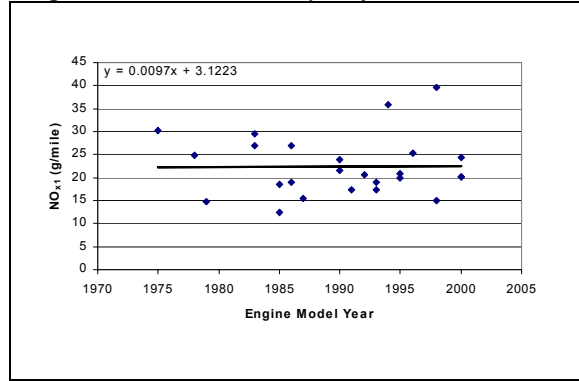
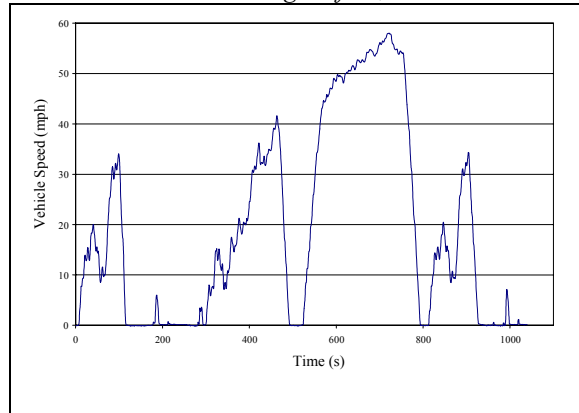

Figure 2: The Heavy Duty Urban Dynamometer Driving Schedule as driven by a 1990 Kenworth road tractor with a 370 hp Cummins M11 engine, a 10-speed manual transmission and a simulated vehicle test weight of 56,000 lbs.



Emissions Testing and Analysis of Dedicated Natural Gas and Diesel Solid Waste Collection Vehicles

Contractor

West Virginia University

Cosponsors

None

Project Officer

Mike Bogdanoff

**Background**

Interest in alternatively fueled vehicles that offer low emissions continues to grow as urban areas work to attain air quality targets. One subset of heavy-duty vehicles that warrant further attention for controlling oxides of nitrogen (NO_x) and particulate (PM) emissions includes refuse collection trucks because they operate heavily in urban settings. One heavy-duty alternative-fuel technology with promising emissions reduction potential and increasing market penetration is the heavy-duty natural gas engine.

Project Objective

The objective of this study was to compare the emissions of current liquid natural gas (LNG), compressed natural gas (CNG), and Dual-Fuel™ natural gas (DFNG) powered vehicle technology to current diesel powered

vehicle technology for application in the urban refuse collection trucks.

The test cycles performed included the AQMD Refuse Truck Cycle and the Heavy-Duty Urban Dynamometer Driving Schedule (UDDS). The refuse truck cycle consists of three modes: transport mode driving from the garage to the collection area and from the collection area to the disposal site; the curbside pick-up mode; and the refuse compaction mode.

Technology Description

Four CNG powered Cummins, four CNG powered John Deere, and three LNG Mack powered trucks were evaluated. Cummins and John Deere have exhaust aftertreatment (oxidation catalysts) but the Mack did not. In addition, one DFNG and two Diesels of which one was equipped with EGR were tested.

Results

Discussion will be limited to the Transport mode for this report.

The John Deere was found to produce the lowest emissions of oxides of nitrogen (NO_x) emission amongst the three engine manufacturers. Cummins averaged 16.0 g/mile, and John Deere averaged 13.78 g/mile as shown in Figure 1.

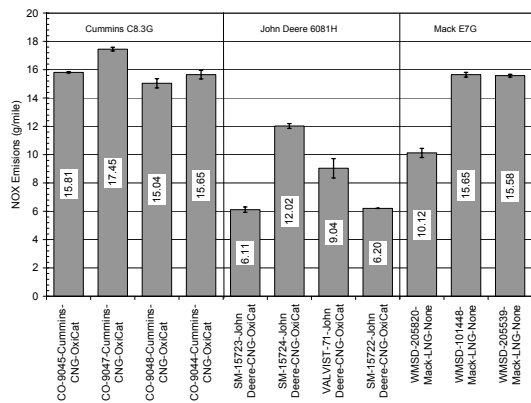

Figure 1. Transport Mode NO_x emissions

PM emissions were low for the Cummins and John Deere engines due the addition of the exhaust aftertreatment. The Cummins averaged 0.039 g/mile, the John Deere averaged 0.009 g/mile while the Mack (without the exhaust aftertreatment) averaged 0.207 g/mile. PM emissions are shown in Figure 2 below.

Hydrocarbon emissions were dominated by the methane (unburned fuel) in the exhaust. GC analysis was performed by WVU to determine the NMHC results for each test. NMHC results are shown in Figure 3 below.

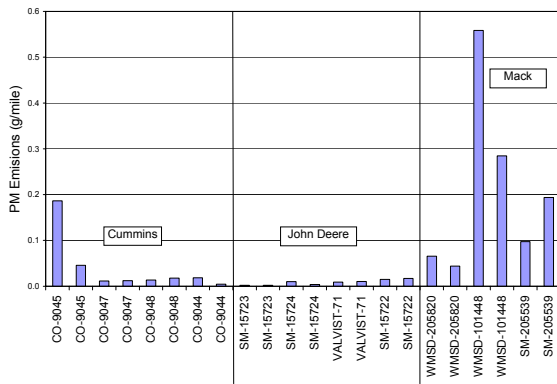

Figure 2. Transport Mode PM Emissions

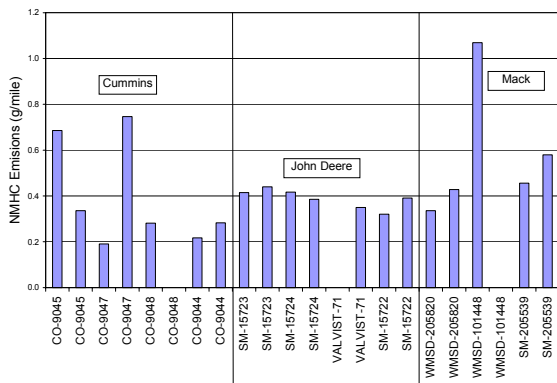

Figure 3. Transport Mode NMHC emissions

Fuel economy for the Cummins averaged 3.94 mpg, the John Deere averaged 4.17 mpg, and the Mack averaged 4.53 mpg. Fuel economy results for each test are shown in Figure 4.

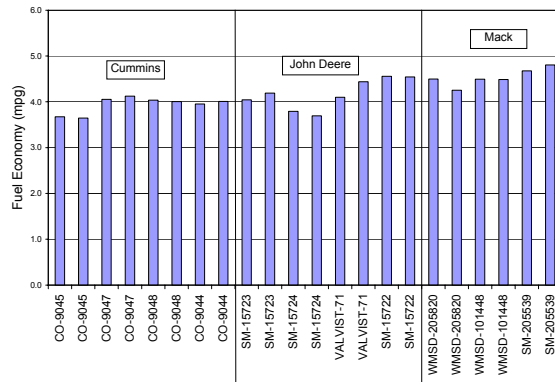

Figure 4. Transport Mode fuel economy results

A MY 2003 Cummins ISM equipped with EGR was also tested in this program. The vehicle was operated on standard CARB No. 2 diesel fuel. Distance specific emissions data (g/mile) for NO_x and CO₂, and PM are shown in Figures 5 and 6, respectively.

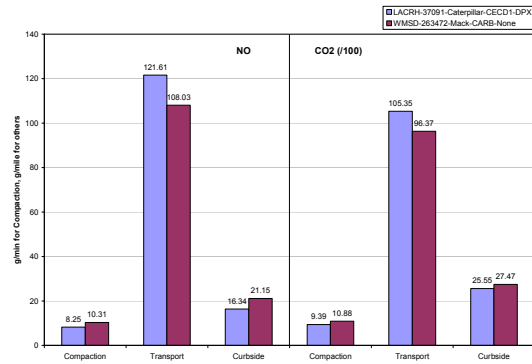

Figure 5. NO_x and CO₂ emissions from MY2003 Cummins ISM EGR 320V engine operating on CARB Diesel No. 2

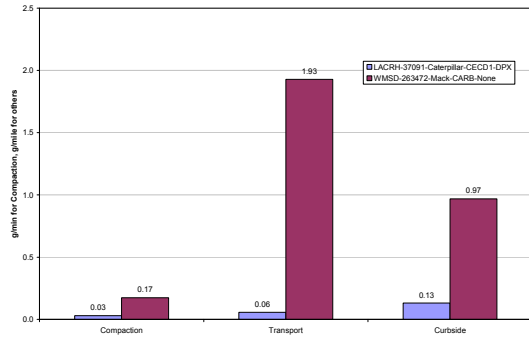

Figure 6. PM emissions from MY2003 Cummins ISM EGR 320V engine operating on CARB Diesel No. 2

Benefits

Natural gas fueled heavy-duty engines with well designed exhaust aftertreatment systems can yield significant reductions in NO_x and PM emissions from refuse trucks. A new refuse truck cycle, which was a modification of the W.H. Martin Cycle was employed in this study. The cycle represented the three different modes of refuse collection operation. The emissions reductions in each mode recorded in this project should be representative of what may be expected in field operation.

Project Costs

The total cost for this testing project \$255,000 was borne entirely by the AQMD. The test vehicles were gratuitously loaned to the program by Burrtec Waste Industries (Cummins EGR diesel), City of Los Angeles (Dual-Fuel™, Caterpillar diesel), City of Ontario (Cummins), the City of Santa Monica (John Deere), Valley Vista Services (John Deere), and Waste Management of San Diego (Mack).

Remote Monitoring of MicroTurbine Generators

Contractor

University of California, Irvine - Advanced Power and Energy Program

Cosponsors

None

Project Officers

Martin Kay and Howard Lange

Background

Microturbine generators (MTGs) are low-emission devices which enable end users to generate their own power. This provides economic benefits while alleviating peak stress on the grid during times when power is in short supply. The latter not only reduces the likelihood that high-emitting diesel backup generators will have to be used at times of severe power shortages, but also displaces emissions from the highest-emitting and least energy-efficient peaking units used by commercial power production entities.

MTGs are available from a number of manufacturers including Bowman, Capstone, Elliott, Ingersol Rand, and Turbec, and represent an option for on-site power generation technology (“distributed generation”). MTGs are available in increments as small as 30 kW and can, in principle, be installed relatively quickly and require little maintenance. In addition to providing electricity, a heat exchanger can be used with the MTG to provide heating or cooling, which increases overall system efficiency (“combined cooling, heating, and power—CCHP”).

Using funds from penalty settlements and emission mitigation fees, the South Coast Air Quality Management District (AQMD) is sponsoring deployment of a large number of MTGs within the four-county area that it serves. The current project is compiling MTG system performance data such as Output Power, Operating Hours, Turbine Exit Temperature, Compressor Inlet Temperature, etc. from 20 selected sites to which MTGs have been deployed. A database-driven web site has been developed

under this project to provide basic information about the operation of the MTGs as well as on-line data plotting capabilities (<http://www.apep.uci.edu/DER/AQMD/>).

Project Objective

The main objective of this project is to collect data from a large population of MTGs used in diverse applications yielding a statistically significant amount of operational data and a breadth of data unparalleled by any other current MTG project. The project consists of monitoring 20 Sites to which microturbines have been deployed. Figure 1, from the website, illustrates the locations to which AQMD has provided MTGs and highlights the monitored sites.

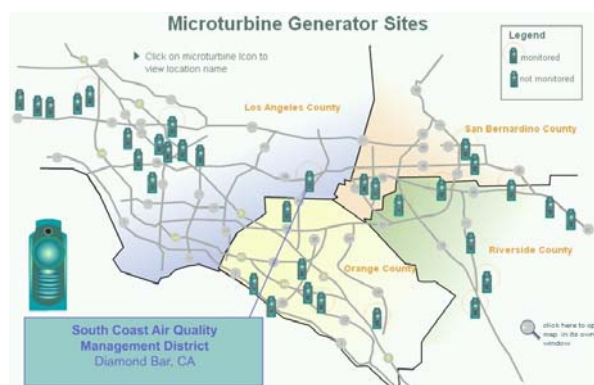

Figure 1. Microturbine Sites

The information and data from this program are providing examples of MTG utilization in a variety of settings, to better the understanding of the long-term operational characteristics and document the contribution to the energy grid.

Technology Description

Collecting and monitoring the MTG data streams required a data acquisition PC, Capstone Remote Monitoring Software (CRMS), Internet connection via dial-up to an Internet Service Provider (ISP) or Ethernet IP connection and utility scripts to automate the data upload process occurring daily. Data is uploaded to a central database server located at the Advanced Power and Energy Program (APEP) facility at UCI. Data from each MTG are first recorded as comma-separated value (CSV) files locally on the hard

disk of the data acquisition PC by using the CRMS system. The auto-dialup and FTP scripts are run daily to upload the data files from the local PC to the Server at APEP. A SQL import program developed in LabVIEW is then used to import the data from the CSV files into the SQL server database. The web server communicates with the database and retrieves data that are used in display on the AQMD Project Web site, an excerpt from which is shown below in Figure 2.

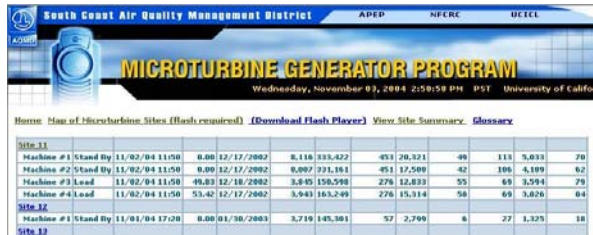

Figure 2. AQMD public website

The website also provides data analysis and creates plots of values such as output power over time shown in Figure 3 below.

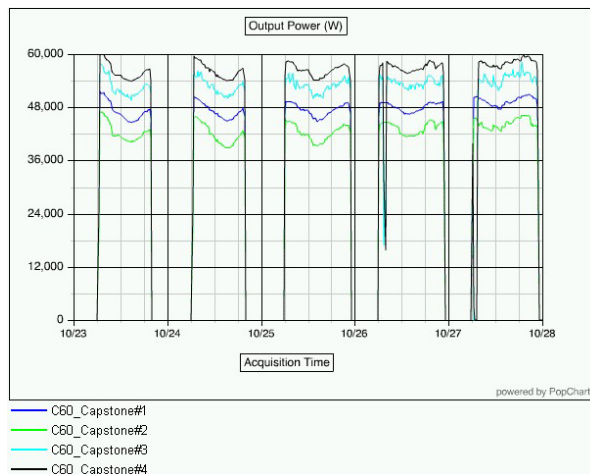

Figure 3. AQMD public website plot(s)

In addition to basic data acquisition PC, three of the Sites (AQMD, CSUN, APEP) are outfitted, via a parallel project, with additional sensor information such as natural gas meter, electric meter, ambient temperature and relative humidity using National Instrument's FieldPoint data acquisition hardware and LabVIEW software code developed at APEP.

Status

The project is complete in terms of setting up data acquisition PCs and connecting hardware at the remote sites. Monitoring the sites, displaying the

cumulative data on the web site and follow-up of non-responding sites are on-going processes for APEP to maintain the overall system up to date as much as possible. The formal data collection period ended October 31, 2004, and a final report has been submitted. APEP is continuing data collection and website maintenance on a voluntary basis. APEP plans to seek additional funds to continue this activity.

Results

The development of the website application using the database and .NET driven technology has been successful in disseminating the MTG system performance data efficiently to the public. In addition, site owners/operators and other interested parties can log into an "Engineering" section of the web site to download the data to a local PC for further analysis of the data.

Establishing and maintaining communications with sites required significant support from site personnel, and the degree of successful monitoring varied greatly among the sites. Some sites that were selected for monitoring became non-operational due to a variety of site-specific problems. Currently 13 of the 20 selected sites are responsive and reliable for data collection, and a substantial body of data has been accumulated for those sites.

Benefits

This project clearly demonstrates that microturbine generators, which are a relatively low-emission power generation technology, are a viable technology choice for distributed power generation in a variety of applications. The technology that was developed to collect and display operational data from numerous microturbine sites may prove valuable for monitoring and controlling distributed generation fleets in the future.

Project Costs

The total cost of the project was \$95,000 funded solely by AQMD. The project benefitted from synergisms with parallel projects funded by other agencies.

Commercialization and Applications

There are no plans to commercialize the technology that was developed in this project.

Technical and Management Assistance for Alternative Fuel Infrastructure

Contractor

USA Pro & Associates

Cosponsors

None

Project Officer

Larry Watkins

Background

The OCTA onboard LNG fuel and methane detection/fire suppression systems have presented significant obstacles, along with supplier delays in providing crucial replacement technology and equipment. The NTSA recall of onboard LNG cryogenic tanks for automotive applications represents an even greater impediment to the safety and engineering functions of the equipment. The equipment supplier group has failed to proceed with upgrades and more serviceable equipment, OCTA has been forced to initiate its own in-house testing for the future fuel and onboard fuel system. Methane detection systems have also presented challenges; however this supplier group has presented OCTA with options, as there are numerous components available from other applications.

OCTA staff has been successful in balancing the challenges for their refueling stations and bus fleet with improved consistency. However, high costs are being expended to ensure the buses get on the road. The resources needed for maintenance, securing backup parts, equipment, and necessary maintenance manpower would have been an overwhelming burden for most private fleets.

Project Objective

USA PRO & Associates (USA PRO) has worked closely with the Orange County Transportation Authority (OCTA) to specifically address LNG operational, engineering, and site-related challenges. These areas focused on resolving specific challenges related to OCTA's LNG bus fleet, refueling station equipment, and site issues pending final approved by the regulatory agencies concerned. During this period of time, construction work has recently been contracted for the refueling station compliance upgrades. Development of the future path for bus refueling and onboard fuel systems upgrade have taken another technical path due to the need to facilitate planning processes prior to purchasing new alternate fueled buses. USA PRO is facilitating the combination of upgrades for the LNG refueling station and onboard fuel system to insure safe operations throughout the fleet.

Technology Description

OCTA has incorporated a series of operational items that are new to the use of LNG for automotive applications. There have been numerous challenges for this technology as the use of underground cryogenic tanks; pump system and saturation on the fly are not common place for this application. Coordinated the functions of the LNG refueling site and the onboard fuel system have provided OCTA with a series of technical and financial challenges. The results of this type of installation are yet to be determined and this site's operation has not encouraged others to utilize this technology.

Status

OCTA has found it necessary to maintain extraordinary timelines for evaluation of all systems pertaining to LNG bus onboard fuel system components, LNG refueling station and integration of the associated equipment for this application. At this time the LNG refueling station is not operating in perfect concert with the onboard fuel system, and appears to be overfilling or under filling some LNG tanks; this has become a safety concern. Continued engineering work on these systems is necessary to keep the fleet rolling and insure that maximum safety is in place.

Results

OCTA is moving forward with their original plan to maintain a fleet that is environmentally acceptable and we do not see any signs of them moving back to a diesel fleet. The time line for the next purchase of buses and the direction for the present day bus fleet's choice of fuel are pending OCTA has instituted a testing and research program that will cost well over one million dollars. The testing and final reviews of the testing project are highly sensitive to coordinated timelines for the next bus purchase. The OCTA team with the support - expertise of USA PRO will continue to seek solutions for the successful operation of the current LNG buses in order to expedite the purchase of new buses.

Benefits

The benefits for this program are to insure that the OCTA fleet continues to support an alternate fuel program and remove the barrier for purchasing additional alternate fuel buses. The task work that is being performed has direct implications for all current and potential LNG fleets within the South Coast Air Quality District. Investigations into the LNG refueling site, onboard fuel system and gas detection system has already prompted changes by OEM's and should provide for more robust components.

Project Costs

The project is within the original budget of \$365,000 and each project task has not exceeded individual estimates. Continued work on this project will necessitate additional funding in order to facilitate the final testing and development of a future plan for purchasing a new alternate fuel fleet of buses.

Commercialization and Applications

There will be numerous applications for commercialization of this technology resulting from the task work. The incorporation of higher standards of safety and functionality will help to develop a systems approach to the integration of the onboard fuel system with the refueling site. These developments will facilitate the forward movement of the use of liquefied natural gas as an automotive alternate fuel.

Construction & Implementation of Fuel Cell Exhibit at California Science Center

Contractor

California Science Center Foundation

Cosponsors

California Air Resources Board; Toyota Motor Sales, USA Inc.

Project Officer

Gary Dixon

Background

The California Science Center is an admission free educational and cultural resource, which serves one of the most culturally and ethnically diverse audiences in the country. More than 500,000 guests have experienced this informal science learning facility since it opened in February 1998.

The California Science Center provides high-quality family-based experiential science learning for millions of children, families and educators. The first phase of the science center, a 245,000 sq ft facility with interactive exhibits and programs, includes two themed exhibition halls: *World of Life* and *Creative World*.

Creative World focuses on three areas of technological innovation: Communication, Structures, and Transportation, where visitors learn that “you have the power to move a vehicle when you know how to turn fuel into motion,” and, also, are advised that “you have the power to protect yourself and the environment when you know the consequences of your actions.”

The new interactive exhibit on fuel cells technology and its promise to provide a much cleaner source of energy helps fill a major gap in the coverage of alternative fuels in the Transportation Gallery.

Project Objective

Develop and install a user-friendly interactive exhibit where visitors can learn about the science behind fuel cells and how they work, explore the environmental benefits of using this technology for transportation as well as the challenges to be met before fuel cell cars can become a viable option for consumers.

Status

The exhibit structures and all the media pieces have been installed and opened to the public on April 22, 2004.



The exhibit incorporating, in its design, a modified Toyota Prius car features three interactive, multimedia programs with text and audio available in both English and Spanish. Following are the main exhibit components:

Fuel Cells Q&A – provides brief but compelling answers to some of the most common questions about fuel cells. The answers combine interviews with scientists and engineers, real world examples of fuel cells in action, and descriptive animations.

The Promise of Fuel Cells - provides more in-depth information in three basic areas:
How fuel cells work uses 3D animation to

explain the chemical reaction that makes electricity from hydrogen with no emissions, and the origin of the hydrogen fuel.

Fuel cells in California looks at population growth and the increase in the number of vehicles as contributing to air quality problems, explains how smog is formed, and provides a near real time daily smog report for Los Angeles basin. Interviews with experts in the field address the benefits as well as the challenges of fuel cell technology for transportation. **Yesterday, today and tomorrow** looks at the surprisingly long history of fuel cells science and technology which began as far back as 1838. It also provides the latest fuel cell news live from the Internet, ensuring that the content is always up-to-date.

Interactive fuel cell model - visitors can touch different parts of a scale-model fuel cell vehicle, launching a corresponding 3D animation on a screen above. The animation shows the function of that component and how it interacts with the entire system.

Comparison sticker - an updateable graphic in the passenger window of the Prius, compares the fuel efficiency and emissions of an internal combustion engine, a hybrid gas/electric vehicle and a fuel cell car.

Fuel Cell Engine - visitors looking through a cut-out window in the hood of the car will see full-size models of typical fuel cell engine components.

Benefits

This exhibit continues building on the strong environmental education partnership established between AQMD and the California Science Center and their commitment to inform the public on transportation issues that relate to the environment and particularly to air quality in the Los Angeles Basin. Millions of visitors will be exposed to fuel cell technology and its benefits and learn that as individuals we can make a difference simply by the choices we make.

Project Costs

AQMD has provided \$226,000 in support of the fabrication, production and installation of the exhibit and the media programs.