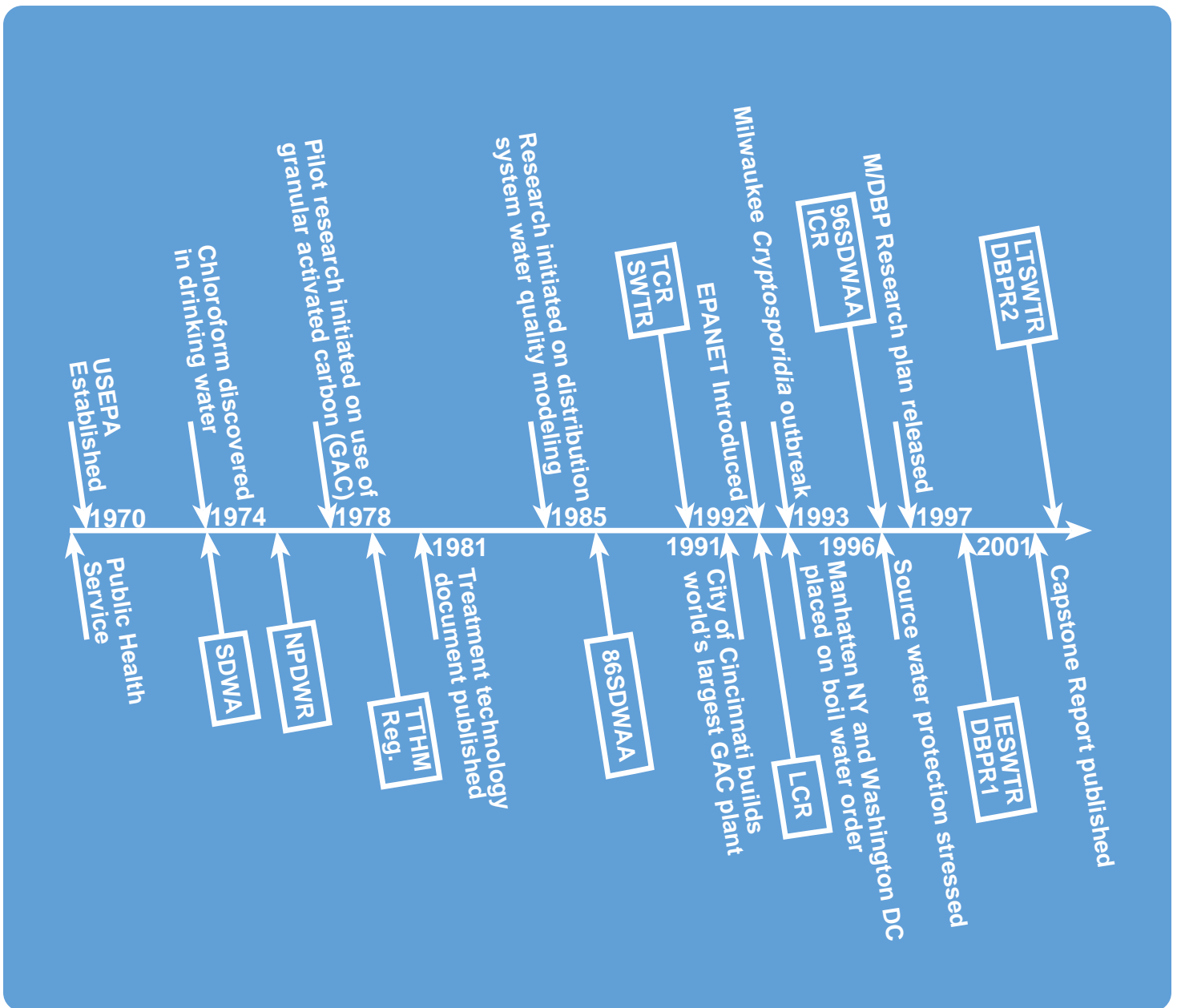




# Controlling Disinfection By-Products and Microbial Contaminants in Drinking Water



# **Controlling Disinfection By-Products and Microbial Contaminants in Drinking Water**

Edited by

Robert M. Clark  
Water Supply and Water Resources Division  
National Risk Management Research Laboratory  
Office of Research and Development  
U.S. Environmental Protection Agency

and

Brenda K. Boutin  
National Center for Environmental Assessment  
Office of Research and Development  
U.S. Environmental Protection Agency

National Risk Management Research Laboratory  
Office of Research and Development  
U.S. Environmental Protection Agency  
Cincinnati, Ohio 45268

## Notice

The information in this report has been subjected to Agency peer and administrative review and has been approved for publication as an EPA document. Mention of trade names or commercial products does not constitute endorsement or recommendation for use.

## Abstract

Historically drinking water utilities in the United States (U.S.) have played a major role in protecting public health through the reduction of waterborne disease. These reductions in waterborne disease outbreaks were brought about by the use of sand filtration, disinfection and the application of drinking water standards. Coincident with the passage of the SDWA of 1974, it was discovered that chloroform was a disinfection by-product (DBP) resulting from the interaction of chlorine with natural organic matter in water. Chloroform is one of a class of compounds called trihalomethanes. This finding posed a serious dilemma because it raised the possibility that chemical disinfection, which clearly reduced the risk of infectious disease, might also result in the formation of potentially harmful chemical by-products. Although disinfection of public drinking water had dramatically reduced outbreaks of diseases attributable to waterborne pathogens, the identification of chloroform in drinking water raised questions about possible health risks associated with these exposures. In the United States, since 1974, additional DBPs have been identified and concerns have intensified about health risks resulting from exposures to them. Although a causal relationship between DBP exposures and these health risks has not been conclusively established, risk managers have responded, in the interest of protecting public health, by developing alternative treatment systems and issuing rules and regulations designed to maintain protective levels of disinfection while reducing potentially harmful levels of DBPs. In 1981, the USEPA issued a report intended to summarize the "state-of-the-art" regarding the control of disinfection by-products in drinking water. However, EPA's current drinking water research program is more sophisticated than it was twenty years ago. For example, when the treatment technology manual was published in 1981, it reported primarily on treatment oriented research. Twenty years later, the technology research program includes source water protection, treatment technology and distribution system studies. The research also reflects a concern over balancing the risks of potential carcinogenic exposure against the risks from microbial infection. This document is intended to summarize the research that has been conducted in technology research by EPA since the publication of the 1981 treatment technology document.

## Foreword

The U.S. Environmental Protection Agency is charged by Congress with protecting the Nation's land, air, and water resources. Under a mandate of national environmental laws, the Agency strives to formulate and implement actions leading to a compatible balance between human activities and the ability of natural systems to support and nurture life. To meet this mandate, EPA's research program is providing data and technical support for solving environmental problems today and building a science knowledge base necessary to manage our ecological resources wisely, understand how pollutants affect our health, and prevent or reduce environmental risks in the future.

The National Risk Management Research Laboratory is the Agency's center for investigation of technological and management approaches for preventing and reducing risks from pollution that threatens human health and the environment. The focus of the Laboratory's research program is on methods and their cost-effectiveness for prevention and control of pollution to air, land, water, and subsurface resources; protection of water quality in public water systems; remediation of contaminated sites, sediments and ground water; prevention and control of indoor air pollution; and restoration of ecosystems. NRMRL collaborates with both public and private sector partners to foster technologies that reduce the cost of compliance and to anticipate emerging problems. NRMRL's research provides solutions to environmental problems by: developing and promoting technologies that protect and improve the environment; advancing scientific and engineering information to support regulatory and policy decisions; and providing the technical support and information transfer to ensure implementation of environmental regulations and strategies at the national, state, and community levels.

This publication has been produced as part of the Laboratory's strategic long-term research plan. It is published and made available by EPA's Office of Research and Development to assist the user community and to link researchers with their clients.

E. Timothy Oppelt, Director  
National Risk Management Research Laboratory

## Preface

As part of his response to a letter from Robert Hooke, Sir Isaac Newton wrote, "If I have seen further . . . it is by standing on the shoulders of giants." This statement, made in the 17th century, could easily describe the progress we have made over the last 25 years in identifying and controlling disinfection by-products (DBPs) and microbial contaminants in drinking water. In 1972, I was assigned to the staff of Dr. Andrew W. Breidenbach, director of EPA's first National Environmental Research Center, and worked with Mr. Gordon Robeck to help bring the Water Supply Research Laboratory into existence. At the time, I had no idea of the impact that the program would have on drinking water in the United States and the world, nor did I have the slightest idea that I would eventually serve as the program's director for 14 years.

I joined the staff of the Water Supply Research Laboratory shortly before the passage of the Safe Drinking Water Act in 1974. At that time, we were just beginning to recognize that chloroform was a by-product resulting from the interaction of chlorine with natural organic matter in drinking water. During my early years in the program, I had a chance to learn from not only Gordon Robeck, but from other such eminent scientists as Dr. James Symons, Mr. Leeland McCabe, and Mr. Edwin Geldreich. Although Robeck, Symons, McCabe, and Geldreich were "giants," there were many other talented and highly productive individuals who contributed to the success of the program as well. In 1981, we published a document titled "Treatment Techniques for Controlling Trihalomethanes in Drinking Water," which was an attempt to summarize contemporary knowledge in that important area. It was highly successful and, at the time, was considered a benchmark in the field. It was so successful that, after the USEPA's supply of the report was exhausted, it was republished by the American Water Works Association and by the Japan Water Works Association. This document is intended to complement the 1981 volume by describing research completed by the National Risk Management Research Laboratory in the 20 years between 1981 and 2001.

In 1972, all of the drinking water research activities conducted by the USEPA were concentrated in the Water Supply Research Laboratory. When the Safe Drinking Water Act was passed in 1974, the Laboratory was blessed with a generous allotment of funds and staff. However, through reorganizations and redirections over the past 20 years, various aspects of the program have been transferred to other organizational units in EPA. In the early 1990s, there was serious consideration of its elimination because it represented "mature technology." Support from the American Water Works Association (AWWA), the American Water Works Association Research Foundation (AWWARF), and the Association of State Drinking Water Administrators (ASDWA) helped it survive that difficult period.

Drinking water research has now become an integral part of the USEPA's base research program. Each of the laboratories and centers in EPA's Office of Research and Development (ORD) has a core research program devoted to various aspects of drinking water research. It is effectively coordinated by Dr. Fred Hauchman, who serves as National Drinking Water Research Program Manager, and by Mr. E. Timothy Oppelt who, as Director of the National Risk Management Research Laboratory (NRMRL), is the Executive Lead. The EPA works collaboratively with other organizations and research programs including the AWWA, AWWARF, ASDWA, the National Association of Water Companies, and the Association of Metropolitan Water Authorities.

Just as the state of drinking water research in EPA has changed, the nature of the science and engineering support for the program has also changed. During the past 20 years, research in the areas of disinfection by-products and microbial contaminant control has become complex and scientifically challenging. NRMRL's Water Supply and Water Resources Division (WSWRD), the direct successor of the Water Supply Research Laboratory that initially focused on treatment technology, has evolved into a program that is fundamental and science-based. It researches small systems technologies, distribution systems, and source water protection, and has sponsored projects throughout the world.

The ORD drinking water program has a long and productive history in EPA and has evolved into a broadly based, complex, and scientifically challenging program. I believe that the material contained in this document reflects the progress that we have made in research related to the control of DBPs and microbial control in drinking water during the past 20 years. The underlying principle that continues to govern all of our research in WSWRD is protecting the public health of the American drinking water consumer.

Robert M. Clark  
Senior Research Engineering Advisor  
Water Supply and Water Resources Division  
National Risk Management Research Laboratory, USEPA

# Table of Contents

Abstract .....	ii
Preface .....	iv
Abbreviations .....	viii
Acknowledgements .....	xiii
<b>Chapter 1</b> <i>Control of Microbes and DBPs in Drinking Water: An Overview</i> .....	1-1
Introduction .....	1-1
Drinking Water Regulations in the United States .....	1-3
Trends in Compliance with the SDWA .....	1-4
Current DBP and Microbial Regulations .....	1-6
Chemistry of DBP Formation .....	1-6
Source Water Protection .....	1-7
Microbial Pathogen Disinfection .....	1-8
Controlling Alternative DBPs .....	1-8
Control of DBPs Using Biological Filtration .....	1-9
Controlling Microbial Contaminants Using Filtration .....	1-9
Controlling DBPs and Microbes Using GAC and Membranes .....	1-10
Removing DBP Precursors Using Enhanced Coagulation .....	1-11
Controlling Microbes and DBPs in Small Systems .....	1-11
Modeling Chlorine Residuals and DBP Formation .....	1-12
Distribution System Water Quality .....	1-12
Cost of Controlling DBPs and Microbial Contaminants .....	1-13
EPA's Technology Research Program: Some Final Thoughts .....	1-14
<b>Chapter 2</b> <i>A Review of Federal Drinking Water Regulations in the U.S.</i> .....	2-1
Introduction .....	2-1
The Safe Drinking Water Act (SDWA)	
<b>Chapter 3</b> <i>Disinfection By-Product (DBP) Chemistry: Formation and Determination</i> .....	3-1
Introduction .....	3-1
General Issues in Disinfection: Disinfectants and Source Material for DBPs .....	3-6
An Overview of Disinfection By-Product Formation Source Material .....	3-11
EPA Research into DBP Formation and Chemistry .....	3-13
Directions in DBP Analytical Chemistry Research .....	3-23
<b>Chapter 4</b> <i>Source Water Protection: Its Role in Controlling Disinfection</i> .....	4-1
<i>By-Products (DBPs) and Microbial Contaminants</i>	
Introduction .....	4-1
The Safe Drinking Water Act and Source Water Protection .....	4-2
Threats to Source Water Quality .....	4-4
Sources of Oocysts .....	4-10
Measuring and Monitoring Pathogens in Source Waters .....	4-13
Protecting Source Waters .....	4-15
Best Management Practices .....	4-19
Source Water Protection and Watershed Management .....	4-22
Modeling and Source Water Protection .....	4-23
Summary and Conclusions .....	4-25
<b>Chapter 5</b> <i>Disinfection</i> .....	5-1
Introduction .....	5-1
Chlorine .....	5-1
Chloramine .....	5-7

## Contents, Cont'd.

Chlorine Dioxide .....	5-9
Ozone .....	5-10
Ultraviolet (UV) Irradiation .....	5-11
Summary .....	5-12
<b>Chapter 6 <i>Alternative Disinfectants</i></b> .....	<b>6-1</b>
Introduction .....	6-1
Models for Assessing Halogenated DBP Precursors .....	6-1
Chloramines .....	6-2
Chlorine Dioxide .....	6-6
Ozone .....	6-9
Summary .....	6-15
<b>Chapter 7 <i>Disinfection By-Product Control Through Biological Filtration</i></b> .....	<b>7-1</b>
Introduction .....	7-1
EPA-Funded Studies .....	7-1
Discussion .....	7-14
<b>Chapter 8 <i>Microbiological Removal by Filtration Processes</i></b> .....	<b>8-1</b>
Introduction .....	8-1
Slow Sand Filtration .....	8-3
Diatomaceous Earth Filtration .....	8-5
Granular Media Filtration .....	8-6
Summary .....	8-16
<b>Chapter 9 <i>Activated Carbon and Membrane Processes for   Disinfection By-Product (DBP) and Microbial Control</i></b> .....	<b>9-1</b>
Introduction .....	9-1
Activated Carbon .....	9-2
Membranes .....	9-13
Conclusions .....	9-23
<b>Chapter 10 <i>Coagulation</i></b> .....	<b>10-1</b>
Introduction .....	10-1
Background .....	10-1
Conventional vs. Enhanced vs. Optimized Coagulation .....	10-3
Enhanced Coagulation's Role in Water Quality .....	10-4
Coagulation With and Without Acid Addition .....	10-6
Comparing Alum and Iron Coagulation .....	10-7
Fractionation .....	10-8
Speciation .....	10-9
Scale Up .....	10-10
Secondary Effects .....	10-11
Summary .....	10-13
<b>Chapter 11 <i>Controlling Disinfection By-Products (DBPs) and   Microbial Contaminants in Small Public Water Systems (PWSs)</i></b> .....	<b>11-1</b>
Introduction .....	11-1
SDWA Coverage .....	11-2
Research Approach .....	11-5
Performance Results .....	11-9
Controlled Turbidity Challenge Experimental Results .....	11-11

## Contents, Cont'd.

Disinfection .....	11-19
Field-Scale Demonstration Projects .....	11-22
Small System Remote Monitoring and Control Technology .....	11-30
Summary .....	11-34
<b>Chapter 12</b> <i>Modeling Chlorine Decay and the Formation of Disinfection By-Products (DBPs) in Drinking Water</i> .....	12-1
Introduction .....	12-1
Chemistry of Disinfectants in Water .....	12-2
Modeling the Decay of Chlorine Residuals .....	12-3
EPA Research Activities .....	12-5
Modeling the Formation of DBPs .....	12-10
EPA Research Activities .....	12-14
Exposure to DBPs from Distribution Systems .....	12-18
Modeling Chlorine Decay and TTHMs in Distribution Systems .....	12-18
Evolution of System Modeling .....	12-24
Water Quality and Tanks .....	12-26
Policy Issues .....	12-28
Summary and Conclusions .....	12-28
<b>Chapter 13</b> <i>Biofilms in Drinking Water Distribution Systems</i> .....	13-1
Introduction .....	13-1
Previous Research .....	13-2
Pilot Systems Research .....	13-5
On-Going and Future Biofilm Research .....	13-7
Summary and Conclusions .....	13-8
<b>Chapter 14</b> <i>Control of Microbial Contaminants and Disinfection By-Products (DBPs): Cost and Performance</i> .....	14-1
Introduction .....	14-1
The Role of Disinfection in the U.S. ....	14-1
Microbiological Control .....	14-2
Formation of DBPs .....	14-3
Treatment Strategies for Controlling DBPs .....	14-4
Comparative Analysis .....	14-10
Summary and Conclusions .....	14-10
<b>Glossary</b> .....	G-1



## Abbreviations

AOC	assimilable organic carbon
AOP	Advanced Oxidation Process
APO	antibiotic-preserved oocysts
ARC/INFO®	ESRI's® (Environmental Systems Research Institute, Inc.) commercial GIS (Geographic Information System) software
ARM-II	Agricultural Runoff Management Model
ASTM	American Society for Testing and Materials
AWBERC	Andrew W. Breidenbach Environmental Research Center
AWWA	American Water Works Association
AWWARF	American Water Works Association Research Foundation
BAA	bromoacetic acid
BAC	biological activated carbon
BAT	best available technology
BCAA	bromochloroacetic acid
BCAN	bromochloroacetonitrile
BDOC	biodegradable dissolved organic carbon
BMP	best management practice
BOM	biodegradable organic matter
BWC	backwash chlorinated
CAA	chloroacetic acid
CCC	Chlorine Chemistry Council
CCL	contaminant candidate list
CFU	colony forming unit
CGR	coliform growth response
CH	chloral hydrate
Ci	curie
CLR	chlorine residual
CLSA	closed loop stripping apparatus
CP	chloropicrin
CSO	combined storm water-sewage overflows
CSTR	continuous-flow stirred-tank reactor
CSU	Colorado State University
CT	contact time
CT-ORW	conventionally treated Ohio River water
CTA	cellulose triacetate
CWA	Clean Water Act
DBAA	dibromoacetic acid
DBAN	dibromoacetonitrile
DBMS	data base management system
DBP	disinfection by-product
DBPFP	disinfection by-product formation potential
DBPR	Disinfection By-products Rule
DCAA	dichloroacetic acid
DCAN	dichloroacetonitrile
D/DBP	disinfectants/disinfection by-products
DE	diatomaceous earth (filtration)

## Abbreviations, Cont'd.

DIC	.....	differential interference contrast
DO	.....	dissolved oxygen
DOC	.....	dissolved organic carbon
DOM	.....	dissolved organic matter
DPO	.....	dichromate-preserved oocyst
DSS	.....	Distribution System Simulator
DVM	.....	Discrete-Volume Method
DWF	.....	dry-weather flow
DWQM	.....	Dynamic Water Quality Model
DWSRF	.....	Drinking Water State Revolving Fund
EBCT	.....	empty bed contact time
ECD	.....	electron-capture detection
EDM	.....	Event-Driven Method
EFL	.....	East Fork Lake
EPA	.....	Environmental Protection Agency (US)
EPANET	.....	An EPA-developed computer program that performs simulation of hydraulic ..... and water quality behavior within drinking water distribution systems
EPS	.....	extracellular polysaccharide
ESCA	.....	Electron Spectroscopy for Chemical Analysis
ESWTR	.....	Enhanced Surface Water Treatment Rule
ETV	.....	Environmental Technology Verification (Program)
FAC	.....	filtration avoidance criteria (Chapter 4)
FAC	.....	free available chlorine (Chapter 11)
FBDOC	.....	fast biodegradable dissolved organic carbon
FC	.....	fecal coliform
FDM	.....	Finite-Difference Method
FID	.....	flame-ionization detection
FISH	.....	fluorescent in situ hybridization
FLOWSED	.....	A one-dimensional mathematical model that computes FLOW conditions ..... and SEDiment movement
FP	.....	formation potential
FRT	.....	filter run time
FS	.....	fecal streptococci
FY	.....	fiscal year
GAC	.....	granular activated carbon
GC	.....	gas chromatography
GC/MS	.....	gas chromatography/mass spectroscopy
GIS	.....	Geographic Information System
GM	.....	geometric mean
GMR	.....	Great Miami River
GS	.....	Green Swamp
GT	.....	coagulant mixing intensities
GWR	.....	Ground Water Rule
GWUDI	.....	ground water under the direct influence of surface water
HAA	.....	haloacetic acid
HAAFP	.....	haloacetic acid formation potential
HAN	.....	haloacetonitrile

## Abbreviations, Cont'd.

HFTF .....	high-flow thin film
HL .....	head loss
HPC .....	heterotrophic plate count
http .....	hyper text transfer protocol
HX .....	hydrohalic acid
IC .....	ion chromatography
IC-ICP-MS .....	ion chromatography inductively coupled plasma mass spectrometry
ICP-MS .....	inductively coupled plasma mass spectrometry
ICR .....	Information Collection Rule
IESWTR .....	Interim Enhanced Surface Water Treatment Rule
IFA .....	indirect fluorescent monoclonal antibody
IMS .....	integrated membrane system
IR .....	infrared (spectroscopy)
JWWA .....	Japan Water Works Association
L .....	liter
LCR .....	Lead and Copper Rule
LTD .....	long-term demand
LTESWTR .....	Long Term Enhanced Surface Water Treatment Rule
MCLG .....	maximum contaminant level goal
MCL .....	maximum contaminant level
M/DBP .....	microbial pathogens/disinfection by-products
MF .....	microfiltration
mg/L .....	milligrams per liter
MIOX .....	mixed oxidants
MR .....	Mississippi River
M/R .....	monitoring and reporting
MRDL .....	maximum residual disinfectant level
MRDLG .....	maximum residual disinfectant level goal
MS .....	mass spectroscopy
MS .....	molecular size
MSL .....	mean sea level
MWCO .....	molecular-weight cutoff
MWL .....	Miami Whitewater Lake
MX .....	Mutagen X
NAS .....	National Academy of Sciences
NBDOC .....	non-biodegradable dissolved organic carbon
NC .....	non-chlorinated
NCER .....	National Center for Environmental Research
ND .....	not detected
NF .....	nanofiltration
NIEHS .....	National Institute of Environmental and Health Sciences
NIPDWR .....	National Interim Primary Drinking Water Regulations
NMR .....	nuclear magnetic resonance
NMWD .....	North Marin Water District
NOM .....	natural organic matter

## Abbreviations, Cont'd

NPDES .....	National Pollutant Discharge Elimination System
NPDWR .....	National Primary Drinking Water Regulations
NPOX .....	nonpurgeable organic halide
NSDWR .....	National Secondary Drinking Water Regulations
NPWA .....	North Penn Water Authority
NRCS .....	Natural Resources Conservation Service
NRMRL .....	National Risk Management Research Laboratory
NTM .....	non-tuberculosis mycobacteria
NTU .....	nephelometric turbidity unit
O&M .....	operation and maintenance
OBP .....	ozone by-products
OR .....	Ohio River
ORD .....	Office of Research and Development
ORP .....	oxidation reduction potential
ORSANCO .....	Ohio River Valley Water Sanitation Commission
ORW .....	Ohio River water
PAC .....	powdered activated carbon
PBS .....	phosphate buffered saline
PC .....	prechlorinated
PCA .....	plate count agar
PCB .....	polychlorinated biphenyl
PCR .....	polymerase chain reaction
PFU/L .....	plaque forming unit/liter
PHS .....	Public Health Service
PM .....	precursor material
POE .....	point-of-entry
POU .....	point-of-use
POX .....	purgeable organic halide
POXFP .....	purgeable organic halide formation potential
PVC .....	polyvinyl chloride
PWS .....	public water system
QUALNET .....	A temporal and spatial prediction model of chlorine distribution in a pipe ..... network under unsteady-flow conditions
R2A .....	A low-nutrient-content growth medium for performing heterotrophic plate ..... counts
Reg-Neg .....	Regulatory-Negotiation Committee
RO .....	reverse osmosis
RF1 .....	A topological and geographic (GIS) coverage of the primary rivers and ..... streams in the coterminous United States
RSSCT .....	Rapid Small Scale Column Test
RTS .....	Remote Telemetry System
RTU .....	remote telemetry unit
SAC .....	spectral absorption coefficient
SAR .....	structure-activity relationship
SBDOC .....	slowly biodegradable dissolved organic carbon
SCADA .....	Supervisory Control and Data Acquisition
SCCRWA .....	South Central Connecticut Regional Water Authority

## Abbreviations, Cont'd.

SDS .....	simulated distribution system
SDWA .....	Safe Drinking Water Act
SDWAA .....	Safe Drinking Water Act Amendments
SL .....	Stonelick Lake
SMCL .....	secondary maximum contaminant level
SOC .....	synthetic organic chemical
SSF .....	slow sand filtration
SSO .....	sanitary sewer overflow
STP .....	sewage treatment plant
SUVA .....	specific ultraviolet absorbance
SWP .....	source water protection
SWTR .....	Surface Water Treatment Rule
TC .....	total coliform
TCAA .....	trichloroacetic acid
TCAN .....	trichloroacetonitrile
TCR .....	Total Coliform Rule
TDM .....	Time-Driven Method
TDS .....	total dissolved solids
T&E .....	test and evaluation
THM .....	trihalomethane
THMFP .....	trihalomethane formation potential
TOC .....	total organic carbon
TOX .....	total organic halide
TOXFP .....	total organic halide formation potential
TPC .....	total particle count
TSA-SB .....	tryptic soy agar-sheep's blood
TSS .....	Ten-State Standards
TT .....	treatment technique
TTHM .....	total trihalomethane
TTHMFP .....	total trihalomethane formation potential
UF .....	ultrafiltration
UFC .....	uniform formation condition
UK .....	United Kingdom
USDHEW .....	United States Department of Health, Education and Welfare
USEPA .....	United States Environmental Protection Agency
USGS .....	United States Geological Survey
UV .....	ultraviolet
UVA .....	ultraviolet absorbance
WASP4 .....	Water Quality Analysis Simulation Program (release number four)
WSWRD .....	Water Supply and Water Resources Division
www .....	World Wide Web
XAD® .....	A functionalized poly (styrene-di-vinylbenzene) resin

## Acknowledgements

Many individuals have worked diligently to make this document possible. Both Mr. Oppelt and Mr. Clyde Dempsey, NRMRL's Assistant Laboratory Director for Water, have provided critical support that has made the research described in this document possible. Mr. Lee Mulkey, Associate Laboratory Director for Ecology in NRMRL, has consistently encouraged us to broaden our research to include watershed management and source water protection. Chapter 4 is a reflection of this more expansive approach. NRMRL's Associate Laboratory Director for Health, Dr. Hugh Mckinnon, has been a constant source of support and encouragement and has continually reminded us of the need to maintain our concern for public health at the forefront of our research.

NRMRL's Technology Transfer and Support Division has partnered with WSWRD by providing a substantial portion of the funds and staff time that made this document possible. We truly appreciate the support provided by Mr. Dan Murray, Director of the Technology Transfer and Support Division (TTSD), and Messers. Randy Revetta, Pat Burke, Steve Wilson, and Ms. Carol Grove, all of TTSD. Mrs. Sue Schock, TTSD, played an indispensable role as Work Assignment Manager for a support contract with SAIC under which the document was produced and edited. Dr. Faysal Bekdash of SAIC developed the glossary and list of abbreviations. Custom Editorial Productions subcontracted with SAIC to perform the editorial and desktop publishing tasks under the management of Ms. Jan Clavey.

Robert M. Clark

Water Supply and Water Resources Division  
National Risk Management Research Laboratory USEPA

## CHAPTER 1

### Control of Microbes and DBPs in Drinking Water: An Overview<sup>1</sup>

#### Introduction

Historically, drinking water utilities in the United States (U.S.) have played the major role in protecting public health through the reduction of waterborne disease. For example, in the 1880s, the typhoid death rate was 158 deaths per 100,000 in Pittsburgh, PA. But by 1935, the typhoid death rate had declined to 5 per 100,000 (Clark et al. 1991). These reductions in waterborne disease outbreaks were brought about by the use of sand filtration, disinfection, and the application of drinking water standards. Despite this excellent record, the occurrence of occasional drinking water quality problems are a reminder of the need for constant vigilance. In 1993, Milwaukee, WI, suffered a Cryptosporidiosis outbreak; it was estimated that over 400,000 people were made ill and an estimated 75–100 immune-compromised people died (Blair 1994). In July of 1993, Manhattan, NY, was placed on a boil water order, as was Washington, D.C., in December of 1993. Both systems experienced microbial maximum contaminant level (MCL) violations under the Federal Safe Drinking Water Act (SDWA) (Clark et al. 1999).

Growing national concern over the need to protect drinking water quality in the United States was reinforced by the U.S. Congress on December 16, 1974. On that date it passed the SDWA, which established the first set of federally enforceable drinking water regulations in the history of the U.S. Section 1401 (1)(D) of the SDWA, Public Law 93-523, states that “the term ‘primary drinking water regulation’ means a regulation which contains criteria and procedures to assure a supply of drinking water which dependably complies with such maximum contaminant levels. . .” and Section 1412 (a)(2) states that “National interim primary drinking water regulations promulgated under paragraph (a)(1) shall protect health to the extent feasible, using technology, treatment techniques, and other means, which the Administrator determines are generally available (taking costs into consideration). . .” This provision of the SDWA established the requirement that a “Treatment Techniques” document must accompany the establishment of an MCL for any regulated contaminant (SDWA 1974).

Coincident with the passage of the SDWA, Rook (1974) and Bellar and Lichtenberg (1974) reported, nearly simultaneously, that chloroform was a disinfection by-product (DBP) resulting from the interaction of chlorine with natural organic matter in water. Chloroform is one of a class of compounds called trihalomethanes. This finding posed a serious dilemma because it raised the possibility that chemical disinfection, which clearly reduced the risk of infectious disease, might also result in the formation of potentially harmful chemical by-products. In the United States, since 1974, additional DBPs have been identified, and concerns have intensified about health risks resulting from exposures to them (Bull 1993). Although a causal relationship between DBP exposures and these health risks has not been conclusively established, risk managers have responded, in the interest of protecting public health, by developing alternative treatment systems and issuing rules and regulations designed to maintain protective levels of disinfection while reducing potentially harmful levels of DBPs (USEPA 1998a, b).

---

<sup>1</sup>Robert M. Clark and Robert C. Thurnau: ORD/NRMRL/WSWRD, AWBERC Mailstop 689, 26 West Martin Luther King Dr., Cincinnati, OH 45268. Corresponding Author: Robert M. Clark, 513-569-7201, clark.robertm@epa.gov.

After discovering that chloroform was, in fact, a by-product of disinfection, it was also determined, using the best information available, that chloroform was a possible carcinogen (Symons et al. 1981). This finding sparked a flurry of research both in and outside the U.S. Environmental Protection Agency (EPA). Results from these studies formed the basis for an amendment to the National Interim Primary Drinking Water Regulations issued on November 29, 1979. The amendment established an MCL of 0.10 mg/L total trihalomethanes (TTHM) in drinking water (Federal Register 1979).

These events caused the EPA to focus its drinking water research program on establishing the scientific basis for control of DBPs. It attempted to answer the following questions (Symons et al. 1981):

1. How does the consumption of trihalomethanes affect the health of consumers?
2. How should trihalomethanes be measured?
3. How do water quality conditions influence trihalomethane formation?
4. What treatment technique(s) can a drinking water utility use to reduce trihalomethane concentrations in distributed water?
5. What effect will altering treatment procedures for controlling trihalomethanes have on the microbiological quality of distributed water?
6. What are the costs of the various treatment alternatives for controlling trihalomethanes?

In 1981, the Drinking Water Research Division of EPA's Municipal Environmental Research Laboratory issued a report entitled "Treatment Techniques for Controlling Trihalomethanes in Drinking Water" (Symons et al. 1981). This document was intended to satisfy the need for a "Treatment Technique" document for the TTHM regulation. It reviewed, as much as was known at that time, the health implications of trihalomethanes in drinking water. It summarized the results of research intended to answer the questions listed above and attempted to help the reader choose the most cost-effective treatment techniques for TTHM control. The EPA published 2000 copies of the document, and it was then republished by the American Water Works Association (AWWA). It was later translated into Japanese and was distributed by the Japan Water Works Association (JWWA).

In the intervening twenty years, EPA has conducted a great deal of research in an attempt to provide answers to the six questions listed above. In 1997, the EPA issued a Research Plan for Microbial Pathogens and Disinfection By-products in Drinking Water (M/DBP) (USEPA 1997a). The M/DBP plan is a comprehensive summary of the multi-disciplinary research program being conducted by EPA to deal with identification and control of disinfection by-products and microbial contaminants in drinking water.

After the passage of the 1986 SDWA Amendments, there was growing concern that a single focus on controlling DBPs could be detrimental to protecting against microbial contamination in drinking water distribution systems. This concern resulted in the Surface Water Treatment Rule (SWTR) and the Total Coliform Rule (TCR), both of which were promulgated to insure that microbes in drinking water systems would be controlled as well as DBPs (USEPA 1989a,b). This concern is also reflected in the research program outlined in the M/DBP plan.

This report herein is intended to provide an overview of the treatment technology research conducted by EPA since the publication of "Treatment Techniques for Controlling Trihalomethanes in Drinking Water" (Symons et al. 1981). It describes the nature and scope of the regulations which have been promulgated since the passage of the SDWA. It discusses recently identified disinfection by-products and related regulations and reviews some of the trends that have developed with respect to compliance with the rules and regulations under the SDWA. Finally, it summarizes and reviews treatment technology research efforts conducted by EPA since 1981.



## **Drinking Water Regulations in the United States**

The U.S. has nearly 60,000 community water supplies serving over 226 million people. Most of the community water systems supply water to less than 500 people. Over 63% of these systems supply water to less than 2.4% of the population, while 5.4% supply water to 78.5% of the population. Clearly, a few large systems supply drinking water to most of the U.S. population. In addition to the 60,000 community water supplies, there are 140,000 non-community water systems that serve schools, recreational areas, trailer parks, etc. Nearly 98% of the non-community systems use ground water as a source, and approximately 80% of the community systems use ground water as a source. Many of the utilities that use ground water practice disinfection only, and a large number do not practice any treatment at all (USEPA 1999a).

In its original form, the SDWA established a set of regulations known as the National Interim Primary Drinking Water Regulations (NIPDWR) (SDWA 1974). The regulations included MCLs for ten inorganic contaminants, six organic contaminants, turbidity, coliform, radium-226, radium-228, gross alpha activity, and man-made radionuclides. The NIPDWR also established monitoring and analytical requirements for determining compliance. Public water systems were defined as those which provided piped water to the public for human consumption and had at least 15 service connections or regularly served an average of 25 persons at least 60 days out of the year.

The MCLs for coliforms, nitrate, and turbidity (surface water only) applied to both community and non-community systems, while the other MCLs applied only to community systems. The SDWA of 1974 required EPA to review and revise the NIPDWR systematically as appropriate. As mentioned previously, a major revision of the NIPDWR occurred in 1979, when an MCL for total trihalomethanes was promulgated (USEPA 1979).

On June 19, 1986, the SDWA was amended by Public Law 99-339, known as the Safe Drinking Water Act Amendments of 1986. The 1986 Amendments promulgated a requirement and a schedule for EPA to implement regulations for 83 contaminants which had been published previously in “Advanced Notices of Proposed Rulemaking” as contaminants being considered for regulation. EPA was allowed to substitute up to seven contaminants onto the list of 83. In addition, EPA was required to publish a list every three years of contaminants “known or anticipated to occur in public water systems and which may require regulation under this act” (those which may have any adverse effect on the health of persons).

The 1986 Amendments stipulated that regulations should contain a maximum contaminant level goal (MCLG), a health-based concentration “at which no known or anticipated adverse effects on the health of persons occur and which allows an adequate margin of safety.” MCLs were to be set at a level as close to the MCLG as feasible. Feasible was defined in the law as “feasible with the use of the best technology, treatment techniques and other means which the Administrator finds, after examination for efficacy under field conditions and not solely under laboratory conditions are available (taking cost into consideration).” Granular activated carbon (GAC) was designated in the law as feasible for the control of synthetic organic chemicals, and any technology, treatment technique, or other means found to be the best available for control of synthetic organic chemicals had to be at least as effective as GAC. Each regulation which established an MCL was required to list the technology, treatment technique, or other means which the Administrator found to be feasible for purposes of meeting the MCL. These have become known as best available technology (BAT).

In the event that EPA found it was not “economically or technologically feasible to ascertain the level of the contaminant,” the law authorized the Administrator to promulgate a regulation that required the

use of a treatment technique in lieu of an MCL. A far-reaching provision of the law required EPA to promulgate a regulation specifying criteria under which filtration was required as a treatment technique for public water systems supplied by surface water sources. Similarly, EPA was directed to promulgate regulations requiring disinfection as a treatment technique for all public water systems.

Passage of the 1996 Amendments to the SDWA focused the attention of water utility managers and public health and regulatory officials on source water protection and its role in protecting public water supplies. Concern over source water protection was not limited to surface water supplies because many ground water supplies proved to be vulnerable as well. Based on the 1996 Amendments, the States will implement programs to decide if a system's source of water is threatened, as well as determine the means to prevent pollution. Communities will be allowed to ask for state assistance, and a certain percentage of the State Revolving Loan Fund has been earmarked to assist with source water protection (Howell 1997).

### ***The Standard Setting Process***

The process of developing drinking water standards in the U.S. is complex. This complexity is primarily due to the need to integrate scientific knowledge with legal requirements and current societal values. The process flows from determining health risks of various contaminants, or risk assessment, to developing regulatory control options, or risk management (Cox 1997).

The risk assessment process begins by reviewing all possible adverse effects of a particular contaminant and determining which effects are significant via drinking water. An analysis is then made of carcinogenic and noncarcinogenic effects. For carcinogens, a classification scheme based on strength of evidence is used as well as quantitative risk extrapolation models. As a policy choice, the health goal level for possible and probable human carcinogens is zero. For noncarcinogens and contaminants with equivocal evidence of carcinogenicity, a safe nonzero level can be set as the health goal. Once the health goal is established, the risk management process is used to determine the regulatory approach and the feasible, enforceable level for each contaminant.

The risk management process begins with an assessment of monitoring feasibility. If a particular contaminant can be monitored, then a MCL is set. If monitoring is not feasible, then the law specifies a treatment technique requirement. In either case, EPA must determine the feasibility of treating contaminated water to levels equaling or approaching the health goal.

Costs must also be considered in terms of both individual systems applying appropriate technologies and the total national costs of various regulatory options. In the final analysis, the protection of public health, including an adequate margin of safety, is the predominant factor.

### **Trends in Compliance with the SDWA**

The SDWA has been in existence long enough to monitor trends for compliance. In order to give a brief picture of trends over the last ten years, compliance with the TTHM rule, nitrate regulations, the total coliform rule, and the number of community water systems with any type of MCL violation are discussed.

#### ***Compliance with the TTHM and Nitrate Rules***

TTHMs form when disinfectants react with natural organic matter in water, and they may have potential chronic health effects. They tend to occur mostly in surface waters. Nitrates have potential acute health effects and occur mostly in ground water systems (which tend to be smaller). Because

trihalomethanes and nitrates are two of EPA's earliest regulated contaminants, tracking compliance with these standards provides a general sense of public drinking water quality over time (USEPA 1999b).

The 1979 standard for TTHMs applies to approximately 3,500 community water systems (those serving at least 10,000 people). The number of community water systems with at least one violation of the TTHM MCL in one year has been decreasing fairly steadily since the mid-1980s, going from a peak of about 70 system (2 percent of the total number of systems that must comply) violations in 1985 to fewer than 10 system violations in 1998. The number of community water systems with monitoring and reporting violations for TTHMs has also been decreasing fairly steadily, going from about 180 systems in 1985 to about 70 in 1998.

The nitrate standard applies to all types and sizes of public water systems. The number of community water systems with MCL violations for nitrate has been decreasing slightly since the mid-1980s, going from a peak of about 340 system violations in 1985 to approximately 190 system violations in 1998. As with TTHMs, the peak number of systems with reported violations represents a small fraction—less than one percent—of the total systems which must comply with the nitrate MCL.

### ***Total Coliform Rule (TCR)***

The Total Coliform Rule became effective in December 1990, although a less stringent standard for total coliform existed (in combination with a turbidity level standard) as one of the interim regulations under the original SDWA. Community water systems with total coliform violations have accounted for the vast majority of community water systems with MCL violations each year. Monitoring is required more frequently for total coliform, thus creating more opportunities for detecting MCL violations (USEPA 1999b).

The number of systems with total coliform MCL violations has decreased fairly steadily since 1980, at a rate of about 200 systems per year. Since 1980, over 80 percent of all community water systems with any MCL violation had a violation for total coliform. However, even the peak number of systems violating the total coliform MCL (approximately 7,000 systems in 1980) represents only about 13 percent of the total number of community water systems that must comply with the standard.

The number of systems with MCL violations for total coliform did not increase after the 1990 rule went into effect. However, the population affected by community water systems with TCR MCL violations more than doubled between 1990 and 1993, going from roughly 12.5 million people affected in 1990 to 28 million in 1993. The population affected has declined steadily by about 4 million people per year since 1993 to about 8 million in 1998.

### ***Compliance with the Surface Water Treatment Rule***

The SWTR took effect in December 1990. The number of community water systems identified as violating the rule's treatment technique requirements increased from about 10 in 1991 to approximately 1,500 in 1994, then dropped to just under 1,000 by 1998. When noncompliance was at its highest, the number of systems violating the SWTR represented about 14 percent of the total number of community water systems that must comply with the rule (USEPA 1999b).

The population affected by these violations increased from about 140,000 people in 1991 to about 26 million in 1994. This affected population was higher than for any other contaminant or rule, with the exception of the TCR in 1993. The population affected gradually decreased to about 18 million in 1998.

The number of systems with monitoring and reporting violations of the SWTR rose from about 120 systems in 1992 to a peak of approximately 600 systems in 1994 and has generally decreased since. The number of people served by systems with violations of monitoring and reporting requirements peaked

at 5 million people in 1994 and declined to about 2 million in 1997. The population affected then rose to about 3.7 million in 1998.

One reason for the high number of systems with treatment technique violations as compared to monitoring and reporting violations is that many systems received treatment technique violations for failure to filter. Because installing filtration is expensive, many large systems have needed more time than the regulations allow to place filtration systems in service.

### ***Effect of System Size and Compliance***

Generally, larger systems have more resources available to comply with regulations, so fewer violations are incurred, despite the fact that larger systems must comply with more regulations than smaller systems (USEPA 1999b). In recent years, it appears that the gap between the percentage of small, medium, large and very large systems with violations has been closing. However, very small systems are still almost 50 percent more likely to incur violations than all other system sizes.

### **Current DBP and Microbial Regulations**

Chapter 2, “A Review of Federal Drinking Water Regulations in the U.S.,” provides an overview of the history of the SDWA in the U.S. He reviews the SDWA and summarizes current MCLs and treatment requirements. He also reviews the regulations that EPA is promulgating or considering for promulgation.

The 1986, SDWA amendments listed disinfectants and disinfection by-products (D/DBPs) among the contaminants that EPA must regulate. Because of the difficult issues associated with this requirement, EPA implemented the Negotiated Rulemaking Act of 1990. A Regulatory-Negotiation (Reg-Neg) committee with representatives from state and local agencies, public water systems (PWSs), elected officials, consumer groups, and environmental organizations met periodically from November 1992 through June 1993 (Cox 1997). Based on the recommendation of the Reg-Neg committee and in response to a wide range of technical comments from stakeholders and members of the public, EPA developed three sets of rules to control microbial pathogens and DBPs. These three rules are as follows: the Information Collection Rule (ICR), a two-stage DBP rule, and a similarly staged Enhanced Surface Water Treatment Rule (ESWTR) (USEPA 1998a, 1998b, 1998c, 1999a).

The 1996 Amendments to the SDWA required EPA to establish a Contaminant Candidate List (CCL) for future regulatory action. EPA’s ORD will identify emerging pathogens and chemicals of public health concern and assess the nature and magnitude of health effects associated with these waterborne agents (USEPA 1998c).

There are many other requirements that follow from the specific details of the rules and regulations that have been promulgated or may be promulgated under the SDWA for both DBP and microbial contaminant control. EPA’s ORD has developed an agenda that is targeted to finding solutions to these problems as discussed in the following sections.

### **Chemistry of DBP Formation**

In Chapter 3, “Disinfection By-Product (DBP) Chemistry: Formation and Determination,” the authors address some of the major issues associated with DBP formation chemistry. They focus primarily on EPA-sponsored or in-house research. The primary disinfectants used in the United States are chlorine, chlorine dioxide, chloramines, ozone, and potassium permanganate. Some disinfectants are generally more effective than others and some are more effective against specific organisms than others. For example, chlorine, which is the most widely used disinfectant in the U.S., is very effective against bacteria and viruses, but is relatively ineffective against parasites such as *Cryptosporidium*. Ozone is

the most generally effective disinfectant, but is so reactive that it would be difficult to maintain a residual in a distribution system.

As has been discussed, the disadvantage of applying a disinfectant is that it may be powerful enough to non-selectively react with substances in the water, other than microorganisms, to form DBPs. There are thousands of DBPs, and they may be categorized into three major classes: inorganic by-products, organic oxidation by-products, and halogenated organic by-products. The health effects of some of these by-products are of little concern, but some are suspected to be carcinogenic or have other health effects and are therefore subject to regulation as discussed previously.

By-products form when the disinfectant reacts with organic or inorganic “precursor” material; however, natural organic matter (NOM) has probably received the most attention. Much of the engineering focus on controlling DBPs is on either controlling the by-products themselves or removing the precursor material to keep the by-products from forming.

## **Source Water Protection**

Many of the drinking water utilities in the U.S. invest a great deal of time, energy, and capital in developing mechanisms for protecting against the impact of sudden changes in influent water quality. Some of these mechanisms include investment in excess capacity and development of emergency procedures (Miller 1989).

Chapter 4, “Source Water Protection: Its Role in Controlling Disinfection By-Products (DBPs) and Microbial Contaminants,” explores Source Water Protection (SWP) as it relates to the control of DBPs and microbial contamination. They discuss the nature of threats to source water quality; techniques and methods for monitoring and assessment of pathogens; technologies for control of water quality; the use of models to assess water utility vulnerability; and the relationship of source water protection to watershed management.

Passage of the 1996 amendments to the Safe Drinking Water Act (SDWAA) focused the attention of water utility managers, public health, and regulatory officials on SWP and its potential for protecting public water supplies. Events such as the 1993 Cryptosporidiosis outbreak in Milwaukee, WI, reinforced the idea that water suppliers which meet all of the SWTR requirements of the SDWA are still vulnerable to microbial breakthrough (Okun et al. 1997; Fox and Lytle 1996). The Milwaukee experience demonstrated that water treatment and/or disinfection alone may not be enough to ensure the provision of potable and safe water to the consumer.

Based on the 1996 amendments, the states will have to implement programs to decide if a system’s source of supply is threatened as well as determine the means to prevent pollution. Communities will be allowed to ask for state assistance, and a certain percentage of the State Revolving Loan Fund has been earmarked to assist with source water protection activities (Howell 1987).

Although the SDWA was passed in 1974 and amended in 1986 and 1996, concerns about SWP actually began with the SDWAA of 1986. The 1986 amendments included provisions for “Protection of Ground Water Sources of Water.” The two programs set up under this requirement were the “Sole Source Aquifer Demonstration Program,” to establish demonstration programs to protect critical aquifer areas from degradation; and the “Wellhead Protection Program,” which requires states to develop programs for protecting areas around public water supply wells to prevent contamination from residential, industrial, and farming-use activities.

Managing microbial risk requires identification and quantification of organisms. The potential sources of pathogens in source water are many and varied, including nonpoint runoff, discharges from treated and untreated sewage, and combined sewer overflows. From a waterborne outbreak and public health

viewpoint, both *Giardia* and *Cryptosporidium* are of primary concern. Monitoring regulations often specify indicator organisms for determining water quality because the analytical methods are easier, faster, and more cost effective than methods for specific organisms. The limitations of relying on indicator organisms for determining the presence of pathogens include the occurrence of false positives and the fact that indicator organisms measure bacteria that live not only in human enteric tracts, but also in the enteric tracts of other animals (Toranzos and McFeters 1997).

Modeling can assist in identifying the vulnerability of a drinking water utility to threats from source water contamination. These models can be used in assessing the impact of upstream point source discharges on downstream users as well as the potential for contamination from nonpoint sources (Clark et al. 1998). Another aspect of contamination modeling is the overland transport of pathogens. Although efforts to model overland transport of *Cryptosporidium* oocysts have been limited, such models are needed to predict oocyst loads and estimate the effectiveness of management practices.

## **Microbial Pathogen Disinfection**

Chapter 5, “Disinfection,” discusses over twenty years of EPA’s research and studies on microbial pathogen inactivation. These pathogens, including bacteria, viral, and protozoan species, comprise a diverse group of organisms which serve as the etiological agents of waterborne disease. Although unit processes, such as coagulation, clarification, and filtration, may dramatically reduce the number of microbial pathogens, disinfection frequently serves as the final and, in some cases, the only barrier to the entry of these organisms into finished water.

The disinfection process may be affected by physical and chemical factors such as temperature and pH, as they are known to play an important role in the inactivation process for most commonly used disinfectants (Hoff 1986). Turbidity and particle protection influence disinfection efficiency as well as clumping of individual microorganisms (Berman et al. 1988). Resistance to chemical disinfection may vary greatly among the various microorganisms of interest and also between different life-stages of individual species, such as is seen with bacterial endospores or encysted forms of protozoa.

Making comparisons among various studies of microbial inactivation are often difficult due to differences in methodology. Factors such as mixing, the type of bioassays employed to determine viability, the volume of sample analyzed, and the reporting of residual versus initial dosing concentrations of the disinfectant may vary greatly from one study to another. Often these parameters are not described in sufficient detail in scientific manuscripts to make a proper evaluation. Data collected under field or pilot-scale conditions may show marked differences from the results of laboratory experiments conducted under oxidant demand-free conditions. These discrepancies, along with the need to determine the efficacy of disinfection for new and emerging waterborne pathogens, have been a major focus of the EPA’s research program on microbial inactivation. Rice discusses potable water disinfection, as categorized by individual oxidants, and summarizes the microbial inactivation research which has been conducted or sponsored by EPA during the time period from 1980 to 1999.

## **Controlling Alternative DBPs**

Chapter 6, “Alternative Disinfectants,” discusses EPA’s research devoted to characterizing and controlling DBPs. Recent studies conducted by or funded by the EPA’s ORD in Cincinnati that examine the use of three alternative oxidants are presented: chloramine, chlorine dioxide, and ozone. As discussed previously, chlorination of drinking water results in the formation of numerous DBPs, several of which are regulated. Water systems seeking to meet MCLs for regulated DBPs might consider various approaches to limiting DBPs such as: removing precursor compounds before the disinfectant is applied,

using less chlorine, using alternative disinfectants to chlorine, or removing DBPs after their formation. Combinations of these approaches might also be considered. As mentioned previously, removing DBPs after their formation is a method that is generally not considered but, no matter which approach is selected, the effectiveness of the disinfection process must not be jeopardized.

Based on the research cited by Miltner, formation of DBPs by chloramines is significantly lower than by free chlorine, with the exception of the formation of cyanogen chloride. Formation of non-halogenated DBPs such as aldehydes and assimilable organic carbon (AOC) is found to be minimal with chloramination.

The formation of DBPs by chlorine dioxide ( $\text{ClO}_2$ ) is also significantly lower than with free chlorine. Chlorine dioxide oxidizes DBP precursors in the treated water to the extent that lower concentrations of DBPs are formed with subsequent chlorination. Using  $\text{ClO}_2$  results in the formation of non-halogenated DBPs such as aldehydes, ketones, and AOC.

The use of  $\text{ClO}_2$  can result in the formation of chlorite and chlorate. Chlorite can be controlled by GAC and through the use of reducing agents. Sulfite and metabisulfite can reduce chlorite, but may form chlorate. Thiosulfate can reduce chlorite without forming chlorate. Ferrous ion can reduce chlorate, but pH adjustment is required to minimize chlorate formation. The use of a reducing agent like thiosulfate or ferrous ion can complicate the application of postdisinfectants.

## **Control of DBPs Using Biological Filtration**

The potential for using biological filtration for controlling DBPs is discussed in Chapter 7, “Disinfection By-Product Control Through Biological Filtration.” DBP control through biofiltration is defined as the removal of DBP precursor material (PM) by bacteria attached to the filter media. Dissolved organic matter (DOM), which is part of the PM, is utilized by the filter bacteria as a substrate for cell maintenance, growth, and replication. This effect makes the PM utilized by bacteria unavailable to react with chlorine to form DBPs. The prerequisite for maximizing bacterial substrate utilization in filters is the absence of chlorine in the filter influent or backwash water.

Sand, anthracite, or GAC can be colonized by bacteria. Since anthracite and sand are considered inert because neither interacts chemically with PM, removal of PM is due solely to biological activity. GAC will initially remove DOM through adsorption and biological substrate utilization until its adsorptive capacity has been exhausted. After that point, PM removal is achieved only through substrate utilization, and the GAC is defined as biological activated carbon (BAC). All drinking water filters will become biologically active in the absence of applied disinfectant residuals. The process of biological colonization and substrate utilization is enhanced by ozonating filter influent water.

Data collected, to date, indicate that biologically active filters remove significant amounts of PM and that preozonated biofilters remove more PM than do non-ozonated filters. The resulting reductions in trihalomethane formation potential (THMFP) and haloacetic acid formation potential (HAAFP) should help many drinking water utilities meet the 80 (THM) and 60 (HAA) g/L limits mandated under the Stage II D/DBP Rule.

## **Controlling Microbial Contaminants Using Filtration**

An area of very active research for EPA has been the use of bench-, pilot-, and field-scale studies to investigate various aspects of surface water filtration. Many of these studies have been oriented toward small drinking water system applications. Chapter 8, “Microbiological Removal by Filtration Processes,” discusses research conducted by EPA which examines various treatment techniques for re-

moving microorganisms from drinking water. Two of these technologies, Slow Sand Filtration (SSF) and Diatomaceous Earth (DE) Filtration, are especially applicable to small systems. In addition, the application of granular filtration, which is utilized by medium to large systems, has been investigated for removal of *Giardia* and *Cryptosporidium*. These studies have considered the various operational conditions that enhance removal efficiency as well as the conditions under which removal efficiency deteriorates.

In the period between 1980 and 1990, *Giardia* cysts and *Cryptosporidium* oocysts were the primary organisms being considered. The effect of various water quality conditions and particle and pathogen loadings were evaluated. It was shown that, in combination with effective chemical addition and coagulation, these processes are capable of efficiently removing high levels of both target organisms. It was found that low water temperature reduced removal efficiency in SSF and conventional filtration, but had little effect on DE performance. The studies conducted by EPA concluded that good turbidity reduction and good particle removal paralleled good microorganism removal.

EPA researchers were the first investigators to monitor filtration efficiency by measuring aerobic endospore removal. Although not a direct surrogate for removal of a specific organism, they demonstrated that endospore removal is an excellent measure of overall filtration performance. Their studies have shown that endospore removal tracks particle and pathogen removal and turbidity reduction. Endospores were shown to be a conservative measure of both particle and pathogen removal.

## **Controlling DBPs and Microbes Using GAC and Membranes**

Chapter 9, “Activated Carbon and Membrane Processes for Disinfection By-Product (DBP) and Microbial Control,” provides a comprehensive review of activated carbon and membrane research for the control of DBPs and pathogens. Much of the work he cites was conducted, or funded, by EPA’s ORD.

GAC can be used as part of a multi-media filter to remove particulates (filter adsorber) or as a postfilter to remove specific contaminants (postfilter adsorber). When used in a filter adsorber mode, the filters are backwashed periodically to alleviate head loss, but the carbon itself is regenerated infrequently, if at all. When used in a postfilter mode, the carbon bed is rarely backwashed and is regenerated as often as needed to control for the contaminant(s) of interest.

Activated carbon in a filter adsorber application removes pathogens by the same mechanisms as any other filter media. It does not remove particulates/pathogens to any greater degree than other filter media types, so it is never recommended for particulate/pathogen removal alone.

Certain types of membranes can be very effective for controlling DBPs, while others are specifically designed to remove particulates/pathogens. For example, reverse osmosis (RO) membranes are very tight and are typically used to remove salts from seawater and brackish waters. Due to their tight membrane structure, they require high pressures to operate effectively.

Nanofiltration (NF) membranes are not as tight as RO membranes, but have been found to remove a large percentage of DBP precursors. Because they are not as tight, they can be operated at lower pressures (typically 5 to 9 bar) than RO membranes while achieving the same, or greater, flux. Ultrafiltration (UF) and microfiltration (MF) membranes are typically used for particulate/pathogen removal only.

Speth concludes that activated carbon is an effective process for removing DBP precursors, but is not effective for pathogen removal. RO and NF are effective processes for removing DBP precursors, and UF and MF membranes are excellent for removing pathogens and particulates and, under some conditions, could be considered as a replacement for conventional treatment.



## Removing DBP Precursors Using Enhanced Coagulation

Chapter 10, “Coagulation,” discusses EPA’s research on enhanced coagulation. He points out that coagulation has historically been used for the control of particulates in drinking water, while simultaneously controlling organic carbon. With the inclusion of DBP control in the Stage I DBPR, the role of coagulation in organic carbon control was expanded to include the removal of DBP precursors. This chapter presents recent studies conducted by the EPA that examined (1) conventional coagulation and coagulation that was enhanced to better control organic carbon and DBP precursors, and (2) the effects on other water quality parameters as enhanced coagulation was employed.

It is expected that many water systems will move from conventional to enhanced coagulation and expand their coagulation objectives from removing turbidity to removing TOC as well. It is anticipated that many systems will be able to meet the requirements of enhanced coagulation for TOC removal with only moderate changes in conventional coagulation. Conventional coagulation removes a greater percentage of the humic fraction than of the non-humic fraction, but enhanced coagulation improves the removal of both fractions. Making the change from conventional to TOC-optimized coagulation generally results in improved removal of heterotrophic plate count (HPC) bacteria, total coliform (TC) bacteria, *C. parvum* oocysts, *Cryptosporidium* oocyst-sized particles, *Giardia* cyst-sized particles, total plate count (TPC) organisms, and bacterial endospores.

A general concern associated with coagulation is that, although it lowers the concentrations of DBP precursor, it shifts the distribution of the DBPs formed by chlorination toward the more brominated species. This shift becomes more pronounced with enhanced or optimized coagulation.

Systems switching from conventional to enhanced coagulation may achieve longer filter run times (FRTs), but the tradeoff will be greater amounts of sludge production. Systems practicing enhanced coagulation should also consider pH adjustment ahead of the filter to achieve longer FRTs. One of the concerns associated with enhanced coagulation is that when alum is the coagulant, higher levels of dissolved aluminum will enter the distribution system.

## Controlling Microbes and DBPs in Small Systems

In Chapter 11, “Controlling Disinfection By-Products (DBPs) and Microbial Contaminants in Small Public Water Systems (PWSs),” the authors describe in-house and field research activities specifically designed to evaluate alternative treatment technologies for small community and non-community water systems. They discuss four major topics: (1) particulate removal, (2) disinfection/destruction, (3) field-scale demonstration, and (4) small system remote monitoring and control. Small systems have many problems that make compliance with drinking water standards more difficult than for medium and large systems. The pilot- and full-scale research efforts described in this chapter are intended to address some of these needs. Because small systems often lack the financial, technical, and managerial capabilities of larger systems and are responsible for the majority of the SDWA violations, they have been targeted in several Federal Rules and Regulations.

EPA’s in-house research has focused primarily on filtration and disinfection technologies that are considered to be viable alternatives to conventional package plants (flocculation, coagulation, media filtration, post-chlorination). Conventional package plants require a high level of operator skill to properly maintain appropriate chemical dosage and flow rates, especially when used to treat surface water. These difficulties, in conjunction with the other small system problems mentioned previously, have resulted in EPA focusing its research on technologies that are easy to operate and maintain and produce minimal residuals. Field demonstration projects have been used to characterize some of the problems that can occur for even the best technology when conditions are not optimal. The remote monitoring and control research efforts

resulted from the fact that many rural systems are located in topographically difficult areas or separated by large distances from other systems, thus precluding any consolidation or regionalization efforts. The software and sensing systems developed as a product of this research will allow individual treatment units to be monitored and operated from a central location. This approach has come to be known as “the electronic circuit rider” concept. One technique that has promise for improving the effectiveness of systems in the field is the use of supervisory control and data acquisition systems.

Results from this research indicate that microfiltration, ultrafiltration, and reverse osmosis systems are effective technologies for the removal of pathogens while still being affordable for small systems. Their conclusions are very similar to those of Speth. New disinfection technologies appear to provide improvements over current systems in handling chemicals and consistency of performance. This is an area undergoing rapid change. Many organisms are readily removed and inactivated in the laboratory, but under field conditions the same effectiveness cannot be taken for granted.

A very important “spin-off” from this research is the EPA Environmental Technology Verification (ETV) Program for Drinking Water Treatment Systems. The goal of this program is to develop performance standards and protocols that can be used to evaluate the performance of small systems technologies. The ETV works in partnership with the private sector in order to provide test results and peer-reviewed data in accelerating the acceptance and use of new, improved, and cost-effective technologies.

## **Modeling Chlorine Residuals and DBP Formation**

Chapter 12, “Modeling Chlorine Decay and the Formation of Disinfection By-Products (DBPs) in Drinking Water,” reviews current and historical research efforts related to the development of models for predicating the decay of disinfectants and the formation of DBPs. It focuses on chlorine as a disinfectant and emphasizes EPA’s research.

In the U.S., chlorine has been the final disinfectant most often used before drinking water is discharged into a drinking water distribution system. It is added to provide a disinfection residual and to protect against microbial contamination. Even treated drinking water exerts chlorine demand due to the reactions with NOM and other constituents in water. Therefore, the disinfectant dose must be enough to meet the inherent demand in the treated water to provide sufficient protection against microbial infection, and at the same time minimize exposure to DBPs.

The conditions that govern the interaction of NOM and chlorine and the resulting formation of DBPs are discussed. Research devoted to models for chlorine decay and the formation of DBPs are reviewed. The factors that affect exposure to DBPs are examined, and EPA field research studies that have provided the basis for current research on chlorine decay and DBP formation are presented. The development of EPANET, a state-of-the-art, public sector water quality/hydraulic model, is reviewed, along with the evolution of numerical modeling techniques. The topic of storage tanks and their impact on water quality and the associated public policy issues are also discussed. Models that predict the formation of MX, a potentially carcinogenic compound, are discussed.

The chapter reviews both the EPA research in this area as well as research done outside the Agency. Clearly, much progress has been made in developing realistic models to support risk management goals. Of particular note is the application of models to field conditions in water utilities. There is, however, much research left to be done before these models are truly predictive.

## **Distribution System Water Quality**

Virtually anywhere a surface comes into contact with the water in a distribution system, one can find biofilms. Biofilms are formed in distribution system pipelines when microbial cells attach to pipe

surfaces and multiply to form a film or slime layer on the pipe. Probably within seconds of entering the distribution system, large particles, including microorganisms, adsorb to the clean pipe surface. Some microorganisms can adhere directly to the pipe surface via appendages that extend from the cell membrane; other bacteria form a capsular material of extracellular polysaccharides (EPS), sometimes called a glycocalyx, that anchors the bacteria to the pipe surface (Geldreich 1988). The organisms take advantage of the macromolecules attached to the pipe surface for protection and nourishment. The water flowing past carries nutrients (carbon-containing molecules, as well as other elements) that are essential for the organisms' survival and growth (USEPA 1992).

The U.S. EPA has conducted a great deal of research into various aspects of biofilms and their impact on water quality. In Chapter 13, "Biofilms in Drinking Water Distribution Systems," Meckes discusses the conditions that lead to biofilm formation in drinking water distribution systems and outlines past studies and the research that has been undertaken by EPA and its investigators. According to Meckes, biofilms are complex and dynamic microenvironments, encompassing processes such as metabolism, growth, and product formation, and finally detachment, erosion, or "sloughing" of the biofilm from the surface. The rate of biofilm formation and its release into a distribution system can be affected by many factors, including surface characteristics, availability of nutrients, and flow velocities. Biofilms appear to grow until the surface layers begin to slough off into the water (Geldreich and Rice 1987). The pieces of biofilm released into the water may continue to provide protection for the organisms until they can colonize a new section of the distribution system.

Few organisms living in distribution system biofilms pose a threat to the average consumer. Bacteria, viruses, fungi, protozoa, and other invertebrates have been isolated from drinking water biofilms (USEPA 1992). The fact that such organisms are present within distribution system biofilms shows that, although water treatment is intended to remove all pathogenic (disease-causing) bacteria, treatment does not produce a sterile water. In fact, some otherwise harmless organisms (opportunistic pathogens) may survive the treatment process and cause disease in individuals with low immunity or compromised immune systems.

Additional work on biofilms within distribution systems is currently underway. This work is designed to further assess the effect of water quality parameters and system operations on biofilm densities. Other research efforts are focused on identification of specific organisms within biofilms and determining the effectiveness of disinfecting agents on these organisms. These efforts are being conducted to determine if biofilm contributions to delivered water may require treatment modifications or amendments.

## **Cost of Controlling DBPs and Microbial Contaminants**

In Chapter 14, "Control of Microbial Contaminants and Disinfection By-Products (DBPs): Cost and Performance," the authors review the current status of disinfection practices in the U.S., the conditions that cause the formation of DBPs, and discuss the various treatment techniques and associated costs for both controlling DBPs and ensuring microbial safety. Making direct comparisons among the various alternatives is difficult. For example, moving the point-of-disinfection (chlorination) would seem to be the lowest cost option. Nanofiltration, although the most expensive technology for precursor removal, has the advantage of removing other contaminants such as total dissolved solids and various inorganics. Therefore, it might be used for achieving other treatment goals in addition to removing DBP precursors. For example, NF effectively removed microorganisms, thus serving as an alternative for chemical disinfection. Although the cost of enhanced coagulation was not evaluated, it could be very effective if a utility is only slightly out of compliance. However, in addition to increased coagulation costs, an additional cost may be associated with sludge handling. Clearly, modifying the disinfection process is the lowest cost option for controlling DBPs but, as noted, there are by-products and problems associ-

ated with the use of some of the alternate disinfectants. For example, chloramination is not as good a disinfectant as chlorine, and ozone may enhance regrowth of some organisms.

Retrofitting may be fairly easy with chloramination. For example, to switch from chlorine to chloramine may only require the addition of ammonia feed equipment. However, the use of ozone will require construction of expensive ozone contactors. The use of chlorine dioxide will probably require the use of a reducing agent such as ferrous chloride, which was not included in this costing analysis.

The technologies discussed would normally be applied incrementally to a utility's existing treatment. Therefore, the base cost associated with an assumed conventional treatment system and the incremental costs associated with various DBP control alternatives have been summarized. The unit processes considered are those that are effective for precursor removal or for the use of alternate disinfectants.

More efficient treatment will be required to meet future regulations. Also, water treatment managers will have to become more knowledgeable about various treatment options that are cost-effective in order for them to meet present and future regulations. Although essentially exempt in the past, small water systems will be required to comply with future regulations.

### **EPA's Technology Research Program: Some Final Thoughts**

After chloroform and other potentially harmful components were determined to be by-products of disinfection, EPA mounted a major research effort to provide the scientific basis for identifying and controlling these by-products. The Drinking Water Research Division of EPA's Municipal Environmental Research Laboratory issued a report in 1981 titled "Treatment Techniques for Controlling Trihalomethanes in Drinking Water" (Symons et al. 1981). This document summarized the technology research which had been completed after the passage of the SDWA from 1974 through 1980. Perhaps the weakest aspect of this research effort was the minimal effort devoted to controlling microbial contaminants. As the importance of striking the proper balance between controlling DBPs and microbes in drinking water was recognized, EPA promulgated the SWTR and the TCR in 1990. This promulgation coincided with the development of a more balanced research program focusing on both DBP and microbe control. Subsequent regulations have reinforced the need to maintain this balance and the importance of the role that technology will play in achieving these regulatory goals. This document is intended to summarize the research that has been conducted in technology research by EPA since the publication of the 1981 treatment technology document.

The current EPA technology research program is supporting research in the following areas:

- The chemistry of DBP formation
- Source water protection
- Microbial pathogen disinfection
- Control of by-products from alternative disinfectants
- Control of by-products using biological filtration
- Control of microbes by filtration
- Control of microbes and DBPs using GAC and membranes
- Removal of DBP precursors using enhanced coagulation
- Small systems technology
- Modeling chlorine residuals and DBP formation
- Distribution system water quality
- Cost of control technology

EPA's current drinking water research program is more sophisticated than it was twenty years ago. For example, when the treatment technology manual was published in 1981, it reported primarily on treat-

ment-oriented research. Twenty years later, the technology research program includes source water protection, treatment technology, and distribution system studies. The research also reflects a concern over balancing the risks of potential carcinogenic exposure against the risks from microbial infection.

As has been discussed, the requirements of the various rules and regulations being promulgated under the SDWA require a high level of expertise in both science and engineering. EPA's ORD is clearly in a position to understand and solve the problems associated with producing safe drinking water.

## References

- Bellar, T. A. and Lichtenberg, J. J. (1974). "Determining volatile organics at microgram-per-liter levels by gas chromatography." *Journal of the American Water Works Association*, 66, 739–744.
- Berman, D., Rice E. W., and Hofr, J. C. (1988). "Inactivation of particle-associated coliforms by chlorine and monochloranfine." *Applied and Environmental Microbiology*, 54(2), 507–512.
- Blair, K. (1994). "Cryptosporidium and public health." *Health Environment Digest*, 8(8), 61–63, December.
- Bull, R. J. (1993). "Toxicology of disinfectants and disinfection by-products." *Safety of water disinfection: Balancing chemical and microbial risks*, G. F. Craun, ed., ILSI Press, International Life Sciences Institute, Washington, D.C., 239–256.
- Clark, R. M., Ehreth, D. J., and Convery, J. J. (1991). "Water legislation in the US: An overview of the Safe Drinking Water Act." *Journal of Toxicology and Industrial Health*, 7(516), 43–52.
- Clark, R. M., Goodrich, J. A., Lykins, Jr., B. W., and Neal, J. R. (1998). "Evaluating the effects of upstream dischargers on downstream water suppliers: A source water protection model." *Journal of Water Supply Research and Technology–Aqua*, 47(5), 1–8.
- Clark, R. M., Rizzo, G. S., Belknap, J. A., and Cochrane, C. (1999). "Water quality and the replacement and repair of drinking water infrastructure: The Washington, D.C. case study." *Journal of Water Supply Research and Technology–Aqua*, 48(3), 106–114.
- Cox, W. E. (1997). "Evolution of the Safe Drinking Water Act: A search for effective quality assurance strategies and workable concepts of federalism." *William and Mary Environmental Law and Policy Review*, 21, 69–164.
- Federal Register*. (1979). 44(No. 231; November 29), 68624–68707.
- Fox, K. R. and Lytle, D. A. (1996). "Milwaukee's crypto outbreak investigation and recommendations." *Journal of the American Water Works Association*, 88(9), 87–94, September.
- Geldreich, E. E. (1988). "Chapter 3: Coliform noncompliance nightmares in water supply distribution systems." *Water quality: A realistic perspective*. University of Michigan, College of Engineering; Michigan Water Pollution Control Association; Michigan Department of Public Health, Lansing, MI.
- Geldreich, E. E. and Rice, E.W. (1987). "Occurrence, significance, and detection of *klebsiella* in water systems." *Journal of the American Water Works Association*, 79(5), 74–79.
- Hoff, J. C. (1986). "Inactivation of microbial agents by chemical disinfectants." EPA/600/286/067, Environmental Protection Agency.
- Howell, M. L. (1997). "SDWA then and now." *Journal of the American Water Works Association*, 89(3), 11.

- Miller, R. (1989). "Why use GAC—A utility viewpoint." *Design and use of granular activated carbon—Predicted aspects*. American Water Works Association Research Foundation, Denver, CO, 15–21.
- Okun, D. A., Craun, G. F., Edzwald, J. K., Gilbert, J. B., and Rose, J. B. (1997). "New York City: To filter or not to filter?" *Journal of the American Water Works Association*, 89(3), 62–74.
- Rook, J. J. (1974). "Formation of haloforms during chlorination of natural waters." *Water Treatment Examination*, 23, 234.
- Safe Drinking Water Act (SDWA). (1974). *Pub. L. No. 93-523, 88 Stat. 1660*.
- Symons, J. M., Stevens, A. A., Clark, R. M., Geldreich, E. E., Love, Jr., O. T., and DeMarco, J. (1981). "Treatment techniques for controlling trihalomethanes in drinking water." *EPA-600/2-81-56*, U.S. Environmental Protection Agency, Drinking Water Research Division, Municipal Environmental Research Laboratory, Office of Research and Development, Cincinnati, OH, September.
- Toranzos, G. A. and McFeters, G. A. (1997). "Detection of indicator microorganisms in environmental freshwaters and drinking waters." *Manual of environmental microbiology*, C. J. Hurst, G. R. Knudsen, M. J. McInerney, L. D. Stetzenback, and M. V. Walter, eds., American Society for Microbiology, ASM Press, Washington, D.C.
- U.S. Environmental Protection Agency (USEPA). (1979). "National interim primary drinking water regulations: Final rule." *Federal Register*, 44, 68624.
- USEPA. (1992). "Seminar publication: Control of biofilm growth in drinking water distribution systems." *EPA/625/R-92/001*, Office of Research and Development, Washington, D.C.
- USEPA. (1997a). "Research plan for microbial pathogens and disinfection by-products in drinking water." *EPA 600-R-97-122*, Office of Research and Development, Washington D.C., December.
- USEPA. (1997b). "New York City filtration avoidance determination." <<http://www.epa.gov/region02/water/shedtop.htm>>; <<http://www.epa.gov/region02/water/nycshed/fadtbl97.pdf>>.
- USEPA. (1989a). "National primary drinking water regulations: Filtration, disinfection; Turbidity, *Giardia lamblia*, viruses, *Legionella*, and heterotrophic bacteria: Final rule." *Federal Register*, 54(124), 27486.
- USEPA. (1989b). "National primary drinking water regulations: Total coliforms (including fecal coliforms and *E. coli*): Final rule." *Federal Register*, 54, 27544.
- USEPA. (1998a). "National primary drinking water regulations: Disinfectants and disinfection by-products: Final rule." *Federal Register*, 63, 69390.
- USEPA. (1998b). "National primary drinking water regulations: Interim enhanced surface water treatment: Final rule." *Federal Register*, 63(241), 69478–69521.
- USEPA. (1998c). "Announcement of the drinking water contaminant candidate list: Notice." *Federal Register*, 63(40), 10273–10287.
- USEPA. (1999a). "Microbial and disinfection by-product rules simultaneous compliance guidance manual." *EPA 815-R-99-015*.
- USEPA. (1999b). "25 years of the Safe Drinking Water Act: History and trends." *EPA 816-R-99-007*, Office of Water, Washington, D.C.

## CHAPTER 2

### A Review of Federal Drinking Water Regulations in the U.S.<sup>1</sup>

#### Introduction

##### *A Brief History of Safe Drinking Water in the U.S.*

Approximately 400 major cities and towns in the U.S. were served by public water systems (PWSs) when Dr. John Snow, an English epidemiologist, proved a cholera outbreak in England was caused by contaminated water supplies in 1855. More than 2500 PWSs would be placed into service in the U.S. over the next 30 to 40 years before scientists and engineers devised ways to remove or inactivate waterborne pathogenic microorganisms with filters or disinfectants (Taras 1981). At the same time these important treatment processes were being integrated into PWSs, some states had independently set drinking water standards to improve drinking water quality and public health (Cox 1997). Despite this progress, there was concern that, as long as the implementation of drinking water standards was left to each state's discretion, there was no guarantee that everyone in the U.S. would have access to safe drinking water.

National drinking water standards for bacteriological contaminants were developed by the Public Health Service (PHS) in 1914 to regulate drinking water provided on common carriers (trains, buses, and ships) engaged in interstate commerce to help prevent the spread of disease across state lines (Cox 1997). Although individual states voluntarily applied these standards to many PWSs, there was no uniformity in their application or effectiveness (Cox 1997). The standards were revised and expanded to include chemicals, as well as microbiological contaminants, in 1925. Further revisions, including changes that actually made the standards more applicable to PWSs, were made in 1942 and 1946. They were revised once more in 1962, setting limits for a total of 28 substances (USDHEW 1969). The application of the PHS Standards to PWSs remained voluntary, and all 50 states eventually adopted them as drinking water regulations or guidelines for their PWSs (Larson 1989).

As the application of the PHS Standards became increasingly common among states, health officials expected the incidence of waterborne disease outbreaks to decrease. However, such was not the case. Confidence in drinking water quality began to wane by the late 1960s. Despite efforts to keep drinking water microbiologically safe, waterborne disease outbreaks continued to plague public health. Moreover, chemicals used in agriculture and industry began to appear in water supplies. Concerns about these conditions were confirmed by a PHS water system survey conducted in 1969 that revealed more than 60 percent of participating treatment facilities had major deficiencies (USDHEW 1970). These findings prompted Federal lawmakers to reconsider the need for Congress to regulate PWSs.

#### The Safe Drinking Water Act

As popular support buoyed Federal activism in the environmental movement during the 1970s, Congress found constitutional authority in the Commerce Clause to regulate public water systems with the Safe Drinking Water Act (SDWA) (USDHEW 1970). The Act was signed into law in 1974 “to assure that water supply systems serving the public met minimum national standards for protection of public health” (H.R. Rep. 1974) by giving the U.S. Environmental Protection Agency (EPA) the authority to (1) establish Federal drinking water standards for protection against all harmful contaminants in every

---

<sup>1</sup>James Owens: ORD/NRMRL/WSWRD, AWBERC Mailstop 689, 26 West Martin Luther King Dr., Cincinnati, OH 45268, 513-569-7235, owens.jim@epa.gov.

U.S. PWS; (2) establish a joint Federal-State system that would assure compliance with these standards; and (3) protect underground sources of drinking water (Cox 1997).

In its original form, the SDWA was designed to control drinking water quality with two types of regulations: enforceable national primary drinking water regulations (NPDWRs) to cover substances with potentially adverse human health impacts (SDWA 1974a) (current NPDWRs are listed in Table 2-1) and non-enforceable national secondary drinking water regulations (NPSDWRs), in the form of performance standards that were to control substances adversely affecting human welfare, i.e., taste and odor (SDWA 1974b). The original SDWA also included a sole-source aquifer protection program that was established to ensure that Federally funded activities did not cause harm to certain aquifers (SDWA 1974c). The Act changed considerably over the next 25 years (Figure 2-1).

Though the original SDWA helped to improve drinking water quality, Congress realized that only a fraction of the potentially harmful contaminants in PWSs were addressed by the Act. Congress intended that EPA promulgate drinking water standards expeditiously until a more comprehensive set of Federal rules was enacted to govern drinking water in the U.S. However, standard-setting under the original terms of SDWA was slow (Cox 1997). Consequently, Congress enacted the first substantive SDWA amendments in 1986 to increase the rate at which EPA regulated contaminants. The 1986 amendments were very ambitious, establishing standard-setting deadlines, requiring the promulgation of enforceable maximum contaminant levels (MCLs), and non-enforceable maximum contaminant level goals (MCLGs).<sup>2</sup> In sum, the 1986 amendments required EPA to regulate 85 contaminants within 3 years: 9 within 12 months, at least 40 more within 24 months, and the remainder within 36 months (Cox 1997). The 1986 amendments also required EPA to list additional contaminants every 3 years thereafter and directed EPA to promulgate rules requiring PWSs supplied by surface water or ground water under the influence of surface water (GWUDI) to disinfect and/or filter with variance systems meeting certain criteria (SDWA 1974d).

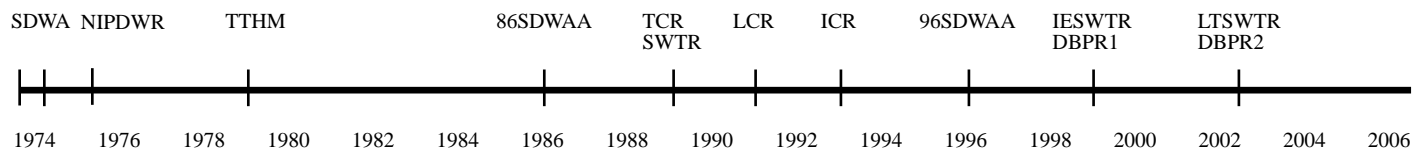
EPA, states, and PWSs attempted to comply with the formidable demands of the 1986 amendments, but ultimately found the requirements to be impossible to meet. EPA was criticized for having an inflexible regulatory schedule, burdening states with unfunded mandates, and failing to incorporate a cost-benefit analysis in the formulation of drinking water regulations. Consequently, Congress substantially revised the SDWA again in 1996 (Pontius 1999). Key points of the 1996 amendments included (1) a revocation of the requirement that EPA regulate 25 contaminants every 3 years;<sup>3</sup> (2) an increase in EPA's authority to consider costs and overall risk reduction when setting standards; (3) the establishment of a state revolving loan program to help communities meet compliance costs; and (4) an expanded source water protection program (Feiner 1997).

---

<sup>2</sup> The SDWA, as amended in 1986, requires EPA to publish a MCLG for each contaminant which, in the judgement of the EPA Administrator, "may have any adverse effect on the health of persons and which is known or anticipated to occur in public water systems" (Section 1412[b][3][A]). MCLGs are to be set at a level at which "no known or anticipated adverse effect on the health of persons occur and which allows an adequate margin of safety" (Section 1412[b][4]). The Act also requires that, at the same time EPA publishes an MCLG, which is a non-enforceable health goal, it also must publish an NPDWR that specifies either an MCL or treatment technique (Sections 1401[1] and 1412[a][3]). EPA is authorized to promulgate a NPDWR "that requires the use of a treatment technique in lieu of establishing a MCL," if the Agency finds that "it is not economically or technologically feasible to ascertain the level of the contaminant."



## Evolution of Federal Drinking Water Regulations



SDWA - Safe Drinking Water Act, enacted in 1974.  
 NIPDWR - National Interim Primary Drinking Water Regulations enacted between 1975 and 1976.  
 TTHM - Total Trihalomethane Rule, promulgated November 29, 1979; effective November 29, 1980 for PWSs serving 75,000 persons; effective November 29, 1981 for PWSs serving 10,000 to 75,000 persons.  
 86SDWAA - Safe Drinking Water Act Amendments of 1986, enacted June 16, 1986.  
 TCR - Total Coliform Rule, promulgated June 29, 1989; effective December 31, 1990.  
 SWTR - Surface Water Treatment Rule, promulgated June 29, 1989; effective December 31, 1990.  
 LCR - Lead and Copper Rule, promulgated June 7, 1991; effective December 7, 1992.  
 ICR - Information Collection Rule, promulgated May 14, 1996; effective June 18, 1996.  
 96SDWAA - Safe Drinking Water Act Amendments of 1996, enacted August 6, 1996.  
 IESWTR - Interim Enhanced Surface Water Treatment Rule, promulgated December 16, 1998; effective February 16, 1999.  
 DBPR1 - Stage 1 Disinfection By-Product Rule, promulgated December 16, 1998; effective February 16, 1999.  
 LTSWTR - Long-term Surface Water Treatment Rule, scheduled for promulgation in May, 2002.  
 DBPR2 - Stage 2 Disinfection Byproduct Rule, scheduled for promulgation in May, 2002.

**Figure 2-1. Time line depicting when major Federal legislation became or will become effective.**

### *EPA Regulations Promulgated Under the SDWA*

The original set of NPDWRs was based on the 28 PHS Standards issued in 1962. Standards were set for (1) six organic chemicals; (2) ten inorganic chemicals; (3) turbidity; and (4) total coliform bacteria in 1975; (5) radionuclides in 1976; and (6) trihalomethanes (THMs) (volatile organic compounds that form when disinfectants react with natural organic matter in water) in 1979. These contaminants were initially regulated by interim standards that would be revised, as necessary, following a comprehensive review by the National Academy of Sciences (NAS). In addition to establishing MCLs for listed contaminants, regulations also required PWSs to meet monitoring, reporting, record keeping, and public notification requirements (USEPA 1979).

EPA was unable to make much progress in establishing additional drinking water standards until the SDWA was amended in 1986. To meet the requirements of the 1986 amendments and to decrease what was considered an unreasonably high risk of waterborne illness under existing rules, EPA promulgated the Total Coliform Rule (TCR) and Surface Water Treatment Rule (SWTR) in 1989. The TCR was implemented to (1) revise the MCL and monitoring requirements for total coliform bacteria; (2) require small systems collecting fewer than five samples/month to have a periodic sanitary survey; (3) have

---

<sup>3</sup>The 1996 amendments have relaxed the rulemaking process. EPA is currently required to list contaminants that could potentially be regulated every 5 years. The Agency must publish the list after consultation with the scientific community, solicitation of public comment, and consideration of an occurrence database. Then EPA shall use formal rulemaking to determine whether or not to regulate at least five of the listed contaminants, beginning not later than 5 years after enactment and every 5 years thereafter. Formal rulemaking generally requires Federal agencies to (a) state the time, place and nature of the rulemaking (including the legal authority for the proposed rule); (b) give interested parties an opportunity to comment on the pending proposed rule; and (c) formulate a statement of the agency's basis and purpose of the rule after the notice and comments.

**Table 2-1. Current NPDWRs**

<b>Contaminants</b>	<b>MCLG<sup>1</sup> (mg/L)<sup>4</sup></b>	<b>MCL<sup>2</sup> or TT<sup>3</sup>(mg/L)<sup>4</sup></b>	<b>Potential Health Effects from Ingestion of Water</b>	<b>Sources of Contaminant in Drinking Water</b>
<b>Inorganic Chemicals</b>				
Antimony	0.006	0.006	Increase in blood cholesterol; decrease in blood glucose	Discharge from petroleum refineries; fire retardants; ceramics; electronics; solder
Arsenic	none <sup>5</sup>	0.05	Skin damage; circulatory system problems; increased risk of cancer	Discharge from semiconductor manufacturing; petroleum refining; wood preservatives; animal feed additives; herbicides; erosion of natural deposits
Asbestos (fiber 10 micrometers)	7 million fibers/L	7 million fibers/L	Increased risk of developing benign intestinal polyps	Decay of asbestos cement in water mains; erosion of natural deposits
Barium	2	2	Increase in blood pressure	Discharge of drilling wastes; discharge from metal refineries; erosion of natural deposits
Beryllium	0.004	0.004	Intestinal lesions	Discharge from metal refineries and coal-burning factories; discharge from electrical, aerospace, and defense industries
Cadmium	0.005	0.005	Kidney damage	Corrosion of galvanized pipes; erosion of natural deposits; discharge from metal refineries; runoff from waste batteries and paints
Chromium (total)	0.1	0.1	Some people who use water containing chromium well in excess of the MCL over many years could experience allergic dermatitis	Discharge from steel and pulp mills; erosion of natural deposits
Copper	1.3	Action Level =1.3; TT <sup>6</sup>	Short term exposure: Gastrointestinal distress. Long term exposure: Liver or kidney damage. Those with Wilson's Disease should consult their personal physician if their water systems exceed the copper action level	Source - reservoirs and plumbing
Cyanide (as free cyanide)	0.2	0.2	Nerve damage or thyroid problems	Discharge from steel/metal factories; discharge from plastic and fertilizer factories
Fluoride	4.0	4.0	Bone disease (pain and tenderness of the bones); Children may get mottled teeth	Water additive which promotes strong teeth; erosion of natural deposits; discharge from fertilizer and aluminum factories
Lead	zero	Action Level =0.015; TT <sup>6</sup>	Infants and children: Delays in physical or mental development. Adults: Kidney problems; high blood pressure	Corrosion of household plumbing systems; erosion of natural deposits

<b>Contaminants</b>	<b>MCLG<sup>1</sup> (mg/L)<sup>4</sup></b>	<b>MCL<sup>2</sup> or TT<sup>3</sup>(mg/L)<sup>4</sup></b>	<b>Potential Health Effects from Ingestion of Water</b>	<b>Sources of Contaminant in Drinking Water</b>
Inorganic mercury	0.002	0.002	Kidney damage	Erosion of natural deposits; discharge from refineries and factories; runoff from landfills and croplands
Nitrate (measured as nitrogen)	10	10	“Blue baby syndrome” in infants under six months - life threatening without immediate medical attention. Symptoms: Infant looks blue and has shortness of breath	Runoff from fertilizer use; leaching from septic tanks, sewage; erosion of natural deposits
Nitrite (measured as nitrogen)	1	1	“Blue baby syndrome” in infants under six months - life threatening without immediate medical attention. Symptoms: Infant looks blue and has shortness of breath	Runoff from fertilizer use; leaching from septic tanks, sewage; erosion of natural deposits
Selenium	0.05	0.05	Hair or fingernail loss; numbness in fingers or toes; circulatory problems	Discharge from petroleum refineries; erosion of natural deposits; discharge from mines
Thallium	0.0005	0.002	Hair loss; changes in blood; kidney, intestine, or liver problems	Leaching from ore-processing sites; discharge from electronics, glass, and pharmaceutical companies
<b>Organic Chemicals</b>				
Acrylamide	zero	TT <sup>7</sup>	Nervous system or blood problems; increased risk of cancer	Added to water during sewage/wastewater treatment
Alachlor	zero	0.002	Eye, liver, kidney or spleen problems; anemia; increased risk of cancer	Runoff from herbicide used on row crops
Atrazine	0.003	0.003	Cardiovascular system problems; reproductive difficulties	Runoff from herbicide used on row crops
Benzene	zero	0.005	Anemia; decrease in blood platelets; increased risk of cancer	Discharge from factories; leaching from gas storage tanks and landfills
Benzo(a)pyrene	zero	0.0002	Reproductive difficulties; increased risk of cancer	Leaching from linings of water storage tanks and distribution lines
Carbofuran	0.04	0.04	Problems with blood or nervous system; reproductive difficulties.	Leaching of soil fumigant used on rice and alfalfa
Carbon tetrachloride	zero	.005	Liver problems; increased risk of cancer	Discharge from chemical plants and other industrial activities
Chlordane	zero	0.002	Liver or nervous system problems; increased risk of cancer	Residue of banned termiticide
Chlorobenzene	0.1	0.1	Liver or kidney problems	Discharge from chemical and agricultural chemical factories

<b>Contaminants</b>	<b>MCLG<sup>1</sup> (mg/L)<sup>4</sup></b>	<b>MCL<sup>2</sup> or TT<sup>3</sup> (mg/L)<sup>4</sup></b>	<b>Potential Health Effects from Ingestion of Water</b>	<b>Sources of Contaminant in Drinking Water</b>
2,4-D	0.07	0.07	Kidney, liver, or adrenal gland problems	Runoff from herbicide used on row crops
Dalapon	0.2	0.2	Minor kidney changes	Runoff from herbicide used on rights of way
1,2-Dibromo-3-chloropropane (DBCP)	zero	0.0002	Reproductive difficulties; increased risk of cancer	Runoff/leaching from soil fumigant used on soybeans, cotton, pineapples, and orchards
o-Dichlorobenzene	0.6	0.6	Liver, kidney, or circulatory system problems	Discharge from industrial chemical factories
p-Dichlorobenzene	0.075	0.075	Anemia; liver, kidney or spleen damage; changes in blood	Discharge from industrial chemical factories
1,2-Dichloroethane	zero	0.005	Increased risk of cancer	Discharge from industrial chemical factories
1-1-Dichloroethylene	0.007	0.007	Liver problems	Discharge from industrial chemical factories
cis-1, 2-Dichloroethylene	0.07	0.07	Liver problems	Discharge from industrial chemical factories
trans-1,2-Dichloroethylene	0.1	0.1	Liver problems	Discharge from industrial chemical factories
Dichloromethane	zero	0.005	Liver problems; increased risk of cancer	Discharge from pharmaceutical and chemical factories
1-2-Dichloropropane	zero	0.005	Increased risk of cancer	Discharge from industrial chemical factories
Di(2-ethylhexyl) adipate	0.4	0.4	General toxic effects or reproductive difficulties	Leaching from PVC plumbing systems; discharge from chemical factories
Di(2-ethylhexyl) phthalate	zero	0.006	Reproductive difficulties; liver problems; increased risk of cancer	Discharge from rubber and chemical factories
Dinoseb	0.007	0.007	Reproductive difficulties	Runoff from herbicide used on soybeans and vegetables
Dioxin (2,3,7,8-TCDD)	zero	0.00000003	Reproductive difficulties; increased risk of cancer	Emissions from waste incineration and other combustion; discharge from chemical factories
Diquat	0.02	0.02	Cataracts	Runoff from herbicide use
Endothall	0.1	0.1	Stomach and intestinal problems	Runoff from herbicide use
Endrin	0.002	0.002	Nervous system effects	Residue of banned insecticide
Epichlorohydrin	zero	TT <sup>7</sup>	Stomach problems; reproductive difficulties; increased risk of cancer	Discharge from industrial chemical factories; added to water during treatment process
Ethylbenzene	0.7	0.7	Liver or kidney problems	Discharge from petroleum refineries
Ethylene dibromide	zero	0.00005	Stomach problems; reproductive difficulties; increased risk of cancer	Discharge from petroleum refineries

<b>Contaminants</b>	<b>MCLG<sup>1</sup> (mg/L)<sup>4</sup></b>	<b>MCL<sup>2</sup> or TT<sup>3</sup> (mg/L)<sup>4</sup></b>	<b>Potential Health Effects from Ingestion of Water</b>	<b>Sources of Contaminant in Drinking Water</b>
Glyphosate	0.7	0.7	Kidney problems; reproductive difficulties	Runoff from herbicide use
Heptachlor	zero	0.0004	Liver damage; increased risk of cancer	Residue of banned termiticide
Heptachlor epoxide	zero	0.0002	Liver damage; increased risk of cancer	Breakdown of heptachlor
Hexachlorobenzene	zero	0.001	Liver or kidney problems; reproductive difficulties; increased risk of cancer	Discharge from metal refineries and agricultural chemical factories
Hexachloro-cyclopentadiene	0.05	0.05	Kidney or stomach problems	Discharge from chemical factories
Lindane	0.0002	0.0002	Liver or kidney problems	Runoff/leaching from insecticide used on cattle, lumber, gardens
Methoxychlor	0.04	0.04	Reproductive difficulties	Runoff/leaching from insecticide used on fruits, vegetables, alfalfa, and livestock
Oxamyl (Vydate)	0.2	0.2	Slight nervous system effects	Runoff/leaching from insecticide used on apples, potatoes, and tomatoes
Polychlorinated biphenyls (PCBs)	zero	0.0005	Skin changes; thymus gland problems; immune deficiencies; reproductive or nervous system difficulties; increased risk of cancer	Runoff from landfills; discharge of waste chemicals
Pentachlorophenol	zero	0.001	Liver or kidney problems; increased risk of cancer	Discharge from wood preserving factories
Picloram	0.5	0.5	Liver problems	Herbicide runoff
Simazine	0.004	0.004	Problems with blood	Herbicide runoff
Styrene	0.1	0.1	Liver, kidney, and circulatory problems	Discharge from rubber and plastic factories; leaching from landfills
Tetrachloroethylene	zero	0.005	Liver problems; increased risk of cancer	Discharge from factories and dry cleaners
Toluene	1	1	Nervous system, kidney, or liver problems	Discharge from petroleum factories
Total trihalomethanes (TTHMs)	none <sup>5</sup>	0.10	Liver, kidney or central nervous system problems; increased risk of cancer	Byproduct of drinking water disinfection
Toxaphene	zero	0.003	Kidney, liver, or thyroid problems; increased risk of cancer	Runoff/leaching from insecticide used on cotton and cattle
2,4,5-TP (Silvex)	0.05	0.05	Liver problems	Residue of banned herbicide
1,2,4-Trichlorobenzene	0.07	0.07	Changes in adrenal glands	Discharge from textile finishing factories
1,1,1-Trichloroethane	0.20	0.2	Liver, nervous system, or circulatory problems	Discharge from metal degreasing sites and other factories
1,1,2-Trichloroethane	0.003	0.005	Liver, kidney, or immune system problems	Discharge from industrial chemical factories
Trichloroethylene	zero	0.005	Liver problems; increased risk of cancer	Discharge from petroleum refineries

<b>Contaminants</b>	<b>MCLG<sup>1</sup> (mg/L)<sup>4</sup></b>	<b>MCL<sup>2</sup> or TT<sup>3</sup> (mg/L)<sup>4</sup></b>	<b>Potential Health Effects from Ingestion of Water</b>	<b>Sources of Contaminant in Drinking Water</b>
Vinyl chloride	zero	0.002	Increased risk of cancer	Leaching from PVC pipes; discharge from plastic factories
Xylenes (total)	10	10	Nervous system damage	Discharge from petroleum factories; discharge from chemical factories
<b>Radionuclides</b>				
Beta particles and photon emitters	none <sup>5</sup>	4 millirems per year	Increased risk of cancer	Decay of natural and man-made deposits
Gross alpha particle activity	none <sup>5</sup>	15 picocuries per L (pCi/L)	Increased risk of cancer	Erosion of natural deposits
Radium 226 and radium 228 (combined)	zero	5 pCi/L	Increased risk of cancer	Erosion of natural deposits
Uranium	zero	30µg/L	Increased risk of cancer, kidney toxicity	Erosion of natural deposits
<b>Microorganisms</b>				
<i>Giardia lamblia</i>	zero	TT <sup>8</sup>	Giardiasis, a gastroenteric disease	Human and animal fecal waste
Heterotrophic plate count	N/A	TT <sup>8</sup>	HPC has no health effects, but can indicate how effective treatment is at controlling microorganisms.	HPC bacteria have no known associated health risks; HPC can be used to measure the treatment efficiency
<i>Legionella</i>	zero	TT <sup>8</sup>	Legionnaire's Disease, commonly known as pneumonia	Found naturally in water; multiplies in heating systems
Total coliforms (including fecal coliform and <i>E. coli</i> )	zero	5.0% <sup>9</sup>	Used as an indicator that other potentially harmful bacteria may be present <sup>10</sup>	Human and animal fecal waste used as an indicator for the presence of potentially hazardous microorganisms
Turbidity	N/A	TT <sup>8</sup>	Turbidity has no health effects but can interfere with disinfection and provide a medium for microbial growth. It may indicate the presence of microbes.	Soil runoff
Viruses (enteric)	zero	TT <sup>8</sup>	Gastroenteric disease	Human and animal fecal waste

\*source of table: <http://www.epa.gov/safewater/mcl.html>

<sup>1</sup> Maximum Contaminant Level Goal (MCLG) - The maximum level of a contaminant in drinking water at which no known or anticipated adverse effect on the health effect of persons would occur, and which allows for an adequate margin of safety. MCLGs are non-enforceable public health goals.

<sup>2</sup> Maximum Contaminant Level (MCL) - The maximum permissible level of a contaminant in water which is delivered to any user of a public water system. MCLs are enforceable standards. The margins of safety in MCLGs ensure that exceeding the MCL slightly does not pose significant risk to public health.

<sup>3</sup> Treatment Technique (TT) - An enforceable procedure or level of technical performance which public water systems must follow to ensure control of a contaminant.

<sup>4</sup> Units are in milligrams per Liter (mg/L) unless otherwise noted.

- <sup>5</sup> MCLGs were not established before the 1986 amendments to the SDWA. Therefore, there is no MCLG for this contaminant.
- <sup>6</sup> Lead and copper are regulated in a Treatment Technique which requires systems to take tap water samples at sites with lead pipes or copper pipes that have lead solder and/or are served by lead service lines. The action level, which triggers water systems into taking treatment steps if exceeded in more than 10% of tap water samples, for copper is 1.3 mg/L and for lead is 0.015mg/L.
- <sup>7</sup> Each water system must certify, in writing, to the state (using third-party or manufacturer's certification) that when acrylamide and epichlorohydrin are used in drinking water systems, the combination (or product) of dose and monomer level does not exceed the levels specified, as follows:  
Acrylamide = 0.05% dosed at 1 mg/L (or equivalent)  
Epichlorohydrin = 0.01% dosed at 20 mg/L (or equivalent)
- <sup>8</sup> The Surface Water Treatment Rule requires systems using surface water or ground water under the direct influence of surface water to (1) disinfect their water, and (2) filter their water or meet criteria for avoiding filtration so that the following contaminants are controlled at the following levels:  
*Giardia lamblia*: 99.9% killed/inactivated  
Viruses: 99.99% killed/inactivated  
*Legionella*: No limit, but EPA believes that if *Giardia* and viruses are inactivated, *Legionella* will also be controlled.  
Turbidity: At no time can turbidity (cloudiness of water) go above 5 NTU; systems that filter must ensure that the turbidity go no higher than 1 nephelometric turbidity unit (NTU) (0.5 NTU for conventional or direct filtration) in at least 95% of the daily samples in any month. HPC: No more than 500 bacterial colonies per milliliter.
- <sup>9</sup> No more than 5.0% samples total coliform-positive in a month (for water systems that collect fewer than 40 routine samples per month, no more than one sample can be total coliform-positive). Every sample that has total coliforms must be analyzed for fecal coliforms. There cannot be any fecal coliforms.
- <sup>10</sup> Fecal coliform and *E. coli* are bacteria whose presence indicates that the water may be contaminated with human animal wastes. Microbes in these wastes can cause diarrhea, cramps, nausea, headaches, or other symptoms.

states review sample-siting plans; and (4) require fecal coliform or *E. coli* testing (USEPA 1989a). The SWTR established (1) MCLGs for *Giardia lamblia*, *Legionella* bacteria, and viruses; (2) disinfection requirements; and (3) criteria under which filtration would be required, including limits on turbidity, and procedures by which states are to determine which PWSs must filter source water (USEPA 1989b).

The 1986 amendments also set forth an aggressive plan to eliminate lead from PWSs by prohibiting its use in the installation or repair of PWSs and plumbing that provides water for human consumption. Furthermore, the amendments banned the sale of any drinking water cooler containing lead in interstate commerce and declared drinking water coolers with lead-lined tanks imminently hazardous consumer products that were to be repaired, replaced, or recalled. Ultimately, the 1986 amendments led to the promulgation of the Lead and Copper Rule (LCR) in June of 1991. This rule established corrosion control measures and source water treatment techniques for PWSs, and required PWSs to replace water service lines containing lead with lead-free materials and inform consumers when lead concentrations exceed action levels of 0.015 mg/L for lead and 1.3 mg/L for copper (USEPA 1991). EPA recently made several minor revisions to the LCR to eliminate unnecessary requirements, streamline and reduce the reporting burden, and promote consistent national implementation; this did not affect the lead or copper MCLGs, the action levels, or the basic regulatory requirements of the rule (USEPA 2000).

The 1986 SDWA amendments also listed disinfectants and disinfection by-products (D/DBPs) among the contaminants that EPA must regulate. Considering the difficult issues associated with this requirement, particularly the risk-risk paradox involving pathogenic microorganisms and the possible toxicological impact of D/DBPs, EPA implemented the Negotiated Rulemaking Act of 1990 to provide stakeholders in the drinking water industry with an opportunity to participate in the development of a rule(s) that would balance health risks associated with waterborne pathogens and those associated with D/DBPs. Thus, EPA initiated negotiated rulemaking among representatives from state and local agencies, PWSs, elected officials, consumer groups, and environmental organizations to address this public health issue. The Regulatory-Negotiation (Reg-Neg) Committee met from November 1992 through June 1993 (Cox 1997).

Early in the process, negotiators agreed that a great deal of data would have to be collected before the most effective plan for concurrently minimizing microbial and DBP risks could be developed. The Reg-Neg Committee concluded that, during the data collection period, EPA should issue a Stage I Disinfection By-Product Rule (DBPR) in order to (1) reduce the current MCL for total trihalomethanes (TTHMs); (2) regulate additional DBPs; (3) set limits for the use of disinfectants; and (4) reduce the level of organic precursor compounds in the source water that may react with disinfectants to form DBPs (USEPA 1998a). Among EPA's most significant concerns in developing regulations for D/DBPs was the need to ensure that drinking water would be microbiologically safe at the limits set for D/DBPs. Therefore, the Reg-Neg Committee considered a range of microbial issues and ultimately agreed that EPA should also propose a companion microbial rule (USEPA 1998a).

Pursuant to the recommendations of the Reg-Neg Committee, in addition to a wide range of technical comments from stakeholders and members of the public, EPA developed three sets of rules to control microbial pathogens and D/DBPs: (1) the Information Collection Rule (ICR) to generate data required to effectively regulate pathogens and DBPs; (2) a two-stage DBPR to minimize health risks attributed to D/DBPs; (3) and a similarly staged Enhanced Surface Water Treatment Rule (ESWTR) to maintain or improve microbiological standards for drinking water as greater restrictions are placed on D/DBPs (USEPA 1998b).

The ICR imposed extensive monitoring requirements on certain categories of PWSs. The primary burden for monitoring and testing under the ICR falls on large water systems—those serving at least 100,000 people from surface water sources and those serving at least 50,000 people from ground water



sources. The ICR focuses primarily on microbial contaminants and DBPs; however, some water systems have also been required to generate data on alternative controls for DBPs and their precursors (Cox 1997). The Stage I DBPR set maximum residual disinfectant level goals (MRDLGs) and maximum residual disinfectant levels (MRDLs) for chlorine, chloramines, and chlorine dioxide, in addition to MCLGs and MCLs for four THMs (chloroform, bromodichloromethane, dibromochloromethane, and bromoform), two haloacetic acids (HAAs) (dichloroacetic acid and trichloroacetic acid), bromate, and chlorite (USEPA 1998a). Stage I DBPR also established monitoring, reporting, and public notification requirements for these D/DBPs (USEPA 1998a).

A controversial issue concerning how chloroform is regulated under the Stage I DBPR has been subject to judicial review. The Chlorine Chemistry Council criticized EPA for maintaining an MCLG of zero for chloroform in the Stage I DBPR, despite the Agency's "repeated and unequivocal" affirmations that the best available science supported a non-zero standard (Pontius 2000). In light of those findings, EPA concluded that it could no longer defend its original decision to retain an MCLG of zero after the issue was brought before the District of Columbia's U.S. Court of Appeals during the development of the Stage II DBPR. Applying what was considered a more appropriate, non-linear method for assessing chloroform health risks, EPA agreed to promulgate a non-zero MCLG using the best available peer-reviewed science (Pontius 2000). EPA has scheduled promulgation of the Stage II DBPR for May of 2002 (USEPA 1999).

An Interim Enhanced Surface Water Treatment Rule (IESWTR) required filtered systems to ensure that when filtration plants were deemed necessary to protect public health, as specified in the SWTR, those plants would afford sufficient protection against *Cryptosporidium* and other pathogenic microorganisms (USEPA 1998b). It is important to note that development of the IESWTR was based on the assumption that all systems would fully comply with all SWTR requirements and adhere to filtration avoidance criteria in the SWTR. Thus, compliance with new provisions in the IESWTR in no way relieves a PWS of its obligation to comply fully with preexisting SWTR requirements (USEPA 1998b).

Key provisions of the IESWTR include an MCLG of zero for the protozoan genus *Cryptosporidium*;<sup>4</sup> a requirement for PWSs that filter to achieve 2 log removal of *Cryptosporidium*;<sup>5</sup> more stringent performance standards and individual filter requirements pertaining to turbidity;<sup>6</sup> disinfection benchmarks to keep PWSs from compromising microbial protection when they make system modifications to comply with DBP standards;<sup>7</sup> the inclusion of *Cryptosporidium* in the definition of GWUDI and in the watershed control requirements for unfiltered public water systems; requirements for covers on new finished water reservoirs; and requirements for states to conduct sanitary surveys for all surface water and GWUDI systems, regardless of size (USEPA 1998b).<sup>8</sup>

EPA promulgated the first phase of the Long Term Enhanced Surface Water Treatment Rule (LTESWTR) in November of 2000 to improve control of microbial pathogens in drinking water, including *Cryptosporidium*, for PWSs serving fewer than 10,000 people; prevent increases in microbial risk

---

<sup>4</sup>Genus rather than species because investigators have not been able to determine whether or not other *Cryptosporidium* species are pathogenic in humans.

---

<sup>5</sup>Surface water systems serving 10,000 or more people, that are required to filter under the SWTR, must achieve at least 2 log removal of *Cryptosporidium*. Systems that use conventional or direct filtration meet this requirement if they comply with strengthened turbidity performance standards for combined filter effluent and meet design and operating conditions as specified by states.

while PWSs serving fewer than 10,000 people control D/DBPs; and require certain PWSs to institute changes to the return of recycle flows within the treatment process to help prevent recycle from compromising microbial controls (USEPA 1998b). Data from ICR and drinking water research will be used to develop the second phase of the LTESWTR, scheduled for promulgation along with the Stage II DBPR in May 2002 (USEPA 1999).

One of the major challenges in providing safe drinking water lies in adequately characterizing risks associated with microbial pathogens and harmful DBPs and then reaching an appropriate balance of those risks. The DBPR and the ESTWR have been crafted to achieve this goal. In accordance with their development, the EPA's Office of Research and Development (ORD) Drinking Water Research Program will provide a sound scientific basis for (1) the promulgation of the Stage II DBPR and the LTESWTR by fiscal year (FY) 2002; (2) any revisions to these rules by FY 2004; and (3) a determination as to whether or not to propose a Stage III DBPR by FY 2007. This will be accomplished by employing the "Risk Assessment/Risk Management Paradigm," whereby research is conducted to first better understand potential health risks of pathogens and DBPs and then evaluate how technologies may harmoniously mitigate those risks to provide safe, economical drinking water.

As EPA begins to use the Contaminant Candidate List (CCL) to protect public health against toxic or pathogenic agents that have recently emerged as potentially harmful drinking water contaminants, ORD's Drinking Water Research Program has made a concerted effort to provide a sound scientific basis for (1) EPA to determine whether or not it should regulate at least five of the contaminants on the first CCL (final list published March 2, 1998) by August 2001; (2) subsequent NPDWRs for any contaminants selected for regulation by FY 2005; and (3) determining whether or not at least five contaminants on the second CCL (required by 2003) should be regulated by FY 2006.

The CCL research process has been divided into two phases. During the first phase, an Implementation Team will evaluate available data to determine if a CCL contaminant poses a public health hazard and if the contaminant is treatable by current drinking water treatment practices. If the data set is inadequate for making such an assessment, the Team recommends that research be conducted to provide more

---

<sup>6</sup>For all surface water or GWUDI systems that use conventional treatment or direct filtration, serve 10,000 or more people, and are required to filter: (a) The turbidity level of a system's combined filtered water at each plant must be less than or equal 0.3 NTU in at least 95% of the measurements taken each month; and (b) the turbidity level of a system's combined filtered water at each plant must at no time exceed 1 nephelometric turbidity unit (NTU).

---

<sup>7</sup>The disinfection profiling requirement applies to surface water systems serving 10,000 or more people and which have (1) measured TTHM levels of at least 80% of the MCL (0.064 mg/L); or (2) measured HAA5 levels of at least 80% of the MCL (0.048 mg/L), based on a 1-year running annual average of representative samples taken in the distribution system. PWSs required to develop a disinfection profile that subsequently decide to make a significant change in disinfection practice must consult with the state prior to implementing such a change.

---

<sup>8</sup>Sanitary surveys are required no less frequently than every 3 years for community systems and no less frequently than every 5 years for non-community systems. For community systems determined by the state to have outstanding performance based on prior sanitary surveys, subsequent sanitary surveys may be conducted no less frequently than every 5 years.

data. In the second phase, research needs for each contaminant identified as a potential hazard that is difficult to treat will be prioritized based on the *potential* public health risk posed by the contaminant. Once those determinations are made, human health risks and the risk management options will be evaluated, in toto.

The CCL process will require several types of research. Methods for measuring or estimating the occurrence of CCL pathogens and chemicals in drinking water will be developed; their frequency of occurrence and the concentration in source and finished waters, as well as water in distribution systems, will need to be determined; and the extent to which human populations are exposed to CCL contaminants will also have to be evaluated. Additional studies must be conducted to evaluate how effective various treatment processes are in controlling or removing these contaminants from drinking water. Other research will have to focus on how the quality of water may be maintained or improved in distribution systems.

As research on specific contaminants is conducted, more comprehensive studies must be designed to: explore how the risks posed by pathogens in drinking water can be characterized; evaluate dose-response relationship models; determine the impact of waterborne pathogens on human subpopulations; and develop systems for characterizing the risks posed by exposure to specific and multiple or complex mixtures of CCL compounds in drinking water.

At the present time, “more than 90% of the [U.S.] population served by community water systems receive water from systems with no reported violations of health-based standards. In the past decade, the number of people served by public water systems meeting Federal health standards has increased by more than 23 million. Although compliance with drinking water contaminant standards is good, public health risks from drinking water can be further reduced” (Whitman 2001). EPA’s Drinking Water Research Program is committed to making this possible—helping to achieve the goal of providing all Americans with easy and affordable access to the safest drinking water possible.

## References

- Cox, W. E. (1997). “Evolution of the Safe Drinking Water Act: A search for effective quality assurance strategies and workable concepts of Federalism.” *William and Mary Environmental Law and Policy Review*, 21, 69–164.
- Feiner, W. P. (1997). “Just when you thought it was safe to go back in the water: A guide to complying with the 1996 amendments to the Safe Drinking Water Act.” *Environmental Law*, 4, 193–223.
- H.R. Rep. (1974). *No. 93-1185*.
- Larson, C. D. (1989). “Historical development of the national primary drinking water regulations.” *Safe Drinking Water Act: Amendments, regulations and standards*. E. J. Calabrese, C. E. Gilbert, and H. Pastides, eds., Lewis Publishers, Chelsea, MI, 3, 10.
- Pontius, F. W. (1999). *History of the Safe Drinking Water Act*. American Water Works Association, Denver, CO.
- Pontius, F. W. (2000). “Chloroform: Science, policy, and politics.” *Journal of the American Water Works Association*, 92(5), 12.
- Safe Drinking Water Act (SDWA). (1974a). *Pub. L. No. 93-523, 88 Stat. 1660* (1974) §300g-1(e).
- SDWA. (1974b). *Pub. L. No. 93-523, 88 Stat. 1660* (1974) §300f(2).

- SDWA. (1974c). *Pub. L. No. 93-523, 88 Stat. 1660* (1974) §300h-3(e).
- SDWA. (1974d). *Pub. L. No. 93-523, 88 Stat. 1660* (1974) § 300g-1(b)(8).
- SDWA. (1986). *Pub. L. No. 93-523, 88 Stat. 1660* (1986).
- Taras, M. J. (1981). *The quest for pure water*, 2nd Ed., Vol. 2, American Water Works Association, Denver, CO.
- U.S. Department of Health, Education, and Welfare (USDHEW). (1969). “Public Health Service drinking water standards–1962.” *Public Health Service Publication No. 956*, Reprinted September 1969.
- USDHEW. (1970). “Community water supply study: Analysis of national survey findings.”
- U.S. Environmental Protection Agency (USEPA). (1979). “National interim primary drinking water regulations; Final rule.” *Federal Register*, 44, 68624.
- USEPA. (1989a). “National primary drinking water regulations: Total coliforms (including fecal coliforms and *E. coli*); Final rule.” *Federal Register*, 54, 27544.
- USEPA. (1989b). “National primary drinking water regulations: Filtration, disinfection; turbidity, *Giardia lamblia*, viruses, *Legionella*, and heterotrophic bacteria; Final rule.” *Federal Register*, 54(No. 124), 27486.
- USEPA. (1991). “Maximum contaminant level goals and national primary drinking water regulations for lead and copper; Final rule.” *Federal Register*, 56, 26460.
- USEPA. (1998a). “National primary drinking water regulations: Disinfectants and disinfection byproducts; Final rule.” *Federal Register*, 63, 69390.
- USEPA. (1998b). “National primary drinking water regulations: Interim enhanced surface water treatment; Final rule.” *Federal Register*, 63, 69478.
- USEPA. (1999). “Microbial and disinfection byproduct rules simultaneous compliance guidance manual.” *EPA 815-R-99-015*.
- USEPA. (2000). “National primary drinking water regulations for lead and copper; Final rule.” *Federal Register*, 65, 1950.
- Whitman, C. T. (2001). *Drinking Water Needs and Infrastructure*. Prepared witness testimony delivered to the Subcommittee on Environment and Hazardous Materials, Committee on Energy and Commerce, March 28.

## CHAPTER 3

### Disinfection By-Product (DBP) Chemistry: Formation and Determination<sup>1</sup>

#### Introduction

##### *The Need for Disinfection*

In the mid 19th century, Chinese workers on the North American transcontinental railroad suffered less illness than other groups. While generally mysterious at the time, today the reason is obvious. The Chinese preference for tea required heating the water, thus killing many of the pathogenic microorganisms. Today, the need to kill microorganisms in water is largely met through the addition of oxidizing chemicals to the source water. The incidence of waterborne illness has decreased dramatically during the 20th century, increasing human productivity and longevity. In addition to affecting the microorganisms, however, the chemicals added to disinfect the water react with nonliving substances that occur naturally in drinking water sources. These disinfection by-products (DBPs), some of which are carcinogenic, are the subject of human health concerns.

While the basic chemistry of disinfectants outlined in this chapter has been fairly well understood for some time, the past 20 years have seen an incredible volume of scientific investigation into DBPs resulting from the use of these substances. At the beginning of the 1980s, a great majority of the work on DBPs was focused on the trihalomethanes (THMs), and much of it was performed by U.S. Environmental Protection Agency (EPA) Drinking Water Research facilities in support of the development of regulation. As interest in the potential health effects of disinfection has dramatically increased, EPA's direct contribution has become a smaller and smaller fraction of the work with each passing year. This reflects not a lack of interest or effort on the part of EPA, but the growth in interest outside the Agency. A perusal of university graduate schools shows the creation of environmental engineering departments as well as divisions of environmental chemistry through this time period. EPA Offices solicit and fund much research using contracts, cooperative agreements, and other vehicles. Most of the funding of unsolicited research proposals is performed by the EPA Office of Research and Development's (ORD) National Center for Environmental Research (NCER). The American Water Works Association Research Foundation (AWWARF) is a research organization dedicated to the needs of water utilities and, thanks to funding from EPA and AWWA members, has produced many results related to water utility operation and disinfection practice.

This chapter addresses some of the major issues in DBP formation chemistry, but focuses mostly on EPA-sponsored or in-house research. In addition to studies that attempt to qualitatively identify by-products, drinking water professionals have tried to understand the conditions that lead to the formation of DBPs and how these compounds are formed. In terms of monitoring and studying DBPs, it is clear that monitoring DBP formation requires appropriate analytical tools. To meet this need, an entire field of analytical chemistry has sprung up to support the study of DBP formation and regulation in potable water.

---

<sup>1</sup>Matthew L. Magnuson, Edward T. Urbansky, Kathleen M. Schenck, and Michael S. Elovitz: ORD/NRMRL/WSWRD, AWBERC Mailstop 681, 26 West Martin Luther King Drive, Cincinnati, OH 45268. Corresponding authors: Matthew L. Magnuson, 513-569-7321, magnuson.matthew@epa.gov and Edward T. Urbansky, 513-569-7655, urbansky.edward@epa.gov.

## Overview of Disinfection Issues

In the U.S., disinfection of drinking water is a common practice, although the choice of disinfectant varies. These disinfectants have in common an ability to inactivate microorganisms. The disinfectants destroy certain microscopic biochemical features of microorganisms, rendering them harmless to human health. Research into chemical treatment technologies has focused on individual disinfectants, although combinations of these disinfectants are often used. Table 3-1 lists the number of water supplies in the U.S. by the type of disinfectants used. Attributes of these disinfectants will be discussed in more detail in following sections of this chapter.

**Table 3-1. Survey of Disinfectant Use (1997)**

Type of Disinfectant	Number of Systems
Chlorine	22,307
Chlorine dioxide	313
Chloramines	135
Ozone	30
Potassium permanganate	1,122

The data in Table 3-1 are taken from a survey of disinfection practices published in 1997 (USEPA 1997). Of the disinfectants in Table 3-1, the use of ozone is increasing quickly, with 264 plants using ozone as of May 1998 (Rice et al. 1998), primarily as a response to the regulatory requirements discussed in more detail in Chapter 2.

Table 3-2 lists some of the microorganisms targeted by disinfection practice and some of the more appropriate disinfectants for each microorganism.

**Table 3-2. Microorganisms and Disinfectants That Inactivate Them**

Organism	Chemical Disinfectant	Health Effects
Bacteria such as <i>Legionella</i> and coliform ( <i>Escherichia coli</i> )	Chlorine Chloramine Chlorine dioxide Ozone	Gastroenteric disease, Legionnaire's disease, death
<i>Giardia lamblia</i> cysts	Chlorine Chlorine dioxide Ozone	Gastroenteric disease, death
<i>Cryptosporidium parvum</i> oocysts	Chlorine dioxide Ozone	Gastroenteric disease, death
Viruses	Chlorine Chlorine dioxide Ozone	Gastroenteric disease, death

Like many technological improvements, disinfection has a downside. Namely, the disinfectants are often so powerful that they nonselectively react with other substances in the water to form what are known as DBPs. There are three classes of DBPs listed in Table 3-3, which also lists the residual disinfectants, i.e., the forms of the disinfectant left in the water. There are actually thousands of DBPs, and Table 3-3 lists some of the more common, more studied, and representative types. Some of the detailed studies are discussed in following sections. The health effects of some of the compounds listed in Table 3-3 (USEPA 1999a) have been investigated. Table 3-4 summarizes these health effects in accordance with the classification scheme described by Table 3-5. Note that EPA is in the process of revising the Cancer Guidelines (USEPA 1996) .

**Table 3-3. List of DBPs and Disinfection Residuals**

<b>Disinfectant Residuals</b>	<b>Halogenated Organic By-Products</b>
Free chlorine	Trihalomethanes
Hypochlorous acid	Chloroform
Hypochlorite ion	Bromodichloromethane
Chloramines	Dibromochloromethane
Monochloramine	Bromoform
Chlorine dioxide	Haloacetic acids <sup>b</sup>
<b>Inorganic By-Products</b>	Monochloroacetic acid
Chlorate ion	Dichloroacetic acid
Chlorite ion	Trichloroacetic acid
Bromate ion	Monobromoacetic acid
<b>Organic Oxygenated By-Products</b>	Dibromoacetic acid
Aldehydes <sup>a</sup>	Haloacetonitriles
Formaldehyde (methanal)	Dichloroacetonitrile
Acetaldehyde (ethanal)	Bromochloroacetonitrile
Glyoxal (ethanedial)	Dibromoacetonitrile
Pyruvaldehyde (oxopropanal)	Trichloroacetonitrile
Other aliphatic aldehydes	Haloketones
Carboxylic acids	1,1-Dichloropropanone
Acetic acid	1,1,1-Trichloropropanone
Other aliphatic monocarboxylic acids	Chlorophenols
Oxalic (ethanedioic) acid	2-Chlorophenol
Ketoacids <sup>a, b</sup>	2,4-Dichlorophenol
Glyoxylic (oxoethanoic) acid	2,4,6-Trichlorophenol
Pyruvic (oxopropanoic) acid	Chloropicrin
Ketomalonic (oxopropanedioic) acid	Chloral hydrate
Assimilable organic carbon	Cyanogen chloride
	Organic chloramines
	MX (3-Chloro-4-(dichloromethyl)-
	5-hydroxy-2(5H)-furanone)

<sup>a</sup> These carbonyl compounds are actually present as geminal diols even though their concentrations are reported in terms of the parent carbonyl compounds. See Urbansky 2000h for further explanation.

<sup>b</sup> Although reported as acids, these species are actually present in water as the deprotonated anions.

**Table 3-4. Status of Health Information for Disinfectants and DBPs**

<b>Contaminant</b>	<b>Cancer Classification</b>
Chloroform	B2
Bromodichloromethane	B2
Dibromochloromethane	C
Bromoform	B2
Monochloroacetic acid	–
Dichloroacetic acid	B2
Trichloroacetic acid	C
Dichloroacetonitrile	C
Bromochloroacetonitrile	–
Dibromoacetonitrile	C
Trichloroacetonitrile	–
1,1-Dichloropropanone	–
1,1,1-Trichloropropanone	–
2-Chlorophenol	D
2,4-Dichlorophenol	D
2,4,6-Trichlorophenol	B2
Chloropicrin	–
Chloral hydrate	C
Cyanogen chloride	–
Formaldehyde	B1 <sup>a</sup>
Chlorate	–
Chlorite	D
Bromate	B2
Hypochlorous acid	–
Hypochlorite	–
Monochloramine	–
Chlorine dioxide	D

<sup>a</sup> Based on inhalation exposure.

**Table 3-5. Scheme for Categorizing Chemicals According to Carcinogenic Potential**

<b>Group</b>	<b>Classification</b>	<b>Definition</b>
A	Human carcinogen	Sufficient evidence in epidemiologic studies to support causal association between exposure and cancer.
B	Probable human carcinogen	Limited evidence in epidemiologic studies (Group B1) and/or sufficient evidence from animal studies (Group B2)
C	Possible human carcinogen	Limited evidence from animal studies and inadequate or no data in humans
D	Not classifiable	Inadequate or no human animal evidence of carcinogenicity
E	No evidence of human carcinogenicity	No evidence of carcinogenicity in at least two adequate animal tests in different species or in adequate epidemiologic and animal studies



Because of concern over these DBPs over the past 25 years, some DBPs have been regulated and/or subject to monitoring rules aimed at meeting the simultaneous goal of disinfecting water and controlling DBPs (USEPA 1999b). Table 3-6 lists these compounds along with important information about them. It is important to remember that Table 3-6 is a small subset of Table 3-3, which itself is a subset of the much larger list of substances sometimes identified as DBPs.

Regulatory issues were covered in more detail in Chapter 2, and a discussion of the Stage 1 DBP Rule explains how the costs and benefits were utilized to determine appropriate risk/exposure reduction (Roberson et al. 1995). From a scientific standpoint, in chlorinated potable water supplies, two classes of DBPs dominate the identifiable organic matter, the THMs and the haloacetates (haloacetic acids or

**Table 3-6. National Primary Drinking Water Regulations Establishing Maximum Contaminant Levels (MCLs) and Maximum Contaminant Level Goals (MCLGs) Related to DBPs**

<b>Compound</b>	<b>MCLG (mg/L)</b>	<b>MCL (mg/L)</b>	<b>Potential Health Effects</b>	<b>Sources of Drinking Water Contamination</b>
Bromate	Zero <sup>a</sup>	0.010 <sup>b</sup>	Cancer	Ozonation by-product
Bromodichloromethane	Zero <sup>b</sup>	see TTHMs	Cancer, liver, kidney, reproductive effects	Drinking water chlorination and chloramination by-product
Bromoform	Zero <sup>a</sup>	see TTHMs	Cancer, nervous system, liver, kidney effects	Drinking water ozonation, chloramination, and chlorination by-product
Chlorite	0.8 <sup>a</sup>	1.0 <sup>b</sup>	Hemolytic anemia	Chlorine dioxide disinfection by-product
Chloroform	Zero <sup>a</sup>	see TTHMs	Cancer, liver, kidney, reproductive effects	Drinking water chlorination and chloramination by-product
Dibromochloromethane	0.06 <sup>a</sup>	see TTHMs	Nervous system, liver, kidney, reproductive effects	Drinking water chlorination and chloramination by-product
Dichloroacetic acid	Zero <sup>a</sup>	see HAA5	Cancer and other effects	Drinking water chlorination and chloramination by-product
Haloacetic acids <sup>c</sup> (HAA5)	N/A	0.060 <sup>b</sup>	Cancer and other effects	Drinking water chlorination and chloramination by-product
Trichloroacetic acid	0.3 <sup>a</sup>	see HAA5	Possibly cancer and reproductive effects	Drinking water chlorination and chloramination by-product
Total trihalomethanes <sup>d</sup> (TTHMs)	N/A	0.08 <sup>b</sup>	Cancer and other effects	Drinking water chlorination and chloramination by-product

Source: 63 *Federal Register* 69390

<sup>a</sup> Finalized on December 16, 1998 (63 *Federal Register* 69390) as established in 40 CFR 141.53.

<sup>b</sup> Finalized on December 16, 1998 (63 *Federal Register* 69390) as established in 40 CFR 141.64.

<sup>c</sup> HAA5 is the sum of the concentrations of mono-, di-, and trichloroacetic acids and mono- and dibromoacetic acids expressed in mg/L.

<sup>d</sup> Total Trihalomethanes are the sum of the concentrations of bromodichloromethane, dibromochloromethane, bromoform, and chloroform expressed in mg/L.

HAA5) and hence are of regulatory interest. In Table 3-7, the THMs are a group of compounds with three halogen atoms. Only the brominated and chlorinated ones are routinely found in potable water. Occasionally, iodinated products are found, and fluorinated ones do not occur naturally and are not formed during disinfection. The THMs are formed when individual carbon atoms are attacked by halogen disinfectants. Small hydrocarbon chains are cleaved from natural organic matter (NOM) mol-

ecules, and the reaction of the halogen species continues until THMs are formed. Small amounts of tetrahalomethanes (carbon tetrahalides) are also formed in this fashion; however, THMs account for some 20% of the halogenated organic carbon found after disinfection (Weinberg 1999).

**Table 3-7. Trihalomethanes (THMs) Found in Potable Water**

Name	Formula
Trichloromethane (chloroform)	CHCl <sub>3</sub>
Bromodichloromethane	CHBrCl <sub>2</sub>
Dibromochloromethane	CHBr <sub>2</sub> Cl
Tribromomethane (bromoform)	CHBr <sub>3</sub>

HAAAs are also formed during chlorination. These DBPs are listed in Table 3-8. Like the THMs, the HAAAs are also linked with increased incidence of cancer in laboratory animals (Xu et al. 1995; Herren-Freund et al. 1987). Unlike the THMs, the HAAAs are capable of dissociating in water. HAAAs are >99% ionized (deprotonated) to the haloacetate anions under drinking water conditions. However, they are regulated and usually reported in terms of the parent acids rather than the carboxylate anions. HAAAs account for about 13% of the halogenated organic matter after disinfection (Weinberg 1999).

**Table 3-8. Haloacetic acids (HAAs) Found in Potable Water**

HAA	Formula	Grouping <sup>a</sup>
Chloroacetic	ClCH <sub>2</sub> CO <sub>2</sub> H	HAA5,6,9
Dichloroacetic	Cl <sub>2</sub> CHCO <sub>2</sub> H	HAA5,6,9
Trichloroacetic	Cl <sub>3</sub> CCO <sub>2</sub> H	HAA5,6,9
Bromoacetic	BrCH <sub>2</sub> CO <sub>2</sub> H	HAA5,6,9
Dibromoacetic	Br <sub>2</sub> CHCO <sub>2</sub> H	HAA5,6,9
Tribromoacetic	Br <sub>3</sub> CCO <sub>2</sub> H	HAA9
Bromochloroacetic	BrClCHCO <sub>2</sub> H	HAA6,9
Bromodichloroacetic	BrCl <sub>2</sub> CCO <sub>2</sub> H	HAA9
Dibromochloroacetic	Br <sub>2</sub> ClCCO <sub>2</sub> H	HAA9

<sup>a</sup> HAA5 concentrations (as the sum) are regulated under the Stage 1 DBP Rule. HAA6 data must be obtained and reported under the Information Collection Rule (ICR). HAA9 data are encouraged to be obtained and reported under the ICR, but not required.

Of the DBPs listed in Table 3-3, bromate is formed from the ozonation of source waters which contain bromide. In ozonated water supplies, a variety of aldehydes and ketones abound as well as some carboxylic acids. In addition to these organic products, inorganic species are also found. These include oxyanions of halogens, such as chlorite, chlorate, and bromate, which can be formed by a variety of oxidizing disinfectants. Bromate is of particular interest since it is suspected of posing one of the highest cancer risks of any DBP.

### General Issues in Disinfection: Disinfectants and Source Material for DBPs

Many excellent reviews have been written (White 1999; USEPA 1999a) about the general chemistry of the disinfectants in Table 3-1. The following sections discuss just a few of the relevant points of each. The source material, with which the disinfectant may react to form DBPs, is also briefly discussed.

## ***Disinfectants that Contain Chlorine: General Chemistry***

### **Chlorine: Chlorine(I) and Chlorine(0) Compounds**

Chlorine is the most widely used disinfectant in the U.S. It is U.S. practice that finished drinking water leaves the treatment plant with a residual disinfectant. When surface water is used as the source for drinking water, residual disinfectant is required by regulation. Therefore, chlorine is often added to finished water, even if a different oxidant is used for primary disinfection. Chlorine is added to water in a variety of forms, usually as a gas or in the solid hypochlorite form.

#### ***Chlorine Gas***

Chlorine gas, properly referred to as dichlorine ( $\text{Cl}_2$ ), is a greenish yellow gas that has a familiar and pungent smell. Chlorine (oxidation state: 0) is modestly soluble in water. When added to water, chlorine hydrolyzes, producing hypochlorous and hydrochloric acids:



Hydrochloric acid is a strong acid and is completely dissociated into hydrogen and chloride ions. Hypochlorous acid (HOCl, chlorine oxidation state: +I) is a weak acid with a  $\text{p}K_a$  of about 7.5, and it dissociates into hydrogen and hypochlorite ( $\text{OCl}^-$ ) ions:



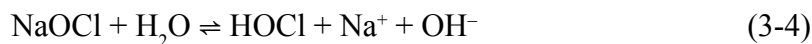
It is believed that chlorine(0) and chlorine(I) compounds work primarily by denaturing enzymes or proteins, thereby inactivating microorganisms. In some cases, physical disruption of cell membranes may also contribute. HOCl is thought to be the more active species.

#### ***Hypochlorite***

The equilibrium in Equation 3-1 can be driven forwards using strong base to deprotonate the hypochlorous acid and to neutralize the hydrogen ion:

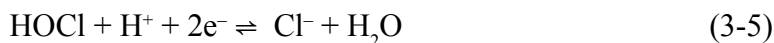


When sodium hydroxide is used as the base, the familiar sodium hypochlorite, found in household bleach, is formed, which in turn undergoes the following reaction:



Thus, the same active species, HOCl, is produced from both the reaction of chlorine gas and solid hypochlorite.

Hypochlorous acid may also be produced by addition of solid calcium hypochlorite salt to water. The choice of using chlorine gas or hypochlorite salts is a matter of preference by water utilities and is often dictated by cost, safety concerns, and the availability of raw materials. The chemistry of chlorine has practical considerations in this regard: The chlorine(I)-cation transfer step means that chlorine and hypochlorous acid both undergo 2-electron reductions. If a reducing agent cannot offer 2 electrons, reactions are generally slow or difficult. The 2-electron reduction can be expressed as follows:



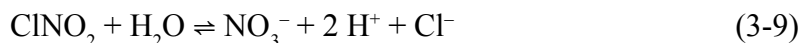
Chlorine(I) is unstable and disproportionates; thus, hypochlorite solutions are slowly converted to chlorate and chloride, which are not disinfection by-products in the sense that no other reactant is required:



Given enough time, solutions of sodium hypochlorite (e.g., chlorine laundry bleach) will be more than 99% converted to chlorate and chloride. Equilibrium is achieved faster at higher temperatures. Chlorate is not a good disinfectant. Although the central chlorine atom has a high oxidation state (+V), chlorate reacts much more slowly than hypochlorite and only in acidic conditions, which, in turn, reacts more slowly than hypochlorous acid. This kinetic barrier precludes its use as an oxidizing disinfectant. Unlike hypochlorous acid, which reacts primarily by chlorine(I) cation transfers, chlorate must react either by a reductant attacking the central chlorine atom or an oxygen atom transfer. Hypochlorite loss via Equation 3-7 requires that a fresh supply of sodium hypochlorite solutions be available. As a rule, most chlorination plants dissolve the chlorine in a small amount of water just before adding it to the main stream, or they add the chlorine gas directly to the stream. Nonetheless, chlorate has been found in these disinfection solutions (Bolyard et al. 1992; Bolyard et al. 1993). By contrast, Cl<sub>2</sub> gas is stable indefinitely if stored properly.

### ***Chlorine Reaction with Inorganic Material***

Chlorine and hypochlorous acid (or hypochlorite) react not only with organic matter, but with a number of inorganic anions as well. In this way, a number of inorganic by-products are also produced. Chlorine(0) and chlorine(I) oxidize primarily by chlorine(I)-cation transfer. Although a net oxygen atom transfer occurs, many reactions proceed through the chlorine(I) transfer, followed by hydrolysis. For example, nitrite is oxidized to nitrate as follows:

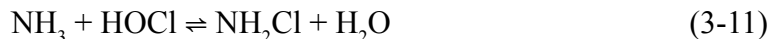


One beneficial reaction may occur when arsenic compounds, namely arsenite (As(III)), are present in the source water. Reaction with chlorine oxidizes arsenite to arsenate, As(V), which is easier to remove from the source water and is less toxic than arsenite:

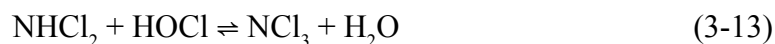


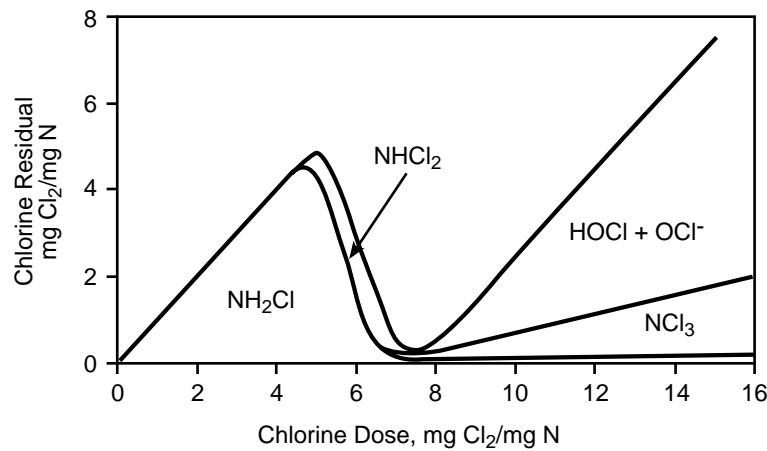
### **Chloramines**

Another chlorine-containing disinfectant is chloramine, which is formed from the reaction of ammonia with hypochlorous acid.



The addition of the ammonia (NH<sub>3</sub>) ties up the “free” chlorine, available as HOCl. It also slows down undesirable reactions of “free” chlorine which form DBPs. The chemistry of chloramines becomes more complicated as shown in the following equations, in which the chloramine reacts with more hypochlorous acid to tie up more chlorine.





**Figure 3-1. Speciation of free and combined chlorine species. When ammonia and chlorine are reacted at various ratios, different concentrations of mono-, di-, and trichloramine are formed. At  $\text{Cl}_2/\text{N}$  (w/w) ratio of about 7, breakthrough occurs, producing  $\text{NCl}_3$ , which is not useful as a disinfectant.**

Together, the chloramines are referred to as combined chlorine. The equilibrium for the three reactions, Equations 3-11 to 3-13, produces the distribution of species shown in Figure 3-1.

Figure 3-1 illustrates that, above a particular chlorine dose, the chlorine residual—and disinfection ability—goes down almost to zero. In other words, the chlorine dose must be carefully controlled to maintain a chlorine residual. If sufficient chlorine is added, another phenomenon known as breakpoint chlorination occurs. In breakpoint chlorination, the nitrogen(–III) in ammonaceous (organic) and ammoniacal (inorganic) species is oxidized to nitrogen(0). Superchlorination (shock treatment) of swimming pools takes advantage of this phenomenon after organic amines and ammonia build up over the winter. In addition, the equilibrium is quite sensitive to the pH. Coupled with the breakthrough phenomenon, the operation of chloramine plants can be complicated because the pH and chlorine dose must be carefully controlled. However, if used properly, chloramination is a tool for DBP control.

### Chlorine Dioxide: a Chlorine(IV) Compound

The various oxidation states of chlorine make it useful in other disinfectants, such as chlorine dioxide ( $\text{ClO}_2$ ), which is very much unlike chlorine and hypochlorous acid. This unusual oxide contains chlorine in the +IV oxidation state. It is a moderately stable radical,  $\text{ClO}_2\cdot$ , which does not undergo further reaction with water after it dissolves. The mechanism by which chlorine dioxide reacts with most other species is believed to be a mixture of oxygen atom-transfer and electron-transfer steps. This allows single-electron reductions along with multiple-electron pathway transfers:

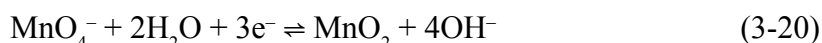
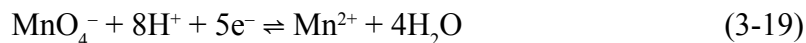
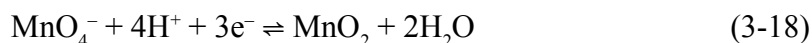


Equations 3-14 to 3-17 illustrate how both chlorite ( $\text{ClO}_2^-$ ) and chlorate ( $\text{ClO}_3^-$ ) can be produced as a result of the use of chlorine dioxide.

## Disinfectants Not Containing Chlorine: General Chemistry

### Potassium Permanganate

Nonchlorine-containing disinfectants require another species to act as oxidizing agent. In terms of disinfection, this usually requires oxygen-containing species that are powerful enough to disrupt the functioning of the microorganism. Potassium permanganate,  $\text{KMnO}_4$ , is a weaker oxidant. It is used mostly for iron and manganese removal, or taste and odor control, but can lower the level of DBP precursor material. The reduction of  $\text{Mn}^{\text{VII}}$  (oxidation state: +VII) to  $\text{Mn}^{\text{IV}}$  (oxidation state: +IV) provides the oxidation ability via the following half-reactions:



These reactions can oxidize some organic and inorganic DBP source material and inactivate some microorganisms, but are not powerful enough to inactivate many bacteria and protozoa. When used in conjunction with another oxidant, such as chlorine, potassium permanganate can be advantageous because it has already oxidized some DBP source material. Thus, DBPs are controlled. If used improperly, the residual permanganate anion renders the water pink. Potassium permanganate is a well-understood system and is not the subject of much research investigation, as the by-products are regarded as innocuous.

### Ozone

Like chlorine dioxide, ozone ( $\text{O}_3$ ) must be generated on site. However, this process is fairly straightforward and less susceptible to problems than chlorine dioxide. Ozone is generated by passing an electrical discharge through dioxygen ( $\text{O}_2$ ):

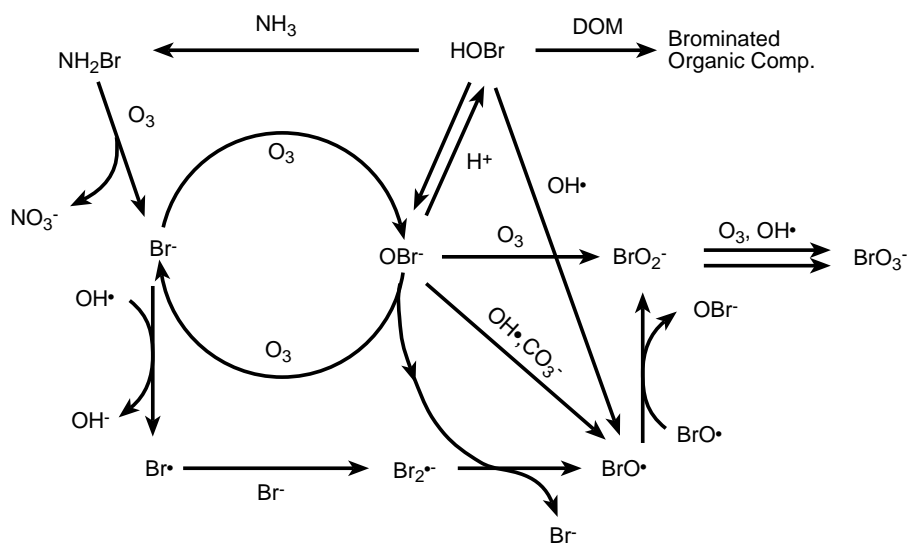


Figure 3-2. Scheme showing the production of bromate in ozonated systems.

Ozone is responsible for the familiar smell associated with lightning strikes. Ozone is a powerful oxidant which engages in oxygen atom transfers. In addition to the direct action of O<sub>3</sub> on living tissue, ozone can cleave water molecules, producing hydroxyl radical (OH•), which also can act as a disinfectant. The contribution of each of the dual pathways, direct ozone and indirect hydroxyl, is highly dependent on the source water quality because various chemicals, such as the ubiquitous carbonate, tend to deactivate the hydroxyl pathways. The reaction of ozone with the bromide ion is important in DBP formation, and its complexities are illustrated in Figure 3-2.

Ozone and hydroxyl radical attack a variety of sites in organic molecules. Of particular interest is the fact that ozone is far more effective than hypochlorite or chlorine for inactivating *Cryptosporidium* oocysts. At the concentrations normally used for disinfecting drinking water, chlorination does not affect cryptosporidians significantly, but ozone does. The reaction of ozone has a tendency to produce many oxygenated compounds, such as carboxylic acids, aldehydes, and ketones, which are nutritious compounds for microorganisms.

## **An Overview of Disinfection By-Product Formation Source Material**

The source material for DBPs is important in understanding the chemistry and mechanism of DBP formation, once the disinfectant reacts with the source material. Other chapters in this book deal with the removal of this material to prevent DBP formation, and other facets of DBP/microbial issues relate to the presence of source material.

### ***Inorganic Sources***

Source material for the formation of DBPs is inorganic and organic in nature. Inorganic components are traced to various minerals and other substances in the water derived from nonbiological sources. These substances occur naturally in the water or may be anthropogenic in nature. One such naturally occurring substance is the anion known as bromide, which is implicated in by-product formation, particularly when used with ozone. Bromide in the water can also contribute, through a series of reactions, to brominated products when chlorine is used. Bromide contamination in chlorine solutions is another route through which bromide enters drinking water.

### ***Natural Organic Matter (NOM)***

Natural waters used as sources for drinking water supplies contain a variety of types of organic matter. Some of this organic matter comes from natural sources. When organisms die, a mixture of biological and chemical processes take place. These processes produce a mixture of compounds that are collectively referred to as NOM. NOM can be highly variable, depending on its source and extent of degradation. Many factors besides native flora and fauna influence NOM composition. These include temperature, rainfall/humidity, light, microbial populations, and geography. There is a complex interplay among the native flora and fauna as well as the climate and season. There is much interest in understanding the makeup of this material. The International Humic Substances Society (<http://www.ihss.gatech.edu>), for instance, comprises scientists interested in NOM.

A variety of schemes have been used to classify NOM. These categories are not mutually exclusive. One of the oldest and most respected (albeit generalized) methods is based on the solubility under different pH conditions. Humic acid is the fraction of NOM in water not soluble at pH < 2, but soluble at higher pH. Fulvic acid is soluble at all pHs. Humin is not soluble at any pH. When describing the conjugate bases (e.g., the sodium salts), the terms humate and fulvate, respectively, are used.

## Characterization of NOM

Typical soluble NOM has a molecular mass range of about 300 to 30,000 unified atomic mass units (or daltons, Da). Common moieties include aromatic rings, alkyl chains, carboxylates, phenols, and other alcohols. Polynuclear (polycyclic) aromatic compounds are not generally thought of as making up a significant portion of NOM. A number of volumes have been dedicated to characterizing NOM (AWWA 1994; Barret and Krasner 2000; Minear and Amy 1996a; Owen et al. 1993; Croue et al. 1999).

Because NOM does not reflect a single compound or even a closely related group of compounds, it is very difficult to characterize. Therefore, NOM is sometimes fractionated based on its physical properties, such as polarity, namely its relative retention on functionalized poly(styrene-divinylbenzene) resins (e.g., Rohm & Haas XAD®). Other physical properties, such as ionizability, are also used. The U.S. Geological Survey has developed elaborate techniques to fractionate NOM and characterize the individual fractions. EPA currently is involved in multiple cooperative efforts to relate NOM characteristics to DBP formation.

Aside from fractionation, another avenue of NOM characterization is to study properties of the bulk solution rather than individual chemical components. As a bulk source of organic carbon, NOM is often measured in raw and finished water using total organic carbon (TOC) analyzers (Urbansky 2001). Modern TOC analyzers convert the carbon in organic carbon compounds to carbon dioxide, which is then measured with an infrared detector. In addition to TOC, which includes suspended particulate matter, dissolved organic carbon (DOC) can also be reported. In practice, DOC is most often used, and most TOC analyzers are more effective at determining DOC than TOC.

Techniques commonly used for characterization rely on identifying individual functional groups, such as amines, thiols, alcohols, carboxylates, and halides. In addition, NOM can be subjected to traditional elemental analysis by combustion. Infrared spectroscopy is one of the instrumental techniques that can assess some of the functional groups present since certain moieties are known to have distinct infrared absorption bands that correspond to O-H stretch, C=O stretch, or other types of independent vibrations. Nuclear magnetic resonance (NMR) spectroscopy is used to distinguish among aromatic, alkyl, and alkenyl compounds. Relative contributions of these different types of carbon-carbon bonds can be estimated from the NMR spectra. Pyrolysis-GC/MS can fingerprint NOM in terms of four biopolymer groupings, namely, polysaccharides, proteins, aminosugars, and polyhydroxyaromatic compounds. The complexity of the sample can produce difficulties in interpretation for whatever technique is used.

## Factors Affecting DBP Formation from the Source Material

A number of factors in addition to the NOM composition determine the composition of DBPs. The choice of oxidizing disinfectant is an obvious factor. The presence of other ions, such as bromide, can have a profound impact on the nature and distribution of the DBPs formed during water treatment. Temperature, pH, and oxidant dosing rates all can affect DBP formation. Hundreds or perhaps thousands of papers have been written on small variations in conditions that affect DBP formation. A whole series, *Water Chlorination Volumes 1–6*, edited by R.L. Jolley (Jolley 1976; Jolley et al. 1978, 1980, 1983, 1985, 1990) was dedicated to water chlorination chemistry. Several recent volumes have continued down this path (Symons 1997; Minear and Amy 1996b; Singer 1999).

More effort is focused on removing DBP precursors (i.e., NOM) (Shorney and Freeman 1999). Many of EPA's surface water treatment rules emphasize this approach. The Stage 1 DBP Rule considers this to be an important aspect because it is neither possible nor practical to identify or monitor the plethora of by-products that form during disinfection with oxidizing compounds. Certain classes of compounds are monitored, but, to account for the many that cannot be, minimizing the amount of precursor material is adjudged to be one of the best approaches.



## EPA Research into DBP Formation and Chemistry

### *Measures of the Proclivity of NOM To Form DBPs*

By definition, NOM is a reducing agent. When an oxidant, such as chlorine or hypochlorous acid, is exposed to NOM, a variety of oxidation-reduction reactions is possible. Every natural water has an oxidant demand. For example, when chlorine is used, the chlorine demand is a measure of the ability of dissolved organic matter to react with chlorine. Until the chlorine demand is satisfied, disinfection is a compromise between the oxidant reacting with the NOM and the microorganism, so disinfection efficiency decreases. Once the chlorine demand is satisfied (essentially everything that can react with chlorine has), additional chlorine goes to disinfection. As far as DBP formation is concerned, the chlorine demand in and of itself is not a measure of the tendency to form DBPs. Much of the chlorine added to meet demand is reduced entirely to chloride rather than being incorporated into a halogenated by-product.

To have some quantitative measure of the proclivity of NOM to form DBPs, a test for the THM formation potential or THMFP has been devised. The formation potential is determined by exposing a raw (untreated) water sample to an excess of oxidizing disinfectant for a period of time at a specific temperature. The change in THM concentration relative to time zero is the THMFP. The total concentration of THMs at any time is expressible as

$$[\text{CHX}_3]_{\text{T}} = [\text{CHCl}_3] + [\text{CHBrCl}_2] + [\text{CHBr}_2\text{Cl}] + [\text{CHBr}_3] \quad (3-22)$$

Thus, the THMFP( $a$ ) at time  $t = a$  is given by

$$\text{THMFP}(a) = [\text{CHX}_3]_{\text{T}}(t = a) - [\text{CHX}_3]_{\text{T}}(t = 0) \quad (3-23)$$

In practice, a quantity of oxidant is added to a fixed volume of water and an aliquot is drawn out at defined time intervals. This aliquot is then analyzed to determine the concentrations of THMs in solution. The THMFP, expressed in concentration units, is an estimate of the maximal concentration of DBPs that may be formed in the presence of a large excess of oxidant. One of the problems with the way the THMFP has been applied is that the measurement conditions were not the same in different investigations. This makes it difficult to compare or contrast the values obtained. In order to standardize the THMFP, a set of *uniform formation conditions* (UFC) has been developed (Summers et al. 1996) under EPA sponsorship. These can be summarized as follows: pH =  $8.0 \pm 0.2$  (borate buffer), temperature =  $20 \pm 1^\circ\text{C}$ , reaction time =  $24 \pm 1$  hr, and active chlorine residual =  $1.0 \pm 0.4$  mg L<sup>-1</sup> as Cl<sub>2</sub> (28 μM), which is representative of routine operating conditions. On the other hand, if a sample of finished water with a typical chlorine residual is monitored for THM concentration as a function of time, this simulates the behavior of the water once it leaves the utility plant and makes its way into the distribution system on its way to consumers. This procedure is referred to as a simulated distribution system (SDS) THM test. In this case, it is possible for all the chlorine to be consumed, unlike the THMFP test. Depending on the location, consumption rate, and water pipe size, treated or finished water may linger for days in the distribution system.

### ***Chlorination By-Products***

#### **Halogenation of NOM**

Halogenated (brominated and/or chlorinated) compounds are of greatest concern due to health effects observed in laboratory animals. Total organic halide (TOX), a concept largely developed/promoted by EPA (Stevens 1984) is defined as the sum of the concentrations of all halogenated organic compounds. The true value of the TOX concentration cannot be determined; the number and identities of the indi-

vidual halogenated compounds formed during disinfection are unknown. Therefore, in practice, the TOX concentration is operationally defined with measurement by a TOX analyzer. TOX analyzers use activated carbon to capture halogenated organic matter. The carbon is then combusted at about 800-1000°C to convert all halogens to the hydrohalic acids (HX). The halide ion is then coulometrically titrated with silver(I) and expressed as chloride. Halogenated organic matter that is not readily or strongly adsorbed to activated carbon is routinely lost, negatively biasing the reported TOX value. Compounds other than THMs and HAAs, such as 2,2,2-trichloroethanediol (chloral hydrate), haloacetonitriles, or trichloronitromethane (chloropicrin), can also be found in chlorinated potable water supplies. Together, the haloacetonitriles make up about 2% of the halogenated organic matter, and 2,2,2-trichloroethanediol also makes up about 2% of the halogenated organic matter after disinfection takes place (Weinberg 1999). These DBP species form regardless of the source of the NOM. It is believed that the same types of structures are responsible for DBP formation on a molecular level. These structures are thought to be duplicated throughout NOM molecules regardless of the overall size of the molecule. This results in fairly uniform distribution of baseline DBPs, such as THMs and HAAs when water is chlorinated. Other by-products can also be formed.

Much of EPA's initial research focused directly on characterizing and exposing NOM to oxidizing disinfectants, especially active chlorine compounds. In this way, EPA identified a number of classes of compounds that make up NOM and established procedures for extracting DBPs from solution using XAD<sup>®</sup> resins (Christman et al. 1980, 1983b). Because algae can be found growing in finished water reservoirs, concern over plant metabolic products led to studies in that area. Extracellular products resulting from algal growth were shown to react with chlorine, forming chloroform in addition to higher-molecular-mass (>1000 u) DBPs (Wachter and Andelman 1984). A number of chlorinated DBPs were determined from the reaction with several NOM sources, including surface water and commercial products isolated from soils (Seeger et al. 1984b, 1984b). XAD<sup>®</sup> resins were used to collect the DBPs, which were eluted with ethyl ether. Many chlorinated aromatic carboxylic acids were found by gas chromatography-mass spectrometry (GC/MS), including some with ether linkages. Oxygenated DBPs were also found, including some longer-chain carboxylic acids (Seeger et al. 1984a, 1984b). As should be expected, chlorination of amino acids produced halonitriles; what was unexpected, perhaps, was the formation of high levels of 2,2,2-trichloroethanediol (Trehy et al. 1986). Chlorination of NOM isolated from a lake in North Carolina was demonstrated to produce a number of short-chain chlorinated carboxylic acids, including haloacetic acids and some alkenyl species in addition to THMs and 2,2,2-trichloroethanediol (Christman et al. 1983a). A variety of mutagenic compounds, including THMs, HAAs, haloacetonitriles, and haloketones were demonstrated to form when NOM is chlorinated directly (Meier et al. 1985). The mutagenicity of some HAAs was demonstrated by EPA (Meier et al. 1997). Accounting for the post-disinfection halogenated organic matter has been continually problematic. In general, studies have accounted for no more than 60% of the halogenated organic matter measured as TOX, and sometimes as little as 15% (Norwood et al. 1983). NOM was characterized by <sup>13</sup>C NMR to distinguish between aliphatic and aromatic portions as well as ultraviolet (UV) spectrophotometry (Reckhow et al. 1990). Chlorination of the NOM gave a mixture of DBPs, including several HAAs and haloacetonitriles. This study also attempted to link the various measurable characteristics of the NOM (humate and fulvate) to the distribution of DBPs. Another study (Fromme et al. 1995) marginally linked the presence of biopolymeric groups quantitated by pyrolysis GC/MS with DBP formation.

### **Other Sources of DBP Precursors**

In addition to natural sources of NOM, anthropogenic (man-made) sources of organic matter exist, too. For example, water treatment chemicals were shown to be a source of organic matter that led to the

formation of DBPs (Feige et al. 1980). The release of industrial chemicals and minerals is largely an unknown contributor to DBP formation. In this case, the type of DBPs is highly site specific. Regulated DBPs, on the other hand, tend to be formed regardless of source water.

Foodstuffs and, indeed, bodily fluids can also potentially be DBP precursors, considering that a quantity of disinfectants are ingested. Because most tap water contains a chlorine residual, it is possible for DBPs to form even after the water is consumed. As a model, when rats consumed sodium hypochlorite (albeit at levels higher than would normally be found in potable water), THMs, HAAs, and haloacetonitriles were detected in both the gastric contents and the plasma (Mink et al. 1983). Oxidizing chlorine compounds can react with a variety of natural compounds, including carboxylic acids found in fruit juices. Such reactions have been shown to produce mutagenic organic compounds (Chang et al. 1988). A recent study demonstrated that foods and beverages could provide an alternate exposure route to DBPs (Raymer et al. 1999a, 1999b).

### ***Influences on and Mechanisms of DBP Formation***

As noted earlier, a number of factors can influence DBP formation (Johnson et al. 1986). EPA has funded or specifically worked on several of these. A significant advance in measuring the proclivity for THM formation was the establishment of the uniform formation conditions (Summers et al. 1996). The location in the plant where chlorination occurs can affect DBP formation. Prechlorination is practiced by many utility plants to oxidize iron(II) and manganese(II) as well as to minimize biological growth in their agglutination-sedimentation facilities. However, agglutination-sedimentation removes a significant fraction of NOM. Accordingly, prechlorination has been demonstrated to lead to additional DBP formation (Solarik et al. 1997).

When waters contain bromide, chlorination produces a variety of brominated by-products. Bromide is oxidized by chlorine(I) to give bromine(I). At drinking water pH, most chlorine(I) is in the form of hypochlorite; however, hypobromite is a stronger base, and so the oxidation-reduction reaction is accompanied by hydrolysis:



HOBr is kinetically more labile than hypochlorous acid even though it is a weaker oxidant from a thermodynamic standpoint. Thus, bromination reactions abound during chlorination. In this fashion, a mixture of brominated, chlorinated, and bromochlorinated by-products are formed during disinfection. Studies have attempted to evaluate the effect of bromide on the formation of mutagenic by-products; for example, a study conducted with Jefferson Parish, LA, water considered the effect of bromide (Coleman et al. 1992). Chlorination of source water containing bromide results in the formation of not only chlorinated DBPs, but also brominated and bromochlorinated DBPs (Coleman et al. 1992). Other studies have identified some of these brominated, chlorinated, and bromochlorinated by-products (Caughran et al. 1999; Richardson et al. 1999a).

The precise quantities of the specific brominated, chlorinated, and bromochlorinated by-products requires further research. Some studies, however, have focused particularly on HAAs and THMs because they are known to make up much of the identifiable DBPs and are the subject of regulation. As pH goes down, the formation of brominated species increases (Pourmoghaddas et al. 1993; Pourmoghaddas 1991). This occurs because most reactions involving hypohalous acids proceed through a halogen(I) cation transfer step (Equation 3-25). This elementary reaction proceeds faster in acidic solutions because a hydroxide leaving group is more favorable than an oxide leaving group (which would have to be converted to hydroxide in water due to the leveling effect of the solvent).



\* In this case, bromine is shown adding to the less-substituted carbon atom. Regioselectivity of these reactions is a complicated subject and beyond the scope of this work.

The tendency to form brominated versus chlorinated species is also dependent on the DBP precursor material (NOM). For example, some types of NOM tend to form brominated HAA species, while some types of NOM tend to form chlorinated species (Magnuson and Kelty 2000).

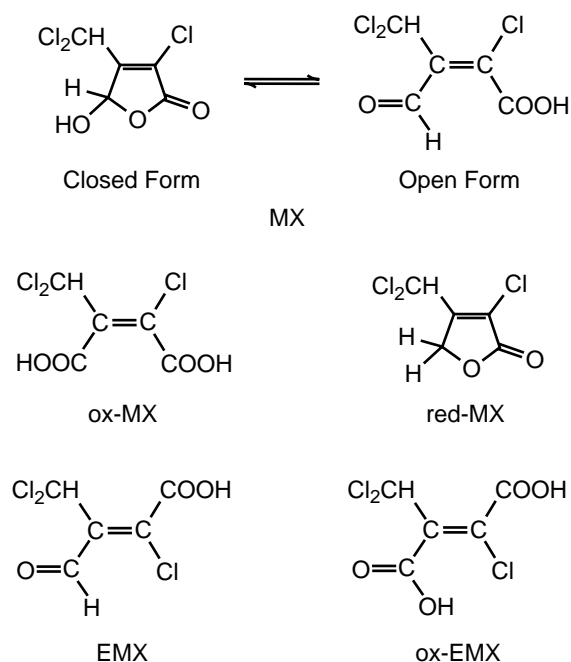
In addition to more fundamental studies of chemical kinetics, attempts have been made to empirically model DBP formation (Clark et al. 1996). Because NOM is an ill-defined material, it is not possible to elucidate rigorously detailed reaction mechanisms. To help water utilities comply with the surface water treatment rules and the disinfection by-product rules, the Office of Water has prepared a modeling program that can be used in conjunction with site-specific chemical and engineering data (USEPA 1992, 1994). More details on modeling developments may be found in Chapter 9.

### ***Investigating DBPs with Genotoxicity Assays***

The goal behind studying and regulating DBPs has been the protection of human health. There are several measures of the effect of DBPs on human health. Some DBPs have been studied extensively enough to be assigned a carcinogenicity rating (refer to Table 3-4). However, given the large number of DBPs, many of which have not been identified, it has not been practical or economically possible to study them all. Therefore, other measures of potential human health effects have been explored. One of these is genotoxicity, which is a measure of the ability of a substance to damage the genetic material of an organism. The Ames Salmonella mutagenicity assay, which detects point mutations, is one of the most commonly used short-term tests for genotoxicity. It has been used extensively to detect the presence of genotoxicity in drinking water sample concentrates. There is substantial evidence that most of mutagenic activity in drinking water originates from the reaction of disinfectants, especially chlorine, with the NOM present in source waters (Meier 1988). Because of the formation of mutagenic compounds during disinfection, the Ames Salmonella assay has been used extensively to determine the levels of mutagenicity in finished water concentrates from both chlorinated (Schenck Patterson and Lykins 1993; DeMarini et al. 1995) and alternative disinfectants (Schenck Patterson and Lykins 1995; Schenck Patterson et al. 1995; DeMarini et al. 1995) as well as wastewaters (Meier and Bishop 1985; Doerger et al. 1992).

In addition to DBPs, source-specific contaminants from various industrial, agricultural, and municipal sources may also contribute to the overall mutagenicity of some drinking waters. Mutagenic contaminants could be introduced during distribution by such things as leaching of mutagenic materials from the inside of pipes or tanks. Also, openings in the distribution system may allow for the entry of contaminants from the outside. The level of mutagenicity in a drinking water may also increase within the distribution system, due to the continued formation of DBPs from the reaction of residual disinfectant with organic matter in the water.

Mutagenic compounds have been concentrated from finished water by reverse osmosis and then subjected to GC/MS (Coleman et al. 1980). GC/MS was originally used to identify and quantify about one-fourth of the TOX, including HAAs, haloacetonitriles, haloketones, and several other compounds (Coleman et al. 1984). GC/MS methods have been developed to measure mutagenic compounds in studies where NOM was chlorinated directly (Meier et al. 1983; Meier and Bull 1984; Meier et al. 1985a; Stevens et al. 1989). These studies are ultimately aimed at providing a model for the formation of mutagens during chlorination of actual drinking water, i.e., to predict which mutagenic DBPs are likely to be formed.



**Figure 3-3. MX and its structural analogues (adapted from Richardson 1998a).**

The discovery of the highly mutagenic compound, originally known only as Mutagen X (MX), prompted considerable research in potable water. The genotoxic and toxic properties of MX and related compounds have been reviewed elsewhere (Meier et al. 1990; Daniel et al. 1993). Many research papers were subsequently devoted to assaying this species. Other studies were carried out to determine the chemical properties of MX (Meier et al. 1987). MX is (*Z*)-2-chloro-3-(dichloromethyl)-4-oxobutenoic acid. It engages in a cyclization equilibrium to form a chlorinated furanone (*R,S*)-3-chloro-4-(dichloromethyl)-5-hydroxy-[5*H*]furan-2-one with the double bond still in the (*Z*)-configuration. Several chlorinated furanones, including MX, were shown to form when NOM was chlorinated directly (Meier et al. 1986). Figure 3-3 shows several of these forms. Despite small structural differences, MX is by far the most mutagenic compound.

MX and related mutagenic compounds can also form when NOM is chloraminated (Kanniganati et al. 1992). MX has been found in U.S. potable water supplies (Munch et al. 1988). It can be recovered from finished chlorinated water using XAD<sup>®</sup> resins (Schenck et al. 1990; Ringhand et al. 1988a, 1988b). Moreover, stability studies suggested that MX could survive in the distribution system for days (Meier et al. 1987).

Studies were made of MX and related compounds using GC with mass spectrometric and/or infrared spectrophotometric detection; these studies helped to identify these species in drinking water matrices (Collette et al. 1991). MX and related compounds have also been separated by liquid chromatography (Meier et al. 1986). The studies on MX were reviewed, outlining its chemical, mutagenic, and toxicological properties (Ringhand et al. 1989). Adverse effects on rats and mice were determined, but human effects were not clear (Daniel et al. 1994). Later, it was determined that MX was substantially detoxified in vivo in rats and that very little was excreted in the urine (Meier et al. 1996). In addition, risk was shown to be considerably lower than that from the THMs because of the level of exposure. Furthermore, the animal studies used concentrations about 1000 times greater than those found in chlorinated water (Melnick et al. 1997). Concentrations of MX in chlorinated water are in the low parts-per-trillion range. By contrast, THM levels in the same waters are typically 1000 times higher.

## ***Trace DBPs in Drinking Water***

Aside from the regulated DBPs, there are hundreds and perhaps thousands of other compounds formed from the reaction of disinfectant with substances in the water. In the strictest sense, products from the reaction between oxidizing disinfectants and either NOM or naturally occurring inorganic constituents are bona fide DBPs. On the other hand, some investigators classify all products formed from reactions with substances in the raw water regardless of source (e.g., anthropogenic chemicals, microorganisms, etc.) as DBPs. The observation of the plethora of chemicals formed was made early on, and much research went into trying to identify other DBPs, motivated by health concerns that trace levels may be problematic for chemicals such as MX or bromate. The problem is that mass spectrometry, a powerful method for identifying and quantifying DBPs, requires larger quantities of some DBPs than are naturally formed in drinking waters. Therefore, early research used concentrated solutions of NOM to increase the amount of DBPs formed and provided early evidence of the suspected link between NOM in water and DBP formation in drinking water (Kopfler et al. 1984). Likewise, a library of DBPs was built based on a natural water that contained an unusually high amount of NOM (Slocum et al. 1988). In this manner, a library of over 780 DBPs was developed (Stevens et al. 1987), with particular regard to the conditions required for formation. Because NOM differs greatly with source, later work was aimed at concentrating the DBP formed from large volumes of water. Several methods for concentrating the water were investigated and compared, and XAD<sup>®</sup> resins were determined to provide advantages over Grob closed loop stripping apparatus (CLSA) and purge and trap (Melton et al. 1981). XAD<sup>®</sup> was used to study 580 compounds in several water supplies (Lin et al. 1981). Although initially undertaken for mutagenicity studies, NOM extracts were subjected to mass spectrometry and other spectral techniques, resulting in the identification of hundreds of compounds (Richardson et al. 1994, 1996, 1999a, 1999b).

## ***DBPs Formed from Alternative Disinfectants***

### **DBP Formation from Alternative Disinfectants**

Alternative disinfectants, namely disinfectants that are not chlorine gas or hypochlorite solutions, have been under study for some time in EPA, and they were the subject of an early review (Stevens and Symons 1984). The outside research community quickly picked up on DBP studies of alternative disinfectants. Within the EPA, the paradigm shift toward risk management (assessment and control) meant that more emphasis was placed on the risks associated with the consumption of water rather than the identification of all DBPs. To this end, several studies were performed to elucidate various issues that were relevant to this effort. One such issue involves ozone reaction pathways (ozone vs. hydroxyl), which are fundamental to understanding how to control the risks associated with ozone use, namely bromate formation. Hydroxyl radicals form during ozonation; a method was developed for rapidly measuring hydroxyl radical concentrations (Ireland and Velinieks 1992). The modeling of ozone/hydroxyl radical behavior and the effect on ozonation was studied, and the  $R_{ct}$  concept was described (Elovitz and von Gunten 2000), namely:

$$R_{ct} = [\text{OH}\cdot]/[\text{O}_3] \quad (3-26)$$

The formation of DBPs by these radicals was studied. In addition to ozonation, hydroxyl radicals are made when titanium dioxide is exposed to UV light, electrons are promoted in energy. This allows water to be cleaved to form hydroxyl radicals. Thus, a number of oxygenated DBPs were formed and later identified by multispectral analysis (Richardson et al. 1996).

Another research venture was preozonation, which, when coupled with chlorination, can be used to reduce DBP formation. The ozone breaks down the NOM into smaller molecules and leaves fewer of

the highly reactive sites; thus, the chlorine has fewer places to react (Miltner et al. 1992). Ozone can react with bromide to produce a variety of oxidized forms of bromine. These have been shown to react with NOM to make bromohydrins (Collette et al. 1994; Cavanagh et al. 1992). Bicarbonate can affect the efficacy of preozonation (Reckhow et al. 1986). Carbonate(1-) radical ( $\text{CO}_3^- \bullet$ ) formed by the action of ozone on bicarbonate is a poor oxidant and would be expected to interfere in preozonation.

In order to better understand potential use of chloramine in reducing DBP formation, literature from the period 1946 to 1984 was reviewed for THM formation from chlorine and chloramine, including in the presence of bromide (Cooper et al. 1985). In summary, chloramine is a weaker oxidant than hypochlorous acid from a thermodynamic standpoint. For this reason, it usually results in lower levels of DBP formation, but it is not as good a disinfectant. The factors affecting DBP formation during chloramination have been studied (Symons et al. 1998; EPA 1989). Cyanogen chloride is one of the most recent chloramination by-products to be identified and studied; it can form when ozonated water is chloraminated (Pedersen et al. 1999). This compound can be formed from the reaction of chloramine and methanal (formaldehyde). The kinetics and mechanism of the reaction have been studied (Pedersen et al. 1999). Methanal is ubiquitous from natural processes, but it can also be formed by the reaction of hypochlorous acid with glycine, an amino acid that can be found in natural waters (Snyder and Margerum 1982).

DBP formation for chlorine dioxide was compared to that from ozone, chlorine, and chloramine (Koffskey 1993; Lykins et al. 1994). These studies found that no quick and easy conclusion could be reached regarding choice of disinfectant in terms of minimizing DBP formation, but that it was necessary to strike a balance among competing needs. Chlorate formation from chlorine dioxide disinfection was demonstrated when treated water is exposed to light, as is possible in coagulation-sedimentation basins (Bolyard et al. 1993).

### ***Analytical Chemistry of Alternative DBPs***

Several analytical methods have been developed for chloraminated water. Purge and trap GC/MS was used for cyanogen chloride analysis (Prakash et al. 1998), which compliments other methods of analysis of chloraminated water. Membrane introduction mass spectrometry was used to study the lifetime of monochloramine in the human body. Human saliva and stomach fluid were examined for monochloramine. Due to low time persistence, any toxic effects associated with chloramine were attributed to DBPs rather than the disinfectant (Kotiaho et al. 1992).

Ozonation by-products have been identified using many of the same techniques and methods that work for chlorination by-products (Richardson et al. 1999a, 1999b). EPA developed Method 556 to determine the aldehydes that form from ozonation (Munch et al. 1998a). The aldehydes make up a major fraction of ozonation by-products. This was followed by the preparation of a user's guide to help laboratories work around some known difficulties of the method (Munch et al. 1998b). Other by-products form, too, such as carboxylic acids, including a number of 2-oxocarboxylates, commonly referred to as ketoacids. A comparison of ion chromatography (IC) versus GC for the determination of the 2-oxocarboxylates showed that the ion chromatographic method was more rugged and less susceptible to problems during the analysis compared to the double derivatization/GC experiment described (Urbansky and Bashe 2000). The GC approach also suffered from interferences due to metal cations commonly found in water supplies (Urbansky 2000d). As with chlorination DBP formation studies, ozonation DBP studies also require the use of a reducing agent to eliminate residual oxidant. Problems with a variety of reagents were identified when applied to the determination of aldehydes (Urbansky et al. 2000a). It was later shown that indigo-5,5',7-trisulfonate and triphenylphosphine could be used as fast-acting ozone-scavenging reagents (Urbansky et al. 2000b).

Many of the DBPs formed from ozonation experiments are highly polar in nature and therefore not amenable to many conventional forms of analysis. The difficulty is that water in which the DBPs are located is polar, and analytical techniques have difficulty separating the trace amounts of polar DBPs out of the far more numerous polar water molecules (Weinberg 1999). These compounds have been extracted from water through the use of solid phase microextraction (Shoemaker et al. 1999) or through the use of derivatizing agents, which convert the polar molecules into less polar ones, which are easier to extract. For example, aldehydes and ketones were analyzed following derivatization with 2,4-dinitrophenylhydrazine (Guo et al. 1998).

The use of spectroscopy techniques in addition to mass spectrometry has been used to help identify DBPs. One of these is infrared (IR) spectroscopy. This has been used in a number of studies with chlorine and non-chlorine disinfectants. For instance, multispectral analytical methods have been applied to determine DBPs in waters disinfected with chlorine and other disinfectants (Richardson et al. 1994, 1995, 1998a). Multispectral techniques have also been applied to identify aldehydes (Richardson et al. 1991). IR spectroscopy was a component of this multispectral analysis and is discussed in some detail separately (Collette 1996).

### ***Analytical Methods Development for Regulated DBPs***

Mass spectrometry allows the study of molecules by, to put it colloquially, weighing them. To be more precise, the mass/charge ration of ions resulting from the fragmentation of a molecule, as well as the fragmentation pattern, is determined accurately. Mass spectrometry has long been the dominant means to identify DBPs regardless of oxidizing agent. The quantification of DBPs through mass spectrometry as well as other detectors forms the basis of many EPA methods to monitor regulated DBPs.

Analytical method development has taken an important role in EPA/ORD DBP strategy, since in order to monitor, study, and regulate a DBP, a reliable method of analysis is necessary. Mass spectrometry is often the recommended technique to identify and/or quantify DBPs, although other detectors are permissible. The use of mass spectrometry, because it produces such a definitive result, has gone far in ensuring the quality of data generated from compliance monitoring and risk management studies. Ensuring the quality is essential if decisions are to be based on those data. EPA has helped to define practices for ensuring quality data (Budde and Eichelberger 1980; Boyd et al. 1996).

This effort has culminated in the development and promulgation of approved methods of analyzing DBPs in drinking water. Many of these methods can be used for determining regulated DBPs as well as unregulated DBPs, which is useful for fundamental studies of these compounds. Table 3-9 summarizes the methods for the regulated DBPs.

**Table 3-9. EPA Methods for Regulatory Compliance Monitoring of Organic DBPs in Drinking Water**

<b>Method No.</b>	<b>Contaminant(s)</b>
551	Halogenated hydrocarbons (including THMs), 2,2,2-trichloroethanediol, haloacetonitriles
502.2	THMs
524.2	THMs
552	HAA5 (see Table 2-2)
552.1	HAA5
552.2	HAA9
556	Aldehydes
300.x	Bromate, chlorite, chlorate
317.0	Bromate
321.8	Bromate



## Trihalomethanes (THMs)

As shown by Table 3-9, there are often multiple methods for each DBP. Each method uses different techniques and equipment because some compliance monitoring laboratories may be skilled in one technique and/or may not have the equipment for another technique. Each method has been rigorously evaluated to meet the requirements for compliance monitoring. These techniques are revised and updated as new technology becomes available.

Closed loop stripping analysis, in which a large volume of water is effectively extracted into a small volume of carbon disulfide, was used when DBP studies were first initiated. The carbon disulfide would be injected into a gas chromatograph for detection with mass spectrometry or another suitable detector (Coleman et al. 1981). With the development of purge and trap technology by EPA, analysis of volatile DBPs was improved. Purge and trap methods are still effective and have been supplemented by liquid-liquid microextraction techniques. The analysis of drinking water developments from 1996 through 1998 has been recently reviewed (Richardson 1999), in which the EPA developed many methods that are not necessarily used in compliance monitoring, but are instead used for specific research purposes.

For the THMs, Methods 502.2 (Ho et al. 1995) and 524.2 (Eichelberger 1995) are based on purge and trap technology. In the purge and trap procedure, the water sample is placed in a specially designed vessel and an inert gas is bubbled through the water sample through a frit, which causes the bubbles to be small. The analytes (THMs) are purged by the inert gas and trapped on an adsorbent material. This adsorbent material is then heated rapidly to release the analytes. A gas chromatograph separates the mixture of analytes more or less by their volatilities and their abilities to partition into the stationary phase of the column. In Method 502.2, the analytes are detected by photoionization and electrolytic conductivity detectors. Detection is by elution time only and can be partially confirmed by the use of a dissimilar chromatography column. For more reliable identification, a mass spectrometer is used in Method 524.2.

Method 551.0 was designed originally for only DBPs, but was later expanded into Method 551.1 to determine a variety of pesticides and halogenated solvents encountered in drinking water (Hautman and Munch 1997). Method 551.1 (Munch and Hautman 1995) extracts the water sample with an organic liquid. The analytes (THMs) are more soluble in the organic liquid than they are in the water, so a portion of the analyte molecules partition into the organic liquid. This organic liquid is then injected into the gas chromatograph and is detected by an electron capture detector, which is very sensitive to the chlorine and bromine atoms in the analytes. Qualitative confirmation of the identity of the analyte is recommended by mass spectrometry.

Aside from these compliance monitoring regulatory methods, EPA has developed alternative methods to analyze THMs for special, i.e., research, purposes. For instance, to investigate more rapid analysis, THMs were purged directly into an electrolytic conductivity detector (Hodakievic and Ho 1990). Treatment studies often have special analytical needs that cannot be met using methods developed for regulatory compliance monitoring. In particular, DBP formation studies require that residual oxidants be quenched to fix the DBP concentrations in time. The EPA method specifies ammonium chloride or sodium sulfite. Recently, ascorbic acid has been used for this purpose for HAAs, haloacetonitriles, THMs, and other analytes of Methods 551.1A/B and 552.2 (Urbansky 1999; Urbansky et al. 2000c) as well as 502.2 analytes (Ho 1995). Bromochloroacetate possesses a chiral carbon atom; thus, some work has focused on determining the enantiomer ratios (Wong et al. 1999).

## **Haloacetic Acids (HAAs)**

HAAs are more difficult to determine than THMs, and the analytical chemistry has been recently reviewed elsewhere (Urbansky 2000e). This is a result of the acidic nature of these contaminants, which causes them to not be amenable to direct GC analysis like the THMs. To solve this problem, EPA Method 552.0 (Hodgeson et al. 1988) provides for the analysis of 5 HAAs using diazomethane to esterify the analytes after extraction into *tert*-butyl methyl ether. The methyl esters are then injected into a GC and detected by electron capture. Advice for using this procedure was provided (Ulmer et al. 1988). Method 552.1 followed, replacing the diazomethane with acidified methanol. In Method 552.1, the analytes were extracted by running the tap water through a solid phase anion exchange resin. The current version of the method, Method 552.2 (Munch et al. 1995b), eliminates the use of explosive diazomethane, which is the most carcinogenic substance known to man (on a base pair methylation basis). Method 552.2 was designed with the preferred steps from both 552 and 552.1. Method 552.2 combines an MTBE extraction with acidified methanol esterification (Pawlecki-Vonderheide et al. 1997). Method 552.2 was verified for all 9 HAAs. Although EPA promulgated Method 552.2 to monitor HAA9 under the Information Collection Rule, many laboratories have continued to use Method 552. More care is necessary with Method 552 because diazomethane used in Method 552 degrades the brominated trihaloacetic acids, especially in white light (Rubio et al. 2000). Following the promulgation of the Information Collection Rule, EPA attempted to discern how well labs were doing using EPA-approved methods for DBP quantification (Stultz et al. 1998). The performance of Method 552.2 is dependent on both the specific water used and the skill of the analyst, particularly for the brominated trihaloacetic acids. As an alternative, complexation electrospray mass spectrometry was recently used to determine HAA9 in drinking water. Because it does not have the acidic methanol step, problems with the brominated trihaloacetic acids are reduced (Magnuson and Kelty 2000).

## **Inorganic DBPs: Bromate and Chlorite**

Inorganic anions, e.g., bromate and chlorite, are produced as DBPs. They have been determined using ion chromatography originally developed in EPA Method 300.0 (Pfaff 1993). Bromate has attracted the most attention due to higher possible health risk. Several IC methods have been developed for this purpose (Hautman and Bolyard 1992a, 1992b, 1992c; Wagner et al. 1998). Lowering the detection limit has been the goal of this research. Several concentration techniques were proposed (Sorrell and Hautman 1993; Hautman 1993). EPA developed a method for bromate based on a chromophoric reaction; this lowered the detection limit substantially (Wagner et al. 1998), but the method can be affected by impurities in the 3,3-dimethoxybenzidine used as a prochromophore (Urbansky and Brown 2000). A GC/MS method has been developed for bromate; bromate is used to produce a volatile brominated organic molecule (Magnuson 1998). IC coupled with Inductively Coupled Plasma Mass Spectrometry (ICP-MS) has been extensively investigated to determine bromate in potable water under a variety of conditions (Creed et al. 1996, 1997a; Brockhoff and Creed 1997). IC-ICP-MS is the basis of Method 321.8 (Creed et al. 1997b). Through the use of IC-ICP-MS, it was determined that brominated HAAs may interfere with the IC analysis of bromate (Creed et al. 1997a). Isotope dilution IC-ICP-MS was investigated for the determination of bromate (Creed and Brockhoff 1999). Isotope dilution involves adding a known amount of bromate labeled with a stable (non-radioactive) bromine isotope to the water sample before analysis. Whatever chemically and physically happens to the analyte (bromate) also happens to the isotopic addition. Therefore, isotopic addition is considered a primary and truly definitive form of measurement.

## Directions in DBP Analytical Chemistry Research

Carcinogenicity has been the primary driving force behind drinking water regulations, and it is likely that carcinogenicity will continue in this role, although other health effects end points may also be of concern. Genotoxicity data, not limited just to mutagenicity assays, will probably continue to be used in assessing health risks of DBPs. However, relatively little effort has been paid to assessing other types of health effects, such as reproduction and sensitive populations (Bove et al. 1995; Waller et al. 1998). Reproductive end points are the subject of current EPA/ORD investigation, and the area of other end points for human health effects could be an interesting area of DBP research for the future. These end points may be associated with biologically active compounds that remain unidentified. Should a DBP be implicated in health risks associated with a form of disinfection, analytical methods will be needed for its analysis.

Another area of future DBP research is in the 60% or so of the halogenated material that is not part of the identifiable classes of compounds (i.e., HAAs, THMs, haloacetonitriles [HANs]). It is possible that some other highly active compounds are present, especially since the nonvolatile polar compounds are not well characterized. With the shift in the risk management paradigm, it is not known whether there will be large-scale continued interest in the identification of new DBPs. In the past, a large effort has been directed toward first identifying DBPs and then pursuing toxicology/pharmacokinetic studies. Unquestionably, this has been successful in encouraging utilities to use treatment practices capable of reducing the concentrations of several key DBPs, including the THMs and HAAs. Because the number of DBPs is essentially limitless due to the wide range of compounds that make up NOM, the feasibility of large-scale DBP identification efforts is discussed (Urbansky 2000f) in light of more directed approaches towards specific human health goals. One such approach is the use of structure-activity relationships (SARs) (McKinney et al. 2000; Moudgal et al. 2000). SARs are based on the presumption that toxicity is not governed simply by the presence of a halogen, but rather that similar functional groups are responsible for the mechanisms of toxicity. There is no *a priori* basis for asserting that halogenated organic compounds are necessarily toxic; indeed, many halogenated organic compounds find use as pharmaceuticals. Likewise, advances in epidemiology and biostatistics can pinpoint human disease end points for further elucidation (Calderon 2000). Combining SARs with epidemiologic studies can focus the analytical chemistry on specific classes of compounds rather than expending time and resources on identifying benign spectator compounds.

New advances in analytical chemistry may complement the use of SARs, epidemiology, and biostatistics. DNA microarray technology permits rapid assessment of individual compounds or groups of compounds to evaluate not only additivity, but also synergy. These methods can be cheaper and faster than traditional animal toxicology/pathology studies, which consume considerable resources and require sacrificing many laboratory animals. Microarrays are currently being used to investigate DBPs and endocrine disruptors (Betts 2000). The National Institute of Environmental and Health Sciences (NIEHS) has created a Microarray Center to study and document genotypic changes (Cooney 2000). Like biological systems, these arrays can be exposed to complex mixtures in order to measure additive and synergistic effects. The arrays are already making headway in pharmaceutical and biotechnology research.

Research on compounds likely to adversely affect health can be further guided by judicious use of fractionated, but unidentified materials (Mount and Anderson-Carnahan 1988). If compounds are separated using chromatographic, electrophoretic, or other means, the individual fractions may be tested on microarrays, using indicator organisms (e.g., helminths, cladocerans, amphipods, insect naiads, or cope-

Pods) that have well-known physiology, anatomy, and biology. Such organisms are routinely collected from natural waterways as ecological indicators of water quality, serving to identify the presence of pollutants. The advantage of using biological organisms is that additive effects can be observed even if the active principles exist at concentrations below the detection limits offered by modern analytical chemistry. Moreover, if the effects are synergistic rather than additive, a biological system can be used to observe the interaction phenomena in ways that no current chemoanalytical method could. The advantage of testing fractionated material before identifying its constituents is that chemicals in samples shown to be devoid of toxicity need not be identified at all. Consequently, these *in vitro* biotoxicity tests serve as a screening mechanism for weeding out countless harmless spectators, saving resources. This approach has been applied to estrogenic materials in sewage plant effluents and other mixtures more complex than finished drinking water (Desbrow et al. 1998).

From a practical standpoint, there are unresolved issues about how many DBPs reach the drinking water consumers. There are often lengthy delays in the water distribution system, and it is not always clear how DBP concentrations change after leaving the water plant and before the water reaches the tap. The stability of DBPs may be affected by reaction with components of the distribution, *i.e.*, pipes, valves, tanks, etc. Kinetic studies of DBP chemistry under distribution system conditions may someday elucidate this. In the case of HAAs, for example, the concentration profiles observed in the distribution system show losses inconsistent with the known chemical kinetics (Urbansky 2000g). It has been speculated that biodegradation is responsible for this loss, but there are many unresolved issues, such as the potential for heterogeneous catalysis or homogeneous catalysis (general acid/base) (Urbansky 2000g).

From the standpoint of considering DBPs for regulation, research must consider whether existing regulations are already sufficient to control a candidate compound for regulation. Suppose that THM regulations require water treatment plants to be operated in such a manner that compound Y, a candidate for regulation, is controlled at the same time. Promulgating a regulation specifically for compound Y would then offer no additional benefit to public health. Accordingly, the expense associated with the development and support of such a regulation would not be warranted.

An additional direction for DBP research may be provided through extramural projects. While the primary focus of this chapter is research conducted or managed by EPA's research laboratories, EPA/ORD's National Center for Environmental Research continues to fund a wide range of research proposals in the area of disinfection by-products, as mentioned previously. For completeness, a list of recent and ongoing projects, along with the investigators' institutions, appears in Table 3-10.

**Table 3-10. DBP Research Funded Through NCER**

<b>Title</b>	<b>Institution</b>	<b>Grant Number</b>
Ion-Pair/Supercritical Fluid Extraction and Derivatization for Polar Organic Pollutant Analysis	Oregon State University	R821195
Novel Method for DBP Removal	Universal Fuel Development Associates, Inc.	68D50145
Development of a Novel Ferroelectric, Cathode-Based Ozonator for Drinking Water Treatment	UHV Technologies, Inc.	68D98149
A Comparison of the Effectiveness of Reverse Osmosis and Ion Exchange Technologies on the Removal of the Bromide Ion	University of Nevada, Reno	GF9501942
Investigation of Model Titania Surfaces for Heterogeneous Photocatalytic Oxidation of Chlorinated Organics	Arizona State University, Tempe	R819286
Development of Biomarkers for Haloacetonitriles-Induced Cell Injury in Peripheral Blood	The University of Texas Medical Branch, Galveston	R825955
Water Solubility and Henry's Law Constant	Lamar University	084LUB5101
Novel Method for DBP Precursor Removal	Universal Fuel Development Associates, Inc.	68D40043
Combined Ozonation and Biological Treatment for the Removal of Humic Substances from Drinking Waters	Michigan State University	GF9500518
Analysis of Organic By-Products from the Use of Ozone/Chlorine and Ozone/Chloramines in Drinking Water Treatment	University of Massachusetts	R825364
Kinetic-Based Models for Bromate Formation in Natural Waters	Arizona State University	R826835
Use of Differential Spectroscopy to Probe Reactions between Natural Organic Matter and Chlorinated Oxidants	University of Washington, Seattle, WA	R826645
Engineering of Oxidation and Granular Activated Carbon Treatment Processes to Meet New Objectives in Drinking Water Treatment	University of North Carolina	R820184
Removal of Chlorine Dioxide By-Products from Drinking Water	Novatek	68D00033
Singlet Oxygen Disinfection of Drinking Water	Fayette Environmental Services, Inc.	68D99049
Zeolite Membranes for Removal of Contaminants in Drinking Water	TDA Research, Inc.	68D50081
Acoustic-Enhanced Ozone Drinking Water Disinfection	Montec Associates, Inc.	68D99059
The Particle Size Distribution of Toxicity in Metal-Contaminated Sediments	Colorado School of Mines, Colorado State University	R826651
Assessment of Human Dietary Ingestion Exposures to Water Disinfection By-Products via Food	Research Triangle Institute, NC	R826836

<b>Title</b>	<b>Institution</b>	<b>Grant Number</b>
Molecular Weight Separation and HPLC/MS/MS Characterization of Previously Unidentified Drinking Water Disinfection By-Products	University of Illinois at Urbana-Champaign and Metropolitan Water District of Southern California	R826834
Formation and Stability of Ozonation By-Products in Drinking Water	University of North Carolina at Chapel Hill	R826833
Mechanisms and Kinetics of Chloramine Loss and By-Product Formation in the Presence of Reactive Drinking Water Distribution System Constituents	University of Iowa	R826832
Mechanistic-Based Disinfectant and Disinfectant By-Product Models for Chlorine Decay and Regulated DBP Formation Derived from Free Chlorination	Arizona State University, University of Massachusetts, University of Colorado, Malcolm Pirnie	R826831
Integrated Approach for the Control of <i>Cryptosporidium parvum</i> Oocysts and Disinfection By-Products in Drinking Water Treated with Ozone and Chloramines	University of Illinois at Urbana-Champaign	R826830
Pilot Studies of the Ozonation/FBT Process for the Control of Disinfection By-Products in Drinking Water	Michigan State University	R826829
Inhalation and Dermal Exposure to Disinfection By-Products of Chlorinated Drinking Water	Environmental and Occupational Health Sciences Institute, University of Medicine and Dentistry of New Jersey	R825953
Development of a New, Simple, Innovative Procedure for the Analysis of Bromate and Other Oxy-Halides at Sub-ppb Levels in Drinking Water	University of North Carolina at Chapel Hill	R825952
Genotoxicity and Occurrence Assessment of Disinfection By-Product Mixtures in Drinking Water	University of Illinois at Urbana-Champaign	R825956
Metabolic Fate of Halogenated Disinfection By-Products In Vivo and Relation to Biological Activity	University of North Carolina at Chapel Hill	R825957
The Secondary Structure of Humic Acid and its Environmental Implications	University of Idaho	R822832
Fate of Bromate Ion and Bromine Compounds in Water Treatment	Purdue University	R821245

## References

- American Water Works Association. (1994). *Natural organic matter in drinking water: Origin, characterization, and removal*. American Water Works Association, Denver, CO.
- Barrett, S. E. and Krasner, S., eds. (2000). *Natural organic matter and disinfection by-products: Characterization and control in drinking water* (ACS Symposium Series), Vol. 761, American Chemical Society, Washington, D.C.
- Betts, K. (2000). "An array of possibilities for evaluating environmental health." *Environmental Science and Technology*, 34, 296A–297A.

- Bolyard, M., Fair, P. S., and Hautman, D. P. (1992). "Occurrence of chlorate in hypochlorite solutions used for drinking water disinfection." *Environmental Science and Technology*, 26, 1663–1665.
- Bolyard, M., Fair, P. S., and Hautman, D. P. (1993). "Sources of chlorate in U.S. drinking water." *Journal of the American Water Works Association*, 85(9), 81–88.
- Bove, F., Fulcomer, M., Klotz, J., Esmart, J., Dufficy, E., and Savrin, J. (1995). "Public drinking water contamination and birth outcomes." *American Journal of Epidemiology*, 141, 850–862.
- Boyd, R. K., et al. (1996). "Mass spectrometry and good laboratory practices." *Journal of the American Society of Mass Spectrometry*, 7, 211–218.
- Brockhoff, C. A. and Creed, T. J. (1997). "The determination of bromate in ozonated drinking waters by ion chromatography with isotope dilution and inductively coupled plasma mass spectrometric detection," Book of abstracts. *214th American Chemical Society National Meeting*, Las Vegas, NV, September 7–11.
- Budde, W. L. and Eichelberger, J. W. (1980). "Performance tests for the evaluation of computerized gas chromatography/mass spectrometry equipment and laboratories." *EPA/600/4-80/025*, Environmental Protection Agency.
- Calderon, R. L. (2000). "The epidemiology of chemical contaminants of drinking water." *Food and Chemical Toxicology*, 38, S13–S20.
- Caughran, T. V., Richardson, S. D., Thruston, Jr., A. D., Chen, P. H., Collette, T. W., and Floyd, T. L. (1999). "Identification of new drinking water disinfection byproducts formed in the presence of bromide," Book of abstracts. *217th American Chemical Society National Meeting*, Anaheim, CA, March 21–25.
- Cavanagh, J. E., et al. (1992). "Ozonation byproducts: Identification of bromohydrins from the ozonation of natural waters with enhanced bromide levels." *Environmental Science and Technology*, 26, 1658–1662.
- Chang, T. L., Stretched, R. P., Zimmer, H., and Munch, J. W. (1988). "The interaction of aqueous solutions of chlorine with malic acid, tartaric acid, and various fruit juices: A source of mutagens." *Analytical Letters*, 21, 2049–2067.
- Christman, R. F., et al. (1980). "Chlorination of aquatic humic substances." Performed and prepared under EPA grant no. R804430.
- Christman, R. F., Norwood, D. L., Millington, D. S., Johnston, J. D., and Stevens, A. A. (1983a). "Identity and yields of major halogenated products of aquatic fulvic acid chlorination." *Environmental Science and Technology*, 17, 625–628.
- Christman, R. F., Johnson, J. D., Millington, D. S., and Stevens, A. A. (1983b). *Chemical reactions of aquatic humic materials with selected oxidants. EPA/600/D-83/117*, Environmental Protection Agency.
- Clark, R. M., Pourmoghaddas, H., Wymer, L. J., and Dressman, R. C. (1996). "Modelling the kinetics of chlorination byproduct formation: The effects of bromide." *Journal of Water Supply Research and Technology–Aqua*, 45, 112–119.
- Coleman, W. E., Melton, R. G., Kopfler, F. C., Barone, K. A., Aurand, T. A., and Jellison, M. G. (1980). "Identification of organic compounds in a mutagenic extract of a surface drinking water by a computerized gas chromatography/mass spectrometry system (GC/MS/COM)." *Environmental Science and Technology*, 14, 576–588.

- Coleman, W. E., et al. (1981). "Determination of organic contaminants by the Grob closed-loop-stripping technique." *Journal of the American Water Works Association*, 73(2), 119–125.
- Coleman, W. E., Munch, J. W., Kaylor, W. H., Streicher, R. P., Ringhand, H. P., and Meier, J. R. (1984). "Gas chromatographic/mass spectroscopy analysis of mutagenic extracts of aqueous chlorinated humic acid: A comparison of the byproducts to drinking water contaminants." *Environmental Science and Technology*, 18, 674–681.
- Coleman, W. E., Munch, J. W., Ringhand, H. P., Kaylor, W. H., and Mitchell, D. E. (1992). "Ozonation/post-chlorination of humic acid: A model for predicting disinfection byproducts." *Ozone: Science and Engineering*, 14, 51–69.
- Collette, T. W. (1996). "Detection and precise identification of environmental contaminants by GC IR," Book of abstracts. *211th American Chemical Society National Meeting*, New Orleans, LA, March 24–28.
- Collette, T. W., Christman, R. F., McGuire, J. M., and Trusty, C. (1991). *Multispectral identification of potentially hazardous byproducts of ozonation and chlorination. Part I. Studies of chromatographic and spectroscopic properties of MX. EPA/600/4-91/004*, Environmental Protection Agency.
- Collette, T. W., Richardson, S. D., and Thruston, Jr., A. D. (1994). "Identification of bromohydrins in ozonated waters." *Applied Spectroscopy*, 48, 1181–1192.
- Cooney, C. M. (2000). "Analyzing toxicants on a chip." *Environmental Science and Technology*, 34, 244A–245A.
- Cooper, W. J., Zika, R. G., and Steinhauer, M. S. (1985). "Bromide-oxidant interactions and THM formation: A literature review." *Journal of the American Water Works Association*, 77(4), 116–121.
- Creed, J. T., Magnuson, M. L., Pfaff, J. D., and Brockhoff, C. (1996). "Determination of bromate in drinking waters by ion chromatography with inductively coupled plasma mass spectrometric detection." *Journal of Chromatography A*, 753, 261–267.
- Creed, J. T., Magnuson, M. L., and Brockhoff, C. (1997a). "Determination of bromate in the presence of brominated haloacetic acids by ion chromatography with inductively coupled plasma mass spectrometric detection." *Environmental Science and Technology*, 31, 2059–2063.
- Creed, J. T., Brockhoff, C. A., and Martin, T. D. (1997b). "Method 321.8: Determination of bromate in drinking waters by ion chromatography inductively coupled plasma-mass spectrometry." Environmental Protection Agency.
- Creed, J. T. and Brockhoff, C. (1999). "Isotope dilution analysis of bromate in drinking water matrices by ion chromatography with inductively coupled plasma mass spectrometric detection." *Analytical Chemistry*, 71, 722–726.
- Croue, J.-P., Korshin, G. V., and Benjamin, M., eds. (1999). *Characterization of natural organic matter in drinking water*. American Water Works Association, Denver, CO.
- Daniel, F. B., Meier, J. R., and Deangelo, A. B. (1993). "Advances in research on carcinogenic and genotoxic byproducts of chlorine disinfection: Chlorinated hydroxyfuranones and chlorinated acetic acids." *Annali dell' Instituto Superiore de Sanita*, 29, 279–291.
- Daniel, F. B., Robnsson, M., Olson, G.R., Stober, J. A., and Page, N. P. (1994). "Toxicological studies on MX, a disinfection byproduct." *Journal of the American Water Works Association*, 86(3), 103–111.



- DeMarini, D. M., Abu-Shakra, A., Felton, C. F., Schenck Patterson, K., and Shelton, M. L. (1995). "Mutation spectra in *Salmonella* of chlorinated, chloraminated, or ozonated drinking water extracts: Comparison to MX." *Environmental and Molecular Mutagenesis*, 26, 270–285.
- Desbrow, C., Routledge, E. J., Brighty, G. C., Sumpter, J. P., and Waldcock, M. (1998). "Identification of estrogenic chemicals in STW effluent. 1. Chemical fractionation and in vitro biological screening." *Environmental Science and Technology*, 32, 1549–1558.
- Doerger, J. U., Meier, J. R., Dobbs, R. A., Johnson, R. D., and Ankley, G. T. (1992). "Toxicity reduction evaluation at a municipal wastewater treatment plant using mutagenicity as an endpoint." *Archives of Environmental Contamination and Toxicology*, 22, 384–388.
- Eichelberger, J. W. (1995). "Method 524.2: Measurement of purgeable organic compounds in water by capillary column gas chromatography/mass spectrometry." *Methods for the determination of organic compounds in drinking water—Supplement III, EPA/600/R-95/131*, Environmental Protection Agency.
- Elovitz, M. S. and von Gunten, U. (2000). "Hydroxyl radical/ozone ratios during ozonation processes. I. The  $R_{ct}$  concept." *Ozone: Science and Engineering*, 21, 239–260.
- Feige, M. A., Glick, E. M., Munch, J. W., Munch, D. J., Noschang, R. L., and Brass, H. J. (1980). "Potential contaminants introduced into water supplies by the use of coagulant aids." *Water chlorination: Environmental impact and health effects*, R. L. Jolley, W. A. Brungs, and R. B. Cumming, eds., Ann Arbor Science, Ann Arbor, MI, 3(69).
- Fromme, W. R., Speth, T. F., and Summers, R. S. (1995). "Evaluation of pyrolysis-GS/MS for characterization of DBP precursors," Book of abstracts. *210th American Chemical Society National Meeting*, Chicago, IL, August 20–24.
- von Gunten, U. and Hoigné, J. (1994). "Bromate formation during ozonation of bromide-containing waters: Interaction of ozone and hydroxyl radical reactions." *Environmental Science and Technology*, 28, 1234–1242.
- Guo, Y., Richardson, S. D., and Caughran, T. V. (1998). "Identification and mechanistic studies of drinking water disinfection byproducts," Book of abstracts. *216th American Chemical Society National Meeting*, Boston, MA, August 23–27.
- Hautman, D. P. (1993). "Analysis of trace bromate in drinking water using selective anion concentration and ion chromatography." *Proceedings, Annual Conference of the American Water Works Association, Water Quality*, 993–1007.
- Hautman, D. P. and Bolyard, M. (1992a). "Using ion chromatography to analyze inorganic disinfection byproducts." *Journal of the American Water Works Association*, 84(11), 88–93.
- Hautman, D. P. and Bolyard, M. (1992b). "Analysis of inorganic disinfection byproducts using ion chromatography." *Proceedings, 1991 Water Quality Technology Conference*, American Water Works Association, Part 2, 1043–1059.
- Hautman, D. P. and Bolyard, M. (1992c). "Analysis of oxyhalide disinfection byproducts and other anions of interest in drinking water by ion chromatography." *Journal of Chromatography A*, 602, 65–74.
- Hautman, D. P. and Munch, D. J. (1997). "Development of U.S. EPA Method 551.1." *Journal of Chromatographic Science*, 35, 221–231.

- Herren-Freund, S. L., Pereira, M. A., Khoury, M. D., and Olson, G. (1987). "The carcinogenicity of trichloroethylene and its metabolites, trichloroacetic acid and dichloroacetic acid, in mouse liver." *Toxicology and Applied Pharmacology*, 90, 183–189.
- Ho, J. S. (1995). "Method 502.2: Volatile organic compounds in water by purge and trap capillary column gas chromatography with photoionization and electrolytic conductivity detectors in series." *Methods for the determination of organic compounds in drinking water—Supplement III*, EPA/600/R-95/131, Environmental Protection Agency.
- Hodakievic, P. A. and Ho, J. S. (1990). "A direct purge method for determination of total trihalomethanes in drinking water with an electrolytic conductivity detector." *Advances in Instrumentation and Control*, 45, 339–347.
- Hodgeson, J. W., Collins, J., and Barth, R. E. (1988). "Method 552.0: Determination of haloacetic acids in drinking water by liquid-liquid extraction, derivatization and gas chromatography with electron capture detection." *Methods for the determination of organic compounds—Supplement II*, EPA 600/4-88/039, Environmental Protection Agency.
- Ireland, J. C. and Valinieks, J. (1992). "Rapid measurement of aqueous hydroxyl radical concentrations in steady-state HO• flux systems." *Chemosphere*, 25, 383–396.
- Johnson, J. D. and Jensen, J. N. (1986). "THM and TOX formation: Routes, rates, and precursors." *Journal of the American Water Works Association*, 78(4), 156–162.
- Jolley, R. L., ed. (1976). *The environmental impact of water chlorination. Proceedings, Conference on the Environmental Impact of Water Chlorination, Oak Ridge National Laboratory, Energy Research and Development Administration, Oak Ridge, TN, October 22–24, 1975.*
- Jolley, R. L., Gorcher, H., and Hamilton, Jr., D. H., eds. (1978). *Water chlorination—Environmental impact and health effects, volume 2. Proceedings, Second Conference on the Environmental Impact of Water Chlorination, Gatlinburg, TN, October 31–November 4, 1977.* Ann Arbor Science Publishers, Ann Arbor, MI.
- Jolley, R. L., Brungs, W. A., Cumming, R. B., and Jacobs, V. A., eds. (1980). *Water chlorination—Environmental impact and health effects, volume 3. Proceedings, Third Conference on Water Chlorination—Environmental Impact and Health Effects, Colorado Springs, CO, October 28–November 2, 1979.* Ann Arbor Science Publishers, Ann Arbor, MI.
- Jolley, R. L., Brungs, W. A., Cotruro, J. A., Cumming, R. B., Mattice, J. S., and Jacobs, V. A., eds. (1983). *Water chlorination—Environmental impact and health effects, volume 4 (Parts 1 and 2). Proceedings, Fourth Conference on Water Chlorination—Environmental Impact and Health Effects, Pacific Grove, CA, October 18–23, 1981.* Ann Arbor Science Publishers, Ann Arbor, MI.
- Jolley, R. L., Bull, R. J., Davis, W. P., Katz, S., Roberts, Jr., M. H., and Jacobs, V. A., eds. (1985). *Water chlorination: Chemistry, environmental impact and health effects, volume 5. Proceedings, Fifth Conference on Water Chlorination—Environmental Impact and Health Effects, Williamsburg, VA, June 3–8, 1984.* Lewis Publishers, Chelsea, MI.
- Jolley, R. L., Condie, L. W., Johnson, J. D., Katz, S., Mattice, J. S., and Jacobs, V. A., eds. (1990). *Water chlorination: Chemistry, environmental impact and health effects, volume 6. Proceedings, Sixth Conference on Water Chlorination—Environmental Impact and Health Effects, Oak Ridge, TN, May 3–8, 1987.* Lewis Publishers, Chelsea, MI.
- Kanniganti, R., Johnson, J. D., Ball, L. M., and Charles, M. J. (1992). "Identification of compounds in mutagenic extracts of aqueous monochloraminated fulvic acid." *Environmental Science and Technology*, 26, 1998–2004.

- Koffskey, W. E. (1993). "Project summary: Disinfection byproduct formation by alternative disinfectants and removal by granulated activated carbon." *EPA/600/SR-93/136*, Environmental Protection Agency.
- Kopfler, F. C., Ringhand, H. P., Coleman, W. E., and Meier, J. R. (1984). "Reactions of chlorine in drinking water, with humic acids and in vivo." *EPA/600/D-84/196*, Environmental Protection Agency.
- Kotiaho, T., et al. (1992). "Time persistence of monochloramine in human saliva and stomach fluid." *Environmental Science and Technology*, 26, 302–306.
- Lin, D. C. K., Melton, R. G., Kopfler, F. C., and Lucas, S. V. (1981). "Glass capillary gas chromatographic/mass spectrometric analysis of organic concentrates from drinking and advanced waste treatment waters." *Advances in the identification and analysis of organic pollutants in water*, Vol. 2, L. H. Keith, ed., Ann Arbor Science, Ann Arbor, MI, 861–906.
- Lykins, Jr., B. W., Koffskey, W. E., and Schenck Patterson, K. (1994). "Alternative disinfectants for drinking water treatment." *Journal of Environmental Engineering Division of the ASCE*, 120, 745–758.
- Magnuson, M. L. (1998). "Determination of bromate at parts-per-trillion levels by gas chromatography-mass spectrometry with negative chemical ionization." *Analytica Chimica Acta*, 377, 53–60.
- Magnuson, M. L. and Kelty, C. A. (2000). "Microextraction of nine haloacetic acids in drinking water at microgram per liter with electrospray-mass spectrometry of stable association complexes." *Analytical Chemistry*, 72, 2308–2312.
- McKinney, J. D., Richard, A., Waller, C., Newman, M. C., and Gerberick, F. (2000). "The practice of structure activity relationships (SAR) in toxicology." *Toxicological Sciences*, 56, 8–17.
- Meier, J. R., Lingg, R. D., and Bull, R. J. (1983). "Formation of mutagens following chlorination of humic acid. A model for mutagen formation during drinking water treatment." *Mutation Research*, 118, 25–41.
- Meier, J. R. and Bull, R. J. (1984). "Mutagenic properties of drinking water disinfectants and byproducts." *EPA/600/D-84/224*, Environmental Protection Agency.
- Meier, J. R., et al. (1985). "Identification of mutagenic compounds formed during chlorination of humic acid." *Mutation Research*, 157, 111–122.
- Meier, J. R. and Bishop, D. F. (1985). "Evaluation of conventional treatment processes for removal of mutagenic activity from municipal wastewaters." *Journal of the Water Pollution Control Federation*, 57, 999–1005.
- Meier, J. R., et al. (1986). "Mutagenic byproducts from chlorination of humic acid." *Environmental Health Perspectives*, 69, 101–107.
- Meier, J. R., et al. (1987). "Studies on the potent bacterial mutagen, 3-chloro-4-(dichloromethyl)-5-hydroxy-2[5H]-furanone: Aqueous stability, XAD recovery and analytical determination in drinking water and in chlorinated humic acid solutions." *Mutation Research*, 189, 363–373.
- Meier, J. R. (1988). "Genotoxic activity of organic chemicals in drinking water." *Mutation Research*, 196, 211–245.
- Meier, J. R., et al. (1990). "Genotoxic and carcinogenic properties of chlorinated furanones: Important byproducts of water chlorination." *Environmental Science Research*, 39, 185–195.

- Meier, J. R., et al. (1996). "Urine mutagenicity and biochemical effects of the drinking water mutagen 3-chloro-4-(dichloromethyl)-5-hydroxy-2[5H]-furanone (MX), following repeated oral administration to mice and rats." *Toxicology*, 110, 59–70.
- Meier, J. R., Stewart, B. E., and Blazak, W. F. (1997). "Genotoxicity studies of sodium dichloroacetate and sodium trichloroacetate." *Environmental Science* (Tokyo), 5, 95–108.
- Melnick, R. L., Boorman, G. A., and Dellarco, V. (1997). "Water chlorination, 3-chloro-4-(dichloromethyl)-5-hydroxy-2[5H]-furanone (MX), and potential cancer risk." *Journal of the National Cancer Institute*, 89, 832–833.
- Melton, R. G., et al. (1981). "Comparison of Grob closed-loop stripping analysis with other trace organic methods." *Advances in the identification and analysis of organic pollutants in water*, Vol. 2, L. H. Keith, ed., Ann Arbor Science, Ann Arbor, MI, 597–673.
- Miltner, R. J., Shukairy, H. M., and Summers, R. S. (1992). "Disinfection byproduct formation and control by ozonation and biotreatment." *Journal of the American Water Works Association*, 84(11), 53–62.
- Minear, R. A. and Amy, G. L., eds. (1996a). *Water disinfection and natural organic matter: Characterization and control* (ACS Symposium Series), Vol. 649, American Chemical Society, Washington, D.C.
- Minear, R. A. and Amy, G. L., eds. (1996b). *Disinfection by-products in water treatment: The chemistry of their formation and control*. Lewis/CRC, Boca Raton, FL.
- Mink, F. L., Coleman, W. E., Munch, J. W., Kaylor, W. H., and Ringhand, H. P. (1983). "In vivo formation of halogenated reaction products following peroral sodium hypochlorite." *Bulletin of Environmental Contamination Toxicology*, 30, 394–399.
- Moudgal, C. J., Lipscomb, J. C., and Bruce, R. M. (2000). "Potential health effects of drinking water disinfection byproducts using quantitative structure toxicity relationship." *Toxicology*, 147, 109–131.
- Mount, D. I. and Anderson-Carnahan, L. (1988). "Methods for aquatic toxicity identification evaluations. Phase I. Toxicity characterization procedures." *EPA/600/3-88/034*, Environmental Protection Agency, Duluth, MN.
- Munch, D. J. and Hautman, D. P. (1995). "Method 551.1: Determination of chlorination disinfection byproducts, chlorinated solvents, and halogenated pesticides/herbicides in drinking water by liquid-liquid extraction and gas chromatography with electron-capture detection." *Methods for the determination of organic compounds in drinking water—Supplement III, EPA/600/R-95/131*, Environmental Protection Agency, Cincinnati, OH.
- Munch, D. J., Munch, J. W., and Pawlecki, A. M. (1995). "Method 552.2: Determination of haloacetic acids and dalapon in drinking water by liquid-liquid extraction, derivatization and gas chromatography with electron capture detection." *Methods for the determination of organic compounds—Supplement III, EPA/600/R-95/131*, Environmental Protection Agency, Cincinnati, OH.
- Munch, J. W., Munch, D. J., Winslow, S. D., Wendelken, S. C., and Pepich, B. V. (1998a). "Method 556. Determination of carbonyl compounds in drinking water by pentafluorobenzylhydroxylamine derivatization and capillary gas chromatography with electron capture detection." *Rev. 1.0*, Environmental Protection Agency, Cincinnati, OH.

- Munch, J. W., Munch, D. J., and Winslow, S. D. (1998b). "A user's guide to aldehyde analysis using PFBHA derivatization and GC/ECD detections: Avoiding the pitfalls." *Proceedings, 1998 Water Quality Technology Conference*, American Water Works Association, 898–913.
- Munch, J. W., Coleman, W. E., Hoadkivic, P. A., Kaylor, W. H., and Meier, J. R. (1988). "Determination of a chlorinated furanone (MX) in treated water." *Proceedings, 1987 Water Quality Technology Conference*, American Water Works Association, 15, 933–942.
- Norwood, D. L., Thompson, G. P., St. Aubin, J. J., Millington, D. S., Christman, R. F., and Johnson, J. D. (1983). "Byproducts of chlorination: Specific compounds and their relationship to total organic halide." *American Chemical Society National Meeting*, Washington, D.C., August 28–September 2.
- Owen, D. M., Amy, G. L., and Chowdhury, Z. K., eds. (1993). *Characterization of natural organic matter and its relationship to treatability*. American Water Works Association, Denver, CO.
- Pawlecki-Vonderheide, A. M., Munch, D. J., and Munch, J. W. (1997). "Research associated with the development of EPA Method 552.2." *Journal of Chromatographic Science*, 35, 293–298.
- Pedersen, E. J., Urbansky, E. T., Mariñas, B. Y., and Margerum, D. W. (1999). "Formation of cyanogen chloride from the reaction of monochloramine with formaldehyde." *Environmental Science and Technology*, 33, 4239–4249.
- Pfaff, J. D. (1993). "Determination of inorganic anions by ion chromatography." *Methods for the determination of inorganic substances in environmental samples, EPA/600/R-93/100*, Environmental Protection Agency.
- Pourmoghaddas, H. (1991). "Project summary: Effect of bromide on chlorination byproducts in finished drinking water." *EPA/600/S2-91/036*, Environmental Protection Agency.
- Pourmoghaddas, H., Stevens, A. A., Kinman, R. N., Dressman, R. C., Moore, L. A., and Ireland, J. C. (1993). "Effect of bromide ion of formation of HAAs during chlorination." *Journal of the American Water Works Association*, 85(1), 82–87.
- Prakash, B., Pepich, B. V., Munch, D., and Frebis, C. (1998). "The performance of a purge and trap-gas chromatography/ion trap mass spectrometry method for the routine analysis of cyanogen chloride in several hundred municipal drinking water samples." *Proceedings, Water Quality Technology Conference*, American Water Works Association, 914–926.
- Raymer, J. H., Pellizzari, E. D., and Shoemaker, J. A. (1999a). "Human exposure to water disinfection byproducts via foods and beverages," Book of abstracts. *218th American Chemical Society National Meeting*, New Orleans, August 22–26.
- Raymer, J. H., Pellizzari, E. D., and Shoemaker, J. S. (1999b). "Analytical methods for water disinfection byproducts in foods and beverages," Book of abstracts. *218th American Chemical Society National Meeting*, New Orleans, August 22–26.
- Reckhow, D. A., Singer, P. C., and Malcolm, R. L. (1990). "Chlorination of humic materials: Byproduct formation and chemical interpretations." *Environmental Science and Technology*, 24, 1655–1664.
- Reckhow, D. A., Legube, B., and Singer, P. C. (1986). "The ozonation of organic halide precursors: Effect of bicarbonate." *Water Research*, 20, 987–998.

- Rice, R. G., Overbeck, P. K., and Larson, K. (1998). "Ozone treatment for small systems." *First International Symposium on Safe Drinking Water in Small Systems*, NSF International/PAHP/WHO, Washington, D.C., May 10–13.
- Richardson, S. D., Thruston, Jr., A. D., Collette, T. W., and McGuire, J. M. (1991). "Application of multispectral techniques to the precise identification of aldehydes in the environment." *Environmental Toxicology and Chemistry*, 10, 991–997.
- Richardson, S. D., et al. (1994). "Multispectral identification of chlorine dioxide disinfection byproducts in drinking water." *Environmental Science and Technology*, 28, 592–599.
- Richardson, S. D., Thruston, Jr., A. D., Collette, T. W., Patterson, K. S., Lykins, Jr., B. W. (1995). "Alternative disinfectants for drinking water," Book of abstracts. *210th American Chemical Society National Meeting*, Chicago, IL, August 20–24.
- Richardson, S. D., Thruston, Jr., A. D., Collette, T. W., Patterson, K. S., Lykins, Jr., B. W., and Ireland, J. C. (1996). "Identification of TiO<sub>2</sub>/UV disinfection byproducts in drinking water." *Environmental Science and Technology*, 30<sup>2</sup>, 3327–3334.
- Richardson, S. D. (1998a). "Drinking water disinfection byproducts." *Encyclopedia of environmental analysis and remediation*, R. A. Meyers, ed., John Wiley & Sons, New York, 1398–1421.
- Richardson, S. D., et al. (1998b). "Identification of new disinfection byproducts using GC/MS, LC/MS, and GC/IR." *Proceedings, Annual Conference of the American Water Works Association, Water Quality*, 2223–2234.
- Richardson, S. D. (1999). "Water analysis." *Analytical Chemistry*, 71, 181R–215R.
- Richardson, S. D., Caughran, T. V., Poiger, T., Guo, Y., and Crumbley, F. G. (1999a). "Identification of polar drinking water disinfection byproducts using LC/MS," Book of abstracts. *217th American Chemical Society National Meeting*, Anaheim, CA, March 21–25.
- Richardson, S. D., et al. (1999b). "Identification of new drinking water disinfection byproducts formed in the presence of bromide." *Environmental Science and Technology*, 33, 3378–3383.
- Ringhand, H. P., et al. (1988a). "Biological and chemical studies on 3-chloro-4-(dichloromethyl)-5-hydroxy-2(5H) furanone: A potent mutagen in kraft pulp chlorination effluent and chlorinated drinking water." *Hazardous Industrial Waste*, 20, 420–433.
- Ringhand, H. P., Meier, J. R., Coleman, W. E., Schenck, K. M., and Kaylor, W. H. (1988b). "Biological and chemical studies on 3-chloro-4-(dichloromethyl)-5-hydroxy-2(5H) furanone: A potent mutagen in kraft pulp chlorination effluent and chlorinated drinking water." *EPA-600/D-88/159*, Environmental Protection Agency.
- Ringhand, H. P., et al. (1989). "Studies on MX: A potent mutagenic byproduct of the chlorination of drinking water and kraft pulp mill effluents." *Trace Substances in Environmental Health*, 23, 269–267.
- Roberson, J. A., et al. (1995). "The D/DBP Rule: Where did the numbers come from?" *Journal of the American Water Works Association*, 87(10), 46–57.
- Rubio, F. J., Urbansky, E. T., and Magnuson, M. L. (2000). "Avoiding pitfalls in the determination of halocarboxylic acids: The photochemistry of methylation." *Journal of Environmental Monitoring*, 2, 248–252.
- Schenck, K. M., Meier, J. R., Ringhand, H. P., and Kopfler, F. C. (1990). "Recovery of 3-chloro-4-(dichloromethyl)-5-hydroxy-2(5H) furanone from water samples on XAD resins and the effect of chlorine on its mutagenicity." *Environmental Science Technology*, 24, 863–867.

- Schenck Patterson, K. and Lykins, Jr., B. W. (1993). "The role of mutagenicity in determining drinking water quality." *Proceedings, Annual Conference of the American Water Works Association, Water Quality*, 809–830.
- Schenck Patterson, K., Lykins, Jr., B. W. and Richardson, S. D. (1995). "Mutagenicity of drinking water following disinfection." *Journal of Water Supply, Research, and Technology–Aqua* (London), 44, 1–9.
- Schenck Patterson, K. and Lykins, Jr., B. W. (1995). "Mutagenicity of drinking water samples treated with alternative disinfectants." *Environmental and Molecular Mutagenesis*, 25, 41–48.
- Seeger, D. R., Moore, L. A., and Stevens, A. A. (1984a). "The formation of acidic trace organic byproducts from the chlorination of humic acids." *Fifth Water Chlorination Conference: Environmental Impact and Health Effects*, Williamsburg, VA, June 3–8.
- Seeger, D. R., Moore, L. A., and Stevens, A. A. (1984b). "The formation of acidic trace organic byproducts from the chlorination of humic acids." *EPA/600/D-84/159*, Environmental Protection Agency.
- Shoemaker, J. A., Munch, J. W., and Behymer, T. D. (1999). "Evaluation of solid phase microextraction for the analysis of hydrophilic compounds." *Journal of Exposure Analysis and Environmental Epidemiology*, 9, 181–191.
- Shorney, H. L. and Freeman, S. (1999). "Control of disinfection byproduct precursors." <[http://www.epa.gov/rgytgrnj/programs/wwpd/workshop99/epa8\\_3\\_99.pdf](http://www.epa.gov/rgytgrnj/programs/wwpd/workshop99/epa8_3_99.pdf)>.
- Singer, P. C., ed. (1999). *Formation and control of disinfection by-products in drinking water*. American Water Works Association, Denver, CO.
- Slocum, C. J., Moore, L. A., and Stevens, A. A. (1988). "Analytical criteria for detection of disinfection byproducts." *Proceedings, 1987 Water Quality Technology Conference, American Water Works Association* (Issue Answers Today's Water Quality Profession), 829–838.
- Snyder, M. P. and Margerum, D. W. (1982). "Kinetics of chlorine transfer from chloramine to amines, amino acids, and peptides." *Inorganic Chemistry*, 21, 2545–2550.
- Solarik, G., Hatcher, V. A., Isabel, R. S., Stile, J. F., and Summers, R. S. (1997). "Prechlorination and DBP formation: The impact of chlorination point and enhanced coagulation." *Proceedings, Water Quality Technology Conference, American Water Works Association*, 2B1/1-2B1/19.
- Sorrell, R. K. and Hautman, D. P. (1993). "A simple concentration technique for the analysis of bromate at low levels in drinking water." *Proceedings, Annual Conference of the American Water Works Association, Water Quality*, 281–290.
- Stevens, A. A. (1984). "TOX (total organic halogen). Is it the non-specific parameter of the future?" *EPA/600/D-84/169*, Environmental Protection Agency.
- Stevens, A. A. and Symons, J. M. (1984b). "Alternative disinfection processes." *EPA/600/D-84/221*, Environmental Protection Agency.
- Stevens, A. A., Moore, L. A., Slocum, C. J., Smith, B. L., Seeger, D. R., and Ireland, J. C. (1989). "Chlorinated humic acid mixtures: Criteria for detection of disinfection byproducts in drinking water." *Advances in Chemistry Series*, 219, 681–695.
- Stevens, A. A., Moore, L. A., Slocum, C. J., Smith, B. L., and Seeger, D. R. (1987). "Chlorinated humic acid mixtures establish criteria for detection of disinfection byproducts in drinking water." *EPA/600/D-87/142*, Environmental Protection Agency.

- Stultz, M. L., et al. (1998). "DBP analyses for the ICR: How well are labs doing?" *Proceedings, Water Quality Technology Conference*, American Water Works Association, 1471–1479.
- Summers, R. S., Hooper, S. M., Shukairy, H. M., Solarik, G., and Owen, D. (1996). "Assessing DBP yield: Uniform formation conditions." *Journal of the American Water Works Association*, 88(6), 80–93.
- Symons, J. M., ed. (1997). *Factors affecting disinfection by-product formation during chloramination*. American Water Works Association Research Foundation, Denver, CO.
- Symons, J. M., et al. (1998). *Factors affecting disinfection byproduct formation during chloramination*. American Water Works Association Research Foundation, Denver, CO.
- Trehy M. L., Yost, R. A., and Miles, C. J. (1986). "Chlorination byproducts of amino acids in natural waters." *Environmental Science Technology*, 20, 1117–1122.
- Ulmer, N. S., Dressman, R. C., Moore, L. A., and Stevens, A. A. (1988). "Problems in the determination of haloacetic acids and chloral hydrate in drinking water." *Proceedings, 1987 Water Quality Technology Conference*, American Water Works Association (Issue Answers Today's Water Quality Profession), 741–750.
- Urbansky, E. T. (1999). "Ascorbic acid treatment to reduce residual halogen-based oxidants prior to the determination of halogenated disinfection byproducts in potable water." *Journal of Environmental Monitoring*, 1, 471–476.
- Urbansky, E. T. and Bashe, W. J. (2000). "Comparative methodology in the determination of the  $\alpha$ -oxocarboxylates in aqueous solution: Ion chromatography versus gas chromatography after oximation extraction and esterification." *Journal of Chromatography A*, 867, 143–149.
- Urbansky, E. T. and Brown, S. K. (2000). "Influence of reagent purity on the ion chromatographic determination of bromate in water using the prochromophore 3,3-dimethoxybenzidine for photometric detection." *Journal of Environmental Monitoring*, 2, 571–575.
- Urbansky, E. T., Magnuson, M. L., Elovitz, M. S., Freeman, D., and Shauntee, J. (2000a). "Interferences due to ozone-scavenging reagents in the GC-ECD determination of aldehydes and ketones as the *O*-(2,3,4,5,6-pentafluorobenzyl)oximes." *Ozone: Science and Engineering*, 2000A, 22, 551–561.
- Urbansky, E. T., Freeman, D. M., and Elovitz, M. S. (2000b). "Ozone-scavenging reagents suitable for use in the determination of aldehydes as the *O*-(2,3,4,5,6-pentafluorobenzyl) oximes by GC-ECD." *Water Research*, 34, 2610–2613.
- Urbansky, E. T., Freeman, D. M., and Rubio, F. J. (2000c). "Ascorbic acid reduction of residual active chlorine in potable water prior to halocarboxylate determination." *Journal of Environmental Monitoring*, 2, 253–256.
- Urbansky, E. T. (2000d). "Influences of metal cations on the determination of the  $\alpha$ -oxocarboxylates as the methyl esters of the *O*-(2,3,4,5,6-pentafluorobenzyl)oximes by gas chromatography: The importance of accounting for matrix effects." *Journal of Environmental Monitoring*, 2, 334–338.
- Urbansky, E. T. (2000e). "Techniques and methods for determining haloacetic acids in potable water." *Journal of Environmental Monitoring*, 2, 285–291.
- Urbansky, E. T. (2000f). "Disinfection byproducts in drinking water." *Analytical Chemistry*, 72, 439A–440A.



- Urbansky, E. T. (2000g). "Modeling the fate and transformation of the haloacetates—fundamental chemical kinetics." (Submitted for publication.)
- Urbansky, E. T. (2000h). "Carbinolamines and geminal diols in environmental chemistry." *Journal of Chemical Education*, 77(12), 1644–1647.
- Urbansky, E. T. (2001). "Total carbon analyzers as tools for measuring carbonaceous matter in natural waters." *Journal of Environmental Monitoring*, in press.
- U.S. Environmental Protection Agency (USEPA). (1989). "Drinking water criteria document for chloramines." *ECAO/600/D002*.
- USEPA. (1992). "Water treatment plant simulation program, Version 1.21." Office of Water.
- USEPA. (1994). "Water treatment plant model for MS Windows 3.1, Version 1.55." *EPA/811/B-94/001*.
- USEPA. (1996). "Drinking water regulations and health advisories." *EPA/882/B-96/002*.
- USEPA. (1997). "Community water system survey—Volumes I and II; Overview." *EPA/815/R-97-001a, -001b*.
- USEPA. (1999a). "Alternative disinfectants and oxidants guidance manual." *EPA/815/R-99/014*.
- USEPA. (1999b). "Microbial and disinfection byproduct rules simultaneous compliance guidance manual." *EPA/815/R-99/011*.
- Wachter, J. K. and Andelman, J. B. (1984). "Organohalide formation on chlorination of algal extracellular products." *Environmental Science Technology*, 11, 811–817.
- Wagner, H. P., Alig, A. E., Pepich, B. V., Frebis, P. C., Hautman, D. P., and Munch, D. (1998). "A study of ion chromatographic methods for trace level bromate analysis in drinking water comparing the selective anion concentration (SAC) method, U.S. EPA Method 300.1, and a postcolumn reagent procedure." *Proceedings, Water Quality Technology Conference*, American Water Works Association, 872–876.
- Wagner, H. P., Pepich, B.V., Hautman, D. P., and Munch, D. J. (1999). "Analysis of 500 ng/L levels of bromate in drinking water by direct-injection suppressed ion chromatography coupled with a single, pneumatically delivered postcolumn reagent." *Journal of Chromatography A*, 850, 119–129.
- Waller, K., Swan S., DeLorenze G., and Hopkins B. (1998). "Trihalomethanes in drinking water and spontaneous abortion." *Epidemiology*, 9, 134–140.
- Weinberg, H. S. (1999). "Disinfection byproducts in drinking water: The analytical challenge." *Analytical Chemistry*, 71, 801A–808A.
- White, G. C. (1999). *Handbook of chlorination and alternative disinfectants*, 4th Ed., John Wiley & Sons, New York.
- Wong, C. S., Garrison, A. W., and Richardson, S. D. (1999). "Enantiomeric composition of chiral haloacetic acid and haloacetonitrile disinfection byproducts in drinking water," Book of abstracts. *217th American Chemical Society National Meeting*, Anaheim, CA, March 21–25.
- Xu, G., Stevens, D. K., and Bull, R. J. (1995). "Metabolism of bromodichloroacetate in B6C3F1 mice." *Drug Metabolism and Disposition*, 23, 1412–1416.



## CHAPTER 4

# Source Water Protection: Its Role in Controlling Disinfection By-Products (DBPs) and Microbial Contaminants<sup>1</sup>

### Introduction

Passage of the 1996 Safe Drinking Water Act Amendments (SDWAA) has focused the attention of water utility managers and public health and regulatory officials on source water protection (SWP) and its role in protecting public water supplies. There is growing awareness that water treatment and/or disinfection may not always be enough to ensure the provision of potable and safe water to the consumer. The 1993 cryptosporidiosis outbreak in Milwaukee, WI, has raised the possibility that even water suppliers which meet all of the Surface Water Treatment Rule (SWTR) requirements of the SDWA are vulnerable (Okun et al. 1997; Fox and Lytle 1996).

Most utilities in the U.S. invest a great deal of time, energy, and capital in developing mechanisms for protecting against the impact of sudden changes in influent water quality. Some of these mechanisms include investment in excess capacity and development of emergency procedures (Miller 1989).

Concern over source water protection is not limited to surface water supplies. Many ground water supplies have proven to be vulnerable as well, resulting in the various states implementing wellhead protection programs. Based on the 1996 amendments, the states will have to implement programs to decide if a system's source of supply is threatened as well as determine the means to prevent pollution. Communities will be allowed to ask for state assistance, and a certain percentage of the State Revolving Loan Fund has been earmarked to assist with source water protection (Howell 1997).

Water supplies vary greatly in the nature of the source water they use and in the circumstances under which they provide water to their customers. Nevertheless, there are some common elements that are applicable to source water protection in general. For example, land-use planning can provide information that is related to source water protection. Information on population densities, the ratio of pervious to impervious land cover, and the location of point and non-point sources of pollution can be important in assessing problems associated with both ground and surface source water protection.

As part of the Clean Water Act (CWA), Comprehensive River Basin Planning was initiated under Section 208 of the CWA. A major effort was undertaken to bring to bear the existing art and science of comprehensive planning in river basins with regard to minimizing the impact of point and non-point pollution on water quality in streams, lakes, and ground water. Many of the approaches suggested in studies developed under this program are very relevant to the issue of source water protection today.

Stream and contaminant transport models provide a mechanism for identifying and assessing the pollutants that are likely to be present in surface sources used for water supply. These models can be used for (1) identification of communities whose water supplies could be vulnerable to contamination resulting from industrial and municipal discharges or urban and agricultural runoff, (2) design of water and wastewater treatment plants, (3) design and implementation of water quality monitoring programs, and (4) other water resource planning efforts requiring information on the quality of surface waters (Clark et al. 1998).

---

<sup>1</sup>Michael Borst, Maureen Krudner, Marie L. O'Shea, Joyce M. Perdek, Donald Reasoner, Michael D. Royer: ORD/NRMRL/WSWRD, 2800 Woodbridge Ave., Edison, NJ, 08837-3679. Corresponding Author: Michael Borst, 732-321-6631, borst.michael@epa.gov.

This chapter will explore SWP as outlined in the Safe Drinking Water Act (SDWA): the nature of threats to source water quality; methods, monitoring, and assessment of pathogens; technologies for control of water quality; the use of models to assess water utility vulnerability; and the relationship of source water protection to watershed management.

## **The Safe Drinking Water Act and Source Water Protection**

The SDWA was passed in 1974 and amended in 1986 and 1996, but SWP under the SDWA actually began with the SDWA Amendments of 1986. The 1986 amendments included provisions for “Protection of Ground Water Sources of Water.” Two programs were set up under this requirement: the “Sole Source Aquifer Demonstration Program,” to establish demonstration programs to protect critical aquifer areas from degradation; and the “Wellhead Protection Program,” which required states to develop programs for protecting areas around public water supply wells to prevent contamination from residential, industrial, and farming activities.

The SWTR, published in June 29, 1989, and effective December 31, 1990, was designed to prevent waterborne diseases caused by viruses, *Legionella*, and *Giardia lamblia*. These disease-causing organisms are present in varying concentrations in most surface waters. This rule requires water systems to filter and disinfect water from surface water sources to reduce the occurrence of unsafe levels of these microbes. Surface water is particularly susceptible to microbial contamination from sewage treatment plant discharges, storm water runoff, and snow melt. The rule sets nonenforceable health goals and maximum contaminant level goals (MCLGs) for viruses, *Legionella*, and *Giardia lamblia* at zero because any amount of exposure to these contaminants represents some health risk. In establishing legal limits for these contaminants in drinking water, the U.S. Environmental Protection Agency (EPA) can set either a maximum contaminant level (MCL), which is a legal limit, and require monitoring for the contaminant in drinking water, or, for those contaminants that are difficult to measure, EPA can establish a treatment technique requirement. Since measuring disease-causing microbes in drinking water is not considered to be feasible, EPA established a treatment technique in this rule.

The SWTR Guidance Manual (USEPA 1991) identifies both natural and human-caused sources of contamination to be controlled. These sources include wild animal populations, wastewater treatment plants, grazing animals, feedlots, and recreational activities. The Guidance Manual recommends that grazing and sewage discharges not be permitted within the watershed of unfiltered systems. Both may be permissible on a case-by-case basis where the watershed provides a long detention time and a high dilution between the location of the activity and the water intake. The nonfiltering utility is required to develop state-approved techniques to eliminate or reduce the effect of the identified point and non-point pathogenic contamination sources.

In the 1996 amendments to the SDWA, protection of source waters was given greater emphasis to strengthen protection against microbial contaminants, particularly *Cryptosporidium*, while reducing potential health risks due to disinfection by-products. This increased protection is embodied in the Interim Enhanced SWTR (IESWTR) (USEPA 1998). This rule applies to public water systems that use surface water or ground water under the direct influence of surface water (GWUDI) and serve at least 10,000 people. The final IESWTR (USEPA 1998), issued December 16, 1998, and effective February 16, 1999, includes several requirements specific to finished drinking water, and three that relate to watershed protection. EPA is to

- set a MCLG of zero for *Cryptosporidium*
- require a 2-log oocyst removal for drinking water systems that filter
- include *Cryptosporidium* in the watershed control requirements for unfiltered public water systems (Filtration Avoidance Criteria [FAC])

- require covers on new finished water reservoirs
- set other requirements that build upon the SWTR's treatment technique requirements

States are to

- conduct sanitary surveys for all surface water systems, regardless of size

The watershed control program for *Cryptosporidium* must identify watershed characteristics and activities that may have an adverse effect on source water quality and monitor the occurrence of activities that may have an adverse effect on source water quality. The state must determine whether the established watershed control program is adequate to limit potential contamination by *Cryptosporidium* oocysts.

The 1996 SDWA amendments also included four prevention approaches as part of establishing a new charter for protecting the nation's public water systems: SWP, State Ground Water Protection, Capacity Development, and Operator Certification. The SWP approach established a new Section 1453 for source water quality assessments. States with public water supply (PWS) primacy were required to submit source water assessment program plans for EPA approval. A state assessment program is required to (1) delineate the boundaries of the areas providing source waters for public water systems, (2) identify, to the extent practicable, the origins of regulated and certain unregulated contaminants in the delineated area, and (3) determine the susceptibility of public water systems to the identified contaminants. Assessments are to be completed for all public water systems within two years after EPA approval of the state's program. To avoid duplication, assessments may make use of sanitary surveys, state well-head protection programs, pesticide state management plans, state watershed initiatives including efforts under the SWTR, and efforts under the Federal Water Pollution Control Act, commonly referred to as the CWA. Section 1453 provides a number of additional features that may be used to assist the state in promoting and developing SWP programs.

In support of the Microbial-Disinfection By-Products (M-DBP) rule-making process, the Information Collection Rule (ICR) was promulgated (May 14, 1996; 61 FR 24354; effective June 18, 1996) to collect occurrence and treatment information to help evaluate the need for possible changes to the current SWTR and existing microbial treatment practices, and to help evaluate the need for future regulation for disinfectants and disinfection by-products (D/DBPs) (USEPA 1996a). The ICR pertains to large public water systems serving at least 100,000 people, and a more limited set of ICR requirements pertain to ground water systems serving between 50,000 and 100,000 people. About 300 PWSs operating 500 treatment plants were involved in the extensive data collection required under the rule. Surface water systems were required to monitor for microbials, including bacteria, viruses, and protozoa (*Giardia* and *Cryptosporidium*), and for disinfection by-products (DBPs), including trihalomethanes (THMs) and haloacetic acids (HAAs). This rule is intended to provide EPA with information on the occurrence in drinking water of microbial pathogens and DBPs. In addition, EPA collected engineering data on how PWSs currently control such contaminants as part of the ICR.

Under the ICR, PWSs were required to monitor source and treated water for the designated contaminants for a period of 18 months. The 18-month monitoring period started in July 1997. PWSs were required to conduct finished water monitoring at any treatment plant at which it detected, during the first 12 months of monitoring, 10 or more *Giardia* cysts, 10 or more *Cryptosporidium* oocysts, or one or more total culturable viruses per liter of water. The PWSs were to analyze finished water samples for the same organisms analyzed in source water until 18 months of source water microbial monitoring were completed. The data were placed in the ICR Federal Database, available to the public at the following Internet address: <http://www.epa.gov/safewater/icr.html>.

Finally, consistent with the emphasis on source water protection, a rule to control public health risk from contaminated ground water was included under the SDWA amendments of 1996. An informal draft of the Ground Water Rule (GWR) preamble was posted on the Internet in February 1999. The proposed GWR was published in May, 2000, for public comment (EPA 2000c). This rule specifies the appropriate use of disinfection in ground water and addresses other components of ground water systems to assure public health protection. The GWR establishes multiple barriers to protect against bacteria and viruses in drinking water from ground water sources and will establish a targeted strategy to identify ground water systems at high risk for fecal contamination. The final GWR was scheduled to be issued in November of 2000, but has not yet been promulgated.

The proposed GWR provides several requirements to assure public health protection. These are

- Sanitary surveys to be conducted by the state and identification of significant deficiencies (every 3 years for community water systems, 5 years for non-community water systems; this is consistent with the IESWTR).
- Hydrogeologic sensitivity assessments for undisinfected systems.
- Source water microbial monitoring by systems that do not disinfect and draw from hydrogeologically sensitive aquifers or have detected fecal indicators within the distribution system.
- Corrective action by any system with significant deficiencies or positive microbial samples indicating fecal contamination.
- Compliance testing for systems which disinfect to ensure that they reliably achieve 4-log (99.99%) inactivation or removal of viruses.

Full details of these requirements will be found in the final rule when published.

## **Threats to Source Water Quality**

Two major threats to source water quality with respect to DBP control and microbial protection are natural organic matter and microbial pathogens. The impacts, sources, and challenges to the management of the former are discussed below. The remaining portions of this chapter will address microbial contamination in more detail, in particular contamination by the pathogens *Giardia* and *Cryptosporidium*.

### ***Natural Organic Matter and DBPs***

DBPs occur due to the reaction of disinfectants with naturally occurring organic matter (NOM) that is present in all surface waters. Under the Stage 1 Disinfectants/Disinfection By-Product Rule promulgated under the 1996 amendments to the SDWA, water utilities must reduce NOM concentrations, expressed as total organic carbon (TOC), in their raw water to certain specified levels before chlorine is applied for disinfection (Hoehn et al. 1994). Minimum TOC removal requirements vary according to the source water TOC concentration and alkalinity, but range between 20–50% (Hoehn et al. 1994). Since the type and extent of required prechlorination treatment and the ability of a utility to meet the maximum contaminant levels for THMs are dictated by the quality of the raw water, attention has recently focused on understanding, characterizing, and controlling the sources of NOM (Hoehn et al. 1994; Stepczuk et al. 1998; Krasner et al. 1996; Minear and Amy 1996).

Sources of NOM in receiving waters can be broadly categorized as either allochthonous (originating outside the receiving water) or autochthonous sources (originating within the receiving water). Examples of the former include watershed sources such as soils, leaves, and plant remains that are transported to the receiving water by runoff or by tributaries, while autochthonous sources include algal matter, aquatic animals, and bacteria (Cooke and Carlson 1989; Cooke et al. 1988; Hoehn et al. 1994).

The relative importance of NOM sources to the total TOC and THM concentration will vary between receiving waters; Hoehn et al. (1994) provide several examples for a variety of watersheds and receiving waters. Past research has indicated that algae are as potent as humic and fulvic acids from allochthonous sources (Graham et al. 1998; Hoehn et al. 1994) and suggests that, for eutrophic water bodies subject to high nutrient loading from their watersheds, algae is likely to be the greatest source of DBP precursors during the growing season (i.e., spring to fall). Recent modeling efforts by New York City's Department of Environmental Protection for their Cannonsville Reservoir demonstrates the need for nutrient loading to be considered in the management control of THMs for eutrophic reservoirs (Stepczuk et al. 1998).

Anthropogenic loadings of nutrients into our nation's atmosphere and aquatic and terrestrial ecosystems have increased dramatically within the past few decades. Significant watershed loadings are associated with both point and nonpoint sources. Examples of the former include municipal point sources such as sewage treatment facilities offering secondary treatment that characteristically provide minimal nutrient removal; storm water that is enriched from the wet and dry atmospheric deposition of nutrients; combined sewers that discharge nutrient-enriched sanitary sewage and rainwater; industrial discharges; and particulate nutrients associated with runoff from construction sites. Nonpoint or diffuse sources that can be locally important include runoff from overfertilized agricultural lands; animal pastures and waste lagoons; storm water runoff from unsewered communities; septic tank and landfill leachate; particulate nutrients from sediment erosion; atmospheric deposition from mobile sources (e.g., automobiles), power facilities, and confined animal-feeding operations; and nitrogen emissions from receiving waters and terrestrial ecosystems.

Challenges to managing the risk posed by nutrients include the determination of which nutrient to control and by how much; the relative importance of sources (i.e., the relative bioavailability of a source's nutrient load); how the relative importance and abundance of these sources vary spatially and seasonally; and the determination of where and when controls are most needed. Since it is typically the dissolved form of nutrients that are most bioavailable (i.e., most capable of fueling eutrophication), many traditional point and nonpoint source pollution controls that are aimed at removing solids and solids-associated pollutants may be minimally effective at controlling nutrients. In addition, many pollutant controls that remove selected pollutants (e.g., solids, metals) may inadvertently fuel eutrophication through the removal of non-nutrient growth factors (e.g., reduced turbidity removing light transmission limitations). Prior to the successful management of nutrients from both point and nonpoint sources, information is required on the relative importance (i.e., bioavailability) of nutrient sources; when (i.e., which season) controls need to be most effective to prevent ecosystem overfertilization; where in the watershed should controls be placed to maximize the cost-effective control; which pollution controls, best management practices (BMPs), and pollution prevention techniques are most effective at removing the bioavailable forms of nutrients during the critical periods when these loads make their maximum contribution to overfertilization; and the costs and cost effectiveness of these controls, practices, and techniques.

Protocol presently exists for determining numeric nutrient loading targets for a given waterbody (USEPA 1999c); however, the process is not a straightforward one. Research is currently planned that will determine which nutrient(s) to control and by how much for the nation's ecoregions (Garber et al. 1999). Once the nutrient(s) that limit eutrophication have been determined; numeric targets defined; continuous, episodic, and seasonal inputs of natural and anthropogenic sources characterized; and cycling processes identified and their relative importance understood, managers can develop waste load/load allocations and a management plan aimed at achieving the desired reductions for the identified sources. Management options for the control of nutrient sources include point-sources controls (e.g., upgrades at water pollution control plants, emissions controls, etc.); the use of structural and nonstructural BMPs for the control or treatment of nonpoint and diffuse sources; land use controls aimed at decreas-

ing population density, protecting vulnerable areas, or maintaining the assimilation capacity of natural ecosystems; and the restoration of ecosystems capable of intercepting and assimilating nitrogen loads (e.g., riparian zones, forests, or wetlands).

Although BMPs are often employed to treat nonpoint sources of watershed pollutants, including nutrients, significant uncertainty is associated with their ability to control this stressor with removals ranging from 10–90% for some of the more common structural BMPs (Griffen 1993). For this reason, nutrient controls are often targeted at point sources where less uncertainty is associated with both expected removals and costs. Non-site specific factors that may influence the effectiveness of BMPs includes their age, capacity, maintenance, and design specifications. Watershed-specific characteristics that can influence effectiveness include soil characteristics; land use; land cover; climate; site location relative to receiving waters; soil processes and ground water hydrology that can influence pollutant infiltration, decomposition, adsorption, and transport; and biogeochemical processes that may differ between drainage basins (Fisher et al. 1992). When many BMPs are applied to different locations within a watershed, it is still more difficult to predict their integrated effects, and few studies have examined BMP effectiveness for nutrient control on a watershed scale (Edwards et al. 1997; Griffin 1995).

In watersheds where surface waters have been degraded by excessive nutrient inputs, land-use controls are often recommended as a means by which to limit future point and nonpoint nutrient inputs (Minei and Dawydiak 1997). Common controls include the purchasing of farmland development rights; the conservation of forests, wetlands, and riparian lands; and changes in zoning. Where available, watershed models calibrated to actual data or regional or national estimates are often used to predict the pollution potential of various land-use scenarios (Houlahan et al. 1992; Preston 1996; Corbett et al. 1997; Valiela et al. 1997). However, as with BMPs, there may be considerable uncertainty associated with these “alternative futures analyses,” in particular where models rely on national or nonlocal estimates of export coefficients.

Restoration of natural features (e.g., riparian forests and wetlands) are often part of management plans aimed at controlling the transport of nutrients to receiving waters. However, the effectiveness of these features at capturing nutrients from upland land uses can be influenced by a number of factors including the magnitude of loadings relative to ecosystem structure (Hopkinson 1992); the relative distribution of natural ecosystems, e.g., uphill versus downhill (Correll et al. 1992); and the infiltration or contact between ground water and root systems (Peterjohn and Correll 1986).

Finally, as the focus of controls shift from point to nonpoint management, the behavior of urban and suburban private land owners may often determine the success of nonpoint and diffuse source control efforts. Although there is recent awareness that economic and social considerations play an important role in the success of nutrient management efforts, few studies have evaluated the role of values, knowledge, income, or other circumstances in an individual’s nutrient use and disposal, or the effectiveness of education and economic or other incentives aimed at reducing nutrient loads.

### ***Pathogen Contamination***

The potential sources of pathogens in source water are many and varied including nonpoint source runoff, discharges from treated and untreated sewage, and combined sewer overflows. From a waterborne outbreak and public health viewpoint, both *Giardia* and *Cryptosporidium* are of primary concern.

*Cryptosporidium* is ubiquitous in the environment. Runoff from unprotected watersheds and treated and untreated sewage discharges transports these microorganisms to water bodies used as intake sites for drinking water supplies. Oocysts resist inactivation by commonly used disinfection practices and temperature extremes (Fayer 1994; Fayer and Nerad 1996). As indicated above, *Cryptosporidium* in



source water, particularly source water serving unfiltered surface water systems, requires special attention mandated by EPA's IESWTR (USEPA 1998).

In the U.S., *Giardia* is the most commonly identified pathogen in waterborne disease outbreaks (LADWP 1996). Contamination of a water supply by *Giardia* can occur in two ways: by the activity of animals, particularly beavers, in a watershed or by the introduction of sewage into the water supply.

For many years, detection and enumeration methods for microbial agents in water focused largely on sanitary indicator bacteria, primarily the total and fecal coliforms, *E. coli* and fecal enterococci. Bacterial pathogens such as *Salmonella*, *Shigella*, *E. coli* 0157:H7, and *Campylobacter* have received some attention due to waterborne illness outbreaks. However, other bacteria, viruses, or protozoan pathogens received very little attention until waterborne outbreaks caused by them were documented.

The occurrence of waterborne disease outbreaks has been the key driver of sanitary microbiology research throughout the past 100 years in the U.S. The most recent waterborne pathogens to arrive on the scene have been the pathogenic protozoa, *Giardia lamblia* and *Cryptosporidium parvum*. Contamination of the soil and aquatic environments occurs through shedding of *Giardia* cysts and *Cryptosporidium* oocysts by infected animals, including man. Control of the occurrence of these pathogens in watersheds and their surface waters will be difficult since many animals have been shown to be infected by these organisms, and human sewage contains sizeable concentrations of cysts and oocysts depending on the level of infection in the community. There may be other waterborne protozoan pathogens to be concerned about as indicated by the research being stimulated by the Contaminant Candidate List, finalized in 1998 (63 FR 10274) by the EPA Office of Ground Water and Drinking Water (USEPA 1998b). This section presents background information on waterborne outbreaks due to *Giardia* and *Cryptosporidium* and on the occurrence of these organisms in surface waters used as drinking water sources, storm water run-off, sewage, and combined storm water-sewage overflows (CSOs).

Giardiasis outbreaks were gradually recognized during the period from 1961–1980 (Craun 1986). Diagnosis was by fecal examination of patients, and there was no suitable method for detection of the cysts in environmental water samples. The first identified cryptosporidiosis outbreak occurred in the United Kingdom (U.K.) in 1983, while the first U.S. outbreak of cryptosporidiosis occurred in Braun Station, TX, in 1984 (Lisle and Rose 1995). *Giardia* and *Cryptosporidium* were both formerly thought to be harmless commensals, and it took some time for sufficient information to be developed that showed them to be disease agents. Since 1984, there have been numerous outbreaks of waterborne cryptosporidiosis, including the massive Milwaukee, WI, outbreak in 1993 that affected 403,000 people. In addition, *Giardia* continues to be one of the most frequently identified etiologic agents of gastrointestinal illness due to contaminated drinking water.

The number of waterborne giardiasis and cryptosporidiosis outbreaks that have occurred in the U.S. since 1960 are shown in Table 4-1. The outbreak data in Table 4-1 include both drinking water and recreational water outbreaks. *Cryptosporidium* oocysts, although much smaller (4–6 µm) than *Giardia* cysts (10–14 µm), behave much the same as *Giardia* cysts with regard to physical removal processes in drinking water treatment, but are much more resistant to chemical disinfection than are *Giardia* cysts. However, to assure maximum removal of *Cryptosporidium* oocysts during water treatment, the physical processes must be optimized and consistently operated. Cysts and oocysts can be detected in a sample using the same methodology, although the detection methodology needs much improvement. The number of reported *Giardia* outbreaks tended to increase from year to year once it was acknowledged as a waterborne pathogen. With *Cryptosporidium*, no such trend has been evident, but this may be due to the lack of a good detection method or to other, as yet poorly understood, factors including environmental survival of oocysts, viable and noninfective versus viable and infective oocysts, a high rate of inapparent infections, and infective dose variation due to both the strain of *Cryptosporidium parvum* and individual host susceptibility.

**Table 4-1. Summary of U.S. Drinking Water and Recreational Waterborne Disease Outbreaks Due to *Giardia* and *Cryptosporidium***

Date	Parasite	No. Outbreaks	No. Cases	References
1961–1965	<i>Giardia</i>	1	123	Craun et al. 1986
1966–1970	<i>Giardia</i>	2	53	Craun et al. 1986
1971–1975	<i>Giardia</i>	13	5,136	Craun et al. 1986
1976–1980	<i>Giardia</i>	26	14,416	Craun et al. 1986
1981–1988	<i>Giardia</i>	120	573	Herwaldt et al. 1991
	<i>Cryptosporidium</i>	2	14,966	Lisle and Rose 1995
1989–1990	<i>Giardia</i>	7	697	Herwaldt et al. 1991
	<i>Cryptosporidium</i>	0	0	Herwaldt et al. 1991
1991–1992	<i>Giardia</i>	8	157	Moore et al. 1994
	<i>Cryptosporidium</i>	5	3,526	Moore et al. 1994
1993–1994	<i>Giardia</i>	9	526	Kramer et al. 1996
	<i>Cryptosporidium</i>	9	403,930	Kramer et al. 1996
1995–1996	<i>Giardia</i>	3	1,536	Levy et al. 1998
	<i>Cryptosporidium</i>	6	8,572	Levy et al. 1998

Several factors likely account for the increases in the number of reported waterborne outbreaks of both giardiasis and cryptosporidiosis, including (1) recognition that *Giardia lamblia* and *Cryptosporidium parvum* are human pathogens; (2) recognition as waterborne pathogens (first recognized waterborne giardiasis outbreak, 1964–65, first recognized cryptosporidiosis outbreak, 1983 in the U.K. and 1984 in the U.S.); (3) improved detection methodology; and (4) improved surveillance and reporting. Good background articles on *Giardia* and *Cryptosporidium* in water were written by Lin (1985) and Rose (1988), respectively. An extensive review of *Cryptosporidium* spp. and cryptosporidiosis in animals was published by Fayer and Ungar (1986) and Fayer (1997). Marshall et al. (1997) published a review of waterborne protozoan pathogens that includes *Cryptosporidium parvum*, *Giardia lamblia*, and six other protozoans as well as a section on water quality protozoan testing and monitoring. Craun et al. (1998) reviewed 35 waterborne cryptosporidiosis outbreaks associated with contaminated drinking water and recreational activities, provided recommendations for prevention of such outbreaks, and assessed the need for epidemiological data.

### ***Pathogens in the Environment and in Wet Weather Flow***

Cysts and oocysts are common in surface water, and the concentration appears to vary with watershed use characteristics (Hansen and Ongerth 1991). It has been established that oocysts are found in most surface waters as shown in Table 4-2. Hansen and Ongerth (1991) found oocysts in 34 of 35 river samples, using a method with a detection limit ranging from 0.04 to 0.14 oocysts per liter and a recovery efficiency of 18.6 to 34.3%. The watersheds examined had a variety of nonurban land uses. In a study conducted on the Allegheny River, *Cryptosporidium* was detected in 50% or more of all samples collected (NRCS 1997). Samples were collected over a 3½ year period, with a recovery efficiency of just 25%. Roughly 22% of the samples collected in the New York City watershed showed *Cryptosporidium* oocysts, with a slightly greater fraction showing *Giardia* cysts (Stern 1996). The background concentration in one drinking water reservoir was estimated at 0.36 oocyst/100 L (Stewart et al. 1998).

Research to determine correlations between *Giardia* and *Cryptosporidium* and other parameters has been inconclusive. LeChevallier et al. (1991a) measured *Giardia* and *Cryptosporidium* in the source waters of 66 surface water treatment plants in the U.S. and Canada. They identified oocysts in 87% of

**Table 4-2. Occurrence of *Giardia* Cysts and *Cryptosporidium* Oocysts in Surface Waters**

Water Type	No. of Samples	% Samples Positive <i>Giardia</i>	% Samples Positive <i>Crypto.</i>	Conc. Range Per L (GM)# <i>Giardia</i>	Conc. Range Per L (GM)# <i>Crypto.</i>	Reference
Surface	51	39	39	–	–	Barthe and Brassard 1996
Rivers/lakes	181	15	51	<0.01–1.4 (0.03)*	<0.01–44 (0.43)*	Rose et al. 1991
Allegheny R.	24	63	63	0–4.2 (0.34)	0–22.3 (0.31)	States et al. 1997
Youghiogheny R.	24	54	63	0–5.3 (1.2)	0–14.7 (0.58)	States et al. 1997
Stream, dairy farm	24	54	82	0–15.7 (0.82)	0–11.05 (0.42)	States et al. 1997
River diversion	19	21	50	0–6.25 (0.22)	0–240 (1.09)	Rose et al. 1988
Lake outlet	20	40	50	0–2.22 (0.08)	0–22 (0.58)	Rose et al. 1988
Stream/river	11	–	77.6	–	2–112 (25.1)*	Ongerth and Stibbs 1987
Surface	107	–	77	–	0.04–18 (0.91)	Rose 1988
Reservoir inlet	60	13.3	5	0.007–0.24 (0.19)	0.007–0.024 (0.012)	LeChevallier et al. 1997
Reservoir outlet	60	15	11.7	0.012–1.07 (0.061)	0.017–0.31 (0.081)	LeChevallier et al. 1991a
Surface water	85	81	87	0.04–66 (2.77)	0.07–484 (270)	LeChevallier et al. 1991a
River/stream canal water	6	–	ng <sup>^</sup>	–	0.8–5,800 (ng)	Madore et al. 1987
Raw source waters	262	45	51.5	0.02–43.8 (2.0)	0.065–65.1 (2.4)	LeChevallier and Norton 1995

# GM = geometric mean

\* = arithmetic mean

^ ng = not given

sampled surface waters, reporting higher densities in waters receiving industrial or sewage effluents and also significant correlations between *Giardia* and *Cryptosporidium* concentrations with turbidity and fecal coliform concentrations. *Giardia* and *Cryptosporidium* concentrations reported in 39% of the surface waters sampled in Canada showed no correlation with either total or fecal coliform concentrations, heterotrophic plate count, pH, temperature, turbidity, or dissolved organic carbon (Barthe and Brassard 1996). One factor to consider in explaining this inconsistency is that reported oocyst concentrations included both viable and nonviable organisms (LeChevallier et al. 1991b).

A national study detected *Giardia* spp. in 81% of source water samples from 66 surface water treatment plants in 14 states and one Canadian province. *Cryptosporidium* spp. were found in 87% of the raw water locations. Higher cyst and oocyst densities were associated with source waters receiving industrial or sewage effluents. Significant correlations were found between *Giardia* and *Cryptosporidium* densities, turbidity, and total and fecal coliform levels. Statistical modeling suggests that cyst and oocyst densities could be predicted on the basis of watershed and water quality characteristics (LeChevallier et al. 1991a).

Concentrations of *Cryptosporidium* and *Giardia* in the Delaware River, a drinking water source for several municipalities including New York, NY, Philadelphia, PA, and Trenton, NJ, increased after rainfall events. The increased *Cryptosporidium* and *Giardia* concentrations correlated with increased coliphage, total coliform, fecal coliform, *E. coli*, and *C. perfringens* concentrations. The increase was attributed to transport through surface runoff, resuspended storm drain, and river bottom sediments (Atherholt et al. 1998).

*Giardia* cysts were found in 94 (43%) of the 222 samples collected over a nine-month period from 17 sampling stations from three pristine rivers in the Pacific Northwest (Ongerth 1989). No statistically supportable seasonal variations were found. *Giardia* cysts were continuously present, though at low concentrations, even in relatively pristine rivers (Rose et al. 1991; Rose 1997).

*Giardia* cysts and *Cryptosporidium* oocysts have been found at low levels in ground waters and springs, as summarized in Table 4-3. In general, contamination of well waters appears more likely for *Cryptosporidium* oocysts than for *Giardia* cysts, but well depth, construction, and state of repair will strongly influence the possibility of contamination. Regardless of the type of well or spring, cyst and oocyst concentrations were usually found to be low.

**Table 4-3. *Giardia* and *Cryptosporidium* in Springs and Ground Waters**

Source	No. Samples or Sites	% Samples Pos.		Range Cyst/Oocysts/100L		References
		<i>Crypto.</i>	<i>Giardia</i>	<i>Giardia</i>	<i>Crypto.</i>	
Well waters	20	0	0	–	–	Barthe and Brassard 1996
Ground waters	18	–	5.5	<0.25	(0.3)*	Rose et al. 1991
Spring, pristine	7	0	57.1	<0.25	<0.25–13(4)	Rose et al. 1991
Vertical wells	149	1	5	–	–	Hancock et al. 1998
Springs	35	14	20	–	–	Hancock et al. 1998
Infiltration galleries	4	25	50	–	–	Hancock et al. 1998
Horizontal wells	11	36	45	–	–	Hancock et al. 1998
Total sites	199	12	12	0.1–120(8)	0.2–45(5)	Hancock et al. 1998
Deep well, pristine	288	–	0	–	–	Benton et al. 1991
Well, coliform positive	138	–	5.8	–	4–92(23)	Badenoch et al. 1990

– = data not given

\* = arithmetic mean

## Sources of Oocysts

*Giardia* cysts and *Cryptosporidium* oocysts are found at significant levels in domestic raw sewage, treated sewage effluents, and CSOs. Table 4-4 summarizes data on *Giardia* and *Cryptosporidium* cysts/oocysts in sewage and CSOs. Source identification and characterization play an important role in determining potential control measures. For example, SWP measures for oocysts from human sewage versus animal sources will be different. Even if the cysts and oocysts are known to be from human sewage, there may still be considerable differences in control options available, depending on whether the cysts and oocysts were discharged due to faulty septic systems, wastewater treatment plant effluent, treatment plant bypass, sanitary sewer overflows (SSOs), CSOs, or storm water. Similarly, significant differences in options occur if the animal source of the oocysts is from a dairy farm, cattle ranch, a concentrated feed, or wild animal populations.

**Table 4-4. *Giardia* and *Cryptosporidium* Cysts/Oocysts in Sewage and Combined Sewer Overflows**

Source	No. of Samples	% Samples Positive		Range Cyst/Oocysts per L(GM) <sup>a</sup>		Reference
		<i>Giardia</i>	<i>Crypto.</i>	<i>Giardia</i>	<i>Crypto.</i>	
Raw sewage	29	100	0.03	130–7900 (1,500) <sup>a</sup>	0–28(ng)	Hirata and Hashimoto 1997
Primary effluent	37	100	– <sup>b</sup>	150–6,600 (1,100) <sup>a</sup>	–	Hirata and Hashimoto 1997
Final effluent	33	82	0	4–130 (14)	–	Hirata and Hashimoto 1997
Sewage <sup>d</sup> influent	24	100	100	200–3,200 (ng)	–	Casson et al. 1990
Return act. sludge	8	100	100	200–900 (ng)	–	Casson et al. 1990
STP trick. filter	8	100	100	4–44 (11)	–	Casson et al. 1990
Raw sewage	–	–	–	11–397 (ng)		Sykora et al. 1987
STP effluents	–	–	–	0.01–13.5 (ng)	–	Sykora et al. 1987
Raw sewage	3–36	100	14	26–3,022 (ng)	0–74(ng)	Roach et al. 1993
STP effluents	–	–	–	2–3,511 (ng)	0–333(ng)	Roach et al. 1993
Sewage effluent	15	80	27	0–4,614 (42)	0–4,927 (43.2)	States et al. 1996
Raw sewage	4	–	100	–	850–13,700 (51.8) <sup>b</sup>	Madore et al. 1987
Treated sewage	9	–	–	–	140–3,960 (1,060) <sup>b</sup>	Madore et al. 1987
Combined overflows, upper, in stream, d.w. <sup>c</sup>	6	100	100	<0.13–0.66 (36)	0.05–0.53 (0.18)	Gibson et al. 1998
Lower, in stream, d.w.	6	100	100	0.21–66 (3.43)	<0.33–1.05 (0.78)	Gibson et al. 1998
Upper, in stream, w.w. <sup>c</sup>	3	100	67	0.67–2.88 (1.15)	<0.39–0.72 (0.70)	Gibson et al. 1998
Lower, in stream, w.w.	3	100	100	4.29–75 (26.5)	4.29–1.77 (7.5)	Gibson et al. 1998
End of pipe	11	100	100	90–2,830 (354)	2.5–400 (60.4)	Gibson et al. 1998
CSO	5	80	–	37–1,140 (287) <sup>d</sup>	8.8–30 (20.1) <sup>d</sup>	States et al. 1997

<sup>a</sup> geometric mean number of cysts/oocysts/L; ng = not given

<sup>b</sup> arithmetic mean

<sup>c</sup> d.w. = dry weather; w.w. = wet weather

<sup>d</sup> 8-hour composite samples

There is little information on septic tanks as a potential source of *Cryptosporidium*. Septic tanks that function poorly are possible sources of oocysts and need to be addressed for public health reasons, including *Cryptosporidium*. The New York City Department of Environmental Protection is conducting a study on the transport of oocysts from functioning septic systems, and a report on its findings was to be available in December 1999 (USEPA 1997).

A variety of mammals, particularly young ruminants, are sources of *Giardia* cysts and *Cryptosporidium parvum* oocysts in the environment. Table 4-5 presents some information on concentrations of *Giardia* cysts and *C. parvum* oocysts in the feces from humans and some animals.

**Table 4-5. Some Human and Animal Sources of *Giardia* Cysts and *Cryptosporidium* Oocysts**

Source	No. Samples	% Samples Pos		Cysts		Oocysts		Reference
		<i>Giardia</i>	<i>Crypto.</i>	<i>Giardia</i>	<i>Crypto.</i>	<i>Giardia</i>	<i>Crypto.</i>	
<b>Human</b>								
Infected	–	–	–	3 × 10 <sup>3</sup> / person/day	–	–	–	Erlandsen and Meyer 1984
AIDS patient, infected	–	–	–	–	–	6 × 10 <sup>6</sup> – 1.2 × 10 <sup>10</sup>	–	Goodgame et al. 1993
<b>Agricultural</b>								
Calves/lambs	–	–	–	–	–	10 <sup>10</sup> /day to 14 days	–	Current and Garcia 1991
Calves, infected	–	–	–	–	–	10 <sup>3</sup> /g, 5–15 Kg feces per day	–	Breach et al. 1994
Cow, infected	–	–	–	–	–	10 <sup>4</sup> /g, 25–30 Kg feces per day	–	Breach et al. 1994
Cattle, infected	108	–	26.8	–	–	–	–	Quilez et al. 1996
Swine, infected	90	–	34.4	–	–	–	–	Quilez et al. 1996
<b>Parks/ Recreational</b>								
Beaver	–	–	–	–	–	–	–	Erlandsen and Meyer 1984
Muskrat	–	–	–	–	–	–	–	Erlandsen and Meyer 1984
Canada geese	9*	100	77.7	75–786/ g feces	–	67–686/ g feces	–	Graczyk et al. 1998

\*pooled sample

Eighty species of mammals have been shown to shed *C. parvum* oocysts (Barry et al. 1998). Most measurements have been completed on domestic animals, with little information available regarding the shedding of *C. parvum* by wildlife. In addition to humans, among the domestic and wild animals found to be hosts for *C. parvum* are cattle (Atwill et al. 1998; Xiao and Herd 1994; Kuczynska and Shelton 1999; Garber et al. 1994), sheep, goats, deer, water buffalo, pigs (Atwill et al. 1997), horses (Forde et al. 1997; Haas and Rose 1994; Johnson et al. 1997), rabbits, opossum, rodents (rats, Webster and McDonald 1995; mice, Klesius et al. 1986; Bajer et al. 1997), beaver and muskrats (Bajer et al. 1997), migratory water fowl, and primates (Graczyk et al. 1998b).

## ***Oocyst Survival***

The ability of oocysts to survive rather harsh environments (e.g., low temperatures, typical drinking water chlorination) enhances their chances of successfully migrating to a treatment plant intake and through the treatment process. Understanding conditions that oocysts can and cannot tolerate can be instrumental in devising effective controls or in estimating when high levels of oocyst survival will occur in source waters (Walker 1998; Graczyk et al. 1998a; Fayer and Nerad 1996).

Fayer and Nerad (1996) have shown that, although freezing at very low temperatures ( $-70^{\circ}\text{C}$ ) inactivated oocysts, freezing at higher temperatures ( $-10$ ,  $-15$ , and  $-20^{\circ}\text{C}$ ) allowed oocysts to retain some level of infectivity. Oocysts frozen at  $-20^{\circ}\text{C}$  for five hours or less remained infective. Oocysts frozen at  $-10^{\circ}\text{C}$  for 168 hours or less, as well as those frozen at  $-15^{\circ}\text{C}$  for 24 hours or less, also remained infective. Although freezing temperatures are detrimental to oocyst survival, this study suggests that, when the surface does not reach low temperatures (below  $-10^{\circ}\text{C}$ ) for prolonged periods of time, some infective oocysts may survive for extended periods.

Jenkins et al. (1999) performed field studies of oocysts exposed to the environment of calf manure piles and the surface of a field soil. Results of this study indicated that exposure to both manure and soil environments significantly increased rates of oocyst inactivation compared to controls. Exposure to freeze-thaw cycles in soil were particularly deleterious to the oocysts. They concluded from their study that spreading manure contaminated with oocysts on snow, in an absence of freeze-thaw cycles, may contribute to sustained oocyst survival and increase the risk of surface water contamination during spring melt and runoff.

Fayer (1994) examined the effect of high temperatures on oocyst infectivity. Oocysts were rendered noninfective within one minute upon reaching a temperature of  $72.4^{\circ}\text{C}$  or higher. Oocysts held at  $64.2^{\circ}\text{C}$  or higher for 2 minutes also lost their infectivity. This study was conducted on oocysts in distilled water. It is possible that temperatures needed to inactivate oocysts on land or in compost may vary. Jenkins et al. (1999) suggest that oocyst infectivity may be significantly reduced within 70 days in manure piles with temperatures between  $35$  and  $50^{\circ}\text{C}$ .

Jenkins et al. (1998) reported that low concentrations of ammonia associated with a barnyard environment inactivated oocysts and can inactivate a viable population in days. They also demonstrated that the pH associated with the various levels of ammonia tested, pH 9 to 11, was not a factor associated with their inactivation.

Results of one study (Chauret et al. 1998) examining the role of biological antagonism in the inactivation of oocysts suggest that biological antagonism may be a primary factor affecting oocyst survival in natural waters. However, this process of natural interactions between organisms appears to be site specific.

## **Measuring and Monitoring Pathogens in Source Waters**

Except for the use of immunological and molecular methods (genetic probes, polymerase chain reaction [PCR], ribotyping) for specific identification of isolates of pathogenic bacteria, cultural methods for the detection, enumeration, and identification of waterborne pathogenic bacteria have not changed significantly over the past three decades. Although somewhat dated, Singh and McFeters (1992) reviewed detection methods for pathogens in water. A comprehensive source of information on environmental microbiology and microbial detection methods may be found in Hurst et al. (1997).

Although most water monitoring involves searching for indicators of fecal pollution, monitoring water for the presence of pathogens is necessary under special circumstances, such as during and after water-

borne outbreaks, when dealing with a water source with a history of contamination, or where wastewater reclamation is involved. The low densities of pathogens usually found in water require that large volumes of water must be examined. For viruses and parasites, this is usually done by filtering a large volume (10–1000 liters [2.6–264 gal]) of water through a filter cartridge to concentrate the target organisms. Sometimes volumes of one liter or more are concentrated by centrifugation or a combination of filtration and centrifugation. The use of large volume samples limits the number of samples that can be examined and increases the costs of testing. Overall, the costs for analysis of water samples for specific bacterial pathogens and for enteric viruses and protozoan pathogens are quite high, with those for viruses and protozoan cysts and oocysts being much higher than for bacteria. Given the limitations of detection and enumeration methodologies and their complexities, a negative result for finding a specific pathogen does not mean that no target pathogens were present, only that none were detected at the detection limit of that method.

## ***Giardia and Cryptosporidium***

The methods currently in use for *Giardia* and *Cryptosporidium* detection in water have been developed since the early 1980s. Since 1992, with the development of a series of regulations (D/DBP Rule, IESWTR, and the ICR), water utilities have been in need of water quality testing laboratories, either in-house or via contract, with the capability of analyzing for *Giardia* cysts and *Cryptosporidium* oocysts in finished drinking water and in source waters. The method of choice in the U.S. for detection of *Giardia* and *Cryptosporidium* in source waters was the proposed American Society for Testing and Materials (ASTM) analytical procedure. The method is technically complex, labor intensive, time consuming, and requires good laboratory quality-control procedures to provide maximum recoveries. The method performance is also affected by variations in sample collection, water quality (turbidity) and analyst training, experience, and competency.

The EPA method used for the ICR (USEPA 1996) differs from the ASTM method by requiring filtration of 100L (26.4 gal) of raw water or 1000 L (264 gal) of finished water and the use of Hoffman modulation or differential interference contrast (DIC) optics instead of phase-contrast optics for confirmation of morphological characteristics of the presumptive cysts and oocysts. Because of method performance issues, modifications to the EPA method resulted in the development of EPA Methods 1622 and 1623 (USEPA 1999a, 1999b), respectively. Each method uses sample concentration by filtration, combined with immunomagnetic separation and fluorescent antibody staining for recovery and enumeration of cysts and oocysts. Method 1622 is a stand-alone method for *Cryptosporidium*, while Method 1623 is for simultaneous detection of *Giardia* and *Cryptosporidium*.

## ***Enteric Viruses***

Viruses are present in very low numbers in most environmental waters. Therefore, methods for the detection of enteric viruses in water, as for the protozoan pathogens, also require concentration of the viruses from a large volume water sample following a protocol involving filtration and centrifugation, recovery of the viruses from the filtration medium, and assay of the concentrated sample for viruses by inoculation into a mammalian cell culture line. The methods published in the USEPA Manual of Methods for Virology (Berg et al. 1983) and in Standard Methods for the Examination of Water and Wastewaters (APHA 1999) were probably the most commonly used prior to the ICR method. However, the ICR virus monitoring protocol, developed by the EPA and modified by consensus agreements from the scientific community (USEPA 1996), represents the methodology most used during the 1990s for detecting enteric viruses in water.



## Protecting Source Waters

This section discusses protection of source water from microbial pathogens found in treated sanitary sewage and wet weather flows (i.e., SSOs, CSOs, and storm water runoff).

### *Separate Sanitary Sewage Systems*

Separate sewage systems require a dedicated infrastructure to carry waste to the treatment plant. Typically, these systems are largely gravity flow-augmented by pumping stations if needed. The system is designed to meet specified flow quantities, and balances flow from all influents with the treatment plant throughput capacity. When the demand exceeds the flow capacity of the system, a surcharge, or SSO, occurs. Under surcharge conditions, the system discharges through alternate escape routes, often backing up into residences or streets, and eventually winding up in receiving waters. Separate sewage systems are seldom leakproof. Connections between pipe sections along the length of the conveyance system are not completely sealed. The connections and the privately owned laterals offer opportunities for waste to escape and for subsurface water to infiltrate the system. Inflow and infiltration can be substantial during rain events, decreasing the flow capacity available for the wastewater. Table 4-6 presents representative data on the type and number of microorganisms found in untreated wastewater (Metcalf & Eddy Inc. 1991). The table reports densities of both indicator and pathogenic microorganisms.

**Table 4-6. Types and Numbers of Microorganisms Typically Found in Untreated Domestic Wastewater**

<b>Organism</b>	<b>Concentration (number/mL)</b>
Total coliform	$10^5$ – $10^6$
Fecal coliform	$10^4$ – $10^5$
Fecal streptococci	$10^3$ – $10^4$
Enterococci	$10^2$ – $10^3$
<i>Shigella</i>	Present <sup>a</sup>
<i>Salmonella</i>	$10^0$ – $10^2$
<i>Pseudomonas aeruginosa</i>	$10^1$ – $10^2$
<i>Clostridium perfringens</i>	$10^1$ – $10^3$
<i>Mycobacterium tuberculosis</i>	Present <sup>a</sup>
Protozoan cysts	$10^1$ – $10^3$
<i>Giardia</i> cysts	$10^{-1}$ – $10^2$
<i>Cryptosporidium</i> cysts	$10^{-1}$ – $10^1$
Helminth ova	$10^{-2}$ – $10^1$
Enteric virus	$10^1$ – $10^2$

<sup>a</sup> Results for these tests are usually reported as positive or negative rather than being quantified.

Concentrations of microorganisms in sewage treatment plant effluent vary depending on the National Pollutant Discharge Elimination System (NPDES) permit issued for the plant (King 1996). The effluent concentrations and level of treatment required are those necessary to achieve receiving water quality standards. Receiving water standards have been established pursuant to the Federal Water Pollution Control Act Amendments of 1972 (Public Law 92-500) to protect beneficial uses of surface waters. One goal is to eliminate pathogens to control transmission of waterborne diseases. In support of this goal, wastewaters that pose a disease risk are disinfected prior to discharge. Generally, NPDES permits require measuring the microbial indicator concentrations in the effluent rather than pathogen concen-

trations. Therefore, treating wastewater so that the permit standard is met does not guarantee an absence of pathogenic microorganisms. Indicators are more representative of some pathogens than others. Olivieri et al. (1977) found that, in raw sanitary sewage, there was a strong positive correlation between the levels of total coliform (TC), fecal coliform (FC), fecal streptococci (FS), and enterococci and the levels of pathogenic bacteria. Only the levels of TC and FC correlated well with the levels of enteric viruses. Metcalf et al. (1995) reported that, on average, virus concentrations of about 50 plaque forming units/liter (PFU/L) can be expected in wastewater treatment plant effluents.

### ***Combined Sewer Systems***

The design of combined sewer systems commingles sanitary and storm water flows in a single conveyance system that routes the entire flow to the wastewater treatment plant. This system treats all collected liquid, including storm water and sanitary sewage, before discharge to the receiving water. By using a single conveyance to carry all flows to the treatment plant, this design requires a total pipe length less than that required by separate storm and sanitary sewers.

At construction, the combined sewer system is sized to meet the existing and projected flows of sanitary (dry-weather flow [DWF]) and storm water flows. Design values are available for the sanitary contribution from various types of structures (e.g., hospital, school, or private home). The DWF volume varies over the course of a day, with morning and evening peaks. Weekend flow patterns differ from the work-week flow patterns. Designers base the storm water flow contribution on regional rainfall statistics and the probability of a given storm-induced runoff volume. Whenever storms generate runoff to create combined sewage flow volumes greater than the capacity of the system, the system relieves the pressure by shunting flow to receiving waters, i.e., a CSO occurs. The total flow of overflow events is often expressed as a multiple of the peak DWF. As combined sewer systems age, the number of sanitary users connected to the system increases. The increased sanitary flow volumes deplete capacity formerly used by storm water and increase the frequency of overflows. Similarly, the increased impervious area associated with the new connections increases the storm water runoff, which also consumes conveyance capacity.

EPA's CSO Control Policy (USEPA 1994) limits the number of annual overflows for combined systems and requires disinfection after primary clarification, using the capacity of the publicly owned treatment works, when it is required by local authorities. Systems are being modified to reduce the number of overflows by providing for in-system storage, on-lot storage (Milliken 1996), and disconnecting inputs such as downspouts. Low-impact development is a method currently being evaluated for reducing runoff volumes (Coffman et al. 1996). Its objectives include restoring the site hydrologic's regime to reflect the natural or predevelopment condition and minimizing the generation and off-site transport of pollutants via storm water runoff.

CSO disinfection is practiced to control the discharge of pathogens and indicator microorganisms into receiving waters. Chlorination is the conventional approach to disinfection. Due to concerns about chlorine's effects on aquatic life, alternative technologies are being investigated for CSO disinfection. The New York City Department of Environmental Protection recently completed evaluations of high-rate disinfection technologies (Camp, Dresser, & McKee and Moffa & Associates 1997). Table 4-7 shows the disinfectant dosages associated with achieving effluent microbial indicator concentrations of 1000 colony forming units (cfu)/100 mL using chlorine, ultraviolet (UV) irradiation, ozonation, and chlorine dioxide. Generally, all four technologies were able to provide 3- to 4-log bacterial reductions. UV disinfection was found to provide reduced effectiveness at higher total suspended solids concentrations (>150 mg/L). Chlorine dioxide disinfection requires doses significantly lower than those required for chlorine disinfection, reducing the toxicity impacts on the receiving water aquatic life.

**Table 4-7. Estimated Disinfection Dosages to Attain Microbial Indicator Concentrations of 1000 cfu/100 mL (Camp, Dresser & McKee and Moffa & Associates 1997)**

	Influent Concentration (cfu/100 mL)	Estimated Dosages			
		Chlorine Dose (mg/L)	UV Dose (mW-s/cm <sup>2</sup> )	OzoneDose (mg/L)	Chlorine Dioxide Dose (mg/L)
Total coliform	10 <sup>6</sup> –10 <sup>7</sup>	>30 <sup>a</sup>	>100 <sup>b</sup>	37	>8 <sup>c</sup>
Fecal coliform	10 <sup>5</sup> –10 <sup>6</sup>	18	50	24	6
<i>E. coli</i>	10 <sup>5</sup> –10 <sup>7</sup>	17	35	23	5.5
<i>Enterococcus</i>	10 <sup>4</sup> –10 <sup>6</sup>	22	35	12	5.5

<sup>a</sup> Target concentrations not achieved with highest applied dosage, i.e. 30 mg/L.

<sup>b</sup> Target concentrations not achieved with highest applied dosage, i.e. 100 mW-s/cm<sup>2</sup>.

<sup>c</sup> Target concentrations not achieved with highest applied dosage, i.e. 8 mg/L.

Particles associated with or occluding microorganisms can reduce the effectiveness of wastewater disinfection by chlorination and by UV irradiation (Parker and Darby 1995). UV irradiation showed lower effectiveness at suspended solids concentrations above 150 mg/L in the New York City studies (Stinson et al. 1998). Understanding the effects of solids content on disinfection effectiveness is necessary for designing treatment systems capable of achieving effluent requirements. Recent EPA research suggests greater disinfection effectiveness is possible by removing solids before UV irradiation and chlorination (Perdek and Borst 2000).

Lijklema et al. (1986) report that CSOs result in increased indicator organism concentrations in the receiving water. They measured TC, FC, *E. coli* FS, somatic coliphages, and F-specific coliphages. Phage concentrations are one to three orders of magnitude smaller than bacterial concentrations. The ratio between the concentrations of different bacterial indicators varies between events, but is generally within 1.5-log units. Ellis and Yu (1995) report that CSOs serve as very effective generators of bacteria and pathogens in urban receiving waters, particularly where available dilution volumes are restricted. A recent EPA investigation showed a thirtyfold increase in FC and enterococci concentrations 28 hours after disinfection by UV light (Wojtenko 1999). Enterococci regrowth after disinfection by chlorine or chlorine dioxide was negligible over the period studied.

### ***Municipal Separate Storm Sewer Systems***

The design of separate sewer systems isolates the sanitary and storm water flows. The sanitary sewage flows to the wastewater treatment plant. The second system routes storm water to nearby receiving waters. In this system design, the storm water runoff remains untreated carrying all the associated contaminants, including microorganisms, directly to the receiving water. The system storm water design capacity is based on expected storm runoff volume under the proposed or existing development. Because the system isolates the two flows, the design requires separate conveyance systems with longer total pipe length and long-term maintenance costs than combined systems. With added development, sanitary and storm systems are sometimes connected inappropriately, resulting in sanitary sewage being carried to the receiving water with no treatment.

The presence of microbial indicators and pathogens in storm water has been confirmed. Olivieri et al. (1977) reported high densities of indicator organisms in urban streams in Baltimore, plus the presence of *Pseudomonas aeruginosa*, *Staphylococcus aureus*, *Salmonella*, and enteric viruses. Analyses of storm water in the study area reported the occurrence of pathogenic bacteria and viruses in storm water runoff. The bacterium *P. aeruginosa* was found in all storm water samples taken from six sampling loca-

**Table 4-8. Microbiological Concentrations of Storm Water**

Contaminant	Concentrations (per 100 mL) in Storm Water	References for Storm Water
Total coliforms	$7-1.8 \times 10^7$	Dutka and Tobin 1978; Dutka and Rybakowski 1978
Fecal coliform	$0.2-1.9 \times 10^6$	Dutka and Tobin 1978; Dutka and Rybakowski 1978
Fecal streptococci	$3-1.4 \times 10^6$	Dutka and Tobin 1978; Dutka and Rybakowski 1978
Enterococci	$1.2 \times 10^2-3.4 \times 10^5$	Gannon and Busse 1989
HPC (#/mL)	$6.94 \times 10^4-4.9 \times 10^5$	Dutka and Tobin 1978
<i>Pseudomonas aeruginosa</i>	$1-1.1 \times 10^7$	Dutka and Tobin 1978; Olivieri et al. 1977
<i>Escherichia coli</i>	$1.2 \times 10^1-4.7 \times 10^3$ $5.7-4.5 \times 10^3$	Gannon and Busse 1989
<i>Salmonella</i>	(MPN/10 L)	Geldreich et al. 1968
<i>Shigella</i>	Not detected	Olivieri et al. 1977
<i>Klebsiella</i>	$4 \times 10^3-1.9 \times 10^5$	Schillinger and Gannon 1985
Enterobacter	Not detected	Dutka and Tobin 1978
Citrobacter	Not detected	Dutka and Tobin 1978
<i>Yersinia enterocolitica</i>	Not detected	NA
<i>Staphylococcus aureus</i> (MPN/100mL)	$1-1.2 \times 10^2$	Olivieri et al. 1977
<i>Legionella</i>	Not detected	NA
<i>Streptococcus</i>	Detected	Geldreich et al. 1968
Viruses (enteric)	Detected	Olivieri et al. 1977
<i>Giardia</i>	–	NA
<i>Cryptosporidium</i>	–	NA
Fungi	$6 \times 10^2-1.2 \times 10^7$	Dutka and Rybakowski 1978
Parasites–nematodes	Detected	Dutka and Rybakowski 1978
Helminth ova	–	NA

HPC = heterotrophic plate count, NA = none available

tions. *Staphylococcus aureus* and *Salmonella* spp. were found at each of the six sampling locations in a majority of the samples taken. Coxsackievirus B, animal virus, poliovirus, and echovirus were found in storm water samples collected from all six of the sampling locations. Makepeace et al. (1995) summarized concentrations of microbial indicators and pathogens found in storm water runoff reported by others, which is presented as Table 4-8.

Sampling was conducted during the summer of 1985 to evaluate the impacts of discharges from storm drains on bacteriological quality on the Huron River in the Ann Arbor, MI, area during both dry and wet weather periods (Gannon and Busse 1989). Each river water sample was analyzed for FC, FS, *E. coli*, and enterococci. The investigators reported that wet weather bacterial densities were statistically significantly higher than dry weather levels, and downstream densities were statistically significantly higher than upstream densities. The FC/FS ratios for the storm drains were low, suggesting that sources were more animal than human.

A 1999 study to determine the source of unexpectedly high river and stream bacterial contaminations near Nashville showed that FC densities were directly related to the density of housing, population, development, percent impervious area, and apparent domestic animal density. The data also showed

that FC counts were much higher in summer than winter, suggesting a possible seasonal variation. The FC/FS ratios were generally low, suggesting primarily animal sources. Surface runoff samples from more densely populated sewer areas generally showed higher bacterial counts than runoff from less developed areas that utilized septic tanks. The investigators concluded that surface runoff from high density urban areas may be a contributor to high fecal bacteria loadings (Young and Thackston 1999). Consistent with these results are those presented by Mallin (1998), who reported patterns of increasing coliform bacteria concentrations in stream samples with increased watershed development and impervious surface in New Hanover County, NC.

Storm water discharges are regulated in selected communities through the NPDES program (USEPA 2000b). In response to the 1987 amendments to the CWA, EPA developed Phase I of the NPDES Storm Water Program in 1990. Phase I requires NPDES permits for storm water discharges from

- Medium and large municipal separate storm sewer systems (MS4s), generally serving or located in incorporated places or counties with populations of 100,000 or more people.
- Eleven categories of industrial activity, one of which is construction activity that disturbs 5 acres or greater of land.

The Final Rule for Phase II of the NPDES Storm Water Program was signed by the EPA Administrator on October 29, 1999. The Phase II Rule requires NPDES permit coverage for discharges from

- Certain regulated small MS4s (primarily all those located in urbanized areas).
- Construction activity disturbing between 1 and 5 acres of land.

### ***Sediment Resuspension***

Pettibone and Irvine (1996) reported levels and sources of indicator bacteria in the Buffalo River, NY, watershed and found that solids present in the water column may offer a vehicle by which bacteria are kept in suspension and transported downstream. Additionally, the sediments provide an environment that promotes microorganism growth and protects them from predators. Sherer et al. (1992) reported longer survival of FC and FS in sediment-laden waters than in the sediment's supernatant and in waters without sediment. When incubated with sediment, FC and fecal *Streptococcus* half-lives were determined to be from 11 to 30 days and from 9 to 17 days, respectively. These are longer than when they are incubated without sediment.

### **Best Management Practices**

In addition to the installation of sewage treatment and combined overflow systems, there are passive pollution prevention and mitigation techniques called best management practices (BMPs). The techniques vary dramatically in application, ranging from social practices to engineering applications. Even the more heavily engineered solutions combine the practitioner's art with traditional engineering tools and rely on common sense approaches to what should work in a given situation.

BMPs are often categorized according to the degree of structural intensity associated with the practice. Low-structural intensity techniques include public education, emphasizing the consequences of specific actions. Many communities, for example, paint fish on storm sewer catch basins to emphasize the link between potential waste disposal and receiving waters. Similarly, community master planning can incorporate practices intended to prevent contaminant introduction. Mitigation techniques can range from requirements for storm water controls during the development process, including leaving designated areas undisturbed, to housing density controls through zoning. The effectiveness of these pollution prevention techniques is, and is likely to remain, uncertain. Even when installed as part of a remedial approach, it is unlikely that investigations can separate the effects of these approaches. The

temporal scale similarly confounds investigations as source elimination will often require many years of natural flushing and attenuation to become apparent in the receiving waters.

Well-planned and well-executed studies of more structurally intensive approaches are also limited and questions of long-term cost and effectiveness remain. A complete evaluation of a given technique requires mass balances over several seasons to ensure that BMP effectiveness does not simply change with timing, i.e., pollutants temporarily accumulate and are discharged in a later storm event. This phenomenon can be identified in some event-specific and short-term evaluations when effluent concentrations, masses, or both exceed the influent (Kurz 1998). These studies are difficult to complete and depend heavily on flow measurement and sample analysis. The inability to automate analytical processes with data logging sensors makes these evaluations expensive.

Although little well-documented research is available presenting the capabilities to control microorganisms, watershed managers routinely install BMPs for storm water treatment. There is strong suggestive evidence that these installations preserve water quality and can reduce water treatment costs. Kurz (1998) documented pathogen and indicator reductions in sand filtration, wet detention, and alum coagulation treatment systems using simulated storm events. Each system produced significant reductions in TC and FC bacteria, male-specific coliphage 2, and beads (used as a protozoa surrogate) concentrations. Often, effluent samples showed greater concentrations of TC, turbidity, and total suspended solids than influent samples. These increases show the incomplete understanding of the mechanisms, processes, and temporal scales of BMP operation.

In 1999, EPA released fact sheets on the use of sand filters, wetlands, and vegetative swales for managing storm water (USEPA 2000a, 2000b, 2000c). Other BMPs include detention ponds, buffer strips, and infiltration trenches. Sand filters are structurally intensive devices installed primarily to remove particulate and particulate-associated contaminants. Sand beds block the migration of particulates as water passes through the media bed. Some biological activity develops as biofilms develop within the device. Augmenting the media with high organic matter such as peat increases sorption within the filter. Sand filters provide very limited flow modification and therefore provide little protection of streambed or stream banks. Filter sizing is based on predicted runoff volume and is therefore based on the size and infiltration properties of the drainage area. These devices have impermeable bottoms to prevent infiltration to ground water. The filters need to have the filter media replaced periodically depending on loading. Typical replacement periods range from three to five years, with expended filter media suitable for landfill disposal (USEPA 1999a).

Storm water wetlands are incidental, natural, or intentionally constructed areas that are usually flooded. Within these areas, physical, chemical, and biological processes trap or degrade entering contaminants. Intentional use of naturally occurring wetlands to treat storm water runoff may be discouraged or prohibited. Storm water wetlands are divided into subsurface and free water surface systems based on the water flow pattern within the wetland. The selected location must have an adequate water supply and appropriate soil characteristics. Sizing techniques vary and may be state regulated. Common approaches include a designated design storm, fraction of watershed area, and sizing to contain the runoff volume generated by most rain events for the local area. Sources recommend an aspect (length to width) ratio between 1 and less than 10 to reduce internal short circuiting. Wetlands are commonly augmented with ponds (USEPA 1999b). Typical reported bacterial removal efficiencies for storm water wetlands are 70% to 80%. The heavy vegetation slows water flow, allowing particulate sedimentation and infiltration to ground water. The standing water promotes physical, chemical, and biological processes. Well-designed and constructed wetlands are long lasting.

Vegetated swales are broad, shallow, terrestrial channels that often serve as substitutes for curb and gutter drainage systems. To operate effectively, swales need a shallow slope with thick vegetation growth. The underlying soil must provide adequate drainage to prevent accumulating standing waters.

There must be enough slope to promote water transport, but not so steep as to cause erosion and scouring; typical values are 2% to 4%. There are no reported measurements of microbial reductions in swales.

Among the more common BMPs, a wet detention pond is an excavated volume designed to capture and slowly release storm water runoff. The wet detention pond maintains a standing pool of water to promote physical, chemical, and biological processes to lower contaminant concentration in runoff. The local rainfall, ground water, and geology must provide a standing water pool. The standing pool typically provides sufficient residence time to promote solids settling and removal of particle-associated contaminants. The edges of the pond commonly have shallow ledges to promote plant growth for nutrient uptake, safety, and aesthetics. The pond design typically has an aspect ratio greater than about two to reduce short-circuiting. The controlled flow discharge reduces the hydrograph peak (Botts et al. 1996; Frederick et al. 1996). Pond sizing is based on the drained area and effective runoff coefficient. The runoff volume is typically modeled using simple hydrology techniques.

Installing buffer strips is a commonly prescribed BMP for protecting receiving waters from storm water runoff in agricultural areas, with *Cryptosporidium* often being the primary concern. Buffer strips, also called filter strips, are vegetated areas using single species or mixtures of grasses, legumes, or other forbs with stem spacing up to one inch installed parallel to the receiving water shore. Although experts debate the minimum required width, a commonly recommended minimum is about ten meters. The strip follows the contour, with variations less than 0.5%. The land slope immediately above the filter is typically 1% to 10% to ensure flow through and control maximum velocities. The adequacy of a buffer strip for protecting receiving waters is based on Natural Resources Conservation Service (NRCS) criteria. The NRCS National Handbook of Conservation Practices (NRCS 1997; NRCS 1998) contains the traditional filter strip design standards. Using these standards for pathogen control, NRCS expects a slight decrease in surface water pathogen contamination.

Moore et al. (1988) cite several studies that show the effectiveness of buffer strips in reducing nutrients and sediments in runoff. The mechanisms contributing to the effectiveness are reduction in volume from increased infiltration, decrease in velocity resulting in increased sedimentation of particulates with adsorbed pollutants, and increased pollutant adsorption to soil particles due to lower ionic concentrations. For a vegetated filter strip to remove sediment-bound organisms, it must provide an appropriate mechanism for removing sediment. Design procedures (Dillaha and Hayes 1991) identify several key considerations when selecting buffer strips. Filter strips are only effective under shallow sheet flow conditions. Sheet flow will occur if the filter strip can be installed approximately on the contour. Fields with extensive internal drainage concentrate surface runoff. Excessive sediment inflow to an effective filter strip will clog and shorten the useful life. Routine maintenance, e.g., mowing to encourage dense vegetation and weed control, inspection and repairs to fill gullies, removing flow-blocking sediment, reseeding, and other measures, prevents concentrated flow. Excluding livestock and vehicles reduces soil compaction and promotes infiltration. Walker et al. (1990) modeled the concentration of indicator bacteria in runoff resulting from a single storm event immediately after land application of waste. The model predicted that a 30-meter filter strip on a 3% slope could remove a maximum of 75% bacteria. The model did not show if increased length would result in further reductions.

Infiltration trenches capture and hold the runoff volume for infiltration. These devices are typically one to four-meter-deep excavations filled with aggregate and gravel installed in well-drained, low-sloped soils. Sufficient underdrainage is critical for proper operation. Sand filters can capture up to 90% of influent particulate matter (Botts et al. 1996). Functionally, infiltration trenches work as coarse-media sand filters discharging to ground water. While the ground water discharge replenishes ground water, there are often concerns about the remaining contaminants and areas with deep water tables. Maintenance is essential to prevent clogging as particulates accumulate in the filter media. More than half the installed infiltration trenches fail after five years from inadequate maintenance (Botts et al. 1996).

## Source Water Protection and Watershed Management

EPA's Office of Water has defined SWP as a common-sense approach to guarding public health by protecting drinking water supplies. SWP measures prevent contamination and reduce the need for treatment of drinking water supplies. SWP includes managing potential contamination sources and developing contingency plans that identify alternate drinking water sources. A community may decide to develop an SWP program based on the results of a source water assessment, which includes the delineation of the area to be protected and an inventory of the potential contaminants within that area (USEPA 2000a). SWP from quality degradation by microbial contaminants (i.e., bacteria, protozoa, viruses, helminths, fungi) is any activity undertaken to minimize the frequency, magnitude, and duration of occurrence of pathogens or indicators (e.g., indicator microorganisms or turbidity) in source waters. SWP may also, by reducing the concentration of NOM, a DBP precursor, reduce the formation of DBP.

SWP strategies comprise the first stage in the multiple-barrier approach to protecting the quality of drinking water. Other major drinking water quality protection barriers include water quality monitoring and selective source withdrawal, water treatment processes for removal or inactivation of pathogens and control of DBP formation, water distribution practices for preventing intrusion or regrowth of pathogens, and point-of-use treatment where required.

SWP strategies are a specific subset of a larger watershed protection strategy applied when the protected receiving water is used as a water supply. Conceptually, watershed protection is heavily linked to pollution prevention, contaminant source identification, and risk management. Although watershed management does not have a universally accepted definition and connotes alternate approaches, each interpretation has an underpinning of holistic approaches to prevent or mitigate threats to the receiving water over a geographic region defined by a common hydrology.

Managing microbial contaminant risks in watersheds requires identification and quantification of organisms. Because of difficulties associated with assaying for specific pathogens, monitoring programs have tested for indicator organisms, including FCs and TCs, to identify possible fecal contamination in water. Monitoring regulations often specify indicators for determining water quality because the analytical methods are easier to complete, faster, and lower-cost than methods for specific organisms. Limitations of relying on indicators for determining the presence of pathogens include the occurrence of false positives. The indicators measure bacteria that live not only in human enteric tracts, but also in the enteric tracts of other animals (Toranzos and McFeters 1997).

Epidemiological studies in recreational waters (Dufour 1984) showed no correlation between measured FC densities and the occurrence of gastrointestinal illness in swimmers in fresh water, but a high correlation between gastrointestinal illness and *E. coli* and *Enterococcus* concentrations. Based on these results, EPA recommended that states adopt *E. coli* and *Enterococcus* as recreational water criteria in 1986, but some feel that these new indicators are inadequate (Calderon et al. 1991).

Methods to identify and quantify pathogens in watersheds require filtering large volumes of water and eluting the organisms from the filter. Detection and quantification are accomplished by culturing or molecular biology methods. Some organisms cannot be identified through culturing techniques, so molecular biology methods, based on nucleotides within nucleic acid sequences, are used. Low recovery efficiencies commonly encountered with filtration recovery make it difficult to estimate original concentrations with confidence. Methods for protozoa are cumbersome and do not indicate viability. Infectivity studies can be done to determine viability, but are expensive and slow. When an outbreak of a waterborne pathogen is suspected and the water is tested, the pathogen may not be detected because the contamination may have been temporary and been flushed out or died off (Moe 1997).



## Modeling and Source Water Protection

Modeling can assist in identifying the vulnerability of a drinking water utility to threats from source water contamination. These models can be used in assessing the impact of upstream point-source discharges on downstream users as well as the potential for contamination from nonpoint sources (Clark et al. 1998). For example, the Water Supply and Water Resources Division (WSWRD) has developed two user-friendly modeling systems which include (1) a simplified model of the entire Ohio River, and (2) a detailed model of the Ohio River mainstream that may be used under emergency spill situations. Both models are built to interact with a Geographic Information System (GIS) for display and/or input generation, and it is anticipated that this approach will be extended to other source waters. The wide-scale model uses representative steady state flow regimes and represents movement by simple travel time relationship and transformations by dilution and decay mechanisms. Pollutants are routed through the RF1 reach file representation of the basin (Clark et al. 1998). The detailed mainstream model uses actual dynamic flow patterns as input to EPA's WASP4 water quality model (Ambrose et al. 1990). WASP4 is a dynamic compartment model that can be used to analyze a number of water quality problems. The Ohio River mainstream is represented in the model from a series of segments ranging in size from two to ten miles in length. The basic equation used in WASP4 governing decay of contaminants is as follows:

$$C_s = (M_g / Q_s) \exp(-k \cdot CT_s) \quad (4-1)$$

where  $Q_s$  (L/s) is the flow in the segment,  $M_g$  is the mass of the pollutant (mg/s) that enters the segment,  $k$  is the decay coefficient with a typical value of 0.5/day,  $CT_s$  is the cumulative time of travel (days), "exp" denotes the exponential function, and  $C_s$  is the concentration in mg/L at the end of the reach. When the pollutant is stable and not reactive, the value for  $k = 0$ .

The detailed model includes a hydraulic model (the Corps of Engineers FLOWSED model), which has been combined with WASP4 to make spill modeling predictions. FLOWSED, which predicts daily flow quantities along the mainstream and portions of major tributaries near their confluence with the Ohio River, is applied daily by the Ohio River Division of the Corps of Engineers. Five-day forecast of stage and flow are generated for 400 mainstream and tributary segments, and the results were made accessible to the Ohio River Valley Water Sanitation Commission (ORSANCO) via telephone lines.

A relational database management system was used to organize the various sources of data used in the study. Individual data files included information on facilities, outfall, permit limits, monitoring data, and codes used in the other files. The NPDES permit number was used as the primary key in each of the files.

GIS modeling and Data Base Management System (DBMS) techniques were integrated into two tools for use by ORSANCO for analyzing spills in the Ohio River. The NETWORK component of ARC/INFO was used to provide a steady state contaminant routing capability. In addition, a C-based spatial decision support system was developed as a spill management system to serve as a quick response tool for analyzing and displaying the results of a pollutant spill into the Ohio River.

Research is underway to extend this modeling approach to microbiological discharges from CSOs. Research is also being conducted which is intended to extend this modeling concept to nonpoint source contamination.

### ***Modeling Overland Migration of Pathogens***

Another aspect of contamination modeling is the overland transport of pathogens. Although efforts to model overland transport of *Cryptosporidium* oocysts have been limited, such models are needed to

predict oocysts loads and estimate the effectiveness of management practices. This information may subsequently be used in reservoir models if accuracy requirements are met. Auer et al. (1998) identified the need for developing pathogen loading data in order to support pathogen fate and transport modeling within reservoirs. Several models exist that are capable of predicting soil loss, runoff, transport of contaminants from animal waste, and bacterial die-off. Whether these models, individually or combined, are capable of accurately predicting *Cryptosporidium* loads or reductions achieved during transport through buffer strips remains to be seen. Considerations in model selection include assumptions made by the model, the size of the watershed, availability of data, and the desired level of accuracy. The ability of a model to simulate oocyst transport is dependent on how well the model assumptions reflect the actual characteristics of oocysts and the landscape over which they travel. EPA has sponsored ongoing research to evaluate factors affecting overland migration of oocysts. A major goal of the research is to determine the degree to which oocysts tend to stick to different materials and then to evaluate their potential for runoff, either in attached or free-floating form. Key components of the project include jar tests to determine partitioning of oocysts among water, clay, or other soil, fecal matter, plant matter, etc.; flume tests to directly evaluate oocyst overland migration; evaluation and development of a modeling framework; and evaluation of protocols for measuring oocysts in high turbidity samples encountered in runoff samples.

Models used in predicting the transport of animal waste over land have typically utilized indicator bacteria. This approach is useful in assessing risk due to fecal contamination since indicator organisms are easily identified, while low levels of pathogens may not be discernable. Although FC is a common indicator organism for fecal wastes, its physical characteristics differ significantly from those of oocysts. This results in differences in die-off rates and soil retention. These differences result in inability of existing models to predict oocyst transport. Identifying and quantifying the mechanisms which affect die-off and retention of oocysts may facilitate the use of existing models for estimating oocyst concentrations.

Crane and Moore (1986) found that, of the several patterns followed during enteric bacteria die-off, the model for first-order die-off kinetics accurately described bacterial die-off under several conditions. However, the rate coefficient was highly variable due to differences in the effect of environmental factors on the assorted types of bacteria. The authors identified pH, temperature, solar radiation, moisture, application method, and application medium as critical factors in determining microbial survival. Information on the effects of these factors on oocyst survival is necessary in order to develop a die-off rate coefficient(s) for *Cryptosporidium*.

Reddy et al. (1981) combined an animal waste model with the Agricultural Runoff Management (ARM-II) Model to simulate the effects on the quality of runoff from land receiving animal waste. The microbiological submodel was developed by simulating FC die-off and retention in the soil. Moore et al. (1988) also developed a model, MWASTE, which follows indicator organisms from the animal waste through leaving the land as surface runoff utilizing bacterial indicator organisms. MWASTE is capable of including data on the slope and width of buffer strips. The model COLI (Walker et al. 1990) also examines the movement of indicator bacteria in runoff. Although these models contain a biological component, they cannot be used to predict oocyst transport. It is possible that newer models, with improved capability to predict hydrology and sediment transport, may be adaptable to predicting oocyst transport if mechanisms controlling overland flow were better understood. The New York City Department of Environmental Protection has conducted an evaluation including pathogen loading in its terrestrial models and determined that improvements in identification and quantification of oocyst sources was required (USEPA 1997).

## Summary and Conclusions

Passage of the 1996 amendments to the SDWA has focused the attention of water utility managers and public health and regulatory officials on SWP and its role in protecting public water supplies. There is growing awareness that water treatment and/or disinfection may not always be enough to ensure the provision of potable and safe water to the consumer. The 1993 cryptosporidiosis outbreak in Milwaukee, WI, has raised the possibility that even water suppliers which meet all of the SWTR requirements of the SDWA are vulnerable (Okun et al. 1997; Fox and Lytle 1996).

Most utilities in the U.S. invest a great deal of time, energy, and capital in developing mechanisms for protecting against the impact of sudden changes in influent water quality. Some of these mechanisms include investment in excess capacity and development of emergency procedures (Miller 1989).

Concern over SWP is not limited to surface water supplies. Many ground water supplies have proven to be vulnerable as well, resulting in the various states implementing wellhead protection programs. Based on the 1996 amendments, the states will have to implement programs to decide if a system's source of supply is threatened as well as determine the means to prevent pollution. Communities will be allowed to ask for state assistance, and a certain percentage of the State Revolving Loan Fund has been earmarked to assist with SWP (Howell 1987).

The SDWA was passed in 1974 and amended in 1986 and 1996, but SWP under the SDWA actually began with the SDWA Amendments of 1986. The 1986 amendments included provisions for "Protection of Ground Water Sources of Water." Two programs were set up under this requirement: the "Sole Source Aquifer Demonstration Program," to establish demonstration programs to protect critical aquifer areas from degradation; and the "Wellhead Protection Program," which required states to develop programs for protecting areas around public water supply wells to prevent contamination from residential, industrial, and farming-use activities.

In the 1996 amendments to the SDWA, protection of source waters was given greater emphasis to strengthen protection against microbial contaminants, particularly *Cryptosporidium*, while reducing potential health risks due to disinfection by-products. This increased protection is embodied in the IESWTR (USEPA 1998). This rule applies to public water systems that use surface water or GWUDI and serve at least 10,000 people.

Two major threats to source water quality with respect to DBP control and microbial protection are natural organic matter and pathogens. As reflected in the previous discussion, the two pathogens which are currently of most concern are *Giardia* and *Cryptosporidium*.

Managing microbial risk requires identification and quantification of organisms. Because of difficulties associated with assaying for specific pathogens, monitoring programs have tested for indicator organisms, including FC and TCs, to identify possible fecal contamination in water. The potential sources of pathogens in source water are many and varied, including nonpoint runoff and discharges from treated and untreated sewage and combined sewer overflows. From a waterborne outbreak and public health viewpoint, both *Giardia* and *Cryptosporidium* are of primary concern. Monitoring regulations often specify indicators for determining water quality because the analytical methods are easier to complete, faster, and lower-cost than methods for specific organisms. Limitations of relying on indicators for determining the presence of pathogens include the occurrence of false positives. The indicators measure bacteria that live not only in human enteric tracts, but also in the enteric tracts of other animals (Toranzos and McFeters 1997).

Microbial pathogens are found in treated sanitary sewage and wet weather flows, i.e., SSOs, CSOs, and storm water runoff. Many factors effect the types of organisms found and the concentrations at which they are detected. These include watershed contributions, treatment plant efficiency, and length of antecedent dry weather period. These treatment technologies can be both sources of contamination as well as protective of source water quality. In addition to the installation of sewage treatment and combined overflow systems, there are passive pollution prevention and mitigation techniques called BMPs. The techniques vary dramatically in application, ranging from social practices to engineering applications.

SWP strategies are a specific subset of a larger watershed protection strategy applied when the protected receiving water is used as a water supply. Conceptually, watershed protection is heavily linked to pollution prevention, contaminant source identification, and risk management.

Modeling can assist in identifying the vulnerability of a drinking water utility to threats from source water contamination. These models can be used in assessing the impact of upstream point-source discharges on downstream users as well as the potential for contamination from nonpoint sources (Clark et al. 1998). Another aspect of contamination modeling is the overland transport of pathogens. Although efforts to model overland transport of *Cryptosporidium* oocysts have been limited, such models are needed to predict oocyst loads and estimate the effectiveness of management practices.

Although SWP is currently more of a collection of practices than a well-defined art or science, it is anticipated that it will become an integral part of water treatment practice in the future. As interest grows in the concept of watershed management, it is likely that interest will grow in understanding the factors that effect the quality of source water for drinking water utilities as well.

## References

- Ambrose, R. B., Wool, T. A., Connoly, J. P., and Schanz, R. W. (1990). *WASP4, A hydrodynamic and water quality model—Model theory, user's manual and programmers' guide*. EPA Environmental Research Laboratory, Athens, Georgia.
- American Public Health Association. (1998). *Standard methods for the examination of water and wastewater*, 20th Ed., American Water Works Association, Water Environment Federation, Washington, D.C.
- Atherholt, T. B., LeChevallier, M. W., Norton, W. D., and Rosen, J. S. (1998). "Effect of rainfall on *Giardia* and *crypto*." *Journal of the American Water Works Association*, 90(9), 66–80.
- Atwill, E. R., et al. (1998). "Age, geographic, and temporal distribution of fecal shedding of *Cryptosporidium parvum* oocysts in cow-calf herds." *American Journal of Veterinary Research*, 60(4), 420–425.
- Atwill, E. R., Sweitzer, R. A., Pereira, M. G. C., Gardner, I. A., Van Vuren, D., and Boyce, W. M. (1997). "Prevalence of and associated risk factors for shedding *Cryptosporidium parvum* oocysts and *Giardia* cysts within feral pig populations in California." *Applied and Environmental Microbiology*, 63(10), 3946–3949.
- Auer, M. T., Bagley, S. T., Stern, D. A., and Babiera, M. J. (1998). "A framework for modeling the fate and transport of *Giardia* and *Cryptosporidium* in surface waters." *Journal of Lake and Reservoir Management*, 14(2–3), 393–400.
- Badenoch, Sir J. (Chairman). (1990). "*Cryptosporidium* in water supplies—Report of the group of experts." Department of the Environment, Department of Health, London, U.K., HMSO.

- Bajer, A., Bednarska, M., and Sinski, E. (1997). "Wildlife rodents from different habitats as a reservoir for *Cryptosporidium parvum*." *Acta Parasitologica*, 42(4), 192–194.
- Barry, J. S., Atwill, E. R., Tate, K. W., Koopman, T. S., Cullor, J., and Huff, T. (1998). "Developing and implementing a HAACCP-based program to control *Cryptosporidium* and other waterborne pathogens in the Alameda Creek watershed: Case study." *American Water Works Association Annual Conference*, Dallas, TX, June.
- Barthe, C. and Brassard, N. (1996). "*Giardia* and *Cryptosporidium* in river water, ground water and tap water in Quebec." *Planning for Tomorrow: Proceedings, 6th National Conference on Drinking Water*, Victoria, B.C., Oct. 16–18, 1994, 207–215.
- Benton, C., Ives, K. J., Miller, D. G., and West, P. A. (1991). "*Cryptosporidium* in water—progress in the United States of America." *Report of an OSTEMS mission, 6-20*. Water Research Centre, Medmenham, Marlow, Buckinghamshire, U.K., 19.
- Berg, G., Safferman, R. S., Dahling, D. R., Berman, D., and Hurst, C. J. (1983). *USEPA Manual of methods for virology, EPA-600/4-84-013*. U.S. Environmental Protection Agency, Cincinnati, OH.
- Botts, J., Allard, L., and Wheeler, J. (1996). "Structural best management practices for storm water pollution control at industrial facilities." *Proceedings, Watershed '96 Moving Ahead Together Technical Conference and Exposition*, Water Environment Federation, Baltimore, MD, June 8–12.
- Breach, R. A., Howells, V. W., Porter, M. J., Furness, M., Dawson, D., and Black, D. W. (1994). "An integrated water utility approach to minimize the risks associated with waterborne *Cryptosporidiosis*." *Proceedings, American Water Works Association Annual Conference*, New York, June 19–23. American Water Works Association, Denver, CO.
- Calderon, R. L., Mood, E. W., and Dufour, A. P. (1991). "Health effects of swimmers and nonpoint sources of contaminated water." *International Journal of Environmental Health Research*, 1, 21–31.
- Camp, Dresser & McKee and Moffa & Associates. (1997). *Draft CSO disinfection pilot study report*. Submitted to New York City Department of Environmental Protection.
- Casson, L. W., Sorber, C. A., Sykora, J. L., Gavaghan, P. D., Shapiro, M. A., and Jakubowski, W. (1990). "*Giardia* in wastewater—effect of treatment." *Research Journal of the Water Pollution Control Federation*, 62(5), 670–675.
- Chauret, C., et al. (1998). "Effect of microbial antagonism on the survival of *Cryptosporidium parvum* oocysts in fresh natural waters." *Proceedings, IAWQ 19th Biennial International Water Quality Conference*, Vancouver, Canada, June 21–26.
- Clark, R. M., Goodrich, J. A., Lykins, Jr., B. W., and Neal, J. R. (1998). "Evaluating the effects of upstream dischargers on downstream water suppliers: A source water protection model." *Journal of Water Supply Research and Technology—Aqua*, 47(5), 1–8.
- Coffman, L. S., Smith, J., and Lahlou M. (1996). "Environmentally sensitive low-impact development." *Proceedings, Watershed '96 Moving Ahead Together Technical Conference and Exposition*, Water Environment Federation, Baltimore, MD, June 8–12.
- Cooke, G. D. and Carlson, R. E. (1989). "Chaper 3: THM production and eutrophication." *Reservoir management for water quality and THM precursor control*. American Water Works Association Research Foundation, Denver, CO, 5–20.

- Cooke, G. D., Palmstrom, N., Martin, A., Watkins, M., Beals, A., and Carlson, R. E. (1988). "Reservoir management for THM precursor control." *American Water Works Association seminar on water quality management in reservoirs*, Orlando, FL. American Water Works Association, Denver, CO, 21–51.
- Corbett, C. W., Wahl, M., Porter, D. E, Edwards, D., and Moise, C. (1997). "Nonpoint source runoff modeling: A comparison of forested watershed and an urban watershed on the South Carolina coast." *Journal of Experimental Marine Biology and Ecology*, 213, 133–149.
- Correll, D. L., Jordan, T. E., and Weller, D. E. (1992). "Nutrient flux in a landscape: Effects of coastal land use and terrestrial community mosaic on nutrient transport to coastal waters." *Estuaries*, 15(4), 431–442.
- Crane, S. R. and Moore, J. A. ( 1986). "Modeling enteric bacterial die-off: A review." *Water, Air, and Soil Pollution*, 27, 411–439.
- Craun, G. F. (1986). *Waterborne diseases in the United States*. CRC Press LLC, Boca Raton, FL.
- Craun, G. F., Hubbs, S. A., Frost, F., Calderon, R. L., and Anad Via, S. H. (1998). "Waterborne outbreaks of Cryptosporidiosis." *Journal of the American Water Works Association*, 90(9), 81–91.
- Current, W. L. and Garcia, L. S. (1991). "Cryptosporidiosis." *Clinical Microbiological Review*, 4(3), 325–358.
- Dillaha, T. A. and Hayes, J. C. (1991). "A procedure for the design of vegetated filter strips—Final report." United States Soil Conservation Service.
- Dufour, A. P. (1984). "Health effects criteria for fresh recreational waters." *EPA-600/1-84-004*, U.S. Environmental Protection Agency, Research Triangle Park, NC, August.
- Dutka, B. J. and Tobin, S. (1978). "Monitoring of storm water runoffs for bacterial and viral pathogens of man." *Research Report No. 87, Project No. 76-8-4*, Ministry of the Environment.
- Dutka, B. J. and Rybakowski, I. (1978). "Microbiological study of some Canadian storm water runoffs at Burlington and Brucewood." *Research Report No. 87, Project No. 75-3-24*, Ministry of the Environment.
- Edwards, D. R., Daniel, T. C., Scott, H. D., Moore, Jr., P. A., Murdoch, J. F., and Vendrell, P. F. (1997). "Effect of BMP implementation on storm flow quality of two northwestern Arkansas streams." *American Society of Agricultural Engineers*, 40(5), 1311–1319.
- Ellis, J. B. and Yu, W. (1995). "Bacteriology of urban runoff: The combined sewer as a bacterial reactor and generator." *Water Science Technology*, (31)7, 303–310.
- Erlandsen, S. L. and Meyer, A. (1984) "*Giardia and Giardiasis: Biology, pathogenesis, and epidemiology*." Plenum Press, New York.
- Fayer, R. (1994). "Effect of high temperature on infectivity of *Cryptosporidium parvum* oocysts in water." *Applied and Environmental Microbiology*, 60(8), 2732–2735.
- Fayer, R. and Nerad, T. (1996). "Effects of low temperatures on viability of *Cryptosporidium parvum* oocysts." *Applied and Environmental Microbiology*, 62(4), 1431–1433.
- Fayer, R., Speer, C. A., and Dubey, J. P. (1997). "The general biology of *Cryptosporidium*." *Cryptosporidium and Cryptosporidiosis*, R. Fayer, ed., CRC Press LLC, Boca Raton, FL.
- Fayer, R. and Ungar, B. L. P. (1986). "*Cryptosporidium* spp. and Cryptosporidiosis." *Microbiological Review*, 50(4), 458–483.

- Fayer, R., ed. (1997). *"Cryptosporidium and Cryptosporidiosis."* CRC Press, LLC, Boca Raton, FL.
- Fisher, T. R., Peele, E. R., Ammerman, J. W., and Harding, Jr., L. W. (1992). "Nutrient limitation of phytoplankton in Chesapeake Bay." *Marine Ecology Progress Series*, 82, 51–63.
- Forde, K. N., Swinker, A. M., Traub-Dargatz, J. L., and Cheney, J. M. (1997). "The prevalence of *Cryptosporidium/Giardia* in the trail horse population utilizing public lands." *Proceedings, 15th Equine Nutrition and Physiology Symposium*, Colorado State University, Fort Collins, CO, 223–237.
- Fox, K. R. and Lytle, D. A. (1996). "Milwaukee's crypto outbreak investigation and recommendations." *Journal of the American Water Works Association*, 88(9), 87–94.
- Frederick, R., Goo, R., Corrigan, M., Bartow, S., and Billingsley, M. (1996). "Economic benefits of urban runoff controls." *Proceedings, Watershed '96 Moving Ahead Together Technical Conference and Exposition*, Water Environment Federation, Baltimore, MD, June 8–12.
- Gannon, J. J. and Busse, M. K. (1989). "*E. Coli* and Enterococci levels in urban stormwater, river water and chlorinated treatment plant effluent." *Water Research*, 23(9), 1167–1176.
- Garber, L. P., Salman, M. D., Hurd, H. S., Keefe, T. J., and Schlater, L. (1994). "Potential risk factors for *Cryptosporidium* infection in dairy calves." *Journal of the American Veterinary Medical Association*, 205, 86–91.
- Garber, J. (1999). "Anthropogenic nitrogen: Too much of a good thing?" Plan for USEPA research on ecological risks posed by increasing loads of anthropogenic nitrogen to the nation's air, land, and water, Draft version 5.1, August 28, 1999.
- Geldreich, E. E., Best, L. C., Kenner, B. A., and Van Donsel, D. J. (1968). "The bacteriological aspects of stormwater pollution." *Journal of the Water Pollution Control Federation*, 40(11), 1861–1872.
- Gibson III, C. J., Staderman, K. L., States, S., and Sykora, J. (1998). "Combined sewer overflows: A source of *Cryptosporidium* and *Giardia*?" *Water Science Technology*, 38(12), 67–72.
- Goel, S., Hozalski, R. M., and Bouwer, E. J. (1995). "Biodegradation of NOM: Effect of NOM source and ozone dose." *Journal of the American Water Works Association*, 87(1), 90–105.
- Goodgame, R. W., Genta, R. M., White, A. C., and Chappell, C. L. (1993). "Intensity of infection in AIDS-associated cryptosporidiosis." *Journal of Infectious Diseases*, 167, 704–709.
- Graczyk, T. K., Fayer, R., Cranfield, M. R., and Conn., D. B. (1998a). "Recovery of waterborne *Cryptosporidium parvum* oocysts by freshwater benthic clams (*Corbicula fluminea*)." *Applied and Environmental Microbiology*, 64(2), 427–430.
- Graczyk, T. K., et al. (1998b). "*Giardia* sp. cysts and infectious *Cryptosporidium parvum* oocysts in the feces of migratory Canada Geese (*Branta canadensis*)." *Applied and Environmental Microbiology*, 64(7), 2736–2738.
- Griffin, C. B. (1993). *Effectiveness and feasibility of best management practices in reducing urban nonpoint sources of nitrogen to Long Island*. State University of New York—College of Environmental Science and Forestry, Syracuse, NY.
- Graham, N. J. D., Wardlaw, V. E., Perry, R., and Jiang, J. (1998). "The significance of algae as trihalomethane precursors." *Water Science Technology*, 37(2), 83–89.
- Griffin, C. B. (1995). "Uncertainty analysis of BMP effectiveness for controlling nitrogen from urban nonpoint sources." *Water Resources Bulletin*, 31(6), 1041–1050.

- Haas, C. N. and Rose, J. B. (1994). "Reconciliation of microbial risk models and outbreak epidemiology: The case of the Milwaukee outbreak." *Proceedings, American Water Works Association 1994*, 517–23.
- Hancock, C. M., Rose, J. B., and Callahan, M. (1998). "Crypto and Giardia in U.S. groundwater." *Journal of the American Water Works Association*, 90(3), 58–61.
- Hansen, J. S. and Ongerth, J. E. (1991). "Effects of time and watershed characteristics on the concentration of *Cryptosporidium* oocysts in river water." *Applied and Environmental Microbiology*, 57, 2790–2795.
- Herwaldt, B. L., Craun, G. F., Stokes, S. L., and Juranek, D. D. (1991). "Waterborne-disease outbreaks, 1989–1990." *CDC Surveillance Summaries, December, 1991, Morbidity and Mortality Weekly Report*, 40 (No.SS-3), 1–22.
- Hirata, T. and Hashimoto, A. A. (1997). "Field survey on occurrence of *Giardia* cysts and *Cryptosporidium* oocysts in sewage treatment plants." *Proceedings, 1997 International Symposium on Waterborne Cryptosporidium*, Newport Beach, CA, March 2–5. C. Fricker, J. L. Clancy, and P. A. Rochelle, eds., American Water Works Association, Denver, CO, 183–193.
- Hoehn, R. C., Hargette, P. H., Knocke, W. R., Dietrich, A. M., Randtke, S. J., and Long, B. W. (1994). "The influence of raw water quality on the formation of disinfection by-products during drinking water treatment." *Proceedings, 1994 Water Quality Technology Conference; Part II*, San Francisco, CA, November 6–10, 1947–1975.
- Hopkinson, Jr., C. S. (1992). "A comparison of ecosystem dynamics in freshwater wetlands." *Estuaries*, 15(4), 549–562.
- Houlahan, J., Marcus, W. A., and Shirmohammadi, A. (1992). "Estimating Maryland critical area acts impact on future nonpoint pollution along the Rhode River Estuary." *Water Resources Bulletin*, 28(3), 553–567.
- Howell, M. L. (1997). "SDWA then and now." *Journal of the American Water Works Association*, 89(3), 11.
- Hurst, C. J., Knudsen, G. R., McInerney, M. J., Stetzenbach, L. D., and Walter, M. V. (1997). *Manual of environmental microbiology*. ASM Press, American Society for Microbiology, Washington, D.C.
- Jenkins, M. B., Bowman, D. D., and Ghiorse, W. C. (1998). "Inactivation of *Cryptosporidium parvum* oocysts by ammonia." *Applied and Environmental Microbiology*, 64(2), 784–788.
- Jenkins, M. B., Walker, M. J., Bowman, D. D., Anthony, L. C., and Ghiorse, W. C. (1999). "Use of a sentinel system for field measurements of *Cryptosporidium parvum* oocysts in soil and animal waste." *Applied and Environmental Microbiology*, 65(5), 1998–2005.
- Johnson, E., Atwill, E. R., Filkins, M. E., and Kalush, J. (1997). "The prevalence of shedding of *Cryptosporidium* and *Giardia* spp. based on a single fecal sample collection from each of 91 horses used for backcountry recreation." *Journal of Veterinary Diagnostics Investigation*, 8, 56–60.
- King, W. C. (1996). *Environmental engineering: P.E. examination guide & handbook*. American Academy of Environmental Engineers, Annapolis, MD.
- Klesius, P. H., Haynes, T. B., and Malo, L. K. (1986). "Infectivity of *Cryptosporidium* sp. isolated from wild mice for calves and mice." *Journal of American Veterinarian Medical Association*, 189(2) 192–193.
- Kramer, M. H., Herwaldt, B. L., Craun, G. F., Calderon, R. L., and Juranek, D. D. (1996). "Waterborne disease: 1993 and 1994." *Journal of the American Water Works Association*, 88(3), 66–80.



- Krasner, S. W., Croue, J-P., Buffle, J., and Perdue, E. M. (1996). "Three approaches for characterizing NOM." *Journal of the American Water Works Association*, 88(6), 66–79.
- Kuczynska, E. and Shelton, D. R. (1999). "Method for detection and enumeration of *Cryptosporidium parvum* oocysts from feces, manure, and soils." *Applied and Environmental Microbiology*, 65, 2820–2826.
- Kurz, R. C. (1998). "Removal of microbial indicators from stormwater using sand filtration, wet detention, and alum treatment best management practices." Southwest Florida Water Management District.
- LeChevallier, M. W., Norton, W. D., and Lee, R. G. (1991a). "Occurrence of *Giardia* and *Cryptosporidium* spp. in surface water supplies." *Applied and Environmental Microbiology*, 57, 2610–2616.
- LeChevallier, M. W., Norton, W. D., and Lee, R. G. (1991b). "*Giardia* and *Cryptosporidium* spp. in filtered drinking water supplies." *Applied and Environmental Microbiology*, 57, 2617–2621.
- LeChevallier, M. W. and Norton, W. D. (1995). "*Giardia* and *Cryptosporidium* in raw and finished water." *Journal of the American Water Works Association*, 87(9), 45–68.
- LeChevallier, M. W., Norton, W. D., and Atherholt, T. B. (1997). "Protozoa in open reservoirs." *Journal of the American Water Works Association*, 89(9), 84–96.
- Levy, D. A., Bens, M. S., Craun, G. F., Calderon, R. L., and Herwaldt, B. L. (1998). "Surveillance for waterborne-disease outbreaks—United States, 1995–1996." *CDC Surveillance Summaries, December, 1998, Morbidity and Mortality Weekly Report*, 47 (No. SS-5):1–33.
- Lijklema, L., Habekotte, B., Hooijmans, C., Aalderind, R. H., and Havellar, A. H. (1986). "Survival of indicator organisms in a detention pond receiving combined sewer overflow." *Water Science Technology*, 18(10), 9–17.
- Lin, S. D. (1985). "*Giardia lamblia* and water." *Journal of the American Water Works Association*, 77(1), 40–47.
- Lisle, J. T. and Rose, J. B. (1995). "*Cryptosporidium* contamination of water in the USA and UK: A mini-review." *Journal of Water Supply Research and Technology–Aqua*, 44(3), 103–117.
- Los Angeles Department of Water and Power (LADWP). (1996). <<http://www.ladwp.com/bizserv/water/quality/topics/giardia/giardia.htm>>.
- Madore, M. S., Rose, J. B., Gerba, C. P., Arrowood, M. J., and Sterling, C. R. (1987). "Occurrence of *Cryptosporidium* oocysts in sewage effluents and select surface waters." *Journal of Parasitology*, 73, 702–706.
- Makepeace, D. K., Smith, D. W., and Stanley, S. J. (1995). "Urban stormwater quality: Summary of contaminant data," Critical reviews. *Environmental Science and Technology*, 25(2), 93–139.
- Mallin, M. A. (1998). "Land-use practices and fecal coliform pollution of coastal water." *Proceedings, 14th Annual North Carolina On-Site Wastewater Treatment Conference*, North Carolina Department of Environment, Health, and Natural Resources. North Carolina State University, Raleigh, NC, October 27–29.
- Marshall, M. M., Naumovitz, D., Ortega, I., and Sterling, C. R. (1997). "Waterborne protozoan pathogens." *Clinical Microbiology*, 10(1), 67–85.

- Metcalf & Eddy, Inc. (1991). *Wastewater engineering: Treatment, disposal, and reuse*. McGraw-Hill, Inc., New York.
- Metcalf, T. G., Melnick, J. L., and Estes, M. K. (1995). "Environmental virology: From detection of virus in sewage and water by isolation to identification by molecular biology—A trip of over 50 years." *Annual Review of Microbiology*, 49, 461–487.
- Miller, R. (1989). "Why use GAC—A utility viewpoint." *Design and Use of Granular Activated Carbon—Predicted Aspects*. American Water Works Association Research Foundation, Denver, CO, 15–21.
- Milliken, B. (1996). "Summary of proposed stormwater management techniques for the village of Woodsong as of January 31, 1996." *Proceedings, Watershed '96 Moving Ahead Together Technical Conference and Exposition*, Water Environment Federation, Baltimore, MD, June 8–12.
- Minear, R. A. and Amy, G. L., eds. (1996). *Water disinfection and natural organic matter, characterization and control*. American Chemical Society, Washington, D.C.
- Minei, V. and Dawydiak, W. (1997). *Proceedings, Second Marine and Estuarine Shallow Water Science and Management Conference, EPA/903/R-97009*. U.S. EPA Region III, Environmental Protection and Assessment Division, Philadelphia, PA.
- Moe, C. L. (1997). "Waterborne transmission of infectious agents." *Manual of Environmental Microbiology*, C. J. Hurst, G. R. Knudsen, M. J. McInerney, L. D. Stetzenback, and M. V. Walter, eds., American Society for Microbiology, ASM Press, Washington, D.C.
- Moore, J. A., Smyth, J., Baker, S., and Miner, J. R. (1988). "Evaluating coliform concentrations in runoff from various animal waste management systems." *Special Report 817*. Agricultural Experiment Stations, Oregon State University, Corvallis, OR.
- Moore, A. C., Herwaldt, B. L., Craun, G. F., Calderon, R. L., Highsmith, A. K., and Juranek, D. D. (1994). "Waterborne disease in the United States, 1991 and 1992." *Journal of the American Water Works Association*, 86(2), 87–99.
- Natural Resource Conservation Service (NRCS). (1998). *National Handbook of Conservation Practices*, Filter Strips, Code 393, September 1998.
- NRCS. (1997). *National Handbook of Conservation Practices*, Contour Buffer Strips, Code 332, July 1997.
- New York City Department of Environmental Protection. (1999). Final report for the Septic Siting Study Project.
- Norton, W. D. and LeChevallier, M. W. (1997). "Survey of open finished water reservoirs for *Giardia* cysts and *Cryptosporidium* oocysts." New Jersey Department of Environmental Protection, Division of Science and Research.
- Okun, D. A., Craun, G. F., Edzwald, J. K., Gilbert, J. B., and Rose, J. B. (1997). "New York City: To filter or not to filter?" *Journal of the American Water Works Association*, 89(3), 62–74.
- Olivieri, P. W., Kruse, C. W., Kawata, K., and Smith, J. S. (1977). "Microorganisms in urban stormwater." *EPA-600/2-77-087*, U.S. Environmental Protection Agency, Cincinnati, OH.
- Ongerth, J. E. (1989). "*Giardia* cyst concentrations in river water." *Journal of the American Water Works Association*, 81(9), 81–86.

- Ongerth, J. E. and Stibbs, H. H. (1987). "Identification of *Cryptosporidium* oocysts in river water." *Applied and Environmental Microbiology*, 53, 672–676.
- Parker, J. A. and J. L. Darby (1995). "Particle-associated coliform in secondary effluents: Shielding from ultraviolet disinfection." *Water Environment Research*, 67(7), 1065–1075.
- Perdek, J. M. and Borst, M. (2000). "Microbial particle association and combined sewer overflow disinfection." *Disinfection 2000*. Water Environment Federation, New Orleans, LA, March.
- Peterjohn, W. T. and Correll, D. L. (1986). "The effect of riparian forest on the volume and chemical composition of baseflow in an agricultural watershed." *Watershed Research Perspectives*, D. L. Correll, ed., Smithsonian Press, Washington, D.C., 244–262.
- Pettibone, G. W. and Irvine, K. N. (1996). "Levels and sources of indicator bacteria associated with the Buffalo River 'area of concern,' Buffalo, New York." *Great Lakes Research*, 22(4), 896–905.
- Preston, S. D. (1996). "Study of nonpoint source nutrient loading in the Patuxent river basin, Maryland." *Water Resources Investigations Report No. WRIR-96-4273*. U.S. Department of the Interior, U.S. Geological Survey.
- Quilez, J., Ares-Mazas, E., Sanchez-Acedo, C., del Cacho, E., Clavel, A., and Causape, A. C. (1996). "Comparison of oocyst shedding and the serum immune response to *Cryptosporidium parvum* in cattle and pigs." *Parasitology Research*, 82, 529–534.
- Reddy, K. R., Khaleel, R., and Overcash, M. R. (1981). "Modeling nonpoint pollution due to animal waste with ARM II." *Modeling Components of Hydrologic Cycle. Proceedings, International Symposium on Rainfall Runoff Modeling*, V. P. Singh, ed., Water Resources Publications, Littleton, CO, 427–508.
- Roach, P., Olson, M., Whitely, G., and Wallis, P. (1993). "Waterborne *Giardia* cysts and *Cryptosporidium* oocysts in the Yukon, Canada." *Applied Environmental Microbiology*, 59, 67–73.
- Rose, J. B., Kayed, D., Madore, M. S., Gerba, C. P., Arrowood, M. J., and Sterling, C. R. (1988). "Methods for the recovery of *Giardia* and *Cryptosporidium* from environmental waters and their comparative occurrence." *Advances in Giardia Research*, P. Wallis and B. Hammond, eds., University of Calgary Press, Calgary, Canada.
- Rose, J. B., Gerba, C. P., and Jakubowski, W. (1991). "Survey of potable water supplies for *Cryptosporidium* and *Giardia*." *Environmental Science and Technology*, 25, 1393–1400.
- Rose, J. B., Darbin, H., and Gerba, C. P. (1988). "Correlations of the protozoa, *Cryptosporidium* and *Giardia* with water quality variables in a watershed." *Proceedings, International Conference on Water Wastewater Microbiology*, Newport Beach, CA, 2, 43-1–43-6.
- Rose, J. B. (1988). "Occurrence and significance of *Cryptosporidium* in water." *Journal of the American Water Works Association*, 80(1), 53–58.
- Rose, J. B. (1997). "Environmental ecology of *Cryptosporidium* and public health implications." *Annual Review of Public Health*, 18, 135–61.
- Rose, J. B., Lisle, J. T., and LeChevallier, M. (1997). "Waterborne Cryptosporidiosis: Incidence, outbreaks, and treatment strategies." *Cryptosporidium and Cryptosporidiosis*, R. Fayer, ed., CRC Press LLC, Boca Raton, FL.
- Schillinger, J. E. and Gannon, J. J. (1985). "Bacterial adsorption and suspended particles in urban stormwater." *Journal of the Water Pollution Control Federation*, 57(5), 384–389.

- Sherer, B. M., Miner, J. R., Moore, J. A., and Buckhouse, J. C. (1992). "Indicator bacterial survival in stream sediments." *Journal of Environmental Quality*, 21, 591–595.
- Singh, A. and McFeters, G. A. (1992). "Detection methods for waterborne pathogens." *Environmental Microbiology*, Wiley-Liss, Inc., New York, 126–156.
- States, S., et al. (1997). "Protozoa in river water: Sources, occurrence and treatment." *Journal of the American Water Works Association*, 89(9), 74–83.
- States, S., Sykora, J., Stadterman, K., Wright, D., Baldizer, J., and Conley, L. (1996). "Sources, occurrence, and drinking water treatment removal of *Cryptosporidium* and *Giardia* in the Allegheny River." *Proceedings, American Water Works Association Water Quality Technology Conference*, New Orleans, LA, November 12–16, 1995. American Water Works Association, Denver, CO, Part II, 1587–1601.
- Stepczuk, C., Owens, E. M., Effler, S. W., Auer, M. T., and Bloomfield, J. A. (1998). "A modeling analysis of THM precursors for a eutrophic reservoir." *Journal of Lake and Reservoir Management*, 14(2–3), 367–378.
- Stern, D. A. (1996). "Monitoring for *Cryptosporidium* spp. and *Giardia* spp. and human enteric viruses in the watersheds of the New York City water supply system." *Proceedings, Watershed '96 Moving Ahead Together Technical Conference and Exposition*, Water Environment Federation, Baltimore, MD, June 8–12.
- Stewart, M. H., Yates, M. V., Anderson, M. A., DeLeon, R., and Wolfe, R. L. (1998). "Modeling the effects of body-contact recreation on a drinking water reservoir." *Proceedings, Source Water Protection Symposium: A focus on Waterborne Pathogens*, San Francisco, CA, October 28–31. American Water Works Association, Denver, CO.
- Stinson, M. K., Field, R., Moffa, P. E., Goldstein, S. L., and Smith K. J. (1998). "High-rate disinfection technologies for wet weather flow (WWF)." *Advances in urban wet weather pollution reduction*. Water Environment Federation, Cleveland, OH, June 28–July 1.
- Sykora, J., States, S. J., Bancroft, W. D., Boutros, S. N., Shapiro, M. A., and Conley, L. F. (1987). "Monitoring of water and wastewater for *Giardia*." *Proceedings, American Water Works Association Water Quality Technology Conference*, Portland, OR, November 16–20, 1986. American Water Works Association, Denver, CO, 1043–1054.
- Toranzos, G. A. and McFeters, G. A. (1997). "Detection of indicator microorganisms in environmental freshwaters and drinking waters." *Manual of Environmental Microbiology*, C. J. Hurst, G. R. Knudsen, M. J. McInerney, L. D. Stetzenback, and M. V. Walter, eds., American Society for Microbiology, ASM Press, Washington, D.C.
- U.S. Environmental Protection Agency (USEPA). (1991). "Guidance manual for compliance with the filtration and disinfection requirements for public water systems using surface water sources." *NTIS Accession No. PB93-222933*, Criteria and Standards Division, Office of Water. March 1991 Edition.
- USEPA. (1994). "CSO Control Policy 59." *Federal Register*, (April 19), 18688.
- USEPA. (1995). "Watershed protection: A project focus." *EPA 841-R-95-003*, August 1995.
- USEPA. (1996a). "National primary drinking water regulations: Monitoring requirements for public drinking water supplies: *Cryptosporidium*, *Giardia*, viruses, disinfection by-products, water treatment plant data and other information requirements." *Federal Register*, 61(94; May 14), 24354–24388.

- USEPA. (1996b). *ICR Microbial Laboratory Manual*, EPA/600/R-95/178, April, Washington, D.C.
- USEPA. (1997). New York City filtration avoidance determination. <<http://www.epa.gov/region02/water/shedtop.htm>; <http://www.epa.gov/region02/water/nycshed/fadtb197.pdf>>.
- USEPA. (1998a). “Announcement of the drinking water contaminant candidate list: Notice.” *Federal Register*, 63(40; Mar. 2), 10273–10287.
- USEPA. (1998b). “Interim enhanced surface water treatment rule.” *Federal Register*, 63(241), 69477–69521.
- USEPA. (1999a). “Storm water technology fact sheet: Sand filters.” *EPA-F-99-007*, September 1999.
- USEPA. (1999b). “Storm water technology fact sheet: Storm water wetlands.” *EPA 832-F-99-025*, September 1999.
- USEPA. (1999c). “Storm water technology fact sheet: Vegetated swales.” *EPA 832-F-99-006*, September 1999.
- USEPA. (1999d). “Method 1622: *Cryptosporidium* in water by filtration/IMS/FA.” *EPA-821-R-99-001*, January, Washington, D.C.
- USEPA. (1999e). “Method 1623: *Cryptosporidium* and *Giardia* in water by filtration/IMS/FA.” *EPA-821-R-99-006*, April, Washington, D.C.
- USEPA. (1999f). “Protocol for developing nutrient TMDLs,” First edition. *EPA Report No. 841-B-99-007*, USEPA Office of Water, Washington, D.C., November 1999.
- USEPA. (2000a). <<http://www.epa.gov/ogwdw/link1.htm>>.
- USEPA. (2000b). <<http://www.epa.gov/owm/sw/about/>>.
- USEPA. (2000c). “National primary drinking water regulations, ground water rule, proposed rules.” *Federal Register*, 65(91; May 10), 30193–30274.
- Valiela, I., et al. (1997). “Nitrogen loading from coastal watersheds to receiving estuaries: New method and application.” *Ecological Applications*, 7(2), 358–380.
- Walker, M. J., Montemagno, C. D., and Jenkins, M. B. (1998). “Source water assessment and nonpoint sources of acutely toxic contaminants: A review of research related to survival and transport of *Cryptosporidium parvum*.” *Water Resources Research*, 34(12), 3383–3392.
- Walker, S. E., Mostaghimi, S., Dillaha, T. A., and Woeste, F. E. (1990). “Modeling animal waste management practices: Impacts on bacteria levels in runoff from agricultural lands.” *Transactions of the American Society of Agricultural Engineers*, 33(3), 807–817.
- Webster, J. P. and Mc Donald, D. W. (1995). “Cryptosporidiosis reservoir in wild brown rats (*Ratus norvegicus*) in the U.K.” *Epidemiology and Infection*, 115, 207–209.
- Wojtenko, I. (1999). Unpublished data.
- Xiao, L. and Herd, R. P. (1994). “Infection patterns of *Cryptosporidium* and *Giardia* in calves.” *Veterinary Parasitology*, 55, 257–262.
- Young, K. D. and Thackston, E. L. (1999). “Housing density and bacterial loading in urban streams.” *Journal of Environmental Engineering Division of the ASCE*, 125(12), 1177–1180.



## CHAPTER 5

### Disinfection<sup>1</sup>

#### Introduction

The primary goal of the disinfection process in drinking water treatment is the inactivation of microbial pathogens. These pathogens comprise a diverse group of organisms which serve as the etiological agents of waterborne disease. Included in this group are bacterial, viral, and protozoan species. The disinfection of potable water supplies was first initiated in the early part of the 20th century, and there have been few developments in the area of public health which have been more effective in the control of infectious diseases. While other unit processes, such as coagulation, clarification, and filtration, may dramatically reduce the number of microbial pathogens, disinfection serves as the final and, in some cases, the only barrier to the entry of these organisms into the finished product water.

The disinfection process may be affected by a variety of both physical and biological factors. Temperature and pH are two physical factors which are known to play an important role in the inactivation process for most commonly used disinfectants (Hoff 1986). In actual practice, turbidity and particle protection are two other physical parameters which influence disinfection efficiency, as well as clumping of individual microorganisms (Berman et al. 1988). Resistance to chemical disinfection may vary greatly between the various microorganisms of interest and also between different life-stages of individual species, such as is seen with bacterial endospores or encysted forms of protozoa.

Studies of microbial inactivation are often difficult to compare with one another owing to differences in methodological approaches. The role of mixing, the type of bioassays employed to determine viability, the volume of sample analyzed, and the reporting of residual versus initial dosing concentrations of the disinfectant are all factors which may vary greatly from one study to another. Often these parameters are not described in sufficient detail in scientific manuscripts of these studies. Further, data collected from field or pilot-scale conditions may show marked differences from the results of laboratory experiments conducted under oxidant demand-free conditions. These discrepancies, along with the need to determine the efficacy of disinfection for new and emerging waterborne pathogens, have spearheaded the U.S. Environmental Protection Agency (EPA) research program on microbial inactivation. The following discussion on potable water disinfection, categorized by individual oxidants, summarizes the microbial inactivation research which has been conducted or sponsored by EPA during the time period from 1980 to 1999.

#### Chlorine

Chlorination is the most frequently used form of halogen disinfection for treating drinking water in the U.S. The use of chlorine has a long history in water treatment, and it has been successfully used in both drinking water and wastewater applications. Data for chlorine inactivation of various organisms have often been used as a baseline measurement for determining a specific microorganism's resistance to disinfection.

---

<sup>1</sup>Eugene Rice: ORD/NRMRL/WSWRD, AWBERC Mailstop 387, 26 West Martin Luther King Dr., Cincinnati, OH 45268, 513-569-7204, rice.gene@epa.gov.

## ***Bacterial Inactivation***

Research on chlorine inactivation of bacterial species represents the first research studies conducted on potable water disinfection. Research in this area was initiated by predecessor organizations (U.S. Public Health Service) of EPA and is notably represented by the pioneering work published by Butterfield (1943) and colleagues on chlorine disinfection of enteric pathogens and sanitary indicator organisms represented by coliform bacteria.

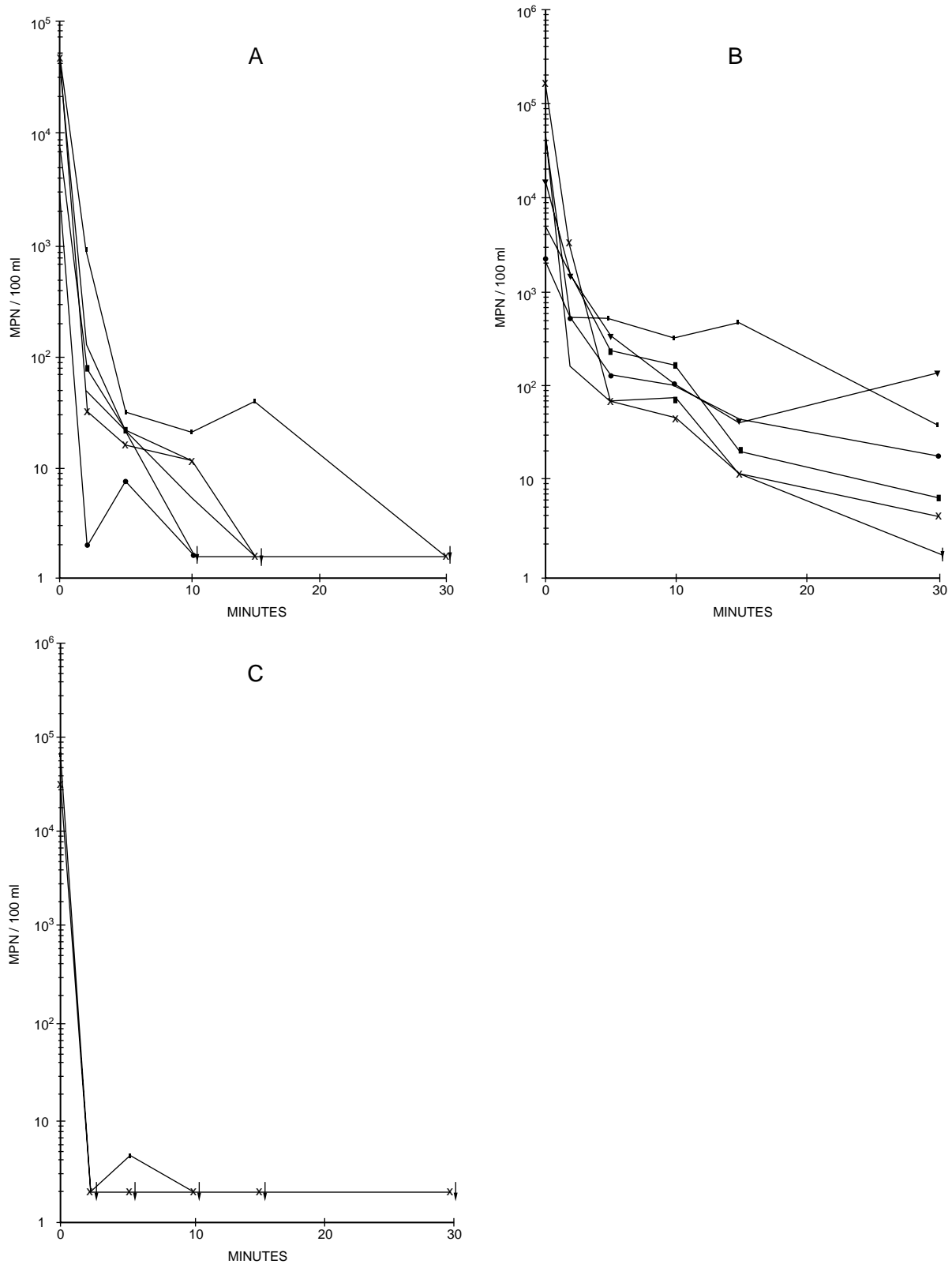
More recent studies on chlorine inactivation of coliform bacteria have centered on naturally occurring organisms associated with particulate material and the protective effect provided by these particles (Berman et al. 1988). In this study, sieves and nylon screens were used to separate primary sewage effluent solids into particle fractions of less than seven micrometers (<7  $\mu\text{m}$ ) or greater than seven micrometers (>7  $\mu\text{m}$ ) in size. The efficiency of separation was determined by electronic particle counting. Indigenous coliforms associated with the particle fractions were tested to determine their resistance to chlorine disinfection. Assays were conducted using the multiple tube fermentation procedure, and levels of organisms were determined by the most probable number technique. Coliform bacteria associated with the <7- $\mu\text{m}$  fraction were inactivated more rapidly than the >7- $\mu\text{m}$  fraction when exposed to 0.5 mg/L free chlorine, at pH 7.0 and 5°C (see Figure 5-1). Homogenization of the >7- $\mu\text{m}$  fraction and exposure to the disinfectant resulted in a rate of inactivation similar to that observed for the <7- $\mu\text{m}$  fraction. It is noteworthy that all of these experiments were conducted in waters with turbidity levels less than 1 NTU. These results indicate that particle association may play an important role in protecting microorganisms from inactivation by chemical oxidation. Such findings support the importance of water clarity in the disinfection process.

Survival of coliform bacteria in association with other biological organisms after chlorination was the subject of two extramural research projects. Levy et al. (1984) reported that *Escherichia coli* and *Enterobacter cloacae* were readily afforded protection from the effects of free-chlorine inactivation when these organisms were associated with the amphipod *Hyaella azteca*. At a free available chlorine level of 1 mg/L, unassociated *E. coli* decreased to less than 1% of the initial level at one minute of exposure, whereas more than 2% of the associated *E. coli* remained viable after 60 minutes of exposure. This phenomenon was also noted for the *E. cloacae* culture. These findings support the contention that bacteria associated with macroinvertebrates, which might commonly be found in water, are more resistant to disinfection. In a similar study, it was demonstrated that bacteria which were ingested by protozoa also exhibited an increased resistance to inactivation by chlorine. Examining both coliform bacteria (*E. coli*, *Citrobacter freundii*, *Enterobacter agglomerans*, *E. cloacae*, *Klebsiella pneumoniae*, and *K. oxytoca*) and several waterborne pathogens (*Salmonella typhimurium*, *Yersenia enterocolitica*, *Shigella sonnei*, *Legionella gormanii*, and *Campylobacter jejuni*), King et al. (1988) reported that ingestion of these organisms by the protozoa *Acanthamoeba castellanii* and *Tetrahymena pyriformis* increased resistance to chlorination by over 50-fold.

*Escherichia coli* O157:H7, a causative organism of hemorrhagic colitis, has emerged as an important waterborne pathogen in both drinking and recreational waters. Chlorination studies were conducted using seven strains of this pathogen and were compared with four nonpathogenic, wild-type *E. coli* strains (Rice et al. 1999a). At a level of 1.1 mg/L of free chlorine, pH 7.0, 5°C, both the pathogenic and nonpathogenic strains were inactivated by over four and half orders of magnitude within 120 seconds under chlorine demand-free conditions (refer to Table 5-1). Results indicated that both the pathogen and wild-type strains were sensitive to chlorination and exhibited essentially the same rates of inactivation.

The outbreak of epidemic cholera in Peru in 1991 prompted renewed interest in this classical bacterial pathogen. At the request of the U.S. Centers of Disease Control, EPA conducted studies regarding the efficacy of water treatment procedures for controlling the specific strains of *Vibrio cholerae* O1 isolated from the South American epidemic. During the course of these investigations it was found that





**Figure 5-1. Effect of 0.5 mg of chlorine per liter at pH 7 and 5°C on inactivation of coliforms associated with sewage effluent particles. (A) Particles <7 μm in size. (B) Particles >7 μm in size. (C) Particles >7 μm in size and homogenized. (Six experiments in each panel are shown, each represented by a different symbol.)**

**Table 5-1. Chlorine Inactivation of *Escherichia coli* 0157:H7 and Wild-Type *E. coli***

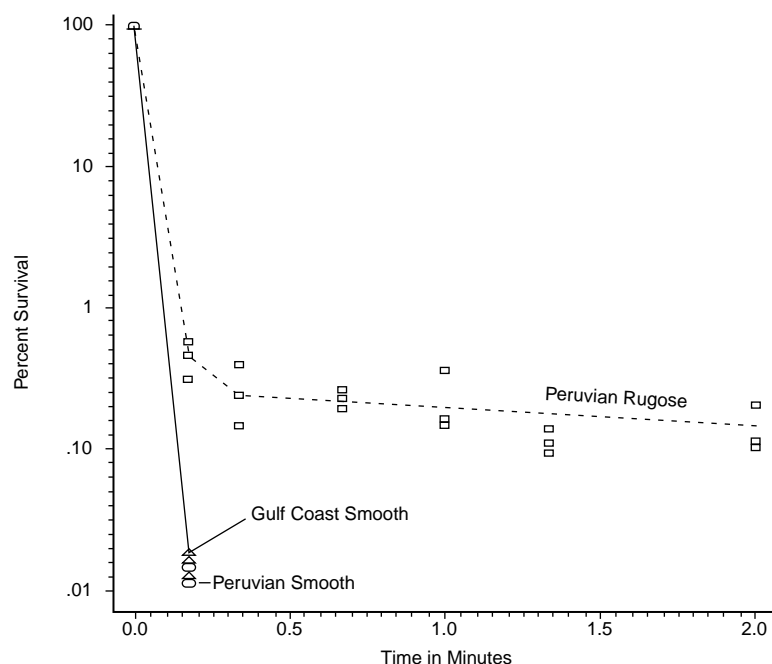
Isolate	Log <sub>10</sub> CFU/ml				Inactivation Rate (sec <sup>-1</sup> )	R <sup>2</sup>
	Initial Inoculation	Exposure Time				
		30 sec	60 sec	120 sec		
<i>E. coli</i> 0157:H7						
N009-6-1	5.63	2.60	1.88	0.82	-2.96	0.82
N6001-8-10	5.78	2.52	1.44	0.72	-3.06	0.68
N6021-5-1	5.78	2.54	1.52	0.66	-3.06	0.54
N60049-26-1	5.68	2.35	1.40	0.54	-3.00	0.86
N6059-7-2	5.72	2.42	1.74	0.86	-3.02	0.72
N6104-5-9	5.62	2.40	1.69	0.72	-2.96	0.89
N6114-7-2	5.63	2.52	1.66	0.89	-2.96	0.82
Mean	5.69	2.48	1.62	0.74	-2.93	0.82
<i>E. coli</i> (wild type)						
A	5.53	2.66	1.80	1.52	-2.51	0.61
B	5.79	2.60	1.48	0.81	-2.68	0.60
C	5.68	2.48	0.92	0.84	-2.61	0.61
D	5.52	2.34	0.95	0.39	-2.50	0.61
Mean	5.63	2.52	1.28	0.89	-2.93	0.71

*V. cholerae* was capable of shifting to a rugose phenotype that exhibited increased resistance to chlorination (Rice et al. 1993; Clark et al. 1994). Viable organisms were able to be recovered after 30 minutes of exposure to 2.0 mg/L free chlorine, pH 7 at 20°C. The rugose variant displayed a deviation from first-order kinetics, with a persistence of a subpopulation of organisms after an initial inactivation of two to three orders of magnitude (see Figure 5-2). Subsequently, it was demonstrated that the rugose form of *V. cholerae* retained its virulence and was capable of infecting human volunteers (Morris et al. 1996). While the natural occurrence of the rugose *V. cholerae* in nature is unknown, these studies emphasize the dramatic differences which may be observed in disinfection kinetics between different phenotypes of the same bacterial species.

Another bacterial pathogen which has been placed on the EPA Contaminant Candidate List (CCL) as a potential waterborne pathogen is *Helicobacter pylori*. Chlorine inactivation experiments conducted at 5°C, at pH 6, 7, 8 (refer to Table 5-2) indicated that, under oxidant demand-free conditions, this organism was very sensitive to disinfection (Johnson et al. 1997). Inactivation studies such as these, coupled with occurrence data, provide useful information to regulatory authorities regarding the potential public health threat posed by emerging pathogens.

Two closely related bacterial pathogens, *Campylobacter jejuni* and *Arcobacter butzleri*, have been implicated as waterborne pathogens. Under EPA funded research, Blaser et al. (1986) examined the chlorine susceptibility of three strains of *C. Jejuni*. A mean level of inactivation in excess of four orders of magnitude occurred after 1 minute exposure at pH 6 to 0.1 mg/L free chlorine at 4°C in buffer. Rice et al. (1999b), reporting on the results of an in-house research project, demonstrated that at 5°C in a well water source (pH 7.1), three strains of *A. butzleri* were inactivated at a mean level of greater than five orders of magnitude after exposure to 0.61 mg/L of total available chlorine residual (refer to Table 5-3). These findings indicate that these organisms are also sensitive to chlorine.

In a study designed to evaluate the role of aerobic endospores as surrogate organisms for evaluating water treatment plant performance, indigenous aerobic endospores from a river water source were



**Figure 5-2. Comparison of inactivation of smooth strain of cholera to rugose variant by free chlorine (2.0 mg/L free chlorine, pH 7.0, 20°C).**

exposed to chlorination (Rice et al. 1996). The experiments using the river water (pH 6.9) were conducted at 23°C. An exposure time of 180 minutes was required at a total available chlorine level of 1.75 mg/L to achieve a three order of magnitude inactivation. These indigenous endospores, existing in different stages of maturity and metabolic dormancy and representing distinct life forms (endospores) of aerobic spore-forming bacteria, exhibited increased resistance to chlorination as opposed to most other vegetative bacterial cells.

**Table 5-2. Chlorine Inactivation of *H. pylori* in Chlorine Demand-Free Buffer, 5°C, 0.5 mg of Free Chlorine per Liter**

Isolate	pH	Log <sub>m</sub> CFU/ml					Inactivation Rate (sec <sup>-1</sup> )	R <sup>2</sup>
		Initial Inoculum	Exposure Time					
			10 sec	20 sec	40 sec	80 sec		
43504	6	4.91± 0.02	2.64±0.05	2.36±0.04	1.30±0.10	<0.20	–	–
	7	4.63± 0.03	3.90±0.05	3.60±0.04	1.78±0.04	<0.20	–	–
	8	4.93± 0.02	3.89±0.03	3.54±0.03	2.18±0.02	<0.20	–	–
CVD33	6	4.74±0.03	2.65±0.03	2.43±0.04	1.95±0.01	<0.20	–	–
	7	4.74±0.03	2.78±0.02	2.56±0.03	2.00±0.08	<0.20	–	–
	8	4.74±0.02	3.49±0.06	2.86±0.04	2.34±0.06	<0.20	–	–
CP41	6	4.04±0.03	3.12±0.03	1.48±0.07	<0.20	<0.20	–	–
	7	4.19±0.03	2.87±0.04	2.62±0.01	2.15±0.02	<0.20	–	–
	8	5.48±0.01	3.86±0.02	3.52±0.02	2.57±0.05	1.70±0.07	–	–
MEAN	6	4.56	2.80	2.09	1.15	<0.20	–3.90	0.82
	7	4.52	3.18	2.93	1.98	<0.20	–3.48	0.94
	8	5.05	3.75	3.31	2.36	0.70	–3.92	0.87

**Table 5-3. Chlorine Inactivation of *Arcobacter butzleri* in Well Water, 5°C, Mean Chlorine Concentrations: 0.46 mg l<sup>-1</sup> Free Chlorine, 0.61 mg<sup>-1</sup> Total Chlorine at pH 7.06**

Organisms Tested	Log <sub>10</sub> CFU ml <sup>-1</sup>				Inactivation Rate (sec <sup>-1</sup> )	R <sup>2</sup>
	Exposure Time					
	Time 0	15 sec	30 sec	60 sec		
Field isolate No. 1	6.07±0.00	2.46±0.01	2.04±0.06	1.09±0.09	–	–
Field isolate No. 2	5.98±0.00	3.16±0.06	1.72±0.12	0.70±0.00	–	–
Mean	6.02	2.83	1.88	0.58	6.09	0.81
<i>Arcobacter butzleri</i> (ATCC 49616)	5.65±0.00	2.90±0.08	1.63±0.15	0.74±0.04	5.80	0.84

### ***Viral Inactivation***

In terms of resistance to chlorine inactivation, animal viruses and bacteriophage are generally considered to be more resistant than vegetative bacterial cells. Hoff (1986) summarized EPA-sponsored research on chlorine inactivation of polio virus under oxidant demand-free conditions. At 5°C, a two order of magnitude reduction occurred over a free-chlorine residual between 0.6 to 2.5 mg/L over a time range of 0.7 to 2.4 minutes of exposure.

In an extensive research project, Berman et al. (1984) studied the inactivation of simian rotavirus SA-11 using several disinfectants. Studies were conducted at 5°C with purified preparations of single virions and with cell-associated virions. A residual available chlorine concentration of 0.5 mg/L under oxidant demand-free conditions yielded a four order of magnitude inactivation at pH 6 in less than 15 seconds of exposure. Under similar conditions at pH 10, a two order of magnitude reduction required approximately 1.5 minutes of exposure. In all instances, the cell-associated virus was more resistant to inactivation than were preparations of single virions.

Berman et al. (1992) also conducted studies on the inactivation of the bacterial virus MS2 coliphage, which uses *E. coli* as its bacterial host. For free available chlorine, it was reported that a 2 mg/L residual yielded inactivation greater than four orders of magnitude in pH 7 oxidant demand-free buffer at 5°C after an exposure time of 1 minute. It was concluded that, under these experimental conditions, MS2 coliphage, like the animal virus rotavirus SA11, was very sensitive to inactivation by free chlorine.

### ***Protozoan Inactivation***

EPA, in response to a congressional mandate, developed the concept of target pathogens. The target pathogen concept was based upon the likelihood of the presence of a pathogen in a given water type and that organism's innate resistance to inactivation by chemical disinfectants. Under the Surface Water Treatment Rule (Federal Register 1989), the cyst stage of the protozoan parasite *Giardia lamblia* was chosen as the target pathogen for surface waters used as a drinking water source. Consequently, several research studies, both internal and extramural, were devoted to determining the inactivation kinetics for *Giardia* (Clark et al. 1989).

Using in vitro excystation to determine cyst viability, Jarroll et al. (1981) concluded that *Giardia* cysts exhibited resistance to free chlorine. Inactivation levels were determined after exposures to chlorine for 10, 30, or 60 minutes at different pH levels and temperatures. Inactivation greater than two orders of magnitude was reported after 10 minutes of exposure to 1.5 mg/L chlorine at pH 6, 7 at 25°C. Similar inactivation occurred after exposure to 1.5 mg/L of chlorine at pH 6 at 15°C. An exposure time of 60 minutes at 5°C, 2 mg/L of chlorine at pH 6 and 7 was required to achieve a greater than two order of magnitude inactivation. This report confirmed that inactivation kinetics occur at a slower rate with decreasing temperature.

In studies conducted on cysts of *G. lamblia* from both symptomatic and asymptomatic human donors, Rice et al. (1981), also using in vitro excystation, reported similar findings for chlorine inactivation. In this study, cysts of *G. muris*, derived from a murine model, were also exposed to chlorination and were shown to exhibit a somewhat greater resistance to chlorination than that observed for *G. lamblia*. Using the murine model, Hoff et al. (1985) compared animal infectivity with in vitro excystation for quantitatively determining the viability of *G. muris* cysts before and after exposure to free residual chlorine. It was concluded that in vitro excystation was an adequate indication of cyst infectivity for the host and could thus be used to determine the effects of chemical disinfection on cyst viability.

The development of an animal model using Mongolian gerbils for the propagation of *G. lamblia* afforded a readily available source of cysts of this human parasite. Rubin et al. (1989) used cysts derived from the gerbil to conduct further chlorine inactivation experiments. The gerbil-derived cysts were reported to be somewhat more resistant than cysts obtained from human donors, suggesting that the host source of cysts may effect cyst resistance to disinfection. The microsporidian parasite *Encephalitozoon intestinalis* has been placed on the EPA's CCL. This parasite is transmitted in the environment in a resistant-spore stage. The small size of the infective spore (circa 2  $\mu\text{m}$ ) presents special challenges for physical removal and thus heightens the need for information on chemical inactivation. Preliminary studies (Rice et al. 1999c) were conducted using spores of *E. intestinalis* produced in tissue culture from a rabbit kidney cell line (RK13). It was found that exposure to 2 mg/L of chlorine for 8 to 16 minutes was sufficient to achieve two orders of magnitude inactivation. Further research is planned to further define inactivation parameters at decreased exposure times.

## **Chloramine**

The use of chloramination in drinking water treatment has gained increasing popularity as concerns have grown regarding adverse health effects attributed to chlorine disinfection by-products. Chemically, chloramines are a complex group of disinfectants; however, only the monochloramine form is of major interest for drinking water treatment. When chlorine and ammonia are mixed in equimolar proportions, nearly all free available chlorine is converted to monochloramine. This is an equilibrium reaction and is affected by the chlorine-to-ammonia ratio. The rate formation is also pH dependent. Monochloramine is considered a weak biocide in comparison to free available chlorine, requiring exposure times of 25 to 100 times greater than chlorine to achieve comparable inactivation. The efficacy of disinfection for monochloramine is pH dependent and increases with decreasing pH values. Traditionally, laboratory studies have concentrated on the use of preformed chloramine, and while these results yield conservative values for inactivation, they are not representative of the disinfectant's effectiveness under field conditions. The chlorine-to-ammonia ratios, pH, and method of application are crucial parameters to consider in chloramine inactivation and must be clearly delineated to determine biocidal effectiveness under various experimental conditions (Hoff 1986).

## ***Bacterial Inactivation***

As part of the study on particle protection from disinfection, Berman et al. (1988) looked at monochloramine inactivation of coliform bacteria. At pH 8, the coliforms associated with the smaller-sized particle fraction were inactivated more rapidly than the organisms associated with the larger-sized particle fractions, thus mimicking the results observed with free available chlorine. The time required to achieve two orders of magnitude inactivation with monochloramine was approximately 50-fold greater than the time required for the same amount of inactivation with free chlorine.

In a study designed to determine the effect of the method of preparing monochloramine, Berman et al. (1992) reported on the inactivation of *E. coli* and *Klebsiella pneumoniae*. The organisms were exposed

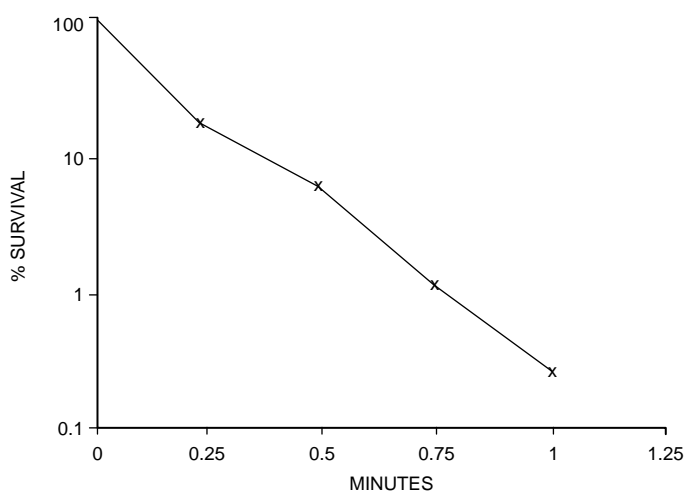
to free chlorine followed by the rapid addition of ammonia to determine inactivation for “forming monochloramine.” This type of inactivation was compared to inactivation using preformed monochloramine. Their results showed that *E. coli* and *K. pneumoniae* were rapidly inactivated by “forming monochloramine,” which was attributed to the brief presence of free chlorine during the formation reaction. Preformed chloramine was also capable of inactivating the bacteria, but at a slower rate.

*Campylobacter* also exhibited greater resistance to inactivation by monochloramine compared to free chlorine (Blaser et al. 1986). Three strains of *C. jejuni* were inactivated more than two orders of magnitude after 15 minutes of exposure to 1.0 mg/L preformed monochloramine at pH 8.0, 5°C. It was also noted in this study that *E. coli* was also more readily inactivated by free chlorine than by monochloramine.

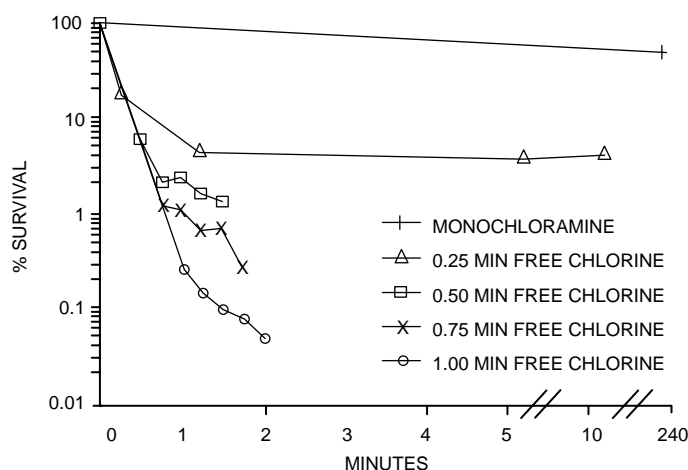
### ***Viral Inactivation***

Preformed monochloramine was used to inactivate simian rotavirus SA11 (Berman et al. 1984). At pH 8, 5°C, a monochloramine level of 10 mg/L was required for over 6 hours of exposure to achieve two orders of magnitude inactivation. As was noted with free available chlorine, the cell-associated SA-11 exhibited increased resistance to monochloramine when compared with the preparation composed of single virions.

MS2 coliphage was used in experiments to determine the effect of the method of preparing monochloramine on inactivation of the bacteriophage (Berman et al. 1992). Monochloramine prepared in situ by initial addition of chlorine to a suspension containing MS2, followed by subsequent addition of ammonia, inactivated the coliphage more rapidly than preformed monochloramine (see Figures 5-3 and 5-4). The exposure to free chlorine was given for the rapid viral inactivation observed in the in situ experiments. Inactivation was more rapid at 15°C than at 5°C and when the chlorine-to-nitrogen weight ratio was 5:1 compared to 3:1.



**Figure 5-3. MS2 inactivation by 2 mg/L chlorine at pH 7, 5°C.**



**Figure 5-4. MS2 inactivation by monochloramine and combined chlorine.**

### ***Protozoan Inactivation***

There has been relatively little research on the role of chloramination for the inactivation of protozoa. Korich et al. (1990) showed that monochloramine was the least effective disinfectant compared to free available chlorine, chlorine dioxide, and ozone for inactivating *Cryptosporidium parvum* oocysts. At 5°C, an exposure to 80 mg/L of monochloramine for 90 minutes was required to achieve a one order of magnitude inactivation.

### **Chlorine Dioxide**

Chlorine dioxide exists as an undissociated gas dissolved in water in the pH range from 6 to 9, and the disinfection efficiency increases within this range with increasing pH. Existing as an undissociated gas makes this oxidant more vulnerable to volatilization than free chlorine or monochloramine. Chlorine dioxide is a relatively stable disinfectant and is less likely to react with oxidant demand substances than free chlorine. Chlorine dioxide is a potent disinfectant and is generally considered to have a biocidal efficiency greater than free chlorine or monochloramine (Hoff 1986).

### ***Bacterial Inactivation***

An extramural project was conducted to determine the role of antecedent growth conditions on the inactivation of *E. coli* and *Legionella pneumophila* by chlorine dioxide (Berg et al. 1988). In this study, chemostat-grown bacteria were compared to batch-culture bacteria after being dosed with an initial concentration of chlorine dioxide of 0.75 mg/L. A resistant subpopulation of each organism survived in the presence of a constant chlorine dioxide residual. The observed resistance was attributed to a phenotypic trait which could be manipulated by altering the antecedent growth conditions in the chemostat cultures.

### ***Viral Inactivation***

Studies were conducted on chlorine dioxide inactivation of simian rotavirus SA11 (Berman et al. 1984). More than two orders of magnitude inactivation was achieved when the virus was exposed to 0.5 mg/L chlorine dioxide at pH 6, 5°C in less than 1 minute. At the same temperature and disinfectant concentration, a greater than two order of magnitude inactivation was achieved in less than 15 seconds at pH 10.

## ***Protozoan Inactivation***

Owens et al. (1999) compared three bioassay procedures for determining the viability of *Cryptosporidium parvum* oocysts exposed to chlorine dioxide. As with other reported studies, it was found that the biocidal activity of chlorine dioxide was pH dependent, with better inactivation occurring at higher pH levels. Differences in inactivation were observed between different lots of oocysts. Differences were also observed between the bioassay procedures. The in vivo neonatal mouse model demonstrated a higher level of inactivation compared to the in vitro tissue culture infectivity assay and a modified excystation procedure. These results led the authors to suggest that care must be taken in evaluating and comparing laboratory inactivation data for this parasite.

## **Ozone**

Ozone represents the most potent biocide examined in disinfection studies sponsored or conducted by EPA. While ozone is a potent biocide, it is also very unstable and highly reactive. Like chlorine dioxide, ozone exists in water as a dissolved gas. It is subject to losses due both to volatilization and reactions with demand substances present in the water. It would appear from most studies that ozone is relatively unaffected by pH within the range normally encountered in water treatment. Maintaining stable ozone levels in either laboratory or field conditions is very difficult, and factors such as applied dose, as well as final residual, must be addressed when describing ozone inactivation studies (Hoff 1986). Concentration of disinfectant, especially in pilot-plant studies, is often determined by averaging dissolved ozone residual measurements collected at various points in the ozone contactor. The average ozone concentration,  $C_{avg}$ , is then multiplied by the mean exposure time,  $T_2$ , to determine the product of the concentration (C) and exposure time (T) (CT) value (mg min/L).

## ***Bacterial Inactivation***

Bacteria are very sensitive to ozone inactivation. Bacterial endospores are the only life-stage of bacteria which have been shown to exhibit resistance to ozonation. In a pilot-plant study, Miltner et al. (1997) noted that indigenous aerobic endospores in filtered Ohio River water (ORW) required a CT value of 19 to achieve a three order of magnitude inactivation (see Figure 5-5).

## ***Viral Inactivation***

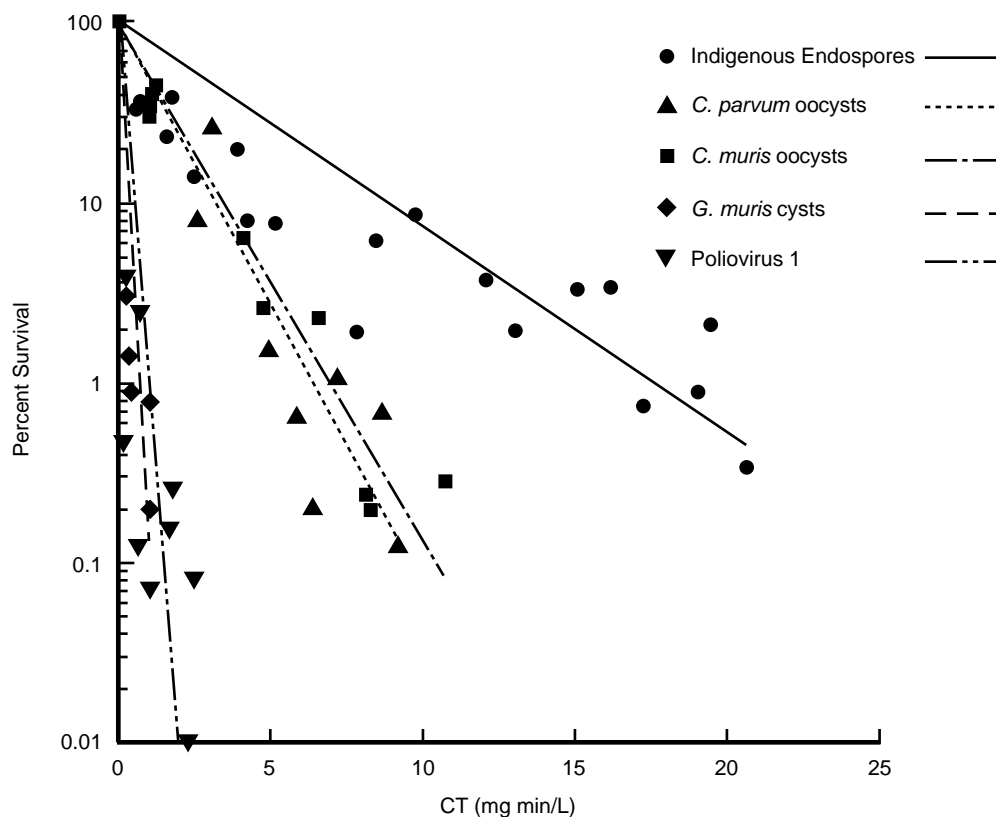
In the same pilot-plant study, Miltner et al. (1997) reported an inactivation of greater than two orders of magnitude for polio virus exposed to a CT of 1.2 mg min/L at pH 7.6 in a temperature range between 23 and 24°C. A tissue culture plaque assay utilizing BGM cells was used to determine virus viability (see Figure 5-5).

## ***Protozoan Inactivation***

Encysted forms of protozoa represent of the most difficult forms of microorganisms to inactivate by disinfection. Consequently, the use of ozonation has gained popularity as a means of inactivating these organisms. Ozone was found to be effective in the inactivation of *Giardia* cysts (Wickramanayake et al. 1985). Using in vitro excystation to determine viability, these investigators noted that the murine surrogate *G. muris* was consistently more resistant to ozonation than *G. lamblia*. The average CT values for a two order of magnitude inactivation at 5°C, pH 7, was 1.9 mg min/L for *G. muris* and 0.55 mg min/L for *G. lamblia* cysts. For the same conditions at 25°C, the mean CT value for *G. muris* was 0.25 mg min/L and 0.17 mg min/L for *G. lamblia*. In a pilot-scale ozonation study, Miltner et al. (1997) reported that at pH 7.65, 23 to 24°C in ORW, a CT value of 0.75 mg min/L was required to achieve two orders of magnitude inactivation of *G. muris* cysts (see Figure 5-5).



**Figure 5-5. Comparison of inactivation of microbial populations exposed to ozone in filtered ORW. Temperatures = 23.6 to 25.2°C.**



Ozone is one of the few chemical oxidants that has been shown to be capable of inactivating *Cryptosporidium* spp. under normal water treatment conditions. Korich et al. (1990) demonstrated that ozone was able to inactivate *C. parvum* oocysts. In this study, using a neonatal mouse assay to determine infectivity, an inactivation of greater than two orders of magnitude was observed after 5 minutes of exposure to 1 mg/L of ozone (circa CT value of 5 mg min/L). Similar results for a 2.5 order of magnitude inactivation (CT value of 6.56 mg min/L) at 20°C were reported by Rennecker et al. (1999) for *C. parvum* using a modified in vitro excystation procedure for determining oocyst viability. In a pilot-scale study using ORW, a CT value of 4.0 mg min/L inactivated approximately 1.4 orders of magnitude of *C. parvum* oocysts at pH 7.6, 23 to 24°C (Miltner et al. 1997) using the neonatal mouse model to determine infectivity.

### Ultraviolet (UV) Irradiation

Microbial inactivation by UV irradiation has not been a major area of research within the Agency's drinking water program. In the 1980s, an extramural research project was sponsored to examine the potential for using UV disinfection for small drinking water systems (Carlson et al. 1985). It was noted that cysts of *Giardia muris* were significantly more resistant to UV treatment than *E. coli* or *Yersinia* spp. Results from this project also suggested that hydraulic short circuiting and entrapped air in UV reactors may decrease the efficiency of inactivation.

An in-house project was also conducted during this time period to study the effect of UV irradiation on cysts of the human pathogen *Giardia lamblia* (Rice and Hoff 1981). In this study, *G. lamblia* cysts were found to be resistant to high doses of germicidal UV irradiation. There has been renewed interest in the use of UV light for inactivating waterborne protozoan parasites. Recent studies suggest that UV irradiation is an effective treatment option for inactivating oocysts of *Cryptosporidium* (Clancy et al. 1998). This finding, in contrast to previous studies regarding the effect of UV light on the inactivation of protozoa cysts, has been related to the method by which viability was determined. Earlier studies relied upon in vitro excystation as a bioassay for determining inactivation. Current research suggests that excystation is not a reliable method for determining inactivation of cysts and oocysts after exposure to UV light. It appears that animal infectivity is necessary to adequately determine the biocidal activity of UV light for the encysted protozoa. Current in-house studies are re-evaluating earlier *Giardia* inactivation studies in light of this development.

## Summary

Studies on microbial inactivation have been a major part of the Agency's research efforts in the area of drinking water treatment over the past 20 years. Disinfection research currently is focused on organisms found on the Agency's CCL. Research on the inactivation of emerging microbial agents coupled with the evaluation of new treatment methodologies remains a priority in the Agency's drinking water program.

## References

- Berg, J. D., Hoff, J. C., Roberts, P. V., and Matin, A. (1988). "Resistance of bacterial subpopulations to disinfection by chlorine dioxide." *Journal of the American Water Works Association*, 80(9), 115–119.
- Berman, D. and Hoff, J. C. (1984). "Inactivation of simian rotavirus SA11 by chlorine, chlorine dioxide, and monochloramine." *Applied and Environmental Microbiology*, 48(2), 317–323.
- Berman, D., Rice, E. W., and Hoff, J. C. (1988). "Inactivation of particle-associated coliforms by chlorine and monochloramine." *Applied and Environmental Microbiology*, 54(2), 507–512.
- Berman, D., Sullivan, R., and Hurst, C. J. (1992). "Effect of the method of preparing monochloramine upon inactivation of MS2 coliphage, *Escherichia coli*, and *Klebsiella pneumoniae*." *Canadian Journal of Microbiology*, 38, 28–33.
- Blaser, M. J., Smith, P. F., Wang, W. L., and Hoff, J. C. (1986). "Inactivation of *Campylobacter jejuni* by chlorine and monochloramine." *Applied and Environmental Microbiology*, 51(2), 307–311.
- Butterfield, C. T., Wattie, E., Megregian, S., and Chambers, C. W. (1943). "Influence of pH and temperature on the survival of coliforms and enteric pathogens when exposed to free chlorine." *Public Health Reports*, 58(51), 1–30.
- Carlson, D. A., et al. (1985). "Ultraviolet disinfection of water for small water supplies." EPA/600/2-85/092, Environmental Protection Agency.
- Clancy, J. L., Hargy, T. M., Marshall, M. M., and Dyksen, J. E. (1998). "UV light inactivation of *Cryptosporidium* oocysts." *Journal of the American Water Works Association*, 90(9), 92–102.
- Clark, R. M., Read, E. J., and Hoff, J. C. (1989). "Analysis of inactivation of *Giardia lamblia* by chlorine." *Journal of Environmental Engineering Division of the ASCE*, 115(1), 80–90.

- Clark, R. M., Rice, E. W., Pierce, B. K., Johnson, C. H., and Fox, K. R. (1994). "Effect of aggregation on *Vibrio cholerae* inactivation." *Journal of Environmental Engineering Division of the ASCE*, 120(4), 875–887.
- Federal Register. (1989). "Drinking water; National primary drinking water regulations; Filtration, disinfection; Turbidity, *Giardia lamblia*, viruses, *Legionella*, and heterotrophic bacteria; Final Rule." 54(No. 124), 40 CFR, Parts 141 and 142.
- Hoff, J. C., Rice, E. W., and Schaefer, III, F. W. (1985). "Comparison of animal infectivity and excystation as measures of *Giardia muris* inactivation by chlorine." *Applied and Environmental Microbiology*, 50(4), 1115–1117.
- Hoff, J. C. (1986). "Inactivation of Microbial Agents by Chemical Disinfectants." EPA/600/2-86/067, Environmental Protection Agency.
- Jarroll, E. L., Bingham, A. K., and Meyer, E. A. (1981). "Effect of chlorine on *Giardia lamblia* cyst viability." *Applied and Environmental Microbiology*, 41(2), 483–487.
- Johnson, C. H., Rice, E. W., and Reasoner, D. J. (1997). "Inactivation of *Helicobacter pylori* by chlorination." *Applied and Environmental Microbiology*, 63(12), 4969–4970.
- King, C. H., Shotts, Jr., E. B., Wooley, R. E., and Porter, K. G. (1988). "Survival of coliforms and bacterial pathogens within protozoa during chlorination." *Applied and Environmental Microbiology*, 54(12), 3023–3033.
- Korich, D. G., Mead, J. R., Madore, M. S., Sinclair, N. A., and Sterling, C. R. (1990). "Effects of ozone, chlorine dioxide, chlorine, and monochloramine on *Cryptosporidium parvum* oocysts viability." *Applied and Environmental Microbiology*, 56(5), 1423–1428.
- Levy, R. V., Cheetham, R. D., Davis, J., Winer, G., and Hart, F. L. (1984). "Novel method for studying the public health significance of macroinvertebrates occurring in potable water." *Applied and Environmental Microbiology*, 47(5), 889–894.
- Miltner, R. J., Shukairy, H. M., Rice, E. W., Owens, J. H., Schaefer, III, F. W., and Dahling, D. R. (1997). "Comparative ozone inactivation of *Cryptosporidium* and other microorganisms." *Proceedings, International Symposium on Waterborne Cryptosporidium*, New Port Beach, CA, March 2–5, 229–241.
- Morris, Jr., J. G., et al. (1996). "*Vibrio cholerae* O1 can assume a chlorine-resistant rugose survival form that is virulent in humans." *Journal of Infectious Diseases*, 174, 1364–1368.
- Owens, J. H., Miltner, R. J., Slifko, T. R., and Rose, J. B. (1999). "In vitro excystation and infectivity in mice and cell culture to assess chlorine dioxide inactivation of *Cryptosporidium* oocysts." *Proceedings, Water Quality Technology Conference*, Tampa, FL, October 31–November 3.
- Rennecker, J. L., Marinas, B. J., Owens, J. W. and Rice, E. W. (1999). "Inactivation of *Cryptosporidium parvum* oocysts with ozone." *Water Research*, 33(11), 2481–2488.
- Rice, E. W. and Hoff, J. C. (1981). "Inactivation of *Giardia lamblia* cysts by ultraviolet irradiation." *Applied and Environmental Microbiology*, 42(3), 546–547.
- Rice, E. W., Hoff, J. C., and Schaefer, III, F. W. (1982). "Inactivation of *Giardia* cysts by chlorine." *Applied and Environmental Microbiology*, 43(1), 250–251.
- Rice, E. W., et al. (1993). "*Vibrio cholerae* O1 can assume a rugose survival form that resists killing by chlorine, yet retains virulence." *International Journal of Environmental Health Research*, 3, 89–98.

- Rice, E. W., Fox, K. R., Miltner, R. J., Lytle, D. A., and Johnson, C. H. (1996). "Evaluating plant performance with endospores." *Journal of the American Water Works Association*, 88(9), 122–130.
- Rice, E. W., Clark, R. M., and Johnson, C. H. (1999a). "Chlorine inactivation of *Escherichia coli* O157:H7." *Emerging Infectious Diseases*, 5(3), 461–463.
- Rice, E. W., Rodgers, M. R., Wesley, I. V., Johnson, C. H., and Tanner, S. A. (1999b). "Isolation of *Arcobacter butzleri* from ground water." *Letters in Applied Microbiology*, 28, 31–35.
- Rice, E. W., Johnson, C. H., Naumovitz, D. W., Marshall, M. M., Plummer, C. B., and Sterling, C. R. (1999c). "Chlorine disinfection studies of *Encephalitozoon (Septata) intestinalis*." Poster presented at *Annual Meeting of the American Society for Microbiology*, Chicago, IL, May 30–June 3.
- Rubin, A. J., Evers, D. P., Eyman, C. M., and Jarroll, E. L. (1989). "Inactivation of gerbil-cultured *Giardia lamblia* cysts by free chlorine." *Applied and Environmental Microbiology*, 55(10), 2592–2594.
- Wickramanayake, G. B., Rubin, A. J., and Sproul, O. J. (1985). "Effects of ozone and storage temperature on *Giardia* cysts." *Journal of the American Water Works Association*, 77(8), 74–77.

## CHAPTER 6

### Alternative Disinfectants<sup>1</sup>

#### Introduction

Chlorination of drinking water results in the formation of numerous disinfection byproducts (DBPs), several of which are regulated. Water systems seeking to meet maximum contaminant levels (MCLs) of regulated DBPs may consider various approaches to limiting DBPs: removing the precursor compounds early in the treatment train before the disinfectant is applied, using less chlorine, using alternative disinfectants to chlorine, and removing DBPs after their formation. Combinations of these approaches may also be considered. Removing DBPs after their formation is a method that is generally not employed. Whatever approach is selected, the system must be certain that the effectiveness of the disinfection is not jeopardized. This chapter presents recent studies conducted by, or funded by, the U.S. Environmental Protection Agency's (EPA's) Office of Research and Development (ORD) in Cincinnati that examine the use of three alternative oxidants: chloramine, chlorine dioxide, and ozone.

#### Models for Assessing Halogenated DBP Precursors

The precursors for halogenated DBP formation are not well known. In the Disinfectants/Disinfection By-Product (D/DBP) Rule, in which enhanced coagulation is used as a treatment technique to control identified and unidentified DBPs, total organic carbon (TOC) is the surrogate for DBP precursors. While TOC or dissolved organic carbon (DOC) may be used as a surrogate, they will not well represent the precursors of specific DBPs. While the precursors for the specific DBPs are not well known, an indirect means of quantitating the control of specific DBP precursors is to sample the water influent to and effluent from a treatment process, chlorinate both waters under a specific set of conditions (pH, temperature, time, etc.), and examine the concentrations of the specific DBPs. Differences in these concentrations may be attributed to the effectiveness of the treatment process. For example, a raw water may form 200 mg/L of total trihalomethane (TTHM), while an ozonated water may form 150 mg/L. Ozonation may then be considered to have oxidized 25% of the TTHM precursors. The set of chlorination conditions driving the DBP reaction is very important. Three models for DBP precursor were employed in the studies discussed in this chapter.

In the formation potential (FP) model, a relatively large dose of chlorine is used, and the reaction time is typically long, e.g., one week. This is assumed to drive the DBP reaction to completion, thus utilizing all the precursor. The fate of precursors can be assessed across treatment processes, but, as conditions are relatively extreme, the resulting DBP concentrations are rarely representative of a system's finished water.

Systems may therefore choose to chlorinate under conditions unique to their distribution system. In the simulated distribution system (SDS) model, the fate of precursors can be assessed; the resulting DBP concentrations are representative of the system's finished water. For example, SDS TTHM concentrations before and after biological filtration may be 85 and 70 µg/L, respectively. The biofilter is shown to remove 17% of the TTHM precursor. The 70 µg/L is meaningful, as the chlorination conditions were

---

<sup>1</sup>Richard J. Miltner: ORD/NRMRL/WSWRD, AWBERC Mailstop 689, 26 West Martin Luther King Dr., Cincinnati, OH 45268, 513-569-7403, miltner.richard@epa.gov.

representative. The 70 µg/L is below the Stage 1 D/DBP Rule MCL of 80 µg/L. If FP conditions were used, the TTHM formation potential (TTHMFP) concentrations before and after biological filtration might have been 140 and 116 µg/L, respectively. The biofilter would show 17% removal of the TTHM precursor, but as chlorination conditions were not representative, the 116 µg/L would incorrectly imply that the MCL was exceeded. Additionally, the use of the FP model might result in a skewed distribution of bromo- and chloro-trihalomethanes (THMs). The chlorine-to-bromide ratio impacts DBP speciation (Shukairy et al. 1994), and this ratio is typically higher when the FP model is employed.

Because chlorination conditions are unique to the systems employing them, the SDS model does not allow for comparison of results from different waters. The uniform formation condition (UFC) model was developed to address this issue (Summers et al. 1996). In this model, the chlorination conditions of the mean national distribution system are targeted, i.e., 1 mg/L free-chlorine residual at 24 hours at pH 8 at 20°C. Thus, DBP precursor control can be assessed, the resulting DBP concentrations can be considered relative to MCLs, and results can be compared from one water to another.

## Chloramines

Chloramines are the second most commonly used final disinfectant in drinking water treatment after free chlorine. Although generally not as effective a disinfectant as free chlorine, an advantage of chloramination is minimization of the formation of DBPs.

### *Halogenated DBP Formation*

The formation of DBPs by chloramines is significantly lower than by free chlorine. Stevens et al. (1989) treated humic acid solutions with free chlorine, monochloramine, and chlorine dioxide at the bench-scale. Monochloramine was dosed as preformed chloramines without free chlorine. The solutions contained no bromide, so only chloro-DBPs resulted. Figure 6-1 shows the relative formation of  $\text{CHCl}_3$  and nonpurgable organic halide (NPOX), a subset of the surrogate total organic halide (TOX). The data show that  $\text{CHCl}_3$  formation and NPOX formation by monochloramine is small compared to that formed by free chlorine, confirming that a treatment strategy for the control of DBPs is the use of chloramines as an alternative final disinfectant to free chlorine.

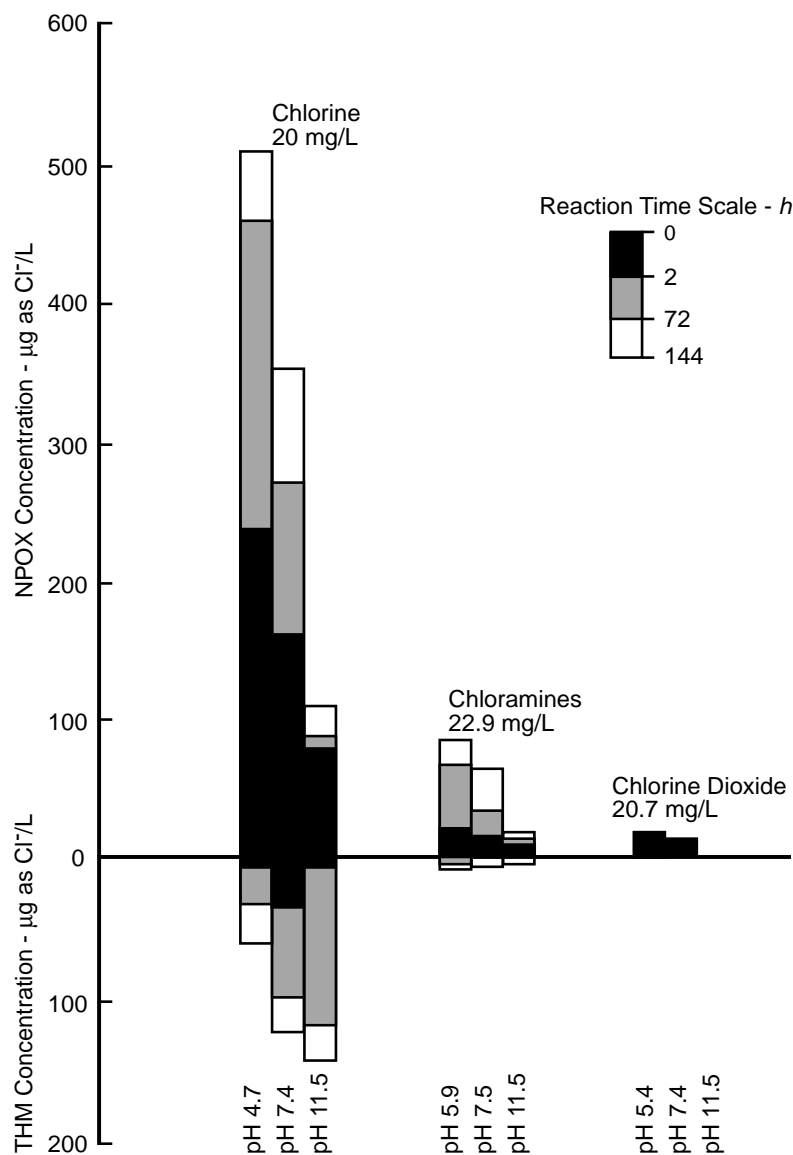
Parallel oxidants were studied at the pilot scale in Jefferson Parish, LA, treating Mississippi River (MR) water (Lykins and Koffskey 1986; Lykins et al. 1989). Coagulated, settled, and filtered waters were treated with free chlorine, monochloramine, chlorine dioxide, and ozone and compared to a parallel nondisinfected water. Results for TOX formation representing the mean of one year of sampling are listed in Table 6-1. Disinfectant contact times averaged 31 minutes. No details were given regarding how monochloramine was prepared or dosed. The TOX formation by monochloramine, however, was low compared to that by free chlorine.

At the pilot-scale, Miltner (1990) studied chlorination and chloramination of Ohio River (OR) water. Parallel plants were predisinfected, alum-coagulated to control turbidity, settled, and filtered. In the

**Table 6-1. Oxidation of MR Water (Lykins and Koffskey 1986)**

Parameter	Disinfectant				
	None	Free Chlorine	Monochloramine	Chlorine Dioxide*	Ozone
Residual, mg/L		1	2.1	0.5	0.5
TOX, µg Cl/L	25	263	117	85	15

\* Chlorite = 0.6 mg/L, free chlorine = 0.1 mg/L



**Figure 6-1. Formation of DBPs by alternative oxidants (Stevens et al. 1989).**

chloramine plant,  $\text{NH}_4\text{OH}$  was added in stoichiometric excess before rapid mix; no free chlorine was present. Chlorine was added to the rapid mix in both plants. Chlorine was dosed on both plants so that residuals carried through the filters and clear wells and met the Ten-State Standards (TSS) (Recommended Standards for Water Works 1992) of 0.2 to 0.5 mg/L free chlorine and 1.0 to 2.0 mg/L combined chlorine “at distant points in the distribution system.” In this study, the distribution system was simulated as clear well waters held 3 days. Table 6-2 shows results for mean sampling of clear well effluents. HAN4 represents four haloacetonitriles (HANs): trichloro- (TCAN), dichloro- (DCAN), bromochloro- (BCAN) and dibromo- (DBAN). Chloropicrin (CP) was not detected. Cyanogen chloride, chloral hydrate (CH), and the haloacetic acids (HAAs) were not analyzed.

THMs, HANs and 1,1,1-trichloropropanone (111-TCP) were detected in the finished water on the prechlorinated plant. As expected, these DBPs were not detected in the finished water on the prechloraminated plant. The TOX concentration was appreciably lower in the effluent of the prechloraminated plant and similar in concentration to the TOX concentration in the OR water influent to the plant.

**Table 6-2. DBP Formation in Finished OR Water (Miltner 1990)**

Parameter	Concentration, µg/L	
	Prechlorinated	Prechloraminated
TOX	115	20
TTHM	15.6	ND
CHCl <sub>3</sub>	10.0	ND
CHBrCl <sub>2</sub>	4.6	ND
CHBr <sub>2</sub> Cl	0.7	ND
CHBr <sub>3</sub>	0.3	ND
HAN4	3.1	ND
TCAN	3.1	ND
DCAN	<0.1	ND
BCAN	ND	ND
DBAN	ND	ND
111-TCP	2.8	ND
CP	ND	ND

ND = not detected

Although bacteria penetrated farther into the chloraminated plant, heterotrophic plate count (HPC) and total coliform (TC) densities were comparable in the two finished waters, indicating that chloramination following the TSS was sufficient for bacterial control.

On the same pilot plant, Miltner et al. (1990) studied parallel post-chlorination and post-chloramination of OR water following preozonation, alum coagulation to control turbidity, and settling. Following settling, the stream was split for parallel filtration. Following filtration, the post-disinfectants were applied to the clear well influents. For monochloramine, NH<sub>4</sub>OH was added in stoichiometric excess prior to chlorine; no free chlorine was present. A parallel plant without preozonation was similarly treated with post-chlorination at the clear well's influent. Finished waters collected from clear wells and held 3 days were used to simulate distribution system waters. Residuals targeted recommendations of the TSS (Recommended Standards for Water Works 1992); residuals after 3 days were near 0.2 mg/L free chlorine and 0.7 mg/L monochloramine. Results are given in Table 6-3. HAA6 represents six HAAs: trichloro- (TCAA), dichloro- (DCAA), chloro- (CAA), bromochloro- (BCAA), bromo- (BAA), and dibromoacetic acid (DBAA).

Comparing ozone/chloramine and ozone/chlorine, the concentrations of 3-day DBPs were significantly lower with use of monochloramine, as expected. TOX was also formed upon chloramination, but at significantly lower concentrations than in the chlorinated waters and only near double the raw water TOX concentration of 24.4 µg Cl/L. The only noted exception in DBP formation was the formation of cyanogen chloride upon chloramination.

The THMs, HAAs, HANs, CH, CP, 111-TCP and CNCl concentrations in Table 6-3 were converted to their TOX equivalents and compared to their TOX concentrations. In the two chlorinated waters, these DBPs accounted for nearly 40% of the TOX, leaving nearly 60% of the TOX unaccounted for, i.e., 60% of the TOX was comprised of compounds other than these DBPs. In the chloraminated water, however, these DBPs made up only 23% of the TOX. Thus, the use of chloramine resulted in significantly lower DBP formation than the use of free chlorine (refer to Table 6-3), but a larger percentage of what was formed was unaccounted for by the measured DBPs. This unaccounted-for, halogenated material may be nitrogenous.



**Table 6-3. DBP Formation in Simulated Distribution OR Water (Miltner et al. 1990)**

Parameter	Concentration, µg/L Unless Noted			T-Test* for Chlorinated Waters		
	O <sub>3</sub> Chloramine	O <sub>3</sub> Chlorine	Post Chlorine	Better With O <sub>3</sub>	Same	Better Without O <sub>3</sub>
TOX, µg Cl <sup>-</sup> /L	51.5	207	259	×		
TTHM	5.6	75.1	90.4	×		
CHCl <sub>3</sub>	4.5	39.6	55.5	×		
CHBrCl <sub>2</sub>	0.8	21.1	24.4		×	
CHBr <sub>2</sub> Cl	0.2	13.0	10.2			×
CHBr <sub>3</sub>	ND	1.5	0.3			×
HAA6	6.1	39.7	62.6	×		
TCAA	1.5	10.0	20.1	×		
DCAA	3.9	19.2	30.9	×		
BCAA	0.3	6.8	8.5	×		
CAA	0.5	1.5	1.4	×	×	
BAA	<0.1	0.3	0.3		×	
DBAA	ND	2.0	1.5			×
HAN4	2.9	4.8	5.7		×	
TCAN	ND	ND	0.2		×	
DCAN	2.4	2.6	3.5		×	
BCAN	0.4	1.7	1.9		×	
DBAN	0.2	0.6	0.1			×
CH	0.8	5.8	4.2			×
CP	0.1	1.6	0.5			×
111-TCP	0.4	1.1	0.8		×	
CNCl	2.5	ND	ND			

\* at 95% confidence level

ND = not detected

Comparing ozone/chloramine and ozone/chlorine, the densities of HPC in the two clear wells were similar. TC bacteria were not detected in any clear wells. These data suggest that chloramination following the recommendations of the TSS was sufficient for bacterial control. With this pilot-scale study and the pilot-scale study noted previously, water distribution system materials could not be simulated during the 3-day storage of chlorinated water in clean glassware; therefore, the question of bacterial regrowth in the presence of the weaker chloramine disinfectant during distribution remains.

### ***Nonhalogenated DBP Formation***

The formation of nonhalogenated DBPs by chloramines is also significantly lower than by free chlorine. Miltner (1993) reported on OR water at the bench-scale with several oxidants. With monochloramine, the formation of formaldehyde and the P17 strain of assimilable organic carbon (AOC-P17) was negligible and similar to the background concentrations. With free chlorine, however, formaldehyde and AOC-P17 formation was evident (see Table 6-4). The data suggest that systems employing monochloramine will experience lower concentrations of these bacterial nutrients in their distribution systems than those employing free chlorine.

**Table 6-4. Oxidation of OR Water (Miltner 1993)**

Oxidant	Dose, mg/L	Time, min	Formaldehyde, µg/L	AOC-P17, µg Ceq/L*
None			0.8 ± 0.15	95
Monochloramine	2	15	0.9	96
ClO <sub>2</sub>	1	15	2.0	129
KMnO <sub>4</sub>	1	15	2.2 ± 0.85	132
Free chlorine	3	15	2.8	158
Ozone	2	7.5	17.1	202

\*as acetate

## Chlorine Dioxide

Chlorine dioxide is a widely used disinfectant in drinking water treatment. It has long been used for taste and odor control and for iron and manganese control and has gained in acceptance as an effective disinfectant. An advantage of ClO<sub>2</sub> treatment is minimization of the formation of DBPs; it does this by oxidation of DBP precursors and by relatively minimal formation of DBPs themselves. A disadvantage is the presence of chlorite and chlorate resulting from ClO<sub>2</sub> treatment. The former is regulated under the D/DBP Rule and the latter is of health concern.

### Halogenated DBP Formation

The formation of DBPs by chlorine dioxide is significantly lower than by free chlorine. Stevens et al. (1989) treated humic acid solutions with free chlorine, monochloramine, and chlorine dioxide at the bench-scale. The solutions contained no bromide, so only chloro-DBPs resulted. Figure 6-1 shows the relative formation of CHCl<sub>3</sub> and NPOX. The data show no CHCl<sub>3</sub> formation and little NPOX formation by chlorine dioxide compared to that formed by free chlorine. Thus, a treatment strategy to control DBPs is the use of chlorine dioxide, an alternative oxidant to free chlorine.

Table 6-1 shows that TOX formation by ClO<sub>2</sub> on the Jefferson Parish pilot plant was low compared to that of free chlorine. Some of the TOX in the ClO<sub>2</sub>-treated water may be a result of inefficient ClO<sub>2</sub> generation, as a yearly average free chlorine residual of 0.1 mg/L was detected following ClO<sub>2</sub> contact.

The effect of ClO<sub>2</sub> on TTHM control was observed by Lykins and Griese (1986) at Evansville, IN. Pilot-plant effluents (no prior disinfection) were treated with chlorine and ClO<sub>2</sub> and held 3 days to simulate distribution system conditions. Results are presented in Table 6-5. Even with a high ClO<sub>2</sub> residual and 3 days' reaction time, TTHM formation was similar to the background TTHM concentration in the raw water and very low compared to the formation by free chlorine.

Based on the success of piloting, a full-scale switch to ClO<sub>2</sub> was made at Evansville. Evansville has two parallel full-scale plants. One was treated with ClO<sub>2</sub> as a preoxidant, with an average dose of 1.4 mg/L ClO<sub>2</sub>. Both plants were chlorinated ahead of the filters. No details were given on the free-chlorine doses to the two plants or whether the free chlorine dose on the ClO<sub>2</sub>-treated plant may have been lower as a

**Table 6-5. TTHM Formation at Evansville (Lykins and Griese 1986)**

Parameter	Simulated Distribution Concentrations	
	Chlorine	Chlorine Dioxide
TTHM, µg/L*	141	1.4
Chlorine residual, mg/L	2.5	—
Chlorine dioxide residual, mg/L	—	1.9

\* TTHM in raw water = 1.2 µg/L.

result of  $\text{ClO}_2$  satisfying some of the chlorine demand. Nevertheless, pretreatment with  $\text{ClO}_2$  was effective in lowering TTHM formation (Lykins and Griese 1986). Finished water TTHM averaged 37.3 mg/L without  $\text{ClO}_2$  and 25.5 mg/L with  $\text{ClO}_2$ . There are two explanations for this improvement. Lykins and Griese (1986) hypothesized that lower TTHM concentrations were a result of  $\text{ClO}_2$ 's oxidation of DBP precursor prior to downstream chlorination. Miltner (1976) showed that  $\text{ClO}_2$  oxidized DBP precursors to the extent that lower concentrations of DBPs were formed with subsequent chlorination. The second explanation contends that, if the free chlorine level was lower on the  $\text{ClO}_2$ -treated plant as a result of  $\text{ClO}_2$ 's oxidation of chlorine demand, lower TTHM may also result.

The effect of  $\text{ClO}_2$  on DBP precursors was also studied by Lykins and Koffskey (1986) at the pilot scale at Jefferson Parish. Coagulated, settled, and filtered waters were treated with free chlorine, chlorine dioxide, and ozone. TTHM and TOX precursors were assessed by FP. Table 6-6 shows  $\text{ClO}_2$  oxidized 34% and 17%, respectively, of TTHM and TOX precursors.

**Table 6-6. Oxidation of DBP Precursors at Jefferson Parish (Lykins and Koffskey 1986)**

Parameter	Percent Removal	
	Chlorine Dioxide	Ozone
TTHMFP	34	44
TOXFP	17	31

### *Nonhalogenated DBP Formation*

While the formation of halogenated DBPs by chlorine dioxide may be minimal compared to free chlorine,  $\text{ClO}_2$  can form nonhalogenated by-products. Miltner (1993) reported on OR water at the bench-scale with several oxidants. With chlorine dioxide, the formation of formaldehyde and AOC-P17 approached that of free chlorine (see Table 6-4).

EPA (unpublished data) sampled a full-scale plant treating OR water with  $\text{KMnO}_4$  and  $\text{ClO}_2$ . The  $\text{ClO}_2$  dose was near 1.0 mg/L. Results in Table 6-7 show the presence, confirmed by chromatograph/mass spectroscopy (GC/MS), of aldehydes and ketones in  $\text{ClO}_2$ -treated water. While the presence of these compounds in the  $\text{ClO}_2$ -treated water may also be a result of their presence in the source water and/or the result of  $\text{KMnO}_4$ 's ability to form them (refer to Table 6-4), the concentration of several of them was enhanced by  $\text{ClO}_2$  treatment.

**Table 6-7. Aldehyde/Ketone Formation in OR Water**

Parameter	Concentration, $\mu\text{g/L}$	
	$\text{KMnO}_4$ Treated Raw	$\text{ClO}_2$ Treated Mixed
Formaldehyde	10.1	10.8 C
Acetaldehyde	11.2	24.1 C
Propanal	1.5	25.1 C
2-Butanone		25.1 C
Butanal	2.6	40.6 C
Pentanal		C
2-Hexanone		C
Hexanal	1.6	16.2 C
Octanal		C
Benzaldehyde		C

C = GC/MS confirmed

Richardson et al. (1994) utilized XAD<sup>®</sup> resin extraction and GC/MS to qualitatively search for by-products in waters taken from a pilot plant in Evansville, IN, employing ClO<sub>2</sub>. They identified 20 compounds in ClO<sub>2</sub>-treated water that were not identified in the raw water. Most were carboxylic acids in the C4 through C16 range. A few ketones were also identified.

### ***Controlling Concentrations of Chlorine Dioxide, Chlorite, and Chlorate***

Chlorite and chlorate are found in ClO<sub>2</sub>-treated waters. They may result from unreacted ClO<sub>2</sub> generator products, the reduction of ClO<sub>2</sub>, or the disproportionation of ClO<sub>2</sub> and its related products. Table 6-1 shows chlorite measured in ClO<sub>2</sub>-treated waters at Jefferson Parish. As both chlorite and chlorate have toxicological implications, as the D/DBP Rule regulates chlorite in drinking water, and as the D/DBP Rule limits the allowable concentration of ClO<sub>2</sub> in finished waters, the control of all three species is important to systems employing ClO<sub>2</sub>.

Granular activated carbon (GAC) with an empty bed contact time of 9.6 minutes was studied at the Evansville pilot plant for control of ClO<sub>2</sub> and chlorite (Lykins et al. 1990; Lykins et al. 1989). Results are given in Table 6-8. They show that much of the ClO<sub>2</sub> is reduced to chlorite downstream of its application, that ClO<sub>2</sub> was completely reduced before entering the GAC bed so its control by GAC could not be evaluated, and that a substantial percentage of the chlorite was controlled by GAC. Chlorite control by GAC would very likely be time dependent; no details were given as to GAC age, bed volumes treated, etc.

**Table 6-8. Control of ClO<sub>2</sub> and ClO<sub>2</sub><sup>-</sup> at Evansville (Lykins et al. 1990)**

	<b>Chlorine Dioxide, mg/L</b>	<b>Chlorite, mg/L</b>
Dose	4.2	
Settled	0.5	2.3
GAC influent	ND	3.0
GAC effluent	ND	0.3

ND = not detected

Griese et al. (1991) studied the use of reducing agents to control ClO<sub>2</sub> and chlorite at the bench scale at Evansville. Applying excess sulfur dioxide and sulfite was found to remove both ClO<sub>2</sub> and chlorite. SO<sub>2</sub>/SO<sub>2</sub><sup>-</sup> was most efficiently applied after the oxidant demand for ClO<sub>2</sub> had been met. The reaction, in part, depended on the dissolved oxygen (DO) concentration. Using this means of control, unreacted SO<sub>2</sub>/SO<sub>2</sub><sup>-</sup> would complicate post-disinfection. They assumed unreacted SO<sub>2</sub>/SO<sub>2</sub><sup>-</sup> would be removed by post-chlorination, but require a higher post-chlorine dose than would otherwise be required. This means of control was not pursued, however, since unacceptable concentrations (exceeding 1 mg/L) of chlorate were formed. They found similar results with the application of excess metabisulfite. Results with excess thiosulfate were more promising. It controlled both ClO<sub>2</sub> and chlorite, was pH and time dependent, was not affected by DO, and did not form complicating concentrations of chlorate. But it would also pose a problem for finished waters, as unreacted thiosulfate would complicate post-disinfection.

Griese et al. (1991) also studied ferrous chloride at the pilot scale at Evansville. They found this to be the most promising reducing agent as it controlled both ClO<sub>2</sub> and chlorite and formed only very low concentrations of chlorate. Residual iron was controlled with prefilter chlorination. Other studies by Griese et al. (1992) at the pilot scale expanded on ferrous iron as a means of control and focused on chlorate. They found chlorate could be present as a product of the ClO<sub>2</sub> generation process, as a result of ClO<sub>2</sub>'s reaction with sunlight, and as a result of uncontrolled ClO<sub>2</sub> and chlorite reacting with post-chlorine. They found that chlorate formation during ferrous iron treatment was higher at lower pH and that adding lime to a pH range of 7.0 to 7.5 minimized chlorate formation.

## Ozone

Ozone is a less commonly used disinfectant in drinking water treatment. Among the many benefits of ozonation of drinking water are effective inactivation of microbes, taste and odor control, iron and manganese control, oxidation of DBP precursors, and the enhancement of biological oxidation in filters. However, ozone results in the formation of bromate and of biodegradable organic matter (BOM). Bromate is regulated under the D/DBP Rule. BOM includes ozone by-products (OBPs) like aldehydes, keto acids, carboxylic acids, AOC, and biodegradable dissolved organic carbon (BDOC). These OBPs may be responsible for regrowth of bacteria in distribution systems and can be controlled in-plant if biological oxidation is allowed to occur in downstream filters. (Refer to Chapter 7, “DBP Control Through Biological Filtration.”)

### *Halogenated DBP Formation*

The formation of halogenated DBPs as a result of ozonation is minimal. EPA unpublished data showed the low-level formation of brominated DBPs by ozone in the conduct of pilot-scale studies (Miltner et al. 1990; Miltner and Summers 1992) of OR water.  $\text{CHBr}_3$ , BAA, and DBAA were occasionally detected at concentrations below 2  $\mu\text{g/L}$ , presumably through the reaction of molecular ozone, bromide, and natural organic matter (NOM). Downstream chlorination significantly increased the concentrations of these DBPs.

Table 6-1 describes TOX concentrations as a result of ozonation of MR water at the Jefferson Parish pilot plant. A 31-minute contact time resulting in a 0.5-mg/L ozone residual did not increase TOX concentrations beyond those in the background water.

### *Oxidation of Halogenated DBP Precursor*

DBP precursors tend to be more humic than non-humic and of higher rather than lower molecular weight. In Chapter 10, Coagulation, Dryfuse et al. (1995) describe TOX, TTHM, and HAA6 precursors located predominantly in the humic and higher-molecular-weight fractions of East Fork Lake (EFL) water. Koechling et al. (1996), studying the reaction of ozone with NOM, found that ozone converted portions of the humic fraction to non-humic compounds and converted portions of the higher-molecular-weight fraction to lower-molecular-weight compounds. Therefore, ozone reacts with NOM to oxidize a portion of the DBP precursors; this results in lower concentrations of DBPs formed by downstream chlorination. Coupled with the low-level formation of bromo-DBPs by ozone itself, this finding supports ozone's role as an alternative oxidant for halogenated DBP control.

Tables 6-9 and 6-10 describe ozone's oxidation of DBP precursor in pilot-scale studies of OR water and EFL water, respectively. In the OR water study (Table 6-9), ozone was applied to raw OR water at a transferred ozone/TOC ratio near 0.8 mg/mg. Miltner et al. (1992) studied ozone dose dependency and demonstrated with pilot-scale ozonation of OR water that, at transferred ozone/TOC ratios above 0.7 mg/mg, no further oxidation of TTHM, HAA6, and TOX precursors occurred. While ozone changed the nature of the DOC (to more non-humic and to smaller-molecular-weight compounds), it did not significantly change its concentration, as Table 6-9 demonstrates. Ozone significantly oxidized compounds that absorb at 254nm (UV254) and consequently lowered the water's specific ultraviolet (UV) absorbance (SUVA), or UV254 divided by DOC. Using FP as a means of assessing DBP precursors, removal of TTHM, HAA6, and TOX precursors by ozone was within the 14% to 19% range. However, ozone altered the nature of CH and CP precursors to the extent that they increased.

In the EFL water study, ozone was applied to coagulated and settled EFL water at a transferred ozone/TOC ratio near 0.9 mg/mg. Table 6-10 shows the removal of DBP precursors first by coagulation and

**Table 6-9. Mean Changes in DBP Precursors in Ozonated OR Water (Miltner 1993)**

Parameter	Raw	Ozonated	Percent Removal
DOC, mg/L	2.28	2.24	
UV254, cm <sup>-1</sup>	0.051	0.027	47
SUVA, L/mg-m	2.23	1.20	46
TTHMFP, µg/L	190	164	14
HAA6FP, µg/L	155	126	19
TOXFP, µg Cl/L	449	367	18
CHFP, µg/L	33	40	+21
CPFP, µg/L	1.5	2.9	+93

**Table 6-10. Mean Changes in DBP Precursors in Ozonated EFL Water (Miltner et al. 1996)**

Parameter	Raw	Coagulated Settled	Coagulated Settled, Ozonated	Percent Removal by Ozonation
DOC, mg/L	5.83	2.77	2.74	
UV254, cm <sup>-1</sup>	0.204	0.068	0.023	66
SUVA, L/mg-m	3.50	2.12	0.84	60
UFC TTHM, µg/L	311	83.6	48.7	42
UFC HAA6, µg/L	332	79.1	52.5	34
UFC TOX, µg Cl/L	984	300	210	30
UFC CH, µg/L	32.2	11.4	18.3	+61
UFC HAN4, µg/L	12.6	6.9	3.6	48
Chlorine demand, mg/L	9.27	3.04	2.86	6

then by ozonation. Precursors were assessed by UFC. Again, ozone did not affect the DOC concentration, but removed SUVA, chlorine demand, and TTHM, HAA6, HAN4, and TOX precursors. Precursors for CH were increased by ozone oxidation.

Ozone oxidation of TTHM and TOX precursors was also observed by Lykins and Koffskey (1986) in pilot-scale Jefferson Parish waters (see Table 6-6).

Results of another pilot-scale study of ozonation of raw OR water (Miltner et al. 1990) are presented in Table 6-3. A preozonated/post-chlorinated stream was compared to a stream that was post-chlorinated only. Post-chlorination was conducted under SDS conditions of 3-day chlorination targeting TSS chlorine residuals (Recommended Standards for Water Works 1992). The data show lower concentrations of finished water TTHM, HAA6, HAN4, and TOX in the preozonated stream. Two factors account for this: (1) preozonation removed a portion of the precursors by oxidation, and (2) preozonation lowered the chlorine demand so that less chlorine was applied and was present to drive DBP formation. Exceptions were finished water concentrations of CH, CP, and 111-TCP, the precursors of which were increased by preozonation.

Table 6-3 shows a statistical test of the two chlorinated finished waters, showing 95% confidence in the lower concentrations of TOX, TTHM, CHCl<sub>3</sub>, HAA6, TCAA, DCAA, and BCAA when preozonated, and showing 95% confidence in the higher concentrations of CHBrCl<sub>2</sub>, CHBr<sub>3</sub>, DBAA, DBAN, CH, and CP when preozonated. Ozone's increase of CH and CP precursors has been previously noted. Ozone's effect on the bromochlorospeciation of halogenated DBPs is just as, if not more, important.

Shukairy et al. (1994) studied ozone's oxidation of DBP precursors in OR water and the resulting bromochlorospeciation. DBP precursors were assessed by chlorinating under FP conditions. Figure 6-2 shows representative results for individual HAAs. Oxidation of precursors for TCAA, DCAA, and BCAA occurred to the extent that, over the range of transferred ozone/DOC ratios up to 2.54 mg/mg, their concentrations decreased upon chlorination. This is consistent with the behavior of HAA6 precursors also observed by Miltner et al. (1992), noted previously.

At transferred ozone/DOC ratios at and below 1.11 mg/mg, however, concentrations of DBAA increased. This behavior is consistent with the statistically significant increases in DBAA concentrations presented in Table 6-3 in which ozonation took place at 0.8 mg/mg transferred ozone/TOC. As the ozone increased, however, there was a significant decrease in DBAA formation. At transferred ozone/DOC ratios at and below 1.11 mg/mg, changes in bromide were small. At higher ozone doses, more bromate was formed from bromide (refer to Table 6-15), thus bromide concentrations fell. As a result, the bromide/DOC ratios and the bromide/free-chlorine ratios decreased. Decreases in either ratio favor the formation of more chlorinated species as was observed above 1.11 mg/mg.

Figure 6-2 also shows the bromide incorporation factor  $n'$ , which is defined as the molar ratio of the brominated HAAs to the total HAA6 (Shukairy et al. 1994). At lower ozone doses, when DBAA concentrations increased,  $n'$  increased; at higher ozone doses, when DBAA concentrations decreased,  $n'$  decreased. Behavior for THMs was similar with increased concentrations of  $\text{CHBr}_2\text{Cl}$  and  $\text{CHBr}_3$  and increased  $n$ , the bromide incorporation factor for TTHM, at lower ozone doses, and decreased concentrations of these two THMs and  $n$  at higher ozone doses. It is important to remember that, although brominated HAAs and THMs in chlorinated waters increase over the range of transferred ozone/DOC ratios common to drinking water treatment, their concentrations are relatively small (below a few  $\mu\text{g/L}$ ); TTHM and HAA6 concentrations, however, decrease, demonstrating ozone's overall benefit in oxidizing DBP precursors.

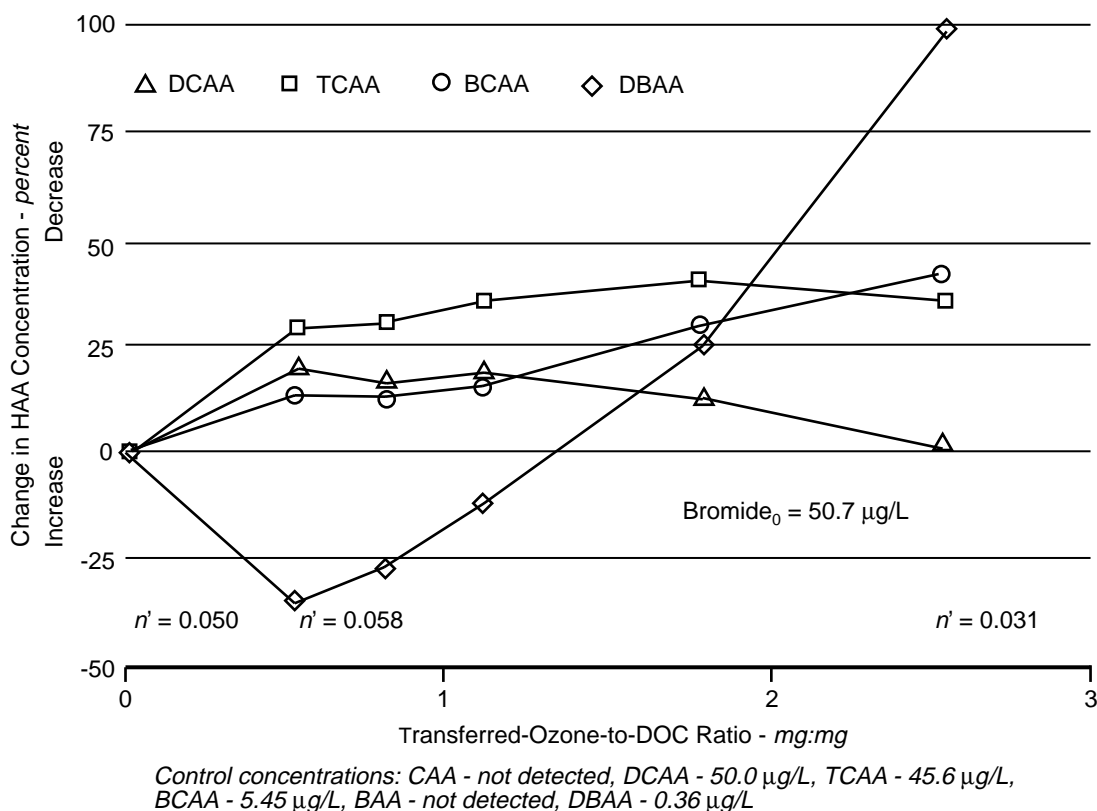


Figure 6-2. Effect of ozone dose on HAA formation in OR water (Shukairy et al. 1994).

In the studies summarized in Tables 6-3 and Tables 6-9 through 6-13, microbial densities were monitored. Ozonation was always observed to bring TC bacterial densities to less than one colony /100 mL. Ozonation never destroyed all HPC bacteria; they flourished sufficiently in nutrient-rich downstream waters to acclimate biological filters. Post-disinfection with chlorine or chloramine to achieve requirements of the TSS (Recommended Standards for Water Works 1992) lowered finished water HPC levels typically to 2 to 3 log/mL densities.

### ***Ozone By-Product Formation***

Ozonation results in the formation of a number of OBPs. Several pilot-scale studies were conducted with transferred ozone/TOC ratios in the 0.8 to 0.9 mg/mg range. Results are presented in Tables 6-11, 6-12, and 6-13. Ozonation of raw OR water over several months (Table 6-11) demonstrated the statistically significant formation of 9 aldehydes and a ketone, principally formaldehyde, acetaldehyde, glyoxal, and methyl glyoxal.

**Table 6-11. Mean Formation of Aldehydes and Ketones in Ozonated OR Water (Miltner et al. 1991; Miltner 1993)**

Parameter	Concentration, µg/L	
	Raw	Ozonated *
Formaldehyde	1.1	11.7
Methyl glyoxal	0.1	11.4
Glyoxal	1.3	7.6
Acetaldehyde	1.1	3.5
Propanal	1.2	2.1
Hexanal	0.4	1.4
Decanal	0.4	1.1
Nonanal	0.5	1.0
Pentanal	ND@0.2	0.3
2-Butanone	**ND@0.1	0.1

ND = not detected

\* Increase with ozone significant at ≥95% confidence level unless otherwise noted.

\*\* Increase with ozone significant at 94% confidence level.

The same pilot study also demonstrated the formation of other OBPs (Table 6-12) over several months' operation: two keto acids, AOC, and BDOC. The aldehydes, ketones and keto acids are small-molecular-weight compounds resulting from ozone's oxidation of the NOM. They are easily biodegradable (assimilable) and are considered to make up portions of the AOC and BDOC. Note that most of these measures of BOM are naturally present in the raw water and are enhanced upon ozonation. The BDOC made up 17% of the DOC in the raw water and was enhanced to 32% following ozonation. Total AOC (the P17 and the NOX fractions) made up 7% of the raw water DOC and was enhanced to 30% following ozonation. Because these OBPs are, by definition, assimilable and biodegradable, they can serve as substrates for bacterial regrowth in distribution systems if not controlled by biological filtration (refer to Chapter 7, "DBP Control Through Biological Filtration").

The nature of the NOM can influence OBP formation. In OR water (Table 6-12) with a DOC concentration of 2.28 mg/L, BDOC and total AOC reached concentrations of 0.71 mg/L and 665 µg Ceq/L, respectively, with transferred ozone/TOC near 0.8 mg/mg. Following coagulation and sedimentation of EFL water, DOC was lowered to a concentration of 2.77 mg/L. With transferred ozone/TOC near 0.9



**Table 6-12. Mean Formation of AOC, BDOC, and Keto Acids in Ozonated OR Water (Miltner 1993)**

Parameter	Raw	Ozonated #
DOC, mg/L	2.28	2.24
BDOC, mg/L	0.39	0.71
AOC-P17, µg Ceq/L*	37	71
AOC-NOX, µg Ceq/L**	129	594
Glyoxylic acid, µg/L	0.2	34.6
Pyruvic acid, µg/L	0.4	12.4

# Increase with ozone significant at ≥95% confidence level except for DOC.

\* as acetate

\*\* as oxylate

**Table 6-13. Mean Formation of OBPs in EFL Water (Miltner et al. 1996)**

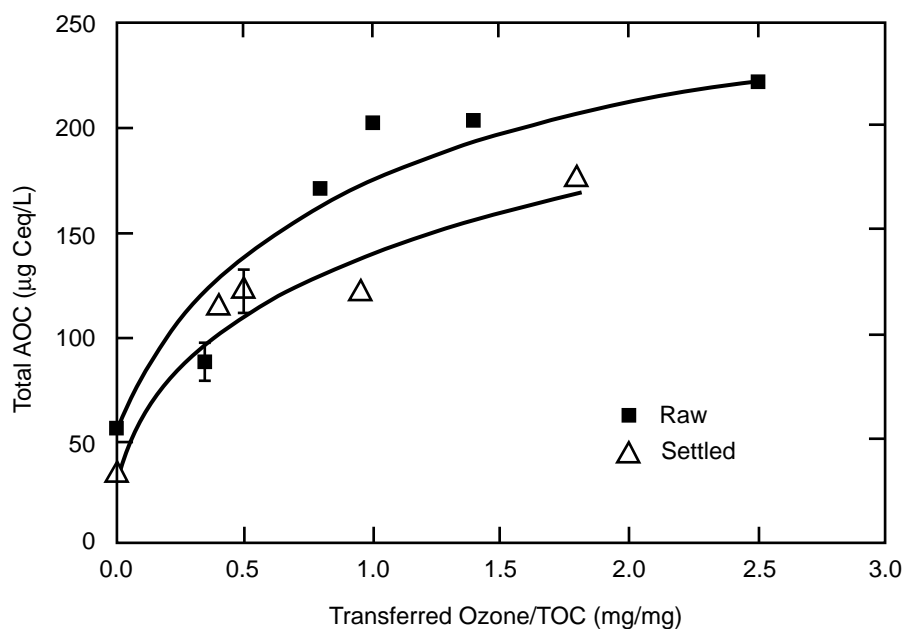
Parameter	Raw	Coagulated Settled	Ozonated
DOC, mg/L	5.83	2.77	2.74
BDOC, mg/L	1.27	0.53	1.21
Total AOC, µg Ceq/L	399	203	1314
Formaldehyde, µg/L	7.7	NA	21.1
Methyl glyoxal, µg/L	0.2	NA	4.4
Glyoxal, µg/L	0.1	NA	15.1
Glyoxylic acid, µg/L	0.2	NA	46.1
Pyruvic acid, µg/L	0.7	NA	15.6

NA = not analyzed

mg/mg, BDOC and total AOC reached 1.21mg/L and 1314 µg Ceq/L, respectively, or roughly twice that of the OR water at approximately the same DOC and transferred ozone/TOC ratio (Table 6-13). A biological filter treating EFL water would have to be more efficient than one treating OR water to ensure similar distribution system loading of AOC and BDOC.

Ozone concentration can influence OBP formation. Several bench- and pilot-scale studies with ozonation of different batches of OR water examined dose dependency (Shukairy et al. 1992; Miltner et al. 1992; Miltner et al. 1998). Maximum transferred ozone/TOC ratios were in the 2.5 to 2.8 mg/mg range. Generally, much of the formation occurs at lower ozone doses. An example is given in Figure 6-3 for total AOC; at a ratio of 2.5 mg/mg, formation was not yet maximized. Similar behavior of still-increasing formation at higher ratios was also observed for BDOC, glyoxylic acid, and formaldehyde (Miltner et al. 1992; Miltner et al. 1998). Maximized and level formation was observed for acetaldehyde and propanal (Miltner et al. 1992; Shukairy et al. 1992).

Pentanal was found to reach a maximum near 1.8 mg/mg and then diminish in concentration as more ozone was introduced (Shukairy et al. 1992). It is possible that pentanal was converted to pentanoic acid at higher ozone doses. Glyoxal and methyl glyoxal exhibited different behaviors in different batches of OR water. In one, it behaved like pentanal, i.e., observed at lower concentration at higher doses after reaching a maximum (Shukairy et al. 1992). In another, they had not yet reached maximums at 2.8 mg/mg (Miltner et al. 1992). At ozone doses more typical of drinking water treatment (0.5 to 1.5 mg/mg transferred ozone/TOC), concentrations of OBPs are generally increasing; therefore, minimizing the ozone dose can limit OBP formation.



**Figure 6-3. Effect of ozone dose on total AOC in OR water (Miltner et al. 1998).**

Ozone staging (when it is applied in the treatment plant) can influence OBP formation. Miltner et al. (1998) studied bench-scale ozonation of raw, coagulated and settled OR waters. Raw water was ozonated at a transferred ozone/TOC ratio of 1.4 mg/mg and settled water at a transferred ozone/TOC ratio of 1.1 mg/mg. These were based on oxidation of SUVA and DBP precursors in raw and settled waters and on achieving the concentration and time (CT) required to inactivate approximately 2 logs *Cryptosporidium parvum* oocysts. The inactivation studies treated *C. parvum* oocyst-spiked OR water (Owens et al. 2000). Table 6-14 shows that ozonating settled water resulted in lower concentrations of OBPs than ozonating raw water prior to coagulation and settling. Coagulation removed some of the ozone-reactive NOM. Further, coagulation removed ozone demand such that the inactivation CT requirements could be met at a lower ozone dose (4.7 mg/L [ $1.4 \times 3.35$ ] in the raw water vs. 2.8 mg/L [ $1.1 \times 2.59$ ] in the settled water). The ozone dose dependency of OBP formation was previously discussed. After formation of OBPs in the raw water, OBP removal by coagulation and settling was minimal. It must be noted, however, that at the bench scale, no biological activity took place in the sedimentation process. Miltner and Summers (1992) demonstrated removal of AOC in a pilot-scale, bioacclimated sedimentation basin at room temperature.

**Table 6-14. Effect of Ozone Staging on OBPs in OR Water (Miltner et al. 1998)**

Parameter	Raw	Settled, then Ozonated (1.1 mg/mg O <sub>3</sub> /TOC)	Ozonated (1.4 mg/mg O <sub>3</sub> /TOC), then Settled
TOC, mg/L	3.35	2.59	2.58
Total AOC, µg Ceq/L	142	297	440
Formaldehyde, µg/L	3.0	11.9	31.4
Glyoxal, µg/L	ND	3.9	7.2
Methyl glyoxal, µg/L	ND	9.2	15.2
Glyoxylic acid, µg/L	ND	64.8	189
Pyruvic acid, µg/L	ND	36.3	119

## Controlling Bromate

Ozone reacts with bromide to form bromate, and bromate is regulated at 10 µg/L under the D/DBP Rule. While this reaction, or series of reactions, is complex, hypobromite ion is an intermediate product. Thus, minimizing pH to favor hypobromous acid over hypobromite ion is cited as a best available technology (BAT) for bromate control in the D/DBP Rule. Other means of control include adding ammonia to form bromamines in place of the free-bromine (hypobromite and hypobromous acid) species and applying ozone in a manner that minimizes the presence of the dissolved ozone residual driving the reaction.

Bromate formation as a function of increasing bromide concentration was studied by Shukairy et al. (1994) in a pilot-scale ozone contactor treating OR water. Owens et al. (2000) studied inactivation of spiked *Cryptosporidium parvum* oocysts in the same pilot-scale ozone contactor treating different batches of OR water. The pH was in the 7.40 to 7.65 range for the bromate study. The results in Table 6-15 show bromate concentration increasing with increasing dissolved ozone residual and with increasing bromide. With ambient bromide (50.7 µg/L), the bromate MCL was exceeded near a transferred ozone/TOC ratio of 1.1 mg/mg, at which approximately 1.3-log inactivation of *C. parvum* oocysts would occur. At relatively high bromide concentrations, prohibitive bromate concentrations occurred at low ozone doses. This pilot-scale contactor was a single, countercurrent chamber. In a full-scale, multi-chamber contactor, the same ozone might be applied over several chambers, minimizing the dissolved ozone driving the bromate reaction, but maintaining the dissolved ozone required for achieving CT.

**Table 6-15. Effect of Ozone Dose and Bromide on Bromate Formation in OR Water (Shukairy et al. 1994; Owens et al. 2000)**

Trans O <sub>3</sub> mg/L	Trans O <sub>3</sub> /DOC mg/mg	Residual O <sub>3</sub> mg/L	CT* mg min/L	Log Inact <i>C. parvum</i> Oocysts	Bromate Concentration, µg/L		
					Br <sup>-</sup> 50.7 µg/L	Br <sup>-</sup> 258 µg/L	Br <sup>-</sup> 550 µg/L
0	0	0	0	0	<0.2	<0.2	<0.2
0.89	0.53	0.28	0.96	0.30	1.1	7.6	14.2
1.37	0.81	0.66	2.15	0.72	4.1	25.4	24.4
1.93	1.11	1.16	3.85	1.31	10.5	45.2	58.8
3.02	1.78	2.15	7.18	2.48	24.1	103	145
4.32	2.54	3.27	10.9	3.79	40.7	198	303

\*CT = C<sub>avg</sub> × T, in which C<sub>avg</sub> = 0.45 to 0.5 residual O<sub>3</sub> and T = theoretical = 7.4 min mean

## Summary

The formation of halogen-containing DBPs by chloramines is significantly lower than by free chlorine. An exception is the formation of cyanogen chloride with chloramination. The formation of non-halogenated DBPs like aldehydes and AOC is minimal with chloramination.

The formation of halogen-containing DBPs by chlorine dioxide is significantly lower than by free chlorine. ClO<sub>2</sub> oxidizes DBP precursors to the extent that lower concentrations of DBPs are formed with subsequent chlorination. ClO<sub>2</sub> forms non-halogenated DBPs like aldehydes, ketones, and AOC.

Chlorite and chlorate can result from the use of ClO<sub>2</sub>. Chlorite can be controlled by GAC and by reducing agents. Sulfite and metabisulfite can reduce chlorite, but may form chlorate. Thiosulfate can reduce chlorite without forming chlorate. Ferrous ion can also reduce chlorate, but pH adjustment is

required to minimize chlorate formation. The use of a reducing agent like thiosulfate or ferrous ion can complicate the application of post-disinfectants.

The formation of halogen-containing DBPs by ozone is significantly lower than by free chlorine. Ozone can form bromo-DBPs like  $\text{CHBr}_3$ , BAA, and DBAA, but at relatively low concentrations. Ozone oxidizes DBP precursors such that lower concentrations of TTHM, HAA6, HAN4, and TOX are formed with subsequent chlorination. However, ozone alters the nature of the precursors to the extent that higher concentrations of CH, CP, and 111-TCP are formed with subsequent chlorination.

Ozone converts portions of the humic fraction to non-humic compounds and converts portions of the higher-molecular-weight fraction to lower-molecular-weight compounds. Examples of lower-molecular-weight materials formed by ozone are aldehydes, keto acids, AOC, and BDOC. Concentrations of these may be appreciable and necessitate control to ensure distribution system biostability. Generally, much of the formation of these OBPs occurs at lower ozone doses. Ozone staging (when it is applied in the treatment plant) can influence OBP formation. Ozonation of raw water results in higher OBP formation than ozonation of downstream waters in which some ozone demand has been removed.

Bromate can result from the use of ozone. Bromate concentration increases with increasing dissolved ozone residual and with increasing bromide.

## References

- Dryfuse, M. J., Miltner, R. J., and Summers, R. S. (1995). "The removal of molecular size and humic/non-humic fractions of DBP precursors by optimized coagulation." *Proceedings, American Water Works Association, Annual Conference*, Anaheim, CA, June.
- Griese, M. H., Kaczur, J. J., and Gordon, G. (1992). "Combining methods for the reduction of oxychlorine residuals in drinking water." *Journal of the American Water Works Association*, 84(11), 69
- Griese, M. H., Hauser, K., Berkemeier, M., and Gordon, G. (1991). "Using reducing agents to eliminate chlorine dioxide and chlorite ion residuals in drinking water." *Journal of the American Water Works Association*, 83(5), 56.
- Koehling, M. T., Shukairy, H. M., and Summers, R. S. (1996). "Chapter 13: Effect of ozonation and biotreatment on molecular size and hydrophylic fractions of natural organic matter." *Water disinfection and NOM: Characterization and control*, Minear and Amy, eds., ACS Symposium Series 649, ACS, Washington, D.C.
- Lykins, B. W., Goodrich, J. A., and Hoff, J. C. (1990). "Concerns with using chlorine dioxide disinfection in the USA." *Journal of Water Supply Research and Technology-Aqua*, 39(6), 376.
- Lykins, B. W., Goodrich, J. A., Hoff, J. C., and Kothari, N. (1989). "Chlorine dioxide for drinking water treatment." *Proceedings, Montana Section, American Water Works Association/WPCA Joint Conference*, Great Falls, MT, March 29–31.
- Lykins, B. W. and Koffskey, W. (1986). "Products identified at an alternative disinfection pilot plant." *Environmental Health Perspectives*, 69, 119.
- Lykins, B. W. and Griese, M. H. (1986). "Using chlorine dioxide for trihalomethane control." *Journal of the American Water Works Association*, 78(6), 88.
- Miltner, R. J., Ollier, L. L., Brown, T. A., and Summers, R. S. (1998). "Assessing the point of application of ozone during conventional treatment." *Proceedings, Water Research, American Water Works Association, Annual Conference*, Dallas, TX, June 21–25.

- Miltner, R. J., Summers, R. S., Dugan, N. R., Koechling, M., and Moll, D. M. (1996). "Comparative evaluation of biological filters." *Proceedings, American Water Works Association, Water Quality Technology Conference*, Boston, MA, November 17–20.
- Miltner, R. J. (1993). "Transformation of NOM during water treatment." *Proceedings, American Water Works Association Research Foundation Workshop on NOM*, Chamonix, France, September.
- Miltner, R. J., Shukairy, H. M., and Summers, R. S. (1992). "Disinfection by-product formation and control by ozonation and biological treatment." *Journal of the American Water Works Association*, 84(11), 53.
- Miltner, R. J. and Summers, R. S. (1992). "A pilot-scale study of biological treatment." *Proceedings, Water Quality, American Water Works Association, Annual Conference*, Vancouver, BC, June 18–22.
- Miltner, R. J., Rice, E. W., and Smith, B. L. (1991). "Ozone's effect on AOC, DBPs and DBP precursors." *Proceedings, American Water Works Association, Water Quality Technology Conference*, Orlando, FL, November 10–14.
- Miltner, R. J. (1990). "Treatment for the control of disinfection byproducts." *Proceedings, Seminar on Current Research Activities in Support of USEPA's Regulatory Agenda, American Water Works Association, Annual Conference*, Cincinnati, OH, June 17.
- Miltner, R. J., Rice, E. W., and Stevens, A. A. (1990). "Pilot-scale investigation of the formation and control of disinfection byproducts." *Proceedings, American Water Works Association, Annual Conference*, Cincinnati, OH, June 17–21.
- Miltner, R. J. (1976). "The effect of chlorine dioxide on trihalomethanes in drinking water." M.S. thesis, University of Cincinnati, Cincinnati, OH.
- Owens, J. H., et al. (2000). "Pilot-scale inactivation of *Cryptosporidium* and other microorganisms in natural water." Accepted for publication in *Ozone Science and Engineering*, 22(5), 501.
- Recommended standards for water works*. (1992). Great Lakes Upper Mississippi River Board of State Public Health and Environmental Managers, Health Education Services, Albany, NY.
- Richardson, S. D., et al. (1994). "Multispectral identification of chlorine dioxide disinfection byproducts in drinking water." *Environmental Science and Technology*, 28(4), 592.
- Shukairy, H. M., Miltner, R. J., and Summers, R. J. (1994). "The effect of bromide on disinfection by-product formation, speciation and control: Part 1, ozonation." *Journal of the American Water Works Association*, 86(6), 72.
- Shukairy, H. M., Summers, R. S., and Miltner, R. J. (1992). "Control and speciation of disinfection by-products by biological treatment." *Proceedings, Water Research, American Water Works Association, Annual Conference*, Vancouver, BC, June 18–22.
- Summers, R. S., Hooper, S. M., Shukairy, H. M., Solarik, G., and Owen, D. (1996). "Assessing DBP yield: Uniform formation conditions." *Journal of the American Water Works Association*, 88(6), 80.
- Stevens, A. A., Moore, L. A., and Miltner, R. J. (1989). "Formation and control of non-THM disinfection by-products." *Journal of the American Water Works Association*, 81(8), 54.



## CHAPTER 7

### Disinfection By-Product Control Through Biological Filtration<sup>1</sup>

#### Introduction

Disinfection by-product (DBP) control through biofiltration is defined as the removal of DBP precursor material (PM) by bacteria attached to the filter media. The PM consists of dissolved organic matter (DOM) and is utilized by the filter bacteria as a substrate for cell maintenance, growth, and replication. The PM utilized by bacteria is no longer available to react with chlorine to form DBPs. All other things being equal, a water with lower PM concentration will yield lower DBP concentrations, at a given chlorine dose, after a given time period. The biological filtration process is cost effective, since the bacteria are naturally present in the water supply, can colonize existing filter media, do not produce a residual that needs disposal, and require almost no modification of ambient conditions. The only prerequisite for maximizing bacterial substrate utilization in filters is the absence of disinfectant in the filter influent or backwash water. The filter media colonized by bacteria can be sand, anthracite, or granular activated carbon (GAC). Anthracite and sand are considered inert because neither interacts chemically with PM. Thus, any removal of PM would be due solely to biological activity. GAC that has been colonized by bacteria will initially remove DOM through adsorption and biological substrate utilization. After the GAC's adsorptive capacity has been exhausted, PM removal is achieved only through substrate utilization, and the GAC is defined as biological activated carbon (BAC). All drinking water filters will become biologically active in the absence of applied disinfectant residuals. The process of biological colonization and substrate utilization is enhanced by ozonating filter influent water.

In the U.S., preozonation is practiced to remove color, taste, and odor, to inactivate *Giardia* and *Cryptosporidium*, and to serve as an alternative to chlorine disinfection. Ozonation decreases the average molecular size and weight of the PM, allowing indigenous bacteria to utilize more of it as substrate in a given amount of contact time. Some fraction of microbes will always survive ozonation. As long as no liquid phase ozone residual is present in the filter influent, the surviving microbes will eventually colonize the filter media. A preozonated biological filter will achieve greater PM removals than one with influent that has not been preozonated. PM is measured as total organic carbon (TOC), dissolved organic carbon (DOC), trihalomethane (THM) formation potential (THMFP), or haloacetic acid (HAA) formation potential (HAAFP). All of the studies discussed in this chapter measure DBP control using one or some combination of the parameters TOC, DOC, THMFP, and HAAFP. Because of its potential to control DBP precursors and its economic advantages, the U.S. Environmental Protection Agency (EPA) Water Supply and Water Resources Division (WSWRD) has performed or funded a number of research studies to characterize the impact of biological filtration on the control of DBPs.

#### EPA-Funded Studies

##### *Pilot-Scale Study, Shreveport, Louisiana, 1982*

A pilot-scale study was executed to investigate the combination of ozone and GAC for THM precursor removal (Glaze et al. 1982). Following conventional treatment (coagulation, flocculation, and sedimentation), the process water was split to a GAC filter, and to an ozone contactor followed by a GAC

---

<sup>1</sup>Nick Dugan: ORD/NRMRL/WSWRD, AWBERC Mailstop 689, 26 West Martin Luther King Dr., Cincinnati, OH 45268, 513-569-7239, [dugan.nicholas@epa.gov](mailto:dugan.nicholas@epa.gov).

**Table 7-1. TOC and THMFP Removal in Pilot-Scale GAC Columns, Shreveport, LA, 1982**

Week	% TOC Removal		% THMFP Removal	
	GAC	O <sub>3</sub> -GAC	GAC	O <sub>3</sub> -GAC
0-21	82	83	83	79
22-52	55	55	56	53
53-62	10	19	19	26
65-83	24	27	24	30

NOTE: Average filter influent TOC  $\approx$  .30 mg/L.

filter (O<sub>3</sub>-GAC) . The results are summarized in Table 7-1. Analysis of the data showed microbial activity to be a significant contributor to the removal process for TOC and THMFP over the long term. THMFP was defined as THM formation after chlorination at 20 mg/L, at a pH of 6.5, a temperature of 26°C  $\pm$  2°C, and a 3-day incubation time.

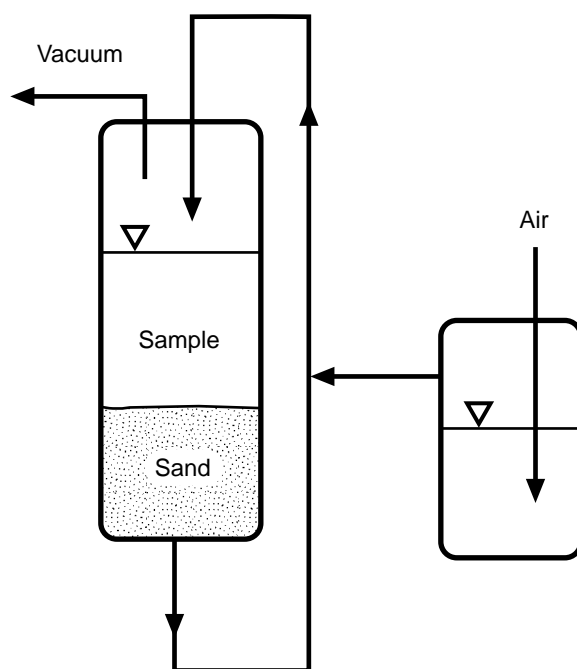
The study was run for 83 weeks. At the beginning of the study (weeks 0-21), both sets of columns achieved approximately 80 percent TOC and THMFP removal. These removals were due primarily to physical adsorption of the PM. In the final phase of the project (weeks 65-83), TOC removals averaged 24 and 27 percent in the GAC and O<sub>3</sub>-GAC columns. During the same time period, THMFP removals averaged 24 and 30 percent, respectively, in the GAC and O<sub>3</sub>-GAC columns. By this time, the GAC columns had each passed more than 50,000 bed volumes, and their adsorptive capacity was exhausted. In the absence of adsorption, TOC and THMFP removals during weeks 65-83 were deemed to be due to biological activity.

### ***Bench-Scale Studies, 1991***

A series of three bench-scale studies was performed to examine the impacts of ozone dose, water type, and attached versus suspended bacteria on the biological removal of DOC, THMFP, and HAAFP. The first study investigated the effect of ozone dose and biological treatment on PM control (Shukairy et al. 1992a). THMFP and HAAFP were measured by chlorinating at 12 mg/L, at a pH of 7.5-8.0, and holding for 7 days at 20 °C. Bench-scale biological treatment was performed in batch recycle tests (see Figure 7-1). The water sample was circulated continuously through a bed of bioacclimated sand for 5 days. Oxygen was provided by applying a vacuum to the head space of the sample chamber and drawing in air through a water trap, which removed foreign bacteria. The 5-day contact time was considerably longer than the 5 to 10 minutes typical of pilot- or full-scale biological filters. As a result, estimates of biological removal in the batch test should be viewed as “ultimate” or “potential” removals, which will be higher than flow-through removals at equivalent organic matter concentrations, compositions, and ozone pretreatment.

Water samples were ozonated at transferred doses of 0.5, 0.8, 1.1, 1.8, and 2.5 mg O<sub>3</sub>/mg DOC. Biological treatment alone resulted in 13 to 14 percent removal of DOC. Ozonation followed by biological treatment yielded 20 to 30 percent DOC removals. Biological treatment alone yielded a 28 percent reduction in THMFP. Ozonation followed by biological treatment yielded a 40 to 47 percent reduction in THMFP. Ozonation followed by biotreatment yielded a 75 to 80 percent reduction in HAAFP. The reduction in THMFP with respect to ozone dose is shown in Figure 7-2. THMFP formation after biotreatment, but without ozonation, was approximately 220  $\mu$ g/L. At the lowest transferred ozone dose of 0.8 mg O<sub>3</sub>/mg DOC, followed by biotreatment, THMFP dropped to 160  $\mu$ g/L. THMFP was not reduced appreciably at higher O<sub>3</sub>/DOC ratios of 1.1, 1.8, and 2.5. The removal behavior of HAAFP through biotreatment as a function of applied ozone dose was similar to that observed for THMFP. These results imply that THMFP reduction through biotreatment is sensitive to the presence or absence of ozonation, but insensitive to the ozone dose after a minimum ozone dose ( $\leq$  0.8mg/mg) is achieved.





**Figure 7-1. Bench-scale biofiltration apparatus.**

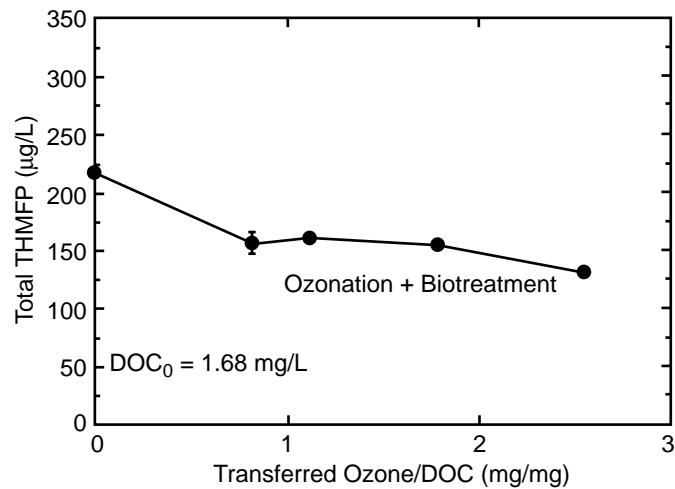
It is possible that the greatest reduction in PM molecular weight, and corresponding increase in PM bioavailability, occurs when ozonation is introduced, and that further increases in ozone dose do not yield proportional decreases in PM molecular weight.

The second study examined DOC removal through ozonation and biofiltration as a function of water type (Shukairy et al. 1992b). The first water was raw surface water from the Ohio River (ORW). The second was an artificial water, produced using a solution of humic substances isolated and concentrated from ground water. The humic substances were mixed with dechlorinated tap water to the desired DOC concentration. Dechlorinated tap water was used to provide the non-carbonaceous nutrients and mineral matrix required for the growth of microorganisms. Humic compounds are one of the major categories of organic substances that make up DOC and which act as PM. The bench-scale biological filter was the one shown in Figure 7-1. DOC removals through biological treatment and ozonation followed by biological treatment are summarized for both water types in Table 7-2. For both waters, the percentage DOC removal approximately doubled when ozonation preceded biofiltration. The percentage of DOC removals observed for ORW were similar to those observed during the previous study. However, DOC removals reported for the artificial water are significantly higher than those observed for any of the previously described studies that used natural waters. It is possible that a water with an organic fraction consisting only of humic substances would have a higher fraction of biodegradable components relative to natural water.

The third bench-scale study assessed the impact on PM removal of attached versus suspended bacteria (Miltner et al. 1992b). Three bench-scale bioreactors were filled with equal volumes of preozonated (0.7 mg O<sub>3</sub>/mg DOC) ORW. The first reactor contained bio-acclimated sand. The second reactor con-

**Table 7-2. DOC Removals Through O<sub>3</sub> and Biotreatment, ORW and Artificial Water, 1992**

Water	% DOC Removal	
	Biofiltration	O <sub>3</sub> -Biofiltration
ORW	12	25
Artificial water	34-48	64-72

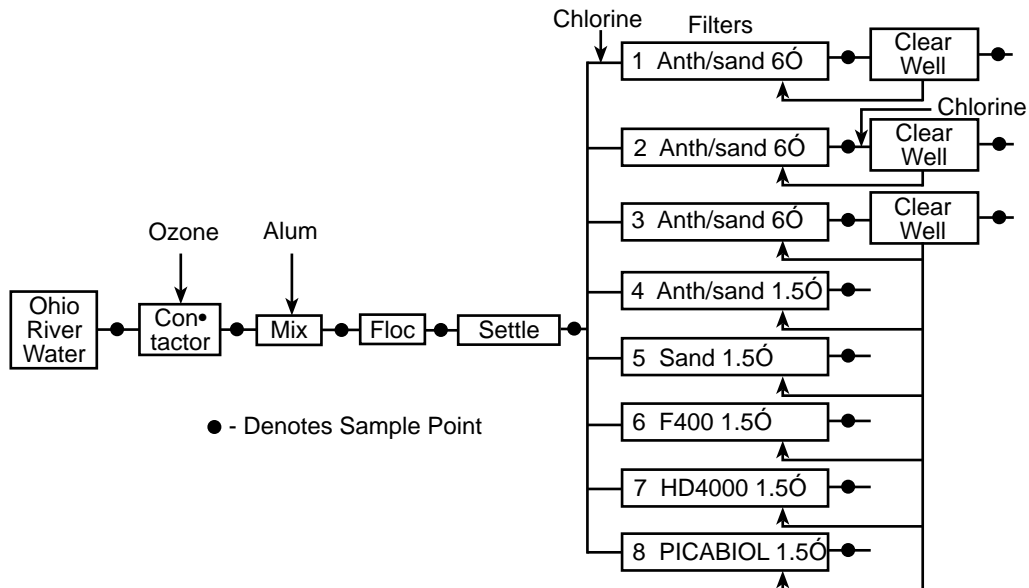


**Figure 7-2. Impact of ozone dose on THMFP removal.**

tained only water and no sand. Reactor 3 was the same as reactor 2, except that the water contained mercuric chloride to suppress any biological activity. After 5 days of operation, DOC reductions in reactors 1, 2, and 3 were 23, 10, and 0 percent, respectively. These results imply that bacteria suspended in the water column can account for a significant fraction of PM reduction, but that bacteria attached to some type of fixed surface are necessary to achieve the full potential of the process.

***Pilot-Scale Study, Cincinnati, OH, 1991–1992***

A year-long pilot-scale study (Miltner et al. 1992a; Miltner 1993) was carried out to assess: the impacts of filter disinfection, filter media and filter biomass on biological PM control (Wang et al. 1995b), biological PM control during a filter cycle as a function of backwash disinfection (Miltner et al. 1995), and the performance of biofilters with respect to depth (Swertfeger et al. 1993). The plant schematic is shown in Figure 7-3. Raw water was ozonated and then subjected to conventional treatment (alum



**Figure 7-3. Biological filtration pilot plant, Cincinnati, OH, 1991–1992.**

**Table 7-3. Filter Configuration, Operation and Performance, 1991–1992, 12-Month Pilot-Scale Study**

Filter	Media	Chlorination	Biomass (nmol lipid PO <sub>4</sub> / gram dry media)		TOC Removal (%) <sup>6</sup>		THMFP Removal (%)		HAAFP Removal (%)	
			Mean	Std. Dev	Mean	Std. Dev	Mean	Std. Dev	Mean	Std. Dev
1	20" Anth./ 10" Sand <sup>4</sup>	Pre + BW	2.0	0.50	8.0	5.0	1.0	11	9	8
2	20" Anth./ 10" Sand	BW	6.0	0.60	16	9.0	13	6.0	28	7
3	20" Anth./ 10" Sand <sup>5</sup>	No	55	1.7	20	6.0	21	8.0	37	4
5	30" Sand	No	91	1.3	20	9.0	23	7.0	–	–
6	26" GAC <sup>1</sup> / 4" Sand	No	310	9.0	29	8.0	40	5.0	–	–
7	26" GAC <sup>2</sup> / 4" Sand	No	470	9.0	27	8.0	34	5.0	–	–
8	26" GAC <sup>3</sup> / 4" Sand	No	380	11	21	7.0	27	3.0	–	–

<sup>1</sup>Filtrisorb 400

<sup>2</sup>Hydrodarco 4000

<sup>3</sup>Picabiol

<sup>4</sup>Based on 12 months of data.

<sup>5</sup>Based on the last 10 months of data.

<sup>6</sup>Filter influent TOC = 1.1 – 2.2 mg/L.

coagulation, flocculation, and settling). After sedimentation, the water was distributed to eight filters, the design, operation, and performance of which are summarized in Table 7-3.

Of special interest during the study were the impacts of prechlorination and media type on PM removal in inert media filters. The filters used in the comparison were Filters 1, 2, 3, and 5. Filters 1 through 3 contained 20 inches of anthracite over 10 inches of sand, while Filter 5 contained 30 inches of sand. Filter 1 received chlorine in the influent and backwash water, Filter 2 received chlorine only in the backwash water, and Filters 3 and 5 received no chlorine. Over the 1-year study period, all four filters were examined for TOC, THMFP, and HAAFP removals, which are summarized in Table 7-3.

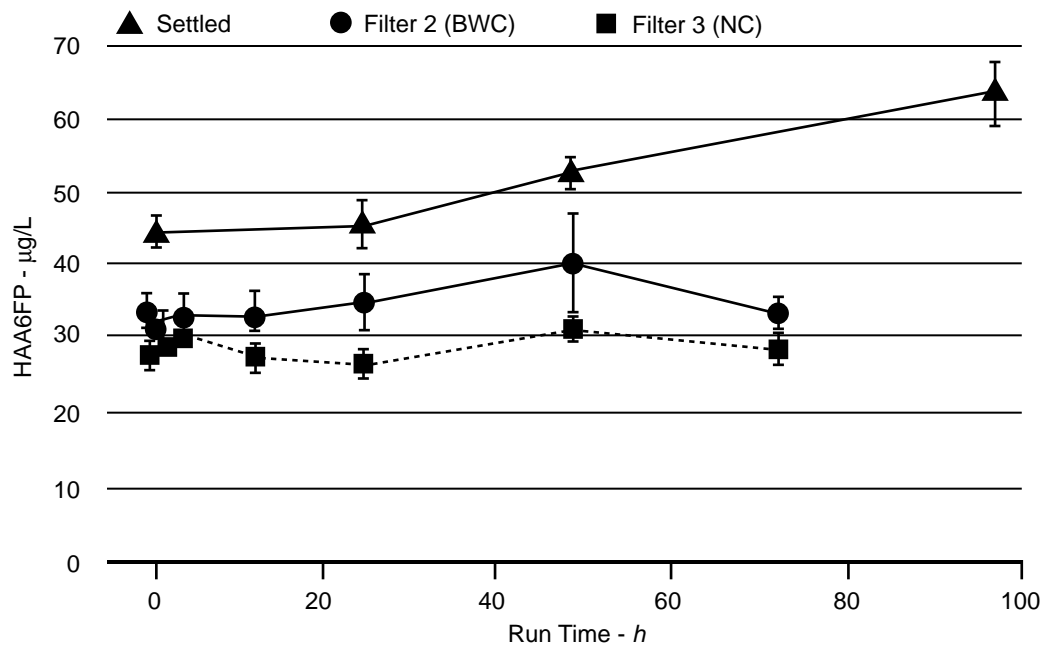
THMFP and HAAFP were determined by chlorinating at 12 to 15 mg/L and incubating the samples for 7 days at 25°C. The non-chlorinated (NC) filters (Filters 3 and 5) removed equivalent or larger fractions of influent TOC, THMFP, and HAAFP than did prechlorinated (PC) Filter 1 and backwash chlorinated (BWC) Filter 2. There were no statistically significant differences (95% confidence level) in PM removals between Filters 3 and 5, implying that the choice of inert filter media did not affect PM removals. PM removals in Filter 1 were not significant, but Filter 2 removed measurable fractions of TOC, THMFP, and HAAFP. In fact, TOC removals in Filter 2 were close to those observed in Filters 3 and 5. The results indicate that PC and BWC combined (Filter 1) will suppress most biological PM control, while BWC chlorination alone (Filter 2) allows most PM removal to proceed.

The application of chlorine in the filter influent or filter backwash can affect biological substrate utilization by altering the nature and concentration of bacterial colonization. As a result, the pilot-scale study investigated the correlations between biomass development and PM removal in the biologically active pilot-scale filters (Wang et al. 1995b). Biomass was defined as the total assemblage of microbial

cells that have colonized the filter media and was quantified using phospholipids (Findlay et al. 1989) as a proxy. Phospholipids are common to all viable bacterial cell membranes, but are broken down quickly in dead cells. Phospholipid concentrations during the pilot-scale study are summarized in Table 7-3. The biomass concentrations are the averages of triplicate samples collected from the tops of filters after 3 months of plant operation. The three GAC filters represented three significantly different types of commercially available activated carbon. None of the GAC filters were chlorinated. After this point in time, biomass levels at the tops of the filters did not change significantly throughout the remainder of the year-long pilot-plant run. The TOC and THMFP removal estimates are averages of samples collected between 155 and 330 days of plant operation. Based on analysis of breakthrough curves, the GAC filters were considered exhausted by this time, and as a result, any observed PM removal would have been due to biological activity.

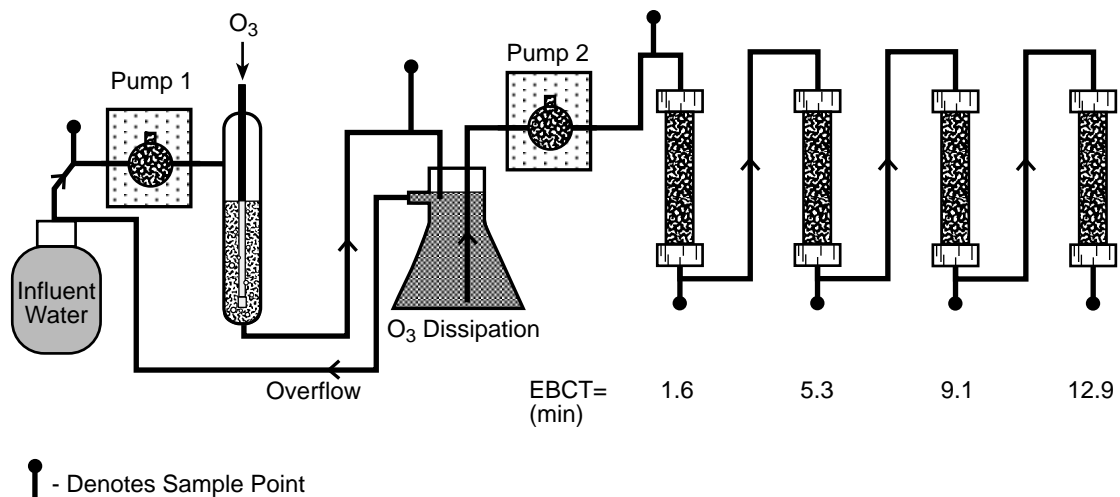
The application of disinfectant in the filter influent or filter backwash water significantly suppressed biomass development relative to NC inert media filters. The PC and BWC dual media filters had biomass levels of 2.0 and 6.0 nmol PO<sub>4</sub>/gram dry media, respectively. In contrast, the NC sand and dual media filters developed 55 to 91 nmol PO<sub>4</sub>/gram dry media. All of the GAC filters accumulated more biomass than did the inert media filters. Biomass levels in the three GAC filters ranged from 310 to 470 nmol PO<sub>4</sub>/gram dry media. Increased biomass development in GAC filters was attributed to its porous structure and to the presence of adsorbed organic material. The large number of pore spaces protected biomass from fluid shear forces exerted during filter operation and backwashing. The adsorbed organic materials potentially provide extra utilizable substrate that is not available to bacteria on inert media. THMFP removals in the PC filter were not significantly different from zero. The THMFP fraction removed in the BWC filter was about an order of magnitude higher than the PC filter, despite similar biomass concentrations. THMFP removals in the NC dual media and sand filters were essentially identical, at 21 to 23 percent. THMFP removals in the three GAC filters were the highest of all the filters, ranging from 27 to 40 percent. With the exception of the PC filter, TOC removals did not appear to be correlated to biomass development. There appeared to be higher correlations between biomass development and THMFP removals, but differences in THMFP removals were not proportionate to differences in biomass concentrations.

In a final portion of the 1-year pilot-scale study, BWC and NC dual media filters were sampled for the control of PM over the course of several filter cycles (Miltner et al. 1995). A filter cycle was the interval between startup following backwash to shutdown prior to the next backwash event. Filters were backwashed at 60 inches of headloss or every 48 hours, whichever came first. Both filters received NC influent and were backwashed for 10 minutes at 50 percent bed expansion. The free chlorine residual in the backwash water for the BWC filter was about 1.0 mg/L. The filter effluents were sampled for TOC, THMFP, and HAAFP immediately prior to backwashing, as well as at selected times (1, 4, 12, 24, 48, and 72 hours) during the next filter cycle. Biomass concentrations in the filter media were also evaluated. Statistically significant declines in biomass levels of approximately 25 percent were observed after backwashing in the BWC filter. The BWC filter biomass concentrations then increased steadily to prebackwash levels by the end of the filter cycle. No significant changes in biomass concentrations were observed in the NC filter with respect to backwashing. Backwashing with NC or BWC water had no detrimental effects on the biological control of TOC, THMFP, or HAAFP at any time during the three filter cycles in which backwash effects were examined. Figure 7-4 illustrates the impact of backwashing on HAAFP control during a filter cycle. The effluent HAAFP concentrations remained constant over the filter cycle, despite the increase in filter influent HAAFP levels. These results imply that HAAFP removal, as a fraction of the influent concentration, actually improved over the course of the filter cycle.

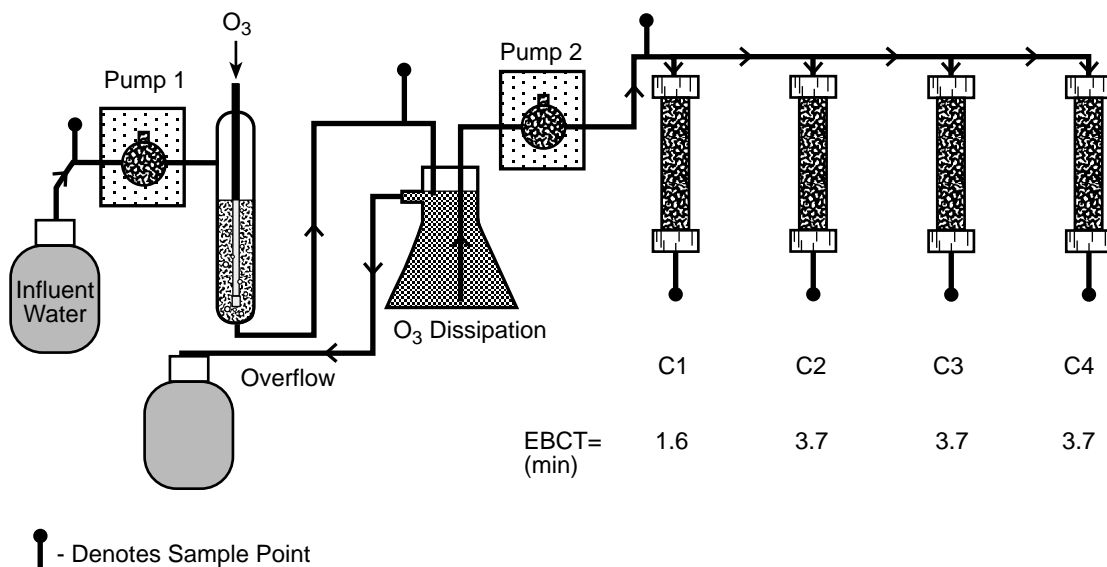


**Figure 7-4. HAA6FP control during a filter cycle, pilot-scale, Cincinnati, OH, 1991–1992.**

At the conclusion of the 1-year pilot-scale study, Filter 5 (30" sand, no PC or BWC) was cored along its full depth to examine the impact of filter depth on biological removal of DOC and THMFP (Swertfeger et al. 1993). The core of biologically acclimated media was divided along its length into four sections, each representing approximately equal increments of contact time. The segmented filters were then run in series, using ORW that had been treated with potassium permanganate addition, followed by conventional treatment and biological filtration. The pretreated water was then ozonated at the bench-scale prior to passage through the segmented filters. The experimental setup is shown in Figure 7-5. The segmented filter was operated for 3 days, and sampling for PM removal was performed on each day. Total DOC removals across the segmented filters averaged 13 percent, with approximately 50 percent



**Figure 7-5. Impact of contact time on biofiltration performance, segmented filter.**



**Figure 7-6. Impact of contact time on biofiltration performance, parallel operation.**

of the removal observed in the first 1.6 minutes of empty bed contact time (EBCT). THMFP removals across the segmented filters also averaged 13 percent. All of the observed THMFP removal occurred by 5.3 minutes of contact time.

After 3 days of sampling, the segmented filters were switched to parallel operation. This arrangement allowed water to directly enter each column segment without contact with previous filter sections. This setup yielded information about the capacity of the biomass in each section to remove compounds at concentrations not previously encountered by that filter section. The new arrangement was operated for 2 days and is detailed in Figure 7-6. DOC removals in segments 1 and 2 were each less than 10 percent. No DOC removals were observed in segments 3 and 4, which comprised the lower half of the original filter. THMFP removals in segments 1 and 2 were each about 12 percent of the influent values. No THMFP removals were observed in columns 3 and 4. The results from the series phase of the study confirmed that the bulk of PM removal tends to occur in the top portion of a biological filter. This implies that the chemical composition of the PM reaching the lower portion of the biological filter may be fundamentally changed and that biomass in the lower level of the filter develops to utilize this remaining fraction. The results from the parallel phase of the study indicated that the biomass in the lower half of the filter might need a certain amount of acclimation time before it can effectively utilize a new type of substrate.

### ***Five-Month Pilot-Scale Study, 1996***

The 1991 to 1992 year-long EPA pilot-scale study did not evaluate the impact of preozonation or disinfectant type in an integrated pilot-scale environment. To fill in some of these gaps, a 5-month long pilot-scale biofiltration study was initiated at EPA in 1996 (Miltner et al. 1996). This pilot plant was supplied with water from a local lake, the raw DOC of 5.8 mg/L of which was significantly higher than that of the ORW used during 1991 to 1992 (1–2 mg/L). Filter design and performance are summarized in Table 7-4. All plant influent water received conventional pretreatment, consisting of alum coagulation, followed by flocculation and sedimentation. Following sedimentation, some of the water was ozonated prior to filtration (Filters 1–5), while the remainder went directly to filtration (Filters 7 and 8). The average transferred ozone dose was 5.6 mg/L. None of the filters were PC. Filters 1 and 8 were

**Table 7-4. Pilot-Scale Biological Filters,<sup>a</sup> Cincinnati, OH, 1996**

Filter	Preozonated	Backwash Disinfectant	Filter Media	Biomass (nmol lipid PO <sub>4</sub> /g dry media)	Percentage Removals		
					DOC <sup>c</sup>	THMFP	HAAFP
1	Yes	Chlorine	20" Anthracite/10" Sand	28	12	8	26
2	Yes	Chloramine	20" Anthracite/10" Sand	120	19	17	33
3	Yes	None	20" Anthracite/10" Sand	130	23	23	39
4	Yes	None	20" GAC <sup>b</sup> /10" Sand	288	42	53	62
5	Yes	None	30" Sand	96	23	21	39
7	No	None	20" Anthracite/10" Sand	66	8	20	27
8	No	Chlorine	20" Anthracite/10" Sand	16	0	24	23

<sup>a</sup>Loading rate for all filters = 2 gal/min per ft<sup>2</sup> (5 m/hr).

<sup>b</sup>Filtrisorb 400

<sup>c</sup>Average filter influent DOC = 2.8 mg/L.

backwashed with chlorinated water (1.6 mg/L), Filter 2 was backwashed with chloraminated water (2.1 mg/L), and the remaining filters received no disinfectant in the backwash. Once the plant reached steady-state operation, biomass development, and removals of DOC, THMFP, and HAAFP across the filters were measured.

Formation potentials were measured under uniform formation conditions (UFC). These consisted of chlorinating to yield 1 mg/L free chlorine residual after 24 hours of holding time at pH 8. Preozonation impacted biomass development and DBPFP removal. Preozonated filters typically developed higher biomass levels and removed larger fractions of DOC. However, the impact on THMFP and HAAFP removals were mixed. The preozonated NC inert media filters (Filters 3 and 5) developed higher levels of biomass and removed more PM, as measured by DOC and HAAFP, than their non-ozonated counterpart Filter 7. However, all three filters removed roughly equivalent amounts of THMFP. The preozonated, chlorinated inert media Filter 1 developed more biomass and removed more DOC than did the non-ozonated, chlorinated, inert media filter (Filter 8). However, both filters removed equivalent fractions of HAAFP, and Filter 8 removed a larger fraction of THMFP. The presence or absence of BWC impacted biomass development, DOC, THMFP, and HAAFP removals in preozonated filters. NC, preozonated Filters 3 and 5 developed more biomass and removed more DOC, THMFP, and HAAFP than did BWC, preozonated Filter 1. BWC had less of an impact on non-ozonated filters. Non-ozonated, NC Filter 7 developed more biomass and removed more DOC than did non-ozonated, chlorinated Filter 8. However, both filters removed equivalent amounts of THMFP and HAAFP.

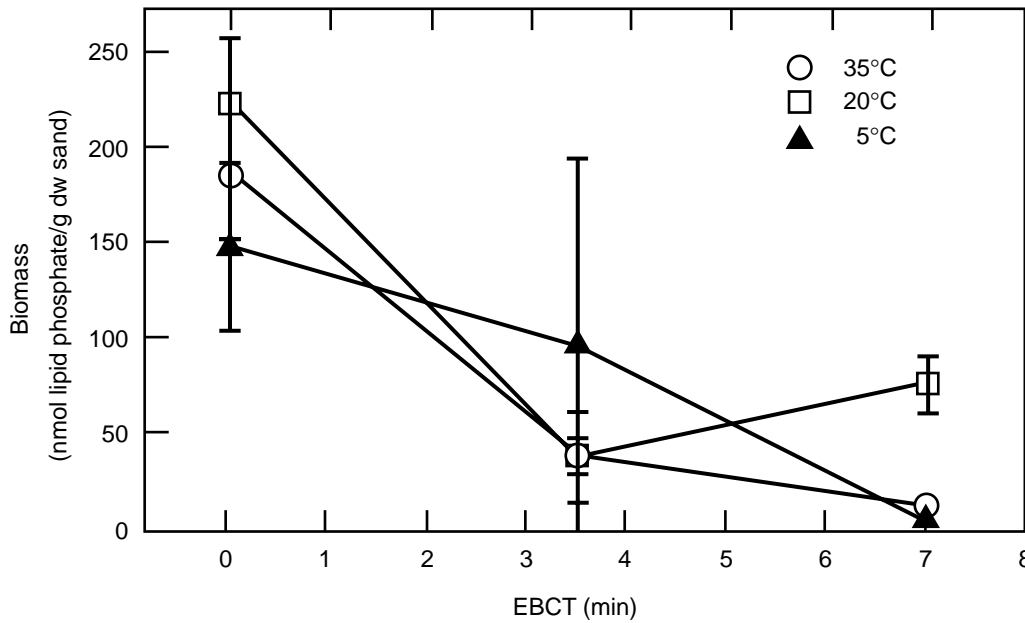
The type of backwash disinfectant had an impact on biofiltration performance. Preozonated, chloraminated Filter 2 developed more biomass and removed more DOC, THMFP, and HAAFP than did preozonated, chlorinated Filter 1. Filter 2 developed as much biomass and removed as much DOC and HAAFP as preozonated, NC Filter 3. As in the 1991–1992 pilot-scale study, the use of anthracite/sand versus sand only as a filter material had no impact on biological filtration performance. Preozonated, NC Filters 3 and 5 developed equivalent amounts of biomass and removed almost identical fractions of DOC, THMFP, and HAAFP. However, the use of exhausted GAC significantly improved biological filtration performance. Preozonated, NC Filter 4 (GAC) developed more biomass and removed roughly twice as much DOC, THMFP, and HAAFP than did Filters 3 and 5. All of the preozonated filters in the current study removed larger DOC fractions than did equivalent filters during the 1991 to 1992 study. This was most likely due to the higher filter influent DOCs.

**Table 7-5. Precursor Control as a Function of Temperature, Cincinnati, OH, 1999**

Parameter	Percent Removal (mean, std. deviation)					
	5°C		20°C		35°C	
DOC	15	3	24	3	24	2
UFC HAA	14	3	31	3	34	2

**Impact of Temperature**

Three biological filters were acclimated at 5, 20, and 35°C during a 73-day study in order to investigate biomass development and PM control as a function of temperature (Moll et al. 1999). For the first 44 days of the study, the filters were acclimated with ozonated ORW. During days 45 through 73, the filters were acclimated with an ozonated, isolated solution of NOM. The NOM was isolated by nanofiltration from a Florida ground water low in particulates and high in DOC. Prior to ozonation, the isolated NOM solution was diluted to a DOC concentration of 4.2 mg/L with dechlorinated tap water. The temperature in the 5 and 35°C filters was regulated using water-jacketed columns. The cooling or heating fluid was recirculated from the columns through constant temperature water baths. The temperature in the 20°C filter was maintained by the ambient internal building temperature. The tops of the filter media were sampled for biomass development on a regular basis. The filters were defined to have reached a biological steady-state when consecutive biomass samples did not vary by more than 20 percent. During the last 2 weeks of the study, the filters were sampled intensively for DOC and HAAFP control. Formation potentials were measured under uniform formation conditions. At the conclusion of the study, the filters were sacrificed and sampled for biomass development with respect to depth. Biomass profiles are summarized in Figure 7-7, and PM control is summarized in Table 7-5. All filters were operated at 3.6 m/hr loading rates. Top of filter biomass development was more extensive in the



**Figure 7-7. Biomass development as a function of filter temperature. Cincinnati, OH, 1999.**



20 and 35°C filters than in the 5°C unit. However, middle of filter biomass levels were higher at 5°C than at the two higher temperatures. DOC removal at 5°C was lower than at the two higher temperatures. There were no significant differences in DOC removals between 20 and 35°C. HAAFP removals at 5°C were about half the level reported for 20 and 35°C. HAAFP removals did not vary significantly between 20 and 35°C.

### Full-Scale Evaluation of Temperature Effects

A study was performed to assess the impact of temperature on biomass growth and PM control in eight full-scale drinking water filters (Fonseca et al. 1999). Filters in these plants were sampled in the summer and winter to capture the extremes in water temperature. All of the filters in these plants received preozonated influent. Filters in three of the plants contained exhausted GAC. Details on filter construction and performance are provided in Tables 7-6 and 7-7, respectively. The average winter and summer temperatures were 6.1 and 24°C, respectively. Top of filter biomass levels remained the same or decreased in all of the filters from winter to summer. On average, DOC removals decreased, while UFC

**Table 7-6. Filter Construction, Full-Scale Temperature Study, 1999**

Plant	GAC (in.)	Anthracite (in.)	Sand (in.)	Garnet (in.)	Chlorinated Backwash	Filter Loading Rate (m/hr)	
						Winter	Summer
Celina, OH	–	–	18	–	Yes	4.6	3.9
Berea, OH	–	–	24	–	Yes	3.9	–
Lake Bluff, IL	48	–	12	–	Yes	4.6	7.3
Somerset, NJ	43	–	9	4.5	Yes	3.7	4.9
Millwood, NY	–	24	12	–	No	2.9	4.4
Andover, MA	43	–	6	–	Yes	5.4	4.6
Santa Clarita, CA	–	72	–	–	No	9.8	15
Sylmar, CA	–	72	–	–	No	11	24

**Table 7-7. Full-Scale Filter Performance and Biomass Development as a Function of Temperature, 1999**

Plant	Winter					Summer				
	Temp (C)	Biomass (nmol PO <sub>4</sub> )	Percent Removal			Temp (C)	Biomass (nmol PO <sub>4</sub> )	Percent Removal		
			DOC	THMFP	HAAFP			DOC	THMFP	HAAFP
Celina	3	115	4	9	14	28	70	12	–	17
Berea	3	7	3	10	9	–	–	–	–	–
Lake Bluff	2	127	48	8	30	21	78	30	32	39
Somerset	7	127	20	28	47	28	71	11	37	55
Millwood	5	31	16	–	3	22	31	2	26	23
Andover	7	106	25	49	81	26	47	28	40	67
S. Clarita	13	47	15	8	41	17	40	10	5	19
Sylmar	9	50	22	24	46	24	38	16	12	41

THMFP and HAAFP removals did not increase significantly from winter to summer. The authors attributed these phenomena to increases in filter loading rates. On average, filter loading rates were 61 percent higher in the summer than in the winter. The corresponding decreases in EBCT may have mitigated the impacts of temperature increases on the rates of biological activity. As in the bench-scale temperature study, however, the data indicated that significant biological utilization of PM occurs even during the winter time.

### ***Modeling Biological PM Control***

A method was developed to predict DOC removal with respect to EBCT in biological filters (Wang and Summers 1995, 1996). The model was based on a steady-state mass balance around a plug-flow reactor (PFR):

$$v_o \frac{\partial C_i}{\partial z} - \varepsilon E_L \frac{\partial C_i}{\partial z^2} + \frac{3}{r} (1 - \varepsilon) k_L (C_i - C_{ir}) = 0 \quad (7-1)$$

The symbol  $z$  is depth within the filter (m),  $v_o$  is the filter loading rate (m/hr),  $C_i$  is the bulk DOC concentration (mg/L),  $C_{ir}$  is the DOC concentration at the surface of the filter media (mg/L) where the biomass is attached,  $r$  is the radius of the filter media (m),  $\varepsilon$  is the filter porosity (dimensionless),  $E_L$  is the substrate diffusivity in the bulk solution (m<sup>2</sup>/s), and  $k_L$  is the overall mass transfer coefficient (m/s) that describes movement of the DOC from the bulk solution to the biomass colonies on the filter media surface. The first term in the above equation describes convection of DOC in the bulk solution. The second term describes diffusion of the DOC in the bulk solution. The third term describes transfer of DOC from the bulk solution to the biomass.

The hydrodynamic conditions in the filter were such that bulk diffusion could be neglected. As a result, the second term in the equation was dropped. DOC was divided into biodegradable (BDOC) and nonbiodegradable (NBDOC) fractions. The BDOC fraction, in turn, was divided into fast (FBDOC) and slowly (SBDOC) biodegradable fractions. The BDOC fraction was defined as the fraction of BDOC that could be biologically utilized in 5 days of contact with acclimated media. The FBDOC fraction was defined as that fraction of substrate that could be utilized in three minutes of EBCT with acclimated media. The SBDOC fraction was the difference between BDOC and FBDOC fractions. FBDOC and SBDOC utilization rates were described mathematically using Monod and first-order kinetics:

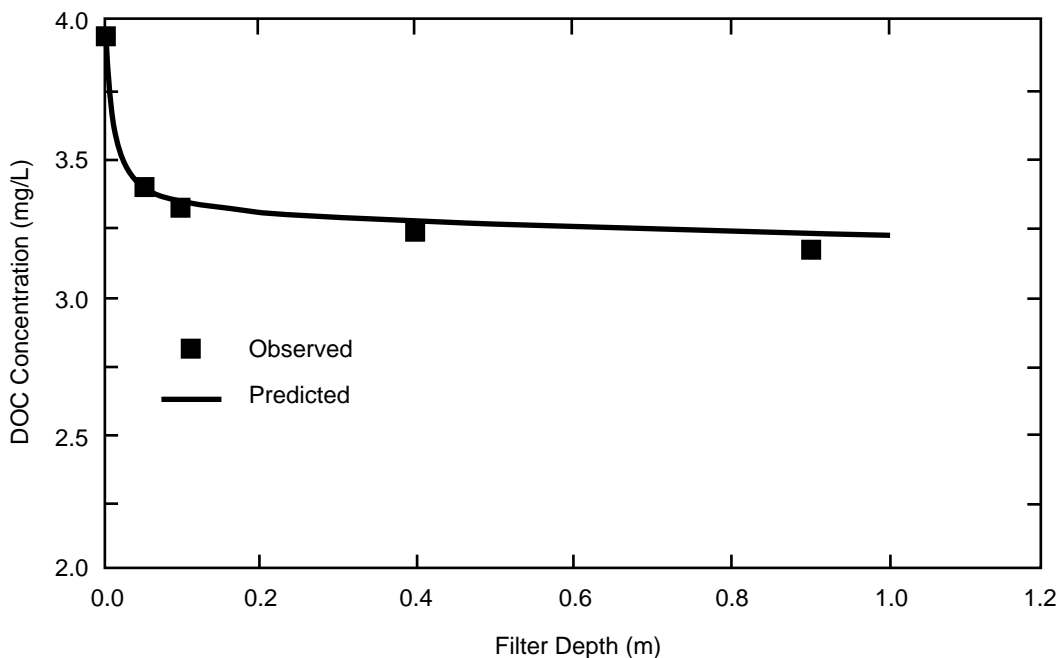
$$\frac{dC_1}{dt} = \frac{V_{max} X C_1}{K_{s1} + C_1} \quad (7-2)$$

$$\frac{dC_2}{dt} = K_2 X C_2 \quad (7-3)$$

$V_{max}$  (mg/mg cells·s) and  $K_{s1}$  (mg/L) are Monod kinetic coefficients, and  $K_2$  (L/mg cells·s) is the first-order kinetic coefficient.  $X$  is the concentration of biomass on the surface of the filter media (mg cells/L). The variation of biomass with respect to filter depth was expressed mathematically as:

$$X = A(1 + B e^{Fz}) \quad (7-4)$$

A, B, and F are regression coefficients, based on fitting the equation to an observed biomass profile. The two kinetic equations and the biomass profile equation were then combined with the mass balance



**Figure 7-8. Observed and predicted DOC utilization, 5 m/hr (2.0 gal/min·ft<sup>2</sup>) loading rate.**

to yield a first-order, linear, homogenous differential equation that could be solved numerically to predict bulk DOC concentration at any depth in the filter. The DOC utilization kinetic coefficients were assumed to be constant with respect to filter depth, and they were determined using a method originally developed by Rittman and McCarty (1980a, b). Acclimated filter media were placed in small biological filters and exposed to influent water with varying concentrations of DOC. Utilization rates of DOC were observed by measuring DOC removals at varying influent DOC concentrations. The observed utilization rates in turn were used to estimate the kinetic parameters  $V_{max}$ ,  $K_{s1}$ , and  $K_2$ . The model was used to predict DOC utilization with respect to filter depth in sand-only biological filters that had been acclimated using a solution of ozonated ground water humic substances. A segmented filter arrangement was used, which permitted the measurement of biomass and DOC concentrations at various filter depths.

The observed DOC concentrations and modeling results are shown in Figure 7-8. The individual points are the observed concentrations, and the solid line is the model prediction. The model was able to closely predict the biological utilization of DOC with respect to depth in the filter.

The applicability of the model would be enhanced if it could accurately predict substrate utilization at the pilot-scale and in the presence or absence of ozonation and backwash disinfection. In order to address these issues, the model was evaluated during the 5-month pilot-scale study (Dugan and Summers 1997). Kinetic parameters were estimated for media acclimated with ozonated and non-ozonated water. All of the filters listed in Table 7-4 were sacrificed at the end of the study in order to determine the biomass development with respect to filter depth. The model predictions and deviations from observed values are summarized in Table 7-8. The model predictions of effluent DOC were compared with the observed average effluent DOCs during the last 4 weeks of the pilot plant study, when DOC removals and biomass levels were at an approximate steady state. With one exception, model predictions fell within ten percent of observed effluent DOCs.

**Table 7-8. Summary of Model Predictions, Pilot-Scale, Cincinnati, OH, 1996**

Filter	Observed Effluent DOC (mg/L)	95% Confidence Interval (mg/L)	Predicted Effluent DOC (mg/L)	Absolute Deviation (mg/L)	Relative Deviation (%)
1	2.3	0.7	2.1	-0.2	-8.7
2	2.1	0.4	1.9	-0.2	-9.5
3	2.0	0.7	1.8	-0.2	-10
5	2.1	0.7	1.8	-0.3	-14
7	2.5	0.9	2.7	+0.1	+6.0
8	2.7	0.7	2.7	0.0	0.0

## Discussion

The data collected so far indicate that biologically active filters remove significant amounts of PM and that preozonated biofilters remove more PM than do non-ozonated filters. The resulting reductions in THMFP and HAAFP could help many drinking water utilities meet the 80 (THM) and 60 (HAA)  $\mu\text{g/L}$  limits mandated under the Stage 2 Disinfection/Disinfection By-Products Rule. The data also raise questions that indicate potential directions for future research. One area is the relationship between biomass levels and PM removals. In general, PM removals increased with increasing biomass levels. However, the relationship was not proportional. Biomass concentrations in PC or BWC filters were often close to an order of magnitude lower than for NC filters. However, PM removals in the PC and BWC filters, for some categories, decreased by less than that amount. Were the bacteria in disinfected filters able to consume more substrate due to decreased competition, or did surviving disinfectant exposure confer some intrinsic metabolic advantage?

Another direction for research would be the performance of biofilters under transient conditions. Only one paper (Miltner et al. 1995) investigated PM control over the course of a single filter cycle. It would be worthwhile to examine biofiltration performance after extended periods of shutdown, rapid changes in loading rate, rapid changes in influent temperature or pH, and as a function of different filter backwashing methods.

## References

- Dugan, N. R. and Summers, R. S. (1997). "A biomass based model to predict substrate utilization in field-scale drinking water biofilters." *Proceedings, American Water Works Association Annual Conference*, Atlanta, GA, June.
- Findlay, R. H., King, G. M., and Watling, L. (1989). "Efficacy of phospholipid analysis in determining microbial biomass in sediments." *Applied and Environmental Microbiology*, 55(11), 2888–2893.
- Fonseca, A. C. et al. (1999). "Impact of temperature on biofilter performance and microbial community structure." *Proceedings, American Water Works Association Annual Conference*, Chicago, IL, June.
- Glaze, W. H. et al. (1982). "Pilot-scale evaluation of biological activated carbon for the removal of THM precursors." *EPA-600/S2-82-046*, Environmental Protection Agency.
- Miltner, R. J. and Summers, R. S. (1992a). "A pilot-scale study of biological treatment." *Proceedings, American Water Works Association Annual Conference*, Vancouver, British Columbia, Canada, June.
- Miltner, R. J., Shukairy, H. M., and Summers, R. S. (1992b). "Disinfection by-product formation and control by ozonation and biotreatment." *Journal of the American Water Works Association*, 84(11), 53–62.

- Miltner, R. J. (1993). "Transformations of NOM during water treatment: Oxidation, formation of disinfection by-products, biodegradation." *Proceedings, American Water Works Association Research Foundation NOM Workshop*, Chamonix, France.
- Miltner, R. J., Summers, R. S., and Wang, J. Z. (1995). "Biofiltration performance: Part 2, effects of backwashing." *Journal of the American Water Works Association*, 87(12), 64–70.
- Miltner, R. J. et al. (1996). "A comparative evaluation of biological filters." *Proceedings, American Water Works Association Water Quality Technology Conference*, Boston, MA, November.
- Moll, D. M., Wang, J. Z., and Summers, R. S. (1995). "NOM removal by distinct microbial populations in biofiltration processes." *Proceedings, American Water Works Association Annual Conference*, Anaheim, CA, June.
- Moll, D. M. and Summers, R. S. (1996). "Performance, biomass and community structure profiles of biological rapid media filters." *Advances in slow sand and alternative biological filtration*. John Wiley and Sons, Chichester, England.
- Moll, D. M. et al. (1999). "Impact of temperature on drinking water biofilm performance and microbial community structure." *Environmental and Science Technology*, 33, 2377–2382.
- Rittman, B. E. and McCarty, P. L. (1980a). "Model of steady-state biofilm kinetics." *Biotechnology and Bioengineering*, 22, 2343–2357.
- Rittman, B. E. and McCarty, P. L. (1980b). "Evaluation of steady-state biofilm kinetics." *Biotechnology and Bioengineering*, 22, 2359–2373.
- Shukairy, H. M., Miltner, R. J., and Summers, R. S. (1992a). "Control of disinfection by-products and biodegradable organic matter through biological treatment." *Revue Des Sciences De L'Eau*, February, 1992, 1–15.
- Shukairy, H. M. and Summers, R. S. (1992). "The impact of preozonation and biodegradation on disinfection by-product formation." *Water Research*, 26(9), 1217–1227.
- Shukairy, H. M., Summers, R. S., and Miltner, R. J. (1992b). "The impact of ozonation and biological treatment on disinfection by-products." *Proceedings, 4th Drinking Water Workshop*, Government of Quebec, Montreal, Canada, November.
- Shukairy, H. M., Summers, R. S., and Miltner, R. J. (1992c). "Control and speciation of disinfection by-products by biological treatment." *Proceedings, American Water Works Association Annual Conference*, Vancouver, British Columbia, Canada, June.
- Swertfeger, J. et al. (1993). "The control of ozonation by-products by biological filtration." *Proceedings, American Water Works Association Annual Conference*, San Antonio, TX, June.
- Wang, J. Z. and Summers, R. S. (1995). "Biomass growth and distribution in drinking water biofilters and its impact on NOM removal." *Proceedings, American Water Works Association Annual Conference*, Anaheim, CA, June.
- Wang, J. Z., Summers, R. S., and Miltner, R. J. (1995). "Biofiltration performance: Part 1, relationship to biomass." *Journal of the American Water Works Association*, 87(12), 55–63.
- Wang, J. Z. and Summers, R. S. (1996). "Biodegradation behavior of ozonated NOM in sand filters." *Revue Des Sciences de L'Eau*.



## CHAPTER 8

### Microbiological Removal by Filtration Processes<sup>1</sup>

#### Introduction

Filtration was originally used to remove contaminants that affect the appearance, odor, and taste of drinking water (i.e., to improve drinking water aesthetics). Records show that James Simpson designed and constructed a slow sand filter used by the Chelsea Water Works Company in London in the 1820s. This filtration system was used on the polluted and turbid water of the River Thames. Aesthetic considerations were the primary reason for construction of this filtration facility. It was not until 50 years later that Robert Koch demonstrated that bacteria in drinking water were causative agents of disease. Koch, a health official, examined intestinal disease morbidity and mortality in relation to use/non-use of filtration in Germany. In Altoona, Germany, unfiltered water was delivered to residents; the rates of intestinal illnesses increased dramatically. As the causes of typhoid fever, cholera, and other diseases were better understood through improved microbiology techniques, major emphasis was placed on the operation of filtration plants to remove bacteria as well as to provide water that was pleasant to the senses (Logsdon and Lippy 1982).

Water treatment technology continued to improve with the addition of disinfection, coagulation, and sedimentation to the treatment process and with further refinement of the filtration process. Public health agencies and water utilities also recognized that water treatment should be accompanied by other measures that will protect the quality of water, such as protecting watersheds from contamination, treating upstream wastewater discharges adequately, certifying operators, and adopting source water quality standards. The multiple barrier concept evolved from the incorporation of protective measures into water treatment technology. This concept is based on the idea that, in the event one barrier fails, the remaining barriers will reduce the impact of the failure.

Even with the advances made in water treatment technology, outbreaks of waterborne disease continue to occur. In fact, the occurrence of reported outbreaks is increasing, as are the number of cases of illness associated with those outbreaks. Outbreaks continue to occur because the multiple barrier concept is not properly applied, and in many cases, filtration is not properly provided or applied (Craun 1991). Recent outbreaks demonstrate the importance of these principles and indicate that current technology is not being properly applied to prevent waterborne disease (Fox and Lytle 1996).

Recent large waterborne disease outbreaks have focused much of the nation's attention on large water systems. When 403,000 people in Milwaukee fall ill, it is headline news, nationally (MacKenzie et al. 1994). Although the numbers of people affected by waterborne disease outbreaks in small systems are smaller than those affected by waterborne disease outbreaks in large systems, many individuals are impacted (Centers for Disease Control and Prevention 2000). The sheer numbers of small systems in the U.S. overwhelm the number of larger systems. In the U.S., there are 186,822 public water systems, and 178,911 (greater than 95%) of those systems serve 3,300 individuals or fewer (Office of Water 1995).

The problems of treating and distributing safe water to prevent waterborne disease in small systems may parallel those of larger systems. These problems are often exacerbated in small systems by the lack of the economies of scale that larger systems enjoy. Smaller systems tend to deal with source

---

<sup>1</sup>Kim Fox: ORD/NRMRL/WSWRD, AWBERC Mailstop 689, 26 West Martin Luther King Dr., Cincinnati, OH 45268, 513-569-7820, fox.kim@epa.gov.

water of worse quality (there may be only one water source available), some deal with antiquated water systems, and many or most may not be financially viable. Based on 1994 compliance data, 1204 public water systems were in significant noncompliance with microbiological and turbidity requirements (even excluding monitoring and reporting violations). Of that number, 1145 of the significantly noncompliant systems were classified as small systems (Office of Water 1995).

Noncompliance issues place communities in situations in which unsafe water is distributed to customers. Long-term boil water orders are known to exist in several small communities. One small community in the mid-western U.S. was on a boil water order for over one year and remained subject to that order until new treatment facilities were built. Other small systems are known to issue boil orders whenever it rains; the unfiltered source water turbidity rises (above 5.0 nephelometric turbidity units, or NTUs) to the point at which a boil order is needed to ensure safe drinking water (Fox 1996).

In the years 1993 and 1994, there were 30 outbreaks associated with water intended for drinking. Of the 30 recorded outbreaks, 21 were in small water supply systems (seven were in private homes, and two were in large systems) (Centers for Disease Control and Prevention 1996). The large system outbreaks made the national news, but the outbreaks in the smaller systems were just as important to those individuals living in the smaller communities. The small system outbreaks consisted of both inorganic contamination (e.g., lead, nitrate, and fluoride) and microbial contamination (e.g., *Cryptosporidium parvum*, *Giardia lamblia*, *Shigella sonnei*, etc.) The small system outbreaks were relatively evenly spread across the U.S. (Centers for Disease Control and Prevention 1996).

The U.S. Environmental Protection Agency (EPA) Water Supply and Water Resources Division (WSWRD) staff have been on-site during several waterborne disease investigations and have investigated outbreaks in small systems that have occurred in untreated ground waters and fully treated surface waters. At one outbreak, the untreated distribution water became contaminated with surface runoff when pipe breaks were being repaired, and in another, a storage tank was contaminated with bird feces. In both of these cases, a number of individuals became ill and several people died. At one small system's treatment plant, improper coagulant dosages caused poor particulate removal and allowed pathogens to pass through the plant, causing illness (Swerdlow et al. 1992) (Clark et al. 1996). No one criterion has been responsible for all waterborne disease outbreaks.

Reacting to changes in source water quality can be difficult in the context of the relatively short operating times characteristic of many small water systems. In one small system in West Virginia, during one rainfall event, for example, the source water turbidity increased from a background of around 20 NTUs to more than 2000 NTUs in a matter of 4 hours. The rapid increase in turbidity required constant changing of coagulant dosages. In this case, the plant's effluent turbidity exceeded 50 NTUs, and the customers were asked to boil the water (or not consume it) until the system was cleaned. The water's residence time in the treatment plant was less than 2 hours, and the operator could not keep up with the changing source water conditions. This is an extreme example, but less extreme situations occur often.

In several of the small system outbreaks, flyers notifying consumers to boil their water were hand delivered to each door (Swerdlow et al. 1992; Clark et al. 1996). In these cases, the small area of concern allowed for quick notification.

What can be done to prevent waterborne disease outbreaks in small systems? Small systems (like their large system counterparts) must aggressively treat their drinking water. This aggressive treatment may mean maintaining proper disinfection (both concentration and contact time), or it may mean controlling coagulant dosages and filtration rates at all times. The integrity of the distribution systems and storage tanks must also be maintained to ensure that properly treated water remains safe prior to delivery to the consumer. One of the ways to help encourage the need for aggressive treatment is to ensure continuing education of the system operators and the local water boards or councils.



The potential for an outbreak exists with every water utility, whether that utility is large or small. The likelihood of an outbreak occurring at any one utility depends on the integrity of the water treatment (both the quality and the methodology) and distribution system at the utility and the utility's dedication to providing safe water.

This chapter discusses water treatment technologies that are especially applicable to small systems, such as Slow Sand Filtration (SSF) and Diatomaceous Earth (DE) Filtration. In addition, the application of granular filtration for *Giardia* and *Cryptosporidium* control is discussed. Granular filtration has applications in systems of all sizes.

## Slow Sand Filtration

SSF is a filtration process in which water (typically untreated) is slowly passed through a sand filter. The sand filter is constructed so that the system remains aerobic, has fine sand grains, and stays wet at all times. The water passes through the sand, and a biomass (schmutzdecke) is formed both on top and in the top layers of the sand. This schmutzdecke is composed of clays and biological matter. It helps remove both clays and biological material from the water. Physical attachment, screening, and deposition of matter also occur within the sand filter as the filter run proceeds. SSF effluent is then disinfected prior to sending it to the consumers. As the schmutzdecke builds up, head loss within the filter increases; when it reaches a predetermined point, the system is taken offline and the top layer of sand is removed. Water is once again sent through the sand, and once the filter has re-ripened, the effluent becomes acceptable (Fox et al. 1984).

Slow sand filters are used extensively in Europe and were widely used in the U.S. prior to 1910. In the years following 1910, rapid sand filtration became the system of choice in the U.S. to treat surface waters. In the early 1980s, WSWRD began to reconsider SSF as a viable option for treating surface waters in small communities. The amount of land required for SSF would likely prohibit its use by large communities. The land issue is not usually considered a problem for small communities. Operation of a slow sand filter is not difficult, and construction of a slow sand filter requires few components. Thus, WSWRD decided to re-evaluate SSF and to determine its capabilities for removing microorganisms from drinking water (Fox et al. 1984).

One of the first projects that WSWRD undertook was in-house testing of a slow sand filter (Fox et al. 1984). Two pilot-scale slow sand filters were constructed and operated in-house. Both filters had a surface area of 0.21 m<sup>2</sup> and a depth of media of 0.76 m. The first filter (Filter A) contained sand as its media, while the second filter (Filter B) had a vertical divider and contained sand on one side and granular activated carbon (GAC) on the other. The filters were challenged with various surface waters from the Cincinnati, OH, area.

Filter A was challenged with a surface water that was collected from a lake located in a Milford, OH, gravel pit. The lake's water resulted from water that migrated from a river and through the gravel beds and then into the lake. The result was a low turbidity water. Spikes of turbidity over 1 NTU were the result of sludge retained in the storage systems at the Andrew W. Breidenbach Environmental Research Center (AWBERC) research facilities. Small amounts of raw municipal sewage were added to the source water (5 gal of raw sewage to 5000 gal of source water) to drastically increase the bacterial load coming into the filter. This filter was routinely challenged with water that contained over 1000 colony forming units (CFU)/100 mL of total coliforms and, at times, up to 10,000 CFU/100 mL. After the initial ripening period, Filter A's effluent had an average turbidity of 0.3 NTU. Except for a minor excursion at about 200 days of operation, when the effluent coliform count reached 10 CFU/100 mL, routine samples showed less than 1 CFU/100 mL of total coliforms. In the first 250 days of operation, only 8 effluent water samples (effluent sampling was once a day) exceeded 1 CFU/100 mL for total

coliforms. Filter A was operated continuously for 2 years and consistently produced high quality water, even when it was challenged with extremely poor quality source water (Fox et al. 1984). This slow sand filter was routinely challenged with influent total coliforms levels ranging from 1,000 CFU to 10,000 CFU/100 mL.

Filter B was constructed with both sand and carbon so that SSF could be evaluated for organic removal. Filter B was operated for about 300 days and was monitored for trihalomethane (THM) formation potential (THMFP) and total organic carbon (TOC) removal in addition to turbidity reduction and coliform removal. THMFP reduction averaged 95%, and TOC removal averaged 90% (Fox et al. 1984). Although Filter B achieved good removal of both THMFP and TOC, a full-scale operating slow sand filter with GAC media would not likely be built due to cost constraints.

The promising results for turbidity reduction and bacterial removal by SSF led WSWRD to fund additional projects to further investigate the capabilities of SSF. A project conducted at Syracuse University (Letterman and Cullen 1985) evaluated SSF maintenance. The project evaluated full-scale SSF systems and related filter maintenance to effluent water quality. The cost of maintenance was also evaluated. The project determined that filter ripening is necessary after filter scraping to ensure that the effluent water is acceptable. Ten ripening periods were followed in six different SSF systems. In four of those ripening periods, it took between 0.25 and 10.00 days for the filter effluent turbidity to drop to levels similar to that of a control filter at the same site. During the other six ripening periods, the test filters were producing effluent turbidities that matched control filters within 5 hours. These filters were monitored for turbidity, particle counts, and standard plate count bacteria. The factor that seemed to have the most effect on filtrate quality was the nature of the particulate matter in the raw water.

Filter maintenance time and cost were also evaluated at the six locations. Under typical conditions of filter scraping (removal of 1 inch of dirty sand with shovels and conveyance of this sand from the filter with motorized or hydraulic transport), the labor requirement was approximately 5 man-hours/1000 ft<sup>2</sup> of filter plant area. A resanding operation that applies 6 to 12 inches of clean sand to the depleted bed requires approximately 50 man-hours/1000 ft<sup>2</sup> (Letterman and Cullen 1985).

Another study funded by WSWRD looked at bacteria, *Giardia*, and THM removal using SSF (Pyper 1985). In this study, a full-scale slow sand filter in McIndoe Falls, Vermont, was monitored and challenged. This unit was no longer being used as a public water supply, thus the researchers were able to challenge the systems with *Giardia*. During the summer operation of this filter system, the filter's influent waters were spiked with high levels of bacteria. In addition to bacterial spiking, eight spikes of *Giardia lamblia* were applied to the top of the slow sand filter.

The slow sand filter produced a finished water that contained an average of 7 CFU/100 mL of total coliforms for the first 8 days after scraping. The average effluent coliforms levels then dropped to an average of 2 CFU/100 mL for the duration of the filter runs. The influent total coliforms ranged from 1000 to 10,000 CFU/100 mL, and thus the SSF routinely achieved greater than 3 log removal of total coliforms.

This slow sand filter achieved 99.9% removal of the *Giardia* during the summer months and warm water temperatures. Removals dropped to 99.5% (and even 93.7% on one sample) during cold water testing. The lowest removal was observed when the influent water was at 0.5°C (other cold water studies were conducted at approximately 2.0°C).

In an effort to look at hydraulic loading rates and efficiency of slow sand filters, a project was sponsored with Colorado State University (CSU) (Bellamy et al. 1985). In this study, three slow sand filters were operated at various flow rates (0.04, 0.12, 0.40 m/hr), and various filter effluent parameters were monitored. In addition to the rate studies, other SSF parameters such as depth of media, sand grain size, nutrient addition, and influent water temperature were evaluated on separate pilot slow sand filters.

In the hydraulic rate studies, *Giardia* cyst removals exceeded 99.9% for all three loading rates. It was noted that the removal did depend on the establishment of a biopopulation within the filter bed. When the sand was new/clean, *Giardia* removals were 99.0%, but the additional 0.9% removal occurred once the filter was considered ripe.

In the temperature studies, there was no difference in *Giardia* removal for waters that were 17°C versus waters that were 5°C. However, total coliform removal was affected by the temperature difference. Percent removal declined from 97 to 87% as the temperature was dropped.

Removals of *Giardia* were 99.9% for all sand sizes tested. Removal of total coliform bacteria declined from 99.4% for 0.128 mm sand to 96.0% for 0.615 mm sand. In the media depth studies, total coliform removals declined from 97 to 95% when the media depth (1.1 meters) was lowered to 0.5 m (0.5 m is considered the lowest depth of media that should be used in a slow sand filter). *Giardia* removal was not investigated in the depth of media studies.

The studies conducted both in-house and by EPA-sponsored research have shown that SSF can be very effective for removing both *Giardia* and total coliform bacteria.

## **Diatomaceous Earth Filtration**

DE filters are in the class of precoat filtration systems. In this class, DE is precoat on a screen, and the water to be treated is passed through the DE coat. The coating of the screen takes place by recirculating a DE slurry mixture through the screen until the desired thickness of precoat is achieved. After precoating, raw water is pumped through the DE cake and particulate material is filtered out. A small amount of DE (body feed) is added to the raw water to build up the DE cake continuously as the filtration process continues. Once the cake becomes too thick, the system is shut down, the cake is washed off, and the process is restarted. Under most conditions, no chemicals are used in the DE process (in some cases, the precoat DE is coated with alum to increase particulate attachment) (Logsdon et al. 1981).

The WSWRD DE pilot system was a 0.1 m<sup>2</sup> DE filter (Logsdon et al. 1981). This filter system was challenged with *Giardia* cysts and radioactive beads to simulate *Giardia*. For these studies, *Giardia muris* was used because its availability was better than *Giardia lamblia*. *Giardia muris* cysts are ellipsoidal in shape (5–13 µm), and the radioactive beads were spherical (9 µm diameter). *Giardia lamblia* cysts are 7–15 µm in diameter and are spherical.

During the bead runs, the pilot DE system demonstrated greater than 99.9% bead removal when the DE was precoat at a concentration of 1 kg/m<sup>2</sup> or higher. When the precoat concentration was dropped to 0.5 kg/m<sup>2</sup>, bead removal was reduced to approximately 90%. The addition of body feed to the incoming source water was not critical to bead removal. However, the body feed was critical in the length of run. The addition of body feed is used to maintain adequate open pore structures. Without body feed, the precoat cake clogs rapidly and requires cleaning more often. Body feed addition increases the length of filter runs and thus increases the time between filter cleaning cycles.

Eleven DE filter runs were spiked with *Giardia muris* cysts in the raw water just prior to entering the DE filter chamber. The concentration of cysts used was in the order of 10<sup>7</sup> cysts per dose. The lowest removal of cysts observed was 99.36%. This removal was observed in one run only. The other 10 runs achieved greater than 99.8% removal of the *Giardia muris* cysts.

WSWRD also established a cooperative agreement with CSU to further investigate *Giardia* removal via DE filtration. In this project (Lange et al. 1984), a pilot DE system was challenged with *Giardia lamblia* cysts and other particles. In these challenge studies, hydraulic loading rate, DE grade, and source water temperature were evaluated to determine their effect on DE filtration efficiency.

Hydraulic loading rates investigated for this study were 2.44, 4.88, and 9.76 m/hr, which covers the range of hydraulic rates typically used by drinking water DE filtration systems. For *Giardia* removal, the hydraulic loading rate did not have an impact on removal. *Giardia* removal was observed to be 99.9% (or higher) for all runs. Removal of total coliform bacteria and total particles were affected by the hydraulic loading rates. Better removal was observed at the lower flow rates than at high flow rates (90% versus 60%, respectively).

Water temperature did not have an effect on removal of any of the parameters tested. DE filtration is a physical screening method and does not rely on chemical reactions or attachment for the bulk of the particulate removal. Thus, temperature will not show a major effect on particle removal by DE.

DE grade did have an impact on bacterial removal. Standard plate count bacteria were removed on an average of 80 to 90% with the finer grades of DE. Removals decreased and ranged from 30 to 40% with the coarser grades of DE. For all of the grades tested (water treatment grades only), there was no impact on *Giardia* cyst removal. Even the coarsest water treatment grade DE removed greater than 99.8% of the *Giardia lamblia* cysts.

## Granular Media Filtration

Granular media filtration in drinking water is typically referred to as conventional filtration (chemical addition, rapid mix, slow mix, settling, and then filtration) or direct filtration (chemical addition, rapid mix, possible slow mix, and then filtration). Typically, direct filtration is used to treat surface waters with normal turbidities less than 10 NTUs (USEPA 1989). WSWRD has conducted both in-house studies and sponsored projects to investigate the ability of both types of filtration to remove various pathogens.

In the early 1980s, WSWRD conducted an in-house study to assess *Giardia* cyst removal via granular media filtration (Logsdon et al. 1981). In this study, a pilot direct filtration system was set up. This pilot system consisted of inline mixers to mix the chemicals, followed by a 3 chamber flocculation basin and then a filter column. The filter column (3.8 cm diameter) held 46 cm of 1.27 mm effective size (e.s.) anthracite on top of 15 cm of 0.36 mm (e.s.) sand. Water was pumped through the system at 0.2 L/min.

One of the first tests performed on the system was to look at *Giardia* removal through the system without any coagulant being added. In this case, the feed water contained 68,000 cysts/L. Effluent samples from this run were collected and analyzed for *Giardia*. The effluent cyst counts ranged from 4,100 cysts to 28,000 cysts/L, resulting in removal ranging from 59 to 94%. Most direct filtration facilities for drinking water treat low turbidity source waters. This means that many of the facilities would use low levels of coagulants to treat their water. Alum was used for the WSWRD test runs, and dosages were approximately 1.4 to 3.0 mg/L. The alum dosages were adjusted to produce a filter effluent turbidity near 1.0 NTU (alum dose was not set to achieve the lowest effluent turbidity possible). In these runs, filtered water with higher turbidity was associated with higher cyst concentrations (lower cyst removal). Refer to Table 8-1. *Giardia* removal in these studies ranged from 23 to 93%.

Filtration rate changes were also investigated with this system. The flow through the system was intentionally increased by 50, 100, and 150% to see the impact on *Giardia* removal and retention within the filter (initial filtration rate was 2.0 gallons per square foot per minute). In a run at 20°C in which the floc was formed using a combination of alum and nonionic polymer, the flow rate changes had no effect on removal. In runs where alum was the sole coagulant or when the temperature was dropped to 10°C, decreased cyst removal was observed. In one run, the turbidity increased by 400% and the effluent cyst concentration increased by 2500%. It was concluded that rate changes should be controlled to minimize impacts on filtered water quality (Logsdon et al. 1985).

**Table 8-1. Low Alum Doses with Granular Media Filtration**

Run & Length (Hr)	Alum Dose mg/L	Filtered Turbidity (NTU)	<i>G. muris</i> Cysts/L Influent	<i>G. muris</i> Cysts/L Effluent
A 0.5–1.5 hr	2.2	0.58–0.51	8500*	1000
A 3.0–4.0 hr	2.1	0.63–0.46		1900
A 4.8–5.7 hr	1.9	0.79–0.77		4000
B 0.9–1.4 hr	1.4	1.0–0.95	5900*	1500
B 2.3–2.7 hr	1.8	0.65–0.60		420

\* Influent cysts concentration done once each run.

A project sponsored with CSU was funded to further evaluate *Giardia* removal using granular media filtration (Al-Ani et al. 1985). This research project used both laboratory-scale and pilot-scale rapid-rate filtration systems. The laboratory-scale pilot plant was a dual train, conventional, rapid-rate filtration plant built to operate under pressure. There were four filter columns: two were single media (sand only), and the other two were dual media (anthracite over sand). The field-scale pilot plant was a 1.3 L/sec (20 gallons per minute or gpm) trailer-mounted package water treatment plant. This unit had one dual media filter. Both treatment units could be operated in three modes of filtration: conventional, direct (rapid mix, flocculation, and filtration), or inline (rapid mix and filtration). Most studies for this project utilized the inline mode of operation because the water used was less than 1 NTU.

Table 8-2 shows some of the results from the laboratory-scale treatment experiments. In these experiments, *Giardia* cysts were spiked into a 1400 L storage tank. Water from the Cache La Poudre River or from the Horsetooth Reservoir (both low turbidity waters) were the source waters used for this study. The spiked water was subsequently pumped through the laboratory-scale system. The effects of chemical pretreatment can be seen in Table 8-2 (this table shows a subset of all of the runs conducted). For the runs in which no coagulant was used, removals of all parameters were normally low, although Run 48 did achieve good *Giardia* removals. High *Giardia* removals were observed in some of the no-coagulant runs, but the majority of these runs showed poor *Giardia* removal. For runs in which chemical pretreatment was used, good removals of all parameters were observed.

**Table 8-2. Laboratory-Scale Inline Filtration Results (Typical)**

Run No.	Filter		Turbidity Reduction (%)	Total Coliform Removed (%)	<i>Giardia</i> Cysts Removed (%)
	Loading Rate (cm/min)	Pretreatment Chemical Dosage (mg/L)			
48	8.26	None 0	-18.2	38.4	99.9
120	32.00	None 0	18.8	-7.5	36.4
69	22.69	alum/573c 15/1.1	73.6	99.9	99.2
52	8.45	alum/572c 2.1/1.2	91.7	99.9	99.7
104	8.26	alum/572c 13.4/0.6	82.4	79.8	98.7
70	22.2	alum/573c 7.6/1.3	88.7	99.5	99.4

573c and 572c are cationic polymers.

Table 8-3 shows a sample of the results from the field-scale pilot system. In all field-scale studies, the water temperature was 1°C or less. Both *Giardia* cysts and coliform bacteria were injected into the source water as it entered into the pilot-scale system. Without a coagulant, coliform bacteria removals were typically 20% or less. *Giardia* removal was a little higher, but never exceeded 30% with no coagulant. The effluent turbidity was higher than the influent for these test runs. When the

**Table 8-3. Field-Scale Inline Filtration Results (Typical)**

Run No.	Pretreatment		Turbidity	Total Coliform	<i>Giardia</i> Cysts
	Chemical	Dosage (mg/L)	Reduction (%)	Removed (%)	Removed (%)
117	none	0	<1	20	30
125	alum	0.4	<1	10	35
138	alum/572c	7.0/2.0	42	98	95

572c is a cationic polymer.

coagulant conditions were optimized (Run 138), removals of all parameters improved. For these runs, turbidity reductions exceeded 42% reducing the 0.7 NTU influent water to less than 0.4 NTU. *Giardia* removals averaged 95%, while total coliform removals were greater than 98%.

This project reaffirmed that proper chemical pretreatment is imperative if rapid rate filtration is to be effective when using low turbidity waters. The range of chemical pretreatment dosages must be correct to achieve high reductions of turbidity, coliforms, and *Giardia*. For these studies, proper chemical pretreatment resulted in greater than 70% reduction of turbidity, 99% removal of total coliform bacteria, and 95% removal of *Giardia* cysts.

A project was sponsored in Utah to examine both *Giardia* and *Cryptosporidium* removal through conventional and direct filtration treatment systems (Nieminski and Ongreth 1995; Nieminski 1997). This project was unique, because in addition to pilot-scale testing, the influent to a full-scale treatment plant was spiked with *Giardia* and *Cryptosporidium*. The effluent from the full-scale plant was wasted during this study. The pilot-scale system was a 0.5 gpm treatment plant; the full-scale plant was a 900 gpm plant. Both systems were operated in both direct and conventional treatment modes.

Table 8-4 shows data from the pilot-scale system. This system was operated at the Jordan Valley Water Treatment Plant.

**Table 8-4. Pilot-Scale Results from the Jordan Valley Pilot Plant**

Run/Mode	<i>Giardia</i> Removal (%)	<i>Cryptosporidium</i> Removal (%)
2-c (conv)	99.16	98.66
6-c (conv)	99.95	99.88
9-c (conv)	99.91	99.69
3-d (direct)	99.78	92.06
7-d (direct)	99.90	99.80
10-d (direct)	99.99	99.84

Data presented represents the average values for each run.

Table 8-5 shows results from the Huntington, UT, full-scale seeding studies. Several factors impacted the results of the full-scale seeding trials, which make the comparison between conventional treatment and direct filtration more dependent on uncontrolled variables. Changes in raw water quality were observed from the time the plant was operated in the conventional mode to the time it was operated in the direct filtration mode. This influenced removal rates more than mode of treatment. The water was treated in the conventional plant during the summer when treatability was more difficult, while direct filtration was used in the fall when the water was easier to treat. The presence of algal blooms in samples collected during the summer runs also created a problem in processing the *Giardia* and *Cryptosporidium* samples.

**Table 8-5. Full-Scale Results from Huntington, UT, Treatment Plant**

Run/Mode	<i>Giardia</i> Removal (%)	<i>Cryptosporidium</i> Removal (%)
1-c (conv)	99.95	99.60
2-c (conv)	**	99.05
4-c (conv)	99.66	**
1-d (direct)	99.97	99.75
2-d (direct)	**	99.82
3-d (direct)	99.97	99.37

\*\*No organisms detected. (Data presented represents the average values for each run.)

This project demonstrated that, in a properly operated treatment plant reducing turbidity to 0.1 to 0.2 NTUs, 99.9% removal of *Giardia* can be expected. *Cryptosporidium* is harder to remove than *Giardia* and, under the same conditions, only 99% removal of the *Cryptosporidium* was observed. Both effectiveness and consistency of the removal of seeded *Giardia* and *Cryptosporidium* cysts depend primarily on the effectiveness and consistency of the turbidity reduction.

As part of in-house laboratory and pilot-plant studies conducted by WSWRD, methods to evaluate treatment plant performance were evaluated. One such promising method was to use endospores to assess treatment (Rice et al. 1994; Rice et al. 1996). Endospores (often referred to as spores) of mesophilic, aerobic, spore-forming bacteria were suggested for use since they are not considered a public health risk and are often found in surface waters at fairly high concentrations. These spores are ellipsoidal to spherical in shape and on the average measure approximately  $0.5 \times 1.0 \times 2.0 \mu\text{m}$ . The spores are noted for their resistance to various environmental conditions and are resistant to disinfection. They are easy to culture and may be present throughout most drinking water treatment trains.

A water sample to be analyzed for spores is pasteurized by heat to 80°C for 10 minutes. This heating inactivates vegetative bacteria, but the endospores survive. The water sample is membrane-filtered (0.24  $\mu\text{m}$  membrane filter), and the membranes are incubated on a nutrient agar. Surviving colonies are counted as endospore colonies.

WSWRD conducted both jar test studies and pilot-scale runs, and removals of endospores were compared to reduction of turbidity and removal of particles. Table 8-6 shows results from several pilot-plant runs, and spore removal tracked particle removal. Table 8-7 shows seasonal log removals from samples collected at an utility.

**Table 8-6. Removals of Aerobic Spores and Particles Across Pilot Plant**

Location	Log Reduction		
	Spores	Particles 3–5 $\mu\text{m}$	Total Particles
Conventional coagulation Settled	0.85	1.11	0.91
Conventional coagulation Chlorinated-filtered	2.12	2.1	1.7
Enhanced coagulation Settled	1.51	1.86	1.39
Enhanced coagulation Chlorinated-filtered	2.42	2.91	2.87

**Table 8-7. Seasonal Cumulative Log Removals Through Unit Process at a Utility**

Season	Unit Process	Log Removals		
		Spores	Particles	
			3–5 $\mu\text{m}$	Total
Winter	Settling	1.19	1.08	1.22
Winter	Sand filtration	2.19	2.12	2.02
Winter	GAC filtration	2.89	2.92	2.96
Spring	Settling	1.39	0.99	1.32
Spring	Sand filtration	2.57	2.00	2.19
Spring	GAC filtration	2.70	2.19	2.30

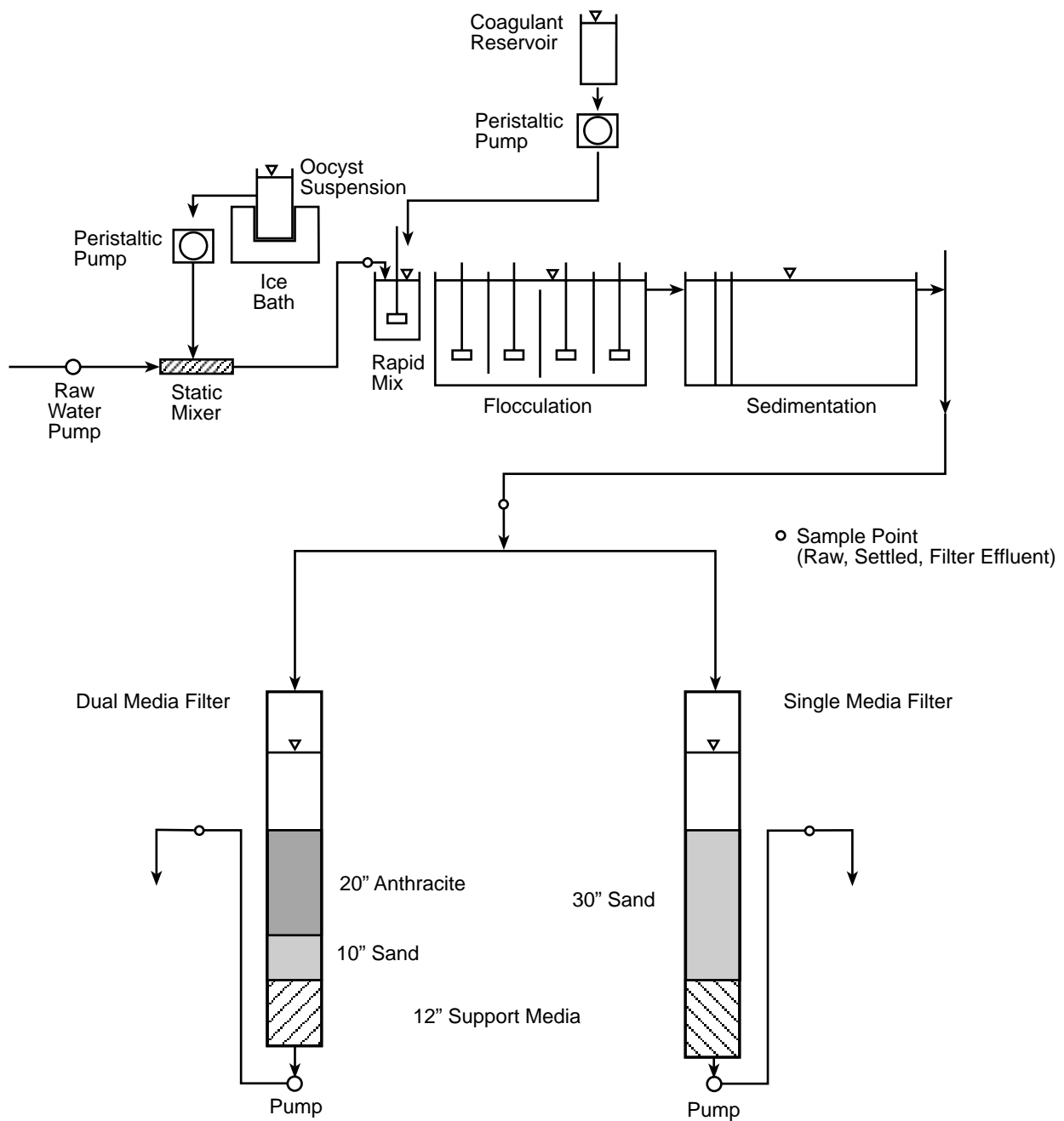
Monitoring for indigenous spores of aerobic spore-forming bacteria represents a viable method for determining water treatment plant performance. Unlike many microbiological parameters, spore concentrations can be detected throughout the treatment process and do not propagate in the water plant. These organisms do not present a public health threat, and because they originate primarily from soil, they would tend to be in surface waters that receive any type of runoff. The analytical technique is straightforward and can be performed by most microbiological laboratories. Thus, these endospores can be used to monitor treatment plant performance.

In an effort to better understand *Cryptosporidium* removal, WSWRD built a small pilot plant (SPP) with theoretical residence time of 10 hours from rapid mix to the weir. This plant was designed to minimize flow rates and permit steady-state feeding of *Cryptosporidium* (Dugan et al. 2000). In each of 14 studies, target concentrations of  $10^6$  *Cryptosporidium* oocysts/L were seeded into the plant influent for 30 to 71 hours. The purpose of these studies was to evaluate the resulting log removals of *Cryptosporidium* oocysts, turbidity, total particle counts (TPCs, 1 to 150  $\mu\text{m}$  diameter), and aerobic endospores (spores). Log removals were evaluated as a function of coagulant type, coagulant dose, raw water quality, filter loading rates, and filter media.

Figure 8-1 is a schematic of the SPP. Two identical SPPs were available for these studies. For this discussion, runs in which both SPPs operated together carry “A” or “B” subscripts to account for parallel operation. The treatment process for each SPP consisted of *Cryptosporidium* addition, inline mixing, coagulant addition at the rapid mix, flocculation, sedimentation, and filtration. Each SPP was designed to run at a flow rate of 450 mL/min. The construction and dimensions of the SPP have been described in detail by Lytle (Lytle and Fox 1998). Raw water from the Ohio River (ORW) was used as source water for all SPP runs. Water quality parameters for the 14 runs are summarized in Table 8-8. The raw water was stored in a 5000 gallon tank, which was equipped with submersible recirculating pumps in order to minimize settling of particulates. The water temperature for all 14 SPP runs was 19 to 21°C (66 to 70°F).

Prior to the initiation of formal pilot testing, *Cryptosporidium* oocysts were fed to the SPP without coagulant addition. The purpose of this run was to examine oocyst removal through attachment to floc tank, sedimentation basin and filter walls, and to filter media. Approximately  $3.5 \times 10^5$  oocysts/L were fed into the raw water for 13 hours. The rapid mix and floc paddles were run at their design speeds, and two parallel dual media filters were run at loading rates of 5 and 10 m/hr. Raw, settled, and filter effluent *Cryptosporidium* samples were collected at 10, 12, and 13 hours. From raw to settled water, the average removal of *Cryptosporidium* was  $0.25 \log_{10}$  ( $\sigma = 0.29$ ). For low and high loading rate filters, *Cryptosporidium* removals were  $-0.04$  and  $-0.05 \log_{10}$ , ( $\sigma = 0.31$  and  $0.38 \log_{10}$ ), respectively. As a result, *Cryptosporidium* attachment to pilot-plant surfaces was not considered a statistically significant fraction of the log removals observed during the 14 pilot-scale runs.





**Figure 8-1. Mini pilot-plant schematic (SSP).**

Runs 1 through 9 used a single pilot plant operating a single dual media filter at a 5 m/hr loading rate. The primary goal of the first 9 runs was to examine the impact of under-coagulation on the downstream removal of *Cryptosporidium*. To achieve this objective, coagulant in Runs 1 through 5 was deliberately underdosed relative to jar test predictions. Runs 6 through 9 were performed with the optimum coagulant concentrations predicted by jar testing. The optimum coagulant dose was defined as the concentration necessary to reach the bottom of the dose versus the settled turbidity curve in a given jar test. In Runs 10 through 14, the focus shifted to examining the impact of filter media, filter loading rates, and coagulant type. In Run 10, a dual media and a single media filter were run in parallel, at 5 m/hr loading rates, to examine the impact of filter media on oocyst removal. In Runs 11 and 12, two pilot plants were run in parallel, with one dual media filter per plant, each operating at 5 m/hr. The goals of

**Table 8-8. Summary of Small Pilot-Plant Runs with *Cryptosporidium***

<b>Run</b>	<b><i>Cryptosporidium</i> Feed Time (hrs)</b>	<b>Raw <i>Cryptosporidium</i> Concentration<sup>a</sup>(× 10<sup>6</sup>/L)</b>	<b>Raw Turbidity (NTU)</b>	<b>Plant A Coagulant and Dose (mg/L)</b>	<b>Plant A Settled Turbidity (NTU)</b>	<b>Plant B Coagulant and Dose (mg/L)</b>	<b>Plant B Settled Turbidity (NTU)</b>
1	36	0.90	63	Alum, 10 <sup>b</sup>	16	–	–
2	36	0.67	23	Alum, 5 <sup>b</sup>	6.8	–	–
3	36	0.53	6.1	Ferric, 4 <sup>b</sup>	3.9	–	–
4	36	0.54	2.3	Alum, 1 <sup>b</sup>	1.9	–	–
5	30	0.41	3.1	Alum, 5 <sup>b</sup>	2.6	–	–
6	36	2.9	88	Alum, 30	3.5	–	–
7	36	0.93	19	Alum, 10	2.4	–	–
8	36	1.2	9.0	Ferric, 15	0.63	–	–
9	33	0.65	28	Ferric, 15	4.2	–	–
10	58	0.85	103	Alum, 50	2.1	–	–
11	55	0.96	14	Alum, 40	1.1	Ferric, 30	1.2
12	56	0.61	0.76	Alum, 15	0.3	Polymer, 14	0.3
13	57	0.71	42	Alum, 40	1.9	–	–
14	71	0.94	23	Alum, 20	2.3	Alum, 60 <sup>c</sup>	1.4

<sup>a</sup>Based on average of raw water samples.

<sup>b</sup>Coagulant deliberately underdosed relative to jar test predictions.

<sup>c</sup>Enhanced coagulation

Runs 11 and 12 were to investigate the relative impacts of alum vs. ferric chloride and alum vs. polymer coagulation, respectively, on the filtration removal of *Cryptosporidium*.

In each run, the coagulant doses for plants A and B were adjusted so that settled turbidities and particle counts, and hence filter influent particle loadings, were as close as possible. As a result, any differences in filtration removal of *Cryptosporidium* would have been due to intrinsic chemical differences between the two coagulants. In Run 13, two dual media filters were run in parallel, at loading rates of 5 and 10 m/hr, to examine the impact of filter loading rates on oocyst removal. The goal of Run 14 was to examine the impact of coagulant dose on the filtration removal of *Cryptosporidium* in high and low loading rate filters. Alum doses for Runs 14A and B were 20 and 60 mg/L, respectively. These represented conventional and enhanced coagulant doses.

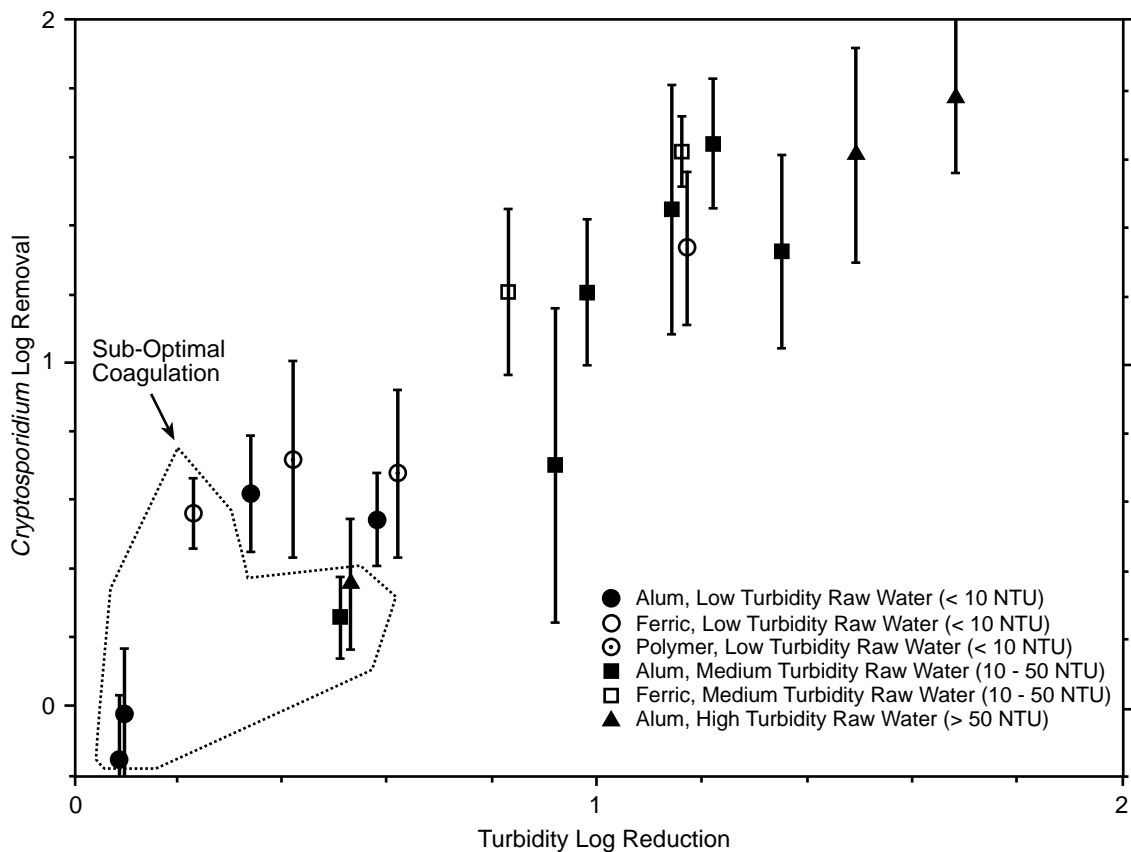
Average sedimentation removals of TPCs, spores, and *Cryptosporidium* and reduction of turbidity for all 14 SPP runs are summarized in Table 8-9. The average turbidity and *Cryptosporidium* removals through sedimentation are plotted against each other in Table 8-9 as a function of raw turbidity and coagulant type. The division of raw turbidities into low (less than 10 NTU), medium (10 to 50 NTU), and high (greater than 50 NTU) ranges was based on an analysis of raw ORW turbidity data collected by the United States Geological Survey (USGS), as part of its National Stream Quality Accounting Network. The data were collected at the USGS sampling station closest to the point where raw water was collected for pilot plant runs, approximately 50 river miles downstream. The 25th and 75th percentiles of the USGS turbidity data fell at approximately 10 and 50 NTU, respectively.

The results from suboptimal coagulation (runs 1 to 5) have been identified in Table 8-9. Sedimentation *Cryptosporidium* removals during these runs averaged  $0.2 \log_{10}$ . Low sedimentation removals of *Cryptosporidium* during sub-optimal runs were observed regardless of raw water turbidity. Sedimentation removals of *Cryptosporidium* averaged  $1.3 \log_{10}$  in all of the remaining runs (6 to 14). In these

**Table 8-9. Sedimentation Performance**

	Run	Turbidity ( $\Delta \log_{10}$ )		TPC ( $\Delta \log_{10}$ )		Spores ( $\Delta \log_{10}$ )		Oocysts ( $\Delta \log_{10}$ )	
		$\bar{x}$	$\sigma$	$\bar{x}$	$\sigma$	$\bar{x}$	$\sigma$	$\bar{x}$	$\sigma$
Suboptimal	1	0.53	0.49	0.71	0.20	0.42	0.14	0.36	0.38
	2	0.51	0.12	0.52	0.061	0.27	0.42	0.26	0.23
	3	0.23	0.13	0.43	0.14	0.22	0.10	0.56	0.20
	4	0.10	0.046	0.15	0.062	0.070	0.37	-0.020	0.38
	5	0.093	0.037	-0.13	1.6	0.10	0.46	-0.16	0.39
	<b>Mean:</b>	<b>0.29</b>		<b>0.34</b>		<b>0.22</b>		<b>0.20</b>	
Optimal	6	1.5	0.53	1.5	0.46	1.4	0.32	1.6	0.62
	7	0.92	0.12	1.1	0.14	1.0	0.44	0.79	0.81
	8	1.2	0.25	1.4	0.093	1.1	0.44	1.3	0.45
	9	0.83	0.022	0.91	0.29	0.76	0.18	1.2	0.48
	10	1.7	0.076	1.8	0.082	1.6	0.16	1.8	0.44
	11A	1.1	0.13	1.2	0.15	1.1	0.37	1.4	0.26
	11B	1.2	0.19	1.2	0.12	1.1	0.52	1.6	0.20
	12A	0.35	0.11	0.53	0.21	0.69	0.32	0.62	0.34
	12B	0.42	0.082	0.62	0.20	0.75	0.34	0.72	0.57
	13	1.4	0.065	1.4	0.090	1.5	0.20	1.3	0.56
14A	0.98	0.084	1.1	0.25	1.3	0.32	1.2	0.43	
14B <sup>a</sup>	1.2	0.11	1.3	0.39	1.5	0.53	1.6	0.37	
	<b>Mean:</b>	<b>1.1</b>		<b>1.2</b>		<b>1.2</b>		<b>1.3</b>	

<sup>a</sup> Enhanced coagulation



**Figure 8-2. Turbidity reduction vs. *Cryptosporidium* removal (raw to settled).**

runs, *Cryptosporidium* removals were positively and linearly correlated with turbidity reduction. The magnitudes of the observed log removals also tended to correlate with raw water quality in runs 6 through 14. The lowest *Cryptosporidium* and turbidity removals were observed in the low turbidity raw waters, and the highest removals were observed in the high turbidity waters. The relationships between TPC, spore, and *Cryptosporidium* removals were similar to the one shown for turbidity and *Cryptosporidium* in Figure 8-2.

Log removals of turbidity, TPCs, spores, and *Cryptosporidium* across filters operating at 5 m/hr loading rates are summarized in Table 8-10. Suboptimal coagulation had a dramatic impact on filtration removals of *Cryptosporidium*. Oocyst removals averaged 1.5 log<sub>10</sub> in the suboptimal runs (1 to 5). In contrast, *Cryptosporidium* removals averaged greater than 3.7 log<sub>10</sub> in all other runs (6 to 14). The relatively poor filtration performances observed in the suboptimal runs were constant with respect to time. The low log removals were not the result of breakthrough behavior. Suboptimal coagulation also had a significant impact on the differences between *Cryptosporidium* and surrogate removals. Average log removals of *Cryptosporidium* and all three surrogate parameters were within 0.5 log<sub>10</sub> of each other for the suboptimal runs. In the remaining runs, average *Cryptosporidium* removals were at least 1.7 log<sub>10</sub> higher than TPC and spore removals, and at least 2.4 log<sub>10</sub> higher than turbidity removals. Relatively poor *Cryptosporidium* removals during suboptimal runs were associated with higher filter effluent turbidities. Filter effluent turbidities during the suboptimal runs averaged 0.31 NTU ( $\sigma = 0.24$ ). During the remaining runs, effluent turbidities averaged 0.08 NTU ( $\sigma = 0.03$ ).

Run 10 examined the impact of filter media on *Cryptosporidium* and surrogate removals at 5 m/hr loading rates. The sand filter had to be backwashed about halfway through the run. However, sand filter

**Table 8-10. Summary of Filtration Performance (5 m/hr)**

	Run	Average	Turbidity		TPC		Spores		Oocysts		Oocyst Nondetects (% of samples)
		Eff.Turbidity (NTU)	$(\Delta\log_{10})$		$(\Delta\log_{10})$		$(\Delta\log_{10})$		$(\Delta\log_{10})$		
			$\bar{x}$	$\sigma$	$\bar{x}$	$\sigma$	$\bar{x}$	$\sigma$	$\bar{x}$	$\sigma$	
Suboptimal Coagulation	1	0.66	1.4	0.17	2.0	0.034	1.2	0.16	1.2	1.1	–
	2	0.13	1.7	0.10	2.3	0.096	1.2	0.39	1.5	0.41	–
	3	0.13	1.4	0.14	1.7	0.50	1.3	0.14	3.6	0.68	–
	4	0.45	0.6	0.10	0.78	0.71	0.61	0.38	0.18	0.19	–
	5	0.18	0.3	0.12	2.0	1.8	0.93	0.55	0.8	0.36	–
	<b>Mean:</b>	<b>0.31</b>	<b>1.1</b>		<b>1.8</b>		<b>1.0</b>		<b>1.5</b>		
Optimal Coagulation	6	0.02	2.3	0.66	2.9	0.63	2.7	1.5	2.9	1.1	–
	7	0.08	1.4	0.39	2.5	0.44	2.0	0.43	4.4	1.1	–
	8	0.14	0.68	0.29	1.4	0.19	0.73	0.44	>3.2	1.9	75
	9	0.15	1.4	0.33	2.1	0.57	1.6	0.15	3.7	0.62	–
	10 (A/S)	0.06	1.6	0.17	2.3	0.25	2.6	0.82	3.5	0.54	–
	10 (sand)	0.06	1.5	0.23	2.1	0.091	1.7	0.25	>3.6	0.48	22
	11A	0.06	1.3	0.18	2.1	0.14	3.4	0.94	>3.6	0.80	38
	11B	0.08	1.1	0.24	2.0	0.19	1.9	0.47	>3.3	0.88	33
	12A	0.09	0.56	0.14	1.4	0.29	1.5	0.53	>4.3	0.39	13
	12B	0.09	0.49	0.20	1.2	0.49	1.3	0.63	>4.4	0.66	13
	13	0.08	1.4	0.50	2.3	0.42	3.0	0.77	>3.6	0.65	33
	14A	0.10	1.4	0.27	2.0	0.87	2.1	0.78	>4.1	0.44	17
	14B	0.08	1.2	0.39	1.6	0.48	1.9	0.43	3.7	1.0	–
	<b>Mean:</b>	<b>0.08</b>	<b>1.3</b>		<b>2.0</b>		<b>2.0</b>		<b>&gt;3.7</b>		

*Cryptosporidium* removals did not appear to decrease over the course of the filter cycle. There were no significant differences in *Cryptosporidium*, turbidity, or TPC log removals with respect to filter media. Spore removals (Table 8-10), however, differed by more than 1 log<sub>10</sub>. It is not known why spore removals in the sand filter were consistently lower relative to the dual media filter.

Runs 11 and 12 evaluated the impact of coagulant type on *Cryptosporidium* control through filtration. Runs 11A and B compared alum and ferric chloride, while runs 12A and B compared alum and polymer. The alum dose in each of the runs was set at the optimum concentration. The alternative coagulant dose in each case was adjusted to yield equivalent settled turbidities. Weir turbidities in runs 11A and B averaged 1.1 NTU ( $\sigma = 0.1$ ) and 1.2 NTU ( $\sigma = 0.2$ ), respectively. Settled TPCs in runs 11A and B averaged  $4.6 \times 10^5/10 \text{ mL}$  ( $\sigma = 0.7 \times 10^5$ ) and  $4.2 \times 10^5/10 \text{ mL}$  ( $\sigma = 0.5 \times 10^5$ ), respectively. Settled turbidities in runs 12A and B both averaged 0.3 NTU ( $\sigma = 0.04$  and  $0.03 \text{ NTU}$ , respectively). Settled TPCs in runs 12A and B averaged  $1.0 \times 10^5/10 \text{ mL}$  ( $\sigma = 0.1 \times 10^5$ ) and  $0.8 \times 10^5/10 \text{ mL}$  ( $\sigma = 0.1 \times 10^5$ ), respectively.

These results indicate that the filters in each run were loaded with water of equivalent particulate concentrations. Consequently, any differences in *Cryptosporidium* removal through filtration should have resulted from intrinsic chemical differences between the two coagulants. However, no significant differences in *Cryptosporidium* control with respect to coagulant type were observed. Filtration removals of *Cryptosporidium* in runs 11A and B averaged greater than 3.6 log<sub>10</sub> ( $\sigma = 0.80$ ) and 3.3 log<sub>10</sub> ( $\sigma = 0.88$ ), respectively. Filtration removals of *Cryptosporidium* in runs 12A and B averaged greater than 4.3 log<sub>10</sub> ( $\sigma = 0.39$ ) and greater than 4.4 log<sub>10</sub> ( $\sigma = 0.66$ ), respectively. With the exception of spores in run 11B, relative surrogate log removals also did not vary with respect to coagulant type.

Run 13 evaluated the impact of filter loading rates on *Cryptosporidium* and surrogate removals. Runs 14A and B investigated the effects of coagulant dose and filter loading rates on *Cryptosporidium* and surrogate removals. Two dual media filters were run in each plant at 5 and 10 m/hr, respectively, in each of these three runs. Removals of *Cryptosporidium* and surrogates were stable at low (5 m/hr) filter loading rates in all three runs. In runs 14A and B, coagulant dose did not significantly affect *Cryptosporidium* removals at low loading rates. Average low-rate filtration removals of *Cryptosporidium* in runs 14A and B were greater than  $4.1 \log_{10}$  ( $\sigma = 0.44$ ) and  $3.7 \log_{10}$  ( $\sigma = 1.0$ ), respectively. Differences in average low-rate surrogate removals as a function of coagulant dose were also not significant (refer to Table 8-10).

## Summary

Over the years, WSWRD has continued to evaluate various treatment techniques for removing microorganisms from drinking water. This evaluation has included not only evaluating under what conditions removals occur, but also under what conditions organism removals deteriorate. The primary filtration processes that were part of WSWRD research include SSF, DE filtration, direct filtration, and conventional filtration.

*Giardia* cysts and *Cryptosporidium* oocysts were the primary organisms investigated during the 1980s and 1990s. The filtration processes were challenged with various water qualities based on particle and pathogen loads. It was shown in these studies that filtration processes are capable of removing high levels of those organisms, but that removal is dependent on the operation of those processes. Poor chemical addition and coagulation reduced the treatment efficiency for removing microorganism and other particles. Temperature was another factor that affected removal. Low water temperature reduced removals in SSF and conventional systems, but had little effect of DE systems. Most of the studies conducted by the WSWRD showed that good turbidity reduction and good particle removal paralleled good organism removal.

One measure of filtration efficiency developed by WSWRD, and now widely used, was that of measuring aerobic endospore removal in a water treatment process. Although not a surrogate for removal of a specific organism, endospore removal was seen as a measure of the overall filtration performance. Studies conducted by the WSWRD showed that endospore removal tracked particle removal, turbidity reduction, and pathogen removal. In studies in which good removals of endospores were achieved, good removals of particle and pathogens were observed. In some cases, good removals of pathogens occurred when poor removals of endospores were demonstrated, but no studies showed poor removals of pathogens when good removals of spores were achieved. Thus, removals of spores may be considered a conservative measure of particle and pathogen removal.

## References

- Al-Ani, M., McElroy, J. M., Hibler, C. P., and Hendricks, D. W. (1985). "Filtration of *Giardia* cysts and other substances: Volume 3." *Rapid rate filtration*. PB 85-194 645/AS, U.S. Environmental Protection Agency, Cincinnati, OH.
- Bellamy, W. D., Silverman, G. P., and Hendricks, D. W. (1985). "Filtration of *Giardia* cysts and other substances: Volume 2." *Slow sand filtration*. PB 85 191 633/AS, U.S. Environmental Protection Agency, Cincinnati, OH.
- Centers for Disease Control and Prevention. (1996). "Surveillance for waterborne-disease outbreaks—United States, 1993–1994." *Morbidity & Mortality Weekly Report*, 45(SS-3).

- Centers for Disease Control and Prevention. (2000). "Surveillance for waterborne-disease outbreaks—United States, 1997–1998." *Morbidity & Mortality Weekly Report*, 49(SS-4).
- Clark, R. M., et al. (1996). "A waterborne *Salmonella typhimurium* outbreak in Gideon, Missouri: Results from a field investigation." *International Journal of Environmental Health Research*, 6, 187–193.
- Craun, G. F. (1991). "Causes of waterborne outbreaks in the United States." *Water Science Technology*, 24(3), 17–20.
- Dugan, N., Fox, K. R., Miltner, R. J., and Owens, J. H. (2000). "Control of *Cryptosporidium* oocysts by conventional treatment." Accepted for publication, *Journal of the American Water Works Association*, March 2001.
- Fox, K. R. (1996). "Waterborne disease outbreaks and small systems." *Journal of the American Water Works Association*, 88(9), 8.
- Fox, K. R. and Lytle, D. A. (1996). "The Cryptosporidiosis outbreak in Milwaukee: Investigation and recommendations." *Journal of the American Water Works Association*, 88(9).
- Fox, K. R., Miltner, R. J., Gary, S. L., Dicks, D. L., and Drolet, L. F. (1984). "Pilot-plant studies of slow-rate filtration." *Journal of the American Water Works Association*, 76(12), 62–68.
- Lange, K. P., Bellamy, W. D., and Hendricks, D. W. (1984). "Filtration of *Giardia* cysts and other substances, Volume 1." *Diatomaceous Earth Filtration. PB 84-212 703*, U.S. Environmental Protection Agency, Cincinnati, OH.
- Letterman, R. D. and Cullen, J. T. R. (1985). "Slow sand filter maintenance: Costs and effects on water quality." *PB 85-199 669/AS*, U.S. Environmental Protection Agency, Cincinnati, OH.
- Logsdon, G. S. and Lippy, E. C. (1982). "The role of filtration in preventing waterborne disease." *Journal of the American Water Works Association*, 74(12), 649–655.
- Logsdon, G. S., Symons, J. M., Hoye, R. L., and Arozarena, M. M. (1981). "Alternative filtration methods for removal of *Giardia* cysts and cysts models." *Journal of the American Water Works Association*, 73(2), 111–118.
- Logsdon, G. S., Thurman, V. C., Frindt, E. S., and Stoecker, J. G. (1985). "Evaluating sedimentation and various filter media for removing *Giardia* cysts." *Journal of the American Water Works Association*, 77(2), 61.
- Lytle, D. A. and Fox, K. R. (1998). "The design of a "mini-scale" conventional/filtration water treatment plant for *Cryptosporidium* research." *American Water Works Association Annual Conference*, Dallas, TX, June 21–25.
- MacKenzie, W. R., et al. (1994). "A massive outbreak in Milwaukee of *Cryptosporidium* infection transmitted through the public water supply." *New England Journal of Medicine*, 331(3), 161–167.
- Nieminski, E. C. (1997). "Removal of *Cryptosporidium* and *Giardia* through conventional water treatment and direct filtration." *PB97-162507*, U.S. Environmental Protection Agency, Cincinnati, Ohio.
- Nieminski, E. C. and Ongreth, J. E. (1995). "Removing *Giardia* and *Cryptosporidium* by conventional treatment and direct filtration." *Journal of the American Water Works Association*, 87(9), 96–106.

- Pyper, G. R. (1985). "Slow sand filter and package treatment plant evaluation: Operating costs and removal of bacteria, *Giardia*, and trihalomethanes." *PB 85-197 051/AS*, U.S. Environmental Protection Agency, Cincinnati, OH.
- Rice, E. W., Fox, K. R., Miltner, R. J., Lytle, D. A., and Johnson, C. H. (1994). "A microbiological surrogate for evaluating treatment efficiency." *American Water Works Association Water Quality Technology Conference*, San Francisco, CA, November 6–9.
- Rice, E. W., Fox, K. R., Miltner, R. J., Lytle, D. A., and Johnson, C. H. (1996). "Evaluating plant performance with endospores." *Journal of the American Water Works Association*, 99(9), 122–130.
- Swerdlow, D. L., et al. (1992). "A waterborne outbreak in Missouri of *Escherichia coli* O157:H7 associated with bloody diarrhea and death." *Annals of Internal Medicine*, 117(10), 812–819.
- U.S. Environmental Protection Agency (USEPA). (1989). "Guidance manual for the compliance with the filtration and disinfection requirements for public water systems using surface water sources." *NTIS PB93-222933*, Washington, D.C.
- USEPA. (1995). "The national public water system supervision program FY 1994 compliance report." *EPA 812-R-95-001*, Office of Water, Washington, D.C.



## CHAPTER 9

### Activated Carbon and Membrane Processes for Disinfection By-Product (DBP) and Microbial Control<sup>1</sup>

#### Introduction

It is likely that many utilities will be able to meet current and upcoming drinking water regulations for DBPs by implementing one of the following relatively low-cost options: changing coagulation conditions, changing the point of chlorination, or switching to an alternative disinfectant (Symons et al. 1981). However, some utilities may wish to utilize activated carbon or membranes either because a lower-cost solution is not practical or because they wish to take advantage of the unique properties of activated carbon or membrane processes. Activated carbon and membrane processes are considered higher-price options (compared to enhanced coagulation) for DBP precursor removal and would most likely require major plant construction, hence they are considered together in this chapter. For point-of-use or point-of-entry discussions, the reader is referred to Chapter 11, “Controlling Disinfection By-Products (DBPs) and Microbial Contaminants in Small Public Water Systems (PWSs).”

For both GAC and membrane processes, it is more economical to remove the DBP precursor material than the formed DBPs. DBP precursors, as a whole, are more readily adsorbed onto activated carbon than DBPs (Symons et al. 1981). Precursor materials have larger molecular sizes than DBPs; therefore, it is easier for membranes to reject precursor material. Also, both activated carbon and membranes have problems handling chlorinated water. Activated carbon quickly reduces free chlorine. This lowers the capacity of the carbon, makes the carbon more brittle, and increases the amount of dioxins formed upon regeneration (Lykins et al. 1988b). Also, because activated carbon reduces the disinfectant, postfilter chlorination will be needed, which will form additional DBPs from the precursor material that was not adsorbed onto the column. Free chlorine attacks membrane material through oxidation pathways, and failure quickly occurs for many of these chlorine-sensitive thin-film membranes. Thin-film membranes are commonly used today because they have better flux and biodegradation characteristics than chlorine-resistant membranes.

Activated carbon is commonly applied as powdered activated carbon (PAC) or in granular activated carbon (GAC) form. PAC is often applied at, or before, the coagulation/flocculation step. The powdered carbon adsorbs contaminants and natural organic matter (NOM) until it is removed downstream in the sedimentation and filtration processes. Unless specific changes are made to the water treatment train (floc blanket clarifier or membranes), the typical adsorption residence time is too short to remove a significant amount of the NOM (DBP precursors), which generally adsorb slowly as compared to synthetic organic chemicals (SOCs). With regard to prechlorinated waters, the PAC adsorption capacities for DBPs are too low for economical removal (Symons et al. 1981). Therefore, PAC is most often used for SOC or taste and odor control.

GAC is utilized in a filter mode. It can be used as part of a multi-media filter to remove particulates (filter adsorber) or as a postfilter to remove specific contaminants (postfilter adsorber). Filter adsorbers are operated as typical inert-media filters. They are backwashed periodically to alleviate head loss, and the carbon is regenerated very infrequently, if at all. When used in postfilter mode, the bed is rarely backwashed, and the GAC is regenerated as often as needed to control for the contaminant(s) of interest.

---

<sup>1</sup>Thomas F. Speth: ORD/NRMRL/WSWRD, AWBERC Mailstop 689, 26 West Martin Luther King Dr., Cincinnati, OH 45268, 513-569-7208, speth.thomas@epa.gov.

Activated carbon has no specific ability to remove microbial pathogens unless it is used as GAC in a filter adsorber application, where it removes pathogens by the same mechanisms as any other filter media. GAC, due to its typically larger size, does not remove particulates/pathogens to any greater degree than other filter media types, so its use is never recommended if particulate/pathogen removal is the only goal. Therefore, this chapter will only cover activated carbon processes for DBP control.

Certain types of membranes can be very effective for controlling DBPs, while others are specifically designed to remove particulates/pathogens. Reverse osmosis (RO) membranes are very tight membranes that have molecular-weight cutoffs (MWCs) below 200 daltons. They are typically used to remove salts from seawater and brackish waters. Due to their tight membrane structure, they are operated at very high pressures (10 to 100 bar).

Nanofiltration (NF) membranes are not as tight as RO membranes. The MWCs for NF membranes are generally considered to range between 200 and 1,000 daltons. They are designed to remove divalent cations, hence they are often referred to as softening membranes, although they have been found to remove a large percentage of DBP precursors. Because they are not as tight as RO membranes, they can be operated at lower pressures (typically 5 to 9 bar) while achieving fluxes that are the same, or greater, than RO membranes. These lower pressures make NF membranes less expensive than RO membranes for a given design flow. Research at the U.S. Environmental Protection Agency (EPA) Office of Research and Development (ORD) has therefore concentrated on NF membranes.

Ultrafiltration (UF) and microfiltration (MF) membranes are typically used only for particulate/pathogen removal. UF membranes have MWCs that range from 1,000 to 500,000 daltons. While some of the UF membranes that have MWCs near 1,000 daltons may remove significant amounts of DBP precursor material, the MWC ranges are arbitrarily set, and therefore, the membrane could be considered a loose NF membrane. MF membranes have an order-of-magnitude larger pore sizes than UF membranes. Typically, MF pores sizes are designated in micrometers and normally range from 0.05 to 5  $\mu\text{m}$ . A rough rule of thumb is that UF membranes can reject viruses, while MF membranes cannot.

This chapter provides a comprehensive review of activated carbon and membrane research for the control of DBPs and pathogens. Much of the work was conducted, or funded, by ORD. Outputs include: peer-reviewed papers, proceedings papers, EPA reports, Master's theses, and Ph.D. dissertations. It also includes other papers that were written under non-ORD projects. Some of these were co-authored by ORD researchers, but many were not. Although the intent is to highlight ORD research, non-ORD projects are included to make the discussion complete.

This work is a follow-up to the EPA work published by Symons et al. (1981). For other recent comprehensive scientific discussions of GAC and membrane technologies, the reader is referred to Jacangelo (1999), Snoeyink et al. (1999), Snoeyink and Summers (1999), and Taylor and Wiesner (1999). Also, the Information Collection Rule (ICR) treatment studies have been recently compiled. The EPA required water utilities of a certain size and water quality to complete GAC or membrane studies so as to create a national data base for advanced DBP removal technologies. The ICR treatment studies were conducted through the auspices of the Office of Ground Water and Drinking Water with very limited ORD involvement.

## **Activated Carbon**

### ***Filter Adsorbers vs. Postfilter Adsorbers***

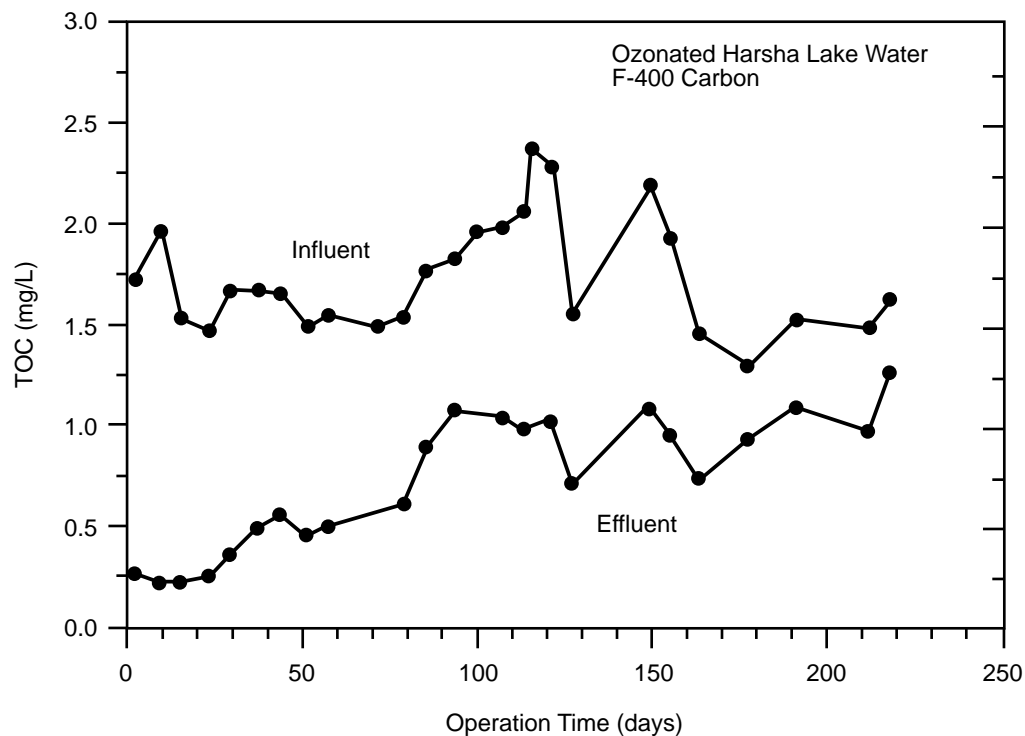
As mentioned previously, the removal of NOM and DBP precursors by PAC is not very efficient (Symons et al. 1981). Therefore, the following discussion will only pertain to GAC filtration technologies. The major limitation for filter adsorbers is their depth. The Ten-State Standards require sand depths of at

least 4 feet. Therefore, this leaves a limited depth of GAC that can be placed above the sand. The lack of depth, or empty bed contact time (EBCT), is crucial for waters that contain moderate- to poor-adsorbing NOM. Early breakthrough would require frequent replacement or regeneration of the carbon. Hartman et al. (1991) determined that filter adsorbers were not cost effective for NOM control. However, due to GAC's ability to maintain a biological community that would remove DBP precursors, systems that need only limited DBP precursor removal may find filter adsorbers to be practical. Wiesner et al. (1987) concluded that filter adsorbers are generally more cost effective than postfilter adsorbers if the desired total organic carbon (TOC) (precursor) removal is less than 55 percent. Under more unique conditions, Wiesner et al. (1987) found that filter adsorbers are cost effective for removals up to 75 percent. Because limited removals can generally be obtained by other means, ORD research has concentrated on postfilter adsorbers which can be highly effective for controlling disinfection by-products under a wide range of conditions.

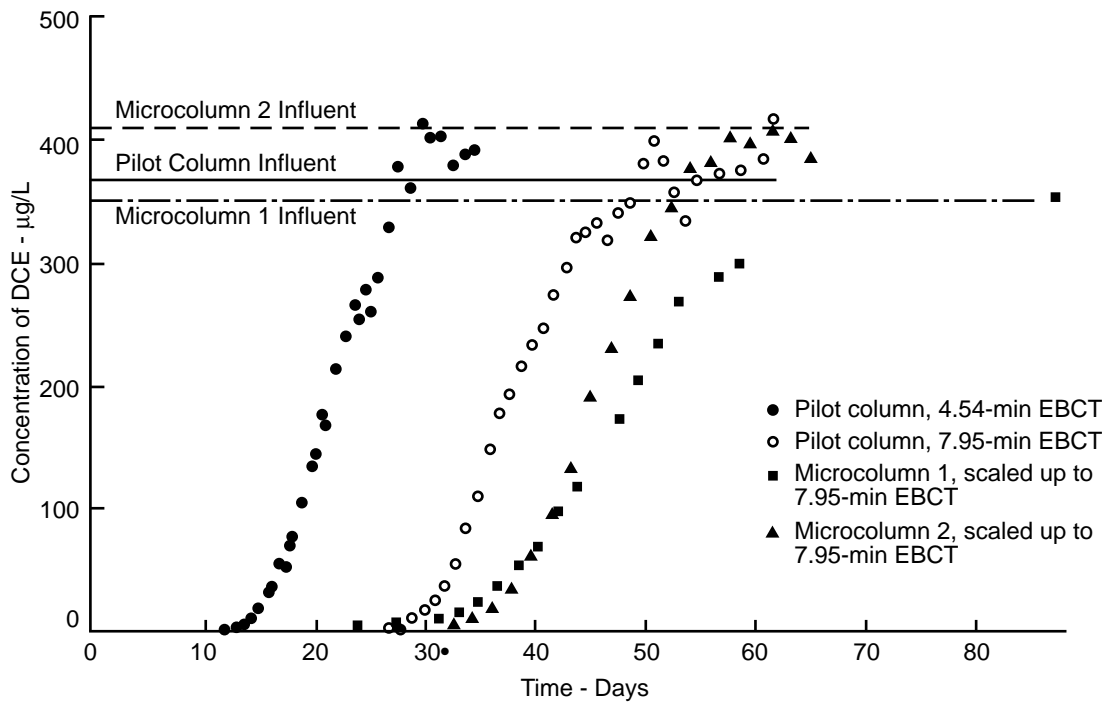
### ***Breakthrough Profiles***

Figure 9-1 contains a typical NOM, as TOC, breakthrough profile for a postfilter GAC column (Miltner et al. 1996). There is immediate TOC breakthrough because a certain portion of the TOC is nonadsorbable. The effluent TOC concentration then slowly increases toward the influent concentration. The breakthrough profile eventually plateaus as the biodegradable or slowly adsorbing fractions are removed.

These results are different than for SOC's that generally show complete removal for a period of time, followed by a sharp "S"-shaped breakthrough to the influent level as shown in Figure 9-2 (Speth and Miltner 1989). Singer (1994) found that three-to six-month run times between regenerations were most common for NOM removal.

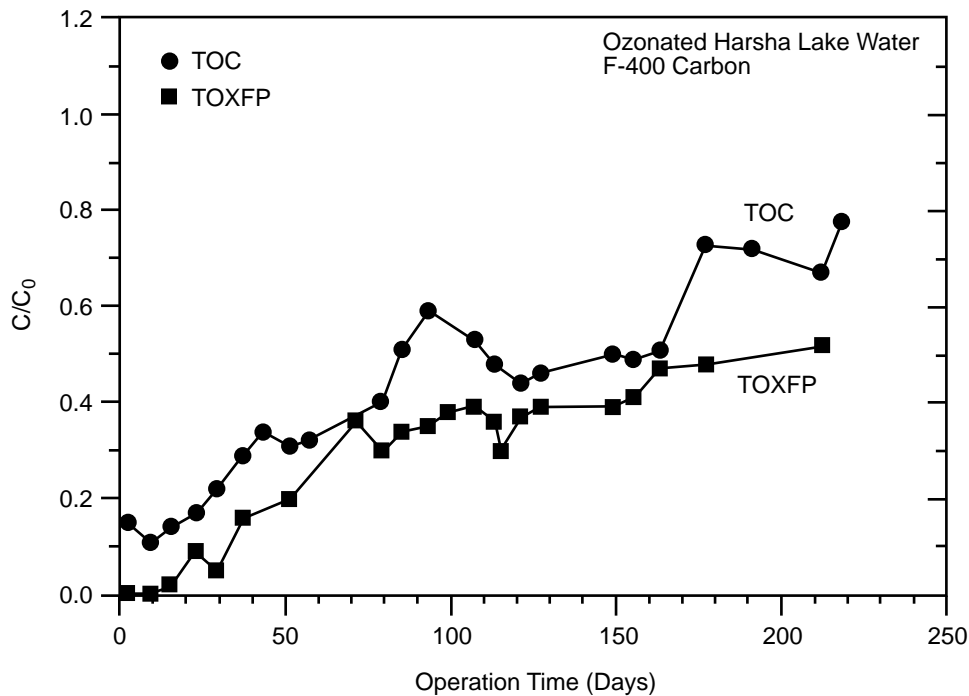


**Figure 9-1. TOC breakthrough profile for F-400 carbon treating ozonated Harsha Lake water (Miltner et al. 1996).**



**Figure 9-2. Breakthrough profile for cis-dichloroethene (Speth and Miltner 1989).**

The breakthrough of certain DBP precursors mimics that of TOC breakthrough (Lykins et al. 1988a; Symons et al. 1981; Summers et al. 1995; Miltner et al. 1996). Figure 9-3 shows breakthrough profiles for TOC and total organic halide formation potential (TOXFP) (Miltner et al. 1996). As can be seen, TOC is an accurate predictor of TOXFP.



**Figure 9-3. Breakthrough profiles for TOC and TOXFP (Miltner et al. 1996).**

Even though DBP formation potential (DBPFP) breakthrough can be predicted by TOC breakthrough, a GAC column's performance for controlling DBPs is not always straightforward. The GAC adsorption performance is predicated on an interwoven matrix of system design, water quality, and chlorination conditions.

### ***GAC Adsorption Performance***

There are many factors that affect GAC adsorption performance. Assuming instantaneous kinetics, an equation to calculate the time to breakthrough in days is:

$$\text{Time to breakthrough (days)} = (K C_0^{1/n} Wt) / (Q C_0) \quad (9-1)$$

where K and 1/n are the Freundlich constants in  $\mu\text{g/g (L}/\mu\text{g)}^{1/n}$ ,  $C_0$  is the influent concentration in  $\mu\text{g/L}$ , Wt is the weight of carbon in g, and Q is the volumetric flow rate in L/day.

Clark et al. (1986) and Clark (1987) developed the logistic function which describes the TOC effluent concentration in terms of time, initial concentration, EBCT, and adsorption capacity as represented by the Freundlich equation.

$$\text{TOC}_f = ([\text{TOC}_0]^{n-1}) / (1 + A e^{-rt})^{1/n-1} \quad (9-2)$$

where A and r are fitting parameters,  $\text{TOC}_f$  is the effluent TOC concentration,  $\text{TOC}_0$  is the influent TOC concentration, t is time, and n is the Freundlich parameter. The fitting parameters A and r were further related to EBCT. The exact equations were determined by fitting the following equations to breakthrough profiles from GAC columns at Jefferson Parish (Clark 1987)

$$A = 0.757(\text{EBCT})^{1.35} \quad (9-3)$$

$$r = 0.0743(\text{EBCT})^{-0.429} \quad (9-4)$$

where EBCT is the empty bed contact time (volume of the bed divided by the volumetric flow rate).

The preceding equations demonstrate the importance of TOC adsorbability, initial concentration, and EBCT for a given carbon. Many other models have been developed for GAC adsorption; however, they have limited applicability to DBP precursor adsorption because of the undeterminable heterogeneity of the natural organics in the influent water. Luft (1984), Crittenden et al. (1987b), Speth (1986), Warta et al. (1995), and Hong (1985) have worked with limited success in developing and applying hypothetical components for predicting TOC adsorption.

### ***Adsorbability***

Different carbons will adsorb DBP precursors to varying degrees. Figure 9-4 shows the breakthrough profiles for three different activated carbons that treated ozonated Harsha Lake Water (Miltner et al. 1996). Wang et al. (1995) found that trihalomethane formation potential (THMFP) removals ranged from 27 to 40 percent, while TOXFP removals ranged from 31 to 52 percent depending on what type of carbon was used.

The NOM and DBP precursors of different waters will adsorb to different extents. Figure 9-5 shows an atypical TOC breakthrough profile for a ground water from Fairfield, OH, using F-400 carbon (Speth and Miltner 1989). In this case, approximately 80 percent of the NOM in the Fairfield water was nonadsorbable. These results can be compared to those in Figure 9-1 for Harsha Lake water. The NOM in the Harsha Lake water was adsorbed to a much greater extent.

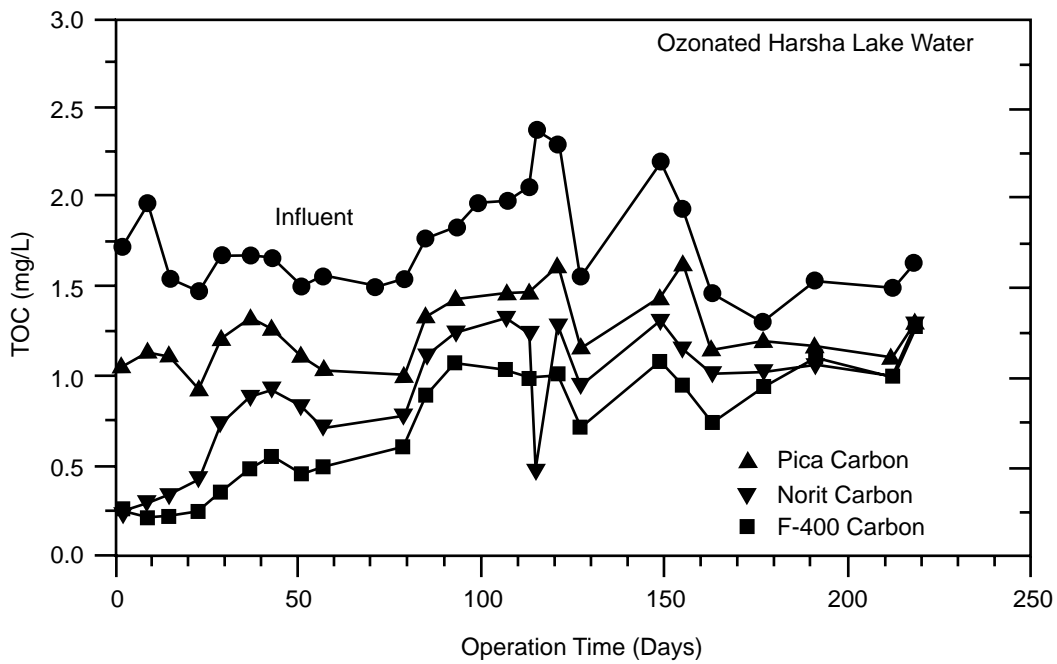


Figure 9-4. TOC breakthrough profiles for different activated carbons treating ozonated Harsha Lake water (Miltner et al. 1996).

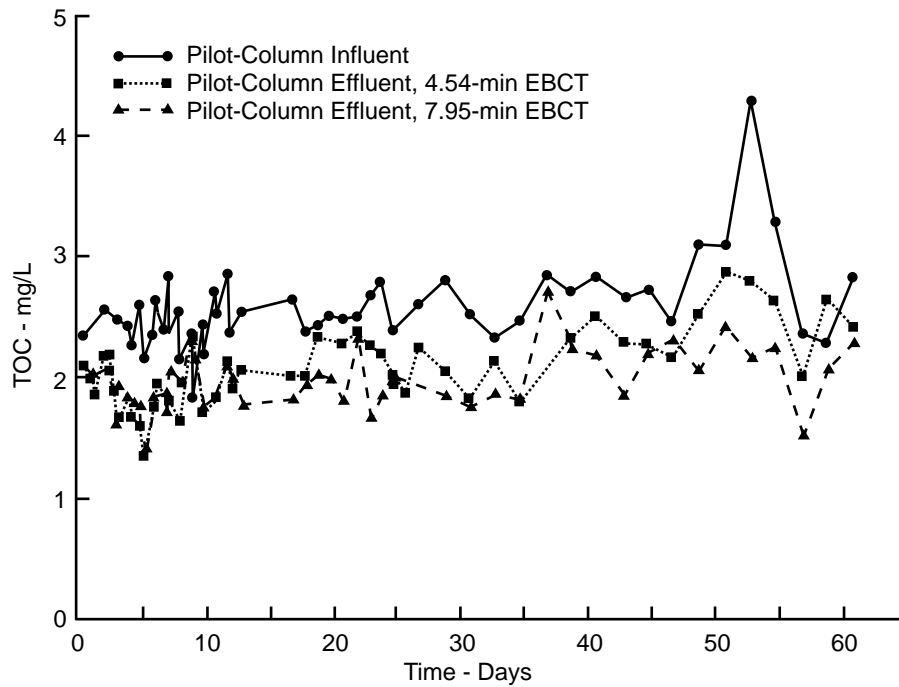


Figure 9-5. TOC Breakthrough profile for ground water from Fairfield, OH (Speth and Miltner 1989).

Generally, smaller NOM molecules adsorb more strongly than larger ones because pore blockage of large molecules can limit the accessibility to adsorption sites. Also, the greater the hydrophobicity of the NOM, the greater the adsorption. Aromatic compounds are generally more strongly adsorbed than nonaromatic compounds. Therefore, terrestrial-derived organic compounds which tend to have greater aromatic character are expected to adsorb to a greater extent than aquatic-derived ones. Proteinaceous compounds are also known to be strongly adsorbed.

The Polanyi potential model can predict adsorption capacities based on the following equation (Speth 1986; Speth and Adams 1991). The Polanyi theory assumes there is a fixed volume close to the adsorption surface where adsorption occurs. The volume is defined by equipotential surfaces which describe the amount of work needed to move any molecule from the bulk solution to the adsorption space. A final form of this development is:

$$K = \rho W \exp((- \rho B R T \ln (C_s)) / M_w) \quad (9-5)$$

where K is the Freundlich parameter,  $\rho$  is the compound density, W and B are fitting constants, R is the ideal gas constant, T is temperature,  $C_s$  is the compound's water solubility, and MW is its molecular weight. The Freundlich K can be used to judge the relative strength of adsorption for a specific compound. As can be seen, if a water has constituents with low solubilities, the capacity of the carbon for that constituent will be high. Also, a lower temperature and higher MW will result in greater adsorption (assuming no pore blockage). Crittenden et al. (1999) has further evaluated adsorption correlations.

Isotherm data for specific contaminants are valuable because kinetic models have been developed to predict full-scale results from isotherm data. Speth and Miltner (1990, 1998) contain isotherm data for numerous DBPs. However, kinetic models are not useful for complex mixtures such as NOM or DBP precursors. Although attempts have been made (Luft 1984; Crittenden et al. 1987b; Speth 1986; Warta et al. 1995; Hong 1985), it is very difficult to predict NOM adsorption.

The logistic function (Equation 9-2) may be the best way to predict GAC performance for the adsorption of NOM. The logistic function's adsorption parameters were determined by fitting the breakthrough profiles from Jefferson Parrish, LA. These NOM breakthrough profiles had moderate adsorbability as compared to other available data.

### ***Initial Concentration***

Initial concentration is a function of the water's source, although it can be affected by pretreatment processes. Different pretreatments will also affect the adsorbability and biodegradability of the NOM. As mentioned earlier, chlorination has a detrimental effect on the control of DBPs primarily due to the lower adsorption capacity of GAC for formed DBPs and detrimental surface reactions with the activated carbon. Semmens et al. (1986b) showed that alum coagulation resulted in improved GAC run times for TOC and THM precursor removal because of reduced initial concentration and the removal of poorly adsorbed high-molecular-weight organics. Hooper et al. (1996) found that enhanced coagulation reduced the concentration of the NOM, but also increased its adsorbability due to the reduced pH imparted from the increased alum dose.

Ozonation makes the NOM more polar, and hence less adsorbable, but it also increases its biodegradability (Sontheimer and Hubele 1987). Therefore, for short beds that are regenerated frequently, preozonation would not be helpful, whereas for longer beds that are infrequently regenerated, preozonation would be a benefit. The reader is referred to other chapters which discuss preozonation's effect on subsequent chlorination reactions (Chapter 5) and preozonation's effect on biodegradation (Chapter 6).

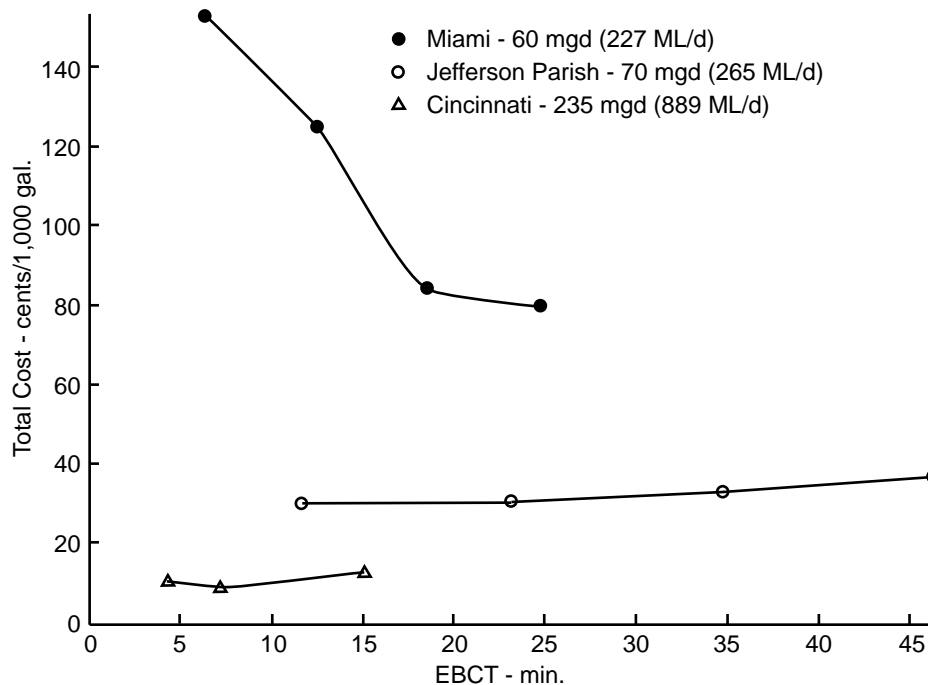
Benz et al. (1992) showed that anion exchange pretreatment can significantly improve the performance of GAC columns. The anion exchange columns extended the GAC performance by a factor of two to three for NOM and DBP precursors. The resin removed the hydrophilic weakly adsorbing NOM that was not amenable to GAC treatment.

Finally, inorganic precipitation can foul GAC. Coagulants can result in an oversaturation of calcium carbonate or iron hydroxides. Also, if air is introduced into an anaerobic ground water, iron and manganese precipitation can coat the carbon, reducing its capacity and slowing film transfer kinetics (Speth 1991).

### **EBCT**

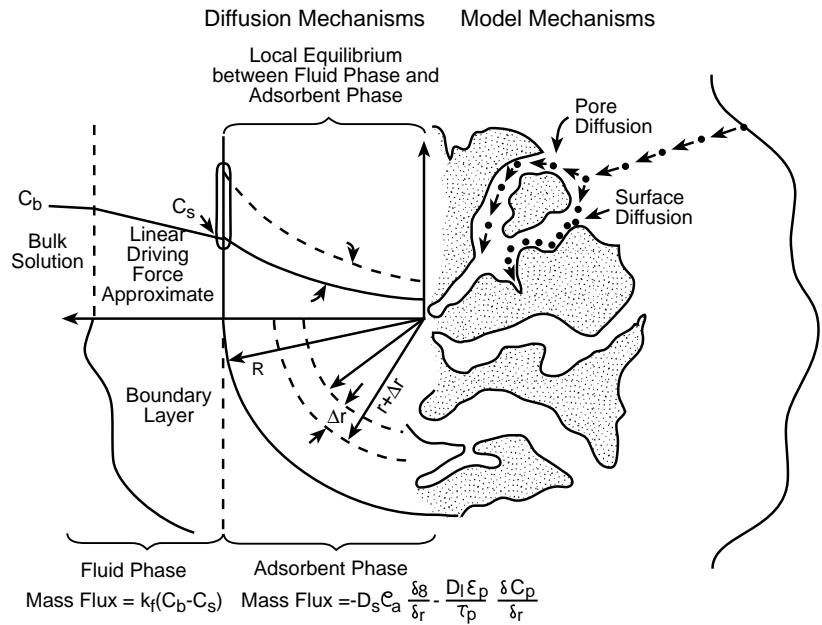
As can be seen in Equation 9-1, EBCT is an important parameter for adsorption performance in GAC columns. The greater the EBCT, the longer the column will remain operational. Figure 9-2 shows the cis-dichloroethene breakthrough profiles for two different EBCTs. As can be seen, the breakthrough profile for the longer EBCT occurs later than the shorter EBCT, as expected. However, doubling the EBCT generally does not necessarily double the run-time length. Summers et al. (1995) showed that columns with EBCTs of 10 and 20 minutes had similar carbon use rates for removing NOM. This suggested that utilities should attempt to minimize the EBCT to reduce capital costs. Wiesner et al. (1987) found that 6 to 12 minutes of EBCT was optimal for TOC removal.

Lykins et al. (1988a) showed that the most cost-effective EBCT will depend on the source water. Figure 9-6 shows the plot of costs versus EBCT. The costs for Jefferson Parish and Cincinnati water did not vary greatly with EBCT, whereas Miami water shows a clear advantage of longer EBCTs. Because of the tradeoff between cost of replacement/regeneration and the increased capital cost of the larger columns, EBCTs typically range somewhere between 10 and 20 minutes. As with the other design factors, the total cost will be a function of how the column effluents are blended together. This issue will be discussed later in this chapter.



**Figure 9-6. Costs versus EBCT for three waters (Lykins et al. 1988a).**

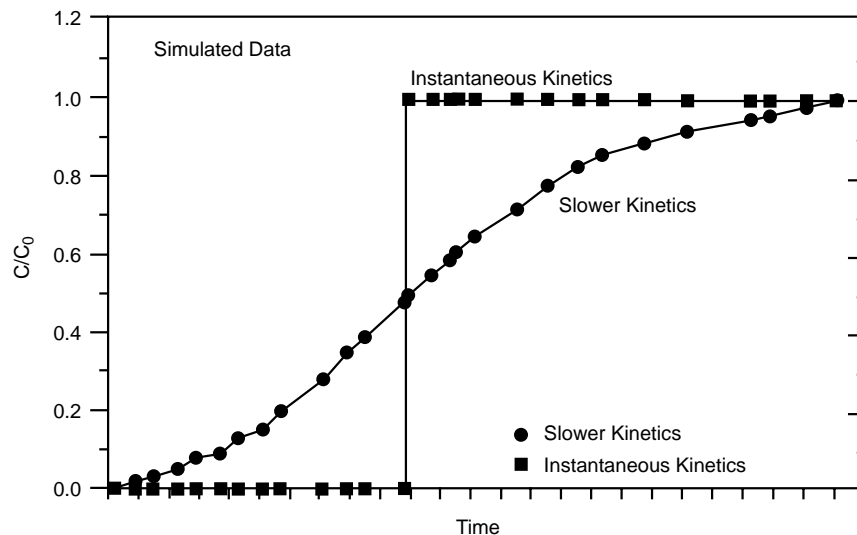




**Figure 9-7. Adsorption kinetics (Crittenden et al. 1987c).**

### *Adsorption Kinetics*

Adsorption kinetics also influence the shape of the adsorption profile. Mechanisms of adsorption kinetics include film diffusion, pore diffusion, and surface diffusion. Figure 9-7 shows the adsorption kinetics around and within a carbon particle (Crittenden et al. 1987c). Kinetic models must account for external (film transfer) and internal (pore and surface diffusion) effects. Slow kinetics will result in a flat breakthrough profile, whereas fast kinetics will result in a steep profile. If the kinetics of adsorption are instantaneous, the breakthrough profile for a single compound will be a step function as shown in Figure 9-8 (Speth 1990). For NOM breakthrough, the breakthrough profile will be flattened even if the kinetics of adsorption are instantaneous. This is because NOM is made up of countless different types of compounds that will breakthrough at different times. In this case, the breakthrough profile will be a series of infinitely small steps.



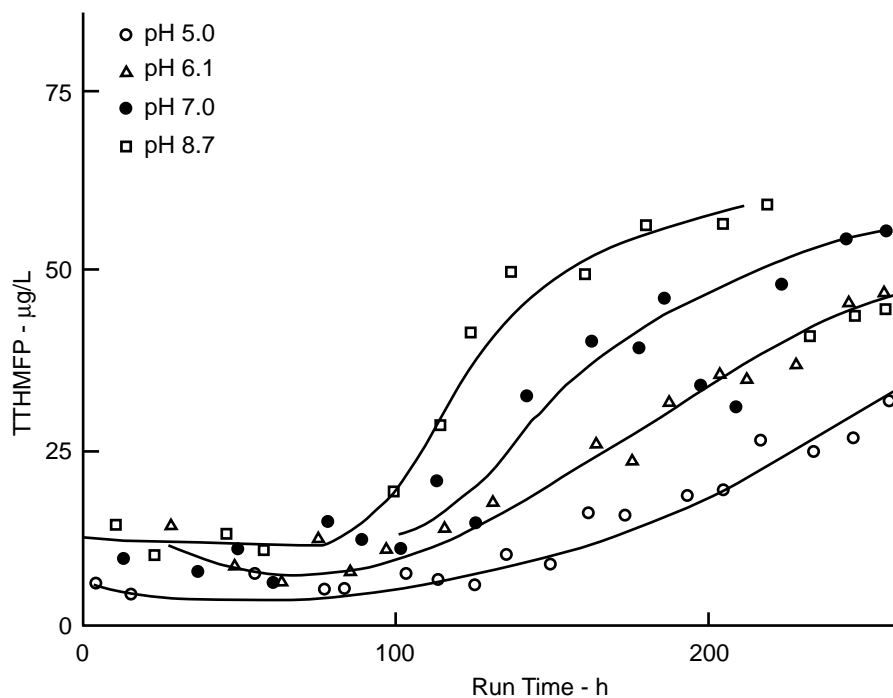
**Figure 9-8. SOC Breakthrough profiles assuming slow and instantaneous kinetics.**

The size of GAC particles used in full-scale columns varies within standard ranges. Postfilter carbon is typically 12 × 40 mesh (1.68 by 0.42 mm), although other sizes are also on the market. These ranges will not, however, produce markedly different adsorption results in a postfilter adsorber. The choice of carbon size is often determined by the smallest size that does not create head loss problems because smaller carbon particles will have faster kinetics, resulting in more efficient bed adsorption. For postfilter adsorbers, this is typically 12 × 40-mesh carbon.

Crittenden et al. (1986, 1987a) developed the Rapid Small Scale Column Test (RSSCT) to help predict full-scale adsorption data. The RSSCT uses smaller particle sizes to obtain full-scale results in a fraction of the time needed to run a pilot column. For example, a RSSCT can be completed in 1 month and be representative of a year-long full-scale study. Therefore, seasonal studies can be conducted without having to account for major changes in influent water quality. Scale-up approaches were developed for a number of diffusivity assumptions. Summers et al. (1995) found that the proportional diffusivity approach developed by Crittenden et al. (1987a) was the most appropriate for TOC breakthrough profiles. However, although useful for planning, the RSSCT is only for pilot-scale design and does not hold practicality for full-scale systems (Speth and Miltner 1989; Speth et al. 1989).

## *pH*

NOM is predominantly negatively charged. Therefore, decreasing the pH renders the predominantly negatively charged organic molecule more neutral. A neutral compound is inherently less soluble in water than a charged molecule and, therefore, more adsorbable. Also, at low pHs, NOM is more coiled due to a less negative-charge repulsion. This may allow for greater access to GAC pores. Semmens et al. (1986a) showed that a lower pH will result in better adsorption. Figure 9-9 shows TTHMFP breakthrough profiles for the same water at different pHs. The lower pH system had a longer bed life. Hooper et al. (1996) also concluded that lower pHs improved NOM/precursor adsorbability.

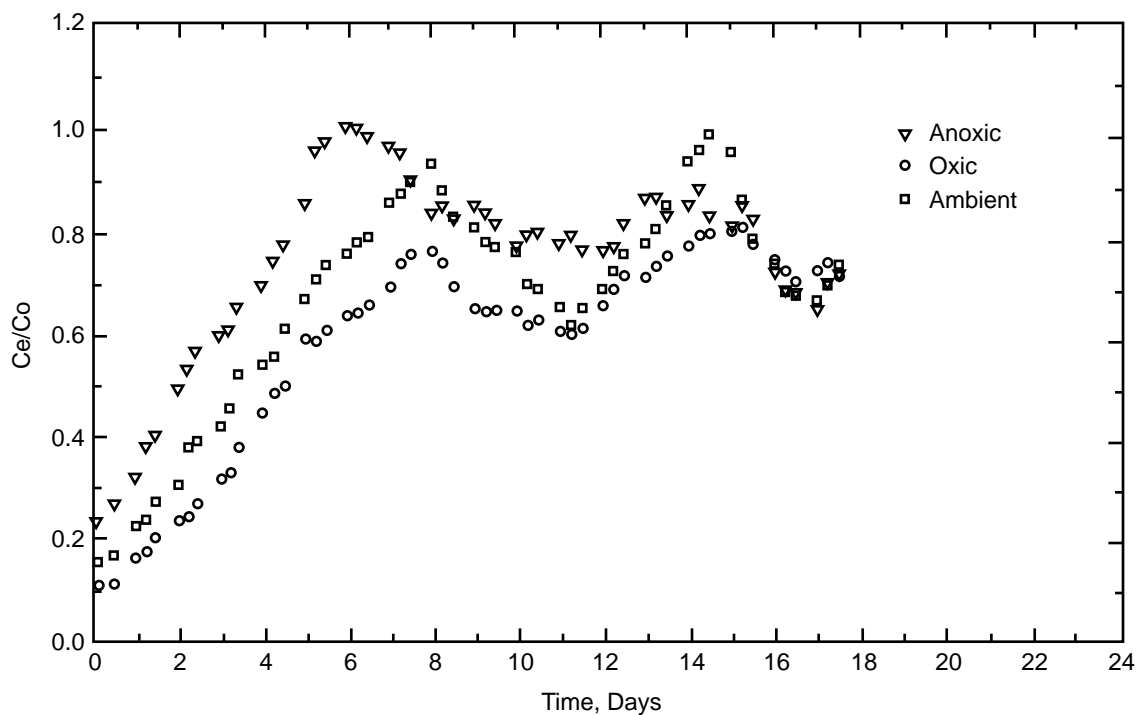


**Figure 9-9. Effect of pH on TTHMFP adsorption (Semmens et al. 1986a).**

## Biogrowth and Dissolved Oxygen

As mentioned previously, biogrowth can improve GAC bed performance for removing DBP precursors. Therefore, introducing oxygen to encourage biogrowth can result in greater biological removal of DBP precursors. Dissolved oxygen also has shown to increase the adsorption of NOM due to their polymerization onto the carbon surface (Warta 1993; Warta et al. 1995). Figure 9-10 shows an example of greater NOM adsorption at high dissolved oxygen levels (Warta et al. 1995). This utility that is drawing anoxic water might consider aerating the water prior to adsorption for maximum NOM removal, although secondary effects such as iron precipitation would have to be taken into account. This increased NOM removal lowers the performance of a column that is treating a specific organic compound that does not polymerize on the GAC surface because the polymerizing NOM competes against the organic compound more effectively for adsorption sites (Vidic et al. 1992; Sorial et al. 1994a; Sorial et al. 1994b; Cerminara et al. 1995). Interestingly, although oxidic polymerization significantly increases the removal of dissolved oxygen content (DOC), Warta (1993) showed that oxidic polymerization only slightly increases the removal of THMFP and TOXFP. Apparently, the fractions of NOM that polymerize on the carbon surface are not precursor material. Warta (1993) did show that air-saturated oxygen levels can significantly increase the removal of THMFP and TOXFP over anoxic and super-saturated oxygen systems. This is presumably due to microbiological processes.

Biological growth occurs in every GAC column that treats drinking water. This is even true for prechlorinated waters because disinfectants are reduced in the top few centimeters of a carbon bed. There are advantages to maintaining biological activity in GAC beds. As mentioned, bioactivity can improve the DBP-precursor-removal performance of GAC columns (Miltner et al. 1994; Miltner et al. 1996; Wang et al. 1995; Warta 1993). Because GAC columns are biologically active, there is typically an increase in the concentration of microbes in the effluent as compared to the influent (Symons et al. 1981). Cold-water systems were found to be the exception, most likely due to the



**Figure 9-10. TOC breakthrough profiles under anoxic, oxic, and ambient conditions (Warta 1993).**

inhibitory effect of low temperatures on microbial growth. Symons et al. (1981) found that adequate post-GAC disinfection produced waters of acceptable quality. Camper et al. (1987) found that GAC columns released disinfection-protected particles that were highly populated with heterotrophic plate counts (HPCs) and coliform bacteria. Camper et al. (1987) concluded that increased bed depth, higher applied-water turbidity, and increased filtration rate exacerbated the bacteria-laden particle problem.

In cases where there is no postfilter disinfectant, such as in-home treatment devices, biological activity is definitely not desired. Silver impregnation has been used to reduce biogrowth, however, Reasoner et al. (1987) found that point-of-use GAC devices that contained silver had concentrations of heterotrophic bacteria as high as units that did not contain silver. Also, it is expected that fouling will further reduce the biocidal properties of the silver. Aside from using preoxidants and adjusting the rate of replacement, or regeneration, a water utility has little control over biodegradation other than to increase it. As previously mentioned, oxidants such as ozone can increase the biodegradability of the NOM in the water. A carbon column that is replaced, or regenerated, frequently (every 1 to 2 months) will not show significant biodegradation. Therefore, it is generally beneficial to lengthen the run time of each column, such as by blending the effluents of multiple columns. The reader is referred to Chapter 6, “Alternative Disinfectants,” for a more in-depth discussion of biological filtration.

### ***Other Effects***

Backwashing is sometimes required to remove particulates from GAC filters. Hong (1985) showed that backwashing had little impact on the removal of TOC and THM precursors for five natural waters.

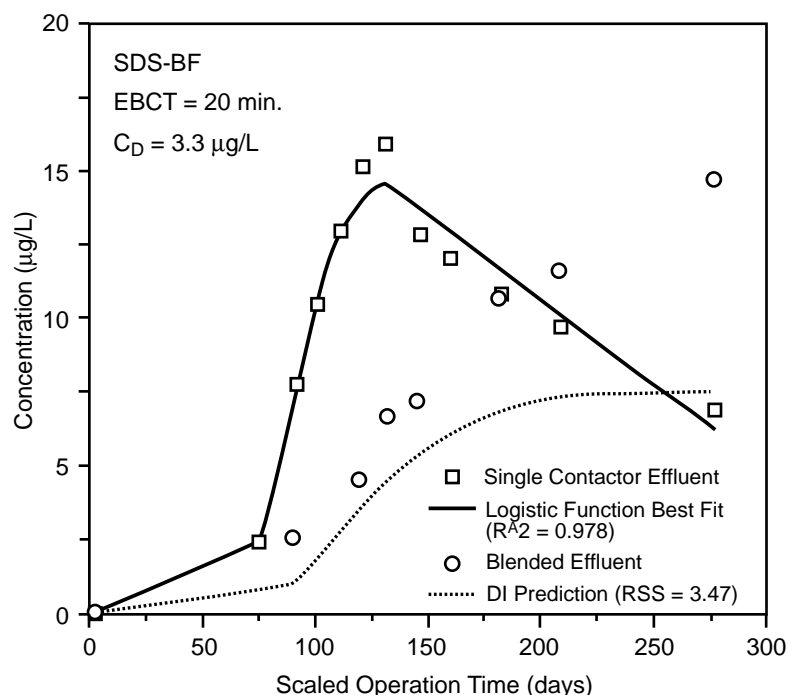
Because adsorption is an exothermic reaction, greater adsorption will occur at lower temperatures. This can be seen in Equation 9-5. Therefore, utilities find better TOC removal in the winter months. This is only one example showing that seasonal effects will change the adsorption characteristics of DBP precursors. Another seasonal change includes changes in the NOM characteristics because of algal and microbial production during the summer months. Neither temperature nor NOM quality is an adjustable parameter for a water utility.

### ***Bromide Issues***

The prediction of brominated DBP breakthrough from GAC columns is more complicated than for certain chlorinated DBPs. Brominated THMs are often found to be elevated in GAC effluent water (Symons et al. 1981). The formation of brominated DBPs is a function of the bromide-to-NOM ratio and the bromide-to-chlorine ratio (Summers et al. 1993). (Refer to Chapter 2 for a speciation discussion.) Because GAC columns remove NOM but do not remove bromide, the bromide-to-NOM ratio in the column effluent will be constantly changing. Early in the column run, the bromide-to-NOM concentration will be very high. This will favor the formation of brominated DBPs over chlorinated DBPs. Eventually, the NOM concentration in the effluent will increase, resulting in higher chlorinated DBPs. Because of this effect, the precursors to the chlorinated DBPs will appear to be removed better than if no bromide was present. Also, and more importantly, the concentration of brominated DBPs may increase quickly and then later drop. Figure 9-11 shows the breakthrough of SDS-bromoform (USEPA 1999). The effluent peaks were much higher than the influent SDS-bromoform concentration due to excess bromide to TOC in the effluent. Eventually, the remaining TOC breaks through, and the SDS-bromoform returns to influent levels.

### ***Blending***

Greater GAC capacity can be realized if columns are run in parallel or in series. If the start times of the columns are staggered, the first column can be run beyond the maximum total effluent concentration because its effluent is being blended with columns in the start of their breakthrough profiles. Hence, the



**Figure 9-11. SDS-Bromofrom breakthrough with model predictions (USEPA 1999).**

total blended effluent still remains below the design effluent concentration. Roberts and Summers (1982) developed a strategy to calculate the benefit of a parallel approach.

For columns in series, the first column can be run to exhaustion, while the TOC mass transfer zone, or breakthrough profile, is contained in the latter columns. When the first column reaches its maximum operational capacity, it can be taken out of series, and the column can be restarted as the last column with fresh GAC. This approach may be best for SOC removal when the breakthrough profile is relatively sharp. The results of Summers et al. (1995) seem to suggest that the NOM breakthrough profiles are too broad for series operation.

## Membranes

### *Membrane Type*

Membranes remove organic compounds, inorganic compounds, and particulates by creating a barrier through which water is preferentially passed. The rejection can be physical or electrochemical. There are many types of membranes that are manufactured, with each having different stability, flux, and rejection characteristics. The type of membranes studied at the EPA were strictly pressure-driven processes such as RO, NF, UF, and MF because these types of membranes have the most applicability to drinking water systems. Membranes with other driving forces such as electric potential and temperature have not been studied. As stated earlier, both RO and NF membranes are fully capable of rejecting DBP precursors; however, higher fluxes from the NF systems make them generally more economical than RO membranes. Although there may be instances where RO membranes have site-specific advantages over NF membranes (i.e., brackish and sea waters), the following discussion will concentrate on NF. The EPA has conducted the majority of its membrane research with NF membranes because of the need to determine the potential for lowering the current maximum DBP levels in drinking water in a cost-effective manner.

Although a NF membrane is inherently a barrier process, membrane manufacturers are reluctant to claim log-removal credit for pathogens due to the potential of glue-line failure. Also, many plants blend pretreated feed waters with the membrane-treated waters to create a less corrosive product water. This practice results in limiting the microbial removal for NF and RO membranes. Therefore, although particulate/microbial removals may be given for NF membranes, this should not be construed as a basis for log removal credit.

Both UF and MF systems are capable of excellent particulate/pathogen removal; however, their DBP removal performance is more consistent with that seen for conventional treatment (10 to 50 percent). Due to the applicability and the economies of scale that favor using UF and MF for small systems, refer to Chapter 11, "Controlling Disinfection By-Products (DBPs) and Microbial Contaminants in Small Public Water Systems (PWSs)," for an additional discussion of these technologies.

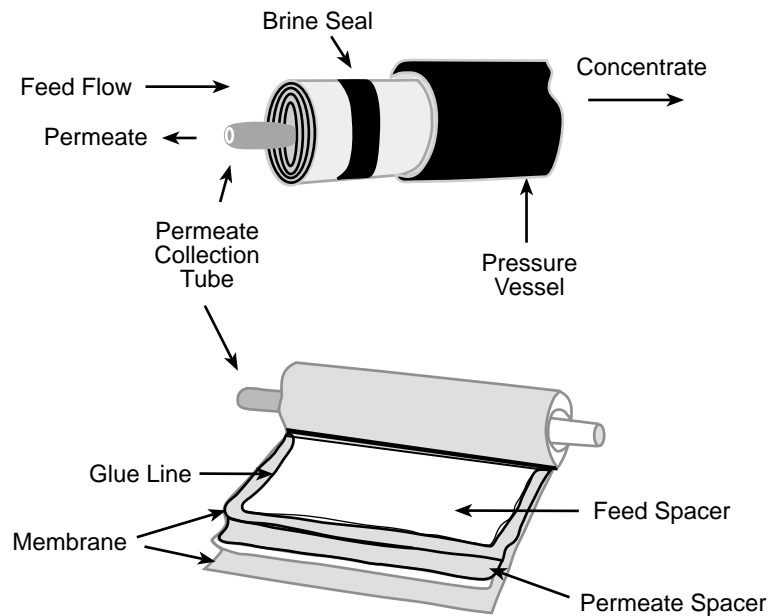
Membranes are made of many materials. Common membrane materials are polysulfone, cellulose acetate, polycarbonate, polypropylene, polytetrafluoroethylene, and polyacrylonitrile. These materials can be classified as hydrophobic or hydrophilic. Membranes made of polyamide, polysulfone, polypropylene, or polytetrafluoroethylene are generally considered hydrophobic membranes. Membranes made of cellulose acetate or polyacrylonitrile are generally considered hydrophilic. Hydrophilic membranes do not foul as fast as hydrophobic membranes (Lainé 1989; Bonner and O'Melia 1991; Eykamp 1978). However, the anti-fouling behavior of hydrophilic membranes is offset by their limitations with regard to pH, chemical, and temperature resistance. This is important for drinking water applications because membrane cleaning is often completed at extreme pHs.

Membranes can be of homogeneous, asymmetric, or composite construction. Composite membranes are most popular due to the thin separation layer that allows for maximization of water flux. The Desal-5, Film-Tec NF-70, Film-Tec NF90, and Fluid Systems' TFCS membranes are of composite thin film design. The film layers on these membranes are of polyamide construction. Reiss et al. (1999a) found that for NF membranes of comparable productivity, NOM rejection was greater for the polyamide versus cellulose acetate membranes. Membranes typically carry a charge. Polyamide, polysulfone, cellulose acetate, and ceramic membranes carry a negative charge (Lahoussine-Turcaud et al. 1990). The charge of a membrane can have implications regarding the rejection of charged, dissolved species.

Along with hydrophobicity and charge, surface roughness, porosity, pore size, and membrane consistency can also affect the extent of fouling (Marshall 1993). The greater the surface roughness, the greater the fouling. Also, the greater the pore size, the greater the particulate fouling. Given the same operating conditions, MF membranes with large pores will foul to a greater extent than MF membranes with smaller pores.

### ***System Configuration***

Full-scale membrane elements are designed in a number of ways to optimize membrane area to element size. The types of membrane vessels include spiral wound, hollow fiber, shell in tube, and rotating disk. Spiral-wound and hollow-fiber systems provide better packing densities compared to shell-in-tube and rotating-disk units. RO and NF elements are commonly of spiral-wound configuration, whereas MF and UF are typically hollow fiber. Figure 9-12 shows a diagram of a spiral-wound vessel (Speth 1998). The membrane material is glued into envelopes with the active film to the outside. Inside the envelope, a permeate spacer sheet is added to allow for the permeate water to flow. The open edge of the envelope is attached to a permeate collection tube. Therefore, any permeate water inside the envelope will, by small pressure gradients, be transferred to the permeate collection tube. The number of envelopes attached to the permeate collection tube varies by element size and manufacturer. A feed-spacer sheet is placed in between the envelopes. The envelopes and the feed-spacer sheets are rolled into a cylinder. The permeate collection tube is plugged at one end. The other end of the permeate collection tube is



**Figure 9-12. Typical spiral-wound membrane element (Speth 1998).**

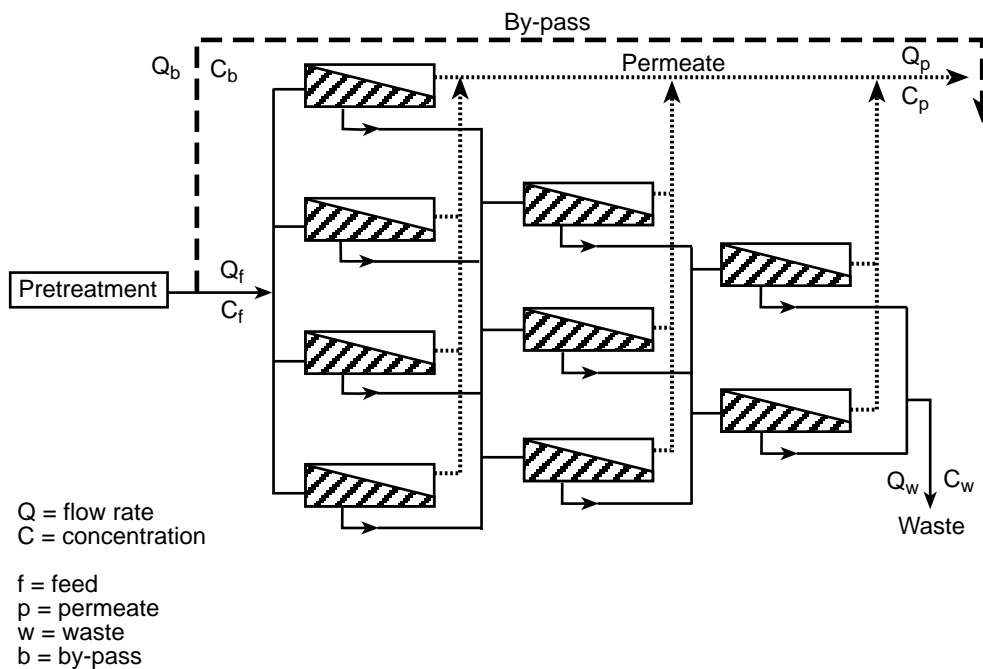
plumbed into a permeate collection line. The feed line to the element is introduced on one end of the membrane cylinder. The feed water runs through the feed-spacer sheet, past the membrane material on either side. At the end of the element, the concentrated feed water, typically referred to as the concentrate, or retentate, is plumbed into a line that is either sent to the next element in series, sent to waste, or recycled back to the feed stream.

Each NF element typically passes 10 to 15 percent of the feed water through the membrane as permeate. The remaining 85 to 90 percent of the feed water leaves the element as reject water. Percent recovery is used to give an indication of the percentage of the water that is produced.

$$\% \text{ Recovery} = (\text{permeate flow}/\text{feed flow}) \times 100 \quad (9-6)$$

Because the amount of concentrate in a single element is typically 85 percent of the feed stream flow, wasting the entire concentrate is not cost-effective. Also, in water plants, the amount of permeate water needed for consumers is large. Therefore, many elements are required to provide the requisite membrane surface area to generate the needed permeate flow. Often the membrane pressure vessels are arrayed in formations in which the concentrate of the first row of elements is fed to the second row of pressure vessels. Because of the loss of permeate water, the second and further rows of pressure vessels are fewer in number than the previous row. This maintains the cross-flow velocity across the membrane surface. Figure 9-13 shows a typical staged array (Speth 1998). Also, to save money on pressure vessels, three elements are usually placed in a single pressure vessel. For testing and research purposes, often only one element is used, with the concentrate stream being recycled to the feed stream to increase the recovery level to that associated with a staged array (typically 70 to 90 percent).

Allgeier and Summers (1995) developed a bench-scale technique using a 4x6-inch flat-plate system to predict the performance of full-scale systems. Although limited in long-term performance, researchers have shown that it can predict rejection, initial flux, and cleaning intervals for full-scale systems (Allgeier et al. 1996; Allgeier et al. 1997; Gusses et al. 1996; Speth et al. 1996; Speth et al. 1997; Gusses et al. 1999).



**Figure 9-13. Typical membrane staged array (Speth 1998).**

## ***Performance***

### **Rejection**

Fronk and Lykins (1998) and Lykins and Clark (1994) showed that RO membranes rejected between 0 and 95 percent of the individual THM species. The thin-film composite membranes had superior rejection properties compared to the other membranes tested. Because precursor material is easier to reject than DBPs, NF membranes are typically only used for precursor removal.

Taylor et al. (1987) found that NF membranes rejected over 90 percent of the DOC in natural waters. Allgeier and Summers (1995) showed that for five natural waters, 67 to 94 percent of the TOC was rejected. Taylor et al. (1987) found that membranes with nominal molecular-weight cutoffs of 400 daltons or less were needed to control DBP precursors. This was confirmed by Taylor et al. (1989). Blau et al. (1992), Watson and Hornburg (1989), and Reiss et al. (1999a) also found that THM precursors could be controlled with NF. Allgeier and Summers (1995) showed that NF membranes removed THM precursors by 66 to 93 percent, haloacetic acid (HAA) six (HAA6) precursors by 67 to 97 percent, as well as precursors for other DBPs. In general, TOC rejection was a good surrogate for DBP precursor control. Speth (1998) also saw good rejection of DBP precursors for a membrane system fed conventionally treated Ohio River water (CT-ORW) for 15 months, as shown in Table 9-1.

### **Fouling and Flux Curves**

The loss of membrane efficiency due to fouling is one of the main impediments to the development of membrane processes for use in drinking water treatment. Membrane fouling is dependent on the water quality as well as the membrane's properties and construction. In general, fouling is defined as the accumulation of material on the surface, or in the pores, of a membrane that decreases the water flux through the membrane. Durham (1993) further distinguishes between membrane fouling and spacer fouling. The consequences of fouling can be severe; fouling can reduce the water flux through a membrane up to 90 percent (Belfort 1977).



**Table 9-1. Organic and Particulate Bulk Rejections for Pilot Systems Fed CT-ORW (Speth 1998)**

Parameter	Mean Feed Conc.	Bulk Rejections (%)	
		4" × 40" System	1.75" × 12" System
TOC, mg/L	1.99 (0.41,43)	94.8 (3.6,43)	95.9 (3.3,43)
UVA, 1/m	4.54 (1.39,46)	97.9 (1.2,46)	98.5 (1.4,46)
Term. THM, µg/L	224 (76,6)	95.6 (0.6,6)	96.1 (0.7,6)
SDS THM, µg/L	97 (49,6)	97.1 (1.1,6)	96.1 (4.9,6)
Term. TOX, µg/L	265 (101,6)	95.8 (0.8,6)	96.5 (1.4,6)
SDS TOX, µg/L	153 (116,6)	95.9 (3.1,6)	96.5 (4.9,6)
Turbidity, NTU	0.23 (0.08,64)	72.7 (11.8,64)	84.8 (10.9,64)
Particle counts, #/ml	882 (265,18)	99.5 (0.4,18)	99.4 (0.5,18)
HPC, CFU/µl	33.5 (27.4,25)	96.9 (4.7,25)	98.9 (3.1,25)
Aerobic spores, CFU/L	100 (NA,1)	81.8 (NA,1)	80.0 (NA,1)

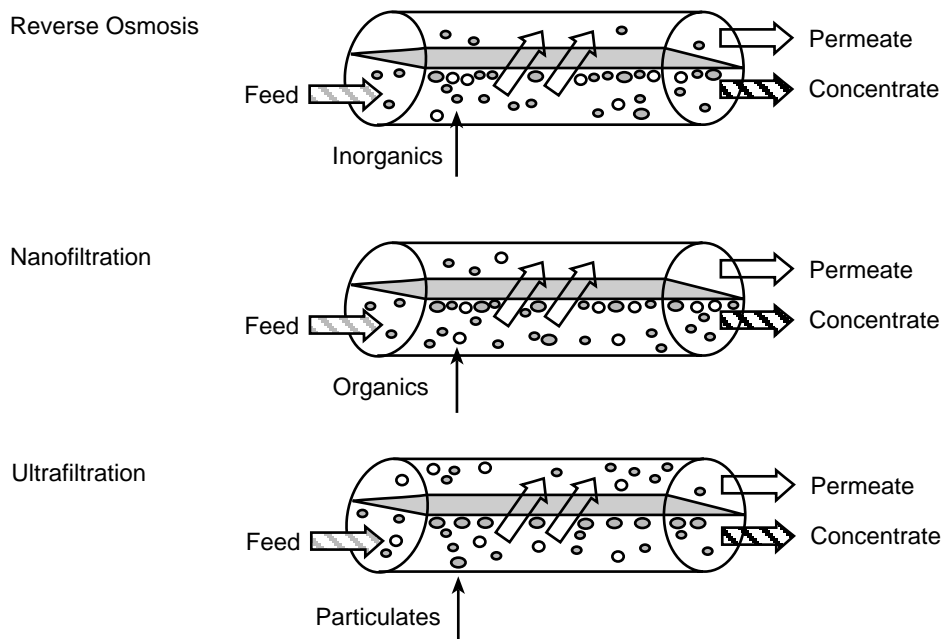
Standard deviations and number of samples are listed in parentheses, respectively.

NA = Not applicable

There are five broad fouling categories: microorganisms, colloidal or particulate matter, dissolved organics, sparingly soluble inorganics, and chemical reactants (Belfort 1977; Matthiasson and Sivik 1980; Potts et al. 1981; Barger and Carnahan 1991; Suratt 1993). Dissolved organics and colloidal matter are considered to be serious foulants due to the difficulty in removing them with pretreatment processes. Biofouling is also a serious and common fouling problem (Paul 1991). Inorganic fouling can often be controlled by acid addition. For instance, the pH needed to control calcium carbonate precipitation can be determined by a Langelier saturation index. Often, the type of foulant is operationally defined by the type of membrane cleaning agent that is effective in recovering water flux. Inorganic foulants are typically removed with acid solutions, whereas organic and biological foulants are typically removed with alkaline/detergent solutions.

Direct methods for determining the nature of the foulant include optical microscopy, scanning electron microscopy, X-ray fluorescence, atomic absorption, transmission and reflection infrared spectroscopy, energy dispersive X-ray, electron spectroscopy for chemical analysis (ESCA), pyrolysis-gas chromatograph/mass spectroscopy (GC/MS), and phospholipid analyses. Optical microscopy is useful for identifying color, size, crystalline structure, and refractive indices of foulants. Scanning electron microscopy can further refine the results determined with optical microscopy. Energy dispersive X-ray analysis and ESCA will give information regarding the elemental composition of the foulant. Infrared spectroscopy can qualitatively fingerprint the foulant in terms of functional groups and chemical structure, while pyrolysis-GC/MS can fingerprint the foulant in terms of biopolymer groupings.

For NF membranes, foulant precipitation is exacerbated by concentration polarization. Concentration polarization occurs when the convective flow of foulants toward the membrane surface is greater than the diffusional flow of foulants to the bulk solution. This only occurs before steady state is achieved. The concentration of foulants will therefore increase near the membrane until steady state is reached. Figure 9-14 shows a schematic of membrane permeation and rejection for RO, NF, and MF systems (Speth 1998). For RO and NF, the elevated concentration of foulants near the membrane surface is often the causative agent for fouling due to precipitation. In dead-end cells, where the concentrate is not removed from contact with the membrane, steady state is not achieved. The continuous accumulation of the components that are rejected by the membrane in the dead-end cells maximizes precipitation and fouling.



**Figure 9-14. Schematic of membrane permeation and rejection for RO, NF, and MF systems (Speth 1998).**

MF and UF membranes do not have the same type of concentration polarization that NF and RO membranes experience because of the lower rejection of dissolved constituents, as shown in Figure 9-14. However, UF membranes have a sparse membrane porosity that results in a local polarization phenomena that may be much greater than the average polarization (Fane and Fell 1987).

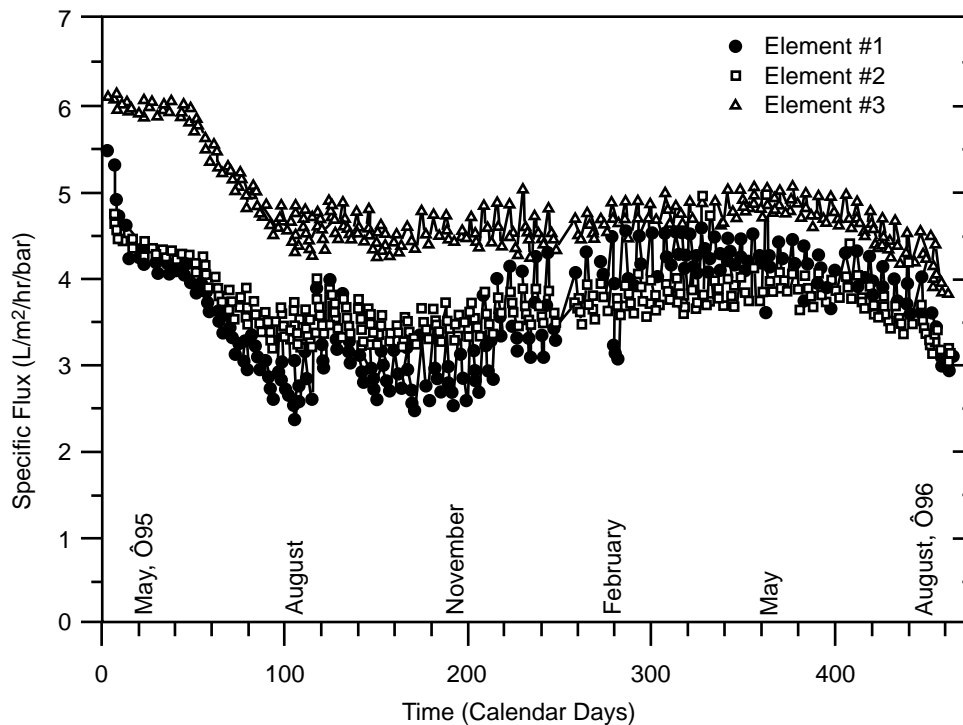
Figure 9-15 shows a flux decline curve for NF membrane elements fed CT-ORW (Speth et al. 1998). The fluxes show a distinct seasonal trend, with the greatest overall flux decline occurring in the summer and fall seasons. During these times, weekly cleaning with acid only partially offset the lost in flux due to fouling. This frequent cleaning would be difficult for a water utility to justify, but it points to the difficulty of using NF on a surface water, even a surface water such as this one with a low organic concentration (average TOC = 2.0 mg/L). Taylor et al. (1992) also have evaluated fouling from surface- and ground-water sources. They found that membranes used to treat surface waters have much higher fouling rates than membranes used to treat ground waters.

Speth et al. (1998) found that the foulant from pilot NF membrane elements fed CT-ORW was a film layer 20 to 80  $\mu\text{m}$  thick, with the greatest depth in the first of three elements in series. Heterotrophic plate counts, phospholipid analyses, and pyrolysis-GC/MS analysis of the foulant showed it to be dominated by biological growth. This explains the flux declines in the summer months.

### Flux Loss Mitigation

Improvements of fluxes can be related to flow and solution characteristics, membrane material, and pretreatment (Van den Berg and Smolders 1990). With regard to equipment design, there are many things that can be done to reduce fouling (Marshall et al. 1993). Membrane manufacturers incorporate many fouling-reducing features into their element construction.

Membranes can be fouled either by adsorption or cake-layer formation. Adsorption involves materials attaching within the pores, or matrix, of the membrane. This type of fouling is generally considered irreversible, although chemical cleaning can be effective in some cases (Belfort 1977). Cake-layer fouling, or



**Figure 9-15. Flux decline curve for NF membrane elements fed CT-ORW (Speth et al. 1998).**

reversible colmatage, involves the accumulation of material on the membrane surface. Cake-layer fouling is thought to be controlled by adjusting hydraulic operating parameters, such as cross-flow velocity or recovery of the systems. Cross-flow velocity is the velocity of the water in the feed channel, whereas recovery is the percentage of permeate flow to the total feed flow.

System recovery will dictate the concentration of dissolved species on the feed side of the membrane. The increased concentration of dissolved species on the feed side of the membrane increases the likelihood of precipitation of inorganic foulants such as calcium carbonate or barium sulfate. Organic contaminants also may be destabilized in the concentration layer. Reducing the system recovery can lead to less fouling.

The fluid pressure can also be manipulated to limit fouling. A higher pressure above the membrane will result in a greater flux of water through the membrane. Many researchers have found that the higher the initial flux, the greater the flux decline (Gutman 1977; Wilkes et al. 1996; Hong and Elimelech 1997; Chellam et al. 1998).

Changing the operating conditions can limit the amount of irreversible fouling. Crozes et al. (1997) found that increasing the cross-flow velocity, reducing the flux, and increasing the backwash frequency limited the short-term reversible fouling. This also controlled the rate of flux loss due to irreversible fouling.

As mentioned previously, the choice of membrane type will also determine the amount of fouling. Elimelech et al. (1997) and Zhu and Elimelech (1998) found that there was a significantly higher fouling rate for a thin-film composite membrane compared to that for a cellulose acetate membrane. The higher fouling rate for the thin-film composite membrane was attributed to greater surface roughness, which is inherent in interfacially polymerized aromatic polyamide composite membranes. Atomic-force microscopy and scanning-electron microscopy images supported the conclusions. The greater

surface roughness would allow for greater depositions of colloids. Ridgway and Safarik (1991) found that biofilms attached more strongly to polyamide surfaces than to cellulose acetate surfaces. They attribute the greater fouling rate of polyamide membranes to biological growth.

Along with fluid flow characteristics and membrane type, fouling can be reduced by optimizing feed-water pretreatment. This may entail adjusting the pH, adding anti-scalant agents, or using a pretreatment unit process such as coagulation, filtration, MF, and/or GAC. Typically, acid addition and anti-scalant agents are used to limit inorganic fouling. Numerous researchers have looked into pretreatment processes to reduce membrane fouling (Laine 1989; Taylor et al. 1989; Wiesner et al. 1989; Reiss and Taylor 1991; Taylor et al. 1992; Amy et al. 1993; Solomon et al. 1993; Chellam et al. 1997; Gusses et al. 1997). Processes used by these researchers were MF, coagulation/sedimentation, filtration, GAC, ozonation, and biologically active sand columns. Solomon et al. (1993) and Gusses et al. (1997) demonstrated that biological-filtration pretreatment showed the most promise with regard to reducing flux decline during UF. Chellam et al. (1997) showed that MF and UF pretreatment of a conventionally treated water gave significantly lower NF fouling rates than just conventional treatment.

For organic fouling of NF membranes, the greater the amount of hydrophobic compounds in a feed water, the greater the degree of hydrophobic adsorption, or fouling. Also, the amount of high-molecular-weight organic matter correlates to greater amounts of cake-layer formation. Carbon adsorption can be an effective, but expensive way, to control hydrophobic organic fouling.

In a follow-up study to the 15-month membrane project shown in Figure 9-15, Speth et al. (2000) evaluated five different additional pretreatments to CT-ORW. The chosen additional pretreatments were intended to produce waters with varying biological-fouling potential. Five parallel membranes were fed CT-ORW, ozonated CT-ORW, ozonated/biofiltered CT-ORW, CT-ORW reduced to 7°C, and chloraminated CT-ORW. All systems showed significant flux decline, indicating that methods beyond those needed for just biogrowth control are required for NF systems treating conventionally treated surface waters. The NF systems fed ozonated, ozonated/biofiltered, and untreated CT-ORW had the least amount of flux decline over the course of the study; however, they had significant amounts of biological growth. Fouling in these systems was attributed to the deposition of extracellular material (polysaccharides) in the cake layer, either from the biogrowth on the membrane or carryover from the pretreatment. The low-temperature system had greater flux decline, but it had lower biogrowth than the ozonated, ozonated/biofiltered, and untreated CT-ORW systems. Although lower in biogrowth, the deposited organic material in the low-temperature system still showed a strong biological signature (polysaccharides and aminosugars). The chloraminated system had the greatest flux decline, but the least amount of biogrowth. The organic material deposited in the chloraminated system showed a high level of proteinaceous character.

As mentioned previously, particulates and colloids can be major foulants. While ground waters generally do not cause concern because of the low particulates found in ground waters, surface waters require at least conventional treatment to remove particulates to acceptable levels. Typically, if the turbidity is less than one NTU, it is acceptable for membrane feed water (Potts et al. 1981).

In a comparison of conventionally pretreated surface water to riverbank-filtered water, Merkel et al. (1998) and Speth et al. (1999) found that riverbank-filtered water had significantly less flux decline than conventionally pretreated river waters. In essence, riverbank filtration changes a surface water to a ground water. Therefore, because ground waters are better source waters for NF treatment, riverbank filtration should be an effective pretreatment for a utility that wishes to utilize membrane technologies. Table 9-2 shows the percent of flux lost after 62 days for two watersheds (Speth et al. 1999). In both cases, the flux lost was much lower in the bank-filtered systems.

**Table 9-2. Flux Loss Comparison for Conventionally Treated and Riverbank-Filtration Pretreated Water (Speth et al. 1999)**

Location	Water	Length of Operation (days)	Number of Cleaning/Flux Cycles	Mean Calculated Cleaning Frequency (days)	% Flux Lost After Approx. 62 Days
Louisville Bank filtered	Ohio River	62	7	75 <sup>#</sup>	4
Louisville Conv. treated	Ohio River	79	8	36 <sup>#</sup>	46
Cincinnati Conv. treated	Ohio River	460	51	8	36
Southwestern Ohio Bank filtered	Little Miami River	79	1	62	12
Southwestern Ohio Conv. treated	Harsha Lake	70	12	8	50

Includes initial cycle.

<sup>#</sup> Not arithmetic mean, projected from slope of entire run.

### Flux Recovery Through Cleaning

There are a number of techniques that can be used to recover flux from a fouled membrane. Typically, acid cleaning is used to remove inorganic foulants. If the membrane is fouled with organic molecules (extracellular material and microbes), a detergent has been found to be successful (Ridgway et al. 1985). Hong and Elimelech (1997) found that a strong chelating agent is effective for removing free and NOM-complexed calcium ions from fouled membranes.

The type of membrane cleaner will be dependent on the membrane material. Some membranes, such as cellulose acetate membranes, are not stable over wide pH ranges. Therefore, acid/base cleaning is not practical for these membranes. Aromatic cross-linked polyamide membranes are generally incompatible with nonionic polyoxyethylene *n*-oxide detergents and cationic surfactants such as quaternary ammonium compounds. In these cases, the cleaner causes rapid and irreversible flux loss.

NF membranes are typically cleaned whenever the permeate flux decreases to 85 percent of the initial permeate flux or when the feed pressure increases to 115 percent of the initial feed pressure for elements operated at a constant flux (Fu et al. 1994). The degree of membrane fouling, which dictates the frequency of cleaning, will have a significant impact on the cost, design, and operation of full-scale facilities. Wetterau et al. (1996) showed that the efficiency of overall water production was not affected by either constant pressure or constant flux operation.

The cleaning of NF and RO membranes is completed in normal flow modes. However, backflushing the membrane has been evaluated (Breslau et al., 1980). Backflushing involves passing water from the permeate side of the membrane to the concentrate side. Backflushing has been found to increase flux, but it does not work well for removing proteins that are strongly adsorbed. Also, backflushing is not recommended for composite membranes because of the potential to destroy the thin film due to the lack of a support layer on the feed side of the membrane.

Most flux decline occurs immediately after startup or chemical cleaning. Although difficult to discern in Figure 9-15, each weekly specific flux decline curve for the membrane-fed CT-ORW was nonlinear in nature with a rapid initial specific flux decline followed by a less rapid specific flux decline. It was found

that the flux curves could be accurately fit by two linear slope segments covering the initial slope and the final slope for a typical weekly flux decline curve (Speth et al. 1998). The initial flux declines were greater than the final flux declines. The final flux declines are used to determine cleaning frequency.

### **Other Issues**

The use of coagulants and powdered adsorbents within the membrane element can improve the final water-quality of MF and UF membrane systems (Jacangelo, 1999). Coagulants and powdered adsorbents can remove DBP precursors while being rejected by the membrane. The membrane system can increase the mean residence time of the coagulant or powdered adsorbent, increasing their effectiveness. This is not an issue for RO and NF membranes because they already have excellent rejection characteristics.

### **Bromide Issues**

NF membranes reject bromide to a lesser extent than NOM or DBP precursors are rejected. Therefore, as with GAC treatment, the effluent/permeate stream will have a higher ratio of bromide to DOC than the feed stream. This will result in a greater percent of brominated DBPs than would normally occur. However, as mentioned previously, typical NF membranes reject such a high percentage of DBP precursors that the absolute amounts of brominated species reaching the consumer is very low. The bromoform to chloroform ratio is high for the membrane treated water; however, there is very little of each.

Summers et al. (1993) found that NF was effective for controlling the formation of chloroform, but it increased the relative percentage of bromo-substituted compounds to chloro-substituted ones. This was the result of higher bromide-to-organic precursor levels in the permeate water. Jacangelo et al. (1993) also found that NF reduced the amount of THMs formed, but altered the speciation of THMs and HAAs. Allgeier and Summers (1995) found that the DBPs of membrane-treated water shifted to the bromo-substituted compounds because of the preferential rejection of organic matter over bromide.

### **Blending**

As mentioned previously, blending membrane product water with pretreated membrane feed water often occurs because utilities with NF membranes wish to lower costs. Because NF can remove such a high degree of precursors, significant blending is possible, even with strict DBP limits. Not only is it more economical to blend, but it helps make the product water less corrosive (Lytle et al. 1996).

### ***Integrated Membrane Systems***

MF and UF membranes can be effective surface-water pretreatments for NF and RO membranes (Taylor et al. 1992; Robert et al. 1999; Reiss et al. 1999b). The combination of MF/UF membranes for particulate pretreatment control and NF/RO membranes for organic control is referred to as integrated membrane systems (IMS). In some hard-to-treat waters, a coagulant is needed prior to the MF/UF pretreatment (Robert et al. 1999).

The advantage of using MF or UF membranes for NF/RO pretreatment is that the MF/UF membranes will remove a sizeable percentage of pathogens. Reiss et al. (1999b) showed that IMS systems removed from 5.4 to 10.7 logs of pathogen surrogate *Bacillus subtilis*. Robert et al. (1999) showed greater than 4 logs of *Bacillus subtilis* removal. The disadvantage of using MF or UF membranes for NF/RO pretreatment is the high cost of installing two different types of membrane systems. Owen et al. (1999) found that MF removed from 4 to 6 logs of spores, while MF/NF systems together removed 8 to 11 logs of spores. Kruithof et al. (1998) found that UF membranes could remove greater than 5 logs of MS-2 phages.

## Conclusions

Activated carbon is an effective process for removing DBP precursors. It is not designed for pathogen removal. The effectiveness for precursor removal is dependent on a number of design issues such as carbon type, filter location, filter depth, filter flow rate, and blending choices. It is also dependent on a number of water quality issues such as initial precursor concentration, precursor adsorbability, precursor adsorption kinetics, temperature, dissolved oxygen levels, pH, and bromide concentration. Although much progress has been made on the modeling of GAC system performance, the applicability of this technology to any drinking water utility will need to be determined by pilot testing.

Membrane technologies are effective processes for removing DBP precursors. MF and UF membranes are excellent for removing pathogens and particulates and can be used as a replacement for conventional treatment. NF and RO membranes are excellent for removing DBP precursors, but are not counted on as a pathogen barrier due to blending and glue-line-failure issues. Reducing the effect of membrane foulants is a main consideration in the design of NF and RO plants, especially for plants treating surface waters. Although much progress has been made on modeling and scaling up small-membrane results, the applicability of this technology will need to be determined by pilot testing.

## References

- Allgeier, S. C. and Summers, R. S. (1995). "Evaluating NF for DBP control with the RBSMT." *Journal of the American Water Works Association*, 87(3), 87–99.
- Allgeier S. C., Gusses, A. M., Speth, T. F., Westrick, J. J., and Summers, R. S. (1996). "Verification of the rapid bench-scale membrane test and the ICR requirements." *Proceedings, GAC, Membranes and the ICR: A Workshop on Bench-Scale and Pilot-Scale Evaluations*, Cincinnati, OH, March 3–5.
- Allgeier, S. C., Gusses, A. M., Speth, T. F., and Summers, R. S. (1997). "Verification of the rapid bench-scale membrane test for use in the ICR." *Proceedings, American Water Works Association Membrane Technology Conference*, New Orleans, LA, February 23–26.
- Amy, G., et al. (1993). "Membrane separation of DBP precursors from low-turbidity surface waters." *Proceedings, American Water Works Association Membrane Technology Conference*, Baltimore, MD, August 1–5, 651–664.
- Barger, M. and Carnahan, R. P. (1991). "Fouling prediction in reverse osmosis processes." *Desalination*, 83, 3–33.
- Belfort, G. (1977). "Pretreatment and cleaning of hyperfiltration (reverse osmosis) membranes in municipal wastewater renovation." *Desalination*, 21, 285–300.
- Benz, M. A., Summers, R. S., Haist-Guide, B., Koching, M., and Sontheimer, H. (1992). "Combined use of ion exchange resins and granular activated carbon for the control of organic matter and disinfection by-products." *Proceedings, American Water Works Association Annual Conference*, Vancouver, B.C., June 18–22.
- Blau, T. J., Taylor, J. S., Morris, K. E., and Mulford, L. A. (1992). "DBP control by nanofiltration: Cost and performance." *Journal of the American Water Works Association*, 84(12), 104–116.
- Bonner, F. A and O'Melia, C. R. (1991). "Some aspects of the fouling of ultrafiltration membranes by natural organic matter in water treatment." *Proceedings, American Water Works Association Membrane Technology Conference*, Orlando, FL, March 10–13.

- Breslau, B. R., Testa, A. J., Milnes, B. A., and Medjanis, G. (1980). *Ultrafiltration membranes and applications*, A. R. Cooper, ed., Plenum, New York, 109–128.
- Camper, A. K., Broadaway, S. C., LeChevallier, M. W., and McFeters, G. A. (1987). “Operational variables and the release of colonized granular activated carbon particles in drinking water.” *Journal of the American Water Works Association*, 79(5), 70–74.
- Cerminara, P. J., Sonial, G. A., Papadimas, S. P., Suidan, M. T., Moteleb, M. A., and Speth, T. F. (1995). “Effect of influent oxygen concentration on the GAC adsorption of VOCs in the presence of BOM.” *Water Research*, 29(2), 409–419.
- Chellam, S., Jacangelo, J. G., Bonacquisti, T. P., and Schauer, B. A. (1997). “Effect of pretreatment on surface water nanofiltration.” *Journal of the American Water Works Association*, 89(10), 77–89.
- Chellam, S., Jacangelo, J. G., and Bonaquisti, T. P. (1998). “Modeling and experimental verification of pilot-scale hollow fiber, direct flow microfiltration with periodic backwashing.” *Environmental Science and Technology*, 32, 75–81.
- Clark, R.M., Symons, J. M., and Ireland, J. C. (1986). “Evaluating field scale GAC systems for drinking water.” *Journal of Environmental Engineering Division of the ASCE*, 112(4), 744–756.
- Clark, R. M. (1987). “Modeling TOC removal by GAC: The general logistic function.” *Journal of the American Water Works Association*, 79(1), 33–37.
- Crittenden, J. C., Berrigan, J. K., and Hand, D. W. (1986). “Design of rapid small-scale adsorption tests for a constant diffusivity.” *Journal of the Water Pollution Control Federation*, 58, 312–319.
- Crittenden, J. C., Berrigan, J. K., Hand, D. W., and Lykins, Jr., B. W. (1987a). “Design of rapid fixed-bed adsorption test for nonconstant diffusivities.” *Journal of Environmental Engineering Division of the ASCE*, 113(2), 243–258.
- Crittenden, J. C., Luft, P., and Hand, D. W. (1987b). “Prediction of fixed-bed adsorber removal of organics in unknown mixtures.” *Journal of Environmental Engineering Division of the ASCE*, 113(3), 486–498.
- Crittenden, J. C., Hand, D. W., Arora, H., and Lykins, Jr., B. W. (1987c). “Design considerations for GAC treatment of organic chemicals.” *Journal of the American Water Works Association*, 79(1), 74–82.
- Crittenden, J. C., et al. (1999). “Correlation of aqueous-phase adsorption isotherms.” *Environmental Science and Technology*, 33, 2926–2933.
- Crozes, G. F., Jacangelo, J. G., Anselme, C., and Laine, J. M. (1997). “Impact of ultrafiltration operating conditions on membrane irreversible fouling.” *Journal of Membrane Science*, 124, 63–76.
- Durham, L. A. (1993). “Factors that influence cleaning of RO systems.” *Proceedings, American Water Works Association Membrane Technology Conference*, Baltimore, MD, August 1–5, 139–148.
- Elimelech, M., Zhu, X., Childress, A. E., and Hong, S. (1997). “Role of membrane surface morphology in colloidal fouling of cellulose acetate and composite aromatic polyamide reverse osmosis membranes.” *Journal of Membrane Science*, 127, 101–109.
- Eykamp, W. (1978). *American institute of chemical engineers symposium series*, 74, 233–235.
- Fane, A. G. and Fell, C. J. D. (1987). “A review of fouling and fouling control in ultrafiltration.” *Desalination*, 62, 117–136.



- Fronk, C. A. and Lykins, Jr., B. W. (1998). "Removal of chlorinated and brominated alkanes from drinking water using reverse osmosis." *Journal of Water Supply Research and Technology—Aqua*, 47(4), 183–195.
- Fu, P., Ruiz, H., Thompson, K., and Spangenberg, C. (1994). "Selecting membranes for removing NOM and DBP precursors." *Journal of the American Water Works Association*, 86(12), 55–72.
- Gusses, A. M., Allgeier S. C., Speth, T. F., and Summers, R. S. (1996). "Verification and use of the rapid bench-scale membrane test." *Proceedings, American Water Works Association Annual Conference*, Toronto, Canada, June 23–27.
- Gusses, A. M., Speth, T. F., Allgeier, S. C., and Summers, R. S. (1997). "Evaluation of surface water pretreatment processes using the rapid bench-scale membrane test." *Proceedings, 1997 American Water Works Association Membrane Technology Conference*, New Orleans, February 23–26.
- Gusses, A. M., Allgeier, S. C., Speth, T. F., and Summers, R. S. (1999). "Impact of membrane sample variability on the performance of the rapid bench-scale membrane test." *Proceedings, American Water Works Association Membrane Technology Conference*, Long Beach, CA, February 28–March 3.
- Gutman, R. G. (1977). "The design of membrane separation plant." *The Chemical Engineer*, July, 510–513, 521–523.
- Hartman, D. J., DeMarco, J., Metz, D. H., Himmelstein, K. W., and Miller, R. (1991). "DBP precursor removal by GAC and alum coagulation." *Proceedings, 1991 American Water Works Association Annual Conference*, Denver, CO, June 7, 1995.
- Hong, S. (1995). "Activated carbon adsorption of organic matter: Backwashing, desorption, and attenuation." Ph.D. dissertation, University of Cincinnati, Cincinnati, OH.
- Hong, S. and Elimelech, M. (1997). "Chemical and physical aspects of natural organic matter (NOM) fouling of nanofiltration membranes." *Journal of Membrane Science*, 132, 159–181.
- Hooper, S. M., Summers, R. S., Solarik, G., and Owen, D. M. (1996). "Improving GAC performance by optimized coagulation." *Journal of the American Water Works Association*, 88(8), 107–120.
- Jacangelo, J. G., Cummings, E. W., P Cote', P., and Mallevalle, J. (1993). "Influence of feedwater characteristics on ultrafiltration and nanofiltration permeate water quality." *Proceedings, American Water Works Association Membrane Technology Conference*, Baltimore, MD, August 1–5, 293–322.
- Jacangelo, J. G. (1999). "Control of disinfection by-products by pressure-driven membrane processes." *Formation and control of disinfection by-products in drinking water*. P. C. Singer, ed., American Water Works Association, Denver, CO, 305–328.
- Kruithof, J. C., Schippers, J. C., Kamp, P. C., Folmer, H. C., and Hofman, J. A. M. H. (1998). "Integrated multi-objective membrane systems for surface water treatment: Pretreatment of reverse osmosis by conventional treatment and ultrafiltration." *Desalination*, 117, 37–48.
- Lahoussine-Turcaud, V., Wiesner M. R., Bottero, J. Y., and Mallevalle, J. (1990). "Coagulation pretreatment for ultrafiltration of a surface water." *Journal of the American Water Works Association*, 82(12), 76–81.
- Lainé, J. M. (1989). "Optimization of organic removal in ultrafiltration of a natural water." Master's thesis, University of Illinois at Urbana-Champaign.

- Lainé, J. M., Hagstrom, J. P., Clark, M. M., and Mallevalle, J. (1989). "Effects of ultrafiltration membrane composition." *Journal of the American Water Works Association*, 81(11), 61–67.
- Luft, P. J. (1984). "Modeling of multicomponent adsorption onto granulated activated carbon in mixtures of known and unknown composition." Master's thesis, Michigan Technological University, Houghton, MI.
- Lykins, Jr., B. W., Clark, R. M., and Adams, J. Q. (1988a). "Granular activated carbon for controlling THMs." *Journal of the American Water Works Association*, 80(5), 85–92.
- Lykins, Jr., B. W., Clark, R. M., and Cleverly, D. H. (1988b). "Polychlorinated dioxin and furan discharge during carbon reactivation." *Journal of Environmental Engineering Division of the ASCE*, 114(2), 300–316.
- Lykins, Jr., B. W. and Clark, R. M. (1994). "U.S. drinking-water regulations: Treatment technologies and cost." *Journal of Environmental Engineering Division of the ASCE*, 120(4), 783–802.
- Lytle, D. A., Schock, M. R., Speth, T. F., and Swertfeger, J. (1996). "Evaluation of corrosion issues for nanofiltration treated water." *Proceedings, GAC, Membranes and the ICR: A Workshop on Bench-Scale and Pilot-Scale Evaluations*, Cincinnati, OH, March 3–5.
- Marshall, A. D., Munro, P. A., and Trägårdh, G. (1993). "The effect of protein fouling in microfiltration and ultrafiltration on permeate flux, protein retention and selectivity: A literature review." *Desalination*, 91, 65–108.
- Matthiasson, E. and Sivik, B. (1980). "Concentration polarization and fouling." *Desalination*, 35, 59–103.
- Merkel, T. H., Speth, T. H., Wang, J. Z., and Summers, R. S. (1998). "The performance of nanofiltration in the treatment of bank-filtered and conventionally treated surface waters." *Proceedings, American Water Works Association Water Quality Technology Conference*, San Diego, CA, November 1–4.
- Miltner, R. J., Nolan, S. A., Dryfuse, M. U., and Summers, R. S. (1994). "The control of DBPs by enhanced coagulation." *Proceedings, 1994 American Water Works Association Water Quality Annual Conference*, New York, June 19–23, 721–735.
- Miltner, R. J., Summers, R. S., Dugan, N. R., Koechling, M., Moll, D. M. (1996). "A comparative evaluation of biological filters." *Proceedings, 1996 American Water Works Association Water Quality Technology Conference*, New York, November.
- Owen, C., Taylor, J. S., Robert, C., and Reiss, C. R. (1999). "Microbial challenge of integrated membrane system large scale pilot plants treating a highly organic surface water." *Proceedings, American Water Works Association Water Quality Technology Conference*, Tampa, FL, October 31–November 4.
- Paul, D. H. (1991). "Reverse osmosis: Scaling, fouling, and chemical attack." *Desalination and Water Reuse*, 1, 8–11.
- Potts, D. E., Ahlert, R. C., and Wang, S. S. (1981). "A critical review of fouling of reverse osmosis membranes." *Desalination*, 36, 235–264.
- Reasoner, D. J., Blannon, J. C., and Geldreich, E. E. (1987). "Microbial characteristics of third-faucet point-of-use devices." *Journal of the American Water Works Association*, 79(10), 60–66.

- Reiss, C. R. and Taylor, J. S. (1991). "Membrane pretreatment of a surface water." *Proceedings, American Water Works Association Membrane Technology Conference*, Orlando, FL, March 10–13.
- Reiss, C. R., Taylor, J. S., Owen, C., and Robert, C. (1999a). "Diffusion-controlled organic solute mass transport in nanofiltration systems." *Proceedings, American Water Works Association Water Quality Technology Conference*, Tampa, FL, October 31–November 4.
- Reiss, C. R., Taylor, J. S., Robert, C., and Hong, S. (1999b). "Successful nanofiltration of 20 mg/L TOC river water." *Proceedings, American Water Works Association Membrane Technology Conference*, Long Beach, CA, February 28–March 3.
- Ridgway, H. F., Rigby, M. G., and Argo, D. G. (1985). "Bacterial adhesion and fouling of reverse osmosis membranes." *Journal of the American Water Works Association*, 77, 97–106.
- Ridgway, H. F. and Safarik, J. (1991) "Biofouling of reverse osmosis membranes." *Biofouling and biocorrosion in industrial water systems*, H. C. Flemming and G. G. Geesey, eds., Springer-Verlag, Berlin, 81–111.
- Robert, C., Taylor, J. S., Reiss, C. R., and Langenderfer, N. (1999). "Surface water treatment by integrated membrane systems with in-line coagulation." *Proceedings, American Water Works Association Membrane Technology Conference*, Long Beach, CA, February 28–March 3.
- Roberts, P. V. and Summers, R. S. (1982). "Performance of granular activated carbon for total organic carbon removal." *Journal of the American Water Works Association*, 74(2), 113–118.
- Semmens, M. J., Norgaard, G. E., Hohenstein, G., and Staples, A. B. (1986a). "Influence of pH on the removal of organics by granular activated carbon." *Journal of the American Water Works Association*, 78(5), 89–93.
- Semmens, M. J., Staples, A. B., Hohenstein, G., and Norgaard, G. E. (1986b). "Influence of coagulation on removal of organics by granular activated carbon." *Journal of the American Water Works Association*, 78(8), 80–84.
- Singer, P. C. (1994). "Control of DBPs in drinking water." *Journal of Environmental Engineering Division of the ASCE*, 120(4), 727–744.
- Snoeyink, V. L., Kirisits, M. J., and Pelekani, C. (1999). "Adsorption of disinfection by-product precursors." *Formation and control of disinfection by-products in drinking water*. P. C. Singer, ed., American Water Works Association, Denver, CO, 259–284.
- Snoeyink, V. L. and Summers, R. S. (1999). "Membranes." *Water quality and treatment*, 5th Ed., R. D. Letterman, ed., McGraw-Hill, Inc., New York, NY, 13.1–13.83.
- Solomon, T., Summers, R. S., and Speth, T. F. (1993). "The reduction of membrane fouling by physical, chemical and biological pretreatment." *Proceedings, American Water Works Association Membrane Conference*, Baltimore, MD, August 1–5, 159–186.
- Sontheimer, H. and Hubele, C. (1987). "The use of ozone and granulated activated carbon in drinking water treatment." *Treatment of drinking water for organic contaminants*. P. M. Huck and P. Toft, eds., Pergamon Press, Oxford.
- Sorial, G. A., Papadimas, S. P., Suidan, M. T., and Speth, T. F. (1994a). "Competitive adsorption of VOCs and BOM—Oxic and anoxic environments." *Water Research*, 28(9), 1907–1919.

- Sorial, G. A., Cerminara, P. J., Papadimas, S. P., Suidan, M. T., and Speth, T. F. (1994b). "Competitive adsorption of VOCs and BOM—Role of molecular oxygen." *Journal of the American Water Works Association*, 86(3), 80–90.
- Speth, T. F. (1986). "Predicting equilibria for single and multicomponent aqueous phase adsorption onto activated carbon." Master's thesis, Michigan Technological University, Houghton, MI.
- Speth, T. F. and Miltner, R. J. (1989). "The effect of preloading on the scale-up of GAC microcolumns." *Journal of the American Water Works Association*, 81(4), 141–148.
- Speth, T. F., Lykins, Jr., B. W., and Miltner, R. J. (1989). "The use of pilot columns for predicting full-scale GAC performance." *Proceedings, Design and Use of Granular Activated Carbon-Practical Aspects*, Cincinnati, OH, May 9–10, 139–143.
- Speth, T. F. and Miltner, R. J. (1990). "Adsorption capacity of GAC for synthetic organics." *Journal of the American Water Works Association*, 82(2), 72–75.
- Speth, T.F. (1990). "Removal of VOCs from drinking water by adsorption." *Significance and treatment of volatile organic compounds in water supplies*, N. Ram, K. Cantor, and R. Christman, eds., Lewis Publishers, Inc., Ann Arbor, MI, 229–260
- Speth, T. F. and Adams J. Q. (1991). "GAC and air stripping design support for the safe drinking water act." *Strategies and technologies for meeting SDWA requirements*, R. Clark and S. Summers, eds., Lewis Publishers, Inc., Ann Arbor, MI, 47–89.
- Speth, T. F. (1991). "Evaluating capacities of GAC preloaded with natural water." *Journal of Environmental Engineering Division of the ASCE*, 117(1), 66–79.
- Speth, T. F., Allgeier, S. C., Summers, R. S., Swertfeger, J., and Mylin, M. L. (1996). "Evaluating bench-scale nanofiltration studies for predicting full-scale performance." *Proceedings, GAC, Membranes and the ICR: A Workshop on Bench-Scale and Pilot-Scale Evaluations*, Cincinnati, OH, March 3–5.
- Speth, T. F., Gusses, A. M., Allgeier, S. C., Summers, R. S., Swertfeger, J. W., and MacLeod, B. W. (1997). "Predicting pilot-scale membrane performance with bench-scale studies." *Proceedings, American Water Works Association Membrane Technology Conference*, New Orleans, LA, February 23–26.
- Speth, T. F. (1998). "Evaluation of nanofiltration foulants from treated surface waters." Ph.D. Dissertation, University of Cincinnati, Cincinnati, OH.
- Speth, T. F. and Miltner, R. J. (1998). "Adsorption capacity of GAC for synthetic organics—Part II." *Journal of the American Water Works Association*, 90(4), 171–174.
- Speth, T. F., Summers, R. S., and Gusses, A. M. (1998). "Nanofiltration foulants from a treated surface water." *Environmental Science and Technology*, 32, 3612–3617.
- Speth, T. F., Merkel, T., Parrett, C. J, Gusses, A. M., Grandin, A. M., and Summers, R. S. (1999). "Riverbank filtration as a pretreatment for nanofiltration membranes." *International Riverbank Filtration Conference*, Louisville, KY, November 4–6.
- Speth, T. F., Summers, R. S., and Gusses, A. M. (2000). "Evaluation of nanofiltration pretreatments for flux loss control." *Desalination*, 130, 31–44.

- Summers, R. S., Benz, M. A., Shukairy, H. M., and Cummings, L. (1993). "Effect of separation processes on the formation of brominated THMs." *Journal of the American Water Works Association*, 85(1), 88–95.
- Summers, R. S., Hooper, S. M., Solarik, G., Owen, D. M., and Hong, S. (1995). "Bench-scale evaluation of GAC for NOM control." *Journal of the American Water Works Association*, 87(8), 69–80.
- Suratt, W. B. (1993). "The reduction of membrane fouling by physical, chemical and biological pretreatment." *Proceedings, American Water Works Association Membrane Technology Conference*, Baltimore, MD, August 1–5.
- Symons, J. M., Stevens, A. A., Clark, R. M., Geldreich, E. E., Love, Jr., O. T., and DeMarco, J. (1981). "Treatment techniques for controlling trihalomethanes in drinking water." *EPA-600/2-81-156*, Environmental Protection Agency, Cincinnati, OH.
- Taylor, J. S., Thompson, D. M., and Carswell, J. K. (1987). "Applying membrane processes to groundwater sources for trihalomethane precursor control." *Journal of the American Water Works Association*, 79(8), 72–82.
- Taylor, J. S., Mulford, L. A., Duranceau, S. J., and Barrett, W. M. (1989). "Cost and performance of a membrane pilot plant." *Journal of the American Water Works Association*, 81(11), 52–60.
- Taylor, J. S., et al. (1992). "Reduction of disinfection by-product precursors by nanofiltration." EPA Project Summary, *EPA/600/SR-92/023*, Office of Research and Development, April.
- Taylor, J. S. and Wiesner, M. (1999). "Membranes." *Water quality and treatment*, 5th Ed., R. D. Letterman, ed., McGraw-Hill, Inc., New York, NY, 11.1-11.71.
- United States Environmental Protection Agency. (1999). "Analysis of GAC effluent blending during the ICR treatment studies." *EPA 815-C-99-002*, September.
- van den Berg, G. B. and C. A. Smolders (1990). "Flux decline in ultrafiltration processes." *Desalination*, 77, 101–133.
- Vidic, R. D., Sorial, G. A., Papadimas, S. P., Suidan, M. T., and Speth, T. F. (1992). "Effect of molecular oxygen on the scaleup of GAC adsorbers." *Journal of the American Water Works Association*, 84(8), 98–105.
- Wang, J. Z., Summers, R. S., and Miltner, R. J. (1995). "Biofiltration performance: Part 1, relationship to biomass." *Journal of the American Water Works Association*, 87(12), 55–63.
- Warta, C. L. (1993). "Effect of oxygen tension on the activated carbon adsorption of natural organic matter in Ohio River water." Master's thesis, University of Cincinnati, Cincinnati, OH.
- Warta, C. L., Papadimas, S. P., Sorial, G. A., Suidan, M. T., and Speth, T. F. (1995). "The effect of molecular oxygen on the activated carbon adsorption of natural organic matter in Ohio River water." *Water Research*, 29(2), 551–562.
- Watson, B. M. and Hornburg, C. D. (1989). "Low-energy membrane nanofiltration for removal of color, organics, and hardness from drinking water supplies." *Desalination*, 72, 11–22.
- Wetterau, G. E., Clark, M. M., and Anselme, C. (1996). "A dynamic model for predicting fouling effects during the ultrafiltration of a groundwater." *Journal of Membrane Science*, 109, 185–204.

- Wiesner, M. R., Rook, J. J., and Fiessinger, F. (1987). "Optimizing the placement of GAC filtration units." *Journal of American Water Works Association*, 79(12), 39–49.
- Wiesner, M. R., Clark, M. M., and Mallevalle, J. (1989). "Membrane filtration of coagulated suspensions." *Journal of Environmental Engineering Division of the ASCE*, 115(1), 20–40.
- Wilkes, D. R., Chellam, S., Bonacquisti, T. P., Long, B.W., and Jacangelo, J. G. (1996). "Conventional treatment as a pretreatment for nanofiltration: Impact on DBP precursor removal, fouling, and facilities design." *Proceedings, American Water Works Association Annual Conference*, Toronto, Canada.
- Zhu, X. and Elimelech, M. (1997). "Colloidal fouling of reverse osmosis membranes: Measurements and fouling mechanisms." *Environmental Science Technology*, 31, 3654–3662.

## CHAPTER 10

### Coagulation<sup>1</sup>

#### Introduction

Coagulation has historically been used for the control of particulates in drinking water, and its role in the simultaneous control of organic carbon is well known. With the inclusion of disinfection by-product (DBP) control as part of the Environmental Protection Agency's (EPA's) drinking water regulatory philosophy, the role of coagulation has expanded to include control of DBP precursors. This chapter presents recent studies conducted by the EPA's Office of Research and Development (ORD) in Cincinnati that (1) examined conventional coagulation and coagulation enhanced to more effectively control organic carbon and DBP precursors, and (2) examined the effects of enhanced coagulation on other water quality parameters.

#### Background

Water systems treating particulate-laden surface waters conventionally coagulate their waters to remove turbidity. Their goal is to achieve sufficiently low levels that downstream filters operate without excessive buildup of head loss (HL) and achieve cost-effective filter run times (FRTs). During conventional coagulation, the concentration of natural organic matter (NOM) is lowered. Since DBP precursors are part of the NOM, a strategy for control of DBP formation is removal of the NOM by coagulation prior to disinfection. Because the NOM is largely unidentified and not directly measurable, total organic carbon (TOC) serves as a surrogate for the DBP precursors. Typically, about 90 percent of the TOC is dissolved organic carbon (DOC); the other 10 percent is sorbed onto particulates. There are surface waters, however, for which the DOC is a lower percentage of the total.

Aluminum and iron salts are typically used for coagulation. For metal salts, two mechanisms for removal of NOM are accepted (Singer and Harrington 1993; Krasner and Amy 1995; Owen et al. 1993). In the first, negatively charged NOM is neutralized by positively charged metals forming insoluble complexes (Al or Fe humates and fulvates), followed by precipitation of NOM with the floc. In the second, NOM adsorbs onto metal hydroxide (Al(OH)<sub>3</sub> floc or Fe(OH)<sub>3</sub> floc) precipitates. The effectiveness of coagulation is strongly dependent on pH and the dose of the coagulant. At higher coagulant doses, more metal for floc or complex formation is available. Typically, coagulation of NOM is most effective in the pH range of 5 to 6, as charge neutralization tends to be more effective at lower pH. At lower pH, the charge density of humic and fulvic acids is reduced, making them more hydrophobic and adsorbable. Lower pH can be achieved by acidification and/or by higher coagulant dosing. More metal hydroxide (Al(OH)<sub>3</sub> or Fe(OH)<sub>3</sub>) is formed at higher coagulant doses, therefore more H<sup>+</sup> in solution lowers the pH. Thus, TOC removal and DBP precursor removal can be enhanced by decreasing pH and/or by increasing coagulants doses.

NOM can be divided into hydrophobic and hydrophilic fractions (Singer and Harrington 1993). The hydrophobic fraction tends to be less soluble, higher molecular weight, and more aromatic and is described as humic. The hydrophilic fraction is described as non-humic. The humic (hydrophobic) fraction is that retained on XAD<sup>®</sup> resin. The non-humic (hydrophilic) fraction passes XAD<sup>®</sup> resin. The humic fraction is more readily coagulated by aluminum and iron salts than the non-humic fraction.

---

<sup>1</sup>Richard J. Miltner: ORD/NRMRL/WSWRD, AWBERC Mailstop 689, 26 West Martin Luther King Dr., Cincinnati, OH 45268, 513-569-7403, miltner.richard@epa.gov.

**Table 10-1. Required Percent Removal of TOC by Enhanced Coagulation (Federal Register 1998)**

Source Water TOC, mg/L	Source Water Alkalinity, mg CaCO <sub>3</sub> /L		
	0 to 60	>60 to 120	>120
>2.0 to 4.0	35	25	15
>4.0 to 8.0	45	35	25
>8.0	50	40	30

Ultraviolet absorbance (UVA) is caused by aromatic and unsaturated double bonds in the NOM and is commonly measured at 254 nm (UV254). Specific UVA (SUVA), or UV254 divided by DOC, is an indicator of the DBP precursor removal treatability (Federal Register 1998). Edzwald (1993) has shown that SUVA in the 4 to 5 L/mg-m range is characteristic of waters with humic (hydrophobic) carbon and is more easily coagulable for DOC control, whereas SUVA in the <3 L/mg-m range is characteristic of waters with non-humic (hydrophilic) carbon, which is less susceptible to DOC removal by coagulation.

Enhanced coagulation has two places in the Disinfectant/Disinfection By-Product (D/DBP) Rule. One is as a treatment technique for the control of precursors for identified and nonidentified DBPs. Another is as a best available technology (BAT) for the control of regulated total trihalomethanes (TTHMs) and five regulated haloacetic acids (HAA5).

As a treatment technique, water systems are not expected to optimize, or maximize, the removal of DBP precursors. Whether coagulation is enhanced or optimized for the control of DBP precursors is a matter of degree. So as not to be cost prohibitive, systems must meet target percent removals of TOC where TOC serves as a surrogate for the identified and nonidentified DBP precursors. The targets are based on two factors, the source water's TOC concentration and the source water's alkalinity. A 3 × 3 matrix results and is shown in Table 10-1 (Federal Register 1998). The table reflects two observed phenomena: relatively more TOC can be removed from higher-TOC waters than from lower-TOC waters, and lower percent removal of TOC is expected in higher-alkalinity waters as higher alkalinity makes depressing the pH more difficult.

Meeting the requirements of the 3 × 3 matrix is termed Step 1 in the D/DBP Rule. Systems may meet these requirements however they choose; enhancing coagulation is an option, as is the use of granular activated carbon, powdered activated carbon, etc.

As stated, the purpose of the TOC removal in the Step 1 matrix is control of precursors for identified and nonidentified DBPs. Systems with good control of DBPs do not have to meet the matrix requirements, i.e., there are alternative compliance criteria to Step 1. These are based on other water quality measures indicative of control of DBP precursors and include: source water TOC < 2.0 mg/L, treated water TOC < 2.0 mg/L, TTHM not > 40 ug/L and HAA5 not > 30 ug/L with the use of chlorine, source water SUVA ≤ 2.0 L/mg-m, and finished water SUVA ≤ 2.0 L/mg-m.

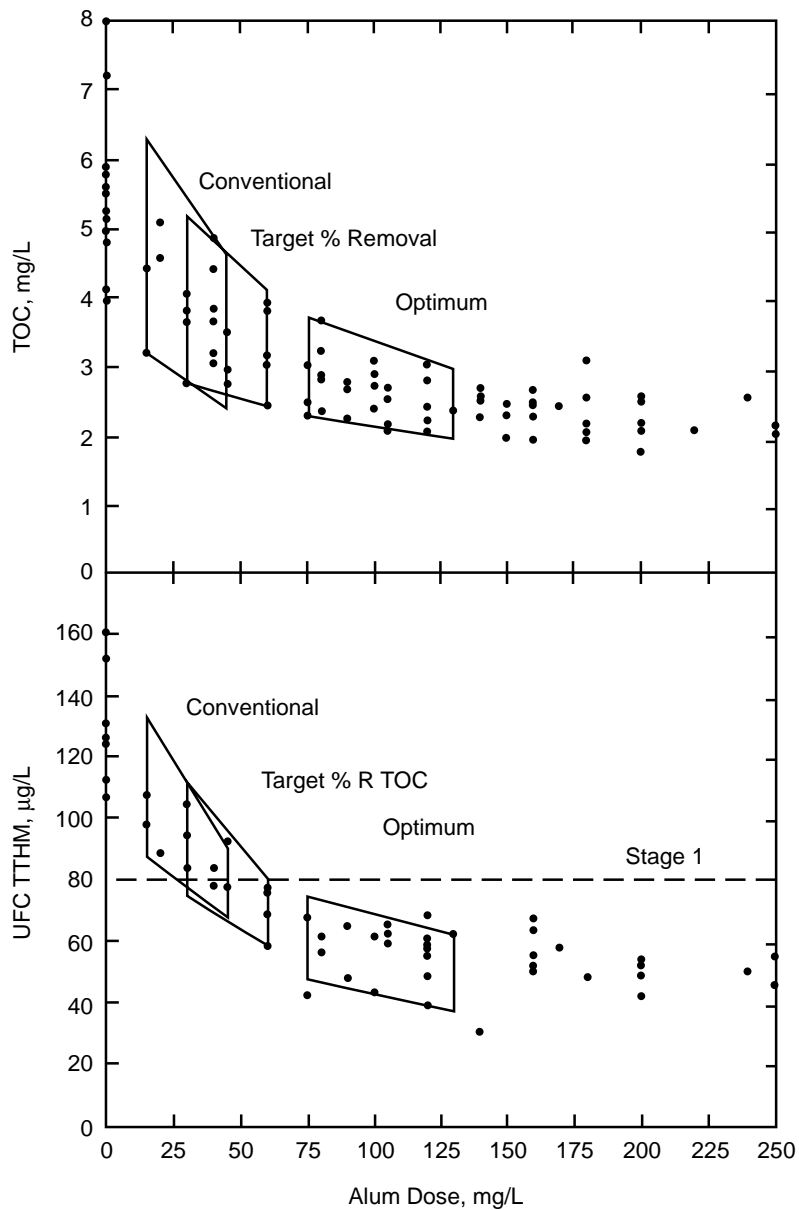
Meeting the requirements of the 3 × 3 matrix is thought to be achievable by 90 percent of drinking water systems, and these systems would realize an incremental improvement in DBP precursor over their conventional practices (Federal Register 1998). Some systems are likely to already meet Step 1 requirements with conventional coagulation (Krasner and Amy 1995).

If systems can not meet the Step 1 criteria because of the nature of their precursor, they must perform jar tests to determine how much TOC removal can be achieved, i.e., they must define alternative performance criteria. This is termed Step 2. The D/DBP Rule will force many water systems to move from conventional to enhanced coagulation and to expand their coagulation objectives to include TOC removal.

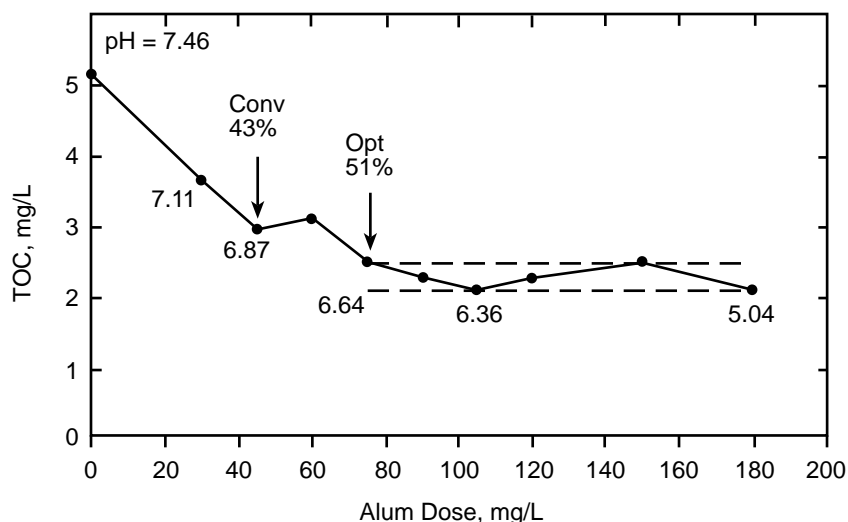


## Conventional vs. Enhanced vs. Optimized Coagulation

Figure 10-1 describes the results of adding alum to move from conventional coagulation (achieving the target percent removal of TOC) to coagulation optimized for the removal of TOC. It represents jar testing of 4 waters: Great Miami River (GMR), East Fork Lake (EFL), Miami Whitewater Lake (MWL), and Stonelick Lake (SL) (Miltner et al. 1994a). Alum doses to control turbidity ranged from as low as 15 mg/L to as high as 45 mg/L as indicated by the conventional box in the figure. Control of turbidity in jar testing was defined as achieving 1 nephelometric turbidity unit (NTU) in settled waters. Jar tested waters consistently resulted in lower settled turbidities than pilot-treated waters; based on these and other studies (Miltner et al. 1994b), jar test settled turbidities near 1 NTU resulted in pilot plant settled turbidities near 2 NTU. At the other extreme, doses to achieve optimized removal of TOC ranged from 75 to 130 mg/L as indicated by the optimum box in Figure 10-1. Optimized coagulation was defined as the lowest coagulant dose resulting in the best removal of TOC. An



**Figure 10-1. Control of TOC and UFC TTHM in GMR, EFL, MWL, and SL waters by coagulation (Miltner et al. 1994a).**



**Figure 10-2. Control of TOC in EFL water by alum coagulation (Miltner et al. 1994a).**

example is given in Figure 10-2 where 75 mg/L alum resulted in 51 percent removal of TOC; at higher doses, TOC concentrations could not be differentiated. Alum doses required to meet the requirements of enhanced coagulation ranged from 30 to 60 mg/L as indicated by the target % R TOC box in Figure 10-1. These results indicate that enhanced coagulation could be achieved at doses below those required to optimize TOC removal and at doses not significantly greater than those required to control turbidity. In some cases, conventional treatment alone was sufficient to meet the requirements of enhanced coagulation as indicated by the overlap of the conventional and target % R TOC boxes. These data support the intentions of the D/DBP Rule, wherein 90 percent of systems would be able to meet the requirements of enhanced coagulation with moderate changes to conventional coagulation.

Figure 10-1 also shows similar data for control of TTHM precursors. Precursors in this chapter were assessed by chlorination under uniform formation conditions (UFCs) (Summers et al. 1996). UFCs represent national, mean, finished-water, distribution-system conditions of 1 mg/L free chlorine after 24 hours at pH 8 at 20 C. Because they are distribution-system conditions, the DBP concentrations represent those reaching the consumer. When control of TTHM is considered for these four waters, conventional coagulation rarely produced TTHM concentrations below the D/DBP Rule Stage 1 maximum contaminant level (MCL) of 0.080 mg/L. Enhancing coagulation to meet the target percent removals of TOC generally resulted in TTHM concentrations below the Stage 1 MCL. In Figure 10-1, 30 mg/L represents only the lowest alum dose that achieved the target percent removal of TOC, i.e., it represents only one water on one date. Optimizing coagulation for TOC control always resulted in Stage 1 MCL compliance. Similar results were obtained for HAA5 and its Stage 1 MCL of 0.060 mg/L. This supports the basis of enhanced coagulation's place in the D/DBP Rule. As a BAT, enhanced coagulation can result in the control of TTHM and HAA5.

## Enhanced Coagulation's Role in Water Quality

Ohio River (OR), Green Swamp (GS) (Dryfuse et al. 1995), MWL, and EFL waters (Miltner et al. 1994a) were jar tested to assess the relationships between TOC, SUVA, chlorine demand, and precursors for total organic halide (TOX), TTHM, six haloacetic acids (HAA6), chloral hydrate (CH), four haloacetonitriles (HAN4) and chloropicrin (CP). Results are given in Table 10-2. The data show that conventional coagulation would not meet the requirements of the 3 × 3 matrix for TOC removal in OR and MWL waters and that additional treatment processes, enhanced coagulation or others, would be

required. Conventional coagulation would meet the requirements, however, in EFL and GS waters. Several trends are apparent in the results presented in Table 10-2. These trends are also apparent in Table 10-3.

### ***Improved Water Quality with Enhanced Coagulation***

Moving from conventional coagulation to coagulation optimized for the removal of TOC results in improved removal of precursors for TTHM, HAA6, CH, HAN4, CP, and the surrogate TOX and in reduction in chlorine demand. Using coagulation of MWL water as an example, optimized coagulation was better than conventional coagulation for all parameters. Based on the relationship between conventional, enhanced, and optimized coagulation described in Figure 10-2, moving from conventional coagulation to enhanced coagulation would result in improved removal of DBP precursors and reduction in chlorine demand, but to a lesser degree than moving to optimized coagulation.

**Table 10-2. Coagulation of OR, MWL, EFL and GS Waters with Alum**

Parameter	Percent Removal							
	OR		MWL		EFL		GS	
	Conv	Opt	Conv	Opt	Conv	Opt	Conv	Opt
	(Dryfuse et al. 1995) DOC = 2.47 mg/L Alkalinity = 59 mg/L TOC Target = 35% R UV254 = 0.05/cm SUVA = 2.02 L/mg-m		(Miltner et al. 1994a) TOC = 4.79 mg/L Alkalinity = 104 mg/L TOC Target = 35% R UV254 = 0.092/cm SUVA = 1.92 L/mg-m		(Miltner et al. 1994a) TOC = 5.16 mg/L Alkalinity = 80 mg/L TOC Target = 35% R UV254 = 0.19/cm SUVA = 3.70 L/mg-m		(Dryfuse et al. 1995) DOC = 15.3 mg/L Alkalinity = 88 mg/L TOC Target = 40% R UV254 = 0.73/cm SUVA = 4.77 L/mg-m	
TOC, DOC	20	46	18	45	43	51	47	71
UV254	20	60	32	54	68	74	67	86
SUVA	0	26	16	17	43	47	38	53
UFC TOX	30	63	36	60	57	73	70	86
UFC TTHM	18	59	16	49	53	74	60	83
UFC HAA6	36	67	44	71	66	79	70	90
UFC CH			22	56	59	72		
UFC HAN4			30	46	45	52		
UFC CP			34	61	43	61		
Cl <sub>2</sub> demand			37	61	53	50		

**Table 10-3. Coagulation of GMR Water with Alum and Ferric Chloride (Miltner et al. 1994a)**

Parameter	Percent Removal			
	Alum		Ferric Chloride	
	Conventional	Optimized	Conventional	Optimized
TOC	22	45	25	54
UFC TOX	9	44	23	51
UFC TTHM	13	46	25	54
UFC HAA6	10	61	31	64
UFC CH	30	66	41	73
UFC HAN4	25	40	26	44
UFC CP	39	44	61	78
Cl <sub>2</sub> demand	50	67	49	58
pH	7.92	7.04	7.85	6.91
Coagulant dose, mg/L	15	120	20	125

### ***TOC as an Indicator of DBP Precursor Control***

Coagulation to remove TOC results in the removal of the precursors for THMs, HAAs, CH, HANs, CP, and the surrogate TOX, and the removal of TOC is generally a conservative indicator of the removal of these DBP precursors. Using conventional coagulation of EFL water as an example, TOC removal was 43 percent, whereas removal of TTHM, HAA6, CH, HAN4, CP, and TOX precursors ranged from 43 to 66 percent. This supports the basis of enhanced coagulation's place in the D/DBP Rule. As a treatment technique, enhanced coagulation to remove TOC can result in the removal of precursors for numerous DBPs. As a BAT, enhanced coagulation can result in the control of TTHM and HAA5.

### ***Better Removal of TOC in Higher-TOC Waters***

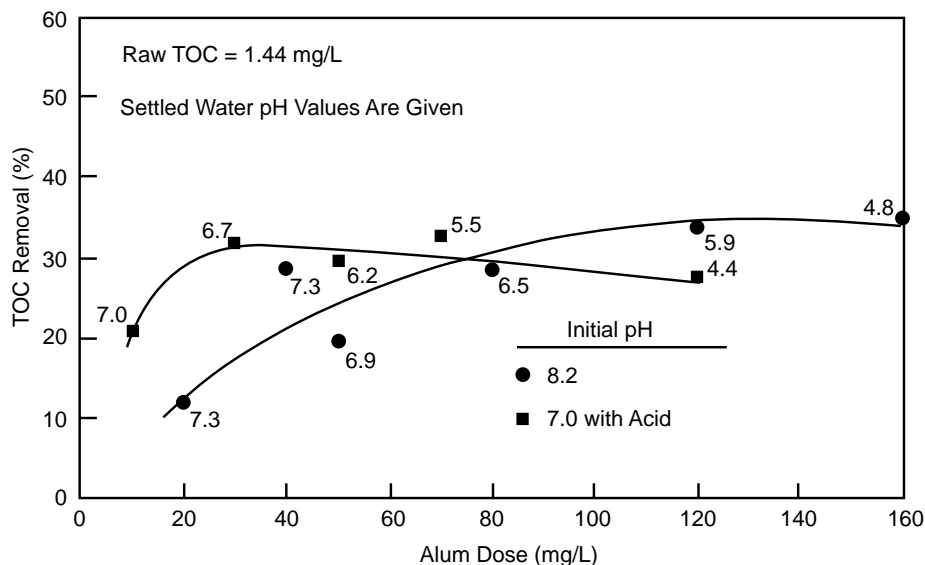
Raw waters higher in TOC tend to have higher percent removals of TOC. OR water with a raw TOC of 2.47 mg/L achieved an optimum TOC removal of 46 percent, whereas GS water with a raw TOC of 15.3 mg/L achieved 71 percent removal. This is consistent with the pattern in the 3 × 3 enhanced coagulation matrix (Table 10-1) in which higher-TOC waters are targeted for higher percent removal of TOC.

### ***SUVA as an Indicator of DBP Precursor Control***

Raw waters higher in SUVA tend to have higher percent removals of DBP precursors. OR and MWL waters with SUVAs near 2 L/mg-m achieved 60 to 63 percent removal of precursors for the DBP surrogate TOX when coagulation was optimized for TOC removal. EFL water with a SUVA of 3.70 L/mg-m achieved 73 percent and GS water with a SUVA of 4.77 L/mg-m achieved 86 percent. Precursors for TTHM and HAA6 generally followed the same trend. This is consistent with SUVA's use in the D/DBP Rule as an indicator of DBP precursor treatability.

### **Coagulation With and Without Acid Addition**

Systems may opt to achieve the lower pH of enhanced coagulation by increasing the coagulant dose and/or by adding an acid. Tryby et al. (1993) studied acid addition in jar testing of OR water. Figure 10-3 shows TOC control in an alum-treated water of ambient pH and an alum-treated water with pH

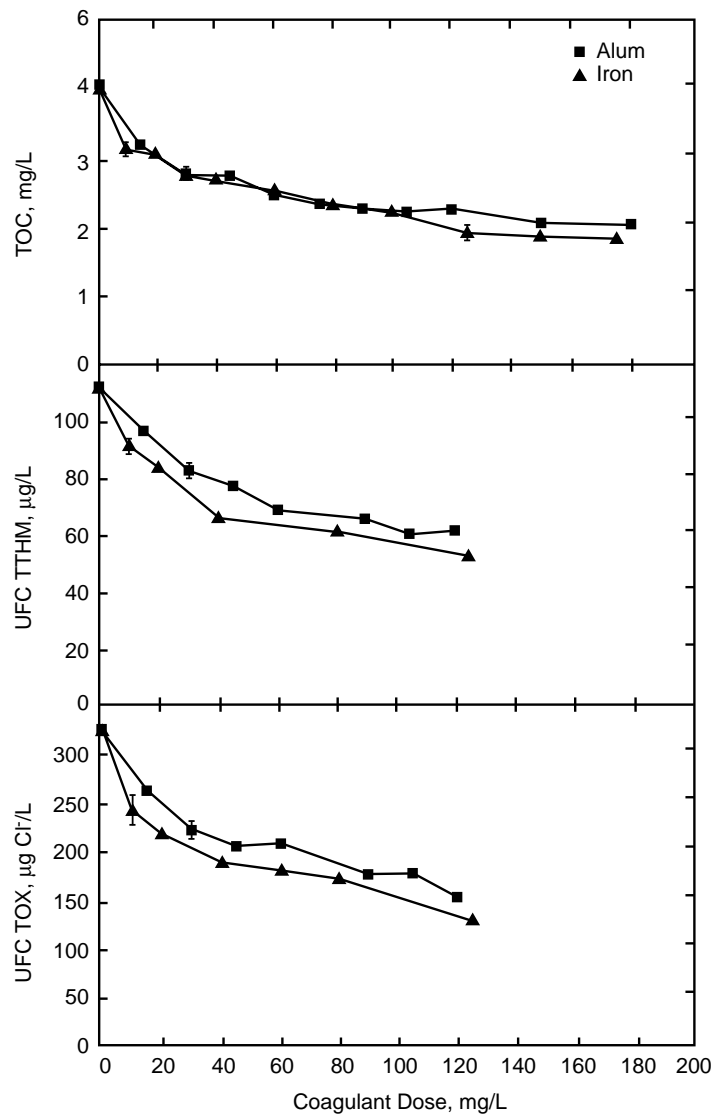


**Figure 10-3. Control of TOC in OR water by alum coagulation (Tryby et al. 1993).**

adjusted to 7 with hydrochloric acid. In each case, about 34 percent optimal removal of TOC was achieved. Without acid addition, 120 mg/L alum was required to achieve optimum TOC removal at pH 5.9. With acid addition, only 30 mg/L alum was required to achieve optimum TOC removal at pH 6.7. Each system attempting to enhance coagulation could decide on acid addition vs. additional coagulant based on factors such as safety, chemical handling, sludge production and handling, and costs.

### Comparing Alum and Iron Coagulation

Table 10-3 and Figure 10-4 show jar testing results in which GMR water coagulated with ferric chloride ( $\text{FeCl}_3 \cdot 6\text{H}_2\text{O}$ ) gave somewhat better removal of TOC and DBP precursors than when alum ( $\text{Al}_2(\text{SO}_4)_3 \cdot 14\text{H}_2\text{O}$ ) coagulated (Miltner et al. 1994a). The exception was in the control of chlorine demand. This may be affected by the reaction between iron and chlorine in meeting the UFC requirement of a 1 mg/L free chlorine residual.



**Figure 10-4. Control of TOC and DBP Precursors in GMR Water by Alum and Iron Coagulation (Miltner et al. 1994a).**

The lower pH that occurs with iron at a given coagulant dose may explain, in part, the better performance of iron compared to alum. These data must be viewed with caution, however, as they are presented on a weight basis. When doses are compared on an equivalence basis, the advantage of treating with ferric chloride is offset as the ferric chloride curves in Figure 10-4 shift to the right about 9 percent, i.e., an 81.9 mg/L dose of  $\text{FeCl}_3 \cdot 6\text{H}_2\text{O}$  is equivalent to a 90 mg/L dose of  $\text{Al}_2(\text{SO}_4)_3 \cdot 14\text{H}_2\text{O}$ . A system's choice of a coagulant should be based not only on treatment effectiveness but also based on factors such as cost, chemical handling, and sludge production and handling.

Table 10-3 also shows data similar to that in Table 10-2, i.e., improving coagulation to better control TOC results in improved control of precursors for TTHM, HAA6, CH, HAN4, CP, and the surrogate TOX.

## Fractionation

Dryfuse et al. (1995) studied OR, EFL, and GS waters for the effects of coagulation on humic and non-humic fractions of DOC and on molecular-sized fractions of DOC. Raw and coagulated jar tested waters were examined before (in bulk) and after fractionation. Both conventional coagulation and coagulation optimized for DOC removal were employed. Waters were fractionated by XAD-8 resin to isolate the non-humic (hydrophilic) fraction in the resin column effluent. The humic (hydrophobic) fraction was determined by difference. Waters were separated by two parallel ultrafiltration membranes into <0.5K and <3K molecular size (MS) ranges. Thus, by difference, <0.5K, 0.5K–3K, and >3K MS ranges were determined.

Results for OR and GS bulk (unfractionated) waters are presented in Table 10-2 and show that DBP precursor removal, as measured by TOX, TTHM, and HAA6, was improved as the coagulant dose was increased from conventional to that optimized for DOC control.

Most of the DOC and the DBP precursors were in the larger molecular size (>0.5K) range. This is described in Table 10-4 in which the fractions represent the mean of the three raw waters. Similarly, most of the DOC and the DBP precursors were in the humic fraction.

**Table 10-4. Molecular Size and H/NH Fractions of OR, EFL, and GS Raw Waters (Taken from Dryfuse et al. 1995; Dryfuse 1995)**

Parameter	Percent of Total			Percent of Total	
	>3K	0.5K–3K	<0.5K	H	NH
DOC	34	45	20	53	47
UFC TOX	53	42	5	68	32
UFC TTHM	33	53	14	67	33
UFC HAA6	44	46	10	73	27

H = humic; NH = non-humic.

The effect of coagulation on MS fractions is seen in Table 10-5 and represents the mean of the three waters. The behavior of the DOC fractions was similar to that of the DBP precursor fractions. Conventional coagulation removed a greater percentage of the >3K MS fraction (61 to 86 percent) than of the smaller-sized fractions (9 to 45 percent). Optimizing coagulation brought about a small improvement in the >3K MS range, i.e., a 0 to 14 percent increase. The greatest improvement with optimized coagulation, however, was in the 0.5K–3K MS range where increases ranged 39 to 49 percent. Improvement in the <0.5 MS range was small, i.e., 0 to 13 percent.

Table 10-6 describes the effect of coagulation on humic and non-humic fractions for the mean of the three waters. The behavior of the DOC fractions was similar to that of the DBP precursor fractions. Conventional coagulation removed a greater percentage of the humic fraction (51 to 62 percent) than of

**Table 10-5. Effect of Coagulation on Molecular-Sized Fractions of OR, EFL, and GS Waters (Taken from Dryfuse et al. 1995; Dryfuse 1995)**

MS Fraction	Percent Removal		
	DOC Conventional	DOC Optimized	Increase
>3K	81	86	5
0.5K–3K	9	49	40
<0.5K	16	26	10
	UFC TOX Conventional	UFC TOX Optimized	Increase
>3K	85	99	14
0.5K–3K	33	72	39
<0.5K	40	41	1
	UFC TTHM Conventional	UFC TTHM Optimized	Increase
>3K	61	61	0
0.5K–3K	22	63	41
<0.5K	45	45	0
	UFC HAA6 Conventional	UFC HAA6 Optimized	Increase
>3K	86	98	12
0.5K–3K	26	75	49
<0.5K	31	44	13

**Table 10-6. Effect of Coagulation on H/NH Fractions of OR, EFL and GS Waters (Taken from Dryfuse et al. 1995; Dryfuse 1995)**

H/NH Fraction	Percent Removal		
	DOC Conventional	DOC Optimized	Increase
H	51	72	21
NH	18	40	22
	UFC TOX Conventional	UFC TOX Optimized	Increase
H	52	83	31
NH	41	62	21
	UFC HAA6 Conventional	UFC HAA6 Optimized	Increase
H	62	86	20
NH	42	66	24

H = humic; NH = non-humic.

the non-humic fraction (18 to 42 percent). Optimizing coagulation brought about similar improvement in the removal of both fractions, i.e., 20 to 31 percent for the humic fraction and 21 to 24 percent for the non-humic fraction.

## Speciation

Coagulation shifts the distribution of DBPs toward the more brominated species when enhanced or optimized coagulation is practiced. Table 10-7 shows TOC concentrations in parallel pilot plants treating EFL water and employing conventional coagulation and coagulation optimized for TOC control (Miltner 1994b). The precursor concentrations for TTHM and HAA6 formation are also shown in Table 10-7. Comparing conventional and optimized coagulation indicates improved removal of these precursors with optimized coagulation. Although the concentrations of THMs and HAAs that would form in post-disinfected water decreased with coagulation, both on a weight basis and on a molar basis, the percentage of brominated species increased as indicated by the ratios of brominated-to-total DBPs.

**Table 10-7. Effect of Alum Coagulation of Pilot Plant-Treated EFL Water on DBP Speciation (Miltner et al. 1994b)**

	TOC mg/L	UFC TTHM ug/L	UFC TTHM umole/L	UFC TTHM-Br umole/L	Ratio TTHM-Br:TTHM
Raw	4.81	102	0.814	0.079	0.097
Conv. settled	3.42	79	0.620	0.072	0.117
Opt. settled	2.21	53	0.424	0.064	0.150
	TOC mg/L	UFC HAA6 ug/L	UFC HAA6 umole/L	UFC HAA6-Br umole/L	Ratio HAA6-Br:HAA6
Raw	4.81	115	0.794	0.0133	0.017
Conv. settled	3.42	65	0.447	0.0126	0.028
Opt. settled	2.21	30	0.216	0.0111	0.051

**Table 10-8. Comparison of Jar Testing and Pilot-Plant Treatment of EFL Water (Miltner et al. 1994b)**

	Percent Removal			
	Conventional Coagulation		Optimized Coagulation	
	Jar Test <sup>a</sup>	Pilot Plant <sup>b</sup>	Jar Test <sup>a</sup>	Pilot Plant <sup>b</sup>
TOC	26	29	52	54
UV254	42	39	65	64
UFC TOX	22	24	41	47
UFC TTHM	46	44	73	73
UFC HAA6	38	36	61	63
Alum dose, mg/L	40	44	130	152
Turbidity, NTU	0.47	0.99	0.37	0.73
pH	7.23	7.34	6.50	6.57

<sup>a</sup> Based on September 14 jar test.

<sup>b</sup> Mean of six sample days from September 2 to September 14.

For example, optimized coagulation lowered TTHM precursors from 79 to 53 ug/L compared to conventional coagulation. With post-disinfection, however, about 15 percent, on a molar basis, of the 53 ug/L resulting from optimized treatment was brominated THMs, while only about 12 percent of the 79 ug/L resulting from conventional treatment was brominated THMs. As the precursor compounds were removed by coagulation, the bromide was unaffected. Thus, the bromide-to-organic carbon ratio increased, resulting in a higher percentage of the DBPs as brominated compounds when chlorinated under UFCs. Tryby et al. (1993) reported the similar trends with jar testing of OR water.

## Scale Up

A concern of the Step 2 jar testing procedure, to define alternate performance criteria for enhanced coagulation, is scale-up reliability. Table 10-8 compares conventional and TOC-optimized coagulation for both jar testing and pilot-scale treatment of EFL water (Miltner et al. 1994b). The jar test was a good predictor of pilot-scale performance, with the exception of turbidity; jar test settled NTUs were about half the pilot-plant settled NTUs. These data suggest that if the coagulant mixing intensities (GT values) for the larger and smaller systems are similar (as they were in this study) and if the tests at both scales are conducted at close to the same time (the water qualities are similar), then jar tests will predict results from the pilot-scale system.



## Secondary Effects

Two concerns with modifying coagulation to better control DBPs are (1) loss of control of microbial, particulate, or inorganic water quality parameters, and (2) operational problems. Several studies of the secondary effects of enhanced or optimized coagulation suggest no detrimental tradeoffs with regard to water quality, but increased sludge and resulting increases in cost.

### *Bacteria*

Lytle et al. (1994) monitored heterotrophic plate count (HPC) bacteria (using R2A media) and total coliform (TC) bacteria through pilot plants treating EFL water using conventional and TOC-optimized coagulation. TOC-optimized coagulation resulted in a 0.54 log increase in removal of HPC bacteria and a 0.34 log increase in removal of TC bacteria.

### *Cryptosporidium Oocysts and Giardia Cysts*

In the same study, Lytle et al. (1994) monitored particle counts in the size range of *Cryptosporidium* oocysts (3.1 to 7.0  $\mu\text{m}$ ) and *Giardia* cysts (8.2 to 13.2  $\mu\text{m}$ ). TOC-optimized coagulation resulted in 0.77 log better removal of *Cryptosporidium* oocyst-sized particles (1.88 vs. 1.11 logs) and 0.80 log better removal of *Giardia* cyst-sized particles (1.79 vs. 0.99 logs) as compared to conventional coagulation.

Ollier et al. (1997) studied the secondary effects of conventional, enhanced, and optimized coagulation in *Cryptosporidium parvum* oocyst-spiked OR, EFL, and Mississippi River (MR) waters. In addition to turbidity and oocysts, they monitored indigenous bacterial endospores (Rice et al. 1996) and total particle count (TPC) as indicators of oocyst removal efficiency. Several coagulation conditions were examined: conventional targeting 5 NTU, conventional targeting 2 NTU, enhanced following the requirements of the regulatory  $3 \times 3$  matrix, optimized for TPC removal, and optimized for TOC removal. Table 10-9 summarizes results for the three waters.

These data suggest that systems that increase the coagulant dose to move from conventional to enhanced coagulation would realize improved removal of *C. parvum* oocysts and that endospores and TPC would be reasonable and conservative indicators of oocyst removal.

**Table 10-9. Control of Microbes and Particulates by Coagulation of OR, EFL, and MR Waters (Ollier et al. 1997)**

Parameter	Mean Log Removal				
	Conv-5	Conv-2	Enhanced	Opt-TPC	Opt-TOC
<i>C. parvum</i> Oocysts	1.3	2.0	2.6	3.3	3.0
Endospores	1.5	2.1	2.4	2.8	2.7
TPC	1.4	1.8	2.1	2.5	2.4
Turbidity	1.5	1.6	1.8	1.8	1.5
n	2	5	5	5	5
Mean alum dose, mg/L	20	36	45	67	112

### *Turbidity and Particles*

Systems that increase the coagulant dose beyond that required by the  $3 \times 3$  regulatory matrix would realize improved removal of *C. parvum* oocysts, endospores, and TPC through the coagulant dose range that optimizes TPC control. As shown in Table 10-9, optimizing for TOC control resulted in

**Table 10-10. Effects of Treatment on Pilot-Scale Filter Operation and Mean Water Quality of EFL Water (Lytle et al. 1994)**

Parameter	Conventional Coagulation		Optimized Coagulation	
	Filter 1 Ambient pH		Filter 2 Ambient pH	Filter 3 pH 8
Change in pH	7.37 to 7.47		6.88 to 6.90	6.68 to 7.95
	+ 0.10		+ 0.22	+ 1.27
Change in TPC/mL	18,207 to 2938		6027 to 205	6027 to 300
	15,269		5822	5727
Change in Al <sup>3+</sup> , mg/L	0.648 to 0.080		0.472 to 0.025 <sup>a</sup>	0.472 to 0.291
	0.568		0.447	0.181
HL buildup, cm/hr	8.89		3.60	1.45
FRT	shortest			longest

<sup>a</sup> dissolved Al detection level = 0.025 mg/L

better removal of oocysts, endospores, and TPC than practicing enhanced coagulation. Optimizing for TOC control appeared to be destabilizing for particles since removal of oocysts and the other indicator parameters deteriorated beyond the coagulant dose range usually selected for optimized TPC control.

### ***Aluminum, Particles, Head Loss, and Filter Run Time***

Lytle et al. (1994) and Miltner et al. (1994b) reported on pilot-scale filter operation during parallel conventional and optimized coagulation of EFL water. Table 10-10 summarizes the results. The pH of coagulation and clarification in the optimized plant was lower (6.88) than in the conventional plant (7.37) because of the additional alum dose required in the optimized plant (see Table 10-8). Two parallel filters were operated in the optimized plant. Chlorine was applied ahead of all three filters in both plants to target UFCs. pH 8 was targeted in all three finished waters for UFCs. In Filters 1 and 2, pH was adjusted at the clear wells. In Filter 3, pH was adjusted to 8 at the filter. In this manner, the effects of pH and aluminum solubility on filter operation could be studied. The moderate pH changes in Filters 1 and 2 occurred because the liquid chlorine was basic.

Optimized coagulation removed more TPC than did conventional coagulation. As a result, the particle loading to Filters 2 and 3 was lower (6027/mL vs. 18,207/mL) and, consequently, the sludge production was higher in the optimized plant. The TPCs in the filter effluents in the optimized plant were approximately one log lower than in the conventional filter effluent (205/mL and 300/mL vs. 2938/mL).

Even though more aluminum was utilized in the optimized plant, more was precipitated. Thus, the dissolved aluminum loading to Filters 2 and 3 was lower (0.472 mg/L vs. 0.648 mg/L). Aluminum solubility increases with pH. Thus, the highest filter effluent dissolved aluminum was in Filter 3, which was adjusted to pH 8. In Filters 1 and 2, where pH was ambient, lower filter effluent dissolved aluminum occurred. Consequently, less aluminum precipitated in the optimized plant filters compared to the conventional plant filter (0.181 mg/L and 0.447 mg/L vs. 0.568 mg/L).

Table 10-10 shows that Filter 1, following conventional treatment, removed more particles and precipitated more aluminum than the other two filters. Consequently, it built up HL faster and had the shortest FRT. Conversely, with optimized treatment, HL buildup was slower and FRTs were longer.

This suggests that systems switching from conventional to enhanced coagulation may achieve more efficient filter operation. The tradeoff will be more sludge production because of the addition of more coagulant, or possibly a different type of sludge if enhanced coagulation was achieved by the addition

of an acid with the coagulant. These data also suggest that systems practicing enhanced coagulation should consider pH adjustment ahead of the filter to improve filter operation. The tradeoff will be higher dissolved aluminum entering their distribution systems.

Costs are always site specific. Because of the cost of additional coagulant or acid, the cost of sludge handling, and the cost of raising the pH to distribute water from plants practicing enhanced coagulation, the cost of water will likely be more expensive than from plants practicing conventional coagulation.

## Summary

With the D/DBP Rule, many water systems will move from conventional to enhanced coagulation, expanding their coagulation objectives from turbidity removal to include TOC removal. Moving from conventional coagulation to enhanced coagulation to coagulation optimized for the removal of TOC results in improved removal of precursors for TTHM, HAA6, CH, HAN4, CP, the surrogate TOX, and chlorine demand. When coagulated, raw waters higher in SUVA and in TOC tend to have higher percent removals of DBP precursors. As a treatment technique, enhanced coagulation to remove TOC can result in the removal of precursors for these DBPs. As a BAT, enhanced coagulation can result in the control of TTHM and HAA5. Many systems should be able to meet the requirements of enhanced coagulation for TOC removal with moderate changes to conventional coagulation.

Although coagulation lowers the concentrations of DBP precursors, coagulation shifts the distribution of the DBPs formed by chlorination toward the more brominated species. This shift is even greater when enhanced or optimized coagulation is practiced.

Most DOC and DBP precursors are in the larger molecular size range, and most DOC and DBP precursors are in the humic fraction. Conventional coagulation removes a greater percentage of the >3K MS fraction than the smaller-sized fractions. Enhancing coagulation brings about small improvements in the >3K MS range and the <0.5 MS range; the greatest improvement with enhanced coagulation is in the 0.5K–3K MS range. Conventional coagulation removes a greater percentage of the humic fraction than the non-humic fraction. Enhancing coagulation brings about similar improvement in the removal of both fractions.

Moving from conventional to enhanced to TOC-optimized coagulation generally results in better control of HPC bacteria, TC bacteria, *C. parvum* oocysts, *Cryptosporidium* oocyst-sized particles, *Giardia* cyst-sized particles, TPC, and bacterial endospores.

Systems switching from conventional to enhanced coagulation may achieve longer FRTs. The tradeoff will be more sludge production. Systems practicing enhanced coagulation should consider pH adjustment ahead of the filter to achieve longer FRTs. The disadvantage of this practice when alum is the coagulant will be higher dissolved aluminum entering their distribution systems.

## References

- Dryfuse, M. J., Miltner, R. J., and Summers, R. S. (1995). "The removal of molecular size and humic/non-humic fractions of DBP precursors by optimized coagulation." *Proceedings, American Water Works Association, Annual Conference, Anaheim, CA, June.*
- Dryfuse, M. J. (1995). "An evaluation of conventional and optimized coagulation for TOC removal and DBP control in bulk and fractionated waters." M.S. Thesis, Department of Civil and Environmental Engineering, University of Cincinnati, Cincinnati, OH.

- Edzwald, J. K. (1993). "Coagulation in drinking water treatment." *Water Science and Technology*, 27(11), 21.
- Federal Register*. (1998). "National primary drinking water regulations: Disinfectants and disinfection by-products; Final rule." 63(No. 241; December 16), 69389.
- Krasner, S. W. and Amy, G. (1995). "Jar-test evaluations of enhanced coagulation." *Journal of the American Water Works Association*, 87(10), 93.
- Lytle, D. A., Dryfuse, M. J., Miltner, R. J., Schock, M. R., and Summers, R. S. (1994). "An evaluation of the secondary effects of enhanced coagulation." *Proceedings, American Water Works Association, Enhanced Coagulation Research Workshop*, Charleston, SC, December 4–5.
- Miltner, R. J., Nolan, S. A., Dryfuse, M. J., and Summers, R. S. (1994a). "The control of DBPs by enhanced coagulation." *Proceedings, Water Quality, American Water Works Association, Annual Conference*, New York, NY, June 19–23.
- Miltner, R. J., Nolan, S. A., Dryfuse, M. J., and Summers, R. S. (1994b). "Evaluation of enhanced coagulation for DBP control." *Proceedings, American Society of Chemical Engineers, National Conference on Environmental Engineering*, Boulder, CO, July 11–13.
- Ollier, L. L. (1998). "Microbial and particulate control under conventional and enhanced coagulation." M.S. thesis, Department of Civil and Environmental Engineering, University of Cincinnati, Cincinnati, OH.
- Ollier, L. L., Miltner, R. J., and Summers, R. S. (1997). "Microbial and particulate control under conventional and enhanced coagulation." *Proceedings, American Water Works Association, Water Quality Technology Conference*, Denver, CO, November 9–12.
- Owen, D. M., Amy, G. L., and Chowdhury, Z. K. (1993). "Characterization of natural organic matter and its relationship to treatability." American Water Works Association Research Foundation, Denver, CO.
- Rice, E. W., Fox, K. R., Miltner, R. J., Lytle, D. A., and Johnson, C. H. (1996). "Evaluating plant performance with endospores." *Journal of the American Water Works Association*, 88(9), 122.
- Singer, P. C. and Harrington, G. W. (1993). "Coagulation of DBP precursors: Theoretical and practical considerations." *Proceedings, American Water Works Association, Water Quality Technology Conference*, Miami, FL, November 7–11.
- Summers, R. S., Hooper, S. M., Shukairy, H. M., Solarik, G., and Owen, D. (1996). "Assessing DBP yield: Uniform formation conditions." *Journal of the American Water Works Association*, 88(6), 80.
- Tryby, M. E., Miltner, R. J., and Summers, R. S. (1993). "TOC removal as a predictor of DBP control with enhanced coagulation." *Proceedings, American Water Works Association, Water Quality Technology Conference*, Miami, FL, November 7–11.

## CHAPTER 11

### **Controlling Disinfection By-Products (DBPs) and Microbial Contaminants in Small Public Water Systems (PWSs)<sup>1</sup>**

#### **Introduction**

The purpose of this chapter is to describe the in-house and field research activities specifically designed to evaluate alternative treatment technologies for small community and non-community water systems. The discussion is comprised of four major sections: (1) Particulate Removal, (2) Disinfection/Destruction, (3) Field-Scale Demonstration, and (4) Small System Remote Monitoring and Control. Small systems face a myriad of problems above and beyond those of the medium and large systems. The pilot- and full-scale research efforts described in this paper are intended to address a subset of these needs. Because small systems (defined below) often lack the financial, technical, and managerial capabilities of larger systems and are responsible for the majority of the Safe Drinking Water Act (SDWA) violations, they have been the focus of specific portions of various Federal Regulations and Rules.

The U.S. Environmental Protection Agency (EPA) Water Supply and Water Resources Division's (WSWRD's) in-house research described in this chapter primarily focuses on filtration and disinfection technologies that are considered to be viable alternatives to conventional package plants (flocculation, coagulation, media filtration, post-chlorination). Conventional package plants require a high level of operator skill to properly maintain appropriate chemical dose and flow rates, especially for surface water supplies. These difficulties, in conjunction with the other small system problems mentioned previously, have resulted in the EPA focusing its research on technologies that are easy to operate and maintain and produce minimal residuals. An objective of this research is to provide technology at the lowest possible cost while producing a finished water that is robust with respect to operator skill and raw water quality. The field demonstration projects describe some of the issues that can result when even the best available technology is not able to produce water of sufficient quantity or quality. The remote monitoring and control research efforts described resulted from the fact that many rural systems are located in topographically difficult areas or separated by large distances from other systems, thus precluding any consolidation or regionalization efforts. The software and sensing systems developed as a product of this research will allow individual treatment units to be monitored and operated from a central location. This approach has come to be known as "the electronic circuit rider" concept.

A very important "spin-off" from this research, but which will not be discussed here, is the EPA Environmental Technology Verification (ETV) Program for Drinking Water Treatment Systems. The goal of this program is to develop performance standards and protocols that can be used to evaluate the performance of small systems technologies. The ETV works in partnership with testing organizations, stakeholder groups, and individual technology developers to provide high quality, peer-reviewed data in order to accelerate the acceptance and use of improved and cost-effective technologies.

---

<sup>1</sup>James A. Goodrich and Roy C. Haught: Water Quality Management Branch, WSWRD, NRMRL, ORD, EPA, 26 W. M. L. King Drive, Cincinnati, Ohio 45268. Corresponding Author: James A. Goodrich, 513-569-7605, goodrich.james@epa.gov.

## SDWA Coverage

There are two main categories of public water systems (PWSs):

**Community Water Systems** provide drinking water to the same people year-round. Today, there are approximately 54,000 community water systems serving more than 250 million Americans. All Federal drinking water regulations apply to these systems.

**Non-Community Water Systems** serve customers on less than a year-round basis. Non-community systems are, in turn, divided into two categories:

- **Nontransient:** Those that serve at least 25 of the same people for more than six months in a year but not year-round (e.g., schools or factories that have their own water source); most drinking water regulations apply to the 20,000 systems in this category.
- **Transient:** Those that provide water to places like gas stations and campgrounds where people do not remain for long periods of time; only regulations that control contaminants posing immediate health risks apply to the 96,000 systems in this category.

There are approximately 170,000 community and non-community drinking water systems in the U.S. serving transient and nontransient populations of 10,000 or fewer people (Goodrich et al. 1999). Table 11-1 describes the size categories of PWS that provided water to at least 25 people or 15 service connections for at least 60 days per year.

**Table 11-1. Size Categories of Public Water Systems (USEPA 1999)**

System Size (population served)	Percent of Community Water Systems			
	1980	1985	1990	1995
Very small (25–500)	67	63	63	61
Small (501–3,300)	22	24	24	25
Medium (3,001–10,000)	6	7	7	8
Large (10,001–100,000)	4	5	5	6
Very large (over 100,000)	1	1	1	1

According to a 1993 survey (MacDonald 1997), small treatment systems serving fewer than 10,000 people represent 94% of all water supply systems in the U.S. and serve 21% of the national population. Tens of thousands of these small PWSs are having difficulty complying with the ever increasing number of regulated contaminants. Small drinking water systems account for 93 percent of the maximum contaminant level (MCL) violations and 94 percent of the monitoring and reporting (M/R) violations. M/R violations are a result of no sampling being performed or data recorded. The majority of the MCL violations are for microbial parameters. According to the National Research Council, the most common monitoring and reporting violation is for total coliform bacteria (NRC 1997). Tables 11-2 and

**Table 11-2. Total Coliform Bacteria Violations for the Period October 1, 1992, through December 31, 1994 (Pollack et al. 1999)**

Population Served	Systems with Violations		Violations by Source Water	
	Number of Systems	Percent of Total (%)	Ground Water Systems (%)	Surface Water Systems (%)
<500	10,509	29.5	95.0	5.0
501–3,300	1,938	13.4	84.8	15.2
3,301–10,000	592	14.4	71.8	28.2
>10,000	487	14.4	59.1	40.9

**Table 11-3. Chemical Contamination Violations for the Period October 1, 1992, through December 31, 1994 (Pollack et al. 1999)**

Population Served	Systems with Violations		Violations by Source Water	
	Number of Consumers	Percent of Total (%)	Ground Water Systems (%)	Surface Water Systems (%)
<500	531	1.5	96.4	3.6
501–3,300	162	1.1	73.5	26.5
3,301–10,000	25	0.6	60.0	40.0
>10,000	15	0.4	33.3	66.7

11-3 present a summary of small system violations in the U.S. for total coliform bacteria and chemical contaminants, respectively, for the period of October 1, 1992, through December 31, 1994.

### ***Impact of the SDWA on Small Communities***

The 1996 Safe Drinking Water Act Amendments (SDWAA) required EPA to

- Assess technologies for three categories of systems:
  - 10,000–3,301 persons
  - 3,300–501 persons
  - 500–25 persons
- List affordable technologies for each category to achieve current and anticipated MCLs
- Identify “variance technologies” if MCLs cannot be met to maximize contaminant reduction and protect public health
- Provide assumptions to be used in determining affordability

The 1996 SDWAA required EPA to produce a variety of outputs in a very short time period. The outputs are

- A final technology list for the Enhanced Surface Water Treatment Rule
- A report on applicability of Point-Of-Use/Point-Of-Entry devices
- A final technology list for National Primary Drinking Water Regulations (NPDWRs)
- A final “variance” technology list for NPDWRs

Future regulations may require a significant reduction in the usage of free chlorine for small systems treating surface water or ground water with high organic content because of the potentially restrictive disinfection by-product (DBP) levels mandated by the amendments. Alternative filtration and/or disinfection systems may need to be added to current small system treatment trains in order to meet enhanced filtration requirements. Alternately, some small systems will have to completely replace or significantly upgrade systems in order to be in compliance.

The practice of chlorination for preoxidation or for disinfection purposes can result in the formation of chlorinated organic by-products. Currently, the regulated DBPs in the U.S. are trihalomethanes (THMs) with a maximum contaminant level of 0.080 mg/L. However, the recently promulgated Disinfectant and Disinfection By-Products (D/DBP) Rule will result in the regulation of several other by-products of chlorination such as haloacetic acids (HAA5) of 0.060 mg/L, along with a potential reduction in the current THM standard of 0.080 mg/L (Federal Register 1998). In some cases, this might result in a change to an alternative preoxidant, or disinfectant, use of membranes or elimination of the use of free chlorine entirely (Pollack et al. 1999).

Microbial contaminant regulations for surface water disinfection are those promulgated under the Surface Water Treatment Rule (SWTR) (EPA 1989) or proposed in the Enhanced Surface Water Treatment Rule (ESWTR) (EPA 1994). The SWTR requires the practice of disinfection for all utilities treating surface water and ground water under the influence of surface water. Most utilities are also required to filter their water unless the following conditions are met in the surface water prior to disinfection:

- Fecal coliform bacteria <20/100 mL in 90% of samples
- Total coliform bacteria <100/100 mL in 90% of samples
- Turbidity <5 nephelometric turbidity units (NTUs)
- Other MCLs met

Treatment plants exempted from filtration must disinfect to achieve 99.99% inactivation of viruses and 99.9% inactivation of *Giardia lamblia* cysts. Compliance with these requirements must be demonstrated with the CT approach (the product of the average disinfectant concentration and  $t_{10}$  contact time). CT values estimated for actual disinfection systems must be equal to or greater than those published in the SWTR Guidance Manual for viruses and *G. Lamblia* cysts, respectively (Pollack et al. 1999).

The two-stage Enhanced Surface Water Treatment Rule and the Ground Water Rule essentially bring all small systems serving less than 10,000 under regulations requiring at least 2-log removal of *Cryptosporidium*, a filtered-water turbidity of less than 0.3 NTU in at least 95% of the monthly measurements, and disinfection of ground water while managing by-product formation. A key issue for all systems to consider under the two-stage Long Term Enhanced Surface Water Treatment Rule is whether or not criteria can be developed for estimating removal efficiencies for *Cryptosporidium*. Filtration issues include

- Pretreatment efficiencies
- How variable are filter performances?
- Source water quality impacts
- Surrogate performance indicators

Issues surrounding disinfection efficiencies and by-product formation include

- Can *Cryptosporidium* inactivation criteria be developed?
- Source water quality impacts
- Treatment technique impacts

### ***Drinking Water State Revolving Fund and Small Communities***

In order to improve small drinking water systems, EPA is required to enter into agreements with eligible states to make capitalization grants to further the health protection objectives of the SDWAA. The Nation's water systems must make significant investments to install, upgrade, or replace infrastructure to continue to ensure the provision of safe drinking water to their 250 million customers. Installation of new treatment facilities can improve the quality of drinking water and better protect public health. Improvements are also needed to help those water systems experiencing a threat of contamination due to aging infrastructure systems.

The 1996 SDWAA established the Drinking Water State Revolving Fund (DWSRF) to make funds available to drinking water systems to finance infrastructure improvements. The program also emphasized providing funds to small and disadvantaged communities and to programs that encourage pollution prevention as a tool for ensuring safe drinking water.



The DWSRF program required that states develop a priority system for funding infrastructure projects based on three criteria from the SDWAA. States are required to solicit and consider public comment when developing their priority systems. Projects are ranked and funding is offered to the highest ranked projects that are ready to proceed. Priority is given to those eligible projects that

1. Address the most serious risk to human health
2. Are necessary to ensure compliance with the requirements of the SDWAA
3. Assist systems most in need, on a per household basis, according to state-determined affordability criteria

A minimum grant amount of 1% of the appropriated funds are available to all states. States that lose primacy will not be eligible for DWSRF funds. Receipt of the funds is linked to states having an EPA-approved capacity development program and operator certification program. Funds can be used for loans, loan guarantees, and as a source of reserve and security for leveraged funds. States must also contribute an amount equal to 20% of the total Federal contribution.

Congress appropriated \$1,275,000,000 for the program in FY1997. This figure included amounts earmarked for the program in FY1994–1996. The appropriations for FY1998 and FY1999 were \$725,000,000 and \$775,000,000, respectively. The appropriation for FY2000 is \$820,000,000. Annual state grants ranged from \$7 to \$80 million.

The regulatory drivers described above have provided a focus for identifying small system solutions. As a consequence, the WSWRD of the EPA National Risk Management Research Laboratory (NRMRL) has been actively demonstrating and evaluating alternative and innovative small system drinking water treatment technologies for several years. In anticipation of the states' needs for innovative and cost-effective small system treatment technology, the WSWRD has focused on the smallest of these systems in the 25–500 population range. Because of the availability of Federal funds through the DWSRF to purchase equipment, research has emphasized those technologies that are easy to operate and maintain. Even though alternative treatment systems are perceived as “high tech” or more expensive to purchase than conventional technologies, in many cases they are easier to operate and less expensive to maintain over the long term. This fact also led to the consideration of remote telemetry and control technology to improve monitoring/reporting and reduce operation and maintenance (O&M) costs. Although such equipment could double the capital costs of a package plant, the O&M paybacks can be quickly realized through lower use of chemicals, low residual production (disposal), and increased reliability. It is believed that technology more appropriately designed for small systems will not only produce higher quality drinking water, but better utilize the resources of the utilities and encourage more timely monitoring and reporting.

## **Research Approach**

The WSWRD conducts small system research at EPA's Test and Evaluation (T&E) Facility located in Cincinnati, OH. These technologies can be packaged into treatment systems for field testing at remote sites. The T&E Facility is described below; some of the technologies that are under evaluation or have been tested are also listed.

### ***Drinking Water Package Plant T&E Facility***

The T&E Facility is a flexible research facility where a wide variety of water treatment and other environmental protection technologies can be evaluated. The facility is equipped with 10,000 gallons

of permanent stainless steel tank storage capacity consisting of two 2,500 gallon tanks and one 5,000 gallon tank. The tanks are used as blending/holding tanks for experimental studies. The drinking water work area also has two 1,000 gallon stainless steel and two 1,500 gallon polyethylene reservoirs.

The following is a list of the technologies installed and in operation as of FY 2000:

- Filtration Systems
  - Slow sand
  - Rapid sand
  - Ultrafiltration
  - Bag
  - Cartridge
- Disinfection Systems
  - On-site electrochemical chlorine generator
  - Ozone, UV, and hydrogen peroxide alone and in combination

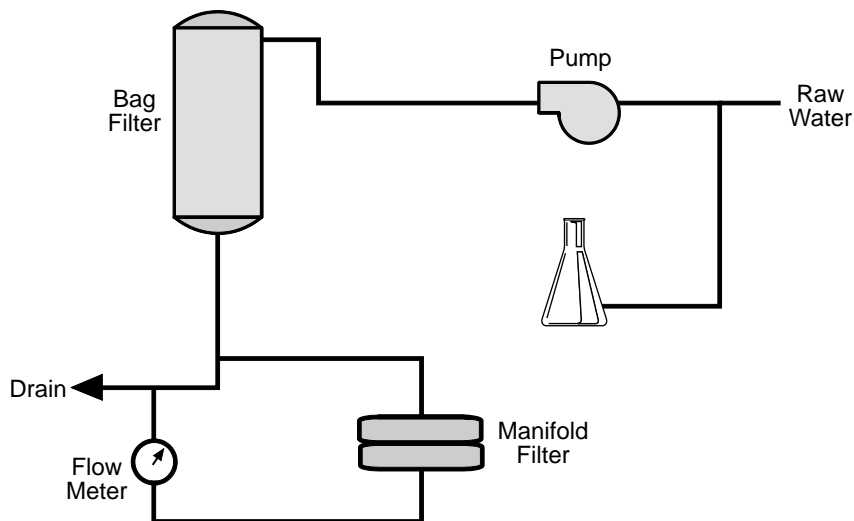
The facility is also equipped with a complete machine shop that provides total support in the engineering and fabrication of the bench- and pilot-scale research studies. The shop supports plumbing, machining, and electrical and electronic services (Table 11-4).

**Table 11-4. Amenities/Facilities of T&E**

<b>Experimental High-Bay Area</b>	<b>Supply Water for Treatment</b>
24,000 ft <sup>2</sup>	Potable
30-ft-tall high-bay area	Chlorinated
16 experimental work area bays	Dechlorinated
Two 5-ton bridge cranes	Non-Potable
552-ft <sup>2</sup> greenhouse	Mill Creek (surface water)
Fully heated and lighted	Waste water
Remote monitoring and control	Primary influent
Ventilation system	Primary effluent
720-ft <sup>2</sup> machine shop	Raw waste water
Low pressure air (15 psi)	Secondary effluent
High pressure air (130 psi)	Laboratory
Electrical supply (110, 240, 480 volt)	Deionize
Three 16-ft overhead doors	Super-Q
<b>Storage Capacity</b>	<b>Remote Telemetry</b>
Tank truck	24 hours per day
Two 2,500-gallon (stainless steel)	Experimental monitoring
One 5,000-gallon (stainless steel)	Experimental control
Two 1,100-gallon (stainless steel)	Facility security
Two 1,500-gallon (PVC)	Facility fire

### ***Test Methodology***

All of the filtration and disinfection technology research described in this chapter focused on removal/inactivation of *Cryptosporidium* and surrogate parameters. The experimental procedures for acquiring, spiking, collecting, and analyzing *Cryptosporidium* follows. *Cryptosporidium parvum* oocysts were isolated from sieved (10-, 20-, 60-, and 100-mesh sieves) feces of Holstein bull calves by centrifugation (1100 × g) through a step gradient of Sheather’s sucrose (Finch et al. 1993). Purified *Cryptosporidium*

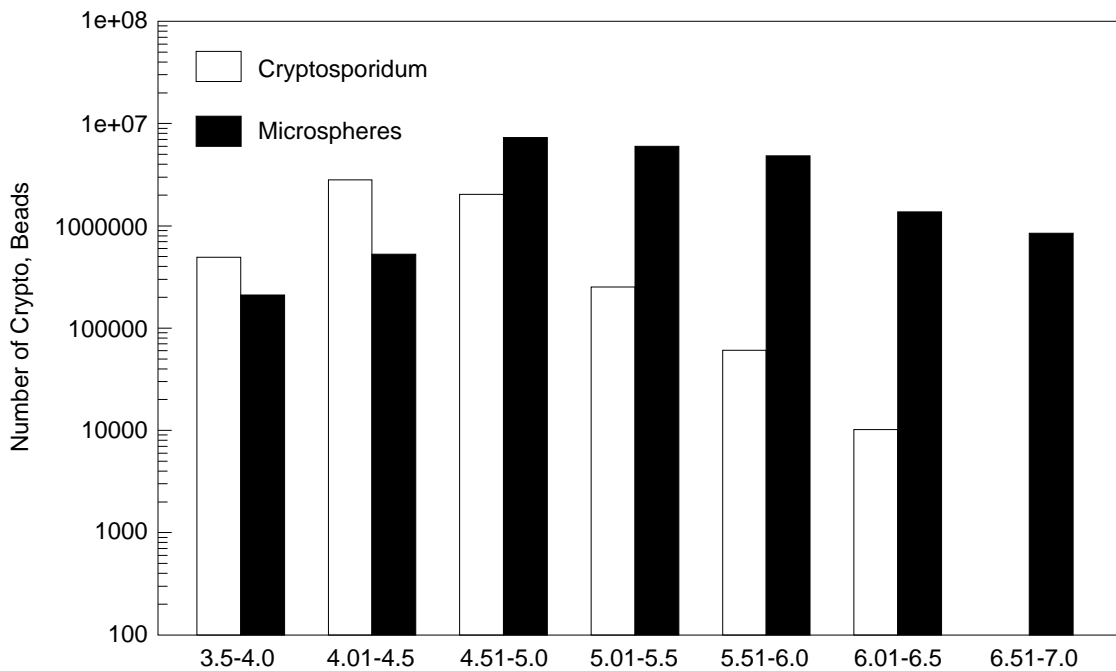


**Figure 11-1. Contaminant injection method.**

oocysts were stored in phosphate buffered saline (PBS) with penicillin (100 unit/mL) and streptomycin (100  $\mu\text{g}/\text{mL}$ ) at 4°C for up to 6–8 weeks. These oocysts are referred to as antibiotic-preserved *Cryptosporidium* oocysts (APO) in this research. A second source of *Cryptosporidium* oocysts was the University of Arizona. These oocysts, which were stored in potassium dichromate at 4°C for approximately one month, are referred to as dichromate-preserved *Cryptosporidium* oocysts (DPO).

Figure 11-1 shows the typical setup for technology evaluations for the injection of *Cryptosporidium* or other surrogate parameters such as polystyrene 4.5  $\mu\text{m}$ -sized microspheres. At the initiation of the research described, there were no accurate and precise methods for determination of *Cryptosporidium* removal rates in filtration systems. Furthermore, the recovery of *Cryptosporidium* varies significantly between different experimental methodologies and procedures (Chapman and Rush 1990), and the direct use of *Cryptosporidium* in treatment studies would pose a potential health risk. Therefore, finding more reliable, non-hazardous surrogates was necessary, such as microspheres, turbidity, and particle counting. These surrogates allowed for more experiments to be conducted, with only a few *Cryptosporidium* experiments being necessary for verification purposes. Polystyrene microspheres are used because they are not hazardous, are easily handled, and are representative of the size of the *Cryptosporidium* oocyst (Figure 11-2). Because of the difficulty and expense of testing directly using *Cryptosporidium*, most experiments either spiked or monitored surrogates such as the microspheres, particle counts, and turbidity. Thus, *Cryptosporidium* oocysts were only used sporadically to verify surrogate results.

A predetermined number of fluorescent 4.5- $\mu\text{m}$  polystyrene microspheres or *Cryptosporidium* oocysts were suspended in a fixed volume of 0.01% (v/v) Tween 20 solution and fed into the raw water upstream of the inlet pump. Approximately 5% of the total effluent volume was filtered with a 1- $\mu\text{m}$  pore size polycarbonate membrane (diameter = 293 mm), supported in a stainless steel filter manifold. The filter was removed from the manifold and eluted with a squeegee using approximately 200 ml 0.01% (v/v) Tween 20 solution. The eluant was concentrated to 0.5–7.5 ml via centrifugation at  $1200 \times g$ . *Cryptosporidium parvum* oocysts in both influent and effluent samples were stained with an indirect fluorescent monoclonal antibody (IFA). Polystyrene microspheres and oocysts were enumerated using a hemacytometer under an ultraviolet (UV) microscope using epifluorescence at  $400\times$  total magnification. Turbidity measurements were conducted with a Hach 2100P portable turbidimeter. The particle count analyses were conducted with a Met One particle counter using a light scattering liquid 211 sensor over a range of 1 to 25  $\mu\text{m}$  (Li et al. 1997). The types of technologies examined using this test methodology are described in the following sections.



**Figure 11-2. *Cryptosporidium* and microsphere size distribution.**

### Particle Filtration

Filtration is likely to be the most practical treatment technology used for *Cryptosporidium* removal in the near future (Chapman and Rush 1990). Investigations have shown that drinking water disinfectants such as chlorine or monochloramine at typical dosages have virtually no effect on the inactivation of *Cryptosporidium* oocysts (Clark et al. 1994). High-dose ozonation appears to be effective for inactivating *Cryptosporidium* oocysts in drinking water (Goodrich et al. 1992; Sabran et al. 1992), but its application may result in generation of disinfectant by-products that exceed proposed MCLs.

Studies developed to determine the pliability of *Cryptosporidium* oocysts indicated that during the filtration process, *Cryptosporidium* oocysts may pass through filtration membrane pores which are smaller than the diameter of the organism, and a fraction of these oocysts remain viable (Li et al. 1995). An understanding of these characteristics is important for evaluation and optimization of filtration-based physical treatment systems and is critical in the development of the experimental methodology described above. Figure 11-3 outlines the filtration technologies described in this section.

Microns	.0005	.05	.5	1-10
Approx. Mol. Wt.	100	10,000	500,000	
Filtration Technology	RO/POU Devices	Ultrafiltration	Cartridge Filtration	Bag Filtration

**Figure 11-3. Filtration technologies studied.**

## Bag Filtration

Three different bag filtration systems were initially studied over the course of one year. Bag filter #1 was a multi-layer fabric made of polypropylene with an average pore size of 1  $\mu\text{m}$ . Bag filter #2 was a single layer of polypropylene with an average pore size of 1  $\mu\text{m}$ . Bag filter #3 was a thick multi-layer polypropylene bag that incorporated airborne particle testing to develop ratings of 99% efficiency in removing material of 2.5- $\mu\text{m}$  and 95% removal of 1.5- $\mu\text{m}$  particles. The average inlet pressure was 50 psi (3.52kg/cm<sup>2</sup>) with influent flow rates of 12.5, 25, and 40 gpm, the recommended maximum (47, 95, and 151 LPM). Microsphere, turbidity, and particle-count measurements were made at various pressure drops as the bags became fouled. Bag filter performance data were collected at pressure drops of 0, 5, 10, 15, and 25 psi (0, 0.35, 0.70, 1.05, and 1.76 kg/cm<sup>2</sup>) for bag filter #2. Data for bag filters #1 and #3 were collected at 0, 7, 15, and 25 psi, respectively (0, 0.49, 1.05, and 1.76kg/cm<sup>2</sup>). The influent concentration ranged from  $9.17 \times 10^3$  to  $1.50 \times 10^5$  per liter, with an average of  $5.53 \times 10^4$  per liter for the polystyrene microspheres which were spiked into the raw water during the course of the experiment typically lasting between one and two hours. For *Cryptosporidium* oocysts, the concentrations ranged from  $7.04 \times 10^3$  to  $1.34 \times 10^5$  per liter, averaged  $3.24 \times 10^4$  per liter, and were tested at only one flow rate (25 gpm/95 LPM).

Particle-count analyses were conducted for particle size ranging from 1 to 25  $\mu\text{m}$ . Unlike the polystyrene microspheres and *Cryptosporidium* oocysts, turbidity and particle counts in the raw water were subject to natural variations due to changes in raw water quality. The measured raw water turbidity during the study period averaged 10.59 NTU, with a maximum of 59.4 NTU and a minimum of 1.81 NTU.

## Performance Results

Removal studies comparing APO and DPO *Cryptosporidium* oocysts for the bag filters were only conducted at one flow rate of 25 gpm (95 LPM) and with new filters because of the expense and time required for *Cryptosporidium* testing (Table 11-5). The duration of each *Cryptosporidium* test was approximately 70 minutes. Three blank tests yielded consistent APO *Cryptosporidium* log removal of 0.12, 0.13, and 0.19 for the vessels only (no bag inserted) for filters #1, #2, and #3, respectively. In comparison, a blank test using the DPO *Cryptosporidium* shows a lower removal rate. In these studies,  $2.70 \times 10^8$  DPO *Cryptosporidium* oocysts were spiked into the influent and  $2.57 \times 10^8$  were recovered in the system effluent for a log removal of 0.02, which was lower than that of the APO *Cryptosporidium* (0.12) for the same filter vessel. The difference was likely to reflect the effect of oocysts' adhesion to surface walls of the system. This phenomenon is significantly decreased when oocysts are stored in potassium dichromate. Previous studies conducted by WSWRD also show that potassium dichromate may change surface characteristics of the oocysts, such as zeta potential (Lytle and Fox 1994). The corrected log removal (accounting for the vessel-only removal effects) of bag filter #1 for APO *Cryptosporidium* ranges from 1.35 to 1.48, with an average of  $1.41 \pm 0.066$ . Bag filter #3 has the highest log removal, ranging from 3.00 to 3.63 with an average of  $3.29 \pm 0.32$ , while bag filter #2 yields the lowest log removal in the range of 0.26 to 0.64.

Table 11-6 shows the observed log removal for turbidity, 4.5- $\mu\text{m}$  microspheres and 4–6- $\mu\text{m}$  particle counts at the various pressure drops. In order to determine if operational parameters influenced filter efficiency, the removal rates were compared to the various pressure drops across the bag filter, the flow rates, and the *Cryptosporidium* and surrogate influent spike levels. The reduction of 4.5- $\mu\text{m}$  polystyrene microspheres at a given flow rate exhibits no significant dependence on pressure drop for bag filter #1 and #2 (Figure 11-4 A, B), but decreases with pressure drop for bag filter #3 (Figure 11-4 C). The log removal ranges from 1.14 to 1.88 with an average of  $1.39 \pm 0.19$  ( $1\sigma$ , n = 23) for bag filter #1, and from 0.14 to 0.72 with an average of  $0.46 \pm 0.17$  ( $1\sigma$ , n = 7) for bag filter #2. In contrast, bag filter

**Table 11-5. Bag Filtration Removal of *Cryptosporidium***

	Inlet Pressure kg/cm <sup>2</sup> (psi)	Pressure Drop kg/cm <sup>2</sup> (psi)	System Flow Rate L/min (gpm)	Inlet Concentration		<i>Cryptosporidium</i> Oocysts		Log Reduction	
				APO/L	DPO/L	Influent	Effluent	Apparent	Corrected
Blanks	3.52 (50)	0 (0)	95 (25)		4.7E+04	2.70E+08	2.57E+08	0.02	NA
Vessel # 1	3.52 (50)	0 (0)	95 (25)	1.90E+04		1.25E+08	9.52E+07	0.12	NA
Vessel # 2	3.52 (50)	0 (0)	95 (25)	135E+04		9.55E+07	7.13E+07	0.13	NA
Vessel # 3	3.52 (50)	0 (0)	95 (25)	1.49E+04		1.06E+08	6.77E+07	0.19	NA
Bag filter 1									
Test 1	3.52 (50)	0 (0)	95 (25)	3.50E+04		2.37E+08	5.92E+06	1.60	1.48
Test 2	3.52 (50)	0.35 (5)	95 (25)	1.60E+04		1.15E+08	3.50E+06	1.52	1.40
Test 3	3.52 (50)	0 (0)	95 (25)	1.38E+04		9.77E+07	93.32+06	1.47	1.35
Bag filter 2									
Test 1	3.52 (50)	0 (0)	95 (25)	7.40E+03		5.00E+07	8.47E+06	0.77	0.64
Test 2	3.52 (50)	1.40 (20)	95 (25)	8.07E+03		5.50E+07	2.30E+07	0.38	0.26
Test 3	3.52 (50)	0 (0)	95 (25)	7.04E+03		5.00E+07	1.65E+07	0.48	0.37
Bag filter 3									
Test 1	3.52 (50)	0 (0)	95 (25)	3.80E+04		2.59E+08	3.87E+04	3.83	3.63
Test 2	3.52 (50)	0.35 (5)	95 (25)	6.78E+04		4.75E+08	1.73E+05	3.44	3.25
Test 3	3.52 (50)	0.35 (5)	95 (25)	1.34E+05		9.77E+08	6.24E+05	3.19	3.00

**Table 11-6. Bag Filtration Results**

System	Log Reduction			
	Pressure Drop (psi)	Microspheres	Turbidity (NTU)	4-6- $\mu$ m Particle Count
Bag filter #1	0	1.36	.84	1.61
	7	1.29	.88	1.16
	15	1.38	.87	1.51
	25	1.24	.86	1.72
Bag filter #2	0	.33	.16	.34
	5	.48	.13	.19
	10	.72	.08	.10
	15	.47	.04	.00
	20	.40	.08	.06
Bag filter #3	0	3.20	1.68	2.65
	7	1.88	1.53	2.49
	15	2.03	1.09	0.76
	25	1.09	0.75	0.88

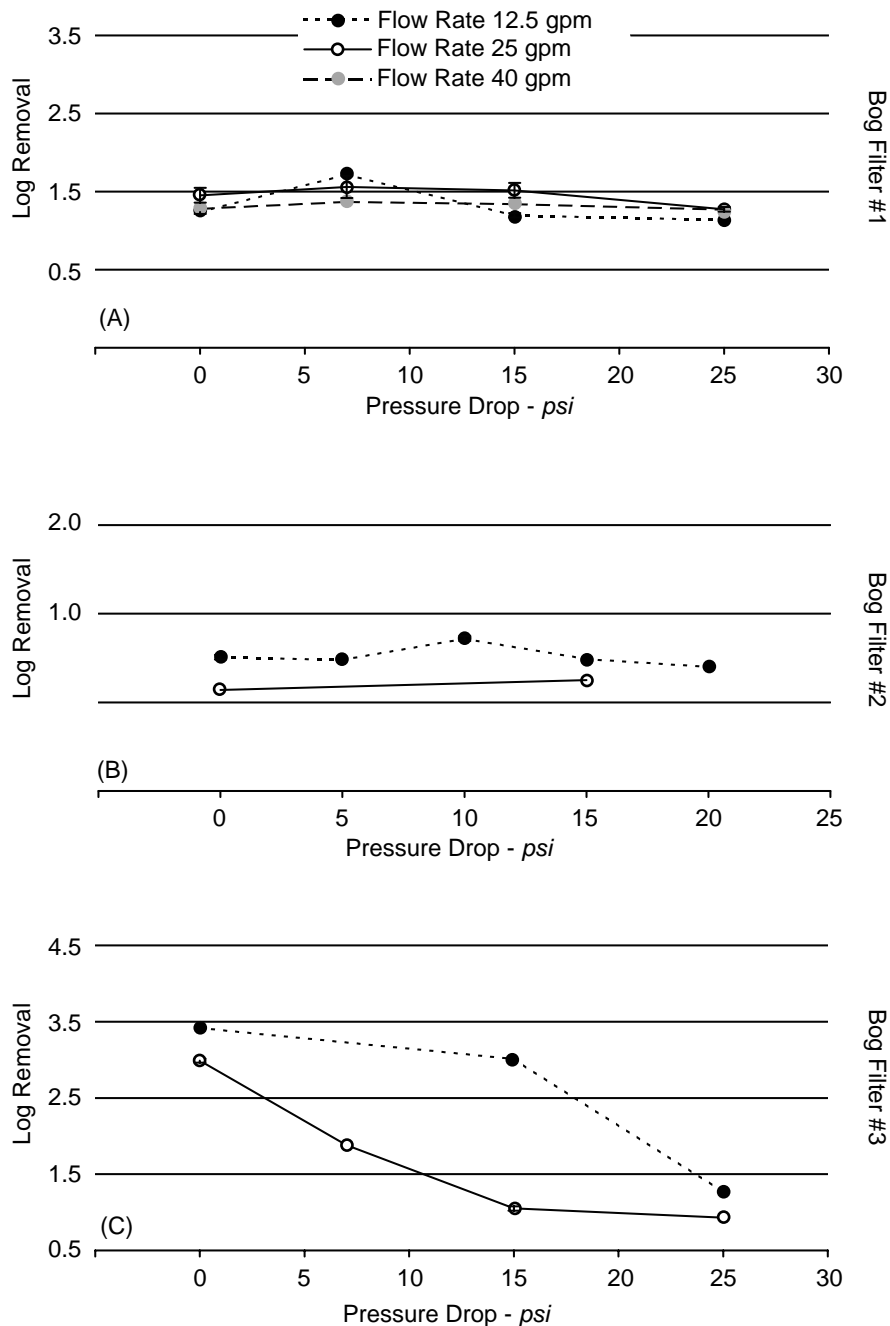
#3 shows significant dependency of log removal on the pressure drop. Log removal for the 4.5- $\mu$ m polystyrene microspheres varies from 0.93 to 3.42 with an average of  $2.08 \pm 1.05$ . Log removal drops significantly as the bag becomes fouled and pressure drop increases. The large standard deviation reflects the effect of pressure drop on performance of the bag filter #3.

Bag filters #1 and #2 displayed fairly constant log removals for the 4.5- $\mu$ m polystyrene microspheres and turbidity, as shown in Figure 11-5, for various spiking concentrations. It is apparent from the lack of correlation that the log reduction for these filters is not dependent on the number of 4.5- $\mu$ m polystyrene microspheres and turbidity loaded in the influent. Log removal for bag filter #3 varied substantially. However, the variation appears to result from significant dependence of bag filter #3's performance on other operational parameters, including pressure drop and flow rate (Figure 11-4 C). There was no statistically significant difference in removal rates at the various operating conditions, influent turbidity levels, or variations in the total number of microspheres loaded onto the filters ( $7 \times 10^7$  to  $9.45 \times 10^8$  influent microspheres).

### Controlled Turbidity Challenge Experimental Results

Different configurations of bag filtration systems were also challenged under controlled turbidity levels and flow rates following the previously discussed experiments. The research was not intended to compare systems but to identify the most important design and operational characteristics that provide for the most economical application at various raw water situations. Important design considerations are bag quality, gasket integrity, and hydraulic reliability. Operational factors include continuous vs. intermittent operation, flow rate, and pressure differential. Turbidity challenges ranged from 1 NTU to 10 NTU. Average log reduction has ranged from 0.4 to 0.85. Of course, at higher influent turbidity levels, greater removals can be demonstrated, but there seems to be a minimum NTU specific to each vendor that can be reached regardless of the initial influent quality.

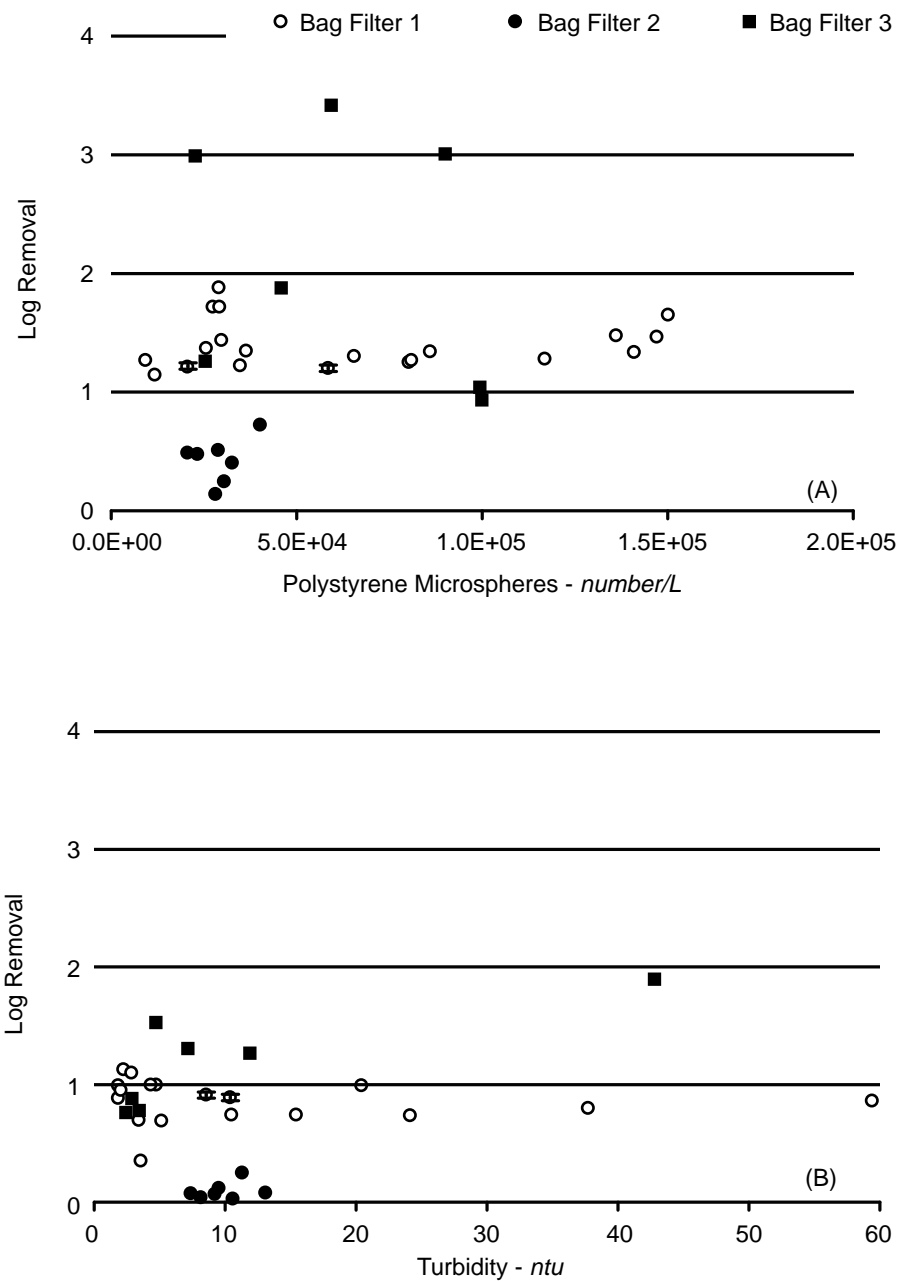
Figure 11-6 demonstrates three different experimental runs. During initial start-up, removal was better and then settled into a fairly steady performance rate until near the end of the bag's life. Flow rate did not seem to be a major factor in filter performance. Figure 11-7 shows run time represented by pressure drop over time for low- and moderate-turbidity challenges. Once a bag begins to foul at 5 to 10 psi differential,



**Figure 11-4. Log removal of 4.5- $\mu\text{m}$  polystyrene microspheres at various pressure drops and flow rates for bag filter 1 (A), bag filter 2 (B), and bag filter 3 (C).**

the time until the bag must be replaced prior to possible failure quickly decreases. High NTU scenarios (>5 NTU) indicate the need for multiple filtration barriers for economical operation. Figure 11-8 reveals the minimum turbidity achievable for a particular bag filter. Despite the influent turbidity range of 1 to 9 NTU, the effluent turbidity was consistently around .5 NTU. Figure 11-9 shows the results of running a bag too long with a subsequent rupture. The treatment barrier is ineffective, with effluent water quality the same or worse than influent. This can be seen readily because of the loss of pressure differential. The results indicate that in systems with little water storage or without on-site/automatic operator control to interrupt operation at this point, it is critical to be conservative in estimating bag life.





**Figure 11-5. Log removal of the *Crystosporidium* surrogates at various loading rates in the influent for the three bag filters.**

Particle-count analyses were also performed simultaneously. Figure 11-10 demonstrates that one of the bags removed nearly all particles during the experiment greater than 8  $\mu\text{m}$  in size, although not immediately after installation. All bags in the study were rated with nominal pore sizes in the 2–5- $\mu\text{m}$  range. The raw water used in these experiments exhibit a preponderance of small (1–3  $\mu\text{m}$ ) particles, whereas other water sources may be more amenable to bag filtration given a different size distribution. Another operational characteristic observed for all filters was an initial loss of removal efficiency and pressure differential when first turned on after having been out of operation for several hours. Within approximately 30 minutes, removal and pressure differential returned to the levels of the previous day (Goodrich et al. 1997).

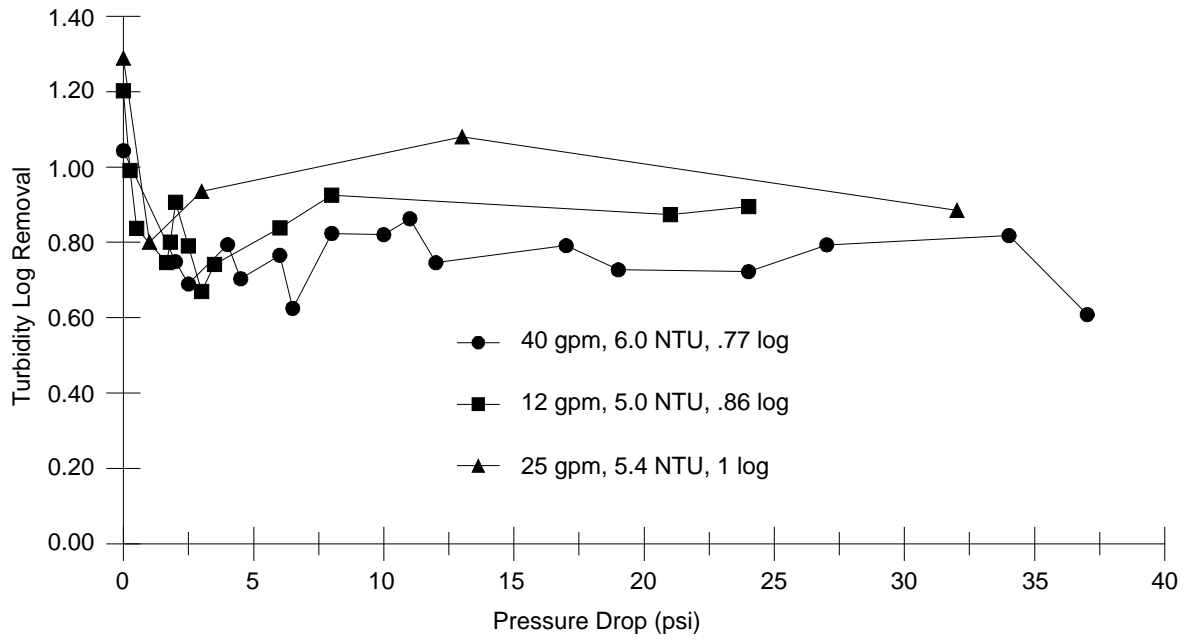


Figure 11-6. Turbidity log removal vs. pressure drop.

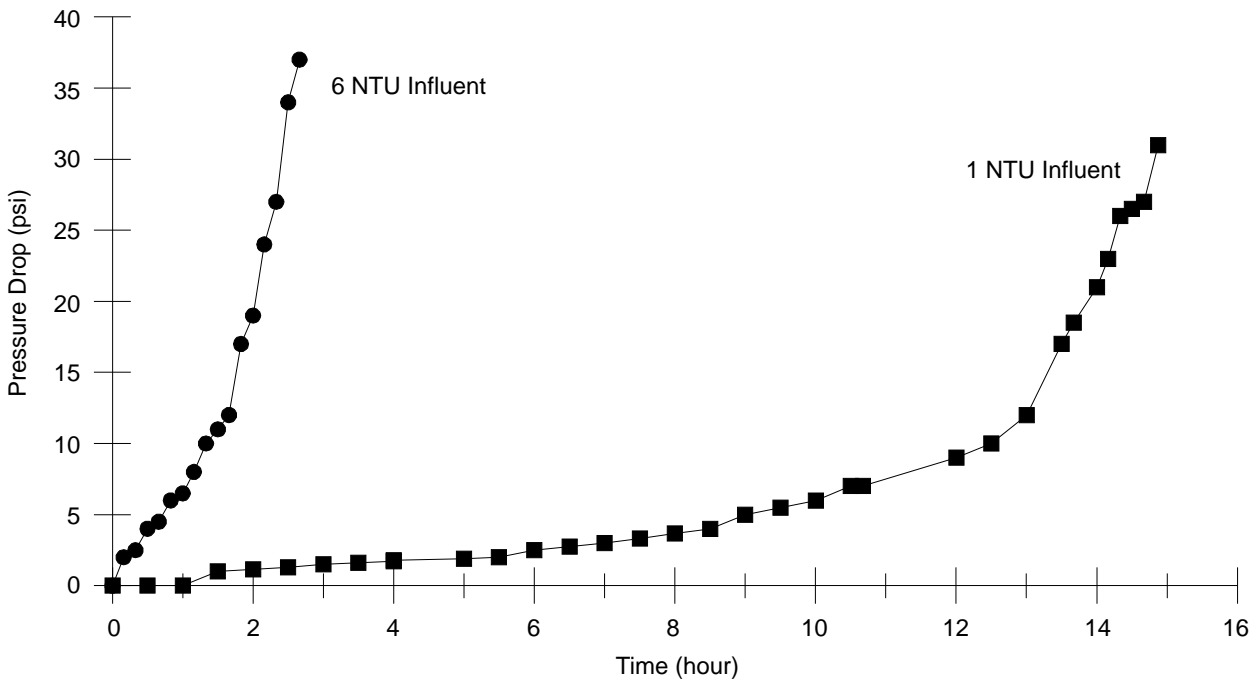
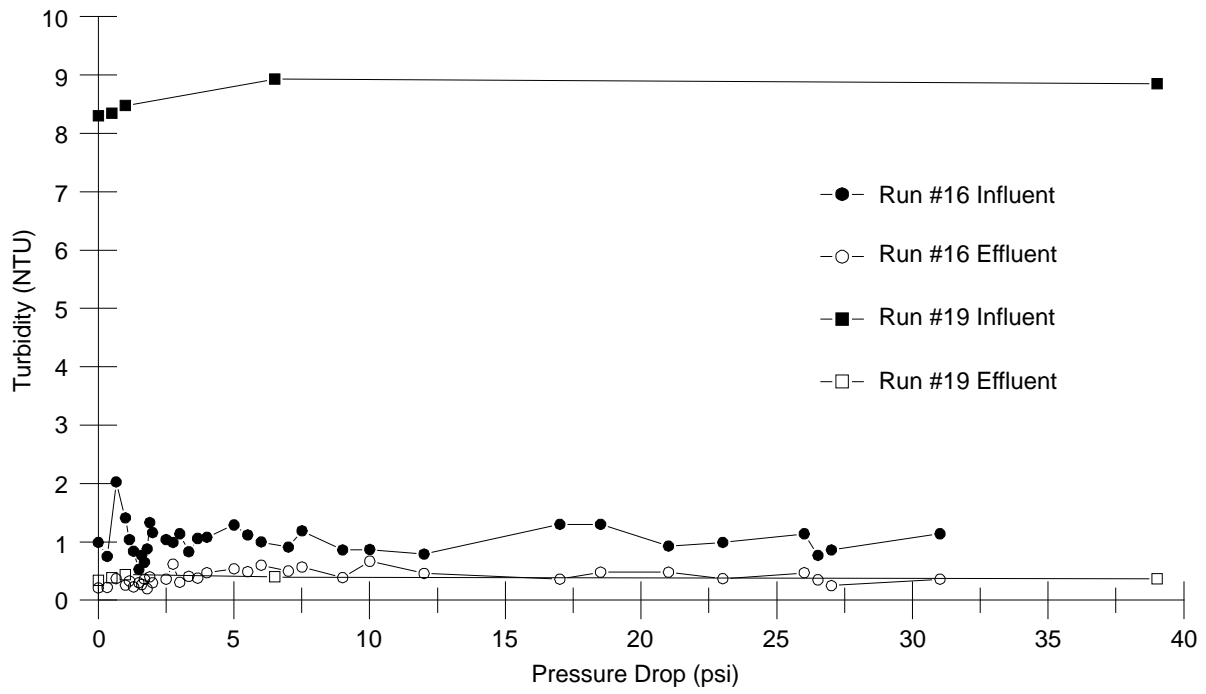
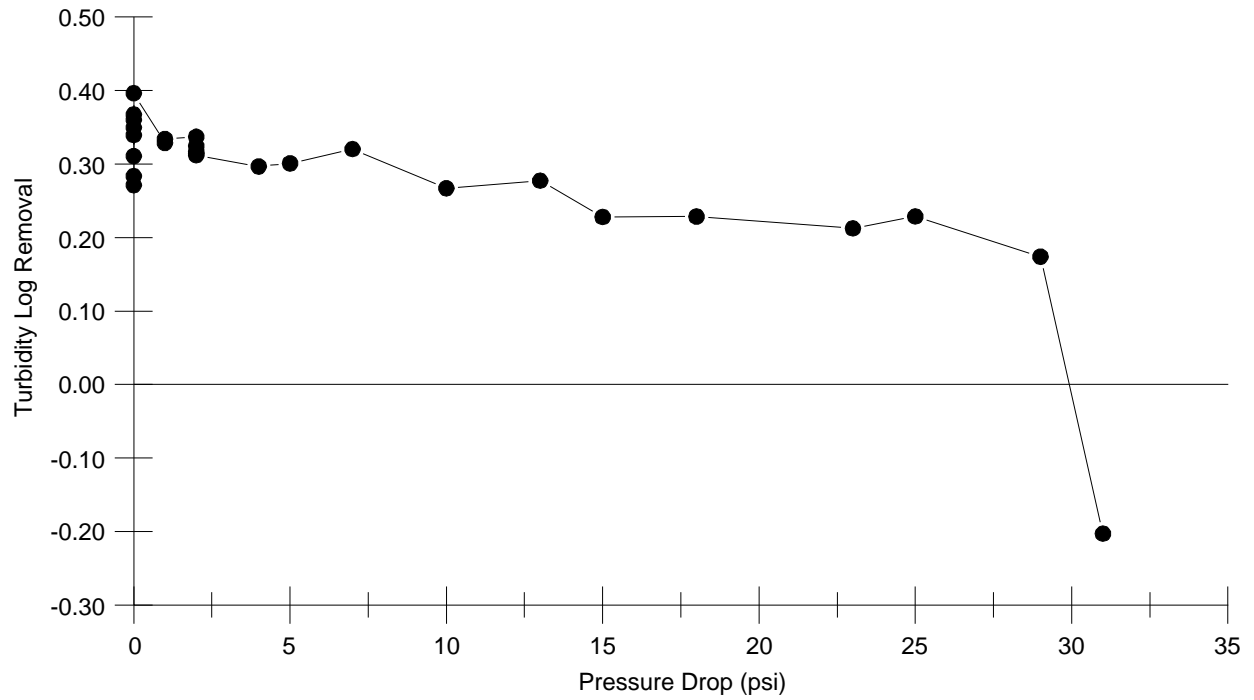


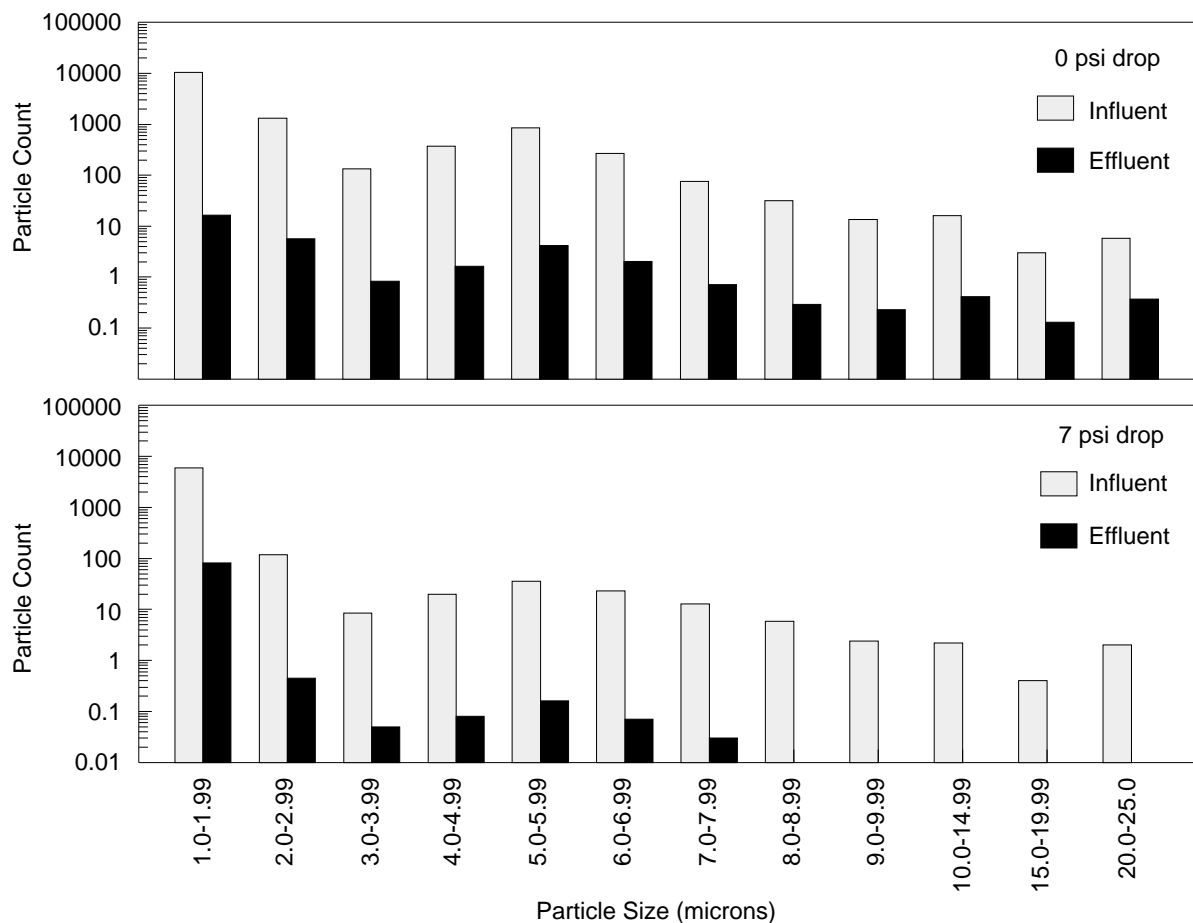
Figure 11-7. Pressure drop vs. time.



**Figure 11-8. Raw and finished turbidity vs. pressure drop.**



**Figure 11-9. Bag break.**



**Figure 11-10. Influent vs. effluent particle counts.**

One bag treated an average of 15,000 gallons of water before having to be replaced. Another bag treated approximately 4,000 gallons of water, but exhibited a much higher effluent water quality. Thus, bag selection is not a straightforward matching of pore size and the size of the particle to be removed. The difficulty lies in the fact that, although bags are rated similarly, their performance can be very different. The selection depends on the specific water quality characteristics and effluent objectives. At a minimum, bag filtration should not be used as the only barrier to *Cryptosporidium* removal, but could be used in conjunction with other technologies as a pretreatment step.

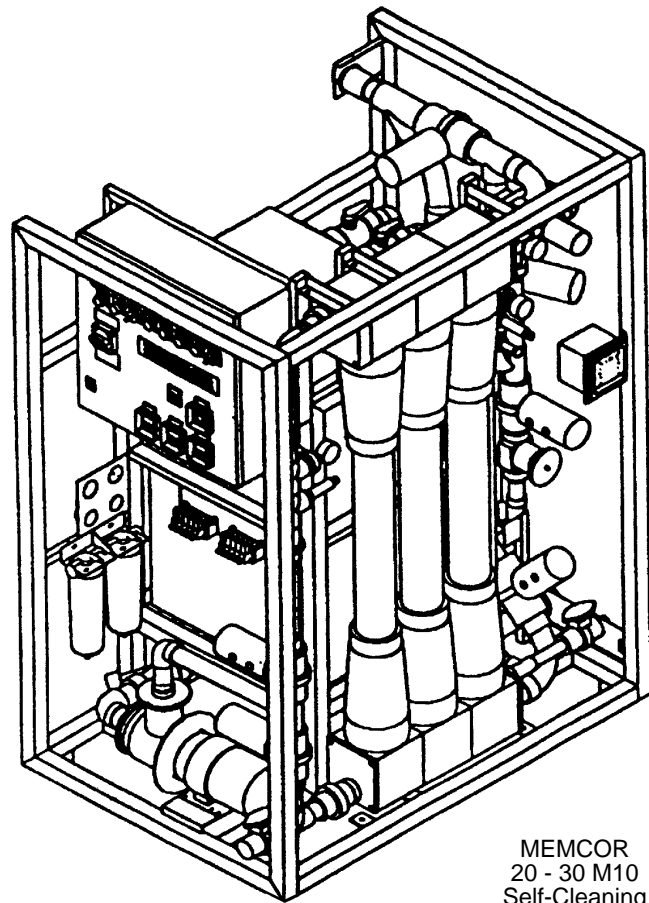
### ***Microfiltration***

Various field evaluations have been conducted to assess the operational performance of microfiltration technology and provide information on the removal of physical and biological constituents under conditions of continuous operation. Microfiltration membranes normally have pore sizes 0.1  $\mu\text{m}$  or greater (Jacangelo et al. 1997). The water flow of the test system was 15 gpm (56.7 LPM) during experimental run number one, two, and three. The water flow of the test system (Figure 11-11) was 34 gpm (128.5 LPM) for the final (test run four) test run. Polystyrene beads (4.5  $\mu\text{m}$ ) were injected into the raw, untreated test water. Treated effluent samples were collected from approximately 3.5% of the total effluent volume for test run one, two, and three (15 gpm) and 1.5% of the total effluent volume for the final test run (35 gpm). Water samples were collected using a 1- $\mu\text{m}$  polycarbonate membrane filter. Experiments one, two, and three demonstrated an average log removal of 3.71+/-0.19std. The log

reduction of turbidity was  $1.33 \pm 0.38$ . Test run number four demonstrated a log reduction of 3.57 for the polystyrene microspheres and 1.78 for the turbidity (Table 11-7). In addition to the data presented in Table 11-7, particle counts were performed for test run four resulting in log removals of 3.85 for particle counts (4–6- $\mu\text{m}$  range) and 3.14 for particle counts in the 1–25- $\mu\text{m}$  range. Collectively, results showed no influence due to the different flow rates. Similar to the bag filter research studies, the log reduction of microspheres is about 2 times the log reduction of turbidity. The results indicate that microfiltration technology is a feasible small system drinking water treatment technology for particle removal (Li 1994).

### ***Ultrafiltration***

A spiral-wound ultrafiltration (UF) membrane package plant has been installed at the T&E Facility (Figure 11-12). Nominal pore size is  $.05 \mu\text{m}$  with a molecular weight cutoff of 10,000 daltons. The package plant can produce up to 15 gpm. During initial testing, 4.5- $\mu\text{m}$  microspheres were observed in the permeate resulting in only 2.5 log removal, suggesting a problem with the system. Upon inspection of the membranes, a plastic adapter on the downstream end of the permeate tube was found to be broken, allowing raw water to pass directly into the permeate. This situation has also been observed in field tests. An advantage that hollow-fiber membranes have compared to spiral-wound membranes is that such a loss of filter integrity would be quickly observed for the hollow-fiber membrane system



MEMCOR  
20 - 30 M10  
Self-Cleaning  
Continuous  
Microfiltration System

**Figure 11-11. Microfiltration system.**

**Table 11-7. EPA Microfiltration Performance Evaluations**

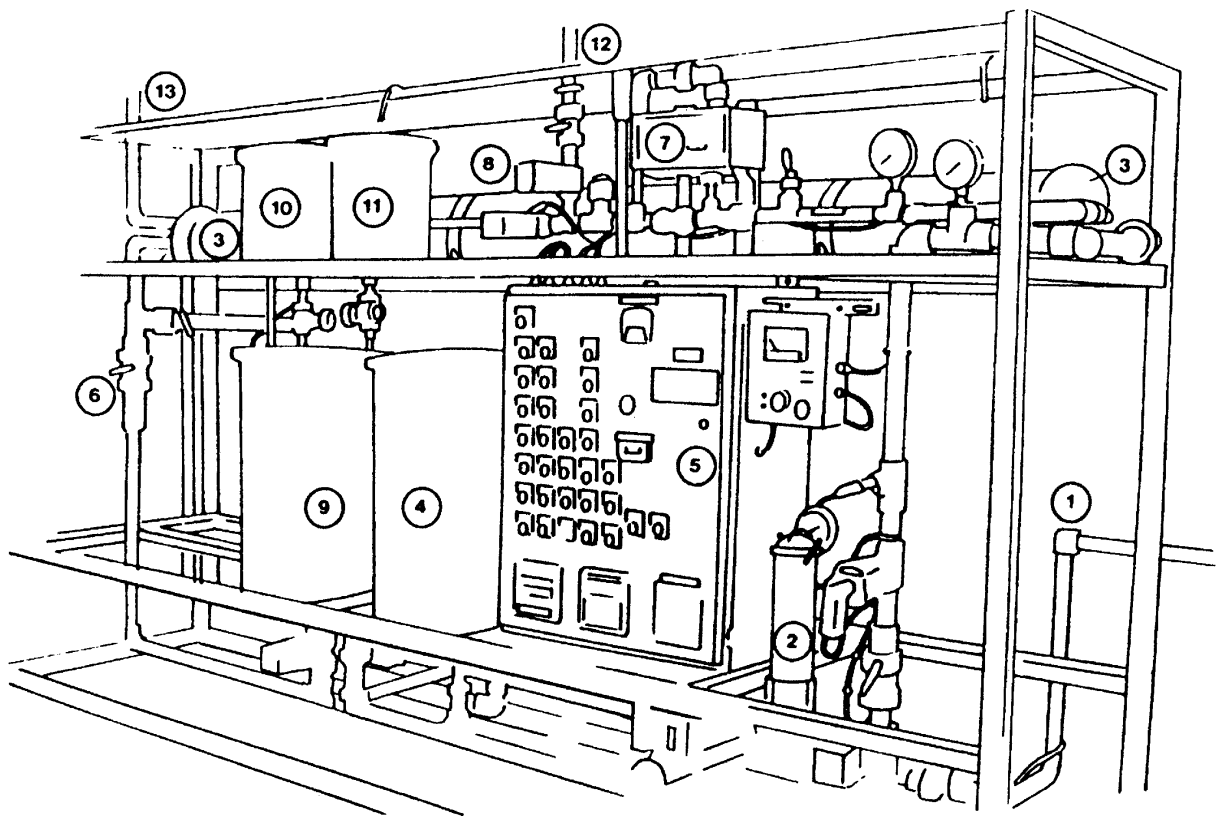
Parameter	Test 1	Test 2	Test 3	Test 4
Pressure in (psi)	23.3	23.2	23.3	22
Pressure out (psi)	10	10	10.3	9.3
Pressure drop (psi)	13.3	13.2	13	12.7
Membrane filter flow (gpm)	15	15	15	33.6
Duration of test (min)	71	60	87	55
Turbidity influent (NTU)	11.7	4.63	5.46	2.39
Turbidity effluent (NTU)	0.63	0.49	0.1	0.04
Turbidity (NTU) log reduction	1.27	0.98	1.74	1.78
Removal efficiency	94.62%	89.42%	98.17%	98.33%
Mass thru membrane (g)	1079	900	1305	1848
Manifold flow rate (gpm)	0.41	0.44	0.40	0.48
Total mass through manifold (gal)	33	26.5	39	25.7
Concentrated effluent (mL)	0.5	0.125	0.23	1.3
No. beads in influent	6.91E+08	4.81E+08	5.78E+08	2.10E+09
No. beads in effluent	1.23E+05	1.49E+05	7.7E+04	5.60E+05
Log reduction of beads	3.75	3.51	3.88	3.57
Removal efficiency	99.98%	99.97%	99.99%	99.97%

through changes in pressure readings. There was no indication from flow, pressure, or turbidity that the spiral-wound system was not properly removing *Cryptosporidium*-sized particles.

Once the adapter was replaced, several experiments at the T&E Facility were conducted similarly to the previously discussed technologies. The microsphere influent concentration averaged  $1.94 \times 10^5/L$ . The *Cryptosporidium* oocyst influent concentration averaged  $1.25 \times 10^6/L$ . These experiments used *Cryptosporidium parvum* isolated from sieved feces of neonatal mice by centrifugation ( $1100 \times g$ ) through a step gradient of Sheather's sucrose compared to the Holstein bull calves used in the previous bag filtration experiments. Cincinnati tap water was used as the raw water. The 24 studies were performed at an average inlet pressure of 29 psi, and effluent permeate flow rate averaged 7.2 gpm. The sample collection duration of each test ranged from 218 to 5,532 minutes with an average of 1,110 minutes. The system was operated continuously and was purged at least 8 hours between each test run with tap water.

Results indicated a 3–4 log removal range of microspheres from the influent to the permeate, with an overall log removal average of 3.47 (Figure 11-13). As a comparison, *Cryptosporidium* filtration achieved a log removal of 3.51 oocysts, which was very similar to the average log removal of the 4.5- $\mu$ m polystyrene microspheres. However, the last data point shown in Figure 11-13 (Run 24) represents samples being taken from the permeate over almost four days compared to just one day for the other data points exhibited in the plot. After 5,532 minutes (approximately 3.84 days) of run time, microspheres were still found in the permeate even though influent spiking had occurred over a two-hour period at the beginning of the experiment four days earlier (Figure 11-14). Log removal was 2.95 for this individual experiment, lower than most of the previous experiments. The higher average removal rate achieved by the shorter experiments could be the effect of insufficient sample collecting time, and suggests that particles may have long residence times in membrane filters but are still capable of ultimately passing through.

Based upon the above technology investigations, it appears that there are alternative filtration technologies to conventional package plants. Depending on raw water characteristics, a likely configuration could consist of filters in series with decreasingly small pore sizes that could in effect remove most microbiological contaminants, reducing the need for chemical coagulants and disinfectants. Operation and maintenance would be simplified, thus enhancing long-term compliance.



- |                       |                       |                           |
|-----------------------|-----------------------|---------------------------|
| 1. Raw Water Inlet    | 5. Control Panel      | 9. Cleaner Tank           |
| 2. Bag Prefilter      | 6. Recirculation Loop | 10. NaOH Reservoir        |
| 3. Membrane Module    | 7. Turbidimeter       | 11. NaOCl Reservoir       |
| 4. Chlorine Reservoir | 8. Chlorine Monitor   | 12. Finished Water Outlet |
|                       |                       | 13. Reject Water Outlet   |

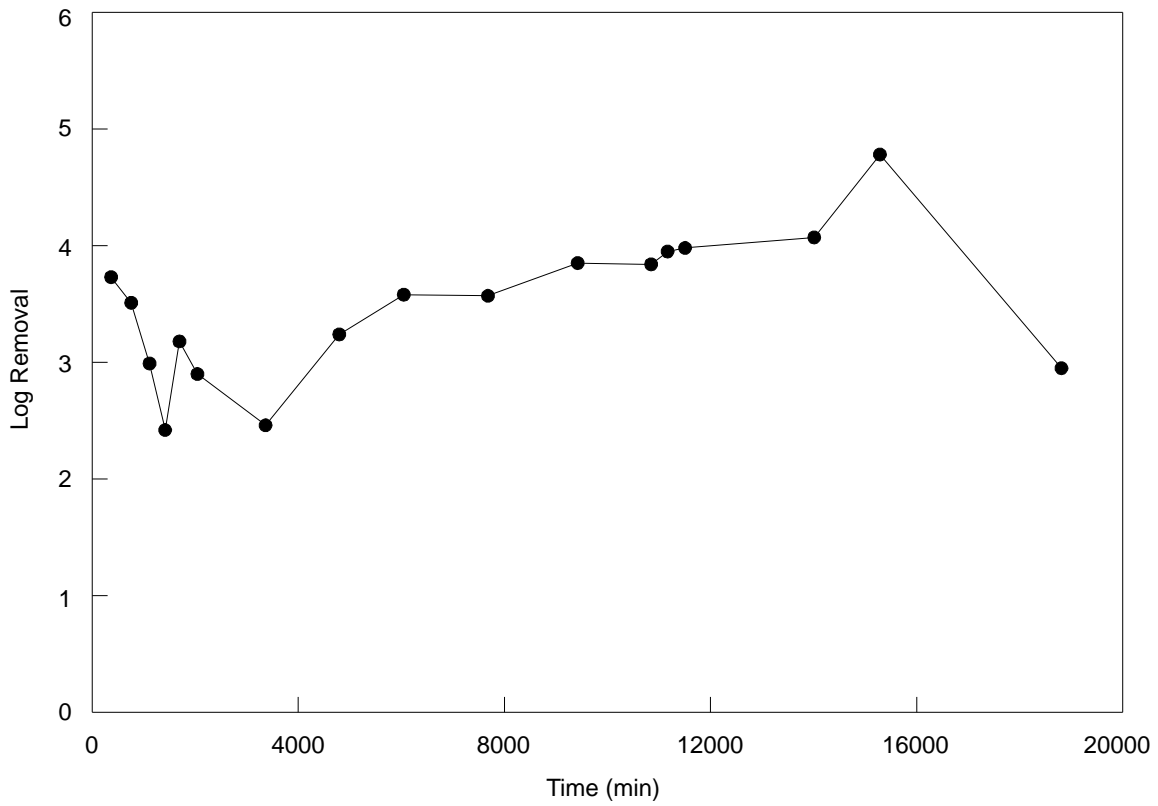
**Figure 11-12. Ultrafiltration package plant.**

## Disinfection

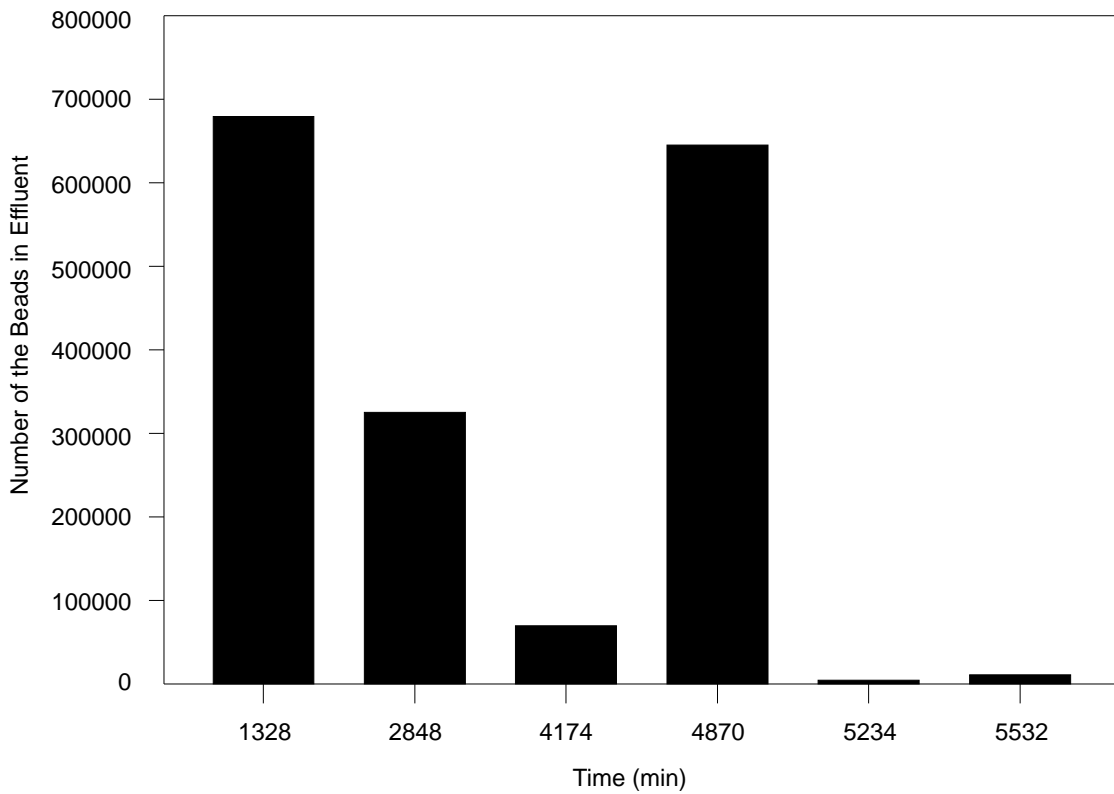
As evidenced by the MCL and M/R violations of the SDWA and its amendments over the years, small systems have difficulty in disinfecting their water and recording and submitting compliance data to the appropriate state agency. In cases where good filtration is lacking or ground water is under the influence of surface water, there is also the potential for using too much disinfectant, resulting in water that is unpalatable or resulting in the formation of by-products which exceed the MCL. As is the concern for systems of all sizes in selecting the most suitable disinfectant, small systems have to be even more concerned with the safe and easy handling, shipping, storage, and the capital and O&M costs of disinfectants. In anticipation of small system needs in meeting the Stage 1 D/DBP Rule, the Ground Water Rule, and the Stage 1 Enhanced Surface Water Treatment Rule, the WSWRD has investigated alternative technologies, focusing on their ability to inactivate *Cryptosporidium* while at the same time being affordable and easy to operate and maintain. One of these technologies was an on-site oxidant generator, described below.

### *On-Site Electrochemical Oxidant Generator*

Salt brine electrolysis generators are generally safer to handle and operate than chlorine gas, sodium hypochlorite, and calcium hypochlorite systems. Salt brine, together with patented electrolytic cells,

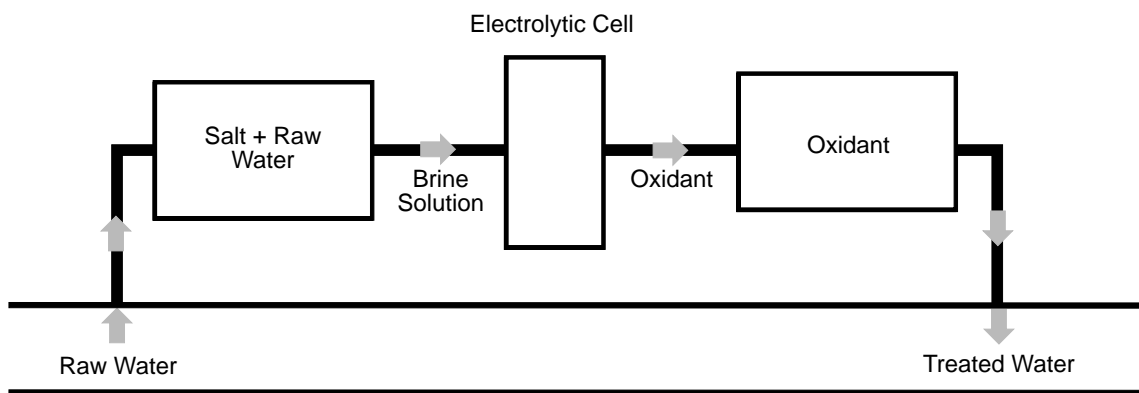


**Figure 11-13. Microsphere removal vs. membrane run time.**



**Figure 11-14. Number of microspheres in effluent vs. run time, run 24.**





**Figure 11-15. Electrochemical oxidant generator system.**

generate an anolyte (from the anode) liquor of primarily hypochlorous acid (Figure 11-15). Enhanced pathogen inactivation has been hypothesized to involve the synergistic actions of ozone, free radicals, chlorine dioxide, and oxyhalogen intermediates that form in the cell. It has also been assumed that this mix of oxidants would facilitate inactivation while minimizing the formation of total trihalomethanes (TTHMs). EPA initiated a project with the following objectives:

- Verify the presence or absence of intermediate oxidants that would facilitate inactivation
- Measure oxidant species and passive inorganic by-products
- Understand interactions and reaction rate

Results of a multi-year study revealed that, because of the very high concentration of free chlorine generated (as much as 400 mg/L) at the electrolytic cell anode, it was very difficult to measure for other oxidant species (Table 11-8). A wide variety of analytical methods were investigated, and analysis of the actual anode and cathode cells concluded that only free chlorine was produced. Table 11-9 lists the typical anolyte liquor concentrations. Results show that the concentration of bromate ion ( $\text{BrO}_3^-$ ) formed varies depending on the bromide ion ( $\text{Br}^-$ ) concentration of the salt used in preparing the brine solutions. The formation of chlorate ion ( $\text{ClO}_3^-$ ) is not a function of chlorine dioxide produced, but rather a result of free available chlorine (FAC) decomposition. Likewise,  $\text{BrO}_3^-$  formation in electrolyzed salt brine solutions does not require the presence of ozone. Thus, ozone, chlorine dioxide, or hydrogen peroxide were not found either immediately at the electrolytic cell anode or in the disinfected water (Gordon et al. 1999).

Mouse studies involving oocysts did not show any enhanced disinfection from using the electrolyzed brine solutions compared to free chlorine (Table 11-10). Nor did the brine solution oxidant and chlorine perform any better than the “no treatment” control that indicated an average  $\text{LogID}_{50}$  reduction of 2.17.  $\text{LogID}_{50}$  variability is most likely due to the initial health of the neonatal mice used in the infectivity analysis. Although  $\text{LogID}_{50}$  values range from 1.9 to 3.12 between experiments, there is quite good

**Table 11-8. Effect of 400 mg/L FAC on Common Analytical Methods**

Method	Determination	Error Caused by 200–400 mg/L FAC
DPD	$\text{ClO}_2$	0.1–100 mg/L $\text{ClO}_2$
Indigo	$\text{O}_3$	0.2–20 mg/L $\text{O}_3$
Horseradish peroxidase	$\text{H}_2\text{O}_2$	0.2–10 mg/L $\text{H}_2\text{O}_2$

**Table 11-9. Typical Analyte Liquor Concentrations Freshly Prepared Solutions**

Species	Lab System (mg/L)	Full-Scale System (mg/L)
FAC	320–350	230–250
ClO <sub>2</sub>	Not detected	Not detected
O <sub>3</sub>	Not detected	Not detected
H <sub>2</sub> O <sub>2</sub>	Not detected	Not detected
pH	3	4.5
Cl-	9–10,000	9–10,000
ClO <sub>2</sub> -	<0.05	<0.05
ClO <sub>3</sub> -	4–5	1–2
BrO <sub>3</sub> -	<0.05	1–2

**Table 11-10. Mouse Infectivity Results**

Experiment	Positive Control logID <sub>50</sub>	Brine Cell-30' logID <sub>50</sub>	Brine Cell-180' logID <sub>50</sub>	Cl-180' logID <sub>50</sub>
June 1998	1.92	1.90	1.90	1.90
July 1998	1.92	N/P	1.98	1.55
February 1999	2.70	1.75	3.04	3.12
June 1999	a	1.85	2.32	2.27
Combined results <sup>b</sup>	2.17	1.83	2.31	2.21

N/P–Not performed

a Calculated logID<sub>50</sub> values had negative values.

<sup>b</sup> Calculated using the grand total of infected neonates and the grand total of neonates sacrificed in each experimental group.

consistency within an experiment. Table 11-11 describes total and individual THM levels for both chlorine and the oxidant produced by the electrolytic cell. Chloroform levels were lower for the brine cell oxidant than for the chlorine, but TTHM formation levels were essentially the same, with chlorine exhibiting lower TTHM levels in some cases because of the higher levels of brominated compounds produced from the brine cell (Goodrich 1999). Variable bromide levels in the salt used to make the brine solution will most likely impact the formation of brominated compounds in the treated water.

## Field-Scale Demonstration Projects

Oftentimes, the difficulty of accepting new drinking water technologies is not related to experimental results obtained under controlled conditions, but in the acceptance by the consumers and regulatory agencies in real-world situations. This section describes field studies incorporating both filtration and disinfection technologies and the “lessons learned” when attempting to balance microbiological and disinfection water quality needs in small systems with limited resources.

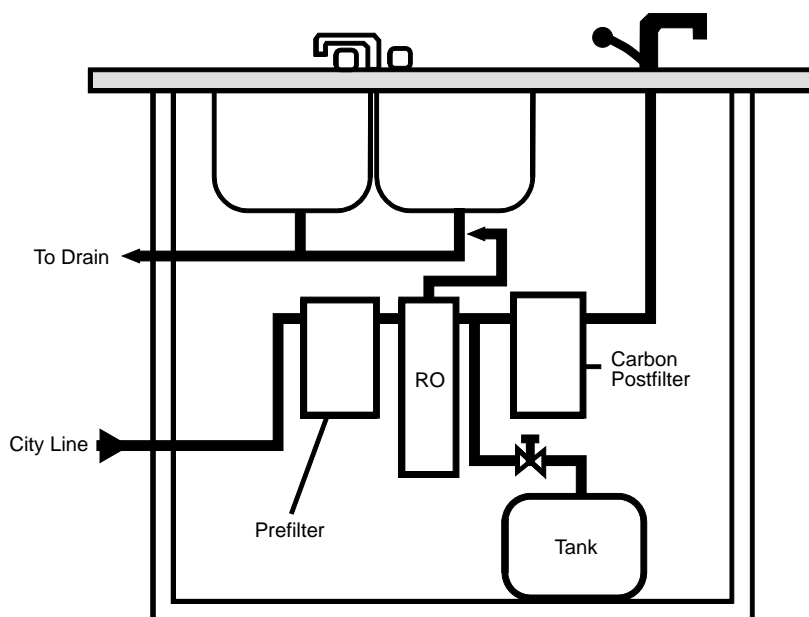
### *Reverse Osmosis Home Membrane Systems*

Unlike the filtration experiments described earlier that took place in-house at the T&E Facility, the experiences presented below are from a field study focusing on removal of naturally occurring fluoride at the tap by a point-of-use (POU) system. The water being supplied to the homes was provided by a well located within the subdivision. However, the driving force in the ultimate acceptance by the State of Virginia was the treatment devices’ ability to provide finished water with acceptable levels of het-

**Table 11-11. Electrolyzed Brine Cell/Chlorine TTHM Results**

	<b>Ohio River Concentration</b>	<b>Cell 30 min.</b>	<b>Chlorine 30 min.</b>	<b>Cell 180 min.</b>	<b>Chlorine 180 min.</b>
TOC (mg/L)	2.62	2.55	3.9	2.4	3.16
CHCL3 (Fg/L)	0.5	40.4	73.5	59.8	99.7
CHBRCL2 (Fg/L)	<0.1	22.4	9.9	34.4	13.2
CHBR2CL (Fg/L)	<0.1	9.1	0.8	12.2	<0.1
CHBR3 (Fg/L)	<0.1	<0.1	<0.1	<0.1	<0.1
TTHM (Fg/L)		71.9	84.2	106.4	112.9
	<b>Mill Creek Concentration</b>	<b>Cell 30 min.</b>	<b>Chlorine 30 min.</b>	<b>Cell 180 min.</b>	<b>Chlorine 180 min.</b>
TOC (mg/L)	5.07	5.14	5.71	5.2	5.56
CHCL3 (Fg/L)	<0.1	84.7	108.5	99.9	131.1
CHBRCL2 (Fg/L)	<0.1	31.9	16.6	42.2	17.5
CHBR2CL (Fg/L)	<0.1	15.7	<0.1	35.4	<0.1
CHBR3 (Fg/L)	<0.1	<0.1	<0.1	<0.1	<0.1
TTHM (Fg/L)		132.3	125.1	177.5	148.6

erotrophic plate counts (HPC). A public-private partnership between the State of Virginia, EPA, and three POU vendors demonstrated the use of reverse osmosis (RO) POU systems to reduce fluoride for a subdivision as a lower cost alternative to abandoning the well and installing a large transmission line to connect with a PWS several miles away. Prior to this project, no treatment existed at the subdivision's well. These standard units were designed to treat only the water that would be used for drinking and cooking, and in some homes, the ice-making units in refrigerators. They consisted of a sediment prefilter, a high-flow, thin film (HFTF) reverse osmosis membrane, a storage tank, and an activated carbon postfilter (Figure 11-16). Basic parameters such as conductivity, fluoride, HPC, total coliform, chlorine residual, pH, sodium, total dissolved solids (TDS), and turbidity were used to evaluate the performance of the RO units.



**Figure 11-16. RO/POU unit.**

Fluoride reduction was easily achieved for the entire duration of the study, maintaining levels below the secondary maximum contaminant level (SMCL) of 2.0 mg/L; however, HPC counts were elevated. The decision was made to centrally chlorinate at the well and replace the HFTF membranes with chlorine-resistant cellulose triacetate (CTA) membranes and remove the activated carbon postfilter. Subsequent sampling demonstrated satisfactory fluoride and HPC levels. Variances in fluoride and HPC concentrations from site to site is explained by membrane degradation and water usage. The life expectancy of the membrane depends on the environmental conditions. High temperatures, bacteria, and high pH have an adverse affect on the membrane life and results in poor performance. Membranes were replaced when the conductivity reduction decreased to 70 percent of the influent. It was observed that conductivity reduction was generally lower than fluoride rejection, so this became a convenient, inexpensive, and conservative means of monitoring system efficacy. A correlation between HPC and chlorine residual was also observed. In fact, much of the project focused on maintaining HPC levels below 500 cfu/mL.

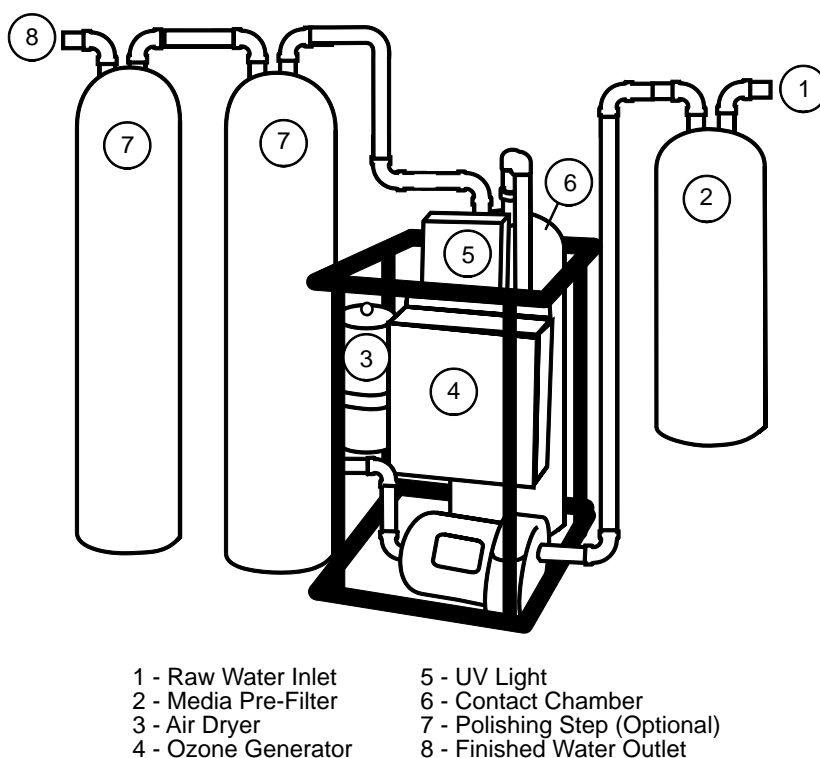
Water quality sampling data indicated that the risk of exceeding 500 cfu/mL at the tap was inversely proportional to the chlorine residual in the post-RO holding tank. Any time the residual exceeded 0.5 mg/L free chlorine, the HPC limit was maintained without exception. This is extremely relevant, because an RO membrane allows some chlorine to pass through, thus maintaining a residual at the tap in this case. The water reaching each household typically exhibited chlorine residuals of 1 to 1.5 mg/L. Concentrations in the holding tank between 0.5 and 1 mg/L were observed frequently, indicating 33 to 50 percent passage of the chlorine through the membrane. This concentration decreases over time in the finished water holding tank as it is consumed through various oxidation reactions. Because of this, it can be presumed that negligible chlorine residuals indicate the unit has not been recently used.

It was concluded that the HPC concern could be eliminated by using chlorine-tolerant membranes and by continually chlorinating the subdivision's well. In most cases, the RO storage tank unit was continually refilled with chlorinated water. The HPC depended on the chlorine residual in the storage tank, and usually the residual chlorine remained high enough to keep the unit clean. However, if the units were not used daily, stagnant water in the tank caused a loss of residual chlorine, and the water was susceptible to microbiological growth. It was found that one way to overcome this was to flush the tank daily. This concept was demonstrated at a business site during the study where the water was only used sporadically.

## **Public Acceptance**

At least 1 gallon per day of RO water was consumed by 77% of the homeowners, corresponding to the 75% who used the system for all of their drinking and cooking needs. Just 6% of the participants claimed to rarely use the RO water (Lykins et al. 1995). Although demonstrating fluoride reduction with RO has been done before, the challenge in this study was maintaining microbiological integrity and gaining public and regulatory acceptance of POU treatment. This required an entirely different relationship between the state authorities and the customers. The initial and exit surveys confirmed not only public acceptance, but showed an increase in customer satisfaction with the POU treatment. When asked to rate the water quality on a scale of 1 to 4, 52% of participants in the initial survey rated the well water (not chlorinated) quality as "fair" or "poor," while 77% rated the RO water as "good" or "very good" shortly after installation. In the exit survey one year later, 94% rated the RO water as good or very good, showing a significant increase in the acceptance of the POU systems. This acceptance may be due, in part, to the treated RO water being softer than the raw water.

The average RO water quality was rated 1.5 points higher than the average tap water quality rating. The average rating was calculated by summing the individual ratings and dividing by the number of responses. In the exit survey, RO water quality averaged 3.5 points on a scale of 1 to 4, while well water



**Figure 11-17. Ozone/UV POE unit.**

quality averaged 2.1 points. Moreover, RO water quality was always rated at least as high or higher than the well water quality, even when the nonchlorinated well water was compared to chlorinated RO water. This is noteworthy because the switch to a chlorinated supply initially precipitated a number of negative comments about taste. Microbiological integrity was not an issue for the consumers, whereas it was the primary driver from the regulatory perspective.

### ***Ozone Point-Of-Entry Field Application***

Most ozone whole-house point-of-entry (POE) applications for drinking water in the past have been utilized for oxidation of inorganic contaminants such as iron and manganese. Recent projects have focused on the use of ozone in conjunction with UV light (Advanced Oxidation Process [AOP]) and granular activated carbon for the destruction of synthetic organic contaminants in ground water and disinfection of surface water supplies. Figure 11-17 describes such a POE unit installed in the cellar of a sportsman's camp that served up to 30 hunters and fishermen daily in a lodge and four cabins. The raw water is filtered through garnet, followed by ozone injection (0.4 mg/L), and then passes by a UV light to a holding tank.

Disinfection results are shown in Table 11-12. Raw water quality was good. Finished and distributed drinking water was negative for total coliform. HPC values varied somewhat, with one episode exceeding 500 cfu/mL. The variability could have been the result of biofilm in one of the cabins. The cabin had not been occupied for days prior to sampling, thus resulting in old stagnant water in the plumbing system's service lines.

Ozonation by-products for the treated water were analyzed once during this brief study and indicated lower levels of all but one of the low-molecular-weight aldehydes found in the raw water (Table 11-13). This could have been the result of the overall good quality of the raw water and lack of ozone-demanding compounds, allowing reduction of the by-products already formed in the raw water.

**Table 11-12. Ozone/UV Disinfection Results**

Date	Total Coliforms (MF) CFU/100 mL			HPC (pour plate) CFU/100 mL		
	Raw	Post AOP	Distributed Water	Raw	Post AOP	Distributed Water
06/18/91	450	<1	<1	56	260	110
07/07/91	LA	LA	LA	1300	<1	33
07/21/91	40	<1	<1	2400	5	1
08/01/91	40	<1	<1	260	38	110
08/14/91	60	<1	<1	76	<1	7
08/25/91	100	<1	<1	50	7	>500
09/03/91	30	<1	<1	80	1	1
09/11/91	240	<1	<1	470	170	73
11/02/91	100	<1	<1	180	9	30

LA = Lab accident

**Table 11-13. Ozone/UV By-Product Results**

Compound	Raw	Post AOP	Distributed
Formaldehyde	40.4	2.4	1.4
Acetaldehyde	6.4	5.0	48.3
Propanol	1.0	ND	ND
2-Butanone	0.8	ND	ND
Butanol		ND	ND
Pentanal		ND	ND
2-Hexanone		ND	ND
Benzaldehyde		ND	ND
Nonanal	0.7	1.0	
Decanal	0.2	0.7	
Glyoxal	4.2	5.4	
Methyl glyoxal		1.8	0.1
Chloral hydrate		<0.1	<0.1

ND = Not detected

In order to produce ozone, low-humidity oxygen is required. This POE unit utilized silica gel to dry the ambient air in the cellar rather than install an expensive oxygen generator. Operational concerns centered around the frequency of reconditioning the air-drying material. Because of the high humidity in the cellar of the lodge, the silica gel had to be reconditioned every few days. Although not expensive or time consuming (30 minutes in an oven at 325°C), constant attention to this might not be maintained in a household, and ozone generation, thus disinfection efficiency, could become highly variable (Goodrich et al. 1993).

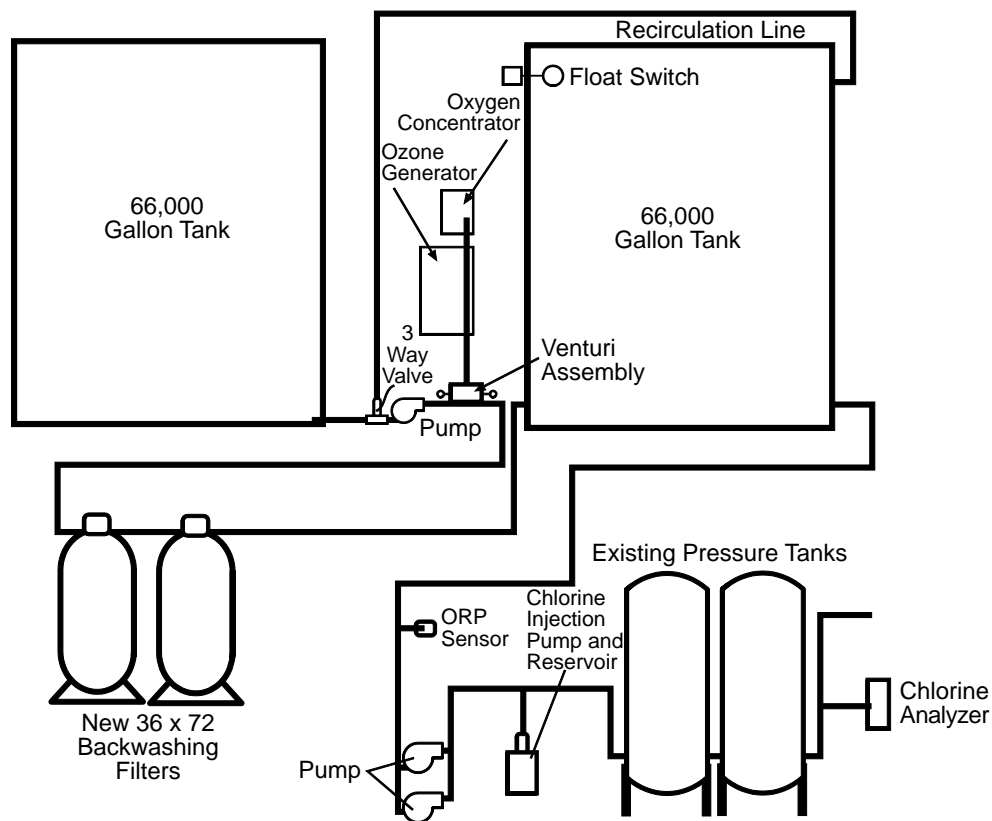
### ***South America Water Treatment Technology Demonstration***

Under the EPA Environmental Technology Initiative, several international technology demonstration projects were conducted in order to introduce U.S. technology into foreign markets. One of these projects involved systems to provide basic filtration and disinfection to three sites in Ecuador (Gallo 1999). Other small system projects have also been carried out in Mexico (still underway) and the People's Republic of China (nitrate and synthetic organic removal) by the WSWRD.

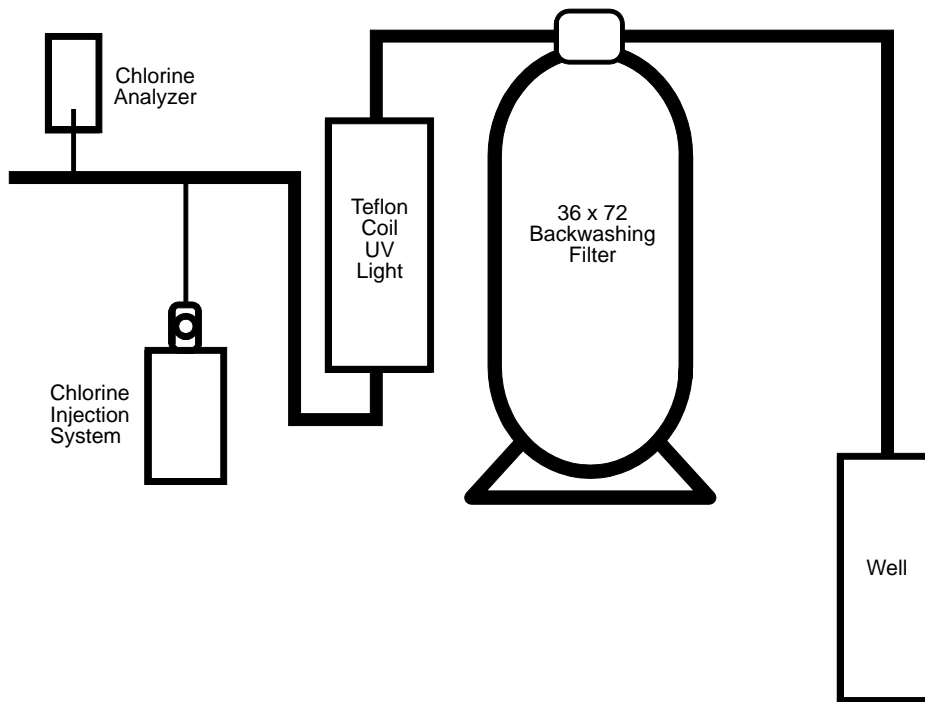
This discussion will focus on the Ecuador studies. The three sites in Ecuador were as follows:

- Hospital Rodriguez Zambrano—a public hospital in the coastal city of Manta, Ecuador. The water treatment system consists of (1) primary disinfection via ozone; (2) filtration; and (3) residual disinfection via chlorination (Figure 11-18).
- Monteoscuro—a rural community of approximately 150 families located 45 minutes from Portoviejo, Ecuador, and fifty miles west of Manta. The treatment plant is composed of three treatment processes: (1) backwashable multimedia filtration; (2) primary disinfection via UV radiation; and (3) residual disinfection via chlorination (Figure 11-19).
- La America—a rural community of approximately 56 homes located near Jipijapa, Ecuador, eighty miles southwest of Manta. Four POU units employing either filtration and UV or iodine disinfection were tested (Figure 11-20). These units were installed at key locations in the community such as the health clinic and the elementary school.

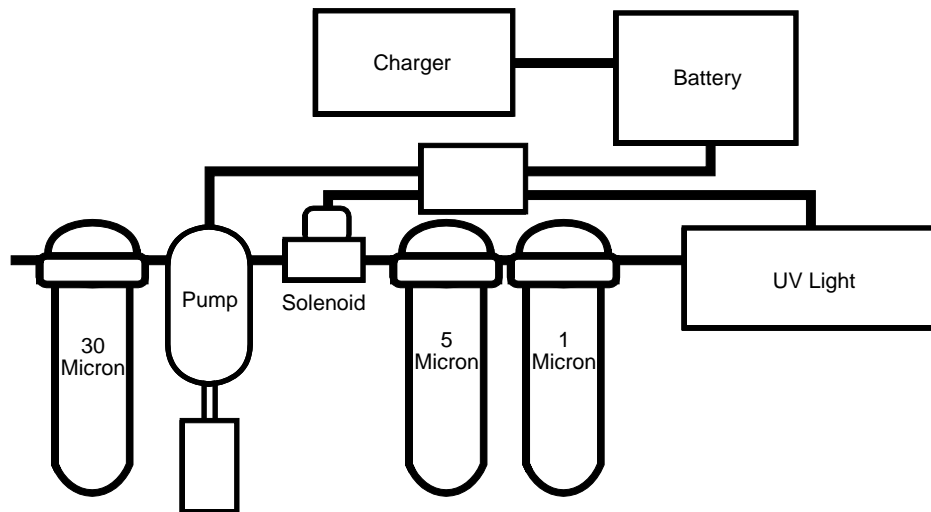
The goal of the project was to demonstrate low-cost, reliable, easy-to-operate POU/POE devices for treating drinking water in small communities. It was carried out cooperatively between WSWRD, the United States Agency for International Development, and Hagler Bailly, a private contractor. The units were installed in Ecuador between May 1996 and July 1996 (Clark et al. 2000).



**Figure 11-18. Hospital Rodriguez Zambrano treatment system.**



**Figure 11-19. Montescuro treatment system.**



**Figure 11-20. 110V/120V filtration/UV system.**

### Results of Pilot Test

Some of the problems that affected the results of the pilot test were as follows:

- The country went through political uncertainty due to elections in August 1996. The president left the country in early 1997, and Congress appointed a new president for a period of 18 months. There was no local government oversight.
- Spare parts for the system in Montescuro disappeared from the storage site.

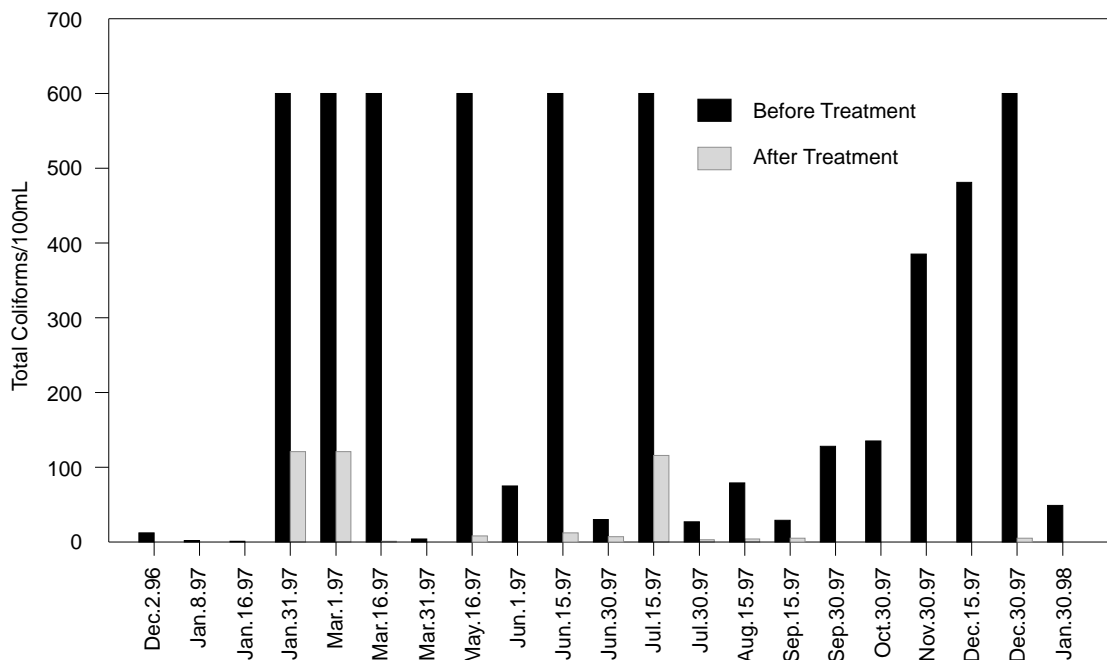


- El Niño caused severe damage in the coastal areas of Ecuador. Monteosuro was the hardest hit. Large mud slides isolated the town for several months.
- A large earthquake hit the Province of Manabi (location of all three sites), causing significant damage in Monteosuro. Water pipes were damaged in the vicinity of the site, and the village was cut off for several weeks.

Over a period of 14 months (December 1996 to January 1998), water samples were collected twice a month at the Hospital in Manta and the health clinic in La America. Samples at Monteosuro were collected only during the month of November 1997.

The package plant at the hospital Rodriguez Zambrano in Manta performed satisfactorily and was relatively sustainable because the hospital had the basic financial and technical resources needed to maintain and operate the system. In addition, problems with power supply and the impact of El Niño were less severe in the city than in the nearby rural areas. However, water shortages were frequent between November and March, and therefore the water had to be supplied by trucks. During 1997, the Province of Manta suffered a drought that severely restricted the city of Manta’s water supply. Because of resulting water shortages, the hospital was forced to shut off the water treatment system in order to prevent losing water that was normally consumed in the daily filter backwash. Every time this occurred and after the city water supply was back to normal, the water storage tanks were supposed to be cleaned and the whole system chlorinated; however, this procedure was not always implemented. Water samples were taken from specific faucets in the hospital.

When the water flow from the municipality was sufficient, the treatment system operated properly and produced the expected result in most cases. Figure 11-21 illustrates the results from the study. The high total coliform values are associated with periods when the hospital water distribution system was contaminated during municipal water shortages and when water was distributed to the hospital by truck and the treatment system was bypassed.



**Figure 11-21. Total coliforms in the water samples at the Manta Hospital.**

As a result of the problems discussed previously, including periodic power outages, the system in Montescuro was operated properly for only one month. When the system was operated properly, it functioned effectively.

In La America, the POU units operated properly most of the time. However, as seen in Figure 11-22, the total coliform removal rates were not as high as in Manta. This occurred because there was no residual disinfection provided by the POU units, and sampling procedures were not properly followed by the clinic staff. For example it was learned that the spigot at which the samples were taken was contaminated (Clark et al. 2000).

### Small System Remote Monitoring and Control Technology

EPA is currently evaluating technologies at the T&E Facility that are related to remote monitoring and control of small drinking water package plant systems and distribution systems. Regulations require all conventional water treatment operators to provide constant monitoring to assure quality of the treatment processes. Small system operators are under the same reporting and water quality requirements as the large treatment operators. Constant monitoring of the water quality can provide substantial savings in costs of time and travel for operation and maintenance. Various package plants at the T&E Facility and in the field (West Virginia) have been equipped with remote telemetry units (RTUs). The distribution systems at the T&E Facility are also controlled and monitored via remote telemetry. EPA is also monitoring various portions of the distribution system in Washington, D.C. Remote telemetry can support regulatory reporting guidelines by providing real-time continuous monitoring of the water quality and reporting the information electronically.

Supervisory Control and Data Acquisition (SCADA) systems of the past were not always used to their fullest potential by small systems due to complex operating systems and controls that usually required specially trained computer programmers or technicians and costly service agreements. Thus, large (financially secure) treatment plant operators typically used the SCADA systems. Usually, the hardware

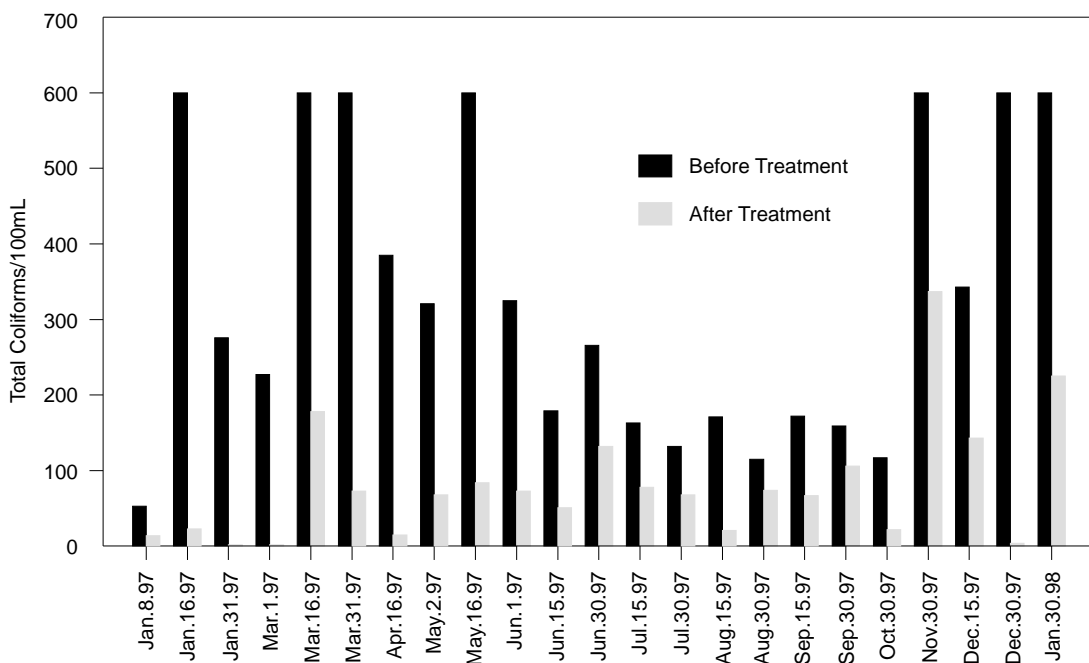


Figure 11-22. Total coliforms in the water samples at La America.

vendor also provided the SCADA system software with his or her own proprietary-user interface. Thus, it was almost impossible even for the average programmer or technician to integrate hardware and software from different vendors. This led to the perception that SCADA systems were expensive data loggers that did not add cost-saving value to the utility. However, in the last few years, SCADA system vendors have changed the way they design and fabricate their systems.

The application of SCADA systems to operate, monitor, and control small systems from a central location (electronic circuit rider) is believed to be one mechanism that can reduce both MCL and M/R violations under the SDWA. Filters could be operated more efficiently for particle removal, disinfectant doses altered in real-time in response to varying raw water conditions, and routine maintenance and chemical resupply scheduled more efficiently. Small independent systems could contract with an off-site O&M firm or join with other small systems to hire O&M services while maintaining ownership. This could help small systems enjoy some economies-of-scale that the medium and larger systems have in purchasing supplies, equipment, and power while also perhaps receiving a more qualified operator. Although some county-wide public utility districts may be responsible for several systems and already benefit from centralized management, limited staff may be forced to be on the road daily to simply check each system. In some states, it is required that an operator be on-site when water is being treated, thus overextending already limited staff in small systems.

Through the use of ultra-fast computers with large memory bases and graphical operating system interfaces, the current SCADA technology can be integrated with very little effort and usually with off-the-shelf, easy-to-learn software. Fairly inexpensive SCADA systems can now collect information and monitor water quality continuously every few seconds. Several treatment systems spread over a wide geographical area can be monitored and controlled from a central location by a single operator. The system operator can monitor, respond, and adjust the treatment system performance in a matter of seconds. Automated “smart” systems can identify operating trends and adjust operating parameters to accommodate most trends. Many of the smart systems can remedy problems before technicians are aware that any problematic situation exists with the treatment system (Haught and Panguluri 1998).

### ***Selection of a Remote Telemetry System (RTS)***

EPA has been evaluating a variety of “small” SCADA systems that would allow a single qualified/certified operator to monitor and control the operation of several small treatment systems from a central location. The following factors should be carefully considered before purchasing an RTS system (Haught and Panguluri 1998):

- Does the water treatment system justify the requirement for an RTS system (is it remotely located)?
- Is the treatment system amenable (can water quality instrumentation and operational controls “send and receive” data in real-time) to automation?
- What types of communication media can be used (phone, radio, cellular, etc.)?
- How much automation and control is available on the treatment system?
- What type of SCADA system is needed (is the goal to monitor, control, or both)?
- How many parameters are going to be monitored and/or controlled?
- Are there any specific regulatory monitoring and reporting requirements?

The above factors will determine the need and the basic design of the RTS. Retrofitting a treatment system for remote operations can be cost prohibitive; many of the small treatment systems currently in use were not originally designed for remote operations. Rural areas have little or no electronic hardware to communicate with a telemetry system. Thus, the cost of upgrading the treatment system for remote operations could be significant. Therefore, it is essential that the treatment system be fairly

amenable to automation. Table 11-14 identifies the amenability of packaged treatment technologies currently used by small water treatment systems to automation and remote control. Membrane technologies are extremely amenable to automation and remote control and also provide efficient removal for a wide range of drinking water contaminants.

**Table 11-14. Amenability of Treatment Technologies Used for Small Water Systems to Automation and Remote Control (Haught and Panguluri 1998)**

Source Water	Technology	Amenability for Automation/Remote Control
Ground	Air stripping	Very good to poor
	Oxidation/filtration	Poor
	Ion exchange	Good to poor
	Activated alumina	Poor
Surface	Coagulation /filtration	Poor
	Dissolved air flotation	Poor
	Diatomaceous earth filtration	Good to poor
	Slow sand filtration	Good to poor
	Bag and cartridge filtration	Good to poor
Ground and surface	Disinfection	Very good
	Corrosion control	Good to poor
	Membrane filtration systems	Good to poor
	ReverseOsmos/nanofiltration	Very good to poor
	Electrodialysis systems	Very good
	Adsorption	Good to poor
	Lime softening	Poor

Prior to the purchase of a remote telemetry system or SCADA system, it is also essential to understand the variability that exists within such systems. Many telemetry and/or SCADA systems may not provide the results needed to justify their purchase. Therefore, once the need for a SCADA system is justified and the suitable monitoring and controlling technologies are identified, the following factors should be carefully evaluated (Haught and Panguluri 1998):

- Cost (initial, training, service agreements, and operation and maintenance)
- Ease of operation (user-friendly to the operator)
- Ease of customization (programmability)
- Networking ability (connecting to several remote systems)
- Remote operability (ease of remote technical diagnosis)
- Scalability (ease of adding monitoring and control devices to the system)
- Vendor support (hardware and software upgrades and remote diagnosis)

Currently, there are several commercially available small-scale SCADA systems in the market. These small-scale SCADA systems should be further evaluated for the use of open standards. A SCADA system must be “scalable” to allow for future growth with respect to the number of input and output channels. These input and output channels are used to communicate with various monitoring and control devices. The SCADA hardware must also contain sufficient memory to store the monitored data for extended periods of time. In case of brownouts or blackouts, the system should normally self-boot upon resumption of power supply. Along with these basic features, the selected system must have some of the advanced features, which include

- Call-out feature—This feature allows the system’s software to notify appropriate personnel if problems develop with a treatment system or water quality. This feature can greatly enhance operator response in emergency situations and prevent costly shutdowns and loss of water and/or water quality.
- Security feature—This feature allows the system to be able to implement security levels of access to the treatment plant. Security levels with passwords can deny or allow monitoring and/or control access.

Whenever possible, a microprocessor-based unit or a “smart” system should be implemented in most cases. The smart systems greatly reduce the cost of on-line communication. The smart systems are typically more expensive, but the payoff is in savings associated with communication, operation and maintenance, and travel/repair costs. All operating functionality should be available to be transferred to the RTS from a remote site. The smart systems also eliminate the need for a dedicated on-line central computer. In such an implementation, the main computer is used only for periodic monitoring, transfer of monitoring and reporting data, troubleshooting, and modifications of control parameters.

### ***Capital Costs of Remote Telemetry System Components***

RTSs primarily consist of four main components: hardware, software, communication media, and electronic instrumentation for control and monitoring. The capital costs of these components are provided in Table 11-15. The total capital cost for the hardware and software for setting up a “smart” remote telemetry SCADA system at an EPA test site was approximately \$33,250.

Computer, hardware, software, and upgrades:	\$6,000
Communication modem and phone line:	\$1,000
Data collection and transportation terminal:	\$5,200
Instrumentation for monitoring and control:	\$21,000
Total capital cost:	\$33,250

**Table 11-15. Cost Estimates of SCADA System Components (Haught and Panguluri 1998)**

<b>SCADA System Component</b>	<b>Component Option</b>	<b>Range of Costs</b>
Hardware	Main computer	\$1,000 to 3,500
	SCADA unit	\$500 to 30,000
Software	Operating system	\$250 to 750 <sup>a</sup>
	Telemetry system	\$500 to 30,000 <sup>b</sup>
	Data collection & loggers	\$250 to 8,000
Communication medium	Telephone	\$75 to 125 <sup>c</sup>
	Cellular	\$250 to 500 <sup>d</sup>
	Radio	\$1,500 to 3,500 <sup>e</sup>
	Satellite	\$20,000 to 75,000 <sup>f</sup>
Instrumentation	Valves	\$25 to 1,500 <sup>g</sup>
	Switch	\$25 to 300 <sup>g</sup>
	Sensor	\$350 to 85,000 <sup>h</sup>

<sup>a</sup> Operating system software is usually included in the purchase price of a computer.

<sup>b</sup> SCADA software is usually included in the purchase price of the hardware.

<sup>c</sup> Monthly service charges are estimated.

<sup>d</sup> Activation, roaming, and monthly service are estimated and included.

<sup>e</sup> Transmission cost of integrated phone, cellular, radio frequency, and satellite system.

<sup>f</sup> Satellite systems cost for transmissions, monthly service, and activation charges are estimated.

<sup>g</sup> Cost per valve and/or switch.

<sup>h</sup> Cost per individual sensor or sensor system.

## Summary

Filtration and disinfection of water supplies are highly effective public health practices. In particular, the WSWRD has conducted extensive pilot- and field-scale experiments on the filtration of particles and disinfection of various microorganisms while controlling by-products geared specifically for small community and non-community systems. When applied in the field, the effectiveness of a package system is highly dependent on site-specific conditions and operator attention. This is a lesson that must be remembered when designing and setting up a package plant treatment system.

Microfiltration, ultrafiltration, and reverse osmosis filtration systems have been shown to be effective technologies for the removal of pathogens while being affordable for small systems. New disinfection systems appear to provide improvements to current systems in handling of chemicals and consistency of performance. This is an area that is undergoing rapid change. Many organisms are readily removed and inactivated in the laboratory but, under field conditions, the same effectiveness cannot be taken for granted. One approach to improve the effectiveness of systems in the field is the use of SCADA systems to operate, monitor, and even record data from remote locations. Advances in computer hardware and software capabilities coupled with decreasing prices have brought what was once thought to be a luxury only affordable by large systems to the point where it is fast becoming a small system necessity.

## References

- Campbell, S., Lykins, Jr., B. W., Goodrich, J. A., Post, D., and Lay, T. (1995). "Package plants for small systems: A field study." *Journal of the American Water Works Association*, 87(11), 39–47.
- Chapman, P. A. and Rush, B. A. (1990). "Efficiency of sand filtration for removing *Cryptosporidium* oocysts from water." *Journal of Medical Microbiology*, 32, 243.
- Clark, R. M., Goodrich, J. A., and Lykins, Jr., B. W. (1994). "Package plants for small water supplies—The U.S. experience." *Journal of Water Supply Research Technology*, 43(1), 23–34.
- Clark, R. M., Rice, E. W., Haught, R. C., Reasoner, D. J., and Goodrich, J. A. (2000). "EPA's small systems disinfection research program," submitted for publication to *Journal of Water Supply Research Technology*.
- Federal Register*. (1998). "National primary drinking water regulations: Disinfectants and disinfection by-products." 63(No. 24; Dec. 16), 40 CFR Parts 9, 141, and 142, 69390–69426.
- Finch, G. R., Daniels, C. W., Black, E. K., Schaefer III, F. W., and Belosevic M. (1993). "Dose response of *Cryptosporidium parvum* in outbred neonatal CD-1." *Applied and Environmental Microbiology*, 59, 3661.
- Gallo, L. J. (1999). *Drinking water treatment technology demonstration: Ecuador 1995–1998*. Hagler Bailly Inc., April.
- Goodrich, J. A. (1999). "Innovative technologies for small drinking water systems." *Proceedings, Japan—U.S. Governmental Conference on Drinking Water Quality Management and Wastewater Control*, Colorado Springs, CO, July 24–30.
- Goodrich, J. A. and Moore, G. T. (1998). *Remote sensing/control for small systems: Literature review/assessment*. U.S. Environmental Protection Agency, Cincinnati, Ohio, January.
- Goodrich, J. A., Lykins, Jr., B. W., and Gordon, P. (1993). "Ozone point-of-entry field applications." *Proceedings, 11th Ozone World Congress*, San Francisco, CA, September 1.

- Goodrich, J. A., Adams, J. Q., Lykins, Jr., B. W., and Clark, R. M. (1992). "Safe drinking water from small systems: Treatment options." *Journal of the American Water Works Association*, 84(5), 49–55.
- Goodrich, J. A., Lykins, B. W., Haught, R. C., and Li, S. Y. (1999). "Bag filtration for small systems." *Providing safe drinking water in small systems*, J. A. Cotruvo, G. F. Craun, and N. Hearne, eds., Pan American Health Organizations, World Health Organizations, ILSI Press, Washington, D.C., 265–272.
- Gordon, G., Gauw, R., Walters, B., Goodrich, J. A., Krishnan, R. A., and Bubnis, B. (1999). "Chemical detail of electrolyzed salt brine solutions." *Proceedings, American Water Works Association National Conference and Exposition*, Chicago, IL, June.
- Haught, R. C. (1998). "The use of remote telemetry to complement the operations and maintenance of a small treatment system." *Proceedings, 1998 American Water Works Association Annual Conference*, Dallas, TX, June 20–24.
- Haught, R. C. and Panguluri, S. (1998). "Innovations for management of remote telemetry systems for small drinking water treatment plants." Paper presented at the *First International Symposium on Safe Drinking Water in Small Systems*, Washington, D.C., May 10–13.
- Jacangelo, J. G., Adham, S., and Laine, J. M. (1997). *Membrane filtration for microbial removal*. American Water Works Association Research Foundation, Denver, CO.
- LeChevallier, M. W. and Norton, W. D. (1992). "Examining relationships between particle counts and *Giardia*, *Cryptosporidium*, and turbidity." *Journal of the American Water Works Association*, 84(12), 54–60.
- Li, S. Y. (1994). "*Cryptosporidium* potential surrogate and compressibility investigations for evaluation filtration-based water treatment technologies." Master's thesis, Miami University, Oxford, Ohio, November.
- Li, S. Y., Goodrich, J. A., Owens, J. H., Willeke, G. E., Schaefer, III, F. W., and Clark, R. M. (1997). "Reliability of non-hazardous surrogates for determination of *Cryptosporidium* removal." *Journal of the American Water Works Association*, 89(5), 90–99.
- Li, S. Y., Goodrich, J. A., Owens, J. H., Clark, R. M., Willeke, G. E., and Schaefer, III., F. W. (1995). "Potential *Cryptosporidium* surrogates and evaluation of pliable oocysts." *Proceedings, 21st Annual RREL Research Symposium, EPA/600/R-95/012*, 305–308.
- Lykins, B. W., Goodrich, J. A., and Hoff, J. C. (1990). "Concerns with using chlorine dioxide disinfection in the USA." *Journal of Water Supply Research and Technology—Aqua*, 39(6), 376–386.
- Lytle, D. A. and Fox, K. R. (1994). "Particle counting and zeta potential measurements for optimizing filtration treatment performance." *Proceedings, 1994 American Water Works Association Water Quality Technology Conference*, San Francisco, CA, November 6–10.
- MacDonald, J. A., Zander, A. K., and Snoeyink, V. L. (1997). "Improving service to small communities." *Journal of the American Water Works Association*, 89(1), 58–64.
- Marinas, B. J., Rennecker, J. L., Teffey, S., and Rice, E. W. (1999). "Assessing ozone disinfection with nonbiological surrogates." *Journal of the American Water Works Association*, 91(9), 79–89.
- National Research Council. (1997). *Safe water from every tap. Improving water service to small communities*. Committee on Small Water Supply Systems, Water Science and Technology Board, Commission on Geosciences, Environment, and Resources, National Research Council, National Academic Press, Washington, D.C.

- Pollack, A. J., Chen, A. S. C., Haught, R. C., and Goodrich, J. A. (1999). *Options for remote monitoring and control of small drinking water facilities*. Battelle Press, Columbus, Ohio.
- Sabran, I., Cross, R., Libby, D., Goodrich, J. A., and Lykins, Jr., B. W. (1992). "Ultrafiltration: One answer to SWRT?" *Water Conditioning and Purification Magazine*, 34(11), 22–26.
- U.S. Environmental Protection Agency (USEPA). (1989). "Drinking water; National primary drinking water regulations; Filtration, disinfection; Turbidity, *Giardia lamblia*, viruses, *Legionella*, and heterotrophic bacteria; Final rule." *Federal Register*, 54(No. 124; June 19), 40 CFR Parts 141 and 142, 27486–27541.
- USEPA. (1994). "National primary drinking water regulations; Enhanced surface water treatment requirements; Proposed rule." *Federal Register*, 59(No. 145; July 29), 40 CFR Parts 141 and 142, 38832–38858.
- USEPA. (1999). "25 years of the Safe Drinking Water Act: History and trends." *EPA 816-R-99-007*, Office of Water, December 3.
- Witt, V. M. and Reiff, F. M. (1966). "Water disinfection technologies for small communities and rural areas." *Water quality in Latin America: Balancing the microbial and chemical risks in drinking water disinfection*, G. F. Craun, ed., Pan American Health Organization, World Health Organization, ILSI Press, Washington, D.C., 139–168.



## CHAPTER 12

### Modeling Chlorine Decay and the Formation of Disinfection By-Products (DBPs) in Drinking Water<sup>1</sup>

#### Introduction

A major objective of drinking water treatment is to provide microbiologically safe drinking water. The combination of conventional drinking water treatment and disinfection has proved to be one of the major public health advances in modern times.

In the U.S., chlorine is most often the final disinfectant added to treated water for microbiological protection before it is discharged into a drinking water distribution system. However, disinfectants, especially chlorine, react with natural organic matter (NOM) to form disinfection by-products (DBPs), which are considered to be of concern from a chronic exposure point of view.

Drinking water disinfection, therefore, poses the dilemma of a risk tradeoff. Chemical disinfection reduces risk of infectious disease, but the interaction between chemical disinfectants and precursor materials in source water results in the formation of DBPs. Although disinfection of public drinking water has dramatically reduced outbreaks of diseases attributable to waterborne pathogens, the identification of chloroform, a DBP, in drinking water (Rook 1974; Bellar and Lichtenberg 1974) raised questions about possible health risks posed by these DBPs. Since 1974, additional DBPs have been identified, and concerns have intensified about health risks resulting from exposures to DBPs.

All natural waters and even treated drinking water exerts disinfectant demand due to the reactions with NOM and other constituents in water. Therefore, the applied disinfectant dose must be sufficient to meet the inherent demand in the treated water, to provide sufficient protection against microbial infection, and at the same time minimize exposure to DBPs.

Consequently, much research has been invested in attempting to characterize the nature of DBPs and the conditions that govern their formation in drinking water. One aspect of this research is the development of mathematical models for predicting the decay of chlorine and other disinfectants and for predicting the formation of DBPs themselves.

This chapter reviews current and historical research efforts related to the development of models for predicting the decay of disinfectants and the formation of DBPs. It focuses on chlorine as a disinfectant and emphasizes U.S. Environmental Protection Agency (EPA) research efforts in this area. The conditions that govern the interaction of NOM and chlorine and the resulting formation of DBPs are discussed. Research devoted to models for chlorine decay and the formation of DBPs are reviewed. The factors that affect exposure to DBPs are examined, and EPA field research studies that have driven the current research on chlorine decay and DBP formation are presented. The development of EPANET, a state-of-the-art public sector water quality/hydraulic model, is reviewed, along with the evolution of numerical modeling techniques. The topic of storage tanks and their impact on water quality and the public policy issues associated with this research is also discussed.

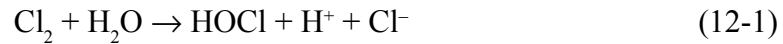
---

<sup>1</sup>Robert M. Clark, Lewis A. Rossman, Mano Sivagesean, Kathleen Schenck: ORD/NRMRL/WSWRD, AWBERC Mailstop 689, 26 West Martin Luther King Dr., Cincinnati, OH 45268. Corresponding Author: Robert M. Clark, 513-569-7201, clark.robertm@epa.gov.

## Chemistry of Disinfectants in Water

In order to understand the nature of the risk tradeoffs associated with the loss of chlorine residuals and the formation of DBPs, it is necessary to review some of the chemistry involved in this process.

Chlorine dissolved in water yields the following (White 1999):



HOCl generally reacts with the various components that make up chlorine demand as follows:



Consequently, chlorine is consumed and chlorine residuals dissipate, which may then result in microbiological regrowth and which, in turn, may increase the system's vulnerability to contamination. Three factors which frequently influence chlorine consumption in drinking water are (1) reaction with organic and inorganic chemicals (e.g., ammonia, sulfides, ferrous iron, manganous ion, humic material) in the bulk aqueous phase; (2) reactions with biofilm at the pipe wall; and (3) consumption by the corrosion process.

A by-product of chlorination is the formation of total trihalomethanes (TTHMs) and other DBPs in waters containing organic precursor compounds, such as humic and fulvic acid substances. Generation of TTHMs has been shown to be a function of various water quality parameters and chlorination conditions including total organic carbon (TOC), the type of organic precursor, chlorination level, pH, temperature, bromide level, reaction time, and UV-254 absorbance. TTHMs are also regulated under the Safe Drinking Water Act (SDWA) and its amendments of 1986 and 1996 (Amy et al. 1987; Clark et al. 1996b). Chlorine decay in distribution systems is generally considered to consist of two components. One component is wall demand, while the other is associated with decay in the bulk phase of the water (Clark et al. 1993a).

Chlorine demand and the formation of DBPs are influenced by both the condition of treatment as well as the constituents in the raw and treated water. Treatment processes change the concentration of drinking water constituents and are likely to change the composition and characteristics of the water distributed to the consumer. Therefore, when modeling chlorine decay and the formation of DBPs, it is important to find modeling-input parameters which can reflect these changes in water quality characteristics. Some common surrogate parameters for NOM are TOC and spectral absorbance. TOC concentration is indicative of the mass of material, whereas spectral absorbance relates more to specific structure and functional groups. DOC is the dissolved fraction of TOC. For NOM, the most commonly used spectral absorbance is the ultraviolet (UV) absorbance (UVA) at a wave length of 254 nm (UVA) which measures conjugated double bonds. The specific UVA (SUVA) is the ratio of UVA to the DOC. Its values give an indication of the NOM's nature, with higher values indicating a more aromatic character (Amy 1993).

For most waters, the reactions of chlorine with NOM make up the majority of the chlorine demand. Chlorine also reacts with various inorganic compounds. For example, chlorine reacts with ammonia to form different species of chloramines. Aqueous chlorine converts  $\text{Br}^-$  into hypobromous acid ( $\text{HOBr}^-$ ), which then attacks organic compounds to form brominated DBPs.

Chlorine will oxidize soluble iron and manganese to the insoluble ferric and manganic forms, respectively. Hydrogen sulfide reacts with chlorine, and successful removal of  $\text{H}_2\text{S}$  by conventional treatment with prechlorination has been reported.

Normally, the reactions between disinfectant and NOM make up the majority of the disinfectant demand and the subsequent formation of DBPs. The demand caused by inorganic or microbial demand is much less than the demand associated with NOM.

Some of the factors that influence both the formation of DBPs and the demand for chlorine are as follows:

- Disinfectant dose: several studies have shown that the formation of DBPs increases with chlorine concentration.
- Reaction time: a longer reaction time generally leads to both higher disinfectant demand and greater DBP formation.
- pH: For chlorine reactions, a shift in pH has little effect on chlorine demand. However, increase in TTHM formation has been observed with increases in pH. The sum of HAA6 (the sum of six of the nine haloacetic acid [HAA] species) has been found to decrease when pH increases.
- Temperature: An increase in temperature has been shown to cause an increase in the rate of both DBP formation and chlorine demand.

As mentioned previously, chlorine residuals are important to ensure the microbial safety of distributed drinking water. Requirements for disinfection of drinking water are defined in the Surface Water Treatment Rule (SWTR). According to the SWTR, treatment including disinfection must reliably achieve at least a 3-log (99.9%) removal and/or inactivation of *Giardia lamblia* cysts, and a 4-log (99.99%) reduction and/or inactivation of viruses prior to the delivery of water to the first consumer (Clark and Feige 1993). A control parameter frequently considered and specified in the SWTR is the CT (the product of the disinfectant residual concentration (mg/L) and contact time (min) measured at peak hourly flow) concept. Contact time is measured from the point of disinfectant application to the first customer (Clark and Feige 1993). Different disinfectants require different CT values because of their variability of action against different types of organisms. For example, chlorine is relatively ineffective against some protozoan, such as *Cryptosporidium*, but is generally very effective against most bacteria and viruses.

The SWTR requires that a minimum disinfectant level be maintained in all parts of a distribution system. Therefore, it is important that the factors that influence chlorine decay be identified and that models that can reliably predict chlorine residual levels in treated and distributed water be developed.

## Modeling the Decay of Chlorine Residuals

A number of investigators have conducted research into the development of models to predict chlorine decay in drinking water. In one of the earliest attempts to model chlorine decay, Feben and Taras (1951) developed the following model:

$$D_t = D_1 t^n \quad (12-3)$$

In Equation 12-3,  $D_t$  = the chlorine consumed at time  $t$  (hr),  $D_1$  = the chlorine consumed after 1 hour, and  $n$  is a constant characteristic of a given water. The 1-hour chlorine demand and  $n$  must be determined experimentally for a given water.

Haas and Karra (1984) investigated several models to describe chlorine decay, including

- First-order decay
- Power-law decay ( $n$ th order)
- First-order decay with stable components

- Power-law decay with stable components (*n*th order)
- Parallel first-order decay

They found that the parallel first-order decay model yielded the best results. This model assumes that there are two constituents in water that react with chlorine: (1) fast-reacting components, which exert an initial decay; and (2) slow-reacting components, which are responsible for long-term chlorine demand. This model was applied by Vasconcelos et al. (1997) in a project conducted jointly by EPA and the American Water Works Association Research Foundation (AWWARF) and is discussed later in this chapter.

A model by Qualls and Johnson (1983) described the short-term chlorine consumption by fulvic acids during the first 5 minutes of a reaction. This model (Equation 12-4) was originally developed for cooling water systems, but was then applied to disinfection of natural waters:

$$-dCl/dt = k_1[Cl][F_1] + k_2[Cl][F_2] \quad (12-4)$$

The chlorine decay is described by the sum of two first-order equations, in which the first part describes a rapid decay within the first 30 seconds, and the second simulates a slower decay from 30 seconds to 5 minutes. In Equation 12-4, [Cl] is the free residual chlorine,  $k_1$  and  $k_2$  are rate constants for the fast and slow reactions, respectively, and  $[F_1]$  and  $[F_2]$  are the concentrations of reactive sites on the fulvic acids for the fast and slow reactions, respectively.

Hao et al. (1991) demonstrated that chlorine reacts with organic material as well as inorganic material by evaluating the kinetics of Mn(II) oxidation with chlorine and examined the effects of chlorine dose and the presence of complexing agents on chlorine demand. They found that Mn(II) oxidation is facilitated by excess chlorine at pH = 8. An autocatalytic model analogous to that for Mn(II) oxidation by O<sub>2</sub> was developed in which the major mechanism for Mn(II) removal was the heterogeneous Mn(II) adsorption onto newly precipitated MnO<sub>2</sub>. The same model also describes the effects of pH and the external addition of MnO<sub>2</sub> on Mn(II) removal.

Ventresque et al. (1990) conducted a study at the Choisy-le-Roi water treatment plant near Paris to identify the organic components that react with chlorine. The plant consists of preozonation, coagulation, sedimentation, sand filtration, ozonation, granular activated carbon (GAC) bio-adsorption, and post-chlorination. The water is dechlorinated before being distributed to the consumer. The authors applied a second-order kinetic model to the long-term chlorine demand data. They analyzed the kinetics at every stage of the plant and found that the initial chlorine demand and the kinetic constants of ozone/GAC-treated water were always lower than those obtained from sand-filtered water. These results demonstrated the effect of activated carbon on the removal of organic matter.

Jedas-Hecart et al. (1992) attempted to identify the organic compounds that react with chlorine from the Seine River entering the final treatment stage at the Choisy-le-Roi plant. They studied the chlorine consumption kinetics of samples of water taken after overall treatment. They divided the chlorine decay into two phases. An initial phase of immediate consumption during the first 4 hours was called the initial chlorine demand. The second, slower consumption phase after the first 4 hours was defined as the long-term demand (LTD). The LTD was interpreted with the following kinetic equation:

$$-\frac{dx}{dt} = k(a-x)^\alpha(b-\frac{x}{n})^\beta \quad (12-5)$$

where  $x$  = chlorine consumption after 4 hours,  $k$  = the rate constant,  $a$  = the total residual chlorine at 4 hours,  $b$  = maximum potential chlorine demand,  $n$  = stoichiometry, and  $\beta$  = partial orders of reaction.

This model cannot be applied from time zero of chlorination because the LTD obeys a different reaction order than the initial chlorine demand.

The Water Treatment Plant (USEPA 1992) model described chlorine decay by dividing the decay curve into three components. These included an initial ( $t$  less than 5 minutes) reaction, a second-order reaction (5 minutes less than  $t$  less than 5 hours), and a first-order reaction ( $t$  greater than 5 hours). These equations apply only when the initial chlorine/TOC ratio is  $\geq 1:1$ .

Zhang et al. (1992) conducted a study of chlorine modeling in sand-filtered water (before post-chlorination) at the Macao treatment plant which draws water from the estuary of the West River (the main stream of the Pearl River in South China). The study indicated that the chlorine consumption in sand-filtered water can be divided into two phases: an initial chlorine consumption during the first hour which corresponds to the contact time in the reservoir of the treatment plant, and a long-term chlorine consumption after 1 hour in the network. This second component is interpreted in terms of an apparent first-order equation. According to the experiments performed on steel and asbestos cement pipes (diameter greater than 250 mm), the chlorine consumption by pipes is negligible. The authors suggested more experiments to be performed to verify the eventual influence of water velocity and diameter of pipe on the chlorine consumption by pipe itself. The chlorine disappearance in the network of Macao can be modeled as a first-order reaction.

To describe the entire disinfectant reaction for one ground water treated in a particular plant, Lyn and Taylor (1993) calculated the chlorine residual (CLR) as a function of chlorine dose, DOC, temperature, and time, using an empirical constant applicable only for that particular water.

Dugan et al. (1995) proposed a saturation model in order to predict the entire chlorine decay curve with one equation. TOC was chosen as the predictive water quality parameter for the saturation model because it represents the compounds exhibiting chlorine demand.

Chambers et al. (1995) conducted a study to test the validity of the exponential decay expression for free and total chlorine modeling using two sample networks and proprietary models. A sampling program was devised to collect information to calibrate the models. Rate constants for free and total chlorine were calculated. The results showed that the exponential decay model is appropriate for modeling chlorine in distribution systems and that it is possible to produce useful water quality models. They also showed that the rate constants for the water in the network were different from the rate constants collected in bench-scale experiments.

## **EPA Research Activities**

The Water Supply and Water Resources Division (WSWRD) of EPA has been very active in conducting research into the factors that affect chlorine decay in drinking water. One of the first projects to investigate the feasibility of modeling water quality and chlorine decay in drinking water distribution systems was conducted under a cooperative agreement initiated between the North Penn Water Authority in Lansdale, Pennsylvania, and EPA (Clark and Coyle 1990; Clark et al. 1988a). The project provided the basis for development of a water quality model called the Dynamic Water Quality Model (DWQM) which was applied to several service areas in the South Central Connecticut Regional Water Authority (SCCRWA). An extensive field sampling study was conducted as part of the model validation and verification. Chlorine demand was calculated according to a first-order decay assumption, which is defined as follows:

$$C = C_0 e^{-kt} \quad (12-6)$$

where  $C$  = the concentration at time  $t$ ,  $C_0$  = initial chlorine concentration,  $k$  = decay rate in  $\text{min}^{-1}$ , and  $t$  = time in min.

It is clear that, as dissolved chlorine travels through the pipes in the network, it reacts with NOM in the bulk water and with biofilm and tubercles on the pipe walls or with the pipe wall material itself (Clark et al. 1993a). This reaction results in a decrease in chlorine residual and a corresponding increase in DBPs, depending on the residence time in the network and the holding time in storage facilities. An early study designed to address these issues using a complete water quality and hydraulics model was conducted by EPA in collaboration with the North Marin Water District in California (Clark et al. 1994). As a follow-on to the North Marin study, Vasconcelos et al. (1997) investigated the factors leading to loss of chlorine residual in several water distribution systems. Kinetic rate equations describing the decay of chlorine were developed, tested, and evaluated using data collected in field-sampling studies conducted at these water utility sites. These studies are discussed in more detail later in this chapter.

Clark (1998) developed an equation for chlorine decay based on the concept of competing reacting substances and on the assumption that the balanced reaction equation can be represented by



In Equation 12-7, if  $A$  and  $B$  are the reacting substances,  $a$  and  $b$  are the proportion of reacting substances, and  $P$  is the product of the reaction, then the rate of reaction is given by

$$\frac{dC_A}{dt} = -k_A C_A C_B \quad (12-8)$$

or

$$\frac{dC_B}{dt} = -k_B C_A C_B \quad (12-9)$$

or

$$\frac{dC_P}{dt} = k_P C_A C_B \quad (12-10)$$

Since both  $C_A$  and  $C_B$  are changing with time, a relation connecting them is written in order to integrate the differential equation. If  $C_{A0}$  and  $C_{B0}$  represent the initial concentrations of  $A$  and  $B$ , respectively, at  $t = 0$  and  $x$  represents the concentration of  $A$  that has reacted, then the concentration of  $B$  that has reacted is given by  $bx/a$ . Consequently,

$$C_A = C_{A0} - x \quad (12-11)$$

and

$$C_B = C_{B0} - \frac{bx}{a} \quad (12-12)$$

From Equation 12-12

$$dC_A = -dx \quad (12-13)$$

and

$$-dC_A = \frac{bx}{a} \quad (12-14)$$

By substituting in Equation 12-8 and rearranging:

$$\frac{dC_A}{(C_{A_0} - x)(C_{B_0} - bx/a)} = k_A dt \quad (12-15)$$

Integrating Equation 12-15 and making the appropriate substitution yields

$$C_A = \frac{K}{1 - Re^{-ut}} \quad (12-16)$$

In Equation 12-16,  $C_A$  is the concentration of free chlorine. Rewriting Equation 12-16 yields

$$Cl(t) = \frac{K}{1 - Re^{-ut}} \quad (12-17)$$

where  $Cl(t)$  = the chlorine concentration in mg/L at time  $t$ ;  $R$  (dimensionless),  $K$  (mg/l), and  $u$  ( $\text{min}^{-1}$ ) are parameters to be estimated; and  $t$  = the time of reaction in minutes. In Equation 12-17, the value for the rate constants can be rewritten as follows:

$$u = M(1 - K) \quad (12-18)$$

where

$$M = \frac{k_A b C_{A_0}}{a} \quad (12-19)$$

Equation 12-16 was applied to a series of data sets collected from the Vasconcelos et al. (1997) study.

Clark and Sivaganesan (1998) utilized the equation developed by Clark (1998) to predict chlorine decay and TTHM formation in a number of field and laboratory data sets. The parameters for Equation 12-16 are estimated using regression analysis. Predictive equations were developed for the parameters  $K$ ,  $M$ , and  $R$  based on initial chlorine concentration ( $C_{A_0}$ ), pH, TOC, and temperature ( $^{\circ}\text{C}$ ). The estimated parameters for Equation 12-16 are as follows:

$$K = e^{0.32(C_{A_0})^{-0.44}(\text{TOC})^{0.63}(\text{pH})^{-0.29}(\text{Temp})^{0.14}} \quad (12-20)$$

$$K = e^{1.49(C_{A_0})^{-0.48}(\text{TOC})^{0.18}(\text{pH})^{0.96}(\text{Temp})^{0.28}} \quad (12-21)$$

and

$$\text{Log}_e(M) = -2.46 - (0.19 \text{ TOC}) - 0.14 \text{ pH} - (0.07 \text{ Temp}) + (0.01 \text{ Temp} * \text{pH}) \quad (12-22)$$

The estimated Model  $R^2$ s are 0.71, 0.78, and 0.42, respectively, for these equations. The model was validated against data collected from two field studies. Using standard statistical techniques, the upper and lower 95% confidence intervals were calculated for each parameter.

Rossmann et al. (1999) examined the factors that characterize the reaction conditions affecting treated water in a distribution system. Some of these factors are the pipe wall material, such as corrosion

products and biofilm slime, which can exert a significant chlorine demand. If chlorine is being consumed within a pipe by non-DBP-producing materials (such as ferrous corrosion products), then there is less available to react with the water's NOM. However, iron tubercles have also been shown to contain organic material that might include DBP precursors. Much of the study was devoted to studying the rate at which DBPs form in a pipe as compared to a glass bottle. One of the conclusions from the study was that the rate constants for chlorine decay in the pipe were an order of magnitude higher than in the bottle.

As an extension to their previous research, Clark and Sivaganesan (in press) hypothesized that two competitive reactions would adequately describe chlorine decay in raw and finished water. One reaction was assumed to represent the fast-reacting components associated with chlorine decay, and the second reaction was assumed to represent the slower-reacting components. In order to test this hypothesis, a model consisting of two competitive reactions was developed as described below:



where  $C_A^1$  is the free chlorine residual reacting with the collection of rapidly reacting components  $C_B^1$ ;  $C_A^2$  is the free chlorine residual reacting with the collection of more slowly reacting components  $C_B^2$ ;  $P^1$  and  $P^2$  are a collection of the by-products of the two reactions; and  $a_1, b_1, p_1, a_2, b_2,$  and  $p_2$  are the stoichiometric coefficients. These equations can be used to quantify the fraction of initial chlorine being utilized by the fast- and slow-reacting components.

The expressions below describe the change in  $C_A^1$  and  $C_A^2$  with time (Clark and Sivaganesan 1998):

$$C_A^1(t) = \frac{Cl_0^1(1 - R_1)}{1 - R_1 e^{-(1-R_1)k_1 t}} \quad (12-25)$$

$$C_A^2(t) = \frac{Cl_0^2(1 - R_2)}{1 - R_2 e^{-(1-R_2)k_2 t}} \quad (12-26)$$

where  $Cl_0^1$  and  $Cl_0^2$  are the initial concentrations of  $C_A^1$  and  $C_A^2$ ;  $C_A^1(t)$  and  $C_A^2(t)$  represent the change in the concentration of  $C_A^1$  and  $C_A^2$  with time;  $k_1, k_2, R_1,$  and  $R_2$  are parameters in Equations 12-25 and 12-26; and  $t$  represents time. The total initial chlorine concentration at time = 0 is

$$Cl_0 = Cl_0^1 + Cl_0^2 \quad (12-27)$$

where  $Cl_0$  is the total initial chlorine residual. If  $Cl_0^1$  and  $Cl_0^2$  are the initial concentrations of chlorine reacting in Equations 12-23 and 12-24, then

$$Cl_0^2 = Cl_0 - Cl_0^1 \quad (12-28)$$

The equation for the complete reaction is assumed as the sum of Equations 12-25 and 12-26 or

$$Cl(t) = \frac{Cl_0^1(1 - R_1)}{1 - R_1 e^{-(1-R_1)k_1 t}} + \frac{(Cl_0 - Cl_0^1)(1 - R_2)}{1 - R_2 e^{-(1-R_2)k_2 t}} \quad (12-29)$$



Given that  $Cl_0$  is known and that  $Cl_0^1$ ,  $k_1$ ,  $k_2$ ,  $R_1$ , and  $R_2$  are unknowns, Equation 12-29 yields a five-parameter equation as follows:

$$Cl(t) = \frac{Cl_0 Z(1 - R_1)}{1 - R_1 e^{(1-R_1)k_1 t}} + \frac{Cl_0(1 - Z)(1 - R_2)}{1 - R_2 e^{(1-R_2)k_2 t}} \quad (12-30)$$

where  $Cl(t)$  is the residual chlorine at  $t$  hours, and  $Z = (Cl_0^1 / Cl_0)$ ,  $k_1$ ,  $k_2$ ,  $R_1$ , and  $R_2$  are unknown parameters. All the model parameters are positive, and  $Z$  cannot be larger than 1.

The SAS procedure NLIN was used (SAS 1990) to estimate the model parameters. Since there is more than one solution to the above model and since the solutions depend on the initial values, model parameters were estimated in three steps to stabilize the solution. First, residual chlorine ( $Cl_t$ ) values from the first 60 minutes (generally 4–6 data points) were used to estimate the parameters  $R_1$  and  $k_1$  in Equation 18. The next step was to fix  $k_1$  at its estimated level and then use all the residual chlorine values to estimate  $Z$ ,  $R_1$ ,  $R_2$ , and  $k_2$  in Equation 12-30. Finally, the estimated  $Z$ ,  $R_2$ , and  $k_2$  values from Equation 12-30 were fixed, and the remaining model parameters  $R_1$  and  $k_1$  were re-estimated using data from the first hour of the experiment.

Thirty seven raw water data sets and twelve treated water data sets were used to develop a general model. The five model parameters were then regressed against TOC level, initial UVA level ( $UVA_0$ ), initial chlorine level ( $Cl_0$ ), pH, initial bromide level ( $Br^-$ ), temperature (Temp) in °C, and alkalinity in mg/L (ALK). The following general multiplicative model was used for each of the parameters:  $k_1$ ,  $k_2$ ,  $R_1$ ,  $R_2$ , and  $Z/(1 - Z)$ :

$$Y = c(\text{TOC} + 1)^d (\text{UVA} + 1)^e (Cl_0 + 1)^f (\text{pH})^g (Br^- + 1)^h (\text{Temp})^i (\text{ALK})^j \quad (12-31)$$

where  $Y$  = the parameter value, and  $c$ ,  $d$ ,  $e$ ,  $f$ ,  $g$ ,  $h$ ,  $i$ , and  $j$  are the exponents. Equation 12-31 can be rewritten as

$$\log(Y) = \log(c) + d\log(\text{TOC} + 1) + e\log(\text{UVA} + 1) + f\log(Cl_0 + 1) + g\log(\text{pH}) + h\log(Br^- + 1) + i\log(\text{Temp}) + j\log(\text{ALK}) \quad (12-32)$$

The SAS procedure “REG” is used to estimate the model parameters in Equation 12-32 (SAS 1992). This model guarantees that the predicted parameters are positive. Only parameters at the 5% level of significance were included in the model. Influential analysis was used to identify the data points which have a major impact on the parameter estimates. If the absolute value of the standardized residual of a data point was larger than 3, then that point was not included in the statistical analysis for any of the five model parameters (Equation 12-30). The resulting parameter-estimating equations are as follows:

$$k_1 = e^{6.58} (\text{TOC} + 1)^{2.66} (\text{UVA} + 1)^{7.63} (Cl_0 + 1)^{-3.25} (\text{pH})^{-1.45} (Br^- + 1)^{0.06} \quad (12-33)$$

$$R_1 = e^{-3.56} (\text{TOC} + 1)^{1.68} (\text{UVA} + 1)^{3.94} (Cl_0 + 1)^{-1.68} (\text{pH})^{1.05} (\text{Temp})^{0.69} \quad (12-34)$$

$$Z/(1 - Z) = e^{4.94} (\text{UVA} + 1)^{2.89} (Cl_0 + 1)^{-0.57} (\text{pH})^{-1.16} (\text{Temp})^{-0.79} \quad (12-35)$$

$$k_2 = e^{-4.83} (\text{TOC} + 1)^{-2.43} (\text{UVA} + 1)^{-7.71} (Cl_0 + 1)^{3.63} (Br^- + 1)^{-0.32} (\text{Temp})^{-0.31} (\text{ALK})^{0.14} \quad (12-36)$$

$$R_2 = e^{0.48} (\text{TOC} + 1)^{1.81} (Cl_0 + 1)^{-1.82} e^{0.03 \cdot \text{Temp}} \quad (12-37)$$

The model  $R^2$  are 0.60, 0.67, 0.57, 0.58, and 0.52, respectively. The model was applied to various data sets in order to test its application, and it was found that, in general, the model fits the experimental data well.

## Modeling the Formation of DBPs

Trusell and Umphres (1978) reviewed the effect of preozonation, bromide, pH, and chlorine dose on the formation of TTHMs in natural waters and proposed a kinetic model that describes their formation. They concluded that some of the factors that might influence the rate of the TTHM reaction are pH, temperature, the level of precursor, the level of chlorine, and the level of bromide ion before chlorine addition. They proposed two equations—one describing the rate of chlorine (Cl) consumption and one describing the rate of reduction of precursor or, conversely, the rate of TTHM production. Assuming that the reaction between chlorine residual and aquatic humic material is related to the concentration of each, a simple relation is obtained for the rate of chlorine consumption.

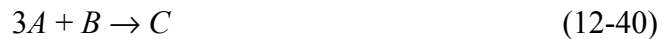
$$\frac{d[Cl_2]}{dt} = -k_1[Cl_2][TOC] \quad (12-38)$$

If it is assumed that the action of the chlorine does not significantly reduce the total concentration of the humic precursor, then the following equation represents the rate of TTHM production and is first order with respect to chlorine residual:

$$\frac{dTTHM}{dt} = -\frac{dC}{dt} = k_2(Cl_2)(C)^m \quad (12-39)$$

where  $m$  is the order of reaction with respect to the precursor concentration and  $C$  is the concentration of the organic precursor. The authors concluded that there are a number of factors of importance in describing the formation of TTHMs including the nature of aquatic humus, the influence of preozonation on TTHM formation, the influence of bromide, the influence of pH, and the influence of chlorine dose.

Kavanaugh et al. (1980) developed a two-parameter kinetic model for predicting THM formation in the distribution system following post-chlorination. They hypothesized that THM formation can be described by the overall stoichiometric expression



where  $A = HOCl$ ,  $B = TOC$ , and  $C = TTHM$ , while the  $n$ th overall rate constant for the reaction is  $k_n$ . Based on this expression, three moles of hypochlorous acid react with one mole of carbon in the organic precursor material to form one mole of TTHM. The rate expression for the formation of TTHM is given by

$$\frac{dC}{dt} = k_n(B)(A)^m \quad (12-41)$$

assuming that the rate of formation is first order with respect to TOC and  $m$ th order with respect to HOCl. The chlorine concentration  $A$  can then be related stoichiometrically to  $C$  by defining a TTHM yield as the moles of TTHM formed per mole of  $Cl_2$  consumed. The rate expression then becomes

$$\frac{dC}{dt} = k_n(B[A_0 - \frac{3C}{f}])^m \quad (12-42)$$

When the free chlorine is exhausted

$$f = \frac{3C}{A_0} \quad (12-43)$$

the yield  $f$  can be determined by measuring the THM concentration when  $A = 0$ . The equation is therefore a three-parameter kinetic model with  $k_n$  as the rate constant,  $m$  the reaction order with respect to  $\text{Cl}_2$ , and  $f$  the TTHM yield which must be determined empirically for the particular system under investigation.

Amy et al. (1987) discussed the formulation and calibration of several models for predicting TTHMs in untreated natural waters subjected to chlorination. Their general approach was to analyze specific portions of a large database derived from several natural water sources in order to isolate the effects of a given parameter on TTHM formation. Two general strategies were used in formulating the models: multiple linear regression models using logarithmic transformations of both independent and dependent variables and multiple nonlinear regression models, which were also developed. Both models assume that a chlorine residual is maintained throughout a 168-hour reaction period and that TTHMs continuously increase with time. Variables such as UV absorbency, chlorine dose, temperature, and TOC were used to predict TTHMs.

McKnight and Reckhow (1992) investigated the reactions of specific ozone by-products (OBPs) with chlorine and chloramines through evaluation of the kinetics and stoichiometry of chlorine demand and total organic halide (TOX) formation as a function of pH. All of the compounds studied had a carbonyl ( $\text{C} = \text{O}$ ) functionality, causing the types of chemical reactions to be similar. Simple compounds were chosen from among the carbonyl compounds, aldehydes, ketoaldehydes, and keto-acids in order to study the relationships between structural characteristics and reactivity towards chlorine and chloramines. Three general classifications of alpha substituents were made: compounds bearing (1) an alpha methyl group; (2) methylene group; or (3) other moieties (hydrogen, hydroxyl, carboxylic acid, etc.). Correlations were developed between these characteristics and chlorine consumption behavior to help in understanding the significance of OBP formation in distribution systems (i.e., persistence of OBPs, formation of chloroform or other DBPs, etc.).

Little or no TOX was produced upon chloramination of all the model compounds studied in this research. Results suggest that acetaldehyde, methyl glyoxal, and pyrovic acid could be important chloroform precursors in chlorinated systems under certain conditions. The higher aldehydes studied reacted slowly with free chlorine and produce minor amounts of TOX. The keto-acids reacted rapidly with both free and combined chlorine. Chloramination of the model OBPs studied resulted in little measurable TOX formation. The rates for chlorination and chloramination at pH 7 were comparable for all three compound classes, but the rates of chlorination increased dramatically with pH. Chloramination rates appear to be only weakly dependent upon pH. These results suggest that aldehydes may persist in distribution systems at low (less than 2 mg/L) chlorine doses and neutral pH, but can undergo significant decomposition at higher chlorine doses and pH. The keto-acids are likely to react rapidly at low chlorine doses and pH 7 or greater. These compounds may also be generated in distribution systems by the reactions of disinfectants with NOM, and their by-products may be sources of assimilable organic carbon (AOC); thus, their presence in a distribution system may be of concern.

Harrington et al. (1992) developed a computer program to simulate DBP formation, removal of NOM, inorganic water quality changes, and disinfectant decay in water treatment processes. Equations were developed that simulate the formation of TTHMs and removal of TOC and UVA by alum coagulation, as well as changes in alkalinity and pH. Model simulations were compared with limited sets of observed values. The central tendency of the model was to underpredict finished-water pH by 4 percent, finished-water TOC by 7 percent, and simulated distribution system TTHMs by 20 to 30 percent.

Shukairy et al. (1994a) conducted a study with the objective of better understanding the chlorination reactions of organic matter by investigating the formation of halogenated DBPs from three molecular-sized (MS) fractions as follows: greater than 3000, 1000–3000, and less than 1000 daltons. The study

was conducted in two phases. In Phase I, the impact of ozonation and biotreatment on DBP precursors under variable reaction conditions was evaluated, and in Phase II, the chlorination kinetics and reactivity of these fractions under constant organic and inorganic precursor concentrations was investigated.

The impact of organic and inorganic precursor limitations on the reactivity and kinetics of halogenated DBPs was also evaluated. It was found that the less-than-1K MS fraction was the most biodegradable fraction and the 1-3K MS fraction the least. Preozonation resulted in chemical transformation of the organic matter, resulting in an increase in biodegradability in all fractions and in a decrease in the reactivity to subsequent chlorination. Biotreatment, with and without ozonation, resulted in equivalent removal of the DOC and the precursor compounds, as no selectivity was observed. They found that, under variable precursor concentrations, the speciation of the THMs was dependent on the bromide-to-DOC ratio. Increases in this ratio resulted in a shift in speciation to the bromo-substituted DBPs, irrespective of the fraction or the treatment. Precursor limitation did not affect the reaction kinetics significantly. However, the yield and the reactivity were affected. Speciation depended on the available organic matter. The less-than-1K MS fraction, under constant precursor concentrations, exhibited the fastest chlorination kinetics as measured by the higher chlorine demand, TTHM, and HAA6 kinetics. The less-than-1K fraction also exhibited the highest reactivity to bromo-substitution.

Cowman and Singer (1996) investigated the effect of bromide ion on the distribution of HAA species resulting from the chlorination and chloramination of waters containing aquatic humic substances. Aquatic humic substances were extracted from both a surface water and a ground water. They were chlorinated and chloraminated at pH levels of 8 and 6 in the presence of bromide concentrations ranging from 0 to 25  $\mu\text{g/L}$ . The samples were analyzed for all nine of the HAA species containing bromine and chlorine. Standards for bromodichloroacetic acid and dibromochloroacetic acid were synthesized for use in this study. It was found that bromochloro-, bromodichloro-, and dibromochloroacetic acids formed easily and constituted at least 10% of the total HAA concentration in waters containing as little as 1.2  $\mu\text{M}$  (0.1 mg/L) bromide. At concentrations normally found in raw drinking water, the mixed bromochloro HAA species were major components of the total HAA concentration. Among the mono-, di-, and trihalogenated forms, the distribution of HAAs appeared to be independent of bromide concentration.

Shukairy and Summers (1992) conducted a study to examine the impact of ozonation and biotreatment on organic precursor characteristics established by evaluating DBP formation, speciation, and kinetics under constant DOC, bromide, and chlorination conditions. The following observations were made:

- Use of ozone resulted in a significant change in the characteristics of the organic matter.
- Treatment, ozonation, or biotreatment decreased chlorine demand, indicating selective oxidation of the organic precursors.
- In nearly all cases, treatment resulted in a decrease in DBPs formed after chlorination. In most cases, TOX and total THM formation decreased more by ozonation and ozonation/biotreatment in comparison to biological treatment, indicating that chemical oxidation of organic matter decreased its reactivity.
- HAA6 formation decreased the most by biotreatment, with and without preozonation. Biotreatment appears to be selective for HAA precursors.
- Spectral absorption coefficient (SAC) decreased significantly after ozonation, resulting in less available reactive aromatic unsaturated organic precursors than in the control, even when the DOC concentration was held constant. The reactive aliphatic (acetyl-)containing precursors created after ozonation seem to favor bromine substitution over chlorine substitution.
- Precursor limitation is very important in determining speciation. In the case where the reaction is precursor limited, bromine substitution is faster than chlorine substitution and will govern the DBP speciation. The formation of chloro-substituted DBPs continues as long as there are available precursors and thus controls DBP distribution. They found that, under

conditions of constant bromide, DOC, chlorination conditions, and holding times, biotreatment did not show any selectivity for DBP precursors, that is, DOC and the precursors were removed to the same extent.

Shukairy (1994) and Shukairy and Summers (1996) conducted a study to examine the impact of ozonation and biotreatment on the organic precursor characteristics by evaluating DBP formation, speciation, and kinetics under constant DOC, bromide, and chlorination conditions. The following observations were made:

- Ozonation resulted in a significant change in the characteristics of the organic matter. SAC decreased while DOC concentration was nearly unchanged, indicating a decrease in UV-absorbing functional groups and the formation of saturated and aliphatic acetyl compounds. Biotreatment resulted in equivalent removal of both SAC and DOC.
- Treatment, ozonation, or biotreatment decreased chlorine demand, indicating selective oxidation of the organic precursors, either chemical or biological.
- In nearly all cases, treatment resulted in a decrease in DBPs formed after chlorination.
- In most cases, TOX and total THM formation decreased more by ozonation and ozonation/biotreatment in comparison to biological treatment, indicating that chemical oxidation of organic matter decreased its reactivity.
- HAA6 formation decreased the most by biotreatment, with and without preozonation. Biotreatment appears to be selective for HAA precursors. However, such a conclusion is only tentative as the decrease in HAA concentration could be due to a shift to the other three more bromo-substituted HAA species that are not quantified.
- Speciation was affected most by ozonation. A shift to bromo-substituted species occurred after ozonation and after combined ozonation/biotreatment.
- No such shift was observed by biotreatment alone. Bromine incorporation factors increased significantly with ozonation. The effect was most pronounced at 6 hours. As the holding time was increased, more TTHM, Cl and HAA6-Cl were formed, increasing DBP formation. The relative increase in DBP-Br with increasing holding time was much smaller.
- SAC decreased significantly after ozonation, resulting in less available reactive aromatic unsaturated organic precursors than in the control, even when the DOC concentration was held constant. The reactive aliphatic (acetyl-)containing precursors created after ozonation seem to favor bromine substitution over chlorine substitution. For the THMs and quantifiable HAAS, DBP-Br formation increased while DBP-Cl formation was much less, relative to the control, because of decreases in the organic precursors.
- Precursor limitation is very important in determining speciation. In the case where the reaction is precursor limited, bromine substitution is faster than chlorine substitution and will govern the DBP speciation. The formation of chloro-substituted DBPs continues as long as there are available precursors and thus controls DBP distribution.

Shukairy and Summers (1996) found that, under conditions of constant bromide, DOC, chlorination conditions, and holding times, biotreatment did not show any selectivity for DBP precursors, that is, DOC and the precursors were removed to the same extent. Ozonation, however, had more of an impact on the organic matter characteristics, as observed by decrease in DBP formation (reactivity) and a shift to the bromo-substituted compounds. Precursor limitations are important in assessing DBP speciation; both DOC and SAC are important parameters that should be considered in evaluating organic precursors.

Shukairy (1998) investigated ozonation and biological treatment as a means of controlling the formation of DBPs as measured by TOX and purgeable organic halides (POX). Organic matter from a ground water and a river water source was used. Chlorine or chloramines were used as the final disinfectant. Chloramination produced significantly fewer organic halides, especially POX, compared to chlorina-

tion. With both disinfectants and for both sources of organic matter, the nonpurgeable organic halide formation rate was found to be much faster than that of POX. Preozonation decreased the amount of organic halide formation by 10 to 40% upon subsequent chlorination. With chloramines, preozonation had no significant impact on the extent of the reaction. Preozonation followed by biotreatment resulted in the least amount of organic halide formation, with a reduction of 50 to 80% when chlorine was used and greater than 90% with chloramines. In all cases, the ratio of organic halides to DOC decreased after biological treatment, indicating a selectivity for the potential reactive sites.

Shukairy (1998) found biodegradation to be very effective for controlling organic halide concentrations. The precursor concentrations were decreased, and the microorganisms seemed to be selective in biodegrading the moieties that are prone to substitution by the chlorine. Biodegradation of nonprecursor compounds may have also occurred, but not to complete mineralization, i.e., no change in DOC. While ozonation yields its own DBPs, e.g., aldehydes and ketones, subsequent biotreatment should help in the removal of these highly oxidized lower-molecular-weight compounds, many of which are biodegradable. In some cases, ozonation followed by biotreatment decreased purgeable organic halide formation potential (POXFP) and total organic halide formation potential (TOXFP) more than the sum of the decrease by the individual treatments, indicating a synergistic effect. Chloramines, which have been found to be as effective as free chlorine in killing attached bacteria in the distribution system, were shown to yield the lowest level of organic halides. Using ozonation followed by biotreatment would decrease the available substrate for microbial regrowth and provide primary disinfection. Smaller amounts of chlorine or chloramines could then be applied to provide adequate post-disinfection and a residual for the distribution system, therefore controlling the DBP concentration in finished water. The authors concluded that further investigations into the impact of biotreatment on individual DBPs is warranted. Similarly, the impact of ozone doses on biotreatment and DBP formation should be investigated to optimize the synergy of these processes. In addition, for both sources of organic matter, the formation rate of nonpurgeable organic halide (NPOX) is much faster than that for POX after either chlorination or chloramination.

- The majority of organic halide formation occurs at disinfectant doses less than 2 mg disinfectant per mg. DOC chloramination significantly decreased the organic halide formation, especially POX, compared to that formed by chlorination or ozonation/chlorination.
- Preozonation significantly decreased the amount of organic halides formed after chlorination, but had no impact on the organic halides formed after chloramination.
- Biological treatment alone and, more effectively, preozonation followed by biological treatment selectively reduced the organic halide precursor compounds compared to the overall background organic matter as measured by DOC.

## **EPA Research Activities**

EPA research into the factors that affect chlorine decay and the formation of DBPs has ranged from pilot-plant studies that have investigated the role of ozone on brominated DBPs to the effect of corroded pipe on the formation of TTHMs and HHA6. Also included in these efforts is research on mutagenicity as a possible DBP and an attempt to define exposure research as it relates to the DBP problem.

Shukairy et al. (1994b, 1995) studied the effect of variable ozone dosage and bromide concentration on the formation of organic DBPs and bromate. Low-ozone dosages resulted in oxidation of organic precursors, yielding decreases in the formation potential for TTHMs, six HAAs, and TOX. Increasing the ozone dosage oxidized bromide to bromate, decreasing the bromide for incorporation into DBPs. Bromate concentrations were linearly correlated with ozone residuals. Changes in the bromine incorporation factors reflected differences in the resulting speciation of THMs and HAAs, respectively. Because

TOX measurements based on chloride equivalence may underestimate the halogenated DBP yield for high-bromide waters, they describe a procedure whereby bromide and bromate concentrations were used to correct the TOX measurement.

The effect of bromide concentration, ozone dosage, and biotreatment on the control of DBPs was also evaluated. Although TTHM precursors were better controlled by ozonation and the precursors of six HAAs were better controlled by biological treatment, the combined processes were effective for the control of all halogenated DBP precursors. Ozone's conversion of bromide to bromate and the chemical or biological oxidation of organic matter changed the ratio of bromide to DOC. Increases in this ratio increased the formation of some brominated DBPs, but these DBP increases were offset by the precursor oxidation provided by the combination of the two processes.

Clark et al. (1996b) developed a first order model to characterize the formation of brominated DBPs. Using a data set generated by Pourmoghaddas et al. (1993), models were developed that describe the formation of THM and non-THM chlorination by-products and their speciation. The model which considered pH, time, chlorine, and bromide concentration demonstrates the effect of bromide concentration on the formation of  $\text{CHCl}_3$  and  $\text{CHBr}_3$ . The model shows that the concentrations of  $\text{CHBr}_2\text{Cl}$  and  $\text{CHBrCl}_2$  increase to a maximum for bromide concentrations of 2.5 mg/L and 0.5 mg/L, respectively, and then decline with increasing bromide levels. Concentrations of  $\text{CHCl}_3$  consistently decline with increasing bromide concentration, while  $\text{CHBr}_3$  consistently increases with increasing bromide concentration.

As a complement to his work on chlorine decay modeling, Clark (1998) developed a TTHM formation model based on chlorine consumption as follows:

$$\text{TTHM} = T(C_{A_0} - [\frac{C_{A_0}(1-R)}{1 - Re^{-ut}}]) \quad (12-44)$$

where

- $T$  = dimensionless parameter
- $C_{A_0}$  = the initial chlorine residual in mg/L
- $R$  = dimensionless parameter from the chlorine decay equation
- $u$  = the reaction rate in  $\text{time}^{-1}$
- TTHM = total trihalomethanes

Clark and Sivaganesan (1998) verified this equation using both field and laboratory data from the study by Vasconcelos et al. (1997) and from laboratory data collected by the WSWRD of EPA.

Schenck et al. (1998) conducted a study to assess the applicability of the model developed by Vartiainen and Liimatainen (1988) to source waters and water treatment practices in the U.S. The model is based on data collected in Finland and relates mutagenicity, as determined in the Ames assay, to TOC concentration of the water, chlorine dose, and to a minor extent, the concentration of ammonia. It has been used as the basis for recent epidemiological studies conducted in Finland that have reported a positive correlation between the mutagenicity of chlorinated drinking waters and certain human cancers. In the work by Schenck et al. (1998), water samples were collected from three full-scale treatment plants and one pilot-scale plant in the U.S. All the plants used chlorine exclusively for disinfection. One full-scale plant used ground water; surface water sources were used by the other plants. TOC and ammonia concentrations were determined analytically, and chlorine doses were obtained from the treatment plants. The water samples were concentrated by resin adsorption for testing in the Ames assay. The observed levels of mutagenicity in the finished waters were 1.5 to 2.0-fold higher than those predicted using the

Vartiainen and Liimatainen (1988) model. The authors concluded that further validation was needed before the Finnish model could be used to assess exposure to mutagenicity in chlorinated drinking waters in the U.S.

Rossmann et al. (1999) examined the factors that characterize reaction conditions affecting treated water in a distribution system versus reaction kinetics as determined in bench studies. Included among these factors are the pipe wall material, such as corrosion products and biofilm slime, which can exert a significant chlorine demand. If chlorine is consumed within a pipe by non-DBP-producing materials (such as ferrous corrosion products), then there is less available to react with the NOM in the water. Some of the factors that may contribute to differences in the rate of DBP formation in a pipe versus bench scale experiments are

- Iron tubercles which contain organic material that might include DBP precursors.
- The organic matrix supporting the growth of biofilm on pipe surfaces may also contain precursors.
- Certain DBPs, such as dichloroacetic acid, are biodegradable.
- The rate at which reactants are transported between the bulk flow and the reaction region near the pipe wall is affected by hydrodynamic conditions within the pipes.

The authors conducted a study to measure the rate of formation of two classes of DBPs in a simulated pipe environment and compared it with rates observed for the same water held in glass bottles. The DBPs studied were THMs and HAAs, both of which are currently regulated by EPA under its Disinfectants/Disinfection By-Products Rule. The simulated pipe environment is located at the EPA Test and Evaluation (T&E) Facility in Cincinnati, OH, and is designed to replicate actual flow conditions within a ductile iron pipe. The pipes used in this test had been subject to significant corrosion and biofilm buildup. The authors found that the production of THM and HAA in the pipe kept pace with that formed in the bottle given that the rate constants of chlorine consumption in the pipe (by mainly non-precursor material) were more than ten times higher than in the bottle. This suggests that chlorine is not a rate-limiting factor in the reactions that produce these compounds for the waters tested. The fact that a small, but consistently higher level of THM was produced in the pipe compared to the bottle for the same reaction time could be due to two reasons. First, the metallic surface of the pipe wall could serve as a catalyst for the THM formation reaction. Second, there could be THM precursors in the scale, tubercles, or biofilm attached to the pipe wall.

To test the second of these hypotheses, another set of experiments was performed with the pipe loop. This time the test water was chlorine demand-free, DBP precursor-free water derived from Cincinnati tap water. This water receives activated carbon treatment at the Cincinnati Water Works and was treated again on-site with a GAC canister to remove any residual chlorine, DBPs, and possible DBP precursors. Experiments were conducted with this water chlorinated to three different levels, without any initial holding time in the feed tanks. The results confirm that there must be a reservoir of precursor material attached to the pipe wall that is available to contribute to the formation of THMs. Results from their experiments led to the following conclusions:

- The rate constants for chlorine decay in the pipe were an order of magnitude higher than in the bottle.
- The high rate of chlorine loss in the pipe did not decrease the rate at which DBPs were produced when compared to the bottle.
- THM4 production in the pipe averaged 15 percent higher than in the bottle over a 24-hour period.
- The distribution of THM species over time, as reflected by the Bromine Incorporation Factor, remained similar between the pipe and the bottle.



- The rate of HAA6 production in the pipe was essentially the same as in the bottle.
- The test pipe contains a reservoir of precursor material on its walls that is available to form THMs.

As an extension of the research conducted by Clark et al. (1996b), Pourmoghaddas et al. (1993), Clark (1998), and Clark and Sivaganesan (1998) discussed previously, Clark et al. (2001) developed a general DBP formation model which is given as follows:

$$DBP_i = A_i \left[ C_{A_0} - \frac{C_{A_0}(1-K)}{1 - Ke^{-M(1-K)t}} \right] \quad i = 1, 2, \dots, 13 \quad (12-45)$$

where  $DBP_i$  = the specific disinfectant by-product subspecies being modeled in micromoles/liter;  $M$ ,  $K$ ,  $t$ , and  $C_{A_0}$  are as defined previously; and  $A_i$  is the ratio in micromoles/liter of by-product  $i$  formed to mg/L of chlorine consumed.

Several functional relationships were examined in an attempt to find a general model to predict  $K$ ,  $M$ , and  $A_i$  in Equation 12-45. The variables  $pH$ ,  $Br^-$ ,  $Cl_0$ , and  $P$

(where  $P = \frac{mBr^-}{(mCl_0 + mBr^-)}$ ,  $mCl_0$  = moles of initial chlorine, and  $mBr^-$  = moles of bromide ion) were utilized in various combinations to develop predictive equations for these parameters. A general model for  $A_i$  was developed for chlorinated, mixed species and brominated compounds.

A multiple regression analysis for  $M$  yielded the following model shown below:

$$M = e^{a_1} e^{b_1 Br^-} e^{c_1 (Cl_0 * pH)} Cl_0^{d_1} e^{e_1 P} e^{f_1 pH} \quad (12-46)$$

where  $a_1$ ,  $b_1$ ,  $c_1$ ,  $d_1$ ,  $e_1$ , and  $f_1$  are parameters to be estimated. In Equation 12-46,  $e^{a_1}$  is a constant,  $e^{b_1 Br^-}$  accounts for the impact of bromide concentration,  $e^{c_1 (Cl_0 * pH)}$  accounts for the interaction of chlorine (mg/L) and pH,  $C_0^{d_1}$  accounts for the impact of chlorine concentration alone in mg/L,  $e^{e_1 P}$  accounts for the ratio of bromide in moles to bromide plus chlorine in moles, and  $e^{f_1 pH}$  accounts for the impact of pH alone.

A multiple regression model for  $\log(K)$  with  $\log(pH)$ ,  $\log(Br^-)$ , and  $\log(Cl_0)$  as the predictor variables yielded the equivalent multiplicative model as shown below:

$$K = e^{a_2} (pH)^{b_2} (Br^- + 1)^{c_2} (Cl_0)^{d_2} \quad (12-47)$$

where  $a_2$ ,  $b_2$ ,  $c_2$ , and  $d_2$  are parameters to be estimated. The first term in Equation 12-47,  $e^{a_2}$ , is a constant,  $(pH)^{b_2}$  reflects the impact of pH,  $(Br^- + 1)$  reflects the impact of bromide concentration in mg/L, and  $(Cl_0)^{d_2}$  accounts for the impact of chlorine concentration in mg/L.

A multiple regression model for  $\log(A_i)$  yielded the equivalent multiplicative model shown below:

$$A_i + a^i = e^{a_3^i} (pH)^{b_3^i} (Cl_0)^{c_3^i} (P + a^i)^{d_3^i} \exp[e_3^i Br^- + f_3^i (Br^-)^2 + g_3^i (Br^-)^3] \quad \forall i = 1, \dots, 13 \quad (12-48)$$

where  $a_3^i$ ,  $b_3^i$ ,  $c_3^i$ ,  $d_3^i$ ,  $e_3^i$ ,  $f_3^i$ , and  $g_3^i$  are parameters to be estimated, and  $a^i$  takes on the value 0.0001 or 1.

In Equation 12-48, the first term on the right hand side ( $e^{a_3^i}$ ) is a constant,  $(pH)^{b_3^i}$  accounts for the effect of pH,  $(Cl_0)^{c_3^i}$  reflects the impact of chlorine, and  $(P + a^i)^{d_3^i}$  accounts for the impact of the molar ratios of bromide to bromide plus chlorine. The last term,  $\exp[e_3^i Br^- + f_3^i (Br^-)^2 + g_3^i (Br^-)^3]$ , was selected to represent the probability of bromine incorporation into the brominated, chlorinated, and mixed species

compounds considered in this analysis. In Equation 12-48,  $a^i$  is set equal to 1 for chlorinated compounds and is otherwise 0.0001.

Using data from Pourmoghaddas et al. (1993), least squares estimates for the parameters were calculated. The estimated parameters for  $K$  and  $M$  are given in Equations 12-49 and 12-50, respectively, as shown below:

$$M = e^{3.96} \cdot e^{-0.305(Br^-)} \cdot e^{0.0145(Cl_0 \cdot \text{pH})} \cdot Cl_0^{-2.32} e^{8.46(P)} e^{-0.231\text{pH}} \quad (12-49)$$

$$K = e^{1.89} \cdot (\text{pH})^{-0.13} \cdot (Br^- + 1)^{0.10} \cdot (Cl_0)^{-0.75} \quad (12-50)$$

The estimated regression model  $R^2$  were 0.70 and 0.95, respectively. Equations were developed for chloroform, dichlorobromomethane, dibromochloromethane, bromoform, monochloroacetic acid (MCAA), dichloroacetic acid (DCAA), trichloroacetic acid (TCAA), monobromoacetic acid (MBAA), dibromoacetic acid (DBAA), tribromoacetic acid (TBAA), bromochloroacetic acid (BCAA), dibromochloroacetic acid (DBCBA), and dichlorobromoacetic acid (DCBAA).

## Exposure to DBPs from Distribution Systems

Traditionally, EPA has established environmental regulatory programs for the protection of the outdoor environment from industrial and commercial sources of contamination. It has become increasingly clear, however, that indoor environments may pose a risk from contaminants that are found outside the household. For example, drinking water can be a carrier of contaminants that volatilize when they enter a household, thereby subjecting the consumer to inhalation, dermal, and ingestion exposure (Clark and Goodrich 1992). An EPA study found that personal or indoor exposures to many toxic or carcinogenic chemicals are greater than to outdoor concentrations. It also found that for all chemicals, except for THMs, the air provided greater than 99% of the exposure. Water provided nearly all of the exposure to the THMs and more than half of most exposure to chloroform.

Clark et al. (1992) demonstrated that the dynamics of multiple source mixing and system operation in a water distribution system can affect lifetime exposures to volatile organic chemicals such as chloroform. The dose received will depend on one's location within the system and the timing of water use. It was found that dynamic water quality models are valuable tools for conducting drinking water exposure assessments. They help in interpreting the results from field monitoring sites so that a clearer picture of the impact of distributed water emerges. They also provide time-varying estimates of drinking water quality at all locations within a service area so that more accurate exposure assessments can be made. A case study showed that for adults, the inhalation pathway for chloroform contributes more to total exposure than does the ingestion pathway at most locations within the service area, although the opposite is true for infants. Showering is the greatest potential contributor to household inhalation exposure. This analysis raised the question of equity in providing safe drinking water (Clark et al. 1992).

## Modeling Chlorine Decay and TTHMs in Distribution Systems

EPA has conducted extensive research related to the application of models to chlorine decay and TTHM formation in drinking water distribution systems. This research has been a major contributor to an understanding of the factors that influence water quality in drinking water distribution systems and is discussed in this section.

### ***North Penn Study***

One of the first projects to investigate the feasibility of modeling water quality in drinking water distribution systems was conducted under a cooperative agreement initiated between the North Penn Water Authority (NPWA) in Lansdale, PA, and EPA. The project focused on the mixing of water from multiple sources and investigated the feasibility for development and application of a steady-state water-quality model. As the study progressed, it became obvious that the dynamic nature of both patterns of demand and variations in water quality required the development of a dynamic model. Techniques for semicontinuous monitoring of volatile organic contaminants were also explored (Clark et al. 1988b). At the time of the NPWA/EPA study, the authority served 14,500 customers in 10 municipalities and supplied an average of 19,000 m<sup>3</sup>/day (5mgd) (Clark et al. 1988b). The NPWA distribution system was modeled in a network representation consisting of 528 links and 456 nodes, and water demands for modeling represented conditions from May to July 1984. The network hydraulic model used was developed by the U.S. Army Corps of Engineers and contained provisions for both steady-state and quasi-dynamic hydraulic modeling for extended-period simulation (Gessler and Walski 1985).

The model revealed that significant portions of the system were subject to flow reversals. The velocity for each link was known from the hydraulic solution for each time period, which was evenly divided into an integer number of computational time steps. Each link was then divided into sublinks by a series of evenly spaced subnodes (though the distance between subnodes varied from link to link or for a link at different time periods), so that the travel time from a subnode (or node) to the adjacent subnode (or node) was approximately equal to a specified time step. A model called the Dynamic Water Quality Model (DWQM) was developed. The solution algorithm used in the DWQM operated sequentially by time period. During a time period, all external forces affecting water quality were assumed to remain constant (e.g., demand, well pumpage, tank head). The DWQM was used to simulate a 34-hour period corresponding to conditions present during the pilot-level sampling program conducted on November 14 to 15, 1985. Parameters of the model were adjusted so that predicted tank levels and flows at selected sites represented those measured during the sampling period. For chloroform, THM, and hardness, the predicted concentrations compared favorably with the observed values at the sampling stations.

### ***South Central Connecticut Study***

The North Penn case study provided an excellent test-bed for development of a dynamic water-quality model (Clark and Coyle 1990). To extend the North Penn application, EPA initiated another cooperative agreement with the University of Michigan and the South Central Connecticut Regional Water Authority (SCCRWA). The purpose of the cooperative agreement was to test the previously developed modeling concepts and to verify and calibrate the model through field investigations (Clark and Goodrich 1993; Clark et al. 1988a). At the time of the study, SCCRWA supplied water to approximately 95,000 customers (380,000 individuals) in 12 municipalities in the Greater New Haven area. The service area was divided into 16 separate pressure/distribution zones. Average production was 190,000 m<sup>3</sup>/day (50 mgd) with a safe yield of approximately 281,200 m<sup>3</sup>/day (74 mgd). Water sources included four surface water sources (Lake Gaillard, Lake Saltonstall, Lake Whitney, and the West River System) and five well fields (North Cheshire, South Cheshire, Mt. Carmel, North Sleeping Giant, and South Sleeping Giant). Approximately 80 percent of the water in use in the system came from surface sources; the remaining 20 percent came from wells. All surface water was treated with chlorination, filtration, and addition of a phosphate-corrosion inhibitor. The system included 22 pumping stations, 23 storage tanks, and approximately 2,091,700 m (1300 miles) of water mains. Preliminary efforts to develop and validate a model for the South Central System were concentrated on the Cheshire service area (Clark 1993b; Clark et al. 1993b).

This area was relatively isolated and provided a prototype for modeling the remainder of the system. To validate the model, an extensive study was planned in which the fluoride feed at the North Well Field was turned off and the propagation of the fluoride feed water was tracked through the system (Clark et al. 1991). Prior to the water-quality modeling effort and the related field study, extensive hydraulic analyses were conducted on the system. For the preliminary modeling effort, the full SCCRWA system network was represented by approximately 520 nodes and 700 links. In most cases, the network was represented by “skeletonizing” the system (i.e., selectively choosing pipes based on their size and perceived impact as transmission mains). The DWQM developed in the North Penn study was applied to the Cheshire system to simulate the propagation of fluoride feed water and also to select sampling locations for a field study. Based on the simulation results and the objectives of the proposed field study, a sampling scheme was designed. Fluoride was selected as the tracer because it was added regularly to the water at a concentration of approximately 1 mg/L, as required by the State Department of Health Services. Tracing the changes in the fluoride concentration in the distribution system allowed accurate travel times to be determined. The time the fluoride feed was shut down at the well fields was compared to the time it dissipated at the sampling points (Skov et al. 1991). The model predictions and the sampling results were extremely close.

The behavior of the storage tanks was of special interest. During the early portion of the sampling period, variations in tank levels were held to a minimum (less than 0.91 m [3 ft]). After 2 days, little change in fluoride concentrations was found in the tank and, as a result, the water level was then allowed to vary approximately 2.8 m (8 ft). The wider range in tank levels had the effect of turning the water over relatively rapidly. Even with the rapid turnover, it took nearly 10 days to completely replace old water with new water in the tanks. It was clear from this analysis that storage tanks could have a detrimental effect on water quality, particularly as water aged in the tank.

On August 13 to 15, 1991, another sampling program at the Cherry Hill/Brushy Plains Service Area was initiated with the goal of validating the previously discussed simulation results. The purpose of this sampling program was to gather information to characterize the variation of water quality in the service area and to study the impact of tank operation on water quality. The Cherry Hill/Brushy Plains Service Area covered approximately  $5.18 \times 10^6 \text{ m}^2$  (2 mi<sup>2</sup>) in the Town of Branford in the eastern portion of the SCCRWA (Clark et al. 1993b). This service area was almost entirely residential, containing both single-family homes and apartment/condominium units. Average water use during the sampling period was 1700 m<sup>3</sup> per day (0.46 mgd).

The water distribution system was composed of 20.3-cm (8-in) and 30.48-cm (12-in) mains. The terrain in the Cherry Hill/Brushy Plains Service Area was generally moderately sloping, with elevations varying from approximately 15.2 m (50 ft) mean sea level (MSL) to 70.1 m (230 ft) MSL. Cherry Hill/Brushy Plains received its water from the Saltonstall system. Water was pumped from the Saltonstall system into Brushy Plains by the Cherry Hill Pump Station. Within the service area, storage was provided by the Brushy Plains tank. The pump station contained two 10.2-cm (4-in) centrifugal pumps with a total capacity of 5300 m<sup>3</sup>/day (1.4 mgd). The operation of the pumps was controlled by water elevation in the tank. Built in 1957, the tank had a capacity of 3800 m<sup>3</sup> per day (1.0 mgd). It had a diameter of 15.2 m (50 ft), a bottom elevation of 58.8 m (193 ft) MSL, and a height (to the overflow) of 80.2 m (263 ft) MSL. During normal operation, the pumps were set to go on when the water level in the tank dropped to 15.2 m (56 ft) and to turn off when the water level reached 19.8 m (65 ft). As had occurred during the study of the Cheshire service area, the hydraulic model developed by Gessler and Wolski (1985) and the DWQM were applied to establish flow patterns within the service area. In addition, during the periods of May 21 to 22, July 1 to 3, July 8 to 10, and July 30 to August 1, 1991, chlorine residuals were monitored at the tank and operational patterns (pump records), and variations in tank water level were studied.

On the basis of these model runs and field data, a sampling strategy was adopted that involved turning the fluoride off at the Saltonstall Treatment Facility and sampling for both fluoride and chlorine in the Cherry Hill/Brushy Plains Service Area. The intention was to use defluoridated water as a conservative tracer for the movement of flow through the system and for calibration the DWQM. The DWQM and a chlorine decay model based on hydrodynamic principles were used to model the dynamics of chlorine decay in the system. Seven sampling sites in the distribution system, in addition to sampling sites at the pump station and tank, were identified. A hydraulic model and the DWQM model were used to simulate the Cherry Hill/Brushy Plains Service Area for a 53-hour period from 9:00 am on August 13 to 3:00 pm on August 15, 1991. A skeletonization was developed representing the Cherry Hill/Brushy Plains distribution system, which included all 30.4-cm (12-in) mains, major 20.3-cm (8-in) mains and loops, and pipes that connected to the sampling sites. Pipe lengths were scaled from a map, actual pipe diameters were used, and, in the absence of any other information, a Hazen-Williams roughness coefficient of 100 was assumed for all pipes. From these results, it is clear that the modeling effort matched the sampling efforts well, with the exception of dead-ends.

It was clear that the pump cycles influenced water quality heavily at several sampling points. For example, at node 11, during the pumps-on cycle, the fluoridated water was pumped into the system. When the system was being fed from the tank (pumps-off), the system was receiving water that had reached an equilibrium concentration of fluoride before the stoppage of the fluoride feeders. As mentioned previously, the two scenarios evaluated during the sampling study were with the pumps-on and pumps-off condition. Using the upstream and downstream chlorine concentration and the residence times in the link, the chlorine decay coefficient was calculated for each link. Chlorine demand was calculated according to a first-order assumption, which is defined as follows:

$$C = C_0 e^{-rt} \quad (12-51)$$

where  $C$  = the concentration at time  $t$ ,  $C_0$  = initial chlorine concentration,  $r$  = decay rate in  $\text{day}^{-1}$ , and  $t$  = time in day. A bench study was conducted in which chlorine demand for the raw water was calculated using Cherry Hill/Brushy Plains water, and the chlorine decay rate was calculated as  $0.55 \text{ day}^{-1}$ . This decay rate might be regarded as the bulk decay rate or the decay rate of chlorine in the treated water. The total system demand was found to be two to three times higher than the bulk decay rate alone. It was concluded that this additional demand was caused by pipe wall demand, biofilm, and tubercles.

### **Development of EPANET**

As a follow-up to the development of the DWQM and as a follow-up to the North Penn and SCCRWA studies, Rossman (1994) and Rossman et al. (1994) developed a mass transfer-based model for predicting chlorine decay in drinking water distribution networks. The model considers first-order reactions of chlorine to occur both in the bulk flow and at the pipe wall. The overall rate of the wall reaction is a function of the rate of mass transfer of chlorine to the wall and is therefore dependent on pipe geometry and flow regime. As observed in the SCCRWA study, the model can thus explain field observations that show higher chlorine decay rates associated with smaller pipe sizes and higher flow velocities. It has been incorporated into a computer program called EPANET that can perform dynamic water-quality simulations on complex pipe networks. It represents a third generation of water-quality models developed by the WSWRD to improve our understanding of the movement and fate of constituents within water distribution systems.

Advances contained in EPANET include a coordinated approach to modeling both network hydraulics and water quality, consideration of both bulk flow and pipe wall reaction mechanisms, and a graphical

user interface to aid in visualizing network behavior. The model's bulk decay rate constant is determined independently in the laboratory. Its wall decay constant can be varied over a range of values that include both reaction rate-limiting and mass transfer rate-limiting values. EPANET is based on the extended-period simulation approach to solving hydraulic behavior of a network. It has proven to be a very effective research tool for modeling the movement and fate of drinking water constituents within distribution systems. EPANET calculates all flows in cubic feet per second (cfs) and has an option for accepting flow units in gallons per minute (gpm), mgd, or liters per second (l/s). The Hazen-Williams formula, the Darcy-Weisbach formula, and the Chezy Manning formula can be used to calculate the head loss in pipes. It also models pumps, valves, and minor loss. To model water quality within distribution systems, the concentration of a particular substance must be calculated as it moves through the system from various points of entry (e.g., treatment plants) and on to water users. This movement is based on three principles: (1) conservation of mass within differential lengths of pipe, (2) complete and instantaneous mixing of the water entering pipe junctions, and (3) appropriate kinetic expressions for the growth or decay of the substance as it flows through pipes and storage facilities.

The model has been validated using data from various field studies. Resulting predictions have been compared with observed chlorine measurements at eight field sites. Good agreement was achieved at locations where the hydraulic conditions were well characterized. Model predictions were less accurate at sites where the hydraulic calibration was less precise. These results underscore the need to obtain accurate hydraulic information before running a network water-quality model.

### ***North Marin Study***

It is clear that, as dissolved chlorine travels through the pipes in the network, it reacts with NOM in the bulk water and with biofilm and tubercles on the pipe walls or with the pipe wall material itself (Clark et al. 1993a). This reaction results in a decrease in chlorine residual and a corresponding increase in DBPs, depending on the residence time in the network pipes and holding time in storage facilities. Understanding these reactions will help water-utility managers deliver high-quality drinking water and meet regulatory requirements under the 1996 SDWA and amendments. Water-quality modeling has the potential to provide insight into the factors that influence the variables affecting changes in water quality in distribution systems. Understanding the factors that influence the formation of TTHMs and maintenance of chlorine residuals is of particular interest (Clark et al. 1995).

EPANET has proved to be especially useful for modeling both formation of TTHMs and the propagation and maintenance of chlorine residuals. Among the first studies to address these issues using EPANET was one conducted by EPA in collaboration with the North Marin Water District (NMWD) in California (Clark et al. 1994). Another recently completed study conducted jointly by EPA and the AWWARF examined these same issues (Vasconcelos et al. 1997). This study evaluated various types of models to describe both the formation of TTHMs and loss of chlorine residual and will be discussed later in this chapter.

At the time of the North Marin study, the district served a suburban population of 53,000 people who live in or near Novato, California. It used two sources of water: Stafford Lake and the North Marin Aqueduct. The aqueduct is a year-round source, but Stafford Lake is in use only during the warm summer months, when precipitation is virtually nonexistent and demand is high. Novato, the largest population center in the North Marin service area, is located in a warm, inland coastal valley with a mean annual rainfall of 68.6 cm (27 in). Virtually no precipitation occurs during the growing season from May through September. Eighty-five percent of total water use is residential, and the service area contains 13,200 single-family detached homes, which accounted for 65 percent of all water use (Clark et al. 1994). The water quality of the two sources differs greatly. Stafford Lake water had a high humic content and was treated with conventional treatment and prechlorination doses of between 5.5 and

6.0 mg/L. The treated water had a residual of 0.5 mg/L when it left the treatment plant clearwell. The potential for formation of THMs in the Stafford Lake water was high. The North Marin Aqueduct water was derived from a Raney Well Field along the Russian River. Technically classified as ground water, the source water contained a high proportion of naturally filtered water. Aqueduct water was disinfected only and was low in precursor material, with a correspondingly low potential for formation of THMs. Both sources carried a residual chlorine level of approximately 0.5 mg/L when the water entered the system.

The major focus of the study was Zone 1 of the NMWD distribution system. Depending on the time of year and the time of day, water entered the system from either one source or both sources. The North Marin Aqueduct source operated year-round, 24 hours per day. The Stafford Lake source operated only during the peak demand period from 6:00 am to 10:00 pm and generally operated for 16 hours per day. EPANET was used to model the system hydraulics, including the relative flow from each source, THMs, and propagation of chlorine residual (Rossman et al. 1994). The model was based on an earlier representation of the network made by Montgomery Watson, Inc., for North Marin and was calibrated based on a comparison of simulated versus actual tank levels for the May 27–29, 1992, period of operation. The dynamic nature of the system led to variable flow conditions and variable water quality in the network. Flow directions frequently reverse within a given portion of the network during a typical operating day. The consequences of these variable flow patterns for water quality are significant.

To characterize the water quality in the NMWD, EPA designed a sampling protocol and sent a team of investigators to work with the district staff for the period May 27–29, 1992. The water quality is highly variable. For example, at the Eighth Street sampling point, chloroform levels varied from 38.4 to 120.1  $\mu\text{g/L}$  over the 2-day period. This variability was caused by the penetration of water from the two different sources. A regression relationship between UV absorbance and THMs was established using the data from both sources. The assumptions of the model (constant variance and normality of error terms) were checked and deemed to be reasonable. Both Stafford Lake water and the North Marin Aqueduct water generally maintained a chlorine residual level of 0.5 mg/L as the treated water entered the system. As mentioned, the Stafford Lake water had a much higher chlorine demand than did the Aqueduct water.

To predict chlorine demand at the various sampling points, a first-order decay relationship was assumed (Clark et al. 1995). In EPANET, chlorine decay is represented by decay in the bulk phase and by decay in the pipe wall. Based on bulk water calculations, the first-order decay coefficients or bulk demand for the Stafford Lake and the Aqueduct sources were 0.31 and 0.03  $\text{day}^{-1}$ , respectively. Using EPANET and the previously assumed hydraulic conditions, the chlorine residuals were estimated. It was evident from the analysis that the pipes in the distribution network exhibited a demand for chlorine. This demand probably comes from tubercles, biofilm, and perhaps the pipe wall material itself (Clark et al. 1995). A comparison between chlorine residuals using the first-order assumptions predicted from EPANET versus actual chlorine residuals provided an excellent illustration of this point. It became clear that the demand in the system went beyond just bulk-water decay. Because EPANET has the capacity to incorporate a wall demand factor in addition to the bulk demand factors for chlorine, the system was simulated again using the bulk demand for the two sources, and trial and error was used to estimate wall demands for four sections of the network. When chlorine residuals were re-estimated at the four sampling points, wall demand obviously played a major role in chlorine residual loss. This pipe wall demand may be the result of the source or the age of the system. For example, the maximum wall demand was found in the areas served primarily by Stafford Lake. However, those pipes were also the oldest in the system.

### ***EPA/AWARF Study***

Vasconcelos et al. (1997), in a study sponsored jointly by EPA and AWWARF, investigated the factors leading to loss of chlorine residuals in drinking water distribution systems. Kinetic rate equations were

developed, tested and evaluated based on data collected from five drinking water utilities. This investigation uncovered a number of findings concerning the mechanisms of chlorine decay and the kinetic models that describe it. The most significant findings of this study included the following:

- Chlorine decay in distribution systems can occur because of reactions within the bulk fluid and with the pipe wall demand.
- The rate of reaction of chlorine at the pipe wall is inversely related to pipe diameter and is mass transfer limited.
- There is no established method for directly determining the kinetics of chlorine decay attributable to pipe wall reactions. These values must be determined from field data.
- A well-calibrated hydraulic model is a prerequisite for attempting to model water quality in a distribution system.
- Calibration of network chlorine decay models can be based on first-order kinetic models for bulk reactions and either first-order or zero-order kinetics for wall reactions.
- The wall kinetic constant appears to be inversely related to the pipe roughness coefficient.
- A non-reacting chemical should be used when calibrating a model during field studies.

Based on the experience gained during this study, the following recommendations for future work are offered:

- More direct methods of estimating pipe wall-related chlorine reaction constants are needed.
- Sensors in the distribution system coupled with remote telemetry may offer a way to perform continuous on-line calibration of network chlorine decay models.
- Water quality models should be enhanced to better accommodate different water sources when each source water exhibits different bulk reaction kinetics.
- As an increasing number of systems calibrate chlorine decay models, it may be possible to establish a database relating kinetic parameters to water chemistry and pipe characteristics.

## **Evolution of System Modeling**

On the basis of the results from the case studies previously described and from other studies reported in the literature, it is obvious that water-quality modeling has the potential to provide insight into the factors that degrade water quality in networks. It has also become increasingly obvious that, despite the treatment investments being forced by regulations in the 1996 SDWA and amendments, the potential exists for deterioration of water quality in the network itself. This realization led to the development of several public- and private-sector water-quality models. Only the public-sector models will be discussed here. EPANET, developed by Rossman (1994) and Rossman et al. (1994), as discussed earlier, was based on mass transfer concepts.

Another approach to the propagation of contaminants was developed by Biswas et al. (1993) using a steady-state transport equation. It accounted for the simultaneous advective transport of chlorine in the axial direction, diffusion in the radial direction, and consumption by first-order reaction in the bulk-liquid phase. Islam (1995) and Islam et al. (1997) developed a model called QUALNET, which predicted the temporal and spatial distribution of chlorine in a pipe network under slowly varying unsteady-flow conditions. Boulos et al. (1995) proposed a technique called the Event-Driven Method (EDM), which is based on a next-event scheduling approach and can significantly reduce computing times.

Several different types of numerical methods have been proposed to solve these types of models, including the Eulerian Finite-Difference Method (FDM), the Eulerian Discrete-Volume Method (DVM), the Lagrangian Time-Driven Method (TDM), and the Lagrangian Event-Driven Method (Rossman and Boulos 1996). The FDM approximates derivatives with finite-difference equivalents along a fixed grid



of points in time and space. Islam et al. (1997) used this technique. The DVM divides each pipe into a series of equal-sized, completely mixed volume segments. At the end of each successive water-quality time step, the concentration within each volume segment is first reacted and then transferred to the adjacent downstream segment. This approach was used in the models that were the basis for the early DWQM studies. The TDM tracks the concentration and size of a non-overlapping segment of water that fills each link of a network. As time progresses, the size of the most upstream segment in a link increases as water enters the link, whereas an equal loss in size of the most downstream segment occurs as water leaves the link. The size of these segments remains unchanged. The EDM is similar in nature to the TDM, but rather than update an entire network at fixed time steps, individual link/node conditions are updated only when the leading segment in a link disappears completely through this downstream node. The development of the EPANET hydraulic model has satisfied the need for a comprehensive public-sector model and has been a key component in providing the basis for water-quality modeling in many utilities throughout the U.S.

### ***Advances in Numerical Modeling Techniques***

In addition to the development and application of EPANET, other “spin-off” research has resulted in models that locate monitoring stations in networks, predict the propagation of disinfectants, and determine the location of booster chlorination. This research is summarized in the following text.

Lee et al. (1991) examined the problem of selecting monitoring stations that will adequately monitor the changes in water quality between the time water leaves the treatment plant and the time it reaches the customer’s tap. They found that there is no uniform schedule or framework for monitoring under the SDWA. This lack of specificity poses both management and technical barriers to states and water systems ultimately responsible for implementation of the regulations. The authors provided systematic and quantitative guidelines for locating monitoring stations. Their guidelines are based on the concept of pathways. The authors applied the concept of coverage and inferred the quality at an upstream node from the quality at a downstream node.

Lu et al. (1993, 1995) developed mathematical models to predict disinfectant concentration profiles under breakpoint chlorination conditions and to predict the growth of biofilm in drinking water distribution systems. The breakpoint chlorination model accounts for concurrent mass transfer and a series of chemical reactions under breakpoint chlorination conditions, and the other is developed to predict disinfectant concentration profiles in the drinking water distribution pipe. The disinfection model is validated by comparing its numerical solutions to experimental data in the literature. The impact of important parameters on the model performance is examined by sensitivity analysis. Practical applications of the model to minimize water-quality deterioration in the distribution system are discussed. It is intended to provide insight into the factors that influence all of the fundamental reactions and disinfectant transport of the breakpoint reaction. Operational criteria for the chlorination of distributed water are derived.

Rossmann and Boulos (1996) compared the formulation and computational performance of four numerical methods for modeling the transient behavior of water quality in drinking water distribution systems. Two are Eulerian-based (the finite-difference and discrete-volume methods) and two are Lagrangian-based (the time-driven and event-driven methods). In the Eulerian approaches, water moves between fixed grid points or volume segments in pipes as time is advanced in uniform increments. The Lagrangian methods update conditions in variable-sized segments of water at either uniform time increments or only at times when a new segment reaches a downstream pipe junction. Each method was encoded into an existing distribution system simulation model and run on several pipe networks of varying size under equal accuracy tolerances. Results show that the accuracies of the methods are comparable. The Lagrangian methods are more efficient for simulating chemical transport. For model-

ing water age, the time-driven Lagrangian method is the most efficient, while the Eulerian methods are more memory-efficient. Results of the study showed the following: the numerical accuracy of the methods was by and large the same, with the exception that FDM occasionally smeared sharp concentration fronts and DVM occasionally accelerated the arrival of concentration changes. All of the methods were capable of adequately representing observed water-quality behavior in actual water distribution systems. Regardless of the method used, network size was not always a good predictor of the solution time and amount of memory required.

Boccelli et al. (1998) studied disinfectants added at discrete locations in a water distribution system. Such a strategy can reduce the mass of disinfectant required to maintain a detectable residual at points of consumption in the distribution system, which may lead to reduced formation of DBPs, in particular THMs. An optimization model is formulated for the dynamic schedule of disinfectant injections, which minimizes the total dose required to satisfy residual constraints over an infinite-time horizon. This infinite-time problem is reduced to a solvable finite-time optimal scheduling model by assuming periodicity of mass injections and network hydraulics. Furthermore, this principle of linear superposition is shown to apply to disinfectant concentrations resulting from multiple disinfectant injections over time. A matrix generator code was developed to interface with the EPANET network water-quality model. This code automatically generates the linear programming formulation of the optimal scheduling model, which is then solved using the simplex algorithm. Results from application of the model suggest that booster disinfection can reduce the amount of disinfectant required to satisfy concentration constraints when compared to conventional disinfection practiced only at the source. The optimal booster schedule reduced the average disinfectant concentration within the distribution system and, in some cases, the variability of these concentrations. The number of booster stations, booster location, and distribution system hydraulics were shown to affect the optimal schedule.

Lu et al. (1995) developed a biofilm model that accounts for simultaneous transport of substrates, disinfectants, and microorganisms and that predicts substantial changes in quality of distributed water. The model consists of a set of mass balance equations for organic substances, ammonia nitrogen, oxidized nitrogen, dissolved oxygen, alkalinity, biomass, and disinfectants in the bulk liquid phase and within the biofilm under laminar and turbulent flow conditions. This model is validated by comparing its solutions with numerical solutions in the literature and is then applied to predict the behavior of a typical water treatment plant effluent through a distribution pipe. The flow properties and disinfectant consumption rate at the pipe wall play a significant role in the determination of potable water quality in the distribution system.

Tryby et al. (1999) examined the feasibility of using booster chlorination in distribution systems. They developed a conceptual model for bulk chlorine decay under booster conditions. The conceptual analysis demonstrated that the use of booster chlorination allows microbial inactivation and maintenance of a detectable residual to be viewed as separate treatment issues. Booster chlorination could allow dosages to be reduced at the water treatment plant without compromising treatment objectives. By reducing dosages, the DBP yields at the water treatment plant may also be reduced and the disinfectant mass conserved can be more efficiently applied at points located in the distribution system. Their studies suggest that increasing residual concentrations alone will not eliminate the risks associated with pathogens and biofilm regrowth in problem areas. Several barriers against the entrance of contaminants are required. However, booster disinfection is the most efficient method of minimizing DBP formation.

## **Water Quality and Tanks**

The issue of water quality as affected by storage tank design and operation has been the object of extensive study. Most of this research has been conducted by EPA and AAWARF. The major studies in this area are presented in the following paragraphs.

Grayman and Clark (1993) conducted a series of studies demonstrating that water quality is degraded as a result of long residence times in storage tanks, which in turn has highlighted the importance of tank design, location, and operation. Computer models were developed to explain the effect of tank design and operation on various water-quality parameters. The diversity of the effects and the wide range of design and environmental conditions make general design specifications for tanks unlikely. The authors recommend that modeling be refined to facilitate site-specific analysis.

Mau et al. (1995) developed explicit analytical mathematical models for use in water-quality simulation studies and management of distribution system storage. The proposed models can be used for investigating the mixing characteristics of tanks and their subsequent effects on water quality. They can directly supplement any of the existing distribution system water-quality simulators. These models are formulated analytically from mass balance principles and based on hydrodynamic processes. The resulting models are simple to understand and implement and are well suited to the needs of practicing engineers. The performance models are validated by application to actual tank data.

Rossmann et al. (1995) studied the factors leading to the loss of disinfectant residual in well-mixed drinking water storage tanks. Equations relating disinfectant residual to the disinfectant's reaction rate, the tank volume, and the fill and drain rates were developed. The authors presented an analytical solution for the minimum disinfectant residual in the tank under constant inflow/outflow conditions. It showed that significant disinfectant loss begins when the product of disinfectant decay constant and the refill time for an empty tank exceeds 0.1 and that disinfectant residuals are relatively insensitive to the fraction of total volume devoted to emergency storage. A second, numerical solution to the model is developed to account for the fact that tank fill and drain rates are constrained by system demand patterns, pump capacity, and pump scheduling. Results from their study showed that pulsed or periodic pumping during a portion of the day can maintain much higher disinfectant residuals than continuous pumping can.

Clark et al. (1996a) demonstrated the use of compartment models to characterize mixing in three tanks. It was found that the mixing regimes in these tanks were well characterized by compartment-type models and that these tanks were not completely mixed, contrary to conventional wisdom. For purposes of this analysis, one-, two-, or three-compartment models were developed. It is clear that, in some cases, compartment models provide a very good representation of the mixing and residence times in tanks. It is also clear that additional research needs to be conducted in this area.

Boulos et al. (1996) conducted an extensive study of reservoir water quality at the Ed Heck reservoir in Azusa, CA. Emphasis was placed on understanding the hydraulic mixing regime and the distribution of the free chlorine residuals in the reservoir. A unique roof-mounted sampling device was developed for the study that allowed samples to be extracted from various depths in the water column. The device proved to be very effective and greatly enhanced the study's findings. The following conclusions were drawn:

- Fluoride tracer studies are useful for determining residence time distributions and internal mixing dynamics
- In the Ed Heck reservoir, the flow pattern was a relatively fast rotational flow around a large outer annular ring coupled with a slower downward flow within a smaller central core.
- For the conditions governing this study, the reservoir behaves, on average, as a completely mixed reactor.
- The mean residence time of 9.7 hours and a negligible loss of free chlorine residual was experienced during the course of the study.
- Short-circuiting between the inlet and outlet lines caused the  $T_{10}$  for the reservoir to be less than half that of a true continuous-flow stirred-tank reactor (CSTR).

Boulos et al. (1998) developed and verified an explicit mathematical model of distribution storage water quality based on a compartmental representation of the reservoir continuum. It was formulated analytically based on mass balance relationships which are applicable to separate inlet and outlet configuration reservoirs with simultaneous dual-directional flow. Previous models considered a common inlet/outlet reservoir configuration with unidirectional flow. The model was verified by application to actual reservoir data taken from a storage reservoir in Azusa, CA. Both conservative (fluoride) and reactive (chlorine) species were considered. A four-compartment model resulted in a reasonable fit between observed and simulated concentrations and should be predictive under operating conditions similar to those under which the model was calibrated.

Rossmann and Grayman (1999) reported on experiments conducted on cylindrical scale-model tanks designed to determine the effect of various factors on mixing in the tanks. It was found that the time required to mix the contents of a tank with water introduced during the fill period was proportional to the initial volume to the two-thirds power divided by the square root of the inflow momentum flux (the product of flow rate and velocity). The time is insensitive to the orientation of the inlet (vertically or horizontally). Complete mixing depends on the ratio of the momentum to buoyancy fluxes of the inlet jet. This is similar to past findings for jet discharges to unconfined bodies of water. The confined geometry of the tank results in a narrower range of conditions that produce stratification. The investigators derive a formula to estimate the minimum volume exchange required for a fill-and-draw cycle to ensure complete mixing before the end of the filling period.

## **Policy Issues**

There are many policy implications to the research discussed in this chapter. Two papers (Clark et al. 1994, 1995) attempted to frame some of the issues that modeling results have raised with respect to water quality in drinking water distribution systems.

Clark et al. (1995) discuss the SDWA and its amendments, which has focused interest on the factors that cause the deterioration of water between the treatment plant and the consumer. The authors discuss how the distribution system itself can contribute to this deterioration. Numerous examples of water-borne outbreaks have demonstrated the importance of the distribution system in preventing disease. The authors discuss water-quality propagation models that can be used to study the factors that contribute to water-quality deterioration. These models have been used in many locations to study contaminant propagation. This paper describes the application of contaminant propagation models in the SCCRWA. In this study, the fluoride feed was cut off at the water treatment plant to calibrate the model and determine residence times in the system. An extensive simulation of the system was conducted to predict conservative contaminant propagation and chlorine decay. After completing the simulation study, a sampling program was conducted to verify the results from the model. In general, the field results verified the model predictions. Water quality varied widely over the service area. Long retention times in storage tanks and pipe wall demand, especially in dead-end sections, caused significant losses in chlorine residuals.

Clark et al. (1994) present models that might be used to evaluate the consequences of investing in treatment and/or investing in replacement, rehabilitation, or repair of the pipe network to improve water quality. The authors point out that water high in humic and organic material that is transported in the network can ultimately lead to pipes that have a high disinfectant demand. Investment in treatment might not only meet water quality; it might also lead to a “cleaner” network.

## **Summary and Conclusions**

Conventional treatment combined with disinfection has proven to be one of the major public health advances of modern times. In the U.S., chlorine has been the final disinfectant most often used before

drinking water is discharged into a drinking water distribution system. It is added to provide a residual and to protect against microbial contamination. However, disinfectants, especially chlorine, react with NOM to form DBPs, which are considered to be of concern from a chronic exposure point of view. Disinfection reduces risk of infectious disease, but the interaction between disinfectants and precursor materials in source water result in the formation of DBPs.

Even treated drinking water exerts chlorine demand due to the reactions with NOM and other constituents in water. Therefore, the disinfectant dose must be sufficient to meet the inherent demand in the treated water, to provide sufficient protection against microbial infection, and at the same time minimize exposure to DBPs.

The factors that cause the disappearance of residuals and the subsequent formation of DBPs has been the subject of extensive study. Much of this effort has been devoted to models which are intended to identify the factors that influence both residual decay and the formation of DBPs. This chapter has reviewed both the EPA-supported research in this area as well as research conducted outside the Agency. Clearly, much progress has been made in developing realistic models to support risk management goals. Of particular note is the application of models to field conditions in water utilities. There is, however, much research left to be done before these models are truly predictive.

## References

- Amy, G. L. (1993). "Using NOM characterization for the evaluation of treatment." *Workshop Proceedings, Natural Organic Matter in Drinking Water Origin, Characterization, and Removal*, Chamonix, France, September 19–22, 19.
- Amy, G. L., Chadik, P. A., and Chowdhury, Z. K. (1987). "Developing models for predicting trihalomethane formation potential and kinetics." *Journal of the American Water Works Association*, 79(7), 89–97.
- Bellar, T. A. and Lichtenberg, J. J. (1974). "Determining volatile organics at microgram-per-liter levels by gas chromatography." *Journal of the American Water Works Association*, 66(12), 739–744.
- Biswas, P., Lu, C., and Clark, R. M. (1993). "A model for chlorine concentration decay in drinking water distribution pipes." *Water Research*, 27(12), 1715–1724.
- Boccelli, D. L., Tryby, M. E., Uber, J. G., Rossman, L. A., Zierolf, M. L., and Polycarpu, M. M. (1998). "Optimal scheduling of booster disinfection in water distribution systems." *Journal of Water Resources Planning and Management*, ASCE, 124(2), 99–111.
- Boulos, P. F., Altman, T., Jarrige, P. A., and Collevati, F. C. (1995). "Discreet simulation approach for network water quality models." *Journal of Water Resources Planning and Management*, ASCE, 121(1), 49–60.
- Boulos, P. F., et al. (1996). "Hydraulic mixing and free chlorine residual in reservoirs." *Journal of the American Water Works Association*, 48–59.
- Boulos, P. F., Mau, R. E., and Clark, R. M. (1998). "Analytical equations of storage reservoir water quality." *Civil Engineering Environmental Systems*, 15, 171–186.
- Chambers, V. K., Creasey, J. D., and Joy, J. S. (1995). "Modelling free and total chlorine decay in potable water distribution systems." *Journal of Water Supply, Research, and Technology—Aqua*, 44(2), 60–69.
- Clark, R. M. (1993a). "Applying water quality models." *Computer modeling of free-surface and pressurized flow*, M. H. Chaudry and L. M. Mays, eds., Kluwer Dordrecht, Netherlands, 581–612.

- Clark, R. M. (1993b). "Development of water quality models." *Computer modeling of free-surface and pressurized flow*, M. H. Chaudry and L. M. Mays, eds., Kluwer Academic Publishers, Dordrecht, Netherlands, 553–580.
- Clark, R. M. (1998). "Chlorine demand and TTHM formation kinetics: A second-order model." *Journal of Environmental Engineering Division of the ASCE*, 124(1), 16–24.
- Clark, R. M. and Coyle, J. A. (1990). "Measuring and modeling variations in distribution system water quality." *Journal of the American Water Works Association*, 82(8), 46–53.
- Clark, R. M. and Feige, W. A. (1993). "Meeting the requirements of the Safe Drinking Water Act." *Strategies and Technologies for Meeting SDWA Requirements*, R. M. Clark and R. S. Summers, eds., Technomic Publishing Company, Inc., Lancaster, PA.
- Clark, R. M. and Goodrich, J. A. (1992). "Modeling human exposure to contaminants from drinking water." *Journal of Water Supply, Research, and Technology–Aqua*, 41(4), 224–230.
- Clark, R. M. and Goodrich, J. A. (1993). "Water quality modeling in distribution systems." *Strategies and Technologies for Meeting SDWA Requirements*, R. M. Clark and R. S. Summers, eds., Technomic Publishing, Lancaster, PA, 344–359.
- Clark, R. M. and Sivaganesan, M. (1998). "Predicting chlorine residuals and the formation of TTHMs in drinking water." *Journal of Environmental Engineering Division of the ASCE*, 124(12), 1203–1210.
- Clark, R. M. and Sivaganesan, M. (in press). "Predicting chlorine residuals in drinking water: A second order model." Accepted for publication by the *Journal of Water Resources, Planning, and Management*.
- Clark, R. M., Grayman, W. M., and Males, R. M. (1988a). "Contaminant propagation in distribution systems." *Journal of Environmental Engineering Division of the ASCE*, 114(4), 929–943.
- Clark, R. M., Grayman, W. M., Males, R. M., and Coyle, J. (1988b). "Modeling contaminant propagation in drinking water distribution systems." *Journal of Environmental Engineering Division of the ASCE*, 3, 137–151.
- Clark, R. M., Grayman, W. M., and Goodrich, J. A. (1991). "Water quality modeling: Its regulatory implications." *Proceedings, American Water Works Association Research Foundation, Environmental Protection Agency Conference on Water Quality Modeling in Distribution Systems*, Cincinnati, OH, February 4–5, 389–416.
- Clark, R. M., Rossman, L. A., and Goodrich, J. A. (1992). "Modeling the variation in human exposure to contaminants from drinking water." *Journal of Exposure Analysis and Environmental Epidemiology*, 1, 59–175.
- Clark, R. M., Goodrich, J. A., and Wymer, L. J. (1993a). "Effect of the distribution system on drinking water quality." *Journal of Water Supply, Research, and Technology–Aqua*, 42(1), 30–38.
- Clark, R. M., Grayman, W. M., Males, R. M., and Hess, A. F. (1993b). "Modeling contaminant propagation in drinking water distribution systems." *Journal of Environmental Engineering Division of the ASCE*, 119(2), 349–364.
- Clark, R. M., et al. (1994). "Managing water quality in distribution systems: Simulating TTHM and chlorine residual propagation." *Journal of Water Supply, Research, and Technology–Aqua*, 43(4), 182–191.

- Clark, R. M., Rossman, L., and Wymer L. (1995). "Modeling distribution system water quality: Regulatory implications." *Journal of Water Resources, Planning, and Management, ASCE*, 121(6), 423–428.
- Clark, R. M., Abdesaken, F., Boulos, P. F., and Mau, R. (1996a). "Mixing in distribution system storage tanks: Its effect on water quality." *Journal of Environmental Engineering Division of the ASCE*, 122(9), 814–821.
- Clark, R. M., Pourmoghaddas, H., Wymer, L. G., and Dressman, R. C. (1996b). "Modeling the kinetics of chlorination by-product formation: The effects of bromide." *Journal of Water Supply, Research, and Technology–Aqua*, 45(1), 1–8.
- Clark, R. M., Thurnau, R. C., Sivaganesan, M., and Ringhand, P. (2001). "Predicting the formation of chlorinated and brominated by-products." *Journal of Environmental Engineering Division of the ASCE*, 127(6), 495–501.
- Cowman, G. A. and Singer, P. C. (1996). "Effect of bromide ion on haloacetic acid speciation resulting from chlorination and chloramination of aquatic humic substances." *Environmental Science and Technology*, 30(1), 16–24.
- Dugan, N. R., Summers, R. S., Miltner, R. J., and Shukairy, H. M. (1995). "An alternative approach to predicting chlorine residual decay." *Proceedings, American Water Works Association Water Quality Technology Conference*, New Orleans, LA, Nov. 12–16, 1317–1338.
- Feben, D. and Taras, M. J. (1951). "Studies on chlorine demand constants." *Journal of the American Water Works Association*, 43(11), 922–932.
- Freund, R. J. and Littell, R. C. (1991). *SAS systems for regression*, 2nd Ed., SAS Institute, Cary, NC, 15–58.
- Gessler, J. and Walski, T. M. (1985). "Water distribution system optimization." *TREL-85-11*, WES, U.S. Army Corps of Engineers, Vicksburg, MS.
- Grayman, W. M. and Clark, R. M. (1993). "Using computers to determine the effect of storage on water quality." *Journal of the American Water Works Association*, 85(7), 67–77.
- Haas, C. N. and Karra, S. B. (1984). "Kinetics of wastewater chlorine demand exertion." *Journal of the Water Pollution Control Federation*, 56(2), 170–173.
- Hao, O. J., Davis, A. P., and Chang, P. H. (1991). "Kinetics of manganese(H) oxidation with chlorine." *Journal of Environmental Engineering Division of the ASCE*, 117(3), 359–374.
- Harrington, G. W., Chowdhury, Z. K., and Owen, D. M. (1992). "Developing a computer model to simulate DBP formation during water treatment." *Journal of the American Water Works Association*, 84(11), 78–87.
- Islam, M. R. (1995). "Modeling of chlorine concentration in unsteady flows in pipe networks." Ph.D. dissertation, Washington State University.
- Islam, M. R., Chaudhry, M. H., and Clark, R. M. (1997). "Inverse modeling of chlorine concentration in pipe networks under dynamic conditions." *Journal of Environmental Engineering Division of the ASCE*, 123(10), 1033–1040.
- Jadas-Hecart, A., El Morer, A., Stitou, M., Bouillot, P., and Legube, B. (1992). "Modelisation de la Demande en Chlore D'une Eau Traitee." *Water Reserves*, 26(8), 1073.

- Kavanaugh, M. C., Trussell, A. R., Cromer, J., and Trussell, R. R. (1980). "An empirical kinetic model of trihalomethane formation: Applications to meet the proposed THM standard." *Journal of the American Water Works Association*, 72(10), 578–582.
- Lee, B. H., Deininger, R. A., and Clark, R. M. (1991). "Locating monitoring stations in water distribution networks." *Journal of the American Water Works Association*, 83(7), 60–66.
- Lu, C., Biswas, P., and Clark, R. M. (1993). "Modeling of breakpoint reaction in drinking water distribution pipes." *Environmental International*, 19(6), 543–560.
- Lu, C., Biswas, P., and Clark, R. M. (1995). "Simultaneous transport of substrates, disinfectants and microorganisms in water pipes." *Water Reserves*, 29(3), 881–894.
- Lyn, T. L. and Taylor, J. S. (1993). "Modeling compliance of chlorine residual and disinfection by-products." *Proceedings, American Water Works Association Water Quality Technology Conference*, Miami, FL, Nov. 7–11, 513–523.
- Mau, R., Boulos, P., Clark, R., Grayman, W., Tekippe, R., and Trussell R. (1995). "Explicit mathematical models of distribution system storage water quality." *Journal of Hydrolic Engineering, ASCE*, 121(10), 699–709.
- McKnight, A. and Reckhow, D. A. (1992). "Reactions of ozonation byproducts with chlorine and chloramines." *Proceedings, American Water Works Association Annual Conference—Water Research*, Vancouver, BC, June 18–22, 399–409.
- Pourmoghaddas, H., Stevens, A. A., Kinman, R. N., Dressman, R. C., Moore, L. A., and Ireland, J. C. (1993). "Effect of bromide ion on the formation of HAAs during chlorination." *Journal of the American Water Works Association*, 85(1), 82–87.
- Qualls, R. G. and Johnson, J. D. (1983). "Kinetics of the short-term consumption of chlorine by fulvic acid." *Environmental Science and Technology*, 17(11), 692–698.
- Rook, J. J. (1974). "Formation of haloforms during chlorination of natural waters." *Water Treatment Examination*, 23, 234.
- Rossmann, L. A. (1994). *EPANET Users Manual*. Drinking Water Research Division, Environmental Protection Agency, Cincinnati, OH.
- Rossmann, L. A. and Boulos, P. A. (1996). "Numerical methods for modeling water quality in distribution systems: A comparison." *Journal of Water Resources Planning and Management, ASCE*, 122(2), 137–146.
- Rossmann, L. A., Brown, R. A., Singer, P. C., and Nuckols, J. R. (1999). "Kinetics of THM and HAA production in a simulated distribution system." *Proceedings, American Water Works Association Water Quality Technology Conference*, Tampa, FL, October 31–November 3.
- Rossmann, L. A., Clark, R. M., and Grayman, W. M. (1994). "Modeling chlorine residuals in drinking-water distribution systems." *Journal of Environmental Engineering Division of the ASCE*, 120(4), 803–820.
- Rossmann, L. A. and Grayman, W. M. (1999). "Scale model studies of mixing in drinking water storage tanks." *Journal of Environmental Engineering Division of the ASCE*, 125(8), 755–761.
- Rossmann, L. A., Uber J. A., and Grayman, W. M. (1995). "Modeling disinfectant residuals in drinking water storage tanks." *Journal of Environmental Engineering Division of the ASCE*, 121(10), 755–761.



- Schenck, K. M., Wymer, L. J., Lykins, Jr., B. W., and Clark, R. M. (1998). "Application of a Finnish mutagenicity model to drinking waters in the U.S." *Chemosphere*, 37(3), 451–464.
- Shukairy, H. M. (1994). "The control of disinfection by-product formation by ozonation and biotreatment." Ph.D. dissertation, University of Cincinnati, Cincinnati, OH.
- Shukairy, H. M. (1998). "Ozonation in drinking water treatment." *Encyclopedia of Environmental Analysis and Remediation*, R. A. Meyers, ed., John Wiley & Sons, Inc., New York.
- Shukairy, H. M., Koechling, M. T., and Summers, R. S. (1994a). "Fractionated organic matter DBP formation: kinetics, reactivity and speciation." *Proceedings, American Water Works Association Annual Conference*, New York, NY, June 19–23, *Water Research*, 941–957.
- Shukairy, H. M., Miltner, J. R., and Summers, R. S. (1994b). "Bromide's effect on DBP formation, speciation, and control: Part 1, Ozonation." *Journal of the American Water Works Association*, 86(6), 72–87.
- Shukairy, H. M., Miltner, R. J., and Summers, R. S. (1995). "Bromide's effect on DBP formation, speciation, and control: Part 2, Biotreatment." *Journal of the American Water Works Association*, 87(10), 71–82.
- Shukairy, H. M. and Summers, R. S. (1992). "The impact of preozonation and biodegradation on disinfection by-product formation." *Water Research*, 26(9), 1217–1227.
- Shukairy, H. M. and Summers, R. S. (1996). "DBP speciation and kinetics as affected by ozonation and biotreatment." *Disinfection by-products in water treatment: The chemistry of their formation and control*, R. A. Minear and G. L. Amy, eds., Lewis Publishers, Chelsea, MI, 311–335.
- Skov, K. R., Hess, A. F., and Smith, D. B. (1991). "Field sampling procedures for calibration of a water distribution system hydraulic model." *Proceedings, American Water Works Association Research Foundation, Environmental Protection Agency Conference on Water Quality Modeling in Distribution Systems*, Cincinnati, OH, February 4–5, 193–200.
- Trusell, R. R. and Umphres, M. D. (1978). "The formation of trihalomethanes." *Journal of the American Water Works Association*, 70(10), 604–612.
- Tryby, M. E., Boccelli, D. L., Koechling, M. T., Uber, J. G., Summers, R. S., and Rossman, L. A. (1999). "Booster chlorination for managing disinfectant residuals." *Journal of the American Water Works Association*, 92(1), 96–108.
- United States Environmental Protection Agency (USEPA). (1992). *Water treatment plant simulation program user's manual, Version 1.21*. Drinking Water Technology Branch, Drinking Water Standards Division, Office of Ground Water and Drinking Water, Malcolm Pirnie, Inc.
- Vartiainen, T. and Liimatainen, A. (1988). "Relations between drinking water mutagenicity and water quality parameters." *Chemosphere*, 17(1), 189–202.
- Vasconcelos, J. J., Rossman, L. A., Grayman, W. M., Boulos, P. F., and Clark, R. M. (1997). "Kinetics of chlorine decay." *Journal of the American Water Works Association*, 89(7), 55–65.
- Ventresque, C., Bablon, G., Legube, B., Jadas-Hecart, A., and Dore, M. (1990). "Development of chlorine demand kinetics in a drinking water treatment plant." *Water chlorination: Chemistry, environmental impact and health effects*, R. L. Jolley, et al., eds., Vol. 6, Lewis Publications, Inc., Chelsea, MI, 715–728.

White, G. C. (1999). *Handbook of chlorination and alternative disinfectants*. J. Wiley & Sons, Inc., New York, 257–258.

Zhang, G. R., Keine, L., Wable, O., Chan, U. S., and Duget, J. P. (1992). “Modeling of chlorine residual in the water distribution system network of Macao.” *Environmental Technology*, 13, 937–946.

## CHAPTER 13

### Biofilms in Drinking Water Distribution Systems<sup>1</sup>

#### Introduction

Virtually anywhere a surface comes into contact with the water in a distribution system, one can find biofilms. Biofilms are formed in distribution system pipelines when microbial cells attach to pipe surfaces and multiply to form a film or slime layer on the pipe. Probably within seconds of entering the distribution system, large particles, including microorganisms, adsorb to the clean pipe surface. Some microorganisms can adhere directly to the pipe surface via appendages that extend from the cell membrane; other bacteria form a capsular material of extracellular polysaccharides (EPS), sometimes called a glycocalyx, that anchors the bacteria to the pipe surface (Geldreich 1988). The organisms take advantage of the macromolecules attached to the pipe surface for protection and nourishment. The water flowing past carries nutrients (carbon-containing molecules, as well as other elements) that are essential for the organisms' survival and growth (USEPA 1992).

Biofilms are complex and dynamic microenvironments, encompassing processes such as metabolism, growth, and product formation, and finally detachment, erosion, or "sloughing" of the biofilm from the surface. The rate of biofilm formation and its release into a distribution system can be affected by many factors including surface characteristics, availability of nutrients, and flow velocities. Biofilms appear to grow until the surface layers begin to slough off into the water (Geldreich and Rice 1987). The pieces of biofilm released into the water may continue to provide protection for the organisms until they can colonize a new section of the distribution system.

Few organisms living in distribution system biofilms pose a threat to the average consumer. Bacteria, viruses, fungi, protozoa, and other invertebrates have been isolated from drinking water biofilms (USEPA 1992). The fact that such organisms are present within distribution system biofilms shows that, although water treatment is intended to remove all pathogenic (disease-causing) bacteria, treatment does not produce a sterile water. In fact, some otherwise harmless organisms (opportunistic pathogens) may survive the treatment process and cause disease in individuals with low immunity or compromised immune systems.

Bacteria comprise the largest portion of the biofilm population. These organisms may survive the disinfection process to colonize the distribution system at the time of installation, or they may be introduced through cross connections, backflow events, line breaks, or repair operations. The public health risk from these organisms is not known (Geldreich 1990). Although biofilms may represent the greatest concentration of biological material (biomass) in the distribution system, health surveys conducted in systems experiencing biofilm growth problems (New Haven, CT; Springfield, IL; and Muncie, IN) have revealed no increase in illnesses due to contaminated drinking water (Geldreich 1988). Most bacteria survive in disinfected drinking water by finding or creating environments where they are protected from the disinfectant residual. Factors related to increased survival of bacteria in chlorinated water include attachment to surfaces, encapsulation, aggregation, low-nutrient growth conditions, and strain variation.

---

<sup>1</sup>Mark Meckes: ORD/NRMRL/WSWRD, AWBERC Mailstop 689, 26 West Martin Luther King Dr., Cincinnati, OH 45268, 513-569-7348, meckes.mark@epa.gov.

Corrosion provides a protective surface for microorganisms, slows water flow, and contributes to backflow occurrences where iron pipe walls corrode. In iron pipes, electrochemical reactions at the pipe surface dissolve the metal to form pits (releasing free ferrous ions) at one point while building a tubercle or nodule (composed of ferric hydroxide) at a remote spot. The pits and nodules formed may catch and concentrate nutrients and provide the organisms with protection from water shear (Allen and Geldreich 1977). Free chlorine itself promotes the pitting type of corrosion by reacting with the ferrous ions and precipitation of ferric hydroxide. This not only accelerates corrosion but also represents another demand on the free chlorine residual (USEPA 1984).

Some heterotrophic bacteria that live in biofilms may cause esthetic problems with water quality, including off-tastes, odors, and colored water problems. Biofilm organisms that fall into this nuisance category include *Actinomyces*, *Streptomyces*, *Nocardia*, and *Arthrobacter* (Geldreich 1990). Complaints about taste and odor have resulted from *Streptomyces* and *Nocardia* spp. at concentrations greater than 10 organisms per 100 mL of water. For pigmented bacteria, the degree of pigment formation observed in cultured cells will depend on the media used for isolating the bacteria in the water sample. Many heterotrophic plate count (HPC) bacteria isolated from distribution system biofilms will produce yellow, orange, or pink colonies when grown on R2A agar (Geldreich 1990; Reasoner et al. 1989; Reasoner and Geldreich 1990; Carter et al. 2000).

## Previous Research

Organic carbon is utilized by heterotrophic bacteria for production of new cellular material (assimilation) and as an energy source (dissimilation). Because heterotrophic bacteria require carbon, nitrogen, and phosphorus in a ratio of approximately 100:10:1 (C:N:P), organic carbon is often a growth-limiting nutrient. Most organic carbon compounds in water supplies are natural in origin, derived from living and decaying vegetation. These compounds may include humic and fulvic acids, polymeric carbohydrates, proteins, and carboxylic acids.

Kaplan and Bott (1990), in a study conducted for the U.S. Environmental Protection Agency (EPA), evaluated the effect of nutrients on bacterial growth in drinking water. Their evaluation showed that incubation vessel surface-to-volume ratio influenced the assimilable organic carbon (AOC) value by enhancing wall growth of reversibly attached cells. The authors noted that the underlying assumptions for the AOC bioassay include (1) organic carbon limits growth of the bioassay organism, (2) the yield of the bioassay organism on naturally occurring AOC is constant and equal to the yield on model organic compounds, and (3) the bioassay organism is an appropriate surrogate for the native microflora of distribution systems in utilizing AOC. Their research showed that some test waters required the addition of phosphorus in order to generate carbon limitation. They also showed that AOC concentrations in a small sampling of surface water sources ranged from 48 to 607 µg/L, while a ground water sample yielded AOC values from 40 to 146 µg/L. Kaplan et al. (1993) modified the AOC bioassay procedure to minimize the potential for contamination and to simplify the procedure so that it could be used routinely by water utilities. These researchers compared media, culture vessels, glassware cleaning methods, physiological condition of the inoculum, and treatments of the inoculation water and concluded that the AOC method could be simplified by the use of precleaned vials as culture vessels. They also noted that the organisms commonly used for the bioassay, *Pseudomonas fluorescens* P-17 and *Spirillum* sp. strain NOX, need not be in log growth phase when inoculated into the culture vessels. They also noted that replication of incubation vessels is the most efficient way to reduce variance and the cost of the AOC measurement.

Researchers at the Compagnie Generale des Eaux in France developed a method to measure biodegradable dissolved organic carbon (BDOC) (Pascal et al. 1986; Hascoet et al. 1986; Servais et al. 1987),

which is the fraction of DOC which is biodegraded by naturally occurring flora under controlled conditions. In the BDOC test, the concentration of DOC for a given water sample is determined. Indigenous bacteria are then allowed to grow for a specified time within another aliquot of the sample under controlled conditions. Finally, these samples are then filtered through prewashed 0.22- $\mu\text{m}$  membrane filters, and an organic carbon analyzer is used to measure the DOC remaining in the water. The difference in the DOC concentration (initial-final DOC) is the BDOC. If the bacteria are incubated in water samples for 10 to 30 days, the test allows measurement of slowly degradable organic materials (Pascal et al. 1986). This procedure has some disadvantages, including insensitivity at low DOC levels and the relatively high cost of a total organic carbon (TOC) analyzer. There are no operational data to relate specific BDOC levels to HPC or coliform problems; however, a level of less than 0.1 BDOC mg/L is thought to produce biologically stable water (i.e., water that is unable to support bacterial growth).

Rice et al. (1990) tested the regrowth potential of three species of coliform bacteria in source, partially treated, and finished water samples. These researchers selected a strain of *Enterobacter cloacae* as the organism of choice for conducting a bioassay for determining the potential for coliform regrowth in waters. In this bioassay, an acclimated culture of the organism is added to filter-sterilized water samples and incubated in the dark for 5 days at 20°C. After 5 days, the density of the organism is determined and compared to the initial density. If the  $\log_{10}$  growth is less than 0.5, the water is not considered to support coliform growth. If the  $\log_{10}$  growth is equal to or greater than 0.5 and less than 1.0, the water is considered to be moderately supportive of coliform growth. If the  $\log_{10}$  growth is equal to or greater than 1.0, then the water is considered to be supportive of coliform growth. Results of the assay on three water sources with multiple treatments showed that water treated with ozone or chlorine and, in one case, coagulated and filtered water yielded a coliform growth response (CGR) of greater than one log, indicating that these waters were capable of supporting growth of coliform organisms.

Shortly after this, Rice et al. (1991) tested the CGR in a variety of water types from different geographical areas and at different stages of water treatment. They found that coliform growth responses correlated with assimilable organic carbon concentrations. They noted that the correlation, although significant ( $p < 0.05$ ), had a low coefficient of determination (8.5%). Using analysis of variance techniques, the authors were able to demonstrate that mean CGR values increased with increasing values of AOC. They also found that significantly higher coliform growth responses were associated with waters that had been exposed to ozonation. This work was completed prior to the introduction of the use of *Spirillum* sp. NOX as a second AOC bioassay organism. This strain is better able to determine the utilization of substrates such as oxalate and other carboxylic acid compounds formed after ozonation. The authors speculate that, if both bioassay organisms had been used, the differences in AOC levels between ozonated and unozonated samples would have been much greater than they reported. They go on to state that the CGR assay does not measure the same parameter as the AOC procedure, and note that this is due to the widely held opinion that the nutrient threshold level for members of the family Enterobacteriaceae exceeds that of the family Pseudomonadaceae. They also note that the lack of a significant positive correlation between the CGR and any of the measured chemical parameters is indicative of the complex nutritional requirements of these coliforms and that this finding parallels the relationship between measured chemical parameters and AOC.

Kaplan et al. (1994) compared three methods for determining biodegradable organic matter (BOM) in a broad range of U.S. drinking waters and treatment processes. The AOC assay, the BDOC assay, and the CGR were used to determine the potential for bacterial regrowth in waters from 109 different sources. These included 53 from surface sources, 26 from ground waters, and 40 collected from a variety of treated waters. Specified utilities were sampled quarterly for a period of 1 year in order to determine if BOM concentrations varied seasonally. Results showed that the source of water samples (e.g., ground water versus surface water) more so than the treatment of the waters had a strong influ-

ence on the AOC and BDOC concentrations. The relationship between AOC and BDOC appeared to be best when AOC values were calculated on the basis of oxalate carbon rather than acetate. No conclusion was presented regarding the CGR assay. This research suggests that the AOC and BDOC are complementary techniques that can be applied for measurement of BOM in water supplies.

The density of organisms entering a water distribution system also affects the biofilm within such systems. Mathieu et al. (1993) used a distribution system simulator to determine the effect of bacterial flux on biofilm formation. The simulator, which was made up of three 30-meter loops of 10-cm diameter cement-lined pipe was operated under conditions of low and high nutrients and low and high levels of disinfecting agents. After several weeks of operating the simulator, they observed that biofilm did accumulate on cement coupons in the presence of relatively high (0.43 mg/L chlorine or 1.06 mg/L chloramine disinfectant residuals). They also noted that the chloraminated system contained more than 3.8 times as many cells/cm<sup>2</sup> than did the system treated with chlorine. A linear relationship was found when the results from the chloraminated system were used to compare the biofilm (log cells/cm<sup>2</sup>) to number of cells in the influent to the simulator loop. This relationship showed that an increase in one log of bacterial cells in system feed water yielded a 0.32 log increase in biofilm density. This demonstrated that the flux of bacteria within a water distribution system can contribute to biofilm accumulation.

Block et al. (1995) briefly reviewed the literature available on biodiversity in drinking water distribution systems. They noted that different trophic levels have been identified within systems of heterotrophic bacteria, free-living protozoa, and macroinvertebrates. They also found that the bacterial species seem to be as diverse as those found in natural systems since more microorganisms develop opportunistic strategies for occupying environments with different temperatures, nutrients, and toxins. They also noted that others have shown that relatively high densities of bacteria, protozoa, and macroinvertebrates can be found within water distribution systems, and there is some indication that seasonal variations in populations exist. Predation of bacteria was noted as having been demonstrated by a number of researchers, but they also noted that the clearing rate has not been documented. They go on to speculate that this may in part be due to the fact that such activity is highly variable. The authors did note that the highest protozoan populations correspond with high bacterial populations. On the other hand, they also noted that, when an experimental distribution system was colonized by *E. coli* under varying water quality conditions, the *E. coli* density remained high in low-nutrient water. This was attributed to low protozoan populations in the low-nutrient content water.

Carter et al. (2000) examined water samples from four sites within a water distribution system. At two of the sampling locations (a pump station and the terminal point in the system), they installed monitoring devices which continuously measured pH, conductivity, water temperature, and free chlorine. At these same locations, they also installed biofilm collection devices. Weekly water samples were assayed for AOC and TOC. Heterotrophic bacteria were measured using three different assay techniques, plate count agar pour plates (PCA), R2A agar spread plates (R2A), and tryptic soy agar with 5% sheep's blood spread plates (TSA-SB). Similarly, they sampled biofilm collection devices on a weekly basis and assayed these samples for heterotrophic bacteria using the same three techniques. Their results showed that plate counts from the three heterotrophic bacteria assays differed markedly between the bulk fluid and biofilm samples. They noted that samples from the bulk fluid generated plate counts ranging from about 4 to 400 CFU/mL, while samples from the biofilm collector yielded plate counts ranging from  $5 \times 10^3$  to  $1.5 \times 10^6$  CFU/cm<sup>2</sup>. They also found that biofilm densities measured using the PCA and R2A assays yielded similar results, while the PCA and TSA-SB techniques yielded comparable results for analysis of fluid samples. These researchers also noted that the number of bacterial colonies exhibiting pigmentation increased from 57% in fluid samples to 76% in biofilm samples which were taken from the terminus.

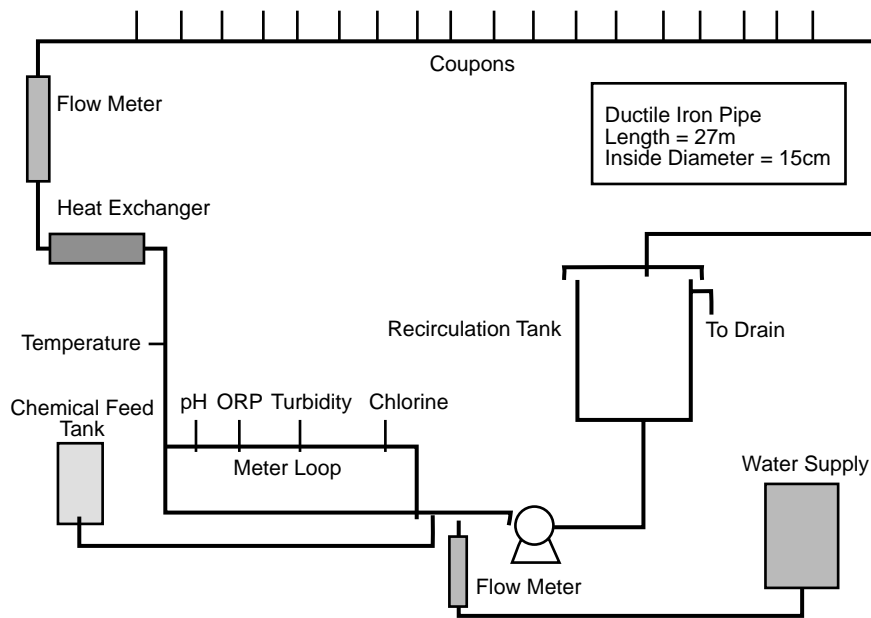
## Pilot Systems Research

In situ sampling of distribution system biofilms presents numerous obstacles. Consequently, distribution system simulators are often used to evaluate the effects of varying water quality parameters on distribution system components and biofilms. Clark et al. (1994) used a distribution system simulator to evaluate the effect of various disinfectants on water quality parameters. In this study, source water treated by one of four treatment trains was disinfected with chlorine or chloramine. These were independently examined in two distribution system simulators which were constructed of three 31-meter lengths of 100-mm diameter, cement-lined, cast iron pipe. Results showed that, as disinfectant residuals decreased within the simulator, biofilm densities increased, regardless of the disinfectant used. No discernable difference was noted in the density of biofilm organisms due to the disinfecting agent used. The biomass that did accumulate was heterogeneous, and growth of surface-associated cells correlated with a decrease in BDOC. These authors also noted that, when a residual chlorine concentration was maintained above 0.4 mg/L, the density of biofilm was much lower on the cement pipe material than on polyethylene.

Clark and Sivaganesan (1999), using data from the previously cited study, developed models which may be used to predict bacterial densities in the bulk water phase and wall biofilms. Data from one of the four treatment trains displayed a linear relationship between the log of the wall microbial density (measured by microscopic identification of epifluorescent cells) and residual disinfectant. The authors used analysis of covariance techniques to demonstrate that chlorine was significantly more effective than chloramine in reducing epifluorescent cell counts in bulk water samples. Similarly, they demonstrated that, when the data from all treatments was considered, the effect of chlorine on log transforms of the epifluorescent cell counts from biofilm samples was significantly greater ( $p < 0.05$ ) than the effect of chloramine.

Cement pipe and polyethylene pipe have surfaces which are considered to be non-reactive with respect to oxidizing disinfectants such as chlorine or its combined forms. Unlined cast or ductile iron pipe surfaces do react with oxidizing agents, which results in corrosion and reduction of residual oxidants. Although no longer used for new installations, unlined cast iron piping remains in use for water distribution throughout the U.S. Consequently, the effects on water quality by these reactive materials is of concern. The EPA National Risk Management Research Laboratory (NRMRL) Distribution System Simulator (DSS-1) was fabricated for the purpose of studying the impact of distribution systems on drinking water quality. This simulator is housed at the NRMRL Test and Evaluation (T&E) Facility located in Cincinnati, OH. The DSS-1 (see Figure 13-1) is made up of six individual 27-m lengths of 15-cm inside-diameter ductile iron pipe configured as independent loops. Stainless steel tanks are located at the base of each loop for the purpose of providing a reservoir which feeds a centrifugal pump used for recirculating water within a loop. Each loop is insulated and equipped with a shell and tube heat exchanger which is used to control the temperature of the water as it moves through a loop. All loops are equipped with valved coupon assemblies. The assembly is designed so that the surface of a coupon fits flush with the interior pipe wall. The valved assembly allows for the removal of the coupon without disruption of flow.

Recirculating flow rates are measured by in-line magnetic flow meters. Feed water flow is measured by in-line rotometers. An instrumentation loop is fitted with pH, oxidation reduction potential (ORP), dissolved oxygen, and pressure and temperature sensors which measure the condition of the water as it moves through the loop. Residual free chlorine is measured using a flow-through monitor, and turbidity is measured using a flow-through nephelometer. Signals from these instruments are polled, recorded, and archived using a supervisory controlled data acquisition system (SCADA). The frequency at which a given instrument is polled may be varied to accommodate data collection requirements for a simulation.



**Figure 13-1. Schematic diagram of a test loop.**

Using the DSS-1, Meckes et al. (1999) observed that biofilm growth could be diminished when organisms are subjected to variations in pH. They suggested that pH adjustments to water within distribution systems could reduce or control biofilm growth. The authors used five of the DSS loops operating in parallel under identical conditions for a period of 2 weeks. They noted that the initial density of biofilm organisms varied between test loops; therefore, one loop was used as a control with no modification of the feed water pH (8.0 standard units), while the other four loops were operated at pHs of 5, 6, 9, and 10. They noted that biofilm densities remained stable within the loops that received alkaline waters, whereas the loops which received acidic water showed a marked reduction in biofilm densities. This was most dramatic in the loop which received pH 5 water, which showed a thousand-fold reduction in viable biofilm organisms. Following 3 weeks of operating at the adjusted pH levels, the pH additives were turned off, and the test loops were permitted to return to their original operating conditions. Within 1 week, the authors noted that biofilm levels increased within the loops which had previously received acidic waters. They also noted that calcium concentrations in the water increased in delivered water samples obtained from the loops which received acidic water and noted that the calcium concentration returned to its original level when the pH of the water returned to its original operating condition. These results suggest that the reduction of biofilm that was observed was due to substrate destabilization rather than growth inhibition.

In addition to the DSS-1, the NRMRL fabricated a second simulator (DSS-2). This simulator is constructed of two individual pipe systems: one is constructed of polyvinyl chloride (PVC), while the second system is constructed of cement-lined steel pipe. Both of these pipe materials are considered to provide non-reactive wetted surfaces. Each pipe has a 15-cm inside diameter and is approximately 110 m long. Several 2.5-cm diameter pipes extend vertically from the main pipe sections. These valved lines are designed to simulate service connections and are used as sample collection points. Both loops are equipped with valved coupon assemblies. These assemblies are designed so that up to 20 coupons can be inserted into the pipe at one of three locations. The valved assembly allows for the removal of one or more coupons without disruption of flow. Quality of the source water for these systems can be



adjusted by addition of agents to a mixed head tank which feeds both pipes. Flow rates through the pipes are monitored by a magnetic flow meter and by rotometers to ensure accurate flow measurement throughout the design range of 0 to 75 L/min. These simulators were designed as single-pass systems without provision for water recycle.

Li et al. (1998) described the PVC pipe system. Using a fluoride tracer, they compared the actual hydraulic residence time of the system to the theoretical detention time under various flow conditions. The results from this work demonstrated that the flow dispersion models described by Levenspiel (1972) closely matched the observed dispersion of tracer. These data, collected under various flow regimes, can be used to calibrate the dispersion model. This information defines the hydraulic conditions of the system under various flow regimes. With this information in hand, these researchers will conduct additional experiments designed to determine the effect of various flow regimes on biofilm densities and residual chlorine within this simulator.

## **On-Going and Future Biofilm Research**

In addition to the planned research noted previously, the EPA DSS-1 is currently being used to determine the effectiveness of various disinfecting agents on biofilms. Biofilms are known to be resistant to residual oxidants; however, combined forms of chlorine are less reactive than chlorine itself. This study is designed to determine if chlorine, chloramines, or mixed oxidants (MIOX) residuals are equally effective in controlling biofilm. Other studies are planned which will determine the effect of various operating conditions and nutrient levels on biofilm growth.

In a cooperative effort with the University of Montana's Biofilm Research Center, EPA is studying the interactions among factors that influence biofilms, bacterial regrowth, and corrosion in distribution systems. The goal of this work is to generate information which can lead to a better understanding of the interactions among those factors which influence microbial growth in water distribution systems and the mitigating effects of chlorination and commonly used corrosion control techniques. This research is also designed to address specific fundamental questions about the availability of sorbed humic substances for biofilm growth.

Much of the work on isolation and enumeration of biofilm organisms has been through the use of microscopy or cultural methods. EPA, in a cooperative agreement with the University of Illinois, is developing molecular biology tools which can be used for characterizing the biofilm community. These tools include fluorescent in situ hybridization (FISH) techniques which can be used to quantify the abundance and activity of biofilm populations and to visualize the three-dimensional structure of the biofilm community and the location of potential pathogens within these communities. Also to be evaluated will be solution-based hybridization methods for the rapid and automated detection and quantification of selected candidate contaminant list (CCL) organisms such as *Aeromonas hydrophila* and *Mycobacterium avium* complex and indicator organisms such as *E. coli*. This work will also compare new molecular methods with currently used bacterial detection methods.

In a similar but more focused effort, EPA is developing group-specific oligonucleotide probes for detection of non-tuberculosis mycobacteria (NTM) such as *Mycobacterium avium* in drinking water and biofilms. This work is designed to determine if paraffin-baiting techniques can be effectively used to capture NTM in biofilm and finished water samples. If successful, this technique will be used to determine the numbers, types, and location of planktonic and biofilm NTM in the EPA DSSes and can lead to the development of reliable control strategies for NTM in distribution system biofilms.

## Summary and Conclusions

Biofilms are found in virtually every water distribution system. The most common organisms found in biofilms are nonpathogenic heterotrophic bacteria. Some bacteria that live in biofilms may cause esthetic problems with water quality, including off-tastes, odors, and colored water problems. The fact that such organisms are present within distribution system biofilms shows that treatment does not produce a sterile water. Consequently, if opportunistic pathogens survive in biofilms, they could potentially cause disease in individuals with low-immunity or compromised immune systems. Factors related to increased survival of bacteria in chlorinated water include attachment to surfaces, encapsulation, aggregation, low-nutrient growth conditions, and strain variation.

There are numerous factors which affect the growth of biofilms within distribution systems. One of the most important factors is the availability of BOM. Much work has been done leading to the development of methods which can be used for determination of BOM. These include: AOC, BDOC, and the coliform growth response. Although each of these methods measures BOM, the results from comparison tests between methods show that they do not correlate well with one another. Such results indicate that additional work in determining the best way of measuring BOM in water may need to be conducted.

Numerous problems exist in the development of experimental protocols which could be used to evaluate biofilm growth in full-scale distribution systems. DSSs have been developed and used to determine the effect that such systems have on water quality. Much of the work conducted using these simulators has resulted in determining the effect of water-quality changes on biofilms in the systems. This research has indicated that biofilms are resistant to disinfection regardless of the agent used. Other work has demonstrated that lowering system pH can reduce biofilm densities; however, such an effect is transient if system pHs are returned to normal operating ranges.

Additional work on biofilms within distribution systems is currently underway. This work is designed to further assess the effect of water-quality parameters and system operations on biofilm densities. Other research efforts are focused on identification of specific organisms within biofilms and determining the effectiveness of disinfecting agents on these organisms. These efforts are being conducted to determine if biofilm contributions to delivered water may require treatment modifications or amendments.

## References

- Allen, M. J. and Geldreich, E. E. (1977). "Distribution line sediments and bacterial regrowth." *Proceedings, American Water Works Association Water Quality Technology Conference*, Kansas City, MO, December 4–7.
- Block, J. C., Sibille, I., Gatel, D., Reasoner, D. J., Lykins, B., and Clark, R. M. (1995). "Biodiversity in drinking water distribution systems: A brief review." *The microbiological quality of water. From the IWSA and FBA Specialized Conference*, London, U.K., December.
- Carter, J. T., Rice, E. W., Buchberger, S. G., and Lee, Y. (2000). "Relationships between levels of heterotrophic bacteria, and water quality parameters in a drinking water distribution system." *Water Research*, 34(5), 1495.
- Clark, R. M., Lykins, B. W., Block, J. C., Wymer, L. J., and Reasoner, D. J. (1994). "Water quality changes in a simulated distribution system." *Journal of Water Supply, Research, and Technology-Aqua*, 43(6), 263.

- Clark, R. M. and Sivaganesan, M. (1999). "Characterizing the effect of chlorine and chloramines on the formation of biofilm in simulated drinking water distribution systems. *EPA/600X-99/027*, U.S. Environmental Protection Agency, Office of Research and Development, Cincinnati, OH.
- Geldreich, E. E. (1988). "Chapter 3: Coliform noncompliance nightmares in water supply distribution systems." *Water quality: A realistic perspective*. University of Michigan, College of Engineering; Michigan Water Pollution Control Association; Michigan Department of Public Health, Lansing, MI.
- Geldreich, E. E. (1990). "Microbial quality control in distribution systems." *Water quality and treatment*, 4th Ed., F. W. Pontius, ed., American Water Works Association, McGraw-Hill, Inc., New York.
- Geldreich, E. E. and Rice, E. W. (1987). "Occurrence, significance, and detection of *Klebsiella* in water systems." *Journal of the American Water Works Association*, 79(5), 74.
- Hascoet, M. C., Servais, P., and Billen, G. (1986). "Use of biological analytical methods to optimize ozonation and GAC filtration in surface water treatment." *Proceedings, American Water Works Association Annual Conference*, Denver, CO, June 22–26, 205.
- Kaplan, L. A. and Bott, T. L. (1990). "Nutrients for bacterial growth in drinking water: Bioassay evaluation." *EPA/600/S2-89/30*, U.S. EPA Office of Research and Development, Risk Reduction Engineering Laboratory, Cincinnati, OH.
- Kaplan, L. A., Bott, T. L., and Reasoner, D. J. (1993). "Evaluation and simplification of the assimilable organic carbon nutrient bioassay for bacterial growth in drinking water." *Applied and Environmental Microbiology*, 59(5), 1532.
- Kaplan, L. A., Reasoner, D. J., and Rice, E. W. (1994). "A survey of BOM in U.S. drinking waters." *Journal of the American Water Works Association*, 86(2), 121.
- Levenspiel, O. (1972). *Chemical reaction engineering*, 2nd Ed., John Wiley & Sons, New York.
- Li, S. Y., Biswas, P., Clark, R. M., Meckes, M. C., Dosani, M. A., and Krishnan, E. R. (1998). "Detection of chlorine decay patterns in water distribution dead-end flow regimes under various hydrodynamic conditions." *Proceedings, American Water Works Association Water Quality Technology Conference*, San Diego, CA., November 1–4.
- Mathieu, L., Block, J. C., Dutang, M., Mailliard, J., and Reasoner, D. J. (1993). "Control of biofilm accumulation in drinking water distribution systems." *Water Supply*, 11, 365.
- Meckes, M. C., Haught, R. C., Dosani, M., Clark, R. M., and Sivaganesan, M. (1999). "Effect of pH adjustments on biofilm in a simulated water distribution system." *Proceedings, American Water Works Association Water Quality Technology Conference*, Tampa, FL, October 31–November 3, 1993.
- Pascal, O., Joret, J. C., Levi, Y., and Dupin, T. (1986). "Bacterial aftergrowth in drinking water networks measuring biodegradable organic carbon (BDOC)." *Proceedings, Ministere de l'Environnement/U.S. Environmental Protection Agency Franco-American Seminar*, Cincinnati, OH, October 13–17.
- Reasoner, D. J. and Geldreich, E. E. (1990). "Distribution systems: Treated water quality versus coliform noncompliance problems." *Methods for the investigation and prevention of waterborne disease outbreaks. EPA/600/1-90/005a*, U.S. Environmental Protection Agency, Office of Research and Development, Washington, D.C.

- Reasoner, D. J., Blannon, J. C., Geldreich, E. E., and Barnick, J. (1989). "Nonphotosynthetic pigmented bacteria in a potable water treatment and distribution system." *Applied and Environmental Microbiology*, 55(4), 912.
- Rice, E. W., Scarpino, P. V., Logsdon, G. S., Reasoner, D. J., Mason, P. J., and Blannon, J. C. (1990). "Bioassay procedure for predicting coliform bacterial growth in drinking water." *Environmental Technology*, 11, 821.
- Rice, E. W., Scarpino, P. V., Reasoner, D. J., Logsdon, G. S., and Wild, D. K. (1991). "Correlation of coliform growth response with other water quality parameters." *Journal of the American Water Works Association*, 83(7), 98.
- Servais, P., Billen, G., and Hascoet, M. C. (1987). "Determination of the biodegradable fraction of dissolved organic matter in waters." *Water Research*, 21, 445.
- United States Environmental Protection Agency (USEPA). (1992). "Seminar publication: Control of biofilm growth in drinking water distribution systems." *EPA/625/R-92/001*, Office of Research and Development, Washington, D.C.
- USEPA. (1984). "Corrosion manual for internal corrosion of water distribution systems." *EPA/570/9-84/001*, Office of Drinking Water, Washington, D.C.

## CHAPTER 14

# Control of Microbial Contaminants and Disinfection By-Products (DBPs): Cost and Performance<sup>1</sup>

### Introduction

The U.S. Environmental Protection Agency (EPA) is in the process of developing a sophisticated regulatory strategy in an attempt to balance the complex trade-offs in risks associated with controlling disinfectants and disinfection by-products (D/DBPs) in drinking water. EPA first attempted to control DBPs in 1974, when trihalomethane (THM) formation in drinking water was identified as a by-product of chlorination. Based on the toxicologic data from the 1970s, chloroform (one of the THMs) was labeled as a suspect carcinogen.

Epidemiological studies also suggested a human risk. Because of these suspected health effects and the potential that a large number of drinking water consumers would be exposed to these by-products, a Total Trihalomethane (TTHM) Regulation was promulgated on November 29, 1979, at a level of 0.10 mg/L (Clark et al. 1994). Since that time, many other objectionable by-products of chlorination have been identified as well.

This chapter will review the current status of disinfection practices in the U.S., the conditions that cause the formation of DBPs, and discuss the various treatment techniques and associated costs for both controlling DBPs and ensuring microbial safety.

### The Role of Disinfection in the U.S.

In the U.S., an estimated 220,000,000 people receive disinfected drinking water (Clark et al. 1994). Chlorine has been the disinfectant of choice for many utilities, and more than 50% of the systems using surface water use chlorine prior to settling and filtration. Many utilities in the U.S. have explored the use of disinfectants other than chlorine to lower their DBP levels below the 0.80 mg/L TTHM and 0.60 mg/L HAA limits. Some utilities have considered switching to chloramines as an alternate disinfectant to chlorine. A survey conducted by the American Water Works Association Research Foundation showed that the vast majority of utilities that changed disinfection practices have switched to chloramines (McGuire and Meadow 1988). In these cases, chloramines are applied as the final disinfectant. Some utilities are considering the possibility of using ozone as a disinfectant followed by chlorine or chloramines. Ozone is drawing increasing interest, but concern with using ozone includes the need for biostabilization of the treated water and possible formation of by-products such as bromate, aldehydes, ketones, and acids. Chlorine dioxide is an effective disinfectant, but there are concerns about its reacting to form the inorganic by-products, chlorite and chlorate.

---

<sup>1</sup>Jeffrey Q. Adams and Robert M. Clark: Water Supply and Water Resources Division, NRMRL, U.S. Environmental Protection Agency, 26 W. Martin L. King Dr., Cincinnati, OH 45268. Corresponding Author: Jeffrey Q. Adams, 513-569-7835, adams.jeff@epa.gov.

## Microbiological Control

Prior to the discovery that protozoan cysts (*Giardia* and *Cryptosporidium*) were a prime cause of water-borne disease outbreaks, the apparent attainment of adequate disinfection was considered to be relatively simple. Many of the commonly available chemical disinfectants (chlorine, ozone, chlorine dioxide, and even chloramines) are successful in reducing coliform bacteria to acceptable levels, which was generally accepted as an indication of safe water. However, it is now known that pathogens can exist even in the presence of high levels of free chlorine. The EPA has therefore evaluated the common chemical disinfectants for their efficacy in inactivating *Giardia* cysts, viruses, and *Cryptosporidium*.

The EPA has adopted the CT concept (concentration in mg/L × time in minutes) in comparing the biocidal effectiveness of disinfectants. Major considerations are the disinfectant concentration and the time needed to attain inactivation of a certain microbial population exposed under specific conditions. The CT concept can be expressed as an empirical equation as shown below (Chick 1908; Watson 1908):

$$K = C^n \cdot t \quad (14-1)$$

where

$C$  = disinfectant concentration in mg/L

$n$  = coefficient of dilution

$t$  = contact time in minutes required for a fixed percent of inactivation

$K$  = constant for a specific microorganism

CT values have been developed for inactivation of various microorganisms for the major disinfectants. An example of these values is shown in Table 14-1 (Clark et al. 1994).

It is evident from Table 14-1 that ozone shows the highest disinfection efficiency, inactivating 99% of most types of microorganisms at very low CT values. Chloramine shows the lowest efficiency. For these data, “ $n$ ” has been shown to vary between 0.7–1.3; therefore, a value of  $n = 1$  was chosen for the referenced analysis (Lykins et al. 1990). In Table 14-1, preformed chloramine was used because it is conservative with respect to CT values.

**Table 14-1. Summary of CT Value Ranges for Inactivation of Various Microorganisms by Disinfectants (mg/L-min) (Symons et al. 1981; Lykins et al. 1990; Hoff 1986; Lykins et al. 1986; Korich et al. 1990)**

Microorganism	Free Chlorine pH 6 to 7	Preformed Chloramine pH 8 to 9	Chlorine Dioxide pH 6 to 7	Ozone pH 6 to 7
<i>E. coli</i>	0.34–0.05	95–180	0.4–0.75	0.02
Polio virus-1	1.1–2.5	768–3740	0.2–6.7	0.1–0.2
Rotavirus	0.01–0.05	3806–6476	0.2–2.1	0.006–0.06
Phage f <sub>2</sub>	0.08–0.18	ND	ND	ND
<i>G. lamblia</i> cysts	47–>150	2200 <sup>a</sup>	26 <sup>a</sup>	0.5–0.6
<i>G. muris</i> cysts	30–630	1400	7.2–18.5	1.8–2.0
<i>Cryptosporidium parvum</i>	7200 <sup>b</sup>	7200 <sup>c</sup>	78 <sup>c</sup>	5–10 <sup>b</sup>

Note: All CT values are for 99% inactivation at 5°C except for *Giardia lamblia* and *Cryptosporidium parvum*.

<sup>a</sup> Values for 99.9% inactivation at pH 6-9

<sup>b</sup> 99% inactivation at pH 7 and 25°C

<sup>c</sup> 90% inactivation at pH 7 and 25°C

ND - No data

## ***Other Treatment Goals***

Oftentimes disinfection can also perform other treatment tasks in a drinking water treatment plant, for example: oxidation of metals, taste and odor control, and enhancement of turbidity removal. Probably the greatest need for an oxidant, other than disinfection, is for precipitation of metals such as iron and manganese. These metals occur in the reduced inorganic state and in metal organic complexes, which are the most difficult forms to remove.

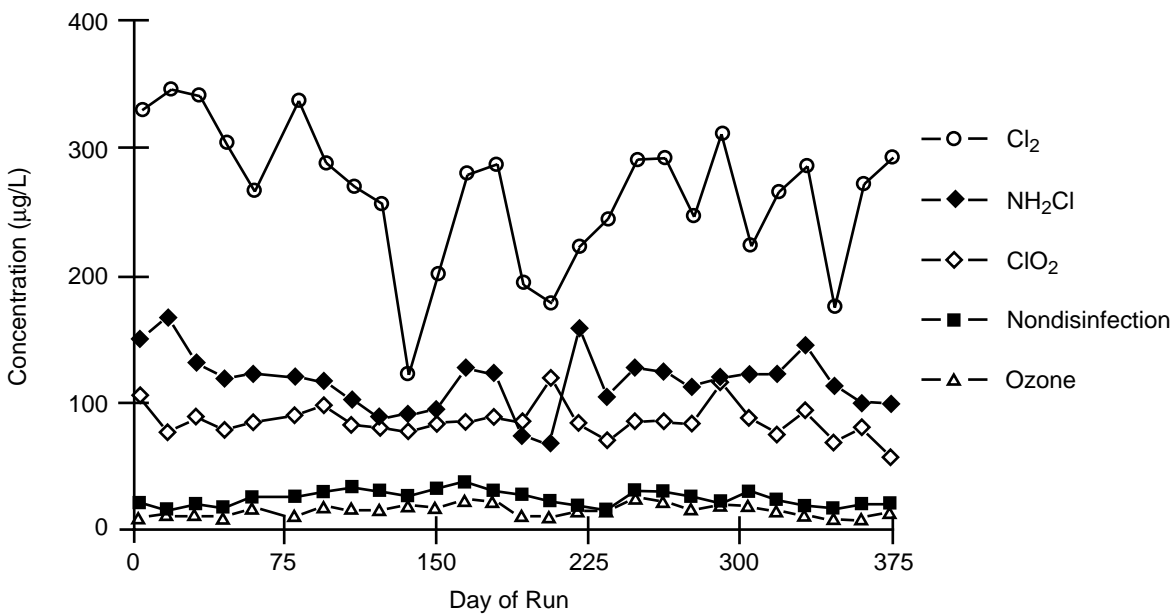
Ozone and chlorine dioxide oxidize metals very well. Both are more effective at removing metals than chlorine. However, chemical costs can be considerably higher with ozone and chlorine dioxide, particularly if there is a high oxidant demand.

## **Formation of DBPs**

Shortly after THMs were identified in chlorinated drinking water, it was recognized that THMs were only one of many halogenated DBPs produced by water chlorination. Compounds such as di- and trichloroacetic acids, haloacetonitriles, halo ketones, chloropicrin, cyanogen chloride, and chlorohydrate have been identified in chlorinated drinking water. Several of these halogenated DBPs, such as dichloroacetic acid, are suspected carcinogens and are believed to be more potent carcinogens than any of the THMs. MX [3-chloro-4-(dichloromethyl)-5-hydroxy-2(5H)-furanone, a halogenated furanone which has been identified in chlorinated drinking water, has been found to be extremely mutagenic. Some undesirable DBPs may be produced with all disinfectants. Halogenated by-products are, of course, of special interest (Singer 1994; Stevens et al. 1987; Bull 1993). Bench-scale studies of the chlorination of natural water and humic acid-spiked water using extraction, capillary column chromatography, and mass-spectral analytical procedures detected more than 500 DBPs (Stevens et al. 1989). Many of these were formed at microgram-per-liter concentrations, and the majority were not identified.

By-product formation at the bench scale and control at pilot and full scale have been evaluated by examining specific by-products and surrogate parameters such as total organic halides (TOX). The TOX data suggest the formation of other DBPs whose total concentrations are likely to equal or exceed those of THMs (Stevens et al. 1989). One bench-scale study showed the concentrations of THMs increased with time for each pH value. Pilot studies have shown that the percentages of removal of DBP formation potential from raw Ohio River water (ORW) to low pH, alum-coagulated, and filtered effluent were within a range of 60 to 80 percent. Bench-scale studies have also shown that bromide heavily influences the nature of the chlorination DBPs formed (Pourmoghaddas et al. 1993; Minear and Bird 1980; Cooper et al. 1983).

At a pilot plant located at the Jefferson Parish, LA, water utility, four major disinfectants (chlorine, chlorine dioxide, ozone, chloramine) were applied in parallel to clarified and filtered lower Mississippi River water during two studies (Lykins et al. 1986). Chlorine produced the highest concentration of TOX, indicating that several other halogenated by-products were formed with chlorination. Ozone produced the lowest concentration of TOX, with concentrations below the nondisinfected feed to the pilot plant, suggesting that some TOX destruction occurred as shown in Figure 14-1. Average instantaneous TOX concentrations were 25 µg/L, 15 µg/L, 85 µg/L, 117 µg/L, and 263 µg/L for the nondisinfected, ozone, chlorine dioxide, chloramine, and chlorine streams, respectively. Not all of the organics produced by the disinfectants evaluated at Jefferson Parish were identified. Flame-ionization detection (FID) and electron-capture detection (ECD) gas chromatographic profiles gave evidence of the extent of by-product formation for the disinfectants. The number of different products formed and concentration of products formed by the various disinfection process streams followed the sequence: chlorine > chloramine > chlorine dioxide > ozone for these measures.



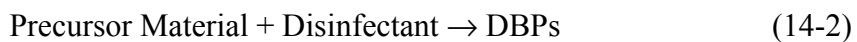
**Figure 14-1. TOX concentrations after 30-minute contact time (Jefferson Parish, LA, pilot plant).**

Although most of the research conducted by the EPA has focused on halogenated by-products, ozone and other oxidants, to a somewhat lesser degree, can also form by-products such as formaldehyde, glyoxal, and acetone. In the EPA's pilot plant in Cincinnati, using ORW, ozonation produced formaldehyde concentrations of approximately 26 µg/L (Miltner 1992). Concentrations of formaldehyde, acetone, and glyoxal subsequently declined through conventional treatment, but increased again due to either clear well chlorination or chloramination. The loss of formaldehyde, acetone, and glyoxal during conventional treatment is assumed to result from biodegradation by heterotrophic plate count (HPC) species, as evidenced by a decline in formaldehyde concentration and an increase in HPC densities.

The occurrence of DBPs in U.S. drinking water was evaluated at 35 water treatment facilities that had a broad range of source water qualities and treatment processes (Krasner et al. 1989). THMs were the largest class of DBPs detected on a weight basis. Haloacetic acids were the next largest class of compounds found. Formaldehyde and acetaldehyde, by-products of ozonation, were also produced by chlorination. Cyanogen chloride was preferentially produced in chloraminated water. The median, TTHM quarterly values in the study (Krasner 1989) were comparable to those seen in a survey of 727 utilities by the American Water Works Association Research Foundation (McGuire and Meadow 1988).

### Treatment Strategies for Controlling DBPs

DBPs are the result of the interaction of the disinfectant with natural organic matter in water as shown by Equation 14-2.



This concept indicates that moving the point of disinfection to the end of the treatment process following precursor reduction will minimize by-product formation. Numerous experiences have verified the effectiveness of this approach (Symons et al. 1981). Other options include the use of a disinfectant that minimizes the formation of by-products, and removal of DBPs once they are formed (Lykins et al.



1990). Stage 1 of the D/DBP Rule will require drinking water utilities to achieve a maximum contaminant level (MCL) of 0.08 mg/L, and Stage 2 may require an MCL as low as 0.04 mg/L. The Interim Enhanced Surface Water Treatment Rule (IESWTR) and the Long Term Enhanced Surface Water Treatment Rule (LTESWTR) will require total organic carbon (TOC) targets as a measure of precursor removal.

In the following section, the effects, technology, and costs associated with these options for controlling DBPs will be discussed. Since the impact of THM control is similar to the control of other halogenated by-products, the costs developed for THM control would be similar to those for removal of other DBPs.

### ***Treatment Alternatives for Controlling DBPs***

Two alternatives for controlling DBPs are to switch to a disinfectant that minimizes by-product formation or to remove by-product precursors prior to disinfection (Lykins et al. 1990). The cost and performance of various options for controlling DBPs as mentioned previously will be explored in this section (Clark 1998). Table 14-2 contains the common cost assumptions that apply to all of the evaluations.

**Table 14-2. Common Cost Assumptions**

<b>Items</b>	<b>Value</b>
Capital amortization	10% over 20 years
Engineering fees	15% of construction
Contractor overhead and profit	12% of construction
ENR construction cost index	6130 (January 2000) (1913 = 100)
Producers price index	134.7 (January 2000) (1982 = 100)
Labor and fringe rate	\$15/hour
Electric power rate	\$0.024 × 10 <sup>-6</sup> Joules (\$0.086/kwh)
Fuel oil prices	\$0.235/liter (\$0.889/gallon)

### **Alternate Disinfectants**

As mentioned previously, the use of disinfectants other than chlorine is one option for controlling the concentration of halogenated by-products. In a study at Jefferson Parish, LA, lower Mississippi River water was clarified and filtered before being diverted to five parallel streams. The major objectives of this study were to evaluate (1) the control of halogenated by-products, (2) the microbiological effectiveness of the disinfectants, and (3) potential health effects associated with the use of these disinfectants. Many of the halogenated by-products of interest were analyzed for each disinfectant stream (Lykins et al. 1990). Of special interest was the potential concentration of these by-products when water was delivered to the customer. This was evaluated by storing samples for a specified time with a disinfectant residual to simulate residence time in the distribution system. It was found that, when chlorine was added prior to and after sand filtration, an average of 45 µg/L of dichloroacetic acid was detected. If ozone was added prior to sand filtration and chlorine after sand filtration, the average concentration was reduced to 32 µg/L. If monochloramine was used prior to and after sand filtration, then the average concentration was reduced to about 8 µg/L. Further reductions were seen for the combination of ozone added before sand filtration and monochloramine after sand filtration (4.6 µg/L average). This trend was seen for other prevalent halogenated by-products such as trichloroacetic acid, bromochloroacetic acid, chloral hydrate, and trichloromethane.

Another potential disinfectant that minimizes halogenated by-products is chlorine dioxide. At a drinking water utility on the Ohio River, a pilot plant was used to compare chlorine dioxide disinfection with chlorine disinfection (Lykins et al. 1986). The addition of chlorine dioxide to the raw water with delayed chlorination permitted coagulation/settling/filtration and oxidation to remove THM precursors, thereby reducing the amount of THMs formed during post-treatment chlorination. A comparison of average THM concentrations for the two disinfectant modes showed a reduction of approximately 60 percent when chlorine dioxide was used. Although chlorine dioxide disinfection can reduce THM concentrations, control of the metabolites (chlorite and chlorate) is essential before chlorine dioxide can be considered a viable disinfection alternative. Equipment is now available to produce chlorine dioxide that is virtually free of chlorite and chlorate. Studies were conducted to minimize chlorite and chlorate concentrations by a reducing agent (Lykins et al. 1990)

### Disinfection Costs

For the purpose of this analysis, the following assumptions were made: Pre-chlorine dose–3 mg/L, post-chlorine dose–1.5 mg/L, pre-ozone dose–2 mg/L, post-chloramine dose (2 mg/L Cl<sub>2</sub> and 0.5 mg/L ammonia), and pre-chlorine dioxide–1 mg/L. The various disinfectants including capital, O&M, and chemical cost for disinfection only are summarized in Table 14-3. In column 1 of Table 14-3, the primary disinfectant is listed first.

**Table 14-3. Alternative Disinfection Costs In ¢/1000 Gallons (¢/cu m) (Jan. 2000)**

Unit Process	Flow in MGD (thou cu m per day <sup>a</sup> )			
	0.1 (0.3785)	1 (3.785)	10 (37.85)	100 (378.5)
Chlorine/Chlorine	42.1 (11.1)	14.4 (3.80)	2.4 (0.634)	1.2 (0.325)
Chlorine/Chloramine	61.5 (16.3)	16.3 (4.32)	2.8 (0.746)	1.7 (0.457)
Ozone/Chlorine	119.5 (31.6)	22.2 (5.87)	7.36 (1.95)	4.2 (1.10)
Ozone/Chloramine	138.9 (36.7)	24.2 (6.38)	7.8 (2.06)	4.5 (1.18)
Chlorine dioxide/Chlorine	139.2 (36.8)	19.8 (5.24)	2.9 (0.778)	1.4 (0.368)

<sup>a</sup> To convert from thou cu m per day to mgd, divide by 3.785.

### *Precursor Removal by Enhanced Coagulation*

Three methods for removing precursor material will be discussed in this section: appropriate coagulation, granular activated carbon, and nanofiltration. The performance and cost of each of these technologies will be discussed in that section. Performance is based on Total Trihalomethane Formation Potential (TTHMFP). Some removal is observed when alum was used as a coagulant for turbidity control, but when the treatment was modified by adding additional alum and reducing the pH, further precursor removal was noted (Table 14-4).

### Cost of Enhanced Coagulation

The EPA has prepared several estimates for treatment optimization that might lead to enhanced coagulation (USEPA 1997). Some of these costs are provided in Table 14-5.

### *Precursor Removal by GAC*

Granular activated carbon (GAC) is an effective means of removing DBP precursors from water at a cost that varies widely according to water quality and treatment goals. An example of the effectiveness

**Table 14-4. Precursor Control by Coagulation (EPA Pilot Plant)  
Percent Removal of Precursor<sup>a</sup>**

TOC		THMFP		TOXFP		TOC		DBPFP <sup>b</sup>	
A	B	A	B	A	B	C	D	C	D
21	46	28	48	4	56	15	40	56	70

<sup>a</sup> Ohio River water

<sup>b</sup> Based on mean formation potential for several halogenated by-products.

A - alum = 20 mg/L, pH = 7.5; for turbidity control

B - alum = 89 mg/L, pH = 6.0; for precursor control

C - alum = 26 mg/L, pH = 7.0; for turbidity control

D - alum = 40 mg/L, pH = 5.7; for precursor control

TOC = Total organic carbon

THMFP = Total trihalomethane formation potential

TOXFP = Total organic halide formation potential

DBPFP = Disinfection by-product formation potential

**Table 14-5. Annual Cost for Enhanced Coagulation in ¢/Thou cu m<sup>a</sup> (¢/1000 gal) (USEPA 1997)**

Unit Process	Design Flow in Thou cu m Per Day <sup>a</sup> (average flow)						
	18.168	41.635	68.130	98.410	193.035	794.850	1,627.580
<b>Modification</b>	<b>(7.949)</b>	<b>(18.925)</b>	<b>(23.308)</b>	<b>(49.205)</b>	<b>(102.195)</b>	<b>(454.200)</b>	<b>(1,021.950)</b>
Chemical addition	0.713–3.406 (2.7–12.9)	0.290–3.247 (1.1–12.3)	0.158–3.168 (0.6–12.0)	0.106–3.115 (0.4–11.8)	0.079–3.036 (0.3–11.5)	0.026–2.930 (0.1–11.1)	0.008–2.904 (0.03–11.0)
Coagulant improvements	2.059 (7.8)	1.320 (5.0)	1.056 (4.0)	0.950 (3.6)	0.818 (3.1)	0.713 (2.7)	0.686 (2.6)
Rapid mix	0.733–0.898 (2.7–3.4)	1.716–2.086 (6.5–7.9)	1.795–2.138 (6.8–8.1)	1.742–2.112 (6.6–8.0)	1.002–1.320 (4.1–5.0)	0.317–0.370 (1.2–1.4)	0.158–0.185 (0.6–0.7)
Flocculation improvements	0.845–1.690 (3.2–6.4)	0.607–1.346 (2.3–5.1)	0.554–1.188 (2.1–4.5)	0.528–1.082 (2.0–4.1)	0.317–0.660 (1.2–2.5)	0.079–0.238 (0.3–1.0)	0.079–0.264 (0.3–0.9)
Settling improvements	0.290–0.581 (1.1–2.2)	0.185–0.449 (0.7–1.7)	0.132–0.396 (0.5–1.5)	0.132–0.370 (0.5–1.4)	0.132–0.343 (0.5–1.3)	0.079–0.185 (0.3–0.7)	0.053–0.106 (0.2–0.4)
Filtration improvements	0.079–5.148 (0.3–19.5)	0.079–2.666 (0.3–10.1)	0.079–1.795 (0.3–6.8)	0.079–1.637 (0.3–6.2)	0.079–1.135 (0.3–4.3)	0.053–0.766 (0.2–2.9)	0.026–0.660 (0.1–2.5)
Hydraulic improvements	0.317–0.739 (1.2–2.8)	0.211–0.581 (0.8–2.2)	0.185–0.502 (0.7–1.9)	0.185–0.475 (0.7–1.8)	0.132–0.396 (0.5–1.5)	0.079–0.317 (0.3–1.2)	0.053–0.238 (0.2–0.9)

<sup>a</sup> To convert from thou cu m per day to mgd, divide by 3.785.

**Table 14-6. Precursor Removal by GAC (Clark et al. 1994)**

Utility	Influent THMFP (µg/L)	% Removal	
		Initial	After 90 Days
Cincinnati, OH	160	98	63
Manchester, NH	72	85	35
Jefferson Parish, LA	93	83	40

of GAC for three water utilities is shown in Table 14-6. Removal is initially good, but diminishes as the time in service increases (Clark et al. 1994).

In some cases, the use of GAC for precursor removal would be unreasonable. For example, based on field tests in Miami, FL, in order to remove TTHMFP in the 15–100-µg/L range, it was found that the carbon would require reactivation every 20 days (Symons et al. 1981).

## Cost of Precursor Removal Using GAC

As mentioned, THM formation is a function of the influent concentration and reactive characteristics of the natural organic matter in the source water. The following cost analysis is based on field scale data collected from studies in Cincinnati, OH, Jefferson Parish, LA, and Manchester, NH (Clark et al. 1994). Influent TOC during the studies ranged from 1.5 to 3.5 mg/L, and TOC effluents ranged from 0.6 to 1.6 mg/L. These effluent levels correspond to THMFP effluent values of approximately 50 µg/L. Because GAC bed life is dependent on influent concentration ( $C_0$ ), the bed lives were adjusted to reflect the target effluent concentrations ( $C_e$ ) to be considered. Table 14-7 contains the assumed bed lives for each of the utilities studied.

**Table 14-7. Bed Life for GAC for Removal of THMFP at an Influent Level of 150 µg/L (Clark et al. 1994)**

	Target Effluent THMFP (µg/L)	Bed Life (days)
Cincinnati	100	225
Cincinnati	50	175
Jefferson Parish	100	103
Jefferson Parish	50	63
Manchester	50	80

The cost calculations are based on the data shown in Table 14-7 and an assumption of a 20-minute empty bed contact time. These target values were used because they were taken from actual studies and are in the range associated with the anticipated regulation. For systems of 0.3785, 3.785, and 37.85 thou cu. m/day (0.1, 1, 10 mgd), pressure contactors were assumed and for systems of 95, 190, and 3785 thou cu. m/day (25, 50, 100 mgd), concrete gravity contactors were assumed. For systems of 0.3785 and 3.785 thou cu. m/day (0.1, 10 mgd), replacement of spent carbon with virgin carbon was used in the calculation, and for 37.8, 95, 190, and 378.5 thou cu. m/day (10, 25, 50, 100 mgd) systems, on-site multihearth reactivation was assumed. Table 14-2 contains the cost assumptions used in this analysis. Additional assumptions included a virgin carbon cost of \$2.38/kg (1.08/lb) for 45.4 kg (100,000 lb) and a carbon loss rate of 15% due to handling. Cost values are indexed to January 2000.

Table 14-8 summarizes the costs for using GAC for removing THM precursor removal based on THMFP to TTHMFP levels of 100 µg/L, respectively.

**Table 14-8. Annual Cost for TTHMFP Removal by GAC in ¢/cu m (¢/1000 gal)**

Target Levels	Design Flow in Thou cu m Per Day <sup>a</sup> (average flow)					
	0.3785 (0.189)	3.785 (1.89)	37.85 (26.495)	94.62 (64.392)	189.25 (132.475)	378.5 (264.95)
Ce <100 µg/L	73.3 (277)	27.5 (104)	16.2 (61)	10.7 (40)	8.8 (33)	7.4 (28)
	to 85.7 (324)	to 38.7 (147)	to 20.6 (78)	to 14.3 (54)	to 11.8 (45)	to 11 (42)
Ce <50 µg/L	75.8 (287)	29.7 (112)	17.3 (66)	11.5 (44)	9.3 (35)	7.9 (30)
	to 95.6 (362)	to 47.8 (181)	to 23.9 (90)	to 17.0 (64)	to 14.3 (54)	to 14.3 (54)

<sup>a</sup> To convert from thou cu m per day to mgd, divide by 3.785.

## Precursor Removal by Nanofiltration

Membrane processes are also promising for removing DBP precursors. Studies in Florida waters have demonstrated that, for ground waters, membranes are an excellent treatment alternative. These studies showed that, with an average raw water concentration of 455 µg/L, trihalomethane formation potential (THMFP) average concentrations of 20 µg/L were being produced (95% rejection) in the product water.

For total organic halide formation potential (TOXFP), an average raw water concentration of 977 µg/L was reduced to 34 µg/L (96% rejection). Additional studies of specific chlorination by-products at Daytona Beach, FL showed that, with a 4-2-1 pressure vessel array, total DBPs expressed as chloride equivalents show a raw water concentration of 530 to 715 µg/L, with an overall system reduction of 95% to 98% (Taylor et al. 1989).

When membranes are used on surface water, however, extensive pretreatment is usually required. Although rejections are good, the membranes will likely require frequent cleaning. When a Florida surface water (tributary of the Peace River) was treated, pretreatment consisted of (1) alum-coagulated and settled water from the full-scale plant, and (2) pressure sand filtration in the pilot plant, membrane filtration. Under these operating conditions, membrane cleaning was required about every 16 days to avoid a production loss greater than 10 percent. Raw water THM formation potential averaged 612 µg/L, and a product water of 37 µg/L was produced (94% rejection). For an average raw water TOX of 1,965 µg/L, the product water was 53 µg/L (97% rejection).

### Cost of Nanofiltration

In this analysis, it is assumed that an 8" × 40" element removes organics with molecular weights greater than 300 molecular weight units (Taylor et al. 1989). These organics are separated from product water primarily by sieving (little is removed by diffusion). Based on field experience, greater than 95% of dissolved organic carbon (DOC), TOX, and DBP are removed. If the concentration in the influent is greater than 150 µg/L of THMFP, then 25 µg/L of formation potential is expected in the effluent permeate. For example, the reference design for a 37.85 thou cu m/day (10 mgd) nanofiltration system is assumed as raw feed water of 44–287 thou cu m/day (11–76 mgd) to yield a permeate flow of 37.8 thou cu m/day (10 mgd) or 85% recovery. A 3-stage membrane configuration was assumed. Two types of systems were considered: ground water with an average pressure of 732 kg/m<sup>2</sup> (150 psi) and an average flux of 0.6 m/day (15 gal/ft<sup>2</sup>/day), with 13 membrane skids (12 on line and one on standby). The reference design was estimated using an approach described by Suratt (1991) and Clark et al. (1998).

The ground water system was assumed to require no advanced treatment, only a 5-µm cartridge, prefilter, and H<sub>2</sub>SO<sub>4</sub> addition for scale control. Two types of disposal were assumed: disposal to a surface pond or stream and deep well concentrate disposal. Surface water treatment requires advanced pretreatment to reduce fouling (alum coagulation, solids contact, rapid sand filtration). Deep well disposal of concentrate was assumed. Table 14-9 summarizes the costs associated with the use of nanofiltration systems at various treatment capacities based on estimates using the reference design and a scaling approach described by Eisenburg and Middlebrooks (1986).

**Table 14-9. Nanofiltration Cost Summary in ¢/cu m<sup>a</sup> (¢/1000 gal)**

Permeate Capacity in Thou cu m <sup>a</sup>	Ground Water System		Surface Water System
	Surface Concentrate Disposal	Deep Well Concentrate Disposal	Alum Coagulation Pretreatment with Deep Well Concentrate Disposal
0.3785	63.2 (239)	74.5 (281)	142 (537)
3.785	41.2 (156)	48.1 (182)	93.4 (354)
8.925	32.4 (123)	37.6 (142)	73.6 (279)
37.85	27.7 (105)	34.9 (132)	68.1 (258)
94.625	28.6 (108)	33.2 (126)	64.8 (245)
189.25	26.1 (99)	30.2 (114)	59.4 (224)
378.50	23.6 (89)	27.4 (104)	53.8 (203)

<sup>a</sup> To convert from thou cu m to mgd, divide by 3.785.

## Comparative Analysis

Making direct comparisons among the various alternatives is difficult. For example, moving the point of disinfection (chlorination) would seem to be the lowest cost option. Nanofiltration, although most expensive for precursor removal, has the advantage of removing other contaminants such as total dissolved solids and various inorganics. Therefore, it might be used for achieving other treatment goals in addition to removing DBP precursors. For example, nanofiltration effectively removed microorganisms, thus serving as an alternative for chemical disinfection. Although enhanced coagulation was not evaluated for cost, it could be very effective if a utility is only slightly out of compliance; however, in addition to increased coagulation costs, an additional cost may be associated with sludge handling. Clearly, changing the type of disinfection was the lowest cost option for controlling DBPs. However, as noted, there are by-products and problems associated with the use of some of the alternatives. For example, chloramination is not as good a disinfectant as chlorine, while ozone may enhance regrowth of some organisms. Retrofitting may be fairly easy with chloramination. For example, to switch from chlorine to chloramine may only require the addition of ammonia feed equipment. However, the use of ozone will incur cost for the construction and operation of ozone contactors. The use of chlorine dioxide will probably require the use of a reducing agent such as ferrous chloride, which was not included in this costing analysis.

### Incremental Costs

The technologies discussed would normally be implemented incrementally to a utility's existing treatment. Table 14-10 summarizes the base cost associated with an assumed conventional treatment system and the incremental costs associated with various DBP control alternatives. The unit processes considered are those that are effective for precursor removal or for the use of alternate disinfectants.

### Summary and Conclusions

Regulations to control contaminants in drinking water in the U.S. are expected to become more and more stringent. Forthcoming DBP regulations will effect virtually every community water system in

**Table 14-10. Incremental Cost for Disinfection By-Product Control in ¢/cu m<sup>a</sup> (¢/1000 gal)**

Item	Design Flow in Thou cu m <sup>a</sup> (average flow)			
	0.3785 (0.189)	3.785 (1.89)	37.85 (26.495)	378.5 (264.95)
Conventional treatment	142 (539)	47.5 (180)	12.6 (48)	8.51(32)
Conventional treatment and nanofiltration	205 (778)	88.7 (336)	40.4 (152)	32.1 (122)
Conventional treatment plus GAC (Ce =100 mg/L)	203 (772) to 216 (818)	70.8 (268) to 82.1 (311)	28.3 (107) to 32.7 (124)	15.7 (59) to 19.2 (73)
Conventional treatment plus GAC (Ce = 50 mg/L)	206 (781) to 226 (856)	73.1 (276) to 91.2 (345)	29.4 (111) to 36.0 (136)	16.2 (61) to 22.5 (85)
Conventional treatment plus				
–Chlorine/Chloramine	147 (556)	47.8 (181)	12.6 (48)	8.5 (32)
–Ozone/Chlorine	163 (619)	49.7 (188)	14 (53)	9.3 (35)
–Ozone/Chloramine	168 (636)	50 (189)	14 (53)	9.3 (35)
–Chlorine dioxide/Chlorine	167 (633)	48.9 (185)	12.6 (48)	8.5 (32)
–Chlorine dioxide/Chloramine	172 (651)	49.1 (186)	12.9 (49)	8.5 (32)

<sup>a</sup> To convert from thou cu m to mgd, divide by 3.785.

the U.S. There are various ways to control DBPs, one of which is to use an alternative to chlorine to control halogenated by-products. However, when this is done, one has to consider the consequences. Water treatment managers will have to become more knowledgeable about various treatment options that are cost-effective in order for them to meet present and anticipated regulations.

## References

- Bull, R. J. (1993). "Toxicology of disinfectants and disinfection by-products." *Safety of Chemical of Microbial Risk*, G. F. Craun, ed., ILSI Press, International Life Sciences Institute, Washington, D.C., 239–256.
- Chick, H. (1908). "An investigation of the laws of disinfection." *Journal of Hygiene*, 8, 92–158.
- Clark, R. M. (1998). "Cost considerations." *Treatment process selection for particle removal*, J. B. McEwen, ed., American Water Works Association Research Foundation/International Water Supply Association, 265–302.
- Clark, R. M., Adams, J. Q., and Lykins, B. W. (1994). "DBP control in drinking water: Cost and performance." *Journal of Environmental Engineering Division of the ASCE*, 120(4), 759–782.
- Clark, R. M., Adams, J. Q., Sethi, V., and Siveganesan, G. (1998). "Control of microbial contaminants and disinfection by-products for drinking water in the U.S.: Cost and performance." *Journal of Water Supply Research and Technology–Aqua*, 46(6), 255–265.
- Cooper, W. J., Meyer, L. M., Bufill, C. C., and Cordal, E. (1983). "Quantitative effects of bromine on the formation and distribution of trihalomethane in groundwater with a high organic content." *Water chlorination: Environmental impact and health effects*, R. L. Jolley, W. A. Bross, J. A. Cotruvo, R. B. Cummings, J. S. Mettice, and V. A. Jacobs, eds., Vol. 4, Ann Arbor Science Publishers, Inc., Ann Arbor, MI, 285–296.
- Eisenburg, T. and Middlebrooks, E. (1986). *Reverse osmosis treatment of drinking water*. Ann Arbor Science, Stoneham, MA, 221.
- Hoff, J. C. (1986). "Inactivation of microbial agents by chemical disinfectants." *EPA/600/286/067*, U.S. Environmental Protection Agency.
- Korich, D. G., Mead, J. R., Madore, M. S., Sinclair, N. A., and Sterling, C. R. (1990). "Effects of ozone, chlorine dioxide, chlorine, and monochloramine on *Cryptosporidium parvum* oocyst viability." *Applied and Environmental Microbiology*, 56, 1423–1428.
- Krasner, S. W., McGuire, M. J., Jacangelo, J. G., Patania, N. L., Reagan, K. M., and Aieta, E.M. (1989). "The occurrence of disinfection by-products in U.S. drinking water." *Journal of the American Water Works Association*, 81(8), 41–53.
- Lykins, Jr., B. W., Clark, R. M., and Westrick, J. J. (1990). "Treatment technologies for meeting U.S. drinking water regulations." *Proceedings, 1990 Joint Conference, Ontario Section American Water Works Association/Ontario Municipal Water Association*, Toronto, Ontario, Canada, May 6–9.
- Lykins, Jr., B. W., Goodrich, J. A., and Hoff, J.C. (1990). "Concerns with using chlorine-dioxide disinfection in the USA." *Journal of Water Supply Research and Technology–Aqua*, 39(6), 376–386.
- Lykins, Jr., B. W., Koffskey, W. E., and Miller, R. G. (1986). "Chemical products and toxicologic effects of disinfection." *Journal of the American Water Works Association*, 78(11), 66–75.

- McGuire, M. J. and Meadow, R. G. (1988). "AWWARF trihalomethane survey." *Journal of the American Water Works Association*, 80(1), 61–68.
- Miltner, R. J. (1992). "Pilot scale treatment for control of disinfection by-products." *Strategies and Technologies for Meeting SDWA Requirements*, R. Clark and S. Summers, eds., Technomics, Inc., Lancaster, PA, 203–236.
- Minear, R. A. and Bird, J. C. (1980). "Trihalomethane: Impact of bromide ion concentration on yield, species distribution, rate of formation and influence of other variables." *Water chlorination: Environmental impact and health effects*, R. L. Jolley, W. A. Brungs, and R. B. Cummings, eds., Vol. 3, Ann Arbor Science Publisher, Inc., Ann Arbor, MI, 151–160.
- Pourmoghaddas, H., Stevens, A. A., Kinman, R. N., Dressman, R. C., Moore, L. A., and Ireland, J.A. (1993). "Effect of bromide ion on formation of HAAs during chlorination." *Journal of the American Water Works Association*, 85(1), 82–87.
- Singer, P. C. (1994). "Control of disinfection by-products in drinking water." *Journal of Environmental Engineering Division of the ASCE*, 120(4), 727–744.
- Stevens, A. A., Moore, L. A., and Miltner, R. J. (1989). "Formation and control of non-trihalomethane disinfection by-products." *Journal of the American Water Works Association*, 81(8), 54–60.
- Stevens, A. A., et al. (1987). "Detection and control of chlorination by-products in drinking water." *Proceedings, Conference on Current Research in Drinking Water Treatment*, Cincinnati, OH, March 24–26.
- Suratt, W. (1991). "Estimating the costs of membrane water treatment plants." *Proceedings, American Water Works Association Membrane Processes Conference*, Orlando, FL, March 10–13.
- Symons, J. M., Stevens, A. A., Clark, R. M., Geldreich, E. E., Love, Jr., O. T., and DeMarco, J. (1981). *Treatment techniques for controlling trihalomethanes in drinking water. EPA 600/2-81-156*, U.S. Environmental Protection Agency, Drinking Water Research Division, Municipal Environmental Research Laboratory, Office of Research and Development, Cincinnati, OH.
- Taylor, J. S., Mulford, L. A., Barrett, W. M., Duranceau, S. J., and Smith, D. K. (1989). "Cost and performance of membranes for organic control in small systems." *EPA 600/2-89/022*, U.S. Environmental Protection Agency, May.
- U.S. Environmental Protection Agency (USEPA). (1997). *Technology costs for the interim enhanced surface water treatment rule*. Office of Ground Water and Drinking Water, Washington, D.C.
- Watson, H. E. (1908). "A note on the variation of the rate of disinfection with change in the concentration at the disinfectant." *Journal of Hygiene*, 8, 536–542.



## GLOSSARY

**assay** A test for a particular chemical biological agent to determine its properties or effect.

**Ames test** A test developed by Bruce Ames that is based on the assumption that any substance that is mutagenic (for the *Salmonella typhimurium* bacteria) may also turn out to be a carcinogen, that is, cause cancer. However, not all known chemicals that cause cancer in animal labs give a positive Ames test (and vice versa). The ease and low cost of the test make it invaluable for screening substances in our environment for possible carcinogenicity.

**Best Available Technology (BAT)** The best technology treatment techniques or other means that are available to remove a contaminant(s) to below the set MCL. BATs are designated by the EPA's Administrator after examination for efficacy under field conditions and not solely under laboratory conditions (taking cost into consideration).

**Best Management Practice (BMP)** Structural, nonstructural, and managerial techniques that are recognized to be the most effective and practical means to control non-point source pollution and are compatible with the productive use of the resource to which they are applied. BMPs are used in both urban and agricultural areas.

**biofilm** A structured community of microorganisms (including protozoa) enclosed in a self-produced polymeric matrix and adherent to an inert or living surface.

**carcinogen** Any substance that can produce cancer in an organism.

**chemical oxygen demand (COD)** An indirect measure of the amount of oxygen used by inorganic and organic matter in water.

**chloramines** Compounds formed by the reaction of aqueous chlorine (or hypochlorous acid) with ammonia.

**chlorine-contact chamber** That part of a water treatment plant where chlorine is applied to water for disinfection purposes.

**chlorine demand** The amount of chlorine that must be applied to water before free chlorine can be detected. Chlorine demand is the difference between the amount of chlorine added to water and the amount of residual chlorine remaining after a given contact time. Chlorine demand varies with dosage, time, temperature, pH, and nature and amount of the impurities in the water.

**chronic** Occurring over a long period of time, either continuously or intermittently; used to describe ongoing exposures and effects that develop only after a long exposure.

**chronic exposure** Long-term, low-level exposure to a toxic chemical.

**clarifier** A large circular or rectangular tank or basin in which water is held for a period of time, during which the heavier suspended solids settle to the bottom. Clarifiers are also called settling basins and sedimentation basins.

**clear well** A reservoir for the storage of filtered water of sufficient capacity to prevent the need to vary the filtration rate with variations in demand.

**coagulants** Chemicals that cause very fine particles to clump together into larger particles. These chemicals help (by changing the particles' surface charge and destabilizing them) in separating the solids from the water by settling, skimming, draining, or filtering.

**coagulation** The process of clumping together of colloids and fine particles into larger particles caused by the use of chemicals (coagulants). This clumping together makes it easier to separate the solids from the water by settling, skimming, draining, or filtering.

**coliform** A group of bacteria found in the intestines of warm-blooded animals (including humans) and also found in plants, soil, air, and water. Coliforms are gas-producing bacteria. Fecal coliforms are a specific class of bacteria which only inhabit the intestines of warm-blooded animals. The presence of coliform is an indication that the water is polluted and may contain pathogenic organisms.

**colloids** Very small, finely divided solids (particles that do not dissolve) that remain dispersed in a liquid for a long time due to their large surface area-to-volume ratio and electrical charge. When most of the particles in water have a negative electrical charge, they tend to repel each other. This repulsion prevents the particles from clumping together, becoming heavier, and settling out.

**combined available residual chlorine** The concentration of residual chlorine which is combined with ammonia (NH<sub>3</sub>) and/or organic nitrogen in water, such as chloramine (or another chloro-derivative), yet is still available to oxidize organic matter and has bactericidal properties.

**combined residual chlorination** The application of chlorine to water to produce combined available residual chlorine. This residual can be made up of monochloramines, dichloramines, and nitrogen trichloride.

**combined sewer** A sewer that transports surface runoff, human domestic wastes (sewage), and sometimes industrial wastes. Wastewater and runoff in a combined sewer may occur in excess of the sewer capacity and cannot be treated immediately. The excess is frequently discharged directly to a receiving stream without treatment or to a holding basin for subsequent treatment and disposal.

**composite (proportional) samples** A composite sample is a collection of individual samples obtained at regular intervals, usually every one or two hours during a 24-hour time span. Each individual sample is combined with the others in proportion to the rate of flow when the sample was collected. The resulting mixture (composite sample) forms a representative sample and is analyzed to determine the average conditions during the sampling period.

**compound** A substance composed of two or more elements whose composition is constant. For example, table salt (sodium chloride—NaCl) is a compound.

**contaminant** Any physical, chemical, biological, or radiological substance or matter that has an adverse effect on air, water, or soil.

**contamination** The introduction into water of microorganisms, chemicals, toxic substances, wastes, or wastewater in a concentration that makes the water unfit for its next intended use.

**continuous sample** A flow of water from a particular place in a plant to the location where samples are collected for testing. This continuous stream may be used to obtain grab or composite samples. Frequently, several taps (faucets) will flow continuously in the laboratory to provide test samples from various places in a water treatment plant.

**conventional filtration** A method of treating water to remove substantial amounts of particulates, biological and chemical contaminants. The method consists of a series of processes including the addition of coagulant chemicals, flash mixing, coagulation, flocculation, sedimentation, and filtration.

**corrosion** The gradual decomposition or destruction of a material by chemical action, often due to an electrochemical reaction. Corrosion may be caused by 1) stray current electrolysis, 2) galvanic corro-

sion caused by dissimilar metals, or 3) differential concentration cells. Corrosion starts at the surface of a material and moves inward.

**corrosive** A chemical (water or otherwise) that reacts with the surface of a material (pipe), causing it to deteriorate, decompose, or wear away.

**corrosivity** An indication of the corrosiveness of water (or other chemical). The corrosiveness of a water is described by the water's pH, alkalinity, hardness, temperature, total dissolved solids, dissolved oxygen concentration, and the Langelier Index.

**CT or CTcalc** The product of "residual disinfectant concentration" (C) in mg/L determined before or at the first customer, and the corresponding "disinfectant contact time" (T) in minutes, i.e., "C" × "T".

**curie** A measure of radioactivity. One curie of radioactivity is equivalent to  $3.7 \times 10^{10}$  or 37,000,000,000 nuclear disintegrations per second.

**decomposition** The conversion of materials to more stable forms by chemical or biological action.

**diatomaceous earth** A fine, siliceous (made of silica) "earth" composed mainly of the skeletal remains of diatoms, a type of free-floating, microscopic plant found in the ocean.

**diatomaceous earth filtration** A filtration method resulting in substantial particulate removal that uses a process in which 1) a "precoat" cake of diatomaceous earth filter media is deposited on a support membrane (septum), and 2) while the water is filtered by passing through the cake on the septum, additional filter media, known as "body feed," are continuously added to the feed water to maintain the permeability of the filter cake.

**direct filtration** A filtration method of treating water which consists of the addition of coagulant chemicals, flash mixing, coagulation, minimal flocculation, and filtration. The flocculation facilities may be omitted, but the physical-chemical reactions will occur to some extent. Compared to conventional treatment, the sedimentation process is omitted from the treatment train. Also see *conventional filtration* and *in-line filtration*.

**disinfectant** Any oxidant, including but not limited to chlorine, chlorine dioxide, chloramines, and ozone, that is added to water in any part of the treatment or distribution process and is intended to kill or inactivate pathogenic microorganisms.

**disinfectant contact time** The time in minutes that it takes for water to move from the point of disinfectant application or the previous point of disinfectant residual measurement to a point before or at the point where residual disinfectant concentration (C) is measured. When only one C is measured, T is the time in minutes that it takes for water to move from the point of disinfectant application to a point before or at where residual disinfectant concentration (C) is measured. Disinfectant contact time in pipelines must be calculated based on plug flow by dividing the internal volume of the pipe by the maximum hourly flow rate through that pipe. Disinfectant contact time within mixing basins and storage reservoirs must be determined by tracer studies or an equivalent demonstration.

**disinfection** The process designed to kill most microorganisms in water, including essentially all pathogenic (disease-causing) bacteria. There are several chemical and physical ways to disinfect, with chlorine being the chemical most frequently used for disinfection in water treatment. Of the physical disinfection methods, UV is the most frequently used method.

**disinfection by-product** A compound formed by the reaction of a disinfectant such as chlorine with organic material in the water supply.

**dissolved oxygen (DO)** Measure of water quality indicating free oxygen dissolved in water.

**enhanced coagulation** To more effectively control TOC and DBP.

**epidemiologic study** Study of human populations to identify causes of disease. Such studies often compare the health status of a group of persons who have been exposed to a suspect agent with that of a comparable non-exposed group.

**epidemiology** A branch of medicine which studies epidemics (diseases which affect significant numbers of people during the same time period in the same locality). The objective of epidemiology is to determine the factors that cause epidemic diseases and how to prevent them.

**fecal coliform bacteria** Bacteria found in the intestinal tracts of animals. Their presence in water or sludge is an indicator of pollution and possible contamination by pathogens.

**filtration** A process for removing particulate matter, microorganisms, and some chemical contaminants from water by passage through porous media.

**finished water** Water that has passed through a water treatment plant; all the treatment processes are completed or “finished.”

**floc** Clumps of microorganisms and particulate impurities that have come together and formed a cluster; found in flocculation tanks and settling or sedimentation basins.

**flocculation** The gathering together of particles and microorganisms in water to form larger particles by gentle mixing after the addition of coagulant chemicals.

**flushing** A method used to clean water distribution lines. In this method, hydrants are opened and water is pumped at a high velocity through the pipes to remove deposits from the pipes that flow out the hydrants.

**free available residual chlorine** That portion of the total available residual chlorine composed of dissolved chlorine gas  $\text{Cl}_2$ , hypochlorous acid ( $\text{HOCl}$ ) and/or hypochlorite ion ( $\text{OCl}^-$ ) remaining in water after chlorination. This does not include chlorine that has combined with ammonia, nitrogen, or other compounds.

**free residual chlorination** The application of chlorine to water to produce a free available chlorine residual equal to at least 80% of the total residual chlorine (sum of free and combined available chlorine residual).

**garnet** A group of hard, reddish, glassy, mineral sands made up of silicates of base metals (calcium, magnesium, iron, and manganese). Garnet has a higher density than sand.

**gastroenteritis** An inflammation of the stomach and intestine resulting in diarrhea, with vomiting and cramps when irritation is excessive. When caused by an infectious agent, it is often associated with fever.

**germicide** A substance formulated ( or a physical method designed) to kill germs or microorganisms such as chlorine and UV.

***Giardia lamblia*** Flagellate protozoan which is shed during its cyst stage into the feces of man and animals. When water containing these cysts is ingested, the protozoan causes a severe gastrointestinal disease called giardiasis.

**giardiasis** Intestinal disease caused by an infestation of *Giardia* with symptoms that include abdominal pains and explosive diarrhea.

**ground water** The supply of fresh water found beneath the Earth's surface, usually in aquifers.

**ground water under the direct influence (UDI) of surface water** Any water beneath the surface of the ground with 1) significant occurrence of insects or other macroorganisms such as algae, or large-diameter pathogens such as *Giardia lamblia*, or 2) significant and relatively rapid shifts in water characteristics such as turbidity, temperature, conductivity, or pH which closely correlate to climatological or surface water conditions. Direct influence must be determined for individual sources in accordance with criteria established by the State. The State determination of direct influence may be based on site-specific measurements of water quality and/or documentation of well construction characteristics and geology with field evaluation.

**gross alpha particle activity** The total radioactivity due to alpha particle emission inferred from measurements on a dry sample.

**gross beta particle activity** The total radioactivity due to beta particle emission inferred from measurements on a dry sample.

**hardness, water** A characteristic of water caused mainly by the salts of calcium and magnesium, such as bicarbonate, carbonate, sulfate, chloride, and nitrate. Excessive hardness in water is undesirable because it causes the formation of soap curds, increased use of soap, and deposition of scale in boilers and pipes. Hardness also may cause damage in some industrial processes and sometimes causes objectionable tastes in drinking water.

**herbicide** A compound, usually a man-made organic chemical, used to kill or control undesired plant growth.

**heterotrophic microorganisms** Bacteria and other microorganisms that use organic matter as an energy source.

**heterotrophic plate count (HPC)** The number of colonies of heterotrophic bacteria grown on selected solid media at a given temperature and incubation period, usually expressed in number of bacteria per milliliter of sample.

**humus** Organic portion of the soil remaining after prolonged microbial decomposition.

**hydrophilic** Having a strong affinity (liking) for water; the opposite of hydrophobic.

**hypochlorite** Chemical compounds containing available chlorine; used for disinfection available as liquids (bleach) or solids (powder, granules, and pellets).

**insecticide** Any substance or chemical formulated to kill or control insects.

**in vitro** In glass; a laboratory experiment performed in a test tube or other vessel.

**in vitro studies** Studies of chemical effects conducted in tissues, cells, or subcellular extracts from an organism (i.e., not in the living organism).

**in vivo** Within a living organism; a laboratory experiment performed in which the substance under study is inserted into a living organism.

**in vivo studies** Studies of chemical effects conducted in intact living organisms.

**ion** An electrically charged atom, radical (such as  $\text{SO}_4^{-2}$ ), or molecule formed by the loss or gain of one or more electrons.

**ionic concentration** The concentration of any ion in solution, usually expressed in moles per liter.

**ionization** The splitting or dissociation (separation) of molecules into negatively and positively charged ions.

**jar test** A laboratory procedure that simulates a water treatment plant's coagulation/flocculation units with differing chemical doses plus energy of rapid mix, energy of slow mix, and settling time. The purpose of this procedure is to estimate the minimum or ideal coagulant dose required to achieve certain water quality goals. Samples of water to be treated are commonly placed in six jars. Various amounts of chemicals are added to each jar, and the settling of solids is observed. The dose of chemicals that provides satisfactory settling removal of turbidity and/or color is the dose used to treat the water being taken into the plant at that time.

**Langelier Index (L.I.)** An index reflecting the equilibrium pH of a water with respect to calcium and alkalinity. This index is used in stabilizing water to control both corrosion and the deposition of scale. Langelier Index =  $\text{pH} - \text{pH}_s$ , where pH = actual pH of the water and  $\text{pH}_s$  = pH at which the water having the same alkalinity and calcium content is just saturated with calcium carbonate.

**legionella** A genus of bacteria, some species of which cause a type of pneumonia called Legionnaires Disease.

**maximum contaminant level (MCL)** The maximum permissible level of a contaminant in water which is delivered to the free-flowing outlet of the ultimate user of a public water system, except in the case of turbidity, where the maximum permissible level is measured at the point of entry to the distribution system. Contaminants added to the water under circumstances controlled by the user are excluded from this definition, except those contaminants (such as lead and copper) resulting from the corrosion of piping and plumbing caused by water quality.

**maximum contaminant level goal (MCLG)** The maximum level of a contaminant in drinking water at which no known or anticipated adverse effect on the health of persons would occur and which allows an adequate margin of safety. Maximum contaminant level goals are non-enforceable limits.

**maximum total trihalomethane potential (MTTP)** The maximum concentration of total trihalomethanes produced in a given water containing a disinfectant residual after 7 days at 25°C or above.

**microbial growth** The activity and growth of microorganisms such as bacteria, algae, diatoms, plankton, and fungi.

**microgram (g)** One-millionth of a gram ( $3.5 \times 10^{-8}$  oz. 0.000000035 oz.).

**micrograms per liter ( $\mu\text{g/L}$ )** One microgram of a substance dissolved in each liter of water. This unit is equal to parts per billion (ppb), since one liter of water is equal in weight to one billion micrograms.

**micron** A unit of length; one millionth of a meter or one thousandth of a millimeter. One micron equals 0.00004 of an inch.

**microorganisms** Living organisms that can be seen individually only with the aid of a microscope.

**milligrams per liter (mg/L)** A measure of concentration of a dissolved substance. A concentration of one mg/L means that one milligram of a substance is dissolved in each liter of water. For practical purposes, this unit is equal to parts per million (ppm), since one liter of water is equal in weight to one million milligrams. Also see *parts per million*.

**most probable number (MPN)** MPN is the most probable number of coliform-group organisms per unit volume of sample water; expressed as the number of organisms per 100 mL of sample water.

**mutagen** An agent that causes a permanent genetic change in a cell other than that which occurs during normal genetic recombination (e.g., mutagen MX).

**mutagenicity** The capacity of a chemical or physical agent to cause permanent alteration of the genetic material within living cells.

**National Pollutant Discharge Elimination System (NPDES)** A system where the regulatory agency (either federal or state) issues a document (permit) which is designed to control all discharges of pollutants from point sources in U.S. waterways. NPDES permits regulate discharges into navigable waters from all point sources of pollution including industries, municipal treatment plants, large agricultural feed lots, and return irrigation flows.

**nephelometric** A means of measuring turbidity in a sample by using an instrument called a nephelometer. A nephelometer passes light through a sample, and the amount of light deflected (usually at a 90° angle) is then measured.

**nephelometric turbidity unit (NTU)** The unit of measure for turbidity.

**non-point source** Pollution sources which are diffuse and do not have a single point of origin or are not introduced into a receiving stream or the environment from a specific outlet. The pollutants are generally carried off the land by stormwater runoff. The commonly used categories for non-point sources are agriculture, forestry, urban, mining, construction, land disposal, and saltwater intrusion.

**non-potable** Water that may contain objectionable pollution, contamination, minerals, or infective agents and is considered unsafe and/or unpalatable for drinking.

**oncology** Study of cancer.

**oxic polymerization** Polymerization of the organic compounds in an oxic environment.

**particle count** The results of a microscopic examination of treated water with a special “particle counter” which classifies suspended particles by number and size.

**particulate** A very small solid suspended in water which can vary widely in size, shape, density, and electrical charge.

**parts per million (PPM)** Parts per million parts, a measurement of concentration on a weight or volume basis. This term is equivalent to milligrams per liter (mg/L), which is the preferred term.

**pathogenic organisms** Organisms, including bacteria, viruses, protozoa, or cysts, capable of causing diseases (typhoid, cholera, dysentery) in a host (such as a person, plant, or animal). There are many types of organisms which do NOT cause disease, such as the bacteria used to process milk into cheese. These organisms are called non-pathogenic.

**pathogens** Microorganisms that can cause disease in other organisms or in humans, animals, and plants. They may be bacteria, viruses, or parasites and are found in sewage runoff from animal farms or rural areas populated with domestic and/or wild animals and in water used for swimming. Fish and shellfish contaminated by pathogens, or the contaminated water itself, can cause serious illnesses.

**pathology** The study of disease.

**pesticide** Any substance or chemical designed or formulated to kill or control undesired plants, insects, or animals. Pesticides include algicide, herbicide, insecticide, and rodenticide.

**pico** A prefix used in the metric system and other scientific systems of measurement which means  $10^{-12}$  or 0.000000000001.

**picocurie (pCi)** A measure of radioactivity. One picocurie of radioactivity is equivalent to 0.037 nuclear disintegrations per second or about two disintegrations per minute.

**point of disinfectant application** The point where disinfectant is applied. Water downstream of that point is not subject to recontamination by surface water runoff.

**point-of-entry treatment device** A treatment device applied to the drinking water entering a house or building for the purpose of treating the drinking water distributed throughout the house or building.

**point-of-use treatment device** A treatment device applied to a single tap used for the purpose of reducing contaminants in drinking water at that individual tap.

**point source** A stationery location or fixed facility from which pollutants are discharged or emitted; also, any single identifiable source of pollution (e.g., pipe, ditch, ship, ore pit, factory smokestack).

**pollutant** Generally, any substance introduced into the environment that adversely affects the usefulness of a resource.

**pollution** Generally, the presence of matter or energy whose nature, location, or quantity produces undesired environmental effects. Under the Clean Water Act, for example, the term is defined as the man-made or man-induced alteration of the physical, biological, and radiological integrity of water.

**polymer** A chemical formed by the union of many monomers (a molecule of low molecular weight). Polymers are used with other chemical coagulants to aid in binding small suspended particles to form larger and heavier aggregates than individual particles for their removal from water. All polyelectrolytes are polymers, but not all polymers are polyelectrolytes.

**prechlorination** The addition of chlorine at the headworks of the plant prior to other treatment processes, mainly for control of tastes, odors, and aquatic growths; also applied to aid in coagulation and settling.

**precipitation** 1) The process by which atmospheric moisture falls onto a land or water surface as rain, snow, hail, or other forms of moisture, and 2) the chemical transformation of a substance in solution into an insoluble form (precipitate).

**precursor** Natural organic compounds found in all surface and groundwaters. These compounds may react with halogens (such as chlorine) to form trihalomethanes (THMs) or other disinfectants to form disinfection by-products.

**primacy** The responsibility for ensuring that a law is implemented, and the authority to enforce a law and related regulations. A primacy agency has the primary responsibility for administering and enforcing regulations.

**public water system** A system for the provision of piped water to the public for human consumption, if such system has at least 15 service connections or regularly serves an average of at least 25 individuals at least 60 days out of the year. Such term includes 1) any collection, treatment, storage, and distribution facilities under control of the operator of such system and used primarily in connection with such system, and 2) any collection or pretreatment storage facilities not under such control which are used primarily in connection with such system. A public water system is either a “community water system” or a “non-community water system.”

**radionuclide** Any man-made or natural element which emits radiation in the form of alpha or beta particles or as gamma rays.

**raw water** Water in its natural state, prior to any treatment, or the water entering the first treatment process of a water treatment plant.

**reaeration** The introduction of air through forced air diffusers into the water. Oxygen from the air dissolves into the water and replenishes the dissolved oxygen.



**residual chlorine** The amount of free and/or available chlorine remaining after a given contact time under specified conditions.

**reverse osmosis** The application of pressure to a concentrated solution which causes the passage of a liquid from the concentrated solution to a weaker solution across a semipermeable membrane. The membrane allows the passage of the solvent (water), but not the dissolved solids (solutes). The liquid produced is a demineralized water.

**Safe Drinking Water Act (SDWA)** Commonly referred to as SDWA, an Act passed by the U.S. Congress in 1974. The Act establishes a cooperative program among local, state, and federal agencies to insure safe drinking water for consumers.

**safe water** Water that does not contain harmful bacteria, toxic materials, or chemicals. Water may have taste and odor problems, color, and certain mineral problems and still be considered safe for drinking.

**sanitary sewer** A sewer that transports only wastewaters (from domestic residences and/or industries) to a wastewater treatment plant.

**Standard Methods** Standard Methods for the Examination of Water and Wastewater is a joint publication of the American Public Health Association, American Water Works Association, and the Water Pollution Control Federation which outlines the procedures used to analyze the impurities in water and wastewater.

**suspended solids** 1) Solids that either float on the surface or are suspended in water or other liquid and which are largely removable by laboratory filtering, and 2) the quantity of material removed from water in a laboratory test, as prescribed in Standard Methods for the Examination of Water and Wastewater.

**teratogenesis** The induction of nonhereditary congenital malformations (birth defects) in a developing fetus by exogenous factors acting in the womb; interference with normal embryonic development.

**teratogenicity** The capacity of a physical or chemical agent to cause teratogenesis in offspring.

**total dissolved solids (TDS)** All of the dissolved solids in a water. TDS is measured on a sample of water that has passed through a very fine mesh filter to remove suspended solids. The water passing through the filter is evaporated, and the residue represents the dissolved solids.

**total residual chlorine** The amount of available chlorine remaining after a given contact time, which is the sum of the combined available residual chlorine and the free available residual chlorine.

**total trihalomethanes (TTHMs)** The sum of the concentration in milligrams per liter of the trihalomethane compounds (trichloromethane [chloroform], dibromochloromethane, bromodichloromethane, and tribromomethane [bromoform]), rounded to two significant figures.

**toxic** A substance which is poisonous to an organism.

**toxic pollutants** Materials contaminating the environment that cause death, disease, birth defects in organisms that ingest or absorb them. The quantities and length of exposure necessary to cause these effects can vary widely.

**toxic substance** A chemical or mixture that may represent an unreasonable risk of injury to health or the environment.

**toxicant** A harmful substance or agent that may injure an exposed organism.

**toxicity** The quality or degree of being poisonous or harmful to plant, animal, or human life.

**toxicology** The science and study of poisons and their effects and control.

**trihalomethane (THM)** One of a family of organic compounds named as derivatives of methane. THMs are generally the by-product from chlorination of drinking water that contains organic material. The resulting compounds (THMs) are suspected of causing cancer.

**turbidity** The cloudy appearance of water caused by the presence of suspended and colloidal matter. In the waterworks field, a turbidity measurement is used to indicate the clarity of water. Technically, turbidity is an optical property of the water based on the amount of light reflected by suspended particles. Turbidity cannot be directly equated to suspended solids because white particles reflect more light than dark-colored particles, and many small particles will reflect more light than an equivalent large particle.

**virus** The smallest form of microorganism capable of causing disease, especially, a virus of fecal origin that is infectious to humans by waterborne transmission.

**waterborne disease outbreak** The significant occurrence of acute infectious illness, epidemiologically associated with the ingestion of water from a public water system that is deficient in treatment or because of a cross connection (e.g., illegal connection of a sewer line to the water supply network) as determined by the appropriate local or state agency.

**water supply system** The collection, treatment, storage, and distribution of safe water from source to consumer.

**watershed** The land area that drains into a stream; an area of land that contributes runoff to one specific delivery point. Large watersheds may be composed of several smaller “subsheds,” each of which contributes runoff to different locations that ultimately combine at a common delivery point.

**wetlands** Any number of tidal and non-tidal areas characterized by saturated or nearly saturated soils most of the year that form an interface between terrestrial (land-based) and aquatic environments. They include freshwater marshes around ponds and channels (rivers and streams) and brackish and salt marshes. Other common names include *swamps* and *bogs*.

**zeta potential** In coagulation and flocculation procedures, the difference in the electrical charge between the dense layer of ions surrounding the particle and the charge of the bulk of the suspended fluid surrounding this particle. The zeta potential is usually measured in millivolts.