

Foreign Nonindigenous Carps and Minnows (Cyprinidae) in the United States – A Guide to their Identification, Distribution, and Biology

Scientific Investigations Report 2005-5041

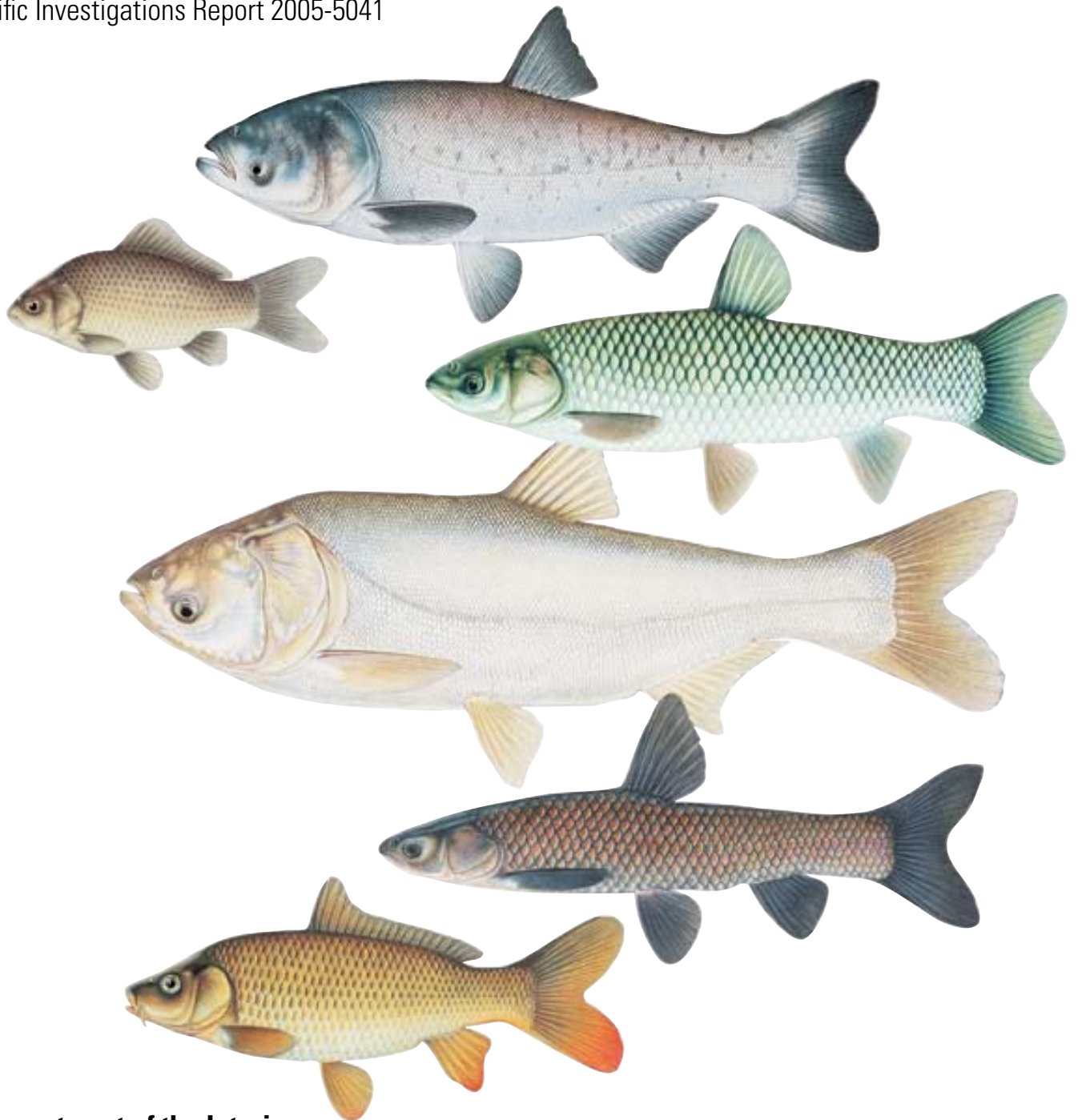

Foreign Nonindigenous Carps and Minnows (Cyprinidae) in the United States—A Guide to their Identification, Distribution, and Biology

By Pamela J. Schofield, James D. Williams, Leo G. Nico,
Pam Fuller, and Matthew R. Thomas



Prepared in cooperation with the
U.S. Fish and Wildlife Service



Scientific Investigations Report 2005-5041

U.S. Department of the Interior
U.S. Geological Survey

U.S. Department of the Interior
Gale A. Norton, Secretary

U.S. Geological Survey
Charles G. Groat, Director

U.S. Geological Survey, Reston, Virginia: 2005

For sale by U.S. Geological Survey
Information Services
Box 25286, Denver Federal Center
Denver, CO 80225

For more information about the USGS and its products:
Telephone: 1-888-ASK-USGS
World Wide Web: <http://www.usgs.gov/>

Any use of trade, product, or firm names in this publication is for descriptive purposes only and does not imply endorsement by the U.S. Government.

Although this report is in the public domain, permission must be secured from the individual copyright owners to reproduce any copyrighted materials contained within this report.

Suggested citation:

Schofield, P.J., Williams, J.D., Nico, L.G., Fuller, P., and Thomas, M.R., 2005, Foreign Nonindigenous Carps and Minnows (Cyprinidae) in the United States—A guide to their Identification, Distribution, and Biology: U.S. Geological Survey Scientific Investigations Report 2005-5041, 103 p.

Cover fish plate artwork: *Joseph R. Tomelleri*
Title page photograph courtesy of: *Leo G. Nico*

Layout/editing: *Twila D. Wilson, USGS*
Graphic production: *Ronald S. Spencer, USGS*

Contents

Introduction	1
Foreign Cyprinids Treated in this Guide	2
What is a Cyprinid?	3
Introduced Versus Native Cyprinids	3
Other Fishes	3
Reporting Discovery of Nonindigenous Species	4
Methods	4
Taxonomy	4
Meristic and Morphometric Measures	4
Pharyngeal Teeth	4
Museum Specimens	5
Maps	5
Key to Species	7
Table of Characters	14
Species Accounts	17
Goldfish (<i>Carassius auratus</i>)	19
Crucian Carp (<i>Carassius carassius</i>)	25
Grass Carp (<i>Ctenopharyngodon idella</i>)	31
Spawning Requirements of Chinese Carps (Silver, Grass, Bighead, and Black)	34
Common Carp (<i>Cyprinus carpio</i>)	39
Silver Carp (<i>Hypophthalmichthys molitrix</i>)	45
Bighead Carp (<i>Hypophthalmichthys nobilis</i>)	51
Ide (<i>Leuciscus idus</i>)	55
Black Carp (<i>Mylopharyngodon piceus</i>)	59
Bitterling (<i>Rhodeus sericeus</i>)	63
Rudd (<i>Scardinius erythrophthalmus</i>)	67
Tench (<i>Tinca tinca</i>)	73
Acknowledgments	77
Addendum	77
References Cited	79
Appendix A—Foreign cyprinids established or reported from the United States	93
Appendix B—Meristics of foreign nonindigenous cyprinids and selected hybrids	97
Appendix C—Nonindigenous aquatic species reporting form	103
Abbreviated diagnostic key to foreign nonindigenous cyprinids of the United States	Inside back cover





Plates

1. Map showing native distribution of the Family Cyprinidae **2**
- 2-12. Maps showing distribution of foreign nonindigenous cyprinids in the United States for:
 2. Goldfish **23**
 3. Crucian Carp **29**
 4. Grass Carp **38**
 5. Common Carp **44**
 6. Silver Carp **49**
 7. Bighead Carp **54**
 8. Ide **58**
 9. Black Carp **62**
 10. Bitterling **66**
 11. Rudd **71**
 12. Tench **76**

Figures

- 1-10. Photographs or images depicting:
 1. Examples of nonindigenous cyprinids, showing those having a long dorsal fin with 13 or more branched rays, and those having a short dorsal fin with 12 or fewer branched rays **7**
 2. Head of Common Carp, showing two fleshy barbels near corner of jaw **7**
 3. Pharyngeal teeth of Common Carp and Goldfish **8**
 4. Concave dorsal fin of Goldfish, and convex dorsal fin of Crucian Carp **8**
 5. Head of Tench, showing single barbel near corner of jaw **9**
 6. Ventral keels of Silver Carp and Bighead Carp **10**
 7. Fused, sponge-like gill rakers of Silver Carp, and slender, comblike rakers of Bighead Carp **11**
 8. Keel of Rudd **12**
 9. Pharyngeal teeth of Grass Carp and Black Carp **13**
 10. Body cavity linings of Grass Carp and Black Carp **13**
11. Goldfish **19**
 12. Pharyngeal teeth **19**
 13. Cultured (fancy) form **21**
 14. Wild (olivaceous) form **21**
15. Crucian Carp **25**
 16. Deep-bodied form **26**
 17. Slender (*humilis*) form **26**
 18. Pharyngeal teeth **27**

19. Grass Carp **31**
 20. Pharyngeal teeth **31**
 21. Subadult male **32**
 22. Adult **32**
 23. Adult **32**
24. Common Carp **39**
 25. Pharyngeal teeth **39**
 26. Scaled variety **41**
 27. Mirror variety **41**
 28. Leather variety **41**
 29. Ornamental Koi in a pond at Lí Yuán Garden, Suzhou, People's Republic of China **42**
30. Silver Carp **45**
 31. Ventral keel **45**
 32. Pharyngeal teeth **46**
 33. Juvenile **46**
 34. Adult **46**
35. Bighead Carp **51**
 36. Ventral keel **51**
 37. Pharyngeal teeth **52**
 38. Juvenile **52**
39. Ide **55**
 40. Pharyngeal teeth **55**
41. Black Carp **59**
 42. Black Carp from the species' native range in the Chang (Yangtze) River Basin, Hunan Province, People's Republic of China **60**
 43. Pharyngeal teeth **60**
44. Bitterling **63**
 45. Pharyngeal teeth **63**
46. Rudd **67**
 47. Pharyngeal teeth **67**
 48. Adult **68**
 49. Ventrolateral and posterior aspect of abdomen showing a scaled keel in Rudd, a partially scaled keel in hybrid Rudd X Golden Shiner, and a naked keel in Golden Shiner **68**
50. Tench **73**
 51. Pharyngeal teeth **73**
 52. Tench taken by anglers from two sites in Europe: Willis's Lake in Belfast, Northern Ireland, and in Belgium **74**



Conversion Factors

Multiply	By	To obtain
centimeter (cm)	0.3937	inch
meter (m)	3.281	foot
kilometer (km)	0.6214	mile
kilogram (kg)	2.2046	pound

Temperature in degrees Celsius (°C) may be converted to degrees Fahrenheit (°F) by:

$$^{\circ}\text{F} = 1.8 \times ^{\circ}\text{C} + 32$$

Abbreviations and Acronyms

<	less than
>	more than
HUC	USGS Hydrologic Unit Code
USGS	U.S. Geological Survey
U.S.	United States

Foreign Nonindigenous Carps and Minnows (Cyprinidae) in the United States—A Guide to their Identification, Distribution, and Biology

By Pamela J. Schofield, James D. Williams, Leo G. Nico, Pam Fuller, and Matthew R. Thomas

Introduction

The family Cyprinidae (carps and minnows) is naturally distributed throughout most of the world except Australia and South America (plate 1). It is the largest family of freshwater fishes with about 2,010 species in 210 genera. Most cyprinids (about 155 genera and 1,060 species) are found in Eurasia (Nelson, 1994). About 300 species in 50 genera are native to North America (Canada, Mexico, United States; Nelson and others, 2004). The high diversity and expansive distribution of cyprinids have contributed to a long history of human use (of both cultured and wild-caught stocks) as food, bait, sport, forage, and ornamentals. A few species are used to control nuisance plants or other problem organisms (for example, disease-carrying snails).

Cyprinids exhibit considerable variation in morphology, diet, and habitat use. The largest member of the family is the Giant Barb (*Catlocarpio siamensis*) of southeastern Asia, which may reach almost 3 m total length (TL) (Smith, 1945). In contrast, the miniature translucent species *Danionella translucida* from Myanmar (formerly Burma) attains only 12 mm standard length (SL), and is the smallest freshwater fish known (Roberts, 1986; Britz, 2003). Trophic diversity is also great, and the family includes planktivores (Bighead Carp, *Hypophthalmichthys nobilis*, and Silver Carp, *Hypophthalmichthys molitrix*), herbivores (Grass Carp, *Ctenopharyngodon idella*), piscivores (Colorado Pikeminnow, *Ptychocheilus lucius*), and omnivores (Common Carp, *Cyprinus carpio*). Many species have

specialized diets, which are reflected in particular morphological adaptations (for example, the Black Carp, *Mylopharyngodon piceus*, has pharyngeal teeth modified for crushing mollusks). Cyprinids live in a wide variety of habitats from stagnant ponds and small streams to large lakes and swift-flowing rivers.

This guide was designed to benefit biologists and others interested in nonindigenous fishes by providing information for the identification of foreign cyprinids introduced into the U.S. In addition to providing identification keys and descriptions of distinguishing characteristics, we give details concerning distribution and environmental biology. This guide is a valuable resource for several reasons:

- (1) The number and variety of foreign fishes introduced into the U.S. has increased dramatically in the past few decades;
- (2) Several introduced cyprinids have caused, or have the potential to cause, environmental or economic harm; and
- (3) Some foreign cyprinids superficially resemble native cyprinids or other (native or introduced) fishes. Consequently, introduced cyprinids may be misidentified or may not even be recognized as non-natives.

Correct identification is critical in documenting the occurrence and dispersal of foreign species and in rapidly responding to the appearance of new foreign species. As learned during recent decades, a swift response is critical to eliminate and/or control harmful non-native fishes before they become widespread and abundant.

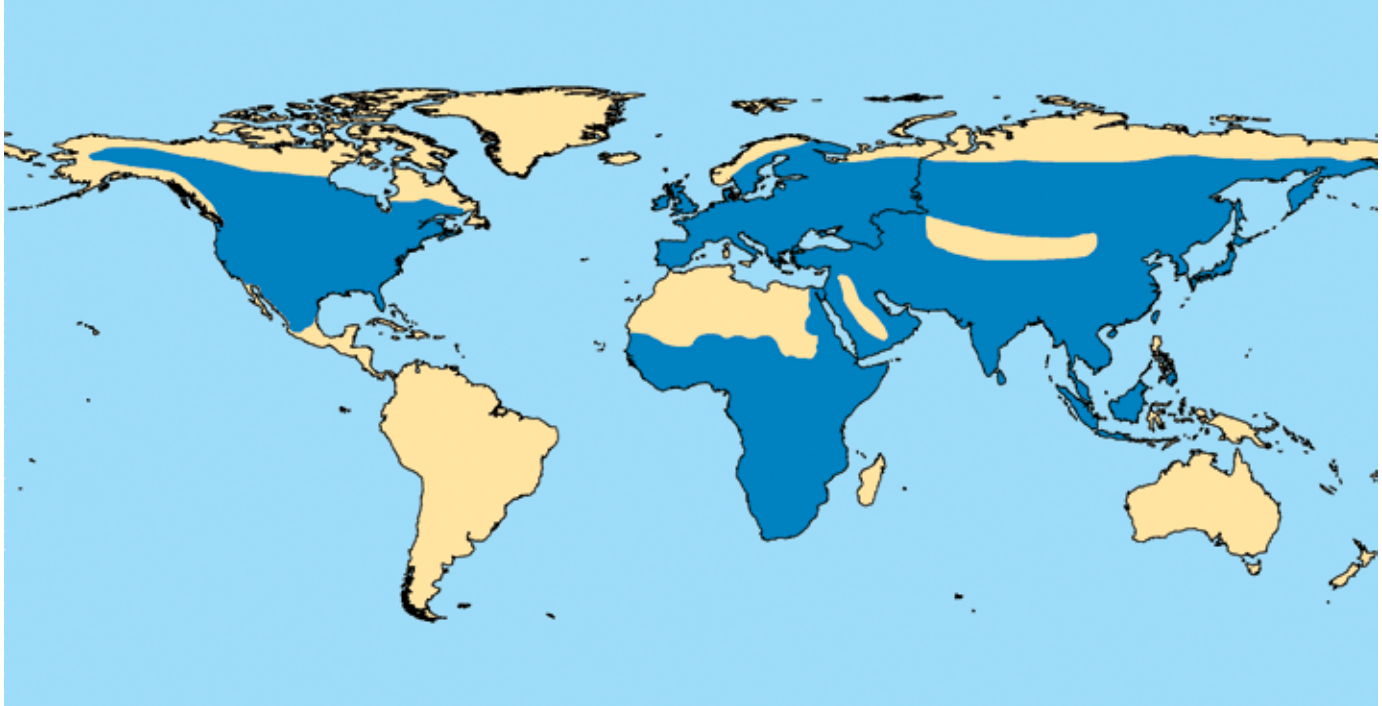

Plate 1. Native distribution of the Family Cyprinidae (in dark blue).

Foreign Cyprinids Treated in this Guide

Eleven foreign nonindigenous cyprinids are included in this guide. Eight species have established breeding populations in the U.S. (Goldfish, Grass Carp, Common Carp, Silver Carp, Bighead Carp, Bitterling, Rudd, and Tench). Three species are not known with certainty to have reproducing populations (Black Carp, Crucian Carp, Ide). There is mounting evidence suggesting that Black Carp is either already established in the wild or that it will become established in the near future (Nico and others, 2005). The Crucian Carp was reported to be thriving in Chicago, Illinois, in the early 1900s (Meek and Hildebrand, 1910); however, it is no longer believed to exist there (Smith 1979). Although there are currently no documented reproducing populations in the U.S., there is a possibility that Crucian Carp is established but has been misidentified or confused with the morphologically similar Goldfish. Also, recent interest in culturing Crucian Carp for the live food fish trade raises the possibility of future introductions. Ide was included based on records of multiple introductions and one established population in Connecticut that was eradicated (Fuller and others, 1999). However, Ide may still be present, but undetected, in other drainages.

Although we include detailed information and accounts for a few foreign cyprinid species not yet established in the U.S. (for example, Crucian Carp), this guide does not provide information for the identification of several other foreign cyprinids that have been found or reported in the U.S. These excluded species include ones that either never became established, or those that only temporarily formed reproducing populations and then subsequently disappeared. The Zebra Danio (*Brachydanio rerio*) is one example; it was reported to have a single reproducing population in a spring system in New Mexico (Sublette and others, 1990; Fuller and others, 1999), but is no longer extant (Nelson and others, 2004). The Zebra Danio was also reported in the open waters of California, Connecticut, and Florida (Fuller and others, 1999), as the result of escapes from fish farms or aquarium releases; however, no evidence of reproduction has been reported. Two ornamental species from Asia, the Blackspot Barb (*Puntius filamentosus*) and the Green Barb (*Puntius semifasciolatus*), had reproducing populations in Nu'uuanu Reservoir No. 2 in Oahu, Hawaii. However, neither species has been seen since the drought of 1984 when the reservoir almost dried (Yamamoto and Tagawa 2000). A few other foreign cyprinids have been reported in open waters of the U.S., but are not known to maintain reproducing populations (appendix A).

What is a Cyprinid?

Cyprinids are not always easy to distinguish from other fishes. Basic cyprinid characteristics include no teeth on the jaws, a single dorsal fin, pelvic fins in an abdominal position, pectoral fins low on the side, and no adipose fin. The first full-length ray of the dorsal and anal fins is hardened into a spine-like structure in some foreign cyprinids (for example, the Common Carp, Crucian Carp, and Goldfish). Native North American cyprinids lack a spine-like ray, except certain genera endemic to the desert southwest (such as the *Plagopterus*, *Meda*, and *Lepidomeda*). Cyprinids have 19 principal caudal-fin rays (17 branched, 2 unbranched). The scales are cycloid and the lateral-line system is typically well developed. The head typically has no scales. Cyprinids do not have jaw teeth; instead, they use a pharyngeal apparatus to process food. This apparatus consists of a modified thick fifth pharyngeal arch that bears teeth and a chewing (masticatory) pad that is located on roof of the pharynx. The size and shape of the arch and teeth are closely tied to the diet of the species. The lips usually are thin, but in some cyprinids they are enlarged and sucker-like or even lobed. Most cyprinids lack barbels on the lips but they are present in a few genera, including a few native to North America. A swim (gas) bladder is always present and usually two-chambered. Cyprinids and several related groups have a Weberian apparatus comprised of modified anterior vertebrae that connect the swim bladder to the inner ear. The Weberian apparatus transmits sound vibrations to auditory receptors in the brain and is thought to give cyprinids a keen sense of hearing. Most cyprinids have a typical minnow-shaped body form, but some are elongated, some compressed, and others robust. Many cyprinids are sexually dimorphic. For example, males of many species become brightly colored during the breeding season, and may temporarily develop nuptial (breeding) tubercles. Females may also develop breeding tubercles, but these are generally less well developed than those of the males. Proliferation and distribution of tubercles on the body varies between sexes and among species, often appearing on parts of the head, body, and fins (Etnier and Starnes, 1993; Jenkins and Burkhead, 1994; Nico and others, 2005).

Introduced Versus Native Cyprinids

Because the family is so diverse, there is no single set of characteristics that distinguishes all introduced cyprinids from native North American cyprinids. Nevertheless, a few introduced cyprinids are distinctive and can easily be identified as non-natives. Among these are Common Carp, Goldfish, and Crucian Carp, which have a stout, spine-like ray in the front part of their dorsal and anal fins. Only a few North American species native to the desert southwest possess similar spine-like rays. In addition, some foreign cyprinids have relatively long dorsal fins with 13 or more branched rays. In contrast, almost all native cyprinids have short dorsal fins, with 11 or fewer (usually 7-9) branched dorsal-fin rays. Moreover, most foreign cyprinids are medium- or large-sized fishes, reaching over a meter long. In contrast, the majority of native cyprinids are fairly small and few species exceed 15 cm TL. One notable exception is the native (and critically endangered) Colorado Pikeminnow, a species historically known to reach almost 2 m long and weigh 40 kg (Minckley 1973).

Other Fishes

Only a few other non-cyprinid fishes native to North America are superficially similar to foreign cyprinids. Some members of the sucker family (*Catostomidae*), such as buffalos (*Ictiobus*) and carpsuckers (*Carpionodes*), resemble the Common Carp, Goldfish, and Crucian Carp. Suckers share some cyprinid characteristics, including pharyngeal teeth, cycloid scales, and nuptial tubercles on breeding males. Suckers also lack jaw teeth and adipose fins. However, suckers can be distinguished from cyprinids by the number of principle caudal-fin rays (18 in suckers, 19 in cyprinids). Barbels are present in some cyprinids, but are always absent in suckers. Additionally, suckers lack spine-like dorsal- and anal-fin rays that are characteristics of the Common Carp, Goldfish, and Crucian Carp. The pharyngeal teeth of suckers are typically long and fine, are arranged in a single comb-like row along the arch, and number 10 or more per side. In cyprinids, the pharyngeal teeth are often (but not always) stout or molar-like, and number less than 10 per side. The mouth of most suckers opens ventrally, and the lips are generally thick and fleshy (Jenkins and Burkhead, 1994).

Reporting Discovery of Nonindigenous Species

The collection of any nonindigenous cyprinid should be reported to state game and fish agencies and to the Nonindigenous Aquatic Species database (<http://nas.er.usgs.gov>; appendix C). For those wishing to report a new record, be aware that positive identification is of the utmost importance. Consequently, we urge that the specimen be retained if possible or at least well documented with photographs. It is especially helpful for photographic images to be well-focused and to include shots of the entire fish from various angles as well as close-up views of the head and fins.

Methods

Taxonomy

Scientific names and authorities were taken from “A Catalog of the Species of Fishes” (Eschmeyer and others, 1998, and amendments) available through the California Academy of Science (online at: <http://www.calacademy.org/research/ichthyology/catalog/fishcatsearch.html>). Common names of fishes follow Nelson and others (2004).

Meristic and Morphometric Measures

Methods of recording meristic (count) and morphometric (measurement) data were standardized by Hubbs and Lagler (1958) and reviewed in Strauss and Bond (1990). Additionally, several publications that provide information on fishes of particular regions or states list useful details regarding identification, including standard formats for expressing meristics and morphometrics (for example, Page and Burr, 1991; Etnier and Starnes, 1993; Jenkins and Burkhead, 1994; Ross, 2001; Boschung and Mayden, 2004). Meristic characteristics are variable within and among the cyprinids treated in this guide. Thus, meristic data from a number of sources are included for each species, including data from both native and introduced populations when available (appendix B). These data were reproduced as given by the original authors. Although most of the original reports follow the standards of Hubbs and Lagler (1958) and Strauss and Bond (1990), some did not (especially those in foreign publications) and, therefore, inconsistencies may exist. For detailed information on methods of data reporting, the cited authority should be consulted.

Fin-ray counts, comprised of unbranched and branched rays, are often useful in the diagnosis of fish species. When reporting fin-ray counts, the first set of Roman numbers represents the number of soft unbranched rays. The second set (in parentheses) represents the number of soft branched rays. For example, a fin with three unbranched rays and eight branched rays would be represented as: iii (8). The spine-like ray present in the dorsal and anal fins of some foreign cyprinids (for example, Common Carp, Goldfish, Crucian Carp) and a few native fishes is counted as an unbranched ray. Because the unbranched rays of the dorsal and anal fins are often difficult to discern, most North American fish books report only a single number representing a single unbranched ray plus all the branched rays. The last two branched rays usually share a common basal skeletal element and are counted as one.

Counts of gill rakers are based on the first (outer) gill arch and normally performed using the outer arch on the left side of fish. Gill rakers are often aligned in two rows on each gill arch, an outer row of longer rakers and an inner row of short stubs. Only rakers on the outer row are counted, including the smallest in the outer-row series at top and bottom of the arch (Calliet and others, 1986). Some authors give either upper and lower limb counts, or inner and outer (anterior and posterior) counts, and those data are listed in this guide.

Length of fishes is conventionally given in either standard (SL) or total length (TL). Standard length is the straight-line distance from the tip of the snout to the posterior end of the vertebral column. The end of the vertebral column can be located by laterally flexing the caudal fin at its base. The crease in the flesh at the base of the caudal fin marks the end of the vertebral column (hypural plate) and the beginning of the caudal fin. Total length is the straight-line distance from the tip of the snout to the posterior tip of the longest caudal-fin rays. North Americans typically measure total length (TL) with the caudal fins compressed dorso-ventrally, resulting in a measure slightly longer than if the caudal fins are left in their natural position (Anderson and Neumann, 1996). Unfortunately, many authors do not report the method used to determine total length.

Pharyngeal Teeth

Cyprinids do not have jaw teeth. Instead, they rely on their pharyngeal teeth and masticatory pads to crush or process their food. The number, size, and shape of the pharyngeal teeth are generally species specific.

In cyprinids, the fifth branchial arches are located on the floor of the posterior pharynx, anterior to its junction with the esophagus. To clearly view the pharyngeal teeth, it is often necessary to extract the pharyngeal arch. This can be accomplished by removing the operculum, gills, and other surrounding tissues. Alternately, the gills and operculum can be folded forward to expose the pharyngeal teeth. Much care must be exercised to extract an arch without damaging the teeth and resulting in an incorrect tooth count. In this guide, dorsal-view illustrations of pharyngeal teeth are given in each species account. The number of pharyngeal teeth is represented by a standardized formula. For example, a count of 0,4-4,0 denotes one inner row of four teeth on each arch. Alternately, a count of 1,1,3-3,1,1 denotes three rows on each side, with three teeth in the innermost row and two outer rows with one tooth each. By convention, pharyngeal teeth are read from the outside of the left to the outside of the right. Some species show dramatic changes with growth, and young individuals sometimes have pharyngeal teeth quite different from adults. The pharyngeal teeth illustrated in this guide are those of adult fish.

Museum Specimens

Preserved specimens referenced in this study are from the following sources: AUM (Auburn University Museum Fish Collection, Auburn, Alabama); SIUC (Southern Illinois University at Carbondale, Fluid Vertebrate Collection, Carbondale, Illinois); TU (Tulane University Museum of Natural History Fish Collection, New Orleans, Louisiana); UF (Florida Museum of Natural History, Department of Ichthyology, Gainesville, Florida).

Maps

The U.S. distribution of each foreign cyprinid species is given on a map plate in the corresponding species account. Distribution information is presented by drainage and by state, each coverage indicating different levels of information.

Distribution by drainage.—U.S. Geological Survey Hydrologic Unit Codes (HUCs) were used as a base to build maps. This is a nationwide system that delineates watersheds based on surface hydrologic regions (for more information, see: <http://nas.er.usgs.gov/hucs.asp>). Maps in this guide use a combination of 6-digit and 8-digit HUCs. The maps distinguish between

HUCs where there is evidence of natural reproduction in the wild (coded as “**reproducing**”) and those where the species has been reported, but without evidence of reproduction (coded as “**reported**”). The distinction is important. Once a nonindigenous fish establishes a reproducing population, it may persist indefinitely, becoming a permanent addition to the fauna.

(1) Reproducing species.—A species is coded as “reproducing” within a HUC if a naturally reproducing population is present. These drainages are color-coded red on the maps. Usually, evidence for reproduction is based on presence of adult fish as well as reports that eggs, larvae, or small juveniles have been collected within the HUC. Sometimes reproduction is inferred by persistence of a species in a particular water body over an extended period of time. Persistent reproduction is usually habitat dependent. Some of the species in this guide are capable of reproducing in still waters, such as lakes and ponds (Common Carp, Goldfish, and Tench). Other species, such as the Chinese carp (Grass Carp, Silver Carp, Bighead Carp, and Black Carp), naturally spawn in rivers.

(2) Reported species.—HUCs are coded as “reported” if the species has been collected, stocked, or observed in one or more parts of a drainage, but no evidence exists that the species is successfully reproducing. These drainages are color-coded pink on the maps. Failed historical introductions (that are known to us) are included in this category.

(3) Eradicated species.—Eradication is the complete elimination of all individuals in a given population. Many eradication attempts fail, as aquatic organisms are especially difficult to completely remove from a system despite vigorous and costly efforts to eliminate them. Years of monitoring are usually required to assure no survivors persist. In some cases, the source of introduction is never identified, consequently individuals continue to repopulate the area. In general, the only successful eradication projects are ones directed at fish confined in small, relatively closed systems, such as a pond or smaller, somewhat isolated reservoirs or drainages (see account on Ide, *Leuciscus idus*). In larger and unconfined water systems (rivers, canal networks, estuary complexes) the possibility of successful eradication is extremely low (or impossible) and the cost of such projects high. There is little hope of completely eradicating some widely-ranging nuisance fishes, especially with the techniques currently available.

Eradication attempts are often poorly documented (typically in the gray or unpublished literature), making it difficult to evaluate their success. Additionally, reports of eradications from selected sites do not always include information on whether the species continued to survive in other parts of the drainage. The confusion and shortage of information complicate the task of tracking and accurately mapping changes in the distribution of introduced populations. For example, Dill and Cordone (1997) reported that a reproducing population of Tench was eliminated from a small farm pond in the Trinity River drainage in California, but did not comment on whether the species was known to exist or was reproducing elsewhere in that drainage. A later report (Moyle 2002) indicated there were no recent records for Tench in the Trinity River. Thus, it is unclear whether the local eradication effort reported by Dill and Cordone (1997) removed the only reproducing population of Tench or whether other reproducing populations of Tench throughout the drainage simply died out over time.

Distribution by state.—In addition to providing the distribution of each species by drainage, we also include distribution information for all 50 states. States color-coded green represent those from which the species has been recorded at least once from natural waters within state borders. In some instances, the record of occurrence may be nonspecific, with no information about the precise drainage or location within the state where the species was reported, released, or captured. In such cases, the entire state is shaded green but no drainage is shaded. In contrast to the HUC units described above, the state colors do not provide information concerning the population status of the species (that is, reproducing versus non-reproducing). If a foreign cyprinid is known only from one site in a drainage, then the entire drainage is color coded (either red or pink). Many HUC units cross state boundaries. For additional information on state-by-state occurrence of foreign cyprinids, see appendix A.

Water bodies included in the coverage.—Distributions delineated on the maps pertain only to records from the wild, including habitats that are natural (rivers, lakes) or artificial (canals, farm ponds, reservoirs). Maps do not include records based on captive indoor settings or outdoor ponds and tanks at

aquaculture facilities, as the focus of the database is to document wild-caught non-native fishes. However, it has become increasingly evident that documentation of the location of aquaculture facilities as well as the fish stocks cultured there is important due to the likelihood of escape from outdoor ponds to nearby open systems. Unfortunately, this data is often difficult to obtain.

Source of map distribution data.—Data used to create these maps were primarily derived from the Nonindigenous Aquatic Species (NAS) database at the U.S. Geological Survey and from the closely related publication on nonindigenous fishes by Fuller and others (1999). The database is built from a variety of sources, including scientific literature, published and unpublished reports, and museum specimens. The database also relies on information from personal communications with scientists and others, as these sources are often the most recent (or only) documentation of a species' occurrence in a particular area. We have attempted to make the maps in this guide as up-to-date as possible. Nevertheless, we may not be informed of all occurrences of nonindigenous cyprinids. Moreover, the distribution of non-native fishes frequently changes over time, with many species expanding their ranges. Consequently, readers are reminded that distributions of introduced species are constantly in flux, so those who are attempting to identify a fish should not rule out a particular species simply because the map shows that it has not previously been reported from the area.

Most of the distribution data provided in this guide can be found by querying the NAS database (<http://nas.er.usgs.gov/queries>). Summary collection information, including date, can be obtained by clicking on the dip-net icon. Detailed information about each collection can be found by clicking on the specimen ID. The database is constantly updated as new records are added and earlier records are reviewed and corrected. Individuals who have relevant information concerning the collection of nonindigenous cyprinids are asked to report their findings to state game and fish agencies and to the NAS database (appendix C; See subsection "Reporting the Discovery of Nonindigenous Fishes" at end of Introduction).

Key to Species

- 1a. Dorsal fin long, with a stout, saw-toothed, spine-like ray anteriorly, followed by 13 or more branched rays (fig. 1A); anal fin also preceded by a stout, spine-like ray [Note: Spine-like rays preceded by one or a few short or rudimentary rays]Go to 2
- 1b. Dorsal fin short, with 12 or fewer branched rays (fig. 1B); dorsal and anal fins without stout, saw-toothed spine-like rayGo to 4

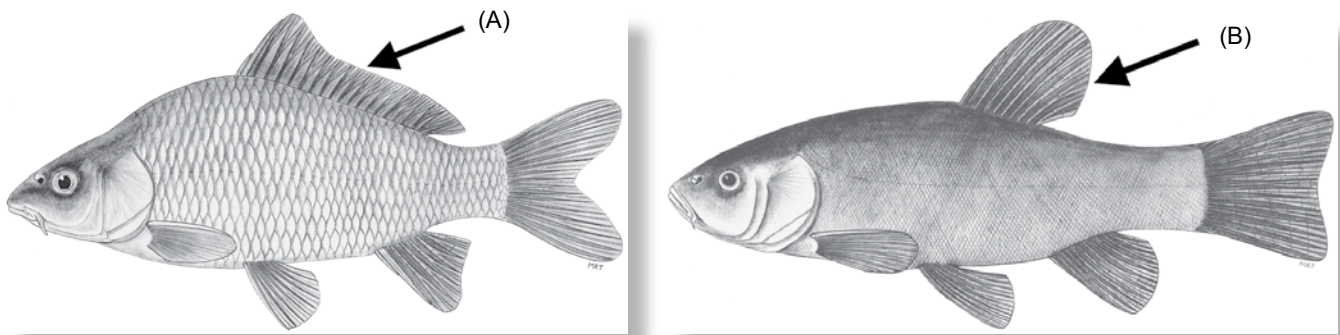

Figure 1. Examples of nonindigenous cyprinids having (A) a long dorsal fin with 13 or more branched rays, and (B) a short dorsal fin with 12 or fewer branched rays.

- 2a. One pair of fleshy barbels on each side of the head, located near corner of mouth on upper jaw, the anterior barbel slightly shorter (fig. 2); pharyngeal teeth molariform, in 3 rows (1,1,3-3,1,1; fig. 3A); color brassy to yellowish, with lower fins often yellow-orange; ornamental varieties may range in color from bright orange, red, black, to white or some combination of these; some genetic strains with only a few large scales (“mirror carp”) or lack scales entirely (“leather carp”).

..... **Common Carp** (*Cyprinus carpio*) Page 39

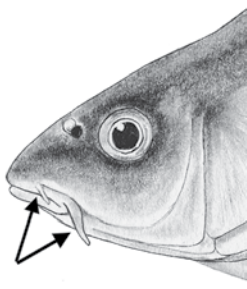

Figure 2. Head of Common Carp, showing two fleshy barbels near corner of jaw.

2b. No barbels around the mouth; pharyngeal teeth in one row (0,4-4,0; fig. 3B); body relatively deep and compressed (except in some stunted forms that are relatively elongate or in certain ornamental forms exhibiting bizarre body shapes).....Go to 3

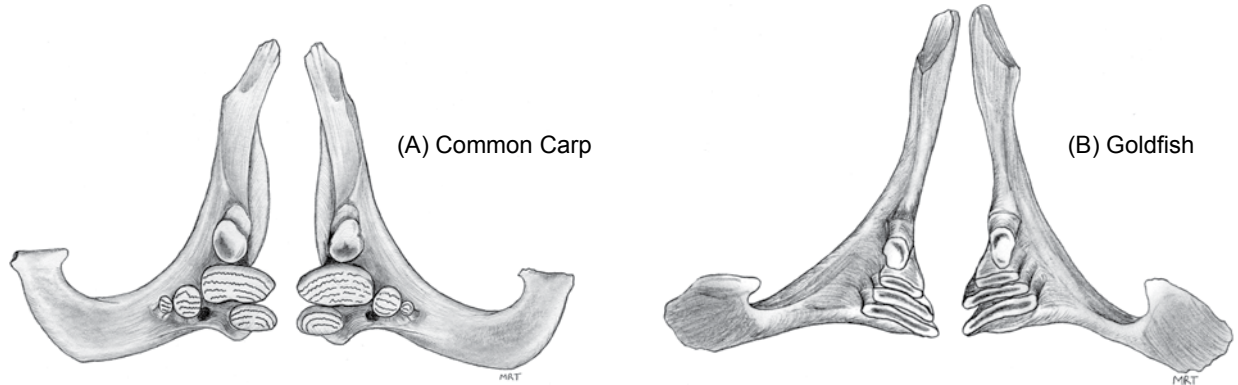

Figure 3. Pharyngeal teeth: (A) Common Carp [1,1,3-3,1,1], and (B) Goldfish [0,4-4,0].

3a. Upper margin of dorsal fin straight or slightly concave (fig. 4A); caudal fin deeply emarginate; rakers on first gill arch 37-52; spine-like ray of dorsal fin deeply serrated on posterior margin with 10-11 teeth (denticles) becoming markedly larger towards tip of ray; lining of abdominal cavity (peritoneum) darkly pigmented; no dark spot at base of caudal fin; color of wild types typically olivaceous or olive bronze, but cultured varieties may be white, silver, pink, gold, brassy gold, orange, or blotched orange, black, or a combination of these colors.
 **Goldfish** (*Carassius auratus*) Page 19

3b. Dorsal-fin margin slightly convex (fig. 4B); caudal fin slightly emarginate; rakers on first gill arch 22-33; spine-like ray of dorsal fin serrated on posterior margin, typically with 28-29 teeth (denticles) of about the same size; lining of abdominal cavity (peritoneum) light; a dark spot at the base of the caudal fin, more evident in juveniles but sometimes also present on adults; color typically coppery-gold but may be silvery-white.
 **Crucian Carp** (*Carassius carassius*) Page 25

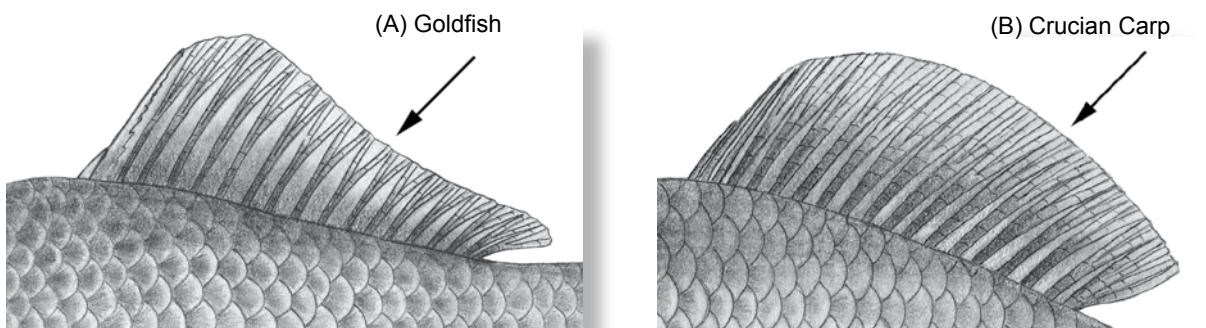

Figure 4. Concave dorsal fin of (A) Goldfish, and convex dorsal fin of (B) Crucian Carp.

- 4a. Scales small, 70 or more in lateral line.....Go to 5
- 4b. Scales large, fewer than 65 in lateral lineGo to 7

5a. A single small, thin barbel on each side of the head, on upper jaw near corner of mouth (fig. 5); belly rounded, without keel on venter; posterior margin of caudal fin straight or slightly forked; color of body variable, dark brown to black, to dark green or greenish yellow, often bronze or yellow below; one variety (“Golden Tench”) uniformly golden yellow with dark blotches.
 **Tench** (*Tinca tinca*) Page 73

5b. No barbels around the mouth; keel present, either along entire midline of belly or posterior to pelvic fin base; caudal fin distinctly forked; body color generally gray or silver above and white or cream belowGo to 6

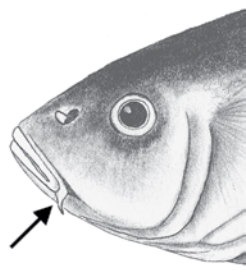

Figure 5. Head of Tench, showing single barbel near corner of jaw.

6a. Body color on sides generally uniformly gray or silver, without scattered irregularly shaped dark blotches; ventral keel long, extending along midline of belly from anus forward almost to junction of gill membranes (fig. 6A); rakers on first gill arch fused into a sponge-like structure (fig. 7A); when appressed, pectoral fin does not extend to base of pelvic fin.
 **Silver Carp** (*Hypophthalmichthys molitrix*) Page 45

6b. Body color on sides gray or silver with numerous small, irregularly shaped dark blotches; ventral keel relatively short, extending from anus forward to near origin of pelvic fins (fig. 6B); rakers on first gill arch long and slender, comb-like, not fused into a sponge-like structure (fig. 7B); when appressed, pectoral fin extends beyond pelvic fin origin.
 **Bighead Carp** (*Hypophthalmichthys nobilis*) Page 51

7a. Lateral-line scales fewer than 50 Go to 8

7b. Lateral-line scales 55-63..... **Ide** (*Leuciscus idus*) Page 56

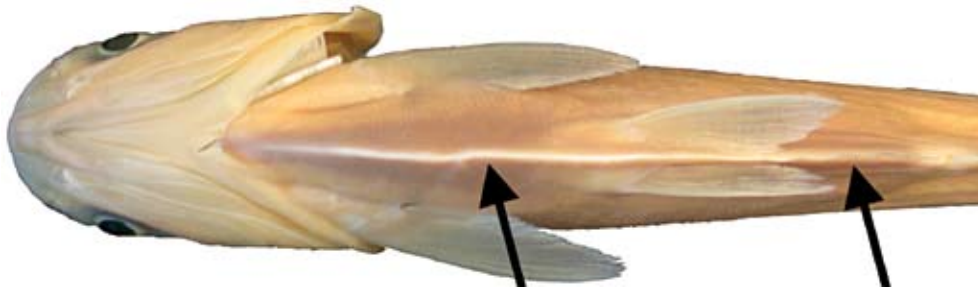

(A) Silver Carp



(B) Bighead Carp

Figure 6. Ventral keels: (A) Silver Carp, and (B) Bighead Carp.

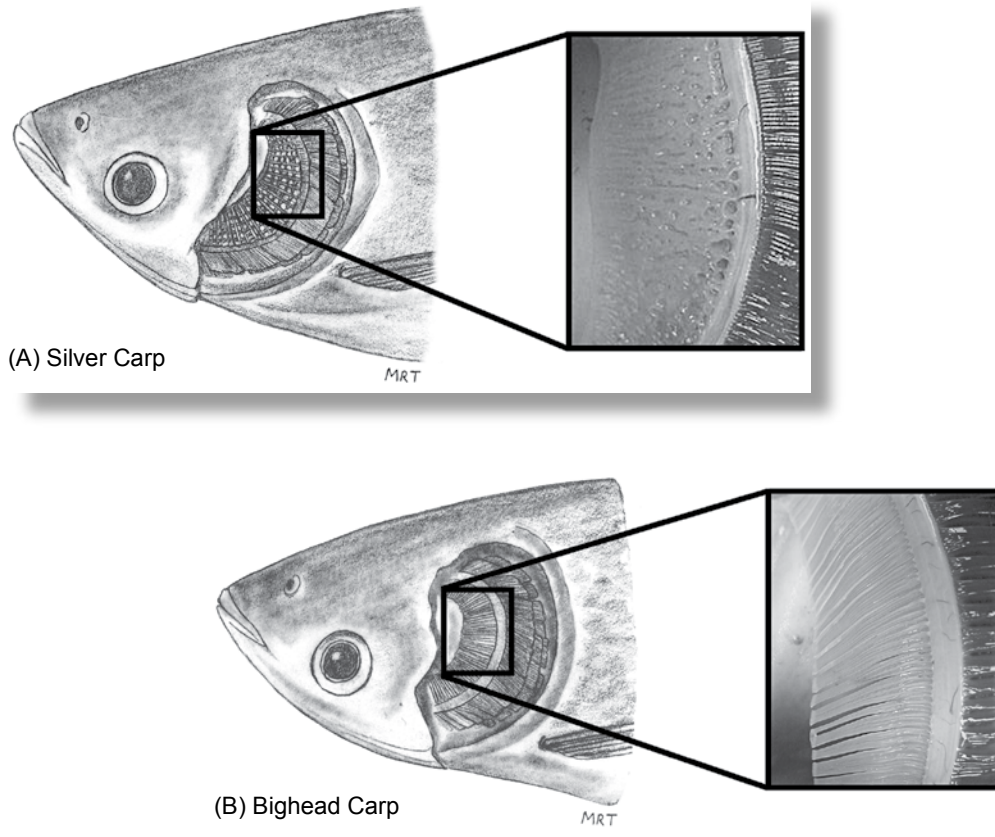

Figure 7. Gill rakers: (A) fused, sponge-like gill rakers of Silver Carp, and (B) slender, comblike rakers of Bighead Carp. (Gill raker photographs courtesy of David Ostendorf, Missouri Department of Conservation.)

- 8a. Keel present on belly between anus and base of pelvic fins (fig. 8).
..... **Rudd** (*Scardinius erythrophthalmus*) Page 67
- 8b. No keel on belly.....Go to 9

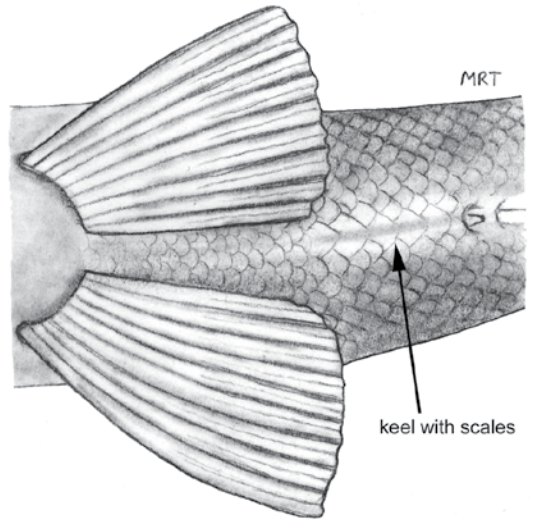

Figure 8. Keel of Rudd. Note: The native morphologically similar Golden Shiner has a similar keel (see fig. 49, p. 68).

- 9a. Pored scales in lateral line 35-45; origin of anal fin posterior to dorsal fin base; membranes of dorsal and anal fin of adults without red pigment; midlateral stripe on caudal peduncle absent; body cylindrical; adults often over 1 m TL.....Go to 10
- 9b. Pored scales in lateral line fewer than 12; origin of anal fin beneath dorsal fin base; membranes of dorsal and anal fins of adults with red pigment; distinct midlateral stripe present on caudal peduncle; body compressed, deep; adults rarely over 11 cm TL.
**Bitterling** (*Rhodeus sericeus*) Page 63
- 10a. Pharyngeal teeth elongate, with prominent grooves or serrations on grinding surfaces, hooks sometimes present, teeth typically 2,5-4,2 (fig. 9A); body typically olivaceous or silvery-white, may be olive-brown above and silver to white below; most fins only lightly pigmented (dusky), never black; lining of body cavity (peritoneum) silvery with dark mottling, large areas may be darkly pigmented (fig. 10A); 12-16 rakers on first gill arch.
 **Grass Carp** (*Ctenopharyngodon idella*) Page 31
- 10b. Pharyngeal teeth massive, molar-like, without hooks, generally smooth (not serrated or grooved), with wide masticatory surfaces, teeth typically in a single row with four or five on each side (fig. 9B), but two rows present in some individuals (in which case the outer row usually consists of a single small tooth, or very rarely two); body usually dark, often blue-gray or black, white or cream below; fins darkly pigmented, almost black; lining of body cavity (peritoneum) typically black (fig. 10B); 14-23 (usually 18-21) rakers on the first gill arch.
 **Black Carp** (*Mylopharyngodon piceus*) Page 59



Figure 9. Pharyngeal teeth: (A) Grass Carp, and (B) Black Carp.

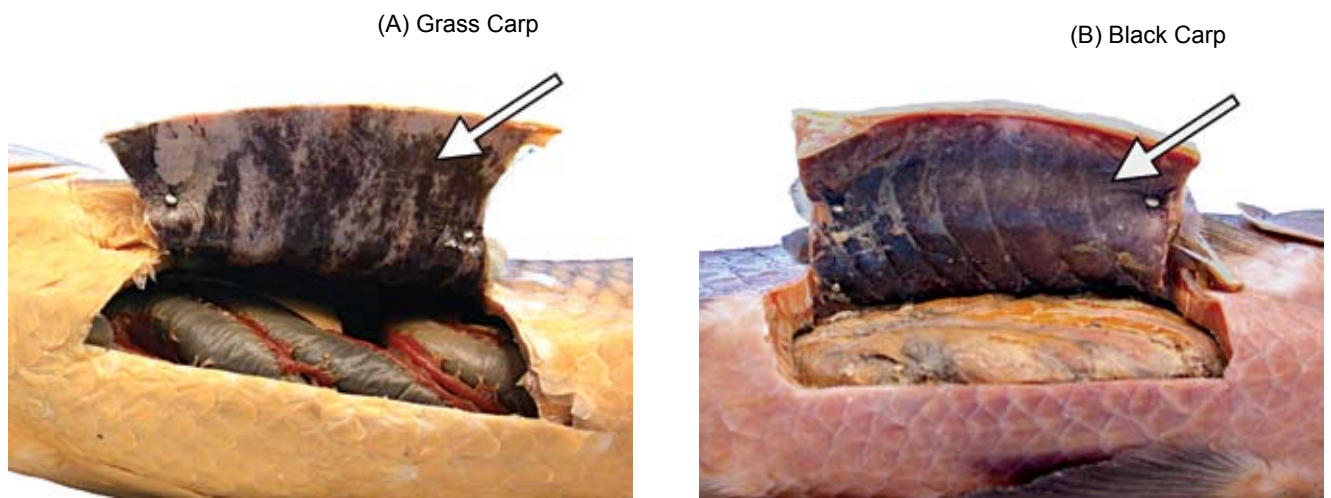

Figure 10. Body cavity linings: (A) Grass Carp, and (B) Black Carp.

Table of Characters.

[TL, total length; cm, centimeter; m, meter]

Scientific name	Common name	Maximum adult size (TL)	Pharyngeal teeth	Tooth morphology	Barbels	Body/fin pigmentation
<i>Carassius auratus</i>	Goldfish	59 cm	0,4-4,0	Somewhat molar-like, but narrow and smooth-edged, without extensive grinding surfaces	absent	Wild types typically olivaceous, but cultured varieties vary considerably
<i>Carassius carassius</i>	Crucian Carp	64 cm	0,4-4,0	Not molariform, without flattened grinding surfaces	absent	Body golden copper, darker dorsally; fins reddish; black spot at base of caudal (more evident in juveniles)
<i>Ctenopharyngodon idella</i>	Grass Carp	1.5 m	2,5-4,2 or 2,4-5,2	Prominent parallel grooves on grinding surfaces	absent	Dark grey or olivaceous dorsally, to silvery white laterally
<i>Cyprinus carpio</i>	Common Carp	at least 1 m	1,1,3-3,1,1	Molariform, with flattened grinding surfaces on main teeth	present (two on each side)	Body color brassy to yellow; lower fins often yellow-orange; considerable variation in cultured varieties
<i>Hypophthalmichthys molitrix</i>	Silver Carp	at least 1 m	0,4-4,0	Grinding surfaces striated	absent	Sides plain, lacking scattered dark blotches
<i>Hypophthalmichthys nobilis</i>	Bighead Carp	at least 1 m	0,4-4,0	Moderately long, bluntly rounded	absent	Sides with numerous small, irregularly shaped dark blotches
<i>Leuciscus idus</i>	Ide	1 m	3,5-5,3	Smooth, not serrated	absent	Dark dorsally and laterally above lateral line; lower portion of sides and belly silver; paired fins reddish
<i>Mylopharyngodon piceus</i>	Black Carp	2 m	0,4-5,0 or 0,5-4,0; sometimes with 1 or 2 small teeth in inner row	Massive, molar-like, smooth (not grooved), wide masticatory surfaces, no hooks	absent	Body and fins blue gray to black; ventral surface of head and abdomen grayish white
<i>Rhodeus sericeus</i>	Bitterling	11 cm	0,5-5,0	Serrate, hooked	absent	Dorsum gray-green; sides and belly silvery; fins pale orange; a gray-green stripe along mid-line of body from under dorsal fin to caudal peduncle
<i>Scardinius erythrophthalmus</i>	Rudd	45 cm	3,5-5,3	Serrate, hooked	absent	Dorsum brassy; upper sides silvery; median fins blood red in large nuptial males
<i>Tinca tinca</i>	Tench	80 cm	0,4-5,0 or 0,5-5,0	Molariform, with flattened grinding surfaces on main teeth; in juveniles wedge-shaped, slightly hooked at tip	present (one on each side)	Variable, dark brown, black, greenish or greenish yellow

Table of Characters. (Continued)

Common Name	Midventral keel	Gill rakers	Branched dorsal-fin rays	Lateral line scales	Branched anal-fin rays	Pectoral fin rays	Pelvic fin rays	Vertebrae	Peritoneum color
Goldfish	none	37-52	13-19, with long, stout serrated spinelike ray preceded by 1-3 rudimentary rays; posterior margin of spinelike ray with 10-11 denticles	26-33	5-6 branched rays, preceded by a serrated spinelike ray and 1-2 rudimentary rays	14-18	7-9	25-31	blackish
Crucian Carp	none	22-33	14-21, preceded by a stout, serrated spine and 2-3 rudimentary rays; posterior margin of spinelike ray with 28-29 fine denticles	28-37	5-8, preceded by a serrated spinelike ray and 1-2 rudimentary rays	14-16	8	31-34	light
Grass Carp	none	12-16	7-8	34-45	8-10	14-20	7-8	± 41	silvery with black blotches
Common Carp	none	18-36	15-23 rays, preceded by a stout serrated spine and 2-4 rudimentary rays; serrated spinelike ray with 10-15 denticles	32-40 (except some domesticated varieties)	4-6, preceded by a serrated spine-like ray and 1-3 rudimentary rays	14-19	7-9	31-38	
Silver Carp	Present, smooth, extends forward from anus almost to junction of gill membranes	Rakers on front of first gill arch fused into a sponge-like apparatus	7	91-124	11-14	16-17	7-8	± 37	
Bighead Carp	Present, smooth, extends forward only to junction of pelvic fins	Long and slender, not fused	7-10	91-120	10-17	16-19	7-9	± 38	
Ide	none	10-14	7-10	55-63	9-13	16-18	8	44-47	
Black Carp	none	14-23	7-9	39-46	7-9	16-18	8	37-41	blackish
Bitterling	none	9-16	7-13	0-10 pored; 32-45 total	6-11	12-13	8	32-38	
Rudd	present, scaled	10-13	8-10	37-43	9-13	15-17	7	37-40	silvery
Tench	none	10-16	6-9	70-120 scales deeply embedded in skin	5-9	13-18		35-44	



Anglers fishing for Carp and Goldfish in Beijing Canal, People's Republic of China, 2004. (Photo by Leo G. Nico.)

Species Accounts



Angler with Goldfish captured in canal in Beijing, People's Republic of China, 2004. (Photo by Leo G. Nico.)

Goldfish

Carassius auratus (Linnaeus 1758)

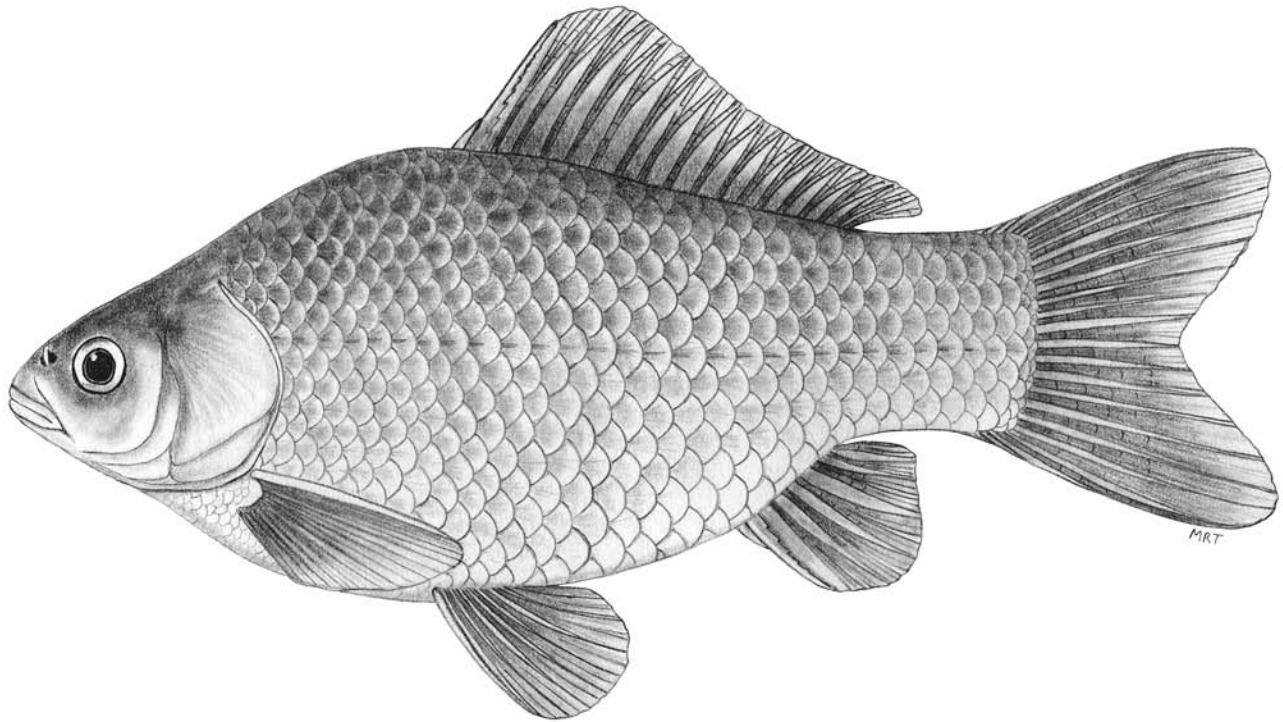

Figure 11. Goldfish, SIUC 22609, 122.5 millimeter SL, from Alexander County, Illinois.

Description

The Goldfish (fig. 11) is a robust, medium-sized cyprinid that generally reaches 15-20 cm TL and weighs 100-300 g (Szczerbowski, 2001). Maximum size is about 59 cm TL and 3 kg (IGFA, 2001). The lateral line is complete, typically with 26-33 scales (range 25-36). The mouth is terminal, slightly oblique, and lacks barbels. The dorsal fin is long with iii-iv (13-19) rays, and a stout, spine-like ray precedes the branched rays. The anal fin has ii-iii (5-6) rays. The caudal fin is deeply emarginate and the belly lacks a keel. Pharyngeal teeth are in one row (0,4-4,0) and are somewhat molar-like, but narrow and smooth edged, without extensive grinding surfaces (fig. 12). Gill rakers on the first arch number 37-53. The peritoneum is blackish. Sexual dimorphism is not pronounced (Dombrowski, 1964, *in* Szczerbowski, 2001). Wild Goldfish are typically olive-green, gray, or silver; ornamental forms exhibit a range of colors (see section on variation, below). Breeding males may develop small nuptial tubercles

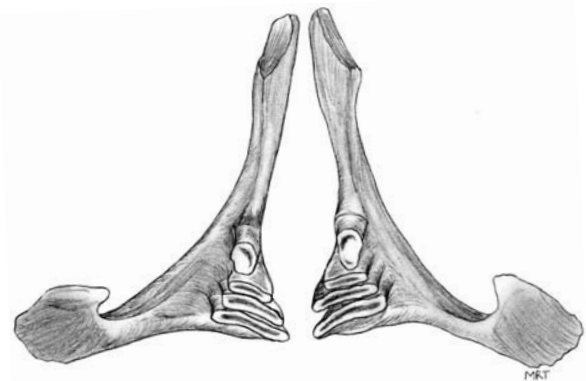

Figure 12. Pharyngeal teeth (0,4-4,0) of Goldfish, SIUC 22609, 122.5 millimeter SL, from Alexander County, Illinois. (Also see fig. 3, p. 8.)

on the operculum, dorsum, and pectoral fin rays (Coad, 2005). These structures are white and small; often giving the false impression the fish is infected with the disease “ich.” Meristics for Goldfish are given in appendix B.

Similar Species

The long dorsal fin of the Goldfish, with a strong, serrated, spinous ray followed by 13 or more branched rays, distinguishes it from most native North American cyprinids, which typically have fewer than 11 rays and usually lack the spine-like ray. Goldfish superficially resemble suckers (family Catostomidae), particularly buffalos (genus *Ictiobus*) and carpsuckers (genus *Carpiodes*); however, suckers do not have spine-like rays in the dorsal and anal fins.

Among foreign nonindigenous cyprinids, the Goldfish most closely resembles the Common Carp and Crucian Carp. Goldfish lacks barbels, which readily distinguishes it from the Common Carp (that has two pairs of barbels). Differences between larval Goldfish and Common Carp were illustrated by Gerlach (1983). Goldfish is distinguished from Crucian Carp by its straight or slightly concave dorsal-fin margin, blackish peritoneum, a deeply emarginate caudal fin, and the absence of a spot at the base of the caudal fin. Crucian Carp has a slightly convex dorsal-fin margin, light peritoneum, a slightly emarginate caudal fin, and a blackish spot at the base of the caudal fin that is more apparent in juveniles. The posterior margin of the large, spine-like dorsal ray has 10-11 large denticles in Goldfish versus 28-29 small denticles in Crucian Carp. Additionally, the Goldfish is typically slightly less deep-bodied than Crucian Carp. The pharyngeal teeth of Goldfish and Crucian Carp are nearly identical.

Variation

The Goldfish exhibits a wide range of sizes, shapes, and colors of the body and fins. Much of the variation is the result of artificial breeding, and some is due to natural causes associated with age or growth changes. For example, as observed in many species, there is an increase in the number of gill rakers on the first arch with growth (Dombrovski, 1964, in Szczerbowski, 2001). Artificial selection from a long history of culture has also intensified variability in body shape and color.

The Goldfish was probably the first cultured fish; its domestication began thousands of years ago in China (Balon, 1995). The classic cultured form, known to aquarists as “Fancy Goldfish” (fig. 13), is reddish golden with yellow fins; however, artificial selection by breeders has produced a number of varieties for the pet trade (for example, Comets, Veiltails, and Shubunkins). Several varieties have been produced with body colors of red, white, gold, black, and combinations of these. Some varieties have been produced that lack a dorsal

fin, others have greatly elongated fins (especially the caudal) or multiple fins (especially the caudal and anal), and some have telescoping eyes (for example, Péntzes and Tölg, 1983). Some cultivars may be variegated and some have no scales. These colorful forms are in contrast to the wild type, which is generally olivaceous, varying in color from gray-green, green-brown or gray (fig. 14). Wild populations of Goldfish often revert to olive-green coloration, presumably because the brightly colored ones are eliminated by bird and fish predators (Moyle, 2002; Wydoski and Whitney, 2003).

In treating *Carassius auratus*, recent authorities often recognize two subspecies: *Carassius auratus gibelio* (Bloch, 1783), commonly known as Prussian, Silver Crucian, European Goldfish, or Gibel Carp; and *Carassius auratus auratus*, generally referred to as Goldfish. However, the taxonomy of the genus *Carassius* is not fully understood due to a combination of confounding factors, including wide morphological variation within purported species, overlap in morphology between species (and also between subspecies), widespread introductions, high frequency of hybridization, and other genetic complexities such as triploidy (Fuller and others, 1999; Iguchi and others, 2003). In addition to other nomenclatural disagreements, some authors recognize *gibelio* as a separate species rather than a subspecies under *C. auratus*. According to Coad (2005), elongate specimens (morpha *humilis*) occur where fish density is high, and deep-bodied specimens (morpha *vovki*) occur where fish density is low; however, the author noted that the names *humilis* and *vovki* have no taxonomic significance. To add to the confusion, Bănărescu (1964) described the same type variation in body shape for *Carassius carassius* (see section on variation under account on the Crucian Carp). Whether *Carassius auratus* is a highly variable species as opposed to a complex of multiple species may only be resolved by further investigation combining morphological and molecular analyses.

The Goldfish naturally hybridizes with Common Carp (see appendix B for meristics) and Crucian Carp, giving rise to individuals that are intermediate in morphology between the two parent species (Smith, 1979; Szczerbowski, 2001). A natural intergeneric hybrid of *Barbus sharpeyi* and *Carassius auratus* was recently described from a small lake in Iran (Al-Mukhtar and Al-Hassan, 1999, cited by Coad, 2005). However, there are no known hybrids with North American cyprinids. For a listing of other known hybrids between Goldfish and various Old World species, refer to Schwartz (1972, 1981).



Figure 13. Cultured (fancy) form of Goldfish; 110 millimeter SL adult purchased from pet store.
(Photo copyright © Richard T. Bryant.)



Figure 14. Wild (olivaceous) form of Goldfish; 170 millimeter SL adult, from Douglas Reservoir, Tennessee.
(Photo copyright © Richard T. Bryant.)

Reproduction

Sexual maturity is reached at 1-2 years of age, and reproduction occurs annually for about 6-7 years (Robison and Buchanan, 1988). Females scatter their adhesive eggs over vegetation, roots, or other fixed objects (Hensley and Courtenay, 1980; Robison and Buchanan, 1988). The Goldfish is a batch

spawner, reproducing in the spring and summer when temperatures are above 16 °C (Robison and Buchanan, 1988). Eggs take 3-7 days to hatch, depending on temperature (Wheeler, 1969; Moyle, 2002; Boschung and Mayden, 2004). Egg and larval development were described in Nakamura (1969) and Jones and others (1978). Exceptional camera lucida illustrations of egg and larval development were presented in Battle (1940).

Ecology

Goldfish may reach 59 cm TL and up to 3.0 kg (IGFA, 2001); however, they generally reach only 15-20 cm TL and weigh 100-300 g (Szczerbowski, 2001). Lifespan is typically 6-7 years, but has been reported as long as 30 years (Essing, 1898, *in* Carlander, 1969).

Typical habitat includes the quiet backwaters of streams and pools, especially those with submerged aquatic vegetation (Hensley and Courtenay, 1980; Trautman, 1981; Robison and Buchanan, 1988). The Goldfish is tolerant of high levels of turbidity (Wallen, 1951), temperature fluctuations (reviewed by Spotila and others, 1979), and low levels of dissolved oxygen (Zhadin and Gerd, 1963; Walker and Johansen, 1977). Laboratory results reported pH tolerance levels between 4.5-10.5, and a preference for pH levels between 5.5-7.0 (Szczerbowski, 2001). Although laboratory tests suggested that eggs and fry are not particularly salinity tolerant (Murai and Andrews, 1977), the Goldfish is reported to live in salt lakes on the coast of the Black Sea and to inhabit the floodplain of the Ob delta in Russia (Zhadin and Gerd, 1963). The Goldfish has been captured in waters with salinities as high as 17 parts per thousand (ppt) (Schwartz, 1964), although studies have shown an inability to withstand long exposures exceeding 15 ppt (Lockley, 1957). Adults thrive equally well in salinities between 0-6 ppt (Canagaratnam, 1959), and can survive water temperatures between 0-41 °C (Carlander, 1969; Moyle, 2002). Additionally, the species is more tolerant of aquatic pollution than most native North American fishes (Robison and Buchanan, 1988).

The omnivorous diet includes planktonic crustaceans, phytoplankton, insect larvae, fish eggs and fry, benthic vegetation, and detritus (Scott

and Crossman, 1973; Hensley and Courtenay, 1980; Robison & Buchanan, 1988; Moyle, 2002). Foraging Goldfish may create high levels of turbidity, which can result in the decline of aquatic vegetation (Richardson and others, 1995).

Native Distribution

The Goldfish is native to Eastern and Central Asia, including China, Russia, Korea, and possibly Japan and Taiwan (Wheeler, 1978; Szczerbowski, 2001). It may also be native to parts of eastern Europe (Raicu and others, 1981); however, widespread transfer over several centuries has obscured the natural distribution.

U.S. Introductions

The Goldfish is thought to be the first foreign fish species introduced to North America (De Kay 1842; Courtenay and others, 1984; Fuller and others, 1999). The first recorded releases in the U.S. probably occurred during the late 1600s (De Kay, 1842; Courtenay & Stauffer, 1990), and the species is now reported in all states except Alaska (Fuller and others, 1999). The Goldfish is raised for the aquarium trade (as both an ornamental and live food), as bait for anglers, and as forage in fish hatcheries. Bait dealers in coastal regions along the Gulf of Mexico sometimes sell Goldfish under the names “Black Saltys” or “Black Salties.” Although not typically eaten by humans in the U.S., it is a valued food fish in China. Escapes from aquaculture facilities and deliberate releases have resulted in the establishment of localized populations across much of the U.S. The exact distribution is difficult to ascertain, as introductions continue intermittently throughout much of the country.

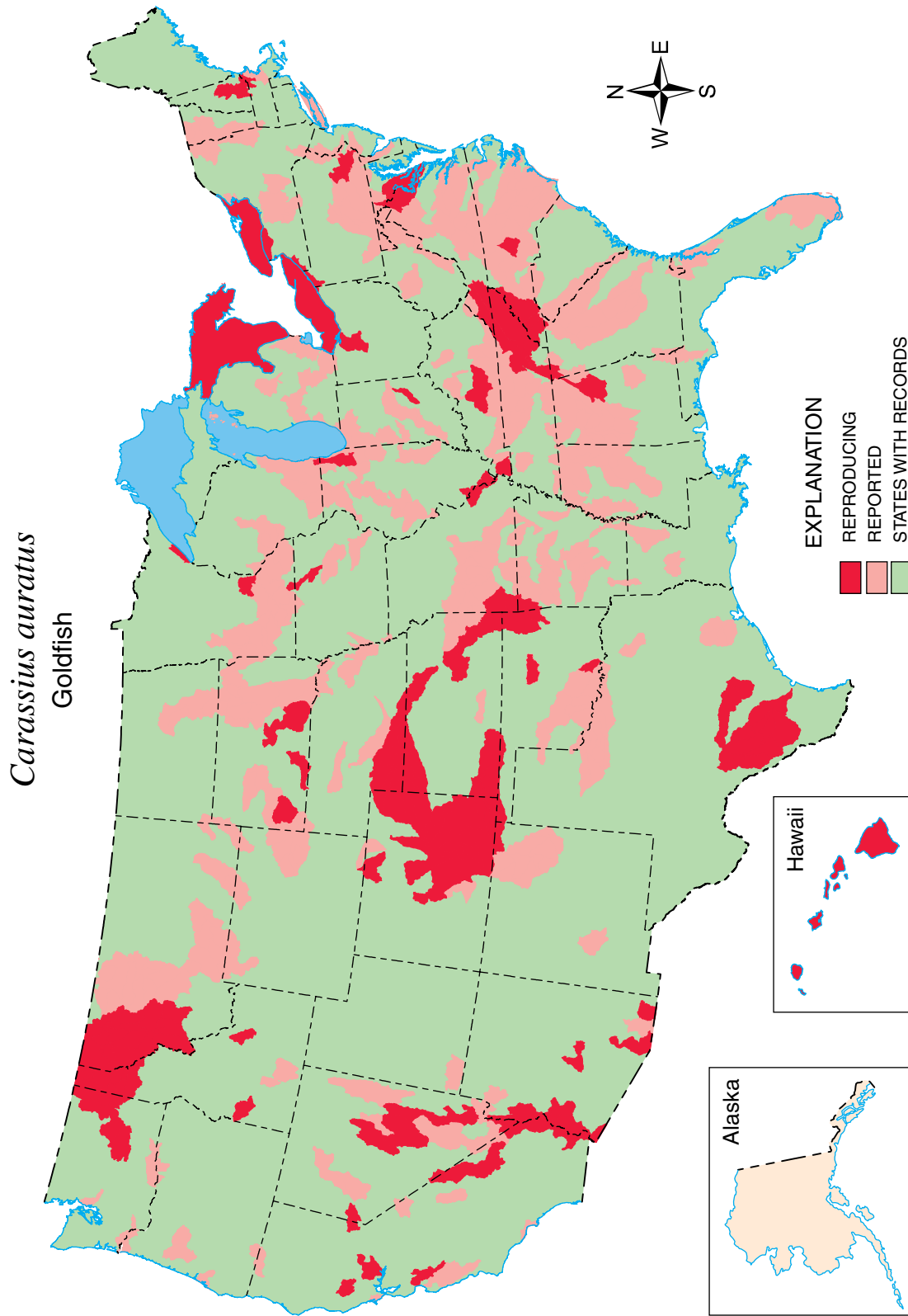

Plate 2. Distribution of Goldfish in the United States. See Methods for details regarding data used to create maps, definitions of “reproducing” and “reported” and shading of HUCs and states.



Crucian Carp from Denmark. Upper photo from Værløse, Denmark; lower photo from Danmarks Akvarium (Denmark's Aquarium), Charlottenlund. (Photos copyright © www.jjphoto.dk, courtesy of Johnny Jensen.)



Crucian Carp

Carassius carassius (Linnaeus 1758)

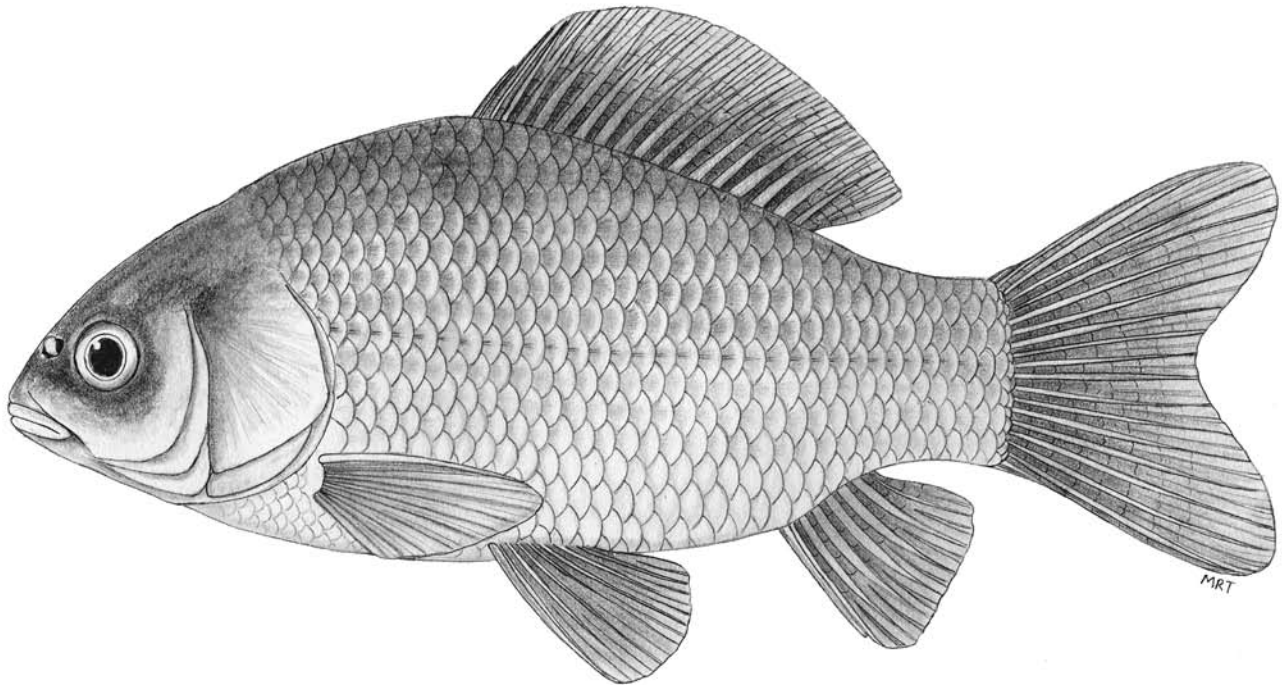

Figure 15. Crucian Carp, UF 30247, 101 millimeter SL, from Yeosu, South Korea.

Description

The Crucian Carp (fig. 15) is medium-sized fish, usually <50 cm TL and 1.8 kg (Wheeler, 1978). Maximum size is about 64 cm TL (IGFA, 2001) and 5 kg (Berg, 1964). Typically, individuals are deep-bodied and laterally compressed (fig. 16); however, a slender “shallow-bodied” variety also exists (fig. 17). The dorsal fin has iii-iv (14-21) rays and a stout, spine-like ray precedes the branched rays. The anal fin has ii-iii (5-8) rays. The mouth is terminal and oblique, and the peritoneum is pale. The lateral line is complete, with 28-37 relatively large scales. The pharyngeal teeth are in one row (0,4-4,0; fig. 18). Gill rakers on the first arch count 22-33. The body is golden copper, darker dorsally, with reddish fins. Sexual dimorphism is not pronounced (Szczerbowski and Szczerbowski, 2001). Meristics are given in appendix B.

Similar Species

The long dorsal fin of the Crucian Carp, with a strong, serrated spine-like ray followed by 15 or more branched rays, distinguishes it from most native North American cyprinids, which usually lack the spine-like ray and typically have fewer than 11 branched dorsal rays.

Of the foreign nonindigenous cyprinids, the Crucian Carp most closely resembles the Goldfish and Common Carp. Crucian Carp is distinguished from Goldfish by its slightly convex dorsal-fin margin and slightly emarginate caudal fin; juvenile and young adult Crucian Carp have a black spot at the base of the caudal fin. The Goldfish has a straight or slightly concave dorsal-fin margin, a deeply emarginate caudal fin, and lacks the spot at the base of the caudal fin. The typical form of the Crucian Carp is slightly deeper bodied than Goldfish. Denticles on the posterior margin of the spine-like dorsal ray are smaller and more numerous in Crucian Carp (28-29) than in Goldfish (10-11). Crucian Carp lacks barbels, which distinguishes it from Common Carp.

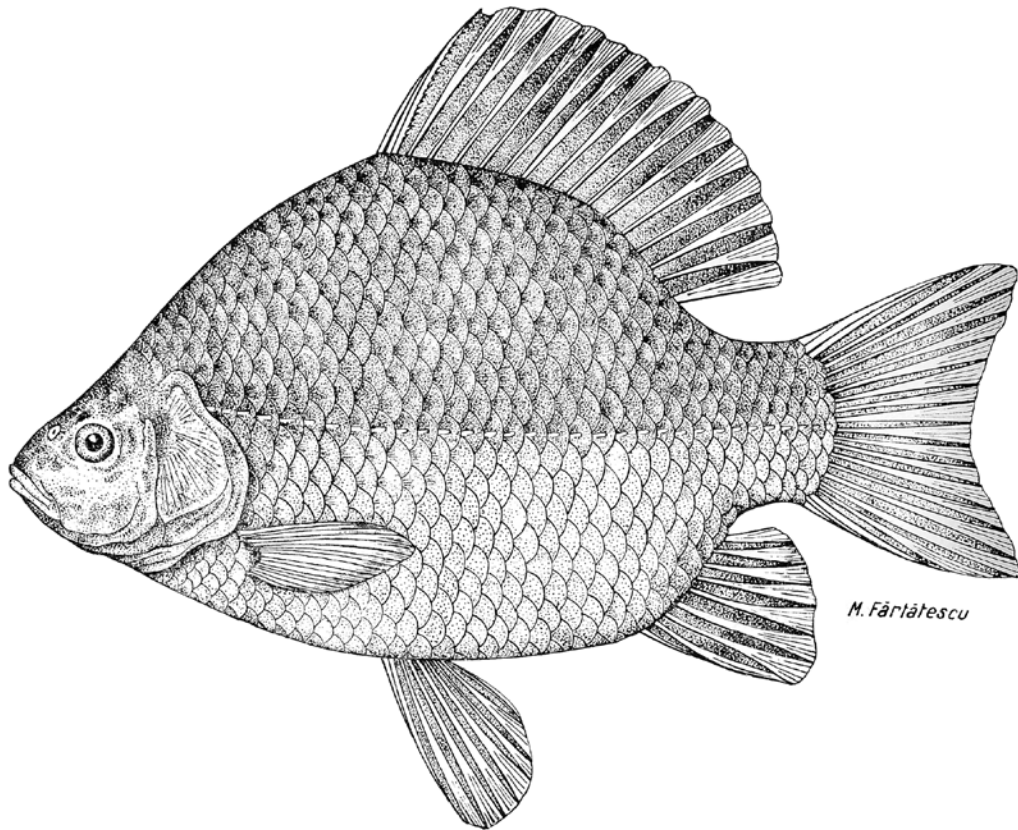

Figure 16. Deep-bodied form of Crucian Carp. (After Antipa (1909); from Bănărescu (1964); reprinted with permission.)

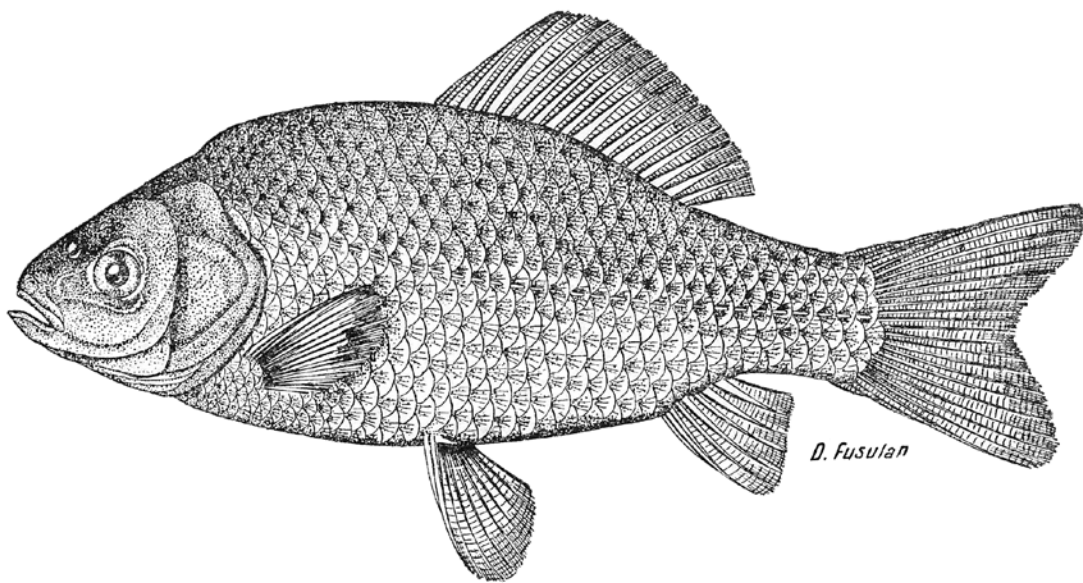

Figure 17. Slender (*humilis*) form of Crucian Carp. (From Bănărescu (1964); reprinted with permission.)

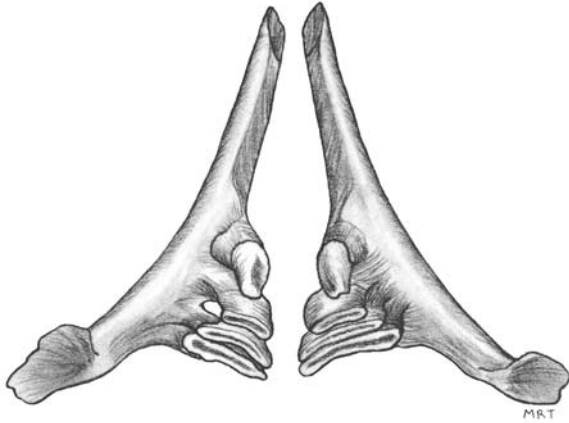

Figure 18. Pharyngeal teeth (0,4-4,0) of Crucian Carp, UF 30247, 101 millimeter SL, from Yeosu, South Korea.

Variation

Due to ecological factors, such as predatory pressure, Crucian Carp varieties can be either deep bodied or shallow bodied (Holopainen and others, 1997). The typical deep-body form is strongly arched dorsally (fig. 16), whereas the shallow-body form, referred to as *humilis* (Bănărescu, 1964), is more fusiform (fig. 17). Many of the systematic problems mentioned in our account on Goldfish also apply to Crucian Carp.

The Crucian Carp regularly hybridizes with Common Carp (Bănărescu, 1964; Berg, 1964; Lin and Peter, 1991). An illustration of a hybrid Crucian Carp X Common Carp originally published by Antipa (1909), appears in Bănărescu (1964, p. 504). Meristics of Crucian Carp X Common Carp hybrids are given in appendix B. The Crucian Carp also hybridizes with Goldfish (Szczerbowski, 2001). Attempts to crossbreed Crucian Carp with other cyprinids (including Grass Carp, Rudd, and Tench) produced hybrids with high levels of mortality (Kasama and Kobayasi, 1989, 1990; and Riabov, 1979, in Szczerbowski and Szczerbowski, 2001).

Reproduction

Age at sexual maturity varies with environmental conditions, with individuals in warmer regions generally maturing faster than those in colder ones. Most Crucian Carp mature between 2-5 years of age, with males generally maturing a year earlier than females. The species is a batch spawner, releasing adhesive eggs over vegetation when water temperatures rise above 18 °C (Aho and

Holopainen, 2000; Szczerbowski and Szczerbowski, 2001). The eggs are spherical, yellow-orange, and are about 1.5 mm in diameter (Laurila and Holopainen, 1990). The eggs remain attached to vegetation until they hatch in about 4 days at 20 °C (Laurila and others, 1987). The larvae possess an adhesive gland on the forehead, which allows them to adhere to submerged vegetation until the yolk sac is absorbed about 10 days after hatching (Szczerbowski and Szczerbowski, 2001). Egg, larval, and juvenile development were described in Laurila and Holopainen (1990).

Ecology

The Crucian Carp typically grows to about 50 cm TL and 1.8 kg (Wheeler, 1978); however, individuals may attain sizes of up to 64 cm TL (IGFA, 2001) and 5 kg (Berg, 1964). The maximum lifespan of wild Crucian Carp is about 10 years (Szczerbowski and Szczerbowski, 2001). Habitat generally includes shallow, slow-flowing parts of rivers, lakes, and ponds with abundant submerged aquatic vegetation. The species is capable of inhabiting temporary ponds by burying into mud as water levels decrease (sometimes for several weeks) until normal water levels become available again (Rybkin, 1958, in Szczerbowski and Szczerbowski, 2001). Predation may significantly alter densities and size-structures of populations. A Swedish study showed that lakes containing predators often contained high densities of shallow-bodied Crucian Carp, whereas lakes without predators contained larger, deep-bodied individuals (Brönmark and others, 1995; Holopainen and others, 1997). The Crucian Carp is a remarkably hardy fish. Historical accounts report the species can live for hours out of the water, and can survive packaging and transport in snow or damp leaves (Seeley, 1886). Like Goldfish, the Crucian Carp is tolerant of low-oxygen conditions and high turbidity. Survival has been documented at water temperatures below 0 °C, and individuals may even survive for a few days with a frozen integument (Szczerbowski and Szczerbowski, 2001). The preferred temperature for Crucian Carp was reported as 27 °C and the upper lethal temperature was 38.5 °C (Hellawell, 1986). The ability to use anaerobic metabolism allows Crucian Carp to survive for several months in anoxic water at low temperatures, for example, in lakes frozen over with ice (Holopainen and Hyvärinen, 1984; Piironen and Holopainen, 1986). In their native range, feeding may stop for several months as the fish rest in a state of “suspended animation” during winter months when ponds become anoxic and covered with

ice (Zhadin and Gerd, 1963; Penttinen and Holopainen, 1992). In addition to depressing cellular energy demands, the Crucian Carp was reported to respond to anoxia by decreasing its swimming activity by about 50 percent of that displayed during normoxia (Nilsson and others, 1993). Crucian Carp can survive indefinitely over a pH range of 4.0-10.5 (Hellowell, 1986). There is some evidence that the species is tolerant to low levels of salinity. For example, in parts of the former Soviet Union, the Crucian Carp inhabits brackish lakes of the steppe with salinities to 16 ppt, and spawns in the saline Volga River Delta (Zhadin and Gerd, 1963).

The Crucian Carp is omnivorous (Prejs, 1973), and its diet varies seasonally (Penttinen and Holopainen, 1992). Diet studies report a predominance of cladocerans as well as trichopterans, rotifers, ostracods, copepods, chironomids, ephemeropterans, nematodes, algae, detritus, and plant matter (Prejs, 1973; Penttinen and Holopainen, 1992).

Native Distribution

The Crucian Carp is native to Europe and Asia. For details of the native range, refer to Szczerbowski and Szczerbowski (2001).

U.S. Introductions

Over the past two centuries, there have been a few scattered reports of the occurrence of Crucian Carp in the U.S. (possibly involving hybrids with either Goldfish or Common Carp). Meek and Hildebrand (1910) reported Crucian Carp thriving in the lagoons and parks of Chicago. However, a more recent work on Illinois fishes (Smith, 1979) suggested this population disappeared long ago. There are no recent reports of established populations of Crucian Carp in the U.S. An earlier report that the species had been introduced into Texas (see Fuller and others, 1999) is now considered unlikely. Robert Howells (Texas Parks and Wildlife Department, personal commun, 2004) believes that the species was never introduced into Texas and that earlier reports were probably based on Goldfish. Although the status of previous introductions is uncertain, fish farmers in Arkansas have recently been contacted by commercial fish markets about the possibility of culturing the species for the live-food fish trade in the U.S. Future importation of Crucian Carp may lead to its introduction and possible establishment. Consequently, its introduction and status remain uncertain. For additional details, refer to Fuller and others (1999).

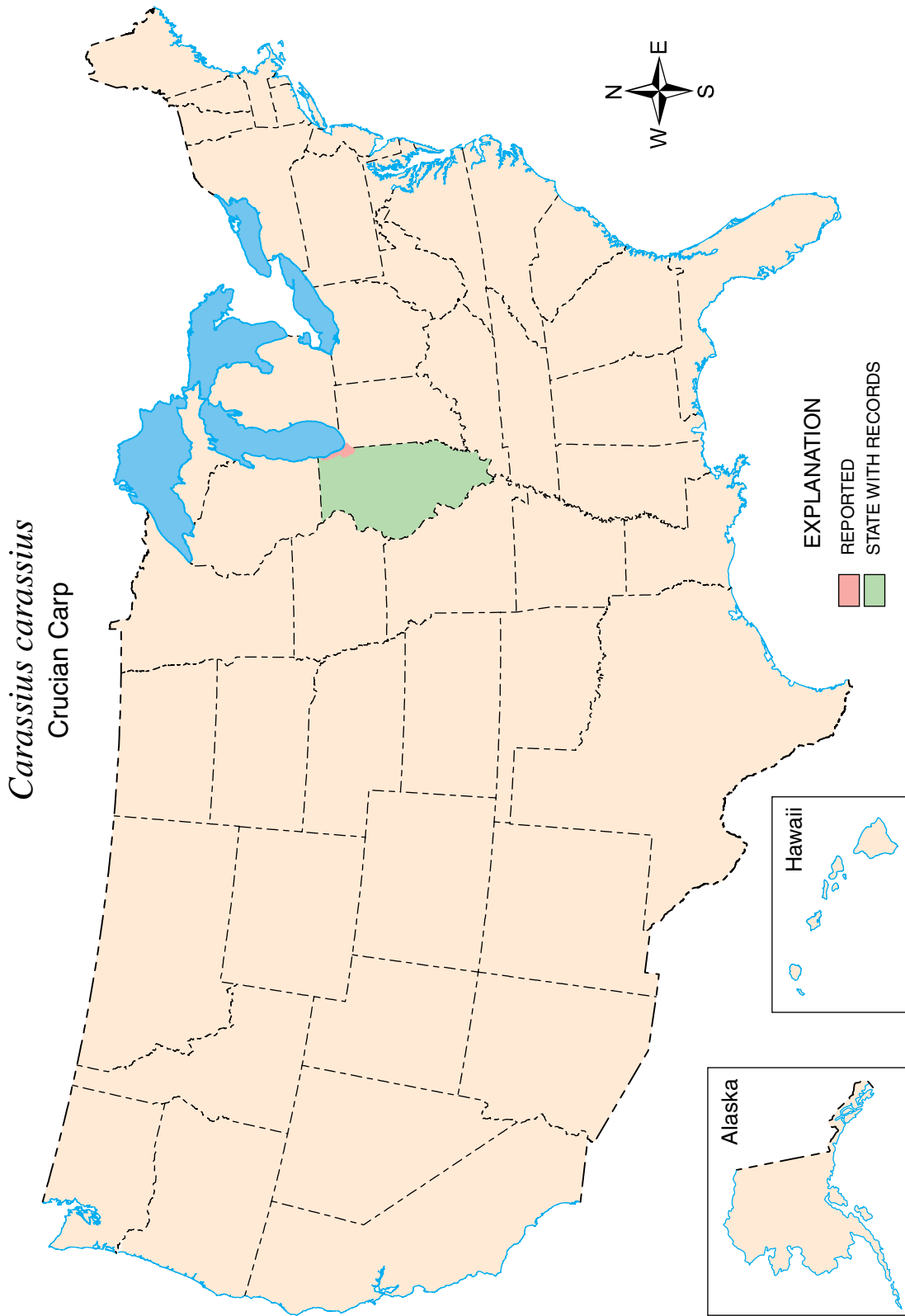

Plate 3. Distribution of Crucian Carp in the United States. See Methods for details regarding data used to create maps, definition of “reported” and shading of HUCs and states.



Commercial fisherman with Grass Carp netted from river in Louisiana, 2004. (Photo by Rusty Kimble.)

Grass Carp

Ctenopharyngodon idella (Valenciennes 1844)

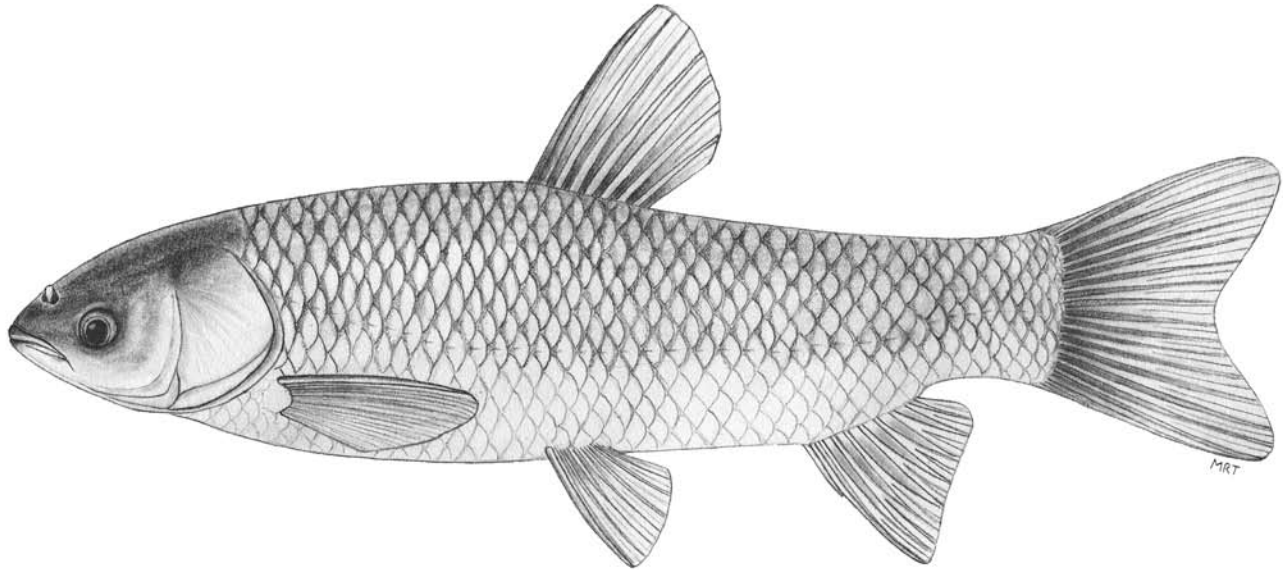

Figure 19. Grass Carp, SIUC 23044, 289 millimeter SL, from Alexander County, Illinois.

Description

The Grass Carp (fig. 19) is a large species, often reaching over 1 m TL. Maximum size is about 1.5 m TL and 45 kg or more (Robison and Buchanan, 1988; Etnier and Starnes, 1993; Laird and Page, 1996). The species has an oblong body, wide head, and rounded belly. The dorsal fin has i-iii (7-8) rays. The anal fin is set far to the rear on the body and has ii-iii (8-10) rays. The origin of the dorsal fin is anterior to the pelvic-fin base. Both dorsal and anal fins are rounded. The caudal fin is deeply forked. All fins are soft-rayed. The lateral line is complete, with 34-45 scales, and is slightly decurved. The mouth is terminal, somewhat oblique, and lacks barbels. The eyes are at the approximate level of the axis of the body or slightly higher. The gill rakers are short, unfused, widely set, and number 12-16 on the first arch. The pharyngeal teeth have deep grooves, are in two rows, and may count 2,5-4,2; 2,4-4,2; or 2,4-5,2 (fig. 20; Shireman and Smith, 1983). Scales along the dorsum and sides are usually dark-edged, giving a cross-hatched effect. Juvenile Grass Carp are silvery (fig. 21). Adults are often dark gray along the dorsal surface and brassy

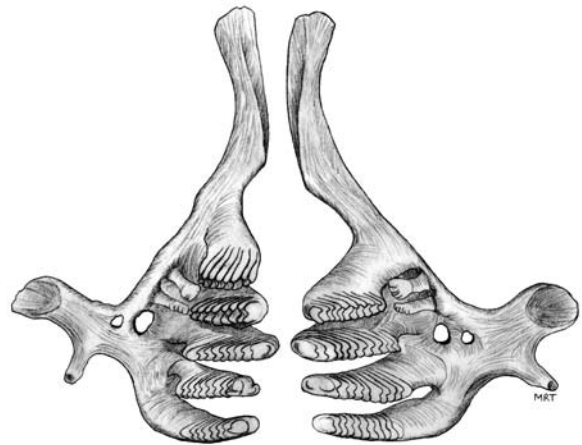

Figure 20. Pharyngeal teeth (2,4-5,2) of Grass Carp, SIUC 23044, 289 millimeter SL, from Alexander County, Illinois. (Also see to fig. 9, p. 13.)

along the sides of the body (fig. 22). In some situations, the species may appear much darker and olivaceous on the dorsal surface (fig. 23). The fins are typically green-gray to dull silver. Grass Carp meristics are given in appendix B.



Figure 21. Subadult male Grass Carp, 218 millimeter SL, from Lonake Hatchery, Arkansas. (Photo by Noel Burkhead.)



Figure 22. Adult Grass Carp, 559 millimeter SL, from Malone Fish Hatchery, Arkansas. (Photo copyright © Richard T. Bryant.)



Figure 23. Adult Grass Carp, 455 millimeter SL, from Reelfoot Lake, Tennessee. (Photo copyright © Richard T. Bryant.)

Although both sexes may develop breeding tubercles, they typically appear only on males. Breeding tubercles may occur along the upper surface of the pectoral fins, the ridges of the pectoral-fin rays, on the first dorsal-fin ray, and over the dorsal surface of the caudal peduncle (Opuszynski and Shireman, 1995).

Similar Species

The Grass Carp can be distinguished from native cyprinids by the position of its anal fin, which is set far back on the body (fig. 19) and the deep lateral grooves in its pharyngeal teeth (fig. 20). Native cyprinids have an anal fin that is more anterior than that of the Grass Carp, and have pharyngeal teeth that lack deep lateral grooves.

The Grass Carp closely resembles Black Carp, but can be distinguished by its pharyngeal teeth and (in most cases) body color. The Grass Carp has long, serrated pharyngeal teeth (sometimes with hooks) whereas those of adult Black Carp are smooth and molariform. Adult Grass Carp are lighter in color than Black Carp, especially the fins. For additional characteristics useful in distinguishing Black Carp from Grass Carp, refer to the Black Carp species account.

Variation

Concern over ecological impacts in natural systems has resulted in widespread use of triploid Grass Carp that are presumably sterile (Clugston and Shireman, 1987). Morphologically, triploids are indistinguishable from (fertile) diploids (Bonar and others, 1988). Triploid Grass Carp may be produced using heat, pressure, or chemical shocking of the fertilized eggs (Clugston and Shireman, 1987; Opuszynski and Shireman, 1995). However, because most treatments used to create triploid Grass Carp are not 100 percent effective, the ploidy of each fish must be verified (that is, either diploid, $2n$ or triploid, $3n$). Ploidy is typically determined by analysis of blood taken from live or freshly killed specimens. The preferred technique uses a particle sizer (for example, Coulter Counter©) with a channelyzer to estimate ploidy by analyzing the distribution of red blood cell nuclear volumes (Wattendorf, 1986).

Before widespread use of triploid Grass Carp became the main alternative to releasing reproductively viable (diploid) individuals, there was limited production and release of a sterile hybrid formed by crossing female Grass Carp with male Bighead Carp (Fuller and others, 1999; Nico, 2005). The resulting offspring of this cross had closely spaced gill rakers and an abdominal keel like the paternal Bighead Carp, as well as pharyngeal

teeth and an elongated body resembling the maternal Grass Carp (Berry and Low, 1970; Verigin and others, 1975; Kilambi and Zdinak, 1981). Although hybrids can allegedly feed on either plankton or macrophytes, Kilambi and Zdinak (1982) reported a preference for zooplankton. Karyology of the hybrid was given in Márián and Krasznai (1978) and Beck and others (1980). Kilambi and Zdinak (1981) described the hybrid larvae. Meristics for Grass Carp X Bighead hybrids are given in appendix B.

Grass Carp have been artificially hybridized with Common Carp (Makeyeva and Verigin, 1974a; Stanley and Jones, 1976; Avault and Merowsky, 1978), Bighead Carp (Andriasheva, 1968; Beck and others, 1980), Silver Carp (Andriasheva, 1968) and Black Carp (Makeyeva and Verigin, 1993).

Reproduction

Sexual maturity is reached at an average age of 2-5 years in subtropical/tropical areas and 4-7 years in temperate regions (Alikunhi and Sukumaran, 1964; Bardach and others, 1972). Males generally mature a year earlier than females (Opuszynski and Shireman, 1995). Shireman and Smith (1983) reported that Grass Carp may mature earlier than these averages. For example, mature 1-year old males and 2-year old females were documented in tropical India and Malaysia (Hickling, 1967). Alternately, maturation can take 9-10 years in cold climates (Makeeva, 1963, *in* Hickling, 1967). The condition of gonads through the stages of development was reviewed by Opuszynski and Shireman (1995). Fecundity has been found to range widely, from 255,000-2,000,000 eggs (Vinogradov and others, 1966; Gorbach, 1972; Shireman and Smith, 1983; Opuszynski and Shireman, 1995), and fecundity reportedly increased with age and mass (Gorbach, 1972). Egg and larval development were described by Bailey and Boyd (1970) and Nakamura (1969). Although Grass Carp spawning commonly occurs in large rivers, Tang (1960a,b) reported an unusual instance of a few spawning events in a Taiwan reservoir. The success of those particular spawning events is uncertain (Nico and others, 2005). Krykhtin and Gorbach (1981), who studied the downstream drift of Grass Carp eggs in the Amur Basin, determined that spawning occurred at water temperatures between 17- 26 °C, with peak activity at 21-26 °C. Stanley and others (1978) reviewed literature from Asia and Europe on requirements for spawning, including temperature, water level fluctuation, and spawning site characteristics.

Spawning Requirements of Chinese Carps

(Silver, Grass, Bighead, and Black Carps)

In general, the four species of Chinese carps require large riverine environments for successful reproduction (Nico and others, 2005). Both migration and spawning activities are initiated in response to a combination of physical and hydrologic changes, such as increasing water levels, flows, and water temperature (Yih and Liang, 1964; Jennings, 1988; Opuszynski and Shireman, 1995). However, the importance of any one factor may vary among different regions (Nico and others, 2005).

Spawning grounds are usually located in river reaches characterized by turbulent or whirlpool-like flow, often in the vicinity of islands or stream junctions (Yih and Liang, 1964; Nico and others, 2005). Reported current velocities of spawning areas in China ranged from 0.33-0.90 m/s with temperatures ranges of 19.2-29.0 °C (Yih and Liang, 1964).

The appropriate environment, particularly with regard to water turbulence and higher water temperatures, is considered critical because it apparently stimulates spawning and is necessary for successful early development of eggs (Nico and others, 2005). The eggs of Chinese carps are semibuoyant and are carried by currents until they hatch (Soin and Sukhanova, 1972).

Introduced populations have been known to successfully reproduce in artificial canals of sufficient length that somewhat mimic the flow of natural rivers, such as the Kara Kum Canal in Turkmenistan (Aliyev, 1976; Nico and others, 2005). Eggs or larvae of Chinese carps found in reservoirs suggest the possibility of spawning in these habitats (Tang, 1960a,b). Nevertheless, uncertainty remains as to whether spawning occurred within the reservoir or in a connected stream (Nico and others, 2005). If spawning does occur in such artificial habitats, it could have been triggered by fluctuations in water levels or wave actions that mimicked natural riverine environments.

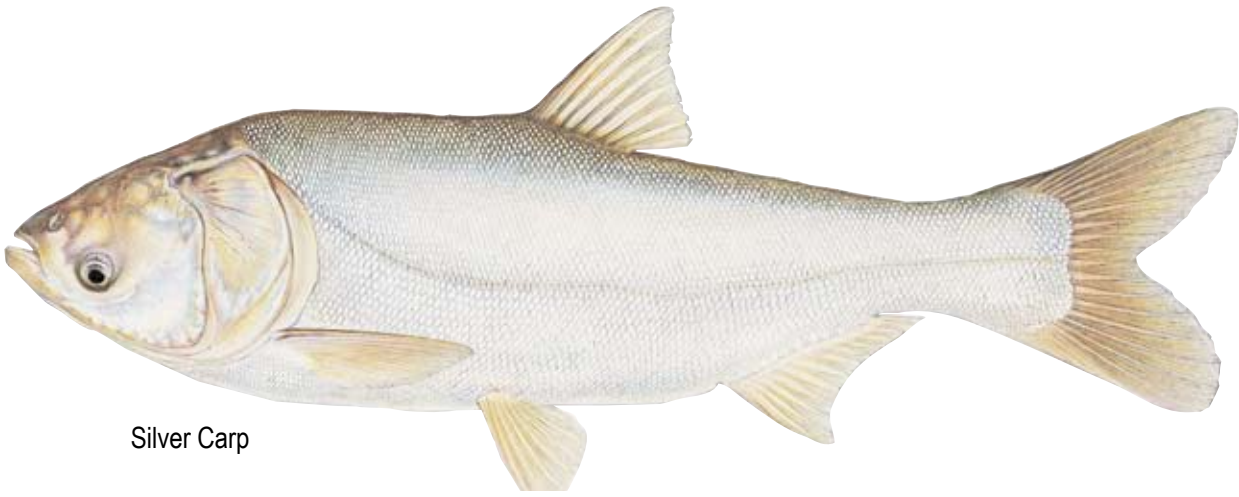

Silver Carp



Grass Carp

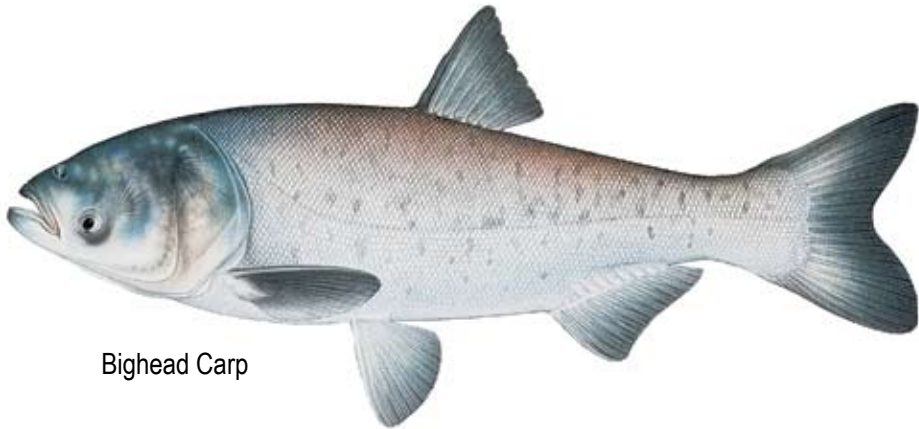

Bighead Carp



Black Carp

Ecology

The Grass Carp is a large species that can attain a weight of 45 kg (Robison and Buchanan, 1988; Etnier and Starnes, 1993) and a length of 1.5 m TL (Laird and Page, 1996). Typical longevity is about 5-11 years (Berg, 1964), but an individual in the Amur River was estimated to be 21 years, based on scale growth rings (Gorbach, 1961). Growth is relatively rapid, especially in the tropics where it can average 10 g per day (Hickling, 1967).

Typical habitat includes quiet waters, such as lakes, ponds, pools, and backwaters of large rivers, and individuals generally do not travel long distances except for the annual spawning migration (Mitzner, 1978; Nixon and Miller, 1978; Bain and others, 1990). Nevertheless, there are reports of juvenile Grass Carp traveling as far as 1,000 km from their original spawning grounds (Stanley and others, 1978). Shallow water is the generally preferred habitat, although deeper waters are used when temperatures decrease (Nixon and Miller, 1978). A number of experimental studies have reported environmental tolerances for Grass Carp. Fry and fingerlings have been reported to tolerate water temperatures from 0-40 °C (Stevenson, 1965; Vovk, 1979), and Stevenson (1965) reported that fingerlings in small ponds in Arkansas survived 5 months under heavy ice cover. Chilton and Muoneke (1992) reported an upper lethal temperature range for fry as 33-41 °C, and for yearlings as 35-36 °C. Bettoli and others (1985) documented a thermal maximum of 39.3 °C and a preferred temperature of 25.3 °C. Collee and others (1978) reported that feeding declined sharply below 14 °C. Nico and others (2005) reviewed temperature tolerance of Grass Carp and the other Chinese carps.

Oxygen consumption (per gram of body mass) increases with higher water temperature and decreases with fish age and mass (Chen and Shih, 1955; Woźniewski and Opuszynski, 1988). The lethal low oxygen level for juveniles was <0.5 mg/L (Negonovskaya and Rudenko, 1974). The maximum pH for culture of Grass Carp was reported as 9.24 (Liang and Wang, 1993). Egg hatching was delayed below pH 6.5 and increased mortality and deformation of larvae occurred below pH 6.0 (Li and Zhang, 1992). Sensitivity to low pH decreased with age (Li and Zhang, 1992). Median lethal concentration of ammonia was determined to be 1.05 mg/L (Gulyás and Fleit, 1990).

The Grass Carp appears to be tolerant of low levels of salinity, and may occasionally enter brackish-water areas. Fry (32-50 mm TL) survived transfer from fresh-

water to a salinity of 12 ppt (Chervinski, 1977). Adults (2+ years) survived 10.5 ppt salinity for about 24 days and 17.5 ppt for 5 hours (Cross, 1970). However, Grass Carp acclimated to 3, 5, and 7 ppt had an upper tolerance of about 14 ppt (Kilambi and Zdinak, 1980). Maceina and Shireman (1980) showed that fingerlings reduce feeding at 9 ppt and stop feeding altogether at 12 ppt; thus, they predicted Grass Carp could inhabit brackish-water bodies up to 9 ppt. Maceina and Shireman (1979) reported that the species can tolerate 14 ppt for as long as 4 days, but that the upper long-term tolerance of fingerlings to saline waters was lower, about 10-14 ppt. Maceina and others (1980) noted that oxygen consumption decreased along a salinity gradient of 0-9 ppt. Movement of Grass Carp from one river to another through a brackish-water estuary (Pavlov and Nelovkin, 1963, *in* Cross, 1970) is not surprising given the species' tolerance to low levels of salinity. Avault and Merowsky (1978) reported food preference and salinity tolerance of hybrid Common Carp X Grass Carp.

The species is probably best known for its ravenous appetite for plant matter (especially macrophytes); however, small Grass Carp feed on invertebrates before switching to plants. Watkins and others (1981) reported that Grass Carp larvae consumed benthic invertebrates (primarily chironomid larvae) and zooplankton until they reach about 55 mm TL. Edwards (1973) reported age-0 Grass Carp consumed oligochaetes, mayflies, caddisflies, amphipods, and chironomids. Fry of Rainbow Trout (*Oncorhynchus mykiss*) and Common Carp were eaten by young Grass Carp (even in the presence of preferred plants), but Grass Carp would not eat the eggs of either species (Edwards, 1973; Singh and others, 1976). Grass Carp larger than 25 cm did not feed on fry in the laboratory (Singh and others, 1976). The size at which Grass Carp begins to feed on plants depends on temperature, with smaller fish switching to plants in warmer waters (Stanley and others, 1978). Adults feed on a variety of aquatic macrophytes, such as water hyacinth (*Eichhornia crassipes*), eelgrass (*Vallisneria americana*), cattails (*Typha* spp.), and *Hydrilla* spp. (Collee and others, 1978; reviewed in Opuszynski and Shireman, 1995; Cassani, 1996). In some cases, Grass Carp will consume animals when plant material is lacking (Nikol'skiy and Aliyev, 1974; Forester and Avault, 1978). Alternatively, Grass Carp may consume terrestrial macrophytes in the absence of aquatic vegetation (Kilgen and Smitherman, 1971; Terrell and Fox, 1974). Kilgen and Smitherman (1971) reported that individuals raised their heads clear of the water to consume terrestrial macrophytes. The species is a voracious herbivore

that can quickly eliminate large volumes of vegetation (Mitzner, 1978). Although some reports indicated that removal of aquatic vegetation by Grass Carp was advantageous for some game fishes (for example, Maceina and others, 1991), such habitat modification could result in habitat loss for native fishes, birds, and invertebrates (Gasaway and Drda, 1977; Forester and Avault, 1978; Ware and Gasaway, 1978; Laird and Page, 1996; Ross, 2001).

Native Distribution

The Grass Carp is native to rivers of eastern Asia, from the Amur River of far eastern Russia and China, south to the West River of southern China (Shireman and Smith, 1983; Li and Fang, 1990).

U.S. Introductions

The Grass Carp was first brought into the U.S. in 1963, when it was imported by aquaculture facilities in Alabama and Arkansas. Subsequently, it was widely stocked for vegetation control (Courtenay and others, 1984; Fuller and others, 1999). Escapes from aquaculture facilities, intentional stocking (both legal and illegal), and movement of introduced populations have expanded its range. The species is now known from almost every state, and is established in the Mississippi, Missouri, and Ohio rivers, as well as the smaller Trinity River (Texas).

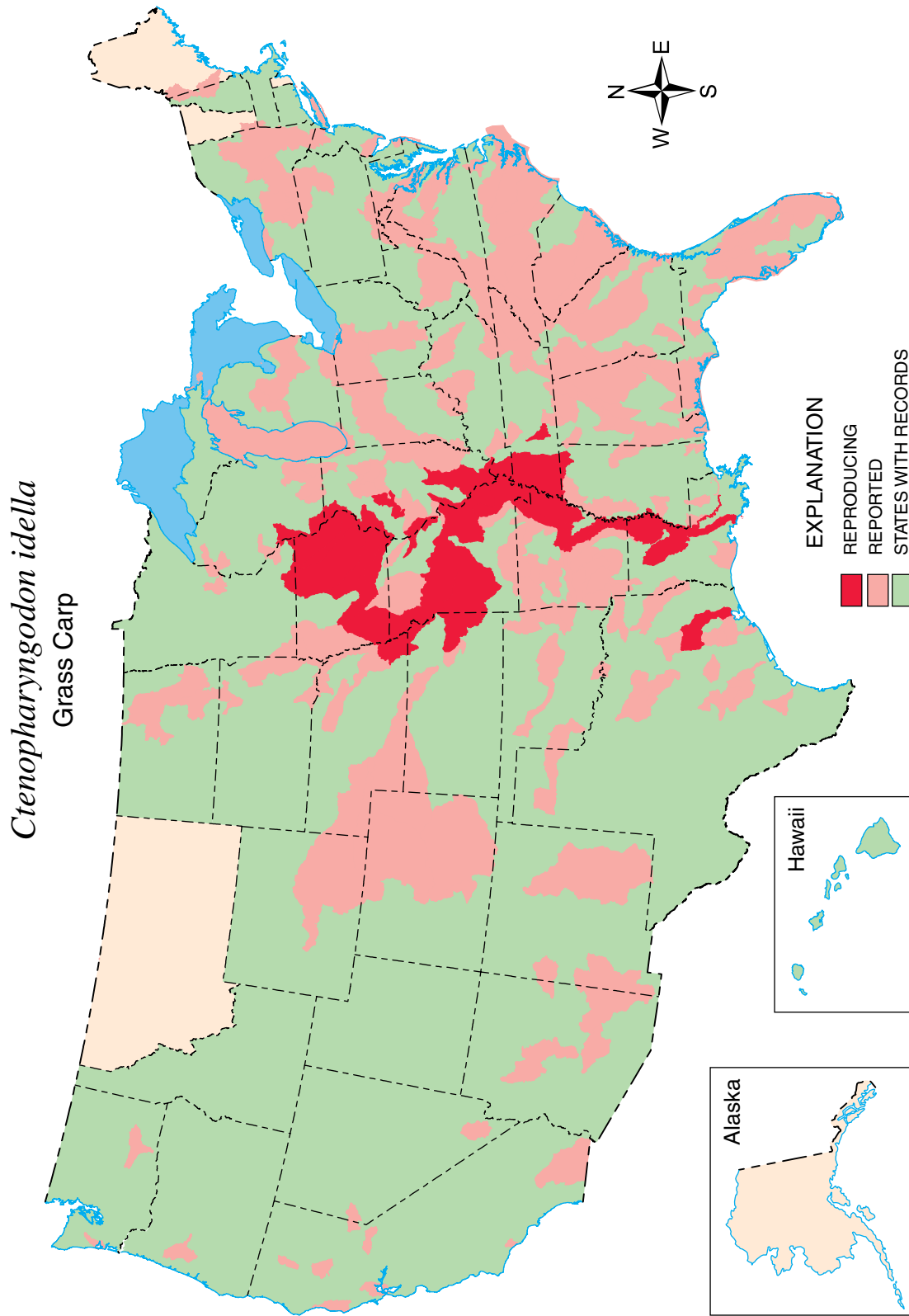

Plate 4. Distribution of Grass Carp in the United States. See Methods for details regarding data used to create maps, definitions of “reproducing” and “reported” and shading of HUCs and states.

Common Carp

Cyprinus carpio Linnaeus 1758

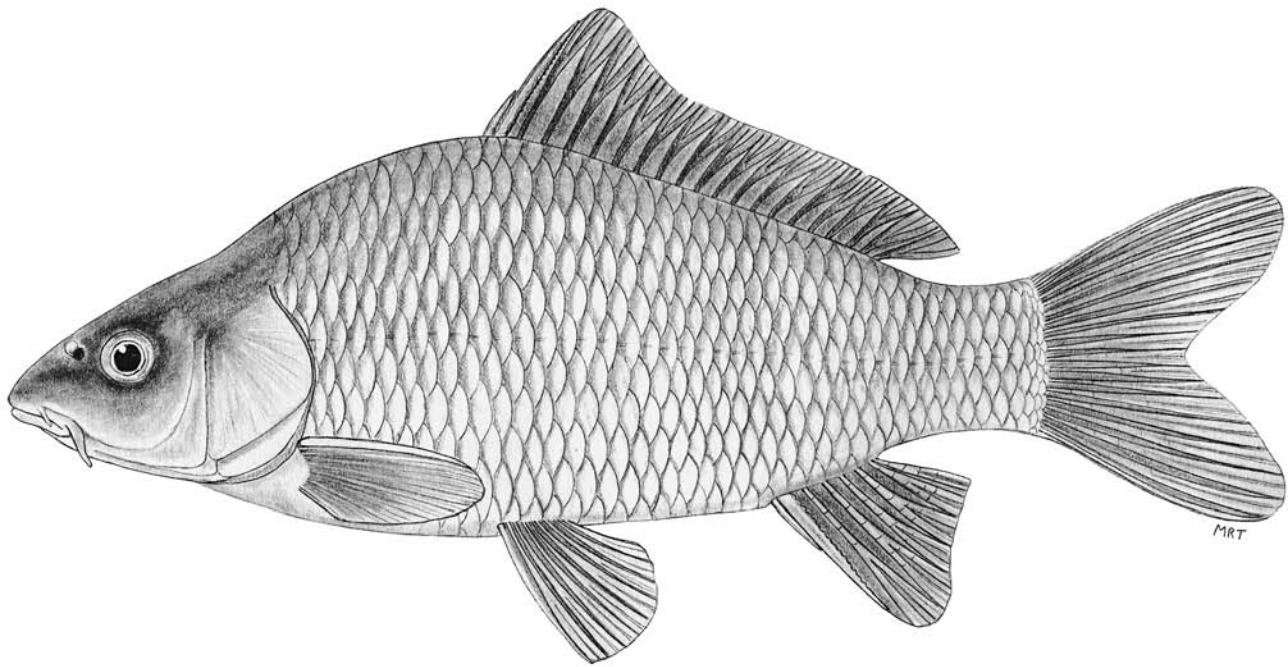

Figure 24. Common Carp, SIUC 42681, 120 millimeter SL, from Lake County, Illinois.

Description

The Common Carp (fig. 24) is a large species, reaching lengths of over 1 m (Berg, 1964). The maximum reported weight is 37.3 kg (IGFA, 2001). The body is wide, elongated, and torpedo-shaped. The scales are large, and number 32-40 along the lateral line. The body is slightly arched anterior to the dorsal fin. The long dorsal fin has ii-iv (15-23) rays that include a strong, serrated spine-like ray followed by 15 or more branched rays. The anal fin has ii-iv (4-6) rays. The caudal fin is moderately forked. The mouth is subterminal with two barbels on each side. The eyes are set high on the head. The pharyngeal teeth are molariform and those in the main row are heavy with flattened grinding surfaces. The pharyngeal tooth formula is 1,1,3-3,1,1 (in three rows; fig. 25). Total gill rakers on the first arch number 18-36. The Common Carp is generally brassy to yellowish, with lower fins often yellow-orange; however, ornamental forms exhibit a wide range of bright colors (see section on variation, below). Meristics are given in appendix B.

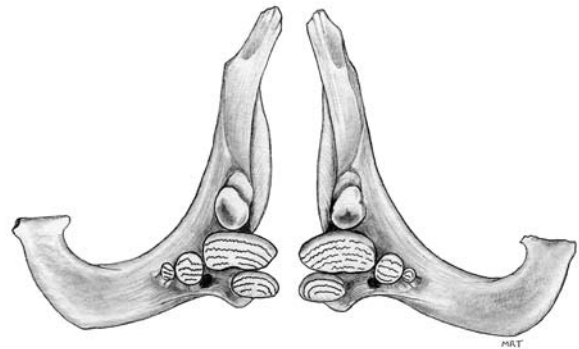

Figure 25. Pharyngeal teeth (1,1,3-3,1,1) of Common Carp, SIUC 42681, 120 millimeter SL, from Lake County, Illinois. (Also see fig. 3, p. 8.)

Shortly before and during spawning, mature males (and some females) develop breeding tubercles (appearing as small granules). In males, the tubercles appear primarily on the opercle, pre-opercle, and under the eyes, although they may also be present elsewhere on

the head, caudal peduncle, fin rays, and the scales below (less frequently above) the lateral line (Balon, 1995; Baruš and others, 2001). When present on females, breeding tubercles only occur on the head (Balon, 1995). Coad (2005) indicated that females are deeper-bodied than males, and also noted sexual differences in fin height and length.

Similar Species

The long dorsal fin includes a strong, serrated spine-like ray followed by 15 or more branched rays. This characteristic distinguishes it from most native North American cyprinids, which typically have fewer than 11 rays and usually lack the spine-like ray.

The Common Carp has two barbels on each side of the head near the posterior end of the upper jaw. This characteristic distinguishes it from Crucian Carp and Goldfish, which lack barbels. Gerlach (1983) listed characteristics that distinguish the larvae of Goldfish from the Common Carp.

Variation

A wide geographic range in combination with a long history of culture and artificial selection has given rise to a number of varieties of Common Carp. Thus, the species exhibits a wide variation in meristic and morphological characteristics (appendix B). Baruš and others (2001) recognized and provided a key for three subspecies: *Cyprinus carpio carpio* (European and Central Asian Common Wild Carp), *Cyprinus carpio haematopterus* (East Asian Common Wild Carp), and *Cyprinus carpio viridiviolaceus* (Southeast Asian Wild Carp).

The number, size, and coverage of scales is variable, especially among domesticated groups. Based on scale patterns, at least four basic forms of Common Carp are recognized (Brylinska, 1986, *in* Baruš and others, 2001). However, common names associated with these forms are sometimes inconsistently applied (for example, Tave, 1988; Howells, 1999):

1. *Scaled Carp* with regular, imbricating scales over the entire body, much like the ancestral wild Common Carp. The large, cycloid scales of the Scaled Carp are pigmented along their posterior edges, producing a reticulated effect (fig. 26);
2. *Mirror Carp* with irregular rows of very large scales (fig. 27);
3. *Leather* or *Naked Carp* either with no scales or few, very large scales (fig. 28).

4. *Line Carp* with a regular single mid-lateral row of scales and elsewhere none or only a few scales (not illustrated);

Coloration is highly variable. Wild strains are generally brassy to yellowish, with lower fins often yellow-orange; however, considerable variation occurs among cultured varieties. Nishikigoi ornamental carp strains (popularly called “Koi”) were developed in Japan over the last two centuries (Balon, 1995), and may be red, white, gold, black or variegated (fig. 29).

Natural hybrids of the wild Common Carp and the Crucian Carp are often found where the two species co-occur (Bănărescu, 1964; Berg, 1964; Lin and Peter, 1991; see appendix B for meristics). The Common Carp naturally hybridizes with Goldfish both in native regions, such as Romania (Bănărescu, 1964) and the Czech Republic (Prokeš and Baruš, 1996) and where they are introduced, such as Canada (Taylor and Mahon, 1977), Australia (Hume and others, 1983), and Ohio (Trautman, 1981). Meristics for Common Carp X Goldfish hybrids are given in appendix B. Common Carp has been artificially hybridized with Grass Carp (Makeyeva and Verigin, 1974a; Stanley and Jones, 1976; Avault and Merowsky, 1978), Bighead Carp (Makeyeva, 1968, 1972; Verigin and Makeyeva, 1974), Silver Carp (Makeyeva, 1968; Makeyeva and Verigin, 1974b), and Tench (Victorovsky, 1966). Crossbreeding of Common Carp with other cyprinids is reviewed in Schwartz (1972, 1981). The Common Carp is not known to hybridize with any cyprinids native to North America.

Reproduction

Males first spawn at an age of about 3 years, after attaining a length of 36 cm SL and weight of 1 kg (Berg, 1964). Maximum fecundity has been estimated from 2–7 million eggs (Baruš and others, 2001; Moyle, 2002; Coad, 2005). The Common Carp is a batch spawner (Balon, 1995), releasing its adhesive eggs over vegetation. Reported minimum temperatures for commencement of spawning vary (10–12 °C, Berg, 1964; 13–16 °C, Bănărescu, 1964; 16.5 °C, Lubinski and others, 1986; 18 °C, Balon, 1995). In its native range, the species reportedly prefers to spawn during periods of high water over freshly flooded meadows at sites where the water depth is 25–50 cm (Berg, 1964; Balon, 1995). Wild carp have also been reported to spawn along the coasts of islands situated in lakes (Kazancheev, 1981, *in* Baruš and others, 2001), and in estuaries along the coastline where the water is shallow and aquatic plants



Figure 26. Common Carp (Scaled variety), 272 millimeter SL, from Lake County, Tennessee. (Photo copyright © Richard T. Bryant.)



Figure 27. Common Carp (Mirror variety), 310 millimeter SL, from Knox County, Tennessee. (Photo copyright © Richard T. Bryant.)

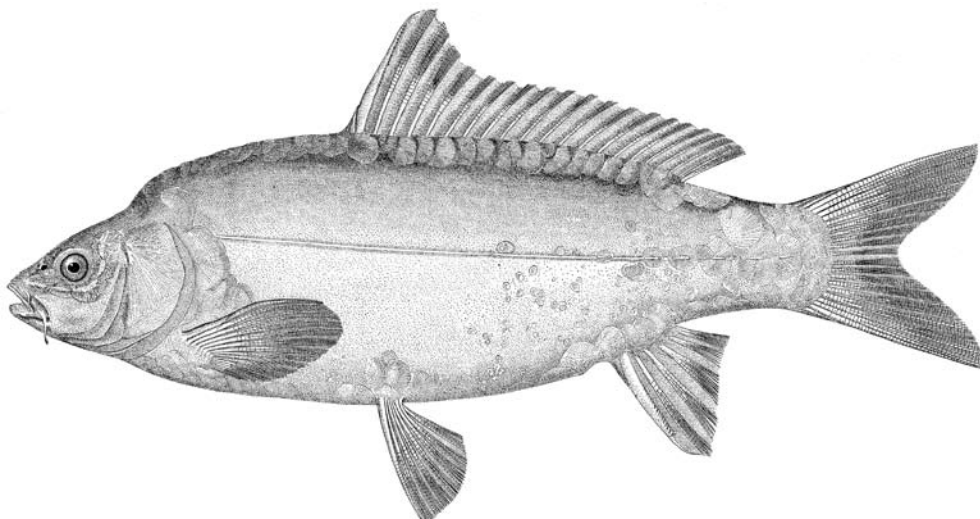

Figure 28. Common Carp (Leather variety). (Bulletin of the U.S. Fish Commission, 1890.)



Figure 29. Koi in a pond at Lí Yuán Garden, Suzhou, People's Republic of China, October 2004. Koi, an ornamental form of Common Carp (*Cyprinus carpio*), has been selectively bred for its array of colors over the past few hundred years by the Japanese. (Photograph by Leo G. Nico.)

are numerous (Baruš and others, 2001). Berg (1964) recorded Common Carp spawning along the coast of the Aral Sea in salinities as high as 10 ppt. At 20 °C, eggs hatch 3-4 days after fertilization (Balon, 1995). Larval development was described in Balon (1995) and Nakamura (1969), and egg and larval development were described and illustrated in Jones and others (1978).

Ecology

The Common Carp is a large species, reaching lengths of over 1 m (Berg, 1964). The largest known specimen captured to date was a 37.3 kg individual taken in Romania (IGFA, 2001). The species is long-lived, frequently attaining an age of 15 years, and sometimes living much longer. For example, a 50-year old wild carp was captured in England (Panek, 1987) and a 47-year old captive individual was reported by Flowers (1935, *in* Carlander, 1969). Misinterpretation of scale circuli is responsible for the erroneous legend (that persisted for over a century) that Common Carp could attain ages of 100 or even 200 years.

The Common Carp is found in a wide variety of habitats. Baruš and others (2001) reported that in the Danube River the preferred habitat included lotic

stretches of the river with mud and sand substrates and abundant submerged aquatic vegetation. Common Carp in the Danube River also used oxbow lakes and other water bodies along the floodplain, such as inundated meadows. The species generally inhabits lakes, ponds, and the lower sections of rivers (usually with moderately flowing or standing water), but is also known from brackish-water estuaries, backwaters, and bays (Baruš and others, 2001). In its native range, the species occurs in coastal areas of the Caspian and Aral Seas (Berg, 1964; Kazanchev, 1981, *in* Baruš and others, 2001) as well as the estuaries of large Ukrainian and Russian rivers. Crivelli (1981) reported that the Common Carp occurred in brackish-water marshes with salinities up to 14 ppt in southern France. In North America, the Common Carp inhabits brackish and saline coastal waters of several states bordering the Atlantic and Pacific Oceans and Gulf of Mexico (Schwartz, 1964; Moyle, 2002) as well as the Atlantic and Pacific coasts of Canada (McCrimmon, 1968). It has been captured in U.S. waters with salinities as high as 17.6 ppt (Schwartz, 1964). In the U.S., the Common Carp is more abundant in manmade impoundments, lakes, and turbid sluggish streams receiving sewage or agricultural runoff, and less abundant in clear waters or streams with a high

gradient (Pflieger, 1975; Trautman, 1981; Ross, 2001; Boschung and Mayden, 2004). Pflieger (1975) noted that the Common Carp tends to concentrate in large numbers where cannery or slaughter-house wastes are emptied into streams.

The species is tolerant to a wide range of environmental conditions. It is somewhat puzzling that although the Common Carp has been reported from estuarine and marine regions in Europe, Asia, and North America, laboratory experiments generally report limited salinity tolerance. Upper tolerance limits have been reported as 6 ppt for young and 4.5 ppt for eggs (Nakamura, 1948, *in* McCrimmon, 1968). Panek (1987) reported that salinities of 1.5-2 ppt were lethal in 1.5 days, although it is unclear whether this study was conducted on adults or juveniles. Wang and others (1997) reported that fingerlings could withstand salinities of 10.5 ppt; however, growth rates at salinities >3 ppt were half those reported for waters with <2.5 ppt salinity. Laboratory studies reported decreased oxygen consumption and standard metabolism at 3 ppt salinity, as less energy was needed to maintain internal equilibrium (Qui Deyi and Qin Kejing, *in* Wang and others, 1997). Common Carp <50 days old were tolerant of temperatures 14-43 °C (Lirski and Opuszynski, 1988a,b). Opuszynski and others (1989) reported an upper lethal limit of 43 or 46 °C (depending on the method of calculation) and an optimum growth temperature for juveniles at 38 °C. Pitt and others (1956) reported a temperature preferendum of 32 °C. The Common Carp is reported to be extremely tolerant to turbidity (Panek, 1987). In a laboratory study, lethal low oxygen concentration varied from about 1.3-0.7 mg/L, and decreased with fish age and weight (Woźniewski and Opuszynski, 1988). Median lethal concentration of ammonia was determined as 0.5 mg/L (Gulyás and Fleit, 1990).

Larval Common Carp feed primarily on zooplankton. In its native range, juveniles and adults feed on benthic organisms (for example, chironomids, gastropods, and other larval insects), vegetation, detritus, and plankton (for example, cladocerans, copepods, amphipods, mysids). Feeding habits are similar in the U.S., where the diet is composed of organic detritus (primarily of plant origin), chironomids, small crustaceans, and gastropods (Summerfelt and others, 1971; Eder and Carlson, 1977; Panek, 1987). The Common Carp is very active when feeding and its movements

often disturb sediments and increase turbidity, causing serious problems in some regions especially where the species is abundant. The species also retards the growth of submerged aquatic vegetation by feeding on and uprooting plants (King and Hunt, 1967). Silt resuspension and uprooting of aquatic plants caused by feeding activities can disturb spawning and nursery areas of native fishes (Ross, 2001) as well as disrupt feeding of sight-oriented predators, such as bass and sunfish (Panek, 1987).

Native Distribution

The Common Carp is native to temperate Eurasia. The precise boundaries of the native range are obscured by a long history of transplantation by humans (see Balon, 1995 and Baruš and others, 2001). The species has been an important food item for humans since ancient times. The remains of Common Carp have been found in archaeological excavations of early human settlements (Balon, 1995), and the species was well known to the ancient Romans. The Common Carp has been raised for thousands of years in Europe and China (Balon, 1995).

U.S. Introductions

The Common Carp is the leading aquaculture species in many countries and also an important sport fish (Baruš and others, 2001). The species has been extensively transferred and now occupies every continent except Antarctica. Considering its importance in the Old World, it is no surprise that it has been widely introduced throughout the U.S. (beginning as early as 1831; Fuller and others, 1999). Common Carp is currently thought to be reproducing in all states except Alaska. The expanded range of Common Carp in the U.S. has occurred via numerous sources, including intentional stocking as food fish and ornamentals (for example, Koi), escapes from aquaculture facilities, use of juveniles as bait fish, and invasions of adjacent water-bodies by existing populations. Also, because the species is tolerant of brackish waters, there is increased likelihood that the Common Carp is capable of migrating through estuaries into adjacent coastal streams (Swift and others, 1977).

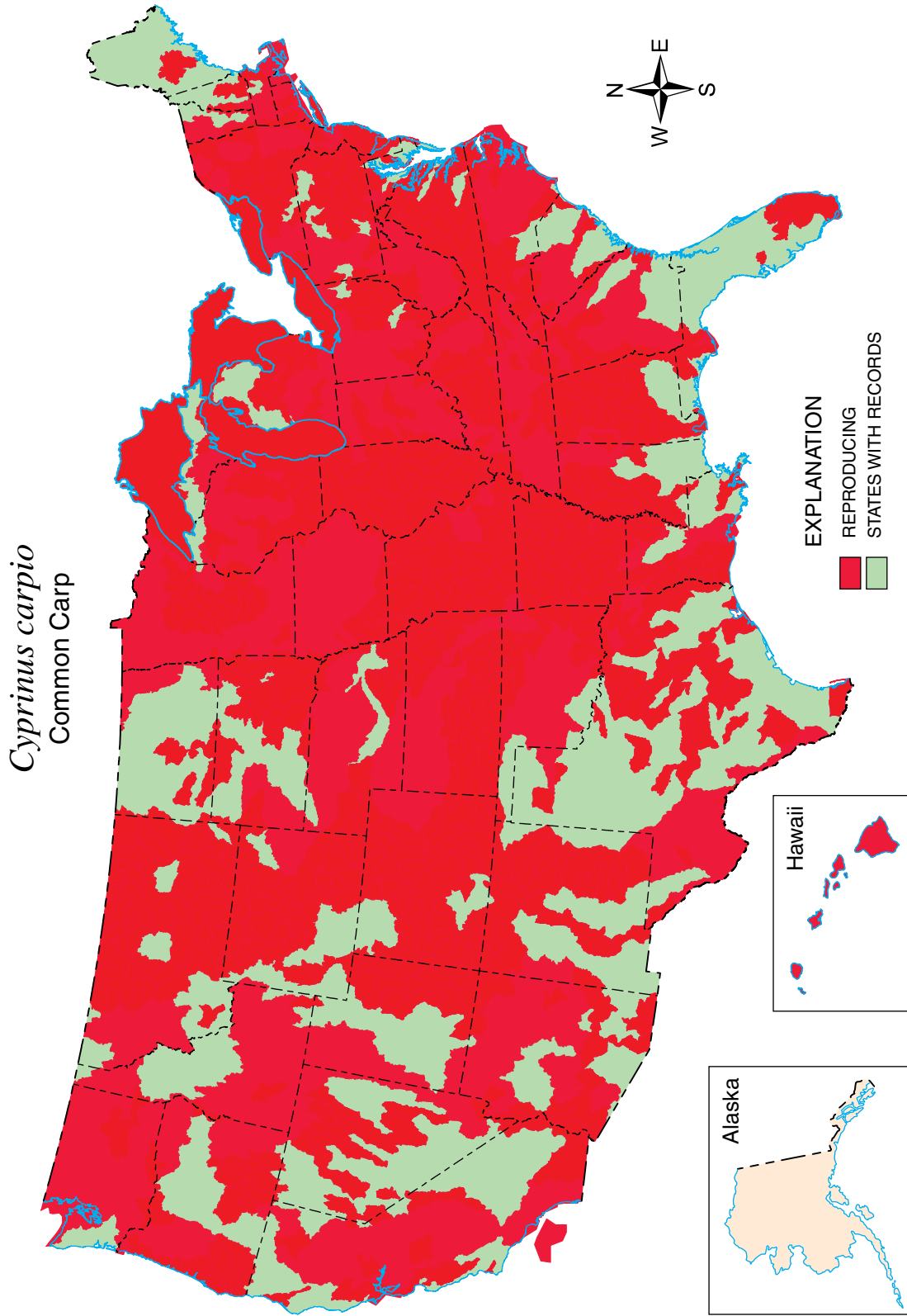

Plate 5. Distribution of Common Carp in the United States. See Methods for details regarding data used to create maps, definition of “reproducing” and shading of HUCs and states.

Silver Carp

Hypophthalmichthys molitrix (Valenciennes 1844)

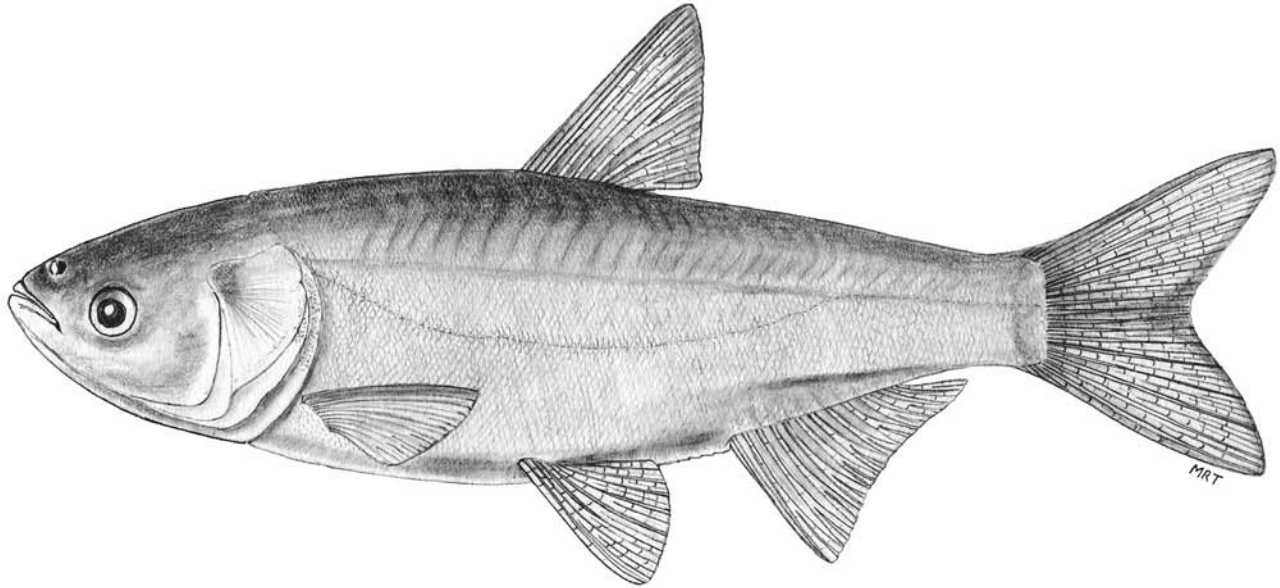

Figure 30. Silver Carp, SIUC 35334, 204 millimeter SL, from New Madrid County, Missouri.

Description

The Silver Carp (fig. 30) is a large fish; individuals have been reported to reach about 1.3 m (Xie Ping, 2003) and weigh over 35 kg (Li and Mathias, 1994). The species is deep bodied and laterally compressed, with a ventral keel that extends forward from the anus almost to the junction of the gill membranes (fig. 31). The lateral line is complete and curved ventrally with 91-124 small scales. The eyes are large and located low on the head. The mouth is large, terminal, and somewhat oblique. The first gill arch has more than 100 gill rakers. The rakers are thin, branched, and fused into a sponge-like apparatus. The pharyngeal teeth are in one row (0,4-4,0) with striated surfaces (fig. 32). Barbels are absent. The dorsal fin is short with ii-iii (7) rays and lacks a thick spine-like ray. The anal fin has ii-iii (11-14) rays. The dorsal surface of the body is olivaceous to grayish black and the sides are silvery (figs. 33 and 34). Meristics for Silver Carp are given in appendix B.

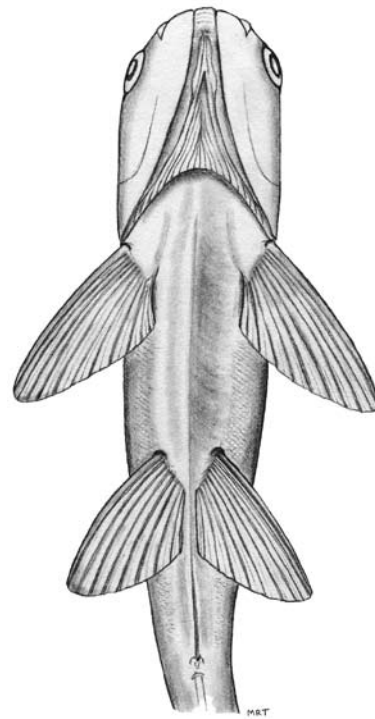

Figure 31. Ventral keel of Silver Carp. (Also see to fig. 6, p. 10.)

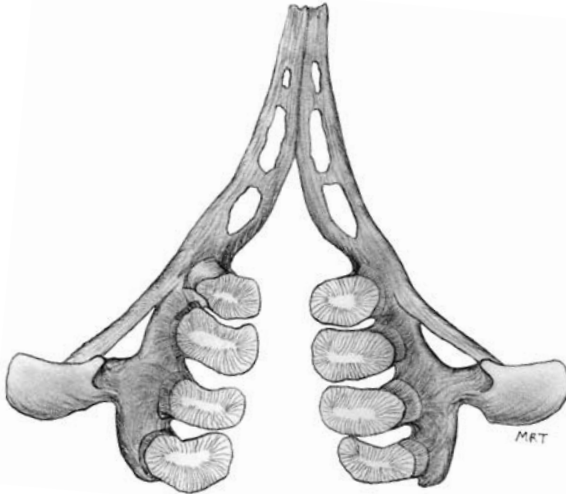

Figure 32. Pharyngeal teeth (0,4-4,0) of Silver Carp, SIUC 35334, 204 millimeter SL, from New Madrid County, Missouri.

Silver Carp fingerlings exhibit an unusual morphological adaptation to low oxygen conditions. Adámek and Groch (1993) report that hypertrophy of the lower lip of Silver Carp fingerlings can appear within 24-48 hours of oxygen depletion. This rapid morphological adaptation serves to increase intake of the surface-water layer, and disappears within 24 hours after the return of normoxia.

Sexual dimorphism in Silver Carp is subtle. Both sexes develop fine tubercles along anterior pectoral-fin rays; however, in females these tubercles are only present on the distal half of the rays (Opuszynski and Shireman, 1995).

Similar Species

Presence of a ventral keel differentiates the Silver Carp and Bighead Carp from all native cyprinids except the Golden Shiner (*Notemigonus*



Figure 33. Juvenile Silver Carp, 130 millimeter SL, from Malone Fish Hatchery, Lonoke County, Arkansas. (Photo copyright © Richard T. Bryant.)



Figure 34. Adult Silver Carp, 438 millimeter SL, from the U.S. Fish and Wildlife Service Fish Hatchery, Stuttgart, Lonoke County, Arkansas. Reddish color of fins in this photograph is a result of bruising during capture and handling. (Photo copyright © Richard T. Bryant.)

crysoleucas). The Golden Shiner has larger and fewer lateral-line scales (39-51) than Silver Carp and Bighead Carp (>60). Additionally, the Golden Shiner typically has five pharyngeal teeth per side (in a single row), whereas Silver Carp and Bighead Carp have only four teeth in a single row (per side). Small juvenile Silver Carp may resemble native shad (family Clupeidae), but can be differentiated by the presence of a lateral line and usually <14 anal rays (versus no lateral line and >16 anal rays in shad).

Silver Carp is most similar to Bighead Carp; however, it has silvery sides in contrast to the mottled sides of the adult Bighead Carp. Additionally, the Silver Carp has long, thin gill rakers that are fused to form a sponge-like apparatus (fig. 7a in Key) and a ventral keel that extends from the anus to the anterior part of the breast, almost to the junction of the gill membranes (fig. 31). The Bighead Carp has long, thin gill rakers that are not fused and has a keel that extends forward only to the base of the pelvic fins. When apressed (held flat against the body), the pectoral fin of the Silver Carp does not extend to the base of the pelvic fins, whereas the pectoral fin of the Bighead Carp extends beyond the pelvic-fin origin. Typically, the eyes of the Bighead Carp are slightly lower on the head than those of the Silver Carp; however, this characteristic may not be diagnostic.

The name “Bigheaded Carps” is often applied collectively to include all the *Hypophthalmichthys* species. For example, in some publications the *Hypophthalmichthys molitrix* is referred to as “Bighead Carp.”

Variation

A closely related species, the Largescale Silver Carp (*Hypophthalmichthys harmandi*; Sauvage 1884) occurs in Hainan Island, China, and northern Vietnam (PRFRI, 1991; Chen, 1998). The Largescale Silver Carp was previously treated as a subspecies of Silver Carp (*H. molitrix harmandi*; Yen, 1985), but it is now considered a distinct species. Largescale Silver Carp has fewer lateral-line scales (78-88) than Silver Carp and more anal rays (15). To date, we are unaware of the occurrence of Largescale Silver Carp in the U.S.

Silver Carp has been artificially hybridized with Common Carp (Makeyeva, 1968, 1975; Makeyeva and Verigin, 1974b) and Grass Carp (Andriasheva, 1968). Silver Carp is also reported to hybridize with Bighead Carp both naturally (Verigin and others, 1979) and through artificial means (Tang, 1965; Green and Smitherman, 1984). Larval development of Silver Carp X Bighead Carp hybrids was described

by Mihai-Bardan (1980). Silver Carp is not known to hybridize with any native North American cyprinid species. The common name “Bighead” is used in this report to refer to *Hypophthalmichthys molitrix*.

Reproduction

Male Silver Carp attain maturity at 2-3 years in subtropical/tropical locales and 4-6 years in temperate regions (Alikunhi and Sukumaran, 1964; Kuronuma, 1968; Bardach and others, 1972; Abdusamadov, 1987). Males generally mature a year before females (Abdusamadov, 1987; Opuszynski and Shireman, 1995). Opuszynski and Shireman (1995) reviewed gonad condition through the stages of development. Fecundity is generally high, and differs among geographic regions and fish ages and sizes. Larger Silver Carp tend to have more eggs and heavier ovary masses (Verigin and others, 1990). Fecundity ranges from about 265,000-2,000,000 eggs per fish (Abdusamadov, 1987; Vinogradov and others, 1966; Kamilov and Komrakova, 1999). Egg and larval development were illustrated in Nakamura (1969) and Soin and Sukhanova (1972).

Krykhtin and Gorbach (1981) studied the downstream drift of Silver Carp eggs in the Amur River Basin of eastern Asia, and determined that spawning occurred at water temperatures between 17-26.5 °C, with peak activity at 21-26 °C. For additional information on spawning requirements of Silver Carp, see the section entitled “Spawning requirements of Chinese carps” in the Grass Carp account.

Ecology

The Silver Carp is a large fish than can attain a maximum length of over 1 meter and a weight of over 35 kg (Li and Mathias, 1994; Xie Ping, 2003). It is a relatively long-lived species, estimated to attain an age of 20 years (Berg, 1964). In its native range, Silver Carp occurs in large rivers, although the species has been stocked in a variety of habitats, including warm-water lakes, fish ponds, and impoundments (Berg, 1964; Abdusamadov, 1987; Fuller and others, 1999; Xie Ping, 2003). The Silver Carp is an active fish that typically swims in the upper water layer. If disturbed, individuals will sometimes leap clear of the water. The sound of an outboard motor often causes the Silver Carp to leap out of the water and collide with boaters, causing serious property damage and human injury. This behavior has received considerable attention in the U.S. (Perea, 2002).

Oxygen consumption (per gram of body mass) has been shown to increase with higher water temperature and decrease with fish age and mass (Chen and Shih, 1955; Woźniewski and Opuszynski, 1988). In about 21 days, larvae are tolerant of oxygen conditions as low as 0.5 mg/L (Woźniewski and Opuszynski, 1988). Rai (2000) reported growth at pH 7.1-9.7. Liang and Wang (1993) reported the maximum pH for culture was 9.24. Egg hatching was delayed below pH 6.5, and increased mortality and deformation of larvae occurred below pH 6.0 (Li and Zhang, 1992). However, sensitivity to low pH decreased with age (Li and Zhang, 1992). Vovk (1979) reported a temperature tolerance of 0-40 °C. Opuszynski and others (1989) reported an upper lethal limit of 43.5 or 46.5 °C (depending on the method of calculation) and an optimum growth temperature of 39 °C for juveniles. Data on salinity tolerance is difficult to interpret. Authors have reported that Silver Carp cannot tolerate salinities >4 ppt (Waller, 1985; Zang and others, 1989), although larvae are known to migrate to brackish-water areas of the Caspian Sea where salinities range from 6-12 ppt (Abdusamadov, 1987). Both oxygen consumption and standard metabolism decrease at 3-4 ppt salinity, as less energy is needed to maintain internal equilibrium (von Oertzen, 1985).

The fused gill rakers are used to sieve plankton from the water column. Once ingested, food is ground against a cartilaginous plate by blunt pharyngeal teeth (Robison and Buchanan, 1988). Larvae feed primarily on zooplankton (Korniyenko, 1971; Nikol'skiy and Aliyev, 1974). Adults feed primarily on phytoplankton and to a lesser extent on zooplankton and detritus (Berg, 1964; Nikol'skiy and Aliyev, 1974; Cremer and Smitherman, 1980; Burke and others, 1986; Dong and

Li, 1994). A primary goal of Silver Carp culture is the improvement of water quality by reduction of phytoplankton populations. However, the efficacy of this species for controlling phytoplankton is controversial (Domaizon and Devaux, 1999). Some researchers have reported that the introduction of Silver Carp has resulted in increased water quality (Kajak and others, 1975, *in* Lazzarro, 1987; Leventer, 1979) and, specifically, reductions in blue-green algae (Vovk, 1979; Starling, 1993). Conversely, other researchers have reported that the presence of Silver Carp increased algal biomass (Burke and others, 1986; Laws and Weisburd, 1990).

Native Distribution

The Silver Carp is native to large lowland rivers of eastern China (Berg, 1964; Li and Fang, 1990).

U.S. Introductions

The Silver Carp was first introduced to the U.S. in 1973 for the purpose of controlling plankton blooms in catfish-production ponds and sewage lagoons (Freeze and Henderson, 1982; Fuller and others, 1999). The species was subsequently raised in government and private aquaculture facilities. By 1980, specimens were found in natural waters, probably the result of escapes from aquaculture facilities (Freeze and Henderson, 1982). Subsequent escapes and contamination of Grass Carp stocking with Silver Carp may have contributed to the expansion of the species' range (reviewed in Fuller and others, 1999). Silver Carp is now reported in 16 states and is established in the middle and lower Mississippi River Basin.

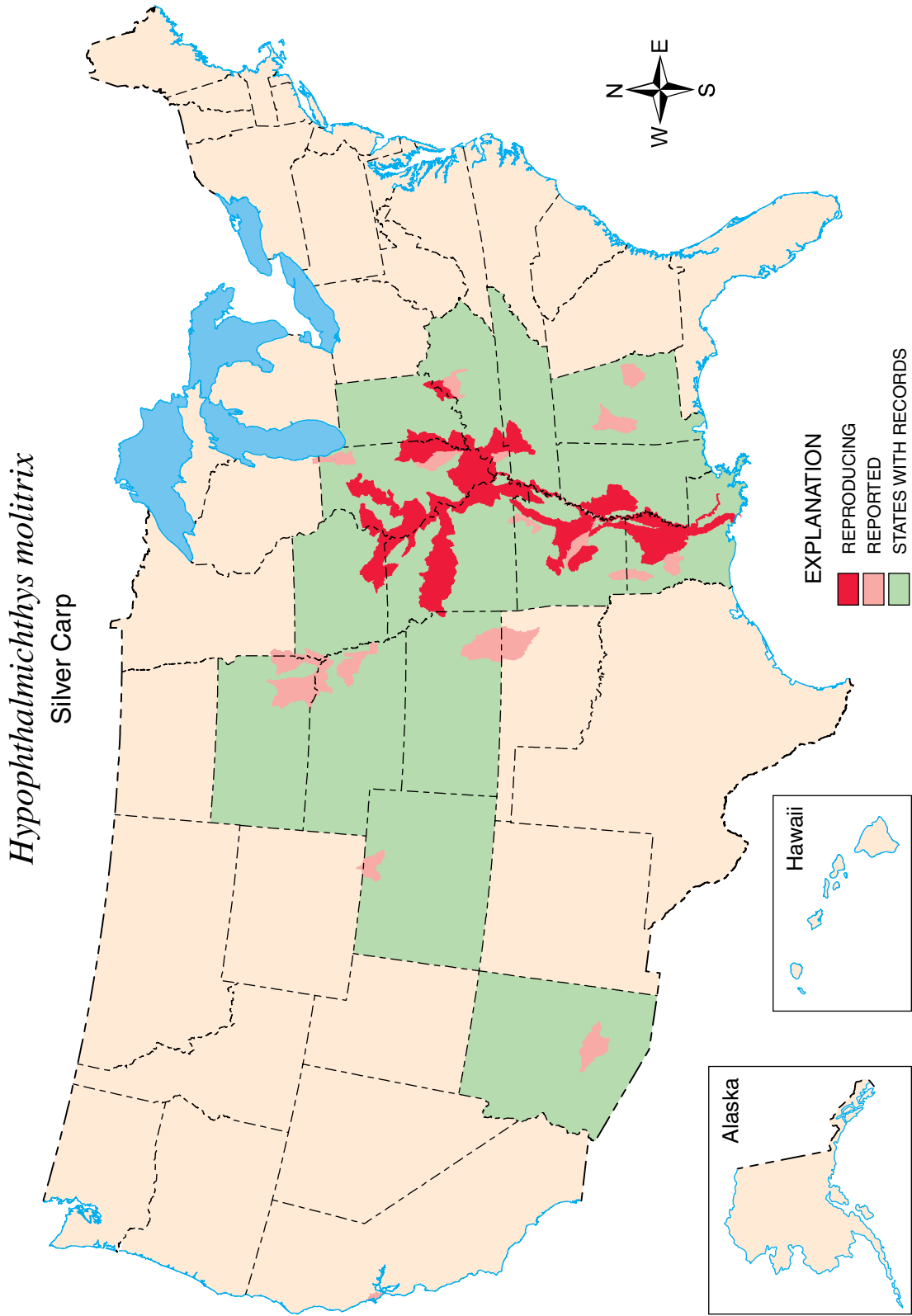

Plate 6. Distribution of Silver Carp in the United States. See Methods for details regarding data used to create maps, definitions of “reproducing” and “reported” and shading of HUCs and states.



Commercial fisherman in Louisiana hauling in hoop net full of Bighead Carp, 2004. (Photo courtesy of Cathy Mohilo and Rusty Kimble.)

Bighead Carp

Hypophthalmichthys nobilis (Richardson 1845)

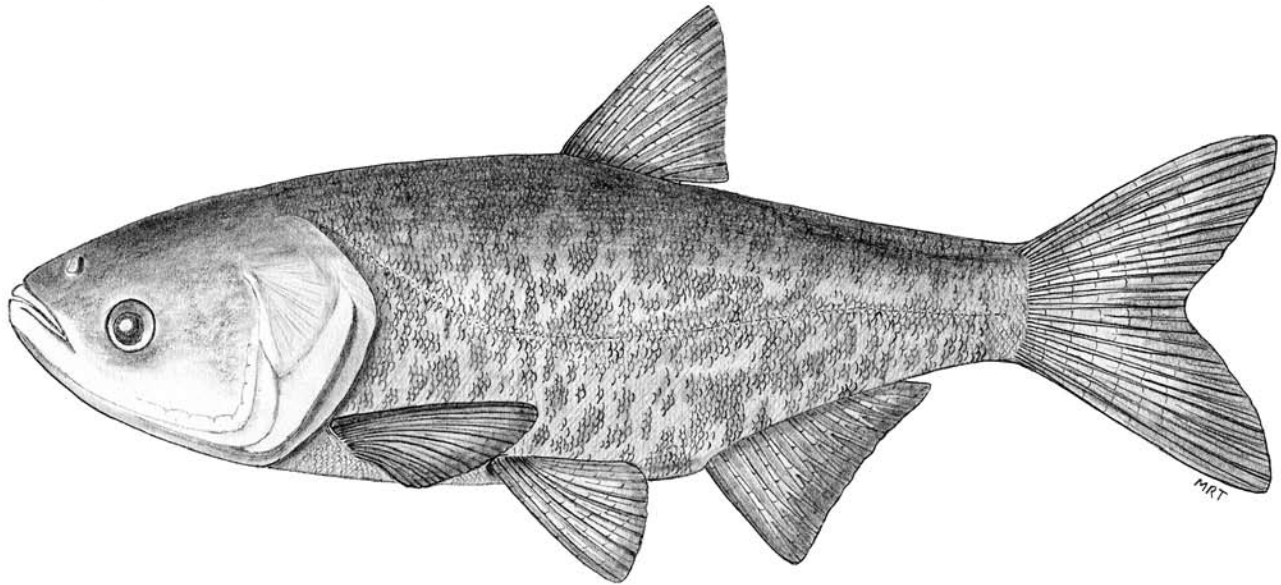

Figure 35. Bighead Carp, SIUC 23919, 207 millimeter SL, from Washington County, Illinois.

Description

The Bighead Carp (fig. 35; previously known as *Aristichthys nobilis*) is a large species that may grow larger than 1 meter TL and weigh up to 40 kg in as little as 9 years (Baltagi, 1979, *in* Jennings, 1988). It is deep-bodied and laterally compressed with a smooth keel that runs from the anus to near the base of the pelvic fins (fig. 36). The lateral line is complete with 91-120 scales and curved ventrally. The head is large (usually $>1/3$ the SL). Eyes are forward on the head and positioned ventrally. The mouth is terminal and large, with the lower jaw slightly longer than the upper one. The premaxillary and mandible form bony, rigid lips. Barbels are absent. The pharyngeal teeth are moderately long, bluntly rounded, and arranged in a single row (0,4-4,0; fig. 37). The gill rakers are long and thin, and number about 130 on the first arch. The numerous gill rakers are closely arranged with membranous septa, but are unfused. The dorsal fin is short, lacks a spine-like ray, and has ii-iii (7-10) rays. The dorsal-fin origin is posterior to the origin of the pelvic fins. The anal fin has ii-iii

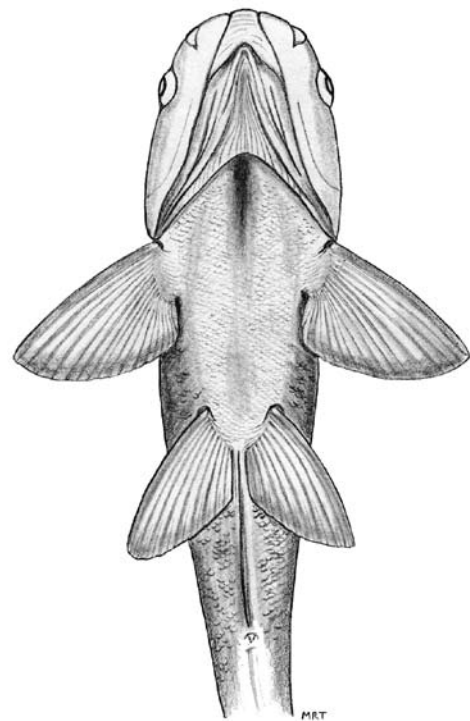

Figure 36. Ventral keel of Bighead Carp. (Also see to fig. 6, p. 10.)

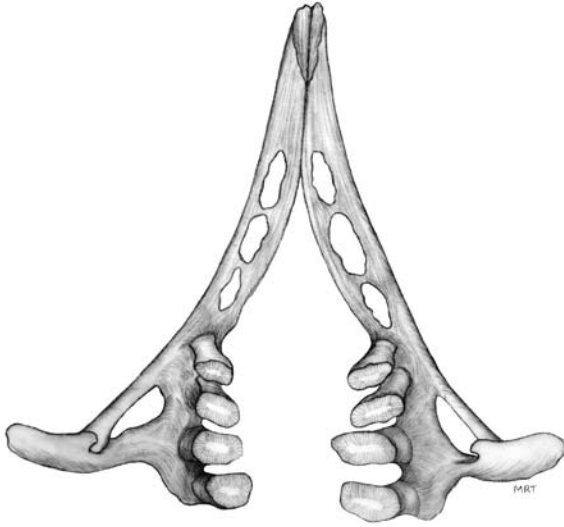

Figure 37. Pharyngeal teeth (0,4-4,0) from Bighead Carp, SIUC 23919, 207 millimeter SL, from Washington County, Illinois.

(10-17) rays. Coloration is dark gray dorsally, fading to off-white below. Young are silvery (fig. 38) until about the age of 8 weeks when numerous irregular blotches of grayish black appear on the body (Jennings, 1988). Meristics for Bighead Carp are given in appendix B.

The Bighead Carp is sexually dimorphic. Males possess a bony, sharp edge along the dorsal surface of several of the anterior pectoral rays. This feature is absent in females. Chang (1966) suggested that this secondary sex characteristic is formed long before the males reach maturity, and lasts throughout life.

Similar Species

The presence of a ventral keel differentiates the Bighead and Silver Carps from all native cyprinids except the Golden Shiner. Bighead and Silver Carps have smaller and more numerous (>60) lateral-line scales than the Golden Shiner (39-51). Additionally, Bighead and Silver Carps have only four teeth in a single row (per side). In contrast, the Golden Shiner typically has five pharyngeal teeth in a single row (per side).

The Bighead Carp can be distinguished from the Silver Carp, its close relative, by differences in the ventral keel and gill rakers. Gill rakers of Bighead Carp lack the fused condition that forms a sponge-like apparatus in Silver Carp. The ventral keel of the Bighead Carp extends forward only to the base of the pelvic fins, whereas the ventral keel in Silver Carp extends to the anterior part of the breast, almost to the junction of the

gill membranes (fig. 36). When appressed, the pectoral fin of the Bighead Carp extends beyond the pelvic base; however, the pectoral fin does not reach the pelvic base in Silver Carp. Typically, the eyes of the Bighead Carp are slightly lower on the head than those of the Silver Carp; however, this characteristic may not be diagnostic. Additionally, adult Bighead Carp have irregular gray or black blotches covering the body that are absent in Silver Carp.

The name “Bigheaded Carps” is often applied collectively to include all the *Hypophthalmichthys* species.

Variation

Bighead Carp have been artificially hybridized with Grass Carp (see Grass Carp account). Hybridization has also been achieved with Common Carp (Makeyeva, 1968, 1972) and Silver Carp (see Silver Carp account). Jennings (1988) reviewed the history of hybridization (including techniques used) and morphological characteristics of the hybrids.

Reproduction

Maturity is reached at 2-4 years in subtropical/tropical locales and 5-7 years in temperate regions (Kuronuma, 1968; Abdusamadov, 1987). Age to maturity varies with food supply and environmental conditions (Huet, 1970; Bardach and others, 1972). Males generally mature a year earlier than females (Opuszynski and Shireman, 1995). Opuszynski and Shireman (1995) reviewed gonad condition through the stages of development. Fecundity increases with mass (Verigin and others, 1990) and can range from about 280,000 to >1,000,000 eggs (Vinogradov and others, 1966; reviewed in Opuszynski and Shireman, 1995). Larval development was reviewed in Jennings (1988).



Figure 38. Juvenile Bighead Carp. (Photo by Noel Burkhead.)

In China, where they are native, Bighead Carp spawned at temperatures between 26-30 °C in the Yangtze River (Chang, 1966, *in* Opuszynski and Shireman, 1995) and as low as 18 °C in the Han River (Zhou and others, 1980). Spawning habits of Bighead Carp in the U.S. have not been well documented; although a preliminary study suggested that the lower Missouri River is conducive to spawning, due to its similarity with areas used for spawning in the native range (for example, rising water and 22 °C temperature) (Schrank and others, 2001). For additional information on spawning requirements, see the section entitled “Spawning requirements of Chinese carps” in the Grass Carp account.

Ecology

The Bighead Carp is a large species that may grow >1 m TL and up to 40 kg in as few as 9 years (Baltagi, 1979, *in* Jennings, 1988). Individuals up to about 1.3 m TL have been captured (Xie Ping, 2003) and maximum size is probably >1.5 m TL. Maximum weight is >50 kg (Li and Mathias, 1994).

The Bighead Carp is one of several large Chinese carps introduced into the U.S. In its native range, the species occurs in large rivers from temperate to subtropical climates. An important aquaculture species, the Bighead Carp has been widely introduced throughout much of the world and now occurs in a variety of habitats and climates (Lever, 1996; Fuller and others, 1999; Xie Ping, 2003). Similar to Silver Carp, the Bighead Carp often swims near the water surface; however, it is less likely to leap out of the water when disturbed (Li and Mathias, 1994). The thermal maximum temperature (derived from laboratory studies) was 38.8 °C and the preferred temperature was 25.3 °C (Bettoli and others, 1985). Liang and Wang (1993) reported the maximum pH for culture was 9.24. Egg hatching was delayed below pH 6.5 and increased mortality and deformation of larvae occurred below pH 6.0 (Li and Zhang, 1992). However, sensitivity to low pH decreased with age (Li and Zhang, 1992). Median lethal concentration of ammonia was determined as 1.12 mg/L (Gulyás and Fleit, 1990).

Oxygen consumption (per gram of body mass) has been shown to increase with increased water temperature and decrease with fish age and mass (Chen and Shih, 1955; Woźniewski and Opuszynski, 1988). Negenovskaya and Rudenko (1974) demonstrated that juveniles were tolerant of oxygen levels lower than 0.5 mg/L. Laboratory studies have shown that juveniles

can tolerate salinities up to 8 ppt for a short period of time (Chervinski, 1980). Salinity tolerance of fry increased with fish age, ranging from 2.3 ppt for 11-day olds to 7.6 ppt for 35-day old fish (Garcia and others, 1999). Larvae are known to migrate to brackish-water areas of the Caspian Sea where salinities range from 6-12 ppt (Abdusamadov, 1987).

Bighead Carp larvae feed primarily on zooplankton and to a lesser extent on phytoplankton and other suspended material (Korniyenko, 1971; Cremer and Smitherman, 1980; Burke and others, 1986; Dong and Li, 1994; reviewed in Jennings, 1988). Adults are filter-feeders that primarily consume phytoplankton in the water column. Opportunistic feeding has been reported, with individuals seasonally shifting from zooplankton to phytoplankton, based on the abundance of the food source (Nikol'skiy and Aliyev, 1974; Burke and others, 1986; Xie Ping, 2003).

The Bighead Carp has been extensively transferred and cultured in aquaculture facilities for water-quality management. The species is thought to improve water quality of ponds by removing plankton, especially filamentous blue-green algae (Voropaev, 1968; Aliyev, 1976; Cremer and Smitherman, 1980; Opuszynski and Shireman, 1993; Dong and Li, 1994). However, some researchers reported that Bighead Carp made no difference in algal density (Burke and others, 1986).

Native Distribution

The Bighead Carp is native to rivers of eastern Asia from southern China north into far eastern Russia (Li and Fang, 1990).

U.S. Introductions

The first introduction of Bighead Carp in the U.S. was in 1972 when a private Arkansas fish farmer introduced the species in an attempt to improve water quality in fish ponds (Fuller and others, 1999). By the early 1980s, the species was taken from open waters of the Ohio and Mississippi rivers, likely as a result of escapes from aquaculture facilities (Jennings, 1988). The Bighead Carp is now firmly established in the Mississippi, Ohio, and Missouri rivers, which is not surprising, given the similarities of these systems to those in the native range. Juveniles have also been taken in small (4 m width) streams in southern Illinois (J. Stewart, SIUC, personal commun. need date).

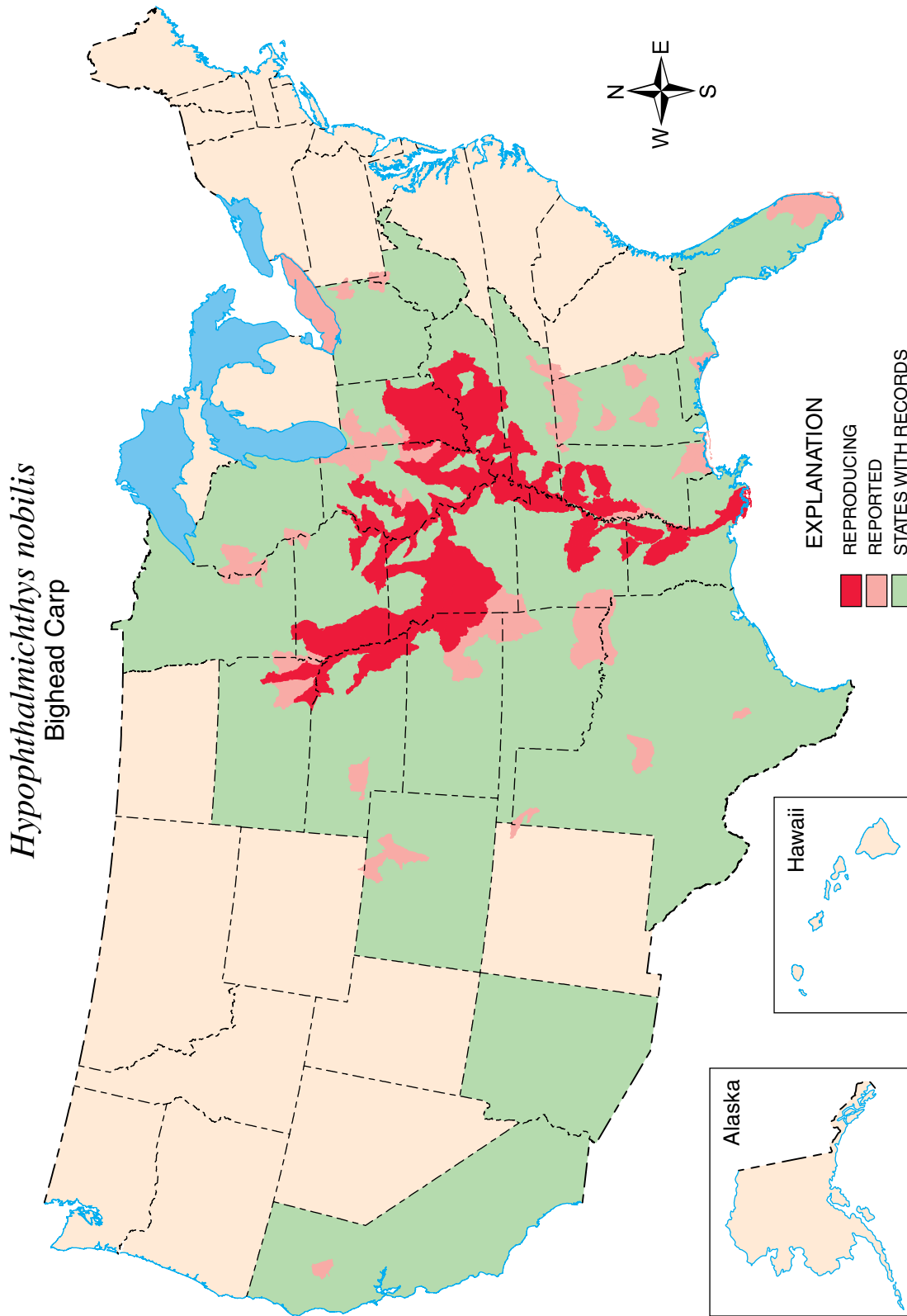

Plate 7. Distribution of Bighead Carp in the United States. See Methods for details regarding data used to create maps, definitions of “reproducing” and “reported” and shading of HUCs and states.

Ide

Leuciscus idus (Linnaeus 1758)

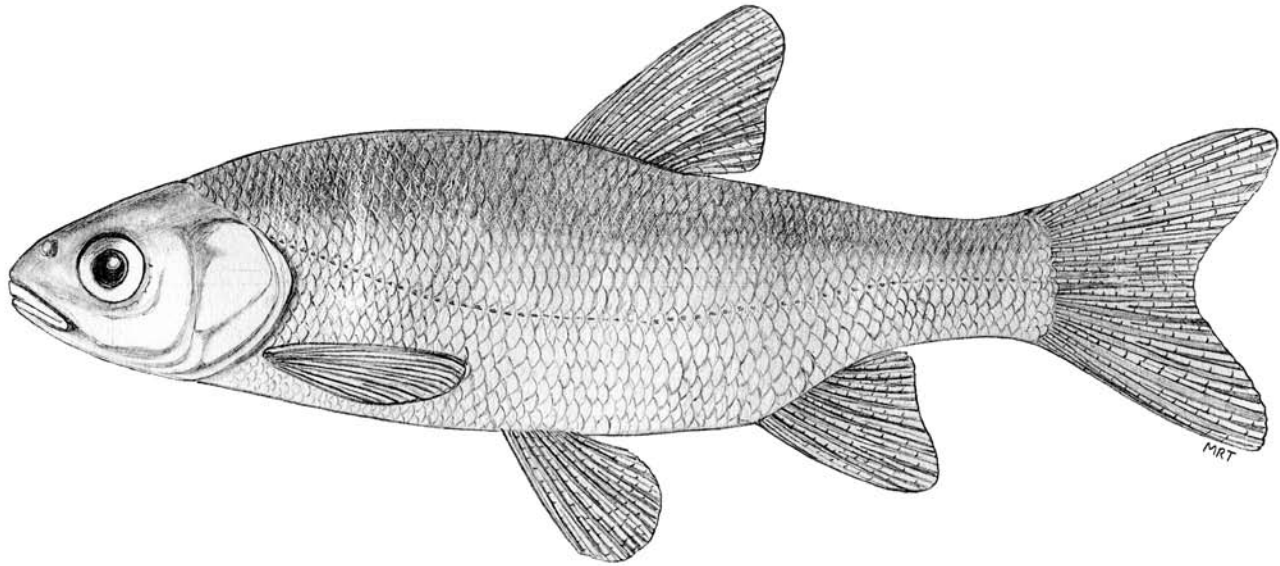

Figure 39. Ide, UF 85165, 113 millimeter SL, from the Danube River, Austria.

Description

The Ide (fig. 39) is a medium-sized fish, typically growing 30-43 cm TL and weighing 680 g (Wheeler, 1978). Maximum size is about 1 m TL and up to 8 kg (Berg, 1964). It has a typical minnow-shaped body that is moderately thick, and older adults have a raised “humped back” nape. Lateral-line scales number 55-63. The snout is blunt and the mouth is small, terminal, and oblique. Gill rakers are short, widely spaced, and number 10-14 on the first arch. The pharyngeal teeth are conic, smooth (not serrated), and arranged in two rows (usually 3,5-5,3; fig. 40). The dorsal fin is short, with iii (7-10) rays, and usually originates over the posterior part of the pelvic fin base. The anal fin has iii (9-13) rays. Adults are dark on the back and sides above the lateral line. The lower parts of the sides are light or silvery. The fins are red, especially the anal fin and paired fins. Meristics for Ide are given in appendix B

Similar Species

The Ide is superficially similar to many native North American cyprinids and does not possess a unique characteristic that sets it apart from native species. Thus, the use of regional or state fish guides is important in

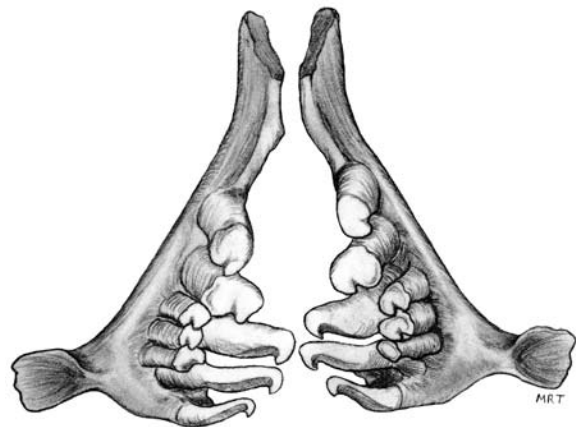

Figure 40. Pharyngeal teeth (3,5-5,3) of Ide, UF 85165, 113 millimeter SL, from the Danube River, Austria.

the identification of the species. Ide can be distinguished from most native North American cyprinids by the following combination of characteristics: pharyngeal teeth 3,5-5,3, no barbels, lateral-line scales 55-63, and usually 8 branched dorsal rays. Ide can be distinguished from other non-native cyprinids by the combination of a short dorsal fin (usually 8 branched dorsal rays) and 55-63 lateral-line scales.

Variation

A golden variety cultured for ornamental garden ponds (“Golden Orfe”) is pale yellow to orange, often with dark patches (Wheeler, 1969).

Two subspecies are recognized: *Leuciscus idus idus* and *Leuciscus idus oxianus*, Turkestan Ide (Bănărescu, 1964; Berg, 1964).

Ide hybridize with other European cyprinids (including Common Carp and Rudd; Schwartz, 1972, 1981). No hybrids with native North American fishes are known.

Reproduction

In Europe and Asia, Ide matures at 3-5 years and spawns in April or May (Berg, 1964; Wheeler, 1969; Cala, 1976). In a Swedish study, Ide matured between 31.5 and 43.1 cm TL, with males reaching maturity at a size about 3 cm smaller than that of females (Cala, 1971). In Romania, the Ide attains sexual maturity at lengths of 22.5-33 cm and an age of 3 years (Bănărescu, 1964). In contrast, Ide inhabiting a reservoir in a more northern location (Finnish Lapland) reached maturity at a larger size and older age (6-7 years) (Mutenia, 1978). Ide spawns in weedy or sandy shallow areas where the adhesive eggs attach to stones or vegetation (Wheeler, 1969; Cala, 1970). Spawning begins in the spring once the water reaches a temperature of about 5 °C for 2-3 days (Cala, 1970). Wieser (1991) reported that spawning begins when water is about 7-14 °C. Fecundity ranged from 39,000-114,000 eggs (average 88,000) in the Dnieper (Berg, 1964), from 15,000-125,280 eggs in Romania (Bănărescu, 1964) and from 42,279-263,412 eggs in Sweden (Cala, 1971). Fecundity increases linearly with fish mass (Cala, 1971). Eggs hatch in about 5 days at 18.5-22 °C, but incubation time increases in cooler temperatures (Cala, 1970; Florez, 1972a). Optimal temperature for embryonic development is 12-18 °C (Wieser, 1991).

Ecology

The Ide typically grows to 30-43 cm TL and 680 g (Wheeler, 1978); however, individuals can reach 1 m TL and up to 8 kg (Berg, 1964). Typical habitat includes pools and slow-flowing or still waters; however, deeper waters are sometimes used in winter (Wheeler, 1969). Page and Burr (1991) reported the species from clear pools of medium to large rivers as well as ponds and lakes. Wheeler (1978) noted that the Ide inhabits the lower reaches of large rivers, lowland lakes, and

brackish estuaries of rivers, adding that it schools in clean, deep water, moving into shallow freshwater to spawn in the spring. Zhadin and Gerd (1963) reported it was one of the most common fishes in reservoirs on the Ob, Novosibirsk, and Bukhtarma-Zaisan rivers of the former Soviet Union. Seeley (1886) reported that the species is not confined to freshwaters, and is found in the Baltic Sea. Cala's (1970) study of the River Kävlingeån in Sweden reported Ide spent the first year of life in the river, and then joined older fish migrating to the Baltic Sea during the summer months. The species returned to the river in the autumn and remained near the mouth and in the lower reaches throughout the winter (Cala 1970). After spawning in the spring, Ide returned to coastal waters (Cala 1970). Specimens in the River Kävlingeån were found to be as old as 14 years.

Laboratory studies showed that mortality of larvae and juveniles was significant at oxygen concentrations <2 mg/L (Florez, 1972b). Cala (1970) noted that fish kills have been noted since 1910 in River Kävlingeån, Sweden, as a result of low oxygen content, high temperatures, and pollution. Upper lethal temperature of larvae and juveniles acclimated to 6-22 °C, varied from 24-29 °C, and was lower in fish acclimated to lower water temperatures (Florez, 1972a).

Ide feeds on insect larvae and adults, cladocerans, worms, spawn of other fishes, small mollusks, diatoms, and filamentous algae (Zhadin and Gerd, 1963; Berg, 1964; Wheeler, 1969, 1978; Mutenia, 1978). Other dietary items include macrophytes, detritus, and small fishes (Zhadin and Gerd, 1963; Lammens and Hoogenboezem, 1991). In Sweden, small (10-80 mm TL) Ide ate cladocerans and copepods, but Ide >140 mm ate plants, isopods, oligochaetes, and insects (Cala, 1970).

Native Distribution

The Ide is native to most of Europe and Western Asia (see Berg, 1964 for details).

U.S. Introductions

The Ide was first imported to the U.S. in 1877 and was cultured by the U.S. Fish Commission and subsequently distributed to several state agencies and individuals (Fuller and others, 1999). Escapes from commercial and government ponds (especially during flooding) have expanded its range in the U.S. The species has been recorded from at least 22 states, but documentation of

its true status in the U.S. is poor and often contradictory (Fuller and others, 1999). The states where the Ide is reported from open waters include those that received shipments from the U.S. Fish Commission during the late 1800's.

There have been reports of localized, reproducing populations in a few areas, but it is uncertain whether any still persist. A reproducing population was discovered in a small pond in the Connecticut River drainage

of Connecticut in the early 1960s, but by the mid-1980s that population was reportedly eradicated (Whitworth, 1996; Fuller and others, 1999). Similarly, a reproducing population of Ide in a private pond in Maine was eradicated. Different domesticated forms, (for example, "Golden Orfe") are occasionally kept in garden ponds, sometimes in combination with Goldfish and Koi. Golden Orfe is also present in commercial aquaculture facilities in California (Dill and Cordone, 1997).

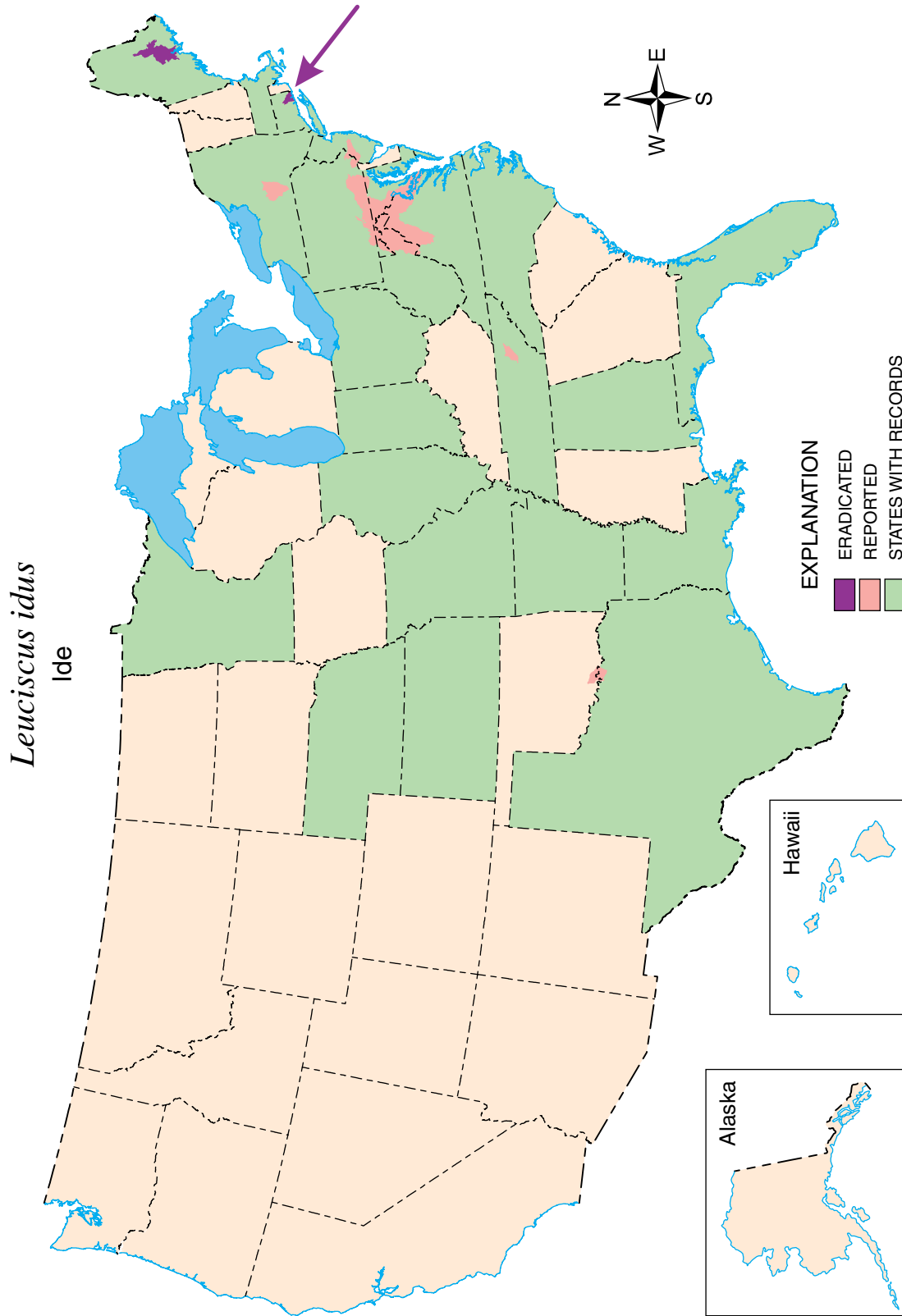

Plate 8. Distribution of *Ide* in the United States. See Methods for details regarding data used to create maps, definitions of “eradicated” and “reported” and shading of HUCs and states.

Black Carp

Mylopharyngodon piceus (Richardson 1846)

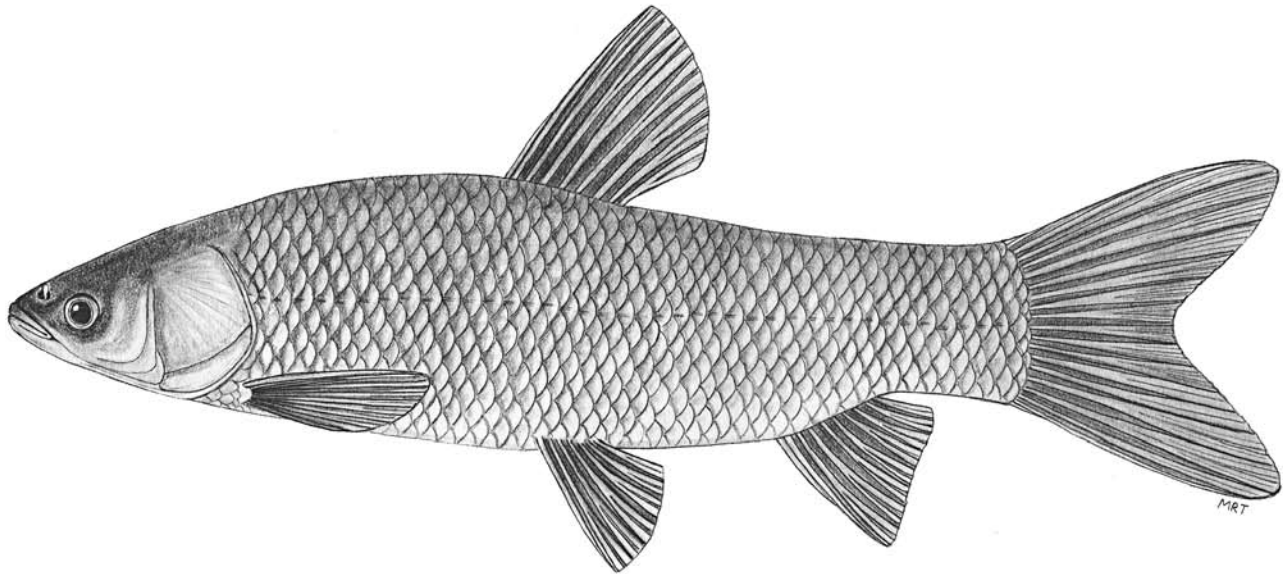

Figure 41. Black Carp, SIUC 46739, 390 millimeter SL, from Randolph County, Missouri.

Description

The Black Carp (fig. 41) is a large cyprinid, often exceeding 1 m SL. The reported maximum size is about 2 m TL and 70 kg (Nico and others, 2005). The body is somewhat stout, rather elongate, and cylindrical to slightly compressed with a short and relatively deep caudal peduncle. The scales are relatively large, ranging from 39-46 along the lateral line. The head is relatively short, with eyes of moderate size. The snout is slightly rounded. The mouth is relatively small to moderate in size, placed terminally or slightly subterminally, and lacking barbels. Gill rakers are short and stout, usually numbering 18-21 (range 14-23). The short dorsal fin has iii (7-9) rays. The anal has iii (7-9) rays. The dorsal-fin origin is slightly anterior to pelvic-fin origin. The caudal fin is large and forked. Body coloration is somewhat variable. Typically, individuals are dark brown or blue-gray to black and the fins, in particular, are darkly pigmented (fig. 42). Meristics for Black Carp are given in appendix B (also see Nico and others, 2005).

The pharyngeal teeth generally form a single row of four or five large molariform teeth per side (fig. 43). Occasionally an outer (secondary) row is

present, consisting of a single tooth (possibly two in rare instances) on one or both sides. Dentition formula is typically 0,4-5,0 or 1,4-4,1. Juvenile and adult Black Carp (31-330 mm TL) pass through several generations of pharyngeal teeth (Liu and others, 1990). In small Black Carp (<30 mm TL), the pharyngeal teeth may be conical.

During the reproductive season, male Black Carp develop breeding or nuptial tubercles, although these may not always be observable (Bardach and others, 1972). Breeding tubercles have been reported on the interorbital region, pectoral-fin rays, operculum, and sides of the body (Kimura and Tao, 1937; Wu and others, 1964b; Chang, 1966; Zhong and others, 1980). Tubercles are absent in females (Chang, 1966).

Similar Species

Few native North American fishes can be confused with Black Carp. Its large adult size distinguishes Black Carp from most native minnows, although a few large catostomids (suckers) and cyprinids have a body shape superficially resembling Black Carp. Several native fishes have heavy pharyngeal teeth modified for feeding



Figure 42. Black Carp (261 millimeter SL) from the species' native range in the Chang (Yangtze) River Basin, Hunan Province, People's Republic of China. (Collected by C. Zhang, F. Fang, and colleagues during trip financed by the European Commission, INCO-DEV program, project ECOCARP, contract number ICA4-CT-2001-10024. Photograph courtesy of Fang Fang Kullander, Swedish Museum of Natural History, Stockholm.)



Figure 43. Pharyngeal teeth of Black Carp, SIUC 46739, 390 millimeter SL, from Randolph County, Missouri. (Also see fig. 9, p. 13.)

on mollusks, similar to Black Carp. Nevertheless, in all cases the combination of size, number, shape, and placement of the pharyngeal teeth of native species is different from that found in Black Carp.

The Black Carp is most similar to its close relative, the Grass Carp, particularly in terms of body size and shape, and the position and size of fins and eyes (Nico and others, 2005). Anatomy of the pharyngeal teeth is the main characteristic used to distinguish the two species, although body color differences may also be useful. Pharyngeal teeth of Black Carp (about >30 mm TL) are large, molariform, and relatively smooth (without grooves or hooks of any kind; fig. 43), whereas those of Grass Carp are elongate with grooves or serrations. Small Black Carp (about <30 mm TL) have pharyngeal teeth that are somewhat conical and could be confused with the teeth of Grass Carp.

The body and fins of Grass Carp are generally lighter in color than those of Black Carp; however, color may vary with age, habitat, and season (Nico and others, 2005). Whereas the Black Carp is rather darkly colored, the Grass Carp is olivaceous, silvery white, or olive-brown above and silvery below, with most fins only partially pigmented (sometimes described as dusky). In both species, the body is counter-shaded, lighter below

than above. In some Black Carp, the ventral part of the body may appear almost white, particularly beneath the head region. Although little information exists on color differences between juvenile Black Carp and Grass Carp, color pattern is probably less reliable in distinguishing between small juveniles of the two species, because of habitat influence. For example, Grass Carp inhabiting tannic waters (sometimes referred to as “black water”) typical of the southern U.S. can be darkly pigmented and confused with Black Carp.

Descriptions of Black Carp in the literature and our own examination of live and preserved specimens indicate that a few other traits may be useful in distinguishing Black Carp from Grass Carp. However, not all of these differences have been adequately confirmed (Nico and others, 2005). Moreover, these additional traits may exhibit more variation than pharyngeal teeth and, therefore, are appropriately used only in combination with teeth anatomy and body color. These additional traits include: number and relative size of gill rakers, shape of head and snout (for example, interorbital width and head length), relative length of the intestine, and color of the peritoneum. Howells (1992) reported that differences in gill-raker counts distinguish Black Carp from Grass Carp. However, our review of the literature and counts on specimens indicate there is overlap, with Black Carp having 14-23 (usually 18-21) gill rakers, and Grass Carp typically having 12-16. Gill rakers in both species are relatively small, but an examination of 30 Black Carp and 30 Grass Carp revealed that those of Black Carp were slightly shorter and stouter. Slight differences in the shape and slope of the head have been observed. For example, our measurements of preserved specimens (about 80-100 mm SL) indicate that the ratio of the interorbital width (IOW) divided into head length

(HL), may be a useful distinguishing characteristic. Measurements ranged from 35-45 percent in Black Carp versus 48-56 percent in Grass Carp. Black Carp have a relatively short digestive tract (intestinal length is about 1-2 times TL), whereas Grass Carp have a longer, more coiled digestive tract (intestinal length about 2.5 times TL; Nico and others, 2005). Based on our own observations and information in the literature, the peritoneum of juvenile and adult Black Carp is dark, whereas in Grass Carp the membrane is generally silver, although heavily mottled with black (fig. 10 in Key).

Variation

There are no recognized subspecies for Black Carp. However, Bíró (1999) suggested that differences in pharyngeal teeth counts provide possible evidence for two subspecies in China.

Hybrids in nature have not been reported. However, the Black Carp has been artificially crossed (with limited success) with Grass Carp, Silver Carp, Bighead Carp, Common Carp, and Black Bream (*Megalobrama terminalis*; Ryabov, 1979; Evtushenko and others, 1994; Bíró, 1999; Nico and others, 2005).

Reproduction

The reproductive requirements of Black Carp are similar to those of Grass Carp (Nico and others, 2005). Please refer to section entitled "Spawning requirements of Chinese carps" in the Grass Carp account.

Ecology

The Black Carp is a large cyprinid, often exceeding 1 m SL and with a maximum size of about 2 m TL and 70 kg (Nico and others, 2005). The typical habitat includes reaches of large rivers that are below 200 m above sea level (Li and Fang, 1990), such as channels of lowland rivers and associated floodplain lakes and backwaters. The species also occurs in artificial habitats (including canals), and some populations survive in lakes and reservoirs, although reproduction and completion of their life cycle require a connection to flowing waters (Nico and others, 2005).

Nico and others (2005) reviewed information on the environmental tolerances of Black Carp. The species is tolerant of temperatures from about 0.5-40 °C. Reproduction and egg development generally occur between 18-30 °C. The Black Carp is known to occasionally inhabit the deltas of rivers (for example,

Yangtze River, China), where it may encounter brackish waters. However, information on salinity tolerance of Black Carp has not been reported.

The species is tolerant of pH from 6-10 for limited periods of time; however, the preferred range is from 7 or 7.5-8.5. Black Carp is tolerant of oxygen levels as low as 2 mg/L.

The diet of Black Carp was reviewed by Nico and others (2005). Larvae and small juveniles feed almost entirely on small invertebrates (such as zooplankton and aquatic insects). Larger juveniles and adults are bottom-feeders that predominantly prey on snails and bivalve mollusks, although crayfish and other benthic invertebrates are sometimes consumed. The heavy pharyngeal arches and large molariform teeth of Black Carp are adapted to crush mollusk shells (Liu and others, 1990; Nico and others, 2005).

Native Distribution

The native range of Black Carp includes most major Pacific Ocean drainages of eastern Asia from the Amur River Basin south to the West-Pearl River Basin, and possibly the Red River of northern Vietnam (Nico and others, 2005).

U.S. Introductions

Black Carp was first imported into the U.S. in the 1970s, and by the 1990s the species was being used in fish farms in several southern states to control pond snails (Nico and others, 2005). Thirty Black Carp were reported as having escaped into the Osage River from a Missouri fish farm during a major flood in April 1994. Because of its widespread use to control snails, escapes from aquaculture ponds have probably added to the wild population. During recent years there have been reports of Black Carp being captured in the wild. The first published report was that of a single Black Carp taken by a commercial fisher from Horseshoe Lake in southern Illinois in March 2003 (Chick and others, 2003). Nico and others (2005) investigated other reports and found evidence that wild populations of Black Carp may have been present in the lower Mississippi River Basin, largely in and around the Red River of Louisiana, since the early 1990s. Reproduction in the Mississippi River has not been documented, but new information and recent collections suggest the species is likely established in the lower part of the Mississippi Basin and possibly elsewhere in the basin (Nico and others, 2005).

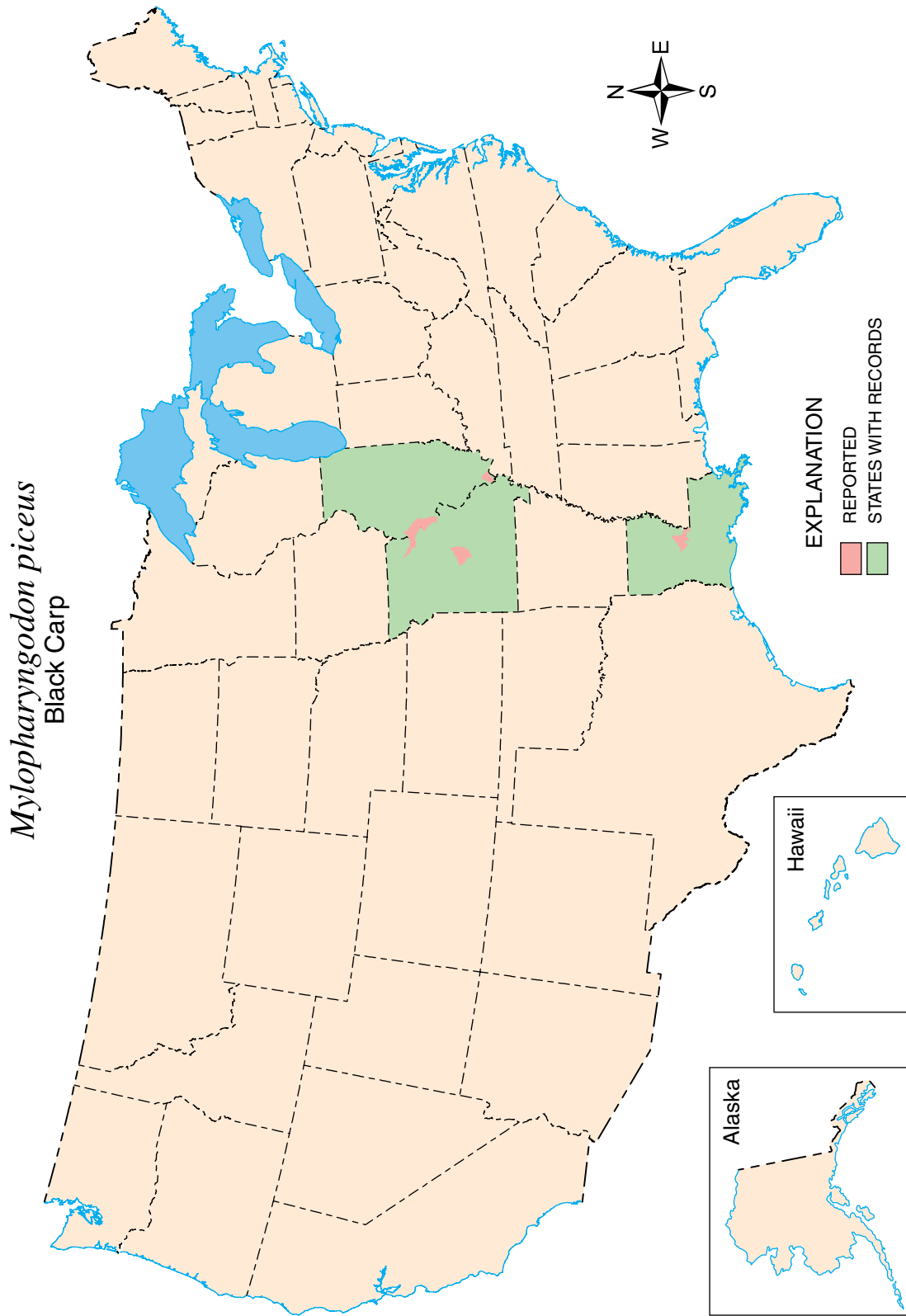

Plate 9. Distribution of Black Carp in the United States. See Methods for details regarding data used to create maps, definition of “reported” and shading of HUCs and states.

Bitterling

Rhodeus sericeus (Pallas 1776)

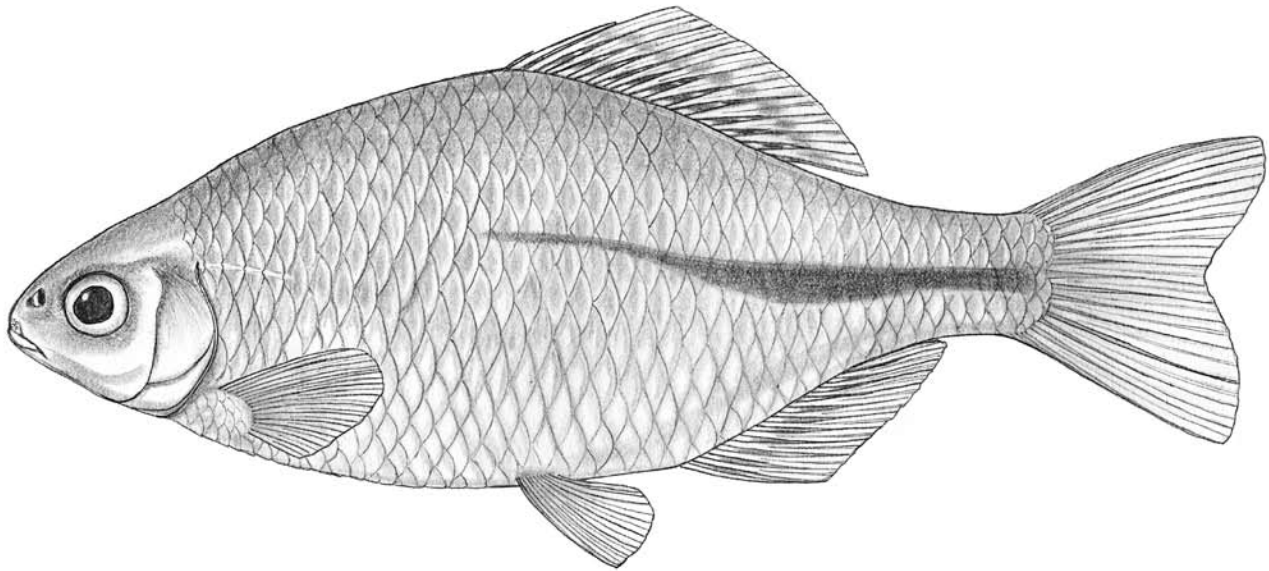

Figure 44. Bitterling, TU 8889, 71.2 millimeter SL, from Westchester County, N.Y.

Description

The Bitterling (fig. 44) is a small species, rarely exceeding 7 cm SL (Smith and others, 2004). Maximum size is about 11 cm TL (Page and Burr, 1991). The species is deep-bodied and moderately compressed, with the back arched anterior to the dorsal fin. The scales are moderately large, with 32-45 lateral scale rows. The lateral line is absent or incomplete, with only 0-10 pored scales. The head is relatively small and the mouth is small, oblique, and lacks barbels. The upper jaw is slightly longer than the lower one. The pharyngeal teeth are hooked and in a single row (0,5-5,0; fig. 45). Gill rakers on the first arch range from 9-16. The dorsal fin has with ii-iii (7-11) rays and originates slightly anterior to the anal fin. The anal fin has ii-iv (6-11) rays. The caudal fin is moderately forked, with roughly equally sized lobes. The back is gray-green to gray-brown, and the sides and belly are silvery. The sides may include some pink. The fins are pale orange, except in breeding males when the dorsal and anal fins become bright red. A gray-green metallic stripe runs along the mid-line of the body from just under the dorsal fin to the caudal peduncle. Meristics for Bitterling are given in appendix B.

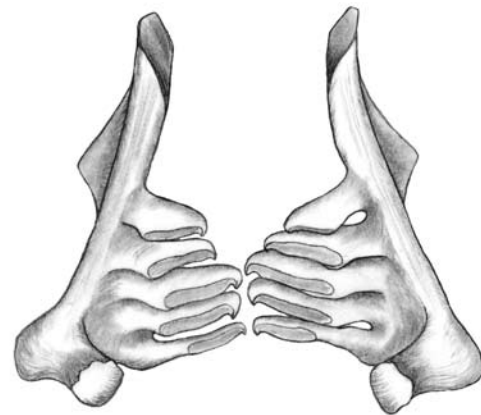

Figure 45. Pharyngeal teeth of Bitterling, TU 8889, 71.2 millimeter SL, from Westchester County, N.Y.

Breeding males are brilliantly colored (Smith and others, 2004). They turn iridescent along the sides and the stripe along the mid-line of the body turns bright blue (Smith, 1985). In addition, the dorsal and anal fins, breast, and belly become orange to blood-red. According to Smith and others (2004), the dorsal fin of mature males is almost black, with a red triangle at its

tip, and the anal fin is red with a dark border. They also noted that the upper part of the iris is red in sexually mature males and remains pigmented the remainder of life. During the spawning season, mature males also develop two patches of white nuptial tubercles on either side of the head (Wheeler, 1978; illustrated in Schmidt and McGurk, 1982). The color of females remains unchanged during the breeding season: gray-green dorsally, silver laterally, and yellow ventrally, and without red pigment around the iris (Smith and others, 2004). Breeding females develop a long, tube-shaped ovipositor anterior to the anal fin. The ovipositor is extended during spawning, but is retracted into the body at other times (Smith and others, 2004). Length of the ovipositor is variable; it is longest shortly before or after spawning when the structure may exceed the body length of the female (Seeley 1886; Berg 1964; Smith and others, 2004). Outside the spawning season females retain an ovipositor. Although much reduced in size, the organ remains obvious and readily distinguishes females from males (Smith and others, 2004).

Similar Species

The Bitterling can be distinguished from most native North American cyprinids as well as all other non-native cyprinids by a combination of characteristics, including large scales (32-45 lateral scale rows), a deep body, and short lateral line (0-10 pored scales).

Variation

The taxonomy of Bitterling remains problematic (Smith and others, 2004). Bănărescu (1964) recognized three subspecies: *Rhodeus sericeus amarus* ranges from the Seine River of France east through central and eastern Europe to the Ural Mountains (but not Spain, Italy, England, or Scandinavia); *Rhodeus sericeus sericeus* from the Amur River Basin region; and *Rhodeus sericeus sinensis* from the Yangtze River Basin. Some researchers consider the western populations a separate species, *R. amarus* (Smith and others, 2004). However, Holčík and Jedlička (1994) documented clinal gradation in characteristics used to separate the geographically isolated subspecies and recommended ending the use of subspecies designations. They noted that characteristics used to separate the eastern and western forms were size and temperature dependent.

Only a few hybrids are reported for the Bitterling, and all are from crosses with Asian cyprinids (Schwartz, 1972, 1981).

Reproduction

Sexual maturity is reached in the second to fourth year (Nikolsky, 1954; Zhul'kov and Nikiforov, 1988). In Europe and nearby regions, spawning occurs between April and August, typically with a peak in May (Smith and others, 2004). According to Reichard and others (2004), spawning is determined by photoperiod and water temperature. Seeley (1886) noted that spawning occurred from May to August in the Seine River (France), and during April in Austria. Wheeler (1969) reported spawning in April and June in northwestern Europe. Zhul'kov and Nikiforov (1988) reported spawning at temperatures from 12-24 °C in Russia.

Reproduction of Bitterling is unusual, involving a symbiotic relationship with various species of freshwater mussels from the families Unionidae and Margaritiferidae (Smith and others, 2004). During the spawning season, the brightly colored males defend territories around mussels. Gravid females use their elongate ovipositor to deposit their eggs into the mantle cavity of the mussel. Male Bitterling then fertilize the eggs inside the mussel by shedding their sperm over the inhalant aperture of the mussel so that water entering the mussel carries the sperm to the eggs (Smith, 1985; Smith and others, 2004). Sterba (1973) reported that females condition the mussels to the stimulus by repeatedly nudging them with their mouth, thus ensuring against closing of the valves during the insertion of the ovipositor. The same female may use a number of mussels, and she deposits only one or two yellow, oval eggs into each (Seeley 1886; Axlerod and Schultz, 1955). The ovipositor is only present during the spawning season, after which it gradually shortens until reduced to a papilla (Seeley 1886; Sterba, 1973). Smith (1985) reported that the ovipositor of one female shrank to one-third of its maximum length within 3 days after spawning. Breder (1933) demonstrated that the Bitterling could use freshwater mussels native to the U.S. for reproduction (for example, *Elliptio complanata* and *Pyganodon* [formerly *Anadonta*] *cataracta*). Contrary to what was previously thought, there is evidence indicating the Bitterling is selective about which mussel species are used for spawning (Smith and others, 2004).

Fecundity of the Bitterling is low compared to cyprinids that broadcast their eggs. A fecundity of only 31-53 eggs per female was reported in the population inhabiting the Bronx River, New York (Schmidt and McGurk, 1982). Zhul'kov and Nikiforov (1988) reported a fecundity of 203-408 eggs per female in a Russian

river. Aldridge (1999) studied an introduced population of Bitterling in Britain, and documented the large size of the eggs (2.6 X 1.7 mm). The elliptical shape of the eggs (versus the more common spherical shape) is reportedly an adaptation to increase transport of respiratory and excretory products across the membrane (Aldridge, 1999). It has been hypothesized that female Bitterling discriminate among egg hosts by inspecting flow velocity and oxygen content of water emerging from the exhalant siphon of the mussels (Smith and others, 2001; Mills and Reynolds, 2002). The stages of development from the egg to the free-swimming larvae are described and illustrated in Aldridge (1999).

The larvae stay inside the mussel for 3-4 weeks, until the egg sac is absorbed and they have reached a length of about 11 mm (Aldridge, 1999). Larval drift of Bitterling in the Danube Basin peaks in late June (Jurajda, 1998; Reichard and others, 2002). Jurajda (1998) reported that the larvae drifted at night near the surface of the water. The larval period of the precocial Bitterling is shorter in duration than many other cypriids (Reichard and Jurajda, 1999). Phosphorus pollution (500 µg/L and higher) has been shown to increase the rate of premature expulsion of larvae from the mussels, leading to increases in larval mortality (Reynolds and Guillaume, 1998).

Ecology

The Bitterling is a relatively short-lived species, generally surviving only about 5 years (Nikolsky, 1954). Maximum size is 11cm TL (Page and Burr, 1991), but it usually only grows to 6-7 cm in Europe (Wheeler, 1969). A total of 138 individuals ranging from 38-66 mm SL (mode = 48 mm SL) were taken from the Bronx River, New York, by Schmidt and McGurk (1982).

The Bitterling inhabits slow-flowing or still waters, such as ponds, lakes, marshes, muddy and sandy pools, and river backwaters (Wheeler, 1969; Page and Burr, 1991). Because the Bitterling depends on freshwater mussels to reproduce, its range is restricted (Smith and others, 2004). Przybylski and Zieba (2000) reported that in Poland the preferred habitats were characterized by low flow and covered by vascular plants.

The species is omnivorous, feeding on both invertebrates (especially in the juvenile stage) and plant matter. Seeley (1886) reported diatoms and algal fragments from the long, coiled intestines of the Bitterling. Wheeler (1969) reported that European Bitterling fed on phytoplankton, crustaceans, insect larvae, tubificid

worms, and vegetable detritus. Five specimens examined by Schmidt and McGurk (1982) from the Bronx River, New York, contained diatoms and detritus. Przybylski (1996) documented that the diet of small (22-36 mm) individuals primarily consisted of chironomids, whereas larger fish (50-75 mm) fed on detritus and plant matter. Feeding occurred primarily during the day (Przybylski, 1996). Koutrakis and others (2003) documented that the diet of a population of Bitterling in Greece consisted of algae, insects, crustaceans, and organic and inorganic matter.

The Bitterling derives its name from its apparently noxious taste (to both humans and fishes), and thus was not recommended as a bait fish by Seeley (1886). Wheeler (1969) suggested its main appeal was as an aquarium fish, and hypothesized that populations found in Britain were due to aquarium releases.

Native Distribution

The Bitterling has a disjunct distribution that has led to some taxonomic confusion. The species occurs in Central and Eastern Europe from the Seine River of France to the Ural Mountains (but not in Spain, Italy, England, or Scandinavia). Pallas described the species in that region as *Rhodeus sericeus*. Bitterling also naturally occurs in the Amur River Basin of eastern Asia, where it was described as *Rhodeus amarus* by Bloch (now *Rhodeus sericeus amarus*). Additionally, a subspecies of Bitterling is found in the Yangtze River Basin (*Rhodeus sericeus sinensis*). There is a wide geographical gap in the northern part of Asia separating the ranges of the European subspecies from those of eastern Asia.

U.S. Introductions

The only known introductions of Bitterling into the U.S. were in the state of New York. The species was introduced into the Sawmill and Bronx rivers sometime before 1925 (Dence, 1925; Myers, 1925). No Bitterling have been collected in the Sawmill River since 1951, and that population is assumed to be extirpated (Schmidt and others, 1981). In the early 1980s, the Bronx River population was estimated to number only about 900 individuals and inhabit 1-2 km of the river (Schmidt and McGurk, 1982). Although native mussels (needed for reproduction) still occur in the Bronx River, the population of Bitterling appears to be declining (R. Schmidt, personal commun., 2005; J. Rachlin, personal commun., 2005).

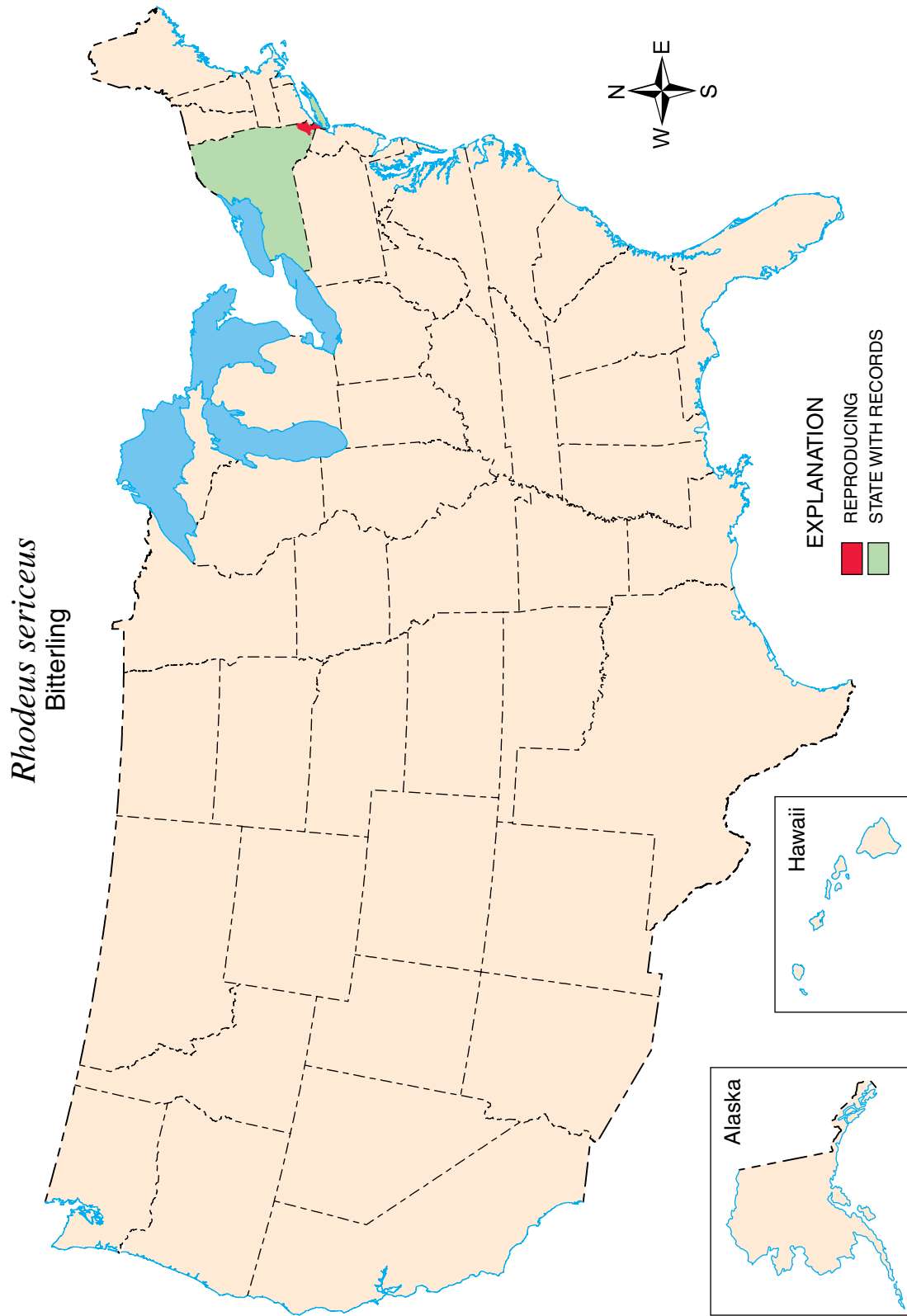

Plate 10. Distribution of Bitterling in the United States. See Methods for details regarding data used to create maps, definition of "reproducing" and shading of HUCs and states.

Rudd

Scardinius erythrophthalmus (Linnaeus 1758)

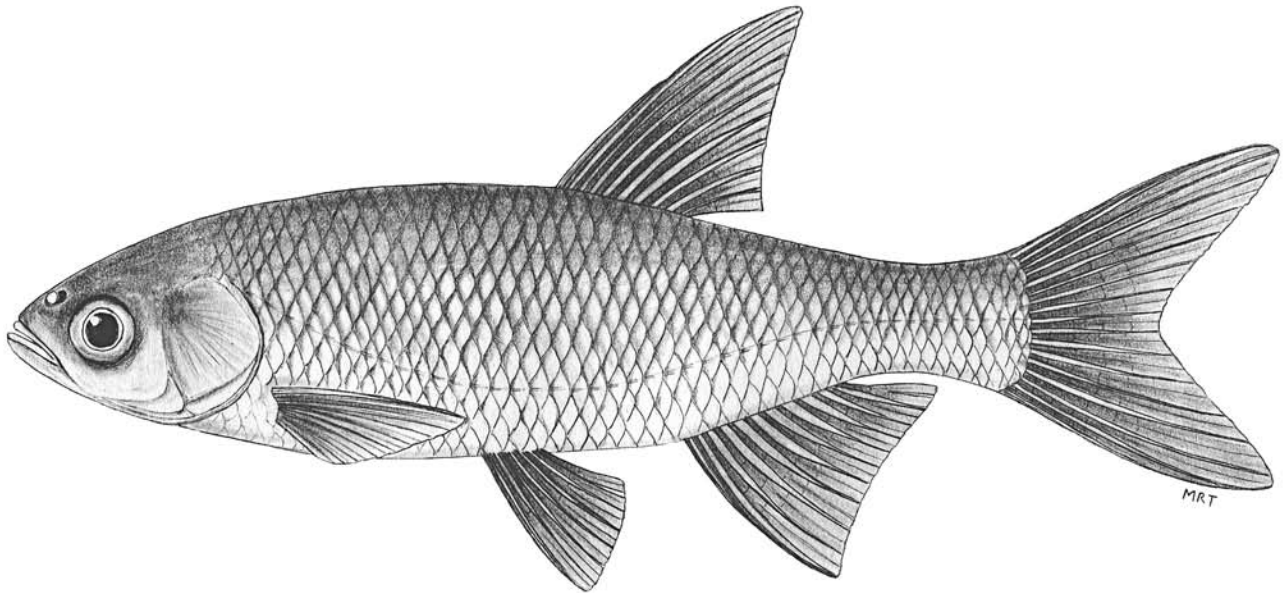

Figure 46. Rudd, SIUC 51749, 105 millimeter SL, from cultured stock in Gainesville, Florida. (The original brood stock came from Arkansas.)

Description

The Rudd (fig. 46) is a medium-sized fish typically attaining about 30 cm TL and 0.8 kg, with a maximum size of about 45 cm TL and 2 kg (Berg, 1964; Wheeler, 1969, 1978; Muus, 1971). The body is deep and moderately compressed with an arched back and a scaled keel between the pelvic fins and anus. The lateral line is complete with 37-43 scales and distinctly curved downward anteriorly. The snout is blunt and the mouth is large, terminal, and oblique. The eyes are laterally positioned. The cranium profile is convex to straight, becoming slightly concave in some larger specimens. Gill rakers on the outer arch range in number 10-13. Pharyngeal teeth are strongly serrated and borne on a stout arch. The dental formula is typically 3,5-5,3 (fig. 47). The peritoneum is silvery and the intestine is S-shaped. The dorsal-fin origin is markedly posterior to the pelvic-fin insertion. The dorsal fin is slightly falcate and has i-iii (8-10) rays. The anal fin is moderately falcate and has i-iii (9-13) rays. The caudal fin is moderately forked, with the lower lobe slightly longer than the upper. Meristics for Rudd are given in appendix B.

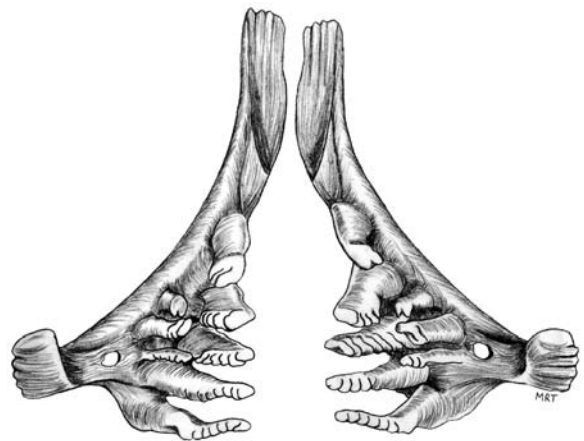

Figure 47. Pharyngeal teeth (3,5-5,3) of Rudd, SIUC 51749, from cultured stock, Gainesville, Florida. (The original brood stock came from Arkansas.)

Coloration of non-nuptial adult Rudd is silvery with a yellow-lime sheen on the upper sides grading to brassy on the back (fig. 48). Pigmentation on the back varies depending on the color of the habitat substrate. Fish from



Figure 48. Adult Rudd, 104 millimeter SL, from cultured stock in Gainesville, Florida. (The original brood stock came from Arkansas; photo by Noel Burkhead.)

pale substrates often lack the distinctive broad middorsal stripe and have a dorsum that is silvery, brassy, or with a lime sheen. The dorsal surface of the head is straw-olive in color. The cheeks and opercles are silver. According to Wheeler (1978), all the fins are reddish and the ventral fins are brilliant blood red. Other authors have described the median fins as having a rose-orange wash and the paired fins as rose-orange (especially in the leading rays). The iris of the eye is golden with a red fleck above (Wheeler, 1978). The Rudd also has a golden color morph that is sometimes used as an ornamental pond fish (Maitland, 1977).

In nuptial males, the venter is silver and the sides are brassy progressing to bright translucent orange along the midback. The back and upper sides are olive-black anterior and posterior to the dorsal fin. The dorsal surface of head is translucent orange. Cheeks and opercles are brassy-orange. The lips are orange and the iris is orange dorsally. The distal two-thirds of the dorsal fin is bright red, and the basal third is paler with olive-black along the rays. The anal and caudal fins are bright red with distinct pale margins. Paired fins are red except the posterior 3-5 rays, which are pale. The coloration of mature females is similar to males, but more subdued.

Nuptial males develop fine tubercles on the head and body (Berg, 1964; Wheeler, 1969). Two small (76 and 81 mm SL) sexually mature males reared in the laboratory exhibited fine, densely spaced tubercles on the head, anterior part of the body, and rays of pectoral, dorsal, and anal fins. Tubercles have not been reported in females. In both sexes, the urogenital opening is present just posterior to the anus and is located in a fleshy pit. The female urogenital opening is about twice the size of the male opening and is ringed with fleshy protuberances.

Similar Species

The Rudd is distinguished from native North American cyprinids by two characteristics. The Rudd has a scaled midventral keel (fig. 49) and a 3,5-5,3 pharyngeal tooth formula (fig. 47). The blood-red color of the pelvic and anal fins in specimens about >40 mm SL may have diagnostic utility.

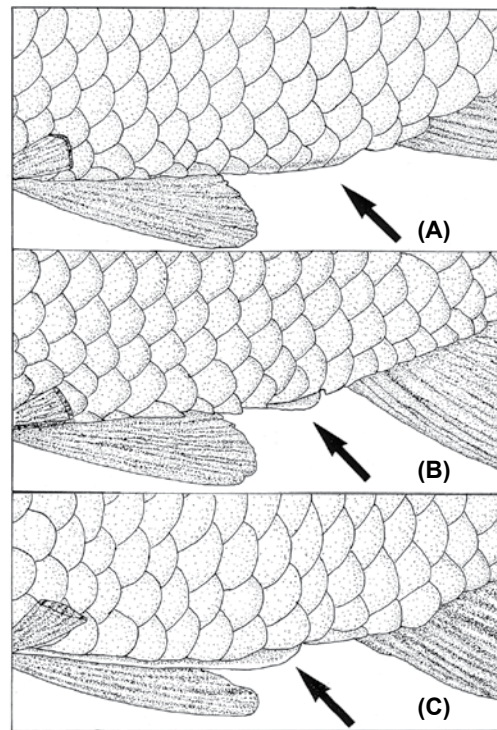

Figure 49. Ventrolateral and posterior aspect of abdomen showing (A) a scaled keel in Rudd, (B) a partially scaled keel in hybrid Rudd X Golden Shiner, and (C) a naked keel in Golden Shiner. (From Burkhead and Williams 1991.) (Also see to fig. 8, p. 12.)

The Rudd is most similar in appearance to the Golden Shiner, the only native North American cyprinid having a midventral keel. However, the keel of the Golden Shiner is scaleless, whereas the keel of the Rudd is crossed with scales. In Rudd X Golden Shiner hybrids the keel is partially scaled (fig 49; Burkhead and Williams, 1991). In both species the fins may be brightly colored; however, the fins of adult Golden Shiners are typically orange or reddish-orange, whereas those of Rudd are generally blood red. If there is any question of identity, the pharyngeal arches should be examined. The pharyngeal teeth of Rudd are in two rows (3,5-5,3); those of the Golden Shiner are in a single row (0,5-5,0).

Early development of the Rudd has been described by Bracken and Kennedy (1967), Kennedy and Fitzmaurice (1974), Cadwallader (1977), and Černý (1977). Newly hatched larvae possess adhesive organs on the head and anterior trunk. Adhesive organs have not been observed in the Golden Shiner (Lippson and Moran, 1974; Snyder and others, 1977).

Variation

A golden color variety is sometimes used as an ornamental pond fish (Maitland, 1977).

A number of subspecies have been recognized (Bănărescu, 1964). Some are no longer considered valid; and a few have been elevated to distinct species (for example, *Scardinius graecus* and *Scardinius scardafa*; Bogutskaya, 1997; Bianco, 2004).

The Rudd has been reported to hybridize with a number of Old World cyprinids, including Goldfish, Common Carp, and Tench (Schwartz, 1972, 1981). There is one report of Rudd X Northern Pike (*Esox lucius*) hybridization (Romashov and Golovinskaia, 1960, in Schwartz, 1972, 1981). The Rudd has also been artificially hybridized with Golden Shiner (Burkhead and Williams, 1991).

Reproduction

Age at maturity varies with geographic latitude. Males may be sexually mature from 1-4 years and females from 2-5 years. Spawning occurs in late spring and summer when water temperatures are above 16 °C (Nikolsky, 1963). Holčík (1967) suggested that the Rudd may be a "portional" spawner, producing two batches of eggs in a spawning season; the first batch being larger than the second. Berg (1964) reported 96,000-232,000 eggs per female, but did not indicate the size range of the fish examined. Kennedy and Fitzmaurice (1974) reported a range of 108,000-211,000 eggs per kg of body mass.

In preparation for spawning, mature males appear at the breeding sites first. Females are present 6-8 days later, although actual spawning reportedly does not occur for another 2-3 weeks (Holčík, 1967). Pre-spawning behavior in the shallow waters of a lake in Sweden was described by Svårdson (1949). Large numbers of fish were involved in the spawning activities, with local aggregations near dense submerged vegetation. The adhesive eggs are shed on vegetation, usually along the shoreline (Wheeler, 1969; Cadwallader, 1977). Černý (1977) reported spawning on rocky substrata close to the banks of a reservoir. The Rudd is also known to join in the spawning shoals of other cyprinids (Cadwallader, 1977; Černý, 1977; Muus, 1971).

Rudd eggs are demersal and adhesive, and newly fertilized eggs are translucent pale yellow to opaque gray-green (Cadwallader, 1977; Černý, 1977). Developmental rates vary widely with temperature. For example, Kennedy and Fitzmaurice (1974) observed that incubation time ranged from 4-5 days at 17.5-21.5 °C to 19-20 days at 10.5-11.5 °C. Larvae are about 4.5-5.9 mm TL at hatching. Early development has been described by Bracken and Kennedy (1967), Kennedy and Fitzmaurice (1974), Cadwallader (1977), and Černý (1977).

Ecology

Berg (1964) stated that adult fish are typically 200-250 mm SL and weigh 100-300 g. However, Rudd from near Moscow may attain 360 mm SL and weigh 1.5-2.0 kg (Berg, 1964). According to Muus (1971), the maximum size is 450 mm and 1.7 kg; however, Wheeler (1969) reported the British angling record as 2.06 kg. The Rudd has a moderately long life span, and individuals >10 years of age are common. Kennedy and Fitzmaurice (1974) reported Rudd from Ireland as large as 1.4 kg and as old as 17 years. Coad (2005) commented that the Rudd life span is up to 30 years.

The Rudd occurs in a variety of freshwater habitats, including subalpine oligotrophic lakes, lowland lakes, reservoirs, ponds, large rivers, oxbows, small streams, thermal springs, and in some areas, it enters brackish water (Wheeler, 1969; Kennedy and Fitzmaurice, 1974; Aneer and Nellbring, 1976; Rheinberger and others, 1987). The species occupies sites that range in elevation from sea level to 1,829 m (Schindler, 1957). The Rudd's tolerance of a variety of habitats has likely contributed to its wide distribution. In streams and rivers, it usually occurs in long, slow pools and backwaters. In ponds, lakes and reservoirs, it is usually found

in the littoral zone. The species is commonly associated vegetation that serves both as cover and a principal component of the diet (Wheeler, 1969; Kennedy and Fitzmaurice, 1974). The Rudd is able to tolerate low levels of salinity and is known to naturally enter brackish water. In Ireland, Kennedy and Fitzmaurice (1974) reported that Rudd occurred in tidal ponds of the Shannon Estuary and in Courtown Harbor where salinity ranges from 1-10 ppt. Individuals have also been captured in the northern Baltic Sea at a salinity of 7 ppt (Aneer and Nellbring, 1976). Experimental studies have shown an ability to tolerate salinity concentrations up to 17 ppt as well as heavy chloride pollution (Hynes, 1970).

The Rudd has a diverse diet. Kennedy and Fitzmaurice (1974) noted that larval Rudd held in laboratory conditions first began to feed at 6.0-6.5 mm TL. At this size, they consumed unicellular algae and some phytoplankton. At approximately 10 mm TL the fish shifted their diet to cladocerans and copepods. Other items in the diet included larvae and pupae of chironomids, flies, and springtails, as well as a variety of small terrestrial insects. Adult Rudd (2+ years) are

omnivorous, feeding mainly on aquatic vegetation as well as surface and aerial insects, snails, crustaceans, diatoms, and occasionally fish eggs (Hartley, 1947; Muus, 1971; Coates and Turner, 1977; Smith, 1985). Wheeler (1969) reported that Rudd in Europe consumed crustaceans (including copepods, ostracods, and amphipods) and occasionally small fishes.

Native Distribution

The Rudd is widespread in Europe and middle Asia (Bănărescu, 1964; Berg, 1964).

U.S. Introductions

To date, the Rudd has been reported from at least 22 states, but it may exist in additional states. Because of incomplete data and contradictory information, the exact distribution of Rudd in the U.S. and the status of many introduced populations remain uncertain (Fuller and others, 1999).

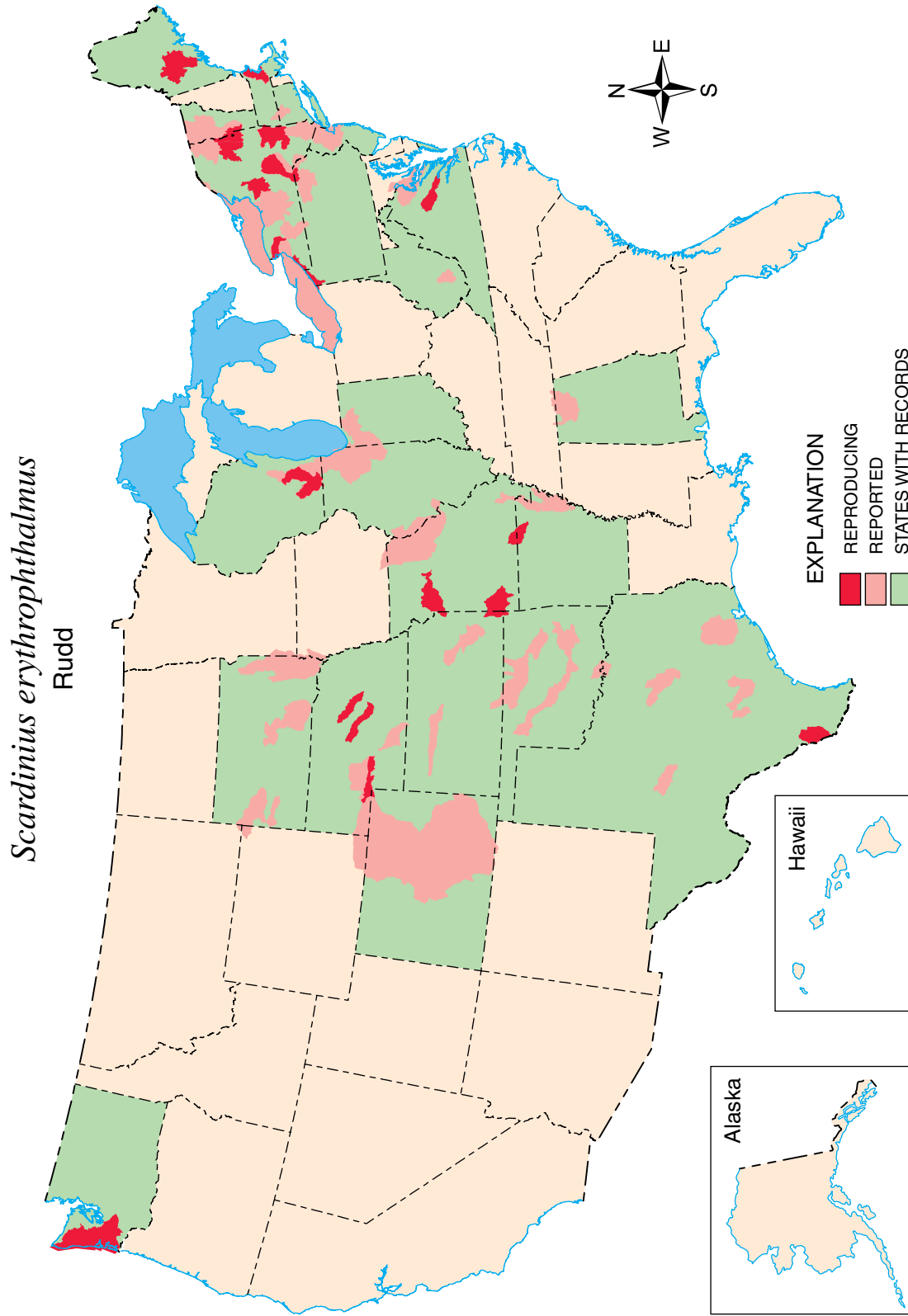

Plate 11. Distribution of Rudd in the United States. See Methods for details regarding data used to create maps, definitions of “reproducing” and “reported” and shading of HUCs and states.



Englishmen angling for Tench and other coarse fish in Bridget Lough, Ireland, 2004. (Photo by Leo G. Nico.)

Tench

Tinca tinca (Linnaeus 1758)

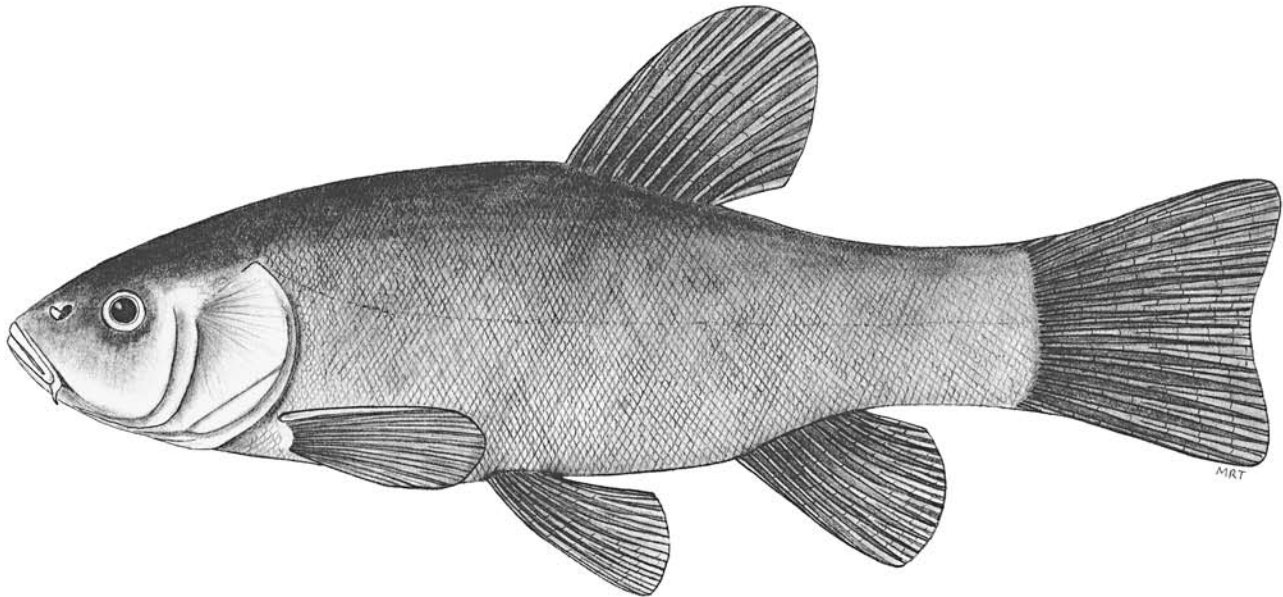

Figure 50. Tench, AUM 15556, 194 millimeter SL, from Bonner County, Idaho.

Description

The Tench (fig. 50) is a medium-sized fish, typically attaining 60-80 cm TL and weighing 2-3 kg (Moyle, 2002) with a maximum size of about 84 cm and 8 kg (Berg, 1964; Wheeler, 1978). The body is thick, and the caudal peduncle is deep and short. The skin is covered with a thick layer of mucous and is extremely slimy. Scales are small, elongated horizontally, and deeply embedded in the skin, leaving only 1/4-1/3 of the scale exposed (Berg, 1964). Lateral-line scales number 70-120. The head is triangular, generally averaging just <30 percent of SL. The snout is relatively long and the interorbital distance is broad. The mouth is terminal, oblique, and small, with a single barbel at the end of each maxilla (corner of jaw). Pharyngeal teeth are in a single row, typically with either four or five on each side (usually 0,5-5,0 or 0,4-5,0; fig. 51). In juveniles, the pharyngeal teeth may be wedge-shaped and slightly hooked at the tip. There are about 10-16 gill rakers on the first arch, although anterior rakers may be difficult to distinguish from “throat tubercles” (Coad, 2005). The rakers are moderately long. The dorsal fin is rounded and has ii-iv (6-9) rays. The anal fin is also rounded and has iii-iv (5-9) rays. The caudal fin is somewhat truncate (squared). Meristics for Tench are given in appendix B.

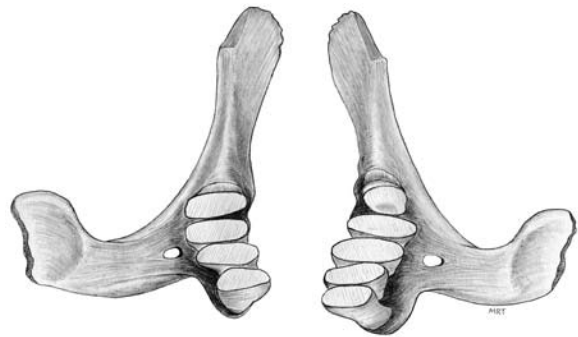

Figure 51. Pharyngeal teeth (0,5-4,0) of Tench, AUM 15556, 194 millimeter SL, from Bonner County, Idaho.

The body is dark green on the back and greenish-brown to dark brown on the sides (fig. 52). The belly typically has a yellowish tinge. Body coloration may vary with habitat, ranging from almost black in shallow, muddy lakes to much lighter in running water or clear water lakes (Berg, 1964). The fins are dark gray to dark brown to black. Eyes are orange-red. An ornamental variety (“Golden Tench”) is orange-yellow or reddish.

Sexual dimorphism is evident but not pronounced. In mature males, the second unbranched ray of the pelvic fins is thickened and is accompanied by a muscular



A



B

Figure 52. Tench taken by anglers from two sites in Europe. (A) specimen from Willis's Lake, a small pond in the suburbs of Belfast, Northern Ireland, September 1999. (Photograph courtesy of Robert Rosell.) (B) specimen from a pond in Belgium, summer 2004. (Photograph courtesy of Mark Adriaenssens.)

protuberance from the flank. Additionally, these fin rays are longer, reaching past the vent and extending to the anal fin (Berg, 1964; Wheeler, 1978; Coad, 2005).

Similar Species

Tench can be distinguished from native cyprinids by the combination of a single barbel at the end of each maxilla and the presence of deeply embedded, fine scales (generally >100 in lateral line). The dorsal fin is short and lacks a heavy spine-like ray, which distinguishes it from Common Carp, Goldfish, and Crucian Carp. Additionally, the Tench has only one pair of barbels (as opposed to the Common Carp, which has two pair), more lateral-line scales (100 or more in Tench, 40 or fewer in Common Carp) and a squared caudal fin (as opposed to a forked one in Common Carp).

Variation

An ornamental variety popular in water gardens (called the “Golden Tench”) is orange-yellow or reddish.

Tench have been crossed with a number of Old World cyprinids, including Goldfish, Common Carp, Ide, Bighead Carp, and Rudd (Victorovsky, 1966; Schwartz, 1972, 1981). There are no known hybrids with native North American cyprinids.

Reproduction

Males generally mature in their third year, a year before females (Moroz, 1968; Wheeler, 1969; Moyle, 2002; Yilmaz, 2002). Spawning is initiated when water temperatures reach 18 °C (Moroz, 1968; Wheeler, 1969; O'Maoileidigh and Bracken, 1989; Neophitou, 1993; Moyle, 2002). The species aggregates for spawning in shallow, densely vegetated areas where the adhesive eggs are broadcast over vegetation (Rosa, 1958; Wheeler, 1969; Moyle, 2002; Wydoski and Whitney,

2003). The Tench is a batch spawner (Moroz, 1968) and will spawn over artificial substrates resembling vegetation (Sanchez-Herrera and others, 1998). The species is reported to reproduce readily in artificial habitats, for example, in some reservoirs in California (Shapovalov, 1944). Fecundity can be high. In Russia, fecundity varied from 280,000-827,000 eggs (Berg, 1964). In the Danube, fecundity varied from 25,800-357,210 eggs (mean 135,200 eggs; Moroz, 1968). In Poland, fecundity ranged from 18,400-416,100 eggs per female (Pimpicka, 1991). Fecundity increases with body mass and length (Moroz, 1968; Pimpicka, 1991). According to Coad (2005), the maximum fecundity is 1,241,200 eggs in eastern Europe. Eggs are small (1-1.2 mm), yellow or green, and hatch in 3-8 days at 22-24 °C (Rosa, 1958; Wheeler, 1969).

Ecology

Within its native range, the Tench grows to 7.5 kg (Berg, 1964). Moyle (2002) reported that individuals reach sizes of 60-80 cm TL and 2-3 kg in California. Wild Tench may live up to 11 years (Neophitou, 1993).

The Tench prefers shallow, vegetated areas of lakes and ponds, lower reaches of slow-moving rivers, adjacent backwaters, and oxbow lakes (Berg, 1964; Moroz, 1968; Wheeler, 1969; O'Maoileidigh and Bracken, 1989; Wydoski and Whitney, 2003). Larvae and juveniles inhabit areas characterized by dense aquatic vegetation (Copp, 1997). During summer months, the Tench seeks cooler temperatures by concentrating in deep holes and shaded areas (Moyle, 2002). It tends to be inactive during the day, resting in favored habitats such as dense aquatic vegetation, and forages for food after dusk (Rosa, 1958; Wieser, 1991; Perrow and others, 1996). Seeley (1886, p. 140) states: “It is timid, but crafty, and comes to the quiet surface of the water only in the evening.”

Tench populations are sensitive to loss of vegetated habitat and predation pressure. Channelization that reduces access to vegetated habitats (such as floodplains) has been associated with a significant reduction in juvenile Tench densities (Jurajda, 1995). In a survey of >600 Swedish lakes across a wide geographical area, population densities were much higher in ponds and lakes without piscivores (Brönmark and others, 1995). Additionally, population declines were documented in a Polish reservoir that became eutrophic (Bnińska, 1991).

The Tench is tolerant of low levels of dissolved oxygen, and has been shown to survive oxygen concentrations <1.0 mg/L (Wheeler, 1969; Zhadin and Gerd, 1963; O'Maoileidigh and Bracken, 1989; Moyle, 2002). Rosa (1958) reported that the species survived in waters with a low oxygen level that would quickly kill other fishes. The 24-hr lethal oxygen concentration was experimentally derived as 1.2 mg/L (Kraiem and Pattee, 1980). Larvae can survive in waters with pH of 5-10, but a range of 7-9 is optimal (Hamáčková and others, 1998).

The Tench is a remarkably hardy fish. Historical accounts from England claim fishmongers would bring individuals to market and return the unsold fish back into water to live (presumably until their next trip to market; Seeley 1886). Live Tench have also reportedly been shipped during winter in boxes of weeds (Rosa, 1958). Individuals from northern Europe can withstand temperatures near freezing; however, optimal temperature for growth was reported between 12-30 °C (Moyle, 2002). Rosa (1958) reported that the species burrows into the mud during winter for protection against the cold where it remains in a motionless condition similar to hibernation. The 24-hr upper lethal temperature for individuals acclimated to 20 °C was determined to be 32.3 °C (Kraiem and Pattee, 1980). The species is also reported to be tolerant to low levels of salinity. Wheeler (1969) reported that the species lives in estuarine conditions in salinities up to 10 ppt in Europe. Moyle (2002) reported survival in salinities as high as 12 ppt. Rosa (1958) reported that the species is found in brackish waters in the Baltic Sea and Tasmania, and calculated a 24-hr lethal salinity of 15.4 ppt.

The Tench appears to be a relatively unselective, generalist predator of invertebrates (especially benthic organisms) in both native and introduced regions. In Ireland, Tench <21 cm (in their fourth year or younger) fed primarily on plankton, whereas larger and older fish consumed mollusks, chironomids, other insects, and plankton (O'Maoileidigh and Bracken, 1989). In Spain, cladocerans, gastropods, small crustaceans, and

insect larvae (especially chironomids) and adults were preferred prey items (Perez-Bote and others, 1998; González and others, 2000). No differences in feeding habits were noted between the sexes (Perez-Bote and others, 1998). In Australia, nonindigenous Tench consumed chironomids, pulmonate gastropods, cladocerans, amphipods, ephemeropterans, and odonates (Rosa, 1958). In England and France, Copp and Mann (1993) studied food habits of Tench and found that young larvae primarily preyed on cladocerans, whereas older larvae and 0+ juveniles primarily consumed cladocerans and copepods. Giles and others (1990) reported that a population of Tench in the United Kingdom ate a wide variety of benthic invertebrates, including bivalves, amphipods, isopods, trichopterans, and other insects. Perrow and others (1996) reported that Tench fed primarily on chironomids. Prejs (1973) documented trichopterans, chironomids, mollusks, odonates, and ephemeropterans in the diet of Tench from a Polish lake. Brönmark (1994) demonstrated that Tench could dramatically reduce the biomass of snails and bivalves in enclosures and that it also fed heavily on insects and zooplankton. Moyle (2002) reported that the diet of small Tench (6-12 cm TL) consisted of aquatic insect larvae, especially mayflies, damselflies, midges, and caddisflies. Larger fish consumed whatever invertebrates were available, including snails and oligochaetes (Moyle, 2002).

Native Distribution

The Tench is native to much of Europe and parts of western Asia (Berg, 1964; Coad, 2005).

U.S. Introductions

The Tench was originally imported into North America from Germany by the U.S. Fish Commission in 1877 and distributed to at least 36 states by 1896. Subsequent stocks probably had other origins. For example, at least one other introduced stock was imported from Italy (Shapovalov, 1944). Intentional stocking and accidental escapes have increased its distribution in the U.S. The Tench has been reported in at least 39 states, but most introductions were unsuccessful, and the species has maintained reproducing populations in only a few areas (Fuller and others, 1999). Although the species was collected in the Richelieu River in the New York/Quebec area following a recent escape in about 2000, it is not yet known to be reproducing in that drainage.

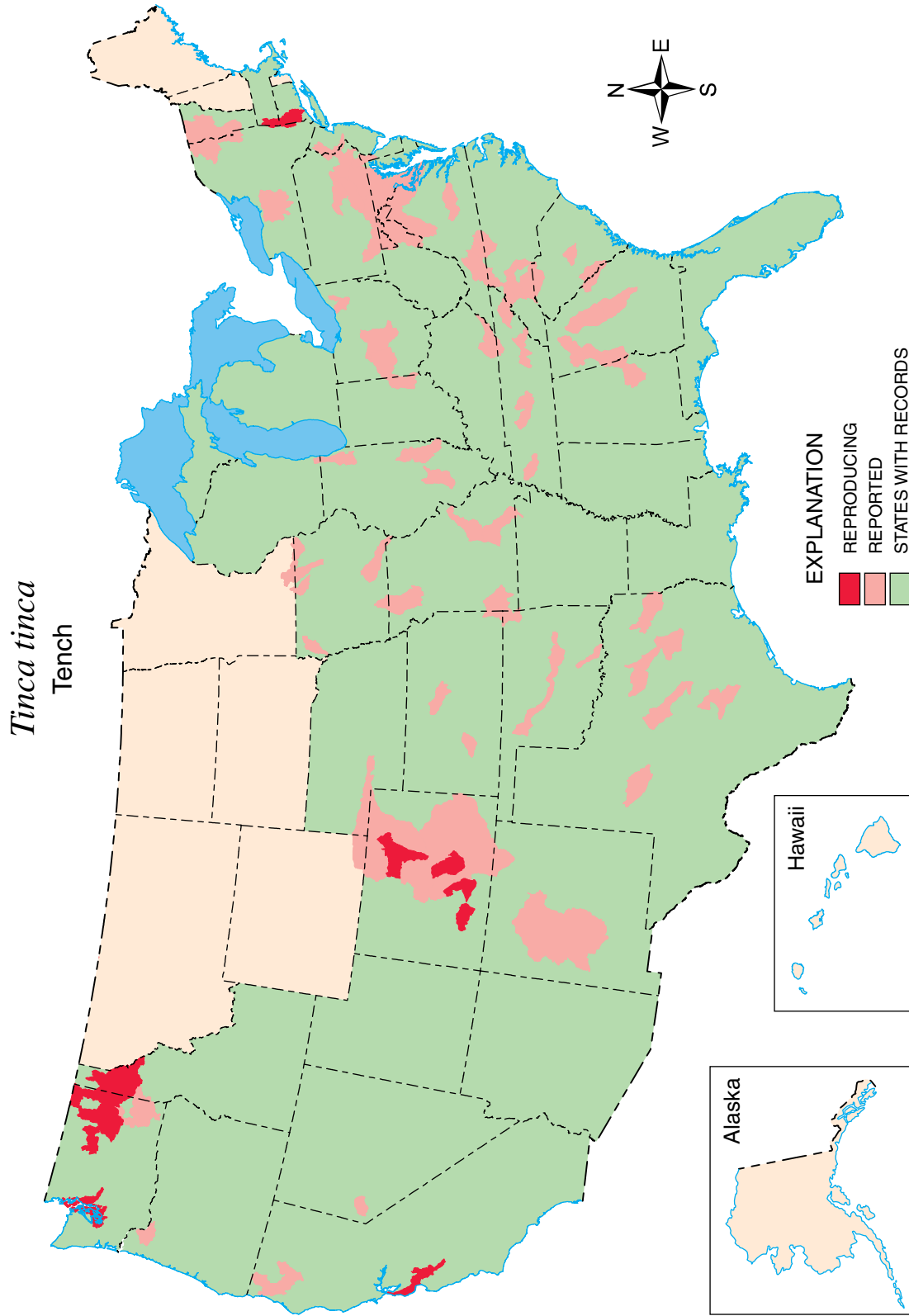

Plate 12. Distribution of Tench in the United States. See Methods for details regarding data used to create maps, definitions of “reproducing” and “reported” and shading of HUCs and states.

Acknowledgments

We thank Dr. Petru Bănărescu for his scientific insight and for allowing us to reprint his Crucian Carp images. Pingfu Chen assisted with Chinese translations. Sherry Bostick and Amy Benson assisted in various aspects of the production of the document. The manuscript was improved by the reviews of Walt Courtenay, Carter Gilbert, Bob Howells, Larry Page, Steve Ross, Todd Slack, and Bill Smith-Vaniz. Howard Jelks provided important suggestions. The following individuals kindly provided original photographs: Mark Adriaenssens, Richard T. Bryant, Noel Burkhead, Johnny Jensen, Rusty Kimble, Fang Fang Kullander, Cathy Mohilo, David Ostendorf, and Robert Rosell. Joe Tomelleri provided original artwork for the cover, and Vanessa Ramos-Munoz designed it. Lora White at the U.S. Geological Survey Leetown Science Center library provided generous assistance with retrieval of literature. Numerous representatives of local, state, and federal agencies, as well as many private citizens, industry employees, and U.S. and foreign researchers supplied information on introduced cyprinid fishes or related subjects. We are grateful for their help. The U.S. Fish and Wildlife Service and the U.S. Geological Survey provided funding for this project.

Addendum

While this report was in press, we became aware of a number of new records of foreign nonindigenous cyprinids in the U.S. as follows: *Carassius auratus* (6 additional records), *Ctenopharyngodon idella* (2), *Cyprinus carpio* (29), *Hypophthalmichthys molitrix* (6), *Hypophthalmichthys molitrix X nobilis* (4), *Hypophthalmichthys nobilis* (2), *Tinca tinca* (1), and *Leuciscus idus* (1).

Most newly acquired records represent occurrences in states or drainages already covered in our maps, but a few represent occurrences in drainages not depicted in our maps. Some of these records reflect populations that have existed for some time but have only recently been reported. Others (such as the Bighead and Silver Carp) reflect expansions of these species' rapidly growing ranges. All of the new records reported in this addendum represent species already covered in this report. To date (May 2005), no new species of foreign cyprinid has become established within the U.S. For details of these records and to access the most current information regarding ranges of foreign nonindigenous cyprinids, see our website at: <http://nas.er.usgs.gov>.

This addendum highlights the dynamic nature of range limits of introduced species and the difficulties involved in maintaining accurate up-to-date maps of them.



Carp for sale in fish market in Shanghai, People's Republic of China, 2004. (Photo by Leo G. Nico.)



References Cited

- Abdusamadov, A.S., 1987, Biology of white amur, *Ctenopharyngodon idella*, silver carp, *Hypophthalmichthys molitrix*, and bighead, *Aristichthys nobilis*, acclimatized in the Terek Region of the Caspian Basin: *Journal of Ichthyology*, v. 26, no. 4, p. 41-49.
- Adámek, Z., and Groch, Ladislav, 1993, Morphological adaptations of silver carp (*Hypophthalmichthys molitrix* Val.) lips as a reaction on hypoxic conditions: *Folia Zoologica*, v. 42, no. 2, p. 179-182.
- Aho, Jussi, and Holopainen, I.J., 2000, Batch spawning of Crucian carp (*Carassius carassius* [L.]) in mono- and multispecies communities: *Annales Zoologici Fennici*, v. 37, p. 101-111.
- Aldridge, D.C., 1999, Development of European bitterling in the gills of freshwater mussels: *Journal of Fish Biology*, v. 54, no. 1, p. 138-151.
- Alikunhi, K.H., and Sukumaran, K.K., 1964, Preliminary observations on Chinese carps in India: *Proceedings of the Indian Academy of Sciences*, v. 60, sec. B, p. 171-188.
- Aliyev, D.S., 1976, The role of phytophagous fishes in the reconstruction of commercial fish fauna and the biological improvement of water: *Journal of Ichthyology*, v. 16, no. 2, p. 216-229.
- Al-Mukhtar, M.A., and Al-Hassan, L.A.J., 1999, A natural intergeneric hybrid of *Barbus sharpeyi* (Günther, 1874) and *Carassius auratus* (L.) from a small water body in Khoozestan (Iran): *Acta Zoologica Bulgarica*: v. 51, no.1, p. 35-41.
- Anderson, R.O., and Neumann, R.M., 1996, Length, weight, and associated structural indices, in Murphy, B.R., and Willis, D.W., eds., *Fisheries techniques* (2d ed.): Bethesda, Md., American Fisheries Society, p. 447-482.
- Andriasheva, M.A. 1968, Some results obtained by the hybridization of cyprinids, in Pillay, T.V.R., ed., *Proceedings of the FAO world symposium on warm-water pond fish culture*, May, 18-25, 1966, Rome, Italy: FAO Fisheries Report no. 44, v. 5, p. 205-314.
- Aneer, G., and Nellbring, S., 1976, A drop-trap investigation of the abundance of fish in very shallow water in the Asko area, northern Baltic, in *Benthic Organisms*: Oxford, Pergamon Press, p. 21-29.
- Antipa, G., 1909, *Fauna ihtiologica Romîniei*: Bucureşti, Adac. Rom., Publ. fond Adamachi, 294 p.
- Avault, J.W., Jr., and Merowsky, Andrew, 1978, Evaluation of hybrid (common X grass) carp for weed control, in Smitherman, R.O., Shelton, W.L., and Grover, J.H., eds., *Symposium on culture of exotic fishes*: Auburn, Ala., American Fisheries Society, p. 184-193.
- Axlerod, H.R., and Schultz, L.P., 1955, *Handbook of tropical aquarium fishes*: New York, McGraw-Hill Book Company, Inc., 718 p.
- Bailey, W.M., and Boyd, R.L., 1970, A preliminary report on spawning and rearing of grass Carp (*Ctenopharyngodon idella*) in Arkansas, in *Proceedings of the 24th Annual Conference of the Southeastern Association of Game and Fish Commissioners*, Atlanta, Ga., September, 27-30, 1970: p. 560-569.
- Bain M.B., Webb, D.H., Tangedal, M.D., and Mangum, L.N., 1990, Movements and habitat use by grass carp in a large mainstream reservoir: *Transactions of the American Fisheries Society*, v. 119, no. 3, p. 533-561.
- Balon, E.K., 1974, *Domestication of the carp Cyprinus carpio L.*: Toronto, Royal Ontario Museum of Life Science, Miscellaneous Publications, 37 p.
- Balon, E.K., 1995, Origin and domestication of the wild carp, *Cyprinus carpio*: From Roman gourmets to the swimming flowers: *Aquaculture*, v. 129, p. 3-48.
- Bănărescu, P., 1964, *Fauna republicii populare Romîne—Pisces-Osteichthyes*: Bucuresti, Editura Academiei Republicii Populare Romîne, v. 8, 959 p. [In Romanian.]
- Bardach, J.E., Ryther, J.H., and McLaren, W.O., 1972, *Aquacultur—The farming and husbandry of freshwater and marine organisms*: New York, Wiley, Interscience, 868 p.
- Baruš, Vlastimil, Peaáz, Milan, and Kohlmann, Klaus, 2001, *Cyprinus carpio* (Linnaeus, 1758), in Bănărescu, P.M., and Paepke, H.-J., eds., *The freshwater fishes of Europe*, v. 5/III; Cyprinidae 2/III, and Gasterosteidae: AULA-G GmbH Wiebelsheim, Germany, p. 85-179.
- Battle, H.I. 1940, The embryology and larval development of the goldfish (*Carassius auratus* L.) from Lake Erie: *Ohio Journal of Science*, v. 40, no. 2, p. 82-93.
- Beck, M.L., Biggers, C.J., and Dupree, H.K., 1980, Karyological analysis of *Ctenopharyngodon idella*, *Aristichthys nobilis*, and their F₁ hybrids: *Transactions of the American Fisheries Society*, v. 109, no. 4, p. 433-438.
- Berg, L.S., 1964, *Freshwater fishes in the U.S.S.R. and neighbouring countries*, Vol. 2 (4th ed.): IPST Catalog no. 742, 496 p. [Translated from Russian by Israel Program for Scientific Translations, Jerusalem.]
- Berry, P.Y., and Low, M.P., 1970, Comparative studies on some aspects of the morphology and histology of *Ctenopharyngodon idellus*, *Aristichthys nobilis*, and their hybrid (Cyprinidae): *Copeia*, no. 4, p. 708-726.
- Bettoli, P.W., Neill, W.H., and Kelsch, S.W., 1985, Temperature preference and heat resistance of grass carp, *Ctenopharyngodon idella* (Valenciennes), bighead carp, *Hypophthalmichthys nobilis* (Gray), and their F₁ hybrid: *Journal of Fish Biology*, v. 27, p. 239-247.

- Bianco, P.G., 2004, Threatened fishes of the world: *Scardinius scardafa* (Bonaparte, 1837) (Cyprinidae): Environmental Biology of Fishes, v. 71, p. 246.
- Bíró, Péter, 1999, *Mylopharyngodon piceus* (Richardson, 1846), in Bănărescu, P., ed., The freshwater fishes of Europe, v. 5/I, Cyprinidae 2/I: Wiebelshiem, Germany, AULU-Verlag, p. 347-365.
- Bnińska, M., 1991, Fisheries, in Winfield, I.J., and Nelson, J.S., eds., Cyprinid fishes: Systematics, biology and exploitation: London, Chapman and Hall, p. 572-589.
- Bochung, Herbert T., Jr. and Mayden, R.L., 2004, Fishes of Alabama: Washington, Smithsonian Institution Press.
- Bogutskaya, N.G., 1997, Contribution to the knowledge of leuciscine fishes of Asia Minor, Part 2. An annotated checklist of leuciscine fishes (Leuciscinae, Cyprinidae) of Turkey with descriptions of a new species and two new subspecies: Mitteilungen aus dem Hamburgischen Zoologischen Museum und Institut, v. 94, p. 161-186.
- Bonar, S.A., Thomas, G.L., and Pauley, G.B., 1988, Evaluation of the separation of triploid and diploid grass carp, *Ctenopharyngodon idella* (Valenciennes), by external morphology: Journal of Fish Biology, v. 33, p. 895-898.
- Bracken, J.J., and Kennedy, M.P., 1967, A key to the eggs and young stages of coarse fish in Irish waters: Science Proceedings of the Royal Dublin Society, v. 2, no. 12, p. 99-108.
- Breder, C.M., 1933, *Rhodeus amarus* spawning in American mussels: Copeia, p. 147-148.
- Britz, Ralf, 2003, *Danionella mirifica*, a new species of miniature fish from Upper Myanmar (Ostariophysi: Cyprinidae): Ichthyological Explorations of Freshwaters v. 14, no. 3, p. 217-222.
- Brönmark, Christer, 1994, Effects of tench and perch on interactions in a freshwater, benthic food chain: Ecology, v. 75, no. 6, p. 1818-1828.
- Brönmark, C., Paszkowski, C.A., Tonn, W.M., and Hargeby, A., 1995, Predation as a determinant of size structure in populations of Crucian carp (*Carassius carassius*) and tench (*Tinca tinca*): Ecology of Freshwater Fish, v. 4, p. 85-92.
- Burke, J.S., Bayne, D.R., and Rea, Harry, 1986, Impact of silver and bighead carps on plankton communities of channel catfish ponds: Aquaculture, v. 55, p. 59-68.
- Burkhead, N.M., and Williams, J.D., 1991, An intergeneric hybrid of a native minnow, the golden shiner, and an exotic minnow, the rudd: Transactions American Fisheries Society, v. 120, no. 6, p. 781-795.
- Cadwallader, P.L., 1977, Introduction of rudd *Scardinius erythrophthalmus* into New Zealand. I—Review of the ecology of rudd and the implications of its introduction into New Zealand: Ministry of Agriculture and Fisheries, Fisheries Technical Report no. 47.
- Cala, Plutarco, 1970, On the ecology of the ide *Idus idus* (L.) in the River Kävlingeån, South Sweden: Drottningholm, Sweden, Report of the Institute of Freshwater Research, v. 50, p. 46-99.
- Cala, Plutarco, 1971, Size and age at maturity, ripening and fecundity of the ide *Idus idus* (L.): Drottningholm, Sweden, Report of the Institute of Freshwater Research, v. 51, p. 31-46.
- Cala, Plutarco, 1976, Age at maturity, testicular development and seasonal changes in the testes of the ide *Idus idus* (L.) (Pisces, Cyprinidae) in the River Kävlingeån, South Sweden: Drottningholm, Sweden, Report of the Institute of Freshwater Research, v. 55, p. 5-14.
- Calliet, G.M., Love, M.S., and Ebeling, A.W., 1986, Fishes: A field and laboratory manual on their structure, identification, and natural history: Prospect Heights, Ill., Waveland Press.
- Canagaratnam, P., 1959, Growth of fishes in different salinities: Journal of the Fisheries Research Board of Canada, v. 16, no. 1, p. 121-130.
- Carlander, K.D., 1969, Handbook of freshwater fishery biology: Ames, Iowa State University Press, v. 1, 752 p.
- Cassani, J.R., ed., 1996, Managing aquatic vegetation with grass carp: A guide for water resource managers: Bethesda, Md., American Fisheries Society, 196 p.
- Cassani, J.R., Caton, W.D., and Clark, B., 1984, Morphological comparisons of diploid and triploid hybrid grass carp, *Ctenopharyngodon idella* (♀) X *Hypophthalmichthys nobilis* (♂): Journal of Fish Biology, v. 25, p. 269-278.
- Černý, Karel, 1977, The early development of chub—*Leuciscus cephalus* (L., 1758), rudd—*Scardinius erythrophthalmus* (L., 1758), and roach—*Rutilus rutilus* (L., 1758): Acta Universitatis Carolinae—Biologica, v. 1-2, p. 1-149.
- Chang, Y.F., 1966, Culture of freshwater fish in China: Beijing, Science Publishers. [Translated from Chinese to English by Koo, Ted S.Y., Department of Fisheries, U.S. Department of Interior; edited by Gangstad, E.O., Department of the Army, Washington, D.C. Draft of translation (January 1980) available as: Chinese fish culture: Report 1 of a series. Technical report A-79-#. Aquatic Plant Control Research Program. Prepared for Office, Chief of Engineers, U.S. Army, Washington, D.C.]
- Chen, Ning-Shen, and Chuan-Fang Shih, 1955, Oxygen consumption of *Ctenopharyngodon idellus*, *Hypophthalmichthys molitrix*, and *Aristichthys nobilis*: Acta Zoologica Sinica, v. 7, no. 1, p. 42-57. [In Chinese with English summary and content.]
- Chen, Y. ed., 1998, Fauna Sinica, Osteichthyes, Cypriniformes II: Beijing, Science Press, 531 p. [In Chinese.]

- Chervinski, Jonathan, 1977, Note on the adaptability of silver carp—*Hypophthalmichthys molitrix* (Val.), and grass carp—*Ctenopharyngodon idella* (Val.), to various salinities: *Aquaculture*, v. 11, p. 179-182.
- Chervinski, Jonathan, 1980, Note on the adaptability of big-head (*Aristichthys nobilis*) to various saline concentrations: *Israeli Journal of Aquaculture (Bamidgheh)*, v. 32, no. 1, p. 27-29.
- Chick, J.H., Maher, R.J., Burr, B.M., Thomas, M.R., 2003, First black carp captured in the U.S: *Science* 300, p. 1876-1877.
- Chilton, E.W., II, and Muoneke, M.I., 1992, Biology and management of grass carp (*Ctenopharyngodon idella*, Cyprinidae) for vegetation control: A North American perspective: *Reviews in Fish Biology and Fisheries*, v. 2, p. 283-320.
- Chu (= Zhu), Xinluo, Yinrui Chen, and others, 1989, The fishes of Yunnan, China, Part I. Cyprinidae: Beijing, Science Press. [In Chinese.]
- Clugston, J.P., and Shireman, J.V., 1987, Triploid grass carp for aquatic plant control: U.S. Fish and Wildlife Service, Leaflet 8, 3 p.
- Coad, B.W., 2005, Freshwater fishes of Iran: Species Accounts—Cyprinidae (revised January 14, 2005): URL <http://www.briancoad.com/Species%20Accounts/cyprinidae.htm>.
- Coates, G.D., and Turner, A.S., 1977, Introduction of rudd *Scardinius erythrophthalmus* into New Zealand, Vol. 2. First survey of a rudd population in New Zealand: Ministry of Agriculture and Fisheries, Fisheries Technical Paper no. 47.
- Collee, D.E., Shireman, J.V., and Rottmann, R.W., 1978, Food selection by grass carp fingerlings in a vegetated pond: *Transactions of the American Fisheries Society*, v. 107, no. 1, p. 149-152.
- Copp, G.H., 1997, Microhabitat use of fish larvae and 0+ juveniles in a highly regulated section of the River Great Ouse: *Regulated Rivers Research and Management*, v. 13, p. 267-276.
- Copp, G.H., and Mann, R.H.K., 1993, Comparative growth and diet of tench *Tinca tinca* (L.) larvae and juveniles from river floodplain biotopes in France and England: *Ecology of Freshwater Fish*, v. 2, no. 2, p. 58-66.
- Courtenay, W.R., Jr., Hensley, D.A., Taylor, J.N., and McCann, J.A., 1984, Distribution of exotic fishes in the continental United States, in Courtenay, W.R., Jr., and Stauffer, J.R., Jr., eds., *Distribution, biology, and management of exotic fishes*: Baltimore, Johns Hopkins University Press, p. 41-77.
- Courtenay, W.R., Jr., and Stauffer, J.R., Jr., 1990, The introduced fish problem and the aquarium fish industry: *Journal of the World Aquaculture Society*, v. 21, no. 3, p. 145-159.
- Cremer, M.C., and Smitherman, R.O., 1980, Food habits and growth of silver and bighead carp in cages and ponds: *Aquaculture*, v. 20, p. 57-64.
- Crivelli, A.J., 1981, The biology of the common carp, *Cyprinus carpio* L. in Camargue, southern France: *Journal of Fish Biology*, v. 18, p. 271-290.
- Cross, D.G., 1970, The tolerance of grass carp *Ctenopharyngodon idella* (Val.) to seawater: *Journal of Fish Biology*, v. 2, p. 231-233.
- De Kay, J.E., 1842, *Zoology of New-York, or the New-York fauna, Part IV: W. and A. White (sic), and Visscher, J., Fishes*: Albany, N.Y., 415 p, 79 plates.
- Dence, W.A., 1925, Bitter carp (*Rhodeus amarus*) from New York State waters: *Copeia*, no. 142, 33 p.
- Dill, W.A., and Cordone, A.J., 1997, History and status of introduced fishes in California, 1871-1996: California Department of Fish and Game, *Fish Bulletin* 178, 1-414 p.
- Domaizon, Isabelle, and Devaux, Jean, 1999, Experimental study of the impacts of silver carp on plankton communities of eutrophic Villerest reservoir (France): *Aquatic Ecology*, v. 33, p. 193-204.
- Dong, Shuanglin, and Li, Deshang, 1994, Comparative studies on the feeding selectivity of silver carp *Hypophthalmichthys molitrix* and bighead carp *Aristichthys nobilis*: *Journal of Fish Biology*, v. 44, p. 621-626.
- Eder, Stephen, and Carlson, C.A., 1977, Food habits of carp and white suckers in the South Platte and St. Vrain Rivers and Goosequill Pond, Weld County, Colorado: *Transactions of the American Fisheries Society*, v. 106, no. 4, p. 339-349.
- Edwards, D.J., 1973, Aquarium studies on the consumption of small animals by 0-group grass carp, *Ctenopharyngodon idella* (Val.): *Journal of Fish Biology*, v. 5, p. 599-605.
- Eschmeyer, W.N., Ferraris, C.J., Jr., Mysi Dang Hoang, and Long, D.J., 1998, A catalogue of the species of fishes [Preliminary Version 2, November 1996]: California Academy of Sciences, URL <http://www.calacademy.org/research/ichthyology/species/>.
- Etnier, D.A., and Starnes, W.C., 1993, *Fishes of Tennessee*: Knoxville, University of Tennessee Press, 681 p.
- Evtushenko, N.Y., Potrokhov, A.S., and Zinkovskii, O.G., 1994, The black carp as a subject for acclimatization (review): *Hydrobiological Journal*, v. 30, no. 5, p. 1-10. [Originally published in Russian in 1993: *Gidrobiologicheskii Zhurnal*, v. 29, no. 3, p. 49-56.]
- Florez, Fabio, 1972a, The effect of temperature on incubation time, growth and lethality of embryos, larvae and juveniles of the ide, *Idus idus* (L.): *Drottningholm, Sweden, Report of the Institute of Freshwater Research*, v. 52, p. 50-60.

- Florez, Fabio, 1972b, Influence of oxygen concentration on growth and survival of larvae and juveniles of the ide, *Idus idus* (L.): Drottningholm, Sweden, Report of the Institute of Freshwater Research, v. 52, p. 65-73.
- Forester, J.S., and Avault, J.W., Jr., 1978, Effects of grass carp on freshwater red swamp crayfish in ponds: Transactions of the American Fisheries Society, v. 107, no. 1, p. 156-160.
- Freeze, Mike, and Henderson, Scott, 1982, Distribution and status of the bighead carp and silver carp in Arkansas: North American Journal of Fisheries Management, v. 2, p. 197-200.
- Fuller, P.L., Nico, L.G., and Williams, J.D., 1999, Nonindigenous fishes introduced into inland waters of the United States: Bethesda, Md., American Fisheries Society, Special Publication 27, 613 p.
- Garcia, L.M.B., Garcia, C.M.H., Pineda, A.F.S., Gammad, E.A., Canta, J., Simon, S.P.D., Hilomen-Garcia, G.V., Gonzal, A.C., and Santiago, C.B., 1999, Survival and growth of bighead carp fry exposed to low salinities: Aquaculture International, v. 7, p. 241-250.
- Gasaway, R.D., and Drda, T.F., 1977, Effects of grass carp introduction on waterfowl habitat: Transactions of the 42nd North American Wildlife and Natural Resources Conference: Washington, D.C., Wildlife Management Institute, p. 73-85.
- Gerlach, J.M., 1983, Characters for distinguishing larval carp, *Cyprinus carpio*, and goldfish, *Carassius auratus*: Copeia, v. 1, p. 116-121.
- Giles, N., Street, M., and Wright, R.M., 1990, Diet composition and prey preference of tench, *Tinca tinca* (L.), common bream, *Abramis brama* (L.), perch, *Perca fluviatilis* (L.), and roach, *Rutilus rutilus* (L.), in two contrasting gravel pit lakes: Potential trophic overlap with wildfowl: Journal of Fish Biology, v. 37, p. 945-957.
- González, Gustavo, Mazé, R.A., Domínguez, Josefa, and Pena, J.C., 2000, Trophic ecology of the tench, *Tinca tinca* in two different habitats in North-West of Spain: Cybium, v. 24, no. 2, p. 123-138.
- Gorbach, E.I., 1961, Age composition, growth and age of onset of sexual maturity of the white *Ctenopharyngodon idella* (Val.) and the black *Mylopharyngodon piceus* (Rich.) amurs in the Amur River basin: Vopr. Ikhtiol, v. 1, p. 119-126.
- Gorbach, E.I., 1972, Fecundity of the grass carp (*Ctenopharyngodon idella* [Val.]) in the Amur basin: Journal of Ichthyology, v. 12, p. 616-625.
- Green B.W., and Smitherman, R.O., 1984, Relative growth, survival and harvestability of bighead carp, silver carp, and their reciprocal hybrids: Aquaculture, v. 37, p. 87-95.
- Gulyás, Pál, and Fleit, Ernő, 1990, Evaluation of ammonia toxicity on *Daphnia magna* and some fish species: Aquacultura Hungarica (Szarvas), v. 6, p. 171-183.
- Hamáčková, Jitka, Kouřil, Jan, and Kozák, Pavel, 1998, The effects of pH upon survival and growth rates in tench (*Tinca tinca* [L.] larvae: Polskie Archiwum Hydrobiologii, v. 45, no. 3, p. 399-405.
- Hartley, P.H.T., 1947, The natural history of some British freshwater fishes: Proceedings of the Zoological Society of London, v. 117, p. 129-206.
- Hellawell, J.M., 1986, Biological indicators of freshwater pollution and environmental management: London, Elsevier Applied Science, 546 p.
- Hensley, D.A., and Courtenay, W.R., Jr., 1980, *Carassius auratus* (Linnaeus), goldfish, in Lee, D.W., Gilbert, C.R., Hocutt, C.H., Jenkins, R.E., McAllister, D.E., and Stauffer, J.R., Jr., eds., Atlas of North American freshwater fishes: Raleigh, North Carolina State Museum of Natural History, p. 147.
- Hickling, C.F., 1967, On the biology of a herbivorous fish, the white amur or grass carp, *Ctenopharyngodon idella* Val.: Proceedings of the Royal Society of Edinburgh, v. 70B, pt. 1, p. 62-81.
- Holčík, Juraj, 1967, Life history of the rudd *Scardinius erythrophthalmus* (Linnaeus, 1758) in the Klíčava Reservoir: Věstník Československé Společnosti Zoologické, v. 31, no. 4, p. 335-348.
- Holčík, Juraj, and Jedlička, Ladislav, 1994, Geographical variation of some taxonomically important characters in fishes: The case of the bitterling *Rhodeus sericeus*: Environmental Biology of Fishes, v. 41, no. 1-4, p. 147-170.
- Holopainen, I.J., Aho, J., Vornanen, M., and Huuskonen, H., 1997, Phenotypic plasticity and predator effects on morphology and physiology of Crucian carp in nature and in the laboratory: Journal of Fish Biology, v. 50, p. 781-798.
- Holopainen, I.J., and Hyvärinen, H., 1984, Ecology and physiology of Crucian carp (*Carassius carassius* L.) in small Finnish ponds with anoxic conditions in winter. Verhandlungen: Internationale Vereinigung für theoretische und angewandte Limnologie, v. 22, no. 4, p. 2566-2570.
- Howells, R.G., 1992, Guide to identification of harmful and potentially harmful fishes, shellfishes, and aquatic plants prohibited in Texas: Austin, Texas Parks and Wildlife Department, Special Publication, 182 p., 88 apps.
- Howells, R.G., 1999, Guide to identification of harmful and potentially harmful fishes, shellfishes, and aquatic plants prohibited in Texas (revised): Austin, Texas Parks and Wildlife Department, Special Publication of the Fisheries Division, 370 p.
- Hubbs, C.L., and Lagler, K.F., 1958, Fishes of the Great Lakes region: Cranbrook Institute, Scientific Bulletin 26, 213 p.
- Huet, Marcel, 1970, Textbook of fish culture: Breeding and cultivation of fish: London, Fishing News (Books) Ltd., 536 p.

- Hume, D.J., Fletcher, A.R., and Morison, A.L., 1983, Interspecific hybridization between carp (*Cyprinus carpio* L.) and goldfish (*Carassius auratus* L.) from Victorian waters: Australian Journal of Marine and Freshwater Research, v. 34, p. 915-919.
- Hynes, H.B.N., 1970, The ecology of running waters: University of Toronto Press, 555 p.
- IGFA [International Game Fish Association], 2001, Database of IGFA angling records until 2001: Fort Lauderdale, Fla.
- Iguchi, Kei'ichiro, Yamamoto, Gunji, Matsubara, Naoto, and Nishida, Mutsumi, 2003, Morphological and genetic analysis of fish of a *Carassius* complex (Cyprinidae) in Lake Kasumigaura with reference to the taxonomic status of two all-female triploid morphs: Biological Journal of the Linnean Society, v. 79, no. 2, p. 351-357.
- Jenkins, R.E., and Burkhead, N.M., 1994, Freshwater fishes of Virginia: Bethesda, Md., American Fisheries Society, 1079 p.
- Jennings, Dawn, 1988, Bighead carp (*Hypophthalmichthys nobilis*): Biological synopsis. U.S. Fish and Wildlife Service, Biological Report, v. 88, no. 29, 47 p.
- Jevtić, Jelena, 1979, Number of spine vertebrae in the populations of tench [*Tinca tinca* L.]: Ichthyologia, v. 11, no. 1, p.15-18. [In Serbo-Croatian with English summary.]
- Jones, J.W., and Linfield, R.S.J., 1972, A note on the identification of a Crucian carp *Carassius carassius* (L.) x common carp *Cyprinus carpio* (L.) hybrid from a still water in Nottinghamshire: Journal of Fish Biology, v. 4, p. 309-310.
- Jones, P.W., Martin, F.D., and Hardy, J.D., Jr., 1978, Development of fishes of the Mid-Atlantic Bight, Vol. I. Acipenseridae through Ictaluridae: U.S. Fish and Wildlife Service, Biological Services Program, FWS/OBS-78/12, 366 p.
- Jurajda, Pavel, 1995, Effect of channelization and regulation on fish recruitment in a flood plain river: Regulated Rivers Research and Management, v. 10, p. 207-215.
- Jurajda, Pavel, 1998, Drift of larval and juvenile fishes, especially *Rhodeus sericeus* and *Rutilus rutilus*, in the River Morava (Danube Basin): Archiv für Hydrobiologie, v. 141, no. 2, p. 231-241.
- Kamilov, B.G., and Komrakova, M.Y., 1999, Maturation and fecundity of the silver carp, *Hypophthalmichthys molitrix*, in Uzbekistan: Israeli Journal of Aquaculture (Bamidgeh), v. 51, no. 1, p. 40-43.
- Kasama, Midoriko, and Kobayasi, Hiromu, 1989, Hybridization experiment between female Crucian carp and male grass carp: Nippon Suisan Gakkaishi, v. 55, no. 6, p. 1001-1006.
- Kasama, Midoriko, and Kobayasi, Hiromu, 1990, Hybridization experiment between *Carassius carassius* (♀) and *Gnathopogon elongatus elongatus* (♂): Japanese Journal of Ichthyology, v. 36, no. 4, p. 419-426.
- Kennedy, M., and Fitzmaurice, P., 1974, Biology of the rudd *Scardinius erythrophthalmus* (L.) in Irish waters: Proceedings of the Royal Irish Academy, 74, sec. B, no. 18.
- Kilambi, R.V., and Zdinak, A., 1980, The effects of acclimation on the salinity tolerance of grass carp, *Ctenopharyngodon idella* (Cuv. and Val.): Journal of Fish Biology, v. 16, p. 171-175.
- Kilambi, R.V., and Zdinak, A., 1981, Comparison of early developmental stages and adults of grass carp (*Ctenopharyngodon idella*) and hybrid carp (female grass carp X male bighead *Aristichthys nobilis*): Journal of Fish Biology, v. 19, p. 457-465.
- Kilambi, R.V., and Zdinak, A., 1982, Food intake and growth of hybrid carp (female grass carp, *Ctenopharyngodon idella* X male bighead, *Aristichthys (Hypophthalmichthys) nobilis*) fed on zooplankton and *Chara*: Journal of Fish Biology, v. 21, p. 63-37.
- Kilgen, R.H., and Smitherman, R.O., 1971, Food habits of the white amur stocked in ponds alone and in combination with other species: The Progressive Fish-Culturist, v. 33, no. 3, p. 123-127.
- Kimura, S., 1934, Description of the fishes collected from the Yangtze-kiang, China, by late Dr. K. Kishinouye and his party in 1927-1929: Shanghai, Journal of the Shanghai Science Institute, section 3, v. 1, p. 11-247.
- Kimura, Shigeru, and Yusan Tao, 1937, Notes on the nuptial coloration and pearl organs in Chinese fresh-water fishes. Report no. 1. Biological studies on Chinese freshwater fishes. Report no. 4: Journal of the Shanghai Science Institute, v. 6, p. 277-318. [Translated from Chinese by Tchaw-ren Chen and edited by Bruce B. Collette.] Translation no. 66, Bureau of Commercial Fisheries, Systematics Laboratory, U.S. National Museum, Washington, D.C.
- King, D.R., and Hunt, G.S., 1967, Effect of carp on vegetation in a Lake Erie marsh: Journal of Wildlife Management, v. 31, no. 1, p. 181-188.
- Korniyenko, G.S., 1971, The role of infusoria in the food of the larvae of phytophagous fishes: Journal of Ichthyology, v. 11, no. 2, p. 241-246.
- Koutrakis, E.T., Kokkinakis, A.K., Tsikliras, A.C., and Eleftheriadis, E.A., 2003, Characteristics of the European bitterling *Rhodeus amarus* (Cyprinidae) in the Rihios River, Greece: Journal of Freshwater Ecology, v. 18, no. 4, p. 615-624.
- Kraiem, M., and Pattee, E., 1980, Temperature and oxygen deficiency tolerance of the barbel [*Barbus barbus* L.] and three other species: Archiv für Hydrobiologie, v. 88, no. 2, p. 250-261. [In French with English summary.]
- Krykhtin, M.L., and Gorbach, E.I., 1981, Reproductive ecology of the grass carp, *Ctenopharyngodon idella*, and the silver carp, *Hypophthalmichthys molitrix*, in the Amur Basin: Journal of Ichthyology, v. 21, no. 2, p. 109-123.

- Kuronuma, K., 1968, New systems and new fishes for culture in the Far East, *in* Pillay, T.V.R., ed., Proceedings of the FAO world symposium on warm-water pond fish culture, 18-25 May, 1966: Rome, Italy, FAO Fisheries Report, v. 44, no. 5, p. 123-142.
- Laird C.A., and Page, L.M., 1996, Non-native fishes inhabiting the streams and lakes of Illinois: Illinois Natural History Survey, Bulletin, v. 35, article 1, 51 p.
- Lammens, E.H.R.R., and Hoogenboezem, W., 1991, Diets and feeding behaviour, *in* Winfield, I.J., and Nelson, J.S., eds., Cyprinid fishes: Systematics, biology and exploitation: London, Chapman and Hall, p. 353-376.
- Laurila, Sari, and Holopainen, I.J., 1990, Features of embryonic and larval development of Crucian carp *Carassius carassius* (L.) with a note on species identification: *Annales Zoologici Fennici*, v. 27, p. 361-367.
- Laurila, Sari, Piironen, Jorma, and Holopainen, I.J., 1987, Notes on egg development and larval and juvenile growth of Crucian carp (*Carassius carassius* [L.]): *Annales Zoologici Fennici*, v. 24, p. 315-321.
- Laws, E.A., and Weisburd, R.S.J., 1990, Use of silver carp to control algal biomass in aquaculture ponds: *The Progressive Fish-Culturist*, v. 52, no. 1, p. 1-8.
- Lazzaro, Xavier, 1987, A review of planktivorous fishes: Their evolution, feeding behaviours, selectivities, and impacts: *Hydrobiologia*, v. 146, p. 97-167.
- Leventer, H., 1979, Biological control of reservoirs by fish: Nazareth Elit, Israel, Mekoroth Water Co., Jordan District Central Laboratory of Water Quality, 71 p.
- Lever, C., 1996, Naturalized fishes of the world: Academic Press, 408 p.
- Li, Sifa, and Mathias, Jack, eds., 1994, Freshwater fish culture in China: Principles and practice: Amsterdam, Elsevier, 445 p.
- Li, Sizhong, and Fang Fang, 1990, On the geographical distribution of the four kinds of pond-cultured carps in China: *Acta Zoologica Sinica*, v. 36, no. 3, p. 244-250. [In Chinese with English abstract.]
- Li, Xinfu, and Fuying Zhang, 1992, Toxic effects of low pH and elevated Al concentration on early life stages of several species of freshwater fishes: *Acta Scientiae Circumstantiae*, v. 12, no. 1, p. 97-104. [In Chinese with English summary.]
- Liang, Xiuquin, and Fuling Wang, 1993, An approach to the problem of water chemical factors and fishery utilization in alkaline waters: *Journal of Dalian Fisheries College*, v. 8, no. 4, p. 67-72. [In Chinese with English summary.]
- Lin, H.R., and Peter, R.E., 1991, Aquaculture, *in* Winfield, I.J., and Nelson, J.S., eds., Cyprinid fishes: Systematics, biology and exploitation: London, Chapman and Hall p. 590-622.
- Lippson, A.J., and Moran, R.L., 1974, Manual for identification of early developmental stages of fishes of the Potomac River estuary: Annapolis, Md., Power Plant Siting Program, Maryland Department of Natural Resources, Special Publication PPSP-MP-13.
- Lirski, Andrzej, and Opuszyński, Karol, 1988a, Lower lethal temperatures for carp [*Cyprinus carpio* L.] and the phytophagous fishes [*Ctenopharyngodon idella* Cal., *Hypophthalmichthys molitrix* Val., *Aristichthys nobilis* Rich.] in the first period of life: *Roczniki Nauk Rolniczych*, v. 101, p. 11-29. [In Polish with English summary.]
- Lirski, Andrzej, and Opuszyński, Karol, 1988b, Upper lethal temperatures for carp [*Cyprinus carpio* L.] and the phytophagous fishes [*Ctenopharyngodon idella* Val., *Hypophthalmichthys molitrix* Val., *Aristichthys nobilis* Rich.] in the first period of life: *Roczniki Nauk Rolniczych*, v. 101, no. 4, p. 31-49. [In Polish with English summary.]
- Liu, Huanliang, Hua Li, Baoxiang Zhai, and Wei Liu, 1990, Post-larval development of the masticating apparatus of black carp *Mylopharyngodon piceus* [Richardson]: *Acta Hydrobiologica Sinica*, v. 14, no. 4, p. 310-320. [In Chinese with English summary.]
- Lockley, A.S., 1957, Adrenal cortical hormones and osmotic stress in three species of fishes: *Copeia*, no. 3, p. 241-242.
- Lubinski, K.S. VanVooren, A., Farabee, G., Janecek, J., and Jackson, S.D., 1986, Common carp in the Upper Mississippi River: *Hydrobiologia*, v. 136, p. 141-153.
- Maceina, M.J., Bettoli, P.W., Klussman, W.G., Betsill, R.K., and Noble, R.L., 1991, Effect of aquatic macrophyte removal on recruitment and growth of black crappies and white crappies in Lake Conroe, Texas: *North American Journal of Fisheries Management*, v. 11, no. 4, p. 556-563.
- Maceina, M.J., Nordlie, F.G., and Shireman, J.V., 1980, The influence of salinity on oxygen consumption and plasma electrolytes in grass carp, [*Ctenopharyngodon idella* Val]: *Journal of Fish Biology*, v. 16, p. 613-619.
- Maceina, M.J., and Shireman, J.V., 1979, Grass carp: Effects of salinity on survival, weight loss and muscle tissue water content: *The Progressive Fish-Culturist*, v. 41, no. 2, p. 69-73.
- Maceina, M.J., and Shireman, J.V., 1980, Effects of salinity on vegetation consumption and growth in grass carp: *The Progressive Fish-Culturist*, v. 42, no. 1, p. 50-53.
- Maitland, P.S., 1977, *The Hamlyn guide to freshwater fishes of Britain and Europe*: London, Hamlyn Publishers, 256 p.
- Makeyeva, A.P., 1968, Hybridization of the common carp with phytophagous fishes: *Problems in Ichthyology*, v. 8, no. 2, p. 294-297.
- Makeyeva, A.P., 1972, Hybridization of the bighead (*Aristichthys nobilis* [Rich.]) and the carp (*Cyprinus carpio* L.): *Journal of Ichthyology*, v. 12, no. 2, p. 274-282.

- Makeyeva, A.P., 1975, The phenomenon of hybrid gynogenesis in fishes: *Journal of Ichthyology*, v. 15, no. 1, p. 72-81.
- Makeyeva, A.P., and Verigin, B.V., 1993, Morphological characters of age 0+ reciprocal hybrids of grass carp, *Ctenopharyngodon idella* and black carp, *Mylopharyngodon piceus*: *Journal of Ichthyology*, v. 33, no. 3, p. 66-75.
- Makeyeva, A.P., and Verigin, B.V., 1974a, Hybridization of the pond carp (*Cyprinus carpio*) with the grass carp (*Ctenopharyngodon idella*): *Journal of Ichthyology*, v. 14, p. 254-259.
- Makeyeva [Makeeva], A.P., and Verigin, B.V., 1974b, A hybrid between common carp and silver carp: *Genetika*, v. 10, no. 2, p. 73-80. [In Russian with English summary.]
- Márián, Teréz, and Krasznai, Zoltán, 1978, Kariological investigations on *Ctenopharyngodon idella* and *Hypophthalmichthys nobilis* and their cross-breeding: *Aquacultura Hungarica* (Szarvas), v. 1, p. 44-50.
- McCrimmon, H.R., 1968, Carp in Canada: Fisheries Research Board of Canada, Bulletin 165, 93 p.
- Meek, S.E., and Hildebrand, S.F., 1910, A synoptic list of the fishes known to occur within fifty miles of Chicago: Field Museum of Natural History, Publication 142, Zoological Series, v. 7, no. 9, p. 223-338.
- Mihai-Bardan, Alina, 1980, Données concernant le développement embryonnaire des hybrides résultats du croisement entre *Hypophthalmichthys molitrix* (Valenciennes, 1844) et *Aristichthys nobilis* (Richardson, 1844) (Osteichthyes, Cyprinidae): *Travaux Museum d'Histoire Naturelle "Grigore Antipa"*, v. 21, p. 205-212. [In French with Romanian summary.]
- Mills, S.C., and Reynolds, J.D., 2002, Mussel ventilation rates as a proximate cue for host selection by bitterling, *Rhodeus sericeus*: *Oecologia*, v. 131, no. 3, p. 473-378.
- Minckley, W.L., 1973, *Fishes of Arizona*: Phoenix, Sims Printing Company, 293 p.
- Mitzner, Larry, 1978, Evaluation of biological control of nuisance aquatic vegetation by grass carp: *Transactions of the American Fisheries Society*, v. 107, no. 1, p. 135-145.
- Moroz, V.N., 1968, Biology of the tench *Tinca tinca* (L.) in the Kiliya Channel, Danube Delta: *Problems of Ichthyology*, v. 8, no. 1, p. 81-89.
- Moyle, P.B., 2002, *Inland fishes of California* (2d ed.): Berkeley, University of California Press, 502 p.
- Murai, Takeshi, and Andrews, J.W., 1977, Effects of salinity on the eggs and fry of the golden shiner and goldfish: *The Progressive-Fish Culturist*, v. 39, no. 3, p. 121-122.
- Mutenia, Ahti, 1978, On the biology of the ide (*Leuciscus idus* L.) in Lokka reservoir, Finnish Lapland: *Luonnon Tutkija*, v. 82, p.135-137. [In Finnish with English summary.]
- Muus, B.J., 1971, *Freshwater fish of Britain and Europe*: London, Collins, 222 p.
- Myers, G.S., 1925, Introduction of the European bitterling (*Rhodeus*) in New York and of the rudd (*Scardinius*) in New Jersey: *Copeia* no. 140, p. 20-21.
- Nakamura, Morizumi, 1963, *Keys to the freshwater fishes of Japan fully illustrated in colors*: Hokuryukan, Japan, 258 p. [In Japanese with English summary.]
- Nakamura, Morizumi, 1969, *Cyprinid fishes of Japan: Studies on the life history of cyprinid fishes of Japan*: Tokyo, Japan, Special Publications of the Research Institute for Natural Resources, no. 4 (Contribution no. 1198), 455 p. [In Japanese with English summary.]
- Negonovskaya, I.T., and Rudenko, G.P., 1974, The oxygen threshold and characteristics of the respiratory metabolism of juvenile herbivorous fishes—The grass carp and the bighead: *Journal of Ichthyology*, v. 14, no. 6, p. 965-970.
- Nelson, J.S., 1994, *Fishes of the world*, (3rd ed.): New York, John Wiley, 600 p.
- Nelson, J.S., Crossman, E.J., Espinosa-Perez, Hector, Findley, L.T., Gilbert, C.R., Lea, R.N., and Williams, J.D., 2004, *Common and scientific names of fishes from the United States, Canada, and Mexico* (6th ed.): Bethesda, Md., American Fisheries Society, Special Publication no. 29, 386 p.
- Neophitou, Christos, 1993, Some biological data on tench (*Tinca tinca* [L.]) in Lake Pamvotida (Greece): *Acta Hydrobiologia*, v. 35, no. 4, p. 367-379.
- Nico, L.G., 2005, Changes in the fish fauna of the Kissimmee River basin, peninsular Florida: Non-Native Additions, in Rinne, J.N., Hughes, R.M., and Calamusso, B., (eds.), *Historical changes in large river fish assemblages of America*: Bethesda, Md., American Fisheries Society Symposium, in press.
- Nico, L.G., Williams, J.D., and Jelks, H.L., 2005, *Black carp: Biological synopsis and risk assessment of an introduced fish*: Bethesda, Md., American Fisheries Society Special Publication 32.
- Nikolsky (= Nikol'skii), G.V., 1956, *Fishes of the Amur River Basin: Results of the Amur River Ichthyological Expedition of 1945-1949*: Moscow, USSR Academy of Sciences Press, Moscow. [In Russian.]
- Nikolsky [=Nikol'skiy], G.V., and Aliyev, D.D., 1974, The role of far-eastern herbivorous fishes in the ecosystems of natural waters in which they are acclimatized: *Journal of Ichthyology*, v. 14, no. 6, p. 842-847.
- Nikolsky, G.V., 1963, *The Ecology of Fishes*: New York, Academic Press, 352 p.
- Nikolsky, G.V., 1954, *Special Ichthyology (Chastnaya ikhtiologiya)* (2d ed.): Moscow, USSR Ministry of Culture, [Translated from Russian, 1961, for the National Science Foundation, Washington, D.C., and the Smithsonian Institution by the Israel Program for Scientific Translations, Jerusalem.]

- Nilsson, G.E., Rosén, Peter, and Johansson, Dan, 1993, Anoxic depression of spontaneous locomotor activity in Crucian carp quantified by a computerized imaging technique: *Journal of Experimental Biology*, v. 180, p. 153-162.
- Nixon, D.E., and Miller, R.L., 1978, Movements of grass carp, *Ctenopharyngodon idella*, in an open reservoir system as determined by underwater telemetry: *Transactions of the American Fisheries Society*, v. 107, no. 1, p. 146-148.
- O'Maoileidigh, N., and Bracken, J.J., 1989, Biology of the tench, *Tinca tinca* (L.), in an Irish lake: *Aquaculture and Fisheries Management*, v. 20, p. 199-209.
- Opuszyński, K., Lirski, A., Myszkowski, L., and Wolnicki, J., 1989, Upper lethal and rearing temperature for juvenile common carp, *Cyprinus carpio* L., and silver carp, *Hypophthalmichthys molitrix* (Valenciennes): *Aquaculture and Fisheries Management*, v. 20, p. 287-294.
- Opuszyński, K., and Shireman, J.V., 1993, Food habits, feeding behaviour and impact of triploid bighead carp, *Hypophthalmichthys nobilis*, in experimental ponds: *Journal of Fish Biology*, v. 42, p. 517-530.
- Opuszyński, Karol, and Shireman, J.V., 1995, Herbivorous fishes: Culture and use for weed management: CRC Press.
- Page, L.M., and Burr, B.M., 1991, A field guide to freshwater fishes of North America north of Mexico: New York, Houghton Mifflin Company.
- Panek, F.M., 1987, Biology and ecology of carp, in Cooper E.L., ed., *Carp in North America*: Bethesda, Md., American Fisheries Society, p. 1-15.
- Pearl River Fisheries Research Institute (PRFRI), 1991, The freshwater fishes of Guangdong Province: Chinese Academy of Fisheries Science, Guangdong Science and Technology Press.
- Penttinen, Olli-Pekka, and Holopainen, I.J., 1992, Seasonal feeding activity and ontogenetic dietary shifts in Crucian carp, *Carassius carassius*: *Environmental Biology of Fishes*, v. 33, nos. 1-2, p. 215-221.
- Pénzes, Bethen, and Tölg, István, 1983, Goldfish and ornamental carp: Woodbury, N.Y., Barron's, 127 p.
- Perea, P.J., 2002, Asian carp invasion: Fish farm escapees threaten native river fish communities and boaters as well: *Illinois Periodicals Online*, Northern Illinois University Libraries, URL: <http://www.lib.niu.edu/ipo/oi020508.html>.
- Perez-Bote, J.L., Blasco, M., Da Silva, J.L., and Ruiz de la Concha, J.I., 1998, The diet of tench, *Tinca tinca*, in Ruiz, M.B., ed., *La Tencha, un Recurso Irrenunciable para Extremadura*, Camara Oficial de Comercio e Industria de Caceres, p. 111-115. [In Spanish with English summary.]
- Perrow, M.R., Jowitt, A.J.D., and Johnson, S.R., 1996, Factors affecting the habitat selection of tench in a shallow eutrophic lake: *Journal of Fish Biology*, v. 48, p. 859-870.
- Pflieger, W.L., 1975, The fishes of Missouri: Missouri Department of Conservation, 343 p.
- Piironen, Jorma, and Holopainen, I.J., 1986, A note on seasonality in anoxia tolerance of Crucian carp (*Carassius carassius* [L.]) in the laboratory: *Annales Zoologici Fennici*, v. 23, p. 335-338.
- Pimpicka, Elżbieta, 1991, Fecundity of tench (*Tinca tinca* L.) females in Lake Drwęckie: *Acta Ichthyologica et Piscatoria*, v. 21, no. 2, p. 129-141.
- Pitt, T.K., Garside, E.T., and Hepburn, R.L., 1956, Temperature selection of the carp (*Cyprinus carpio* Linn.): *Canadian Journal of Zoology*, v. 34, p. 555-557.
- Prejs, Andrzej, 1973, Experimentally increased fish stock in the pond type Lake Warniak. IV: Feeding of introduced and autochthonous non-predatory fish: *Ekologia Polska*, v. 21, no. 30, p. 465-504.
- Prokeš, Miroslav, and Baruš, Vlastimil, 1996, On the natural hybrid between common carp (*Cyprinus carpio*) and Prussian carp (*Carassius auratus gibelio*) in the Czech Republic: *Folia Zoologica*, v. 45, no. 3, p. 277-282.
- Przybylski, M., 1996, The diel feeding pattern of bitterling, *Rhodeus sericeus amarus* (Bloch) in the Wieprz-Krzna Canal, Poland: *Polskie Archiwum Hydrobiologii*, v. 43, no. 2, p. 203-222.
- Przybylski, M., and Zieba, G., 2000, Microhabitat preference of European bitterling, *Rhodeus sericeus* in the Drzęqiczka River (Pilica Basin): *Polskie Archiwum Hydrobiologii*, v. 47, no. 1, p. 99-114.
- Rai, Ash Kumar, 2000, Evaluation of natural food for planktivorous fish in Lakes Phewa, Begnas, and Rupa in Pokhara Valley, Nepal: *Limnology*, v. 1, p. 81-89.
- Raicu, P., Taisescu, E., and Bănărescu, P., 1981, *Carassius carassius* and *C. auratus*, a pair of diploid and tetraploid representative species (Pisces, Cyprinidae): *Cytologia*, v. 46, p. 233-240.
- Reichard, Martin, and Jurajda, Pavel, 1999, Patterns of ontogenetic changes in relative growth in the precocial cyprinid, bitterling (*Rhodeus sericeus*): *Netherlands Journal of Zoology*, v. 49, no. 2, p. 111-124.
- Reichard, Martin, Jurajda, Pavel, and Ondračková, M., 2002, Interannual variability in seasonal dynamics and species composition of drifting young-of-the-year fishes in two European lowland rivers: *Journal of Fish Biology*, v. 60, no. 1, p. 87-101.
- Reichard, Martin, Jurajda, Pavel, and Smith, Carl, 2004, Male-male interference competition decreases spawning rate in the European bitterling (*Rhodeus sericeus*): *Behavioral Ecology and Sociobiology*, v. 56, p. 34-41.
- Reynolds, J.D., and Guillaume, H.P., 1998, Effects of phosphate on the reproductive symbiosis between bitterling and freshwater mussels: Implications for conservation: *Journal of Applied Ecology*, v. 35, no. 4, p. 575-581.

- Rheinberger, Veronika, Hofer, Rudolf, and Wieser, Wolfgang, 1987, Growth and habitat separation in eight cohorts of three species of cyprinids in a subalpine lake: *Environmental Biology of Fishes*, v. 18, no. 3, p. 209-217.
- Richardson, M.J., Whoriskey, F.G., and Roy, L.H., 1995, Turbidity generation and biological impacts of an exotic fish *Carassius auratus*, introduced into shallow seasonally anoxic ponds: *Journal of Fish Biology*, v. 47, p. 579-585.
- Roberts, Tyson, 1986, A new species and genus of fish from Burma, one of the smallest living vertebrates: *Environmental Biology of Fishes*, v. 16, p. 231-241.
- Robison, H.W., and Buchanan, T.M., 1988, *Fishes of Arkansas*: Fayetteville, Ark., University of Arkansas Press, 536 p.
- Rosa, H., Jr., 1958, A synopsis of biological data on tench, *Tinca tinca*: Food and Agriculture Organization, Fisheries Division, FAO/58/2/951, 24 p., 2 pls.
- Ross, S.T., 2001, *Inland fishes of Mississippi*: University Press of Mississippi, 624 p.
- Ryabov, I. N., 1979, Intersubfamily hybridization of the family Cyprinidae: *Journal of Ichthyology*, v. 19, no. 6, p. 57-73.
- Sanchez-Herrera, C.F., Gallardo, J.M., Ceballos, E.G., Perez, J.M.O., and Dominguez, J.G., 1998, Utilization of artificial spawning substrate in the reproduction of tench *Tinca tinca* (L.): *Polish Archives of Hydrobiology*, v. 45, no. 3, p. 435-438.
- Schindler, Otto, 1957, *Freshwater fishes*: London, Thames and Hudson.
- Schmidt, R.E., and McGurk, J., 1982, Biology of the European bitterling *Rhodeus sericeus* (Pisces: Cyprinidae) in the Bronx River, New York, USA: An apparently benign exotic species: *Biological Conservation*, v. 24, p. 157-162.
- Schmidt, R.E., Samaritan, J.M., and Pappantoniou, Antonias, 1981, Status of the Bitterling, *Rhodeus sericeus*, in southeastern New York: *Copeia*, no. 2, p. 481-482.
- Schrank, S.J., Braaten, P.J., and Guy, C.S., 2001, Spatiotemporal variation in density of larval bighead carp in the Lower Missouri River: *Transactions of the American Fisheries Society*, v. 130, p. 809-814.
- Schwartz, F.J., 1964, Natural salinity tolerances of some freshwater fishes: *Underwater Naturalist*, v. 2, no. 2, p. 13-15.
- Schwartz, F.J., 1972, World literature to fish hybrids with an analysis by family, species, and hybrid: *Publications of the Gulf Coast Research Laboratory Museum*, no. 3. 328 p.
- Schwartz, F.J., 1981, World literature to fish hybrids with an analysis by family, species, and hybrid: Supplement 1: Seattle, Wash., National Oceanic and Atmospheric Administration (NOAA), Technical Report NMFS SSRF-750. 507 p.
- Scott, W.B., and Crossman, E.J., 1973, *Freshwater fishes of Canada*: Ottawa, Fisheries Research Board of Canada, Bulletin 184, 966 p.
- Seeley, H.G., 1886, *The freshwater fishes of Europe*: London, Cassell and Company, 444 p.
- Shapolvalov, Leo, 1944, The tench in California: *California Fish and Game*, v. 30, no. 1, p. 54-57.
- Shireman, J.V., and Smith, C.R., 1983, Synopsis of biological data on the grass carp, *Ctenopharyngodon idella* (Cuvier and Valenciennes, 1844): *FAO Fish Synopsis* 135, FIR/S135, 86 p.
- Singh, S.B., Dey, R.K., and Reddy, P.V.G.K., 1976, Some additional notes on the piscivorous habits of the grass carps (*Ctenopharyngodon idella*): *Aquaculture*, v. 9, p. 195-198.
- Smith, Carl, Reichard, Martin, Jurajda, Pavel, and Przybylski, Miroslaw, 2004, The reproductive ecology of the European bitterling (*Rhodeus sericeus*): *Journal of the Zoological Society of London*, v. 262, p. 107-124.
- Smith, Carl, Rippon, Karina, Douglas, Alexa, and Jurajda, Pavel, 2001, A proximate cue for oviposition site choice in the bitterling (*Rhodeus sericeus*): *Freshwater Biology*, v. 46, no. 7, p. 903-911.
- Smith, C.L., 1985, *The inland fishes of New York State*: Albany, New York State Department of Environmental Conservation, 522 p.
- Smith, H.M., 1945, *The fresh-water fishes of Siam or Thailand*: U.S Natural Museum, Bulletin 188, 622 p.
- Smith, P.W., 1979, *The fishes of Illinois*: Urbana, University of Illinois Press, 314 p.
- Snyder, D.E., Mulhall Snyder, M.B., Douglas, S.C., 1977, Identification of golden shiner, *Notemigonus crysoleucas*, spotfin shiner, *Notropis spilopterus*, and fathead minnow, *Pimephales promelas*, larvae: *Journal of the Fisheries Research Board of Canada*, v. 34, no. 9, p.1397-1409.
- Soin, S.G., and Sukhanova, A.I., 1972, Comparative morphological analysis of the development of the grass carp, the black carp, the silver carp and the bighead (Cyprinidae): *Journal of Ichthyology*, v. 12, no. 1, p. 61-71.
- Spotila, J.R., Terpin, K.M., Koons, R.R., and Bonati, R.L., 1979, Temperature requirements of fishes from eastern Lake Erie and upper Niagara River: *Environmental Biology of Fishes*, v. 4, no. 3, p. 281-307.
- Stanley, J.G., and Jones, J.B., 1976, Morphology of androgenetic and gynogenetic grass carp, *Ctenopharyngodon idella* (Valenciennes): *Journal of Fish Biology*, v. 9, p. 523-528.
- Stanley, J.G., Miley, W.W., II, Sutton, D.L., 1978, Reproductive requirements and likelihood for naturalization of escaped grass carp in the United States: *Transactions of the American Fisheries Society*, v. 107, no. 1, p. 119-128.
- Starling, Fernando, L.R.M., 1993, Control of eutrophication by silver carp (*Hypophthalmichthys molitrix*) in the tropical Paranoá Reservoir (Brasília, Brazil): A mesocosm experiment: *Hydrobiologia*, v. 257, p. 143-152.

- Sterba, Günther, 1973, Freshwater fishes of the world: Neptune City, N.J., T.F.H. Publications.
- Stevenson, J.H., 1965, Observations on grass carp in Arkansas: Progressive Fish-Culturist, v. 27, p. 203-206
- Strauss, R.E., and Bond, C.E., 1990, Taxonomic methods: Morphology, in Schreck, C.G., and Moyle, P.B., eds., Methods for fish biology: Bethesda, Md., American Fisheries Society, p. 109-140.
- Sublette, J.E., Hatch, M.D., and Sublette, Mary, 1990, The fishes of New Mexico: Albuquerque, University of New Mexico Press, 393 p.
- Summerfelt, R.C., Mauck, P.E., and Mensinger, Gary, 1971, Food habits of the carp, *Cyprinus carpio* L. in five Oklahoma reservoirs: Proceedings of the Southeastern Association of Game and Fish Commissions, v. 24, p. 352-377.
- Svärdson, Gunnar, 1949, Note on spawning habits of *Leuciscus erythrophthalmus* (L.), *Abramis brama* (L.), and *Esox lucius* (L.): Institute of Freshwater Research, Sweden, Drottningholm, Report no. 29, p.102-107.
- Swift, Camm, Yeager, R.W., and Parrish, P.R., 1977, Distribution and natural history of the fresh and brackish water fishes of the Ochlocknee River, Florida and Georgia: Tallahassee, Fla., Tall Timbers Research Station, Bulletin no. 20, 111 p.
- Szczerbowski, J.A., 2001, *Carassius auratus* (Linnaeus, 1758), in Bănărescu, P.M., and Paepke, H.J., eds., The freshwater fishes of Europe, v. 5/III; Cyprinidae 2/III and Gasterosteidae: AULA-Verlag GmbH Wiebelsheim, Germany, p. 5-41.
- Szczerbowski, J.A., and Szczerbowski, A.J., 2001, *Carassius carassius* (Linnaeus, 1758), in Bănărescu, P.M., and Paepke, H.J., eds., The freshwater fishes of Europe, v. 5/III; Cyprinidae 2/III and Gasterosteidae: AULA-Verlag GmbH Wiebelsheim, Germany, p. 43-78.
- Tang, Yun-An, 1960a, Report of the investigation on spawning of Chinese carps in Ah Kung Tian Reservoir: Tainan, Taiwan: Taiwan Fisheries Research Institute, Taiwan Fish Culture Station, 11 p.
- Tang, Yun-An, 1960b, Reproduction of the Chinese carps, *Ctenopharyngodon idellus* and *Hypophthalmichthys molitrix* in a reservoir in Taiwan: Japanese Journal of Ichthyology, v. 8, nos. 1-2, p.1-2.
- Tang, Yun-An, 1965, Progress in the hormone spawning of pondfishes in Taiwan: Proceedings of the Indo-Pacific Fisheries Council, v. 11, no. 2, p. 122-127.
- Tave, Douglas, 1988, Genetics of scale pattern in common carp: Aquaculture Magazine, November/December, p. 59-61.
- Taylor, Jane, and Mahon, Robin, 1977, Hybridization of *Cyprinus carpio* and *Carassius auratus*, the first two exotic species in the lower Laurentian Great Lakes: Environmental Biology of Fishes, v. 1, no. 2, p. 205-208.
- Terrell, J.W., and Fox, A.C., 1974, Food habits, growth, and catchability of grass carp in the absence of aquatic vegetation, in Rogers, W.A., ed., Proceedings of the 28th Annual Conference of the Southeastern Association of Game and Fish Commissioners, p. 251-259.
- Trautman, M.B., 1981, The fishes of Ohio: Columbus, Ohio State University Press, 782 p.
- Verigin, B.V., and Makeeva, A.P., 1974, Hybridization of the carp and bighead: Soviet Genetics, v. 8, no. 7, p. 844-851.
- Verigin, B.V., Makeeva, A.P., and Shubnikova, N.G., 1975, The morphology of underyearling hybrids of the bighead *Aristichthys nobilis* and the grass carp *Ctenopharyngodon idella*: Journal of Ichthyology, v. 15, no. 2, p. 226-231.
- Verigin, B.V., Makeeva, A.P., and Shubnikova, N.G., 1979, A case of natural hybridization between *Hypophthalmichthys molitrix* and *Aristichthys nobilis* (Pisces, Cyprinidae): Zoolosicheskifi Zhurnal, v. 58, no. 2, p. 190-196. [In Russian with English summary.]
- Verigin, B.V., Shakha, D.N., and Kamilov, B.G., 1990, Correlation among reproductive indicators of the silver carp, *Hypophthalmichthys molitrix*, and the bighead, *Aristichthys nobilis*: Journal of Ichthyology, v. 30, p. 80-92.
- Victorovsky, R.M., 1966, (Morphological characteristic of carp [*Cyprinus carpio* L.] X tench [*Tinca tinca* L.] hybrids): Izv. Gos. Nauchno-Issled. Inst. Ozern. Rechn. Rybn. Khoz., v. 66, p. 136-142. [In Russian with English summary.]
- Vinogradov, V.K., Erokhina, L.V., Savin, G.I., and Konradt, A.G., 1966, Methods of artificial breeding of herbivorous fishes: Biological Abstracts, v. 48, no. 20. [Abstract 99805, 1967.]
- von Oertzen, Jörg-A., 1985, Resistance and capacity adaptation of juvenile silver carp, *Hypophthalmichthys molitrix* (Val.), to temperature and salinity: Aquaculture, v. 44, no. 4, p. 321-333.
- Voropaev, N.V., 1968, Morphological characteristics, diet and certain fish farming attributes of silver carp and bighead and their hybrids: Aquatic Weeds Abstracts, v. 20, no. 2. [Abstract no. 744, 1970.]
- Vovk, P.S., 1979, Temperature and food adaptation of the Far East herbivorous fishes: Pacific Science Congress Proceedings, p. 41-42.
- Walker, R.M., and Johansen, P.H., 1977, Anaerobic metabolism in goldfish, *Carassius auratus*: Canadian Journal of Zoology, v. 55, no. 8, p. 1304-1311.
- Wallen, I.E., 1951, The direct effect of turbidity on fishes: Oklahoma Agricultural and Mechanical College, Bulletin, v. 48, no. 2., p. 1-27.
- Waller, U., 1985, Study on the physiological responses of the silver carp *Hypophthalmichthys molitrix* under the specific conditions in Schleswig-Holstein with special regard to its brackish water tolerance, in Experiences and problems

- in introducing nonindigenous species: Hamburg, Arbeiten des Deutschen Fischerei-Verbandes, no. 37a., p. 105-128. [In German with English summary.]
- Wang, Ji-Qiao, Huanliang Lui, Hongyu Po, and Lina Fan, 1997, Influence of salinity on food consumption, growth and energy conversion efficiency of common carp (*Cyprinus carpio*) fingerlings: *Aquaculture*, v. 148, p. 115-124.
- Ware, F.J., and Gasaway, R.D., 1978, Effects of grass carp on native fish populations in two Florida lakes: Proceedings of the 30th Annual Conference of the Southeastern Association of Fish and Wildlife Agencies, p. 324-335.
- Watkins, C.E., Shireman, J.V., Rottman, R.W., and Collee, D.E., 1981, Food habits of fingerling grass carp: *The Progressive Fish-Culturist*, v. 43, no. 2, p. 95-97.
- Wattendorf, R.J., 1986, Rapid identification of triploid grass carp with a Coulter counter and channelyzer: *Progressive Fish-Culturist*, v. 48, no. 2, p. 125-132.
- Welcomme, R.L., 1988, International introductions of inland aquatic species: Food and Agriculture Organization of the United Nations (FAO), Rome, Italy, FAO Fisheries Technical Paper 294, 318 p.
- Wheeler, Alwyne, 1969, The fishes of the British Isles and north-west Europe: East Lansing, Michigan State University Press, 613 p.
- Wheeler, Alwyne, 1978, Key to the fishes of northern Europe: London, Frederick Warne Ltd.
- Whitworth, W.R., 1996, Freshwater fishes of Connecticut (2d ed.): State Geological and Natural History Survey of Connecticut, Bulletin 114, 243 p.
- Wieser, W., 1991, Physiological energetics and ecophysiology, in Winfield, I.J., and Nelson, J.S., eds., *Cyprinid fishes: Systematics, biology and exploitation*: London, Chapman and Hall, p. 426-455.
- Woźniewski, Michał, and Opuszyński, Karol, 1988, Threshold oxygen content in water for juvenile stages of the cyprinids (*Ctenopharyngodon idella* Val., *Hypophthalmichthys molitrix* Val., *Aristichthys nobilis* Rich., *Cyprinus carpio* L.): *Roczniki Nauk Rolniczych*, v. 101, no. 4, p. 51-59. [In Polish with English summary.]
- Wu, Hsien-Wen, and others 1964a, Chinese fishes of the family Cyprinidae, Vol. 1: Shanghai, China, Shanghai Publishing House of Science and Technology. [In Chinese.]
- Wu, Xian-Wen, Gan-Rong Yang, Pei-Qi Yue, and Hong-Jin Huang, eds., 1964b, The economic animals of China: Freshwater fishes: Beijing, China, Science Press, [In Chinese.]
- Wydoski, R.S., and Whitney, R.R., 2003, Inland fishes of Washington: Bethesda, Md., American Fisheries Society and the University of Washington Press.
- Xie Ping, 2003, Silver carp and bighead, and their use in the control of algal blooms: Beijing, Science Press, 134 p.
- Yamamoto, M.N., and Tagawa, A.W., 2000, Hawaii's native and exotic freshwater animals: Honolulu, Mutual Publishing, 200 p.
- Yen, Mai Dinh, 1985, Species composition and distribution of the freshwater fish fauna of the North of Vietnam: *Hydrobiologia*, v. 121, p. 281-286.
- Yih, Peh-Lu, and Tze-Sin Liang, 1964, Natural conditions of the spawning grounds of the "domestic fishes" in Yangtze River and essential external factor for spawning: *Acta Hydrobiologica Sinica*, v. 5, no. 1, p.1-15. [In Chinese with English summary.]
- Yilmaz, F., 2002, Reproductive biology of the tench *Tinca tinca* (L., 1758) inhabiting Porsuk Dame Lake (Kutahya, Turkey): *Fisheries Research*, v. 55, no. 1-3, p. 313-317.
- Yue, Peiqi, and others, 2000, Fauna sinica; Osteichthyes; Cypriniformes III: Beijing, China, Science Press, 661 p.
- Zang, Weiling, Wu Wang, Ling Ye, Zheng Yu, Guofan Ni, and Bin Zhao, 1989, Toxic effects of salinity (S ppt) on some freshwater fishes: *Oceanologia et Limnologia Sinica*, v. 20, no. 5, p. 445-452. [In Chinese with English summary.]
- Zhadin, V.I., and Gerd, S.V., 1963, Fauna and flora of the rivers lakes and reservoirs of the U.S.S.R.: Translated from Russian by the Israel Program for Scientific Translations, Jerusalem, 626 p. [Originally published in Moscow, 1961, by Gosudarstvennoe Uchebno-Pedagogicheskoe Izdatel'stvo Misisterstva Prosveshcheniya RSFSR.]
- Zhong, L., Chao, J., Zeng, M., Ouyang, H., Chen, F., Li, Y, Zhao, A., and Su, Z., 1980, Pond fish culture in China: Guangzhou, Pearl River Fisheries Research Institute, China National Bureau of Aquatic Products.
- Zhou, Chunsheng, Zhixin Liang, and Heinan Huang, 1980, Ecological features of the spawning of certain fishes in the Hanjiang River after the construction of dams: *Acta Hydrobiologica Sinica*, v. 7, no. 2, p. 188-193. [In Chinese with English summary.]
- Zhul'kov, A.I., and Nikiforov, S.N., 1988, Some morphological and biological data on the bitterling *Rhodeus sericeus* from the Tym' River (Sakhalin I.): *Journal of Ichthyology*, v. 28, no. 1, p. 149-153.



One of the earliest U.S. records of Silver Carp from the wild, this fish was captured in the lower Mississippi River near Greenville, Mississippi, about 1990. (Photo by Leo G. Nico.)

Appendixes



Goldfish, 2.2 kg, from Kalvemose Lake, Denmark. (Photo copyright © www.jjphoto.dk, courtesy of Johnny Jensen.)

Appendix A. Foreign cyprinids established or reported from the United States.

Nonindigenous foreign cyprinids introduced to inland waters are listed by state. The matrix is largely based on Fuller and others (1999) although several records have been added or modified due to new information.

Key to symbols:

E - Established, one or more breeding populations known to exist.

E? - reported from state, possibly established, existence of a breeding population not confirmed.

X – Only known established population(s) eradicated or extirpated.

X? - previously known to be established, recent information indicates possible extirpation.

R - reported from one or more localities, no evidence of establishment.

R? - reported, but record or records not fully confirmed (that is, some doubt remains concerning identification).

asterisk (*) – indicates that we have located (or found published reference to) voucher specimen(s) that support one or more of a state's records. In most cases, the voucher has been deposited and catalogued in a recognized ichthyological collection; however, not all specimens have been examined to verify identification.

Note: For states where a species is listed as established, possibly established, or extirpated, other records may indicate that the species has been reported from one or more sites within the same state.

Appendix A. Foreign cyprinids established or reported from the United States. (Continued)

Common Name	Montana	Nebraska	Nevada	New Hampshire	New Jersey	New Mexico	New York	North Carolina	North Dakota	Ohio	Oklahoma	Oregon	Pennsylvania	Rhode Island	South Carolina	South Dakota	Tennessee	Texas	Utah	Vermont	Virginia	Virginia	Washington	West Virginia	Wisconsin	Wyoming	E/E?	R/R?	X/X?	Totals	
Zebra Danio						X																					0	3	1	4	
Goldfish	E	E*	E*	E*	E?*	E?	E*	E?*	E?	E*	E	E?	E*	E*	E*	E	E*	E*	R	R	R	E*	E	E*	E	E	45	4	0	49	
Crucian Carp																			R?								0	1	1	2	
Grass Carp	E?	R	R	R	R	R	R*	R	R	R	R	R	R	R	R	R	R	R	R	R	R	R	R	R	R	R	11	34	0	45	
Common Carp	E	E*	E*	E*	E*	E*	E*	E*	E*	E*	E*	E*	E*	E	E*	E*	E*	E*	E*	E*	E	E*	E*	E*	E*	E*	49	0	0	49	
Malabar Danio			R																								0	2	0	2	
Silver Carp		R														R	E										9	7	0	16	
Bighead Carp		E								R	R					R	E										11	12	0	23	
Ide		R					X*	R?		R?		X				R	R			X	X						1	16	5	22	
Black Sharkminnow																											0	1	0	1	
Black Carp																											1	3	0	4	
Rosy Barb																											0	1	0	1	
Blackspot Barb																											0	0	1	1	
Dwarf Barb																											0	1	0	1	
Tinfoil Barb																											0	1	0	1	
Green Barb																											0	0	1	1	
Tiger Barb																		R							R	0	4	0	4		
Bitterling																											0	0	1	1	
Rudd	E	R	R	X	E*		R	E?		E?					E	E?				R*	E*?	E*?	R	R	X	8	11	3	22		
Tench	R	R	R	R	X*	X?	R	R	R	R	R	X*	R	R	R	R	R	R	R	R	R?	X*	X*	E*	R?	R	5	28	6	39	
Total	2	8	5	3	6	5	7	5	3	6	6	4	6	2	4	6	7	9	4	4	4	6	5	7	6	4					
E/E?	2	5	2	2	2	2	3	2	2	2	2	2	3	2	2	3	5	4	1	1	1	3	3	2	2	2					
R/R?	0	3	3	1	3	1	1	3	1	4	4	1	2	0	2	3	2	5	3	3	3	1	1	2	5	3	2				
X/X?	0	0	0	0	1	2	3	0	0	0	0	1	1	0	0	0	0	0	0	0	0	2	2	0	0	1	0				

Number of species by state



Grass Carp, Caloosahatchee River, Florida, December 19, 1997. (Photo by Leo G. Nico.)

Appendix B. Meristics of foreign nonindigenous cyprinids and selected hybrids.

This appendix contains meristic characters for the eleven foreign nonindigenous cyprinids treated in this guide, as well as some of their hybrids. Each table presents meristic information from a number of reports, generally ranging over a wide geographic area (often including data from populations in both native and non-native areas). Because the soft rays of the dorsal and anal fins are often difficult to discern, many authors typically report only a single number, which includes one unbranched ray plus all branched rays. We have reproduced these counts as given by the original authors. In contrast, some authors give counts for both unbranched and branched rays in the fins. The format of these counts has been standardized by using Roman numerals to indicate unbranched rays followed by Arabic numerals (in parentheses) to represent the number of soft branched rays. Gill-raker counts are based on the first (outer) gill arch. All gill rakers are counted, including small rudimentary ones. Some authors give either upper and lower limb counts, or inner and outer (anterior and posterior) counts, and we have reported those data where available. For more information on reporting meristics, see “Methods.”

Goldfish (*Carassius auratus*)

Citation	Nikolyukin 1946, <i>in Berg</i> (1964)	Berg (1964)	Kiselov (1962), <i>in</i> Szczerbow- ski (2001)	Taylor and Mahon (1977)	Radimowski (1973), <i>in</i> Szczerbow- ski (2001)	Radimowski (1973), <i>in</i> Szczerbow- ski (2001)	Bănărescu (1964)	Scott and Cross- man (1973)	Yue and others (2000)	Nakamura (1969)	Wheeler (1969)
Source locale	Russia	Russia	Ukraine	Laurentian Great Lakes	China	Ukraine	Romania	Canada	China	Japan	NW Europe
Lateral-line scales	28-31	28-33	26-31	28-31	28-30	26-31	28-32	27-30	27-30	30-33	28-33
Dorsal rays	iii-iv (15-18)	iii-iv (14-19)	iii-iv (13-19)	ii-iii (15-18)	iii (16-18)	iii (15-19)	iii-iv (14-18)	(15-18)	iii (15-19)	iii (16-18)	iii-iv (15-19)
Anal rays	iii (5-6)	ii-iii (5-6)		ii-iii (5-6)	iii (5-6)	iii (5-6)	iii (5)	(5-6)	iii (5)	iii (5)	ii-iii (5-6)
Pectoral rays				i (13-15)			i (14-18)	(15-17)	i (16-17)		
Pelvic rays				i (7-9)			i (7-8)	(8-9)	i (8)		
Vertebrae	29-31	29-31	29-31		26-31	25-31	29-31	28-29		28-30	
Gill rakers	40-48	39-50	38-47	39-47 outside, 47-53 inside	37-46	38-45	40-52	37-43			

Crucian Carp (*Carassius carassius*)

Citation	Drjagin (1949, <i>in</i> Szczerbowski and Szczerbowski (2001)	Szczerbowski (1995), <i>in</i> Szczerbowski and Szczerbowski (2001)	Nikolyukin (1946), <i>in</i> Berg (1964)	Bănărescu (1964)	Yue and others (2000)	Nikolyukin (1946), <i>in</i> Berg (1964)	Wheeler (1969)
Source locale	Russia	Poland	Russia	Romania	China	Russia	NW Europe
Lateral-line scales	28-37	32-35	32-35	30-35	32-34	29-36	32-35
Dorsal rays	iii-iv (14-21)	iii-iv (16-19)	iii-iv (16-19)	iii-iv (14-17)	iii (16-18)	iii-iv (16-20)	iii-iv (14-21)
Anal rays	ii-iii (6-8)	ii-iii (5-8)	iii (5-6)	iii (5-7)	iii (6-7)	iii (6-7)	iii (6-8)
Pectoral rays					i (14-16)		
Pelvic rays					i (8)		
Vertebrae	31-33	30-33	31-34			32-33	
Gill rakers	22-33	22-28	28-33	23-33		26-30	26-31

Common Carp (*Cyprinus carpio*)

Citation	Berg (1964)	Taylor and Mahon (1977)	Kirpichnikov (1967), in Baruš and others (2001)	Bănărescu (1964)	Balon (1974, 1995)	Scott and Crossman (1973)	Yue and others (2000)	Nakamura (1969)	Wheeler 1969
Source locale	Russia	Laurentian Great Lakes	China	Romania	Danube River	Canada	China	Japan	NW Europe
Lateral-line scales	32-40	37-40	33-39	34-40	34-40	35-39	32-40	33-36	35-40
Dorsal rays	iii-iv (15-21)	iii (18-20)	(18-21)	ii-iv (17-22)	ii-iv (18-22)	(18-20)	iv (16-22)	iii (19-21)	iii-iv (17-22)
Anal rays	iii (5-6)	ii-iii (5)		ii-iii (4-6)	ii-iii (4-5)	(5)	iii (5)	iii (5)	ii-iii (5)
Pectoral rays		i (13-15)		i (14-19)	i (14-19)	(14-17)	i (14-16)		
Pelvic rays		i (7-8)		ii (7-9)	ii (7-9)	(8-9)	ii (8)		
Vertebrae	36-38					35-36		31-32	
Gill rakers	21-29	21-29 outside, 27-31 inside	18-21	22-28	22-28 inside; 29-36 outside				

Common Carp X Goldfish (*Cyprinus carpio* X *Carassius auratus*)

Citation	Bănărescu (1964)	Taylor and Mahon (1977)	Prokeš and Baruš (1996)
Source locale	Romania	Laurentian Great Lakes	Czech Republic
Lateral-line scales	38-39	32-35	36
Dorsal rays	iii (21)	iii-iv (17-18)	iv (17)
Anal rays	iii (6)	ii-iii (5)	iii (5)
Pectoral rays		i (13-15)	i (15)
Pelvic rays	ii (8-9)	I (7-8)	ii (8)
Vertebrae	35		35
Pharyngeal teeth	1,1,3-3,1,1	0-1 on first and second row, 4 on third row	1,1,3-3,1,1
Gill rakers	24	30-40 outside, 25-42 inside	25 outside, 31 inside

Common Carp X Crucian Carp (*Cyprinus carpio* X *Carassius carassius*)

Citation	Nikolyukin (1937), in Berg (1964)	Nikolyukin (1946), in Berg (1964)	Jones and Linfield (1972)	Bănărescu (1964)
Source locale	Russia	Russia	Britain	Romania
Lateral-line scales	35-38	36-39		35-39
Dorsal rays	iii-v (16-21)	iii-iv (17-21)	(19)	iv (17-21)
Anal rays	v-vv (5-6)	iii (5-6)	(6)	iii (4-5)
Vertebrae	33-36			33-37
Pectoral rays			(15)	
Pelvic rays			(8)	
Caudal rays			(21)	
Pharyngeal teeth	Most often 1,4-4,1	Most often 1,4-4,1	1,4-4,1	Various, see text
Gill rakers		26-32		
Barbels			One on each side	

Grass Carp (*Ctenopharyngodon idella*)

Citation	Berry and Low (1970)	Berg (1964)	Nakamura (1969)	Chen (1998)	Kilambi and Zdinak (1981)
Source locale	Malaysia	Russia	Japan	China	Arkansas, USA
Lateral-line scales	40-42	43-45	37-39	38-44	38-45
Dorsal rays	i-ii (8)	iii (7)	iii (7)	iii (7)	
Anal rays	ii (8-9)	iii (8)	iii (8)	iii (8-9)	8-10
Pectoral rays	i (14-16)			i (16-18)	15-18
Pelvic rays	i (7-8)			ii (8)	
Vertebrae			41		
Gill rakers		12			8-12 (lower limb, first arch)

Grass Carp X Bighead Carp (*Ctenopharyngodon idella* X *Hypophthalmichthys nobilis*)

Citation	Berry and Low (1970)	Andriasheva (1968)	Cassani and others, (1984)	Verigin and others (1975)	Kilambi and Zdinak (1981)
Source locale	Malaysia	Russia	Arkansas		Arkansas
Lateral-line scales	52-65	60-67	42-59		42-57
Dorsal rays	ii (8)		i (6-8)	(7)	
Anal rays	ii (10-11)		0-i (8-11)		(8-10)
Pectoral rays	i-ii (17-19)		i (16-20)		17-21
Pelvic rays	i-ii (7-8)		i (7-8)		
Gill rakers					18-23 (lower limb, first arch)
Keel	present	present	Sometimes present		
Pharyngeal teeth	0,4-5,0		variable (see citation)	1,4-5,1	

Black Carp (*Mylopharyngodon piceus*)

Citation	Kimura(1934)	Berg (1964)	Nikolsky (1956)	Nakamura (1963, 1969)	Wu and others (1964a)	Chu (1984)	Chu and others (1989)	Chen (1998)
Source locale	China	Russia	Russia	Japan?	China	China	China	China
Lateral-line scales	43	39-43	42-43	41-44	39-45	39-46	40-44	39-44
Dorsal rays	iii (7)	iii (7-8)	iii (7)	8-9 or iii (7-8)	iii (7-8)	iii (7)	iii (7)	iii (7)
Anal rays	iii (8)	iii (8)	iii (8)	8-9 or iii(7-8)	iii (8-9)	iii (8)	8-9	iii (8-9)
Pectoral rays	i (16)				i (16)		i (16)	i (16-18)
Pelvic rays	i (8)				i (8)	ii (8)	i (8)	ii (8)
Vertebrae		38-41	38-41	38 (n=1)	37-40			
Gill rakers	4+14	19-21	19-21	14-18	15-21 usually 18-20	15-16	18-20	

Bighead Carp (*Hypophthalmichthys nobilis*)

Citation	Antalfi and Tolg, in Opuszynski and Shireman (1995)	Nakamura (1969)	Nakamura (1963)	Chen (1998)	Berry and Low (1970)
Source locale	Poland?	Japan	Japan	China	Malaysia
Lateral-line scales	114-120	99-112	106	91-108	98-100
Dorsal rays	iii (10)	iii (7,10)	8-11	iii (7-8)	ii (8)
Anal rays	iii (15-17)	iii (12-14)	13-14	iii (10-13)	ii (12-14)
Pectoral rays				i (16-19)	ii (17019)
Pelvic rays				i (7-8)	i (8-9)
Gill akers			130		
Vertebrae		38			

Silver Carp (*Hypophthalmichthys molitrix*)

Citation	Berg (1964)	Chen (1998)	PRFRI (1991)	Nakamura (1969)
Source locale	Russia	China	China	Japan
Lateral-line scales	110-124	91-120	108-120	98-116
Dorsal rays	ii (7)	iii (7)	iii (7)	iii (7)
Anal rays	ii-iii (12-14)	iii (11-13)	iii (13)	iii 12-14)
Pectoral rays		i (16-17)	i (17)	
Pelvic rays	i (7)	i (7-8)	i (8)	
Vertebrae	37		37	37
Gill rakers				about 110

Ide (*Leuciscus idus*)

Citation	Chen (1998)	Bănărescu (1964)	Berg (1964)	Wheeler (1969)
Source locale	China	Romania	Russia	Western Europe
Lateral-line scales	55-59	55-61	55-63	56-61
Dorsal rays	iii (8)	iii (7-9)	iii (8)	iii (8)
Anal rays	iii (9-11)	iii (9-11)	iii (9-12)	iii (9-10)
Pectoral rays	i (16-17)			
Pelvic rays	ii (8)			
Vertebrae		44-47	44-45	
Gill rakers		10-11	10-14	

Bitterling (*Rhodeus sericeus*)

Citation	Wheeler (1969)	Bănărescu (1964)	Holčík and Jedlička (1994)	Holčík and Jedlička (1994)
Source locale	NW Europe	Romania	Europe	Amur Basin
Lateral-line scales	5-6 pored; 34-38 total scales on side	4-7 pored; 35-38 total scales on side	4-10 pored; 33-44 total scales on the side	0-9 pored, 32-45 total scales on the side
Dorsal rays	iii (9-10)	iii (8-10)	ii-iii (8-11)	ii-iv (7-11)
Anal rays	iii (8-9)	iii (8-10)	ii-iii (8-11)	ii-iv (6-11)
Pharyngeal teeth	0,5-5,0	0,5-5,0		
Gill rakers			9-16 (outside)	9-13 (outside)

Rudd (*Scardinius erythrophthalmus*)

Citation	Burkhead and Williams (1991)	Berg (1964)	Bănărescu (1964)
Source locale	Arkansas	Russia	Romania
Lateral-line scales	38-41	37-43	39-42
Dorsal rays	9-11	iii (8-10)	iii (8-9)
Anal rays	11-14	iii (9-12)	iii (10-12)
Pectoral rays	15-16		
Pelvic rays	8-9		
Vertebrae	37-40		38-39
Gill rakers	10-13	11-12	11-12

Tench (*Tinca tinca*)

Citation	Scott and Crossman (1973)	Berg (1964)	Jevtić (1979)	Coad (2005)	Wheeler (1969)
Source locale	Canada	Russia	Yugoslavia	Iran (and other locations)	NW Europe
Lateral-line scales	95-105	90-110 (males); 87-115 (females)		70-120	
Dorsal rays	9	iii-iv (8)		ii-iv (6-9)	iii (8)
Anal rays	7-8	iii (6-8)		iii-iv (5-9)	iii (6-8)
Pectoral rays				13-18	
Vertebrae	38-39		38-41	35-44	
Gill rakers	13			10-16	



Grass Carp, Caloosahatchee River,
Florida, January 16, 1995.
(Photo by Leo G. Nico.)



United States Geological Survey

Florida Integrated Science Center
 Nonindigenous Aquatic Species Program
 7920 NW 71st Street
 Gainesville, Florida 32653
 Telephone (352) 378-8181 Fax (352) 378-4956
<http://nas.er.usgs.gov>

Nonindigenous Aquatic Species Reporting Form

Common Name _____

Genus _____ Species _____

Subspecies _____ Date Collected _____

State _____ County _____ Drainage _____

Location (please be as specific as possible; for example, road crossing, distance, and direction to nearest town): _____

Identified by _____

Collected by _____

Method of collection _____

Number collected _____ Age class _____ Size _____

(Adult, Juvenile, young-of-year)

(TL, SL, or FL)

Method of disposal _____

(released, discarded, preserved, mounted, deposited in museum)

Specimen storage _____

(museum or agency's name and catalogue number)

Comments _____

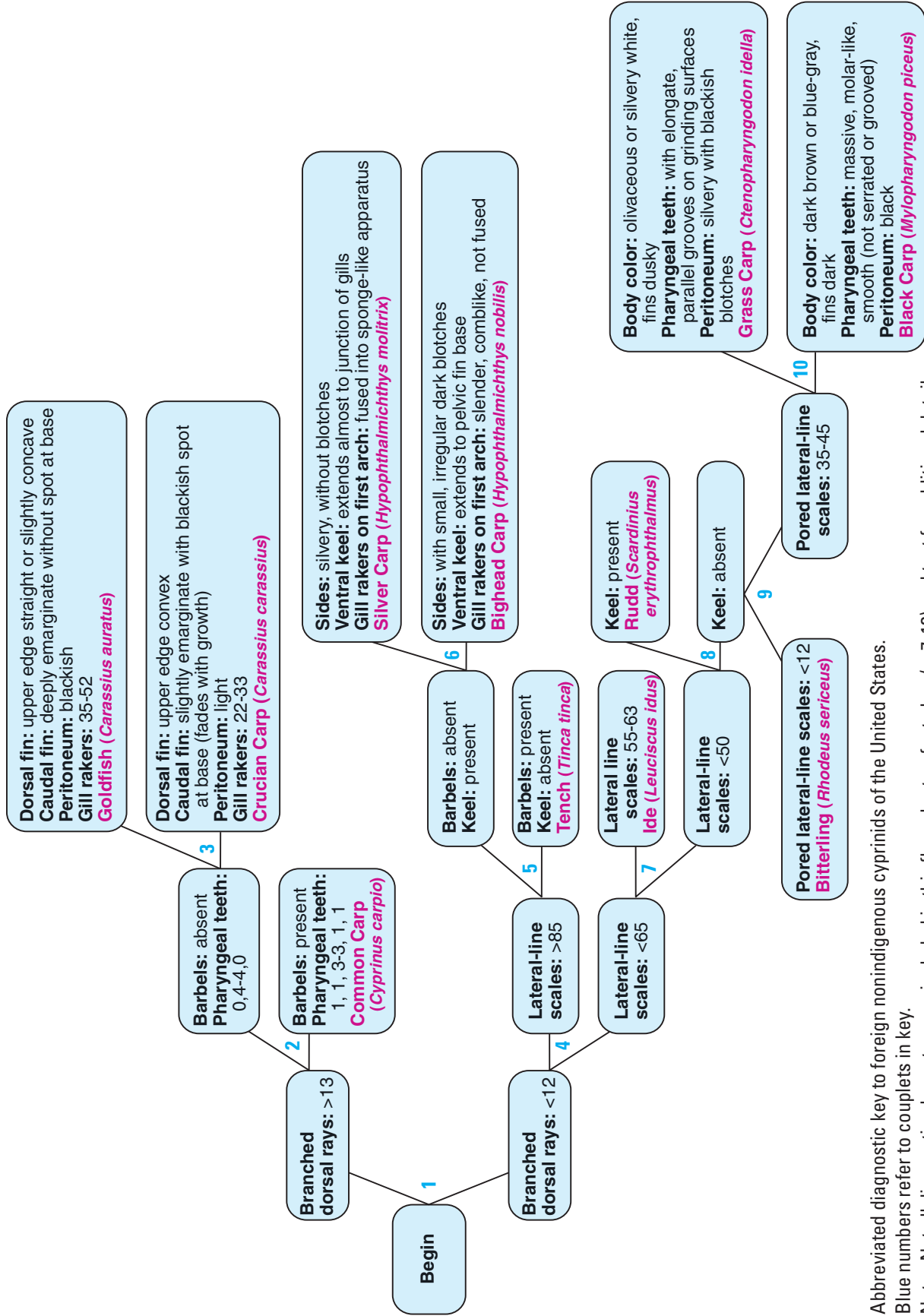

Abbreviated diagnostic key to foreign nonindigenous cyprinids of the United States.
 Blue numbers refer to couplets in key.
 Note: Not all diagnostic characters are included in this flow chart; refer to key (p. 7-13) and text for additional details.