

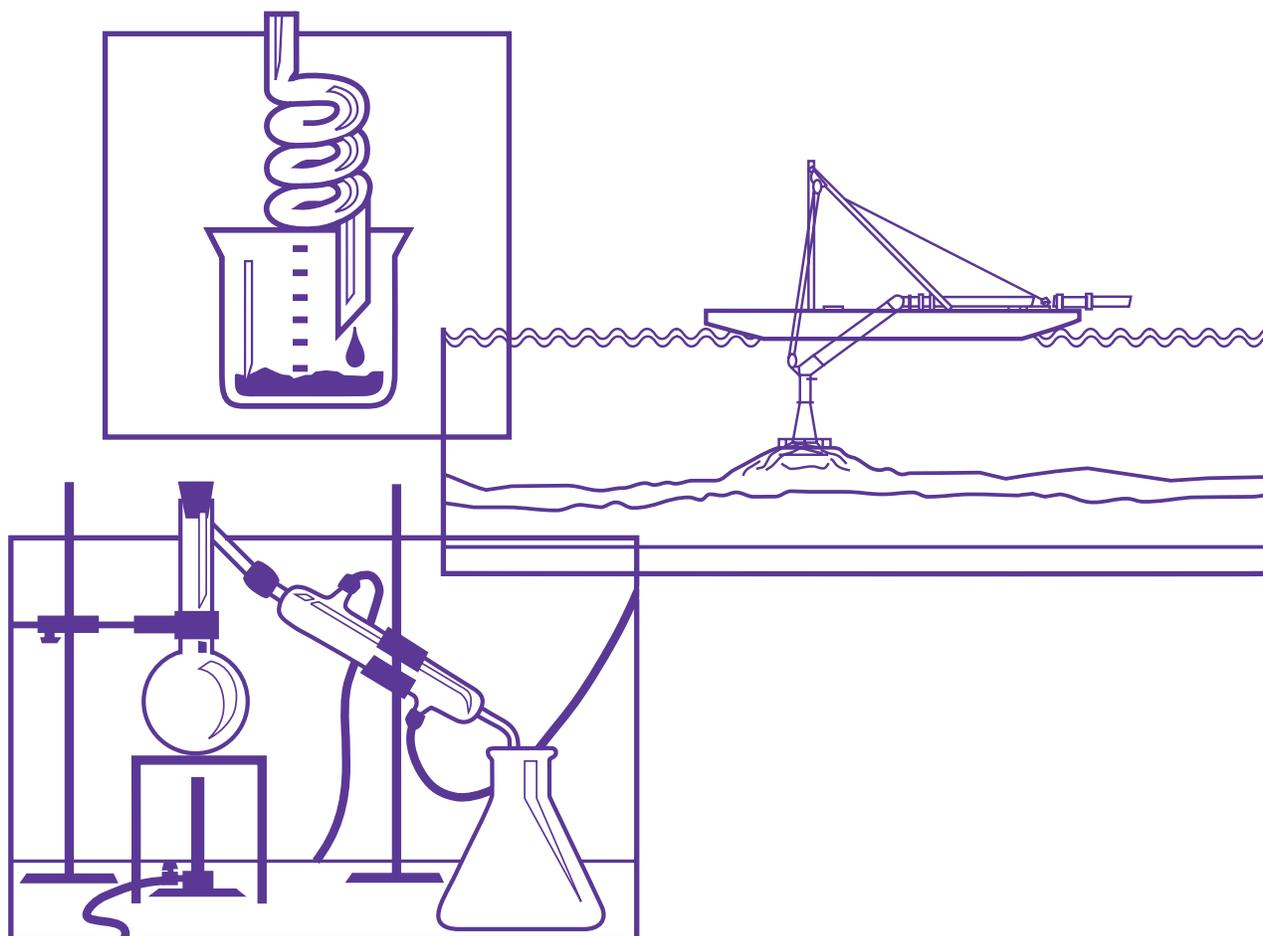

# National Conference on Management and Treatment of Contaminated Sediments

Proceedings  
Cincinnati, OH  
May 13-14, 1997



# **National Conference on Management and Treatment of Contaminated Sediments**

Proceedings  
Cincinnati, OH  
May 13-14, 1997

Technology Transfer and Support Division  
National Risk Management Research Laboratory  
Office of Research and Development  
U.S. Environmental Protection Agency  
Cincinnati, OH

## **Notice**

Mention of trade names or commercial products does not constitute endorsement or recommendation for use.

# Foreword

The U.S. Environmental Protection Agency is charged by Congress with protecting the nation's land, air, and water resources. Under a mandate of national environmental laws, the Agency strives to formulate and implement actions leading to a compatible balance between human activities and the ability of natural systems to support and nurture life. To meet this mandate, EPA's research program is providing data and technical support for solving environmental problems today and building a science knowledge base necessary to manage our ecological resources wisely, understand how pollutants affect our health, and prevent or reduce environmental risks in the future.

The National Risk Management Research Laboratory is the Agency's center for investigation of technological and management approaches for reducing risks from threats to human health and the environment. The focus of the laboratory's research program is on methods for the prevention and control of pollution to air, land, water and subsurface resources; protection of water quality in public water systems; remediation of contaminated sites and ground water; and prevention and control of indoor air pollution. The goal of this research effort is to catalyze development and implementation of innovative, cost-effective environmental technologies; develop scientific and engineering information needed by EPA to support regulatory and policy decisions; and provide technical support and information transfer to ensure effective implementation of environmental regulations and strategies.

This publication has been produced as part of the laboratory's strategic long-term research plan. It is published and made available by EPA's Office of Research and Development to assist the user community and to link researchers with their clients.

E. Timothy Oppelt, Director  
National Risk Management Research Laboratory



# Contents

1. EPA's National Sediment Quality Survey: A Report to Congress on the Incidence and Severity of Sediment Contamination in Surface Waters of the U.S. .... 1  
**Thomas M. Armitage** and **F. James Keating**  
Office of Science and Technology  
U.S. Environmental Protection Agency  
Washington, D.C.
2. EPA Role in Managing Contaminated Sediment ..... 9  
**Thomas M. Armitage** and **Jane Marshall Farris**  
Office of Science and Technology  
U.S. Environmental Protection Agency  
Washington, D.C.
3. Strategies and Technologies For Cleaning Up Contaminated Sediments in the Nation's Waterways: A Study by the National Research Council ..... 12  
**Spyros P. Pavlou**  
Member, NRC Marine Board Committee on Contaminated Marine Sediments, 1993-1996  
Technical Director of Environmental Risk Economics, URS Greiner Inc., Seattle, WA  
**Louis J. Thibodeaux**  
Member, NRC Marine Board Committee on Contaminated Marine Sediments, 1993-1996  
Emeritus Director, Hazardous Substance Research Center (South/Southeast), USEPA and Jesse Coates Professor of Chemical Engineering, Louisiana State University, Baton Rouge, LA
4. Solving Great Lakes Contaminated Sediment Problems ..... 18  
**Marc Tuchman** and **Callie Bolattino**  
U.S. Environmental Protection Agency  
Great Lakes National Program Office  
Chicago, IL  
**Jan Miller**  
U.S. Army Corps of Engineers  
North Central Division  
Chicago, IL
5. Perspective on Remediation and Natural Recovery of Contaminated Sediments ..... 27  
**Dolloff F. Bishop**  
National Risk Management Research Laboratory  
U.S. Environmental Protection Agency  
Cincinnati, OH
6. Natural Recovery of Contaminated Sediments—Examples from Puget Sound ..... 37  
**Todd M. Thornburg** and **Steve Garbacia**  
Hart Crowser, Inc.

## Contents (continued)

7. *In-Situ* Capping of Contaminated Sediment: Overview and Case Studies ..... 44  
**Michael R. Palermo**  
Research Civil Engineer, U.S. Army Engineer Waterways Experiment Station,  
Vicksburg, MS
8. Observations Regarding Brownfields and Sediment Disposal at Indiana Harbor ..... 52  
**David M. Petrovski**, Environmental Scientist  
U.S. Environmental Protection Agency  
Region 5, Chicago, IL  
**Richard L. Nagle**, Attorney  
U.S. Environmental Protection Agency  
Region 5, Chicago, IL  
**Jan Miller**, Environmental Engineer  
USACE, Great Lakes and Ohio River Division  
Chicago, IL  
**Gregory N. Richardson**, Principal  
G.N. Richardson & Associates  
Raleigh, NC
9. Environmental Dredging and Disposal Overview and Case Studies ..... 65  
**Michael R. Palermo**, Research Civil Engineer  
U.S. Army Engineer Waterways Experiment Station (WES)  
Vicksburg, MS  
**Norman R. Francingues**, Chief,  
Environmental Engineering Division, WES  
**Danny E. Averett**, Chief,  
Environmental Restoration Branch, WES
10. Integrated Sediment Decontamination for the New York/New Jersey Harbor ..... 71  
**E. A. Stern**  
U.S. Environmental Protection Agency, Region 2, New York, NY  
**K. R. Donato**  
U.S. Army Corps of Engineers, New York District, New York, NY  
**N. L. Clesceri**  
Rensselaer Polytechnic Institute, Troy, NY  
**K. W. Jones**  
U.S. Department of Energy, Brookhaven National Laboratory, Upton, NY
11. The Fully Integrated Environmental Location Decision Support (FIELDS) System:  
An Approach to Identify, Assess and Remediate Contaminated Sediment ..... 82  
**Matthew H. Williams, George D. Graettinger, Howard Zar,**  
**Dr. Yichun Xie and Brian S. Cooper**
12. Remediation Strategies and Options for Contaminated Sediment ..... 85  
**Carol Ancheta**  
Scientific Project Officer  
Environment Canada  
Remediation Technologies Program  
Downsview, Ontario, Canada
13. The Automated Dredging and Disposal Alternatives Modeling System (ADDAMS):  
Summary and Availability ..... 90  
**Paul R. Schroeder**  
Research Civil Engineer  
U.S. Army Engineer Waterways Experiment Station (WES)  
Vicksburg, MS  
**Michael R. Palermo**  
Research Civil Engineer WES

## Contents (continued)

14. Overview of Ongoing Research and Development ..... 94  
**Dennis L. Timberlake**  
U.S. Environmental Protection Agency  
National Risk Management Research Laboratory  
Cincinnati, OH
15. Corps of Engineers Research Programs on Contaminated Sediments ..... 97  
**Norman R. Francingues**  
Chief, Environmental Engineering Division (EED)  
U.S. Army Engineer Waterways Experiment Station (WES)  
Vicksburg, Mississippi  
**Michael R. Palermo**  
Research Civil Engineer, EED, WES  
**Daniel E. Averett**  
Chief, Environmental Restoration Branch WES.  
**Robert M. Engler**  
Senior Research Scientist WES
16. Potential for Phytoremediation of Contaminated Sediments ..... 101  
**Steven A. Rock**  
Environmental Engineer  
Land Remediation and Pollution Control Division  
National Risk Management Research Laboratory  
United States Environmental Protection Agency  
Cincinnati, OH
17. Treatment of Metal-Bearing Solids: *Using a Buffered Phosphate Stabilization System ...* 106  
**Thomas Stolzenburg**, Senior Applied Chemist  
RMT, Incorporated  
Madison, WI
18. Treatment of Dredged Harbor Sediments by Thermal Desorption ..... 112  
**Mary Hall, Ed Alperin** and **Stuart Shealy**, IT Corporation  
**Keith Jones**, Brookhaven National Laboratory
19. Solvent Extraction Process Development to Decontaminate Sediments ..... 119  
**Philip DiGasbarro**  
Metcalf & Eddy, Inc., Branchburg, NJ  
**John Henningson**, P.E.  
Formerly of Metcalf & Eddy, Inc.  
**Georges Pottecher**  
Anjou Recherche/GRS, Paris, France  
**John J. Cardoni**, P.E.  
Metcalf & Eddy, Inc., Branchburg, NJ
20. Containment Research for Contaminated Sediment and Contaminated  
Dredged Material Management—A Review ..... 131  
**Louis J. Thibodeaux, Danny D. Reible**, and **Killait T. Valsaraj**  
Hazardous Substance Research Center/S & SW  
College of Engineering, Louisiana State University  
Baton Rouge, LA

## Contents (continued)

21. Summary of Conference on Management and Treatment of Contaminated Sediments ..	138
Panel Participants:	
<b>Norman Francingues</b>	
U.S. Army Corps of Engineers (U.S. COE)	
Vicksburg, MS	
<b>Emily Green</b>	
Sierra Club	
Madison, WI	
<b>Michael Palermo</b>	
U.S. COE	
Vicksburg, MS	
<b>Louis Thibodeaux</b>	
Louisiana State University	
Baton Rouge, LA	
<b>Dennis Timberlake</b>	
National Risk Management Research Laboratory (NRMRL)	
U.S. EPA	
Cincinnati, OH	
22. Exhibitor List .....	143

# Acknowledgments

The success of the conference and this document is due largely to the efforts of many individuals. Gratitude goes to each person who was involved.

## Presenters and Exhibitors

A special thanks goes to the authors of the papers and demonstrations that were presented at the conference. Their efforts in preparing papers made this document possible and led to the overall success of the conference. The participation of the exhibitors whose displays added to the conference is also appreciated.

## Special Thanks

The contributions of the following individuals in the development of the conference are especially appreciated.

Thomas Armitage, Ph.D., EPA, Office of Water, Washington, D.C.

Edwin Barth, Jr., EPA, Office of Research and Development, Cincinnati, OH

Bonnie Eleder, EPA, Region 5, Chicago, IL

Norman Francinques, USACOE, Waterways Experiment Station, Vicksburg, MS

Dennis Timberlake, EPA, Office of Research and Development, Cincinnati, OH

Marc Tuchman, Ph.D., Great Lakes National Program Office, EPA, Chicago, IL

Joseph Zelibor, Ph.D., National Research Council, Washington, D.C.

## Technical Direction and Coordination

Joan Colson, EPA, ORD, NRMRL, Cincinnati, OH, provided technical direction throughout the development of the conference and the preparation of the conference proceedings. Eastern Research Group, Inc. of Lexington, MA, handled conference logistics and provided support for many aspects of the conference.

## Editorial Review and Document Production

Jean Dye and Carol Legg of EPA's Office of Research and Development, Cincinnati, OH, guided the compilation and editing of this publication. John McCready provided graphics support.

# Introduction

The National Conference on Management and Treatment of Contaminated Sediment was held in Cincinnati, OH, May 13 to 14, 1997. This technology transfer meeting was held for 213 professionals from various EPA divisions and other organizations, including Environment Canada, the U.S. Army Corps of Engineers, the National Research Council, academia, and the private sector, to disseminate information on how to manage and treat contaminated sediments. During the conference, 24 speakers presented various treatment options available for high- and low-end contaminated sites; future research needs, questions, and comments were addressed during an interactive panel discussion; and private vendors who have experience in the treatment of contaminated sediments were available for information at 23 vendor booths.

Contaminated sediments is growing as an area of environmental concern, particularly when assessing ecological and public health risks. Costs for treatment and removal of typically high-volume, low-contaminant concentrations; inadequate measuring techniques for predicting the effectiveness of cleanup strategies; and lack of comprehensive performance data for various emerging technologies pose technological challenges for controlling and remediating sediment contamination. While investigations have been conducted to assess the ecological effects of contaminated sediments, and to establish general sediment quality criteria used for the basis of some policy decisions, research is ongoing. This conference provided information on the status of treatment technologies and the results from various research programs in the following areas:

- Nature and extent of contaminated sediments
- Significance of biological and chemical effects of the sediment contamination problem
- Sediment quality criteria
- Management of sediments, including dredging and containment
- Various *in situ* and *ex situ* sediment contamination treatment options
- Current research case studies conducted by public, academic and private sectors
- Panel discussion to identify future research needs

The purpose of this proceedings document is to present papers from the conference and provide information to interested individuals unable to attend. This document will be useful to individuals who are currently looking for information and techniques to treat contaminated sediments in rivers, harbors, lakes, and/or Superfund sites because of the associated ecological and/or public health risks or for navigational purposes. These individuals include environmental regulatory personnel at the federal, state, and local level; university professors, researchers, and students; and private sector personnel, including industry representatives and environmental consultants. The goal of sharing this information with a broader audience is to help educate others about the various technological advances that have been made in sediment contamination research; to present an overview of the control and treatment options available; and to highlight the future research needs for treating and managing contaminated sediments.

---

# **EPA's National Sediment Quality Survey: A Report to Congress on the Incidence and Severity of Sediment Contamination in Surface Waters of the U.S.**

Thomas M. Armitage and F. James Keating  
Office of Science and Technology  
U.S. Environmental Protection Agency  
Washington, D.C.

The U.S. Environmental Protection Agency (EPA) has completed work on a Report to Congress entitled, "The Incidence and Severity of Sediment Contamination in Surface Waters of the United States." (U.S. EPA, 1997[a], 1997[b], 1997[c]) The report describes the accumulation of chemical contaminants in river, lake, ocean, and estuary bottoms, and the probability of associated adverse effects on human and environmental health. The EPA has prepared this report in response to requirements set forth in the Water Resources Development Act (WRDA) of 1992, which directed EPA, in consultation with the National Oceanic and Atmospheric Administration (NOAA) and the U.S. Army Corps of Engineers (USACE), to conduct a comprehensive national survey of data regarding the quality of aquatic sediments in the U.S. The Act required EPA to compile all existing information on the quantity, chemical and physical composition, and geographic location of pollutants in aquatic sediment, including the probable source of such pollutants and identification of those sediments which are contaminated. The Act further required EPA to report to the Congress the findings, conclusions, and recommendations of such survey, including recommendations for actions necessary to prevent contamination of aquatic sediments and to control sources of contamination. In addition, the Act required EPA to establish a comprehensive and continuing program to assess aquatic sediment quality. As part of this continuing program, EPA must submit a national sediment quality report to Congress every two years.

## **Role of Sediments in Watershed Health**

Sediment provides habitat for many aquatic organisms and functions as an important component of aquatic ecosystems. Sediment also serves as a major repository for persistent and toxic chemical pollutants released into the environment. In the aquatic environment, chemical waste products of anthropogenic origin that do not easily degrade can eventually accumulate in sediment. Sediment has been described as the ultimate sink for pollutants (Salomons et al., 1987).

Contaminated sediments can affect aquatic organisms in a number of ways. Areas with high sediment contaminant levels can be devoid of sensitive species and, in some cases, all species. For example, benthic amphipods were absent from contaminated waterways in Commencement Bay, WA (Swartz et al, 1982). In Rhode Island, the number of species of benthic molluscs was reduced near an outfall where raw electroplating wastes and other wastes containing high levels of toxic metals were discharged into Narragansett Bay (Eisler, 1995). In California, pollution-tolerant oligochaete worms dominate the sediment in the lower portion of Coyote Creek, which receives urban runoff from San Jose (Pitt, 1995).

Sediment contamination can also adversely affect the health of organisms and provide a source of contaminants to the aquatic food chain (Lyman et al., 1987). Fin rot and a variety of tumors have been found in fish living near sediments contaminated by polycyclic aromatic hydrocarbons (PAHs) (Van Veld et al., 1990). Liver tumors and skin lesions have occurred in brown bullheads in an area of the Black River in Ohio contaminated by PAHs from a coke plant (Baumann et al., 1987). Examples of risks to fish-eating birds and mammals posed by sediment contaminants include reproductive problems in Forster's terns on Lake Michigan (Kubiak et al., 1989) and in mink which were fed Great Lakes fish (Auerlich et al., 1973). Bioaccumulative toxic contaminants in sediment have also been linked to human health problems such as birth defects, cancer, neurological disorders, reduced IQ, heart disease, and kidney ailments. Most sediment-related human exposure to contaminants is through indirect routes that involve the transfer of pollutants up the food chain. Consumption of contaminated fish is a major human exposure pathway for sediment contaminants. Many surface waters in the U.S. have fish consumption advisories or fishing bans in place because of the high concentrations of PCBs, mercury, dioxin, kepone, and other contaminants found in sediment. In 1996, over 2,000 water bodies in the U.S. had fish consumption advisories in place. The observed effects of sediment

---

contaminants upon human health and the environment demonstrate that sediment cleanup is central to effective ecosystem management, and that impaired aquatic ecosystems cannot be restored without cleaning up toxic sediment.

## Sources of Sediment Contamination

Sediment contaminants enter aquatic ecosystems from many different sources. Municipal and industrial point source discharges are potential sources of sediment contaminants. Municipal point sources of sediment contaminants include sewage treatment plants and overflows from combined sewers. Industrial point sources include manufacturing plants and power-generating operations. Atmospheric deposition of contaminants such as mercury, polychlorinated biphenyls (PCBs) and pesticides can also contribute to sediment contamination. EPA estimates that 76 to 89% of PCB loadings to Lake Superior have come from air pollution (EPA, 1994). Urban stormwater and nonpoint source runoff from agricultural fields, landfills, toxic waste disposal sites, and inactive and abandoned mining sites can also contribute to sediment contamination.

## EPA's Report to Congress

Recognizing that sediment contamination poses significant human health and ecological risks, Congress directed EPA to develop a national inventory of contaminated sediment sites (WRDA, 1992). In response to the WRDA mandate, EPA developed the National Sediment Inventory (NSI), and conducted a screening level assessment identifying the most severely contaminated sites for additional study, source control and remediation. WRDA, 1992 defined contaminated sediment as, "sediment containing chemical substances in excess of appropriate geochemical, toxicological, or sediment quality criteria or measures; or otherwise considered to pose a threat to human health or the environment." The NSI is a compilation of existing sediment quality data; protocols used to evaluate the data; and various reports and analyses presenting the findings, conclusions, and recommendations for action. EPA has produced the first report to Congress in four volumes: Volume 1: National Sediment Quality Survey—screening analysis to estimate the probability of adverse human or ecological effects based on a weight of evidence evaluation; Volume 2: Data Summary for Areas of Probable Concern—sampling station location maps and chemical and biological summary data for watersheds where sediment contamination may be associated with adverse effects on human health or the environment; Volume 3: Sediment Contaminant Point Source Inventory—screening analysis to identify probable point source contributors of sediment pollutants; and Volume 4: Sediment Contaminant Nonpoint Source Inventory—screening analysis to identify probable nonpoint source contributors of sediment pollutants. (This volume is in preparation for subsequent biennial reports.)

## Description of the NSI Database

The NSI is the largest set of sediment chemistry and related biological data ever compiled by EPA. It includes approximately two million records for more than 21,000 monitoring stations across the U.S. To efficiently collect usable information for inclusion in the NSI, EPA sought data that were available in electronic format, represented broad geographic coverage, and represented specific sampling locations identified by latitude and longitude coordinates. The minimum requirements for inclusion of data sets in the NSI were locational information, sampling date, latitude and longitude coordinates, and measured units. The NSI includes data from the following storage systems and monitoring programs: Selected data from the EPA Storage and Retrieval System (STORET), the National Oceanic and Atmospheric Administration Coastal Sediment Inventory (COSED), EPA Ocean Data Evaluation System (ODES), EPA Region 4 Sediment Quality Inventory, the Gulf of Mexico Program Contaminated Sediment Inventory, EPA Region 10/U.S. Army Corps of Engineers Seattle District Sediment Inventory, EPA Region 9 Dredged Material Tracking System (DMATS), EPA Great Lakes Sediment Inventory, EPA's Environmental Monitoring and Assessment Program (EMAP), and the U.S. Geological Survey (Massachusetts Bay) Data. In addition to sediment chemistry data, the NSI includes fish tissue residue data, sediment toxicity bioassay data, benthic abundance data, histopathology data, and fish abundance data. The sediment chemistry, fish tissue residue, and toxicity data were evaluated to develop the NSI report to Congress. Data collected during the period from 1980 through 1993 were used in the NSI evaluation, but older data are also maintained in the database. Figure 1 illustrates the kinds of data evaluated to develop a screening level assessment of NSI sampling stations.

## Data Evaluation Approach

The approach used to evaluate the NSI data focuses on risks to benthic organisms exposed directly to contaminated sediments, and risks to human consumers of organisms exposed to sediment contaminants. EPA evaluated sediment chemistry data, chemical residue levels in edible tissue of aquatic organisms, and sediment toxicity data taken at the same sampling stations. The following measurement parameters and techniques were used to evaluate the probability of adverse effects. To evaluate potential impacts of sediment contaminants on aquatic organisms, three assessments were conducted. 1) Sediment chemistry measurements were compared to sediment chemistry screening values. These values included EPA proposed sediment quality criteria (SQC) (USEPA, 1992, 1993), EPA sediment quality advisory levels (SQAL) (EPA, 1992, 1993), sediment effects range-median (ERM) and effects range-low (ERL) values (Long et al., 1995), probable effects levels (PEL) and threshold effects levels (TEL) (Florida Department of Environmental Protection (FDEP, 1994), and apparent effects thresholds for selected organics and metals (Barrick et al., 1988). 2) The molar concentration of acid

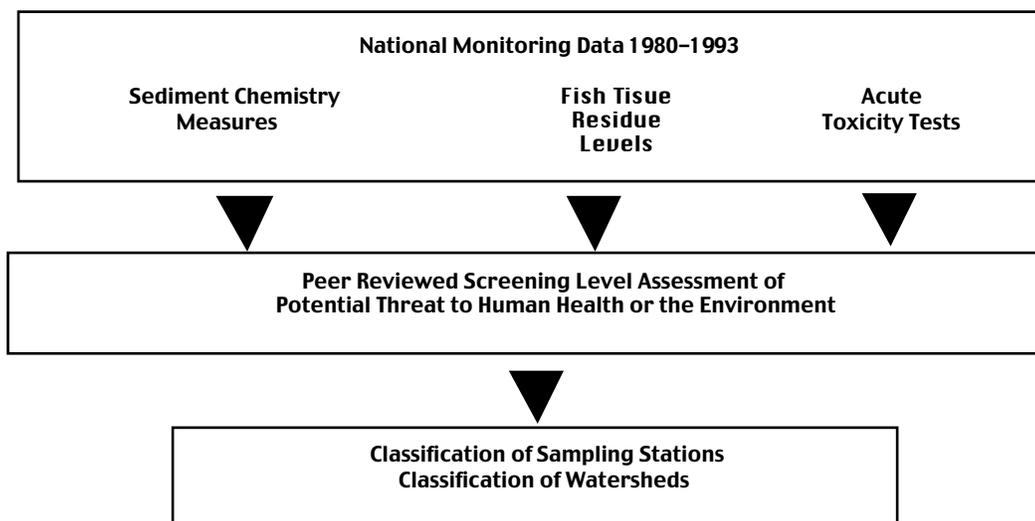

**Figure 1.** National sediment inventory data.

volatile sulfides ([AVS]) in sediment was compared to the molar concentration of simultaneously extracted metals ([SEM]) in sediment. 3) Available sediment toxicity test data were used to evaluate potential effects to aquatic life. To evaluate the potential effects of sediment contaminants on human health, two assessments were conducted. 1) The theoretical bioaccumulation potential (EPA, and U.S. Army Corps of Engineers, 1998) of measured sediment contaminants was compared to EPA cancer and noncancer risk levels (EPA, 1989, 1994) and Food and Drug Administration tolerance, action, or guidance values (Department of Health and Human Services, 1994; 40CFR 180.213a and 180.142). 2) Fish tissue contaminant levels were compared to EPA cancer and noncancer risk levels and FDA tolerance, action, or guidance values.

The sediment chemistry screening values used in this analysis were contaminant concentration reference values above which potential threats to aquatic life may occur. Independent analyses of matching chemistry and bioassay data reveal that sediments are frequently nontoxic when chemical concentrations are lower than ERL/ERMs and TEL/PELs. Sediments are frequently toxic when chemical concentrations exceed these values (Figure 2). The sediment chemistry screening values used in the NSI analysis include both theoretically and empirically derived values. The theoretically derived screening values (e.g., SQC, SQAL, [SEM]-[AVS]) rely on the physical/chemical properties of sediment and chemicals to predict the level of contamination that would not cause an adverse effect on aquatic life under equilibrium conditions. The empirically derived, or correlative screening values (e.g., ERM/ERL, PEL/TEL, AET) rely on paired field and laboratory data to relate incidence of observed biological effects to the dry-weight sediment concentration of a specific chemical. Correlative screening values can relate measured concentrations of contaminants to a probability of association with adverse

effects, but do not establish a cause and effect for a specific chemical. Sediment toxicity bioassays were also used in the NSI analysis to evaluate sediment sampling stations.

Theoretical bioaccumulation potential (TBP) and tissue residue data may be indicative of exposure to contaminated sediments, and were used in the NSI analysis to evaluate the potential human health effects of sediment contaminants. TBP is an estimate of contaminant concentration at equilibrium in tissue derived from the sediment concentration of that contaminant. This calculation is based on median biota sediment accumulation factors (BSAFs) for various classes of chemicals. EPA fish tissue risk levels to which TBP and fish tissue residue measurements were compared represent tissue concentrations of contaminants that should protect consumers from adverse health effects over a lifetime of exposure.

## Incidence of Sediment Contamination

Sediment sampling stations in the NSI were classified according to probability of adverse effects. Tier 1 stations are those with sediment contamination associated with a higher probability of adverse effects. Tier 2 stations are those associated with a lower to intermediate probability of adverse effects, and Tier 3 stations are those with no indication of adverse effects. Figure 3 presents the methodology used to classify sampling stations in these three tiers. Upper thresholds in Figure 3 include SQCs, ERMs, PELs, and AET (high values). Lower thresholds include ERLs, TELs, AET (low values), and SQALs. Human health risk levels include FDA action levels and EPA risk levels. The distribution of more than 21,000 sampling stations into these tiers is illustrated in Figure 4. Of the sampling stations evaluated, 5,521 (26%) were classified as Tier 1, 10,401

Chemical Concentrations	Amphipod Survival Tests			More Sensitive Bioassays		
	% not toxic	% signif. toxic	% highly toxic	% not toxic	% signif. toxic	% highly toxic
All <ERLs	64	23	12	67	5	28
>1 or more ERL	59	22	19	20	15	64
>1 or more ERM	45	13	42	13	7	80
All <TELS	61	29	10	90	5	5
>1 or more TEL	62	21	17	22	19	59
>1 or more PEL	49	13	38	14	8	78

**Figure 2.** Predicting toxicity with correlative aquatic life screening values. (Long et al., in press)

(49%) were classified as Tier 2, and 5,174 (25%) were in Tier 3.

Stations were located in 6,744 individual river reaches (or water body segments) across the contiguous U.S., or approximately 11% of all river reaches in the country (based on EPA's River Reach File 1). A river reach can be part of a coastal shoreline, a lake, or a length of stream between two major tributaries ranging from approximately 1 to 10 miles long. Most of the NSI data were obtained from monitoring programs targeted at areas of known or suspected contamination. Analysis of the NSI data indicates that 3.8% of all river reaches in the contiguous U.S. have at least one station identified as Tier 1, while 4.5% of reaches have at least one station identified as Tier 2 (but none as Tier 1), and all of the sampling stations were identified as Tier 3 in 2.4% of reaches. Studies conducted by EPA as part of the Environmental Monitoring and Assessment (EMAP) Program suggest that approximately 10% (by area) of the near coastal water sediments in the Virginian and Louisiana Provinces are sufficiently contaminated to cause acute toxicity to amphipods (Richard Swartz, Personal Communication, December 27, 1996). Analysis of the NSI data indicates that the areal extent of sediment

associated with acute toxicity to amphipods is likely to range from 6-12% nationally.

Data related to more than 230 different chemicals or chemical groups were included in the NSI evaluation. Approximately 40% of the chemicals or chemical groups were found to occur at levels resulting in classification of sampling stations as Tier 1 or Tier 2. Figure 5 displays the sediment contaminants most frequently associated with potential adverse effects. The contaminants most frequently occurring at levels in fish or sediment associated with a higher probability of adverse effects were PCBs and mercury. Pesticides, most notably DDT and metabolites and polynuclear aromatic hydrocarbons (PAHs) were also frequently associated with a higher probability of adverse effects

### Areas of Probable Concern

Areas of probable concern for sediment contamination (APCs) were identified in the evaluation of NSI data. APCs are watersheds that include at least ten Tier 1 sampling stations and in which at least 75% of all sampling stations were classified as either Tier 1 or Tier 2. The NSI data evaluation identified 96 watersheds

	Sediment Chemistry Aquatic Life	Sediment Chemistry Human Health	Tissue Residue Human Health	Toxicity Tests Aquatic Life
Tier 1	Exceeds 2 upper thresholds* (or SQC) [SEM]-[AVS]>5	TBP exceeds risk levels	Exceeds risk levels	2 or more tests (different species) demonstrate significant mortality
Tier 2	Exceeds 1 lower threshold [SEM]-[AVS]>0	TBP exceeds risk levels	TBP exceeds risk levels	At least 1 test demonstrates significant mortality
Tier 3	None of above conditions met			

\* Except for AVS metals (Cu, Cd, Pb, Ni, Zn)

\*\* Except for PCBs and Dioxins (tissue residue data alone can place site in Tier 1)

**Figure 3.** Sample station classification methodology.

- Tier 1: Sampling stations with sediment contamination associated with a higher *probability* of adverse effects
- Tier 2: Sampling stations with sediment contamination associated with a lower to intermediate *probability* of adverse effects
- Tier 3: No indication of adverse effects (data may be very limited or quite extensive)

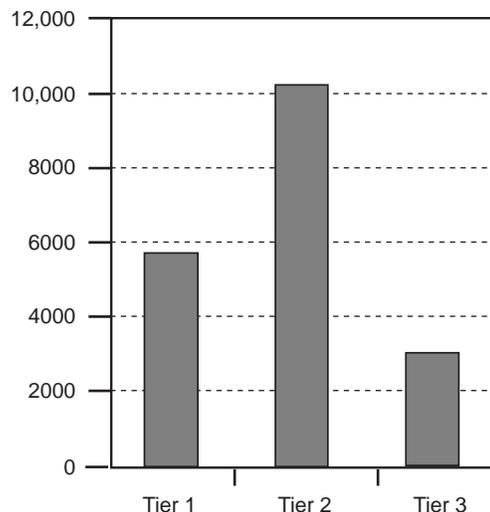

**Figure 4.** Classification of NSI sampling stations.

throughout the U.S. as APCs (Figure 6). An APC designation could result from extensive sampling throughout a watershed, or from intensive sampling at a single contaminated location or a few contaminated locations. A list of these watersheds, identified by U.S. Geological Survey cataloging unit and name, is available in EPA's NSI database. EPA has completed an analysis to identify, within each of the 96 APC watersheds, the average percent of stations that are contaminated by various classes of chemicals. This analysis indicates that at the Tier 1 level of contamination, PCBs are the dominant chemical class. At the combined Tier 1 and Tier 2 level of contamination, metals are the dominant chemical class of contaminant, followed by PCBs and pesticides, mercury, PAHs, and other organics. The relative importance of these classes of chemicals reflects both the occurrence of those contaminants in APCs as well as the evaluation methodology used for the analysis.

**Percent of stations indicating a probability of adverse effects**

	Tier 1 (%)	Tier 1 and 2 (%)
PCBs	58	34
Mercury	20	27
Pesticides	1-15	14-21
PAHs	3-8	7-13
Metals	0-5	7-45
Number of Stations	5,521	15,922

**Figure 5.** Chemical indicators of probable effects.

## Conclusions

Evaluation of the NSI data strongly suggests that sediment contamination may be significant enough to pose risks to aquatic life and human health at some locations in the U.S., particularly within the Areas of Probable Concern. EPA's evaluation of the NSI data was the most geographically extensive investigation of sediment contamination ever performed in the U.S. The evaluation was based on procedures to address the probability of adverse effects to aquatic life and human health. Based on the evaluation, sediment contamination exists at levels indicating a probability of adverse effects in all regions and states within the U.S. The water bodies affected include streams, lakes, harbors, nearshore areas, and oceans. At the most severely contaminated sites identified in the NSI, PCBs, mercury, organochlorine pesticides, and PAHs are the most frequent chemical indicators of sediment contamination. The NSI evaluation methodology was designed to provide a screening-level assessment of sediment quality. Therefore, further evaluation may be required to confirm that sediment contamination poses risks to aquatic life or human health for any given sampling station or watershed. Although Areas of Probable Concern were selected by means of a screening exercise, they represent the highest priority areas for further ecotoxicological assessments, risk analyses, temporal and spatial trend assessment, contaminant source evaluation, and management action.

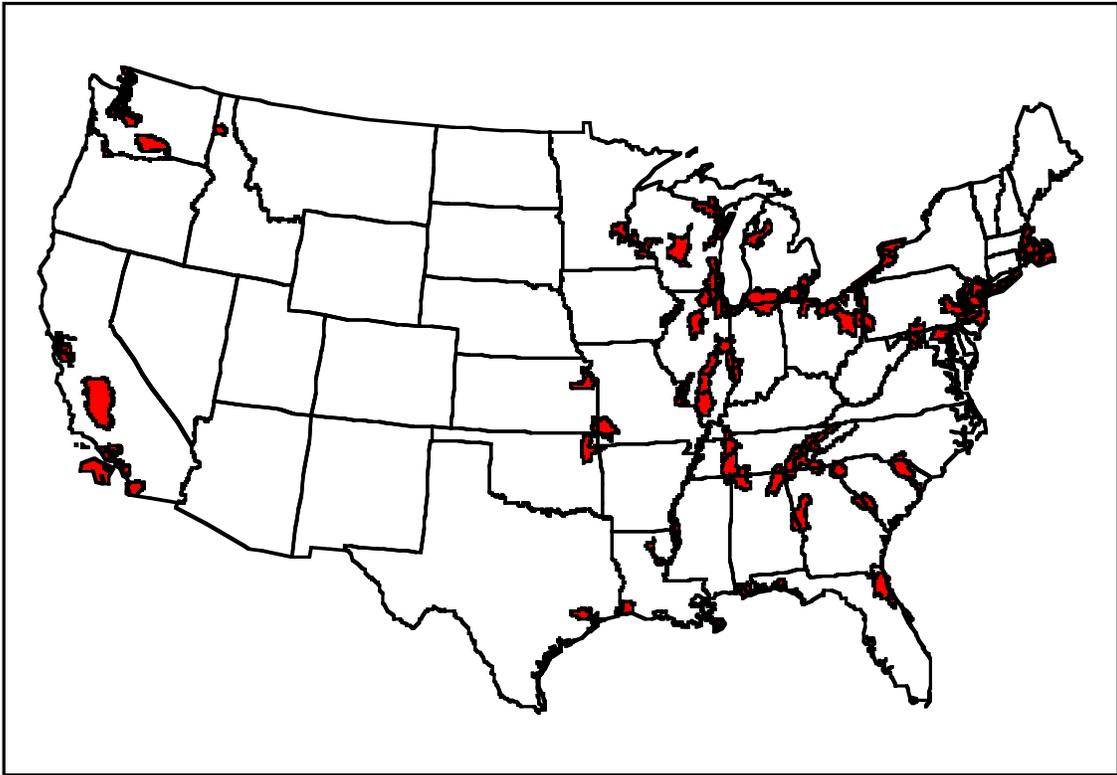

**Figure 6.** Areas (watersheds) of probable concern for sediment contamination.

---

## References

1. Aurlich, R. J., R.K. Ringer, and S. Iwamoto. 1973. Reproductive failure and mortality in mink fed on Great Lakes fish. *Journal of Reproductive Fertility Suppl.* 19:365.
2. Barrick, R., S. Becker, L. Brown, H. Heller, and R. Pastorok. 1988. *Sediment Quality Impairment: 1988 Update and Evaluation of Puget Sound AET*. Volume 1. Prepared for the Puget Sound Estuary Program, Office of Puget Sound.
3. Baumann, P.C., W D, Smith, and W.K. Parland. 1987. Tumor frequencies and contaminant concentrations in brown bullheads from an industrialized river and a recreational lake. *Transactions of the American Fisheries Society* 18:706-727.
4. Eisler, R. 1995. Electroplating wastes in marine environments. A case history of Quonset Point, Rhode Island. In: *Handbook of ecotoxicology*, ed. D.J. Hoffmann, B.A. Rattner, G.A. Burton, Jr., and J. Cairns, Jr., pp 609-630. Lewis Publishers, Boca Raton, Florida.
5. Florida Department of Environmental Protection. 1994. Approach to the assessment of sediment quality in Florida coastal waters, Vol 1. *Development and evaluation of sediment quality assessment guidelines*. Prepared for Florida Department of Environmental Protection, Office of Water Policy, Tallahassee, Florida, by MacDonald Environmental Sciences, Ltd., Ladysmith, British Columbia.
6. Kubiak, T.J., H.L. Harris, L.M. Smith, T.R. Schwartz, D.L. Stalling, J.A. Trick, L. Sileo, D.E. Docherty, and T.C. Erdman. 1989. Microcontaminants and reproductive impairment of Forster's tern on Green Bay, Lake Michigan, 1983. *Archives of Environmental Contamination and Toxicology* 18:706-727.
7. Long, E.R., D.D. MacDonald, S.L. Smith, and F.D. Calder. 1995. Incidence of adverse biological effects within ranges of chemical concentrations in marine and estuarine sediments. *Environmental Management* 19(1):81-97.
8. Long, E.R., L.J. Field, and D.D. MacDonald. Predicting toxicity in marine sediments with numerical sediment guidelines. Submitted to *Env. Toxicol. Chem.*
9. Lyman, W.J., A.E. Glazer, J.H. Ong, and S.F. Coons. 1987. *An Overview of Sediment Quality in the United States*. Prepared for U.S. Environmental Protection Agency, Office of Water Regulations and Standards, Washington, D.C.
10. Pitt, R.E. 1995. Effects of urban runoff on aquatic biota. In: *Handbook of Ecotoxicology*, ed. D.J. Hoffmann, B.A. Rattner, G.A. Burton, Jr., and J. Cairns, Jr., pp 609-630. Lewis Publishers, Boca Raton, Florida.
11. Salomons, W., N.M. De Rooji, H. Kerdijk, and J. Bril. 1987. Sediment as a source for contaminants? *Hydrobiologia* 149:13-30.
12. Swartz, R.C. , W.A. Deben, K.A. Sercu, and J.O. Lamberson. 1982. Sediment toxicity and distribution of amphipods in Commencement Bay, Washington, U.S.A. *Marine Pollution Bulletin* 13:359-364.
13. Van Veld, P.A., D.J. Westbrook, B.R. Woodin, R.C. Hale, C.L. Smith, R.J. Huggett, and J.J. Stegman. 1990. Induced cytochrome P-450 in intestine and liver of spot (*Leiostomus xanthurus*) from a polycyclic aromatic contaminated environment. *Aquatic toxicology* 17:119-132.
14. U.S. EPA. 1989. *Risk Assessment Guidance for Superfund. Volume 1. Human Health Evaluation Manual*. Interim final OSWER Directive 9285.7-01a. U.S. Environmental Protection Agency, Office of Solid Waste and Emergency Response, Washington, D.C. December, 1989.
15. U.S. EPA. 1992. *Sediment Classification Methods Compendium*. EPA 823-R-92-006. U.S. Environmental Protection Agency, Office of Water, Washington, D.C.
16. U.S. EPA. 1993. *Technical Basis for Establishing Sediment Quality Criteria for Nonionic Organic Contaminants for the Protection of Benthic Organisms by Using Equilibrium Partitioning*. Draft. EPA 822-R-93-011. U.S. Environmental Protection Agency, Office of Science and Technology, Health and Ecological Criteria Division, Washington, D.C.
17. U.S. EPA. 1994. *Guidance for Assessing Chemical Contamination Data for Use in Fish Advisories, Volume II : Development of risk-based intake limits*. U.S. Environmental Protection Agency, Office of Science and Technology, Washington, D.C.
18. U.S. EPA and U.S. Army Corps of Engineers. 1998. *Evaluation of Dredged Material Proposed for Discharge in Waters of the U.S. -- Testing manual* EPA-823-B-98-004. U.S. Environmental Protection Agency, Office of Water and U.S. Army Corps of Engineers, Washington, D.C.
19. U.S. EPA. 1997(a) *The Incidence and Severity of Sediment Contamination in Surface Waters of the United States. Volume 1: National Sediment Quality Survey*. EPA-823-R-97-006. U.S. EPA Office of Science and Technology, Washington D.C.
20. U.S. EPA. 1997(b) *The Incidence and Severity of Sediment Contamination in Surface Waters of the*

---

*United States. Volume 2: Data Summaries for Areas of Probable Concern.* EPA-823-R-97-007. U.S. EPA Office of Science and Technology, Washington D.C.

21. U.S. EPA. 1997(c) *The Incidence and Severity of Sediment Contamination in Surface Waters of the United States. Volume 3: National Sediment Contaminant Point Source Inventory.* EPA-823-R-97-008. U.S. EPA Office of Science and Technology, Washington D.C.

---

# EPA Role in Managing Contaminated Sediment

Thomas M. Armitage and Jane Marshall Farris  
Office of Science and Technology  
U.S. Environmental Protection Agency  
Washington, D.C.

More than ten federal statutes provide authority to many EPA program offices to address the problem of contaminated sediment. These statutes provide authority for activities such as regulating the use of pesticides and toxic substances that may accumulate in sediment, remediating in-place sediment contamination, controlling the industrial and municipal discharge of sediment contaminants to water and air, and regulating the disposal of dredged material. Authority for these activities is provided to EPA under such statutes as: the National Environmental Policy Act (NEPA), the Clean Air Act (CAA), the Coastal Zone Management Act, the Federal Insecticide, Fungicide, and Rodenticide Act (FIFRA), the Marine Protection Research and Sanctuaries Act (MPRSA), the Resource Conservation and Recovery Act (RCRA), the Toxic Substances Control Act (TSCA), the Clean Water Act (CWA), and the Comprehensive Emergency Response, Compensation, and Liability Act (CERCLA). A complete summary of EPA authorities for addressing sediment contamination is provided in *Contaminated Sediments - Relevant Statutes and EPA Program Activities* (U.S. EPA, 1990).

EPA program offices implement contaminated sediment management activities or coordinate implementation where EPA has established geographically focused programs, such as the Chesapeake Bay, the Great Lakes, and the Gulf of Mexico. EPA program offices with sediment management responsibilities include: the Office of Water, the Office of Pollution Prevention and Toxics, the Office of Pesticide Programs, the Office of Emergency and Remedial Response, and the Office of Solid Waste. EPA's Office of Research and Development conducts research to support sediment management activities conducted by the program offices.

## Contaminated Sediment Management Goals

EPA's Contaminated Sediment Management Strategy (EPA, 1998) describes actions the Agency intends to take to accomplish four strategic sediment manage-

ment goals: 1) prevent further sediment contamination that may cause unacceptable ecological or human health risks; 2) reduce the volume of contaminated sediment that adversely affects the Nation's water bodies or their uses, or that causes other significant effects on human health or the environment; 3) ensure that sediment dredging and dredged material disposal are managed in an environmentally sound manner; 4) develop and consistently apply methodologies for analyzing contaminated sediments.

## Elements of Contaminated Sediment Management

EPA can accomplish the Agency's strategic goals for management of contaminated sediment by taking action in the areas of contaminated sediment assessment, prevention, remediation of dredged material, research, and outreach. This paper summarizes EPA's role in each of these areas.

## Assessment

Many different methods have been developed to assess contaminated sediment. EPA is working to develop improved assessment methods, standardize the assessment methods, and ensure that all Agency program offices use standard methods to determine whether sediments are contaminated. The Agency has also developed chemical-specific sediment quality criteria for the assessment of contaminated sediment. EPA has developed standard acute sediment toxicity test methods, and the Agency is currently developing standard chronic sediment toxicity test methods. In addition, EPA has developed a national inventory of sites and sources of sediment contamination. A screening level assessment of data in this inventory has been completed, and the Agency has published the *National Sediment Quality Survey, a Report to Congress on the Incidence and Severity of Sediment Contamination in Surface Waters of the United States*, (EPA, 1997 [a] [b] [c]). EPA can use the National Sediment Inventory data to help iden-

---

tify sites associated with adverse effects to human health and the environment. Through the use of consistent sediment assessment methods and the National Sediment Inventory, EPA can focus on cleaning up the most contaminated water bodies and ensuring that further sediment contamination is prevented. The EPA Office of Water can use standard sediment toxicity and bioaccumulation test methods for monitoring and interpretation of narrative water quality standards. The EPA Office of Pesticide Programs pesticides can use standard sediment toxicity tests when registering or reregistering pesticides. The EPA Office of Pollution Prevention and Toxics can use standard sediment toxicity tests to assess the toxicity of industrial use chemicals. The EPA Office of Emergency and Remedial Response can use standard sediment toxicity and bioaccumulation test methods to evaluate contaminated sediment sites by incorporating these methods into remedial investigation and feasibility studies, and the EPA Office of Solid Waste can use biological sediment toxicity test methods for assessing and monitoring contaminated sediment at hazardous waste facilities. Sediment quality criteria, when final, can be used by all EPA program offices conducting sediment monitoring to interpret sediment chemistry data.

### ***Prevention***

EPA's role in prevention of contaminated sediments involves the use of authority provided under the Clean Water Act, the Federal Insecticide Fungicide, and Rodenticide Act, and the Toxic Substances Control Act to control the discharge of toxic sediment contaminants to surface waters, and to regulate the use of pesticides and industrial use chemicals. In order to regulate the use of pesticides that may accumulate to toxic levels in sediment, EPA can include sediment toxicity assessment in the review processes required to support registration, reregistration, and special review of pesticides likely to sorb to sediment. In addition, EPA can require sediment toxicity assessment to support industrial uses of new chemicals, and EPA can develop guidelines for the design of new chemicals to reduce the bioavailability and partitioning of toxic chemicals to sediment.

EPA's Office of Enforcement and Compliance Assurance can take action to prevent sediment contamination by negotiating, in appropriate cases of noncompliance with permits, enforceable agreements to require sediment contaminant source recycling and source reduction activities. The Agency can also monitor the progress of federal facilities toward emissions reduction goals.

EPA's Office of Water and other EPA program offices can work with nongovernmental organizations and the states to prevent point and nonpoint sources of contaminants from accumulating in sediments. EPA can take the following actions to regulate point and nonpoint sources of sediment contaminants: 1) promulgation of new and revised technology based effluent guidelines for industries that discharge sediment contaminants; 2) encouragement of states to use biological sediment test

methods and sediment quality criteria to interpret narrative water quality standards of "no toxics in toxic amounts"; 3) encouragement of states to develop Total Maximum Daily Loads for impaired watersheds specifying point and nonpoint source load reductions necessary to protect sediment quality; 4) use of discharge data to identify point sources of sediment contaminants for potential permit compliance tracking after evaluation using program-specific criteria; 5) ensuring that discharges from CERCLA and RCRA facilities subject to NPDES permits comply with future NPDES permit requirements to protect sediment quality; and 6) use of National Sediment Inventory data to identify watersheds where technical assistance and grants could effectively be used to reduce nonpoint source loads of sediment contaminants.

### ***Remediation***

EPA has an important role in remediation of contaminated sediment. Under a number of statutes, EPA can take action directed at remediation of contaminated sediment. Where sediments are contaminated to levels that cause ecological harm or pose a risk to human health, EPA may implement a range of remediation strategies to effectively reduce the risk. In certain circumstances, the best strategy may be to implement pollution prevention measures as well as point and nonpoint source controls, to allow natural recovery processes such as biodegradation, chemical degradation, and the deposition of clean sediments to diminish the risks associated with the sites. In other cases, active remediation is necessary. Statutory authority enables EPA to 1) compel responsible parties to clean up the sites they have contaminated, 2) recover costs from responsible parties for EPA-performed cleanups, and 3) coordinate with natural resource trustees to seek restitution from responsible parties. EPA's Office of Water, Office of Emergency and Remedial Response, Office of Solid Waste, and Office of Enforcement and Compliance Assurance can use National Sediment Inventory data, and other high quality data, to help target sites for further study that may lead to enforcement action requiring contaminated sediment remediation.

### ***Dredged Material Management***

EPA and the Corps of Engineers are responsible for the dredged material discharge permitting process under the Marine Protection Research and Sanctuaries Act and the Clean Water Act. The program is responsible for implementing cost-effective, environmentally sound options for disposal and management of contaminated dredged material.

### ***Contaminated Sediment Research***

EPA's Office of Research and Development, working with the Agency's other program offices, conducts contaminated sediment research. Research is conducted to understand the extent and severity of sediment contamination, develop methods and data to assess human health and ecological effects of sediment contaminants,

---

develop and validate chemical-specific sediment quality criteria, and to develop and evaluate sediment cleanup methods.

### ***Contaminated Sediment Planning and Outreach Processes***

Outreach is also a critical component of EPA's role in contaminated sediment management. Public understanding of the ecological and human health risks associated with sediment contamination, and of solutions to the problem, is key to successfully managing contaminated sediment. EPA's role in outreach is to educate key audiences about the risks, extent, and severity of contaminated sediment. EPA can engage stakeholders by: 1) defining sediment management themes or messages, 2) identifying target audiences and needs, 3) developing appropriate outreach materials, and 4) providing channels to facilitate two-way communication on sediment management issues. EPA can communicate four contaminated sediment themes to target audiences. The first theme is that sediment contamination comes from many sources, which must be identified, and that source control options must be evaluated according to risk reduction potential and effectiveness. The second theme is that sediment contamination poses threats to human health and the environment. The risks must be identified and effectively communicated to the public. The third theme is that sediment contamination can be effectively managed through assessment, prevention, and remediation. The fourth theme is that EPA's strategy for managing contaminated sediment will depend upon inter-agency coordination and on building alliances with other agencies, industry, and the public.

### **References**

1. U.S. Environmental Protection Agency. 1990. *Contaminated Sediments, Relevant Statutes and EPA Program Activities*. EPA-506-6-90-003. U.S. Environmental Protection Agency, Washington, D.C.
2. U.S. Environmental Protection Agency. 1998. *EPA's Contaminated Sediment Management Strategy*. EPA-823-F-98-001. U.S. Environmental Protection Agency, Washington D.C.
3. U.S. Environmental Protection Agency. 1997(a). *The Incidence and Severity of Sediment Contamination in Surface Waters of the United States. Volume 1: National Sediment Quality Survey*. EPA-823-R-97-006. U.S. EPA Office of Science and Technology, Washington D.C.
4. *U.S. Environmental Protection Agency. 1997(b). The Incidence and Severity of Sediment Contamination in Surface Waters of the United States. Volume 2: Data Summaries for Areas of Probable Concern. EPA-823-R-97-007. U.S. EPA Office of Science and Technology, Washington D.C.*
5. U.S. Environmental Protection Agency. 1997(c). *The Incidence and Severity of Sediment Contamination in Surface Waters of the United States. Volume 3: National Sediment Contaminant Point Source Inventory*. EPA-823-R-97-008. U.S. EPA Office of Science and Technology, Washington D.C.

---

# Strategies and Technologies For Cleaning Up Contaminated Sediments in the Nation's Waterways: A Study by the National Research Council

Spyros P. Pavlou

Member, NRC Marine Board Committee on Contaminated Marine Sediments, 1993-1996  
Technical Director of Environmental Risk Economics, URS Greiner Inc., Seattle, WA

Louis J. Thibodeaux

Member, NRC Marine Board Committee on Contaminated Marine Sediments, 1993-1996  
Emeritus Director, Hazardous Substance Research Center (South/Southeast), USEPA and Jesse Coates Professor of Chemical Engineering, Louisiana State University, Baton Rouge, LA

## Introduction

This presentation is an overview of a study performed by the National Research Council (NRC) Marine Board Committee on Contaminated Marine Sediments. The fifteen-member committee included national experts from academia, industry, and the professional services sector. The committee was established in the spring of 1993 and completed its work in the summer of 1996. The committee's deliberations were published in a report released by the NRC in March 1997.

The committee's activities were sponsored through the NRC by the US Environmental Protection Agency (USEPA), the US Army Corps of Engineers (USACE), the US Navy, the National Marine Fisheries Service of the US Department of Commerce, the Maritime Administration of the US Department of Transportation, and the US Geological Survey. The names and affiliations of the committee members, government liaison representatives, and NRC staff are listed in Table 1.

## The Challenge

Contaminated marine sediments pose a threat to ecosystems, marine resources, and human health. Sediment contamination also interferes with shipping activities and growth of trade resulting from delays in dredging and/or the inability to dredge the nation's harbors due to controversies over risks and costs of sediment management. Given that approximately 95% of total U.S. trade passes through dredged ports, potential economic impacts due to sediment contamination may be severe.

The management of contaminated sediments is a complex and difficult process. The factors that contribute to the complexity are multiple and, in combination, exacerbate the problem. In summary, these are:

- High public expectations for protecting human health and the environment
- Multiple stakeholder interests and priorities
- Conflicting and overlapping jurisdictions of federal, state, and local regulatory authorities
- Relatively low levels of contamination
- Large quantities of affected sediments
- Uncertainty in quantifying and managing risk
- Limitations of handling and treatment technologies

All of the above factors may result in non-cost-effective management actions with controversial outcomes and marginal benefits.

## Conceptual Framework for Contaminated Sediment Management

The committee recognized the challenges associated with contaminated sediment management and developed a risk-based framework for making management decisions and for selecting remediation technologies. This framework, presented in Figure 1, provides the

---

**Table 1.** Committee on Contaminated Marine Sediments

---

HENRY BOKUNIEWICZ, co-chair, State University of New York at Stony Brook  
KENNETH S. KAMLET, co-chair, Linowes and Blocher  
W. FRANK BOHLEN, University of Connecticut, Avery Point  
J. FREDERICK GRASSLE, Rutgers University  
DONALD F. HAYES, University of Nebraska  
JAMES R. HUNT, University of California at Berkeley  
DWAYNE G. LEE, Ralph M. Parsons Company  
KENNETH E. MCCONNELL, University of Maryland  
SPYROS P. PAVLOU, URS Greiner, Inc  
RICHARD PEDDICORD, EA Engineering, Science, and Technology  
PETER SHELLEY, Conservation Law Foundation, Inc.  
RICHARD SOBEL, Clean Sites, Inc.  
LOUIS J. THIBODEAUX, Louisiana State University  
JAMES G. WENZEL, NAE, Marine Development Associates, Inc.  
LILY Y. YOUNG, Rutgers University

**Government Liaison Representatives**

SABINE APITZ, U.S. Navy  
CHARLES C. CALHOUN, U.S. Army Waterways Experiment Station  
MILES CROOK National Marine Fisheries Service  
ROBERT ENGLER, U.S. Army Waterways Experiment Station  
KENNETH HOOD, U.S. Environmental Protection Agency  
EVIE KALKETENIDOU, Maritime Administration  
DANIEL LEUBECKER, Maritime Administration  
FRANK MANHEIM, U.S. Geological Survey  
JANET MORTON, U.S. Geological Survey  
ANNA PALMISANO, U.S. Navy  
CARL SOBREMISANA, Maritime Administration  
MARK SPRENGER, U.S. Environmental Protection Agency  
CRAIG VOGT, U.S. Environmental Protection Agency  
LARRY ZARAGOZA, U.S. Environmental Protection Agency

**Staff**

JOSEPH L. ZELIBOR, Project Officer  
LAURA OST, Editor

---

# Conceptual Overview of Contaminated Sediment Management

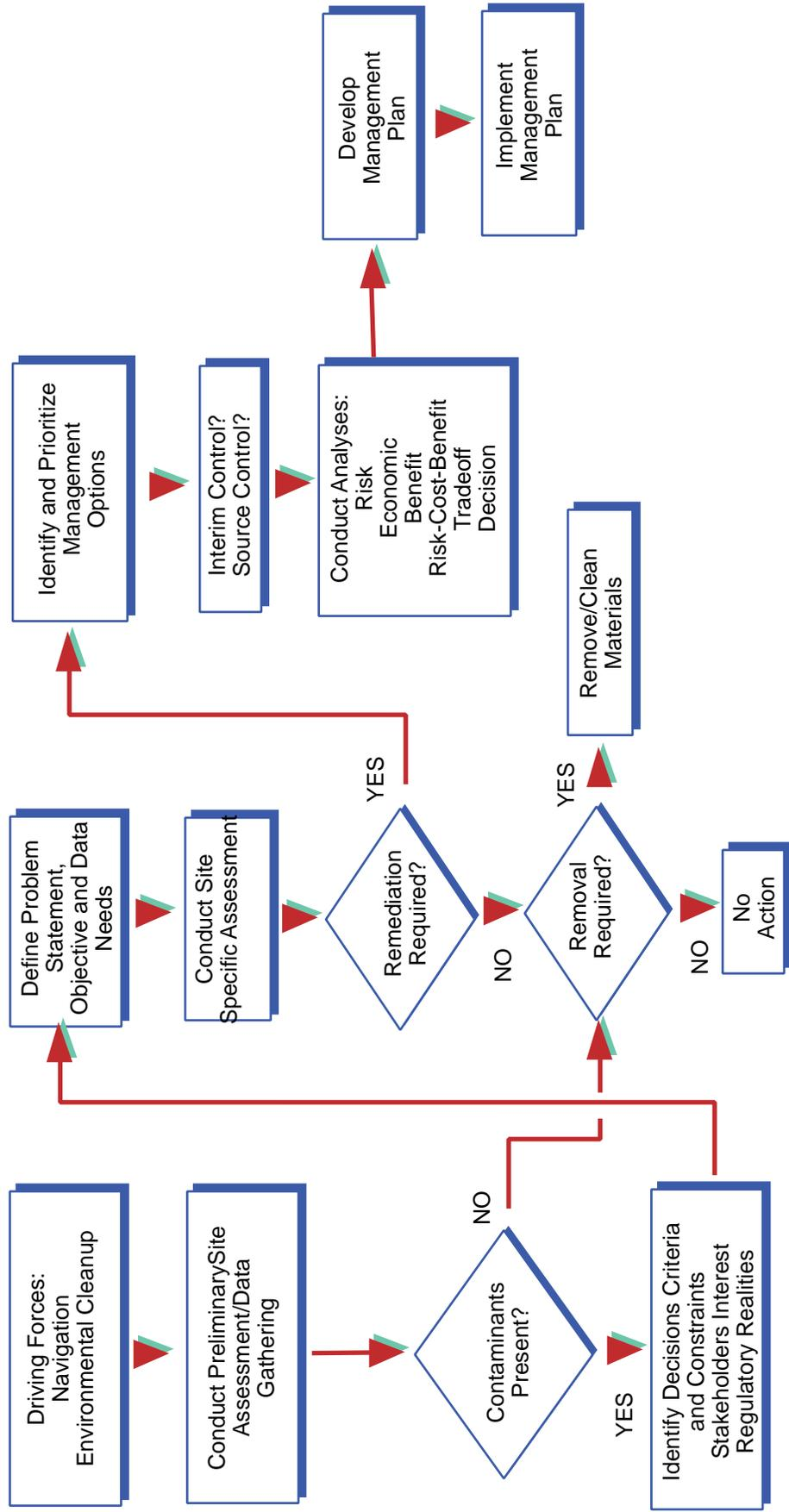

Figure 1. Conceptual overview of contaminated sediment management.

---

basis for a systematic and consistent approach to contaminated sediment management, including dredging and disposal.

It must be emphasized here that the approach appears similar to existing decision-making frameworks developed by USEPA and USACE. One of these decision-making frameworks was developed by USEPA for evaluating alternatives for remediation in Superfund projects. The other was developed jointly by USEPA and USACE for evaluating alternatives for the disposal of dredged material associated with navigation projects. While the committee recognized the utility of these formal decision-making approaches, this schematic representation (Figure 1) has a different purpose. It was developed as a generic overview of the contaminated sediment management process to assist the committee members in addressing the various decision components in a logical sequence of evaluations.

## Scope of the Study and Approach

The committee's charge was to: (1) assess best management practices and emerging technologies for reducing adverse environmental impacts; (2) appraise interim control measures for use at contaminated sediment sites; (3) address how information about risks, costs, and benefits can be used and communicated to guide decision making and; (4) assess existing knowledge and identify research needs for enhancing contaminated sediment remediation technology.

Technical information was reviewed and assessed. Committee members interacted closely with researchers, regulators, stakeholders, engineers and operators. Six case studies of contaminated sediment remediation were evaluated and one sediment remediation project site was visited. In addition, the committee conducted workshops on interim controls and long-term technologies, summarized site assessment methods, and evaluated the application of decision tools to the contaminated sediment management process.

The results obtained from the above tasks were then assembled and organized under three major categories: decision making, remediation technologies, and project implementation. Opportunities for improvement were identified in all categories. The discussion that follows summarizes the committee's conclusions and recommendations.

## Conclusions and Recommendations

### *Improving Decision Making*

Factors influencing decision making include regulatory realities, stakeholder interests, site-specific characteristics and data uncertainty, and availability of remediation technologies. The committee examined all of the above factors in making the following conclusions and recommendations:

- Stakeholder involvement early in the decision process is important in heading off disagreements and building consensus among all parties involved. In situations where decisions are complex and divisive, obtaining consensus among stakeholders can be facilitated by using formal analytical tools, e.g., decision analysis.
- The trade-off evaluation of risks, costs and benefits and the characterization of their associated uncertainties in selecting a preferred management alternative offer the best chance for effective management and communication of the decision-making process to stakeholders.
- Risk analysis is an effective method for selecting and evaluating management alternatives and remediation technologies. More extensive use of appropriate methods for cost-benefit analysis has the potential to improve decision making.
- The USEPA and USACE should sponsor research to quantify the relationship between contaminant availability and corresponding human health and ecological risks. The main goal is to evaluate projects using performance-based standards, i.e., risk reduction from in-place sediments, disturbed sediments and sediments under a variety of containment, disposal and treatment scenarios. This information is critical to the successful trade-off evaluations of risks, costs, and benefits to make technically defensible decisions in selecting a preferred management alternative.
- The use of systems engineering can strengthen project cost effectiveness and acceptability. In choosing a remediation technology, systems engineering can help ensure that the solution meets all removal, containment, transport, and placement requirements while satisfying environmental, social and legal demands.
- Federal, state, and local agencies should work together with appropriate private sector stakeholders to interpret statutes, policies, and regulations in a constructive manner so that negotiations can move forward and sound solutions are not blocked or obstructed.
- The USEPA and USACE should continue to develop uniform or parallel procedures to address human health and environmental risks associated with freshwater, marine, and land-based disposal, containment, or beneficial reuse of contaminated sediments.
- The USEPA and USACE should develop and disseminate information to stakeholders regarding: the availability and applicability of decision analytical tools; appropriate risk analysis techniques to be used throughout the management process, including the selection and evaluation of

---

remedial alternatives; and the demonstration and appropriate use of decision analysis in an actual contaminated sediment remediation case.

- The USACE should modify their cost-benefit analysis guidelines and practices to ensure comprehensiveness and uniformity in method application.

### **Improving Remediation Technologies**

Technologies were identified and grouped into four categories: interim control, *in-situ* management, sediment removal and transportation, and *ex-situ* management. Technologies were compared qualitatively in terms of state of maturity, frequency of usage, scale of application, cost per cubic yard, and use limitations. The technologies were then scored according to four criteria: effectiveness, feasibility, practicality, and cost. Based on the latter information, technologies were ranked according to preference factors. Other topics addressed included technology cost issues across all categories and the need for remediation technology research, development, testing, and demonstration.

### **Technology Costs**

- Capping, containment and natural recovery are effective management methods for most contaminated sediments. Where remediation is necessary, high-volume low-cost technologies are the first choice, assuming they are feasible and succeed in attaining the required risk reduction for protecting human health and the environment. Because treatment is expensive, reducing volume is important.
- Treatment is usually justified only for relatively small volumes of highly contaminated sediments. Advanced treatment is too costly in the majority of cases, which typically involve low-level contamination.
- Cost data for full-scale remediation systems must be improved to allow for fair overall comparisons and development of benchmarks for R&D and systems design. The USEPA and USACE should develop guidelines for calculating costs of remediation systems, including technologies and management methods. The agencies should maintain a database on the costs of systems that have actually been used.

### **In-situ Controls**

- Natural recovery is viable and can be considered as an optimum remediation solution when contaminant concentrations are low. If natural recovery is not feasible, capping may be appropriate to reduce bioavailability. Monitoring is required to test the efficacy of capping. The use of capping might be advanced if it were viewed as a permanent remedy under Superfund.

- *In-situ* chemical treatment has conceptual advantages but considerable R&D will be needed before successful application can be demonstrated. Similarly, using bioremediation to treat in-place sediments requires further R&D to resolve microbial, geochemical, and hydrological issues.

### **Sediment Removal Technologies**

The high costs of *ex-situ* treatment relative to dredging calls for improvement of dredging technologies to enable sediment removal at near *in-situ* densities and precise removal of contaminated sediments to limit the capture of clean sediments and water. In this manner, the volume of dredged material requiring containment or treatment can be reduced.

### **Ex-situ Controls**

- Research is needed to improve control of contaminant releases, long-term monitoring methods, and techniques for preserving the capacity of existing confined disposal facilities (CDFs).
- The potential for acceptability of constructing contained aquatic disposal (CAD) facilities on or near contaminated sites must be explored fully. The USEPA and USACE should support research to improve design tools for preventing containment failure, improve monitoring methods for assessing long-term performance, control contaminant loss, and determine risk-reduction effectiveness through contaminant isolation.
- The USEPA and USACE should support research for promoting the reuse of CDFs and CADs and for improving tools for the design and evaluation of their long-term stability and effectiveness.
- R&D on *ex-situ* treatment technologies is warranted in the search for cost-effective treatment of large sediment volumes. Bench- and pilot-scale testing of *ex-situ* treatment technologies, and, eventually, full-scale demonstrations in marine systems, are needed to improve cost estimates, resolve technical problems, and improve treatment effectiveness.

### **Technology Innovation**

Additional R&D and demonstration projects are needed to improve existing technologies and reduce risks associated with developing and implementing innovative approaches. The advancement of cost-effective and innovative technologies could be facilitated by peer review of R&D proposals and side-by-side demonstrations of new and current technologies. The USEPA and USACE should develop a program to support such R&D and demonstration projects.

---

## ***Improving Project Implementation***

Although improvements in decision-making and remediation technologies would contribute to cost-effective contaminated sediment management, a variety of practical issues must be addressed to remove constraints in project implementation. These include responsibility for source control, site characterization needs and technologies, interim controls, and promotion of beneficial uses. The committee's conclusions and recommendations regarding these issues are presented below.

- As ports currently bear an unfair share of the responsibility for remediation and placement of contaminated sediments, project implementation would be facilitated by transferring the burden for source control to states and polluters. Federal and state regulators, together with the ports, should investigate the use of appropriate legal and enforcement tools to require the upstream contributors to the contamination to share equitably in the cleanup costs.
- New and improved techniques are needed to reduce the costs and enhance the precision of site assessments. The use of remote sensing technologies, including rapid and accurate sensors may accomplish this goal. The USEPA and USACE should jointly support R&D to advance the state of science in site assessment technologies. Objectives should include the identification and development of advanced survey approaches and new and improved chemical sensors for surveying and monitoring.
- In cases where sediment contamination poses an imminent danger, administrative and engineering

or structural controls can be used to reduce risks to potential human and ecological receptors from exposure to contaminated sediments over a short term until a more permanent remedy can be implemented.

- Beneficial uses of dredged contaminated material can provide disposal alternatives that are socially acceptable. These may include creation of islands for seabird nesting, landfills for urban development, beach nourishment, wetlands, shoreline stabilization, topsoil for landfill covers, and other potential marketable uses of the material. The USACE should revise its policies to allow for placement strategies that incorporate the beneficial use of contaminated sediments even if they are not the lowest cost alternatives. Regulatory agencies involved in contaminated sediment disposal should develop incentives for and encourage implementation of beneficial use alternatives. Funding should be continued for R&D of innovative beneficial uses of contaminated sediments and the development of technical guidance and procedures for environmentally acceptable beneficial reuse.

## **Summary**

There is no simple solution to the problems created by contaminated marine sediments. However, the NRC Marine Board study summarized in this presentation indicates that careful problem formulation and good information provide the foundation for good decisions in managing contaminated sediments. Incremental improvements can be made in decision making, remediation technologies, and project implementation that may result in cost-effective, socially acceptable, and environmentally sound solutions.

---

# Solving Great Lakes Contaminated Sediment Problems

Marc Tuchman and Callie Bolattino  
U.S. Environmental Protection Agency  
Great Lakes National Program Office  
Chicago, IL

Jan Miller  
U.S. Army Corps of Engineers  
Great Lakes and Ohio River Division  
Chicago, IL

## Introduction

Formed by glacial activity approximately 12,000 years ago, the Great Lakes comprise a unique ecosystem that, as a result of industrialization and human intervention, has been degraded over time. The five lakes hold 95% of the surface freshwater found in the United States and represent 18% of the world's supply of surface freshwater. This wealth of freshwater reaches deep into North America, sustaining abundant and diverse populations of plants and animals, providing a drinking water supply to support 24 million people and yielding the mobility to enhance technological production and transportation (1).

Years of point and nonpoint source discharges from industrial and municipal facilities and urban and agricultural runoff to the Great Lakes and its tributaries have introduced toxic substances to the Great Lakes ecosystem. The slow flushing process of replenishing water in the lakes allows contaminants in the water column to settle out and accumulate in bottom sediments. As a result, sediments have become a repository for contaminants. Though discharges of toxic substances to the Great Lakes have been reduced in the last 20 years, persistent high concentrations of contaminants in the bottom sediments of rivers and harbors have raised considerable human concern about potential risks to aquatic organisms, wildlife and humans. As a result, advisories against fish consumption are in place in most locations around the Great Lakes.

In 1987, a protocol (Annex 14) that was added to the already existing Great Lakes Water Quality Agreement between the United States and Canada (originally signed

in 1972) specifically recognized that there is a need to jointly address concerns about persistent toxic contaminants in the Great Lakes (2). It went on to direct that the information obtained in addressing these concerns be used to guide development of Lakewide Management Plans and Remedial Action Plans (RAPs) for specific Areas of Concern (AOCs) in the Great Lakes Basin. These 43 AOCs (Figure 1) are defined as places where beneficial uses of water resources such as drinking, swimming, fishing and navigation are impaired by anthropogenic pollution or perturbation. It has been documented by the International Joint Commission that sediment contamination is a major cause of such impairment in 42 of the 43 AOCs (3). For the 31 AOCs on the U.S. side, all RAPs written to date have identified contaminated bottom sediments as a significant problem that must be addressed to restore beneficial uses (4).

In an attempt to focus efforts on the issue of contaminated sediments, in the 1987 amendments to the Clean Water Act, Congress authorized the U.S. Environmental Protection Agency's (EPA) Great Lakes National Program Office (GLNPO) to coordinate and conduct a 5-year study and demonstration project relating to the appropriate treatment of toxic pollutants in bottom sediments. Five areas were specified by Congress as requiring priority consideration in conducting demonstration projects: Ashtabula River, OH; Buffalo River, NY; Grand Calumet River, IN; Saginaw Bay, MI; and Sheboygan Harbor, WI. To fulfill the requirements of this Congressional mandate, GLNPO initiated the Assessment and Remediation of Contaminated Sediments (ARCS) Program. ARCS was an integrated program for the development and testing of remedial action alternatives for contaminated sediments.

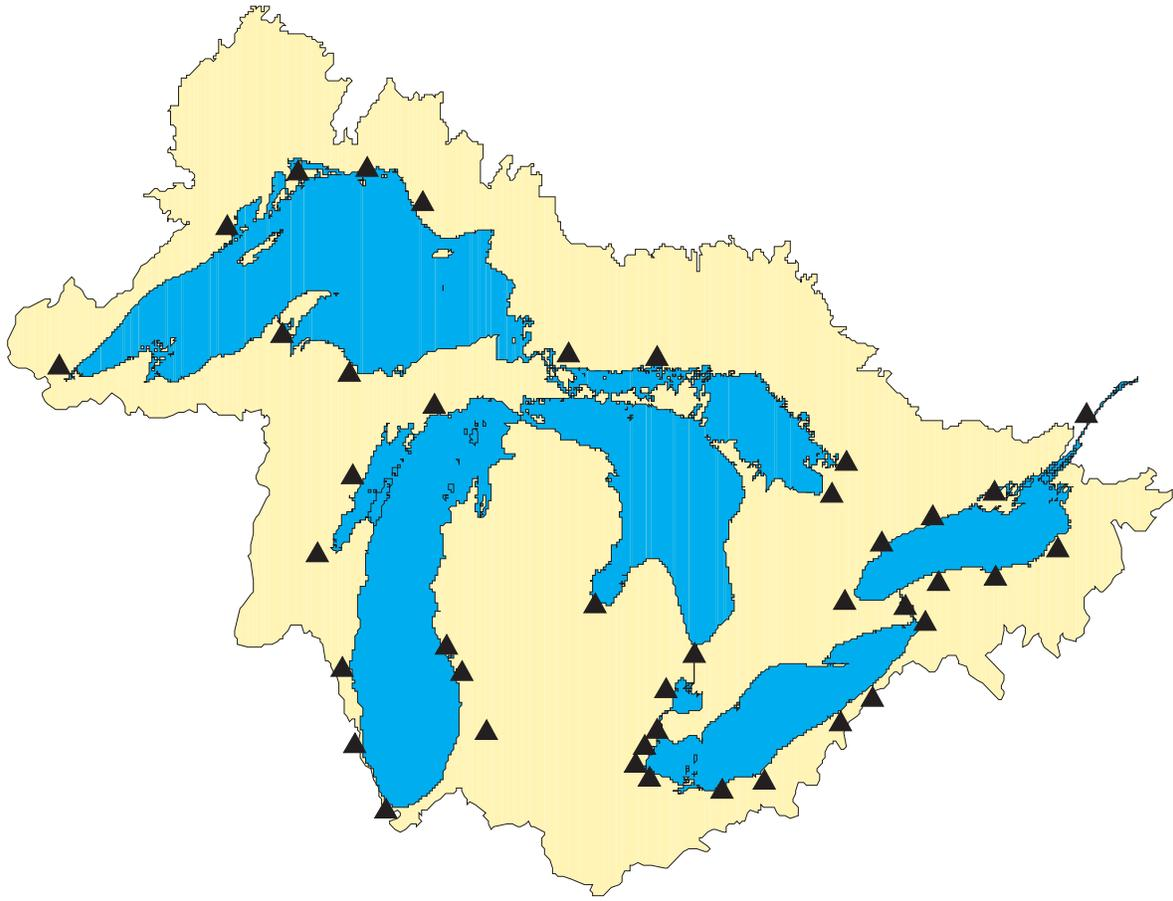

**Figure 1.** Forty-three areas of concern where beneficial use of water resources is impaired.

A primary goal of the ARCS Program was to develop an integrated, comprehensive approach to assessing the extent and severity of sediment contamination, assessing the risks associated with that contamination, and selecting appropriate remedial responses. The program developed the following objectives that were designed to meet this goal and the requirements of the Clean Water Act:

- Assess the nature and extent of bottom sediment contamination at selected Great Lakes AOCs;
- Demonstrate and evaluate the effectiveness of selected remedial options, including removal, immobilization, and advanced treatment technologies, as well as the “no action” alternative; and
- Provide guidance on contaminated sediment problems and remedial alternatives in the AOCs and other locations in the Great Lakes (5).

Consistent with these objectives, the ARCS Program directed its efforts toward developing and demonstrating sediment assessment and cleanup approaches that were scientifically sound, and technologically and economically feasible.

In meeting the set objectives, issues such as determining the nature and extent of sediment contamination, defining three-dimensional boundaries of sediment problems, identifying available remedial alternatives and their likelihood of success, determining the environmental impacts of remediation and calculating the economic costs associated with remedial actions were addressed. The major findings and recommendations of the ARCS Program included:

- Use of an integrated sediment assessment approach, incorporating chemical analyses, toxicity testing and benthic community surveys, is essential to define the magnitude and extent of sediment contamination at a site.
- Risk assessment and modeling activities are valuable techniques for evaluating the potential impacts associated with contaminated sediments.
- A number of treatment technologies are effective in removing or destroying sediment contamination.
- Broad public involvement and education are critical in any sediment assessment and remedy se-

---

lection study in order to develop a common understanding of the problem and the environmental and economic impacts of alternative remedial actions (5).

Though the ARCS Program was completed in August 1994, the guidance that was provided and the technical knowledge that was gained continue to influence the ongoing process of addressing contaminated sediments in the U.S. AOCs.

## Assessment

In response to the momentum gained from the ARCS Program in evaluating sediment contamination in the Great Lakes, various assessment tools have been utilized and have proven to be beneficial in obtaining an understanding of sediment contamination and dynamics. A few of these tools include:

- Chemical and Biological Testing
- Research Vessel (R/V) *Mudpuppy*
- Acoustical Mapping of Bottom and Subbottom Sediments
- Sediment Resuspension Modeling
- Database Management

**Chemical and Biological Testing**—One of the recommendations from the ARCS Program that is continually utilized to define the nature and extent of sediment contamination at a particular site is the integrated sediment assessment approach (6, 7). This integrated approach involves performing chemical analyses to determine which toxic substances are present; toxicity testing to provide information on how toxic substances are affecting organisms; and benthic community surveys to evaluate the long-term impacts that may result from toxic contamination. Integration of these results thus provides a clear picture of the amounts and effects of contaminants present in the sediments.

**R/V *Mudpuppy***—Conducting integrated sediment assessments typically requires that many samples be taken in order to adequately characterize the magnitude and extent of contamination at a given site. One such route for gathering the assessment samples and site information has been through the use of the *R/V Mudpuppy*. The *Mudpuppy* is a 32-foot flat-bottom boat specifically designed for sediment sampling in shallow rivers and harbors. It is equipped with a vibro-coring unit that allows the sampling of cores up to 15 feet long. It also has a differentially corrected global positioning system (GPS) with submeter accuracy that allows for precise and accurate determinations of sample locations. Once samples are collected, they can be subsampled and processed on board or at land-based facilities. A triple-axle trailer allows the vessel to be transported easily from one project location to the next.

GLNPO typically works closely with state agencies and local communities involved in the RAP process to develop sampling plans, testing protocols, and Quality Assurance Project Plans (QAPPs) for individual projects. *Mudpuppy* surveys provide data that allow the three-dimensional mapping of these project sites. To date, the *Mudpuppy* has been used to perform sediment assessments at 18 Great Lakes AOCs (Figure 2). Typically, projects implement an integrated sediment assessment in a two-phased approach. The first phase includes a comprehensive sampling of the entire AOC to help pinpoint the location of “hot spots.” These hot spots are then delineated in the second phase to provide information necessary for making remedial decisions. The overall goal of this effort is to generate the information needed to make scientifically defensible remediation decisions.

**Acoustical Mapping of Bottom and Subbottom Sediments**—A cost-effective and rapid means of mapping the distribution of sediments in harbors and rivers facilitates the remediation decisions facing environmental managers and forms the basis for any remediation plan. Presently, sediment cores are collected at preselected sites and the sediment lithography is extrapolated between core sites. Often, due to spatial variation, this extrapolation provides inaccurate estimates of soft sediment volume and distribution which may require remediation.

Acoustical profiling of bottom and subbottom sediments may provide an accurate cost-effective method for mapping sediment distribution. The acoustical coring analysis method developed by Caulfield Engineering and applied, under contract to the U.S. Army Corps of Engineers, Waterways Experiment Station, was developed to classify sediments for dredging operations. This approach has been shown to have an accuracy of 95% in estimating density in normal marine sediments (8). This technology has been transferred for use in mapping sediment distribution in harbors and rivers of the Great Lakes. Figure 3, illustrates the acoustical profiling method.

This technology has been demonstrated on a pilot basis in the Detroit River's Trenton Channel. The Trenton Channel provided sites of shallow water depth (2-30 feet) and sediments exhibiting high spatial variability and micro-gas bubble content. Survey line cross-sections were plotted from the acoustical data and illustrate horizontal and vertical sediment distribution. Sediment core lithography has been overlaid on the acoustical lithography demonstrating the close agreement between collected cores and acoustical sediment density estimates (Figure 4). Acoustical data can also be used to plot the location and volume of soft sediment deposits which may require removal. The results of this Trenton Channel work will be evaluated to determine its applicability to other AOCs.

**Sediment Resuspension Modeling**—When attempting to remediate contaminated sediments it is important not only to know the chemical and biological composi-



**Figure 2.** Nineteen Great Lakes sites sampled with *R/V Mudpuppy*.

tion of the sediments, but also to understand the resuspension/erosion properties associated with the sediments. Most contaminants are sorbed to fine-grained sediments which are buried at depths of up to several meters. It is critical to understand whether these buried contaminated sediments can be exposed and eroded during large floods and storms. Hydrodynamic models can be utilized to quantitatively predict changes in volumes, depths, and velocities of water in response to changes in flow and water surface elevation. Additionally, the models can be used to understand the resuspension and erosion properties of sediments at high-shear stress during flood and storm events (9).

Under the ARCS Program, researchers at the University of California, Santa Barbara, investigated the resuspension properties of bottom sediments in two Great Lakes AOCs through the use of laboratory experiments, field measurements and numerical models. To obtain data for model inputs they utilized an annular flume, a portable resuspension device (Shaker) and later, a Sediment Erosion at Depth Flume (Sedflume). All of these methods enhanced the researchers ability to approximate the resuspension properties of undisturbed sediments as a function of shear stress and time after deposition. Their results highlighted the potential of these techniques by determining distinct differences in

resuspension properties between the sediments in each of the rivers and between muddy and sandy sediments within a river (10).

**Database Management**—Another important component of a sediment assessment program involves the clear and concise management of all chemistry data, as well as toxicity and benthos data. Having all the available data for a particular area in a database can provide the basis for short- and long-term decision making. The combination of a database and GIS mapping capabilities enhances both Agency decision making and public education at all stages of a sediment project.

## Toward Remediation

Following completion of the characterization and assessment of a site, a determination must be made as to whether remediation will be required. If so, a variety of remedial options should be evaluated and a suitable option ultimately selected. Historically, placement of sediments in a confined disposal facility (CDF) or landfill has been the option of choice. Recently however, there has been more effort placed into examining the feasibility of using alternative treatment technologies as a method for remediating contaminated sediments.

## Typical Shallow Seismic System Configuration

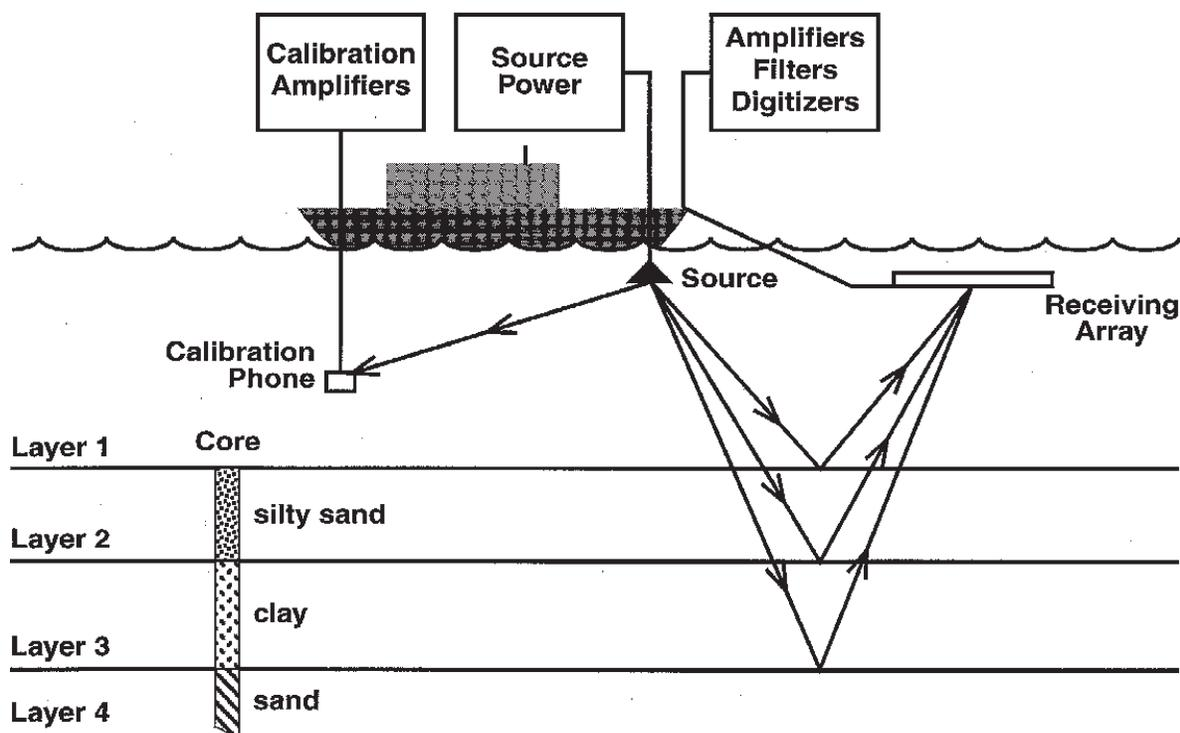

Figure 3. Typical shallow seismic system configuration.

The U.S. EPA's ARCS Program was one of the first programs in the Great Lakes to examine the feasibility of utilizing treatment technologies as an alternative to placing contaminated sediments in CDFs. The ARCS Program evaluated and demonstrated in the laboratory and field the effectiveness, feasibility and cost of numerous remediation treatment technologies (5). A number of the technologies tested were found to be technically feasible, although they varied in their effectiveness depending on the contaminants present. All options did cost more than traditional confined disposal.

Guidance on making remedial decisions based on the results of these activities is provided in the *ARCS Remediation Guidance Document* (11). Of the treatment technologies evaluated and demonstrated by the ARCS Program, no single technology was effective for all contaminants. Technologies that extract contaminants from sediments were identified as having high potential for successful remediation. Cost savings can be achieved by applying extractive technologies first, thus reducing the volume of material requiring further treatment by more expensive destructive methods.

### ARCS Bench-Scale Demonstrations

The ARCS Program examined more than 250 treatment technologies, most of which had been previously demonstrated on contaminated sediments. Of these, nine

were selected for bench-scale testing and four were selected for pilot-scale demonstration projects. The nine technologies selected for bench-scale work were tested in the laboratory on up to a few kilograms of sediment collected from the priority AOCs. The selection of technologies to be used depended on matching the characteristics of each technology with the specific sediment type and contaminants present. The results of the bench-scale testing provided preliminary feasibility data and design data for the pilot-scale demonstrations.

### ARCS Pilot-Scale Demonstrations

Pilot-scale demonstrations were conducted at the five ARCS priority AOCs and involved the onsite field testing of up to several thousand cubic yards of sediment.

**Thermal Desorption at Buffalo River, NY**—Low temperature thermal desorption, which uses indirect heat to separate organic contaminants from contaminated sediments through volatilization, was demonstrated on 12 cubic yards of sediment from the Buffalo River (12). Organic contaminants are volatilized from the sediments and then condensed and collected in a separate residual oil product. This technology was used in the Buffalo River specifically to examine its effectiveness at removal of the polycyclic aromatic hydrocarbon (PAH) fraction, which is of particular concern at this site. This



---

## Current Bench-Scale Demonstrations

Building upon information gained from the ARCS program, current projects continue to expand the knowledge base of technologies to remediate contaminated sediments.

**Buffalo River Dredging Demonstration**—A demonstration of various dredging technologies was conducted by the U.S. Army Corps of Engineers (ACE) in collaboration with the U.S. EPA GLNPO. Mechanical and hydraulic dredging equipment were demonstrated for precise removal of contaminated sediments in the Buffalo River, with monitoring to evaluate efficiency and resuspension (16).

**Trenton Channel Treatability Study**—As a followup to work conducted under the ARCS Program some new work is currently taking place in conjunction with the Michigan Department of Environmental Quality on the Trenton Channel of the Detroit River AOC. The main sediment contaminants in the Trenton Channel include PCBs, PAHs and mercury. Up to 12 gallons of sediment were shipped to five different vendors to conduct bench-scale testing. The technologies being examined include: solvent extraction, soil washing, solidification, plasma vitrification, and thermal desorption followed by cement production. The treatment technologies that were chosen for the Trenton Channel Study were predominantly based on being able to achieve a cleanup standard that would allow reuse of the sediments once “cleaned.” Possible reuses include industrial/commercial/highway fill and augmentation of cement production. It is anticipated that the results from these bench-scale tests will aid in the selection for a full-scale remedial effort on the Trenton Channel. The study also has implications for sediment remediation outside of the Trenton Channel, including the Detroit River and Southeast Michigan contaminated sediment sites.

## Remediation

Over the last few years a number of sediment cleanups have occurred in the Great Lakes basin. All of these have been conducted in association with enforcement actions, either under Superfund or other authorities. Descriptions of a number of these cleanups are included below.

**Manistique River, MI**—The Manistique River is a tributary to Lake Michigan that is both an AOC and on the National Priorities List (NPL) for Superfund. The contaminant of concern is PCBs, with concentrations ranging upwards of 2,500 ppm. Approximately 18,000 pounds of PCBs are found in the sediments, with estimates of 100 pounds per year being discharged into Lake Michigan. Concentrations in carp (*Cyprinus carpio*) average approximately 6 ppm of PCB.

*In-situ* capping had been the preferred alternative of the Potentially Responsible Parties (PRPs), but the U.S. EPA Region 5 preferred that the contaminated sedi-

ments be removed (dredged). In 1995-6, Region 5 conducted an emergency removal of approximately 18,000 cubic yards of contaminated sediments from a portion of the River and placed a temporary cap on another deposit to prevent its erosion. Dredging was conducted using diver assisted techniques to reduce the amount of resuspension. Prior to commencing of dredging activities in 1995, EPA designed, built or installed:

- Sheet piling and silt barriers to prevent any releases of resuspended sediments;
- An on-site water treatment plant to dewater dredged sediments and treat dredge water prior to its discharge back into the Manistique River; and,
- Two 1.2-million-gallon lagoons for storage of treated dredge water.

The dredged material was processed with a series of screens in order to separate the fine-grained and coarse materials. Coarse materials, predominantly wood chips, contained the bulk of PCBs, and were transported to a Chemical Waste Landfill in Utah. The fine-grained sediments were sent to a local landfill for disposal, at a significantly lower cost.

After much discussion over selection of what technology to be used for the remediation of the remainder of the contaminated sediments, a total dredging remedy was selected and supported by the PRP and local community. The PRPs agreed to pay \$6.4 million for EPA to finish dredging all the river and harbor sediments. Dredging of the rest of the sediments (approximately 100,000 cubic yards) is slated to be started in the Spring of 1997.

**Sheboygan River, WI**—The Sheboygan River, WI, is an AOC and Superfund site, located on Lake Michigan. PCB concentrations range upwards of 4,000 ppm and as a result the entire AOC was included on the NPL in May 1986. In 1989 and 1990 Tecumseh Products conducted a voluntary pilot study to evaluate bioremediation and sediment armoring of PCB-contaminated sediments. To conduct the bioremediation studies, a 14,000 square-foot confined treatment facility (CTF) was constructed incorporating a double liner in each of four treatment cells and a leak detection/leachate collection system. The four treatment cells allowed for the testing of different environments in which to study the effectiveness of degrading PCBs by enhanced natural biodegradation. The CTF has a capacity for approximately 1,500 cubic yards of sediments.

Sediment armoring (*in-situ* capping) was also conducted in the upper reaches of the river. Approximately 15,000 square feet of sediments with PCB concentrations averaging 100 ppm were armored in place. After placement of silt curtains around the sediment area to be removed, a geotextile material was first placed over the area. The sediment area was then armored with roadbed material consisting of fine to coarse-grained material. A second layer of geotextile was then placed over the roadbed

---

material and gabions placed around the edges to permanently hold the fabric in place. A layer of cobbles was placed over the geotextile and a layer of roadbed material was spread over the gabions.

Aside from the CTF and armoring work, an additional 2,500 cubic yards of material was removed and placed into a storage tank on PRP property. The ultimate disposal of this material, and remedial decisions regarding the remainder of contaminated sediments in the river is still being considered.

**Waukegan Harbor, IL**—Waukegan Harbor is an AOC and NPL site, located on Lake Michigan, and was one of the first sediment remediation projects completed on the Great Lakes. In 1988, Outboard Marine Corporation, the U.S. EPA and the State of Illinois signed a consent decree specifying the final terms for the removal of over 300,000 pounds of PCBs from Waukegan Harbor. The highest concentration of PCBs were found in Slip 3 with levels up to 17,000 ppm.

The sediments that contained PCBs over 500 ppm were dredged and thermally treated using the Taciuk process. The Taciuk process is a thermal treatment system that separates PCBs from soils and sediments by vaporizing them at high temperatures. When the vapors cooled, the PCBs were condensed into a liquid, removed, and destroyed at an off-site facility. Over 12,700 tons of material were treated by this process and 35,000 gallons of PCBs were extracted and taken off-site for destruction. The Taciuk process was operated and evaluated under EPA's Superfund Innovative Technology Evaluation (SITE) program, which assists EPA and industry in determining promising and innovative Superfund technologies.

For the materials between 50 and 500 ppm PCBs, Slip 3 was made into a permanent containment cell by constructing a cutoff wall and a slurry wall. The 290-foot cutoff wall consisted of two steel braces placed every 30 feet along the wall and keyed 12 feet deep into the clay. A 3-foot wide slurry wall was built around the entire perimeter of Slip 3. Approximately 32,000 cubic yards of PCB-contaminated sediment was placed into this containment cell. This work was completed in the fall of 1993.

**Black River, OH**—The Black River is an AOC and tributary to Lake Erie, near Lorain, OH. The primary contaminant of concern is PAHs, which have been associated with a number of fish tumors and abnormalities in the river. The U.S. EPA Region 5 and USX-Kobe Steel Company signed a consent decree in 1985 resulting from violations of the Clean Air Act, the Clean Water Act and the Resource Conservation and Recovery Act (RCRA). Under the terms of the agreement, USX-Kobe agreed to remove contaminated sediments from a portion of the Black River.

Between 1988-9, USX-Kobe removed approximately 40,000 cubic yards of contaminated sediments from the

Black River using a mechanical dredge, fitted with a closed-bucket clamshell and silt curtains. The sediments were placed in dumpsters for transport by truck to a disposal site constructed on USX-Kobe property.

**Grand Calumet River/Indiana Harbor Canal, IN**—The Grand Calumet River and Indiana Harbor Canal are an AOC located at the southern end of Lake Michigan, in northwest Indiana. This waterway has one of the largest concentrations of steel and petrochemical industry in the Midwest, and the sediments are among the most contaminated of any on the Great Lakes, having elevated levels of PCBs, PAHs, metals, and nutrients. The U.S. EPA Region 5 and Indiana Department of Environmental Management (IDEM) have successfully pursued a series of enforcement actions against industries and municipalities in northwest Indiana for violations of various federal and state environmental laws. A significant amount of the compensation obtained through these actions will be directed at contaminated sediment remediation.

The first sediment remediation action completed in this AOC was conducted by LTV Steel in a slip adjacent to Indiana Harbor. Approximately 100,000 cubic yards of contaminated sediments were removed in 1994-5. Initially, dredging was conducted using diver-assisted suction lines because of concerns for sediment resuspension and the proximity of the steel mill's main water intake to the dredging location. A conventional cutterhead dredge was later used to overcome the slow pace associated with diver assisted dredging.

Sediments were dewatered on site utilizing filter presses and surplus wastewater treatment capability of the steel mill. The dewatered sediments were trucked to a disposal facility off site.

**St. Lawrence River, NY**—The Massena-GM Superfund project removed approximately 14,000 cubic yards of PCB-contaminated sediments from the harbor in 1996. Because of the amount of cobbles and stone present in the sediments, dredging was conducted using a modified backhoe which allowed for separation of the stone from fine-grained sediments during excavation. The dredging area was surrounded by a sheet pile wall to prevent off-site migration of sediments during dredging. The cobbles were washed and considered free of contaminants. The fine-grained materials were transported to a disposal facility off site.

Dredging, even to a greater than planned depth, proved unable to create a bottom surface with PCB levels below the negotiated target (10 ppm). Consequently, the excavated area was subsequently covered with a composite cap of 6 inches of carbon/sand filler and armored with 12 inches of gravel and stone.

Some of the sediment cleanups that have been conducted in the Great Lakes over the past 10 years have been presented in this paper. Numerous others are planned or under design. It is hoped that by continuing

---

to remediate the contaminated sediments, many of the beneficial uses in the Great Lakes, identified by the GLWQA, will be restored.

For further information on sediment activities being undertaken by the U.S. EPA GLNPO please visit the following Internet site: <http://www.epa.gov/glnpo/>.

## Acknowledgments

The authors would like to thank the following people for assisting with the completion of this paper: John Filkins, U.S. EPA, ORD-LLRS, Grosse Ile, MI; Brian Stage, U.S. EPA, GLNPO, Chicago, IL; and Art Ostaszewski, Michigan Department of Environmental Quality, Lansing, MI.

## References

1. Hartig, J.H., and Thomas, R.L. 1988. Development of Plans to Restore Degraded Areas in the Great Lakes. *Environmental Management*. Vol.12, Number 3, pp 327-347.
2. United States and Canada. 1987. *The Great Lakes Water Quality Agreement* as revised by Protocol on November 1, 1987. Windsor, Ontario, Canada.
3. Hartig, J.H., and Zarull, M.A., eds. 1992. *Under RAPs: Toward Grassroots Ecological Democracy in the Great Lakes Basin*. University of Michigan Press. Ann Arbor, MI.
4. U.S. EPA. 1988. *U.S. Progress in Implementing the Great Lakes Water Quality Agreement*, Annex Reports to the IJC. EPA 905/9-89/006. Chicago, IL.
5. U.S. EPA. 1994. *ARCS Program Final Summary Report*. EPA 905-S-94-001. Chicago, IL.
6. U.S. EPA. 1994. *ARCS Assessment Guidance Document*. EPA 905-B94-002. Chicago, IL.
7. Chapman, P.M. 1986. Sediment Quality Criteria from the Sediment Quality Triad—An Example. *Environ. Toxicol. Chem.* 5: 957-964.
8. McGee, R.G., Ballard, R.F., Jr., and Caulfield, D.D. 1995. *A Technique to Assess the Characteristics of Bottom and Subbottom Marine Sediments*. Technical Report DRP-95-3. U.S. Army Engineer Waterways Experiment Station. Vicksburg, MS.
9. Lick, W., Yao-Jun, X., and McNeil, J. 1995. Resuspension properties of sediments from the Fox, Saginaw, and Buffalo Rivers. *Journal of Great Lakes Research*. 21(2):257-274.
10. Cardenas, M., and Lick, W. 1996. Modeling the transport of sediments and hydrophobic contaminants in the lower Saginaw River. *Journal of Great Lakes Research*. 22(3):669-682.
11. U.S. EPA. 1994. *ARCS Program Remediation Guidance Document*. EPA 905-B94-003. Chicago, IL.
12. U. S. EPA. 1993. *ARCS Program Pilot Scale Demonstration of Thermal Desorption for the Treatment of Buffalo River Sediments*. EPA 905-R93-005. Chicago, IL.
13. U.S. EPA. 1994. *ARCS Program Pilot Scale Demonstration of Sediment Washing for the Treatment of Saginaw River Sediments*. EPA 905-R94-019. Chicago, IL.
14. U.S. EPA. 1994. *ARCS Program Pilot Scale Demonstration of Solvent Extraction for the Treatment of Grand Calumet River Sediments*. EPA 905-R94-003. Chicago, IL.
15. U.S. EPA. 1994. *ARCS Program Pilot Scale Demonstration of Thermal Desorption for the Treatment of Ashtabula River Sediments*. EPA 905-R94-021. Ch IL.
16. Averett, D.E., B.D. Perry, E.J. Torrey, and J.A. Miller. "1990 Review of containment and treatment technologies for remediation of contaminated sediment in the Great Lakes." Miscellaneous Paper EL-90-25. U.S. Army Engineer Waterways Experiment Station, Vicksburg, MS.

---

# Perspective on Remediation and Natural Recovery of Contaminated Sediments

Dolloff F. Bishop  
National Risk Management Research Laboratory  
U.S. Environmental Protection Agency  
Cincinnati, OH

Sediments include material, particularly clays and organic matter, that control sediment cohesiveness. Cohesive sediments have large surface area-to-volume ratios, a net negative charge on their surface and exchangeable cations (1). Thus cohesive sediments adsorb both organic and inorganic contaminants strongly. Indeed the bulk of the contaminant load in watersheds is usually adsorbed to cohesive sediments that act as a transporting system for contaminants (2, 3). The contaminants in sediments, therefore, include a wide variety of organic compounds and metals adsorbed to the cohesive material (4).

Metals in sediments cannot be destroyed but can be transformed by bioprocesses often to less available forms. The important organic contaminants belong to the high molecular weight organic classes, especially polychlorinated biphenyls (PCBs), highly chlorinated pesticides, dioxin/dibenzofurans and polynuclear aromatic hydrocarbons (PAHs) from widely used multicomponent aroclors, pesticides, and creosotes. These organics partition strongly to and persist in sediments (4, 5, 6). In addition, less widely used chlorinated organics such as hexachlorobenzene and trichlorobenzenes can be important contaminants at specific sites (4, 7).

## Attenuation Chemistry and Biology

Attenuation mechanisms of the contaminants in sediments include biodegradation, biotransformation, bioturbation (mixing by sediment organisms), dispersion, dilution, adsorption, volatilization, chemical stabilization or destruction and burial by clean sediment. With organic contaminants in sediments often highly hydrophobic which can significantly increase the volatility of high molecular weight organics in wet environments, volatilization as well as biodegradation can provide substantial sediment contaminant removal (8, 9). The attenuation mechanisms at sites are significantly affected by highly variable flow in watersheds and by removal through

bioaccumulation in the food chain which also produces potential human health and environmental risks (4, 6).

Quiescent sediments with substantial organic contamination are anaerobic except in the upper layer (a few cm) adjacent to the water column (10). Dissolved oxygen levels of approximately 8.0 mg/L in water, slow oxygen diffusion into sediments, and slow diffusion of contaminants, especially in sediments with extended contaminant contact time (aging), to bioactive sites limit the rates of aerobic degradation or transformation processes (11). Indeed, mass transport limitations in quiescent sediments reduce bioavailability of metals and organic contaminants, but also increase persistence of the aerobically degradable organic contaminants.

Turbulent mixing with high flows or strong tides transports and disperses highly contaminated sediments over wide areas (4, 12). The mixing and dispersion blend contaminated and clean sediment which may subject the persistent contaminants in the sediment to accelerate bioaccumulation. The mixing of sediments into the water column usually produces only limited and slow aerobic oxidation or transformation of aerobically degradable or transformable contaminants because the sediment transport, sorption and bioaccumulation processes are usually substantially faster than the aerobic degradation or transformation processes (13). Finally, with dispersion and dilution by clean sediments, biodegradation and/or transformation of the sediment contaminants may be limited because of low concentrations of contaminant and insufficient biodiversity in the microbial community.

Concentrations of trace metals in sediments are not good measures of metal toxicity in watersheds because field and laboratory studies have revealed that different sediments exhibit different degrees of toxicity for the same total quantities of metals (14, 15). Since most contaminated sediments have low redox potentials, metal

reduction processes and precipitation reactions with sulfides sequester many metals in sediments, usually as insoluble sulfides (4, 16). The sequestering reduces the environmental availability and toxic impact of metals to benthic organisms, watershed fish, animals and humans (17 - 19).

As an empirical characteristic of sediments, acid volatile sulfide (AVS) is the sulfide liberated when a sediment is treated with hydrochloric acid at room temperature under anoxic conditions (19). Ferrous sulfide is the major component of AVS in anoxic sediments (16). The AVS controls the activity and availability of trace divalent metals in the pore water of anoxic sediments (16 - 19). Metals that are extracted by the hydrochloric acid treatment are called simultaneously extracted metals (SEMs). Important SEMs have sulfide solubility products that are smaller than the solubility product of ferrous sulfide and include nickel, zinc, cadmium, lead, copper, and mercury (16 - 19). As a result these important SEMs have low divalent metal ion concentrations in pore water of sediments with high ferrous sulfide content.

Based upon research on freshwater and marine sediments at EPA's Narragansett Environmental Research Laboratory, EPA's Office of Science and Technology has selected a difference in mol concentrations of (SEMs) - (AVS) > 5 as an empirical condition which establishes high probabilities for most metal toxicity and availability in sediments (4). Since mercury sulfide is easily transformed to methyl mercury, mercury is not included in the (SEMs) - (AVS) empirical characterization to determine its probability of metal toxicity or availability (4, 20).

Volatilization of hydrophobic contaminants with appropriate Henry Constants in sediments can occur significantly in tidal and riverbank sediments exposed to fluctuations in water levels. The exposure of sediments to the atmosphere permits direct contaminant losses from the wet sediment through volatilization (8, 9) or by wind transport of dried sediment fines. Volatilization from the surface of water is controlled by diffusion and bioturbation of contaminants in the sediment and pore water, by diffusion and dispersion of contaminants and sediments through the water column, and by wind dynamics at the water surface. Currently, uncertainty exists concerning the relative importance of the volatilization routes and the other attenuation mechanisms for reduction of contaminant concentrations and ecological and health risk from contaminated sediment.

Intrinsic degradation of high molecular weight organic compounds occurs naturally but slowly in soils and sediments and is usually catalyzed by indigenous anaerobic and aerobic microorganisms (21 - 26). In general, the greater the molecular weight of the organic contaminants the greater the partitioning to sorption sites. Large resident times of contaminants in the sediment (aging) usually results in increased sequestration. Both effects reduce the availability of the organic compounds to microorganisms and thus reduce the extent and rates of biodegradation.

The PAHs biodegrade most readily through aerobic processes and the degradation rates usually decrease as the number of aromatic rings increases (24 - 26). Biodegradation of most PAHs does not occur appreciably under anaerobic conditions. Thus, the PAHs persist in anoxic or anaerobic sediments (4, 6).

In contrast, highly chlorinated congeners of PCBs and other chlorinated contaminants may gradually dechlorinate naturally in contaminated anaerobic sediments (27 - 29); the PCBs to congeners with the residual chlorines at the ortho position on the biphenyl molecule (27, 28). Lightly chlorinated PCBs and other partially dechlorinated organic species, in general, bioaccumulate less than the highly chlorinated congeners or species. The lightly chlorinated PCBs exhibit significantly less potential human carcinogenic and dioxin-like (coplanar structure) toxicity (28, 30) but may be transformed in humans with potential for other human toxicity (31). While aerobic processes may then biodegrade the lightly chlorinated PCB congeners and other lightly chlorinated organics (32, 33), the anaerobic or anoxic conditions in many sediments limit significant degradation and these partially dechlorinated organics may accumulate and persist (4, 33).

Chlorinated pesticides and other chlorinated organics may also be transformed or partially degraded in sediments. Unfortunately the degradation products may be equally or more toxic and persistent than the original pesticide or chlorinated organic. As an example, dichloro-diphenyl-trichloroethane (DDT) can be transformed under anaerobic conditions to dichloro-diphenyl-dichloroethane (DDD) and under aerobic conditions to dichloro-diphenyl-dichloroethylene (DDE) (34, 35). Although all three DDT constituents may be found in sediments, DDE is the constituent most widely detected in the environment (7, 36) and the constituent that is resistant to further biotransformation (37).

## Bioaccumulation

Persistent organic compounds and some metals, principally mercury, bioaccumulate in watersheds with significant biomagnification in fish (4). The persistent organic contaminants generally partition strongly to organic phases and thus rapidly bioaccumulate. Unfortunately, some metals are also biologically transformed to more toxic or biologically available forms. As examples, mercury, lead, selenium and arsenic can be biologically methylated. Methylation increases their mobility and, for mercury, its bioconcentration potential (38). Arsenic sulfides can also be biologically oxidized, if sediments are oxygenated, to water soluble arsenate, a more readily available form of arsenic (39, 40). In addition, metals may also bioaccumulate directly via uptake by benthic organisms in the sediments (38).

Bioaccumulation with substantial biomagnification in fish increases the ecological and health risk associated with large volumes of low (ppb) to moderately contaminated sediments and thus ultimately threatens fish-consuming

---

predators and humans (7). Institutional controls such as fish consumption advisories have not been completely successful, especially with people who use fishing to supplement their diets (41, 42).

Finally, while low concentrations of contaminants and site conditions may not induce microbial activity, these low concentrations can still bioaccumulate (4). Indeed, high concentrations of contaminants in limited volumes of sediments, but representing relative low mass loadings to a contaminated watershed, may provide less bioaccumulative impact on migratory fish than large volumes of low-to-moderately contaminated sediment which are dispersed over a wide area. Non-migratory fish and shellfish in highly contaminated areas obviously will exhibit higher bioaccumulation of contaminants in their tissues than those in areas with lower levels of contamination.

### Site Characterization

Site characteristics impacting natural attenuation/recovery in sediments include hydraulic flow rates and their potential chaotic variability; tidal effects; types, depths and redox conditions of contaminated sediment; distribution, concentrations and types of contaminants; concentrations of total organic carbon in sediments; shoreline and water uses and conditions; and navigational requirements. The effects of these site characteristics on the fate and transport of contaminants are not fully understood, especially for estuarine and marine sediments. Indeed, the rates of natural degradation or transformation of contaminants under various site conditions are not generally available.

Hydraulic transport of uncontaminated sediments in watersheds can lead to natural covering of contaminated sediments. Such covering can reduce the availability of the contaminants and thus bioaccumulation. As an example, the kepone contaminated sediments in the James River, VA, were covered by uncontaminated sediment (43). The process of covering or burial by uncontaminated sediment, a component of natural attenuation/recovery, led to a significant reduction in the ecological and health risks associated with fish and shellfish in the James River (44). Unfortunately, such natural recovery depends upon the uncertain natural maintenance of the uncontaminated sediment cap.

Indeed, the contaminated sediments in rivers and streams and erodible soils at Superfund sites are large reservoirs of contaminants. Severe storms and precipitation events such as occurred in the Fox River in Wisconsin (13) can easily erode soil, scour sediments and redistribute the contaminants over wide areas.

The various types of contaminants may be poorly attenuated or require conflicting conditions to support effective natural attenuation/recovery. As examples, divalent metals in general need anaerobic conditions with sufficient sulfides (AVS) to minimize metals released to the water column and eventual bioaccumulation. How-

ever, biomethylation of mercury, increasing mobility and bioaccumulation potential of mercury, is produced under both anaerobic and aerobic conditions (20). PCB dechlorination requires anaerobic conditions and sufficient organic carbon, probably generating appropriate amounts of molecular hydrogen, to efficiently dechlorinate the dioxin-like meta and para chlorine on the biphenyl molecule. Anaerobic conditions, unfortunately, prevent practical aerobic degradation of the resulting lightly chlorinated PCBs and other aerobically degradable organics such as PAHs. Thus, poor attenuation of some contaminants and conflicting site conditions necessary to efficiently attenuate other contaminants coupled with relatively rapid bioaccumulation and biomagnification effects, even at low contaminant concentrations, significantly minimize the effectiveness of natural attenuation.

### Monitoring

Long-term monitoring of contaminants in sediments, the water column and in fish or shellfish has revealed decreasing concentrations of both metals and persistent organic contaminants (7). With the attenuation mechanisms at sites removing contaminants, with the banning of many persistent compounds and the improved removal from industrial and municipal point sources, contaminant concentrations would be expected to continue to decrease.

In surveys on PCBs in migratory fish tissue (Figures 1 and 2) in the Great Lakes, the fish in Southern Lake Michigan revealed an initial substantial decrease in tissue PCB concentrations with time. However, recently a leveling of the PCB concentration in the tissue has been observed (7). In an ongoing survey of mussels and oysters conducted by the National Oceanic and Atmosphere Administration at 100 U.S. coastal sites, the concentration of 14 monitored contaminants revealed some decreases (217 test areas) and some increases (41 test areas) with time in the contaminant levels in the shellfish (45). The main finding, however, was that in the majority of cases (1898 test areas) there was no statistical change in tissue contaminant concentration.

Indeed, while natural attenuation or recovery may occur, these recent findings suggest that quasi-steady-state contaminant concentrations in fish and shellfish appear to be very widespread. Finally, this recently observed leveling of contaminant concentrations in fish tissues and shellfish is likely caused by continuing sediment transport at high flow conditions in streams and estuaries and subsequent sediment dispersion over large areas of the watershed.

### Modeling and Risk Assessment

A key factor controlling the fate and migration of persistent contaminants in watersheds is the resuspension (sediment erosion), transport and dispersion of cohesive and non-cohesive sediments over wide areas of watersheds. The non-cohesive sediments such as sand do

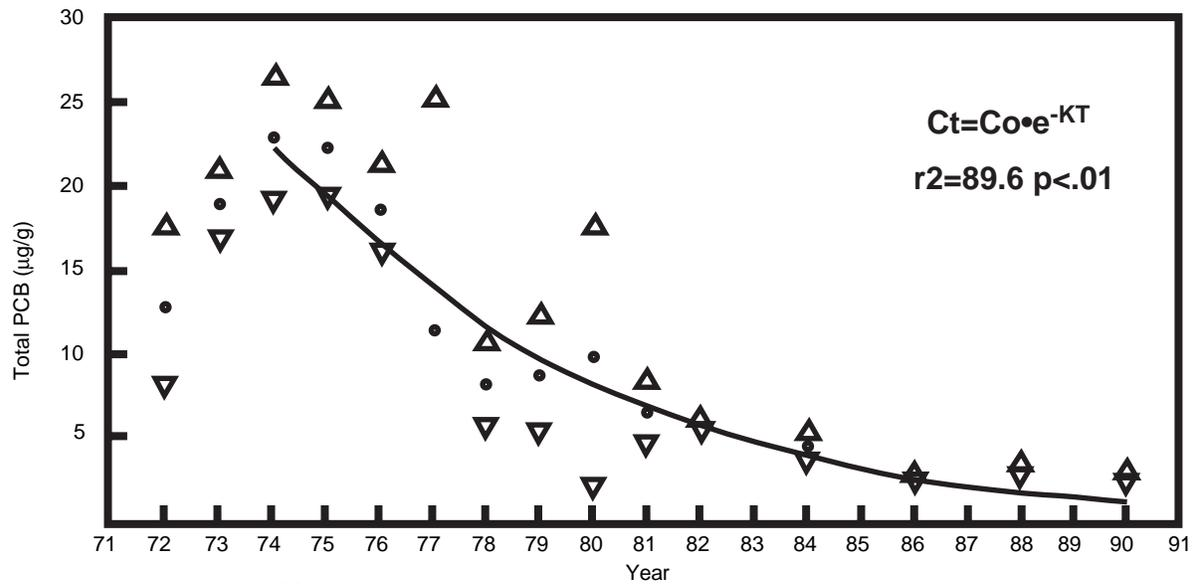

Figure 1. Lake Michigan lake trout (7).

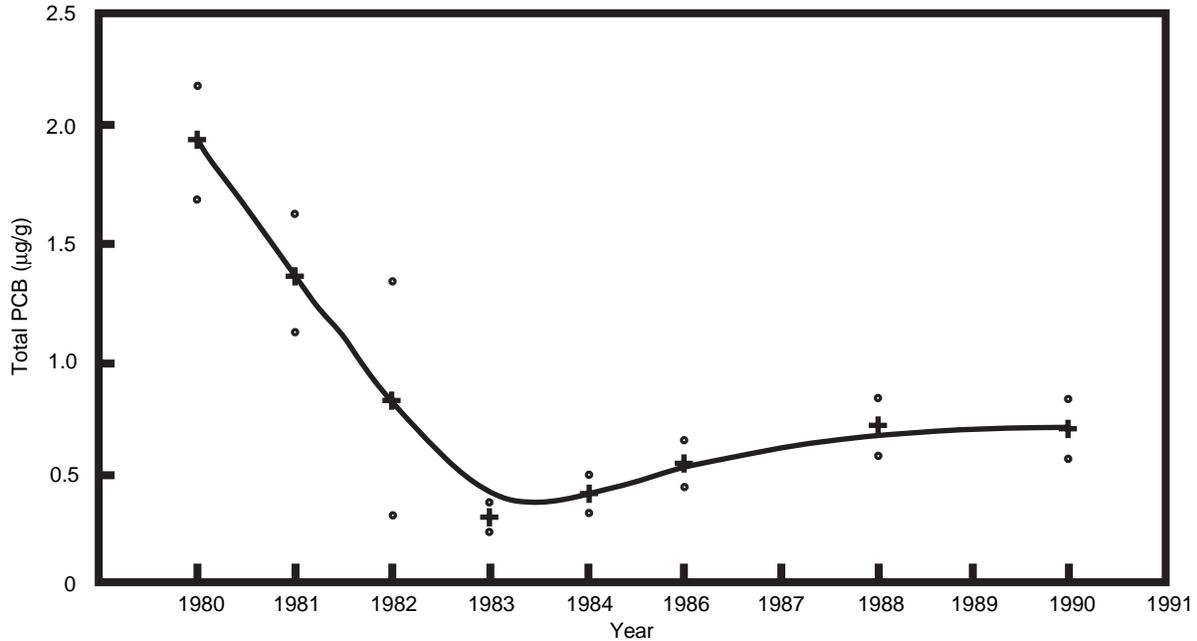

Figure 2. Coho salmon fillets (7).

not strongly adsorb contaminants, but do dilute and bury the contaminated cohesive sediments. A series of models have been developed by the U.S. Environmental Protection Agency and the Corp of Engineers to characterize the resuspension of sediments in rivers and streams, estuaries and coastal areas and other large bodies of water (1, 12, 46 - 52). These models have been applied and calibrated at various sites (13, 53 - 57). Some of the models, especially for estuaries and marine coastal areas, are complex numerical modeling methods and may require modification to specifically address sediment resuspension, transport and dispersion in the watershed. The state-of-the-art for modeling, however, is reasonably developed to permit assessments using field data.

A second factor affecting contaminant transport in watersheds involves water erosion of contaminated soil. Three types of water erosion are usually recognized; sheet, rill and gully (58). A suitable model for estimating soil erosion is the Modified Universal Soil Loss Equation (MUSLE) (59).

Methods for assessing ecological and health risk associated with contaminated sediments are described in appendices B through I of the National Sediment Quality Survey (4). The methods described in these appendices with appropriate supporting references include sediment screening parameters; EPA's draft sediment quality criteria (SQC) and sediment quality advisory levels (SQALs) for nonionic organic chemicals; EPA's empirical toxicity

assessment approach for divalent metals using SEM and AVS concentrations; methods for selecting biota-sediment accumulation factors and percent lipid in fish tissue used to derive theoretical bioaccumulation potentials; screening values of chemicals and frequency of detection values with estimates of the probability effect levels; watershed species characteristics related to tissue bioaccumulation; methodology for evaluating toxicity levels; and additional analyses providing perspective on the important contaminants, PCBs and mercury (Figures 3 and 4; Tables 1 and 2).

Detailed EPA methods are also available for assessing toxicity and bioaccumulation of contaminants associated with sediments for freshwater (60) and marine waters (61).

### Practical Remediation Approaches

Practical remedial approaches for contaminated sediments include removal by dredging with offsite containment or treatment, *in-situ* containment (capping), natural attenuation/natural recovery with long-term monitoring, and no action with long-term monitoring and institutional controls. A review of remediation technologies and costs are provided in EPA's Assessment and Remediation of Contaminated Sediments (ARCS) Program: Remediation Guidance Document (11). Selection of remedial ap-

proaches should involve a site specific risk based cost/benefit assessment of the various approaches. Procedures are available or can be developed to evaluate cost/benefits for dredging with offsite containment or treatment of the dredged sediment and for natural attenuation/natural recovery. Dredging costs, including the cost for improved environmental dredging technology, and the costs of site characterization and monitoring for natural attenuation/natural recovery can be readily determined. The effectiveness of *in-situ* containment (capping) and no-action with monitoring and institutional controls are uncertain, although costing of the approaches on a site specific basis can be estimated.

### Natural Attenuation/Recovery Uncertainties

In summary, a number of factors contribute to uncertainty in and limit the utility of natural attenuation/recovery as a means of remediation of contaminated sediments. These factors include:

- Anaerobic conditions in sediments that limit aerobic biodegradation of PAHs, partially dechlorinated PCBs and other aerobically degradable contaminants.

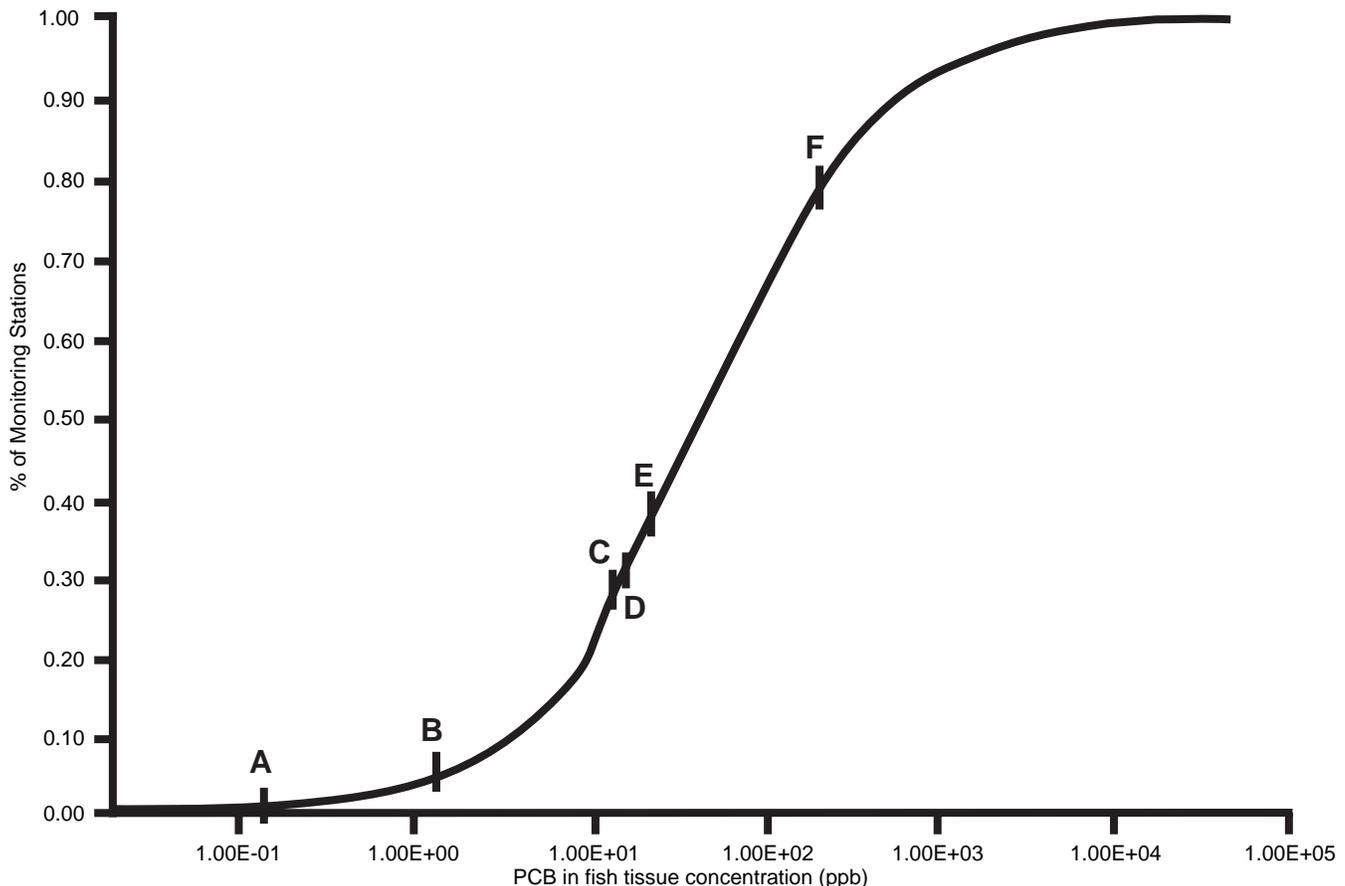
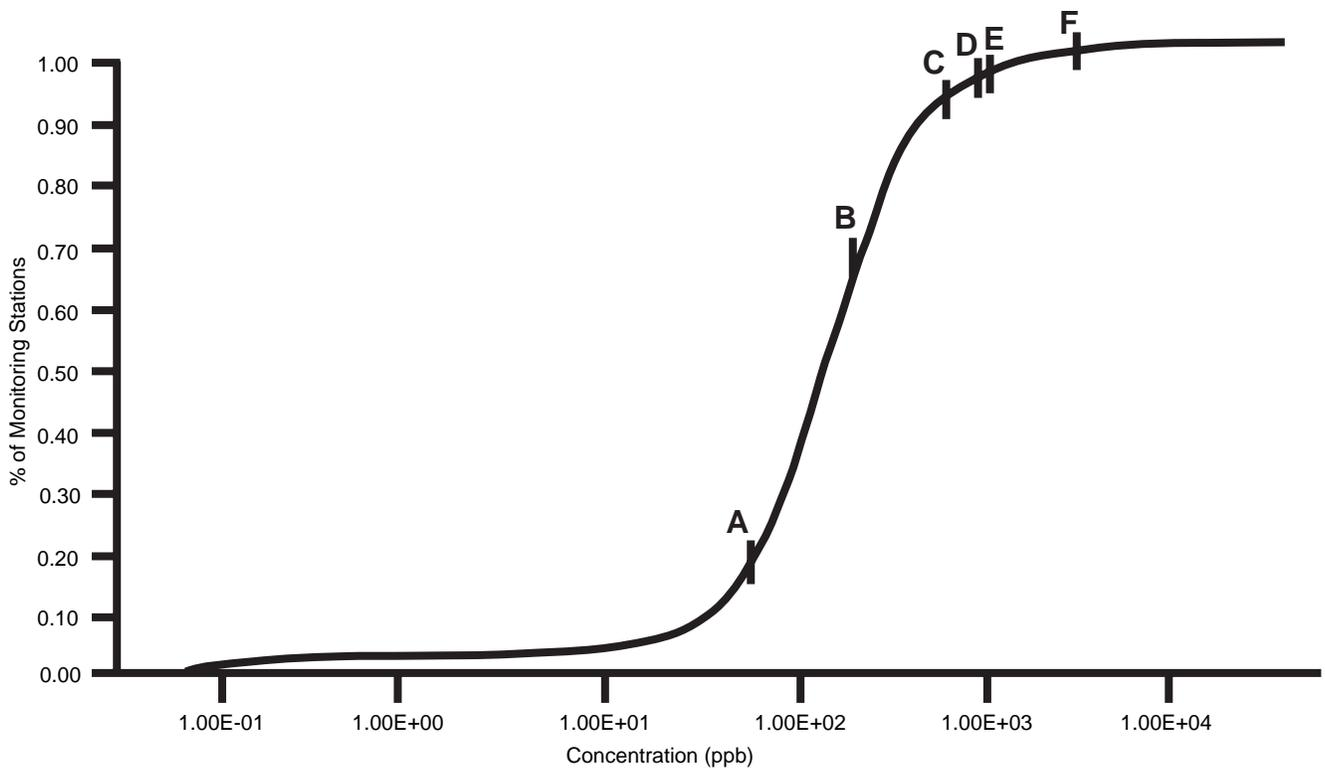

Figure 3. Cumulative frequency distribution of PCB fish tissue data (4).



**Figure 4.** Cumulative frequency distribution of mercury fish tissue data (4).

**Table 1.** Fish Tissue Sampling Stations with Detectable Levels of PCBs that Exceed Various Screening Values (4)

Protection of consumers	Associated level (ppb)	Level letter in PCB	Number of stations exceeding level	Percentage of stations	
Cancer risk level	10-6	1.4	A	2,354	99.3
	10-5	14	B	2,256	95.2
	10-4	140	C	1,686	71.1
Noncancer hazard quotient of 1	220	E	1,473	62.2	
FDA tolerance level	2000	F	489	20.6	
Wildlife criteria	160	D	1,620	68.4	

**Table 2.** Fish Tissue Sampling Stations with Detectable Levels of Mercury that Exceed Various Screening Values (4)

Protection of consumers	Associated level (ppb)	Level letter in mercury figures	Number of stations exceeding level	Percentage of stations
Canadian guideline	200	B	908	35.1
Noncancer hazard quotient of 1 (1995)	1,100	E	91	3.5
Noncancer hazard quotient of 1 (pre-1995)	3,231	F	15	0.6
Noncancer hazard quotient of 1 (pre-1995 for infants)	646	C	204	7.9
FDA action level	1000	D	103	4.0
Wildlife criteria	57.3	A	2,150	83.0

- Mobilization of metals by microbial activity such as methylation of mercury.
- Undefined and wide variability in site specific rates of attenuation of persistent organic contaminants, especially when low contaminant concentrations and limited biodiversity restrict microbial activity.
- Uncontrolled dispersion of reservoirs of contaminated sediments and erodible soils caused by high and chaotic hydraulic flow rates or tidal effects. This lack of control leads to uncertainty in burial of contaminated sediment and eroded soils by clean sediment.
- Air emissions of hydrophobic contaminants with uncertain impact on ecological and health risks.
- Bioaccumulation and biomagnification of contaminants even from low [ppb] but widely dispersed concentrations in sediments.
- With aging of sediments, continued contaminant availability to bioaccumulation and biomagnification but reduced availability of persistent organics to biodegradation.
- Widespread quasi-steady-state contaminant residuals in fish and shellfish.
- Ineffective institutional controls to prevent human consumption of contaminated fish and shellfish.
- Uncontrollable consumption of contaminated fish and shellfish by watershed predators.

## References

1. Hayter, E.J., M.A. Bergs, R. Gu, S.C. McCutcheon, and S.J. Smith. 1997. *SED2D, A Finite Element Model for Cohesive Sediment Transport*. Draft report. U.S. Environmental Protection Agency. Environmental Research Laboratory. Athens, GA.
2. Dyer, K.R. 1986. *Coastal and Estuarine Sediment Dynamics*. John Wiley and Sons. London.
3. Preston, A., D.F. Jefferies, J.W.R. Dutton, B.R. Harvey, and A.K. Steele. 1972. British Isles coastal waters: The concentration of selected heavy metals in seawater, suspended matter and biological indicators - A pilot survey. *J. Environ. Poll.* 3:69-72.
4. U.S. EPA. 1996. *The National Sediment Quality Survey: A Report to Congress on the Extent and Severity of Sediment Contamination in Surface Waters of the United States*. EPA-823-D-96-002. U.S. Environmental Protection Agency. Office of Science and Technology. Washington, DC. July.
5. Karickhoff, S.W., D.S. Brown, and T.A. Scott. 1979. Sorption of hydrophobic pollutants on natural sediments. *Water Res.* 13:241-248.
6. Safe, S. 1980. Metabolism uptake, storage, and bioaccumulation. In: *Halogenated Biphenyls, Naphthalenes, Di-benzodioxins and Related Products*. R. Kimbrough, ed. Elsevier, North Holland. pp 81-107.
7. U.S. EPA. 1992. National Study of Chemical Residues in Fish, Volumes I and II. EPA 823-R-92-008a,b. U.S. Environmental Protection Agency. Office of Science and Technology. Washington, DC. September.
8. MacKay, D., and P.J. Leinonen. 1975. Rate of evaporation of low solubility contaminants from water bodies to atmosphere. *Environ. Sci. Technol.* 9:1179-1180.
9. Swackhamer, D.L., B.D. McVeety and R.A. Hites. 1988. Deposition and evaporation of polychlorobiphenyl congeners to and from Siskiwit Lake, Isle Royale, Lake Superior. *Environ. Sci. Technol.* 22:664-672.
10. National Research Council. 1997. *Contaminated Sediments in Ports and Waterways*. National Academy Press. Washington, DC. p66.
11. U.S. EPA. 1994. *Assessment and Remediation of Contaminated Sediments Program: Remediation Guidance Document*. EPA/905/R-94/003. U.S. Environmental Protection Agency. Great Lakes National Program Office. Chicago, IL.
12. Velleux, M., J. Gailani, and D. Endicott. 1996. Screening-level approach for estimating contaminant export from tributaries. *J. Environ. Engr.* 122:503-514.
13. Velleux, M., and D. Endicott. 1994. Development of a mass balance model for estimating PCB export from the Lower Fox River to Green Bay. *Great Lakes Res.* 20:416-434.
14. DiToro, D.M., J.D. Mahony, D.J. Hanson, K.S. Scott, M.B. Hicks, S.M. Mays, and M.S. Redmond. 1990. Toxicity of cadmium in sediments: The role of acid-volatile sulfide. *Environ. Toxicol. Chem.* 9:1487-1502.
15. Luoma, S.N. 1983. Bioavailability of trace metals to aquatic organisms - A review. *Sci. Tot. Environ.* 28:1-22.
16. Allen, H.E., G. Fu, and B. Deng. 1993. Analysis of acid-volatile sulfide (AVS) and simultaneous extracted metals (SEM) for estimation of potential toxicity in aquatic sediments. *Environ. Toxicol. Chem.* 12:1441-1453.

17. DiToro, D.M., J.D. Mahony, D.J. Hansen, K.J. Scott, A.R. Carlson, and G.T. Ankley. 1992. Acid-volatile sulfide predicts the acute toxicity of cadmium and nickel in sediments. *Environ. Sci. Technol.* 26:96-101.
18. Casas, A.M., and E.A. Creceilus. 1994. Relationship between acid-volatile sulfide and the toxicity of zinc, lead and copper in marine sediments. *Environ. Toxicol. Chem.* 13:529-536.
19. Meyer, J.S., W. Davison, B. Sundby, J.T. Ores, D.J. Lauren, U. Forster, J. Hong, and D.G. Crosby. 1994. Synopsis of discussion sessions: The effects of variable redox potential, pH and light on bioavailability in dynamic water-sediment environments. In: Bioavailability, Physical, Chemical, and Biological Interactions. *Proceedings of the Thirteenth Pellston Workshop*. Eds. J.L. Hamelink, P.F. Landrum, H.L. Bergman, and W.H. Benson, Lewis Publishers. Boca Raton, FL. Pp. 155-170.
20. Bisogni, J.J., and A.W. Lawrence. 1973. *Kinetics of Microbially Mediated Methylation of Mercury in Aerobic and Anaerobic Aquatic Environments*. Report to OWRR. Department of the Interior. Technical Report No. 63. Cornell University Water Resources and Marine Science Center. Ithaca, NY.
21. Bedard, D.L., and R.J. May. 1996. Characterization of the polychlorinated biphenyls in sediments of Woods Pond: Evidence for microbial dechlorination of aroclors 1260 in-situ *Environ. Sci. Technol.* 30:237-245.
22. Brown, J.F., Jr., R.E. Wagner, H. Feng, D.L. Bedard, M.J. Brennan, J.C. Carnahan, and R.J. May. 1987. Environmental dechlorination of PCBs. *Environ. Toxicol. Chem.* 6:579-593.
23. Abramowicz, D.A., and D.R. Olsen. 1995. Accelerated biodegradation of PCBs. *Chemtech.* 24:36-41.
24. Shuttleworth, K.L., and C.E. Cerniglia. 1995. Environmental aspects of PAH biodegradation. *Appl. Biochem. Biotechnol.* 54:291-302.
25. Cerniglia, C.E. 1992. Biodegradation of polycyclic aromatic hydrocarbons. *Biodegradation* 3:351-368.
26. Seech, A., B. O'Neil, and L.A. Comacchio. 1993. Bioremediation of sediments contaminated with polynuclear aromatic hydrocarbons (PAHs). In: *Proceedings of the Workshop on the Removal and Treatment of Contaminated Sediments. Environment Canada's Great Lakes Cleanup Fund*. Wastewater Technology Centre, Burlington, Ontario.
27. Brown, J.F., Jr., R.E. Wagner, H. Feng, D.L. Bedard, M.J. Brennan, J.C. Carnahan, and R.J. May. 1987. Environmental dechlorination of PCBs. *Environ. Toxicol. Chem.* 6:579-593.
28. Quensen, J.F., III, S.A. Boyd, and J.M. Tiedje. 1990. Dechlorination of four commercial polychlorinated biphenyl mixtures (aroclors) by anaerobic microorganisms from sediments. *Appl. Environ. Microbiol.* 56:2360-2369.
29. Liu, S.M., and W.J. Jones. 1995. Biotransformation of dichloroaromatic compounds in non-adapted and adapted freshwater sediment slurries. *Appl. Microbiol. and Biotech.* 43:725-732.
30. Safe, S. 1992. Toxicology structure-function relationship and human environmental health impacts of polychlorinated biphenyls: Progress and problems. *Environ. Health Perspect.* 100:259-268.
31. Bolger, M. 1993. Overview of PCB toxicology. In: *Proceedings of the U.S. Environmental Protection Agency's National Technical Workshop "PCBs in Fish Tissue"* EPA/823-R-93-003. U.S. Environmental Protection Agency, Office of Water. Washington, DC. September. pp 1-37 to 1-53.
32. Flanagan, W.P., and R.J. May. 1993. Metabolic detection as evidence for naturally occurring aerobic PCB biodegradation in Hudson River sediments. *Environ. Sci. Technol.* 27:2207-2212.
33. Harkness, M.R., J.B. McDermott, D.A. Abramowicz, J.J. Salvo, W.P. Flanagan, M.L. Stephens, F.J. Mondello, R.J. May, J.H. Lobos, K.M. Carrol, M.J. Brennan, A.A. Bracco, K.M. Fish, G.L. Wagner, P.R. Wilson, D.K. Dierich, D.T. Lin, C.B. Morgan, and W.L. Gately. 1993. *In-situ* stimulation of aerobic PCB biodegradation in Hudson River sediments. *Science* 159:503-507.
34. Johnsen, R.E. 1976. DDT metabolism in microbial systems. *Residue Rev.* 61:1-28.
35. Rochkind, M.L., and J.W. Blackburn. 1986. *Microbial Decomposition of Chlorinated Aromatic Compounds*. EPA/600/2-86/090 U.S. Environmental Protection Agency. Office of Research and Development. Hazardous Waste Environmental Research Laboratory, Cincinnati, OH.
36. Stull, J.K., D.J.P. Swift, and A.W. Niedoroda. 1996. Contaminant dispersal on the Palos Verdes continental margin: I. Sediments and biota near a major California wastewater discharge. *Sci. of the Total Environment* 179:73-90.
37. National Research Council, National Academy of Sciences. 1977. *Drinking Water and Health, Part II, Chapter VI. Report of the Safe Drinking Water Committee*. PB-270-423. pp 97-105.

38. Callahan, M.A., M.W. Slimak, N.W. Gabel, I.P. May, C.F. Fowler, J.R. Freed, P. Jennings, R.L. Durfee, F.C. Whitmore, B. Maestri, W.R. Mabey, B.R. Holt, and C. Gould. 1979. *Water-Related Environmental Fate of 129 Priority Pollutants*. EPA-440/4-79-029a. U.S. Environmental Protection Agency, Office of Water Planning and Standard and Office of Water and Waste Management. Washington, DC.
39. Waslenchak, D.G., and H.L. Windom. 1978. Factors controlling the estuarine chemistry of arsenic. *Estuaries coastal Mar. Sci.* 7:455-464.
40. Waslenchak, D.G. 1979. The geochemical controls on arsenic concentrations in southeastern United States' rivers. *Chem. Geol.* 24:315-325.
41. U.S. EPA. 1993. *Guidance for Assessing Chemical Contaminants Data for Use in Fish Advisories*. EPA 823-R-93-002. U.S. Environmental Protection Agency, Office of Water. Washington, DC. August.
42. Hesse, J.L. 1993. Case study: Michigan. In: *Proceedings of the U.S. Environmental Protection Agency's National Technical Workshop "PCBs in Fish Tissue."* EPA/823-R-93-003. U.S. Environmental Protection Agency, Office of Water. Washington, DC. September. p 4-45.
43. Hugget, R.J., M.M. Nichols, and M.E. Bender. 1980. Kepone contamination of the James River Estuary. In: *Contaminants and Sediments*. R.A. Baker, ed. *Amer. Chem. Soc. Ann Arbor Science Publishers, Inc.* Ann arbor, MI. pp 33-52.
44. Nichols, M.M. 1990. Sedimentologic fate and cycling of Kepone in an estuarine system: Example from the James River Estuary. *Sci. And the Total Environment*. Elsevier Science Publishers B.V. Amsterdam. pp 407-440.
45. O'Conner, T.P. 1996. Trends in chemical concentration in mussels and oysters collected along the U.S. coast from 1996-1993. *Marine Environ. Res.* 41:183-200.
46. Velleux, M., J. Gailani, and D. Endicott. 1994. *User's Guide to the In-place Pollution Export (IPX) Water Quality Modeling Framework*. Draft report. U.S. Environmental Protection Agency. Large Lakes Res. Station. Grosse Ile, NH.
47. Gravens, M.B. 1992. *User's Guide to Shoreline Modeling System (SMS)*. Instruction Report CERC-92-1. Department of the Army. U.S. Corps of Engineers. Waterways Experiment Station. Vicksburg, MS. August.
48. Hanson, H., and N.C. Kraus. 1989. *Genesis: Generalized Model for Simulating Shoreline Change*. Technical Report, CERC-89-19. Department of the Army. U.S. Corps of Engineers. Waterways Experiment Station. Vicksburg, MS. December.
49. Rosati, J.D., R.A. Wise, N.C. Kraus, and M. Larson. 1993. *SBEACH: Numerical Model for Simulating Storm-induced Beach Change, User's Manual*. Instruction Report CERC-93-2. U.S. Army corps of Engineers. Coastal Engineering Research Program. Washington, DC. May.
50. Thomas, W.A., and W.H. McAnally. 1991 (Revised). *User's Manual for the Generalized Computer Program System, Open Channel Flow and Sedimentation*. TABS-MD. IR HL85-1. USAE Waterways Experiment Station. Vicksburg, MS. Orig. Publication date July 1985.
51. Spasojevic, M., and F.M. Holly. 1994. *Three-Dimensional Numerical Simulation of Mobile Bed Hydrodynamics*. CR HL-94-2. USAE Waterways Experiment Station. Vicksburg, MS.
52. Engel, J.J., R.H. Hotchkiss, and B.R. Hall. 1995. Three dimensional sediment transport modeling using CH3D computer model. In: *Proceedings of the First International Water Resources Engineering Conference*. W.H. Espey, Jr. and P.G. Combs, eds. *Amer. Soc. of Civil Engr.* NY. 628-632.
53. Velleux, M., S. Bums, J.V. DePinto, and J.P. Hassett. 1995b. A Screening Level Mass Balance Analysis Mirex Transport and Fate in the Oswego River. *J Great Lakes Res.* 21:95-111.
54. Gailani, J., W. Lick, C.K. Ziegler, and D. Endicott. 1996. Development and calibration of 2 fine grained sediment transport models for the Buffalo River. *J Great Lakes Res.* 22:765-778.
55. Teeter, A.M. 1988. *New Bedford Harbor Superfund Project, Acushnet River Estuary Engineering Feasibility Study of Dredging and Dredged Material Disposal Alternatives: Report 2-Sediment and Contaminant Hydraulic Transport Investigators*. Department of the Army. U.S. Corps of Engineers. Waterways Experimental Station. Vicksburg, MS. December.
56. Heath, R.E., T.L. Fagerburg, and T.M. Parchure. 1995. Scour of contaminated sediments in the Ashtabula River. Water Resources Engineering, vol. *Proceedings of the First International Conference sponsored by the Water Resources Division of ASCE*. San Antonio, TX.
57. Scheffner, N.W. 1996. Systematic analysis of long-term fate of disposed dredge material. *J. Waterway, Port Coastal and Ocean Engr.* 122:127-133.

- 
58. Buckman, H.O., and N.C. Brady. 1969. *The Nature and Properties of Soils: Seventh Edition*. The MacMillan Company, NY. p 229.
59. Williams, J.R. 1975. Sediment yield prediction with universal equation using run off energy factors. In: *Present and Prospective Technology for Predicting Sediment Yields and Sources*. ARS-S-40. U.S. Department of Agriculture.
60. U.S. EPA. 1994. *Methods for Measuring the Toxicity and Bioaccumulation of Sediment Associated Contaminants with Freshwater Invertebrates*. U.S. Environmental Protection Agency, Office of Research and Development, Duluth, MN. June.
61. Lee, H., 11, B.L. Boise, J. Pollitier, M. Winsor, D.T. Specht, and R.C. Randall. 1993. *Guidance Manual: Bedded Sediment Bioaccumulation Tests*. EPA/600/R-93/183. U.S. Environmental Protection Agency. Office of Research and Development. Washington, DC. September.

---

# Natural Recovery of Contaminated Sediments— Examples from Puget Sound

Todd M. Thornburg and Steve Garbaciak  
Hart Crowser, Inc.

## Introduction

With the development of Sediment Quality Objectives (SQOs) for the Commencement Bay Superfund Site in Tacoma [1] and the promulgation of the Washington State Sediment Management Standards (SMS [2]), state and federal regulatory agencies have been actively pursuing the investigation and cleanup of contaminated sediment sites in Puget Sound. This paper presents case studies on the application of natural recovery at three such contaminated sediment sites, and a survey of technical approaches which are available for evaluating the speed and effectiveness of the recovery process and predicting future risk at a site.

Natural recovery is a fundamental component of state and federal regulatory programs, and of EPA's Contaminated Sediment Management Strategy [3]. These programs emphasize that the aggressiveness of a cleanup remedy should be commensurate with the level of risk posed by contaminated sediments to human health and the ecological community, to ensure the most efficient use of our limited resources. Higher risk areas may require more aggressive removal or containment actions (i.e., dredging or thick capping), whereas areas which pose a lower risk may be suitable for natural recovery.

EPA [3] states that active remediation may not be required "if a combination of pollution prevention and source controls will allow the sediments to recover naturally in an acceptable period of time." Natural recovery encompasses the cumulative physical, chemical, and biological processes which result in a reduction in contaminant concentrations and the risks posed by contaminated sediments over time. Natural recovery is contingent on source control to prevent ongoing recontamination of sediments. Source control efforts should consider pollutant inputs to a water body (i.e., control of outfall discharges, bank/soil erosion, groundwater seepage, etc.) as well as containment of in-water hot spots which could disperse contaminants into surrounding areas if left unremediated.

The advantages of natural recovery include (1) existing benthic habitat is not disturbed; (2) buried contaminants are not remobilized during remedial construction activities; and (3) low cost. The disadvantages include (1) residual contamination is left in place and must be monitored; (2) the alternative may not be viable in navigational areas which require maintenance dredging; (3) the public may perceive natural recovery as a "do nothing" alternative, and may require education regarding the advantages of this approach for optimizing our limited resources as we strive to minimize site risk. To properly evaluate the feasibility of natural recovery, regulatory guidance must be provided regarding the time period over which recovery can take place, the depth of compliance for sediment concentrations, the level of risk that can be tolerated during the recovery period, and the monitoring requirements during recovery.

## Natural Recovery Processes and Data Needs

Given an appropriate level of source control, natural recovery of contaminated sediments can occur through a variety of physical, chemical, and biological processes, including those depicted on Figure 1. Physical processes include sediment transport and redistribution processes involving currents (advection), tides (dispersion), sedimentation and resuspension—processes which can bury or dilute existing contaminants with inputs of clean sediment. Chemical processes include diffusion from sediments to the overlying water column, and volatilization to the atmosphere—processes which allow contaminants to diffuse from sediments into more fluid media where they are rapidly dispersed. Biological processes include biodegradation, which can metabolize organic contaminants to carbon dioxide resulting in a permanent loss of risk, and bioturbation. Bioturbation refers to the overturning and mixing of surface sediments (usually the upper 5 to 20 centimeters) by benthic organisms, a process which can mitigate the impacts of short-lived pollutant loads, such as storm events, upsets in wastewater discharges, or other slug loads.

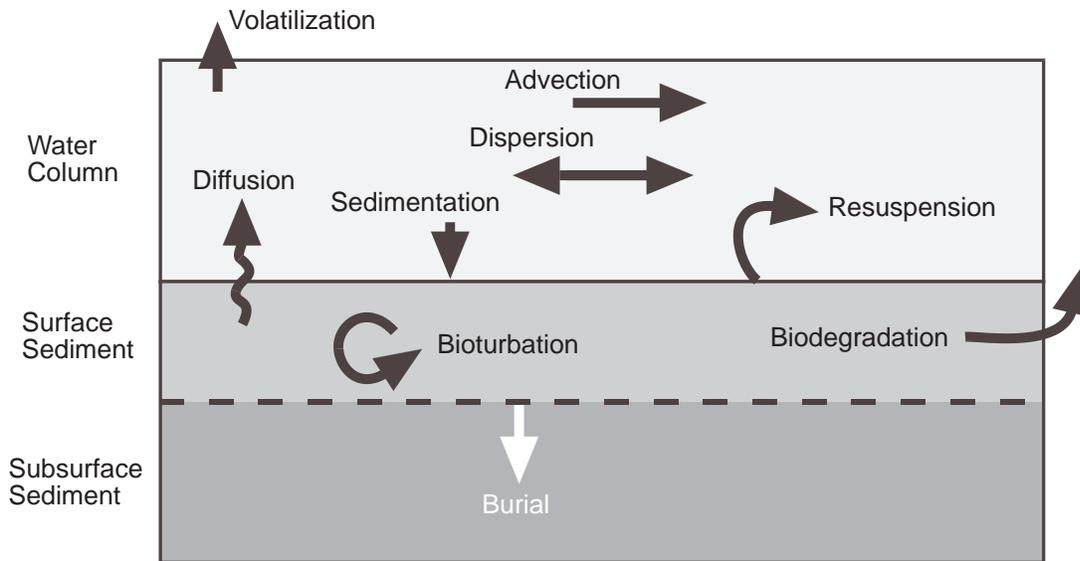

**Figure 1.** Summary of physical, chemical, and biological processes which contribute to the natural recovery of sediments, provided source controls are in place.

Several types of site-specific data are needed to make a technically defensible demonstration that natural recovery is a viable remedial alternative. A detailed map of contaminant distributions in surface sediments is needed to define initial conditions, and to outline in a preliminary manner those areas which may be suitable for natural recovery versus those which may require a more active remedy. Current and tidal dynamics in an estuary (ad-

vection and dispersion terms) may be obtained from current meter deployments, dye-tracing studies, or by analysis of salinity distributions. Sediment transport parameters (sedimentation and resuspension rates) are typically developed using sediment trap deployments and age-dated sediment cores. Sediment cores may be dated by radioisotopic methods (cesium-137 and lead-210 being the most common), or by the identifica-

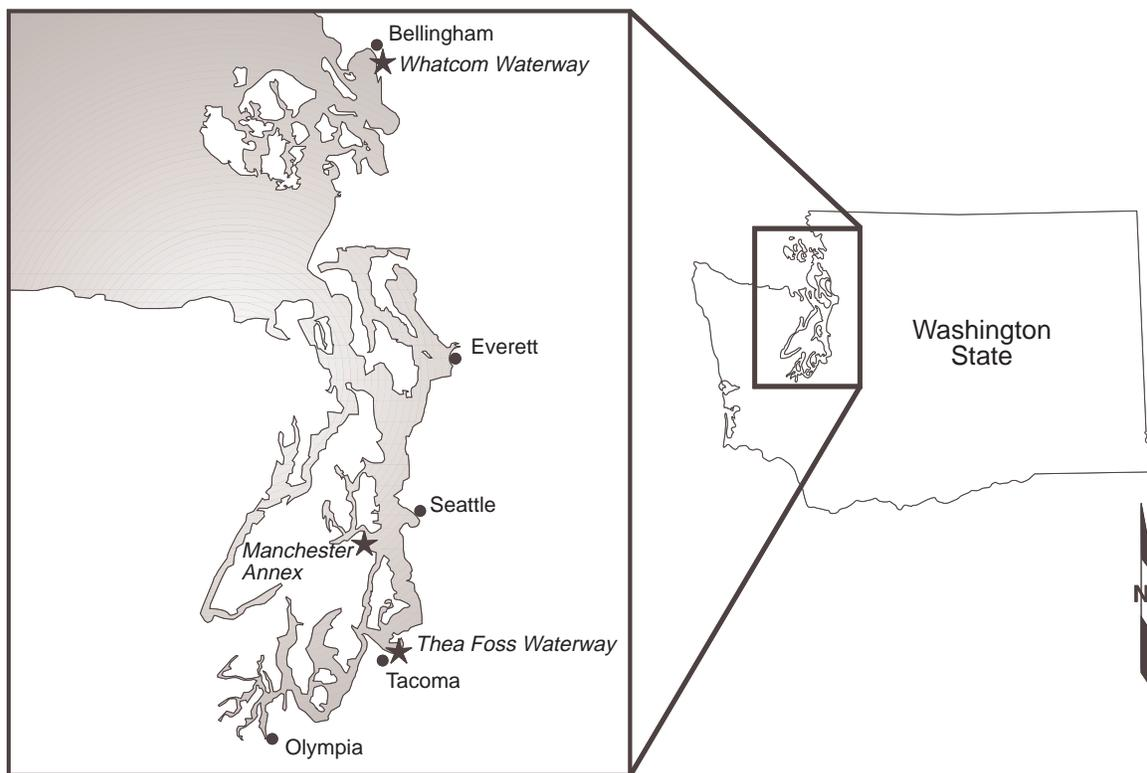

**Figure 2.** Location map of Puget Sound case studies. Whatcom Waterway is a state-lead (Dept. of Ecology) RI/FS; Manchester Annex is a federal-lead (Corps of Engineers) RI/FS; Thea Foss Waterway is a federal-lead (EPA) remedial design.

tion of stratigraphic markers, such as the depth to a geologic contact which corresponds to a datable dredging event. Finally, a quantitative assessment of current source loads to the water body, and potential pollutant reductions which may be realized by implementing additional source controls in upland drainages, is a critical component of the evaluation.

## Case Studies in Puget Sound

Case studies are presented for three contaminated sediment sites in Puget Sound where natural recovery is or will be a key component of the cleanup strategy. The sites include the Whatcom Waterway in Bellingham, the Manchester Annex near Bremerton, and the Thea Foss Waterway in Tacoma (Figure 2).

The sites provide examples of the application of natural recovery analysis to sediments containing a variety of chemicals of concern (mercury, PCBs, and PAHs). In addition, the sites provide examples of three different technical approaches to natural recovery analysis, including (1) empirical trend analysis, (2) one-dimensional

sedimentation/bioturbation modeling [4], and (3) two-dimensional contaminant transport modeling [5].

### Whatcom Waterway Site

The Whatcom Waterway site occupies the primary federal navigation channel on the Bellingham waterfront. The site is undergoing a RI/FS under the lead of the Washington State Department of Ecology. The primary contaminant of concern in sediments is mercury, derived from historical discharges from a chlor/alkali plant at a pulp and paper mill on the waterway. Untreated chlor/alkali wastewater was discharged from 1965 to 1970, at which time aggressive source control measures were implemented and the discharge was practically ceased. Present-day sediment contamination is the result of residual mercury accumulations in the Whatcom Waterway which have also dispersed into the inner parts of Bellingham Bay. Natural recovery is not proposed for the waterway itself, because much of the channel is already above navigation depth; however, natural recovery is a viable alternative for lower-risk mercury concentrations in the sediments of the inner bay.

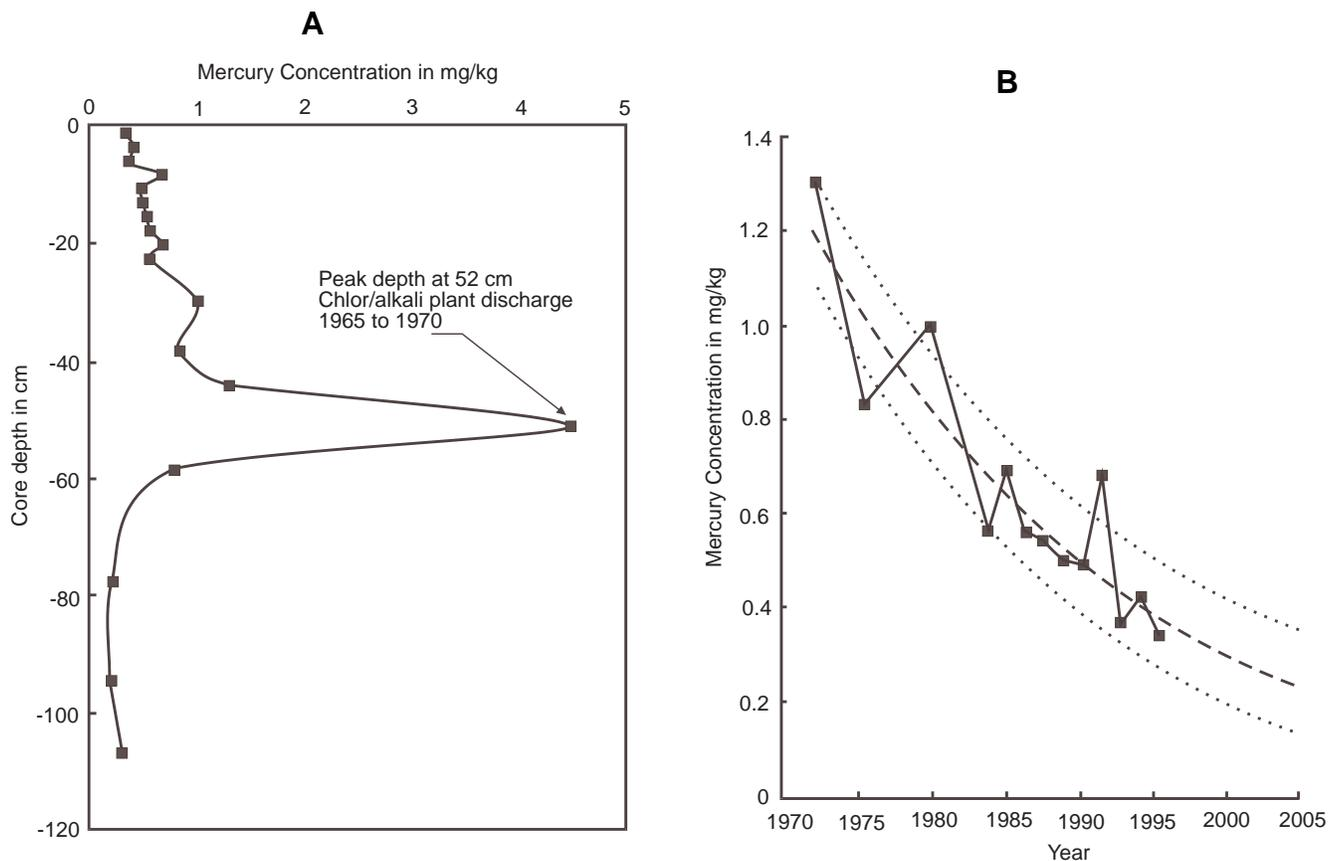

**Figure 3.** Empirical projection of sediment concentrations following source control, Whatcom Waterway, Bellingham. (A) High-resolution core profile of subsurface mercury concentrations; mercury peak of 4.5 mg/kg at 52 cm depth corresponds to chlor/alkali plant discharges from 1965 to 1970. (B) Trend analysis of upper 45 cm of core (period following source control). Depth axis is converted to time using a sedimentation rate of 1.6 cm/yr. Data are fit with an exponential decay curve to allow predictions of future recovery rates.

A high-resolution mercury profile in a sediment core from the inner bay is shown on Figure 3A. The subsurface mercury peak of 4.5 mg/kg, between about 45 and 55 cm depth, corresponds to the peak historical discharges between 1965 and 1970. Following source control, mercury concentrations were abruptly reduced, to about 1 mg/kg, and concentrations have continued to decrease through time to less than 0.5 mg/kg at the present sediment surface.

The depth profile of mercury in the sediment core was translated into a time series, shown on Figure 3B, using a sedimentation rate of 1.6 cm/yr which was independently estimated using radioisotopic dating methods. A least-squares regression line was fit to the post-1970 data (the period following source control) using an exponential decay model. The regression line indicates that mercury concentrations undergo a 50% reduction every thirteen years; this decay rate can be extrapolated to estimate future mercury concentrations in the inner bay.

The advantage of this type of trend analysis lies in its simplicity. The disadvantages include its limited applicability, which is largely restricted to historical discharges which were shut down at some point in the past. In addition, the extrapolation may be invalidated if the

dynamics of the site are changed. For example, if removal actions are implemented in the navigation channel such that the channel no longer contributes suspended sediments with elevated mercury concentrations to the inner bay, natural recovery will be accelerated.

### Manchester Annex Site

The Manchester Annex site is a historical Navy fuel depot where a coastal lagoon was infilled with solid waste between 1946 and 1962, forming a coastal landfill which extends onto the upper tideflat of Clam Bay. Some of the landfill debris contained waste oil contaminated with PCBs, and PCBs have since dispersed into the tideflat sediments and the clams that live in those sediments. The landfill continues to provide an ongoing source of PCBs to the tideflat, largely through mechanical erosion of the toe of the landfill. However, the preferred remedial alternative at this site includes excavation of the intertidal portion of the landfill, and hydraulic and structural controls for the upland portion of the landfill, which should eliminate future inputs of PCBs to the tideflat sediments. The risk associated with this site

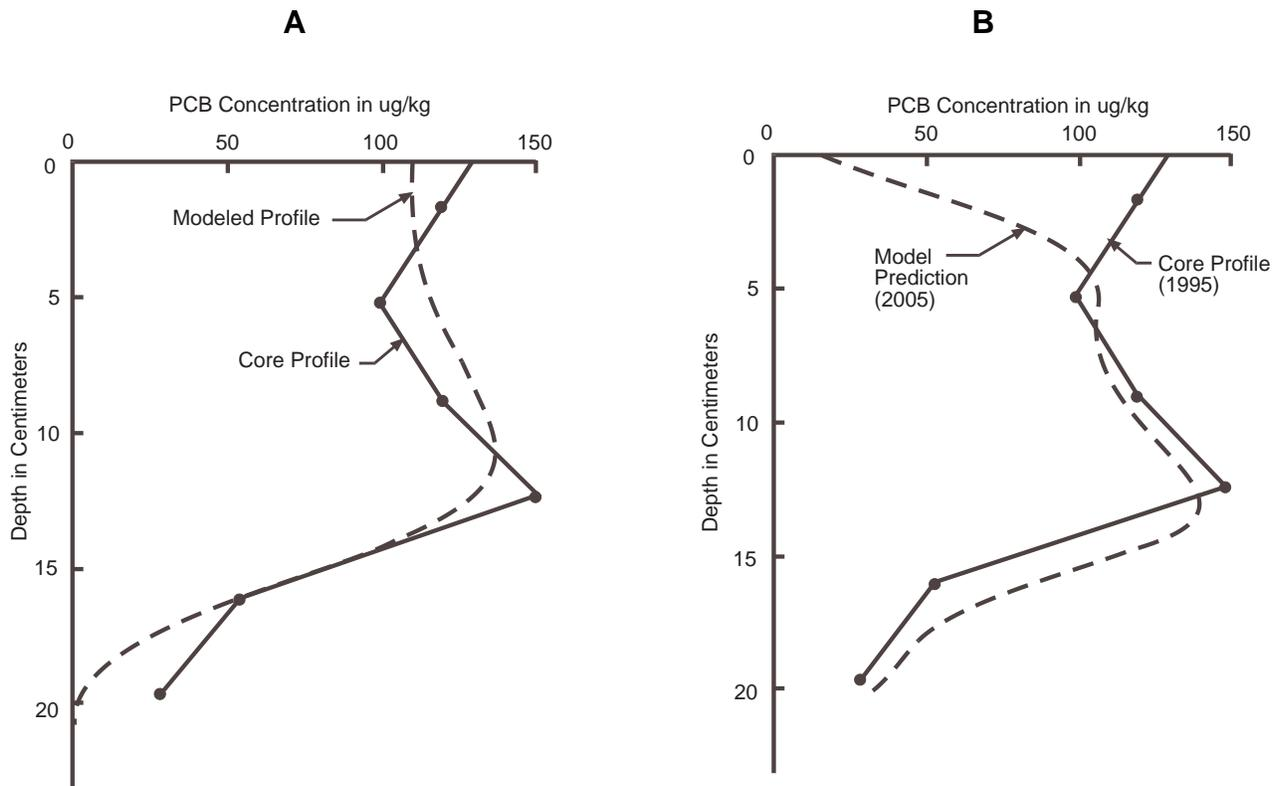

**Figure 4.** Application of 1-D sedimentation/bioturbation model (Officer and Lynch, 1989) to natural recovery predictions, Manchester Annex Site near Bremerton. (A) Model verification step—core profile is simulated using a peak “discharge” period from 1946 to 1962 resulting from PCB disposal in a coastal landfill. (B) Ten-year model prediction shows relatively rapid recovery in upper 5 cm of sediment in response to burial and resuspension of surface sediments, following isolation of source inputs from the landfill.

---

is primarily a human health concern from ingestion of PCB-contaminated shellfish.

The PCB profile in a sediment core from the upper tidelflat, just beyond the edge of the landfill, is shown on Figure 4A. The solid line depicts the actual analytical results from this core, and the dashed line is the PCB profile which was simulated using a one-dimensional sedimentation/ bioturbation model developed by Officer and Lynch [4]. The PCB profile was simulated by supplying a history of PCB source inputs, and specifying sedimentation and resuspension rates, a bioturbation coefficient (a dispersion term), and a bioturbation depth, below which dispersion of contaminants ceases. The modeled profile agrees well with the actual data.

A subsurface peak concentration of 150 µg/kg, between about 10 and 15 cm depth, corresponds to the period of active infilling of the lagoon; PCBs were also mixed to greater depths and into native sediments by bioturbation. PCB concentrations remain elevated to the present-day sediment surface, as a result of continued inputs from coastal erosion of the landfill.

The modeled PCB sediment profile was run forward in time for ten years, assuming that remediation of the landfill would reduce future PCB inputs by at least 90%; the predicted profile ten years after remediation is shown on Figure 4B. The model predicts that PCB concentrations in the upper 5 cm of the core will recover rapidly following the curtailment of source inputs. The processes responsible for the PCB reductions include burial of contaminated sediments with new clean sediments, and mixing of clean sediments into the upper sediment column through bioturbation. The PCB concentrations in clam tissue are also expected to recover rapidly, because these filter-feeding organisms are primarily exposed to PCBs in the upper few centimeters of sediment, i.e., those sediments which are available for resuspension into the water column. Based on a correlation between sediment and tissue PCB concentrations at the site (biota-to-sediment accumulation factor [BSAF]), the natural recovery model for PCBs in sediment also predicts that PCBs in clam tissue will be reduced to an acceptable level of risk within ten years.

### ***Thea Foss Waterway Site***

The Thea Foss Waterway is a navigation channel that was carved into the Puyallup River delta near the turn of the century; the waterway is part of the Commencement Bay Superfund Site and is presently undergoing remedial design. The waterway has had a long and complex urban land use history, and has accumulated a variety of contaminants, but PAHs and phthalates appear to pose the greatest risk to the ecological community. In

addition, two large storm drains—remnants of a once-natural stream channel—collect runoff from much of the City of Tacoma and discharge to the head of the waterway.

A more complex model was warranted at this site, due to the complexity of sources, the diversity of contaminants, and to help the City manage pollutant loads associated with storm water discharges. A two-dimensional configuration of the EPA-supported computer code WASP (Water Quality Analysis Simulation Program) was developed. The site was partitioned into seven horizontal segments and four vertical segments (surface and deep water, surface and subsurface sediment segments), as shown on Figure 5A. Comprehensive data collection efforts were required to develop site-specific model input parameters, including age-dated cores, sediment trap deployments, hydrodynamic studies, long-term out-fall monitoring, water column sampling, sediment leachability testing, and biodegradation rate measurements.

An example of model output for phenanthrene (a low-molecular weight PAH) is shown on Figure 5B. The model predicts surface sediment concentrations (segments 15 through 21) on a yearly basis for ten years; shaded boxes indicate predicted sediment concentrations which exceed the Sediment Quality Objective (SQO) for phenanthrene (1,500 µg/kg) in Commencement Bay. Although initial sediment concentrations are above the SQO at the head of the waterway (segments 19, 20, and 21) and in an isolated hot spot at the mouth of the waterway (segment 16), sediment concentrations are everywhere predicted to recover to below the SQO within eight years in all waterway segments.

Although it usually requires more costly data collection efforts and more rigorous calibration, the WASP model is a flexible and powerful analytical tool for use in natural recovery predictions, and for managing contaminated sediments in general. The model is capable of describing all of the contaminant transport processes depicted on Figure 1, and is one of the best tools available for quantifying the relationship between spatially distributed source loads and sediment concentrations in a receiving water body.

### **Conclusions**

Natural recovery should be given due consideration in the formulation of sediment remedial alternatives, if not alone, then in combination with more active remedial technologies such as dredging and/or capping. Natural recovery has been successfully applied as a key component in cleanup strategies at several sites in Puget Sound, and has been recognized by regulators for its importance in optimizing our limited resources while reducing site risk. Several technical approaches to natural recovery analysis are available, with varying levels of complexity, which can be tailored to the special needs of a project.

# (A) WASP Model Segments Thea Foss Waterway

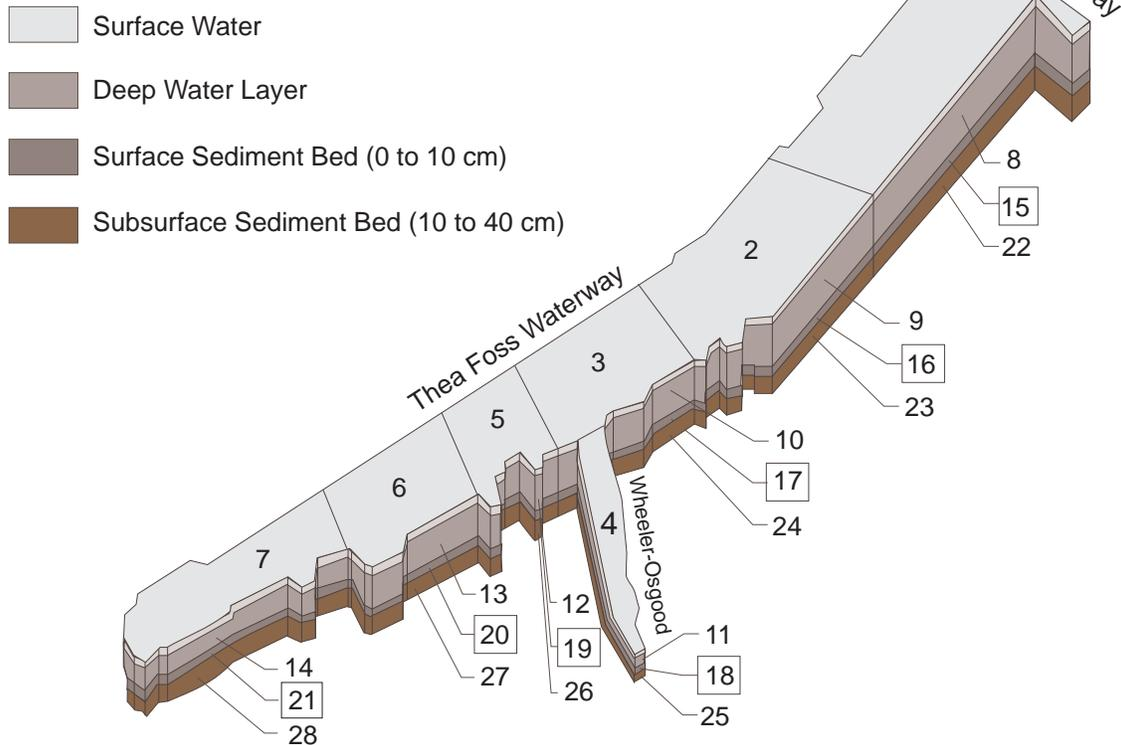

## (B) Predicted Phenanthrene Concentration in Surface Sediment ( $\mu\text{g}/\text{kg}$ )

Year	Surface Sediment Segment Number						
	15	16	17	18	19	20	21
0	1,240	2,790	1,230	1,090	2,490	1,800	3,050
1	1,170	2,530	1,150	1,100	2,040	1,530	2,650
2	1,100	2,300	1,090	1,110	1,710	1,350	2,340
3	1,050	2,100	1,040	11,20	1,480	1,220	2,100
4	995	1,920	998	1,130	1,310	1,140	1,900
5	948	1,770	962	1,130	1,190	1,080	1,740
6	906	1,640	933	1,130	1,110	1,050	1,620
7	868	1,520	909	1,140	1,040	1,020	1,520
8	834	1,410	889	1,140	997	1,000	1,450
9	804	1,320	872	1,140	964	991	1,380
10	777	1,240	859	1,140	941	982	1,330
Steady-State	540	673	791	1,150	878	963	1,140

Predicted Sediment Concentration Exceeds SQO

**Figure 5.** Application of EPA’s Water Quality Analysis Simulation Program (WASP) to natural recovery predictions, Thea Foss Waterway, Tacoma. (A) 2-D model segmentation scheme, including 7 horizontal segments and 4 vertical segments (surface and deep water, surface and subsurface sediment). (B) Ten-year model predictions of surface sediment concentrations for phenanthrene (a PAH). Shaded boxes indicate exceedences of the cleanup level in segments 16, 19, 20, and 21; however, these areas are predicted to recover within 2 to 8 years.

---

## References

1. U.S. EPA, 1989. Commencement Bay Nearshore/Tideflats Record of Decision, Region 10, Seattle, WA, September 1989.
2. Washington State Department of Ecology, 1995. Sediment Management Standards, Chapter 173-204 *Washington Administrative Code*, Amended December 1995.
3. U.S. EPA, 1994. EPA's *Contaminated Sediment Management Strategy*, Washington, DC, August 1994.
4. Officer, Charles B., and Daniel R. Lynch, 1989. Bioturbation, Sedimentation and Sediment-Water Exchanges. *Estuarine, Coastal and Shelf Science* 28:1-12.
5. Ambrose, Robert B., Tim A. Wool, and James L. Martin, 1993. *The Water Quality Analysis Simulation Program, WASP 5*, Environmental Research Laboratory, Athens, GA, September 20, 1993.

---

# ***In-Situ Capping of Contaminated Sediment Overview and Case Studies***

Michael R. Palermo

Research Civil Engineer, U.S. Army Engineer Waterways Experiment Station, Vicksburg, MS

## **Abstract**

*In-situ* capping, the placement of a subaqueous covering or cap of clean isolating material over an *in-situ* deposit of contaminated sediment, is a potentially economical and effective approach for remediation of contaminated sediment. A number of sites have been remediated by *in-situ* capping operations worldwide. EPA has developed detailed guidelines for planning, design, construction, and monitoring of *in-situ* capping projects. This paper briefly describes the major aspects of *in-situ* capping as an option and provides a summary of recent case studies.

## ***In-Situ Capping Defined***

*In-situ* capping (ISC) refers to placement of a subaqueous covering or cap over an *in-situ* deposit of contaminated sediment. The cap may be constructed of clean sediments, sand, gravel, or may involve a more complex design with geotextiles, liners and multiple layers. *In-situ* capping can serve three primary functions:

- a. physical isolation of the contaminated sediment from the benthic environment,
- b. stabilization of contaminated sediments, preventing resuspension and transport to other sites, and
- c. reduction of the flux of dissolved contaminants into the water column.

To achieve these results, an *in-situ* capping project must be treated as an engineered project with carefully considered design, construction, and monitoring. The basic criterion for a successful capping project is simply that the cap required to perform some or all of these functions be successfully designed, placed, and maintained.

## **Design Guidance for *In-Situ* Capping**

Detailed guidelines for designing, constructing and managing *in-situ* capping as a sediment remediation alternative have been developed by the U.S. Environmental

Protection Agency (USEPA) under the Assessment and Remediation of Contaminated Sediments Program, administered by USEPA's Great Lakes National Program Office, in Chicago, IL. (1) The major activities associated with evaluating an ISC option include:

1. Set a cleanup objective, i.e., a contaminant concentration or other benchmark. The cleanup objective will be developed as a prerequisite to the evaluation of all remediation alternatives.
2. Characterize the contaminated sediment site under consideration for remediation. This includes gathering data on waterway features (water depths, bathymetry, currents, wave energies, etc.); waterway uses (navigation, recreation, water supply, wastewater discharge, etc.); and information on geotechnical conditions (stratification of underlying sediment layers, depth to bedrock, physical properties of foundation layers, potential for groundwater flow, etc.). Determine if advective processes are present and the ability of the cap to control advective contaminant losses. Determine any institutional constraints associated with placement of a cap at the site.
3. Characterize the contaminated sediments under consideration. This includes the physical, chemical, and biological characteristics of the sediments. These characteristics should be determined both horizontally and vertically. The results of the characterization, in concert with the cleanup objective, will determine the areal extent or boundaries of the area to be capped.
4. Make a preliminary determination on the feasibility of ISC based on information obtained about the site and sediments. If site conditions or institutional constraints indicate that ISC is not feasible, other remediation options must be considered.
5. Identify potential sources of capping materials, including clean sediments that might be dredged

---

and upland sites or commercial sources for soil, gravel and stone.

6. Design the cap composition and thickness. Caps will normally be composed of clean sediments, however, other materials such as armor stone or geotextiles may be considered. The cap design must consider the need for effective short- and long-term chemical isolation of contaminants, bioturbation, consolidation, erosion, and other pertinent processes. If the potential for erosion of the cap is significant, the cap thickness can be increased, provisions can be made for placement of additional cap material following erosion, other capping materials could be considered, or an armor layer could be incorporated into the design. Cross sections illustrating the designs of several caps are shown in Figure 1.
7. Select appropriate equipment and placement techniques for the capping materials. The potential for short-term contaminant losses associated with cap placement should be considered in selecting a placement approach.
8. Evaluate if the capping design meets the cleanup objectives. If not, either reevaluate cap design or consider other alternatives.
9. Develop an appropriate monitoring and management program to include construction monitoring during cap placement and long-term monitoring following cap placement. The site management program should include actions to be taken based on the results of monitoring and provisions for future maintenance.
10. Develop cost estimates for the project to include construction, monitoring and maintenance costs. If costs are acceptable, implement. If costs are unacceptable, reevaluate design or consider other alternatives.

## Case Studies

A number of ISC operations have been performed under varying site conditions, and are summarized in Table 1. ISC has been applied to riverine, nearshore, and estuarine settings. Conventional dredging and construction equipment and techniques have been used for ISC projects, but these practices were precisely controlled. The success of projects to date and available monitoring data at several sites indicates that ISC can be an effective technique for long-term containment of contaminants.

*In-situ* capping of nutrient-laden sediments with sand has been demonstrated at a number of sites in Japan, including embayments and interior lakes (2). The primary objective of the capping was to reduce the release of nutrients (nitrogen and phosphorous) and oxygen depletion by bottom sediments which were contributing

to degraded water quality conditions. Studies have included measurements of nutrients in interstitial and overlying water at capped sites, development of a numerical model for predicting water quality improvements from capping, and monitoring benthos recovery at capped sites.

A variety of ISC projects have been conducted in the Puget Sound area. At the Denny Way project, a layer of sandy capping sediment was spread over a three-acre contaminated nearshore area with water depths of 20 to 60 feet (see Figure 2). A combination of a sewer outfall discharge and combined sewer overflow (CSO) had contaminated the site with lead, mercury, zinc, PAHs and PCBs. The capping was a cooperative effort between the Municipality of Metropolitan Seattle (METRO) and the Seattle District, USACE (3, 4). At the Simpson-Tacoma Kraft paper mill, ISC was conducted as part of a Superfund project. Discharges of paper and pulp mill waste had contaminated the site with PAHs, naphthalene, phenol, dioxins, and other contaminants. A 17-acre area was capped with material from a sand bar in the adjacent Puyallup River. An *in-situ* capping project at the Eagle Harbor Superfund site at Brainbridge Island placed a 3-to-6 foot layer of sand over creosote contaminated sediments in water depths of 40-60 feet. Sediments dredged from the Snohomish River navigation project were transported to Eagle Harbor and placed over a capped area of about 54 acres (4). It was decided to cap two areas at the site with different materials (see Figure 3). Areas 1 and 2 are at a water depth of 17 and 13 m, respectively. A split hull barge was used in Area 1 and the water jet washing of material off of a barge was used for Area 2. Other ISC projects in the Puget Sound area include those at the West Waterway and Piers 51, 53, and 54.

ISC, with an armoring layer, has also been demonstrated at a Superfund site in Sheboygan Falls, WI. This project involved placement of a composite cap, with layers of gravel and geotextile to cover several small areas of PCB-contaminated sediments in a shallow (<5 feet) river and floodway (see Figure 1). A total area of about one acre of cap was placed with land-based construction equipment and manual labor (5).

At Eitrhein Bay in Norway, a composite cap of geotextile and gabions was constructed as a remediation project in a fjord at an area contaminated with heavy metals (6). A total area of 100,000 square meters was capped, in water depths of up to 10 meters.

At Manistique, MI, an interim cap of 40-mil thick plastic liner was placed over a small (0.5 acre) deposit of PCB-contaminated sediments in order to prevent the resuspension and transport of sediments until a final remediation was implemented. A larger area was evaluated for capping, with the cap design incorporating an armor layer and sand layer enhanced with activated carbon (see Figure 1).

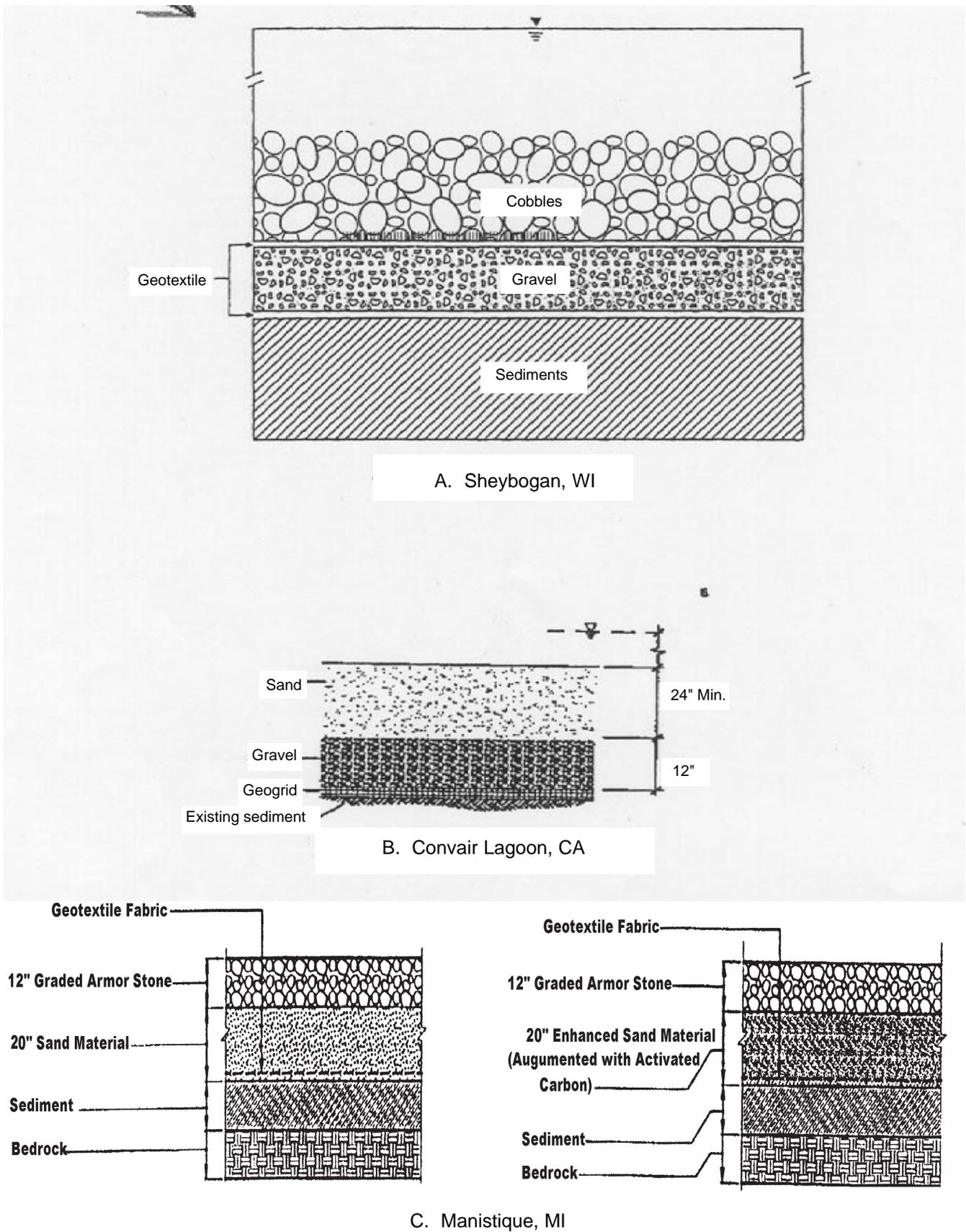

Figure 1. Illustrations of alternative combinations of cap components.

**Table 1.** Summary of Selected In-Situ Capping Projects

Project Location	Contaminants	Site Conditions	Cap Design	Construction Methods	Reference
Kihama Inner Lake, Japan	Nutrients	3,700 m <sup>2</sup>	Fine sand, 5 and 20cm		
Akanoi Bay, Japan	Nutrients	20,000 m <sup>2</sup>	Fine sand, 20 cm		
Denny Way, WA	PAHs, PCBs	3 acres nearshore with depths from 20 to 60 ft.	Avg 2.6 of sandy sediment	barge spreading	Sumeri et al. 1995
Simpson-Tacoma, WA	creosote, PAHs, dioxins	17 acres nearshore with varying depth	4 to 20 feet of sandy sediment	hydraulic pipeline with "sandbox"	Sumeri et al. 1995
Eagle Harbor, WA	creosote	54 acres within embayment	3 ft of sandy sediment	barge spreading and hydraulic jet	Sumeri et al. 1995
Sheboygan River, WI	PCBs	several small areas of shallow river/ floodplain	sand layer with armor stone	direct mechanical placement	Eleder
Manistique River, MI	PCBs	20,000 ft <sup>2</sup> shoal in river with depths of 10–15 ft	40 mil plastic liner	placement by crane from barge	Hahnenberg, pers comm
Hamilton Harbor, Ontario	PAHs, metals, nutrients	10,000 m <sup>2</sup> portion of large, industrial harbor	0.5 m sand	Tremie Tube	Zeman, pers comm
Convair Lagoon, CA	PCBs	5 acres nearshore	sand and gravel	under construction	
Eitrheim Bay, Norway	metals	100,000 M <sup>2</sup>	geotextile and gabions	deployed from barge	Instanes 1994
St. Lawrence River, Massena, NY	PCBs	75,000 ft <sup>2</sup>	6 in sand/6 in gravel/6 in stone	placed by bucket from barge	Kenna, pers comm

PCB-contaminated sediments at the General Motors Superfund site in Massena, NY, were removed from the St. Lawrence River by dredging. The remedial objective for the site was 1 ppm, but areas remaining at concentrations greater than 10 ppm after repeated dredging attempts were capped. An area of approximately 75,000 square feet was capped with a three-layer ISC composed of 6 inches of sand, 6 inches of gravel and 6 inches of armor stone.

At Convair Lagoon, in San Diego Bay, a multilayer cap with a layer of gravel and sand is currently under construction (7). The total area to be capped is approximately 5 acres (see Figure 4). The full sand and gravel cap will be placed over a portion of the site, and a sand cap layer over a less-contaminated portion. The site will also be confined by a submerged gravel berm. This project is unique in that the gravel layer was incorporated into the cap design to prevent bioturbation by deep burrowing shrimp which were known to inhabit the area. The gravel layer was located below the sand layer as a barrier to the burrowing shrimp (see Figure 1). The materials are to be placed from barges.

At Hamilton Harbor, in Burlington, Ontario, a 0.5 m-thick sand cap was placed over a 10,000 m<sup>2</sup> area of PAH-contaminated sediments (see Figure 5) as a technology demonstration conducted by Environment Canada (8,9). The cap material was placed using a barge-mounted array of tremie tubes for sand spreading. The barge was guided by a system of anchors and cables for precise positioning (see Figure 6).

Field monitoring studies have been conducted on long-term effectiveness of dredged material caps located in Long Island Sound, the New York Bight, and in Puget Sound. Sequences of cores taken over time periods of up to 15 years (10, 11, 12) show a clear visual transition from cap to contaminated sediment and are closely correlated with sharp changes in the sediment chemistry profiles. The data collected to date suggests that there has been minimal long-term transport of contaminants up into the caps. All of the *in-situ* capping projects mentioned above have monitoring programs in place, so there will be a great deal of additional data on capping effectiveness available in the future.

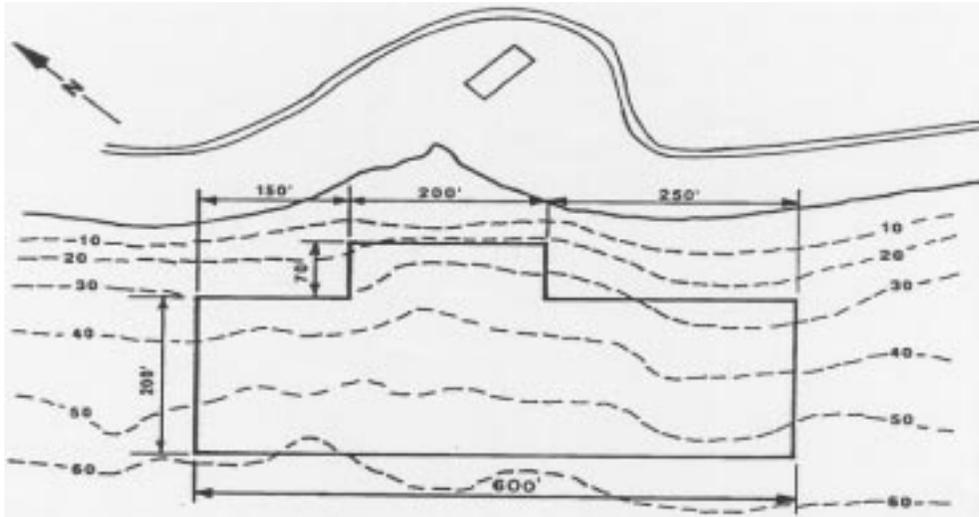

Figure 2. Sandy capping sediment over a three-acre contaminated nearshore area—Denny Way project.

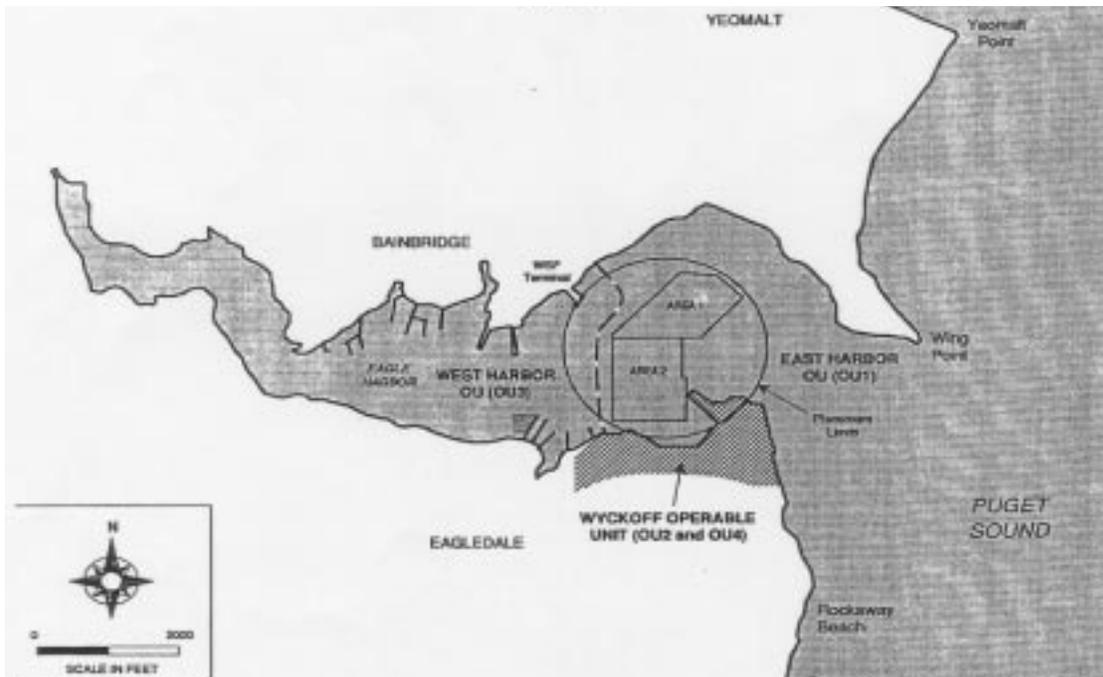

Figure 3. Sandy capping sediment over a three-acre contaminated nearshore area—Eagle Harbor project.

## Summary

An ISC operation must be treated as an engineered project with carefully considered design, construction, and monitoring to ensure that the design is adequate. A number of ISC projects have been implemented worldwide for a wide range of project conditions. These

projects have incorporated several types of cap designs, cap materials, and cap placement methods. Detailed guidance for planning, design, construction, and monitoring of *in-situ* capping projects has been developed by EPA and should be followed when evaluating the feasibility of *in-situ* capping as a sediment remediation technique.

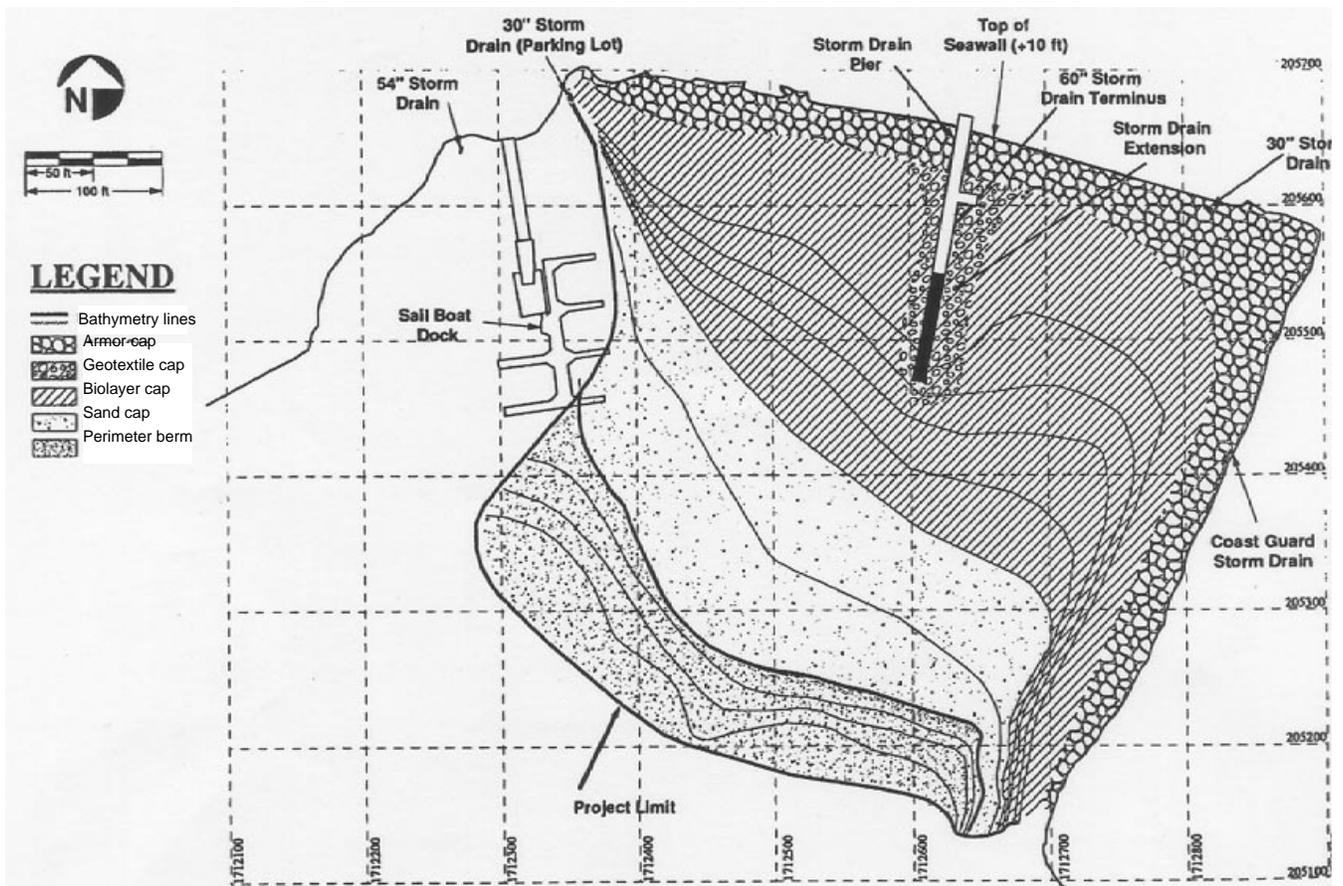

Figure 4. Total area to be capped (approximately 5 acres, Convair Lagoon).

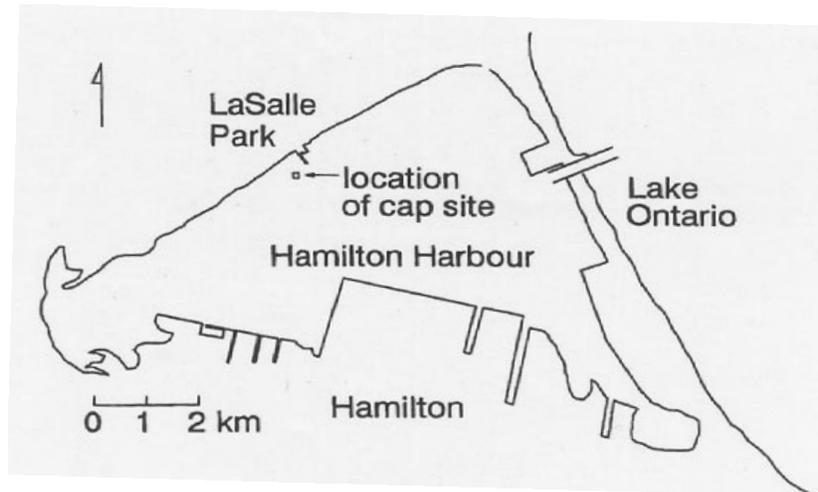

Figure 5. Sand cap over PAH-contaminated sediments (Hamilton Harbor, Burlington, Ontario).

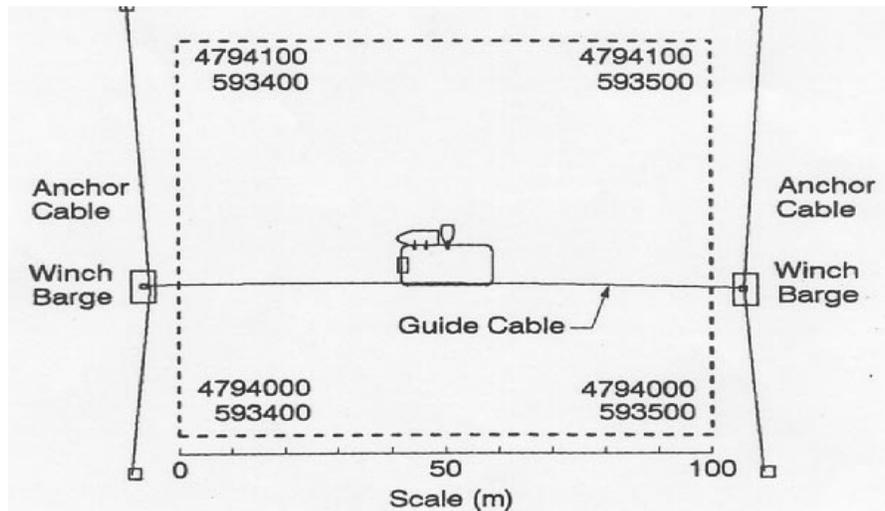

Figure 6. System of anchors and cables for precise positioning (Hamilton Harbor, Burlington, Ontario).

## Acknowledgment

This paper summarizes work conducted for the U.S. Environmental Protection Agency Assessment and Remediation of Contaminated Sediments (ARCS) Program by the U.S. Army Engineer Waterways Experiment Station. Permission to publish this material was granted by the Chief of Engineers.

## References

- Palermo, M.R., S. Maynard, J. Miller, and D. Reible, *Guidance for In-Situ Subaqueous Capping of Contaminated Sediments*, EPA 905-1396-004, Assessment and Remediation of Contaminated Sediments Program, Great Lakes National Program Office, U.S. Environmental Protection Agency, Chicago, IL.
- Zeman, A. J., S. Sills, J.E. Graham, and K.A. Klein, 1992. *Subaqueous Capping of Contaminated Sediments: Annotated Bibliography*, NWRI Contribution No. 92-65, National Water Research Institute, Burlington, Ontario.
- Sumeri, A. 1989. "Confined Aquatic Disposal and Capping of Contaminated Bottom Sediments in Puget Sound," 12th World Dredging Congress, Orlando, FL.
- Sumeri, A. 1995. "Dredged Material is Not Spoil—A Status on the Use of Dredged Material in Puget Sound to Isolate Contaminated Sediments," 14th

- 
- World Dredging Congress, Amsterdam, The Netherlands.
5. Eleder, B. 1992. "Sheboygan River Capping/armoring Demonstration Project," Presented at a Workshop on Capping Contaminated Sediments, May 27–28, 1992, Chicago, IL.
  6. Instanes, D. 1994. "Pollution Control of a Norwegian Fjord by Use of Geotextiles," Fifth International Conference on Geotextiles, Geomembranes, and Related Products, Singapore, 5–9 September 1994.
  7. Ogden Environmental and Energy Services. 1993. *Environmental Impact Report—Remedial Action Plan - Convair Lagoon Remediation*, Report prepared for San Diego Unified Port District, San Diego, California.
  8. Zeman, A.J. and T.S. Patterson, 1996a. "Preliminary Results of Demonstration Capping Project in Hamilton Harbor," NWRI Contribution No. 96-53, National Water Research Institute, Burlington, Ontario.
  9. Zeman, A.J. and T.S. Patterson, 1996. "Results of the *In-situ* Capping Demonstration Project in Hamilton Harbor, Lake Ontario," NWRI Contribution No. 96-75, National Water Research Institute, Burlington, Ontario.
  10. Fredette, T. J., J.D. German, P.G. Kullberg, D.A. Carey, and P. Murray, 1992. "Chemical Stability of Capped Dredged Material Disposal Mounds in Long Island Sound, USA." 1st International Ocean Pollution Symposium, Mayaguez, Puerto Rico. Chemistry and Ecology.
  11. Brannon, J., and M.E. Poindexter-Rollins, 1990. "Consolidation and Contaminant Migration in a Capped Dredged Material Deposit," *Sci. Tot Env.*, 91, 115–126.
  12. Sumeri, A., T.J. Fredette, P.G. Kullberg, J.D. German, D.A. Carey, and P. Pechko, 1994. "Sediment Chemistry Profiles of Capped Dredged Material Deposits Taken 3 to 11 Years after Capping," Dredging Research Technical Note DRP-5-09, U.S. Army Engineer Waterways Experiment Station, Vicksburg, MS.

---

# Observations Regarding Brownfields and Sediment Disposal at Indiana Harbor

David M. Petrovski, Environmental Scientist  
U.S. Environmental Protection Agency  
Region 5, Chicago, IL

Richard L. Nagle, Attorney  
U.S. Environmental Protection Agency  
Region 5, Chicago, IL

Jan Miller, Environmental Engineer  
USACE, Great Lakes and Ohio River Division  
Chicago, IL

Gregory N. Richardson, Principal  
G.N. Richardson & Associates  
Raleigh, NC

## Abstract

To date, the 25-year delay in dredging the federal project at Indiana Harbor in East Chicago, IN, has emphasized the difficulties associated with implementing the current federal approach to the disposal of contaminated sediments in the Great Lakes. The current method is premised upon the availability and provision of a clean, close, cost-free upland or in-water site, which reverts back to the provider after disposal operations have ceased. An urban setting, high contaminant concentrations, and liability concerns have made application of this strategy at Indiana Harbor especially challenging. Efforts to predict the liability exposure associated with the use of a former refinery to dispose of Indiana Harbor sediments have raised issues which may possess generic utility. Concepts rooted in these issues suggest a new approach for the disposal of contaminated sediments. The new approach would preferentially select contaminated brownfield sites associated with especially challenging remedial issues for the construction of sediment disposal facilities. Properly implemented, this would enhance public acceptance, reduce expenditures, remediate unaddressed contaminated sites and allow problematic dredging projects to proceed in a more timely fashion.

---

The views contained in this paper represent those of the authors and not the policies or positions of the U.S. EPA or the USACE.

## Introduction

Every year in the Great Lakes approximately 4 million cubic yards of sediments are dredged. Most of the dredging is performed to maintain safe depths for commercial and recreational navigation. Approximately half of these dredged materials are clean, and can be disposed in an unrestricted manner. The remaining 50% of the sediments dredged (2 million cubic yards) are sufficiently contaminated to preclude direct release to the environment. Although some contaminated dredged material may be suitable for beneficial uses such as daily landfill cover or fill, such low-cost environmentally acceptable disposal options are not always available. In the absence of such disposal options, contaminated dredged materials are generally placed in a confined disposal facility (CDF).

The United States Army Corps of Engineers (USACE) constructs CDFs for the disposal of contaminated sediments dredged from federal navigation projects. In several cases, CDFs have also been constructed for the disposal of clean material where open-water disposal was infeasible and a beneficial use was not identified. CDF designs reflect both the nature of the sediments slated for disposal and characteristics of the disposal site (1). CDFs constructed at upland sites typically resemble a simple landfill, consisting of a perimeter earthen dike with a weir for sediment dewatering. CDFs have also been constructed in open-water settings, commonly with perimeter dikes of graded stone. The graded

---

stone dike functions as a large filter, retaining the sediment particles while allowing the free passage of water. The USACE has constructed some 44 CDFs for the disposal of contaminated dredged material from navigation projects in the Great Lakes. The size of these facilities ranges from several to hundreds of acres, with capacities of less than 100,000 to more than 15 million cubic yards.

The siting, construction, operation and closure of CDFs are handled by the USACE under its civil works project guidance. Application of this guidance is focused upon the identification of a "local sponsor" for the proposed dredging project. Referred to as "lands, easements & rights-of-way," the central responsibility of the local sponsor is to provide the USACE with a piece of property for the construction of the CDF. According to the civil works guidance (2), the site must be environmentally clean, suitably close to the water body under consideration, sufficiently sized to meet the projected disposal needs and without debilitating access problems or other restrictions. This regulation specifically mandates that the site either be uncontaminated initially or that the local sponsor render the site clean before providing it to the Corps. The purpose of this requirement is the elimination of any potential state or federal Superfund liability under the Comprehensive Environmental Response, Compensation and Liability Act (CERCLA) or hazardous waste liability under the Resource Conservation and Recovery Act (RCRA-Subtitle C), due to the provision of a contaminated site by a local sponsor.

The Water Resource Development Act of 1996 contains several sections which clarify federal policy on CDFs, including the responsibilities of local sponsors. For all deep-draft navigation projects (<18 feet), the local sponsor must provide a share of the construction costs as well as the land, easements and rights-of-way for the CDF. The cash cost share for the local sponsor ranges from 25 to 50%, depending upon the depth of the harbor and the value of the property used for CDF construction. The local sponsor must be a public entity with taxing authority; typically a municipality, county, state or in several cases a port authority. Once the facility is constructed, filled with sediments and closed, the site and CDF revert back to the local sponsor for long-term care and maintenance.

As discussed below, this approach is difficult to apply and can act as a barrier to the timely implementation of navigation dredging projects. In addition to implementation problems, many of the perceived clean-site benefits as well as contaminated-site liabilities could prove illusory.

## **The Two Traditional Approaches And Associated Problems**

### ***The In-Water Approach***

In practice, the CDF siting strategy has been implemented in the Great Lakes in one of two ways. The more

common scenario centers upon a local sponsor providing the USACE with a near-shore portion of lake or river bottom upon which a CDF can be constructed and filled. After filling and final closure, the site and the CDF reverts back to the sponsor for long-term maintenance and care. This approach is generally workable if the sediments slated for disposal are viewed as only mildly contaminated (i.e., could be essentially considered fill) and the environmental concerns associated with the project are regarded as limited. In-water sponsor identification can also be relatively straightforward, as a sub-aqueous site provided to the USACE at nominal cost can result in the acquisition of a valuable piece of waterfront property. In essence, the closed CDF's value as real estate compensates for the costs of maintenance and monitoring, as well as making any liability concerns more palatable. However, if the contaminant concentrations are viewed as elevated, implementation of the in-water approach tends to become problematic. In this case, environmental concerns can cause the in-lake/water CDF disposal to become highly controversial, dissipate local support and make regulatory approval questionable.

In February of 1986, the problems this scenario can entail were manifested with effect by a previous attempt to dredge Indiana Harbor. A Draft Environmental Impact Statement (DEIS) was prepared and released under the National Environmental Policy Act (NEPA) (3). The preferred alternative in the 1986 DEIS consisted of the construction of an in-lake CDF. The closed facility would have formed a small island in Lake Michigan just east of Jeorse Park in East Chicago, IN. Due to elevated contaminant concentrations (documented in the DEIS) and the associated environmental considerations, local, state and federal opposition became strident. After the inevitable delays and significant negative press, the proposal was dropped.

### ***The Upland Approach***

The second CDF siting scenario is premised upon a local sponsor providing a clean upland site at no cost to the USACE for CDF construction and sediment disposal. Like an in-water site, the CDF subsequently reverts back to the local sponsor after closure. As noted, in addition to the need for a suitably sized proximal site USACE policy has traditionally required that the site be uncontaminated. This requirement is in accordance with USACE guidance and is consistent with generally held presumptions regarding future liability and site preparation costs.

Not surprisingly, implementation of the upland disposal scenario for highly contaminated sediments (e.g., Indiana Harbor) has also proven difficult. Like Indiana Harbor, most federal dredging projects are found in highly urbanized/industrial settings, where clean, adequately sized sites are rare. Should an acceptable contaminant-free site be identified, its acquisition is almost invariably not cost free. Apparently, few entities seem willing to provide clean, multiple-acre urban sites to the federal

---

government for the land disposal of contaminated sediments without compensation. In addition, but in contrast to the filled-inlake CDF (i.e., newly created waterfront property), reacquiring an upland site after CDF closure is generally not viewed as economically advantageous. Above and beyond maintenance responsibilities and costs, the local sponsor may also have significant concerns regarding site liability.

Lastly, as the public views an upland CDF as a landfill, the necessary public support can also be limited. Because of the urban setting, the surviving clean, adequately sized sites proximal to many federal projects exist primarily as parks or preserves. Other sites may have escaped industrialization because of the presence of wetlands and are now unavailable because of their ecological importance and state and federal protection. Invariably, local preferences for the use of these relatively rare uncontaminated properties do not include the construction of land disposal facilities, and upland CDF proposals typically find little or no support from either the local community or environmental organizations. Should the selected proposal require trucking the sediments from the federal project to the upland CDF site, the costs of transportation can be coupled with enhanced local concerns and opposition.

### ***Application at Indiana Harbor***

The difficulties outlined above tend to magnify as sediment contaminant levels increase, making efforts to implement either the in-water or the upland disposal scenarios at Indiana Harbor especially difficult. The highly industrialized urban setting in conjunction with the no-contamination stipulation in the Corps' civil works guidance, disqualified numerous sites proximal to the navigation channel from further consideration. Of the 20 clean sites identified and subjected to varying degrees of further review, all were eliminated due to excessive acquisition costs or distances to the federal project, insufficient acreage, and/or wetland or ecologic issues.

The inability of the standard federal approach to effectively identify an acceptable disposal site has precluded dredging Indiana Harbor for over 25 years. The absence of dredging has imparted a significant environmental cost on Lake Michigan in the form of the continual and unhindered migration of the grossly contaminated project sediments into the southern portion of the basin. The nature of the project sediments is discussed later in the paper. As the factors hindering disposal site selection are unlikely to abate, consideration of other disposal strategies is warranted. The purpose of this paper is to suggest and outline an alternative approach.

### **Navigational Projects And Brownfields**

The United States Environmental Protection Agency (USEPA) has defined brownfields as abandoned, idled or under-utilized industrial or commercial sites where expansion and redevelopment is hindered by real or perceived environmental contamination (4). Ownership

of brownfield sites can range from private individuals and corporations to states or municipalities which acquired the property through tax default. The current brownfield site owner may have had little or no involvement with the activities which contaminated the site and is commonly unable or unwilling to finance the site's remediation. Brownfield redevelopment can mitigate the need to develop pristine, ecologically valuable areas, while increasing the economic viability of the surrounding community through supporting the local tax base and creating jobs. Unlike the rare and costly clean properties, brownfield sites are frequently common in urban settings.

As reflected in the USACE regulation, the real or perceived presence of environmental contamination fosters reluctance on the part of owners and potential developers to invest in the site. This hesitation is a manifestation of the concern that they could become liable for site remediation even if they had no involvement with the contamination of the property. Financial institutions are also disinclined to grant loans on brownfield properties because of the same liability concerns and the fear that the remedial costs could exceed the value of the property (4).

Although reluctant to spend large sums on remediation, current brownfield owners are frequently anxious to find a productive use for their vacant or under-utilized property. Site-use proposals which would address at least a portion of the site's remedial needs would receive receptive consideration from many brownfield owners. Use scenarios coupled to entities willing to share in remedial costs and other liabilities (real or perceived), should be especially welcome. If remedial expenditures can be kept reasonable, brownfield investors would be attracted by low costs of site acquisition or access, centralized urban locations, and the likelihood of sharing the remedial costs and any liability with the current owner as well as any associated potentially responsible parties (PRPs). Site-use proposals coupled with remediation may also prove more acceptable to the local community and interested environmental groups. Given an estimated 450,000 brownfield sites in the U.S. (4) and the tendency for these sites to concentrate in the historically urbanized and industrialized areas which surround federal navigation projects, brownfield candidate sites should be readily identifiable at many locations where CDFs are needed.

The remedial needs of brownfield sites can range from the trivial to the intractable. This range is a reflection of the nature of the hydrogeologic factors at the site and the nature and extent of the contamination. Through the Technical Impracticability (TI) guidance, the USEPA has acknowledged that the presence of immiscible non-aqueous phase liquids (NAPLs) at a site can entail remedial issues which are especially challenging and which may pose technical limitations to aquifer restoration (5). Essentially this is due to the immobility of a significant portion of the NAPL contamination under most groundwater flow conditions. The immobile NAPL

fraction resides as small discontinuous accumulations in the pore space of the geologic material, and is termed, residual saturation ( $V_{\text{NAPL}}/V_{\text{VOIDS}}$ ) (6, 7). The concept of residual saturation has long been recognized by the petroleum industry as a limitation to the recovery of crude oil from petroleum reservoirs (8). Residual saturation for NAPLs typically ranges from 10 to 20% in the unsaturated zone, and from 10 to 50% saturated zone (6, 7). NAPLs can be both more dense than water (DNAPLs), or less dense than water (LNAPLs). LNAPL accumulations are commonly composed of hydrocarbons and can generally be found at sites associated with the refining and storage of crude oil products.

The remedial technologies available to address NAPL contamination are not as advanced as the approaches developed for other groundwater contamination problems (6, 9, 10). NAPL accumulations at residual saturation can act as a significant and long-term source of groundwater contamination (6). Due to the practical limitations regarding NAPL recovery, containment of the NAPL may be a technically implementable and environmentally acceptable remedial option (7).

Conceptually, containment can be conducted in one of four ways. While not eliminating the source of the contamination, the purpose behind all containment approaches is to render the impact of the contamination in the area to be contained on adjacent areas environmentally negligible. With proper consideration of the site's hydrogeology, all of the containment approaches discussed below can be incorporated into the design of the CDF.

The first approach relies on the manipulation of the groundwater gradients in the vicinity of the region under consideration through the creation of areas of low hydraulic head. This can eliminate or significantly mitigate the migration of impacted water from the area to be contained. Gradient alteration is generally conducted by the placement of water removal mechanisms (commonly in the form of wells). Without the physical placement of a barrier material between the area to be segregated and the adjacent areas of the site, hydraulic isolation can effectively segregate the contaminated area from the other portions of the site. In contrast, a second approach would rely on the placement of a physical barrier between the contamination and the adjacent materials. Usually a barrier material associated with a reduced ability to transmit water (e.g., hydraulic conductivity values in the range of  $10^{-6}$  to  $10^{-7}$  cm/s, comparable to a compacted soil liner) would be constructed around the area to be isolated. A third approach is a composite design which couples both of the gradient control and barrier placement approaches. Specifically, this involves constructing a barrier with a reduced ability to transmit around the area to be isolated and placing a water removal mechanism within the interior side of the perimeter to control the hydraulic gradient. Most containment systems which incorporate physical barriers also include groundwater extraction (7). Currently, a fourth approach is receiving much attention and is ac-

tively being investigated by the research community (7, 11). This method consists of surrounding the area to be contained (or at least a section of the down-gradient boundary) with a barrier composed of a reactive material. As impacted groundwater migrates through the reactive barrier, the contaminant concentration(s) is sufficiently reduced through chemical, physical or biological processes to meet the remedial needs of the site.

At brownfield sites where containment is viewed as an appropriate remedial goal, the remedial containment components could be incorporated into the proposed CDF design. Such a "composite or remedial CDF," addressing at least a portion of the site's environmental needs could significantly enhance the potential for local acceptance as well as support from interested environmental organizations. After closure of the CDF, the property could be used for a variety of low-impact applications, such as parks (e.g., a golf course), or light industry.

## The Indiana Harbor Experience

### *Indiana Harbor*

The Grand Calumet River and the Indiana Harbor Canal (GCR/IHC) drain an area of approximately 174 km<sup>2</sup> (67 mi<sup>2</sup>) located on the southern shore of Lake Michigan in northwest Indiana (12) (Figure 1). The area surrounding the GCR/IHC is home to one of the most significant concentrations of heavy industry in the world. The federal navigation project extends from the harbor at Lake Michigan to approximately 4 miles upstream and covers approximately 265 acres (Figure 2). Initially a drainage ditch, the federal project at Indiana Harbor was originally authorized by the River and Harbor Act of 1910, and has been repeatedly widened, deepened and dredged since that time. Sediments which enter the GCR/IHC tend to accumulate in the artificially deepened federal navigation channel, reducing depths and ultimately restricting navigation traffic. In order to maintain adequate navigational depths, the USACE is authorized to dredge these sediments when necessary.

From 1955 to 1972, approximately 75,000 m<sup>3</sup> of sediments were dredged annually from the federal project at Indiana Harbor (12). Until 1966, dredged materials were dumped directly into Lake Michigan at approved open-lake disposal areas. During the next several years, maintenance dredgings were placed at several lake-fill disposal sites in the vicinity of the project. However, since 1972, the inability to identify an acceptable disposal site has precluded dredging. This has resulted in the accumulation of over 760,000 m<sup>3</sup> (one million cubic yards) of highly contaminated sediments within the limits of the federal project.

Current contaminant sources for the federal project include municipal and industrial discharges, combined sewer overflows, runoff from urban and industrial areas, contaminated sediment migration from the upstream river reaches, and potential erosion of contaminated soil

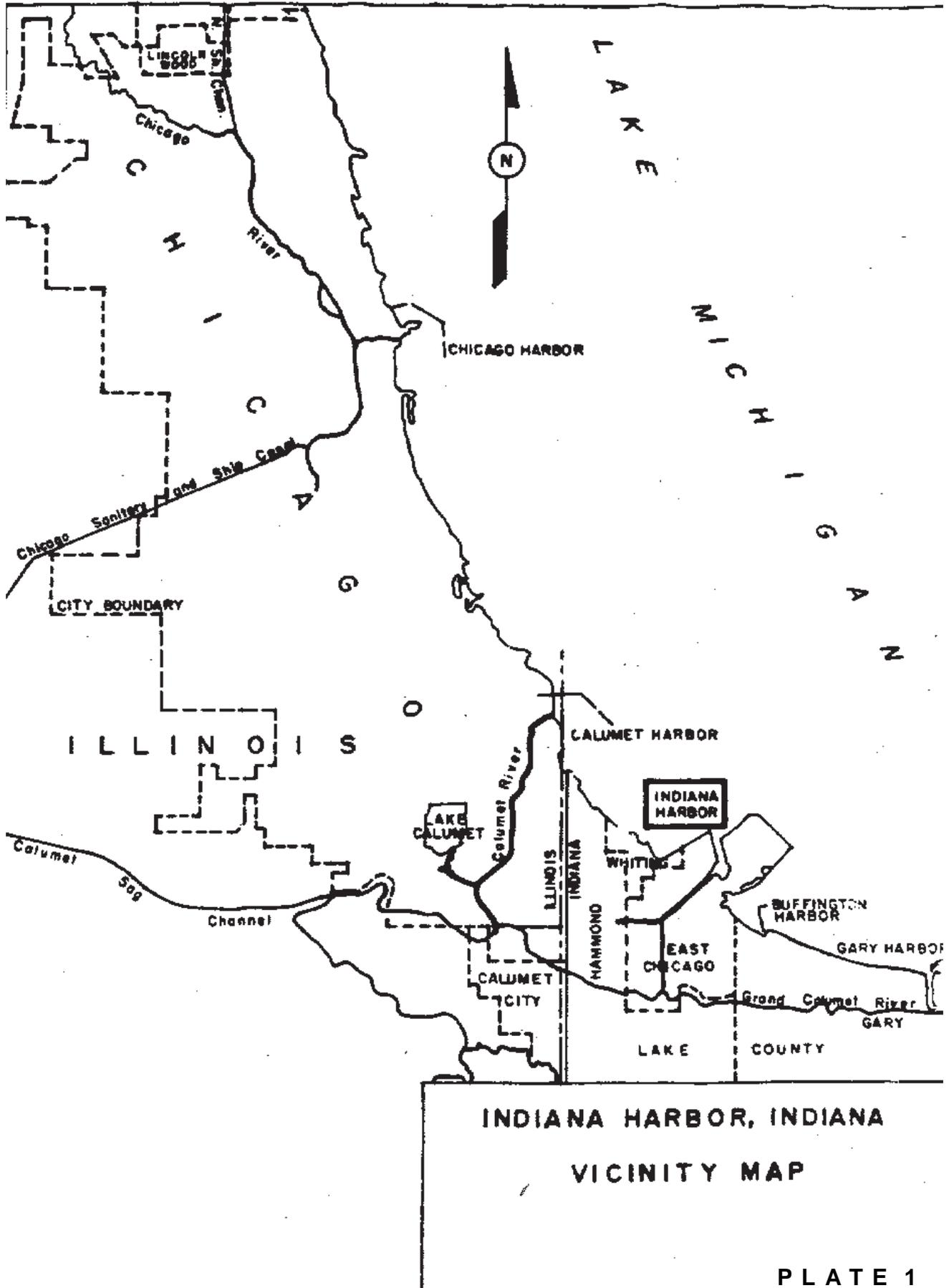

Figure 1. Location of Indiana Harbor (3).



and fill along the unrestrained portions of the channel banks. Municipal and industrial discharges, combined sewer overflows and urban runoff have been estimated to contribute over 110,000 m<sup>3</sup> of sediment to the IHC/GCR annually (12). A significant portion of the existing sediment contamination is considered to be the result of spills and point-source releases which predated most of the current federal and state environmental legislation including the Clean Water Act.

Indiana Harbor contains some of the most heavily contaminated sediments in the Great Lakes. The bottom sediments in all portions of the IHC/GCR are known to be associated with a variety of contaminants, including free phase oil, polychlorinated biphenyls (PCBs), polycyclic aromatic compounds (PAHs), volatile organic compounds, and heavy metals. For example, dry weight oil and grease concentrations for 0.91 m (3 ft) core samples collected by the USACE in 1979 from 13 locations within the project, averaged 56,146 mg/kg (3). In 1973, the IHC/GCR were designated a "Problem Area" by the International Joint Commission (IJC) for the Great Lakes. In addition, the project sediments have been classified as "heavily polluted," under the USEPA 1977 Guidelines for the Pollutional Classification of Great Lakes Harbor Sediments (13), and in 1981, the IJC designated IH/GCR as one of the Areas of Concern (AOC) around the Great Lakes (12). Two reaches of the channel have been found to contain PCB concentrations exceeding 50 ppm, and would be regulated under the Toxic Substance Control Act (TSCA) if dredged. Through a sampling effort in 1992, Region 5 determined that a portion of the sediments in the outer harbor would require handling under the RCRA-Subtitle C as hazardous waste if dredged.

The federal project at Indiana Harbor has not been dredged since 1972. As a result, it is believed that the federal channel is no longer functioning as a trap for the sediments which enter the project. In essence, sediment input into the federal project equals sediment output to Lake Michigan. This conclusion is supported by 25 years of bathymetric survey data. These data reveal that the rates of sediment accumulation in the project were greatest between 1972 and 1980 and that subsequently sedimentation rates have decreased notably (12). Currently, sediments which would settle within the limits of the project if dredged to authorized depths, are discharging to the Lake. The contaminated nature of the sediments make their release to Lake Michigan highly undesirable. Contaminants which enter Lake Michigan are quickly dispersed by wave action and near-shore currents, rendering subsequent capture and remediation unlikely. The USACE has estimated that 75,000 to 150,000 m<sup>3</sup> of contaminated sediments are currently being discharged from the mouth of Indiana Harbor annually (12). Restoring and maintaining the navigation channel at authorized depths would create a sediment trap capable of reducing this release rate by an estimated 50 to 70% (12).

## ***Current Indiana Harbor Proposal***

A second DEIS for the dredging of Indiana Harbor was jointly issued by the USACE and USEPA Region 5 in October 1995. Despite the USACE preference for clean sites, the recommended alternative in the DEIS consisted of the construction of an upland CDF at the Energy Cooperative Incorporated (ECI) site in East Chicago, IN (Figure 3). As documented in the DEIS, the selection of the ECI property was based upon the absence of available, clean, close, cost-effective, adequately sized sites in the area surrounding the federal navigation project at Indiana Harbor (12).

From 1919 until the early 1980s, the ECI site housed a petroleum refining operation. In 1980, ECI acquired interim status under RCRA Subtitle C through the operation of several onsite hazardous waste units. Shortly thereafter, ECI declared bankruptcy under chapter 7. Subsequently, the facility structures were razed and the site was graded. Despite these activities, the RCRA hazardous waste units were never formally closed and the onsite contamination was never addressed. In compensation for taxes, the site was acquired by the City of East Chicago in 1990. As a consortium of companies, ECI left an estate of almost \$33 million upon filing for chapter 11 bankruptcy in 1984. In May of 1992, the Department of Justice on behalf of USEPA and the Coast Guard, filed a claim for the costs of environmental remediation. This activity resulted in the procurement of \$13.22 million for site remediation and CDF construction. As discussed in more detail below, the site remediation components and the CDF design components exhibit considerable overlap, thereby further reducing the expenditures associated with the use of the ECI site.

Covering approximately 168 acres, the ECI site-use proposal is large enough to meet the disposal needs at Indiana Harbor for approximately 30 years. The site also is located to the north of the Lake George Branch of the federal navigation project (Figure 3). This proximal location minimizes transportation difficulties, costs and any associated public concerns. In addition, because of the nature and extent of the onsite contamination, the ECI site is available for use by a local sponsor through the City of East Chicago at nominal cost.

The geology at the ECI site consists of a 30-foot layer of sand overlying a glacial till of low permeability. In addition, much of the site is covered by a thin veneer of fill (generally thought to consist primarily of iron and steel slag), ranging in thickness from several to approximately 10 feet and hydraulically behaving much like the sand (14). The water table at the site ranges from grade to several feet below grade. The 60-plus years of refinery operations severely contaminated the onsite soil materials and ground water. Over large portions of the site, the water table is covered by a layer of lighter-than-water free-phase hydrocarbons (oil) or LNAPLs, which in places

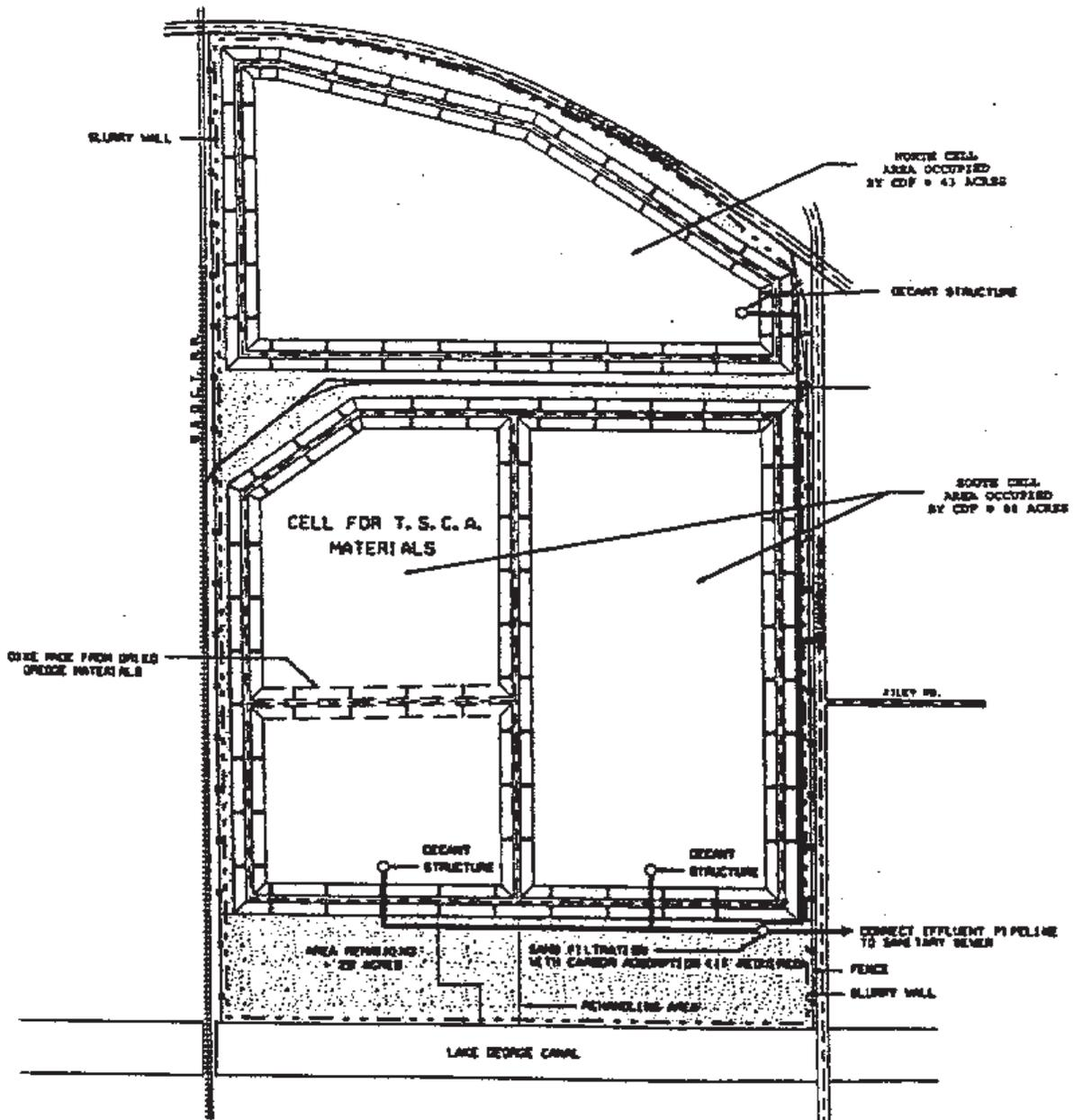

400 200 0 400  
 SCALE IN FEET

N

**INDIANA HARBOR  
 CONFINED DISPOSAL FACILITY  
 ECI SITE  
 RCRA CLOSURE/CORRECTIVE ACTION  
 WITH CDF PROJECT  
 PLAN VIEW  
 CHICAGO DISTRICT  
 US ARMY CORPS OF ENGINEERS**

Figure 3. Plan view of the proposed ECI site CDF (12).

---

can exceed a thickness of 8 feet. In addition to the hydrocarbon contamination, other contaminants known to be associated with the site include PCBs and heavy metals. Many of these same contaminants are also found in the IHC sediments. The ground water at much of the site initially discharged to the Lake George Branch of the federal navigation project. This resulted in the release of free-phase oil from the site to the surface water in the IHC. This situation was corrected in the early 1990s, when under the direction of the Indiana Department of Environmental Management (IDEM), an oil removal system was installed along the edge of the canal.

## Composite/remedial CDF Design

In the early 1990s, Region 5, USACE, IDEM, the City of East Chicago and other parties became actively involved in assessing the feasibility of coupling the conceptual CDF design with the outstanding RCRA closure and corrective action needs of the site. After extensive discussions, consensus was reached regarding a CDF design which would meet the engineering necessities of the USACE, and fulfill the closure and corrective action needs of RCRA. If constructed and operated properly, this CDF design would provide a comprehensive environmental solution for the underlying portions of the ECI site and a sediment disposal capacity projected to meet USACE needs for 30 years. The proposed CDF design would cover approximately 168 acres of the ECI site, and would have a containment capacity of 4.7 million cubic yards. Once the CDF is filled and closed, future site use options could include use as a park or a golf course.

The proposed CDF design (Figure 4) features a trapezoidal dike wall which would surround the perimeter of the facility. The interior face of the dike wall will be covered by a compacted layer of clay several feet thick. The compacted layer of clay will be tied into an underlying vertical slurry wall of low permeability. The slurry wall would extend down through the slag and sand layers into the underlying low permeability clay till. A series of well points located along the interior perimeter of the CDF would function as a gradient control/sediment dewatering/leachate collection system (12) (see figure 4). After the CDF is filled, the closure design would consist of a layer of compacted clay, overlain by a drainage layer and topped by a layer of seeded top soil. The proposed CDF design should ensure the containment of the underlying *in-situ* LNAPL contamination, address the RCRA corrective action requirements and comply with the closure performance specifications for RCRA hazardous waste units. In addition, the CDF will also environmentally isolate the contaminated IHC sediments, meet the TSCA requirements for PCB contaminated sediment disposal, fulfill the USACE's engineering requirements for sediment disposal and meet the long-term disposal capacity needs of the USACE at Indiana Harbor. Obviously, the same CDF design components will meet the needs of various overlapping regulatory and engineering requirements. For example, the well

points placed into the underlying sand aquifer and used to extract ground water from the interior of the facility, would function as a gradient control, sediment dewatering and/or leachate collection system. As all of these terms refer to the same mechanism, language preferences would tend to be Agency and program dependent.

## Liability Considerations

Successful CDF partnerships are commonly based upon the equitable partitioning of the liability which the CDF could represent. Liability for existing CDFs is shared between USACE and the local sponsor. The sponsor is required to "hold harmless" the federal government from any damages not due to the fault or negligence of the Corps or its contractors. Essentially, the USACE retains liability for the CDF design and construction in perpetuity, while the sponsor is primarily liable for maintenance of the facility after closure and any damages or impacts due to a lack of maintenance during the post-closure period. The time needed for CDF construction, project completion and CDF closure can range from several years to several decades. For example, the projected operational life of the Indiana Harbor CDF is 30 years. Should a third party wish to use the CDF for sediment disposal, an agreement for the partitioning of the associated liability would need to be established.

In the case of Indiana Harbor, a worst-case remedial scenario has been projected as a situation which would require complete replacement of the CDF's perimeter slurry wall. The cost of implementing this worst-case scenario has been estimated to be approximately \$6 million (1993 dollars). During the approximately 30 years needed to construct, operate and close the CDF, the USACE will bear most of the liability associated with the site, and could be called upon should the CDF require some form of remediation. During this same period, the local sponsor would need to establish the assurances required to effectuate the worst-case remedial scenario (the \$6 million at the same 1993 valuation). This would need to be completed prior to the reversion of the site back to their control. Lastly, any local entity which used the CDF for sediment disposal would also acquire a portion of the liability represented by the CDF. This could be converted into a negotiated cash sum provided to the local sponsor and/or the USACE.

At Indiana Harbor, although final agreements have not been reached, a conceptual framework for the management of the liability has been discussed. These ideas include: environmental insurance purchased as part of the local sponsor's annual operation and maintenance (O&M) responsibilities; a per-cubic yard surcharge to the local CDF users for the establishment of the \$6-million fund; and local bonding that would provide the necessary funds through a number of possible surcharges.

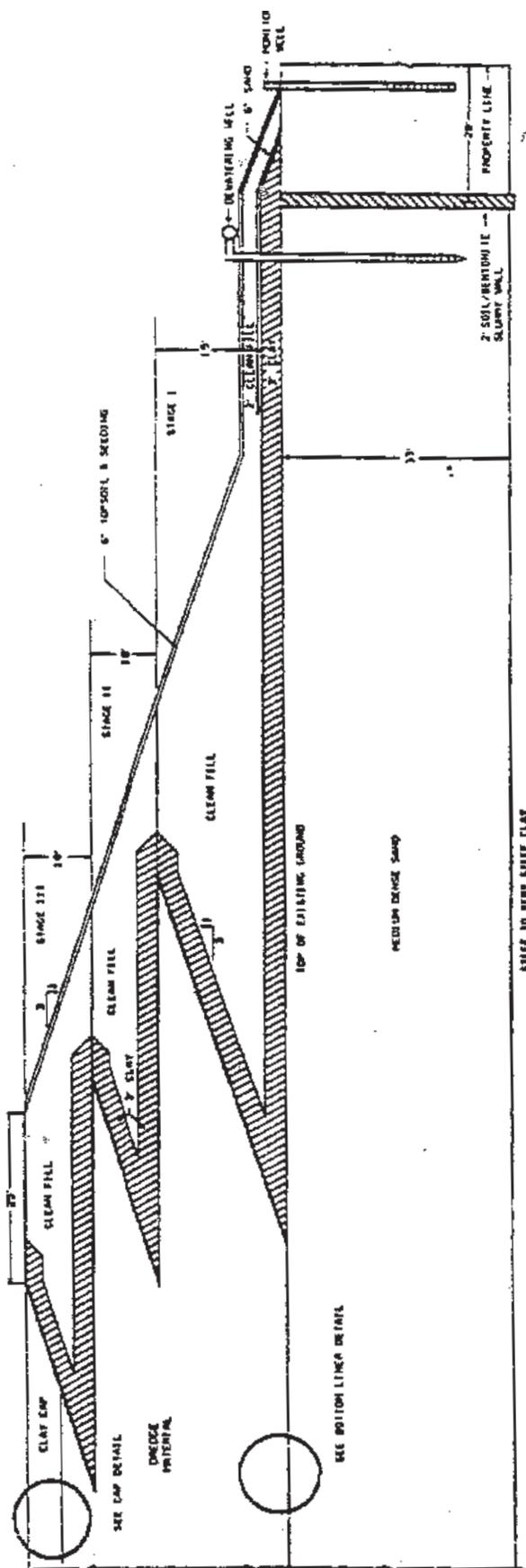

**SECTION**  
N. T. S.

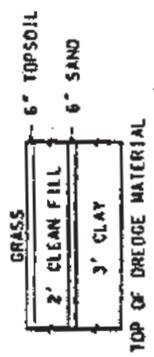

**CAP DETAIL**  
N. T. S.

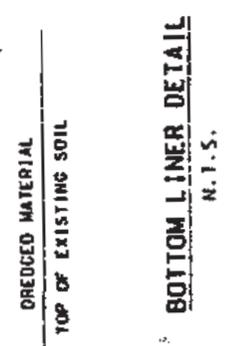

**BOTTOM LINER DETAIL**  
N. T. S.

INDIANA HARBOR  
 CONFINED DISPOSAL FACILITY  
 ECI SITE  
 RCRA CLOSURE/CONNECTIVE ACTION  
 WITH CDF PROJECT  
 SECTION VIEW  
 CHICAGO DISTRICT  
 US ARMY CORPS OF ENGINEERS  
 JUNE 1993

Figure 4. Section view of the proposed ECI site CDF (12).

---

## Brownfields vs. Greenfields

At first glance, although use of a green site would appear to have fewer liability concerns than use of a brownfield site, this may not always be the case. The soils and ground water at a pristine site would need to be kept pristine. Consequently, acceptable green-site CDF designs for highly contaminated sediments tend to be more involved and costly to construct than an acceptable brownfield site design. Although site-specific, an upland clean-site CDF designed to contain highly contaminated sediments could entail several feet of compacted clay, and one or more synthetic liners and leachate collection systems. Generally, these green/clean-site CDF design components would cover the entire base of the facility. Such enhanced designs are premised upon the need to isolate the contamination associated with the sediments from the proximal environment and preclude groundwater contamination. However, should a contaminant release to ground water occur despite the more-involved design, the resulting remediation effort can entail significant and long-term expenditures. Lastly, groundwater monitoring at a pristine CDF site needs to be sufficiently sensitive to detect slight alterations in the aqueous chemistry of the underlying aquifer. Such monitoring programs can entail significant costs through both the operational and post-closure periods.

The environmental benefits associated with the construction of a more-enhanced and costly clean/green site CDF design at locations with significant LNAPL accumulation, could be limited. At such sites, the additional expenditures required by the enhanced green-site design components may only succeed in segregating the *in-situ*/onsite contamination from the contamination associated with the sediments. Specifically, the placement of such a green-site design at the ECI site would do little to remediate the underlying LNAPL contamination, and would leave the RCRA corrective action and closure needs unaddressed. Should a more-costly green-site CDF design be placed at the ECI site, a second containment unit for the underlying onsite hydrocarbon contamination could still be needed. If both the green-site CDF and an underlying containment unit were constructed, these stacked containment units would perform in a manner comparable to the current proposal. These stacked units (with their duplicative design components) would substantially increase the complexity and cost of the project, while providing little additional environmental benefit.

A review of the potential liability exposure associated with use of the ECI site versus a clean site also raises some interesting issues. Many of the liability issues encountered are rooted in the current technical limitations associated with the remediation of sites with NAPL contamination. As discussed, the soils and ground water at a pristine site used for CDF construction would need to be kept pristine. Once constructed, should the more involved green-site CDF design fail and a contaminant release to the adjacent soils and ground water occur, remediation would need to be initiated. This would in-

clude steps to correct the facility defect which caused/allowed the release, as well as the remediation of any impacted soils and ground water. Such a green-site event could represent significant liability exposure, as standard groundwater cleanup approaches tend to be long-term and costly. In contrast and as acknowledged by USEPA, the probable remediation scenarios at a NAPL site such as ECI can be much more limited (5, 7). Unfortunately, at ECI the same LNAPL contamination which the slurry wall will be placed to contain also exists in abundance on the exterior of the slurry wall. As the characteristics of the contamination outside as well as isolated by the slurry wall are similar, the same remedial limitations associated with the *in-situ* contamination underlying the CDF (once constructed) would also generally apply to the contamination beyond the CDF boundary. These remedial limitations would not be altered by a short-term release from the CDF. Consequently, in the event of a release from the proposed CDF, an argument could be made that the required remedial steps should focus upon correcting the facility defect which allowed the release to occur. In addition it should also be noted that the ECI site is located in an area where the problems associated with LNAPL contamination are well documented. Due to the widespread nature of the problem, Agency representatives and local property owners are attempting to address the issue from a regional perspective.

Traditionally, under many waste disposal programs, (e.g., TSCA, RCRA-Subtitle C, RCRA-Subtitle D), the performance of the waste disposal unit is monitored through the periodic assessment of the adjacent groundwater quality down-gradient of the unit's perimeter. The detection of or an increase in the concentration of a contaminant known to be associated with the waste in the disposal unit, is generally viewed as an indication of unit failure. This definition of failure presumes a notable difference in the chemical nature and/or concentration of contaminants associated with the material in the unit versus the material along the unit's exterior. However, these prerequisites may not exist at the ECI site. Due to the similarities between the IHC sediment and onsite contamination, and the extensive and problematic nature of the onsite contamination (LNAPLs); monitoring the performance of the proposed CDF through alterations in the quality of the groundwater adjacent to the facility may not be feasible. In essence, the nature and extent of the contamination within the unit may be little different from the contamination along the unit's exterior. Although groundwater samples could be collected and alterations in the level of chemical constituents would no doubt be measured, these alterations may involve significant interpretational challenges and have little to do with the performance of the CDF. Properly constructed and operated, measured alterations in groundwater quality are at least as likely to reflect events which occurred on the CDF's exterior than an indication of contaminant migration from the facility interior. Since it seems probable that water quality monitoring along the facility perimeter would provide little direct indication of unit performance, facility performance monitoring may need

---

to rely primarily upon monitoring the hydraulic gradient across the slurry wall. The hydraulic gradient would be monitored by tracking the hydraulic head values on both the interior and exterior sides of the vertical slurry wall. As long as the hydraulic head value (groundwater levels) along the exterior of the facility exceeded the hydraulic head value along the adjacent facility interior, the flow of groundwater would be directed toward the interior of that portion of the CDF.

## **Application to Sediment Remediation Projects**

Contaminated sediments have been identified as a significant non-point source of pollution in many rivers, harbors and lakes. Contaminated sediments have been positively linked to elevated levels of contaminants in fish, degraded water quality conditions, and waterway use limitations. At all of the 43 Areas of Concern (AOCs) in the Great Lakes identified under the Great Lakes Water Quality Agreement between the U.S. and Canada, contaminated sediments have been associated with a number of use impairments. The remediation of contaminated sediments is also an integral part of the Remedial Action Plans at many of these AOCs, and is the focus of numerous remedial activities under Superfund and other cleanup authorities.

There are several prerequisites which must be met to initiate the remediation of contaminated sediments. First and most critically, a source of funding must be identified. This has resulted in a number of projects where enforcement cases were brought against responsible parties with the ability to fund sediment cleanups (e.g., Waukegan Harbor-OMC; Black River-USX Kobe; Indiana Harbor-LTV Steel). Unfortunately, the sediment contamination at most sites commonly originated from a variety of point and non-point sources. This can make it difficult to assign responsibility, and require a substantial effort to build a sediment enforcement case. Although rarely seen as the sole funding source, public funding (federal or state) has also been used to augment or match funding provided by the responsible party.

In addition to funding, sediment remediation projects that involve removal (dredging) invariably entail access and use of a piece of property. Ideally, the site is adjacent to the area to be dredged, minimizing logistical costs and difficulties. Where the volume of sediments removed is small, and ultimate disposal is to an existing disposal facility (not uncommonly a commercial landfill), the property is needed to conduct sediment dewatering and rehandling (e.g., Cedar Creek-Tecumseh; Manistique River-Manistique Paper). For projects with large sediment volumes, where commercial facilities are unavailable or cost prohibitive, the property is also needed for CDF construction (e.g., Waukegan Harbor-OMC; Black River-USX Kobe; Sheboygan River-Tecumseh).

As exhibited by the discussion above, the prerequisites needed for navigation dredging and sediment remediation

can exhibit considerable overlap. Both require a proponent (i.e., local sponsor or responsible party) armed with sufficient funds, and access to a suitably placed and appropriately sized piece of property. For a navigation project, the proponent must provide all the property and a portion of the funding, although the federal government provides the larger share of the construction costs. For an enforcement-based sediment remediation project, the proponent(s) may be responsible for all or part of these requirements. The primary need for brownfield restoration is an investor willing to work with the site owner and the appropriate agencies to review and approve an acceptable restoration plan for the property. In the case of a remedial CDF constructed for sediment cleanup, the required investor could consist of the PRP(s) liable for the contamination, or a partnership consisting of the PRP(s) and the brownfield site owner. The PRP(s) in turn would acquire use or access of a suitably sized and located brownfield site at minimal cost, while the site owner would have a site-use scenario identified which would address at least a portion of the site's remedial needs.

## **Conclusions**

The considerations outlined above are not unique to the USACE project at Indiana Harbor or the ECI site. The approach outlined in this paper preferentially selects highly contaminated brownfield sites where containment is a preferred remedial option for the construction of sediment disposal facilities. Such brownfield sites adjacent or proximal to a federal navigation channel in need of dredging should prove much more common than proximal, clean, and sufficiently sized upland sites. In contrast to the owners of clean upland sites, the owners of a contaminated brownfield may welcome local sponsor status and may prove willing to not only provide the needed property, but also help finance a CDF project which would utilize their idle site as well as address at least a portion of the site's environmental/remedial needs. Should the future performance of the CDF prove inadequate, it is likely that the costs to upgrade the CDF and/or remediate any resultant environmental contamination would be shared by the local sponsor(s) and other involved parties. A brownfield CDF, coupling the overlapping remedial and engineering aspects into the design and addressing the underlying *in-situ* soil and groundwater contamination can be simpler and less costly than a green-site design. Arguments can also be made that such remedial CDFs can represent less future liability than a comparable facility constructed at an uncontaminated upland site. As discussed in this paper, the selection of a site adjacent to the federal project also minimizes logistical expenditures and eliminates any associated public relations problems. The inherent remedial aspects of the CDF design should also help to enhance overall public acceptance for the project. Should this approach prove generically feasible, long-delayed dredging projects could be initiated removing large volumes of contaminated sediments from ecologically sensitive near shore channels and harbors, and idle

---

brownfield sites could be addressed and utilized. This same approach may also be applicable to the remediation of contaminated sediment sites.

## References

1. Richardson G.N., D.M. Petrovski, R.C. Chaney, and K.R. Demars, 1995. State of the Art: CDF Containment Pathway Control, from *Dredging, Remediation and Containment of Contaminated Sediments*, ASTM, STP 1293, ASTM publication code number 04-012930-38.
2. USACE, June 1992. *Hazardous, Toxic, and Radioactive Waste (HTRW) Guidance for Civil Works*, ER 1165-2-132
3. USACE, February 1986. Draft Environmental Impact Statement, Indiana Harbor Confined Disposal Facility and Maintenance Dredging, Lake County, Indiana.
4. U.S. EPA, January 1996. *Basic Brownfields*, U.S. EPA Region 5 Fact Sheet Publication
5. U.S. EPA, September 1993. Interim Final Guidance for Evaluating the Technical Impracticability of Water Restoration, EPA/540-R-93-080
6. Mercer J.W. and R.M. Cohen, 1990. A review of Immiscible Fluids in the Subsurface: Properties, Models, Characterization and Remediation. *Journal of Contaminant Hydrology*, 6, pp. 107-163.
7. U.S. EPA, 1996b, *Pump-and-Treat Ground-Water Remediation, A Guide for Decision Makers and Practitioners*, EPA/625/R-95/005, July 1996.
8. Levorsen A.I., 1967. *Geology of Petroleum*, 2nd Edition, p 461
9. Fetter C.W., 1993. *Contaminant Hydrogeology*
10. Domenico P.A. and F.W. Schwartz, 1990. *Physical and Chemical Hydrogeology*
11. Rumer R.R. and J.K. Mitchell, editors, 1995, Chapter 11. *Assessment of Barrier Containment Technologies/A Comprehensive Treatment for Environmental Remediation Applications*; U.S. DOE/ U.S. EPA/DuPont Company, product of an International Containment Technology Workshop in Baltimore, Maryland, August 29-31, 1995.
12. USACE, 1995. Letter Report and Draft *Environmental Impact Statement, Maintenance Dredging and Disposal Activities, Indiana Harbor and Canal, Lake County, Indiana*.
13. U.S. EPA, Region 5, 1977. *Guidelines for the Pollutional Classification of Great Lakes Harbor Sediments*.
14. USGS, 1997. *Characterization of Fill Deposits in the Calumet Region of Northwestern Indiana and Northeastern Illinois, Water-Resources Investigations Report 96-4126*

---

# Environmental Dredging and Disposal Overview and Case Studies

Michael R. Palermo, Research Civil Engineer  
U.S. Army Engineer Waterways Experiment Station (WES)  
Vicksburg, MS

Norman R. Francingues, Chief,  
Environmental Engineering Division, WES

Danny E. Averett, Chief,  
Environmental Restoration Branch, WES

## Abstract

Contaminated sediments are a nationwide problem, and a wide range of remediation approaches have been proposed for specific projects. Sediment removal or "environmental dredging" is viewed by the public as the most obvious alternative, and is being considered in some of the most seriously contaminated areas. Environmental dredging followed by treatment and disposal of the contaminated material has been accomplished at several Superfund sites. This paper summarizes technical considerations for environmental dredging and disposal of contaminated sediments and presents case studies of three recently completed projects.

## Background

Sediments act as a sink for many contaminants, and consequently, bottom sediments in many locations nationwide have become polluted because of municipal and industrial discharges and non-point sources. Options for remediating contaminated sediments include no action, non-removal and removal. No action involves simply allowing natural processes to gradually improve conditions. Non-removal options are those which involve restricted use of a contaminated area or treatment or isolation of the contaminated sediments in place. Removal options are those which involve environmental dredging followed by treatment or disposal of the sediments at another location. If the decision is made to remove the sediments, the environmental dredging operation cannot be considered as a separate activity. The dredging operation and the subsequent disposal and management of the removed sediments must be compatible.

In recent years, the U.S. Environmental Protection Agency (USEPA), the U.S. Army Corps of Engineers (USACE), and others have published a wealth of information on contaminated sediment remediation (1 thru 14). Environmental dredging, sediment treatment, disposal options, and a wide range of other related topics have been described at varying levels of detail from citizen's guides to technical guidance for designers. These publications are a resource for acquiring more detailed information.

## *Environmental Dredging*

Dredging for cleanup purposes has been considered for some time as a primary means for managing contaminated sediments (15, 16). Guidance for selection of dredging equipment and advantages and limitations of various types of dredges in the navigation dredging context is available (17), and this information is generally applicable in the context of environmental dredging. However, resuspension of sediment and associated release of contaminants and removal precision are key environmental concerns when dealing with contaminated sediments.

All dredges resuspend some sediment during the dredging process. Some contaminants in the dissolved form and some contaminants associated with resuspended particles will be released and transported away from the dredging site. Removal precision refers to how accurately a given dredge can remove desired areas and thicknesses of contaminated sediment. Precision is important from the standpoint of removing the contaminated material layers while leaving behind as little residual contamination as possible. Also, precision is critical from

---

the standpoint of not removing excessive amounts of clean sediment, since any sediments removed would likely be treated as contaminated material with the associated high cost of disposal and management.

Research supplemented by field demonstrations has resulted in general guidance for selection of equipment and techniques for dredging contaminated sediments (11,18,19, 20, 21, 22). Much can be done to limit sediment resuspension from conventional dredges without substantial impact upon the efficiency of the dredging operation. Precautions in operation and/or minor plant modifications can be made with only a small increase in cost. In general, pipeline cutterhead dredges and hopper dredges without overflow generate less resuspended sediment than clamshell dredges or hopper dredges with overflow. It should be recognized, however, that other factors such as maneuverability requirements, hydrodynamic conditions, and location of the disposal site may dictate the type of dredge that must be used. The strategy then must be to minimize the resuspension levels generated by any specific dredge type. If conventional dredges are unacceptable, a special purpose dredge may be required. These dredges generally resuspend less material than conventional dredges, but associated costs may be much greater. As in the case of conventional dredges, the selection of a special purpose dredge will likely be dictated by site-specific conditions, economics, and availability.

### ***Treatment and Disposal Alternatives***

Environmental dredging involves removal of contaminated sediment from a water body. What to do with this dredged material, i.e. what disposal or management option is appropriate or acceptable, is a major consideration for any cleanup project.

A large number of options for dredging, placement of sediments, treatment processes, and control measures are available. The resulting range of possible alternatives or scenarios is therefore potentially large. Any strategy for evaluation of treatment and disposal options must be technically sound, consistent, and compatible with applicable laws and regulations (23).

The basic approaches for management and disposal of material removed by environmental dredging include containment, treatment, or combinations. Containment refers to the placement and management of a material at a site such that the contaminants are isolated from the environment. Examples include subaqueous capping, confined (diked) disposal facilities (CDFs), or disposal in licensed landfills. Treatment refers to processes which destroy, detoxify, or immobilize the contaminants. Pre-treatment may be required prior to sediment treatment and disposal and refers to processes such as solids separation or dewatering which might be required for a sediment treatment process to be effective. There are many potential sediment treatment processes, and these generally are categorized as biological, chemical, ex-

traction, immobilization, or thermal. Usually, several pre-treatment and treatment process must be used in sequence, forming a "treatment train" to achieve a desired result. Both untreated and treated material must ultimately be disposed of, and options include CDFs, landfills, subaqueous capping and beneficial use (if the treatment results in a material acceptable for a given use).

The following three case studies illustrate some of the principal technical considerations and lessons learned in recent projects involving environmental dredging and disposal.

### **New Bedford Harbor Hot Spot Case Study**

The New Bedford Harbor Superfund site is located in New Bedford, MA, south of Boston. Sediments throughout the harbor are contaminated with polychlorinated biphenyls (PCBs) and heavy metals as a result of discharges from industries that operated along the waterfront. The harbor has been the focus of intensive study since the late 1970s. This case study is summarized from Otis (24).

The site is divided into three geographical study areas: the hot spot area, the Acushnet River Estuary, and the Lower Harbor and Upper Buzzards Bay. This summary focuses on the hot spot remediation. The hot spot is a 20,200 square meter area located along the western bank of the Acushnet River Estuary, directly adjacent to an electrical capacitor manufacturing facility that was the major source of PCB discharges to the harbor. The hot spot is defined as those areas where the sediment PCB concentration is 9000 parts per million (ppm) or greater. Concentrations to over 100,000 ppm have been detected in this area. Contamination at these levels is found in the top 0.6 meters of sediment and extends to a depth of 1.2 meters in several areas. In addition to PCBs, heavy metals (notably cadmium, chromium, copper, and lead) are found in the sediment. The volume of sediment to be removed from the hot spot was originally estimated at approximately 7,650 cubic meters and contained approximately 45% of the total PCB mass in sediment from the entire site.

The remedy selected by EPA consisted of the following components: 1) removal using a small hydraulic pipeline dredge, 2) disposal and dewatering of the sediments in a CDF with treatment of the water prior to discharge back into the harbor, 3) incineration of the sediments with disposal of the ash in the CDF, and 4) capping of the CDF.

Several studies evaluating dredging as a means of removing the contaminated sediments from the harbor were performed, including a full-scale field Pilot Study in the estuary area which involved the onsite evaluation of three hydraulic dredges. Site specific dredging procedures were developed during the Pilot Study that resulted in the removal of the contaminated sediments while minimizing the resuspension of sediments.

---

A confined disposal facility (CDF) had been constructed along the New Bedford shoreline to contain the contaminated sediments removed during the Pilot Study. The facility was modified and used again during the hot spot remedial action. The modifications included dividing the facility into three cells to facilitate the water treatment process, installation of a high density polyethylene geomembrane liner and installation of a floating cover over the large cell into which the dredged material was initially pumped to control volatilization.

Construction activity began in August 1993 with modifications to the CDF and construction of the water treatment facility. Ongoing community opposition to the incineration component of the project resulted in construction delays and eventually led to the elimination of this phase of the project. Dredging began in April 1994. The contractor used an Ellicott Model 370 dredge with the sediments being pumped from the hot spot to the CDF through approximately 1.6 kilometers of floating pipeline. Silt curtains and oil booms were installed around the dredge prior to the start of operations.

Once dredging began, it quickly became apparent the production rate on which the contract was based could not be sustained. Dredging operations brought a layer of PCB oils to the surface which resulted in elevated levels of volatilized PCBs in the air. Dredging procedures and equipment were modified to minimize the oil releases. These included reducing the dredge's swing speed, fabricating a shroud to catch oil as it was released, and using multiple swings of the dredgehead to remove a lift of material prior to advancing the dredge. Silt curtains were removed because they appeared to be contributing to the oil problem by their continuous disturbance of the bottom in the varying tidal and weather conditions. With these modifications, the dredging effort proved successful in removing contaminated sediments. There were no problems with sediment resuspension or contaminant release in the water column.

The operation of the CDF was largely successful. The effluent discharged during filling operations was controlled by addition of flocculents for enhanced suspended solids removal and treatment using UV oxidation. The removal of the hot spot material was completed in September 1995, with a total volume of 15,000 cubic yards of material placed in the CDF. Following elimination of incineration as a treatment option, EPA initiated treatability studies which are now nearing completion. The material currently remains in the CDF awaiting a final decision on treatment.

The major lessons learned from the New Bedford experience were related to the levels of release of PCBs during the dredging process, which proved to be much higher than anticipated. The hot spot sediments had such high concentrations of PCB that they exhibited a non-aqueous or oil-like phase which was easily released as a floating sheen and exhibited a high volatilization rate. This problem greatly affected the dredge production, resulting in a much slower removal rate than antici-

pated. Contaminant release pathways other than sediment resuspension (such as release of oil phases or volatilization) must be carefully considered when dredging highly contaminated sediments.

## **Marathon Battery Case Study**

The Marathon Battery Project involved cleanup of a Superfund site located in the Village of Cold Spring, NY, located upstream of New York City on the Hudson River. Marathon Battery produced nickel-cadmium batteries for the military and for commercial use from 1952 until 1979 (25). During its operation, wastewater was discharged into the Hudson River and into cove and marsh areas hydraulically connected to the Hudson, contaminating sediments in these areas with cadmium, nickel, and cobalt. The site was placed on the National Priorities List in 1981. Remedial investigations and feasibility studies culminated in a plan to dredge the top one foot of sediment to achieve 10 ppm residual cadmium in sediments in the cove and achieving an action level of 100 ppm cadmium in the marsh. Attaining the marsh action level required excavation of 12 to 42 inches of sediment (26). After dredging and excavation, the ROD specified that sediments would be dewatered, chemically fixed, and transported to an offsite disposal area.

Remedial design for the Marathon Battery remedial action was originally performed by the USACE through an interagency agreement with the USEPA. The original design concept involved constructing an earthen berm around the marsh and flooding the marsh, hydraulic dredging of the contaminated sediments from the marsh with cadmium concentrations greater than 100 milligrams per kilogram (mg/kg), thickening of the dredged sediments, chemical fixation of the thickened sediments, truck transport of the fixated sediments to a local sanitary landfill, and restoration of the marsh. As the design progressed, it was determined that the bermed marsh would also be used to dewater dredged sediments from East Foundry Cove and the Hudson River (25, 27).

As part of the design, scientists and engineers from the USACE, USEPA, and Malcolm Pirnie convened for a five-day value engineering session to evaluate the remediation plan specified in the ROD. This is believed to be the first application of value engineering to a hazardous waste project. More than 60 variations on techniques to remediate the site were formulated, and then evaluated and scored with regard to technical feasibility and cost. The alternatives were narrowed down to three concepts that were to be implemented, including: 1) using amphibious equipment rather than traditional hydraulic dredging to remove marsh sediments, 2) reusing clean berm material as an integral part of the final marsh restoration rather than trucking in new fill, and 3) restoring the wetland as a more ecologically valuable "low marsh" rather than a "high marsh," reducing the extent of fill operations.

After the project had been advertised for a construction contract, the principal responsible parties (PRPs) agreed

with the U.S. District Court to perform the remedial action in accordance with the RODs and the construction plans and specifications developed by the USACE. Cleanup activities began in 1993 and were substantially complete in 1995 (27). Value engineering proposals were made by the PRP contractor modifying some of the original design concepts. These included: 1) dewatering by mechanical methods vs. containment/settling basins, 2) use of a water-filled containment structure vs. an earth containment dike, and 3) use of a proprietary chemical stabilization process vs. the generic solidification mix presented in the contract documents.

Sediments in shallow, open-water areas (coves/ponds), were removed using a small hydraulic, horizontal auger, dredge operated by Aqua Dredge, Inc. The 8-ft wide auger was reported to be capable of a vertical precision control of 0.1 inch (27). Low tides limited daily production times for the dredge, but during optimum conditions, a production rate of 1000 cu yds per day was reported. Dredged material from the hydraulic dredge was initially piped directly to the pre-treatment/dewatering process. Some areas of the site were obstructed with rocks, debris, and other physical limitations to the small hydraulic dredge. These areas were excavated with a clamshell bucket and transported by scow to an off-loading area prior to treatment. Marsh areas of the site were excavated using low ground pressure amphibious excavating equipment with hoppers for transport to the treatment facilities. Project plans called for removing approximately 52,000 cu yds from the cove and pond areas, 10,000 cu yds from pier areas, and 14,000 cu yds from the marsh (27).

The treatment and disposal process for the dredged material consisted of dewatering, solidification/stabilization, and transport by rail to a landfill in Michigan. The PRP contractor originally chose a mechanical dewatering system consisting of screens and centrifuges. However, the dewatering system did not perform as expected. The variability of the physical characteristics of the dredged material, rocks, wood, and vegetation, plugged the coarser screens, and the fine silts and clays blinded the finer screens and overloaded the centrifuges (28). To overcome these problems, the dewatering system was modified to include settling ponds prior to the mechanical dewatering system (consistent with the original design) to equalize the feed and remove debris. Settled solids were excavated mechanically from the ponds and stockpiled into a paved staging area to await further dewatering using belt filter presses. Excess water from the dredging operation was treated with a polymer and filtered through a sand filter prior to release to the waterway. Dewatered solids were stabilized using the proprietary Maectite process to pass leachate testing, loaded onto rail cars, and transported to an offsite landfill in Michigan (27).

One important lesson learned can be drawn from the Marathon Battery experience. Conventional waste water treatment trains are not easily adapted to treatment of sediment pumped directly to the treatment train by hy-

draulic dredges. Variability of the material to include changing water content, grain size, presence of debris, etc. presents substantial difficulty with respect to materials handling and tends to reduce the efficiency of treatment process components designed for a more uniform "feed". Conventional settling basins (essentially CDFs) attenuate changes in the material characteristics as dredging progresses and can eliminate these problems.

## Bayou Bonfouca Case Study

Bayou Bonfouca is a Superfund project located in Slidell, LA, approximately 45 miles northeast of New Orleans. Region 6, USEPA and the USACE New Orleans District combined efforts to implement a remedial action. This case study is summarized from Ives (29) and Sensebe (30).

The site is an abandoned creosote wood treatment facility located along a body of water known as Bayou Bonfouca, and is adjacent to a very expensive residential area. The source of contamination is the former American Creosote plant. The plant was constructed around the turn of the century to create creosote pilings and is located at the head of a Federal navigation channel, which includes a small luxury boat marina. The land site consists of approximately 50 acres of land area. Over 160,000 cubic yards of sediment contaminated with creosote in Bayou Bonfouca were dredged. The contractor for the site remediation was a joint venture between IT-Environmental and OH Materials, Inc. The environmental dredging was subcontracted with Bean Dredging Corporation.

The action level for cleanup was 100 mg/kg total polynuclear aromatics (PNAs). The material to be dredged and disposed were classified as silts and clays. Excavation included both fine grain silty materials and stiff clays which extend below the sedimentation in the bayou. The cleanup operations included computerized mechanical dredging from a floating platform, separation of debris, slurry operations to pump the material using two Mudcat dredges, dewatering using filter presses, incineration in a portable rotary kiln, and final disposal of the incinerator ash in an onsite secure (RCRA) double-lined, landfill. In addition, there were five air monitoring stations around the site.

The dredging/excavation was typically done between 8:00 a.m. to 5:00 p.m., Monday through Friday. A total of 164,246 cubic yards of sediment was removed. A new dredge (Bonacavor) was designed and specially constructed for this site by Bean Dredging Corporation. It consists of a floating plant, a five cubic yard, mechanical bucket operated like a backhoe, and a large hopper/screen where the dredged sediments/debris were dumped. High-pressure fire hoses were used to wash the sediment from the debris in the bar screen/(grizzly) hopper. Precision dredging was required by the contract with a strict penalty for overdepth dredging. The dredging was designed only to remove the layer of contaminated sediments with minor allowances for dredging

accuracy. Actual tolerances achieved were within 6 inches and an average overredge dimension of 0.17 feet. The excavation depth criteria set by the USEPA were met or exceeded in all cases.

The screened, dredged sediments were pumped to a holding pond (small CDF) where the water was separated for treatment in a 500 gpm treatment plant consisting of physical, chemical, and biological unit operations. Lime was used in the wastewater treatment plant to precipitate the solids. The settled solids were pumped by two mudcat dredges to the conditioning and re-handling (dewatering) facility. About 250 tons/day were processed for feed as filter cake which is transported by an enclosed conveyor belt to the rotary kiln, incinerator. The incinerator trial burns were completed in November 1994, and the entire operation went online immediately thereafter. The incinerator is required to meet destruction removal efficiencies (DREs) of four 9s. The ash has to meet a PNA concentration less than 10 ppm. Any material greater than 100 ppm PNA is sent to the incinerator. The incineration of the material is scheduled to be completed in 1997.

Lessons learned from Bayou Bonfouca are related to the overall success of the operation. Use of a specially designed dredge, with careful control during the operation, resulted in removal within tight tolerances, reducing the amount of material to be treated. Although a complex treatment train was involved, the overall design accommodated separation of debris and variations in the material characteristics.

## Summary

Environmental dredging is a contaminated-sediment remedial option requiring removal of sediments from the water body followed by treatment or disposal of the sediments at another location. The dredging operation and the subsequent disposal and management of the removed sediments must be compatible. Control of sediment resuspension and removal precision are key environmental concerns for the removal process. A large number of options are available for management and disposal of material removed by environmental dredging including containment, treatment, or combinations. Options for ultimate disposal include CDFs, landfills, subaqueous capping and beneficial use. Field experience from completed projects will continue to yield valuable information and lessons learned which can be applied to future projects.

## Acknowledgment

This paper summarizes investigations conducted under various programs of the U. S. Army Corps of Engineers and the U.S. Environmental Protection Agency. Permission to publish this material was granted by the Chief of Engineers.

## References

1. Averett, D.E., B.D. Perry, E.J. Torrey, and J.A. Miller, 1990, "Review of Removal, Containment, and Treatment Technologies for Remediation of Contaminated Sediments in the Great Lakes," Miscellaneous Paper EL-90-25, U.S. Army Engineer Waterways Experiment Station, Vicksburg, MS.
2. Demars, K.R., G.N. Richardson, R.N. Yong, and R.C. Chaney, (editors). 1995. *Dredging, Remediation, and Containment of Contaminated Sediments*, American Society of Testing and Materials (ASTM) Special Technical Publication 1293, ASTM, Philadelphia, PA.
3. National Research Council, 1989, *Contaminated Marine Sediments—Assessment and Remediation*, Marine Board, National Research Council, National Academy Press, Washington, DC.
4. National Research Council, 1997, *Contaminated Sediments in Ports and Waterways—Cleanup Strategies and Technologies*, Marine Board, National Research Council, National Academy Press, Washington, DC.
5. Permanent International Association of Navigation Congresses (PIANC). 1996. "Handling and Treatment of Contaminated Dredged Material from Ports and Inland Waterways—CDM," *Report of Working Group No. 17 of the Permanent Technical Committee I, Supplement to Bulletin No. 89*, 1996, Permanent International Association of Navigation Congresses, Brussels, Belgium.
6. USACE/EPA, 1992, *Evaluating Environmental Effects of Dredged Material Management Alternatives—A Technical Framework*, EPA842-B-92-008, U.S. Army Corps of Engineers and U.S. Environmental Protection Agency, Washington, DC.
7. USEPA. 1991. *Handbook—Remediation of Contaminated Sediments*, EPA/625/6-91/028, Environmental Protection Agency, Washington, D.C.
8. USEPA. 1993. *Selecting Remediation Techniques for Contaminated Sediment*, EPA-823-B93-001, Environmental Protection Agency, Washington, D.C.
9. USEPA . 1993. "Risk Assessment and Modeling Overview Document," EPA 905-R93-007, Assessment and Remediation of Contaminated Sediments Program, Great Lakes National Program Office, Chicago, Illinois.
10. USEPA. 1994a. *Assessment Guidance Document*, EPA 905-R94-002, Assessment and Remediation of Contaminated Sediments Program, Great Lakes National Program Office, Chicago, Illinois.

11. USEPA. 1994b. *Remediation Guidance Document*, EPA 905-R94-003, Assessment and Remediation of Contaminated Sediments Program, Great Lakes National Program Office, Chicago, Illinois.
12. USEPA. 1994c. *Bench-scale Evaluation of Sediment Treatment Technologies: Summary Report*, EPA 905-R94-023, Assessment and Remediation of Contaminated Sediments Program, Great Lakes National Program Office, Chicago, Illinois.
13. USEPA. 1994. *EPA's Contaminated Sediment Management Strategy*, EPA 823-R-94-001, Office of Water, U.S. Environmental Protection Agency, Washington, D.C.
14. USEPA. 1995. *Cleaning Up Contaminated Sediment—A Citizen's Guide*, EPA 905-K-95-001, Assessment and Remediation of Contaminated Sediments Program, Great Lakes National Program Office, Chicago, Illinois.
15. Engler, R.M., N.R. Francingues, and M.R. Palermo, 1991. "Managing Contaminated Sediments: Corps of Engineers Posturing to Meet the Challenge," *World Dredging and Marine Construction*, August 1991.
16. Palermo, M.R., R.M. Engler, and N.R. Francingues, 1993, "The U.S. Army Corps of Engineers Perspective on Environmental Dredging," *Buffalo Environmental Law Journal*, Vol. 1, No. 2., Buffalo, NY.
17. USACE. 1983. *Dredging and Dredged Material Disposal*, Engineer Manual 1110-2-5025, 25 March 1983, Office, Chief of Engineers, Washington, D.C.
18. Hayes, D. L. 1986. "Guide to Selecting a Dredge for Minimizing Resuspension of Sediment," *Environmental Effects of Dredging Technical Note EEDP 09-1*, U.S. Army Engineer Waterways Experiment Station, Vicksburg,
19. Hayes, D. L. 1988. "A Preliminary Evaluation of Contaminant Release at the Point of Dredging," *Environmental Effects of Dredging Technical Note EEDP-09-3*, U.S. Army Engineer Waterways Experiment Station, Vicksburg, MS.
20. Herbich, J.B., and S.B. Brahme, 1991. A Literature Review and Technical Evaluation of Sediment Resuspension During Dredging, *Technical Report (in preparation)*, US Army Engineer Waterways Experiment Station, Vicksburg, MS.
21. Palermo, M.R. 1991. "Equipment Choices for Dredging Contaminated Sediments," *Remediation*, Autumn 1991.
22. Palermo, M.R. and D.F. Hayes, 1992. "Environmental Effects of Dredging," Vol. 3, Chapter 15 of *Handbook of Coastal and Ocean Engineering*, Gulf Publishing Company, Houston, Texas.
23. Palermo, M.R. and J.A. Miller, 1995. "Strategies for Management of Contaminated Sediments," in *Dredging, Remediation, and Containment of Contaminated Sediments*, edited by Demars, K.R., G.N. Richardson, R.N. Yong, and R.C. Chaney, American Society of Testing and Materials (ASTM) Special Technical Publication 1293, ASTM, Philadelphia, PA.
24. Otis, M.J. 1994. "New Bedford Harbor, Massachusetts Dredging/Disposal of PCB Contaminated Sediments," *Dredging 94—Proceedings of the Second International Conference on Dredging and Dredged Material Placement*, American Society of Civil Engineers, 1, 579-587.
25. Simmons, Thomas M., Gregory P. Matthews, and Nick Multari. 1994. "Preparation of bid documents for dredging/excavating contaminated sediments, soils and marsh deposits at the Marathon Battery Superfund Site Cold Spring, NY," *Dredging 94—Proceedings of the Second International Conference on Dredging and Dredged Material Placement*, American Society of Civil Engineers, 2, 1201-1209.
26. Nocera, John J., and Thomas M. Simmons. 1994. "Development of an excavation plan for heavy metal contaminated marsh deposits [for Marathon Battery]," *Dredging 94—Proceedings of the Second International Conference on Dredging and Dredged Material Placement*, American Society of Civil Engineers, 2, 1220-1229.
27. Taylor, Michael P., Pamela N. Tames, and Alan R. Elia. 1994. "Marathon Battery Superfund Project—a review of design, construction, and lessons learned," *Dredging 94—Proceedings of the Second International Conference on Dredging and Dredged Material Placement*, American Society of Civil Engineers, 2, 1210-1219.
28. Logigian, John M., Edward A. Dudek, and Michael R. Palermo. 1994. "Design of dredge containment and dewatering facilities [for Marathon Battery]," *Dredging 94—Proceedings of the Second International Conference on Dredging and Dredged Material Placement*, American Society of Civil Engineers, 2, 1230-1239.
29. Ives, Pete, 1994. "Bayou Bonfouca," *The Military Engineer*, No. 566.
30. Sensebe, Joe, 1994. "Bayou Bonfouca Superfund Site, Slidell, Louisiana—An Overview," *Proceedings of the Southern States Annual Environmental Conference Session on Federal Waste Cleanup Experiences*, Biloxi, Mississippi.

---

# Integrated Sediment Decontamination for the New York/New Jersey Harbor

E. A. Stern

U.S. Environmental Protection Agency, Region 2, New York, NY

K. R. Donato

U.S. Army Corps of Engineers, New York District, New York, NY

N. L. Clesceri

Rensselaer Polytechnic Institute, Troy, NY

K. W. Jones

U.S. Department of Energy, Brookhaven National Laboratory, Upton, NY

## Abstract

Disposal of dredged material taken from the New York/New Jersey (NY/NJ) Harbor is problematic because of the presence of inorganic and organic contaminants that under revised testing criteria render it unsuitable for return to the ocean or for beneficial reuse. Decontamination of the dredged material followed by beneficial reuse is one attractive component of the comprehensive dredged material management plan being developed by the U.S. Army Corps of Engineers, New York District. A demonstration program to validate decontamination processes and to bring them into full-scale use in the NY/NJ Harbor is now in progress. Tests of selected technologies have been completed at the bench-scale and pilot-scale (2-15 m<sup>3</sup>) levels. Procedures for demonstration testing on scales from 750 m<sup>3</sup> to 75,000 m<sup>3</sup> are being developed with the goal of producing a usable decontamination system by the end of 1999. The overall project goals and present status of the project are reviewed here.

## Introduction

The Port of New York and New Jersey requires dredging approximately 4,000,000 m<sup>3</sup> of sediment each year from navigational channels and from many different types of public and private berthing areas. At this time the fraction of dredged material that can be disposed of in the coastal Atlantic Ocean at the Historic Area Remediation Site (HARS) represents perhaps 25% of the total. Other disposal options must be chosen for the bulk of the material. One option or component to dredged material management is to decontaminate the sediments and put the treated material to a beneficial reuse (1).

The cleanup goal is clearly achievable from a purely technical standpoint and has already been demonstrated in many soil remediation projects. However, in the Port there are additional factors to consider in the actual creation of a decontamination processing option. The facility must be large enough for handling and stockpiling an enormous amount of material (some fraction of the total yearly dredging volume) that arrives at highly irregular time intervals throughout the year, and it must do so with a treatment cost which can be borne by the various customers in the Port. The minimal costs for dredging followed by unrestricted ocean disposal can be in the range from \$6 to \$12 per m<sup>3</sup>. Additional costs that can be borne presently by the larger of the Port customers are estimated to be no more than \$35 per m<sup>3</sup>. A cost decrease is needed to keep the Port viable and competitive for the future. Thus, there is a strong impetus for the development of beneficial reuses which can generate a revenue stream that can be combined with a tipping fee of the magnitude just mentioned to give the foundation for an economically viable business.

In addition, there is need for substantial capital funding for decontamination infrastructure construction. The largest volume of dredged material is generated by the U.S. Army Corps of Engineers and the Port Authority of New York/New Jersey. Under present contract procedures, it is impossible to provide assurances of long-term streams of materials to a vendor and/or facility capable of decontaminating the dredged material. This makes the development of a business difficult using private funding alone since the risks to potential investors is very high. Thus, in the long term, the use of innovative public-private partnership arrangements may be necessary at the inception of individual enterprises.

The purpose of this report is to summarize, from a technical and practical standpoint alone, the work that is in progress in the Harbor of New York and New Jersey, as called for under the Water Resources Development Acts (WRDA) of 1992 and 1996. This project is aimed at development and construction of a large-scale decontamination facility as part of a stable long-term solution to the handling of dredged material in the region. Earlier summaries have been given by Stern et al. (2) and Jones et al. (3). Cost considerations will be presented elsewhere (4).

## Project Components

There are many components contained in a project designed to produce an operating facility for dredged material processing and decontamination. There are also many different research, university, and industrial sector institutions working on tasks that relate to the needs of the project. However, in general, there is no pathway for coordinating and integrating the data and results produced into a systems package that is useful for meeting specific decontamination goals for a range of sediment contaminants. As a result, the present work has components that span a range of research and development activities from relatively basic science to applied engineering and business activities. Some of the key components that are needed in producing an operational treatment facility are:

- Treatment train development
  - Selection and testing of treatment technologies
  - Pretreatment (physical separation/dewatering)
  - Facility siting
  - Facility design and construction
  - Technology and facility permitting
- Fundamentals
  - Sediment toxicity identification evaluations
  - Toxicity testing of post-treated material
  - 3-D visualization of contaminant distributions to assist in making dredging decisions
  - Environmental and human health risk assessment. This includes risks from the material and from operation of the decontamination procedures.
  - End-use criteria. How clean is clean?
- Operational requirements

- Public outreach
- Business development for beneficial reuse products
- Develop cost- and profit-sharing public-private partnerships for operation of the facility

## Characteristics of NY/NJ Harbor Dredged Material

The physical characteristics of the sediments found in the Port are generally very fine-grained silts and clays (80-95%) with a small fraction of larger grain sizes and large-size debris. The total organic content of Harbor sediments ranges from 3-10%. The bulk material has the consistency of a black mayonnaise or gel. The solids content of the dredged material is 30% to 40% when obtained using a conventional clam-shell bucket dredge. The NY/NJ Harbor estuarine salinity ranges from 1.5 to 28 parts per thousand. The concentrations of major contaminants and metals found in dredged material from Newtown Creek, NY, are shown in Table 1. This is of interest in considering possible pathways for beneficial reuse as manufactured soil, cement, or glass.

Inorganic contaminants include heavy metals such as cadmium, mercury, lead, arsenic, and chromium. Organic compounds include dioxins and furans, polychlorinated biphenyls (PCBs), polynuclear aromatic hydrocarbons (PAHs), petroleum hydrocarbons, and chlorinated pesticides and herbicides. Generally, the material is chemically stable and is found to pass the toxicity characteristic leaching program (TCLP) for testing the leachability of contaminants. The concentrations found in Newton Creek sediments are not high enough to warrant classification as hazardous materials, but are sufficient to cause them to fail bioaccumulation and toxicity tests required prior to ocean disposal and specifications for soil cleanup levels in New York and New Jersey. Contaminant concentrations found in Newtown Creek, NY, and in Port Newark, NJ, sediments are also compared to several soil criteria for the States of New York and New Jersey in Table 1. These chemicals are characteristic of a historically used, heavily industrialized urban port.

## Results of Bench- and Pilot-scale Testing Programs

Technologies that have been tested have fallen into those that are carried out (1) at ambient or at least low temperatures, (2) intermediate temperatures that do not destroy the organic constituents, and (3) high temperatures above the decomposition point of the organic compounds. The wide variety of contaminants and differing concentration levels make it plausible to search for technologies that can be applied to specific concentration levels. In addition, the low-temperature technologies may be more acceptable to the local and regulatory communities and they may be easier to permit. The

**Table 1.** Contaminant Concentrations of Untreated As-Dredged NY/NJ Harbor Sediments (Dry Weight)

Contaminant	Newtown Creek (Bench)	Newtown Creek (Pilot)	Port Newark	NJ Non-Resid. <sup>1</sup>	NJ Resid. <sup>2</sup>	NY Resid. <sup>3</sup>
2,3,7,8 TCDD (ppt)	42	81	66	—	—	—
OCDD (ppt)	17,463	38,881	5560	—	—	—
TCDD/TCDF TEQ (ppt)	518	1570	109	—	—	—
Total PCBs (ppm) <sup>4</sup>	1.55	1.78	0.141	2	0.49	1
Anthracene (ppb)	3702	1074	167	10,000	10,000	50,000
Benzo(a)anthracene (ppb)	4484	8970	283	4000	900	224
Chrysene (ppb)	4564	9973	365	40,000	9000	400
Total PAHs (ppb) <sup>4</sup>	113,000	130,000	30,000	—	n/a <sup>5</sup>	396,500
Arsenic (ppm)	33	42	15	20	20	7.5
Cadmium (ppm)	37	47	6	100	1	1
Chromium (ppm)	376	432	171	—	—	10
Copper (ppm)	1171	1410	212	600	600	25
Lead (ppm)	617	631	300	600	400	SB <sup>6</sup>
Mercury (ppm) total	1.3	3.7	2.2	270	14	0.1
Zinc (ppm)	1725	2070	526	1500	1500	20

<sup>1</sup> NJ Department of Environmental Protection. Non-residential soil, direct contact. J.J.A.C. 7:26D, revised 7/11/96.

<sup>2</sup> NJ Department of Environmental Protection. Residential soil, direct contact. J.J.A.C. 7:26D, revised 7/11/96.

<sup>3</sup> NY Department of Environmental Conservation. Recommended soil cleanup objectives. HWR-94-046 (Revised). January 24, 1994.

<sup>4</sup> See Reference 12.

<sup>5</sup> n/a = not available.

<sup>6</sup> SB = Site background.

higher temperature technologies may be more applicable to the most contaminated sediments that are found outside of navigational channel and depositional areas. These areas may lend themselves to “Hot Spot” remediation. High temperature technologies may well produce beneficial use products that have higher resale values. Examples of the technologies that fit each sediment contamination category are:

- Low contamination. Solidification/stabilization, manufactured soil, and phytoremediation. U.S. Army Corps of Engineers (5)
- Low-to-medium contamination. Sediment washing and chemical extraction. BioGenesis Enterprises Inc. (6)
- Medium contamination. Solvent Extraction. Metcalf & Eddy, Inc. (7)
- High contamination. High-temperature rotary kiln. Institute of Gas Technology (8)
- High contamination. High-temperature plasma torch. Westinghouse Electric Corporation, Science & Technology Center (9)

Taken together these technologies form the basis of an integrated “treatment train” for the management of contaminated dredged material from the Port of NY/NJ or other locations worldwide.

### ***U.S. Army Corps of Engineers***

The simplest approach to decontamination is the preparation of a manufactured soil using dredged material. The advantages of this method include relatively low cost and easy implementation with no need for complex capital equipment or dewatering of the material. The disadvantages are that establishing growth of cover plants may be difficult since degradation of some compounds may be slow, and trophic transfer issues could restrict use as a topsoil since removal of contaminants is an *in-situ* process that proceeds slowly and needs long-term monitoring.

The soil is produced by mixing the sediment with a cellulose material such as wood chips, sawdust, or yard-waste compost, cow manure or sewage sludge, and lime and fertilizer as needed. Specific mixtures that were tested contained dredged material, sawdust or yard waste, and cow manure. The tests showed that the optimum dredged material concentration was about 30% of the soil mixture by weight, thus giving an overall

reduction in contaminant concentrations through dilution. These concentrations are compared to New York and New Jersey standards for residential and industrial soil cleanup standards in Table 2. It was found that some of the contaminant concentrations exceeded the soil cleanup criteria. Hence, a decontamination procedure may be advisable for producing a soil meeting state standards. The suitability of the soil for growth of different plant species was tested for tomato, marigold, rye grass and vinca. The soil was most suitable for the growth of rye grass.

## BioGenesis

A schematic diagram of the sediment-washing equipment of BioGenesis is shown in Figure 1. The first step in the process is to use surfactants combined with a water jet to break up agglomerates and solubilize hydrocarbons coating the individual sediment grains. The second step combines a chelating agent and high-velocity water jet that further strip organic coatings from the particles and remove metals sorbed to the base materials. The water-solid mixture is then passed through a cavitation-oxidation unit to break up the organic components, followed by steps to separate the processed

solids from the water which contains the remains of the contaminants. The water is processed to meet standards required for disposal at wastewater treatment plants. The testing program to date has been confined to study of the contaminant reduction efficiency. Results obtained for reduction of PAHs and metals in one experiment are shown in Table 3. These values are compared to the standards for soil cleanup given by NY and NJ. Similar values have been obtained for other contaminants.

The bench-scale experimental results indicate that it is possible to expect reductions that exceed 90% in a single pass through the apparatus. Results found from sequential passes through the system have been encouraging and make it plausible to think that further improvements in the system efficiency can be attained. The next step would be testing on a pilot-scale level of up to 1000 yd<sup>3</sup>. The final product can be combined with the manufactured soil approach of the Corps of Engineers to produce a material suitable for unrestricted use as long as the dredged material contamination can be reduced to acceptable levels consistent with those mentioned above.

**Table 2.** Summary of Results for U.S. Army Corps of Engineers Waterways Experiment Station Bench-scale Manufactured Soil Demonstration: 30% Dredged Material, 50% Sawdust, 10% Cow Manure

Contaminant	As Dredged	Man. Soil 30% As Dredged	Percent Reduction	NJ Non-Resid. <sup>1</sup>	NJ Resid. <sup>2</sup>	NY Resid. <sup>3</sup>
2,3,7,8 TCDD (ppt)	41.5	15.2	63.4	---	---	---
OCDD (ppt)	17463	5290	69.7	---	---	---
TCDD/TCDF TEQ (ppt)	518	182	64.9	---	---	---
Total PCBs (ppm) <sup>4</sup>	1.22	0.782	68.0	2	0.49	1
Anthracene (ppb)	3700	1590	57.0	10,000	10,000	50,000
Benzo(a)anthracene (ppb)	4480	3130	30.1	4	900	224
Chrysene (ppb)	4560	3720	18.4	40	9000	400
Total PAHs (ppb) <sup>4</sup>	57,900	35,800	38.2	---	n/a <sup>5</sup>	396,500
Arsenic (ppm)	33.5	12.5	62.7	20	20	7.5
Cadmium (ppm)	3.0	7.9	78.6	100	1	1
Chromium (ppm)	377	140	62.9	---	---	10
Copper (ppm)	1172	393	66.5	600	600	25
Lead (ppm)	617	331	46.4	600	400	SB <sup>6</sup>
Mercury (ppm) total	1.29	---	---	270	14	0.1
Zinc (ppm)	1725	514	70.2	1500	1500	20

<sup>1</sup> NJ Department of Environmental Protection. Non-residential soil, direct contact. J.J.A.C. 7:26D, revised 7/11/96.

<sup>2</sup> NJ Department of Environmental Protection. Residential soil, direct contact. J.J.A.C. 7:26D, revised 7/11/96.

<sup>3</sup> NY Department of Environmental Conservation. Recommended soil cleanup objectives. HWR-94-046 (Revised). January 24, 1994.

<sup>4</sup> See Reference 12.

<sup>5</sup> n/a = not available.

<sup>6</sup> SB = Site background.

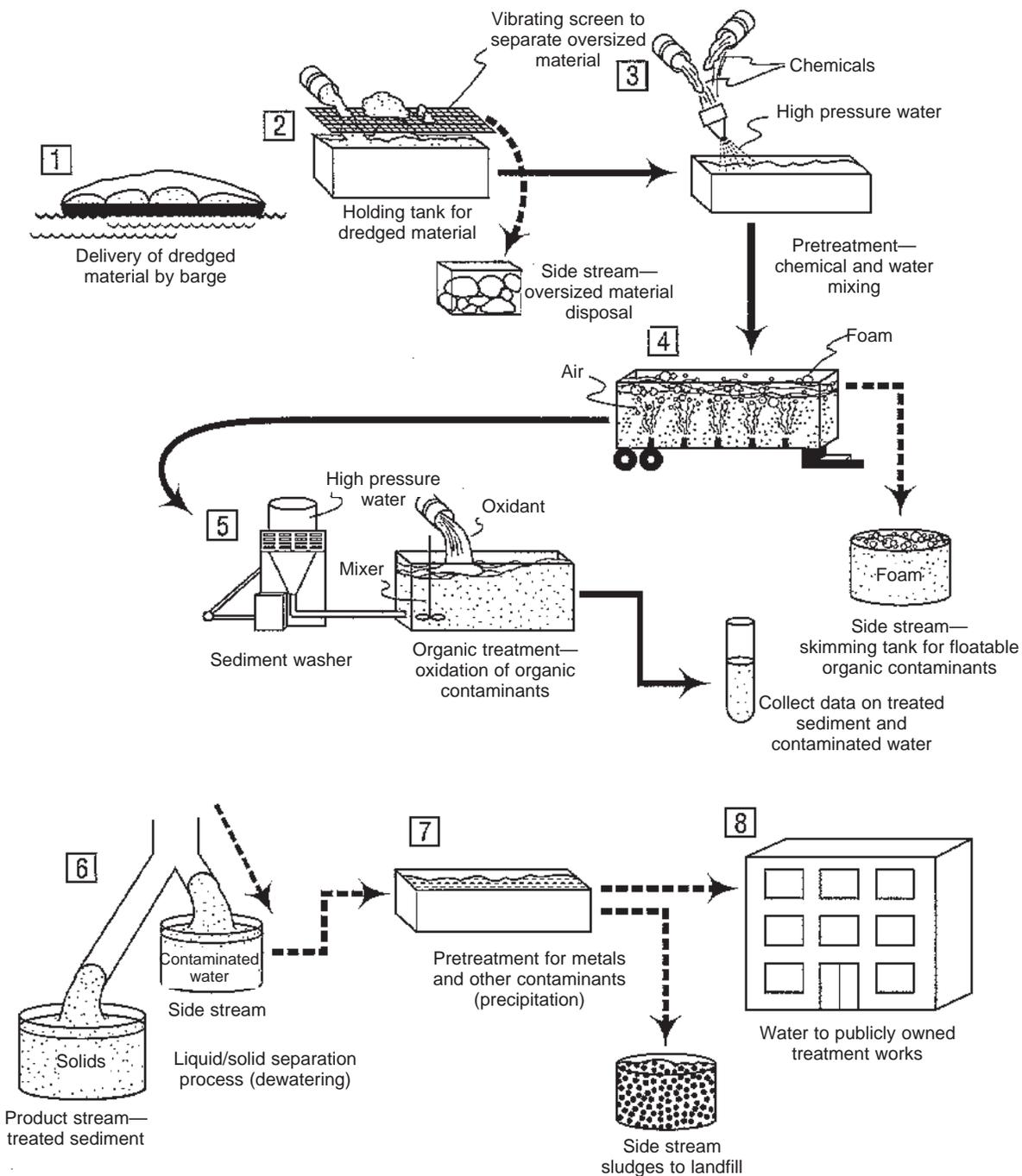

**Figure 1.** Schematic diagram showing the steps in the sediment washing and chemical extraction processing system developed by BioGenesis Enterprises.

### **Metcalf & Eddy**

Solvent extraction procedures are similar to the sediment washing process of BioGenesis in the sense that a chemical solvent is used to remove the surface coatings of contaminated materials. Removal of volume contamination depends on the porosity of the material and the treatment time as well as on the details of the chemical interactions of the contaminants with the bulk material of the sediment. A block diagram of the apparatus used by Metcalf & Eddy is shown in Figure 2. The extraction

process operated at a temperature of 37.7-60.0°C and employed isopropyl alcohol and isopropyl acetate as the solvents. These conditions require more elaborate apparatus than the BioGenesis process and require more attention to operating conditions because of fire/explosion hazards. Pilot-scale experiments were carried out using multiple passes through the system and in a continuous mode. Results obtained for decontamination are shown in Table 4 for a 5-cycle treatment. This particular experiment did not use a chelator and the metal levels are not substantially reduced.

**Table 3.** Summary of BioGenesis Sediment-Washing Process

Contaminant	As-dredged	Treated	Percent Reduction	NJ Non-Resid. <sup>1</sup>	NJ Resid. <sup>2</sup>	NY Resid. <sup>3</sup>
Anthracene (ppb)	771	177	77.0	10,000	10,000	50,000
Benzo(a)anthracene (ppb)	1793	234	86.9	4000	900	224
Chrysene (ppb)	1994	286	85.7	40,000	9000	400
Total PAHs (ppb) <sup>4</sup>	19,502	3207	83.6	—	n/a <sup>5</sup>	396,500
Arsenic (ppm)	22.2	12.8	42.3	20	20	7.5
Cadmium (ppm)	18.2	1.4	92.3	100	1	1
Chromium (ppm)	226	63	72.1	—	—	10
Copper (ppm)	n/a <sup>5</sup>	n/a <sup>5</sup>	—	600	600	25
Lead (ppm)	454	60	86.8	600	400	SB <sup>6</sup>
Mercury (ppm) total	13.1	0.3	97.7	270	14	0.1
Zinc (ppm)	—	n/a <sup>5</sup>	—	1500	1500	20

<sup>1</sup> NJ Department of Environmental Protection. Non-residential soil, direct contact. J.J.A.C. 7:26D, revised 7/11/96.

<sup>2</sup> NJ Department of Environmental Protection. Residential soil, direct contact. J.J.A.C. 7:26D, revised 7/11/96.

<sup>3</sup> NY Department of Environmental Conservation. Recommended soil cleanup objectives. HWR-94-046 (Revised). January 24, 1994.

<sup>4</sup> See Reference 12.

<sup>5</sup> n/a = not available.

<sup>6</sup> SB = Site background.

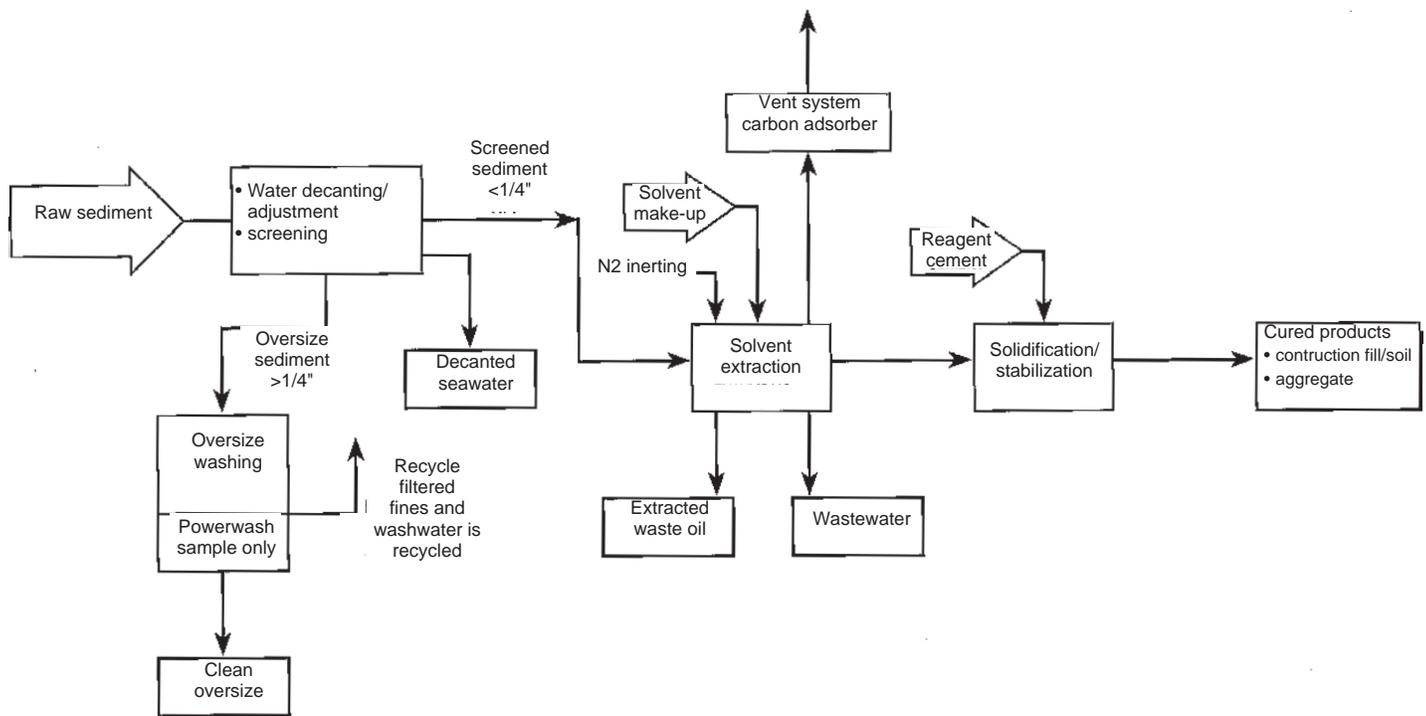

**Figure 2.** Schematic diagram showing the Metcalf & Eddy solvent extraction process for treatment of dredged material.

The testing included production of stabilized materials from both untreated and treated dredged material by Metcalf & Eddy, Inc. and the U.S. Army Corps of Engineers Waterways Experiment Station. The results are summarized in Table 5. It can be seen that compressive strengths of over 100 pounds per square inch can be

achieved. These values are comparable to values reported by Tanal et al. (10) and Samtani et al. (11) for a project carried out on dredged material from the Port of Boston. Other relevant physical properties of the solidified and stabilized dredged material are also given in Table 5.

## Institute of Gas Technology

The Institute of Gas Technology demonstrated the use of a rotary kiln for the destruction of organic compounds and immobilization of metals in the cementitious structure. A block diagram of the apparatus is shown in

Figure 3. The process requires adding common mineral compounds to optimize the overall composition of the material for pozzolan production. The technology employed is that commonly in use at existing cement plants. This is encouraging since it means that existing off-line facilities could possibly be devoted to processing

**Table 4.** Summary of Results for the Metcalf & Eddy Solvent Extraction Process

Contaminant	As-dredged	Treated 7-stage	Percent Reduction	NJ Non-Resid. <sup>1</sup>	NJ Resid. <sup>2</sup>	NY Resid. <sup>3</sup>
2,3,7,8 TCDD (ppt)	35	10	71	—	—	—
O CDD (ppt)	13411	3047	77	—	—	—
TCDD/TCDF TEQ (ppt)	648	106	84	—	—	—
Total PCBs (ppm) <sup>4</sup>	1.54	0.029	98.1	2	0.49	1
Anthracene (ppb)	62,900	1292	97.9	10,000	10,000	50,000
Benzo(a)anthracene (ppb)	38490	894	97.7	4000	900	224
Chrysene (ppb)	33.76	1.01	97.0	40,000	9000	400
Total PAHs (ppb) <sup>4</sup>	858,000	17,000	98.0	—	n/a <sup>5</sup>	396,500
Arsenic (ppm)	68	85	—	20	20	7.5
Cadmium (ppm)	29	32	—	100	1	1
Chromium (ppm)	319	373	—	—	—	10
Copper (ppm)	1090	1310	—	600	600	25
Lead (ppm)	632	795	—	600	400	SB <sup>6</sup>
Mercury (ppm) total	3.5	5.3	—	270	14	0.1
Zinc (ppm)	1505	1750	—	1500	1500	20

<sup>1</sup> NJ Department of Environmental Protection. Non-residential soil, direct contact. J.J.A.C. 7:26D, revised 7/11/96.

<sup>2</sup> NJ Department of Environmental Protection. Residential soil, direct contact. J.J.A.C. 7:26D, revised 7/11/96.

<sup>3</sup> NY Department of Environmental Conservation. Recommended soil cleanup objectives. HWR-94-046 (Revised). January 24, 1994.

<sup>4</sup> See Reference 12.

<sup>5</sup> n/a = not available.

<sup>6</sup> SB = Site background.

**Table 5.** Results of Physical Testing of Solidification/Stabilization Products\*

	Metcalf & Eddy Treated Sediment		U.S. ACE-WES Screened As-Dredged Sediment		
	15% Cement Mix	30% Cement Mix	10% Cement Mix	20% Cement Mix	40% Cement Mix
USC in psi	217	614	29	128	492
Water Content at 60°C	53.0	26.9	60.7	27.7	18.1
Water Content at 100°C	71.6	53.7	70.3	5.4	32.1
Specific Gravity	2.70	2.69	2.53	2.61	2.63
Coefficient of Permeability-cm/sec	1.16E-06	4.15E-07	1.42E-05	5.46E-06	3.12E-07
Dry Density in lbs/ft <sup>3</sup>	51.6	64.1	38.1	47.5	57.5
Atterburg Limits					
Liquid	103	—	126	—	—
Plastic	59	—	67	—	—
Slope Angle Degrees	—	—	35.5	—	—

\* All analytical data are based upon the average of all sample test results provided by U.S. ACE-WES.

of dredged material. The results for contaminant reduction are shown in Table 6. There is essentially complete destruction of organic compounds. The metals are reduced by dilution and by loss to the gaseous side-stream. Moreover, the metal values are in the range found for commercially available cements. Strength tests have been carried out and show that the sediment-derived product meets compressive strength standards. Cement production is therefore a method that is successful in reducing the contamination levels and provides an end product suitable for beneficial reuse.

### Westinghouse

The Westinghouse Science and Technology Center demonstrated the use of a plasma torch for destruction of organic contaminants and immobilization of metals in a glassy matrix. The plasma torch is an effective method for heating sediments to temperatures higher than can be achieved in a rotary kiln. On the other hand, feeding of the material into the plasma region is more complex since dewatering is necessary, and residence times in the high temperature regions are difficult to adjust. A schematic diagram of the Westinghouse apparatus is shown in Figure 4. The results for contaminant reduction are given in Table 7. The end goal of the processing is not only to reduce contaminant concentrations, but, also to produce a useful final product. In order to do this, the overall composition of the treated material is optimized for glass production. Glass tiles and fiber glass materials were successfully produced during the pilot-scale test

work. Glass production can, therefore, be considered as successful in reduction of contaminant levels and production of a valuable end product.

### 5. Operational-Scale Program

As mandated under WRDA 1996, the end goal of the testing program is to produce one or more production-level demonstration facilities that can be used as part of the total solution for management of dredged material from the harbor. Detailed engineering designs of plants for the production of cement and glass are now in progress and will be completed in early 1998. Construction of the facilities may begin in 1998 with a prospective completion date prior to the next century. This schedule is dependent on availability of funding from the private sector. Demonstrations of the sediment-washing approach are planned for early 1998 and operation of a large-scale demonstration facility by the end of 1998.

### Conclusions

A short description has been given of the highlights of a unique federal program for dredged material demonstrating decontamination. This program began with tests at the bench-scale level and will progress to a goal of production-scale volumes of up to 375,000 m<sup>3</sup> utilizing a "treatment train" approach. The breadth of the program has been increased through cooperation with groups who have carried on self-funded test programs. The bench- and pilot-scale results described here demonstrate that decontamination may be a viable method for

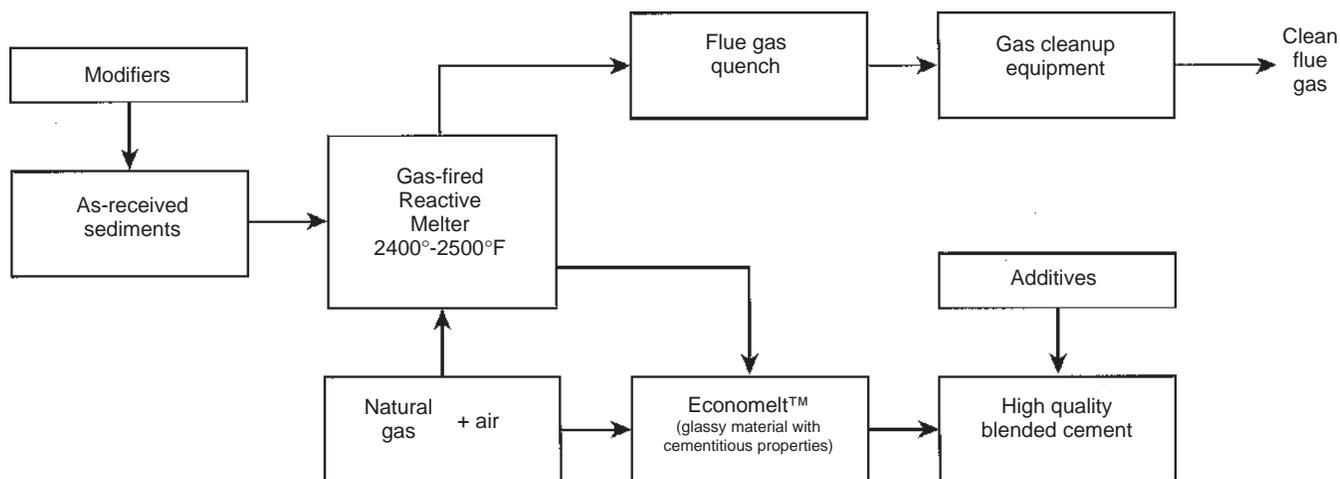

Figure 3. Schematic diagram showing the Institute of Gas Technology system for production of blended cement from dredged material.

**Table 6.** Summary of Results for the Institute of Gas Technology Cement Process

Contaminant	As-dredged	Treated	Percent Reduction	NJ Non-Resid. <sup>1</sup>	NJ Resid. <sup>2</sup>	NY Resid. <sup>3</sup>
2,3,7,8 TCDD (ppt)	23	0.35	98.47	—	—	—
O CDD (ppt)	11879	3.7	99.97	—	—	—
TCDD/TCDF TEQ (ppt)	513.2	1.406	99.72	—	—	—
Total PCBs (ppm) <sup>4</sup>	8.6	0.31	96.39	2	0.49	1
Anthracene (ppb)	18735	0	100	10,000	10,000	50,000
Benzo(a)anthracene (ppb)	17155	0	100	4000	900	224
Chrysene (ppb)	16878	0	100	40,000	9000	400
Total PAHs (ppb) <sup>4</sup>	293,854	0.16	100	—	n/a <sup>5</sup>	396,500
Arsenic (ppm)	39	1.52	96.10	20	20	7.5
Cadmium (ppm)	27	0.66	97.55	100	1	1
Chromium (ppm)	298	632.5	212	—	—	10
Copper (ppm)	1012	306	69.76	600	600	25
Lead (ppm)	542	29.4	94.57	600	400	SB <sup>6</sup>
Mercury (ppm) total	2.8	0.092	96.71	270	14	0.1
Zinc (ppm)	1535	280	81.76	1500	1500	20

<sup>1</sup> NJ Department of Environmental Protection. Non-residential soil, direct contact. J.J.A.C. 7:26D, revised 7/11/96.

<sup>2</sup> NJ Department of Environmental Protection. Residential soil, direct contact. J.J.A.C. 7:26D, revised 7/11/96.

<sup>3</sup> NY Department of Environmental Conservation. Recommended soil cleanup objectives. HWR-94-046 (Revised). January 24, 1994.

<sup>4</sup> See Reference 12.

<sup>5</sup> n/a = not available.

<sup>6</sup> SB = Site background.

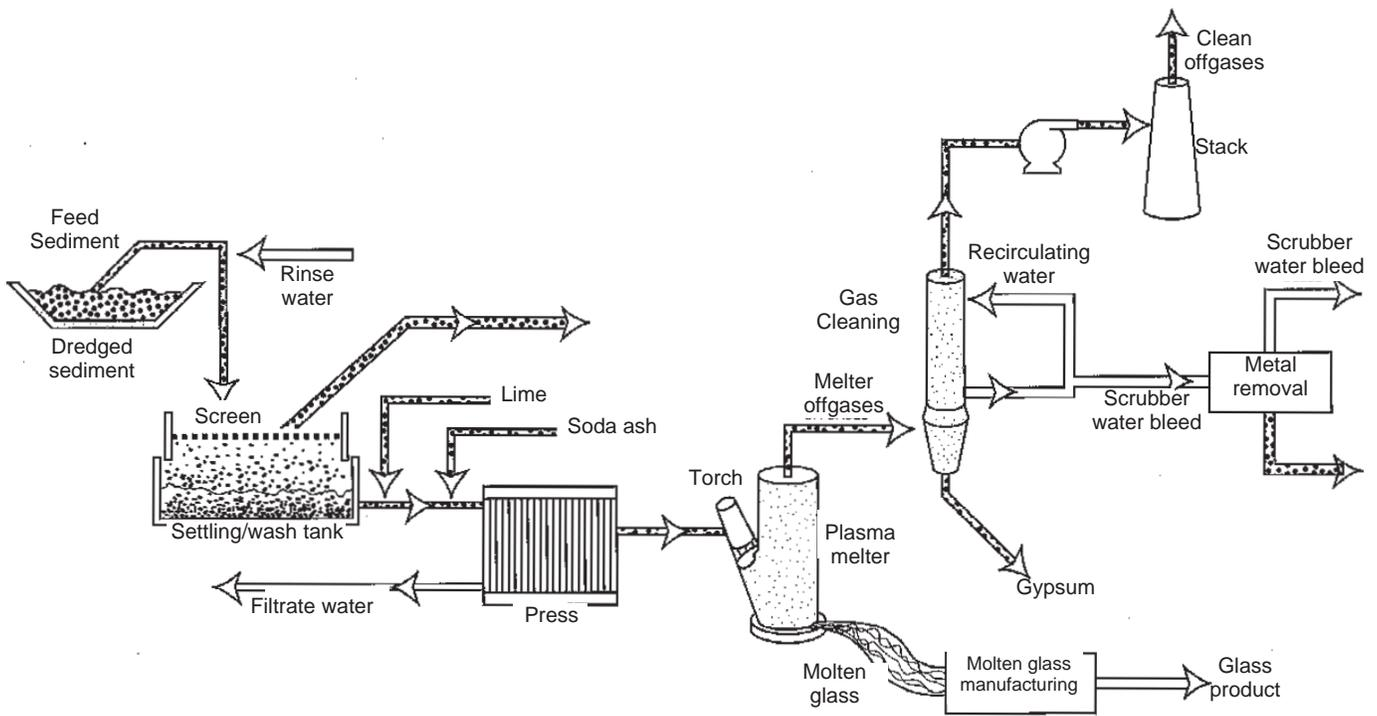

**Figure 4.** Schematic diagram showing the production of glass from dredged material using the Westinghouse Science and Technology Center plasma torch melter.

**Table 7.** Summary of Results for the Westinghouse Vitrification Process

Contaminant	As-dredged	Treated	Percent Reduction	NJ Non-Resid. <sup>1</sup>	NJ Resid. <sup>2</sup>	NY Resid. <sup>3</sup>
2,3,7,8 TCDD (ppt)	19.0	—	100	—	—	—
O CDD (ppt)	9655	8.0	100	—	—	—
TCDD/TCDF TEQ (ppt)	335	0.07	100	—	—	—
Total PCBs (ppm) <sup>4</sup>	0.900	0	100	2	0.49	1
Anthracene (ppb)	7.72	0	100	10,000	10,000	50,000
Benzo(a)anthracene (ppb)	7.19	0	100	4000	900	224
Chrysene (ppm)	8.76	0	100	40,000	9000	400
Total PAHs (ppb) <sup>4</sup>	109	0	100	—	n/a <sup>5</sup>	396,500
Arsenic (ppm)	15.8	4.94	68.7	20	20	7.5
Cadmium (ppm)	33.3	0.948	97.1	100	1	1
Chromium (ppm)	344	1001	—	—	—	10
Copper (ppm)	1145	1077	5.9	600	600	25
Lead (ppm)	594	105	82.3	600	400	SB <sup>6</sup>
Mercury (ppm)	2.08	0.087	95.8	270	14	0.1
Zinc (ppm)	1695	1240	26.8	1500	1500	20

<sup>1</sup> NJ Department of Environmental Protection. Non-residential soil, direct contact. J.J.A.C. 7:26D, revised 7/11/96.

<sup>2</sup> NJ Department of Environmental Protection. Residential soil, direct contact. J.J.A.C. 7:26D, revised 7/11/96.

<sup>3</sup> NY Department of Environmental Conservation. Recommended soil cleanup objectives. HWR-94-046 (Revised). January 24, 1994.

<sup>4</sup> See Reference 12.

<sup>5</sup> n/a = not available.

<sup>6</sup> SB = Site background.

handling at least a portion of the contaminated dredged material from NY/NJ Harbor.

erlands, 16-20 September 1996. *Estuaries*. In press.

## Acknowledgments

Work at Brookhaven National Laboratory was supported in part by the U.S. Department of Energy under Contract No. DE-AC02-76CH00016 and by Interagency Agreements between the U.S. Environmental Protection Agency (Nos. DW89941761-01-0 and DW89937890-01-0), the U.S. Army Corps of Engineers (No. NYD-94-39), and the U.S. Department of Energy.

## References

1. U.S. Army Corps of Engineers, New York District. September 1996. *Dredged Material Management Plan for the Port of New York and New Jersey. Interim Report.*
2. Stern, E. A., Donato, K., Jones, K. W., and Clesceri, N. L. "Processing contaminated dredged material from the Port of New York/New Jersey." Presented at the *Estuarine and Coastal Sciences Association (ECSA) Estuarine Research Federation (ERF) 96 Symposium*, Middelburg, The Netherlands, 16-20 September 1996. *Estuaries*. In press.
3. Jones, K. W., Stern, E. A., Donato, K., and Clesceri, N. L. "Processing of NY/NJ Harbor estuarine dredged material. Dredging and Management of Dredged Material," *Proceedings of 3 Sessions Held in Conjunction with the Geo-Logan 97 Conference*, The Geo-Institute/ASCE, July 16-17, 1997, Logan, UT. pp. 49-66.
4. Jones, K. W., Stern, E. A., Donato, K. R., and Clesceri, N. L. Commercialization of dredged-material decontamination technologies. *Remediation*. 8 (2) 43-54 (1998).
5. C. R. Lee, U.S. Army Corps of Engineers, Waterways Experiment Station, Attention: CEWES-ES-F, Environmental Processes and Effects Division, 3909 Halls Ferry Road, Vicksburg, MS 39180-6199.
6. Mohsen Amiran, BioGenesis Enterprises Inc., 610 West Rawson Avenue, Oak Creek, WI 53154.

- 
7. John Cardoni, Metcalf & Eddy, Inc., Post Office Box 1500, Somerville, NJ 008876-1251.
  8. Amir G. Rehmat, Institute of Gas Technology, 1700 South Mount Prospect Road, Des Plaines, IL 60018-1804.
  9. Nancy H. Ulerich, Westinghouse Electric Corporation, Science & Technology Center, 1310 Beulah Road, Pittsburgh, PA 15235-5098.
  10. Tanal, Vahan; Wang, Jaw-nan; Samtani, Naresh C.; and Lancellotti, Anthony. "Lime stabilization and disposal of contaminated dredged harbor sediments." *Proceedings of Geoenvironment 2000*, New Orleans, LA, February 1995.
  11. Samtani, Naresh C.; Tanal, Vahan; Wang, Joe; and Lancellotti, Anthony R. "Effect of lime admixtures on contaminated dredged sediments." *Proceedings of First International Congress on Environmental Geotechnics*, Edmonton, Alberta, Canada, July 10-15, 1994.
  12. NOAA. 1996. *Contaminant Levels in Muscle and Hepatic Tissue of Lobster from the New York Bight Apex*. Report to the U.S. Environmental Protection Agency and the U.S. Army Corps of Engineers. National Oceanic and Atmospheric Administration, National Marine Fisheries Service, James J. Howard Marine Science Laboratory, Highlands, NJ. May 1996.

---

# The Fully Integrated Environmental Location Decision Support (FIELDS) System

## *An Approach to Identify, Assess and Remediate Contaminated Sediment*

Matthew H. Williams, George D. Graettinger, Howard Zar, Dr. Yichun Xie and Brian S. Cooper

### Introduction

Sound and timely environmental decisions are best made using complete and reliable information that can effectively be communicated to all appropriate audiences. The better and faster GIS-based tools can help people identify and analyze environmental problems, the better the chance to understand these problems and find ways to solve them.

This paper reviews the practices, achievements, and future of geographic information system (GIS) based decision support systems used by the United States Environmental Protection Agency (USEPA) at its Region 5 Water Division and Superfund programs in Chicago. The Region 5 office covers six midwestern states of Illinois, Indiana, Ohio, Michigan, Minnesota, and Wisconsin, and has further responsibilities for the Great Lakes. Several groups in the region are applying and refining comprehensive databases and innovative GIS tools to significantly advance the Agency's efforts to protect and enhance the environment.

The presentation accompanying this paper will provide examples of how GIS tools can be used to help solve environmental problems from "start" to "finish".

### Overview

As a practice, geographic areas of interest are defined by government (state, county, city), environment (waterbody, geology, soil), or by other interests (demographics, urban, rural, industrial, residential, land use). It has always been difficult to display multi-variant data from these areas on a two dimensional sheet of paper. Data were commonly evaluated by one theme, or data layer, at a time—not in their actual multilayered, three-dimensional states.

The process of collecting, organizing, analyzing and visualizing data for a geographic area in multiple layers is often a complex, time-consuming and expensive task. With the advancement of GIS technologies over the past ten years, this process has made noteworthy gains in some areas, while presenting new sets of complexities in others. Current systems can already represent environmental situations in their three-dimensional states with impressive visual displays and are becoming easier to use and more affordable. However, the functionality of these systems must be improved along with the methods of collecting the data that is put into the system.

Nevertheless, the trend is clear: databases and the GIS tools applied to them will continue to have a profound impact on the way environmental decisions are being evaluated, determined and improved. Those who can sift through the mounting networks of environmental information to extract or compile critical data, will be most adept at understanding environmental problems and most focused on creating the GIS tools to help solve them.

### GIS Groups

Many environmental agencies and organizations now have centralized GIS groups charged with providing technical support for programs. Fundamental to establishing a successful GIS-based decision support system is the challenge of bringing together a well-rounded, highly skilled group of individuals to do the work.

We have brought together one such a group at USEPA Region 5 and in our partner universities to support Water Division and Superfund Program needs. The Water Division GIS Team and FIELDS Group includes individuals with the following technical expertise:

- Aerial Mapping (photography, digital orthoquads-DOQs, imaging)
- Computer System Administration
- Communications
- Differential Global Positioning Systems (DGPS)
- Environmental Assessment (Sampling and In-field Analytical)
- Geographic Information Systems (GIS)
- Human Health and Ecological Risk Assessment
- Internet Web Design and Graphics
- Relational Database Design and Management
- Remediation Alternatives and Costs
- Remediation Project Management
- Statistics

A focused and technically balanced team is essential because the power of a GIS tool will reflect the collective knowledge of those who developed it and the quality of the data they put into it. Users of these tools can then benefit greatly by having that knowledge and data fully integrated and immediately available for their use.

## Communication

Maps and images are essential to effective communication. They can portray large- and small-scale problems simply and rapidly to decision makers—helping them to pursue worthwhile, long-term environmental solutions. Based on this, the future of databases and GIS tools is to allow users to identify, manage and view both old and new environmental data in a “real-time” fashion. Future GIS users should be able to instantaneously link newly acquired real-time data with relevant historical data to perform analyses and obtain displays to support their decision-making needs.

## Fully Integrated Environmental Location Decision Support System—FIELDS

***On the Web: <http://ceita.acad.emich.edu/fields/SHARED/PAGES/FLDHOME.HTM>***

The FIELDS system is a collection of technical tools and applications incorporating relational databases, GIS, GPS, statistical techniques and in-field analytical technologies to inform decision-makers about a variety of conditions at a site or geographic area of special concern. The FIELDS focus is an in-depth evaluation of current and historical site-specific conditions to provide

fast, reliable and affordable support to decision-makers at some of the region’s most contaminated sites.

FIELDS has supported Region 5 site/program managers with determining the spatial distribution of contaminants, volume, mass, human health risk, and remedial options and costs for sediment hotspot areas. The statistical/spatial analytical tools in FIELDS have been used for establishing and tracking sediment cleanups of environmental sites in Region 5 states.

The system was developed by the FIELDS Group that resides in the Region 5 Water Division and Superfund program. The group provides multimedia (groundwater, surface water, soil, sediment, etc.) technical assistance for many priority environmental sites in the region.

The FIELDS Group helps address site-specific contaminated sediment issues by:

- Identifying hot spots and pollutant sources
- Assessing risks and contaminant mass loadings
- Prioritizing and targeting areas for cleanup
- Evaluating remedial alternatives and costs
- Effectively visualizing and communicating options to decision-makers
- Implementing and tracking environmental clean-ups

Meeting these objectives allows users to make scientifically based, mission-critical decisions about areas of environmental concern.

There are four main modules of the FIELDS system.

### 1. The Basemap

The first step to focusing on a specific geographic site is to create a spatially accurate basemap of the area of concern. Typically, this process involves obtaining an aerial photograph or digital ortho quad of sufficient quality. This image must then be made into a map by using software (e.g. ARC/INFO) to register and rectify the photograph to vertical and horizontal ground control points. The control points are established using a variety of methods such as real-time global positioning systems (GPS) with sub-meter accuracy.

### 2. GIS-Based Sampling Design and Collection

Once an accurate basemap is created, FIELDS can support the display and analysis of numerous layers of spatial data. The FIELDS process utilizes the basemap to design a GIS-based sampling plan for contaminants of concern within the geographic area of interest. The sampling design module runs using ArcView Avenue/

---

Dialogue Designer scripts as a stand alone extension to support statistically based hotspot and user defined sampling designs. The FIELDS sampling design module generates x-y coordinates and sample identification values associated with sample locations and directly generates a waypoints file (a file with latitude and longitude coordinates for samples) that can be exported to a GPS unit. This waypoint file is then used to navigate, using the GPS, to the design sample locations where samples are to be collected for analysis. These sample sites are then input into the FIELDS database and are ready to receive the chemical analytical data as it is returned.

### 3. Real-Time Analytical

Samples collected from locations defined by the FIELDS GIS-based sampling design and collection module, can be analyzed for chemicals of concern using rapid, in-field analytical techniques such as onsite Gas Chromatograph/Mass Spectrometer (GC/MS), x-ray fluorescence and immunoassay kits. Real-time analysis and the sample design module allows these data to be used as soon as the results are available as the database is already set up to receive and use these analytic data. Obtaining real-time data about the levels of chemicals of concern in field samples provides maximum efficiency in mapping hotspots of contamination while in the field, as well as reducing the overall costs and time associated with these activities.

### 4. Database Loading Function

The data resulting from in-field analyses of environmental samples can be immediately loaded into the FIELDS database structure using the Database Loading Function module. The Database Loading function is a standalone Visual Basic/Map Objects application to an Access database. The data are input to the designed sample sites and become part of the FIELDS Database/GIS system. These data can then be used to perform numerous database and GIS analyses for the site.

The result of the FIELDS four-part process is a site-specific decision support system that can:

- Map contaminants
- Define hotspots
- Calculate area, volume, mass, loadings
- Estimate risks—human health and ecological
- Prioritize areas for cleanup
- Evaluate remedial alternatives and costs
  
- Create communication tools—Internet-ready products such maps, images, data summaries and briefings

These capabilities provide immediately useful and highly valuable information to support environmental decision-making and actions in areas of specific concern.

## Data Quality

The application of FIELDS will continue to expand in scope and capability. At the same time, the detail and quality of the environmental data upon which the tools are applied must be more closely monitored and assessed. The quality of environmental data put into GIS systems must be clearly determined in order to understand the limitations of decisions made against these data. Data quality assessment includes evaluating the accuracy and precision of sample locations, collection, storage, custody and analysis (raw data sheets, data quality standards, detection limits, reporting limits, etc.) Therefore, efforts should be made to incorporate data quality criteria into databases and GIS tools so that users can determine the appropriate use of data.

The FIELDS Group has developed and will be expanding its capacity to provide GIS and characterization data to a broad base of users via a real-time, online mapping tool that will deliver products in an interactive session.

It is anticipated that before long, maps relating to some environmental issues will become so widely accessed by Internet and other means that their familiarity will be not unlike weather maps of today. Although the public may not be any more persuaded of the decisions made by environmental officials than they are of today's weather predictors, they may be much better informed.

## Conclusion

The future of FIELDS and other GIS-based decision support systems is to potentially drive when, where, why and how an environmental problem can be solved. The more efficient the identification, acquisition and management of relevant environmental data the more likely that decisions based on these data will achieve measurable environmental benefits.

This will require a continued emphasis on the design of comprehensive and fully integrated spatial data platforms capable of managing important environmental information from the initial identification of a problem to the development and implementation of a final solution.

USEPA Region 5 programs have had a great deal of success with combining GIS, GPS and statistics with environmental sciences and engineering to help address a variety of contaminated sediment concerns. The FIELDS Group provides a wide array of skills, technology, data and institutional knowledge to the programs or projects we support. Responding to customer needs, focusing on obtaining solutions, and adapting to political and environmental concerns has allowed us to be a highly effective unit. FIELDS will continue to support USEPA Region 5 efforts to locate, define and cleanup contaminated sediment.

*This paper has been adapted from USEPA Region 5's paper written for the Geoinformatics '98 Conference held in Beijing, China, June 17-19, 1998.*

---

# Remediation Strategies and Options for Contaminated Sediment

Carol Ancheta  
Scientific Project Officer  
Environment Canada  
Remediation Technologies Program  
Downsview, Ontario, Canada

## Executive Summary

When faced with the problem of contaminated sediment, one must look at all of the options for the site and select which option or options are most feasible on a site specific basis. This paper introduces the reader to some of the issues which must be addressed to understand the problem before making decisions on a solution. An overview of remedial options and applicable technologies is outlined with a brief discussion on selection methodologies for preferred options and technologies. The case study on Thunder Bay provides a current example of how contaminated sediment is being remediated.

## Understanding the Problem

To determine when remediation is required, the following question needs to be addressed sufficiently: Does the site pose a threat to the ecosystem and/or human health? The complexity of the answer to this question is site specific. In general, one must undertake a site assessment. Four phases to understanding the nature and extent of contamination at a site include:

1. Phase I: Existing information is collected. Examples include conducting interviews, visiting the site, reviewing historical information including existing reports, describing the site and surrounding area in detail, and identifying historical and ongoing sources of contamination.
2. Phase II: Sample collection is undertaken. A screening level sampling program is designed and implemented, and if necessary, followed up with a more detailed sampling program in identified area(s) within the site.
3. Phase III: Severity of chemical contamination is analyzed and compared with available guidelines. Biological contamination is analyzed by measur-

ing (a) benthic community structure; (b) fish community structure; and (c) bioassays. Bioavailability and bioaccumulation studies should also be considered during this phase of the evaluation. It is important to note that even though the benthic community may suggest a healthy structure, persistent toxics present in the sediment may be bioavailable/bioaccumulative to other organisms in the food chain, including humans. For this reason, uptake studies are useful to measure contaminant release from the sediment into the water column. Tissue residue studies are also useful to measure the availability of contaminants to biota and potential for transfer of contaminants through the food chain.

4. Phase IV: Risk assessment is undertaken to identify exposure pathways and evaluate impacts associated with environmental, economic, social, legal, and technical issues.

## An Introduction to Remedial Options

Remedial options for contaminated sediment include: do nothing; *in-situ* treat; cap; contain; and dredge (see Figure 1). For all options, end use of the material needs to be considered. Particularly if the material is to be dredged, end use could include disposal or beneficial reuse of the material. An introduction to each option is discussed below, and technologies applicable to each activity are identified. Options and technologies can be selected individually or can be used in combination with one another.

### **Natural Remediation**

Nature is allowed to take its own course with this option. Normally, this option is preferred when natural biodegradation of the contaminants are anticipated and/or sedimentation and natural burial will most likely occur in the area of concern. If this option is selected, monitoring of

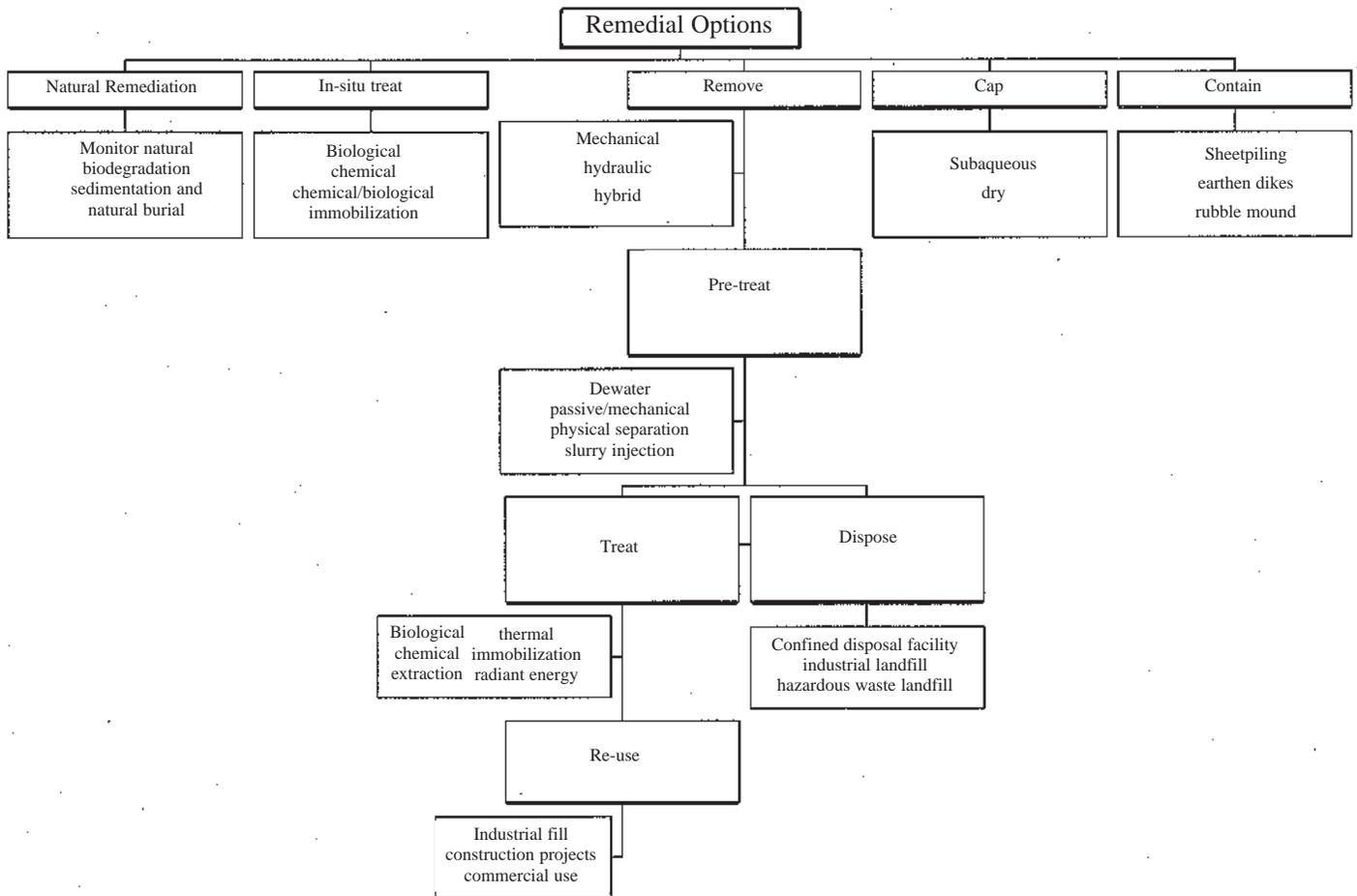

Figure 1. Remedial options and technologies.

the area over time is required to determine the implications and affects of deciding to leave the site alone.

### ***In-situ Treat***

This option allows for the treatment of sediment in place. Understanding the chemical nature of the contaminants at the site is an essential component to this option. Potential chemical reactions may occur due to the change in the environment from application of one or more of these techniques. These reactions will need to be investigated prior to selection of this option to determine environmental effects. Monitoring these reactions during and after application is required.

*In-situ* treatment technologies include:

**Biological:** Microorganisms, in the presence of oxygen and nutrients (aerobic) or in oxygen-deficient areas (anaerobic), biodegrade organic contaminants.

**Chemical:** Chemicals are used to neutralize, precipitate, or dechlorinate contaminants.

**cal/biological:** A combination of both chemical and biological processes are used. An oxidizing agent is injected into the sediment in order to facilitate microbial metabolic activity and degradation of contaminants.

**Immobilization (solidification/stabilization):** technologies which change the state of the sediment, either physically or chemically, and reduce the potential for contaminant migration. Fixatives such as cements, pozzolans, and thermoplastics are used.

### ***Cap***

This option allows for clean material to be placed over top of the contaminated sediment. The clean material creates a physical barrier between the contaminants and the overlying and surrounding environment. Examples of possible environmental issues to consider before selection of this option include groundwater effects, contaminant migration, bioturbation zones, durability and weathering effects of the cap over time. Monitoring and possible maintenance of the cap in perpetuity is required.

Capping technologies include:

---

Subaqueous cap: Controlled and accurate placement of clean material is laid over top of in place contaminated sediment creating a bioturbation zone.

Dry cap: placement of a large volume of clean material over the sediment so that the final elevation of the cap surface is above the water level.

## **Contain**

This option allows for containment of the site by creating a physical barrier which surrounds the zone of contamination. Examples of possible environmental impacts to consider before selection of this option include ground-water effects, site security from humans and terrestrial wildlife, weathering and storm events. Monitoring and possible maintenance of the containment structure will be required in perpetuity.

Techniques used to contain a site include, but are not limited to:

Sheetpiling: Metal piles are driven into the bottom of the waterbed. Once anchored, steel sheets are placed between each piling.

Earthen dikes: generally homogeneous earth material.

Rubble mound: The core material is usually clay. The core is surrounded by either: (1) fine granular material, increasing in coarseness and grain size as it moves outward away from the core; or (2) surrounded by a synthetic filter material.

## **Dredge**

This option allows for the physical removal of the contaminated sediment from the site. End use of the material needs to be determined prior to selection of this option. Disposal or beneficial re-use of the material should be considered. Disposal of the dredged material may include placement into a confined disposal facility, a licensed industrial landfill or a licensed hazardous waste landfill. Beneficial re-use may include using the material for construction projects, as industrial fill, or for any other use where the quality of material meets the local government standards for use on the identified lands, (e.g. the material meets commercial/industrial criteria for use on industrial land), and is acceptable to the local community. Pretreatment and/or treatment of the material may be required to meet the end use goal.

Some factors to consider before selecting this option include: (1) contaminant variability of the site is an important factor in delineating both vertical and horizontal site boundaries; (2) positioning accuracy of the dredge, both vertical and horizontal, and experience of the operator; (3) type of contaminants present and potential for chemical reactions during the operation (e.g. dredging highly contaminated polycyclic aromatic hydrocarbons such as naphthalene may cause a release of volatile organic carbons into the atmosphere and consequently

cause a negative impact on air quality and a potential health and safety concern for site workers); (4) presence of debris and possible impact on operational performance of the dredge; and (5) environmental monitoring of the site before, during, and after the dredge operation to ensure environmental compliance.

Dredge technologies include:

Mechanical: dredges which use mechanical force to remove sediment from the bottom of a water column. Examples include clamshell, backhoe, bucket ladder, dragline, and dipper.

Hydraulic: dredges which use water, mixed with the sediment, to remove and transport the material in a slurry phase. Air is sometimes substituted for water in pneumatic dredging operations. Examples include cutterhead, suction, eddy pump, matchbox fluidizer, hopper, pneuma, oozer, and portable dredges.

Hybrid: mechanical force is used for the initial handling of the material, followed by pumping. An example includes the amphibex.

Contaminants are found predominantly in fine grain size sediment including clay, silt and sand. Regardless of the end use of the material, contaminated dredged material is usually pre-treated to reduce water content, remove debris, remove oversized uncontaminated particles, to accelerate settling time and/or to accelerate microbial action.

Pre-treatment technologies include:

Dewatering: dewatering sediment involves reducing the water content of the sediment.

Passive: air drying technologies which dewater the sediment passively over time.

Mechanical: dewatering processes which use energy to force water out of the sediment.

Slurry injection:

Chemical: chemicals such as polymers and flocculants, can be injected into the pipeline of an hydraulic dredging operation to condition the dredged material for accelerated settling in a disposal or treatment facility.

Microorganisms: microbes and nutrients can be injected into the dredged material at the disposal facility to enhance the biodegradation of organics.

Physical separation: classification of coarser sediment grains and debris allows for oversized material to be removed from the dredged material with little or no treatment requirements. Examples include vibrating screens, grizzlies, trommels, hydrocyclones, froth floatation, magnetic separation, and gravity separators.

---

Treatment technologies may be used to change the state of the contaminants to levels acceptable for end use goals. Many types of technologies are on the market today. The following is a generic list of treatment categories.

**Biological:** treatment technologies which use bacteria, fungi and/or enzymes to accelerate the natural biodegradation of organic contaminants or to transform the contaminants to less or nontoxic forms. Accelerated growth of microorganisms and the increased production of enzymes, balanced with nutrients, oxygen and temperature, are the mechanisms whereby target contaminants are converted to less or nontoxic byproducts. Examples include landfarming, and bioslurry.

**Chemical:** technologies which add chemical reagents to the sediment in order to destroy, detoxify, or remove the contaminants. Examples include dechlorination, and oxidation.

**Extraction:** uses a solvent to desorb or separate the organic contaminants from the particulate solids, and concentrate them in reduced volumes. Examples include inorganic and organic.

**Radiant energy:** any system where waves of energy are used to treat contaminants. Wave forms include light at various wave lengths (e.g. visible light, UV, electron beam), sound waves and radio waves.

**Immobilization (stabilization/solidification):** technologies which change the state of the sediment to reduce the potential for contaminant migration (i.e. leaching, erosion, volatilization potential of contaminants) after its disposal. Solidification examples include cements, silicates, and pozzolans. Stabilization examples include polymers such as urea formaldehyde.

**Thermal:** technologies which heat the sediment to several degrees above ambient temperature to destroy, encapsulate, desorb or volatilize contaminants. Examples include pyrolysis, vitrification, high-pressure oxidation, thermal desorption and incineration.

## Case Study Thunder Bay

Thunder Bay is located on the northern shores of Lake Superior, Ontario, Canada. In 1997, a five-party consortium, including three private sector and two public sector groups, signed an agreement to remediate creosote based contaminated sediment in the harbour. Remedial options for the site were investigated individually and collectively. Public consultation was extensive and played a large role in the decision making process. The Thunder Bay project is currently underway and involves the natural remediation, contain, cap, and dredge options. Once dredged the material will be pre-treated, treated and re-used as industrial fill.

All options for the site were assessed individually and collectively. Individually, options were either found not

suitable for the site due to the level and varying degrees of contamination or the options were deemed very expensive and not feasible to implement. By combining the options, all levels of contamination are addressed. Also, by combining the options, desirable characteristics of all approaches are optimized while minimizing the possible negative attributes associated with individual approaches.

The Thunder Bay project was developed to reflect remediation needs in different zones of contamination, resulting in the integration of containment, removal, treatment and capping activities. A site specific, risk assessment approach was used to establish a cleanup criterion. In establishing this criterion, the objective was to maximize aquatic enhancement while at the same time permitting an economically viable remediation project. The primary cleanup criterion for sediment was based on the toxicity of the sediment to organisms most likely to come into contact with the contaminants. Those sediment responses which resulted in a severe toxic biological effect were recommended to be isolated from the lake waters or removed. A secondary criterion was developed based on less severe toxic biological effects. It was recommended that contaminants be isolated from the water column when the sediment elicited this secondary response. Those sediments below the secondary criterion which appeared to elicit no observed toxic biological response from the test organisms were to be left in place and monitored for natural biodegradation and sedimentation over time.

Based on the project specific clean up criteria, various activities are currently being implemented. An environmental clay barrier and offshore containment berm has been constructed to contain and isolate the majority of contaminants from the harbour. Severely toxic sediments have and are currently being removed with use of an environmental dredge. The dredged material will be treated to a level consistent with the Canadian Council of Ministers of the Environment (CCME) Industrial Soil Criteria. Once treated to acceptable levels, the material will be used as industrial fill along with other clean fill. The fill will be placed behind the new containment berm, creating new industrial lands. To compensate for the construction of the berm, infilling activities and fish habitat loss, a fish habitat program is being implemented. This program will include the excavation and sculpting of reclaimed marshland and development of new habitat for fish, waterfowl and wildlife. The zone of contamination left outside of the containment berm will be left in place for natural degradation, on the basis that these contaminants are relatively immobile, some are found to be "hard packed" and less susceptible to resuspension. Monitoring programs are in place to determine the effectiveness of the remediation activities.

## Remedial Option Selection Methods

There are a variety of methods which can be used to determine a preferred remedial option. One or more may be used at a given time during the decision making process. Examples include:

---

Risk assessment: evaluation of environmental, social, economical, legal, scientific and technical issues.

Cost/benefit analysis: monetary values are given to project components of each remedial option and summations of each dollar value are compared.

Open bidding process: competitive bids decide the preferred option.

Demonstration technology evaluation: bench and/or pilot scale testing technologies

Weighted scoring system (e.g. Concordance Method): rank and give weights to selection criteria based on their order of importance. Highest weighted options are selected as preferred options.

Project team: consensus is given among project team members.

### **Technology Selection:**

Many variables need to be considered when selecting applicable technologies for the preferred option. Some key considerations include:

Cost versus budget allocation

End use of the material (disposal versus re-use)

Productivity

Time availability

Type of contaminants and variability

Environmental performance

Accurate positioning of equipment (if applicable)

Transportability

Compatibility with site conditions (e.g. size, depth of contamination, currents)

Compatibility with other technologies in the process stream

Experience of team

### **SEDTEC**

SEDTEC, Sediment Technology Directory, is a user-friendly computer software product listing removal and treatment technologies for contaminated sediment and treatment technologies for contaminated soil and sludges. Based on an international inventory of manufacturers and vendors of technologies, this database was originally developed by Environment Canada to identify suitable technologies for dealing with contaminated sediment. Today, it is a tool which identifies technologies for site specific needs, provides case studies for projects, outlines costs and operational efficiencies, lists contacts for technology auditors, project funding agencies, and technology vendors/manufacturers worldwide. This directory was demonstrated on May 14, 1997 at the U.S. EPA National Conference on Management and Treatment of Contaminated Sediments in Cincinnati, OH.

### **Conclusion**

This paper introduces the reader to phases involved in a site assessment, to the types of remedial options available and to the sediment remediation technologies on the market today. Selection methodologies and considerations for technology selection are also provided.

Understanding the nature and extent of sediment contamination is the first step to defining the solution. Investigating all of the options, individually and collectively, and identifying suitable technologies is instrumental in determining the preferred options. Selecting the remedial solution for the area of concern is site specific. One should draw upon other experiences through case studies. In many cases, the decision will be community based.

### **References**

1. Ancheta, C. 1996. *Randle Reef Sediment Remediation Project, Analysis of Alternatives Report*. Hamilton Harbour Remedial Action Plan. Burlington, Ontario. Volume 3.
2. *Environment Canada et al. 1996. Northern Wood Preservers Site Sediment Remediation Project, Thunder Bay Harbour, Comprehensive Study Report*. Downsview, Ontario.
3. Jaagumagi, R. and D. Persaud. 1995. *Sediment Assessment and Remediation Ontario Approach*. Sediment Remediation '95. Windsor, Ontario.

# The Automated Dredging and Disposal Alternatives Modeling System (ADDAMS): Summary and Availability

Paul R. Schroeder  
Research Civil Engineer  
U.S. Army Engineer Waterways Experiment Station (WES)  
Vicksburg, MS

Michael R. Palermo  
Research Civil Engineer WES

## Background

Planning, design, and management of dredging and dredged material disposal projects often require complex or tedious calculations or involve complex decision-making criteria. In addition, the evaluations often must be done for several disposal alternatives or disposal sites. The Automated Dredging and Disposal Alternatives Modeling System (ADDAMS) is an interactive per-

sonal computer (PC)-based design and analysis system for dredged material management (1). ADDAMS contains a collection of computer programs (applications) designed to assist in managing dredging projects and in evaluating the environmental effects of dredged material management alternatives in accordance with the USACE/USEPA technical guidance (2). (See Figure 1.) This paper describes the system, currently available applications, mechanisms for acquiring and running the system, and provisions for revision and expansion.

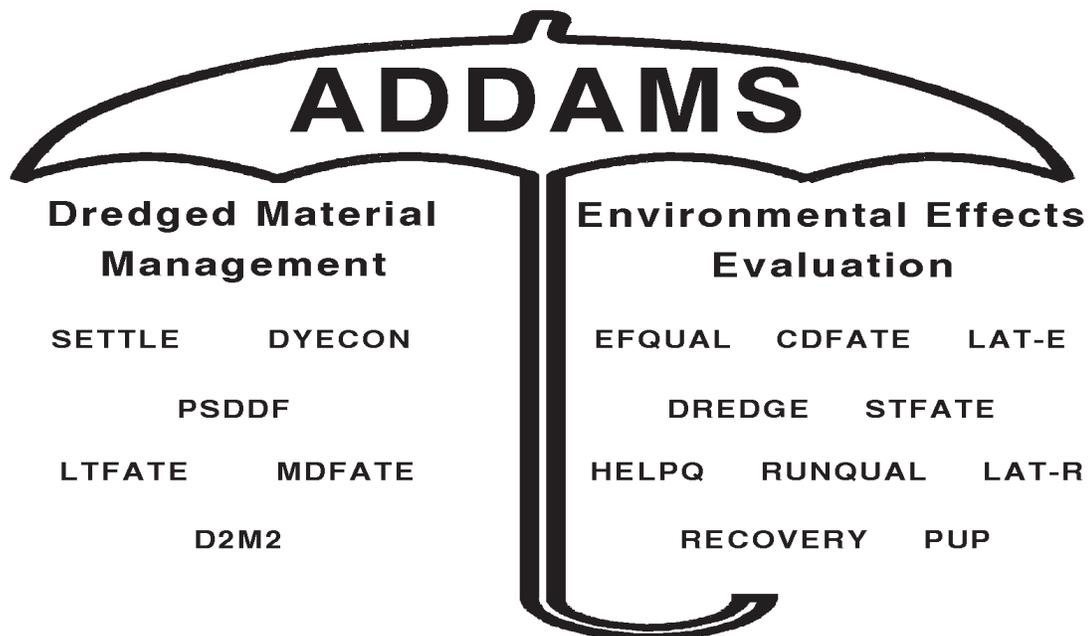

Figure 1. ADDAMS modules.

---

## Description of ADDAMS

ADDAMS is composed of individual modules or applications, each of which has computer programs designed to assist in the evaluation of a specific aspect of a dredging project. The creation of the system was in response to requests by Corps field offices for tools to rapidly evaluate dredged material management alternatives. The objective of the ADDAMS is to provide state-of-the-art computer-based tools that will increase the accuracy, reliability, and cost-effectiveness of Corps dredged material management activities in a timely manner.

Most of the current ADDAMS programs employ a menu-driven environment and support full-screen data entry. Single keystrokes (usually the F1-F10 function keys, number keys, Esc key, cursor keys, and the Enter key) select menu options in the system. The newer applications are programmed to run in the Microsoft Windows environment, and all modules will eventually be converted to a Windows format.

Each ADDAMS application has documentation describing how to run that application, and how that application functions. A list of references is provided directly on-screen within the applications including those concerned with the technical background and theory involved and documentation for the programming as appropriate. Points of contact for each application are also listed directly on the screens for answering questions regarding the respective applications. In addition, computerized demonstrations are available for many applications and example data files are provided for all applications.

ADDAMS applications and their methodologies are richly diverse in sophistication and origin, reflecting the nature of dredged material management activities. The contents range from simple algebraic expressions, both theoretical and empirical in origin, to numerically intense algorithms spawned by the increasing power and affordability of computers. A brief description of each of the currently available applications follows.

### SETTLE

SETTLE [full title: *Design of Confined Disposal Facilities (CDFs) for Suspended Solids Retention and Initial Storage Requirements*] provides a computer program to assist users in the design of a CDF for solids retention and initial storage. Various settling processes occurring in the CDF control the initial storage during filling, clarification, and effluent suspended solids. Laboratory column settling tests are an integral part of these design procedures, and the data from these tests are required in order to use this application. The SETTLE application analyzes laboratory data from the settling tests and calculates design parameters for CDFs.

### PSDDF

PSDDF [full title: *Primary Consolidation, Secondary Compression, and Desiccation of Dredged Fill*] provides a mathematical model to estimate the storage volume occupied by a layer or layers of dredged material in a confined disposal facility (CDF) as a function of time. Management of CDFs to provide maximum storage capacity is becoming more necessary as both the storage capacity of existing sites and availability of land for new sites decrease. Maximum site capacity is achieved through densification of the dredged material by removal of interstitial water. The volume reduction and the resulting increase in storage capacity are obtained through both consolidation and desiccation (drying) of the dredged material. The PSDDF model relies on the results of laboratory consolidation tests to estimate the magnitude and rate of consolidation and on climatic data for estimation of the rates of drying at a given site. This updated module has improved solution techniques, a secondary compression model, and an on-line data base of consolidation properties.

### DYECON

DYECON [full title: *Determination of Hydraulic Retention Time and Efficiency of Confined Disposal Facilities*] provides a computer program to determine mean hydraulic retention time and hydraulic efficiency of a confined disposal facility (CDF) from a dye tracer slug test. Determination of retention time of ponded water is an important aspect of CDF design. Dye tracer studies may be undertaken to provide retention time data for large sites or those with unusual characteristics. In the absence of dye tracer data, the hydraulic efficiency can be estimated empirically.

### D2M2

D2M2 [full title: *Optimization of Long-Term Operation, Expansion, and Acquisition of Multiple Disposal Sites for Multiple Dredging Reaches*], developed by the U.S. Army Engineer Hydrologic Engineering Center (HEC) and modified for the San Francisco District, is a simulation-optimization model for systematic analysis of long-term operation and expansion of multiple disposal sites. The model provides a means of determining the optimum usage of multiple disposal areas to meet the dredging requirements at multiple dredging sites, for example, along the length of a navigation channel. D2M2 uses a linear-optimization approach in determining the optimum usage based on input data for dredging volumes, location, frequencies, transportation facilities, and associated costs.

### STFATE

STFATE [full title: *Short-Term Fate of Dredged Material Disposed in Open Water for Predicting Deposition and Water Quality Effects*] provides mathematical modeling of the physical processes determining the short-term fate of dredged material disposed at open-water sites,

---

that is, within the first few hours after disposal. STFATE was developed from the DIFID (Disposal From an Instantaneous Dump) model. In STFATE, the behavior of the material is assumed to be separated into three phases: convective descent, dynamic collapse, and passive transport-dispersion. The model provides estimates of receiving water concentrations of suspended sediment and dissolved constituent and the initial deposition of material on the bottom. Estimates of water column concentrations are often needed to determine mixing zones; whereas, the initial deposition pattern of material on the bottom is required in long-term sediment transport that assess the potential for erosion, transport and subsequent redeposition of the material. This model can also serve as a valuable aid in field monitoring programs. STFATE can be used in evaluating water column effects of open-water disposal of dredged material in accordance with section 103 of the Marine Protection, Research, and Sanctuary Act and section 404(b)(1) of the Clean Water Act.

## EFQUAL

EFQUAL [full title: *Analysis of Modified Elutriate Test Results for Prediction of Effluent Water Quality and Dilution Requirements for Confined Disposal Facilities*] provides a computer program to analyze the results of modified elutriate tests and predict the chemical quality of effluent discharged from confined disposal facilities (CDFs) during hydraulic filling operations. Such predictions are necessary to evaluate the acceptability of the effluent discharge under section 404 of the Clean Water Act. The effluent may contain both dissolved and particle-associated contaminants. The modified elutriate test was developed for use in predicting both the dissolved and particle-associated concentrations of contaminants in the effluent. Results of the modified elutriate and column settling tests may be used to predict the total concentrations of contaminants for a given set of CDF operational conditions.

## RUNQUAL

RUNQUAL [full title: *Comparison of Predicted Runoff Water Quality with Standards and Prediction of Dilution Requirements*] provides a computer program to analyze the results of surface runoff quality tests and to predict the chemical quality of the surface runoff discharged from confined disposal facilities (CDFs). Such predictions are necessary to evaluate the acceptability of the surface runoff under section 404 of the Clean Water Act. The surface water runoff may contain both dissolved and particle-associated contaminants. Results of the surface runoff quality tests and the column settling tests may be used to predict the dissolved and total concentrations of contaminants for a given set of CDF operational conditions.

## HELPQ

HELPQ [full title: *Hydrologic Evaluation of Leachate Production and Quality*] couples the USEPA Hydrologic

Evaluation of Landfill Performance (HELP) model with an equilibrium partitioning model for contaminant transport. The model generates estimates of leachate production, collection and leakage from upland confined dredged material disposal facilities as well as estimates of contaminant concentrations and mass fluxes in the leachate.

## PUP

PUP [full title: *Prediction of Contaminant Uptake by Freshwater Plants*] predicts the contaminant uptake from dredged material by freshwater plants using DTPA extract data. The model compares the predictions with reference sites to determine the acceptability of the uptake in upland and flooded environments.

## CDFATE

CDFATE [full title: *Fate of Continuous Discharges from Dredged Material Disposal for Estimating Mixing Zones*] predicts mixing zone requirements to meet water quality standards or predicts compliance with water quality standards given a mixing zone. The model is applicable for nearly all continuous discharges from dredged material disposal operations. The operations considered by the module include discharge of effluents or runoff from upland confined disposal from a weir, pipe, or stream; leakage through porous dikes; overflows from hopper dredges or barges; and discharge of dredged material from a pipeline.

## DREDGE

DREDGE [full title: *Resuspension of Sediments and Contaminants by Dredging*] generates estimates of suspended solids and contaminants released to the water column during dredging and predicts dispersion.

## LTFATE

LTFATE [full title: *Long-Term Fate of Dredged Material Disposed in Open Water*] predicts the erosion and dispersion of deposited dredged material and sediment by storm waves.

## MDFATE

MDFATE [full title: *Fate of Dredged Material from Multiple Disposals in Open Water*] predicts the development, topography, and elevations of dredged material mounds formed by multiple dumps from barges and hopper dredges.

## RECOVERY

RECOVERY [full title: *Evaluation of Contaminant Release from Bottom Sediments*] predicts the diffusion of contaminants from *in situ* sediments and capped sediments. It is useful to evaluate the bottom contaminant flux from the "no action" alternative, capping alternatives, and new exposure from dredging.

---

## LAT-E / LAT-R

LAT-E and LAT-R [full titles: *Laboratory Analysis of Toxicity from CDF Effluent / CDF Runoff*] are programs for analysis of water column bioassay tests which compute the toxicity (LC50) of CDF effluent or runoff discharges.

### Revisions, Updates, Availability, and Workshops

The ADDAMS applications are revised and updated as new technical approaches become available. New applications will be developed to address additional management needs. Each application is designed as a module so that revisions or the addition of new applications can be easily accomplished. New users are provided with the most current version of each respective application. Version numbers are displayed on-screen for the ADDAMS system and the various applications. Announcements of revisions to specific applications and for the entire system will be published in the Environmental Effects of Dredging Programs' (EEDP) information exchange bulletin and on the WES Dredging Operations Technical Support (DOTS) World Wide Web page (<http://www.wes.army.mil/el/dots/dots.html>).

The latest versions of ADDAMS applications and computerized demonstration programs are available either by mail or by electronic transfer from a WES FTP server or the WES World Wide Web pages (<http://www.wes.army.mil/el/elmodels/index.html#addams>).

In addition, workshops are held on an as-needed basis to provide Corps personnel with hands-on instruction of the ADDAMS system. Workshops can also be arranged for other governmental agencies. Training for both the private and public sectors is presented at the USACE/USEPA Dredged Material Assessment and Management Seminar which is held once or twice per year. Requests for additions to the mailing list for the EEDP bulletin or the technical note series and inquiries regarding the scheduling of ADDAMS workshops should be sent to the following address:

U.S. Army Engineer Waterways Experiment Station  
ATTN: CEWES-EP-D  
3909 Halls Ferry Road  
Vicksburg, MS 39180-6199

### References

1. Schroeder, P.R. and Palermo, M.R. 1995. "The Automated Dredging and Disposal Alternatives Management System (ADDAMS)," Technical Note EEDP-06-12, U.S. Army Engineer Waterways Experiment Station, Vicksburg, MS.
2. Department of the Army and U.S. Environmental Protection Agency. 1992. "Evaluating Environmental Effects of Dredged Material Management Alternatives—A Technical Framework," EPA842-B-92-008, Washington, DC.

---

# Overview of Ongoing Research and Development

Dennis L. Timberlake  
U.S. Environmental Protection Agency  
National Risk Management Research Laboratory  
Cincinnati, OH

## Introduction

The mounting evidence of the ecological risk associated with contaminated sediments makes clear the realization that remediation of contaminated sediments will sometimes be necessary in order to control risks. With this realization, however, comes the awareness that many times effective techniques simply do not exist for the management of contaminated sediments. A clear need exists to conduct research into the development and evaluation of sediment management techniques. The following is a discussion of research and development opportunities for the risk management of contaminated sediments. Specific lessons learned are presented from EPA's National Risk Management Research Laboratory's (NRMRL) experience in developing a research program.

## Rationale Behind Sediment Management Research

While sediments are technically a type of soil, the two are considered distinct media by the remediation community. When soils are referred to, it is generally in reference to upland soils which are meant, while the term sediments is used to refer to naturally deposited material that exists in rivers, lakes, harbors, and marine environments. A number of physical and chemical differences exist between soils and sediments which influence treatment technology efficiency:

- *Moisture Content*—The moisture content of sediments is considerably higher than that of soils necessitating the use of technologies that are compatible with a high moisture content. Alternatively, if technologies not compatible with a high moisture content are utilized, the sediment will have to be dewatered prior to treatment resulting in increased processing costs.
- *Particle-Size Distribution*—Sediments typically consist of a high percentage of fine-grained material

(silts and clays) which can present material handling difficulties for many treatment processes.

- *Organic Content*—The organic content of sediments is typically higher than that of soil, resulting in contaminants being tightly sorbed and creating an increased oxygen demand for oxidative treatment processes.
- *Contaminant Concentration*—The concentration of contaminant in sediments requiring treatment is typically lower than that encountered in soils requiring treatment. Contaminants present in sediment are, in general, much more bioavailable than contaminants in upland soils, resulting in relatively low concentrations of contaminants displaying a measurable impact on an ecosystem. Removing relatively low levels of contaminant is difficult and results in increased treatment costs.
- *Mix of Contaminants*—Sediments serve as an effective sink for hydrophobic contaminants, so contaminated sediments usually contain a mix of contaminants, both organic and inorganic. The contaminant mix may require the use of multiple treatment steps, thereby increasing remediation costs.
- *Salt Content*—Estuary and marine sediments have a high salt content which can negatively impact the efficiency of some treatment processes such as biological treatment.
- *Material Handling*—The high moisture content, presence of fines, and the presence of debris can create material handling difficulties.

All of these physical and chemical factors differentiate sediments from soils and have a negative impact on the efficiency of most soil treatment technologies. The technologies that perform well with sediments typically do so at an increased cost relative to the cost of treating upland soils.

---

## Types of Sediment to be Managed

Sediments requiring treatment, or some other risk management approach, may be generated in two different manners. First, historical pollution may have led to the contamination of sediments in a river, lake, or harbor. These sediments may serve as a significant continuing source of organic and inorganic contaminants in many freshwater and marine ecosystems. Removal and/or treatment of the sediments may be necessary in order to guarantee the future health of the ecosystem. The second source of contaminated sediments is maintenance dredging activities. In the course of keeping shipping and docking channels open, sediments may be dredged which are considered too contaminated for traditional deep water disposal.

A research program for developing and evaluating techniques for the management of contaminated sediment must consider whether the sediments are the result of maintenance dredging or remediation efforts. Issues such as *in-situ* versus *ex-situ* management, cost constraints, time line for implementation, scale of operation, and level of contamination are all influenced by the reason for sediment management.

## NRMRL's Program

NRMRL first became involved in sediment management research through hosting a workshop on innovative sediment treatment technologies. The workshop was held in June, 1990 and was a success in bringing together researchers and the community of technology users. What became apparent during the course of the workshop, however, was that while there were a number of technologies which possibly could be effective in treating sediments, there were no technologies available which were developed with the issues unique to sediments in mind. The technologies which could be applied to sediment risk management typically were less cost efficient than when used in soil remediation.

In determining the allocation of a limited sediment research budget, NRMRL concluded that the focus of research should be on developing and/or evaluating management solutions that address those problems unique to sediments. NRMRL would develop new and innovative approaches to sediment treatment. A positive consequence of this decision was that low-cost technologies developed for sediment remediation might also see application with upland soil sites.

NRMRL conducted an informal survey of EPA personnel within Program Offices and the Regions plus a range of experts outside of the Agency. People were asked to identify the key risk management issues surrounding contaminated sediments that needed to be addressed. Three priority areas emerged from this effort: (1) *in-situ* treatment, (2) the treatment of high volume/low concentration sediments, and (3) *in-situ* containment.

NRMRL's current Contaminated Sediment Research Program was initiated in FY96 and focuses on the development of low-cost options for the management of contaminated sediment resulting from maintenance dredging operations and remedial actions. The program has been designed by NRMRL to build upon existing technical expertise developed through research into the risk management of contaminated soils, but with the aim of developing risk management solutions unique to contaminated sediments. Initial efforts consist of a number of projects exploring the use of physical, chemical, and biological treatment approaches. Since the program is just beginning, initial efforts are necessarily laboratory-scale and will address the fundamentals of contaminated sediment risk management. As research progresses, however, it is anticipated that successful projects will increase in scale, eventually up to the field-scale level.

The Contaminated Sediments Research Program focuses on (1) the development and/or evaluation of *in-situ* management approaches, (2) the development and/or evaluation of technologies for treating sediment contaminants within Confined Disposal Facilities, (3) the development and/or evaluation of affordable *ex-situ* technologies, and (4) research into the fate and transport of contaminants in sediments. Another vital item, while not research, is NRMRL's ongoing effort to provide technical assistance to the regions.

## Future Research Directions

As has been stated, traditional *ex-situ* treatment technologies tend not to be cost-effective in sediment risk management. While new *ex-situ* technologies will continue to be developed, it is unlikely that costs can be reduced by an order of magnitude from current levels, a step necessary for these technologies to compete with options such as containment. Given the high price tag, the use of *ex-situ* technologies will find the most application in the remediation of hot spots.

While treatment resulting in the ultimate destruction of contaminants may be the preferred risk management option, the economics of contaminated sediment management often dictates the selection of other management options. Containment, both *in-situ* and *ex-situ*, is a traditional and cost-efficient management strategy and the economics of sediment management suggest that it will continue to be used in the future. Research, however, is needed to develop methods for quantifying and, if need be, controlling contaminant releases and reclaiming disposal facility capacity.

The development of *in-situ* treatment approaches, while difficult, holds the promise of permitting large quantities of contaminated sediment to be remediated in a cost-effective manner.

The goal of the research community should be to provide decision makers with a range of solutions for the

---

risk management of contaminated sediments. Risk management options should range from low-cost “partial” solutions to high-cost “complete” solutions. There will never be one silver bullet that works in every contami-

nated sediment management situation. Recognizing this, research programs can be designed to investigate the entire range of options needed to address the risk management of contaminated sediments.

---

# Corps of Engineers Research Programs on Contaminated Sediments

Norman R. Francingues  
Chief, Environmental Engineering Division (EED)  
U.S. Army Engineer Waterways Experiment Station (WES)  
Vicksburg, Mississippi

Michael R. Palermo  
Research Civil Engineer, EED, WES

Daniel E. Averett  
Chief, Environmental Restoration Branch WES.

Robert M. Engler  
Senior Research Scientist WES

## Abstract

The U.S. Army Corps of Engineers (USACE), along with other federal agencies, such as the U.S. Environmental Protection Agency (USEPA), has developed over the last twenty-five years, a research base that emphasizes the identification, assessment, and management of contaminated sediments. In this paper, the authors present a brief overview of the research programs being conducted by the USACE on contaminated dredged material and contaminated sediments. In the basic research program, a risk-based approach to assessment and evaluation, along with a preponderance of evidence is the foundation for determining whether a sediment to be dredged is suitable for placement in the ocean, estuary, waterway, or upland environment in unrestricted disposal or must be managed. In the applied research programs, the emphasis is on moving technologies from the laboratory to the field for the treatment and management of contaminated sediments in the USACE Civil Works Programs. The authors conclude by emphasizing the need to continue to conduct basic and applied research on contaminated sediments to find solutions to the contaminated sediment problem. The research should include risk assessment, management techniques, and full-scale demonstration projects to verify and refine the basic research products.

## Introduction

Navigation has long been a primary USACE mission, and the USACE is viewed as the nation's dredging agency. In many industrial and urbanized waterways,

we must dredge, transport, and relocate sediments to perform our navigation mission. Some of these sediments are considered contaminated. The USACE also has a major regulatory role under Section 10 of the Rivers and Harbors Act, Section 404 of the Clean Water Act, and Section 103 of the Ocean Dumping Act, the three principal laws which regulate dredging and disposal of dredged material. Although only a small percentage of the sediments dredged to maintain navigation on a nationwide basis is contaminated, the problem is severe in certain areas, and the technical problems and public perception associated with contaminated sediments affects the entire navigation program. There is also concern that contaminated areas outside the navigation channel are contributing to contamination problems within the channel.

Through the direction of the Congress, the USACE has developed a significant technical expertise in dredging, dredged material disposal, and management of contaminated sediments to meet the needs of its navigation program. Regulations, policies, and technical guidance prepared and used by the USACE are based on extensive operating experience and results from comprehensive research programs and project specific studies (1). Over \$125 million has been invested in research and development on dredged material management, and this effort has had significant influence on legislation, regulations and international treaties concerned with dredged material disposal.

---

## Background

Environmental research in the 1970s on sediments was broad and included the basic understanding of ecological impacts associated with management of clean and contaminated sediment. Research in the 1980s emphasized verification of improved tests and procedures for the identification, assessment and management of contaminated sediment. Research in the 1990s focuses on highly contaminated materials emphasizing chronic/sublethal effects and genotoxicity evaluations, cleanup and remediation of hot spots, risk analysis, endangerment assessments, and treatment technology (1,2).

The need to continue research on the environmental consequences of contaminated sediments was stated by the USACE during Congressional hearings in early 1980 and most recently in 1997. The Congress, as a result of testimony received, has continued to express concern over the long-term environmental effects of contaminated sediments in our Nation's inland waterways, Great Lakes, estuaries and coastal harbors.

### **USACE Environmental Effects of Dredging Programs**

The USACE research on contaminated sediments is managed and conducted by the U.S. Army Engineer Waterways Experiment Station, WES, in Vicksburg, MS.

### ***Corps of Engineers Dredged Material Research Program (DMRP) (1973-1978).***

The DMRP was a comprehensive nationwide research program that evaluated the environmental effects of various dredged material disposal options, including open-water, upland, and wetland disposal. The program concluded that no single disposal alternative is presumptively suitable for any given project (3). Included in the DMRP were laboratory studies to determine the amenability of contaminated dredged material to treatment by physical or chemical processes. The conventional treatment techniques available during the 1970s were found not economically feasible or impractical because of the relatively high solids content, low organic content, high flow rates, and variable nature of dredged material slurry. Most technologies applied to the treatment of dredged material require temporary storage in a confined disposal facility (CDF) to equalize dredge flows and to pretreat or dewater the material. Settling and consolidation processes, dewatering techniques, filtration technologies, particle separation technologies, and effluent control measures investigated by this program have application to treatment trains for contaminated sediments.

### ***Field Verification Program (FVP) (1981-1987)***

The FVP was a cooperative effort of the Corps and the U.S. Environmental Protection Agency (4). FVP studies

compared placement of contaminated dredged material in wetland and upland environments to aquatic disposal. Contaminant losses were evaluated for each alternative. Soil amendments and tolerant plant species were added to an upland site to address stabilization of the surface layer and minimization of contaminant mobility.

### ***Long-term Effects of Dredging Operations Research Program (1980-present)***

LEDO activities are managed under the umbrella of the USACE Center for Contaminated Sediments at the Waterways Experiment Station. The principal research effort is accomplished in the Long Term Effects of Dredging Operations (LEDO) research program. This program was initiated by Congress in 1980 because of concern about the long-term environmental consequences of dredged material disposal. The LEDO program is designed to develop new or improved state-of-the-art technology for predicting long-term environmental impacts of dredging operations and to improve and develop methods for minimizing any adverse impacts associated with dredged material placement. LEDO is planned as a continuing program, as applied environmental research must be responsive to the dynamic nature of current pollution problems and research priorities must as a consequence be responsive to these needs.

The underlying premise of the research is to embody the effects-based approach to evaluation of dredged material. The determination that a sediment is contaminated and unsuitable for unrestricted aquatic disposal is made by application of effects-based testing and a preponderance of evidence leading to a determination. The effects-based approach has been developed by the USACE and USEPA over the past two decades and is implemented through regulatory testing manuals and a technical framework for dredged material management (5).

Assessment and control technologies are required for aquatic, wetland, and upland environments. Current research emphasizes development and refinement of predictive tests for determining bioaccumulation and consequences in aquatic organisms; techniques for predicting leachate quality from CDFs; relationships between sediment geochemistry and biological impacts; evaluation of chronic sublethal and genotoxic effects of contaminated material; and investigation of physical, chemical, and biological processes for contaminant control at CDFs.

### ***Water Resources Development Act of 1990, Section 412(c) (1991-1994)***

The USACE studied options for treatment and disposal of contaminated sediments from New York/New Jersey Harbor as part of the Section 412 studies. Available technologies for treatment of dioxin-contaminated sediment were reviewed, and bench-scale evaluations for four treatment technologies were completed (6). Solvent

---

extraction, incineration, and base-catalyzed destruction were effective in removing or destroying dioxins in this marine sediment.

Alternatives were developed for six treatment technologies and three disposal alternatives and were compared on the basis of effectiveness, implementability, and costs. Treatment alternatives were projected to be at least an order of magnitude higher in cost than disposal alternatives.

### ***Dredging Operations and Environmental Research Program (1997-Present)***

The Dredging Operations and Environmental Research Program (DOER) was established by the USACE to address critical field needs in finding solutions to dredging related problems in the Nation's navigation system. The objective of DOER is to balance environmental and operational requirements while economically maintaining a viable navigation system. Research is required to address operations and environmental demands in six major focus areas: contaminated sediment characterization and management; instrumentation for monitoring and site management; near-shore and aquatic placement of dredged materials; environmental windows for dredging operations; innovative equipment and technologies demonstration; and, environmental risk management for dredging and disposal activities. Benefits will include application of environmental windows, cost-effective identification and management of contaminated sediments, greater flexibility for dredging in sensitive ecological areas, and expanded options for beneficial uses of dredged materials. Major program goals for FY 1997 include selection of cost-effective sediment screening test methods for dioxins and investigations to establish accuracy, precision and analytical costs; established guidance for suitable environmental, economic and engineering factors for site selection for nearshore beneficial placement of dredged sediments; selection of basic ecological risk assessment frameworks for contaminated dredged material for detailed development, in conjunction with EPA; and survey of critical fiscal and managerial aspects of seasonal environmental dredging restrictions.

### ***Overview of DOER Contaminated Sediments Focus Area***

Two of the most commonly considered alternatives for contaminated sediments are placement in confined disposal facilities (CDFs) and capping, an option for containment in subaqueous sites. CDFs are located on land or in areas of relatively sheltered water. Many CDFs are near closure; future CDF locations may include nontraditional areas such as offshore. Treatment to reclaim CDF capacity may be promising for certain sites. Capping has significant potential as a disposal alternative, but issues related to its long-term effectiveness and potential application to deeper waters or high-energy environments require additional environmental investi-

gation. DOER will address high-priority research needs aimed at reducing costs associated with screening, assessing potential impacts associated with contaminants, and increasing the reliability and acceptability of CDF and capping options for management of contaminated sediments.

The DOER Contaminated Sediments Focus Area is addressing high-priority field needs in this area. DOER will develop low-cost, rapid, and interpretable biological screening methods for chlorinated hydrocarbons and other contaminants. These methods will reduce the number and cost of chemical analyses and quickly identify contaminated sediments and marginally contaminated dredged material in existing CDFs that can be reused. Tiered screening tools will be developed for estimating contaminant losses from CDFs and capped sites in order to reduce the need for more expensive environmental testing. Techniques requiring minimal data, such as bulk sediment chemistry, will be emphasized and developed for implementation on desktop computers.

Research will develop risk-based assessments for contaminated dredged material for both open water and CDF placement options. The risk assessment process for contaminated sediments includes effects and exposure assessment (e.g. contaminant pathway testing). Results of risk-based assessments facilitate risk management which, for contaminated dredged material, may include identification of design requirements for contaminant controls and treatment. Effects assessments for dioxin contaminated dredged material will tie directly into the overall environmental risk assessment framework developed under the DOER focus area on risk. Effects data from laboratory testing will be compared with field measurements of effects on populations of organisms in areas where sediments are contaminated with chlorinated hydrocarbons (dioxins). Cost-effective laboratory test procedures and predictive tools for exposure assessment will address CDF groundwater leachate, surface runoff, and volatile pathways.

CDF research will develop and validate contaminant controls, treatment methods, and management techniques. Design of CDFs as treatment structures, groundwater and surface water protection, and overall contaminant retention will be emphasized. Design criteria for treatment and/or control of toxic contaminants will be developed including low-cost, effective methods for CDF management to meet State Water Quality Certification requirements. Research on filtration treatment structures and enhanced biodegradation of contaminants in CDFs will receive the highest priority. Techniques for reclamation of CDF capacity will be developed for sites with materials marginally contaminated with chlorinated hydrocarbons. Tools for predicting capped material chemical migration will be refined and used as a basis for more cost-effective capping designs. Research on environmental aspects of capping and CDFs will be integrated with research on physical aspects under the DOER Nearshore and Offshore Placement

---

focus area to provide comprehensive guidance for these management options. Laboratory studies and technical assessment of control and containment technologies for open water disposal other than capping will also be conducted.

Benefits will include the ability to improve the cost-effectiveness of identification and assessment procedures, to reuse existing disposal capacity for contaminated materials, and to design and manage disposal facilities for enhanced capacity, treatment, and containment objectives.

## Summary

There are millions of cubic yards of contaminated sediments in the waters of the United States requiring dredging as part of a navigation project or for environmental cleanup. Innovative solutions will need to be developed, or costs will escalate and inhibit any real progress.

The USACE and other federal agencies over the past twenty-five years have developed a significant research base on the effects of contaminated sediments when dredged for the purpose of navigation and sediment remediation. However, the emphasis must shift from studying the problems to finding solutions. Now, more than ever, the USACE and USEPA need to continue to conduct intensive basic and applied research on contaminated sediments to find workable solutions to the problem. The research should include risk assessment, management techniques, and full-scale demonstration projects to verify and refine the basic research products. Future research and development expenditures will produce direct benefits in many areas, including reduced testing costs and more cost-effective project selection and implementation. Detailed information on USACE dredging research can be found on the WES Dredging Operations Technical Support (DOTS) homepage at [www.wes.army.mil/el/dots](http://www.wes.army.mil/el/dots).

## Acknowledgment

This paper summarizes research conducted by the USACE under a variety of research programs. The technical summaries were based on research investigations being conducted under the USACE Environmental Effects of Dredging Programs at the U.S. Army Engineer Waterways Experiment Station, Vicksburg, MS. Permission to publish this material was granted by the Chief of Engineers.

## References

1. Engler, R. M., Patin, T. R., and Theriot, R. F. 1990. "Update of the Corps' Environmental Effects of Dredging Programs (FY89)," Miscellaneous Paper D-90-2, U.S. Army Engineer Waterways Experiment Station, Vicksburg, MS.
2. Engler, R.M., Francingues, N.R., and Palermo, M.R. 1991. "Managing Contaminated Sediments: Corps of Engineers Posturing to Meet the Challenge," *World Dredging and Marine Construction*, August 1991.
3. Saucier, R. T., Calhoun, C. C., Jr., Engler, R. M., Patin, T. R., and Smith, H. K. (1978). *Dredged Material Research Program Executive Overview and Detailed Summary*, Technical Report DS-78-22, U.S. Army Engineer Waterways Experiment Station, Vicksburg, MS.
4. Peddicord, R. K. (1988). *Summary of the U.S. Army Corps of Engineers—U.S. Environmental Protection Agency Field Verification Program*, Technical Report D-88-6, U.S. Army Engineer Waterways Experiment Station, Vicksburg, MS.
5. USEPA and U.S. Army Corps of Engineers. (1992). *Evaluating Environmental Effects of Dredged Material Management Alternatives--A Technical Framework*, EPA 842-B-92-008, Washington, DC.
6. Tetra Tech, Inc., and Averett, D. F. (1994). "Options for Treatment and Disposal of Contaminated Sediments from New York & New Jersey Harbor," Miscellaneous Paper EL-94-1, U.S. Army Engineer Waterways Experiment Station, Vicksburg, MS.

---

# Potential for Phytoremediation of Contaminated Sediments

Steven A. Rock  
Environmental Engineer  
Land Remediation and Pollution Control Division  
National Risk Management Research Laboratory  
United States Environmental Protection Agency  
Cincinnati, OH

## Abstract

Phytoremediation is an innovative technology that is being applied to soil and groundwater cleanup. Techniques for using plants for remediation are gaining regulatory and commercial acceptance in the U.S. This paper considers the potential for application of phytoremediation to the remediation of contaminated sediments, projecting from what is known about plant-contaminant mechanisms.

The use of plants to remediate soil and groundwater problems has been studied for many years and is being applied nationally. Some of the mechanisms that have been identified may be applicable for use in sediments.

Planting a contaminated sediment with shallow water wetland plants or deeper water emergent plants can form a vegetative root mass that acts as a cap to prevent movement of the sediment or contaminant while bioremediation is occurring. A dense root mass not only holds existing sediments in place, it collects and gathers sediments that had been held in suspension, adding to the protective cap over the contamination.

Vascular plants release oxygen and enzyme exudates from their roots. Some plants that grow in aquatic environments along streams, river banks, and in lakes may release enough oxygen and exudates into the subsurface sediments to promote contaminant degradation.

## Background

The term phytoremediation applies to the use of a wide variety of plants to remediate an equally wide variety of contaminants. Prairie grasses have been studied to reduce concentrations of polyaromatic hydrocarbons (Aprill). Poplar trees have been shown to reduce excess fertilizer, pesticides and herbicides from agricultural run-

off (Licht). Cottonwood trees are being used to intercept a TCE groundwater plume. Some plants have been shown to degrade PCBs from transformers (Fletcher). Ryegrass has been shown to reduce PCP and creosote from a wood preserving site (Ferro). Various grasses and field crops have been studied to measure their effect on petroleum contamination in soil (Banks). Indian Mustard can extract heavy metals such as lead, and chromium (Raskin), and sunflowers have been shown to concentrate uranium in their roots (Dushenkov). Wetlands can be used as phytoremediation processes. Constructed wetlands planted with reeds and cattails are used to prevent acid mine drainage from polluting streams. Other wetlands plants such as duckweed are also being studied to degrade TNT and its breakdown products.

Phytoremediation seems to be best suited for cleanups over a wide area, with contaminants in low-to-medium concentrations. If the concentration of contaminants is too high, phytotoxicity results, with no or poor plant growth. The plant roots physically must contact or be in very close proximity to the target contaminant, so the media to be cleaned must be within range of the root growth. Planted areas can be used in conjunction with other technologies, for example, following a removal action of high contaminant concentration once these hot spots are removed.

## Phytoremediation Mechanisms

Because the term phytoremediation covers a range of plants remediating a range of contaminants, there are different mechanisms used for different types of phytoremediation. Some plants in some instances may use more than one mechanism either sequentially or simultaneously. The mechanisms that various plants use in phytoremediation can be classified into four broad categories.

- Enhanced Rhizosphere Biodegradation
- Phytodegradation
- Physical Effects
- Accumulation of metals

Enhanced rhizosphere biodegradation is a series of effects that plants have on the microbial population in the rhizosphere (the immediate area surrounding the root). There is some symbiosis which occurs between a plant and its microbial neighbors. Microbial populations have been reported to be two orders of magnitude higher in the soil of the root zone than in adjacent unplanted soil (Schnoor). The limiting factors for most aerobic microbial consortium growth include oxygen, nutrients, and water (Cunningham). The roots of many plants provide these requirements to the microbial zone as a byproduct of normal plant growth. As roots penetrate and loosen the sediment there is passive aeration, and active aeration as the roots release oxygen as part of normal plant respiration. Wetland plants have been examined for their ability to release oxygen from roots (Armstrong, Brix 90, Michaud). The mechanisms of oxygen transfer have been described by Brix.

As a natural function of reacting to changing environmental conditions, parts of plant roots die off during seasonal water and temperature fluctuations (Anderson). These abandoned or sloughed roots and root hairs become a nutrient source to the rhizosphere microbial community. These nutrients may serve as cometabolites, sustaining microbes that incidentally degrade contamination as part of their metabolism, as in the degradation of PCBs (Lee).

Phytodegradation is the process of the plant itself degrading the contamination. This may occur as metabolism of a contaminant within the plant, or by transforming or mineralizing it to a less toxic form through exudates. Various plants produce different enzymes, many of which are useful in the destruction of contaminants. Nitroreductase, dehalogenase, peroxidase, and others have been found to be exuded by some plants (Bollag, Schnoor). These enzymes can either detoxify a contaminant, or render it vulnerable to microbial consumption. At the Iowa Army Ammunition Superfund Site, where wetland phytoremediation was chosen as part of the Record of Decision (ROD), 18 of 42 plants screened were shown to contain the enzyme nitroreductase, a key element in the degradation pathway of TNT, the target contaminant (Carriera).

One physical effect plants can have on contaminated sites is erosion control. Vegetation has long been used to prevent soil from washing or blowing away, with the dust bowl of the 1930s as an example of what happens when the role of vegetation in soil conservation is ignored. Hazardous wastes and municipal landfills can be covered and capped with soil and plants, a process also known as forming a vegetative cap. A vegetative cap consisting of grasses, clovers, shrubs and trees is being used to prevent both wind and water erosion on a

Montana mining site. Caps consisting of trees and grass have been used to cap municipal landfills (Licht). In Texas a lagoon of hazardous waste has been naturally vegetated, and now measures a three-foot soil layer (Fletcher).

Some plants do accumulate heavy metals in their roots (Dushenkov) and stems and leaves (Chaney, Raskin). These plants and these contaminants are not appropriate candidates for a vegetative cap. Plants do not tend to accumulate organics within the plant structure as do some metals (Banks). Therefore if contaminated sediments can be contained, the environment can be protected, and the ecosystem can be restored. A vegetative cap could promote a diverse ecosystem on top of a contaminated layer.

## Phytoremediation of Sediments

Sediments with organic contaminants are hazardous to human health and the environment through two pathways; through suspension in the water table and consumption of that water directly, or by suspension and consumption by fish and other aquatic species.

Conventional technologies try to block these pathways either by removing sediments (dredging), covering them with clean soil (thin or thick cap), or by covering them with soil and concrete and metal pieces called rip-rap or armoring (Lee, M). Dredging and armoring are expensive options, and capping without an armor layer is subject to washout during storm events.

Shallow freshwater vegetative caps may be established to accomplish the same pathway blocking function. By forming an interlocking root mat the plants will tend to hold the sediments in place. Flowing water is slowed passing through vegetated wetlands as compared to unplanted areas, increasing sediment deposition (Brown). Suspended solids attach to plants stems and are later added to the sediment layer. As plants drop leaves and stem material, this build up of organic matter further contains suspended soil particles.

Once established, these plants can grow for many years, propagating themselves, slowly degrading compounds while providing a vegetative cap for the site to hold contaminants in place to limit the possibility of human or ecosystem exposure. As the plants grow, drop vegetative matter, and collect sediments the protective cap will continue to become thicker and more resistant to disturbance.

Sediments are anaerobic except in the upper layer adjacent to water. Dissolved oxygen of approximately 8.0 mg/l in water, slow oxygen diffusion into sediments, and slow diffusion of contaminants to the sites of microbial activity limit the kinetically more-rapid aerobic degradation processes. The mass transport limitations reduce bioavailability and increase the persistence of aerobically degradable organic contaminants in sediments.

---

Many contaminants which are persistent in an anaerobic environment are available to aerobic degradation if an effective and economical means of delivering oxygen to the site of microbial activity were available. One possible technique for delivery of oxygen to contaminants below the water-sediment interface is by utilizing the natural tendency of vascular plants to release oxygen from their roots as part of their respiration cycle (Brix 93).

Wetland technology is steadily growing in the United States for wastewater and pollution control (Brown). While the knowledge base is increasing on how to use plants in wetland configurations, planting for aquatic vegetative caps for containment or remediation of sediments has not been implemented to date.

## Plant Selection

Many species of submerged or emergent wetland plants may be considered for phytoremediation. The selection of an appropriate set of plants adapted to the exact site conditions is crucial to the successful application of the technology. Plants must be adapted for the water and climatic conditions, whether shallow or deeper water or fluctuating water levels. Final plant selection for a project will depend on plant tolerance to the contaminant in the sediment. Each candidate plant species should be subjected to the phytotoxicity testing, consisting of measuring seed germination and root elongation in various concentrations of the contaminated sediments.

Plant selection for a field application of a vegetative cap will depend on many factors besides the plants ability to grow in a contaminated sediment. A variety of factors would have to be balanced: for example, the common reed *Phragmites australis* has little food value for wildlife, which is a negative attribute if one of the goals of the site is increasing wildlife habitat. *Phragmites* is preferred for some constructed wetlands precisely because it is not an attractive food source, and not is not a target for consumption. Animal predation can make environmental engineering with planted systems less predictable.

Bulrushes or cyperus could be used to represent plants which grow in shallow water. These fast growing, fast spreading plants thrive in up to two feet of water. They are hardy and likely to survive fairly high concentrations of pollutants and have a habitat range from Maine to Florida, and from East to West Coast.

Another species that may be used is *Vallisneria americana*, also known as eelgrass, tapegrass, or wild celery. This plant grows in water to twelve feet deep. Its range is also widespread; from Maine to Florida, and from North Dakota to Texas. The vegetation of the plant is flexible enough not to cause a navigation hazard, although boat traffic can damage the plants. If *Vallisneria* can be shown to help remediate sediments *in situ* at normal growth depths, a large number of sites could benefit.

Plant screening and selection will be an important component of any project. The selection may be based on one or more of the following criteria:

- a. Plants that are likely to be viable under the conditions of the study and eventually in the field.
- b. Plants that form a dense sediment retentive cap (plants that form dense root masses of the appropriate depth, appropriately dense masses of shoots that will facilitate the deposition of sediment from flowing water)
- c. Plants that provide some habitat value or that at least are not objectionable because of invasive or noxious attributes.
- d. Plants that are potentially good oxygen pumps

Initial selection can be made using the peer-reviewed literature and consultation with researchers, plant suppliers and vendors. After the candidate plant species target is identified, phytotoxicity tests using the site specific sediment should be initiated.

Analysis of plant enzymes may be an important component in determining appropriate plant selection. Enzyme analysis of a candidate species could be performed either at the USEPA Lab in Athens, GA, with Dr. Steve McCutcheon, or with Dr. Laura Carrieria at the PhytoWorks Laboratory.

## Measuring Phytoremediation Effects in Sediments

Various test are available to evaluate the progress of phytoremediation in a sediment environment. Changes in contamination levels may not be apparent for several years, but other changes can be gauged by monitoring treatment progress and differences of sediment COD and sediment TPH. Data on bioaccumulation and phytotoxicity assays can be determined over the course of time. In addition, the changes in EMF measurements and three sets of phospholipid fatty acid analyses (PLFA) can be used to evaluate the changes in the microbial populations in the rhizosphere of the plant roots.

Sediment transport and containment in planted areas can be characterized and compared to corresponding sediment transport in unplanted controls. The speed and volume of water moving will produce a range of flow conditions. Containment measurements can be achieved by regularly measuring turbidity, and the amount of sediment captured or eroded can be assessed by fixed depth measurements.

Sediment contaminant remediation can be expected to take place as a result of several of the previously discussed possible plant mechanisms. To examine the role of plant uptake of contaminant, tissue of shoots and leaves should be analyzed for the contaminant of inter-

---

est. To examine the role of metabolism within the plant, the leaf and shoot analysis should also search for breakdown products of aerobic degradation. Enhancement of microbial remediation in the rhizosphere can be studied by fatty acid methyl ester analysis. This analysis will show changes in microbial populations, both quantities and constituents, and give an indication of an increase in degrader population.

Contaminant toxicity should be measured to determine the effect of the remediation. Carolyn Acheson and others at the USEPA NRMRL Laboratory in Cincinnati, OH, have found that decreased toxicity and reduction of contaminant concentration do not always correspond linearly. Invertebrate toxicological tests and plant root elongation tests are common tests for determining terrestrial toxicity. Fish toxicity tests may be more appropriate for sediments tests.

Fixed electromotive force (EMF) probes have been used by Greg Sayres, et al, of the USEPA NRMRL Laboratory in Cincinnati, OH, for measuring subsurface oxygen changes. Probes can be installed at various depths and various distances from the plants to assess the rhizospheric change in anaerobic/anoxic/aerobic conditions as measured by electrical potential.

### **Specific Research Efforts on Phytoremediation Effects in Sediments**

Research divisions with USEPA ORD/NHEERL are involved in many lines of sediment research that are directly related to potential phytoremediation of sediments research. NHEERL scientists have developed several sediment toxicity test methods to assess toxicity of contaminated sediments, some of which are proposed for use in the present study. Other NHEERL research involves determining sediment phases that control the bioavailability of organic contaminants in sediments (primarily organic carbon), and using this understanding to predict the toxicity of sediments based on chemical composition.

The experience of the Waterways Experiment Station (WES) of the Army Corps of Engineers in constructing and testing wetlands could be extremely valuable in determining plant selection and aquacultural considerations.

Several organizations including Tennessee Valley Authority (TVA) and WES have experience in wetland construction and maintenance for treatment of contaminated groundwater. Their constructed wetland facility at Milan, TN, has been operating since 1996 treating groundwater contaminated with TNT and its breakdown products.

Washington State Departments of Transportation and Ecology are jointly engaged in searching for alternatives to conventional dredging and capping in the waterways in and around the Puget Sound. Bellingham Bay has

been designated an area for testing and evaluating alternative sediments handling.

### **Conclusions**

It is hypothesized that establishing wetland plants in a sediment will decrease the mobility of the sediment and hence its bioavailability compared to unplanted sediments. The main objective of a vegetative or any other cap is to prevent the movement or reentrainment of sediments in the water column and to accelerate the deposition of entrained sediments. In the case of contaminated sediments, the accelerated deposition of fresh sediments over contaminated areas promotes the natural recovery of the area.

If it provides an equally effective alternative to conventional techniques of dredging, capping and armoring, a vegetative cap would be more economical than conventional methods. It would offer wildlife habitat benefits by providing food and shelter for fish, birds, and other animals. A vegetative cap avoids the problem of resuspension of contaminants that occurs during dredging and armoring installation.

It is possible that phytoremediation mechanisms, which may include oxygenation, root enzyme production, plant uptake of contamination, and in-plant metabolism will decrease contaminant concentration compared to unplanted sediments. Phytoremediation of sediments will have many of the same advantages and disadvantages of phytoremediation of soils and groundwater: decreased cost but longer time frames, possibly widely applicable, but as yet unproven.

A key indicator of a healthy ecosystem is a sustainable and diverse population of plants. Plants not only indicate the health of an ecosystem, they provide much of the structure of an ecosystem. A planted sediment zone tends to add sediment layers as compared to an unvegetated shallows, which encourages other plant growth and animal utilization.

If the health of an ecosystem can be assessed by the size and diversity of the population of plants and animals then if the remediation of an area directly causes an increase in appropriate plant and animal populations, ecosystem restoration has begun to occur. Conventional technologies of sediment containment are specifically destructive to plant and animal habitat in rivers, lakes, and coastal areas. Developing a containment technology that is as effective as the best conventional treatment at preventing contact between contaminants and at-risk population, is less expensive and hence more widely applicable, and also creates the very conditions of ecosystem restoration, is one of the goals of EPA research.

If successful, phytoremediation may be shown to provide an *in-situ* method for managing large volumes of contaminated sediment for affordable ecosystem restoration and environmental protection. Small- and full-

scale research is still to be done to determine if that potential will be realized.

## References

1. Anderson, Todd A. 1996. Rhizosphere technology for Phytoremediation International Phytoremediation Conference, Arlington, VA.
2. Aprill, W., and R.C. Sims. 1990. Evaluation of the use of prairie grasses for stimulating polycyclic aromatic hydrocarbon treatment in soil. *Chemosphere*, 20:253-265.
3. Armstrong, W.; Armstrong, J.; Beckett, P.M. Measurement and Modeling of Oxygen Release from Roots of *Phragmites australis*. *J Tissue Cultures Assn*, 29:207-212.
4. Brown, Donald S.; Reed Sherwood C. 1994. Inventory of Constructed Wetlands in the U.S. *Water Science Tech*. Vol. 29 No. 4 pp 309-318
5. Brix, Hans; Schierup, Hans-Henrik. 1990. *Soil Oxygenation in Constructed Reed Beds: The Role of Macrophyte and Soil-Atmosphere Interface Oxygen Transport Constructed Wetland in Water Pollution Control*, P.F. Cooper ed. Pergamon Press, Oxford.
6. Brix, Hans. 1993. *Macrophyte-Mediated Oxygen Transfer in Wetlands: Transport Mechanisms and Rates. Constructed Wetlands for Water Quality Improvement*, CRC Press.
7. Bollag, Jean-Marc. 1992. Decontaminating Soil with Enzymes. *Environ. Science Technology*, Vol. 26, No.10.
8. Carriera, L. H. 1997. "The Use of Antibody Assays to Predict Plants Capable of Phytoremediation" *The Second International Phytoremediation Conference, Seattle, WA*. International Business Communications, Southborough, MA.
9. Chaney, R.L. 1983. Plant uptake of inorganic waste constituents. In: *Land Treatment of Hazardous Wastes*, J.F. Parr et al. (eds.). Noyes Data Corp., Park Ridge, NJ, pp. 5076
10. Cunningham, Scott; Berti, William. 1993. Remediation of contaminated soils with green plants: An overview. *In Vitro Cellular & Developmental biology-Plant* 29P (4): 227 -2 32 1993
11. Dushenkov, Viatcheslav; Kumar, P. B. A. Nanda; Motto, Harry; Raskin, Ilya. 1995 Rhizofiltration: the Use of Plants to Remove Heavy Metals from Aqueous Streams *Environ Sci Technol* v29, n5, p1239(7) May.
12. Ferro, Ari. 1997. Report on Reclamation of PCP Contaminated Soils Using Plants. Unpublished.
13. Fletcher, J. 1997. *The Role of Phytoremediation in Intrinsic Bioremediation In Situ and On Site Bioremediation: Vol. 2*, Batelle Press.
14. Lee, Euisang; Banks, M. K., Kansas State University. 1993 Bioremediation of Petroleum Contaminated Soil Using Vegetation: A Microbial Study *J Environ Sci Health-Environ Sci Eng* vA28, n10, p2187(12)
15. Lee, M., Bowen B., Washington Dept. Of Transportation Personal communication 1997
16. Michaud, Susan; Richardson, Curtis. 1993. Efficiencies of Substrates, Vegetation, Water Levels and Microbial Populations: Relative Radial Oxygen Loss in Five Wetland Plants, *Constructed Wetlands for Wastewater Treatment*, CRC Press.
17. Raskin, I., P.B.A.N. Kumar, S. Dushenkov, and D.E. Salt. 1994. Bioconcentration of heavy metals by plants. *Current Opinion in Biotechnology*. 5:285
18. Schnoor, Jerald L., University of Iowa, Iowa City; Licht, Louis A.; McCutcheon, Steven C.; Wolfe, N. Lee; Carreira, Laura H. 1995. Phytoremediation of Organic and Nutrient Contaminants *Environ Sci Technol* v29, n7, p318A(6) July.

---

# Treatment of Metal-Bearing Solids

## *Using a Buffered Phosphate Stabilization System*

Thomas Stolzenburg, Senior Applied Chemist  
RMT, Incorporated  
Madison, WI

### Introduction

Solid wastes or metal-impacted soils can be classified as hazardous by their leaching characteristic. The test protocol used for classification is the Toxicity Characteristic Leaching Procedure (TCLP). The TCLP was designed to predict potential mobility (dissolution) of metals after disposal, particularly after co-disposal with other wastes in a municipal landfill. The acetic acid used in a TCLP represents the organic acids encountered in a municipal landfill environment.

In many cases, metal-bearing solids are not co-disposed in a municipal landfill, or in the case of sediments, may even remain in place. The potential for leaching metals from these solids is more appropriately modeled with simulated rain water or site-specific water. Simulated rain water leaching is accomplished by using the Synthetic Precipitation Leaching Procedure (SPLP).

Conceptually, a wide variety of treatment alternatives are available to treat metal-bearing solids so that the residue is nonhazardous by leaching characteristic. These alternatives include:

- Solidification
- Stabilization
  - pH Control
  - Chemical Fixation
- Vitrification
- Physical Separation
- Thermal Separation
- Chemical Extraction

However, from an economic perspective, any *ex-situ* process will usually cost more than an *in-situ* process for several reasons. In most cases, permitting requirements are more extensive for *ex-situ* treatment. Each materials

handling step in an *ex-situ* remediation accounts for a significant additional cost. Transport and disposal of residues is another add-on cost not associated with *in-situ* treatment.

Not all *in-situ* treatment alternatives are necessarily economical either. For instance, volume increases associated with chemical addition that causes bulking may represent an intractable full-scale dilemma. Also, excessive energy requirements or impracticability of mixing or chemical delivery can preclude cost-effective implementation of *in-situ* treatment alternatives. For many of these reasons, *in-situ* chemical stabilization is conceptually one of the best treatment alternatives for treating metal-bearing solids.

Not all RCRA metals exhibit similar chemistry, and therefore would not respond similarly to a single chemical stabilization technology. Of the RCRA metals, lead has attracted the most regulatory concern, primarily because of its widespread release into the environment. Sources of lead in contaminated solids, soils, and sediments include:

- Iron foundries
- Steel mills
- Brass foundries
- Smelters
- Battery recyclers
- Leaded paint
- Shooting ranges
- Mine tailings
- Lead arsenate pesticides
- Ash

Some of the chemical stabilization alternatives available to treat lead include:

- pH Control
  - Lime
  - Carbonates: limestone, dolomite
  - Magnesium oxide
- Chemical Fixation
  - Iron Hydroxides
  - Phosphates
  - Sulfides: dithiocarbamates
- Chemical Reduction
  - Metallic iron

This paper discusses the use of a pH-buffered phosphate chemical fixation system for treating solids impacted with lead, cadmium and/or zinc (zinc leaching does not cause a solid to be classified as hazardous, but it is nevertheless problematic in some cases, and treatable by the described process). The described process is effective at rendering lead and cadmium solids non-hazardous by the TCLP, and it is also effective at minimizing metal solubility under rain water and/or ambient water leaching conditions. This process has been applied *ex situ* and *in situ* at full-scale at hundreds of sites, and has been applied to sediments at a few sites, which will be described here.

## Chemistry of Lead, Cadmium, and Zinc

Certain metals exhibit an amphoteric behavior; that is, they are highly water-soluble at both low and high pH conditions. This is a generalization that does not fully account for the various solid phases that can form for any particular metal. However, it is a good rule of thumb for understanding lead chemistry.

Figure 1 shows the solubilities of various lead solid phases. A classic amphoteric pattern is illustrated. Of equal importance to note is that, depending on the combining anion, a lead solid phase may exhibit more or less water solubility than the hazardous waste limit of 5 mg/L. Therefore, both pH and the associated anion strongly influence lead solubility.

Lead in solid wastes in the environment often occurs as lead hydroxide, lead oxide, or lead sulfate. All of these forms of lead are rather soluble compared to some other forms of lead, such as lead carbonate or lead phosphate. As might be predicted, if lead occurs in a solid as lead hydroxide, that solid is often characterized as hazardous in the TCLP (note how high the solubility of lead hydroxide is at the low pH conditions of the TCLP).

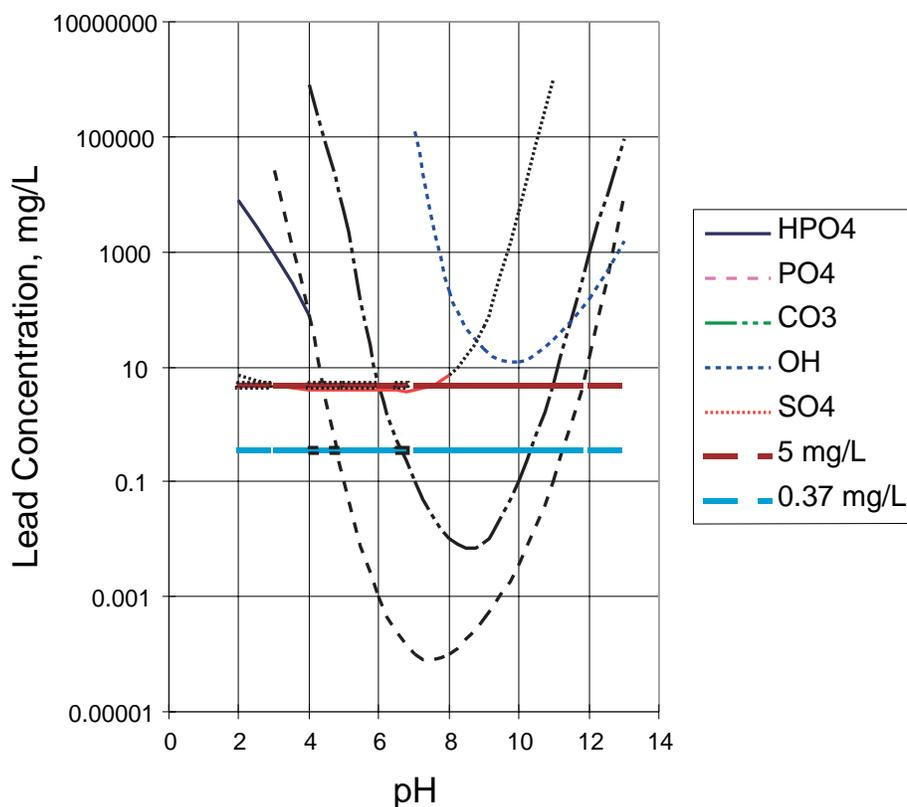

Figure 1. Solubility of lead species as a function of pH.

The solubility of cadmium in water is also highly dependent on pH and on the associated anion forming the solid phase. Figure 2 shows the pH-solubility pattern for various cadmium species. Note that cadmium is not strongly amphoteric. If cadmium species exhibits higher solubilities at high pH conditions, then it is only at extreme values.

Figure 3 is a smoothed plot of data for hundreds of sampling points for zinc-impacted solids at a site. Despite the fact that compositional zinc concentrations and the anion composition were highly variable, the data showed a remarkable adherence to the graph. As can be seen, zinc exhibits an amphoteric behavior similar to that of lead.

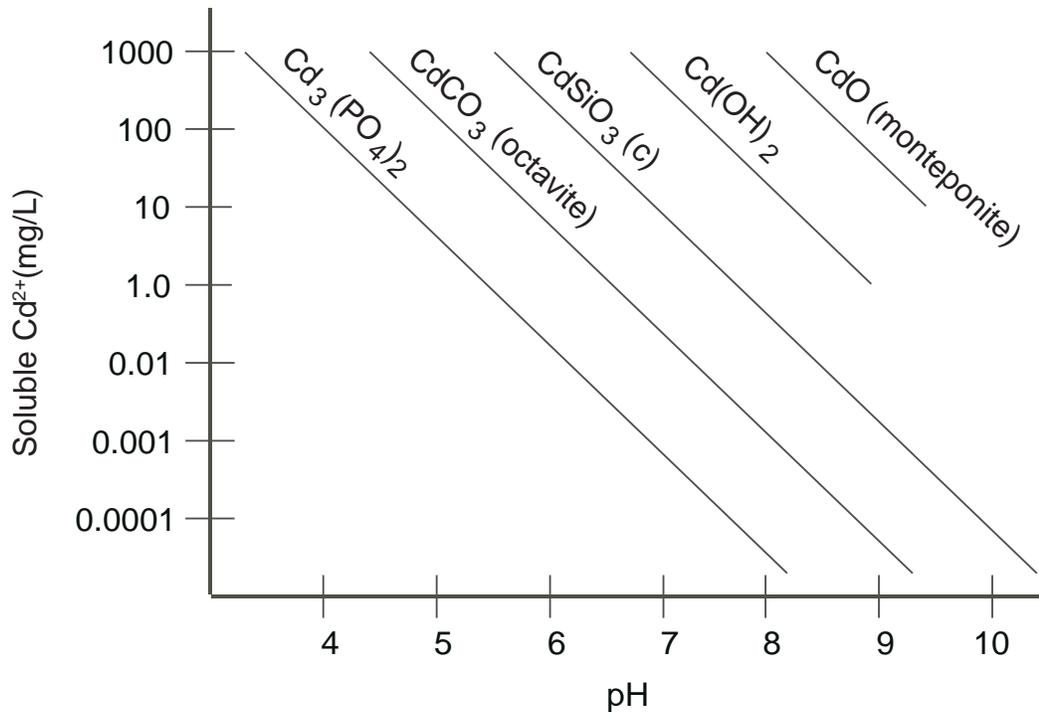

Figure 2. Solubility of cadmium species as a function of pH.

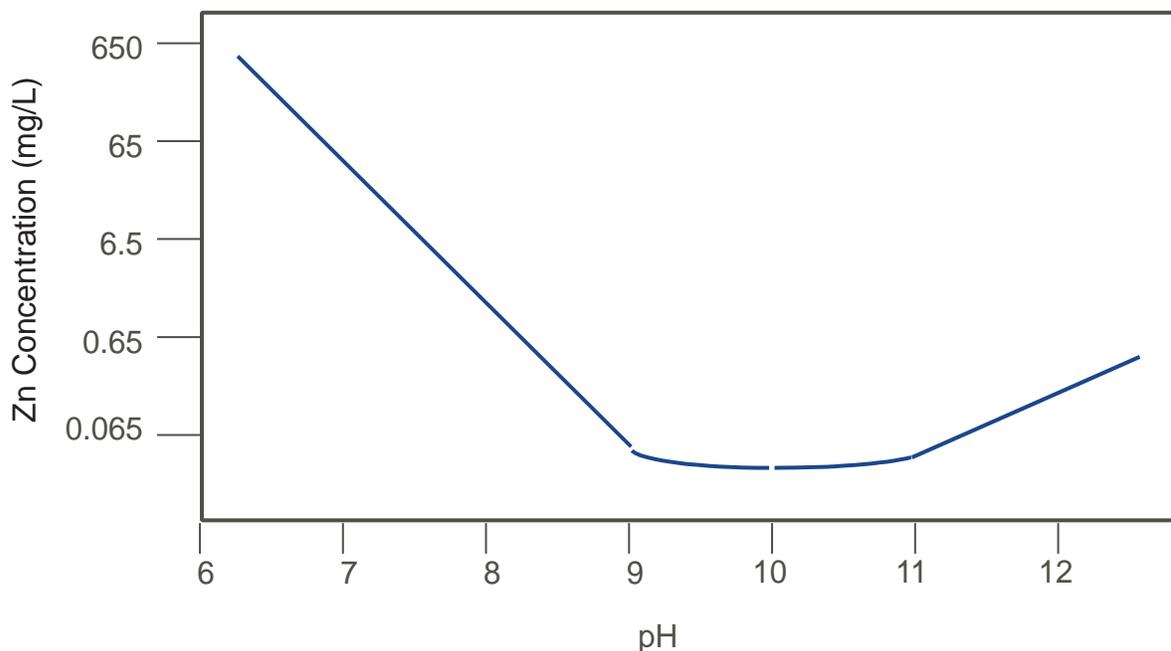

Figure 3. Zinc-contaminated site soils—zinc solubility curve.

Figure 4 is a plot of actual data for leachable lead in foundry wastes. Once again, the data are remarkably consistent to a single pH-solubility curve.

Table 1 lists leachable lead data for both TCLP and SPLP tests of untreated and treated lead-bearing smelter waste. The data dramatically illustrate the amphoteric

behavior of lead. High pH treatment additives, such as lime or cement, are successful in lowering the pH in the TCLP, and rendering the waste nonhazardous. However, if this waste is placed in a monofill, or placed anywhere other than an acid condition, the lead is at risk of leaching because of the high pH environment caused by the addition of lime or cement.

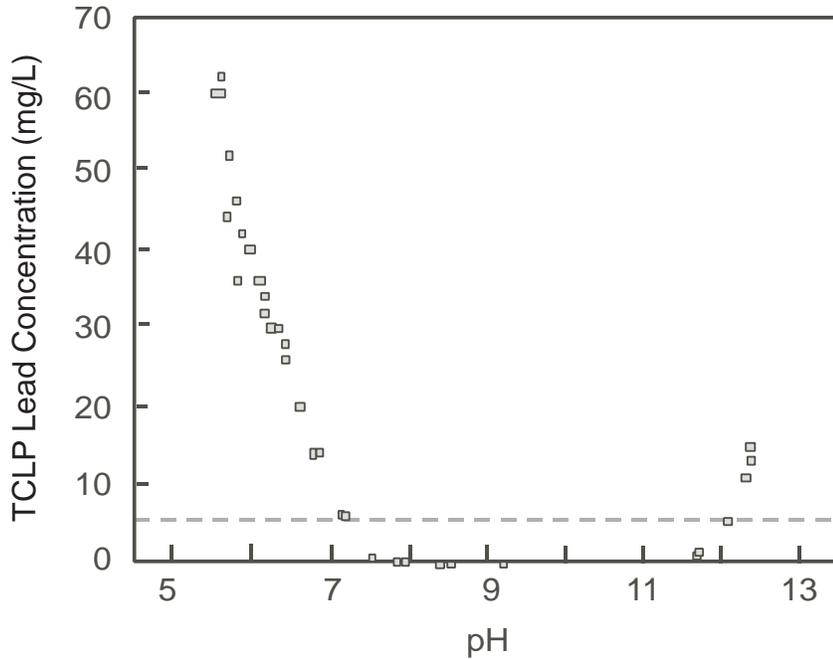

Figure 4. Foundry waste.

Table 1. Leachability of Smelter Waste\*

	TCLP Test		SPLP Test	
	Lead (mg/L)	Final pH <sub>f</sub>	Lead (mg/L)	Final pH <sub>f</sub>
Untreated	600	6.0	<0.003	8.2
Lime (% by weight)				
+5	76	6.5	290	12.2
+10	0.2	8.6	540	12.5
+15	6.2	10.4	510	12.5
Portland Cement (% by weight)				
+5	450	5.3	19	11.5
+15	<0.2	10.4	11	11.9
+25	1.2	11.6	12	11.9
+50	10.0	12.0	3.0	12.1
P + pH (% by weight)				
+4	2.4	5.8	<0.003	10.6
+6	0.4	5.5	<0.003	10.3
+8	<0.2	5.6	<0.003	8.5

Figure 5 illustrates the data shown in Table 1. In a TCLP scenario, the “Before” data point (A) represents the pH of the untreated waste subjected to the acid leaching medium of the TCLP. The acetic acid lowers the pH to a point where lead is quite water-soluble, and specifically at a concentration greater than the hazardous waste limit. Adding lime or cement offsets the acetic acid such that “After” treatment (point B) the pH in the TCLP is in a neutral range, effectively lowering the lead solubility to below the hazardous waste limit. Although this treatment is successful in rendering this waste nonhazardous using the TCLP, the actual lead leaching of this waste in the environment is probably better represented by points C and D, if the waste is not co-disposed with municipal solid waste. In a water leaching test (or SPLP), the “Before” point (C) represents the actual pH of the untreated waste in the water leaching test. According to these data, the waste is nonproblematic for lead leaching. However, by adding lime or cement to this waste, the pH is raised to a point “After” treatment (D) where lead leaching is significant. In other words, because of the amphoteric nature of lead, adding a high pH treatment chemical can cause increased lead leaching in the waste disposal environment.

### pH-Buffered Phosphate Chemistry

A pH-buffered phosphate chemical addition is more robust than most chemical fixation treatment processes, because it addresses the amphoteric nature of lead in an environmentally friendly way. Phosphate forms of

lead are very insoluble (Figure 1), and are naturally occurring in soils, but may not occur in lead-bearing wastes because of the absence of phosphate. Economical forms of phosphate can be used in combination with a pH buffer (Patent Numbers 5,037,479 and 5,202,303) to create ideal conditions that minimize lead leaching in both an environment of co-disposal with municipal wastes (represented by the TCLP) and a nonacidic environment (represented by the SPLP). A complete description of this chemistry can be found in (1). The selection of a pH buffer is crucial to maintaining an ideal pH. Lime and cement can drive the pH too high, but magnesium oxide (also covered by the patents) can both raise the pH in a TCLP and prevent the pH from excessively high values in a SPLP. The form of phosphate is also crucial, as some forms are too acidic and others are nonreactive. Triple superphosphate or TSP (also covered by the patents) is an effective and economical form of phosphate for treatment.

### Full-Scale Application to Sediment

The pH-buffered phosphate chemical fixation process has been applied several times to sediment. In one case, a 17-acre lagoon containing 370,000 cubic yards of hazardous lead-bearing sediment was treated in a unique way. A hydraulic dredge was used to remove the sediment and transport it via pipeline to a dewatering basin. Treatment chemical was injected in-line within the pipeline. By the time the treated sediment slurry was discharged to the dewatering basin, it was well mixed

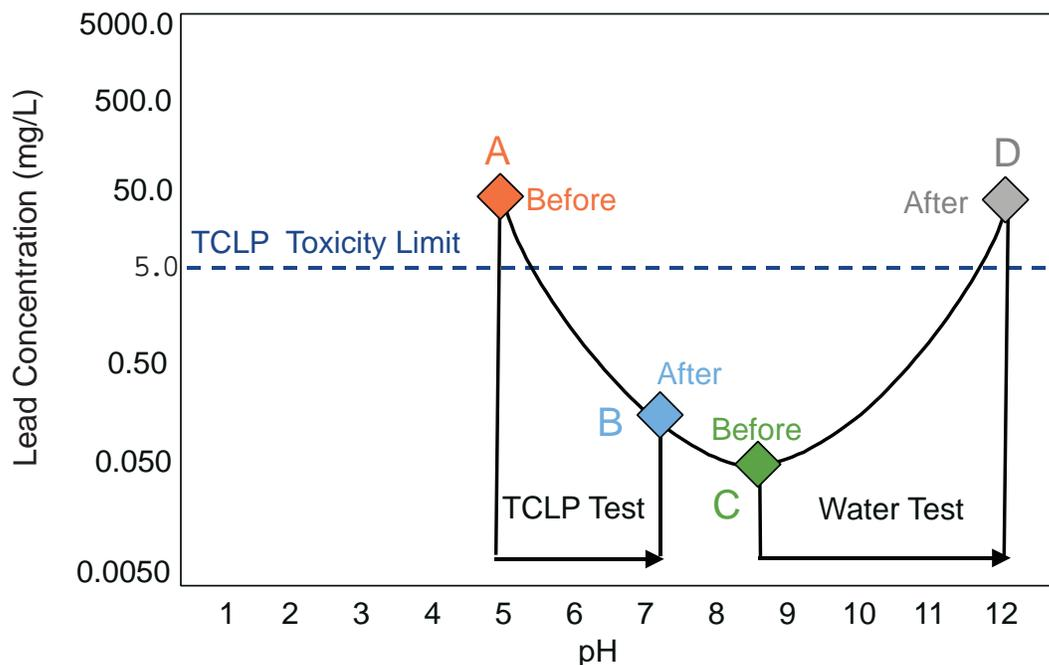

Figure 5. Lead solubility vs. pH.

---

with the treatment chemical. The sediment that settled out was nonhazardous for lead, and the return water (to the original lagoon) was treated for residual phosphate with iron hydroxide.

In another case, a bridge reconstruction required the placement of a new footing in sediment that was classifiable as hazardous for lead leaching. Because of regulations, treatment of the sediment *ex situ* would require permitting, but *in-situ* treatment would not. A coffer dam around the affected area was already required for construction, so the dam was used as a means to conduct *in-situ* treatment. During treatment an inward gradient was maintained within the coffer dam to ensure no leakage of resuspended material or treatment chemical. Treatment chemical was added to the top layer of sediment with standard equipment (a backhoe), and mixed to a practical depth. After mixing, the top layer of treated sediment was removed and dewatered. It was later transported from the site and disposed as a nonhazardous waste at a fraction of the cost of hazardous waste treatment. A more complete description of this case can be found in (2).

## Summary

A pH-buffered phosphate chemical fixation process (patented), which has been used successfully at hundreds of uplands sites, has also been implemented at full-scale in sediment settings. With minimal engineering controls it is an economic, environmentally friendly, and robust process that can be applied *in situ* for lead-, cadmium-, and zinc-contaminated sediments.

## References

1. Tickanen, L.D., and P.D. Turpin. 1996. "Treatment of Heavy Metal-Bearing Wastes Using a Buffered Phosphate Stabilization System." *Proceedings of the 51st Industrial Waste Conference*. Ann Arbor Press, Inc., Chelsea, MI.
2. Wible, L., S. McAnulty, R. Stanforth, A. Chowdhury, and M. Warner. 1994. "In-Situ Treatment of Hazardous Sediment." *Proceedings of Second International Conference and Exhibition on Dredging and Dredged Material Placement*. American Society of Civil Engineers, Waterway, Port, Coastal, and Ocean Division. November 13-16, 1994.

---

# Treatment of Dredged Harbor Sediments by Thermal Desorption

Mary Hall, Ed Alperin and Stuart Shealy, IT Corporation

Keith Jones, Brookhaven National Laboratory

The New York/New Jersey Harbor must be regularly dredged to maintain shipping channels and berthing areas for commerce and safe navigation. Ocean disposal of the sediments from this dredging operation has been the primary option for disposal. Revised guidance from the U.S. Army Corps of Engineers—New York District (NYDCOE) and the U.S. Environmental Protection Agency, Region 2 (EPA-Region 2) established more-stringent biological and chemical test criteria for the option of ocean disposal. This was published in *Draft Regional Guidance for Performing Tests on Dredged Material Proposed for Ocean Disposal* (Draft, December 1992). Under these new guidelines, the volume of contaminated dredged material prohibited from ocean disposal has increased to approximately 500,000 cubic yards of material requiring treatment each year.

Decontamination technologies were actively investigated by the EPA-Region 2 and the NYDCOE under Section 405 of the Water Resources and Development Act of 1992 authorizing investigations, including testing and demonstration. These technologies were demonstrated to determine their environmental-acceptability and cost-effectiveness. Treatment may require several different procedures before disposal is possible due to the complex nature of the contaminants and their widespread spatial distribution within the harbor.

Dredged sediments from various areas of the harbor may contain elevated levels of a wide variety of contaminants, including heavy metals, polynuclear aromatic hydrocarbons (PAHs), and organochlorines such as dioxins, furans, polychlorinated biphenyls (PCBs), pesticides (OCPs), and herbicides. The treatment system must be capable of sufficiently reducing the contaminant levels by separation, destruction, immobilization, or other methods to render dredged sediments suitable for unrestricted ocean disposal, land disposal or, preferably, beneficial use. IT Corporation (IT) investigated a three-stage treatment process that included dewatering the sediment, removing organic contaminants by thermal

desorption, followed by cement based solidification/stabilization (S/S) of thermally treated sediment.

Two waste forms designed to meet different disposal options were investigated. The first waste form was a monolithic, high-strength block of treated material suitable for ocean disposal. These blocks would provide hard surfaces for reef development. Artificial reefs have proven to provide habitat for numerous fish and invertebrate species, and increase opportunities for recreational anglers. These stabilized blocks could be provided to state sponsored artificial reef programs. The second waste form was a thermally treated, dry soil-like material that was treated to reduce leachability of metals. This product is suitable for fill or road base construction.

## Treatment Objectives

Treatability study objectives, as established by Brookhaven National Laboratory (BNL) were to test methods of dewatering, thermal treating and S/S of dredged estuarine sediments (DES) to produce a final product that may be acceptable for unrestricted marine disposal and that provides a beneficial use. To meet that first goal, the final product must meet disposal criteria as specified in *Draft Regional Guidance for Performing Tests on Dredged Material Proposed for Ocean Disposal*. To accomplish the second goal, the final product will be formed into blocks suitable for encouraging growth of marine organisms. The goals of the final product were:

- an unconfined compressive strength (UCS) of 290 pounds per square inch (psi) or greater,
- metal leaching results below the Toxicity Characteristic (TC) regulatory threshold, and
- minimization of Lethal Concentrations or LC<sub>50</sub> results.

An additional testing agenda was added to the study to investigate a land based disposal option. The objective of this option was to produce a nonhazardous material to be used as road base or landfill. The goals of the land based material were:

- no free liquid
- UCS of 20 psi, and
- metal leaching results below TC regulatory threshold.

Data generated by this study will be used by BNL to determine:

- treatment effectiveness as determined by a critical evaluation of the data from chemical and physical analyses and bioassay testing as well as their relative contribution to the assessment of the technology,
- composition of end product(s), effluent, and by-products,
- unit treatment cost estimates and time-scales for scaleup operations, and
- potential environmental and occupational hazards posed by the treatment technology or system.

Testing for this treatability study was conducted in three stages as Figure 1 visualizes. Stage 1 was to dewater the received material. Stage 2 was to thermally desorb the remaining moisture and organics from the DES. Stage 3 was to solidify/stabilize (S/S) the thermally desorbed DES to prevent the leaching of the inorganic contaminants.

## Sample Description

Four 5-gallon buckets of sample were obtained by NYDCOE using barge mounted clamshell dredging equipment. The sample IT received was fine-grained sludge with a high organic content. The percent (%) solids were 34.6%. The gross organic levels were 462 ppm of organo-chlorinated pesticides, 2997 ppm PCBs, 52,540 ppm PAHs and 0.3 ppm dioxins/furans (as 2, 3, 7, 8-TCDD TTEs). The sample also contained leachable cadmium, copper, lead, nickel and zinc. Due to the small amount of material used in some of the tests, the DES

was screened prior to use and material 1/2" or larger was removed.

## Dewatering

The water content of the DES was  $\geq 60\%$  (by weight). This is too high for optimal thermal desorption operation. High water content lowers the treatment capacity and increases the energy requirements for a thermal desorber system. High water content may also result in material handling problems in typical feed equipment. This results in higher treatment costs, therefore dewatering of high moisture sediments is frequently performed prior to thermal treatment. Drainage beds and filter aids were investigated under this program.

Drainage beds are concrete-lined pads or pits where piles of materials are allowed to release free-draining water. Plate and frame and belt filter presses have also been effective. Lime or filter aid additives were used in an attempt to improve dewatering performance. A bed height of 6 feet on a standard 25 cubic-feet-per-minute (SCFM) filter mesh was simulated to represent field conditions. Only 11 milliliters (mls) of liquid was collected in 61 seconds. This material was determined to be non-drainable.

High pressure, 120 psi, filtration was tested and only 30 mls of liquid was collected in 15 minutes. A filter aid of hyflo diatomaceous earth was added at a 5% concentration which caused the binding of the filter press with the collection of only 44 mls in 15 minutes. This material was also determined to be non-filterable.

The sample was allowed to air dry in a hood to produce a lower moisture level prior to thermal treatment. Four aliquots were taken for preliminary thermal desorption analysis and samples from these aliquots were sent to laboratories for characterization analyses. This data is presented in Table 1.

## Thermal Desorption

The purpose of the thermal treatment was to identify treatment conditions (time/temperature) needed to remove pesticides and PCBs from the DES and generate enough thermally treatment material for S/S testing. All thermal tests were performed in IT's Rotary Thermal Apparatus (RTA), see Figure 2. The RTA is a batch, bench-scale device that is used to treat material in an indirectly heated rotary tube. The device simulates the



Figure 1. Three-stage treatment process for DES.

**Table 1.** Total Pesticides ( $\mu\text{g}/\text{kg}$  dry) Untreated and Thermally Treated Dredged Estuary Sediment

Analyte	Untreated	Treatment Temperature ( $^{\circ}\text{C}$ ) /Residence Time (min)			
		350/5	450/0	450/5	550/5
Aldrin	75	<3.4	<3.4	<3.4	<3.4
4,4'-DDD	162.1	<3.4	<3.4	<3.4	<3.4
4,4'-DDE	150.6	<3.4	<3.4	<3.4	<3.4
Dieldrin	74.5	<3.4	<3.4	<3.4	<3.4

Total Aroclors (PCBs) ( $\mu\text{g}/\text{kg}$  dry) Untreated and Thermally Treated Dredged Estuary Sediment

Analyte	Untreated	Treatment Temperature ( $^{\circ}\text{C}$ ) /Residence Time (min)			
		350/5	450/0	450/5	550/5
Aroclor 1016	<930	<66	<66	<66	<66
Aroclor 1221	<930	<66	<66	<66	<66
Aroclor 1232	<930	<66	<66	<66	<66
Aroclor 1242	1400	<66	<66	<66	<66
Aroclor 1248	<930	<66	<66	<66	<66
Aroclor 1254	1500	<66	<66	<66	<66
Aroclor 1260	<930	<66	<66	<66	<66

Total Polyaromatic Hydrocarbons ( $\mu\text{g}/\text{kg}$  dry) Thermally Treated Dredged Estuary Sediment

Analyte	Untreated	Treatment Temperature ( $^{\circ}\text{C}$ ) /Residence Time (min)			
		350/5	450/0	450/5	550/5
Naphthalene	2729	<660	86	<660	67
Acenaphthylene	1288	<660	<650	<660	<650
Acenaphthene	1042	<660	<650	<660	<650
Fluorene	1389	<660	<650	<660	<650
Phenanthrene	6588	<660	<650	<660	<650
Anthracene	3702	<660	<650	<660	<650
Fluoranthene	10324	<660	<650	<660	<650
Pyrene	7102	<660	<650	<660	<650
Benzo(a)anthracene	4484	<660	<650	<660	<650
Chrysene	4585	<660	<650	<660	<650
Benzo(b)fluoranthene	2922	<660	<650	<660	<650
Benzo(k)fluoranthene	1107	<660	<650	<660	<650
Benzo(a)pyrene	2550	<660	<650	<660	<650
Indeno(1,2,3-cd)pyrene	1076	<660	<650	<660	<650
Dibenz(a,h)anthracene	397	<660	<650	<660	<650
Benzo(ghi)perylene	1255	<660	<650	<660	<650

heat and mass transfer of a full-scale rotary kiln or calciner. Soil is charged into an alloy tube, rotated and purged with air. Indirect heating is provided by an electric furnace that encloses the tube. As the DES heats to treatment temperature, steam (from desorption of the sediment moisture) and desorbed organics evolved and are carried by the purge air into an offgas treatment system.

The offgas system used for these tests was a spray scrubber followed by a carbon absorber. The spray scrubber removes acid gases, semivolatile organic compounds (SVOCs) and some oxygenated organics. The carbon absorber removes volatile organic compounds (VOCs).

Four runs were performed on a homogenous sample to identify optimal temperature and retention time at temperature to minimize the organic content prior to production runs. The matrix used to determine the time/temperature is 1) 350 C for 5 minutes (at temperature), 2) 450 $^{\circ}\text{C}$  for 0 minutes, 3) 450 $^{\circ}\text{C}$  for 5 minutes, and 4) 550 $^{\circ}\text{C}$  for 5 minutes. This matrix was determined by past testing experience. The treated material was analyzed for PAHs, PCBs and OCPs and compared with the initial characterization. This comparison is tabularized in Table 1. The comparison of the chemical analyses did not provide adequate information to select the run to carry forward to production to produce the necessary volume for S/S testing. Therefore, the selection was based on the biotoxicity analysis.

The biotoxicity test was performed to determine the temperature and time necessary for treatment for ocean disposal. Treated and untreated sediments crushed to 3/8" and extracted with a 3% Instant Ocean solution. The amount of Instant Ocean used to leach the samples was four times the volume of the treated specimen by the method. The samples were extracted on a rotary tumbler for 1 hour. The extracts were then centrifuged at 2000 rpm for 1/2 hour to separate the supernatant from the solids. The extracts were then tested to determine the Lethal Concentration of LC<sub>50</sub> values. This value represents the amount of leachate necessary to be lethal to 50% of the test population. Acute mortality of the leachate was tested using three common salt water arthropods. The arthropods used as the population were Silverside Minnow (*Menidia berylina*), Mysid Shrimp (*Mysidopsis bahia*), and Mussel Larvae (*Mytilus edulis*).

The relative toxicity of the leachates of all run conditions compared to a sample of the extraction fluid showed lower toxicity when compared to the untreated material. Toxicity decreased in severity as the thermal treatment increased. The run condition of 550 $^{\circ}\text{C}$  for 5 minutes at temperature gave the lowest residual contaminant content, and this was also the least toxic leachate. This run condition was chosen to generate thermally treated material for S/S testing. Twenty-six RTA runs, treating 25 kg DES, were required to produce 13.7 kg of thermally treated material.

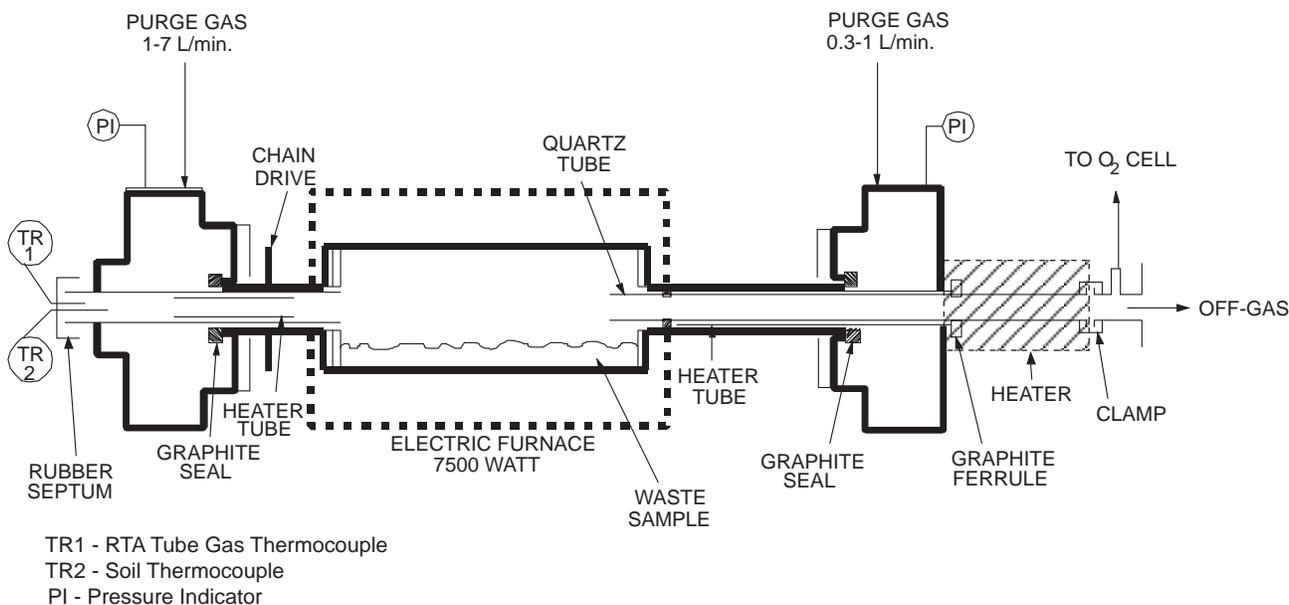

**Figure 2.** Rotary thermal apparatus (RTA) schematic.

To generate residuals for a mass balance determination, the scrubber system was replaced by a series of water impingers in an ice bath, followed by a small carbon trap. The first impinger contained only enough water to act as a condenser. The weights of liquid removed from the system were recorded and the liquids were collected in a pail. The oil phase that formed was separated from the liquid phase and the volumes estimated. The carbon at the end of the offgas system was composited into one jar. The weights of the collected phases were submitted for analyses and the data used to perform a mass balance as seen in Table 2.

As Table 2 shows, the PCBs in the sediments were lowered from 6969  $\mu\text{g}/\text{kg}$  to 1.8  $\mu\text{g}/\text{kg}$  (dry basis), while the dioxins (2,3,7,8-TCDD TTF) lowered from 695 to 154 ng/kg (dry basis). The condensate oil contained 452 mg/kg PCBs and 28  $\mu\text{g}/\text{kg}$  dioxin TTE. PCB and dioxin mass balances were 110 and 122%, respectively, based on the characterization results. The condensate oil also contained 93% of the PCBs and 52% of the dioxins and the activated carbon contained 2  $\mu\text{g}/\text{kg}$  dioxin TTE.

These results show that thermal desorption is effective in removing or reducing toxic organics (OCPs, PAHs, PCBs and dioxins) from the DES. It also reduces the biotoxicity of the thermally treated material.

### Solidification/Stabilization

Optimal additive ratios and requirements for the conversion of thermally treated DES into a nonleachable durable matrix was the primary objective of the stabilization study. The additives studied were determined by IT's past experience with the expected waste contaminants. This experience assisted in selecting additives for a

preliminary evaluation. The additives were: Portland cement (PC), Class C flyash (FA), blast furnace slag (BFS), and silica fume (SF). A minimum and maximum percentage of additive loadings based on the amount of sample were determined and a statistical experimental design was used to isolate the most important additives and to reduce the number and amount of additives necessary to treat the material. The experimental design matrix is a basic  $2^{4-1}$  fractional factorial design. The design matrix uses eight formulations for the ocean disposal study, see Run Numbers 1-8 in Table 3. There are no centroid data points and the amount of water to be added was determined by the consistency of the grout mixture.

Formulations would be carried forward based on data from unconfined compressive strength (UCS) (American Society for Testing and Materials (ASTM) D-2166), and Toxicity Characteristics Leaching Procedure (TCLP [EPA SW-846 method 1311]). Biotoxicity testing would be performed on samples that had a UCS greater than 290 psi and passed TCLP analyses for constituent metals. Two formulations for the backfill disposal alternative, 9 and 10 in Table 3, were formulated using the UCS and TCLP data produced by the ocean disposal alternative. Biotoxicity testing is not necessary since this alternative is land based. The additives evaluated for the land based alternative included PC, BFS, and lime (reagent CaO). The TCLP data is tabulated in Table 4.

Comparison of the TCLP and UCS data trends, see Table 4, assisted IT in reformulating Sample 3 to reduce costs by eliminating the expensive additive SF, reducing the BFS and increasing a less-expensive additive FA. Formulation 3 was sticky and wet and the reformulation was more workable and would reduce the problems with

**Table 2.** Mass Balance Data for Thermal Treatment of Dredged Estuarine Sediments

Stream Description	Mass (g)	Carbon <sup>5</sup>		Ash <sup>5</sup>		PCBs <sup>5</sup>		Dioxin, TTE <sup>3,5</sup>	
		(wt%)	(g)	(%)	(g)	(µg/kg)	(mg)	(ng/kg)	(µg)
<b>In</b>									
Feed DES	24,989	4.7	1,177.0	47.7	11,919.8	2,996.7	74.9	299	7.47
Scrubber Water	2,082								
Total In	27,071		1,177.0		11,919.8		74.9		7.47
<b>Out</b>									
Treated DES	13,744	5.5	714.7	91.5	12,579.9	1.8	0.0	154	2.12
Condensate Aqueous	12,536	0.5	62.7			na <sup>4</sup>		63	0.79
Condensate Oil	170	85.0	144.5			452,370.0	76.9	28,147	4.78
Offgas Solids	147	5.2	7.6	85.0	125.0				0.00
Offgas			211.9						
Carbon Traps	498					na <sup>4</sup>		1,845	0.92
Glassware Rinse	640					8,692.6	5.6	888	0.57
Total Out	26,597 <sup>1</sup>		1,141.4 <sup>2</sup>		12,704.8		82.5		9.18
Recovery %	98.2		97.0		106.6		110.2		122.9

<sup>1</sup> Overall mass balance was completed around the desorber and impingers and does not include the carbon traps and solvent rinse of the glassware.

<sup>2</sup> Carbon (organic) content of aqueous condensate and offgas are estimated from earlier work on other soils.

<sup>3</sup> Dioxin is reported as nanogram/kg of 2,3,7,8-tetrachlorodioxin Total Toxicity Equivalents.

<sup>4</sup> Not Analyzed.

<sup>5</sup> Wt% carbon, ash, PCB, dioxins have been corrected for 57% moisture content of partially dried DES used in the RTA tests.

**Table 3.** Formulation Matrix for Preliminary Evaluation

Run Number	Portland Cement (g)	Blast Furnace Slag (g)	Silica Fume (g)	Fly Ash (g)	Sediment (g)
1	20	4	0	4	100
2	20	4	3	30	100
3	20	50	3	4	100
4	20	50	0	30	100
5	50	50	0	4	100
6	50	50	3	30	100
7	50	4	3	4	100
8	50	4	0	30	100
3R	20	14	40	0	100
9	5	0	5	0	100
10	5 (Lime)	10	0	0	100

material handling in the field. This reformulation is designated as 3R in Table 3. Two of the ocean disposal formulations and the reformulation of Sample 3 were selected to go forward to the biotoxicity testing. All ocean disposal formulations had high concentrations of BFS to make them more durable in sea water. Formulations would be carried forward based on data from unconfined compressive strength (UCS) (American Society for Testing and Materials (ASTM) D-2166), Toxicity Characteristics Leaching Procedure (TCLP) (EPA SW-846 method 1311). Biotoxicity testing would be performed on samples that had a UCS greater than 290 psi and passed TCLP analyses for constituent metals.

The only method used to compare the land based formulations was to perform a biotoxicity analysis, so Formulations 9 and 10 were included in the analysis. Formulation 9 was designed to use PC for strength and BFS to react with the calcium hydroxide by product made by cement hydration reactions. Formulation 10 was based on treating soils and oily materials. This formulation was given a 1:2 (w/w) lime to FA to lower the alkalinity for better results in the biotoxicity analysis and cost.

**Table 4.** S/S TCLP Results

Formulation Number	Arsenic (mg/L)	Barium (mg/L)	Cadmium (mg/L)	Chromium (mg/L)	Copper (mg/L)	Lead (mg/L)	Nickel (mg/L)	Selenium (mg/L)	Silver (mg/L)	Zinc (mg/L)	UCS (psis)
1	<0.178	0.308	<0.026	<0.028	<0.011	<0.201	<0.03	<0.147	<0.017	0.076	310
2	<0.178	0.371	<0.026	<0.028	<0.011	<0.201	<0.03	<0.147	<0.017	0.100	240
3	<0.178	0.429	<0.026	<0.028	<0.011	<0.201	<0.03	<0.147	<0.017	0.087	360
4	<0.178	0.451	<0.026	<0.028	<0.011	<0.201	<0.03	<0.147	<0.017	0.076	420
5	<0.178	0.477	<0.026	<0.028	<0.011	<0.201	<0.03	<0.147	<0.017	0.096	420
6	<0.178	0.491	<0.026	<0.028	<0.011	<0.201	<0.03	<0.147	<0.017	0.104	550
7	<0.178	0.513	<0.026	<0.028	<0.011	<0.201	<0.03	<0.147	<0.017	0.098	460
8	<0.178	0.604	<0.026	<0.028	<0.011	<0.201	<0.03	<0.147	<0.017	0.120	330
9	<0.178	0.412	<0.026	<0.028	<0.011	<0.201	<0.03	<0.147	<0.017	0.115	380
10	<0.178	0.361	<0.026	<0.028	<0.011	<0.201	<0.03	<0.147	<0.017	0.100	40
Air Dried DES	<0.178	0.277	0.325	<0.028	0.286	0.242	2.43	<0.147	<0.017	18.2	34
Thermally Treated DES <sup>1</sup>	<0.178	0.305	0.665	<0.028	1.58	0.159	1.75	<0.147	<0.017	26.1	NA <sup>2</sup>

<sup>1</sup> 550°C for 5 minutes.

<sup>2</sup> Not analyzed.

All untreated samples passed the TC regulations for metals. The thermally treated sediments contained low levels of leachable (TCLP) cadmium, copper, lead, nickel and zinc. Stabilization was performed to determine if the metals could be fixed into the matrix. All stabilization formulas resulted in effective the fixation of metals. All metals but zinc were nondetected in the TCLP. Leachable (TCLP) zinc was reduced from 26.1 mg/L to 0.115 - 0.076 mg/L. The UCS of monolith formulas ranged from 240 to 550 psi.

All TCLP analyses were nondetected for the tested parameters. The test materials were metals, pesticides, herbicides, VOC, SVOC, dioxins, and furans. This shows that very little of the constituents are leaching. This agrees with the very low LC<sub>50</sub> and EC<sub>50</sub> values for the chosen formulation.

All PCB, pesticides, and herbicides were non-detect in the total analysis. Comparing the thermally treated/stabilized material with the untreated material, percent reductions were calculated using the method detection limits for nondetected analytes. The PCB and pesticides were reduced by >99.6 and >90.9%, respectively. The SVOCs were all non-detects except for the constituents shown in Table 5. The percentage reduction for SVOCs was >93.7%. This percentage reduction value is limited by all the nondetected values in the product. There were multiple dioxins present in the total analysis. The total toxicity equivalent as 2,3,7,8-TCDD was 59.0 ng/kg

(dry). This was well below the normal EPA guideline of 1.0 µg/kg for unrestricted landfill.

Biotoxicity results were not improved by stabilization as measured by screening tests. Land based final waste forms had higher biotoxicity results than thermally treated sediments. This increased toxicity of these waste forms was probably due to higher pH of extracts caused by leachable lime. The Mortality in 100% Sample (EC) was also calculated and represents the percentage of organisms, out of 20 per batch, that die in a solution that is 100% from the DES and treated DES material. The biotoxicity of the stabilized thermally treated material is presented in Table 6.

The thermal process effectively removed most of the hazardous organic compounds for the DES. The stabilization process appears to partially hold or fixate the metal compounds by the clay and sulfide in the DES and the S/S additives.

The land based Formulations 9 and 10 showed higher toxicity levels than the ocean disposal formulations. This was expected due to the higher alkalinity and salinity of the leachates from the low UCS values of these formulations.

Formulation 3R has identical toxicity as the thermally treated DES. The LC<sub>50</sub> values for Formulation 3Rare all greater than 100% leachate, the leachable metals are

low and the USC is greater than 290 psi. These three factors indicate that Formulation 3R has significant potential for regulatory acceptance for unrestricted ocean disposal. This formulation was, therefore selected for scale up for the >5 kg sample to be sent for analysis.

### Conceptual Treatment Process

Based on 100,00 cubic yards of DES per year, the treatment process would start with thermal drying to reduce water content to 30%. The offgas from the dryer would be carbon treated to eliminate the release of organics. The material would be fed to a rotary calciner

for thermal desorption where the offgas would be treated in a flameless oxidizer. The thermally treated DES would be stabilized in a batch mixing plant.

### Cost Estimate

The process costs are base on a 12 mo-24 hr operation. The capital cost for the treatment system is estimated at \$23,650,000 or \$23.65 per yd<sup>3</sup> of sediment. Utilities (power and fuel) are estimated to be \$21.48 per yd<sup>3</sup>. Labor will consist of a substantial staff to cost \$19.99 per yd<sup>3</sup>. Add \$16 per yard for monolithic waste for a total of \$88.64/yard<sup>3</sup>.

**Table 5.** Detected Treated Material SVOCs Comparisons With Feed

SVOC Analyte	µg/kg in the Product	µg/kg in the Feed
Naphthalene	47.9	2729
2-Methylnaphthalene	25.0	2304
Diethylphthalate	33.4	—*
Di-n-butylphthalate	60.4	—*
bis-2-Ethylhexylphthalate	243.3	48631

\* Common laboratory contaminant often arising from the gloves, rubber O-rings, and plastic containers in contact with the sample or a leachate of the sample.

**Table 6.** Biototoxicity Testing Results

Biological Species	Procedure	Formulation							
		Air Dried DES	Thermally Dried DES <sup>1</sup>	3R	4	5	9	10	Blank <sup>2</sup>
<i>Menidia berylina</i> (Silverside Minnows)	LC <sub>50</sub> (% Sample)	58.79	>100.0	>100.0	>100.0	>100.0	65.7	66.39	>100.0
	Mortality in 100% sample (%)	95	0	15	25	10	100	82.5	17.5
<i>Mysidopsis bahia</i> (Mysid Shrimp)	LC <sub>50</sub> (% Sample)	82.78	>100.0	>100.0	>100.0	>100.0	31.57	22.36	>100.0
	Mortality in 100% sample (%)	65	2.5	27.5	42.5	17.5	70	100	0
<i>Mytilus edulis</i> (Mussel Larvae)	LC <sub>50</sub> (% Sample)	75.02	>100.0	>100.0	>100.0	>100.0	>100.0	87.06	>100.0
	Mortality in 100% sample (%)	77.0	15.8	44.0	35.0	30.0	41.5	52.5	42.0
	EC <sub>50</sub> (% Sample))	24.04	71.2	>100.0	58.38	54.68	58.44	23.41	59.22
	Effected in 100% sample (%)	100	92.3	94.9	97.1	97.1	100.0	100.0	94.9

<sup>1</sup> Thermally treated at 550°C for 5 minutes.

<sup>2</sup> Instant Ocean® extraction fluid.

---

# Solvent Extraction Process Development to Decontaminate Sediments

Philip DiGasbarro  
Metcalf & Eddy, Inc., Branchburg, NJ

John Henningson, P.E.  
Formerly of Metcalf & Eddy, Inc.

Georges Pottecher  
Anjou Recherche/GRS, Paris, France

John J. Cardoni, P.E.  
Metcalf & Eddy, Inc., Branchburg, NJ

## Abstract

Solvent extraction of organic contaminants is one of the relatively low-cost methods currently under development for decontaminating sediments. The technology has been used extensively in industrial applications. Solvent extraction is applied in analytical methods to remove the organic contaminants from various materials. Furthermore, the technology has been applied successfully on contaminated soils and sludges with low moisture content. However, the application of this technology to contaminated sediments presents unique challenges. The high moisture content, the low toxic contaminant concentrations and high fine-grain material characteristics of the sediment require special attention to solvent selection and processing features. This describes the technical issues associated with solvent extraction and recent bench- and pilot-scale test results. These tests indicate that this technology is safe and cost-effective for further development and engineering design as part of a full-scale commercial plant.

## I. Introduction

Sediments slowly accumulate in our ports, harbors, rivers, and lakes and eventually restrict shipping access and navigational safety. Accordingly, both the U.S. Environmental Protection Agency (EPA) and U.S. Army Corps of Engineers (USACE) manage and regulate the dredging of approximately 400 million cubic yards of sediments each year in the United States. It is estimated that approximately 14 to 28 million cubic yards/year of sediments from the federal waterways and from the industrial sites are contaminated with low levels of toxic-regulated organics and/or heavy metals. To date,

dredged sediments were mainly disposed of in the ocean. However, recent regulatory restrictions to protect the environment will require treatment or upland disposal of these contaminated sediments.(1)(2)

For example, the NY/NJ port is evaluating the various options in the planning document titled "Dredged Material Management Plan for the Port of New York and New Jersey." The options for solving the contaminated sediments problem are containment islands, direct upland disposal in landfills, and treatment by several technologies.(3) The overall treatment cost of using these technologies (including credits for reusable products) will have to be less than the landfill disposal costs to be viable. The disposal costs are estimated at \$30 to \$60 per cubic yard without considering the possible future liability of not treating the material.

One of the promising technologies for treating sediments is solvent extraction, which has been extensively used in the manufacturing industries as well as for the decontamination of soils/sludges. Moreover, it is effective in extracting contaminants for high-resolution gas chromatograph analysis, such as polychlorinated biphenyls (PCBs) and dioxin/furans. Solvent extraction removes only organics and can be part of the overall treatment plant to produce useable products that potentially have some resale value. Heavy metal contaminants, if any, will have to be treated by other technologies such as chemical extraction and stabilization/fixation.

This paper discusses the technical issues of applying solvent extraction to contaminated sediments, which exhibit high moisture content, low toxic contaminant concentrations, and high fraction of fines. The paper

also presents some of the results of the recent bench- and pilot-scale tests conducted on the NY/NJ Harbor sediments for which the ORG-X proprietary process was applied in combination with stabilization/solidification. The effects of some of the important process variables are reported. The performance results and conceptual treatment costs are favorable for continuing to the next phases:

- 1) additional investigation of other process variables to improve and optimize contaminants removal; and
- 2) preliminary engineering of a commercial plant with a capacity of 100,000 to 500,000 cubic yards/year.

## **II. Technical Considerations for Applying Solvent Extraction**

### **A. General**

There are three fundamental technical considerations for applying solvent extraction to treat contaminated sediment. These are

- the chemical and physical characteristics of the sediment to be treated;
- the clean-up goal(s) for the selected final product(s) or treatment objectives for the solvent extraction process; and
- the process to achieve the goal(s).

The latter involves the development and application of the particular solvent extraction process to convert the contaminated raw sediments to the desired final product(s). In order to effectively treat the sediments by solvent extraction, many process development issues must be investigated and examined closely. This is best accomplished by briefly reviewing the solvent extraction technology, as well as the applications and approaches to contaminant removal.

After presenting the background on the Metcalf & Eddy/GRS process, the bench and pilot test results will be discussed. Générale de Réhabilitation des Sites (GRS) is a French affiliate of the larger CGE/Anjou Recherche organization.

### **B. Sediment Characterization**

Although sediment comes from numerous locations and differ in physical and chemical content, there are some general common characteristics. It is usually a black, sticky and mayonnaise-like muck. It has a high water content in the range of 60 to 70% *in situ* because of the high total surface area from the high percentage of hydrophilic fines (clays and silt). Carbon content is high (2 to 10% TOC on a dry basis), and a variety of heavy metals and organic contaminants, usually generated by various industrial/commercial activities, can be found.

These organic contaminants, which are the focus of this solvent extraction process, are usually non-volatile, insoluble in water, and not readily biodegradable. Among these, the hydrophobic organic contaminants of concern are usually low levels of dioxins, furans, PCBs, and polyaromatic hydrocarbons. If the sediment is dredged from the nearby ocean, the salinity in the water phase can be as high as 3%.

Sediments can be removed from the site using traditional techniques to produce low solids to water ratios, or by use of novel techniques to produce material almost in the *in-situ* state. After removal of debris, the viscous sediments may be pumpable as is, or with some dilution using piston pumps.

The physical and chemical characteristics of the sediment from Newtown Creek in the NY/NJ Harbor are presented in Table 1.

In this case the objectionable organic contaminants are dioxins, furans, and PCBs, based on ecological studies. A few other contaminants in the pesticides and semi-volatiles groups may also be unacceptable. The odor and semi-solid/liquid state is also undesirable when placed upland and exposed to the atmosphere. Often heavy metals are not a problem according to the TCLP criteria for upland disposal. However, it may effect the suitability for reuse and should be stabilized.

### **C. Sediment Treatment Objectives and Solvent Extraction Process Objectives**

The overall objective of a sediment management program is to minimize cost over a given time horizon while satisfying various constraints/criteria/desires/specifications. Cost minimization also applies to treating the contaminated sediments with the solvent extraction process. Although a clean-up criteria has not been established for low but undesired levels of toxic compounds, reasonably safe goals can be proposed for useful products. For example, if the dioxin/furan levels are set at 1 ppt (total equivalent to 2,3,7,8 TCDD) and PCBs levels are set at 1 ppb, the required removal is usually 1-3 orders of magnitude. Other organics and odoriferous compounds would also be removed using the solvent extraction process.

Depending on the type of product desired for beneficial reuse, the organic-free sediments can be solidified by drying/pelletizing, or stabilized with Portland cement or other agents to fix metals. The types of possible products are 1) construction backfill and landfill cover for the stabilized sediment; and 2) an additive for landscaping and composting soil blends for the treated, not stabilized, sediment. This beneficial reuse not only eliminates a disposal cost, but may provide a financial contribution if the product is sold at \$5 - \$10/per cubic yard.

After setting the overall goal(s), some of the desirable objectives of the organic extraction plant are

**Table 1.** Newtown Creek (NY Harbor) Sediment Characteristics**Physical Characteristics - Almost in the *In Situ* State**

Solids (%)	30 - 40%
Gravel (% of solids)	0.1 - 34%, frequently on low side
Sand (% of solids)	35 - 47%, frequently near average
Silt (% of solids)	8 - 43%, frequently near average
Clay (% of solids)	10 - 65%, frequently near average

**Chemical Characteristics**

Organics	Level	TCLP
PAHs	1 - 50 ppm	<0.01 mg/l
Pesticides	ND - 177 ppb	<0.01 - 0.0005 mg/l
Dioxins/Furans (total)	0.01 - 15 ppb	<0.001 - 0.01 ng/l
PCBs (total)	1 - 10 ppm	0.0001 - 0.02 &g/l
Total Organic Carbon	2 - 8%	---
Metals	Level	TCLP
Arsenic	5 - 33 ppm	<0.1 mg/l
Cadmium	1 - 20 ppm	<0.1 mg/l
Chromium	100 - 400 ppm	0.03 mg/l
Copper	61 - 770 ppm	
Lead	68 - 554 ppm	<0.05 mg/l
Mercury	1 - 3 ppm	<0.001 mg/l
Nickel	12 - 140 ppm	
Silver	2 - 3 ppm	
Zinc	104 - 1260 ppm	

- to treat a variety of organic contaminants at various concentrations;
- to pretreat sediments to reasonable but flexible specifications;
- to design the commercial plant with flexible level of organics removal in order to attain the safe levels of the reusable product;
- to produce various desirable products to maximize reuse; and
- to integrate the solvent extraction plant with a solidification plant and its requirements (i.e., produce organic contaminant-free sediment with moisture content required by solidification plant).

**D. Brief Review of Solvent Extraction Technology, Applications and Approach****1. Organic Contaminant Extraction Approach**

Applying solvent extraction for treating sediments is more complex than the two standard types found in textbooks: liquid-solid extraction or liquid-liquid extrac-

tion. The sediments are already two phases (liquid and solid) in the form of an aqueous slurry, and the introduction of a partially miscible solvent creates a second liquid phase. Moreover, there is a multitude of contaminants and not just one or a few solutes as found in most industrial applications. Figure 1 shows two approaches for extracting contaminants.

One approach is to eliminate the aqueous phase by drying the sediment and thereafter conduct the conventional liquid-solid extraction. This is practiced in many industrial applications such as sugar from sugar beets or sugar cane, vegetable oil from oil seeds, caffeine from coffee, turpentine and resins from wood, and residual oil from fish(4). This approach was not selected for two main reasons:

- the energy cost to evaporate the 60 to 70% water in sediment adds \$5 to \$10 per cubic yard to the operating cost; additional drying and fines processing equipment is required;
- aggressive mechanical dewatering is ineffective and forms a gel-like material with little or no release of water.

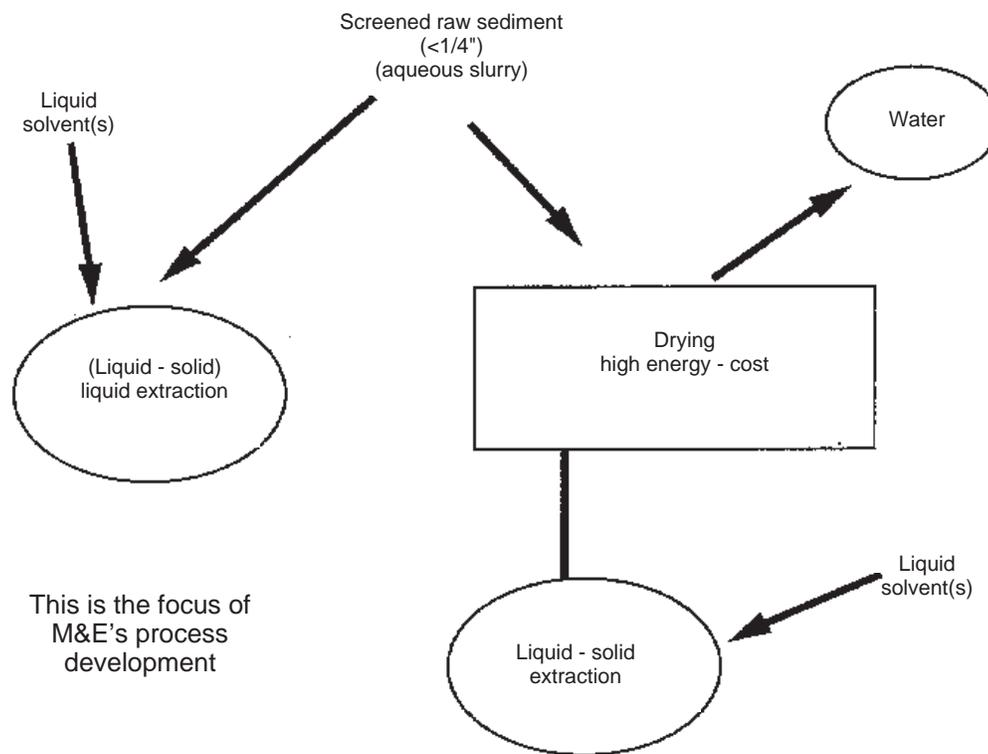

**Figure 1.** Solvent extraction approaches for contaminant removal from sediments.

The second approach is to keep the water, view the aqueous slurry as the "dense" liquid phase, and use a partially miscible solvent as the second phase of the liquid-liquid extraction. This is practiced widely in the separation of aromatics from aliphatics, sulfur compounds from oil, antibiotics from fermenter broth, vitamins from oil, and pollutants from wastewaters.

Selectivity for specific contaminants can still be achieved by using partially miscible acetate/alcohol solvent blends. Figure 2 shows the complex equilibrium stage.

There are two possible mechanisms for the contaminants to transfer from the solid particle to the solvent layer. This is shown in Figure 3. The first mechanism is for the organic contaminant to first dissolve in the new aqueous/organic layer and then transfer to the organic layer/droplets. This is probably effective because the new solvent blend can penetrate the sediment particles. The second mechanism is for the organic phase solvent blend to contact the solid particles with proper mixing, and to extract the organic contaminant directly. This is effective in solvating molecules such as PCBs, which are also non-polar.

## 2. Brief Review of Solvent Extraction Processes for Soils/Sediments and Types of Industrial Solvents Used

There are numerous industrial extraction applications applying many types of common solvents:

- Chlorinated Hydrocarbons ( $\text{CHCl}_2$ ,  $\text{CHCl}_3$ , PERC)
- Ketones (Acetone, MEK, MIBK...)
- Acetates (Methyl Acetate, Ethyl Acetate...)
- Alcohols (Methanol, Ethanol, Propanol...)
- Aromatics (Benzene, Toluene, Xylene...)
- Aliphatics (Propane, Butane, Hexane...)

These processes were developed by proper solvent selection, meaningful pilot tests and good scaleup (5). There are several solvent extraction processes that are emerging from the pilot phase to full-scale production mainly for contaminated soil. Although some of these have been tried on sediments using a pilot plant, the performance was not very successful, or not available to the authors. Table 2 lists the main process and vendor. Some of the vendors used solvents that are now hazardous and regulated.

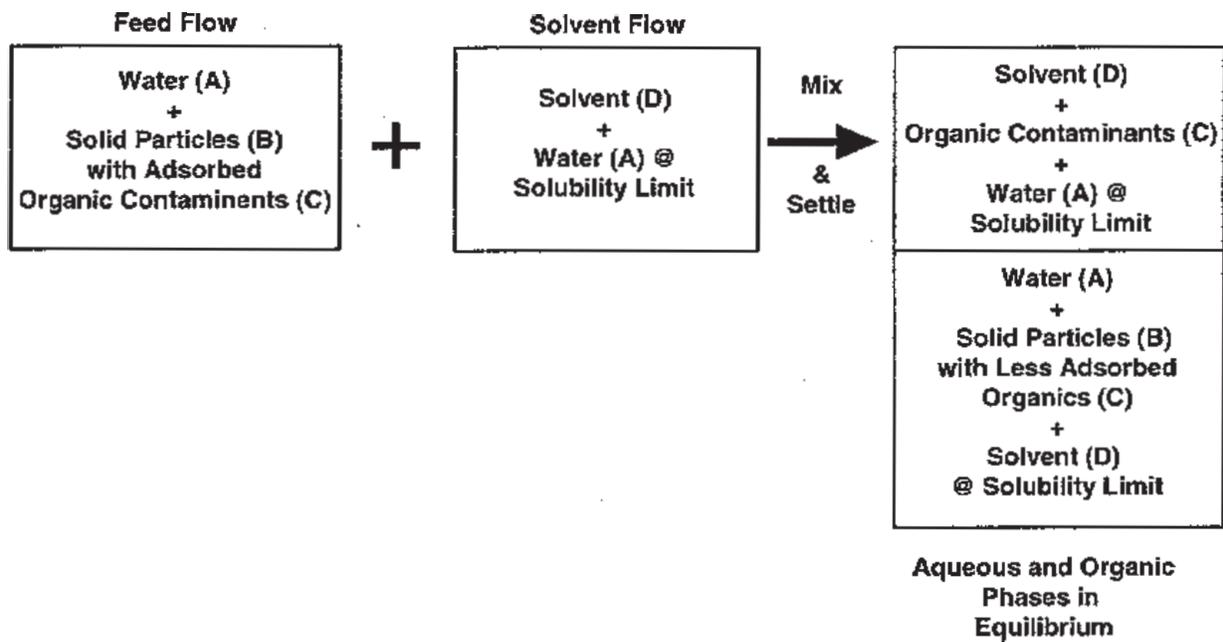

Figure 2. Single contact stage of contaminated sediments and solvent at equilibrium.

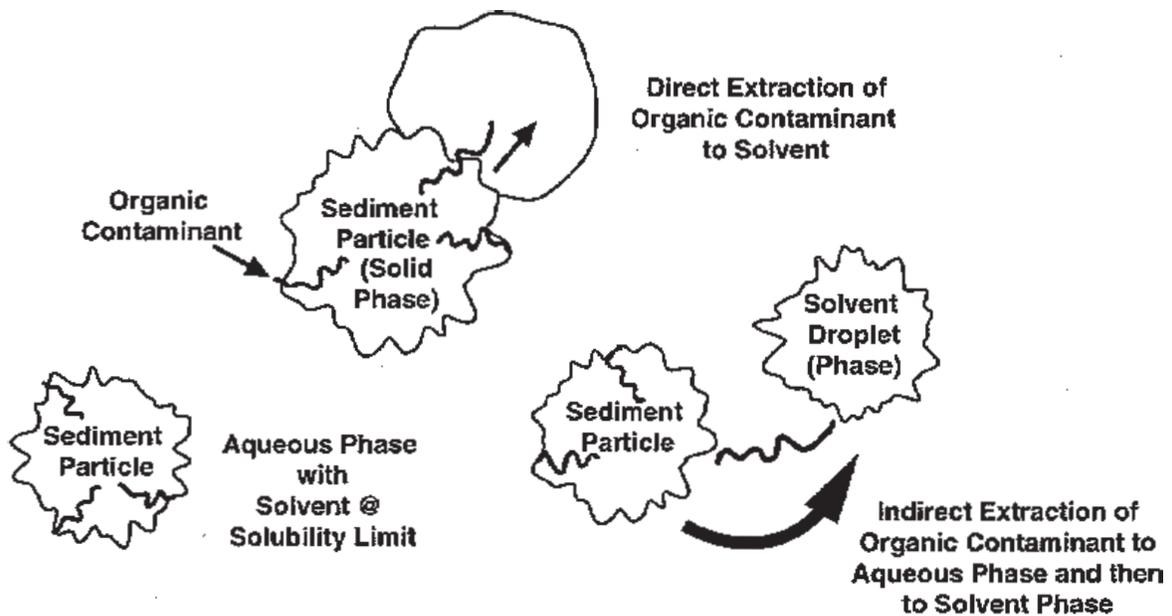

Figure 3. Contaminant transfer mechanisms on mixing.

**Table 2.** Solvent Extraction Processes for Soils/Sediments Treatment

Process/Vendor	Solvents	Extraction Temperature (T) and Pressure (P)	Solvents Solubility in Water (Sediment Slurry)
ART International	Proprietary: 1st: hydrophilic (acetone, methanol, isopropanol); 2nd: hydrophobic	Ambient @ 1 Atmosphere	1st: very high 2nd: very low
RCC/Ionics	Triethylamine (now ECRA-hazardous)	Ambient to 100°C @ 1 Atmosphere	High at low Temp. Low at high Temp.
CFS/M-K	CO <sub>2</sub> , propane, ethers	Ambient temperatures @ Critical Pressure (P <sub>c</sub> )	High at critical T and P
Terra-Kleen	Proprietary Mixture of up to 14 solvents	Ambient @ 1 Atmosphere	Not known
M&E	Acetates, alcohols, and other special blends	Ambient to 100°C @ 1 Atmosphere	Moderate

The ART International technology initially uses a hydrophilic solvent to extract the organic contaminants from sediments or soil. The solvents used are acetone, methanol, or isopropanol. Then a hydrophobic solvent is used to extract the contaminants from the hydrophilic solvent. This requires separation of the two solvents and additional equipment for handling and recovery of individual solvents.

The RCC/Ionics technology uses triethylamine which is hydrophilic (high solubility in water) at less than 20°C and hydrophobic at greater than 20°C with wet sediments or soil slurries. Therefore, the mixtures must be cooled and heated in cycles for each stage. It should be noted that triethylamine is now a listed hazardous waste and additional regulatory and health risks need to be addressed.

The CF/MK technology uses very low boiling solvents (carbon dioxide, hexane, or ethers) at supercritical conditions to attain a one liquid and one solid phase with wet sediment/soil slurries. Then the pressure is reduced to attain two liquid phases for separation. Equipment designed for high pressure costs considerably more than equipment designed for atmospheric service.

The Terra-Kleen technology uses many solvents to extract the contaminants from soil in batch tanks. Then fractional distillation or possibly molecular sieves are used to remove organic contaminants.

The technology from M&E and its sister company GRS uses various solvents and has been applied mainly for contaminated soils in France. M&E has modified the process for the recent bench and pilot studies done for the NY/NJ Harbor sediments, using a blend of acetate/alcohol solvent.

### 3. Solvent Selection Guidelines/Criteria for M&E/GRS Process

There are many factors considered for selection of the acetate/alcohol blend to extract contaminants from the wet sediments. These factors can be classified under selectivity for contaminants, physical and material handling properties, thermal stability, safety and environmental considerations, and cost.(4)

*Selectivity*—Solvent choice is influenced by the interactions of the structure of the chemicals. The main contaminants of concern are the non-polar to slightly polar polyaromatic hydrocarbons, and multi-chlorinated hydrocarbons such as PCBs, dioxins, furans and pesticides. The acetate offers both a slightly polar and non-polar group and provides affinity for the contaminants. Unfortunately, the solubility of the acetates increases as the aliphatic group increases. To increase solubility of the acetate in water, an alcohol is added. This blend also provides the additional benefit of increasing the solubility of other contaminants selective to the alcohol. This blend also exhibits higher than expected solubility and penetration into the sediments as shown in Figure 4. The sensitivity of solubility to solids content is very high. This is favorable as it occurs in the 30 to 35% solids range, where the two low viscosity liquid layers readily mix and quickly separate for decanting.

The acetate/alcohol blend has several important properties that reduce processing cost. First, some combinations form heterogeneous minimum azeotropes with water. This allows the removal of essentially all the solvent from sediments without removing most of the water. Second, the heterogeneous azeotrope improves the solvent recovery distillation step. Third, the density of the acetate/alcohol blend is significantly less than water or aqueous slurry and makes the separations easy. Fourth, the solvated sediment mixture flows well

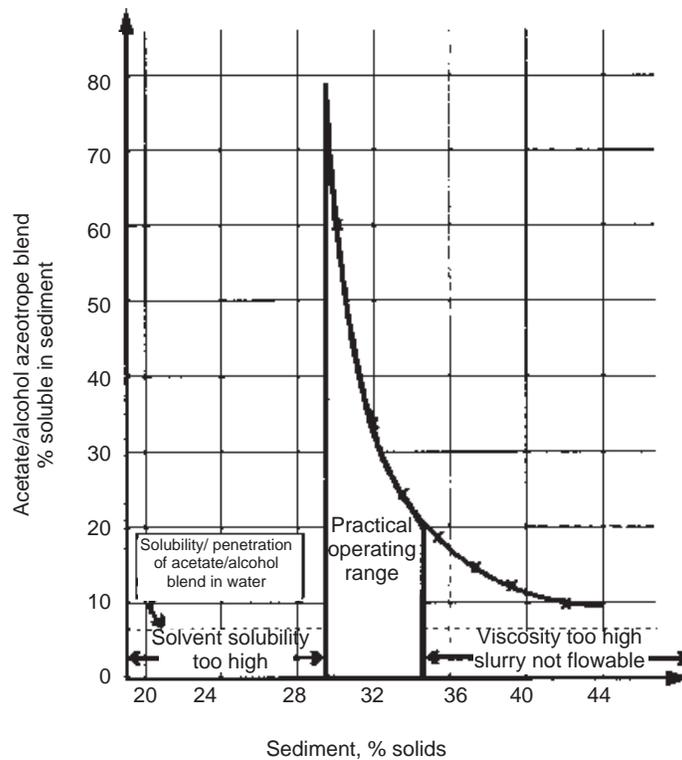

**Figure 4.** Solubility of acetate/alcohol azeotrope mixture in sediment.

and is non-sticking to inexpensive materials of construction such as carbon steel, plastics, and glass.

**Thermal Stability and Non-Reactivity**—The solvent blends of acetate/alcohol are thermally stable and non-reactive at the processing temperatures (maximum temperature expected at distillation reboiler is <math><200^{\circ}\text{C}</math>) and neutral conditions. The concern that the acetates hydrolyze to the primary alcohol and acetic acid is minimal as the pH of the sediment is near neutral.

**Safety and Environmental Considerations**—The selected acetate/alcohol blend is nontoxic to workers and the OSHA exposure threshold levels are relatively high. Some of these compounds are used in household products and are considered safe. Unfortunately, in the purer nonaqueous state, these solvents are flammable and present an explosion hazard. This is overcome by inerting and specifying explosion-proof equipment systems. Dust releases are also limited by keeping the sediments wet with water during operation.

The acetate/alcohol solvent blend does not pose environmental problems. The solvents are biodegradable if trace quantities are left in the sediment. The compounds selected are not listed in the Phase III land disposal restrictions and are not ECRA-hazardous. Atmospheric emissions are controlled by enclosure of unit operations. The wastewater effluent is steam stripped to low solvent levels for acceptance by the POTW or in-plant treatment.

**Costs**—Cost is an important consideration when selecting solvents for two reasons. One, the solvents should be commercially available and relatively inexpensive. Although the solvent is recovered, some makeup is needed to replenish the amount lost from fugitive emissions and the amount left in the waste oil to maintain fluidity. Two, the solvents are recovered efficiently from downstream operations. The energy cost is minimized by not removing all of the water from the sediments. The high volatility and minimum azeotrope with water also helps to keep energy costs low during the distillation and steam stripping steps. This is important because experience has often shown that only 15% of the investment and 5% of the operating cost is associated with the extraction step. The balance of 85% of the investment and 95% of the operating cost are associated with the solvent recovery steps.(5)

### III. Bench-Scale and Pilot-Scale Tests

#### A. Test Program and Objectives

Metcalf & Eddy, Inc. completed both bench-scale and pilot-scale tests to evaluate its Integrated Sediment Decontamination System (ISDS) using sediments dredged from Newtown Creek in the New York Harbor. The studies were funded under the Water Resources Development Set and jointly administered by U.S. Environmental Protection Agency and U.S. Army Corps of Engineers. The ISDS system, shown in Figure 5, consists of three sequential technologies:

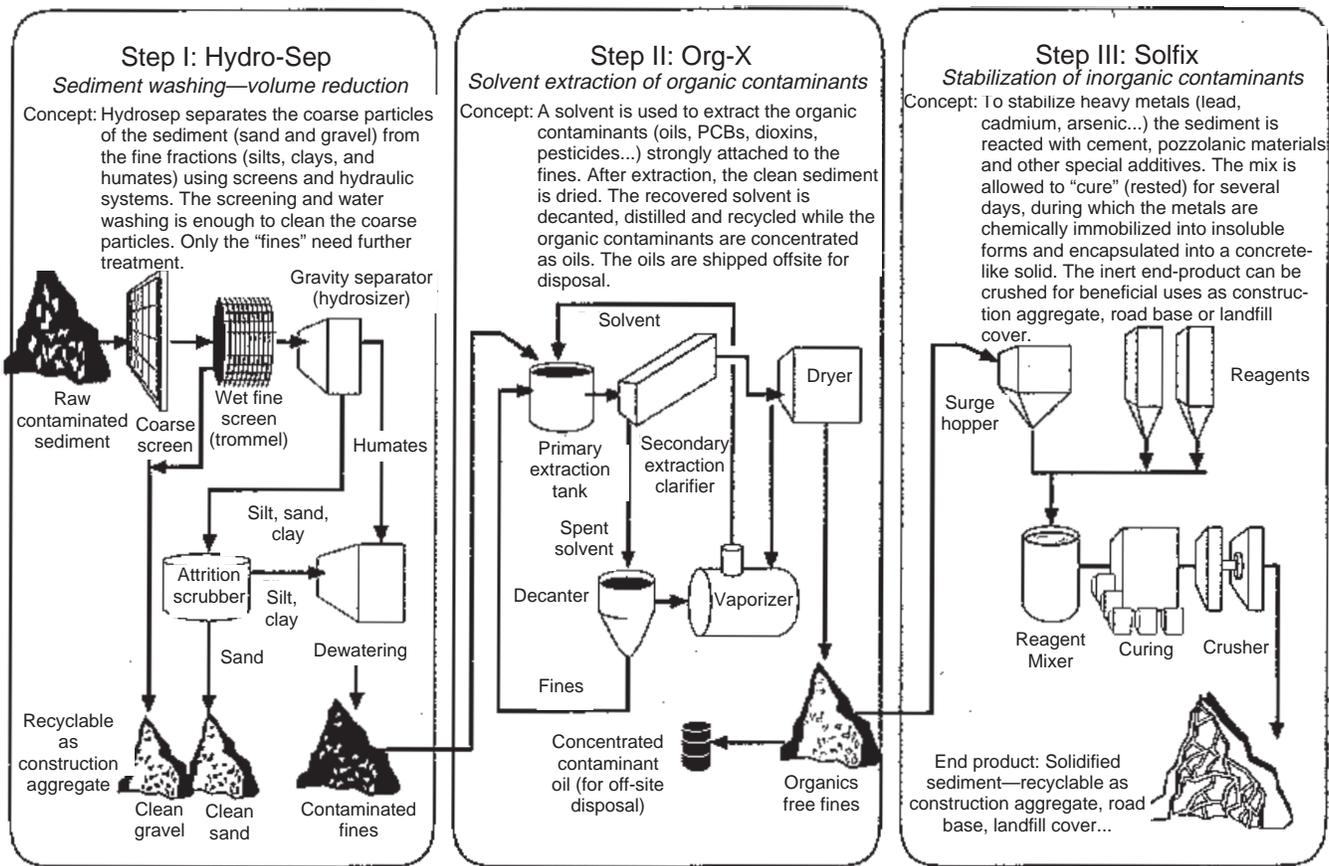

Figure 5. M&E Integrated Sedimer

Step I HYDRO-SEP<sup>SM</sup>: A soil washing process to produce clean, larger-size fractions and reduce the quantity of sediments to be treated by downstream operations. It consists mainly of scalping debris for disposal and separating sands, gravel, and cobbles for water washing. Dewatering is not necessary if solids content is greater than 30%.

Step II ORG-X<sup>SM</sup>: A solvent extraction process to remove organics contaminants and produce organic contaminant-free sediments and a waste oil for off-site disposal (incineration). The solvent is recovered by partially drying the sediment, distilling the waste oil and steam stripping the wastewater.

Step III SOLFIX<sup>SM</sup>: A solidification/stabilization process that adds Portland Cement to the sediments to improve the leaching properties of inorganic contaminants and to improve the mechanical/physical properties to produce useful end-products.

After completing bench-scale treatability studies that showed promise of decontamination and production of

potential useful products, a pilot plant was operated at Port Newark in the Fall of 1996 to treat 10 cubic yards of sediments. The objectives of the test program were:

- to demonstrate how most of the steps of the technologies can decontaminate a significant quantity (10 cy) of actual sediment feedstock, and produce products with desirable physical properties; and
- to collect process data for the preliminary design of a commercial facility.

The test program, illustrated as a block flow diagram in Figure 6, focused on these tests:

- screening the sediments to remove debris, >1/4" oversize and >18 mesh oversize.
- removing organics contaminants using a batch solvent extraction and semi-continuous solvent recovery process. The solvent was a blend of warm acetate/alcohol believed to offer high removal at reasonable cost. The main operating variables were 1:1 solvent to sediment ratio for each extraction that was well-agitated for 15 min-

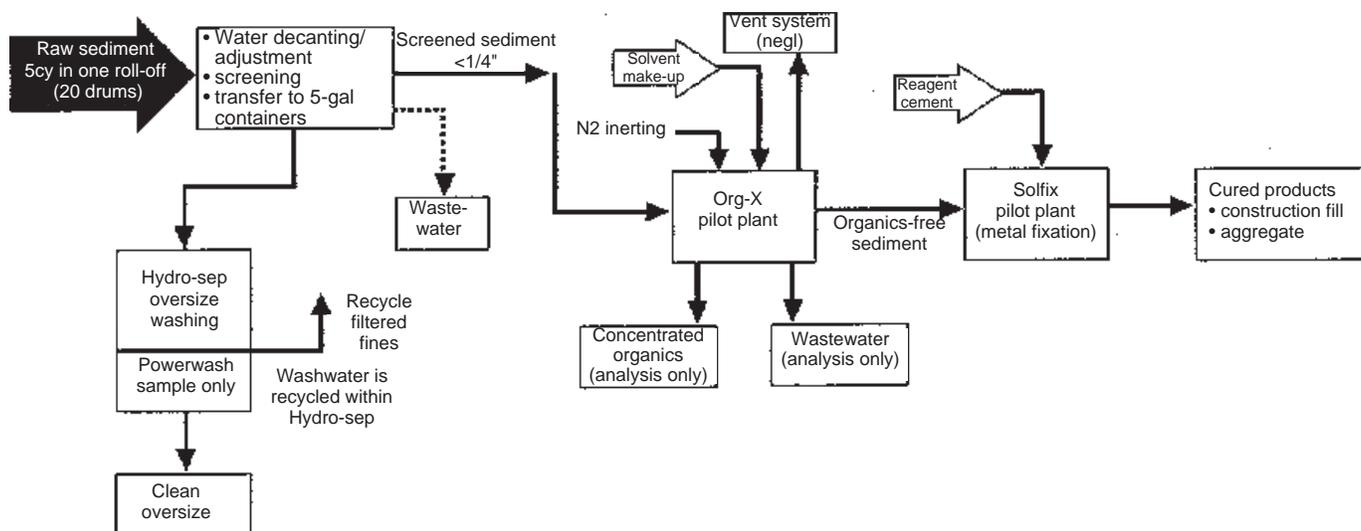

Figure 6. Block flow diagram of pilot test program.

utes and settled for 10 minutes prior to decanting the solvent phase with extracted contaminants. Organic contaminant removal was investigated for 3, 5, and 7 extractions.

- removing organic contaminant using a continuous system with a glass Scheibel column having 18 mixing/settling zones. The objective was to investigate an alternative to the more expensive mixer-settler type extractor.
- recovering the solvent for repetitive reuse; drying the decontaminated sediments; concentrating the waste oil; and stripping the wastewater.
- stabilizing/solidifying the organic-free sediments to produce end-products with improved physical properties. The organic-free sediment with 45 to 50% water was blended with 0.15 parts and 0.30 parts cement.

## B. Test Results

1. HYDRO-SEP<sup>SM</sup>/Pre-Treatment Process—A full-scale solvent extraction plant requires large quantities of homogeneous screened (<1/4") feedstock for proper control of operation. The desired solids content is 30-35%. The sediment is delivered in barges/scows up to a size of 10,000 cy. After removing any water on top, the settled sediment can be pumped or removed by a clam shell directly to a vibrating grizzly. Subsequently, the sediment can be screened, mixed and adjusted for moisture content, pumped and stored in silos. These unit operations are already practiced in the mining/dredging industry. The pilot plant demonstrated that the 35-40% solids sediments can be

screened with vibratory screens down to 18 mesh. The oversize can be washed to produce clean cobbles, gravel and sand, or can be crushed. Depending on the sediment granulometry, washing can reduce the quantity of sediment to be treated by as much as 85% for very coarse sediment. However, the Newtown Creek sediments used for the pilot plant only contained a few percent of the +1/4" oversize.

2. Chemical Test Results from Solvent Extraction Process—The performance of the ORG-X solvent extraction plant is presented in Table 3 for the bench treatability study using only the acetate solvent. The percent removal with three extraction stages was moderate (low 90s%) for most organic contaminants and low for dioxins/furans.

Difficulty was encountered in two areas:

- Penetration of the solvent into the sediment required intensive mixing and a long period (> 20 minutes).
- The sediment was difficult to handle as it adhered to laboratory hardware.

In order to overcome these difficulties and seek greater organics contaminant removal, the pilot-plant program was improved by using a mixture of warm acetate/alcohol as the solvent. Moreover, some of the extraction equipment was coated to reduce fouling due to stickiness of the sediment. The sensitivity of organics removal was measured versus the number of extraction stages. The performance of a continuous extraction column was also compared with the mixer-settler type extractor.

**Table 3.** Bench-Scale Chemical Results Using Three Extraction Stages and Acetate Solvent

Parameters/Contaminants	% Removal
Light Hydrocarbons	99.9
Medium-Weight Hydrocarbons	86
Total Hydrocarbons	91
Heavy Hydrocarbons	92
Pesticides	94 - 98
PCBs	79 - 92
Dioxin/Furans	*
Residual Carbon	37
Total Organic Carbon	30
TCLP Metals	Below MDL
TCLP Organics	Up to 99

\* Not meaningful due to low concentration and precision. The solvent contained 81-84% of initial total dioxins/furans.

The pilot-plant performance improved considerably compared to the bench scale. Table 4 presents the reduction for the main contaminants of concern: dioxins, furans, and PCBs. The reduction in total group PCBs increased by almost one order of magnitude to the high 90s%. The reduction improved to the low 80s% for total dioxin and to the high 80s% for total furans. In terms of the total equivalency quotient (TEQ) (using toxicity factors compared to 2,3,7,8-TCDD), the reduction was a few percent lower than calculated using the actual concentration values. The reduction improves as the number of extractions increases, but is not very sensitive after five extractions. The operation of the continuous extraction column with 18 zones is approximately equivalent to 5-stage mixer/settler extractions.

Although removal of most organic contaminants is high, it may not be adequate for dioxins/furans. The final concentration attained is about 1 ppb total dioxin, 3 ppb total furan, and 129.8 ppt total individual dioxins plus furans (TEQ). These dioxins/furans are more difficult to extract than PCBs, and the extraction rate may be more sensitive to other parameters, such as agitation intensity, contact time, or a different solvent blend with another non-polar solvent such as hexane or heptane. Further laboratory work is recommended to potentially improve removal performance to 90–99%.

The performance of the SOLFIX solidification/fixation process is presented in Table 5 in terms of leachability (TCLP method). Except for PCBs, the reduction is not calculable as the concentrations are below the minimum detectable limits. The heavy metals already meet the upland disposal criteria. As expected, the reduction in

amount of total group PCB extracted is significantly greater with the solvent-extracted-and-stabilized sediments than the stabilized-only sediments.

3. Physical Properties and Product Uses—Solidification of the sediments with Portland cement (or other weaker binding agents such as flyash or kiln dust) also changes the physical properties of the products made. By varying the amount of water and cement, different properties can be attained. Table 6 presents the properties of both the SOLFIX-only products and the ORG-X + SOLFIX products as measured by USACE-WES.

The addition of a small proportion of cement (0.1, 0.15 and 0.2 parts to 1 part sediments) produces a light and soft agglomerated material that can be crushed to various sizes. The soil-like material meets the specifications for operational and interim landfill cover or construction fill for depressions, sinkholes, and stripmine areas. It can also be blended with other materials such as compost, manure, sludge, other soils to produce a landscaping soil. The addition of larger proportions of cement (0.3 and 0.4 parts) produces a cured block of material that is stronger with the unconfined compressive strength (UCS) approaching 1,000 psi. The cured material is similar to a soft sandstone that can be crushed to various sizes to resemble crushed stone or aggregate. However, it does not meet the specifications for use as a road sub-base. The material crumbles with vibrations and expansions/contractions, as indicated by the freeze and thaw tests. For the same reason, it appears that producing other more expensive structural concrete-like products may not be practical.

The ORG-X process produces a viscous, flowable slurry at the optimal moisture content (40-50%) for solidification with Portland cement in a pugmill. This lower moisture content than the 60-70% of the raw sediment requires less cement to attain similar properties. If heavy metals are not a problem, the ORG-X product can also be used directly with other dry materials to produce a landscape soil or construction fill.

4. Process Design—The operation of the batch and semi-continuous pilot plant generated some process data to design a full-scale automated plant with some confidence. The full-scale plant should be fully continuous, with large flexibility to accommodate sediment with varying granulometry and contaminants. The best extractor type appears to be the mixer-settler. It is favorable over the column type extractors, which are for more specific applications with low residence times (minutes to hours). The mixer-settlers are widely used in the industry because of their reliability, flexibility, and high capacity. The large volume of inventory is another advantage. It can provide the residence time (many hours) that may be required for the extraction of contaminants with slow diffusion rates.

The solvent can be evaporated from sediments in a steam jacketed ribbon dryer. Packed or sieve distillation columns are appropriate for recovering the solvent and

**Table 4.** Comparison of Pilot Test and Bench-Scale Tests for Dioxin, Furan, and PCB Removal

Contaminant/ Class	Screened Untreated Sediment Used in Pilot Plant @ Port Newark Concentration	ORG-X Only Pilot Scale @ Port Newark (5 extractions with Acetate/Alcohol) Conc./% Reduction	ORG-X Only Pilot Scale @ Port Newark (7 extractions with Acetate/Alcohol) Conc./% Reduction	ORG-X Only Pilot Scale @ Port Newark (Continuous extraction with Acetate/Alcohol) Conc./% Reduction	ORG-X Only Bench Scale @ GRS, France (3 extractions with Acetate) Conc./% Reduction
Total Individual Dioxins (TEQ)	123 ppt	27.7 ppt 77.6%	29.1 ppt 76.5%	30.3 ppt 75.5%	Not meaningful
Total Dioxins	5,342 ppt	1,029 ppt 80.7%	1,030 ppt 80.7%	1,062 ppt 80.1%	-35% to +66%
Total Individual Furans (TEQ)	750 ppt	96.8 ppt 87.1%	97.4 ppt 87.0%	99.3 ppt 86.8%	Not meaningful
Total Furans	30,200 ppt	3,382 ppt 88.8%	3,300 ppt 89.1%	3,198 ppt 89.4%	-80% to +40%
Total Group PCBs	7,946 ppb	125.3 ppb 97.8%	125.0 ppb 98.4%	134.3 ppb 97.7%	79 - 92%

## Notes:

All analyses are on a dry basis.

ppb = parts per billion

ppt = parts per trillion

TEQ = Total Equivalency Quotient (ref. 2,3,7,8-TCDD)

**Table 5.** SOLFIX Performance Using Leachability, TCLP Method

Contaminant	Regulatory Toxicity Characteristics	Bench-Scale Screened Untreated Sediment	Pilot SOLFIX-Only 0.2 Parts Cement	Pilot ORG-X + SOLFIX 0.15 Parts Cement
Total Group PCBs		133 ng/L	64 ng/L	8 ng/L
Semi-volatiles		<200 µg/L	<200 µg/L	<100 µg/L
Total Dioxins/Furans		<100 pg/L	<100 pg/L	<100 pg/L
Metals (mg/L)				
Arsenic	5.0	<0.100	0.018	0.018
Barium	100	<0.500	0.232	0.292
Cadmium	1.0	<0.010	<0.001	0.035
Chromium	5.0	<0.028	0.017	0.100
Lead	5.0	<0.050	<0.002	0.007
Mercury	0.2	<0.001	<0.0004	0.034
Selenium	1.0	<0.100	0.014	0.016
Silver	5.0	<0.010	0.001	0.192

**Table 6.** Physical Characterization Data for Stabilized/Solidified Sediments

Sample, Cement/ Sediment Ratio	UCS, psi	Water Content @ 60°C	Water Content @ 100°C	Particle Specific Gravity	Permeability, cm/sec	Bulk Dry Density, lbs/cu ft
0.1 Cement SOLFIX Only	26	60.1	69.8	2.54	8.05E-06	37.7
0.2 Cement SOLFIX Only	123	27.9	51.2	2.61	7.05E-06	48.9
0.4 Cement SOLFIX Only	501	18.1	31.0	2.63	2.81E-07	58.8
0.15 Cement ORG-X + SOLFIX	234	50.3	71.1	2.70	1.61E-06	51.4
0.3 Cement ORG-X + SOLFIX	658	23.4	53.7	2.69	5.62E-07	64.7

concentrating the waste oil. Packed or sieve columns are appropriate for stripping organics from wastewater with direct steam. The wastewater is generated because the water content of the final product is less than the initial content in the sediment feed. The wastewater can be treated with conventional techniques to meet the POTW or other direct discharge requirements.

5. Costs—The operating cost of a full-scale solvent extraction plant mainly depends on the quantity and cost of makeup solvent, energy to recover the solvent, incineration of non-regulated waste oil, labor, and costs from maintenance, overhead and depreciation. It is estimated that unit costs can approach the \$30 to \$40 per cubic yard range, especially if the plant capacity is large ( $\geq 500,000$  cubic yards/yr) and fully utilized. Stabilization/solidification adds approximately \$10 per cubic yard for each 0.1 part of Portland cement added. There is also the potential credit of \$5 to \$10 per cubic yard if the product can be beneficially used. The disposal cost of the waste oil can vary considerably depending on the contaminant content. There is a credit if the waste oil can be used as a fuel supplement for the plant boiler. If the waste oil contains a regulated concentration of  $>1$  ppb TEQ dioxin/furan, the unit cost increases by almost \$40 per cubic yard at \$2/lb incineration cost. Both the capital and operating costs can be estimated for various cases and sites by preparing a preliminary engineering design. Moreover, the markets for beneficial use products must be developed further.

#### IV. Conclusions

Solvent extraction is a promising and competitive technology for removal of organic contamination from sedi-

ments. The acetate/alcohol solvent blend is highly effective in removing most organic contaminants without dewatering/drying the sediments. The treatment costs are comparable with landfill disposal and are probably less for large-scale plants. The authors recommend further process development to improve the dioxin/furan removal efficiency and completion of preliminary engineering design to refine costs.

#### References

1. Priore, W. and E. Cichon. 1996. Sediment Management, Dredging Material from U.S. Waterways. *Water Environment & Technology*. (October).
2. National Research Council. 1997. *Contaminated Sediments in Ports and Waterways*. Washington, DC. National Academy Press.
3. U.S. Army Corps of Engineers. 1996. *Dredged Material Management Plan for the Port of New York and New Jersey. Interim Report*. (September).
4. Kirk-Othner. 1980. *Encyclopedia of Chemical Technology*. Volume 9, Third Edition. New York, NY. John Wiley & Sons. pp. 672-739.
5. Cusack, R. W. and D. J. Glatz. 1996. Apply Liquid-Liquid Extraction to Today's Problems. *Chemical Engineering*. (July). pp. 94-103.

---

# Containment Research for Contaminated Sediment and Contaminated Dredged Material Management—A Review

Louis J. Thibodeaux, Danny D. Reible, and Killait T. Valsaraj  
Hazardous Substance Research Center/S & SW  
College of Engineering, Louisiana State University  
Baton Rouge, LA

## Introduction

Chemical contaminants including inorganics, metals and organics exist within sediment beds of water bodies both fresh and marine. These substances may exist in relative high concentrations such that they are transported in solution and as colloids by both active and passive processes to the water column. Quantities in high loadings on solid particles may also exist at the sediment bed-water interface. The result of such existence and movement is the eventual exposure of life forms to quantities of these chemical constituents. This exposure may result in enhanced health risks. One effective means of reducing this risk is to contain these chemical constituents within a bed-like form so that their mobility and hence propensity for contacting the biota can be managed. This paper covers some of the research activities, ongoing and planned, aimed at enhancing the technology of chemical containment as a risk management option for contaminated sediment.

## Theory of In-bed Containment

Environmental niches in water bodies where bottom currents are weak usually accumulate particles. The process is called bed accretion. Particles in all size ranges from clay to sand size settle from the water column in these relatively quiet places and, with time, layers of sediment accumulate. These particles move closer together with time expelling porewater upward and become consolidated. Except for a relatively fluffy interface layer the consolidation process renders the bed somewhat resilient to erosion during low to moderate increases in water flow. However, storm events can cause severe erosion at some locations on the bed.

With the chemical contaminants, both in solution and sorbed onto arriving particles, the bed accretion process aids in the formation of layers of high chemical concentration in the bottom sediment. Many of these contaminated beds have been in existence for long time periods

with some sites accumulating material fifty years or more. A general lack of chemical mobility over this period suggests several positive things about the bed being an effective containment zone.

Sites where this accumulation occurs are natural traps for particles. Storm events over the years have undoubtedly moved some quantities about, however the bed remains relatively secure. But there are other transport processes besides particle scour; these include molecular diffusion of solutes in porewater after desorption from solids and out-diffusion of colloids and bioturbation. These and other in-bed release processes are illustrated in Figure 1. In order to assess the overall effectiveness of any proposed remediation technology, the concentration at the sediment-water interface, both on particles and the adjoining porewaters, must be known. Bed residing life forms, both infaunal and epifaunal, usually bioaccumulate substances here. Due to feeding by fish and out-migration, these organism-bound chemicals may enter human food chains. In addition, an outward flux of chemicals to the water column occurs. This release process regulates chemical concentration levels in the bed, at the sediment-water interface and within the water column (1). To effectively address issues of containment research, these in-bed processes must be thoroughly understood. Significant amounts of information exist but much work needs to be done.

Chemical release processes from the particle-bound state to the adjoining porewater are key in initiating the movement process. Much research effort has been directed toward this complex process. The local equilibrium assumption (LEA) that relates concentration ratios on particles and adjoining porewaters is not universally applicable to this situation. There can be a slow kinetic release of the mobile fraction, however an irreversible fraction remains on the solids (2,3). Because of these two aspects, LEA will overestimate the porewater concentration. In the case of hydrophobic organics and inorganics, in-particle hindered diffusion release (4) and

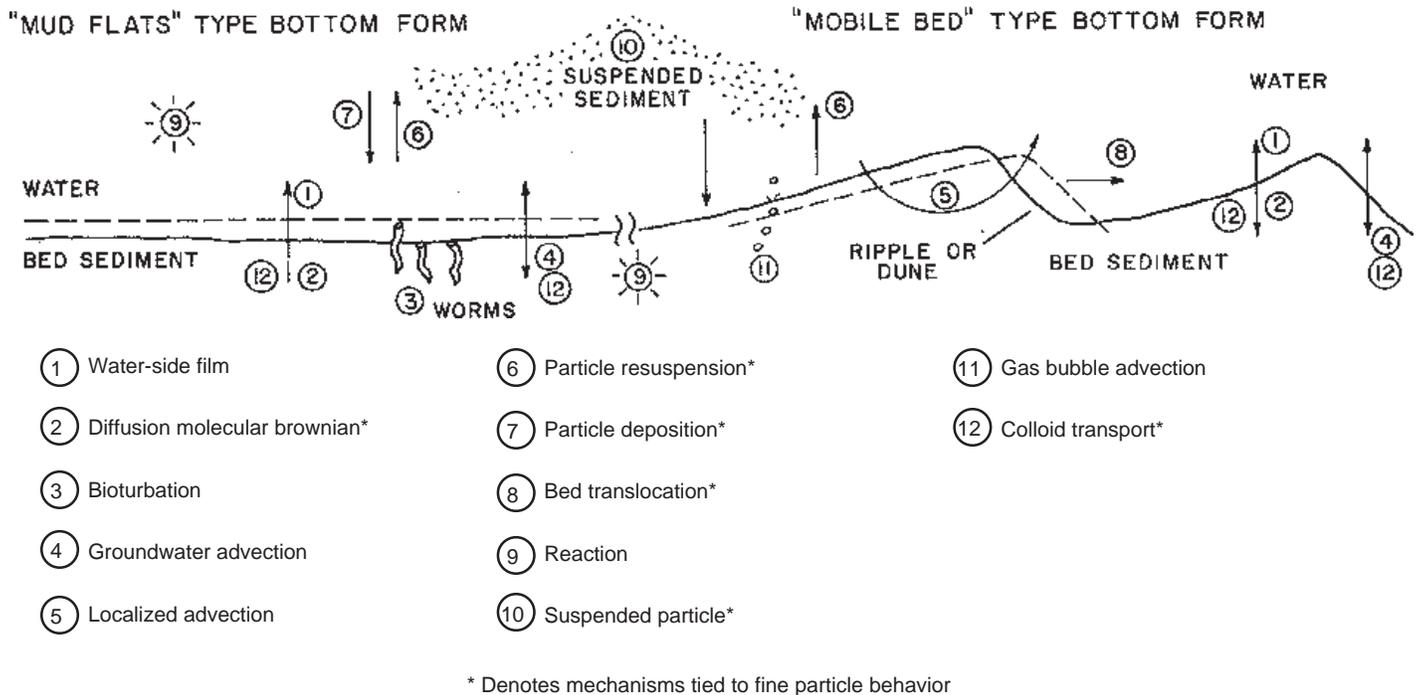

Figure 1. Bed-sediment chemical processes.

quantification of the irreversible fraction for organics (3) appear to yield a realistic process and algorithms for quantifying release rate and source strength.

Once released to the porewaters the solute species moves upward toward the sediment-water interface and downward further into the bed. Data on this process both in the laboratory (5,6) and in the field (7) indicate that molecular diffusion is active and that it is very slow. Slow mobility is due to the difficulty of solute molecule diffusion in liquid water and the pathway blocking of silt and clay platelets creating a tortuous route. The high degree of containment effectiveness of several technologies is due to this very slow process when it can be engineered into the system. Another closely related process is the Brownian diffusion of colloids in porewaters. Due to their high organic fraction these small particles contain elevated concentrations of hydrophobic constituents and are transported similar to the solute fraction (8,9). Quantitative models have been verified that allow good computational estimates of the rates of release from beds (10).

In layers several centimeters thick adjoining the sediment-water interface, macrofauna, when present, augments and enhances the contaminant availability and release processes. A review of these bioturbation processes, so-called because the biota gives rise to both particle and fluid turbulence-type phenomena as they relate to contaminants in the bed, has been performed (11). Due to its complexity, the process is under

active investigation (12,13). Typically Fickian type chemical transport models have been used to quantify this process and algorithms exist with which to compute release rates (14,4). The latter reference contains algorithms and procedures for computations of release rates and bed-surface concentrations for the coupled processes of molecular diffusion, bioturbation and hydrodynamic boundary layer resistance to transport.

Typically, contaminants, both organics and metals, exist in a bed layer ten-to-fifty centimeters in thickness. Figure 2 shows typical profiles, and they represent approximately a half century accumulation of two Aroclors in the bed of New Bedford Harbor, MA. The relative depletion of PCBs near the surface is due to outward transport from the bed and the arrival and deposition of clean sediment particles on the surface. Bioturbation is active in the upper approximately ten centimeters. Particle exchange at the surface occurs even in water bodies undergoing net bed accretion. This occurs as a result of storm events, possibly the only times sufficient water currents are present to dislodge particles from the bed. This dislodgement moves material about contaminating regions downcurrent with higher-concentration material. It is likely that the near-interface peak in the concentration profile at site DR is due to downcurrent/storm movement of material from Site Fx(7). Storm events lead to increased suspended sediment loading in the water column. During and after the storm, quantities of soluble and colloidal bound chemicals enter the water phase. While the particle transport process is somewhat well

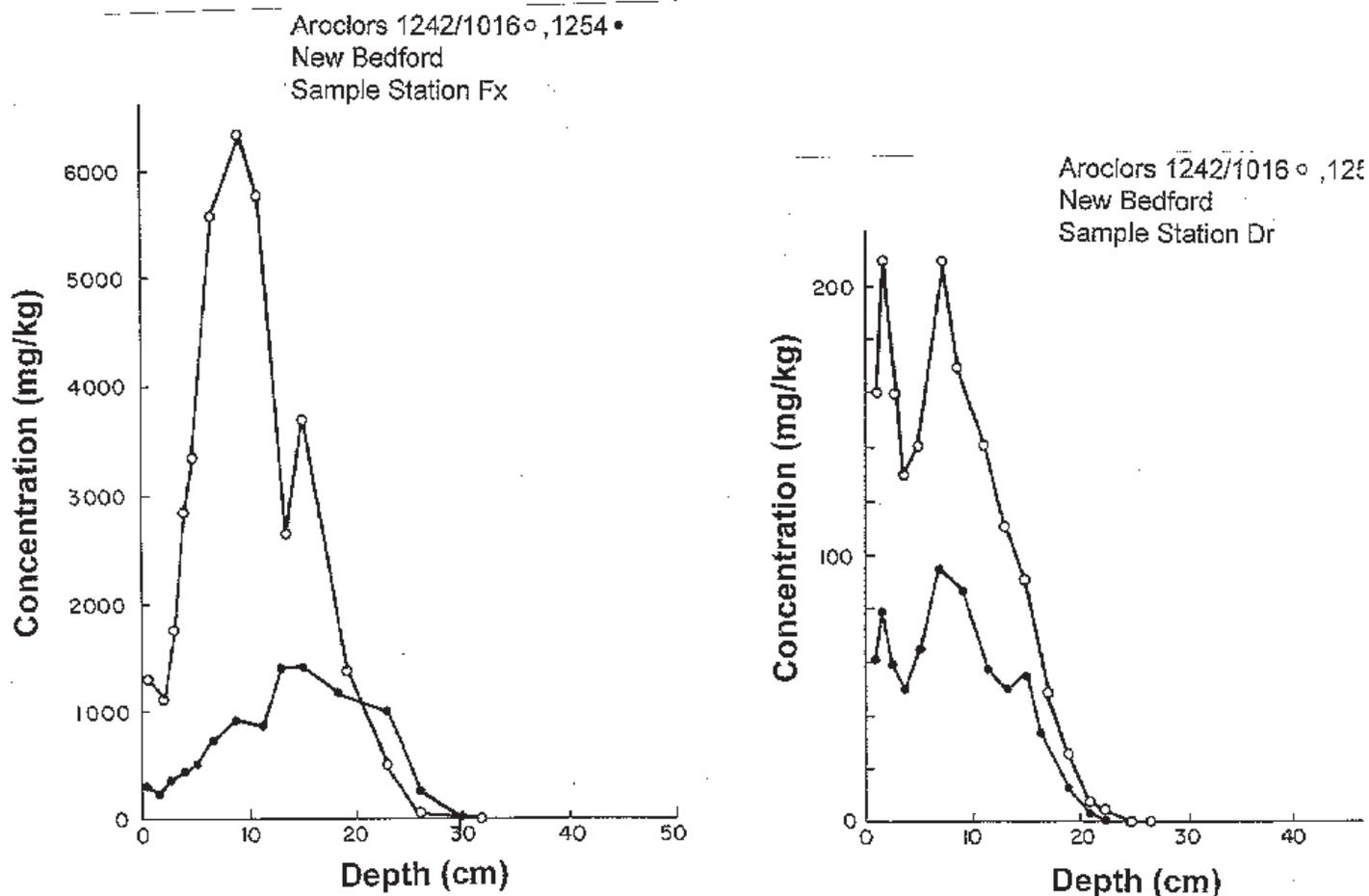

Figure 2. PCB concentration profiles in the bed.

understood conceptually and means of quantifying rates of release and concentrations in the water column exist (15), a real understanding of contaminant release remains elusive. Recent laboratory work with contaminated particles in re-suspension chambers is starting to clarify this complex process (19, 20). While particle dislodgement and movement computation algorithms for noncohesion particles are well developed, those for cohesive particles are under active investigation (16, 17, 18). Once this is completed, the process of contaminant release associated with suspended particles needs to be developed into quantitative algorithms that allow predictions of release rates and concentration.

Any proposed containment technology for a so-called operable site must be judged against the existing release and exposure process. This means that release rates from the bed and concentrations on particles near and on the surface, plus those in the water, must be predictable in an engineering design sense. Comparable released and exposed quantities must be quantified for the proposed containment technologies. The engineering community and EPA are presently using

this approach (21) although much uncertainty exists in the design algorithms for predicting released quantities for all site conditions and remediation technologies.

### Containment Technologies

These can take various forms; Figure 3 is a conceptual illustration showing containment locations in and near the water body. Although the illustration is for an estuarine system, the technologies also apply to lake and riverine systems. A total of five technologies are illustrated: natural recovery, *in-situ* capping, contained aquatic disposal (CAD), a confined disposal facility (CDF), and an upland solid waste landfill. A recent National Research Council report (22) highlights these technologies. This paper will address aspects of the first four technologies.

#### Natural recovery

Conceptually natural recovery consists of in-bed processes that retain, destroy, and retard the release of contaminants. It can be very effective due to a combina-

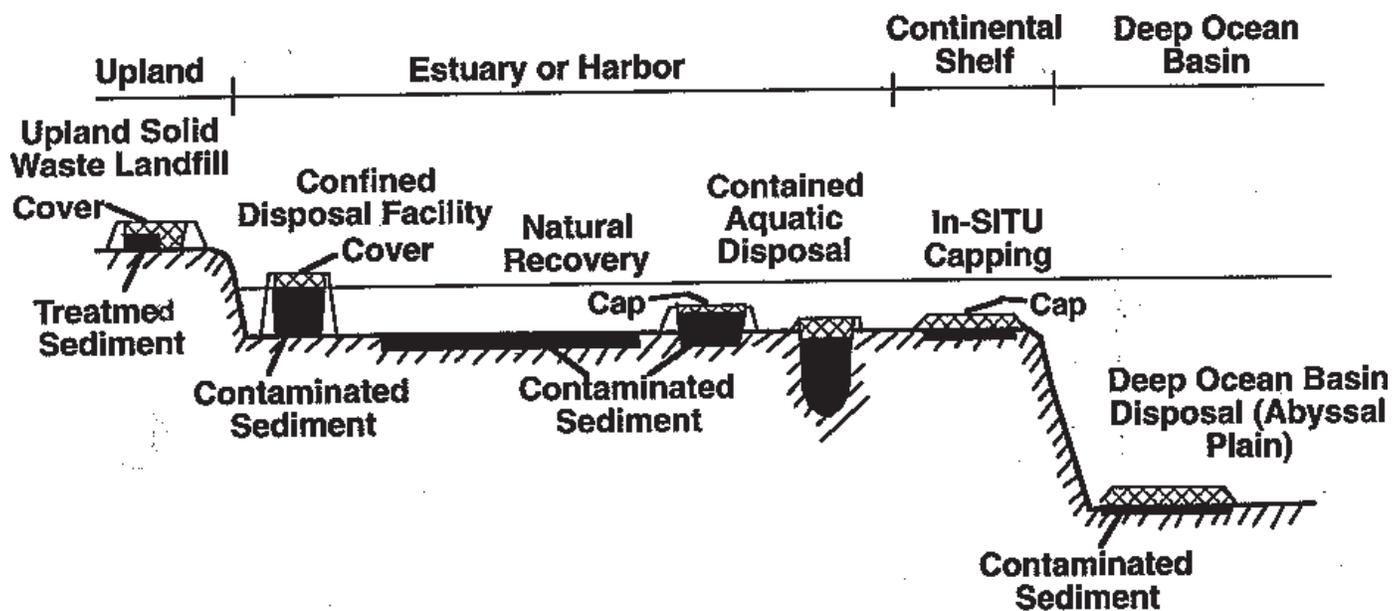

Figure 3. Conceptual illustration—containment, disposal and natural recovery technologies for contaminated bed sediments (adapted from Mike R. Palermo, USAE, Vicksburg, MS).

tion of simultaneous processes. Fresh particles arrive on the bed surface; this lengthens the diffusion transport path, dilutes the concentration in the surface layer and provides fresh sorptive surfaces to sequester the bed-residing contaminants. Chemical reactions, either biotic or abiotic, may occur within the bed to degrade the species. Burial at depth occurs as the column of solids builds. This puts significant quantities deep in the bed and below the bioturbated zone which has the overall effect of removing them from the biosphere. These processes are known and have been investigated individually and a few algorithms capable of quantifying combined and key processes for engineering design prediction purposes have appeared (23). Nevertheless the technology suffers from underdevelopment. A unified theory connecting its many contributing processes needs to be developed and key features verified by experiment. For this reason, some of the positive attributes of natural recovery are unappreciated and therefore often unrealized by practitioners.

Natural recovery as a remediation technology has been selected by choice in only a few situations. It was selected for Kepone in the Chesapeake Bay (24). Most contaminated sediment sites are undergoing natural recovery by default. This occurs because of many factors including the complexities of the decision making process plus political and economic considerations. Healing of the effects of contaminations is clearly occurring at some sites where concentrations in the media and the biota continue to decrease with time. Where ongoing monitoring, the dominant technological activity on a site undergoing natural recovery, is indicating healing, it is doubly burdensome on advocates of more aggressive technologies that are based on mass removal to demon-

strate enhance effectiveness. Undertaking more aggressive technologies usually involves dredging. Environmental dredging is not a well-developed technology (22). The fact is that the dredging process may release significant quantities; this is a short-term effect. In addition, removal efficiency at most complex and large sites is not 100%; likely significant quantities remain. This is a long-term effect. The removed quantity must be re-contained and/or treated. These operations will result in additional releases.

### ***In-situ Capping***

This involves the dredging of clean material which is then transported and placed upon the contaminated bed. The theory and practice of *in-situ* capping is well developed. The theory for this chemical containment process has undergone extensive model development and laboratory verification (7, 25, 26). Field Data on measured chemical profiles below and within the cap material are very suggestive verifications of the models (27). Detailed pilot- or full-scale studies of interbed bed migration, water column release, and other related contaminant mobility studies need to be done to further verify and test this technology as an aid in its further adoption.

### ***Contained Aquatic Disposal (CAD)***

This option, considered to be more aggressive, involves dredging and transporting the contaminant mass. In some instances such as maintaining the required water depth in ports and harbors, mass removal is necessary. After transporting the material it must be placed on the bottom again. This can be on-the-flat or within a depres-

---

sion in the bottom. This depression can be a natural one or one formed by excavation of bed sediment. A low aspect-to-height ratio mound is formed when the clean material is placed on the pre-deposited contaminated material mound. Bokuniewicz, an early advocate of CAD containment, describes the mounding process at field sites in the Northeast U.S. (28). Field studies have dominated the research activities related to the CAD technology (29). Because of the required mass removal operations noted previously, CAD suffers several disadvantages with regard to knowledge about short-term and long-term contaminant releases. As noted, research is needed to evaluate and quantify the amount and effects of dredging related chemical releases and the quantity left behind at the original site. Once in place and capped, the CAD technology has most of the engineering design and release aspects of the *in-situ* capping technology (7,25,26,30).

### **Confined Disposal Facility**

The final chemical containment option to be considered is that which occurs when contaminated dredged material is placed in a confined disposal facility (CDF). These facilities are constructed near or adjacent to the shoreline in shallow water as shown in the illustration of Figure 3. Earthen-type engineered retaining walls are constructed out into the water enclosing a finite area. Dredged material is placed in this diked area to the extent that dry land is created with the material extending above the mean water level. Once in place, the contaminated material can exhibit several release mechanisms unrelated to those covered above.

Rainwater enters top-side; this can produce a leachate that exits through the retaining walls. Tidal pumping of the external water body also results in contaminant release (31). Once the upper surface of a CDF is directly connected to the atmosphere, volatile losses will occur. An evaluative study ranked the drying surface soils as the largest source of volatile organic chemicals (32). Laboratory studies have quantified the magnitude of such releases and models are in an advanced state of development (33). When finalized, these will contain algorithms for making engineering design estimates of losses based on the contaminant content of the surface soils and other environmental parameters. The authors and co-investigators at the U.S. Army Engineers Waterways Experiment Station are developing a field site to verify VOC emission models developed for CDFs.

### **Research Paradigm**

The research paradigm for containment of contaminated sediment and contaminated dredged material is a unique engineering undertaking. In research on the treatment of waste and in large part in the remediation of environmental contamination, the traditional engineering approach is to undertake some biological, physical and/or chemical activity. Treatment of gaseous, water and solid material by measuring percentage contaminant removal is accepted practice. However, in the case of contami-

nated sediment which exists in thin layers covering large areal expanses, removal is very problematic. Once removed there appears to be no "silver bullet" treatment technologies for the vast majority of this material. The suite of *in situ* or *ex situ* process train treatment technologies needed is very expensive and largely unverified (22). However, if the goal in remediation of contaminated sediment is risk management at reasonable cost, then containment with or without dredging must be an option that warrants serious consideration. In this case, the research paradigm must focus on designing for and measuring small quantities being released.

Research activities related to the above technologies of natural recovery, capping, CAD and CDF must be aimed at developing engineering design algorithms capable of realistically quantifying the trace quantities of chemicals being released in each case and the related media (air, water, solids, biota) concentrations produced. The algorithms need to be robust so that alternatives and unique conditions at individual sites can be incorporated into the designs. It is a key issue that designers of such containment devices focus on the finite quantities of contaminants being released rather than on complete (i.e. 100%) containment. The idea here is that one is on thin ice, so to speak, attempting a technical argument proposing zero release for any of these devices. First, you cannot prove it, and if you try, the concept is unbelievable in the eyes of many stakeholders. However, finite but low quantities based on sound scientific principles and backed by laboratory and field data can be defended. Whereas a zero release cannot be defended since it can't be measured.

Another research focus area should be on the detection of failures in the containment barriers. It is unlikely (i.e., very low probabilities) that a catastrophic failure of the entire barrier system will occur; however, it is very likely (i.e. 100% probability) that some parts may fail at some time. For example, in the cases of the natural recovery, capping and CAD options, storms may destroy parts of the barrier. Protocols involving instrumentation, sensors, monitoring procedures, etc., need to be developed so that failures are detected and the magnitudes can be quantified. As with any engineered system, failure always has a finite probability. In the case of these containment options, the breaches can be effectively repaired. In other words, the structures will always be in need of maintenance just as does a bridge, highway, waterway, etc. With these designs the mass of contaminated material remains in the bed and removal by dredging and transporting remains an option. This final solution should be made when containment becomes too risky. In order to defend maintenance as an element that must be included, the probability of failures must be quantified and effectively communicated to the impacted stakeholder. Research is needed in predicting the likely type of failures that can occur, when these are most likely to occur, and the number and severity expected each year. With this information monitoring and mainte-

nance activities can be planned so that breaches in the barriers can be repaired effectively and promptly.

## Conclusions

This manuscript contains a brief review of the state of containment research for contaminated bed sediment and contaminated dredged material primarily from a university/academic perspective. In large part this review has reflected many of the ongoing activities of the Hazardous Substance Research Center, South and Southwest, because its main mission is the development of remediation technologies for this category of hazardous substances. Four containment technologies: natural recovery, capping, CAD and CDF were described and their respective research activities reviewed. It can be concluded that while much work has been done, much remains to be done. This work must produce high-quality engineering design algorithms based on laboratory and field data capable of predicting the release of trace chemical quantities from each containment device. In addition, research efforts should be focused on detecting containment structure failure and on making realistic probability estimates of the type and frequencies of such failures.

## Acknowledgment

This work was supported through the U.S. Environmental Protection Agency Cooperative Agreement No. R819165. It was performed at the Hazardous Substance Research Center South and Southwest, Louisiana State University, Baton Rouge, LA. Dr. Danny D. Reible is Center Director.

The results and opinions given are those of the authors and do not reflect official U.S. EPA positions or policies.

## Literature Cited

1. Valsaraj, K.T., L.J. Thibodeaux and D.D. Reible. 1997. A Quasi Steady Pollutant Flux Methodology for Sediment Quality Criteria. *Env. Toxicology and Chemistry*, 16: 391-396.
2. Kan, A., G. Fu, and M. Tomson. 1994. Adsorption/Desorption Hysteresis in Organic Pollutant and Soil/Sediment Interaction. *Environ. Science Technology* 28: 859-867.
3. Kan, A., G. Fu, M.A. Hunter, W. Chen, C.H. Ward and M.B. Tomson. 1998. Irreversible Adsorption of Neutral Organic Hydrocarbons-Experimental Observations and Model Predictions (in preparation.)
4. Thibodeaux, L.J. 1996. *Environmental Chemodynamics*. New York, N.Y: John Wiley, pp. 323-330.
5. Formica, S.J., J.A. Baron, L.J. Thibodeaux and K.T. Valsaraj. 1988. PCB Transport into Lake Sediment. Conceptual Model and Laboratory data. *Environ. Sci. Technol.* 22: 1435-1440.
6. Baron, J.A., L.J. Thibodeaux, D.D. Reible, P.H. Templet and C.B. Henry, Jr. 1990. Laboratory Simulation of Diffusion in Contaminated Marine Sediments. *Estuaries*: 13: 81-88
7. Thibodeaux, L.J., D.D. Reible and W.S. Bosworth. 1990. *A Theoretical Evaluation of the Effectiveness of Capping PCB Contaminated New Bedford Harbor Bed Sediment*. Baton Rouge. La. State University Hazardous Waste Research Center Final Report pp. 10-12.
8. Reible, D.D., K.T. Valsaraj and L.J. Thibodeaux. 1991. Chemodynamic Models for Transport of Contaminants from Sediment Beds. In O. Hutzinger, Ed. *Handbook of Environmental Chemistry*. Heidelberg: Springer-Verlag pp. 187-228.
9. Thoma, G.J., A.C. Koulermos, K.T. Valsaraj, D.D. Reible and L.J. Thibodeaux, 1991. The Effect of Porewater Colloids on the Transport of Hydrophobic Organic Compounds from Bed Sediments. R.A. Baker, Ed. Chapter 13 in *Organic Substances in Soils and Sediments*. Boca Raton. Lew Publishers: pp. 231-250.
10. Valsaraj, K.T., S. Verma, I. Sojrita, D.D. Reible and L.J. Thibodeaux, 1993. Diffusive Transport of Organic Colloids from Sediment Beds. *Jo. Environmental Engineering* 122: 722-729.
11. Bosworth, W.S. and L.J. Thibodeaux, 1990. Bioturbation: A Facilitator of Contaminant Transport in Bed Sediment. *Environmental Progress* 9: 211-217.
12. Mahanty, S. and D.D. Reible, 1998. A Levy Flight-Random Walks Model of Bioturbation. *Water Research* (submitted).
13. Reible, D.D., V. Popov, K. T. Valsaraj, L.J. Thibodeaux, F. Lin, M. Dikshit, M.A. Todaro and J.W. Fleeger. 1996. Contaminant Fluxes from Sediment Due to Tubiflex Bioturbation. *Water Research* 30: 704-714.
14. Thibodeaux, L.J., D.D. Reible and W.S. Bosworth. 1990. *A Theoretical Evaluation of the Effectiveness of Capping PCB Contaminated New Bedford Harbor Bed Sediment*. Baton Rouge. La. State University Hazardous Waste Research Center Final Report pp. 12-16.
15. Wilberg, P.L. and C.A. Butman. 1991. Bed Response During Storms at the STRESS Inner Shelf Site EOS. *Trans. AGU.* 72 (44).
16. Dennett, K.E., T.W. Sturm, A. Amirtharajah and T. Mahmood. 1995. "Effect of Adsorbed Natural Or-

- ganic Matter on the Erosion of Kaolinite Sediments." *Proceedings of the 68<sup>th</sup> Annual Conference Water Env. Fed.*, WEFTEC '95 4:1 pp. 5-115.
17. Dennett, K.E., T.W. Sturm, A. Amirtharajah, and T. Mahmood. 1995. "Erosion of Cohesive Sediment in Uniform Flows." *Proceedings Georgia Water Resources Conf.*, Athens, GA. April: pp. 221-223.
  18. Dennett, K.E., T.W. Sturm, A. Amirtharajah, and T. Mahmood. 1995. "Flume Studies on the Erosion of Cohesive Sediments." *Proceedings First International Conf. Water Resources Engineering*. ASCE. August: pp. 199-203.
  19. Valsaraj, K.T., R. Ravikrishna, J. Orlius, L.J. Thibodeaux, D.D. Reible, J.S. Smith. 1997. Sediment-to-Air Fluxes of Semi-volatile Organic Compounds due to Sediment Resuspension in Water. *Advances in Environmental Research* (in press).
  20. Valsaraj, K.T., B. Choy, G. deSeze, D.D. Reible and L.J. Thibodeaux. 1998. Sediment-to-Water Mass Transfer of Semi-volatile Contaminants due to Sediment Resuspension in Water. *Advances in Environmental Research* (accepted).
  21. U.S. EPA. 1992. West Harbor Operable Unit Wyckoff/Eagle Harbor Superfund Site Record of Decision. Region 10, Seattle, Washington.
  22. National Research Council. 1997. *Contaminated Sediments in Ports and Waterways*. National Academy Press. Washington, D.C.
  23. Thibodeaux, L.J. 1996. *Environmental Chemodynamics*. New York, N.Y: John Wiley, pp. 311-344, 350-356.
  24. Hugett, R.J. and M.E. Bender. 1980. Kepone in the James River. *Environ. Sci. Technology* 14: 918-923.
  25. Wang, X.Q., L.J. Thibodeaux, K.T. Valsaraj and D.D. Reible. 1991. The Efficiency of Capping Contaminated Sediments in Situ: 1. Laboratory Scale Experiment of Diffusion/Adsorption in the Capping Layer. *Environ. Sci. Technology* 25: 1578-1584.
  26. Thoma, G.J., D.D. Reible, K.T. Valsaraj and L.J. Thibodeaux. 1993. Efficiency of Capping Contaminated Sediments in Situ: 2. Mathematics of Diffusion/Adsorption in the Capping Layer. *Environ. Sci. Technology* 27: 2412-2419.
  27. Sumeri, A., T.J. Fredette, P.G. Kellog, J.D. Germano, D.A. Carey and P. Pechko. 1991. "Sediment Chemistry Profiles of Capped *in Situ* and Dredged Sediment Deposits: Results from USAE Offices." *Proceedings 24<sup>th</sup> Annual Dredging Seminar*. Texas A & M, College Station, Report No. 321.
  28. Bokuniewicz, H. 1989. Behavior of Sand Caps on Subaqueous Dredged-Sediment Disposal Sites. In: Hood, D.W., A. Schoener and P.K. Parks, Eds. *Ocean Processes in Marine Pollution V. 4, Sci. Monitoring Strategies for Ocean Waste Disposal*. Krieger Pub., Malabar, FL.
  29. Zeman, A.J. and T.S. Patterson. 1997. Preliminary Results of Demonstration Capping Project in Hamilton Harbor. *Water Qual. Res. J. Canada* 32: 439-452.
  30. Poindexter-Rollings, Marian E. 1990. *Methodology of Analysis of Subaqueous Sediment Mounds*. Technical Report D-90-2, U.S. Army Engineers Waterways Experiment Station, Vicksburg, MS.
  31. Reible, D.D., S.A. Savant-Malhiet, L.J. Thibodeaux, K.T. Valsaraj, and T.E. Myers. 1994. "Seepage Through Dike Walls of Confined Disposal Facilities." *Proceedings of Second International Conference on Dredging and Dredged Material Placement '94 Conf.*, Orlando, FL.
  32. Valsaraj, K.T., L.J. Thibodeaux and D.D. Reible. 1995. *Modeling Air Emissions from Contaminated Sediment Dredged Materials*. ASTM Special Technical Publication 1293: pp. 227-238.
  33. Valsaraj, K.T., B. Choy, R. Ravikrishna, L.J. Thibodeaux, D.D. Reible, C.B. Price, J.M. Brannon and T.E. Myers. 1998. Air Emissions from Exposed Sediments and Contaminated Dredged Material 1. Experimental Data in Laboratory Microcosms and Mathematical Modeling. *Jo. Hazardous Materials* (submitted).

---

# Summary of Conference on Management and Treatment of Contaminated Sediments

## Panel Participants:

Norman Francingues  
U.S. Army Corps of Engineers (U.S. COE)  
Vicksburg, MS

Emily Green  
Sierra Club  
Madison, WI

Michael Palermo  
U.S. COE  
Vicksburg, MS

Louis Thibodeaux  
Louisiana State University  
Baton Rouge, LA

Dennis Timberlake  
National Risk Management Research Laboratory (NRMRL)  
U.S. EPA  
Cincinnati, OH

## Summary of Panel Discussion: Future Direction/Research Needs

The panel discussion provided an opportunity for attendees and speakers to identify future research needs for the management and treatment of contaminated sediments and an open forum for questions and comments arising from the conference presentations. Below is a list of the panel participants, followed by a summary of comments/questions and subsequent responses.

### I. Questions/Comments by Spyros Pavlou, URS Greiner, Inc., Seattle, WA

**Comment 1.** The stability of a cap and its ability to minimize flux is a function of bottom currents and the physical dynamics of the aqueous-solid interface. Louis Thibodeaux's presentation, Containment Research for Contaminant Sediment and Dredged Materials, outlined various ongoing research projects at Hazardous Substance Research Center South/Southwest. The research described in Dr. Thibodeaux's presentation typically included experiments at quiescent conditions under low flow. Can the release of diffusive flux from the caps in a turbulent environment be measured? Has Dr. Thibodeaux

considered running experiments under a larger scale where modifications of the dynamics and movement of water could be altered to observe the effects of turbulent mixing on the system?

**Response 1.** Dr. Thibodeaux has not addressed turbulent conditions in his experiments; however, some researchers have started to analyze the effects on the cap diffusion rate. Benthic flux chambers and peepers (oily strips placed into sediment to analyze the migration of materials up and into the cap from the contaminated layers) are two technology options suggested to monitor the diffused flux rate for field study migration projects. More field study migration projects are needed to compile data and further investigate alternative cap materials and engineering techniques. Conference participant, Brian Ross, EPA Region 9, also identified a project where field flux measurements were taken in the outer channel area of northern San Diego Bay by a Navy project group. Mr. Ross offered to locate more information to identify the main contact person on the project.

**Comment 2.** During the conference, a few presenters discussed the use of natural recovery as a remedial option. Some consider natural recovery to be a risk

---

reduction and management alternative, not a remedial option. In order for natural recovery to be effective, the time it takes to reduce a contaminant concentration in the sediments to a maximum allowable level must be shorter than the maximum time a population can be exposed to the contaminant without health risks. The National Research Council considers natural recovery to be very effective in conjunction with other technologies, particularly with hot spot remediation where highly contaminated sediments are removed and the marginally contaminated sediments consequently have sufficient time to reach the maximum allowable concentration. The concept of natural recovery needs to be looked at separately for each site, and requires further study.

**Response 2.** Mike Palermo on the panel responded that natural recovery is always a part of a remediation solution. Every contaminated site has gradients of contamination, as it is not possible to dredge, remove, or cap it all. There is always a cut-off at some distance from a hot spot, beyond which natural recovery is the remedial option.

**Comment 3.** The commercialization of remedial technology is escalating at a fast rate. A wide array of remedial development and management options is being researched to treat sediment contamination levels. The beneficial uses and the marketability of dredged sediments are important; however, the costs and benefits and the outcome of beneficial sediment uses were not fully addressed in this conference.

**Response 3.** Norman Francingues, U.S. COE, announced that the Corps is sponsoring a conference in Baltimore, Maryland July 29 to August 1, 1997, that will identify case studies and methods on how sediments can be used beneficially.

## II. Question by An Unidentified Attendee

**Comment.** Contaminated sediment treatment or remedial technologies presented during the conference ranged from options that treat highly contaminated levels of sediments (nationally characterized as low volume and high rate of return on investment) to the treatment options for lower levels of contaminant (nationally characterized as high volume and low rate of return on investment). Traditionally high-end treatment technologies that work well are being reviewed as alternatives for the low-end contaminated sites. Since site projects are often limited by money and sediment volume, and regions are overloaded with information and need help to effectively consider the ever-growing list of possibilities, a classification or set of guidelines developed from these workshops would be useful for decision-making. This framework would help the regions efficiently evaluate treatment and remedial alternatives appropriate for a specific site. The need for a guidance document was further reiterated by Brian Ross, who requested a better, clearer guidance document, written in more accessible terms, that would include state, federal, and public outreach efforts to show the public that low-technology

solutions may be acceptable at sites with marginal contamination.

**Response.** Mike Palermo stated that the alternatives for treating contaminated sediments need to be classified in the context of the project scope. A clear distinction needs to be made between projects that include dredging for navigation and projects that have been initiated for remedial purposes. Navigation dredging projects typically encounter high volumes of low-level contaminated sediments, whereas the strictly remedial projects typically encounter sites with higher levels of contamination. He stated that guidance material is already available, but that a step-by-step procedure is not appropriate because of the variation in each site. Emily Green also responded to the request by identifying a project by the International Joint Commission for Great Lakes Region; over the next few years, the commission will be working on a decision-making guidance document for treating contaminated sediments.

## III. Question by Another Unidentified Attendee

**Comment.** How can one respond to the skeptics who think that capping harbor sediment, which is a highly liquefied, mobile layer of contamination, will not work because the sand placement of the cap will only force the spread and movement of the contamination? How serious a problem is this movement of contaminant layers when capping?

**Response.** Field data have proven that we can place capping sediments on very soft, contaminated material above the liquid level; however, capping material for these sites has to be placed in a controlled manner with specified technologies, like hydraulic discharging or split-hull barges for feathering material. These controlled methods enable the cap to gradually build up without displacing the contaminated sediments. Not enough information is available about the geotechnical aspects of the buildup or the speed at which the capping sediments can be placed on the contaminated area; the U.S. COE will perform research and development activities related to capping sediments throughout the next several years.

## IV. Questions by Brian Ross

**Comment.** Mr. Francingues is presently a member of a working group, Permanent International Association Navigation Conferences, that addresses maintenance and construction of port waterway facilities. Introduction of contaminants into the facilities is one of the biggest issues facing the maintenance of the international waterways. Because channels collect sediment from point and nonpoint source discharges, the causes and sources of the sediment and the contamination into channels need to be addressed. Otherwise, long-term maintenance (e.g., dredging, capping) will always be required. Besides addressing historical point source discharges, what actions are occurring in watershed management?

---

**Response.** Dennis Timberlake, NRMRL, USEPA, Cincinnati, OH, acknowledged the need to address watershed management, and he explained that EPA is trying to incorporate watershed management into its efforts. EPA is trying to place more emphasis on ecosystem restoration and ecosystem health in conjunction with human health issues, which were the only issues addressed in the past.

**V. Question by Jason Goffinet, Scientist from Consoer Townsend Envirodyne Engineers, Inc.**

**Question.** Has the deposition of sediments increased in navigational channels due to increased travel along the channel and increased industrialization? Are any methods being taken to reduce erosion (i.e., bank stabilization) and subsequent problems?

**Response.** Mike Palermo identified some research and development in the sediment reduction areas that U.S. COE has performed. The New York Corps District is in the process of developing a dredge material management plan to meet its long-term needs. One of the issues being addressed in the plan is the reduction in the load input into the channels, which will require interagency cooperation and further research and development. Emily Green noted that the Sierra Club, Wisconsin Department of Natural Resources, EPA, and other agencies are collaborating efforts to analyze tools (total maximum daily loads and the National Pollutant Discharge Elimination System for point sources) that will enable the incorporation of sediment pollution loads into the river when setting a maximum daily load. That cooperative group is also investigating its authority to set permit costs based on perceived future cleanup costs, in hopes to encourage pollution prevention and contaminant reduction.

**Summary of Questions and Responses**

**Questions From Day 1 of Sediments Conference**

**I. Question by Brian Ross to Thomas Armitage, Office of Water, EPA, Washington, DC, Following Presentation of EPA's National Sediment Quality Survey**

**Question.** How does EPA plan on improving the quality and the depth of its inventory database, especially when the regulatory agencies in the regions are not receiving any money or resources to compile or to electronically transfer this data? In addition, how is EPA going to prevent the problems previously associated with obtaining effective monitoring data for regulatory purposes?

**Response.** Information currently in the survey database was compiled from large national databases, which were made available to EPA. Additional data for the

database should be made available upon individual discussions with the various states, as EPA has not yet obtained data from the state monitoring programs. Efforts to obtain more data will increase as the funds become available. Some of the current limitations of the database identified in the presentation are the age and the quality of the data (roughly data from 1980 to 1993 or older); the incomplete sampling coverage (11% of river and coastline segments); and the dearth of TOC, acid volatile solids, and toxicity test data in national scale databases. While these limitations do not prevent the intended uses of the database, temporal trends of the data, details of the quality of the data set, and a closer look at the most current conditions across the country will be incorporated to improve the database and to improve future reports to Congress.

**II. Question by John Stansbury from the University of Nebraska to Todd Thornburg, Hart Cowser, Inc., Seattle, WA, Following Presentation on the Natural Recovery of Contaminated Sediments—Examples From Puget Sound**

**Question.** In the presented studies on natural recovery, it was shown that contamination concentration decreased over time. What is the mechanism (e.g., burial and dilution, degradation) by which the contamination is decreasing?

**Response.** Mechanisms for reduction in the contamination vary from site to site and from chemical to chemical (i.e., some chemicals are more susceptible to volatilization, while others may not volatilize). Sedimentation is generally the most important physical process for natural recovery; continuous sedimentation of clean material on top of contaminated sediments can help to control the contamination problem.

**III. Question by Gail Garman, National Oceanic and Atmospheric Administration—Hazardous Waste Remedial Actions Program, to David Petrovski, Chicago, IL, Following Presentation on Brownfields and Sediment Disposal at Indiana Harbor**

**Question.** In Mr. Petrovski's presentation, he discussed shared liability as an advantage for projects where a potential exists to combine sediments from various sites at a facility or in specific parts of the country. Typically, shared liability is regarded as a disadvantage. Has the problem of shared liability been resolved; can Mr. Petrovski offer any guidance on the advantages of sharing liability?

---

**Response.** Mr. Petrovski indicated that Mr. Nagle, an attorney who is a co-author of the paper, could not attend the conference; however, he could give advice on the advantages of shared liability. Contact Mr. Petrovski for Mr. Nagle's telephone number.

#### **IV. Question by Unidentified Attendee to Douglas Austin, Severson Environmental Services, Inc., Munster, IN, Following Presentation on *Environmental Dredging and Disposal—Overview and Case Studies***

**Question.** Why were the cleanup standards presented during the discussion in terms of totals instead of the more common TCLPs?

**Response.** A number of standards have been adopted by regulators to deal with the uncertainty of treatment systems, one of which is a total standard criteria. Mr. Austin used the example of total lead concentrations. Chemical systems do not alter total lead concentrations, but the systems can tie up the lead into a non-leachable form; therefore, applying a total lead standard to chemical systems is completely inappropriate. Likewise, requiring uniform compressive strength or capping to the requirements for treatment plans is also not applicable to chemical treatment systems. The list of methods the regulators use to deal with treatment systems includes much uncertainty and not all the methods are necessarily applicable to chemical treatment systems.

#### **Questions From Day 2 of Sediments Conference**

#### **V. Question by Mike Palermo to Carol Ancheta, Environment Canada, Downsview, Ontario, Canada, Following Presentation on *Remediation Strategies and Options for Contaminated Sediment: Thunder Bay Case Study Using SEDTEC® in Decision-Making***

**Question.** In what computer program was SEDTEC®, a directory of contaminated sediment removal and treatment technologies, created? Can the SEDTEC® program be altered to fit a specific customer's needs?

**Response.** SEDTEC® is currently available in Microsoft Access, so it is easily altered to fit the specific needs of a customer. SEDTEC® will also be available on the Internet by fall 1997. The current cost for SEDTEC® is \$250 Canadian; the Environment Canada price is only set to recover costs.

#### **VI. Question by Doug Grosse, NRMRL, EPA, to Norman Francingues Following Presentation on *U.S. COE Research Programs***

**Question.** What is the difference between bioaccumulation and biomagnification?

**Response.** Bioaccumulation and biomagnification are two words that have been used interchangeably. Mr. Francingues was not clear on the distinction between the two terms. Attendees Gail Garman and Spyros Pavlou attempted to clarify the difference, describing bioaccumulation as a process whereby certain substances accumulate along the whole trophic chain while biomagnification is a process whereby substances are transferred from one trophic level to another via the food chain. Likewise, EPA Terms of Environment<sup>1</sup> defines bioaccumulants as substances, not easily metabolized or excreted by living organisms, that increase in concentration as the organism takes in contaminated air, water, or food; biological magnification is defined as a process whereby certain substances, such as pesticides or heavy metals, become concentrated in tissues or internal organs as they move up the chain. These substances migrate up the food chain by working their way into rivers or lakes where they are eaten by aquatic organisms such as fish, which in turn, are eaten by large birds, animals, or humans.

#### **VII. Questions to John Quensen, Michigan State University, East Lansing, MI, Following Discussion on *Microbial Dechlorination and Bioremediation of PCBs***

**Question 1.** What are the effects of oxygen on the application of ferrous sulfate in the microbial dechlorination and bioremediation system?

**Response 1.** Dechlorination is inhibited by the presence of oxygen. Ferrous sulfate has been produced under anaerobic conditions.

**Question 2.** What are the limiting conditions in a sediment that is close to the surface? Does the system need to be completely anoxic for treatment processes to proceed?

---

<sup>1</sup> U.S. EPA. 1993. *Terms of Environment: Glossary, Abbreviations, and Acronyms*. EPA 175-B-93-001. February 1993.

---

**Response 2.** Oxygen is normally consumed within the first few millimeters or centimeters of the sediment surface, depending on a variety of factors (e.g., organic content). In an earlier test performed by Mr. Quensen, incubated bottles of sediment left open to the atmosphere reportedly produced substantial dechlorination. This experimental result indicates that oxygen is consumed as it diffuses through the first few millimeters or centimeters of sediment. Ken Fisher, from General Electric, performed more detailed experiments on limiting conditions in surface sediments. Mr. Fisher buried test tubes of sediments in an aquarium; the test tubes were open to the overlying oxygenated water. In this experiment, surficial sediments appeared to undergo a combined anaerobic/aerobic process; dechlorination was reported below the first few millimeters.

**VIII. Questions to Thomas Stolzenburg, RMT, Inc., Madison, WI, Following Presentation on the *Treatment of Metal-Bearing Solids***

**Question 1.** What were the physical conditions of the Foundry Waste project site?

**Response 1.** The Foundry Waste project site consisted of a 17-acre lagoon with variable sediment grain size, ranging from sandy to fine-grained material. Sediments onsite were not high in plasticity, and were separated and sorted effectively. Consequently, when the sediments were hydraulically dredged, clumping and sticking did not occur, and the sediments mixed easily in the in-line treatment system.

**Question 2.** What was the chemical source used in the reaction described for the coffer dams?

**Response 2.** Triple super phosphate (TSP) was used in this reaction. Because TSP has some residual phosphoric acid, a highly reactive, local limestone was also incorporated into the reaction to buffer the pH. A variety of phosphate sources may be used in the reaction described by Mr. Stolzenburg; however, some very reactive phosphates are too acidic, while other phosphate rock available does not react in the required time frame.

---

## Conference on Management and Treatment of Contaminated Sediments Exhibitor List

**Robert Amick**

Senior Project Manager  
IT Corporation  
11499 Chester Road  
Cincinnati, OH 45246  
513-782-4700  
Fax: 513-782-4807

**Carol Ancheta**

Remedial Technologies Program  
Environmental Technologies  
Advancement Division  
Environment Canada  
4905 Dufferin Street  
Downsview, Ontario, M3H 5T4  
Canada  
416-739-5874  
Fax: 416-739-4342

**Douglas Austin**

Regional Manager  
Sevenson Environmental  
Services, Inc.  
9425 Calumet Avenue - Suite 101  
Munster, IN 46321  
219-836-0116  
Fax: 219-836-2838

**Ed Barth**

Environmental Engineer  
Site Management Support Branch  
National Risk Management  
Research Laboratory  
U.S. Environmental  
Protection Agency  
26 West Martin Luther King Drive  
Cincinnati, OH 45268-0001  
513-569-7669  
Fax: 513-569-7585  
E-mail: barth.ed@epamail.epa.gov

**L.V. Benningfield**

Vice President of Operations  
CF Environmental  
18300 West Highway 72  
Arvada, CO 80007  
303-420-1550  
Fax: 303-420-2890

**Paul Bucens**

Project Manager  
Grace Bioremediation Technologies  
3451 Erindale Station Road  
Mississauga, Ontario, L5C 2S9  
Canada  
905-272-7474  
Fax: 905-272-7472

**Bruce Coufombe**

Hydrogeologist  
RETEC  
1001 West Seneca Street  
Ithaca, NY 14850  
607-277-5716  
Fax: 607-277-9057

**Georgia Dunaway**

Environmental Protection Specialist  
Site Management Support Branch  
National Risk Management  
Research Laboratory  
U.S. Environmental  
Protection Agency  
26 West Martin Luther King Drive  
(472)  
Cincinnati, OH 45268-0001  
513-569-7650  
Fax: 513-569-7585  
E-mail:  
dunaway.georgia@epamail.epa.gov

**Bob Ferguson**

Director of Sales  
Grace Bioremediation Technologies  
3451 Erindale Station Road  
Mississauga, Ontario, L5C 2S9  
Canada  
905-272-7473  
Fax: 905-272-7472

**Annette Gatchett**

Office of Research and Development  
U.S. Environmental Protection  
Agency  
26 West Marfin Luther King Drive  
Cincinnati, OH 45268-0001  
513-569-7697  
Fax: 513-569-7920

**Norman Grant**

President  
Normrock Industries  
3360 Boulevard De Enterprises  
Terrebonne, Quebec, J6X 4J8  
Canada  
514-477-5132  
Fax: 514-477-2020

**Renee Haltmeier**

BioGenesis Enterprises, Inc.  
7420 Alban Station Boulevard  
Suite B-208  
Springfield, VA 22150  
703-913-9700  
Fax: 703-913-9704

**John Henningson**

North Eastern Region  
Operations Manager  
Hart Crowser, Inc.  
One Exchange Place - Suite 1000

---

Jersey City, NJ 07802-3902  
201-309-3087  
Fax: 201-309-3040  
E-mail: jzh@hartcrowser.com

**Tom Janszen**  
IT Corporation  
312 Directors Ddve  
Knoxville, TN 37923  
423-690-3211, Ext. 2133  
Fax: 423-690-3626

**Michael Mensinger**  
Institute of Gas Technology  
ENDESCO Services, Inc.  
1700 South Mount Prospect Road  
Des Plaines, IL 60018  
847-768-0602  
Fax: 847-768-0516  
E-mail: mensing@igt.org

**Ian Orchard**  
Chief  
Remedial Technologies Program  
Environmental Technologies  
Advancement Division  
Environment Canada  
4905 Dufferin Street  
Downsville, Ontario, M3H 5T4  
Canada  
416-739-5874  
Fax: 416-739-4342  
E-mail: ian.orchard@ec.gc.ca

**Spyros Pavlou**  
URS Greiner, Inc., for  
National Research Council  
2101 Constitution Ave. N.W.  
Washington D.C. 20418

**William Priore**  
National Director of Sediment  
Remediation Services  
Metcalf & Eddy, Inc.  
2800 Corporate Exchange Drive  
Suite 250  
Columbus, OH 43231  
614-890-5501, Ext. 223  
Fax: 614-890-7421  
E-mail: bpriore@acc-net.com

**Denise Rousseau**  
Hazardous Substance Research  
Center  
Louisiana State University  
Baton Rouge, LA  
504-388-6770

**Paul Schroeder**  
Waterways Experiment Station  
U.S. Army Corps of Engineers  
(CEWES-EE-P)  
3909 Halls Ferry Road  
Vicksburg, MS 39180  
601-634-3709  
Fax: 601-634-3707  
E-mail: schroep@exl.wes.army.mil

**Mark Serwinowski**  
Manager, Business Development  
Blasland, Bouck, and Lee  
6723 Towpath Road  
P.O. Box 66  
Syracuse, NY 13214  
315-446-9120  
Fax: 315-449-0023  
E-mail: mas2%bbl@mcimail.com

**Howard Shaffer**  
Program Development Manager  
Science and Technology Center

Westinghouse Electric Corporation  
1310 Beulah Road  
Pittsburgh, PA 15235-5098  
412-256-2740  
Fax: 412-256-1222  
E-mail: shaffer.h.w@wec.com

**Eric Stern**  
Project Manager  
New York Harbor Project  
U.S. Environmental  
Protection Agency  
290 Broadway - 24th Floor  
New York, NY 10007-1866  
212-637-3806

**Nancy Ulerich**  
Program Manager  
Science and Technology Center  
Westinghouse Electric Corporation  
1310 Beulah Road  
Pittsburgh, PA 15235-5098  
412-256-2198  
Fax: 412-256-1222

**Starnes Walker**  
Vice President of Technology  
CF Environmental  
18300 West Highway 72  
Arvada, CO 80007  
303-420-1550  
Fax: 303-420-2890