

**Arsenic Removal from Drinking Water by Iron Removal
U.S. EPA Demonstration Project at City of Sandusky, MI
Six-Month Evaluation Report**

by

**Julia M. Valigore
Abraham S.C. Chen
Wendy E. Condit**

**Battelle
Columbus, OH 43201-2693**

**Contract No. 68-C-00-185
Task Order No. 0029**

for

**Thomas J. Sorg
Task Order Manager**

**Water Supply and Water Resources Division
National Risk Management Research Laboratory
Cincinnati, Ohio 45268**

**National Risk Management Research Laboratory
Office of Research and Development
U.S. Environmental Protection Agency
Cincinnati, Ohio 45268**

DISCLAIMER

The work reported in this document was funded by the United States Environmental Protection Agency (EPA) under Task Order 0029 of Contract 68-C-00-185 to Battelle. It has been subjected to the Agency's peer and administrative reviews and has been approved for publication as an EPA document. Any opinions expressed in this paper are those of the author(s) and do not, necessarily, reflect the official positions and policies of the EPA. Any mention of products or trade names does not constitute recommendation for use by the EPA.

FOREWORD

The U.S. Environmental Protection Agency (EPA) is charged by Congress with protecting the Nation's land, air, and water resources. Under a mandate of national environmental laws, the Agency strives to formulate and implement actions leading to a compatible balance between human activities and the ability of natural systems to support and nurture life. To meet this mandate, EPA's research program is providing data and technical support for solving environmental problems today and building a science knowledge base necessary to manage our ecological resources wisely, understand how pollutants affect our health, and prevent or reduce environmental risks in the future.

The National Risk Management Research Laboratory (NRMRL) is the Agency's center for investigation of technological and management approaches for preventing and reducing risks from pollution that threaten human health and the environment. The focus of the Laboratory's research program is on methods and their cost-effectiveness for prevention and control of pollution to air, land, water, and subsurface resources; protection of water quality in public water systems; remediation of contaminated sites, sediments and ground water; prevention and control of indoor air pollution; and restoration of ecosystems. NRMRL collaborates with both public and private sector partners to foster technologies that reduce the cost of compliance and to anticipate emerging problems. NRMRL's research provides solutions to environmental problems by: developing and promoting technologies that protect and improve the environment; advancing scientific and engineering information to support regulatory and policy decisions; and providing the technical support and information transfer to ensure implementation of environmental regulations and strategies at the national, state, and community levels.

This publication has been produced as part of the Laboratory's strategic long-term research plan. It is published and made available by EPA's Office of Research and Development to assist the user community and to link researchers with their clients.

Sally Gutierrez, Director
National Risk Management Research Laboratory

ABSTRACT

This report documents the activities performed during and the results obtained from the first six months of the EPA arsenic removal technology demonstration project at the City of Sandusky, MI facility. The objectives of the project are to evaluate (1) the effectiveness of Siemens Water Technologies' Enhanced AERALATER[®] Type II Arsenic Removal Technology in removing arsenic to meet the maximum contaminant level (MCL) of 10 µg/L, (2) the reliability of the treatment system for use at small water facilities, (3) the required system operation and maintenance (O&M) and operator skill levels, and 4) the capital and O&M cost of the technology. The project also characterizes water in the distribution system and residuals generated by the treatment process. The types of data collected include system operation, water quality, process residuals, and capital and O&M cost.

After engineering plan review and approval by the state, the AERALATER[®] was installed and became operational on June 14, 2006. The fully-automated, packaged system consisted of a 12-ft diameter aluminum detention tank atop a 12-ft diameter, three-cell gravity sand filter plus ancillary equipment including an air distribution grid, an air compressor pack, a blower, two chemical feed systems, a high service pump, sample taps, and associated instrumentation. The filter contained 226 ft³ of sand and was designed for filtration rates up to 3 gpm/ft².

Source water had an average pH of 7.2 and contained fluctuating concentrations of arsenic and iron due, in part, to the use of up to four source water wells. Total arsenic concentrations ranged from 7.3 to 23.5 µg/L and averaged 10.9 µg/L. The predominant species was As(III) with an average concentration of 7.8 µg/L. Total iron concentrations ranged from 236 to 3,214 µg/L and averaged 860 µg/L. Chlorine was used to oxidize As(III) and Fe(II) to form filterable As(V)-laden particles within the detention tank. However, due to the presence of 0.3 mg/L of ammonia (as N) in source water, breakpoint chlorination was not achieved with the 2.9 mg/L (as Cl₂) of NaOCl applied. The formation of chloramines might have partially inhibited the oxidation of As(III), leaving as much as 2.1 µg/L of As(III) in the treated water. After gravity filtration, total arsenic concentrations ranged from 1.0 to 6.3 µg/L and averaged 2.3 µg/L, consisting of As(III) and As(V). The system operated at approximately 168 gal/min (gpm), producing approximately 29,406,000 gal of water through December 14, 2006. The flowrate corresponded to a detention time of 67 min and a filtration rate of 1.5 gpm/ft².

Comparison of the distribution system sampling results before and after the system startup demonstrated a decrease in arsenic (7.4 to 3.0 µg/L) and iron (360 to 30 µg/L). Manganese and lead concentrations did not appear to be affected, but copper concentrations increased from 209 to 511 µg/L after system startup. Alkalinity and pH increased and decreased, respectively, at two locations. Uncertainties of water sources during baseline sampling and changes to the post-treatment chemicals might have impacted the trends.

Filter tank backwash occurred automatically about three times/week based on a day and time setpoint. Approximately 6,000 gal of wastewater was discharged to the sanitary sewer for each event, totaling 1.7% of the treated water volume during the first six months. On average, the backwash wastewater contained 109 mg/L of total suspended solids (TSS), 52 mg/L of iron, 0.9 mg/L of manganese, and 0.4 mg/L of arsenic, with the majority existing as particulates. Based on solids sampling, approximately 3 lb of solids were discharged per event including 2.45 lb of iron, 0.05 lb of manganese, and 0.02 lb of arsenic.

The capital investment for the system was \$364,916 consisting of \$205,800 for equipment, \$27,077 for site engineering, and \$132,039 for installation, shakedown, and startup. Using the system's rated capacity of 340 gpm (or 489,600 gal/day [gpd]), the capital cost was \$1,073/gpm (or \$0.75/gpd). This unit cost does not include the cost of the building to house the treatment system.

O&M cost, estimated at \$0.24/1,000 gal, included only the incremental cost for electricity and labor. There was no incremental chemical consumption cost since chlorination was previously performed on-site.

CONTENTS

DISCLAIMER	ii
FOREWORD	iii
ABSTRACT.....	iv
APPENDICES	vii
FIGURES.....	vii
TABLES	viii
ABBREVIATIONS AND ACRONYMS	ix
ACKNOWLEDGMENTS	xii
Section 1.0 INTRODUCTION	1
1.1 Background	1
1.2 Treatment Technologies for Arsenic Removal	2
1.3 Project Objectives	2
Section 2.0 SUMMARY AND CONCLUSIONS	5
Section 3.0 MATERIALS AND METHODS.....	7
3.1 General Project Approach	7
3.2 System O&M and Cost Data Collection	8
3.3 Sample Collection Procedures and Schedules	9
3.3.1 Source Water.....	9
3.3.2 Treatment Plant Water	9
3.3.3 Backwash Water	9
3.3.4 Distribution System Water.....	9
3.3.5 Residual Solid	9
3.4 Sampling Logistics.....	12
3.4.1 Preparation of Arsenic Speciation Kits.....	12
3.4.2 Preparation of Sampling Coolers	12
3.4.3 Sample Shipping and Handling.....	12
3.5 Analytical Procedures	12
Section 4.0 DEMONSTRATION SITE AND TECHNOLOGY EVALUATED.....	14
4.1 Site Description.....	14
4.1.1 Existing Facility	14
4.1.2 Distribution System and State Sampling Requirements	15
4.1.3 Source Water Quality.....	15
4.1.4 Facility Modifications	17
4.2 Treatment Process Description	18
4.3 Treatment System Installation.....	23
4.3.1 System Permitting	23
4.3.2 Building Construction	23
4.3.3 System Installation, Startup, and Shakedown	23
Section 5.0 RESULTS AND DISCUSSION.....	27
5.1 System Operation	27
5.1.1 Service Operation.....	27
5.1.2 Backwash Operation	29
5.1.3 Residual Management.....	29
5.1.4 Reliability and Simplicity of Operation	30

5.1.4.1	Pre- and Post-Treatment Requirements.....	30
5.1.4.2	System Automation.....	30
5.1.4.3	Operator Skill Requirements.....	30
5.1.4.4	Preventative Maintenance Activities.....	30
5.1.4.5	Chemical Handling and Inventory Requirements.....	31
5.2	System Performance.....	31
5.2.1	Treatment Plant Sampling.....	31
5.2.1.1	Arsenic.....	33
5.2.1.2	Iron.....	33
5.2.1.3	Manganese.....	36
5.2.1.4	pH, DO, and ORP.....	36
5.2.1.5	Chlorine and Ammonia.....	37
5.2.1.6	Other Water Quality Parameters.....	38
5.2.2	Backwash Water and Solids Sampling.....	38
5.2.3	Distribution System Water Sampling.....	38
5.3	System Cost.....	41
5.3.1	Building Cost.....	41
5.3.2	System Cost.....	41
5.3.3	O&M Cost.....	41
Section 6.0 REFERENCES		44

APPENDICES

- Appendix A: OPERATIONAL DATA
- Appendix B: ANALYTICAL DATA TABLES

FIGURES

Figure 3-1.	Process Flow Diagram and Sampling Schedule and Locations.....	11
Figure 4-1.	Pump House for Well No. 1 and Water Tower.....	14
Figure 4-2.	System Piping and Chlorine and Phosphate Addition Systems.....	15
Figure 4-3.	Screenshot of Water Tower Setpoints for Well Control.....	18
Figure 4-4.	Layout and Schematic of Siemens' AERALATER [®] Unit.....	20
Figure 4-5.	Treatment System Components.....	20
Figure 4-6.	Control Panel and Ancillary Equipment.....	21
Figure 4-7.	New Treatment Plant Building.....	24
Figure 4-8.	Equipment Delivery and Unloading.....	24
Figure 4-9.	Blower Piping Modification.....	25
Figure 5-1.	Daily Demand of AERALATER [®] System (Unit 1).....	28
Figure 5-2.	Daily Demand of Each Well by Both AERALATER [®] Units.....	28
Figure 5-3.	Arsenic Speciation Results at Inlet (IN), After Detention Tank (AD), and After Filter Cells (TT).....	34
Figure 5-4.	Total Arsenic Concentrations Across Treatment Train.....	35
Figure 5-5.	Total Iron Concentrations Across Treatment Train.....	35
Figure 5-6.	Total Manganese Concentrations Across Treatment Train.....	36
Figure 5-7.	Chlorine Residuals Through Treatment System.....	37

TABLES

Table 1-1. Summary of the Arsenic Removal Demonstration Sites	3
Table 3-1. Predemonstration Study Activities and Completion Dates	7
Table 3-2. Evaluation Objectives and Supporting Data Collection Activities	8
Table 3-3. Sampling Schedule and Analyses.....	10
Table 4-1. Well No. 1 Source Water Quality Data.....	16
Table 4-2. Well Capacities and Control.....	18
Table 4-3. Wells No. 3, 6, and 9 Source Water Quality Data.....	19
Table 4-4. Physical Properties of Silica Sand Media.....	19
Table 4-5. Design Features of the AERALATER® System.....	22
Table 4-6. Installation Issues Encountered	25
Table 5-1. AERALATER® System Operational Parameters	27
Table 5-2. Settings for Backwash Operations.....	29
Table 5-3. Summary of Arsenic, Iron, and Manganese Results	31
Table 5-4. Summary of Other Water Quality Parameter Results	32
Table 5-5. Backwash Water Results	39
Table 5-6. Backwash Solids Results.....	39
Table 5-7. Distribution System Sampling Results	40
Table 5-8. Capital Investment for Siemens' AERALATER® System	42
Table 5-9. O&M Cost for Siemens' AERALATER® System.....	43

ABBREVIATIONS AND ACRONYMS

AAL	American Analytical Laboratories
Al	aluminum
AM	adsorptive media
As	arsenic
ATS	Aquatic Treatment Systems
bgs	below ground surface
Ca	calcium
C/F	coagulation/filtration
Cl	chlorine
CRF	capital recovery factor
Cu	copper
DBP	disinfection byproducts
DBPR	Disinfection Byproducts Rule
DO	dissolved oxygen
EPA	U.S. Environmental Protection Agency
F	fluoride
Fe	iron
Fe ₂ (SO ₄) ₃	ferric sulfate
FedEx	Federal Express
gpd	gallons per day
gpm	gallons per minute
HAA	haloacetic acid
HIX	hybrid ion exchanger
HOA	hand/off/auto
hp	horsepower
ICP-MS	inductively coupled plasma-mass spectrometry
ID	identification
IX	ion exchange
LCR	(EPA) Lead and Copper Rule
LOU	letter of understanding
MCL	maximum contaminant level
MDEQ	Michigan Department of Environmental Quality
MDL	method detection limit
MEI	Magnesium Elektron, Inc.
Mg	magnesium
m	micrometer
Mn	manganese
mV	millivolts

Na	sodium
NA	not available or not analyzed
NaOCl	sodium hypochlorite
ND	not detected
NS	not sampled
NSF	NSF International
NTU	nephelometric turbidity units
O&M	operation and maintenance
OIP	operator interface panel
OIT	Oregon Institute of Technology
ORD	Office of Research and Development
ORP	oxidation-reduction potential
P	phosphorus
Pb	lead
PLC	programmable logic controller
PO ₄	phosphate
POU	point-of-use
psi	pounds per square inch
PVC	polyvinyl chloride
QA	quality assurance
QA/QC	quality assurance/quality control
QAPP	Quality Assurance Project Plan
RFQ	request for quotation
RPD	relative percent difference
RO	reverse osmosis
Sb	antimony
SCADA	system control and data acquisition
scfm	standard cubic feet per minute
SDWA	Safe Drinking Water Act
SiO ₂	silica
SMCL	secondary maximum contaminant level
SO ₄	sulfate
SOC	synthetic organic compound
STS	Severn Trent Services
TDH	total dynamic head
TDS	total dissolved solids
TE	Townley Engineering, LLC
THM	trihalomethane
TOC	total organic carbon
TSS	total suspended solids
UPS	United Parcel Service
USDA	U.S. Department of Agriculture
V	vanadium

VFD
VOC

variable frequency drive
volatile organic compound

ACKNOWLEDGMENTS

The authors wish to extend their sincere appreciation to the staff of the division of public works in Sandusky, MI. The plant operators monitored the treatment system and collected samples from the treatment and distribution systems on a regular schedule throughout this study period. This performance evaluation would not have been possible without their support and dedication. Ms. Julia Valigore, who is currently pursuing a doctoral degree at the University of Canterbury in New Zealand, was the Battelle study lead for this demonstration project.

Section 1.0 INTRODUCTION

1.1 Project Background

The Safe Drinking Water Act (SDWA) mandates that U.S. Environmental Protection Agency (EPA) identify and regulate drinking water contaminants that may have adverse human health effects and that are known or anticipated to occur in public water supply systems. In 1975 under the SDWA, EPA established a maximum contaminant level (MCL) for arsenic at 0.05 mg/L. Amended in 1996, the SDWA required that EPA develop an arsenic research strategy and publish a proposal to revise the arsenic MCL by January 2000. On January 18, 2001, EPA finalized the arsenic MCL at 0.01 mg/L (EPA, 2001). In order to clarify the implementation of the original rule, EPA revised the rule text on March 25, 2003, to express the MCL as 0.010 mg/L (10 µg/L) (EPA, 2003). The final rule required all community and non-transient, non-community water systems to comply with the new standard by January 23, 2006.

In October 2001, EPA announced an initiative for additional research and development of cost-effective technologies to help small community water systems (<10,000 customers) meet the new arsenic standard and provide technical assistance to operators of small systems in order to reduce compliance costs. As part of this Arsenic Rule Implementation Research Program, EPA's Office of Research and Development (ORD) proposed a project to conduct a series of full-scale, on-site demonstrations of arsenic removal technologies, process modifications, and engineering approaches applicable to small systems. Shortly thereafter, an announcement was published in the *Federal Register* requesting water utilities interested in participating in Round 1 of this EPA-sponsored demonstration program to provide information on their water systems. In June 2002, EPA selected 17 out of 115 sites to host the demonstration studies.

In September 2002, EPA solicited proposals from engineering firms and vendors for cost-effective arsenic removal treatment technologies for the 17 host sites. EPA received 70 technical proposals for the 17 host sites, with each site receiving from one to six proposals. In April 2003, an independent technical panel reviewed the proposals and provided its recommendations to EPA on the technologies that it determined were acceptable for the demonstration at each site. Because of funding limitations and other technical reasons, only 12 of the 17 sites were selected for the demonstration project. Using the information provided by the review panel, EPA, in cooperation with the host sites and the drinking water programs of the respective states, selected one technical proposal for each site.

In 2003, EPA initiated Round 2 arsenic technology demonstration projects that were partially funded with Congressional add-on funding to the EPA budget. In June 2003, EPA selected 32 potential demonstration sites and the community water system in the City of Sandusky, MI was one of those selected.

In September 2003, EPA, again, solicited proposals from engineering firms and vendors for arsenic removal technologies. EPA received 148 technical proposals for the 32 host sites, with each site receiving from two to eight proposals. In April 2004, another technical panel was convened by EPA to review the proposals and provide recommendations to EPA with the number of proposals per site ranging from none (for two sites) to a maximum of four. The final selection of the treatment technology at the sites that received at least one proposal was made, again, through a joint effort by EPA, the state regulators, and the host site. Since then, four sites have withdrawn from the demonstration program, reducing the number of sites to 28. Siemens Water Technologies' Enhanced AERALATER® Type II Arsenic Removal Technology was selected for demonstration at the Sandusky facility. As of October 2007, 37 of the 40 systems have been operational, and the performance evaluation of 24 systems has been completed.

1.2 Treatment Technologies for Arsenic Removal

The technologies selected for the Round 1 and Round 2 demonstration host sites include 25 adsorptive media (AM) systems (the Oregon Institute of Technology [OIT] site has three AM systems), 13 coagulation/filtration (C/F) systems, two ion exchange (IX) systems, and 17 point-of-use (POU) units (including nine under-the-sink reverse osmosis [RO] units at the Sunset Ranch Development site and eight AM units at the OIT site), and one system modification. Table 1-1 summarizes the locations, technologies, vendors, system flowrates, and key source water quality parameters (including As, Fe, and pH) at the 40 demonstration sites. An overview of the technology selection and system design for the 12 Round 1 demonstration sites and the associated capital costs is provided in two EPA reports (Wang et al., 2004; Chen et al., 2004), which are posted on the EPA website at <http://www.epa.gov/ORD/NRMRL/wswrd/dw/arsenic/index.html>.

1.3 Project Objectives

The objective of the arsenic demonstration program is to conduct full-scale arsenic treatment technology demonstration studies on the removal of arsenic from drinking water supplies. The specific objectives are to:

- Evaluate the performance of the arsenic removal technologies for use on small systems.
- Determine the required system operation and maintenance (O&M) and operator skill levels.
- Characterize process residuals produced by the technologies.
- Determine the capital and O&M cost of the technologies.

This report summarizes the performance of the Siemens' system at the City of Sandusky in Michigan during the first six months from June 14 through December 14, 2006. The types of data collected included system operation, water quality (both across the treatment train and in the distribution system), residuals, and capital and preliminary O&M cost.

Table 1-1. Summary of Arsenic Removal Demonstration Sites

Demonstration Location	Site Name	Technology (Media)	Vendor	Design Flowrate (gpm)	Source Water Quality		
					As (µg/L)	Fe (µg/L)	pH (S.U.)
<i>Northeast/Ohio</i>							
Wales, ME	Springbrook Mobile Home Park	AM (A/I Complex)	ATS	14	38 ^(a)	<25	8.6
Bow, NH	White Rock Water Company	AM (G2)	ADI	70 ^(b)	39	<25	7.7
Goffstown, NH	Orchard Highlands Subdivision	AM (E33)	AdEdge	10	33	<25	6.9
Rollinsford, NH	Rollinsford Water and Sewer District	AM (E33)	AdEdge	100	36 ^(a)	46	8.2
Dummerston, VT	Charette Mobile Home Park	AM (A/I Complex)	ATS	22	30	<25	7.9
Felton, DE	Town of Felton	C/F (Macrolite)	Kinetico	375	30 ^(a)	48	8.2
Stevensville, MD	Queen Anne's County	AM (E33)	STS	300	19 ^(a)	270 ^(c)	7.3
Houghton, NY ^(d)	Town of Caneadea	C/F (Macrolite)	Kinetico	550	27 ^(a)	1,806 ^(c)	7.6
Newark, OH	Buckeye Lake Head Start Building	AM (ARM 200)	Kinetico	10	15 ^(a)	1,312 ^(c)	7.6
Springfield, OH	Chateau Estates Mobile Home Park	AM (E33)	AdEdge	250 ^(e)	25 ^(a)	1,615 ^(c)	7.3
<i>Great Lakes/Interior Plains</i>							
Brown City, MI	City of Brown City	AM (E33)	STS	640	14 ^(a)	127 ^(c)	7.3
Pentwater, MI	Village of Pentwater	C/F (Macrolite)	Kinetico	400	13 ^(a)	466 ^(c)	6.9
Sandusky, MI	City of Sandusky	C/F (Aeralater)	Siemens	340 ^(e)	16 ^(a)	1,387 ^(c)	6.9
Delavan, WI	Vintage on the Ponds	C/F (Macrolite)	Kinetico	40	20 ^(a)	1,499 ^(c)	7.5
Greenville, WI	Town of Greenville	C/F (Macrolite)	Kinetico	375	17	7827 ^(c)	7.3
Climax, MN	City of Climax	C/F (Macrolite)	Kinetico	140	39 ^(a)	546 ^(c)	7.4
Sabin, MN	City of Sabin	C/F (Macrolite)	Kinetico	250	34	1,470 ^(c)	7.3
Sauk Centre, MN	Big Sauk Lake Mobile Home Park	C/F (Macrolite)	Kinetico	20	25 ^(a)	3,078 ^(c)	7.1
Stewart, MN	City of Stewart	C/F&AM (E33)	AdEdge	250	42 ^(a)	1,344 ^(c)	7.7
Lidgerwood, ND	City of Lidgerwood	Process Modification	Kinetico	250	146 ^(a)	1,325 ^(c)	7.2
<i>Midwest/Southwest</i>							
Arnaudville, LA	United Water Systems	C/F (Macrolite)	Kinetico	770 ^(e)	35 ^(a)	2,068 ^(c)	7.0
Alvin, TX	Oak Manor Municipal Utility District	AM (E33)	STS	150	19 ^(a)	95	7.8
Bruni, TX	Webb Consolidated Independent School District	AM (E33)	AdEdge	40	56 ^(a)	<25	8.0
Wellman, TX	City of Wellman	AM (E33)	AdEdge	100	45	<25	7.7
Anthony, NM	Desert Sands Mutual Domestic Water Consumers Association	AM (E33)	STS	320	23 ^(a)	39	7.7
Nambe Pueblo, NM	Nambe Pueblo Tribe	AM (E33)	AdEdge	145	33	<25	8.5
Taos, NM	Town of Taos	AM (E33)	STS	450	14	59	9.5
Rimrock, AZ	Arizona Water Company	AM (E33)	AdEdge	90 ^(b)	50	170	7.2

Table 1-1. Summary of Arsenic Removal Demonstration Sites (Continued)

Demonstration Location	Site Name	Technology (Media)	Vendor	Design Flowrate (gpm)	Source Water Quality		
					As (µg/L)	Fe (µg/L)	pH (S.U.)
Tohono O'odham Nation, AZ	Tohono O'odham Utility Authority	AM (E33)	AdEdge	50	32	<25	8.2
Valley Vista, AZ	Arizona Water Company	AM (AAFS50/ARM 200)	Kinetico	37	41	<25	7.8
<i>Far West</i>							
Three Forks, MT	City of Three Forks	C/F (Macrolite)	Kinetico	250	64	<25	7.5
Fruitland, ID	City of Fruitland	IX (A300E)	Kinetico	250	44	<25	7.4
Homedale, ID	Sunset Ranch Development	POU RO ^(f)	Kinetico	75 gpd	52	134	7.5
Okanogan, WA	City of Okanogan	C/F (Electromedia-I)	Filtronic	750	18	69 ^(c)	8.0
Klamath Falls, OR	Oregon Institute of Technology	POE AM (Adsorbisia/ARM 200/ArsenX ^{np}) and POU AM (ARM 200) ^(g)	Kinetico	60/60/30	33	<25	7.9
Vale, OR	City of Vale	IX (Arsenex II)	Kinetico	525	17	<25	7.5
Reno, NV	South Truckee Meadows General Improvement District	AM (GFH/Kemiron)	Siemens	350	39	<25	7.4
Susanville, CA	Richmond School District	AM (A/I Complex)	ATS	12	37 ^(a)	125	7.5
Lake Isabella, CA	Upper Bodfish Well CH2-A	AM (HIX)	VEETech	50	35	125	7.5
Tehachapi, CA	Golden Hills Community Service District	AM (Isolux)	MEI	150	15	<25	6.9

AM = adsorptive media; C/F = coagulation/filtration; HIX = hybrid ion exchanger; IX = ion exchange process; RO = reverse osmosis

ATS = Aquatic Treatment Systems; MEI = Magnesium Elektron, Inc.; STS = Severn Trent Services

(a) Arsenic existing mostly as As(III).

(b) Design flowrate reduced by 50% due to system reconfiguration from parallel to series operation.

(c) Iron existing mostly as Fe(II).

(d) Replaced Village of Lyman, NE site which withdrew from program in June 2006.

(e) Facilities upgraded systems in Springfield, OH from 150 to 250 gpm, Sandusky, MI from 210 to 340 gpm, and Arnaudville, LA from 385 to 770 gpm.

(f) Including nine residential units.

(g) Including eight under-the-sink units.

Section 2.0 SUMMARY AND CONCLUSIONS

Siemens Water Technologies' AERALATER[®] treatment system has been operating at the City of Sandusky, MI since June 14, 2006. Based on the information collected during the first six months of operation, the following preliminary conclusions were made relating to the overall project objectives.

Performance of the arsenic removal technology for use on small systems:

- At an average NaOCl dosage of 2.9 mg/L (as Cl₂), breakpoint chlorination was not achieved due to the presence of 0.3 mg/L (as N) of ammonia in source water. The formation of chloramines might have partially inhibited the oxidation of As(III), leaving as much as 2.1 µg/L of As(III) in the treated water.
- The gravity filter consistently removed arsenic to <10 µg/L without supplemental iron addition. The measured filtration rates ranged up to 2.8 gpm/ft², which were slightly higher than the design value of 2.5 gpm/ft², but lower than the maximum value of 3.0 gpm/ft².
- A filter run could last for as long as 48 hr for a throughput of 483,000 gal without having breakthrough of iron particles from the filter. Particulate iron breakthrough did occur on three separate occasions during the course of the study, leaving as much as 523 µg/L of iron in the filter effluent. A special study will be conducted during the remainder of the study to determine the maximum run time until arsenic and iron breakthrough.
- Backwash at a loading rate of 7.4 gpm/ft² effectively restored the gravity filter for subsequent service runs. Backwash was performed on a day and time setting for Monday, Wednesday, and Friday.
- The water quality in the distribution system changed significantly since system startup. The most noticeable changes included a decrease in arsenic and iron concentrations from 7.4 to 3.0 µg/L and from 360 to 30 µg/L, respectively, and an increase in copper concentrations from 209 to 511 µg/L.

Required system O&M and operator skill levels:

- Very little time was required to oversee the system operations. The daily demand on the operator was typically 30 min to visually inspect the system and record operational parameters. The AERALATER[®] unit and all ancillary equipment were fully automatic and controlled by a programmable logic controller (PLC).
- The system was reliable, easy to operate, and experienced no downtime.

Characteristics of residuals produced by the technology:

- Approximately 6,000 gal of wastewater and 3 lb of residual solids were produced during each backwash event. The solids discharged to the sanitary sewer included 2.45 lb of iron, 0.05 lb of manganese, and 0.02 lb of arsenic.
- The total amount of wastewater produced was equivalent to 1.7% of the amount of water treated.

Capital and O&M cost of the technology:

- The capital investment for the system was \$364,916, including \$205,800 for equipment, \$27,077 for site engineering, and \$132,039 for installation, shakedown, and startup. The building was funded by the City and, therefore, not included in this cost.
- The unit capital cost was \$1,073/gpm (or \$0.75/gpd) based on a 340-gpm peak capacity.

- The O&M cost, estimated at \$0.24/1,000 gal, included only incremental cost for electricity and labor.

Section 3.0 MATERIALS AND METHODS

3.1 General Project Approach

Following the predemonstration activities summarized in Table 3-1, the performance evaluation study of the Siemens treatment system began on June 14, 2006. Table 3-2 summarizes the types of data collected and considered as part of the technology evaluation process. The overall system performance was based on its ability to consistently remove arsenic to below the target MCL of 10 µg/L through the collection of water samples across the treatment train. The reliability of the system was evaluated by tracking the unscheduled system downtime and frequency and extent of repair and replacement. The unscheduled downtime and repair information were recorded by the plant operator on a Repair and Maintenance Log Sheet.

The O&M and operator skill requirements were assessed through quantitative data and qualitative considerations, including the need for pre- and/or post-treatment, level of system automation, extent of preventative maintenance activities, frequency of chemical handling and inventory, and general knowledge needed for relevant chemical processes and related health and safety practices. The staffing requirements for the system operation were recorded on an Operator Labor Hour Log Sheet.

Table 3-1. Predemonstration Study Activities and Completion Dates

Activity	Date
Introductory Meeting Held	September 1, 2004
Draft Letter of Understanding (LOU) Issued	October 18, 2004
Final LOU Issued	October 27, 2004
Request for Quotation (RFQ) Issued to Siemens	October, 28, 2004
Siemens' Quotation Received	December 21, 2004
Facility Letter Report Issued	March 1, 2005
RFQ Issued to Townley Engineering	March 29, 2005
Townley Engineering's Quotation Received	April 22, 2005
Purchase Order Established with Siemens	May 20, 2005
Purchase Order Established with Townley Engineering	June 13, 2005
Engineering Package Submitted to MDEQ	August 5, 2005
System Permit Granted by MDEQ	September 7, 2005
Building Construction Permit Granted to City	November 8, 2005
Building Construction Began	November 21, 2005
System Arrived at Facility	February 16, 2006
System Installation Began	February 17, 2006
Performance Evaluation Study Plan Issued	February 28, 2006
Building Construction Completed	March 1, 2006
System Installation Completed	April 6, 2006
System Shakedown Completed	May 5, 2006
Performance Evaluation Began	June 14, 2006
Operator Training Completed by Battelle	June 22, 2006

MDEQ = Michigan Department of Environmental Quality

Table 3-2. Evaluation Objectives and Supporting Data Collection Activities

Evaluation Objective	Data Collection
Performance	– Ability to consistently meet 10 µg/L of arsenic in treated water
Reliability	– Unscheduled system downtime – Frequency and extent of repairs including a description of problems, materials and supplies needed, and associated labor and cost
System O&M and Operator Skill Requirements	– Pre- and post-treatment requirements – Level of automation for system operation and data collection – Staffing requirements including number of operators and laborers – Analysis of preventative maintenance including number, frequency, and complexity of tasks – Chemical handling and inventory requirements – General knowledge needed for relevant chemical processes and health and safety practices
Residual Management	– Quantity and characteristics of aqueous and solid residuals generated by system operation
System Cost	– Capital cost for equipment, engineering, and installation – O&M cost for chemical usage, electricity consumption, and labor

The quantity of aqueous and solid residuals generated was estimated by tracking the volume of backwash water produced during each backwash cycle. Backwash water and solids were sampled and analyzed for chemical characteristics.

The cost of the system was evaluated based on the capital cost per gal/min (gpm) (or gal/day [gpd]) of design capacity and the O&M cost per 1,000 gal of water treated. This task required tracking the capital cost for equipment, engineering, and installation, as well as the O&M cost for chemical supply, electricity usage, and labor.

3.2 System O&M and Cost Data Collection

The plant operator performed daily, weekly, and monthly system O&M and data collection according to instructions provided by the vendor and Battelle. On a daily basis, the plant operator recorded system operational data, such as pressure, flowrate, totalizer, and hour meter readings on a Daily System Operation Log Sheet; checked the sodium hypochlorite (NaOCl) level; and conducted visual inspections to ensure normal system operations. If any problem occurred, the plant operator contacted the Battelle Study Lead, who determined if the vendor should be contacted for troubleshooting. The plant operator recorded all relevant information, including the problem encountered, course of actions taken, materials and supplies used, and associated cost and labor incurred, on a Repair and Maintenance Log Sheet. On a weekly basis, the plant operator measured several water quality parameters on-site, including temperature, pH, dissolved oxygen (DO), oxidation-reduction potential (ORP), and residual chlorine, and recorded them on a Weekly On-Site Water Quality Parameters Log Sheet. Monthly backwash data also were recorded on a Backwash Log Sheet.

The capital cost for the arsenic removal system consisted of the cost for equipment, site engineering, and system installation. The O&M cost consisted of the cost for chemical usage, electricity consumption, and labor. Consumption of NaOCl was tracked on the Daily System Operation Log Sheet. Electricity consumption was determined from utility bills. Labor for various activities, such as routine system O&M, troubleshooting and repairs, and demonstration-related work, were tracked using an Operator Labor Hour Log Sheet. The routine system O&M included activities such as completing field logs, replenishing NaOCl solution, ordering supplies, performing system inspections, and others as

recommended by the vendor. The labor for demonstration-related work, including activities such as performing field measurements, collecting and shipping samples, and communicating with the Battelle Study Lead and the vendor, was recorded, but not used for the cost analysis.

3.3 Sample Collection Procedures and Schedules

To evaluate system performance, samples were collected at the influent, across the treatment plant, during filter backwash, and from the distribution system. The sampling schedules and analytes measured during each sampling event are listed in Table 3-3. In addition, Figure 3-1 presents a flow diagram of the treatment system along with the analytes and schedules at each sampling location. Specific sampling requirements for analytical methods, sample volumes, containers, preservation, and holding times are presented in Table 4-1 of the EPA-endorsed Quality Assurance Project Plan (QAPP) (Battelle, 2004). The procedure for arsenic speciation is described in Appendix A of the QAPP.

3.3.1 Source Water. During the initial site visit, one set of source water samples was collected and speciated using an arsenic speciation kit (Section 3.4.1). The sample tap was flushed for several minutes before sampling; special care was taken to avoid agitation, which might cause unwanted oxidation. Analytes for the source water samples are listed in Table 3-3.

3.3.2 Treatment Plant Water. The plant operator collected samples weekly, on a four-week cycle, for on- and off-site analyses. For the first week of each four-week cycle, samples taken at the inlet (IN), after the detention tank (AD), and after the filter cells (TT), were speciated on-site and analyzed per Table 3-3 for monthly treatment plant water. For the next three weeks, samples were collected at the same three locations and analyzed per Table 3-3 for the weekly treatment plant water.

3.3.3 Backwash Water. Backwash water samples were collected monthly by the plant operator. Connected to the tap on the discharge line, tubing directed a portion of backwash water at approximately 1 gpm into a clean, 32-gal container over the duration of the backwash for each filter cell. After the content in the container was thoroughly mixed, composite samples were collected and/or filtered on-site using 0.45- μm disc filters. Analytes for the backwash samples are listed in Table 3-3.

3.3.4 Distribution System Water. Samples were collected from the distribution system to determine the impact of the arsenic treatment system on the water chemistry in the distribution system, specifically, the arsenic, lead, and copper levels. Prior to the system startup from February to June 2005, four sets of baseline distribution water samples were collected from two residences and one business within the distribution system. These locations are part of the City's historic sampling network under the EPA Lead and Copper Rule (LCR). Following the system startup, distribution system sampling continued on a monthly basis at the same three locations.

Samples were collected following an instruction sheet developed according to the *Lead and Copper Monitoring and Reporting Guidance for Public Water Systems* (EPA, 2002). The dates and times of last water usage before sampling and of sample collection were recorded for calculation of the stagnation time. All samples were collected from a cold-water faucet that had not been used for at least 6 hr to ensure that stagnant water was sampled.

3.3.5 Residual Solids. Residual solids produced by the treatment process included backwash solids. After the solids in the backwash water containers (Section 3.3.3) had settled and the supernatant was carefully decanted, residual solids samples were collected. A portion of each solids/water mixture was air-dried for metals analyses.

Table 3-3. Sampling Schedule and Analyses

Sample Type	Sample Locations^(a)	No. of Samples	Frequency	Analytes	Collection Date(s) and Results
Source Water	At Wellhead	1	Once (during initial site visit)	On-site: pH, temperature, DO, and ORP Off-site: As (total and soluble), As(III), As(V), Fe (total and soluble), Mn (total and soluble), U (total and soluble), V (total and soluble), Na, Ca, Mg, Cl, F, SO ₄ , SiO ₂ , PO ₄ , NH ₃ , NO ₂ , NO ₃ , TOC, TDS, turbidity, and alkalinity	Table 4-1 (09/01/04)
Treatment Plant Water	IN, AD, TT	3	Weekly	On-site ^(b) : pH, temperature, DO, ORP, Cl ₂ (free and total) Off-site: As (total), Fe (total), Mn (total), P (total), SiO ₂ , turbidity, and alkalinity	Appendix B
			Monthly	Same as above plus following off-site analytes: As (soluble), As(III), As(V), Fe (soluble), Mn (soluble), Ca, Mg, F, NO ₃ , SO ₄ , NH ₃ , and TOC	Appendix B
Backwash Water	BW	3	Monthly	As (total and soluble), Fe (total and soluble), Mn (total and soluble), pH, TDS, and TSS	Table 5-5
Distribution Water	Two LCR Residences and One LCR Non-residence	3	Monthly	Total As, Fe, Mn, Cu, and Pb, pH, and alkalinity	Table 5-7
Residual Solids	SS (Backwash Solids from Each Cell)	3	Once	Total Al, As, Ca, Cd, Cu, Fe, Mg, Mn, Ni, P, Pb, Si, and Zn	Table 5-6 (10/25/06)

- (a) Abbreviations corresponding to sample location in Figure 3-1, i.e., IN = at inlet, AD = after detention, TT = after filter cells, BW = at backwash discharge line; SS = sludge sampling location
(b) On-site measurements of chlorine not collected at IN.

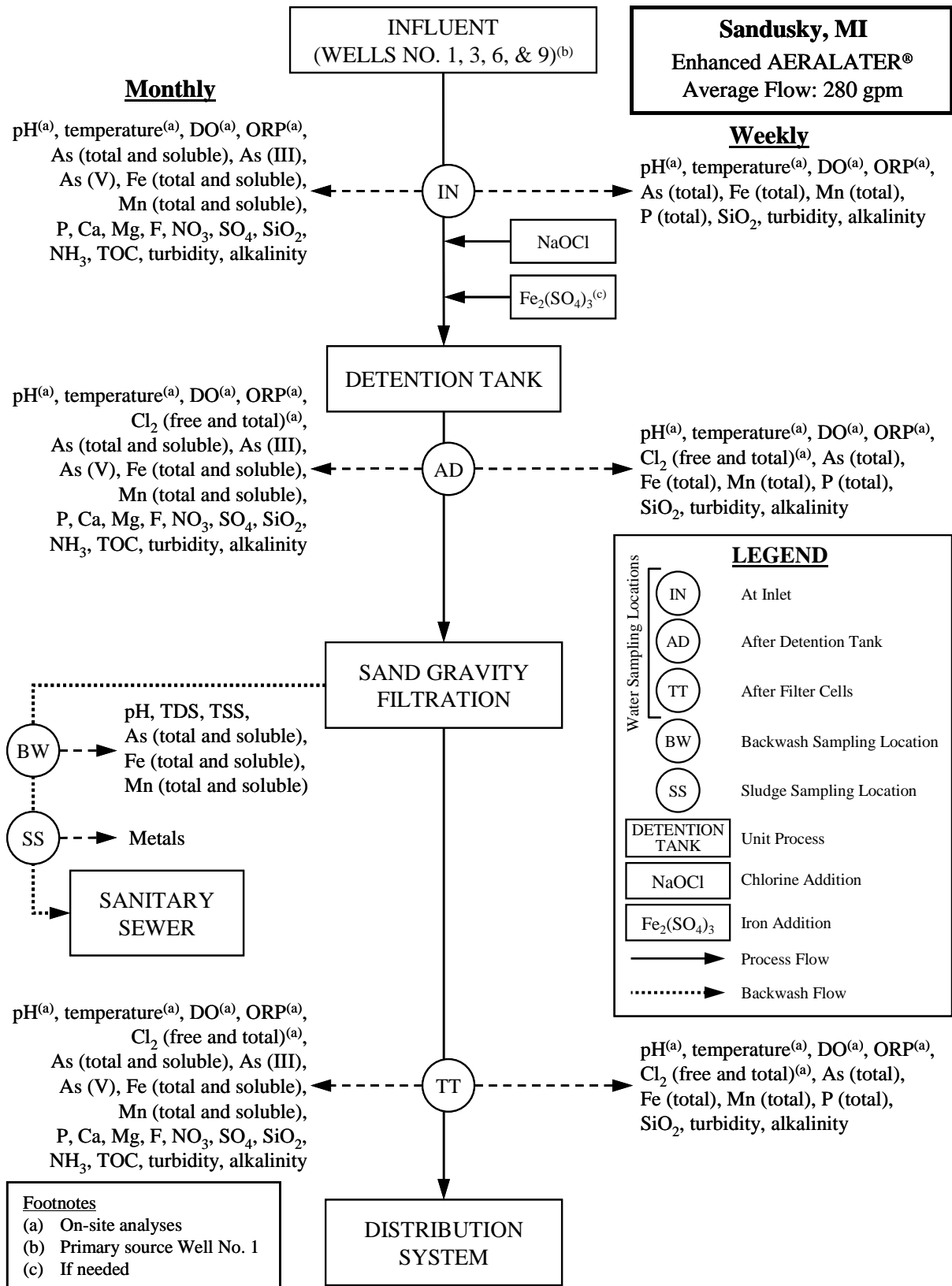

Figure 3-1. Process Flow Diagram and Sampling Schedule and Locations

3.4 Sampling Logistics

3.4.1 Preparation of Arsenic Speciation Kits. The arsenic field speciation method uses an anion exchange resin column to separate the soluble arsenic species, As(V) and As(III) (Edwards et al., 1998). Resin columns were prepared in batches at Battelle laboratories according to the procedures detailed in Appendix A of the QAPP (Battelle, 2004).

3.4.2 Preparation of Sample Coolers. For each sampling event, a sample cooler was prepared with the appropriate number and type of sample bottles, disc filters, and/or speciation kits. All sample bottles were new and contained appropriate preservatives. Each sample bottle was affixed with a pre-printed, colored-coded label consisting of the sample identification (ID), date and time of sample collection, collector's name, site location, sample destination, analysis required, and preservative. The sample ID consisted of a two-letter code for the demonstration site, the sampling date, a two-letter code for a specific sampling location, and a one-letter code designating the arsenic speciation bottle (if necessary). The sampling locations at the treatment plant were color-coded for easy identification. The labeled bottles were separated by sampling locations, placed in Ziplock[®] bags, and packed in the cooler.

In addition, all sampling- and shipping-related materials, such as disposable gloves, sampling instructions, chain-of-custody forms, prepaid/addressed UPS air bills, and bubble wrap, were included. The chain-of-custody forms and air bills were complete except for the operator's signature and the sample dates and times. After preparation, the sample cooler was sent to the site via FedEx for the following week's sampling event.

3.4.3 Sample Shipping and Handling. After sample collection, samples for off-site analyses were packed carefully in the original coolers with wet ice and shipped to Battelle. Upon receipt, the sample custodian verified that all samples indicated on the chain-of-custody forms were included and intact. Sample IDs were checked against the chain-of-custody forms, and the samples were logged into the laboratory sample receipt log. Discrepancies noted by the sample custodian were addressed with the plant operator by the Battelle Study Lead.

Samples for metal analyses were stored at Battelle Inductively Coupled Plasma-Mass Spectrometry (ICP-MS) Laboratory. Samples for other water quality analyses by Battelle's subcontract laboratories, including American Analytical Laboratories (AAL) in Columbus, OH and Belmont Labs in Englewood, OH, were packed in separate coolers and picked up by couriers. The chain-of-custody forms remained with the samples from the time of preparation through collection, analysis, and final disposition. All samples were archived by the appropriate laboratories for the respective duration of the required hold time and disposed of properly thereafter.

3.5 Analytical Procedures

The analytical procedures described in Section 4.0 of the QAPP (Battelle, 2004) were followed by Battelle ICP-MS, AAL, and Belmont Labs. Laboratory quality assurance/quality control (QA/QC) of all methods followed the prescribed guidelines. Data quality in terms of precision, accuracy, method detection limits (MDLs), and completeness met the criteria established in the QAPP (i.e., relative percent difference [RPD] of 20%, percent recovery of 80 to 120%, and completeness of 80%). The quality assurance (QA) data associated with each analyte will be presented and evaluated in a QA/QC Summary Report to be prepared under separate cover upon completion of the Arsenic Demonstration Project.

Field measurements of pH, temperature, DO, and ORP were conducted by the plant operator using a handheld field meter, which was calibrated for pH and DO prior to use following the procedures provided in the user's manual. The ORP probe also was checked for accuracy by measuring the ORP of a standard

solution and comparing it to the expected value. The plant operator collected a water sample in a clean, plastic beaker and placed the probe in the beaker until a stable value was obtained. The plant operator also performed free and total chlorine measurements using Hach chlorine test kits following the user's manual.

Section 4.0 DEMONSTRATION SITE AND TECHNOLOGY EVALUATED

4.1 Site Description

4.1.1 Existing Facility. The City of Sandusky has four supply wells that provide a maximum daily capacity of 750,000 gal with an average daily demand of 262,000 gal to a population of 2,916. Prior to the demonstration study, the lead well was rotated monthly among Wells No. 1, 6, 7, and 9. A fifth well, Well No. 3, was seldom used due to high iron levels. Well No. 1, which was designated for this study, was 10-in in diameter and 136 ft deep. The static water level depth was 30 ft below ground surface (bgs). The submersible pump for Well No. 1 previously operated at 210 gpm at 130 ft of total dynamic head (TDH) to the height of the water tower. A pump test performed in December 2004 indicated that the aquifer was capable of sustaining an increased extraction rate of approximately 280 gpm at a reduced TDH of only 18 ft to the height of the treatment system. A new 15-hp pump, capable of producing 340 gpm, was installed in March 2006 prior to the installation of the arsenic removal system.

Figure 4-1 shows the existing pump house for Well No. 1 and 300,000-gal water tower, and Figure 4-2 shows the system piping for Well No. 1 with associated valves, flow totalizer, and pressure gauges. Existing water treatment consisted of a sodium hypochlorite (NaOCl) addition at 3 mg/L (as Cl_2) to reach a target free chlorine residual level of 0.5 to 1.0 mg/L (as Cl_2), and a blended phosphate feed (85% ortho- and 15% poly-phosphate) at 4 mg/L as a sequestering agent for iron and for corrosion and scale control. Figure 4-2 shows the 55-gal phosphate and chlorine addition tanks and a scale. The water was pumped to the distribution system and stored in the water tower as shown in Figure 4-1.



Figure 4-1. Pump House for Well No. 1 and Water Tower



Figure 4-2. System Piping and Chlorine and Phosphate Addition Systems

4.1.2 Distribution System and State Sampling Requirements. The distribution system consists of 4-in and 8-in cast iron and 8-in polyvinyl chloride (PVC) piping, which was added in 2000. The two residences and one business selected for the monthly baseline and distribution system water sampling are impacted by all of the wells in the distribution system and are part of the City's historic LCR sampling network. Individual service hookups are $\frac{3}{4}$ - and 1-in copper piping.

For compliance purposes, the City samples water periodically from the distribution system for several parameters: monthly at two residences for bacterial analysis; yearly at four residences for trihalomethanes (THMs) and haloacetic acids (HAAs) under the EPA Disinfection Byproducts Rule (DBPR); and once every three years at 10 residences for lead and copper under the LCR. Well No. 1 also is sampled quarterly for arsenic, yearly for partial chemistry (i.e., chloride, fluoride, hardness, nitrate, nitrite, sulfate, sodium, and iron) and volatile organic compounds (VOCs), once every three years for synthetic organic compounds (SOCs), and once every nine years for metals and radionuclides.

4.1.3 Source Water Quality. Source water samples were collected from Well No. 1 on September 1, 2004. The analytical results are presented in Table 4-1 and compared to the historic data collected by the facility, Battelle (on July 23, 2002), and Michigan Department of Environmental Quality (MDEQ) (from March 7, 2001 through March 15, 2004).

Total arsenic concentrations of source water ranged from 14 to 36 $\mu\text{g/L}$. Based on the September 1, 2004, results obtained by Battelle, out of 15.8 $\mu\text{g/L}$ of total arsenic, 9.7 $\mu\text{g/L}$ (or 60%) existed as As(III) and 4.0 $\mu\text{g/L}$ (or 25%) as As(V). Arsenic speciation performed by Battelle on July 23, 2002, however, showed a total arsenic concentration twice as high with As(III) and As(V) existing almost evenly at 14.9 and 15.3 $\mu\text{g/L}$, respectively. The variations in arsenic concentration in Well No. 1 water were, therefore, closely

Table 4-1. Well No. 1 Source Water Quality Data

Parameter	Unit	Facility Data	Battelle Data		MDEQ Data
			07/23/02	09/01/04	03/07/01 - 03/15/04
<i>Date</i>		NA	07/23/02	09/01/04	03/07/01 - 03/15/04
pH	S.U.	6.9	NA	6.9/7.2	NA
Temperature	°C	NA	NA	12.9	NA
DO	mg/L	NA	NA	0.5	NA
ORP	mV	NA	NA	-62	NA
Alkalinity (as CaCO ₃)	mg/L	361*	NA	314	NA
Hardness (as CaCO ₃)	mg/L	468	NA	525	407-546
Turbidity	NTU	NA	NA	17	NA
TDS	mg/L	NA	NA	736	NA
TOC	mg/L	NA	NA	1.5	NA
Nitrate (as N)	mg/L	NA	NA	<0.04	<0.4
Nitrite (as N)	mg/L	NA	NA	<0.01	<0.05
Ammonia (as N)	mg/L	NA	NA	0.3	NA
Chloride	mg/L	NA	NA	130	71-192
Fluoride	mg/L	NA	NA	0.3	0.5-0.7
Sulfate	mg/L	113*	NA	89.0	95-120
Silica (as SiO ₂)	mg/L	16.0*	NA	13.9	NA
Orthophosphate (as P)	mg/L	ND	NA	<0.1	NA
As (total)	µg/L	25.0	30.9	15.8	14-36
As (soluble)	µg/L	NA	30.2	13.7	NA
As (particulate)	µg/L	NA	0.7	2.1	NA
As(III)	µg/L	NA	14.9	9.7	NA
As(V)	µg/L	NA	15.3	4.0	NA
Ca (total)	mg/L	115*	NA	133.6	NA
Fe (total)	µg/L	1,400	1,563	1,387	500-1,700
Fe (soluble)	µg/L	NA	1,212	1,276	NA
Mg (total)	mg/L	44*	NA	46.3	NA
Mn (total)	µg/L	35*	33.6	38.3	NA
Mn (soluble)	µg/L	NA	31.3	37.7	NA
Na (total)	mg/L	43*	NA	109.4	43-106
U (total)	µg/L	NA	NA	0.7	NA
U (soluble)	µg/L	NA	NA	0.6	NA
V (total)	µg/L	NA	NA	1.2	NA
V (soluble)	µg/L	NA	NA	1.1	NA

*EPA sample analysis.

TDS = total dissolved solids; TOC = total organic carbon; NA = not analyzed

monitored throughout the course of the demonstration study. Because the treatment process relies upon coprecipitation and adsorption of As(V) with/onto iron solids, prechlorination was required to oxidize As(III) to As(V).

Iron concentrations in source water ranged from 500 to 1,700 µg/L. Manganese concentrations ranged from 33.6 to 38.3 µg/L. Based on the speciation sampling conducted on July 23, 2002, and September 1, 2004, 78 to 92% of iron and 94 to 98% of manganese existed in the soluble form. These results, along with the presence of As(III) at the levels observed, were consistent with the low DO (0.5 mg/L) and ORP (-62 mV) values measured during the September 1, 2004, sampling event. For effective arsenic removal by iron solids, the general recommendations are that the soluble iron concentration is at least 20 times the

soluble arsenic concentration (Sorg, 2002), and that the pH values fall within the range of 5.5 to 8.5 (note that improved arsenic removal most likely would occur at the lower end of this pH range). The results obtained on July 23, 2002, and September 1, 2004, indicated soluble iron to soluble arsenic concentration ratios of 40:1 and 93:1, respectively, and a pH range of 6.9 to 7.2. Therefore, no provisions were made for pH adjustment, but an iron addition system was included in case additional iron was required to lower the arsenic level in the treated water.

Based on the September 1, 2004, results, 0.3 mg/L (as N) of ammonia was present in raw water. The presence of ammonia will increase the chlorine demand. Addition of chlorine to raw water will oxidize As(III) and other reducing species, such as Fe(II) and Mn(II), and also react with ammonia and organic nitrogen compounds, if any, to form combined chlorine (i.e., mono- and dichloramines within a pH range of 4.5 to 8.5). In order to attain the target free chlorine residual of 0.5 mg/L (as Cl₂), “breakpoint” chlorination must be achieved. Thus, the theoretical chlorine dosage required would include the following: (1) amount to oxidize As(III), Fe(II), Mn(II), and any other reducing species, which was estimated to be 0.9 mg/L (as Cl₂) (Ghurye and Clifford, 2001), (2) amount to oxidize ammonia and combined chlorine formed during chlorination, which was estimated to be 2.3 mg/L (as Cl₂) (Clark et al., 1977), and (3) amount to provide the target free chlorine residual of 0.5 mg/L (as Cl₂).

With the addition of 3.7 mg/L of NaOCl (as Cl₂), there is potential for the formation of disinfection byproducts (DBPs), including THMs and HAAs, due to the presence of approximately 1.5 mg/L of total organic carbon (TOC) in raw water. Factors affecting the DBP formation include type of disinfectant, dosage, contact time, water pH and temperature, and concentration and characteristics of precursors, such as TOC (EPA, 2006). Formation of DBPs is monitored by the State through yearly collection of samples for THMs and HAAs analyses (Section 4.1.2). Furthermore, chlorine residuals, ammonia, and TOC were monitored during the performance evaluation study.

Other source water quality parameters also were analyzed (Table 4-1); results were mostly comparable to those obtained by the facility and MDEQ. The September 1, 2004 results indicated a high turbidity value of 17 nephelometric turbidity units (NTU), presumably due to precipitation of iron and other constituents after sampling. The facility has added phosphates to source water to sequester iron (Section 4.1.1). The treatment process was expected to greatly reduce turbidity levels through iron removal. Concentrations of orthophosphate, silica, fluoride, vanadium, and uranium were relatively low and not expected to impact the arsenic removal. Total dissolved solids (TDS) and sulfate concentrations were elevated, but probably would not cause concern for the treatment process. Hardness levels measured ranged from 407 to 546 mg/L (as CaCO₃); some customers of the water system have installed point of entry softeners to lower the hardness.

4.1.4 Facility Modifications. Prior to the startup of the EPA-funded AERALATER[®] (designated as Unit 1), the City installed a second AERALATER[®] (designated as Unit 2) to meet the State’s firm capacity requirements and began a water main project financed by U.S. Department of Agriculture (USDA) Rural Development. The City also installed and tested a generator for backup power to the treatment systems after the building was completed. The two AERALATER[®] units have a combined capacity of 680 gpm. Via a common header, Wells No. 1 and 3 were connected to the treatment units in May 2006, and Wells No. 6 and 9 were connected in mid-August 2006. Control of these wells (Table 4-2) and monitoring of the AERALATER[®] systems’ operations were facilitated via a system control and data acquisition (SCADA) system at the City’s wastewater treatment plant office. The wells’ start and stop setpoints were controlled by the established water levels in the storage tanks and could be easily adjusted to change each well’s operation. For example, Well No. 1, designated as ‘Tower’ in Figure 4-3, has the highest water level setpoint at 26 ft, which requires it to operate most often.

Table 4-2. Well Capacities and Control

Well No.	Capacity (gpm)	Lead/Backup
1	280	Lead
3	150	Backup
6	150	Backup
9	120	Backup

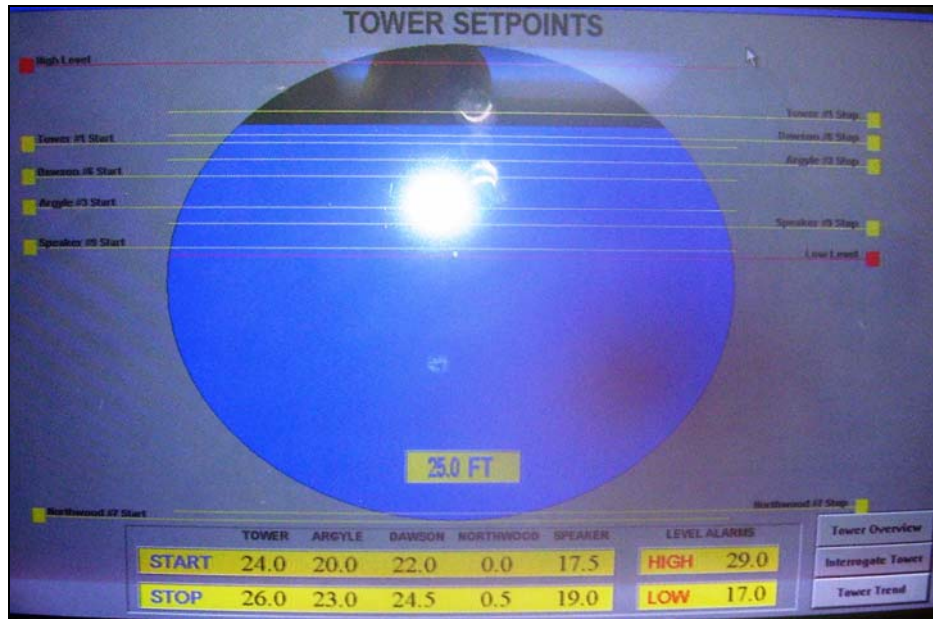

Figure 4-3. Screenshot of Water Tower Setpoints for Well Control

Upon completion of the watermain project, the distribution system consisted of a looped distribution line supplied by Wells No. 1, 3, 6, and 9. The facility used Well No. 1 as the lead well with Wells No. 3, 6, and 9 as backup wells to meet the City’s daily demand. Source water data obtained from MDEQ for Wells No. 3, 6, and 9 are summarized in Table 4-3. It appeared that arsenic concentrations of the blended water would still be above 10 µg/L and, therefore, would require treatment through the AERALATER® units. Due to the high iron concentrations in Well No. 3 water when compared to those in Wells No. 6 and 9 water, Well No. 3 was used as the main backup well during this demonstration study.

4.2 Treatment Process Description

Siemens proposed to use a vertical, prepackaged unit, referred to as an Enhanced AERALATER® Type II Arsenic Removal System, to remove iron and arsenic from raw water. Sized at 10-ft diameter for 210 gpm in Siemens’ original proposal to EPA, the system was upgraded at the City’s request and expenses, based on the pump test results discussed in Section 4.1.1, to 12-ft diameter for 340 gpm in order to accommodate the City’s future expansion. The treatment train included prechlorination/oxidation, coprecipitation/adsorption, and gravity filtration. The filter media is silica sand, which is listed by NSF International (NSF) under Standard 61 for use in drinking water applications. The physical properties of this media are summarized in Table 4-4.

Table 4-3. Wells No. 3, 6, and 9 Source Water Quality Data

Parameter	Unit	Well No. 3	Well No. 6	Well No. 9
<i>Date</i>		07/09/04– 10/04/05	03/09/04– 10/04/05	03/09/04–10/04/05
Hardness (as CaCO ₃)	mg/L	620–693	324–351	171–180
Nitrate (as N)	mg/L	<0.4	<0.4	<0.4
Nitrite (as N)	mg/L	<0.05	<0.05	<0.05
Chloride	mg/L	177–197	28–45	8–10
Fluoride	mg/L	0.5	0.7	0.9-1.0
Sulfate	mg/L	131–160	62–64	16–18
As (total)	µg/L	28–43	13–38	12–18
Fe (total)	µg/L	2,500–3,000	500–600	200–400
Na (total)	mg/L	74–105	41–50	25–26

Source: MDEQ

Table 4-4. Physical Properties of Silica Sand Media

Property	Value
Color	Light brown to light red
Effective Size (mm)	0.45–0.55
Uniformity Coefficient	≤1.6
Acid Solubility (%)	< 5
Specific Gravity	>2.5
Bulk Density (lb/ft ³)	100

The AERALATER[®] treatment system includes one each chemical feed system for chlorine and supplemental iron addition (if necessary), a detention tank with air diffuser grid, a three-cell gravity filter with aluminum plate underdrains, a blower and motor starter enclosure, an air compressor pack, an aluminum V-notch weir board, a high service pump with variable frequency drive (VFD), sample taps, and associated instrumentation. The main body of the AERALATER[®] unit is constructed of corrosion-resistant aluminum, and the tank bottom was solvent cleaned prior to undercoat applications. Metal surfaces of all carbon steel, cast iron, and ductile iron pipe, flanges, and fittings greater than 3-in diameter were blast cleaned, coated with 3 to 4 mils of primer, and painted with 4 to 8 mils of epoxy.

The treatment system is fully automated with a wall-mounted control panel that houses a touchscreen operator interface panel (OIP) (Allen Bradley model PanelView 1000), a PLC (Allen Bradley model SLC 5/04), and a modem (U.S. Robotics model V.92). A solenoid panel (Phoenix Contact model UK 5 N) also is included for the manual override of different valves. Figure 4-4 presents the layout and schematic of the AERALATER[®] unit. Figures 4-5 and 4-6 contain photographs of the system components and control panel and ancillary equipment, respectively. Key system design parameters are listed in Table 4-5. The major steps of the treatment process include:

- **Intake.** The well pumps are activated and deactivated based on water tower level setpoints. The system primarily treats the flow from Well No. 1, but also occasionally receives water

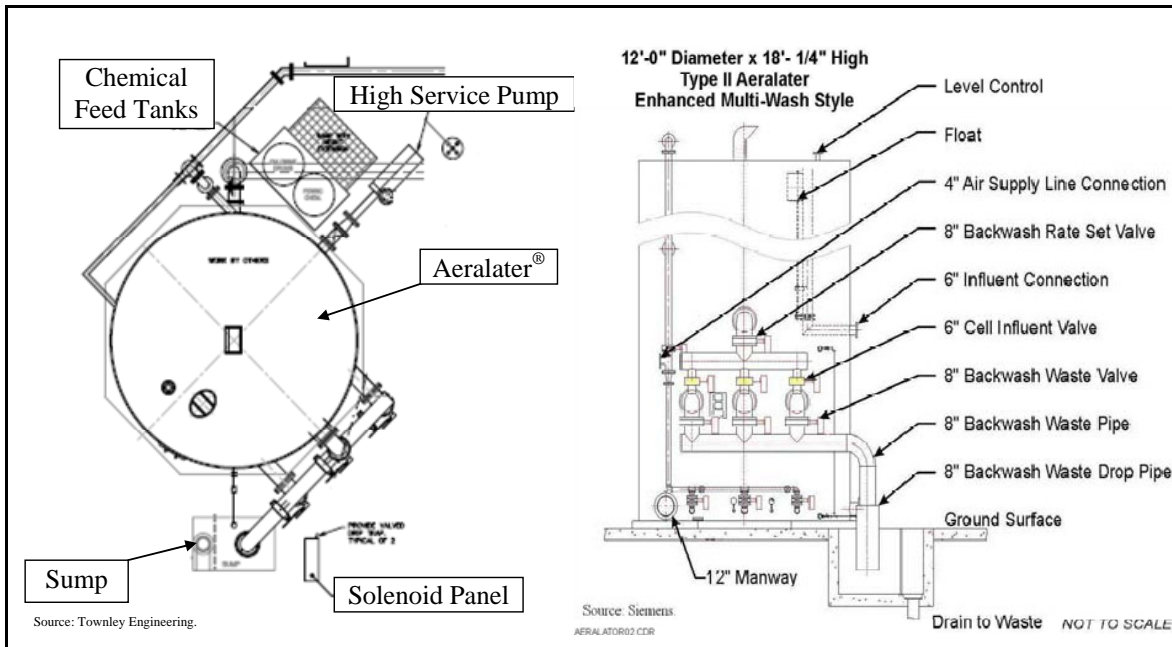

Figure 4-4. Layout and Schematic of Siemens' AERALATER® Unit



Figure 4-5. Treatment System Components

(Clockwise from Left: Inlet Piping from Wells; Air Diffuser Grid within Detention Tank; Influent Piping and Prechlorination Equipment; AERALATER® Unit with Detention Tank Effluent above Gravity Cell Influent; and Discharge Piping with Siphon Breaker to Sump)



Figure 4-6. Control Panel and Ancillary Equipment

(Clockwise from Top Left: Control Panel and VFD; Low Pressure Limit Switch and Head Loss Gauge; High Service Pump; Blower; Compressor; and Solenoid Panel)

from Wells No. 3, 6, and 9. Influent (and effluent) flowrates and throughput were monitored using Siemens' Sitrans F Magflow flowmeters. The inlet piping from the wells into the building and the combined influent piping to the treatment system is shown in Figure 4-5.

- **Chlorine Addition.** A 12.5% NaOCl solution is injected to oxidize As(III) to As(V) and Fe(II) to Fe(III) in raw water. The chemical feed system includes a 0.58-gal/hr (gph) LMI metering pump, a check valve, a 4-function anti-siphon pressure relief valve, suction tubing, a foot valve and a foot valve weight, discharge tubing, an injector check valve, and an LMI 50-gal polyethylene chemical day tank with cover (Figure 4-5). The pump was proportionally paced according to the influent flowrate. One calibration cylinder was included for direct dosage (i.e., gph) measurements. The City also provided a drum scale and eye wash station at its own expense.
- **Iron Addition.** Enough natural iron is expected to exist in source water to effectively remove arsenic through coprecipitation with and adsorption onto the iron solids formed from chlorine addition. Nonetheless, a 0.42-gph LMI metering pump (with flow pacing capabilities), a check valve, a 4-function anti-siphon pressure relief valve, suction tubing, a foot valve and a foot valve weight, discharge tubing, an injector check valve, and an LMI 50-gal polyethylene chemical day tank for ferric sulfate ($\text{Fe}_2[\text{SO}_4]_3$) solution are available, if needed, for supplemental iron addition.
- **Detention.** A 12-ft-diameter by 10.8-ft-tall aluminum detention tank provides over 40 min of contact time to improve the formation of filterable iron flocs. The water level is monitored by a pressure transducer (Rosemount model 2088), which regulates the speed of the high service pump via a VFD (PumpSmart model PS75) connected to the control panel. A high

Table 4-5. Design Features of the AERALATER® System

Parameter	Value	Remarks
Pretreatment		
Chlorine Addition (mg/L [as Cl ₂])	Field Determined	≥0.9 mg/L based on demand for As(III), Fe(II), and Mn(II) (Section 4.1.3)
Supplemental Iron Addition (mg/L)	0	Used only if needed
Detention		
Tank Size (ft)	12 D × 10.8 H	High water level at 9.8 ft
Volume (gal)	11,340	Includes volume of filter freeboard
Detention Time (min)	40	Based on average flowrate of 280 gpm
Filtration		
Filter Size (ft)	12 D × 7.3 H	Three cells in parallel with 1.6 ft underdrain
Filter Freeboard (ft)	3.7	–
Media Depth (ft)	2.0	Silica sand media
Surface Area (ft ²)	113	37.7 ft ² /cell
Media Volume (ft ³)	226	75.3 ft ³ /cell
Peak Flowrate (gpm)	340	–
Average Flowrate (gpm)	280	Typically expected
Filtration Rate (gpm/ft ²)	2.5	Based on average flowrate of 280 gpm
Daily Production (gal)	489,600	Based on peak flowrate, 24 hr/day
Hydraulic Utilization (%)	53.5	Based on a daily demand of 262,000 gal
Backwash		
Duration (min)	45	15 min/cell
Flowrate (gpm)	280	–
Hydraulic Loading Rate (gpm/ft ²)	7.4	–
Air Wash (scfm)	75	2.0 scfm/ft ²
Wastewater Production (gal)	12,600	Per backwash for three filter cells
Frequency (gal)	650,000	Based on throughput (or 38.7 hr of run time)

D = diameter; H = height

level setpoint prevents overflow of the detention tank by signaling the well pump(s) to shut off. The detention tank has a 6-in inlet connection and includes an 18-in-diameter access manhole and an air diffuser below the water surface. An air diffuser grid further oxidizes and mixes the chlorinated water. Air supply to the diffuser is provided by a 15-horsepower (hp), 340-standard-ft³/min (scfm) positive displacement blower (Unimac model SB4L-15). Figure 4-5 shows photographs of the detention tank and air diffuser grid, and Figure 4-6 shows the VFD and blower.

- Gravity Filtration.** A 6- and 8-in piping manifold on the front of the unit transfers water from the detention tank to the 12-ft-diameter, 7.3-ft-tall aluminum General Filter MULTIWASH gravity filter with aluminum plate underdrains. Three cells arranged in parallel contain 24 in or 75.3 ft³ (per cell) of silica sand and provide a total filtration area of 113 ft². The filter has a 6-in effluent connection to a 25-hp, centrifugal high service pump (Gould model 3656M [Figure 4-6]) sized for 340 gpm at 130 ft TDH, which pressurizes the treated water for distribution. During normal system operation with all three cells in-service, a 280-gpm flowrate provides a filtration rate of 2.5 gpm/ft².
- Backwash.** During the filtration process, solids are collected in the filter cells, resulting in head loss across the filter. Backwash can be initiated manually, semiautomatically, or automatically based on a throughput or a day and time setpoint. A low pressure limit switch (USFilter model 10-in Hg) connected to the underdrain also provides added protection to shut

down the high service pump and signal an alarm if a backwash is overdue. An air compressor pack consisting of two 1-hp, 5.0-cfm air compressors (Quincy model QC01006DD [Figure 4-6]) with an alternating starter panel actuates the filter valves during the backwash sequence. Each filter cell is backwashed in succession with water produced by the other two in-service filter cells and receives an air wash from the blower. The resulting wastewater is sent to a backwash waste sump with a V-notch weir board for flowrate indication and then to the sanitary sewer through 8-in-diameter schedule 40 steel piping (Figure 4-5).

4.3 Treatment System Installation

This section provides a summary of the system installation, startup, and shakedown activities and the associated prerequisites including permitting and building construction.

4.3.1 System Permitting. The complete engineering package including civil, architectural, structural, mechanical, and electrical plans for the water treatment plant was prepared according to the Ten States Standards by Townley Engineering, LLC (TE). The plans detailed connections of the AERALATER[®] systems from the inlet piping and to the City's water distribution and sanitary sewer systems. In addition, system general arrangement, electrical and mechanical drawings, and component specifications were provided by Siemens for inclusion in the package. Extensive communications among Siemens, TE, the City, and Battelle ensured that accurate contract documents existed for proper fabrication and installation of the equipment. Siemens accommodated all necessary adjustments to the standard AERALATER[®] design, such as system orientation, air piping elevation, and chemical feed equipment. The submittal was certified by a Professional Engineer registered in the State of Michigan and submitted to MDEQ for review and approval on August 5, 2005. After MDEQ's review comments were addressed, the package was resubmitted on August 29, 2005, and a water supply construction permit was issued by MDEQ on September 7, 2005. System fabrication began shortly thereafter.

4.3.2 Building Construction. A building construction permit was issued by Sanilac County on November 8, 2005. After receiving funding from USDA Rural Development on November 16, 2005, the City began and completed its building construction on November 21, 2005, and March 1, 2006, respectively. The 60 $\frac{2}{3}$ -ft \times 31 $\frac{1}{3}$ -ft building provides ample space to house three 12-ft diameter AERALATER[®] units and includes one 12-ft \times 42 $\frac{2}{3}$ -ft annex divided into a generator room and a blower/compressor room. Sidewall and roof peak heights are 19 $\frac{1}{3}$ and 27 $\frac{1}{2}$ ft, respectively. A section of 16 $\frac{2}{3}$ -ft-wide removable panel enabled ease of equipment placement and installation. The footing is 52 in deep. The concrete floor in the building is 4 in thick with a 16-in thick reinforced concrete pedestal atop compacted sand backfill beneath the AERALATER[®] units. A 4 ft \times 2 $\frac{1}{2}$ ft \times 2 $\frac{3}{4}$ ft sump (one for each unit) fed two 3,100-gal precast concrete equalization tanks that emptied into the sanitary sewer to facilitate wastewater discharge. Figure 4-7 shows the new treatment plant building. In addition to electrical and plumbing connections, a phone line also was installed to enable the vendor to dial into the modem in the control panel for any troubleshooting.

4.3.3 System Installation, Startup, and Shakedown. The AERALATER[®] unit and all ancillary equipment were delivered to the site on February 16, 2006, and system installation began following the offloading (Figure 4-8). Subcontracted to TE, Franklin Holwerda Co. in Wyoming, MI, performed all mechanical connections and Blank Electric Co. in Snover, MI, performed all electrical work. Installation work performed through April 6, 2006, included setting all equipment in place, installing the air diffuser and face piping manifold, hooking up the chemical feed systems, connecting the piping, and painting exposed piping. The issues encountered during system installation are summarized in Table 4-6.



Figure 4-7. New Treatment Plant Building



Figure 4-8. Equipment Delivery and Unloading

Table 4-6. Installation Issues Encountered

Issue Encountered	Remarks
Blower received not as specified	<ul style="list-style-type: none"> • Modifications required to add hand/off/auto (HOA) switches and transformers • Starter and air flow gauge replaced due to malfunction
Low pressure limit switch received not as specified (Figure 4-6)	<ul style="list-style-type: none"> • Model previously declined by City in lieu of non-mercury model still supplied • Issue never rectified by vendor
Blower piping modification desired by City (Figure 4-9)	<ul style="list-style-type: none"> • Piping installed according to engineering drawings, however, City opted to add an elevated loop before the 'T' to prevent backflow from detention tank or filter cells to blower • TE advocated change as preventative measure since blower would not be operating full-time as designed because of sufficient oxidation provided via prechlorination
Some equipment missing from original shipment	<ul style="list-style-type: none"> • Delays in completing installation work experienced • Remaining equipment eventually received on March 30, 2006 (1½ months later), and TE then able to finish installation work



Figure 4-9. Blower Piping Modification

In mid-April 2006, Siemens was on-site for system inspection and O&M training while TE and its subcontractors completed media loading, leak testing, and electrical continuity testing. The vendor added the following parameters/features to the OIP: (1) system run time, (2) volume of wastewater generated during backwash, and (3) blower control status with ability to toggle between operation for aeration and backwash or for backwash only. Startup and shakedown of the AERALATER[®] unit was completed from May 2 to 5, 2006. The common 8-in effluent PVC pipe for both units burst in mid-May and was replaced by TE and its subcontractors with 8-in ductile iron pipe. Although Well No. 1 was connected to the treatment system in late May 2006, it could not be used until after subsequent bacterial tests passed on June 13, 2006. The performance evaluation study began on June 14, 2006, when water supply by Well No. 1 commenced.

Battelle performed system inspection and training of three operators on sample and data collection from June 21 to 23, 2006. During this time, the replacement blower starter was installed, and the air wash flowrate was set during the course of a backwash by throttling the blower and/or adjusting the air wash rate set valve. Media loss coincided with the air wash flowrate from 40 to 100 scfm with negligible media loss occurring without air wash.

Section 5.0 RESULTS AND DISCUSSION

5.1 System Operation

5.1.1 Service Operation. The operational parameters for the first six months of the system operation, from June 14 through December 14, 2006, are tabulated and attached as Appendix A. The key parameters are summarized in Table 5-1. During this study period, the EPA-funded AERALATER[®] system (Unit 1) treated approximately 29,406,000 gal of water. This throughput was almost 60% of the City's demand, based on flow totalizer readings for Unit 1 and compared to wellhead totalizer readings for each well from the City's water production reports. The remainder of the flow was either treated by Unit 2 or did not require treatment. The daily demands for Unit 1 ranged from 74,000 to 289,000 gal and averaged 161,000 gal (Figure 5-1), equivalent to a utilization rate of 33% over the 26-week period. Well No. 1 was the primary well while Wells No. 3 and 6 also were used frequently (Figure 5-2) based on water tower level start and stop setpoints for each well (Section 4.1.4).

Chlorine addition ranged from 1.3 to 6.7 mg/L (as Cl₂) and averaged 2.9 mg/L (as Cl₂). The dosage was calculated based on daily NaOCl consumption (by weight) and system effluent totalizer readings. This dosage was significantly less than the theoretical dosage of at least 3.7 mg/L required to provide a free chlorine residual of 0.5 mg/L (as Cl₂) as discussed in Section 4.1.3. The implications of this dosage and other confounding data are discussed in Section 5.2.1.5.

Table 5-1. AERALATER[®] System Operational Parameters

Parameter	Value
Operational Period	06/14/06–12/14/06
<i>Service Operation</i>	
Throughput (gal)	29,406,000
Average Demand [Range] (gpd)	161,000 [74,000–289,000]
Average Flowrate [Range] (gpm)	168 [49–316]
Average Chlorine Dosage [Range] (mg/L [as Cl ₂])	2.9 [1.3–6.7]
Iron Addition (mg/L)	Not required
Average Detention Time [Range] (min)	67 [36–231]
Average Filtration Rate [Range] (gpm/ft ²)	1.5 [0.4–2.8]
Average Head Loss [Range] (ft H ₂ O)	1.4 [0.3–2.0]
<i>Backwash Operation</i>	
Frequency (time/week)	3
Flowrate (gpm)	280
Hydraulic Loading Rate (gpm/ft ²)	7.4
Duration (min)	21
Wastewater Produced (gal/event)	6,000

Because the system run time was based on the run time of the high service pump, calculated flowrates based on run time and flow totalizer readings were not available due to an incorrect setting on the VFD, which caused the pump to idle even when the treatment system was off. The idling pump incorrectly reflected excessive system run time during this study period, but the VFD setting was later corrected on January 9, 2007. Therefore, system flowrates were tracked only by instantaneous readings on the effluent flow meter, which ranged from 49 to 316 gpm and averaged 168 gpm, which was significantly lower than the 280-gpm design flowrate (and the capacity of Well No. 1) due largely to the split of the influent flow

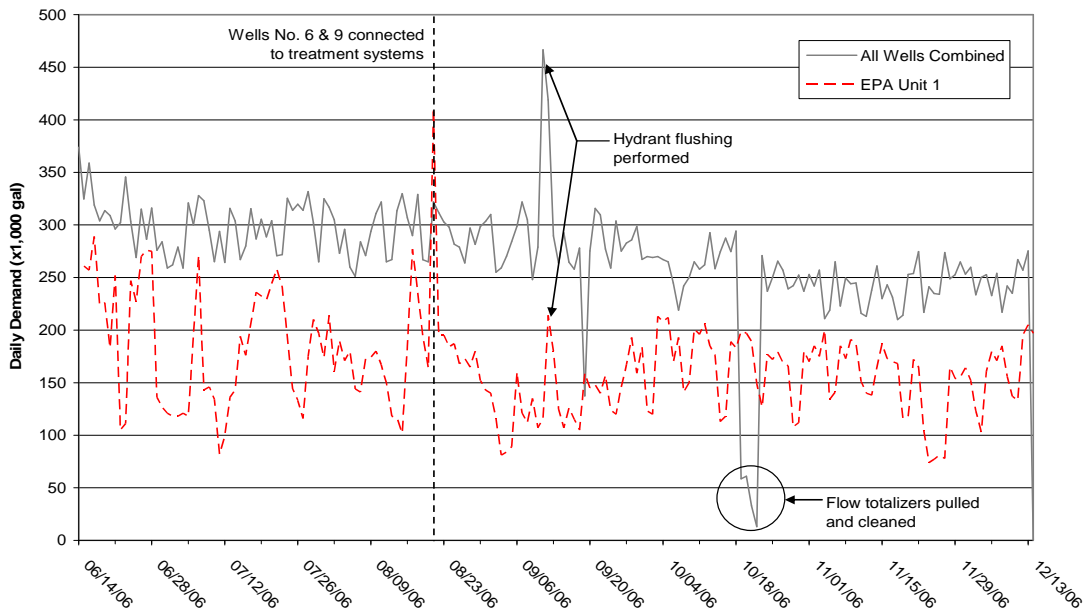

Figure 5-1. Daily Demand of AERALATER® System (Unit 1)

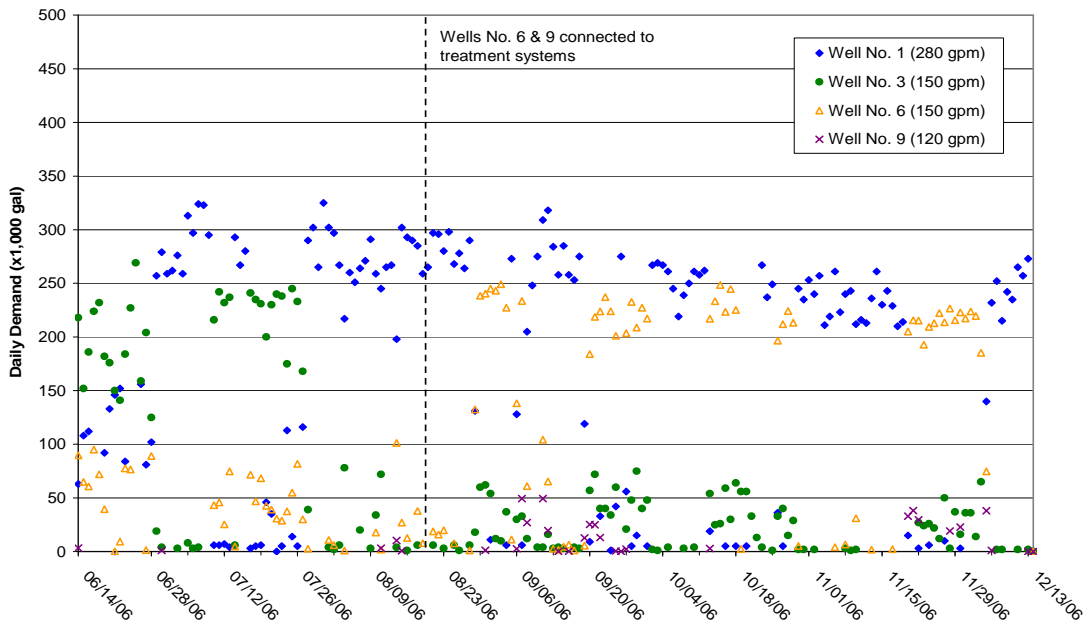

Figure 5-2. Daily Demand of Each Well by Both AERALATER® Units

between Units 1 and 2. The corresponding detention time ranged from 36 to 231 min and averaged 67 min and the corresponding filtration rate ranged from 0.4 to 2.8 gpm/ft² and averaged 1.5 gpm/ft². The respective ranges of each of the parameters were inclusive of the design values shown in Table 4-5, but varied significantly based on the influent flowrates. Air supply from the blower to the diffuser, originally

intended to provide constant aeration to the detention tank, was used only once a week to prevent the diffuser from becoming plugged since the feed water was already oxidized with chlorine. Head loss varied from 0.3 to 2.0 ft of water (ft of H₂O) and did not increase noticeably between two consecutive backwash cycles.

5.1.2 Backwash Operation. The backwash settings are listed in Table 5-2. The system was automatically backwashed approximately three time/week based on a day and time setpoint of Monday, Wednesday, and Friday mornings (exact time was adjusted periodically from 6:00 to 8:00 a.m. during the study). Instead of using a throughput setting, the facility preferred to use this mode for backwash to ensure that an operator was on-site should any problem arise during backwash. This frequency corresponded to a throughput of 322,000 to 483,000 gal (or a filter run time of 32 to 48 hr [at an average flowrate of 168 gpm]) based on the average daily demand, which seemingly was more frequent than the throughput setting of 650,000 gal but actually was about the same as the corresponding filter run time of 38.7 hr (at a design flow rate of 280 gpm). Occasionally, manual backwash cycles also were initiated for testing and sampling of backwash water and solids.

Table 5-2. Settings for Backwash Operations

Parameter	Range	Factory Setting	Field Setting
Throughput Trigger (1,000 gal)	100–2,000	650	899
Day and Time Trigger	Any	–	MWF 08:00
Air Wash Start Delay Timer (sec/cell)	30–300	60	45
Backwash Duration (min/cell)	5–30	10	5
Backwash Flowrate (gpm)	0–340	NA	280
Air Purge Duration (min/cell)	1–50	2	2
Air Wash Flowrate (scfm)	0–340	NA	60–70
Blower Control Status ^(a)	AB or BO	NA	BO

(a) Ability to toggle between operation for aeration and backwash (AB) or backwash only (BO).
NA = not available

The backwash flowrate was controlled with a backwash rate set valve located on the face piping manifold. If the influent flowrate was below the 280-gpm setting when backwash was triggered, additional wells would be called upon by the PLC to attain sufficient flow prior to commencing the backwash process. Water levels in the floor sump also provided visual estimates for backwash flowrate according to heights on the V-notch weir board. The operator indicated that the water level in the sump was usually at or near a specified height corresponding to a flowrate of 280 gpm (or 7.4 gpm/ft²). Each filter cell was backwashed in succession with water produced by the other two in-service filter cells for 7 min, including 5 min with water only followed by 2 min with air wash at 60 to 70 scfm and water to remove particulates. Approximately 6,000 gal of wastewater was produced during each backwash cycle, which was significantly less than the design value due to the shorter backwash duration, i.e., 7 vs. 15 min/cell. In essence, the system was backwashing more frequently with less water at the design flowrate and slightly lower air wash flowrate, which appeared to be adequate to fully backwash the filter cells. Section 5.1.3 provides additional information on wastewater management.

5.1.3 Residual Management. The only residual produced by the AERALATER[®] unit was backwash wastewater and solids. Wastewater from backwash was discharged to the building sump,

which emptied to the sanitary sewer. Backwash water discharge was tracked by totalizing the volume of water passing through the influent flow meter during the backwash process. During the first six months, 490,800 gal of wastewater, or 1.7% of the water treated, was generated as a result of this gravity filtration process.

5.1.4 Reliability and Simplicity of Operation. No system downtime was required. However, some difficulties were encountered with the blower (Unimac model SB4L-15) and loss of head gauge (USFilter model), which are shown in Figure 4-6. The air wash provided by the blower occasionally fluctuated outside of the 60 to 70 scfm range. To make adjustments, the operator needed to climb a ladder to reach the set valve located below the 'T' in Figure 4-9. The loss of head gauge, which measures differential pressure across the filter, could be improved with the use of a smaller scale (e.g., 0 to 10 ft of H₂O) and/or finer graduations. Five increments from 0 to 32 ft of H₂O with backwash required at about 8 ft of H₂O hinders readability and makes it difficult to monitor increases in head loss especially since readings ranged only from 0.3 to 2.0 ft of H₂O.

5.1.4.1 Pre- and Post-Treatment Requirements. Prechlorination with 12.5% NaOCl was performed to oxidize As(III) and Fe(II) and to provide chlorine residuals to the distribution system. The operator tracked the consumption of the solution daily with a drum scale and measured chlorine residuals regularly with a Hach meter. Analytical results from the first six months of system operation indicated that satisfactory arsenic removal was achieved without supplemental iron addition due primarily to the low levels of arsenic in raw water. No post-treatment was required; however, the facility chose to resume blended phosphate (25% ortho- and 75% poly-phosphate) addition in October 2006 for corrosion control.

5.1.4.2 System Automation. The AERALATER[®] unit was automatically controlled by the PLC in the control panel. The control panel contained a modem and a touchscreen OIP that facilitated monitoring of system parameters, toggling the blower status, adjusting backwash setpoints, and checking the alarm status. The OIP was equipped to provide alarms for high service pump or blower failure, low or high detention tank level, backwash requirements (for manual or semiautomatic mode), and low underdrain pressure. Backwash was automatic based on a day and time setpoint; however, it also could be semiautomatically initiated or manually conducted by operating the blower and individual valve function switches using the OIP. The PLC included control loops to ensure that the proper equipment, such as chemical feed and high service pumps, were operating concurrently with the system. In addition, electrode control programming for the level sensors in the detention tank enabled the well pump motor starters, the high service pump VFD, and the water tower's plant demand switch to maintain proper water levels in the detention tank.

5.1.4.3 Operator Skill Requirements. The daily demand on the operator was about 30 min for visual inspection of the system and recording of operational parameters, such as volume, flowrate, and chemical usage on field log sheets. In Michigan, operator certifications are classified on a level of 1 (most complex) to 5 (least complex) (MDEQ, 2006). The primary operator was Limited Water Treatment Level 4 (D-4) and Water Distribution Level 3 (S-3) certified. After receiving proper training during the system startup, the operator understood the PLC, knew how to use the touchscreen OIP, and was able to work with the vendor to troubleshoot and perform minor on-site repairs.

5.1.4.4 Preventative Maintenance Activities. The vendor recommended routine maintenance activities as provided by the equipment manufacturers to prolong the integrity of the treatment system components within its comprehensive O&M manual (Siemens Water Technologies, 2006). Such tasks included checking and changing lubrication, replacing worn parts, seals, and gaskets, and cleaning instrumentation as prescribed.

5.1.4.5 Chemical Handling and Inventory Requirements. The operator tracked the 12.5% NaOCl usage daily, coordinated the solution supply through Elhorn Chemical, and refilled the day tank every 1 to 2 weeks. The solution did not require any dilutions and was usually supplied in 30-gal drums. The facility provided an emergency eye wash and shower station for safety measures.

5.2 System Performance

5.2.1 Treatment Plant Sampling. The treatment plant water was sampled on 25 occasions including two duplicate events and seven speciation events during this study period. Table 5-3 summarizes the analytical results for arsenic, iron, and manganese. Table 5-4 summarizes the results of the other water quality parameters. Appendix B contains a complete set of analytical results. The results of the water samples collected throughout the treatment plant are discussed below.

Table 5-3. Summary of Arsenic, Iron, and Manganese Results

Parameter	Location	Sample Count	Concentration (µg/L)			Standard Deviation
			Minimum	Maximum	Average	
As (total) (Figures 5-3 and 5-4)	IN	27	7.3	23.5	10.9	3.5
	AD	27	7.4	21.6	10.8	3.4
	TT	27	1.0	6.3	2.3	1.5
As (soluble)	IN	7	7.3	10.4	8.9	1.1
	AD	7	1.3	3.4	2.1	0.8
	TT	7	0.9	2.9	1.8	0.7
As (particulate) (Figure 5-3)	IN	7	0.2	8.7	2.3	3.0
	AD	7	6.3	9.0	7.4	1.0
	TT	7	<0.1	0.3	0.1	0.1
As(III) (Figure 5-3)	IN	7	6.0	9.8	7.8	1.2
	AD	7	<0.1	2.1	0.8	0.7
	TT	7	<0.1	2.1	0.8	0.7
As(V) (Figure 5-3)	IN	7	0.6	1.8	1.1	0.4
	AD	7	1.0	1.6	1.3	0.2
	TT	7	0.6	1.5	1.0	0.3
Fe (total) (Figure 5-5)	IN	27	236	3,214	860	570
	AD	27	239	1,951	807	379
	TT	27	<25	523	55.5	132
Fe (soluble)	IN	7	610	990	744	130
	AD	7	<25	<25	<25	-
	TT	7	<25	<25	<25	-
Mn (total) (Figure 5-6)	IN	27	21.6	30.6	25.3	2.1
	AD	27	21.1	35.6	25.9	2.9
	TT	27	<0.1	21.0	7.9	6.4
Mn (soluble)	IN	7	23.5	30.1	26.8	2.3
	AD	7	6.3	18.8	11.4	3.7
	TT	7	2.1	20.8	9.5	7.1

One-half of detection limit used for nondetect results and duplicate samples included for calculations.

Table 5-4. Summary of Other Water Quality Parameter Results

Parameter	Location	Unit	Sample Count	Concentration			Standard Deviation
				Minimum	Maximum	Average	
Alkalinity (as CaCO ₃)	IN	mg/L	27	293	350	317	15.8
	AD	mg/L	27	295	350	318	14.2
	TT	mg/L	27	293	346	319	15.4
Ammonia (as N)	IN	mg/L	7	0.1	0.4	0.3	0.1
	AD	mg/L	7	0.1	0.3	0.2	0.1
	TT	mg/L	7	0.1	0.4	0.2	0.1
Fluoride	IN	mg/L	7	0.6	3.4	1.2	1.0
	AD	mg/L	7	0.5	1.8	0.9	0.5
	TT	mg/L	7	0.5	1.9	1.0	0.6
Sulfate	IN	mg/L	7	87	105	95	6.2
	AD	mg/L	7	89	107	97	7.1
	TT	mg/L	7	76	102	93	8.8
Nitrate (as N)	IN	mg/L	7	<0.05	<0.05	<0.05	-
	AD	mg/L	7	<0.05	<0.05	<0.05	-
	TT	mg/L	7	<0.05	<0.05	<0.05	-
Phosphorus (as P)	IN	µg/L	27	<10	27.0	<10	5.3
	AD	µg/L	27	<10	29.7	<10	5.4
	TT	µg/L	27	<10	25.4	<10	3.9
Silica (as SiO ₂)	IN	mg/L	27	11.2	13.3	11.9	0.5
	AD	mg/L	27	11.2	13.9	11.8	0.6
	TT	mg/L	27	10.0	13.8	11.7	0.6
Turbidity	IN	NTU	27	2.1	16.0	9.4	3.4
	AD	NTU	27	0.5	9.9	1.4	1.7
	TT	NTU	27	<0.1	1.7	0.5	0.4
TOC	IN	mg/L	6	<1.0	1.1	<1.0	0.3
	AD	mg/L	6	<1.0	1.1	1.0	0.2
	TT	mg/L	6	<1.0	1.1	<1.0	0.3
pH	IN	S.U.	25	7.0	7.7	7.2	0.1
	AD	S.U.	25	7.0	7.7	7.2	0.1
	TT	S.U.	25	7.1	7.6	7.2	0.1
Temperature	IN	°C	25	11.3	13.3	12.1	0.5
	AD	°C	25	11.0	13.1	11.7	0.5
	TT	°C	25	11.1	16.2	12.1	1.1
DO	IN	mg/L	25	0.8	3.7	1.9	0.6
	AD	mg/L	25	2.0	4.2	2.8	0.5
	TT	mg/L	25	2.0	5.6	2.9	0.7
ORP	IN	mV	24 ^(a)	248	406	293	32.9
	AD	mV	25	284	552	380	92.1
	TT	mV	25	291	566	384	95.1
Free Chlorine (as Cl ₂) ^(b)	AD	mg/L	25	0.2	2.3	0.7	0.6
	TT	mg/L	25	0.1	3.1	0.7	0.9
Total Chlorine (as Cl ₂) ^(b)	AD	mg/L	22	1.9	4.6	3.3	0.7
	TT	mg/L	22	1.3	4.7	3.3	0.8
Total Hardness (as CaCO ₃)	IN	mg/L	7	375	436	395	20.4
	AD	mg/L	7	377	431	401	20.8
	TT	mg/L	7	379	432	404	17.0

Table 5-4. Summary of Other Water Quality Parameter Results (Cont'd)

Parameter	Location	Unit	Sample Count	Concentration			Standard Deviation
				Minimum	Maximum	Average	
Ca Hardness (as CaCO ₃)	IN	mg/L	7	247	300	266	17.9
	AD	mg/L	7	250	297	270	18.3
	TT	mg/L	7	252	295	273	16.3
Mg Hardness (as CaCO ₃)	IN	mg/L	7	115	136	128	8.5
	AD	mg/L	7	121	148	131	8.8
	TT	mg/L	7	119	140	131	7.5

(a) One outlier (i.e., 2.6 mV on 08/08/06) omitted from calculations.

(b) See Figure 5-7.

One-half of detection limit used for nondetect results and duplicate samples included for calculations.

5.2.1.1 Arsenic. Figure 5-3 presents the results of seven speciation events, and Figure 5-4 shows total arsenic concentrations measured across the treatment train. Total arsenic concentrations in source water fluctuated significantly during the first six months, due, in part, to the operation of different wells (i.e., Wells No. 1, 3, 6, and 9) throughout the study. However, even while operation of only one well was confirmed over several weeks, no discernable trends were apparent. Source water arsenic concentrations ranged from 7.3 to 23.5 µg/L and averaged 10.9 µg/L with 2.3 µg/L existing in the particulate form and 8.9 µg/L in the soluble form. The soluble arsenic consisted of 7.8 µg/L of As(III), the predominant arsenic species, and 1.1 µg/L of As(V). The range of total arsenic concentrations measured during this six-month period was lower than that of previous results for Well No. 1 (Table 4-1).

Following the detention tank, the average total arsenic concentration remained the same at 10.8 µg/L with 7.4 µg/L existing in the particulate form and 2.1 µg/L in the soluble form (including 0.8 µg/L of As[III] and 1.3 µg/L of As[V]). The decrease in As(III) and increase in particulate arsenic after prechlorination and detention indicated oxidation of As(III) and subsequent coprecipitation/adsorption of As(V) with/onto the iron solids also formed upon chlorination. As much as 2.1 µg/L of As(III), however, was observed following detention, indicating incomplete oxidation caused, presumably, by the presence of ammonia. As(III) most likely was oxidized initially by free chlorine before free chlorine reacted with ammonia to form chloramines (Frank and Clifford, 1986). Ghurye and Clifford (2001) reported that only limited As(III) oxidation occurred due to the presence of monochloramine formed in situ.

Total arsenic concentrations after gravity filtration ranged from 1.0 to 6.3 µg/L and averaged 2.3 µg/L. Based on average influent results, the ratio of soluble iron to soluble arsenic was 84:1, which was more than adequate compared to the rule of thumb ratio of 20:1 for effective arsenic removal.

5.2.1.2 Iron. Figure 5-5 presents total iron concentrations measured across the treatment train. Similarly to arsenic concentrations, source water iron concentrations also fluctuated significantly. Total iron concentrations in source water ranged from 236 to 3,214 µg/L and averaged 860 µg/L. Speciation sampling indicated that iron existed primarily in the soluble form with an average concentration of 744 µg/L. Maximum iron concentrations coincided with maximum arsenic concentrations and were seen in Well No. 1 water. According to historical results presented in Table 4-3, highest arsenic and iron concentrations were expected in Well No. 3 water. Well No. 6 water contained the lowest iron concentrations, which were lower than historical ranges. Well No. 9 water, however, might have even lower concentrations, but samples were not collected during periods of its operation. Even at lower-than-expected influent iron concentrations, arsenic removal was not impacted due mainly to the relatively low levels of arsenic observed in source water.

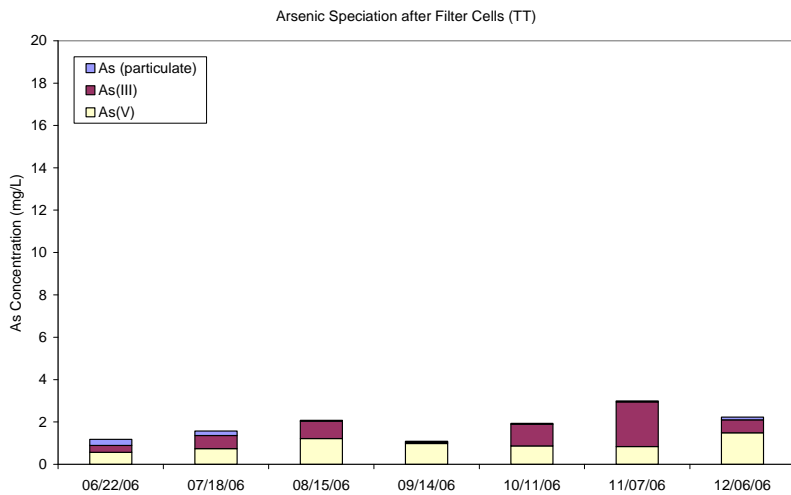
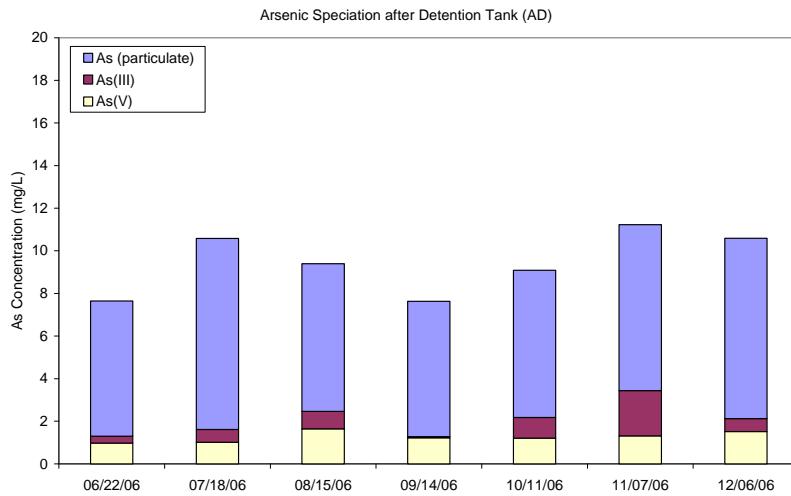
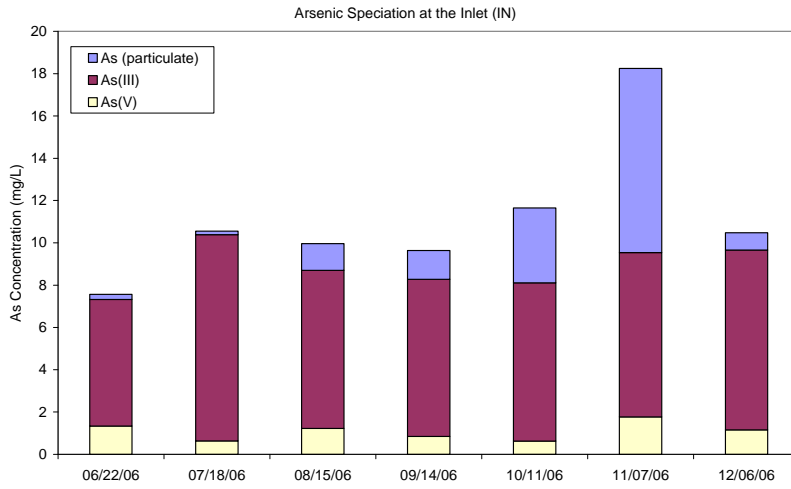

Figure 5-3. Arsenic Speciation Results at Inlet (IN), After Detention Tank (AD), and After Filter Cells (TT)

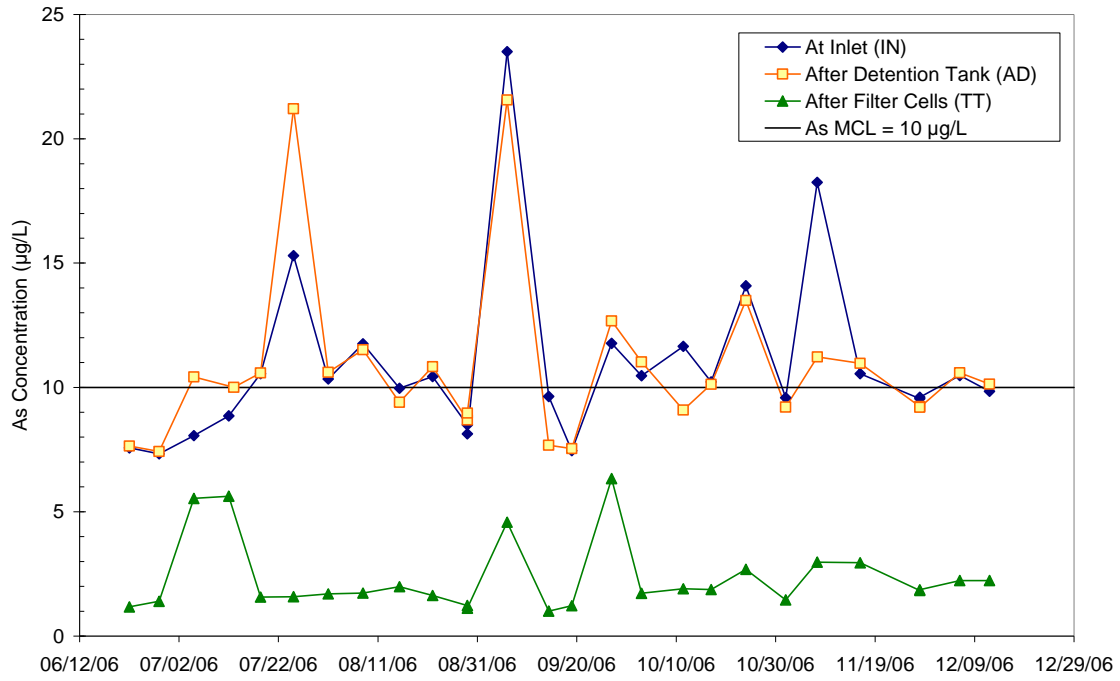

Figure 5-4. Total Arsenic Concentrations Across Treatment Train

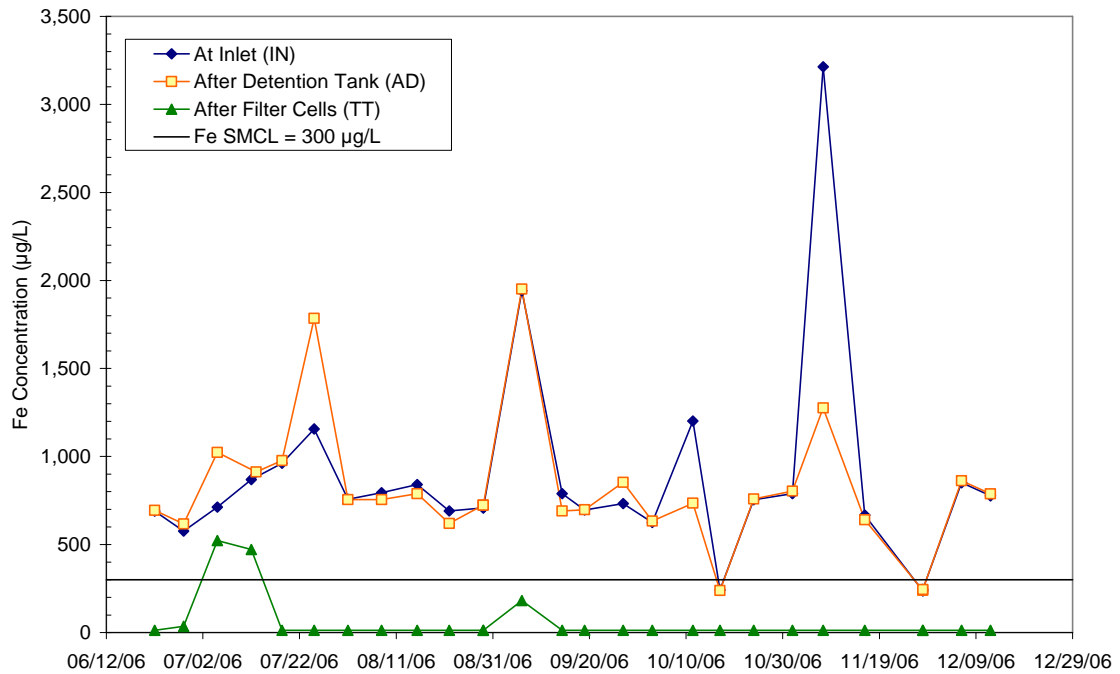

Figure 5-5. Total Iron Concentrations Across Treatment Train

The treated water contained low iron concentrations, mostly near and/or less than the analytical reporting limit of 25 µg/L, except for three exceedances ranging from 182 to 523 µg/L, two of which were above the 300-µg/L secondary maximum contaminant level (SMCL). All soluble iron concentrations were <25 µg/L after prechlorination, detention, and filtration, indicating that the presence of chloramines did not inhibit the complete oxidation of Fe(II). The low iron levels in treated water indicated that iron was effectively removed by the filter and did not buildup significantly between backwash events. A special study will be conducted during the next six months to determine the extent of particulate arsenic and iron breakthrough, if any, between two backwash events and to determine if the backwash frequency may be reduced.

5.2.1.3 Manganese. Figure 5-6 presents total manganese concentrations measured across the treatment train. Manganese concentrations in source water ranged from 21.6 to 30.6 µg/L, which existed primarily in the soluble form as Mn(II) at an average concentration of 26.8 µg/L. With prechlorination and detention time, approximately 57% of the Mn(II) was converted to particulate manganese (i.e., 11.4 µg/L of Mn(II) and 15.4 µg/L of particulate manganese after the detention tank), which was then removed by the filter media. The results indicate that only partial oxidation of Mn(II) was achieved with the presence of chloramines. However, even in the absence of ammonia, previous studies also have found that incomplete oxidation of Mn(II) occurred using free chlorine at pH values less than 8.5 (Knocke et al., 1987 and 1990; Condit and Chen, 2006). Filtration media such as sand and Macrolite® do not remove manganese unless present in the particulate form, so soluble levels after the detention tank were similar to total and soluble levels after the filter cells.

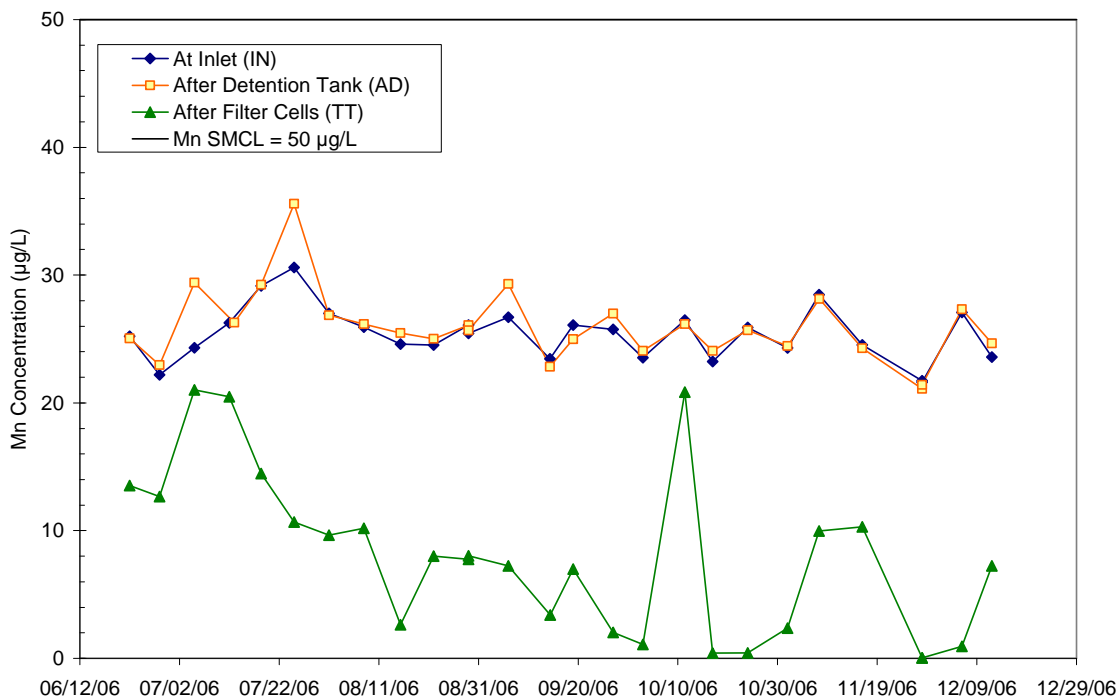

Figure 5-6. Total Manganese Concentrations Across Treatment Train

5.2.1.4 pH, DO, and ORP. pH values of source water ranged from 7.0 to 7.7 and averaged 7.2. This range was comparable to those obtained by Battelle during sampling of Well No. 1 water on September 1,

2004 (i.e., 6.9 and 7.2 [Table 4-1]). Average DO levels at the inlet were relatively low at 1.9 mg/L, and then increased slightly to 2.8 mg/L after the detention tank. Although the air diffuser grid was only used once a week to prevent plugging, some aeration did occur as raw water entered the detention tank. As a result of prechlorination and some aeration, average ORP levels increased from 293 mV in source water to 380 mV after the detention tank. DO and ORP readings in source water were much higher than those measured by Battelle on September 1, 2004 (i.e., 0.5 mg/L and -62 mV, respectively). Some source water samples might have been partially aerated during the demonstration study period.

5.2.1.5 Chlorine and Ammonia. Ammonia concentrations ranged from 0.1 to 0.4 mg/L (as N) across the treatment train and averaged 0.3 mg/L (as N) at the inlet and 0.2 mg/L (as N) after detention and after filtration. Judging by the amount of total chlorine residuals measured after detention and after filtration (see discussion below), ammonia should have been completely oxidized. Note that the reporting limit for ammonia was 0.1 mg/L (as N), which was very close to the average amount (i.e., 0.2 mg/L) measured after chlorine addition and filtration.

Free and total chlorine residuals measured after the detention tank and after the filter cells are presented in Figure 5-7. As shown in the figure, data for total and, especially, free chlorine residuals were widely scattered from 1.3 to 4.7 (3.3 on average) and from 0.1 to 3.1 (0.7 on average) mg/L (as Cl₂), respectively. On several occasions, free chlorine residuals were significantly greater than total (e.g., 3.1 versus 1.7 mg/L [as Cl₂] on July 25, 3.1 versus 0.4 mg/L [as Cl₂] on September 6, 1.9 versus 0.9 mg/L [as Cl₂] on October 11, and 2.5 versus 0.9 mg/L [as Cl₂] on November 1, 2006). These observations, along with the fact that only 2.9 mg/L (as Cl₂), on average, of NaOCl had been added to raw water (Section 5.1.1), suggested that the concentrations measured might have been somewhat higher than the actual concentrations.

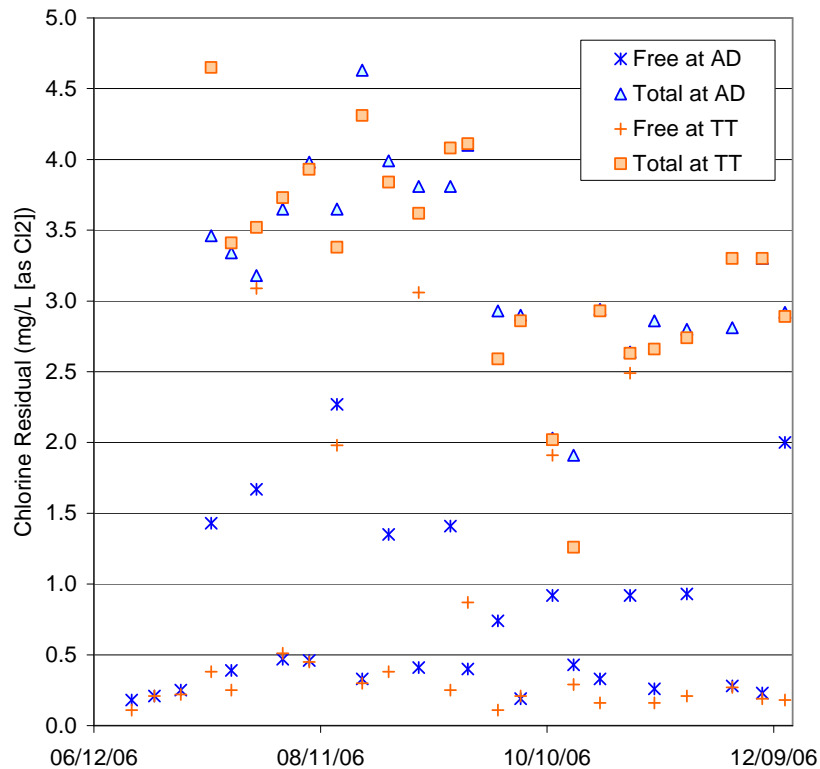

Figure 5-7. Chlorine Residuals Through Treatment System

Considering that 2.9 mg/L (as Cl₂) of NaOCl was applied to raw water, 0.5 mg/L (as Cl₂) would have reacted with As(III), Fe(II), and Mn(II) based on the average amounts (i.e., 7.8, 744, and 26.8 µg/L, respectively) present in raw water (Table 5-3), and 2.4 mg/L (as Cl₂) would have reacted with 0.3 mg/L (as N) of ammonia to form 2.4 mg/L (as Cl₂) of combined chlorine. As such, no free chlorine residuals should have been formed. This decree seems to be supported by the majority of free chlorine data, which showed no more than a few tenth mg/L (as Cl₂) and were very close to the MDL of 0.1 mg/L (as Cl₂).

5.2.1.6 Other Water Quality Parameters. Alkalinity, fluoride, sulfate, nitrate, phosphorus, silica, TOC, temperature, and hardness levels remained consistent across the treatment train and were not affected by the treatment process (Table 5-4). Average turbidity decreased from 9.4 to 0.5 NTU with treatment via the removal of particulates.

5.2.2 Backwash Water and Solids Sampling. Table 5-5 presents the analytical results of the backwash water samples along with the minimum, average, and maximum of each parameter for all three cells combined. The pH, TDS, and TSS values of backwash water ranged from 7.4 to 7.7, from 672 to 784 mg/L, and from 52 to 232 mg/L, respectively. The average pH value of backwash water (i.e., 7.5) was somewhat higher than that across the treatment train (i.e., 7.2). Concentrations of total arsenic, iron, and manganese averaged 0.4, 52, and 0.9 mg/L, respectively, with the majority existing as particulate. Assuming that all arsenic was adsorbed onto the iron solids, the arsenic (in µg) to iron (in mg) ratio would have been 8.2 (on average). Applying the average iron, manganese, and arsenic results, approximately 2.59 lb of iron, 0.04 lb of manganese, and 0.02 lb of arsenic would have been produced and discharged in 6,000 gal of backwash wastewater during each backwash cycle.

The solids loading to the sanitary sewer system was further monitored through collection of backwash solids (Section 3.3.5). The analytical results of solids samples collected in October 2006 are presented in Table 5-6. Based on an average TSS concentration of 109 mg/L in backwash water, approximately 3 lb of solids were produced as listed in Table 5-6. The iron, manganese, and arsenic compositions of 2.45 lb, 0.05 lb, and 0.02 lb, respectively, agreed well with the results derived from the water quality data. The calcium composition also was noteworthy at 0.41 lb or 14% of the total solids mass.

5.2.3 Distribution System Water Sampling. Table 5-7 summarizes the results of the distribution system samples. During the baseline sampling, the City was predominantly operating Wells No. 1, 6, 7, and 9 to meet demand. Blended phosphate (85% ortho- and 15% poly-phosphate) also was added at 4 mg/L at the wellheads for iron sequestration and corrosion control. Once the wells were connected to the treatment plant and treatment commenced in June 2006, Well No. 1 was primarily used without phosphate addition. Beginning in October 2006, post-treatment using blended phosphate (25% ortho- and 75% polyphosphate) resumed for corrosion control at 1 to 2 mg/L.

Average arsenic concentrations improved from 7.1 to 7.6 µg/L at baseline to 2.9 to 3.1 µg/L after the system startup and similarly for iron from 120 to 626 µg/L to <25 to 42 µg/L at the three locations. Alkalinity and pH increased and decreased, respectively, at DS2 and DS3 compared to baseline levels. Lead and manganese concentrations remained fairly consistent and did not appear to be affected by the treatment system; average copper concentrations increased from 129 to 263 µg/L to 396 to 699 µg/L. Explanations for this increase are not apparent due to uncertainties of water sources during baseline sampling and changes to the post-treatment chemicals. The water in the distribution system was comparable to that of the treatment system effluent for arsenic and iron, so the treatment system appeared to have beneficial effects on these parameters since they decreased significantly.

Table 5-5. Backwash Water Results

Sampling Event	Cell 1										Cell 2										Cell 3										
	pH	TDS	TSS	Total As	Soluble As	Particulate As	Total Fe	Soluble Fe	Total Mn	Soluble Mn	pH	TDS	TSS	Total As	Soluble As	Particulate As	Total Fe	Soluble Fe	Total Mn	Soluble Mn	pH	TDS	TSS	Total As	Soluble As	Particulate As	Total Fe	Soluble Fe	Total Mn	Soluble Mn	
No.	Date	S.U.	mg/L	mg/L	µg/L	µg/L	µg/L	µg/L	µg/L	µg/L	S.U.	mg/L	mg/L	µg/L	µg/L	µg/L	µg/L	µg/L	µg/L	µg/L	S.U.	mg/L	mg/L	µg/L	µg/L	µg/L	µg/L	µg/L	µg/L	µg/L	
1	06/28/06	7.7	718	232	702	3.1	699	199,191	48.7	1,355	16.2	7.6	742	190	524	3.3	521	72,171	77.2	1,003	17.1	7.6	714	172	485	3.3	482	77,198	80.3	932	17.0
2	07/26/06	7.5	756	156	420	2.2	418	53,399	<25	1,023	15.2	7.5	784	128	400	2.2	398	49,488	<25	946	11.0	7.5	770	88	326	2.1	324	39,039	<25	750	13.8
3	08/29/06	7.5	718	58	244	2.4	241	27,856	85.6	648	11.5	7.6	728	62	245	2.5	242	27,144	105	649	10.8	7.6	748	52	237	2.5	235	26,205	81.4	630	11.9
4	09/27/06	7.6	748	74	293	6.9	286	28,795	97.1	798	12.7	7.6	708	86	290	6.7	283	28,746	96.4	822	8.2	7.6	756	84	316	7.0	309	30,684	86.6	878	7.0
5	10/25/06	7.5	726	84	393	3.9	390	42,151	80.8	905	9.5	7.6	700	88	419	4.0	415	45,934	102	950	10.4	7.5	694	84	356	3.5	352	42,651	85.1	829	8.0
6	12/11/06	7.4	700	114	449	3.4	446	45,637	45.8	914	9.7	7.5	672	102	515	3.6	512	50,148	52.2	1,016	8.4	7.5	674	104	447	4.1	443	43,409	114	840	10.1
All Cells Combined	Minimum										Average										Maximum										
	7.4	672	52	237	2.1	235	26,205	<25	630	7.0	7.5	725	109	392	3.7	389	51,658	70.8	883	11.6	7.7	784	232	702	7.0	699	199,191	114	1,355	17.1	

Table 5-6. Backwash Solids Results

Filter	Mg mg/g	Al mg/g	Si µg/g	P mg/g	Ca mg/g	Fe mg/g	Mn mg/g	Ni µg/g	Cu µg/g	Zn µg/g	As mg/g	Cd µg/g	Pb µg/g	As/Fe µg/g
Cell 1	6.4	1.3	225	1.3	89.3	449	10.2	9.4	22.5	203	3.8	<0.1	4.2	8.5
Cell 2	5.5	1.2	330	1.3	66.3	466	9.9	11.1	19.0	198	3.8	<0.1	4.5	8.2
Cell 3	6.2	1.2	197	1.3	68.1	435	9.4	8.3	49.7	243	3.5	<0.1	5.6	8.1
Average	6.1	1.2	251	1.3	74.6	450	9.8	9.6	30.4	215	3.7	<0.1	4.8	8.2

Table 5-7. Distribution System Sampling Results

Sampling Event		DS1								DS2 ^(a)								DS3 ^(b)							
		LCR								LCR								LCR							
		1st draw								1st draw								1st draw							
		Stagnation Time	pH	Alkalinity	As	Fe	Mn	Pb	Cu	Stagnation Time	pH	Alkalinity	As	Fe	Mn	Pb	Cu	Stagnation Time	pH	Alkalinity	As	Fe	Mn	Pb	Cu
No.	Date	hr	S.U.	mg/L	µg/L	µg/L	µg/L	µg/L	µg/L	hr	S.U.	mg/L	µg/L	µg/L	µg/L	µg/L	µg/L	hr	S.U.	mg/L	µg/L	µg/L	µg/L	µg/L	µg/L
BL1	02/23/05	10.5	7.5	270	6.3	168	9.4	0.3	113	8.5	7.9	225	8.8	149	3.2	0.4	272	7.0	7.8	225	9.0	63.3	4.3	0.7	224
BL2	03/22/05	8.5	7.8	333	5.0	587	14.9	0.9	152	11.8	7.7	311	6.5	235	13.8	0.2	159	7.0	7.5	320	8.2	138	5.5	1.1	265
BL3	04/26/05	8.8	7.2	326	7.7	534	19.7	5.6	57.3	14.8	7.4	330	8.2	530	27.7	0.5	253	8.0	7.5	286	6.6	186	3.6	2.2	349
BL4	06/01/05	9.0	7.2	312	9.5	1,214	21.7	3.2	193	14.3	7.4	321	7.0	424	21.3	0.4	262	7.0	7.7	223	5.5	92.1	2.5	0.8	213
Average		-	7.4	310	7.1	626	16.4	2.5	129	-	7.6	297	7.6	335	16.5	0.4	236	-	7.7	264	7.3	120	4.0	1.2	263
1	07/13/06 ^(c,d)	8.0	7.4	306	2.5	128	16.5	1.2	910	13.1	7.3	310	2.8	158	19.4	0.2	453	8.0	7.3	314	2.0	<25	16.0	1.0	491
2	08/08/06 ^(d)	8.3	7.5	302	3.7	<25	13.9	1.0	418	14.5	7.5	302	3.6	<25	15.8	0.5	382	7.8	7.5	298	3.6	<25	15.3	1.1	473
3	09/06/06 ^(d)	9.3	7.4	331	2.6	<25	5.1	0.1	406	14.6	7.4	335	2.8	<25	4.8	<0.1	324	7.8	7.3	326	2.8	<25	11.0	0.3	355
4	10/31/06	22.0	7.3	335	2.6	<25	4.1	<0.1	922	12.8	7.3	346	2.5	<25	5.4	<0.1	520	8.0	7.2	333	3.1	<25	0.5	0.1	275
5	11/29/06	9.0	7.3	314	3.1	<25	6.4	0.3	840	14.1	7.2	342	3.3	<25	4.9	0.1	505	7.0	7.4	320	4.0	<25	0.5	0.2	384
Average		-	7.4	318	2.9	35.6	9.2	0.5	699	-	7.3	327	3.0	41.5	10.0	0.2	437	-	7.4	318	3.1	<25	8.7	0.6	396

(a) BL1 collected from different location with water softener present.

(b) Water softener present at this location.

(c) Fe and As treatment plant results also elevated for 07/12/06 possibly due to inadequate backwash.

(d) No PO₄ addition to treated water.

BL = baseline sampling; NA = not available.

Lead action level = 15 µg/L; copper action level = 1.3 mg/L.

Alkalinity measured in mg/L as CaCO₃.

5.3 Building and System Cost

5.3.1 Building Cost. A 60 $\frac{2}{3}$ -ft \times 31 $\frac{1}{3}$ -ft building with sidewall and roof peak heights of 19 $\frac{1}{3}$ and 27 $\frac{1}{2}$ ft, respectively, was constructed by the City to house the treatment system and provide space for two additional systems to meet the State's firm capacity requirements and City's future expansion needs (Section 4.3.2). The total cost for the building construction, site improvements (including sanitary sewer service and holding tanks), water system telemetry, well connections (to the treatment systems) and improvements, and Unit 2 installation, was \$663,654, which reflects some price escalation resulting from the aftermath of hurricane Katrina. This cost was not included in the capital cost or used to evaluate the system cost because the work was outside of the scope of this demonstration project and funded separately by the City.

5.3.2 System Cost. The system cost was evaluated based on the capital cost per gpm (or gpd) of design capacity and the O&M cost per 1,000 gal of water treated. The total capital investment cost for the AERALATER[®] unit was \$364,916 consisting of \$330,374 (from EPA) for the proposed 10-ft diameter unit plus \$34,542 (from the City) for upgrade to the 12-ft diameter unit (Table 5-8). The equipment cost of \$205,800 (or 56% of the total) included cost for the detention tank and three-cell filter, process valves and piping, 157 ft³ of sand, two chemical feed systems, an air diffuser grid and other ancillary equipment, instrumentation and controls, labor, and freight. The system warranty was also included in the cost, which covered repair and replacement of any defective components for one year after the system startup.

The engineering cost covered the cost for preparing the required system permit application submittal by TE, including system general arrangement, electrical and mechanical drawings, component specifications, connections to the entry piping and the City's water distribution and sanitary sewer systems, and obtaining the required approval from MDEQ. The engineering cost of \$27,077 was 7% of the total capital investment.

The installation, shakedown, and startup cost covered the labor and materials required to unload, install, paint, and test the system for proper operation. All installation activities were performed by Franklin Holwerda Co. and Blank Electric Co., both subcontracted to TE. All startup and shakedown activities were performed by Siemens, TE, and TE's subcontractors with the operator's assistance. The installation, startup, and shakedown cost of \$132,039 was 36% of the total capital investment.

The total capital cost of \$364,916 was normalized to \$1,073/gpm (\$0.75/gpd) of design capacity using the system's rated capacity of 340 gpm (or 489,600 gpd). The total capital cost also was converted to a unit cost of \$0.19/1,000 gal using a capital recovery factor (CRF) of 0.09439 based on a 7% interest rate, a 20-yr return period, and full-time system operation at the rated capacity. Since the system produced only 29,406,000 gal of water during the six-month period, the total unit cost increased to \$0.59/1,000 gal.

5.3.3 O&M Cost. O&M cost included electricity consumption and labor for a combined unit cost of \$0.24/1,000 gal (Table 5-9). No cost was incurred for repairs or chemicals since chlorination was already performed prior to the demonstration study. Electrical power consumption was calculated based on the difference between the average monthly cost from electric bills before and after building construction and system startup. The difference in cost was approximately \$884/month or \$0.18/1,000 gal of water treated. The routine, non-demonstration related labor activities consumed 30 min/day (Section 5.1.4.3). Based on this time commitment and a labor rate of \$18/hr, the labor cost was \$0.06/1,000 gal of water treated.

Table 5-8. Capital Investment for Siemens' AERALATER® System

Description	Cost	% of Capital Investment Cost
<i>Equipment</i>		
Detention Tank and Filter Cells	\$64,100	–
Process Valves, Piping, and Air Diffuser Grid	\$13,431	–
Silica Sand Media (157 ft ³)	\$883	–
Instrumentation and Controls	\$44,882	–
High Service Pump, Compressor Pack, and Blower	\$11,435	–
Chemical Feed Systems	\$2,314	–
Sample Taps and Totalizers/Meters	\$1,571	–
Siemens' Labor	\$34,978	–
Freight	\$6,460	–
Equipment Surcharge for Upgrade	\$25,746	–
Subtotal	\$205,800	56%
<i>Engineering</i>		
Siemens Labor	\$11,077	–
TE Labor	\$16,000	–
Subtotal	\$27,077	7%
<i>Installation, Shakedown, and Startup</i>		
Installation Material	\$15,120	–
TE Labor for Installation	\$24,126	–
Subcontractor Labor for Installation	\$66,380	–
Installation Surcharge for Upgrade	\$8,796	–
Siemens Labor and Travel for Shakedown/Startup	\$17,617	–
Subtotal	\$132,039	36%
<i>Total Cost for 12-ft Diameter System</i>		
10-ft Diameter System	\$330,374	91%
Upgrade to 12-ft Diameter System	\$34,542	9%
Capital Investment Total	\$364,916	100%

Table 5-9. O&M Cost for Siemens' AERALATER® System

Category	Value	Remarks
Volume Processed (1,000 gal)	29,406	From 06/14/06 through 12/14/06
<i>Chemical Usage</i>		
Chemical Cost (\$/1,000 gal)	\$0.00	No incremental NaOCl consumption; iron addition not required
<i>Electricity Consumption</i>		
Electricity Cost (\$/month)	\$884.00	Average incremental consumption after system startup including building heating and lighting
Electricity Cost (\$/1,000 gal)	\$0.18	
<i>Labor</i>		
Labor (hr/week)	3.5	30 min/day, 7 day/week
Labor Cost (\$/1,000 gal)	\$0.06	Labor rate = \$18/hr
Total O&M Cost (\$/1,000 gal)	\$0.24	-

Section 6.0 REFERENCES

- Battelle. 2004. *Quality Assurance Project Plan for Evaluation of Arsenic Removal Technology*. Prepared under Contract No. 68-C-00-185, Task Order No. 0029, for U.S. Environmental Protection Agency, National Risk Management Research Laboratory, Cincinnati, OH.
- Battelle. 2005. *System Performance Evaluation Study Plan: U.S. EPA Demonstration of Arsenic Removal Technology Round 2 at Sandusky, Michigan*. Prepared under Contract No. 68-C-00-185, Task Order No. 0029, for U.S. Environmental Protection Agency, National Risk Management Research Laboratory, Cincinnati, OH.
- Chen, A.S.C., L. Wang, J.L. Oxenham, and W.E. Condit. 2004. *Capital Costs of Arsenic Removal Technologies: U.S. EPA Arsenic Removal Technology Demonstration Program Round 1*. EPA/600/R-04/201. U.S. Environmental Protection Agency, National Risk Management Research Laboratory, Cincinnati, OH.
- Clark, J.W., W. Viessman, and M.J. Hammer. 1977. *Water Supply and Pollution Control*. IEP, a Dun-Donnelley Publisher, New York, NY.
- Condit, W.E. and A.S.C. Chen. 2006. *Arsenic Removal from Drinking Water by Iron Removal, U.S. EPA Demonstration Project at Climax, MN, Final Performance Evaluation Report*. EPA/600/R-06/152. U.S. Environmental Protection Agency, National Risk Management Research Laboratory, Cincinnati, OH.
- Edwards, M., S. Patel, L. McNeill, H. Chen, M. Frey, A.D. Eaton, R.C. Antweiler, and H.E. Taylor. 1998. "Considerations in As Analysis and Speciation." *J. AWWA*, 90(3): 103-113.
- EPA. 2006. *Initial Distribution System Evaluation Guidance Manual for the Final Stage 2 Disinfectants and Disinfection Byproducts Rule*. EPA/815/B-06/002. U.S. Environmental Protection Agency, Office of Water, Washington, D.C.
- EPA. 2003. Minor Clarification of the National Primary Drinking Water Regulation for Arsenic. *Federal Register*, 40 CFR Part 141.
- EPA. 2002. *Lead and Copper Monitoring and Reporting Guidance for Public Water Systems*. EPA/816/R-02/009. U.S. Environmental Protection Agency, Office of Water, Washington, D.C.
- EPA. 2001. National Primary Drinking Water Regulations: Arsenic and Clarifications to Compliance and New Source Contaminants Monitoring. *Federal Register*, 40 CFR Parts 9, 141, and 142.
- Frank, P.L. and D.A. Clifford. 1986. *Arsenic (III) Oxidation and Removal from Drinking Water*. EPA/600/S2-86/021. U.S. Environmental Protection Agency, Water Engineering Research Laboratory, Cincinnati, OH.
- Ghurye, G.L. and D.A. Clifford. 2001. *Laboratory Study on the Oxidation of Arsenic III to Arsenic V*. EPA/600/R-01/021. U.S. Environmental Protection Agency, National Risk Management Research Laboratory, Cincinnati, OH.
- Knocke, W.R., R.C. Hoehn, and R.L. Sinsabaugh. 1987. "Using Alternative Oxidants to Remove Dissolved Manganese From Waters Laden With Organics." *J. AWWA*, 79(3): 75-79.

Knocke, W.R., J.E. Van Benschoten, M. Kearney, A. Soborski, and D.A.Reckhow. 1990. "Alternative Oxidants for the Removal of Soluble Iron and Mn." AWWA Research Foundation, Denver, CO.

MDEQ. 2006. *Operator Training and Certification*. Website:
<http://www.michigan.gov/deqoperatortraining>.

Siemens Water Technologies. 2006. *Multiwash Enhanced Type II AERALATER Packaged Iron and Arsenic Removal Unit – City of Sandusky Water Treatment Plant, Sandusky, Michigan: Operation and Maintenance Manual*.

Sorg, T.J. 2002. "Iron Treatment for Arsenic Removal Neglected." *Opflow*, 28(11): 15.

Wang, L., W.E. Condit, and A.S.C. Chen. 2004. *Technology Selection and System Design: U.S. EPA Arsenic Removal Technology Demonstration Program Round 1*. EPA/600/R-05/001. U.S. Environmental Protection Agency, National Risk Management Research Laboratory, Cincinnati, OH.

APPENDIX A
OPERATIONAL DATA

US EPA Arsenic Demonstration Project at Sandusky, MI - Daily System Operation

Week No.	Date	Time	12.5% Cl ₂ Usage lb	Inlet Flow			Effluent Flow				Head Loss ft H ₂ O	Backwash		
				Flow rate gpm	Meter kgal	Daily Flow kgal	Flow rate gpm	Meter kgal	Daily Flow kgal	Cum. Flow kgal		Elapsed Volume kgal	Cum. Volume kgal	Kgal/event
1	06/14/06	7:00	25	185	4386	225	139	4451	225	NA	1.5	365	71.7	NA
	06/15/06	7:00	28	260	4643	257	312	4712	261	261	1.5	251	NR	NA
	06/16/06	7:00	26	261	4895	252	311	4969	257	518	2.0	507	77.6	NA
	06/17/06	7:00	NA	182	5179	284	164	5258	289	807	1.5	276	NR	NA
	06/18/06	7:00	27	185	5398	219	141	5482	224	1031	1.5	500	83.4	NA
2	06/19/06	7:00	29	186	5621	223	223	5708	226	1257	1.5	76	89.4	6.0
	06/20/06	7:00	20	187	5804	183	232	5891	183	1440	1.5	172	NR	NA
	06/21/06	7:00	28	188	6050	246	242	6143	252	1692	1.5	424	NR	NA
	06/22/06	7:00	11	267	6152	102	283	6248	105	1797	1.5	88	101.9	NA
	06/23/06	7:00	12	0	6261	109	0	6359	111	1908	NA	20	107.9	6.0
	06/24/06	7:00	NA	189	6506	245	236	6606	247	2155	1.5	238	NR	NA
06/25/06	7:00	28	190	6727	221	131	6833	227	2382	1.5	464	NR	NA	
3	06/26/06	7:01	35	266	6992	265	316	7103	270	2652	1.5	NR	107.9	NA
	06/27/06	6:57	35	0	7262	270	0	7379	276	2928	NA	638	113.9	6.0
	06/28/06	6:49	37	264	7531	269	301	7654	275	3203	1.5	363	113.9	NA
	06/29/06	7:02	19	240	7668	137	0	7790	136	3339	NA	809	125.5	11.6
	06/30/06	7:06	19	0	7792	124	0	7917	127	3466	NA	682	125.5	NA
	07/01/06	7:11	20	136	7913	121	137	8038	121	3587	1.4	780	131.4	5.9
	07/02/06	7:10	18	0	8028	115	0	8156	118	3705	NA	662	131.4	NA
4	07/03/06	7:00	19	0	8144	116	0	8274	118	3823	NA	355	131.4	NA
	07/04/06	7:00	25	0	8263	119	0	8395	121	3944	NA	778	137.3	5.9
	07/05/06	7:00	21	131	8379	116	121	8513	118	4062	1.5	660	137.3	NA
	07/06/06	7:00	22	0	8517	138	235	8652	139	4201	1.5	769	143.1	5.8
	07/07/06	7:00	21	0	8650	133	0	8788	136	4337	NA	632	143.1	NA
	07/08/06	7:00	NA	118	8792	142	127	8931	143	4480	1.3	756	148.9	5.8
07/09/06	7:00	27	0	8934	142	0	9077	146	4626	NA	610	148.9	NA	
5	07/10/06	7:15	26	0	9065	131	0	9211	134	4760	NA	476	148.9	NA
	07/11/06	7:00	22	76	9149	84	0	9293	82	4842	NA	817	154.8	5.9
	07/12/06	7:00	24	76	9246	97	0	9392	99	4941	NA	718	154.8	NA
	07/13/06	7:00	30	191	9381	135	296	9528	136	5077	1.5	767	160.6	5.8
	07/14/06	7:00	26	185	9522	141	268	9671	143	5220	1.5	624	160.6	NA
	07/15/06	7:00	29	188	9712	190	116	9865	194	5414	1.3	709	166.4	5.8
07/16/06	7:00	25	0	9884	172	0	41	176	5590	NA	533	166.4	NA	
6	07/17/06	7:13	33	187	10802	NA	218	14183	NA	NA	1.6	NA	166.4	NA
	07/18/06	7:00	39	187	11043	241	122	14419	NA	NA	1.5	669	172.3	5.9
	07/19/06	6:57	40	188	11280	237	264	14087	NA	NA	1.7	432	172.3	NA
	07/20/06	6:57	44	184	11516	236	238	14316	NA	NA	1.5	680	178.1	5.8
	07/21/06	7:01	NA	75	11623	107	110	14560	NA	NA	1.5	573	178.1	NA
	07/22/06	6:39	32	75	11734	111	75	14818	NA	NA	1.4	799	183.9	5.8
07/23/06	6:48	30	75	11830	96	0	15059	NA	NA	NA	704	183.9	NA	
7	07/24/06	7:00	30	92	1156	NA	110	1336	NA	6885	1.5	601	183.9	NA
	07/25/06	7:00	35	90	1299	143	56	1480	144	7029	1.4	767	189.9	6.0
	07/26/06	7:00	35	94	1429	130	110	1613	133	7162	1.5	634	189.9	NA
	07/27/06	7:00	31	239	1545	116	0	1729	116	7278	NA	790	195.6	5.7
	07/28/06	7:00	36	115	1717	172	117	1904	175	7453	1.4	615	195.6	NA
	07/29/06	7:00	38	0	1923	206	0	2114	210	7663	NA	705	201.4	5.8
07/30/06	7:00	37	0	2116	193	0	2311	197	7860	NA	508	201.4	NA	
8	07/31/06	7:00	31	281	2286	170	306	2485	174	8034	1.5	334	201.4	NA
	08/01/06	7:03	40	178	2496	210	236	2699	214	8248	1.5	699	207.2	5.8
	08/02/06	7:06	32	213	2667	171	273	2860	161	8409	1.5	761	213.0	5.8
	08/03/06	7:04	37	198	2854	187	0	3050	190	8599	NA	722	219.0	6.0
	08/04/06	6:56	32	0	3020	166	0	3221	171	8770	NA	551	219.0	NA
	08/05/06	7:12	35	0	3198	178	0	3401	180	8950	NA	727	224.8	5.8
08/06/06	7:14	28	152	3340	142	153	3545	144	9094	1.5	583	224.8	NA	

US EPA Arsenic Demonstration Project at Sandusky, MI - Daily System Operation

Week No.	Date	Time	12.5% Cl ₂ Usage lb	Inlet Flow			Effluent Flow				Head Loss ft H ₂ O	Backwash		
				Flow rate gpm	Meter kgal	Daily Flow kgal	Flow rate gpm	Meter kgal	Daily Flow kgal	Cum. Flow kgal		Elapsed Volume kgal	Cum. Volume kgal	Kgal/ event
9	08/07/06	7:00	28	152	3477	137	202	3686	141	9235	1.5	442	224.8	NA
	08/08/06	7:00	34	0	3647	170	0	3859	173	9408	NA	734	230.0	5.2
	08/09/06	7:00	34	175	3818	171	108	4033	174	9582	1.5	560	230.0	NA
	08/10/06	7:00	36	178	3995	177	151	4213	180	9762	1.5	730	236.0	6.0
	08/11/06	7:00	35	0	4158	163	0	4380	167	9929	NA	563	236.0	NA
	08/12/06	7:00	26	0	4308	150	0	4530	150	10079	NA	754	242.0	6.0
	08/13/06	7:00	37	120	4423	115	200	4648	118	10197	1.5	636	242.0	NA
10	08/14/06	7:00	29	121	4539	116	211	4765	117	10314	1.5	519	242.2	NA
	08/15/06	7:00	29	0	4640	101	0	4867	102	10416	NA	804	248.0	5.8
	08/16/06	7:00	38	0	4823	183	0	5052	185	10601	NA	768	253.8	5.8
	08/17/06	7:15	52	270	5095	272	314	5329	277	10878	1.5	645	259.7	5.9
	08/18/06	7:00	42	224	5533	438	192	5296	NA	10845	1.5	441	259.7	NA
	08/19/06	7:00	42	0	5730	197	0	5490	194	11039	NA	712	265.5	5.8
	08/20/06	7:00	35	170	5898	168	0	5654	164	11203	NA	544	265.5	NA
11	08/21/06	7:00	37	0	5817	NA	0	6065	NA	11614	NA	377	265.5	NA
	08/22/06	7:00	43	169	6018	201	234	6260	195	11809	1.5	708	271.4	5.9
	08/23/06	7:00	41	0	6201	183	0	6455	195	12004	NA	513	271.4	NA
	08/24/06	7:10	42	172	6383	182	154	6639	184	12188	1.5	721	277.2	5.8
	08/25/06	7:09	41	171	6566	183	177	6826	187	12375	1.5	534	277.2	NA
	08/26/06	6:43	37	0	6732	166	0	6994	168	12543	NA	739	283.1	5.9
	08/27/06	6:30	40	171	6902	170	256	7167	173	12716	1.6	566	283.1	NA
12	08/28/06	7:13	38	168	7064	162	0	7332	165	12881	NA	401	283.1	NA
	08/29/06	7:14	39	170	7512	NA	153	7512	180	13061	1.5	720	288.9	5.8
	08/30/06	7:18	40	91	7392	NA	89	7664	152	13213	1.5	754	294.8	5.9
	08/31/06	7:12	40	76	7534	142	89	7807	143	13356	1.4	611	294.8	NA
	09/01/06	6:49	39	76	7671	137	0	7947	140	13496	NA	471	294.8	NA
	09/02/06	7:02	42	60	7787	116	180	8063	116	13612	1.5	789	300.6	5.8
	09/03/06	6:45	38	60	7868	81	0	8144	81	13693	NA	708	300.6	NA
13	09/04/06	7:15	37	61	7952	84	172	8228	84	13777	1.5	624	300.6	NA
	09/05/06	7:00	38	0	8042	90	0	8317	89	13866	NA	812	306.5	5.9
	09/06/06	7:00	36	0	8199	157	0	8477	160	14026	NA	652	306.5	NA
	09/07/06	7:00	33	225	8319	120	260	8598	121	14147	1.5	778	312.4	5.9
	09/08/06	7:00	36	160	8430	111	225	8710	112	14259	1.4	895	318.2	5.8
	09/09/06	7:00	34	118	8561	131	0	8845	135	14394	NA	760	318.2	NA
	09/10/06	7:00	27	119	8667	106	206	8952	107	14501	1.5	653	318.2	NA
14	09/11/06	7:00	30	117	8783	116	220	9068	116	14617	1.5	897	324.1	5.9
	09/12/06	7:00	40	117	8993	210	171	9282	214	14831	1.5	683	324.1	NA
	09/13/06	7:00	39	116	9172	179	198	9462	180	15011	1.5	898	329.9	5.8
	09/14/06	7:00	31	116	9295	123	231	9587	125	15136	1.5	772	329.9	NA
	09/15/06	7:00	29	117	9402	107	0	9694	107	15243	NA	898	335.8	5.9
	09/16/06	7:00	32	0	9526	124	0	9820	126	15369	NA	772	335.8	NA
	09/17/06	7:00	28	0	9639	113	0	9935	115	15484	NA	657	335.8	NA
15	09/18/06	7:00	24	117	9744	105	219	40	105	15589	1.5	896	341.7	5.9
	09/19/06	7:15	26	162	9901	157	279	199	159	15748	1.5	899	344.4	2.7
	09/20/06	7:05	25	87	44	143	120	344	145	15893	1.5	896	347.6	3.2
	09/21/06	7:00	13	0	190	146	0	492	148	16041	NA	775	349.5	1.9
	09/22/06	7:00	23	74	325	135	181	632	140	16181	1.5	635	349.5	NA
	09/23/06	7:00	21	79	482	157	102	789	157	16338	1.5	772	355.3	5.8
	09/24/06	7:00	22	79	607	125	93	913	124	16462	1.5	648	355.3	NA
16	09/25/06	7:00	34	283	721	114	0	1033	120	16582	NA	528	355.3	NA
	09/26/06	7:00	33	170	867	146	241	1179	146	16728	1.5	753	361.2	5.9
	09/27/06	7:00	36	284	1030	163	0	1346	167	16895	NA	586	366.1	4.9
	09/28/06	7:10	40	97	1220	190	106	1539	193	17088	1.5	706	367.3	1.2
	09/29/06	7:00	40	158	1376	156	136	1698	159	17247	1.5	547	367.3	NA
	09/30/06	7:00	40	80	1559	183	0	1882	184	17431	NA	899	379.3	12.0
10/01/06	7:00	34	80	1679	120	91	2005	123	17554	1.5	776	379.3	NA	

US EPA Arsenic Demonstration Project at Sandusky, MI - Daily System Operation

Week No.	Date	Time	12.5% Cl ₂ Usage	Inlet Flow			Effluent Flow				Head Loss	Backwash		
				Flow rate	Meter	Daily Flow	Flow rate	Meter	Daily Flow	Cum. Flow		Elapsed Volume	Cum. Volume	Kgal/event
				gpm	kgal	kgal	gpm	kgal	kgal	kgal		ft H ₂ O	kgal	kgal
17	10/02/06	7:00	32	160	1798	119	0	2125	120	17674	NA	897	385.2	5.9
	10/03/06	7:00	31	0	2006	208	0	2338	213	17887	NA	684	385.2	NA
	10/04/06	7:00	30	0	2210	204	0	2546	208	18095	NA	899	391.1	5.9
	10/05/06	7:00	30	260	2419	209	307	2758	212	18307	1.5	687	391.1	NA
	10/06/06	7:00	27	0	2584	165	0	2928	170	18477	NA	899	396.9	5.8
	10/07/06	7:00	27	0	2775	191	0	3121	193	18670	NA	706	396.9	NA
10/08/06	7:00	22	177	2913	138	87	3262	141	18811	0.3	565	396.9	NA	
18	10/09/06	7:00	25	170	3060	147	112	3412	150	18961	1.5	898	402.9	6.0
	10/10/06	7:11	27	173	3258	198	248	3613	201	19162	1.5	697	402.9	NA
	10/11/06	7:07	30	167	3451	193	224	3809	196	19358	1.4	896	408.8	5.9
	10/12/06	7:14	30	173	3651	200	105	4015	206	19564	1.5	691	408.8	NA
	10/13/06	7:12	29	144	3833	182	159	4200	185	19749	1.5	506	408.8	NA
	10/14/06	6:59	35	78	4007	174	179	4376	176	19925	1.5	734	414.6	5.8
10/15/06	6:50	31	78	4117	110	126	4489	113	20038	NA	622	414.6	NA	
19	10/16/06	7:00	30	95	4234	117	136	4607	118	20156	1.5	504	414.6	NA
	10/17/06	7:00	34	95	4418	184	91	4796	189	20345	0.8	719	420.6	6.0
	10/18/06	7:00	36	158	4598	180	105	4979	183	20528	1.3	536	420.6	NA
	10/19/06	7:00	37	97	4792	194	106	5178	199	20727	1.3	710	426.5	5.9
	10/20/06	7:00	35	97	4985	193	133	5375	197	20924	1.3	513	426.5	NA
	10/21/06	7:00	35	95	5170	185	0	5564	189	21113	NA	716	432.3	5.8
10/22/06	7:00	33	95	5316	146	0	5713	149	21262	NA	567	432.3	NA	
20	10/23/06	7:00	29	96	5441	125	102	5840	127	21389	0.7	440	432.3	NA
	10/24/06	7:00	31	0	5615	174	0	6017	177	21566	NA	728	438.3	6.0
	10/25/06	7:00	29	147	5784	169	49	6189	172	21738	0.7	556	438.3	NA
	10/26/06	7:00	30	149	5961	177	208	6368	179	21917	1.5	732	444.2	5.9
	10/27/06	7:00	32	80	6126	165	77	6537	169	22086	0.8	564	444.2	NA
	10/28/06	7:00	36	80	6289	163	87	6703	166	22252	0.7	741	450.0	5.8
10/29/06	7:00	30	81	6395	106	83	6811	108	22360	0.7	633	450.0	NA	
21	10/30/06	7:03	29	282	6505	110	0	6923	112	22472	NA	521	452.0	2.0
	10/31/06	7:11	31	264	6684	179	245	7103	180	22652	1.5	919	456.0	4.0
	11/01/06	6:52	28	257	6849	165	225	7273	170	22822	1.5	549	456.0	NA
	11/02/06	7:08	32	258	7032	183	170	7458	185	23007	1.5	716	461.9	5.9
	11/03/06	6:56	28	151	7203	171	80	7633	175	23182	1.5	541	461.9	NA
	11/04/06	7:06	31	0	7400	197	0	7833	200	23382	NA	699	467.0	5.1
11/05/06	7:07	23	0	7531	131	0	7967	134	23516	NA	565	467.0	NA	
22	11/06/06	7:00	24	171	7669	138	176	8108	141	23657	1.5	424	467.7	0.7
	11/07/06	7:08	31	143	7849	180	151	8293	185	23842	1.5	728	473.7	6.0
	11/08/06	7:02	27	304	8018	169	229	8466	173	24015	0.3	555	473.7	NA
	11/09/06	7:03	29	170	8206	188	174	8657	191	24206	1.5	722	479.6	5.9
	11/10/06	7:16	29	160	8390	184	185	8844	187	24393	1.5	534	479.6	NA
	11/11/06	7:15	25	0	8539	149	0	8995	151	24544	NA	756	485.5	5.9
11/12/06	7:04	26	173	8676	137	175	9135	140	24684	1.5	616	485.5	NA	
23	11/13/06	7:00	24	174	8811	135	180	9273	138	24822	1.5	478	485.5	NA
	11/14/06	7:00	28	0	8973	162	0	9438	165	24987	NA	744	491.4	5.9
	11/15/06	7:00	29	0	9155	182	0	9625	187	25174	NA	557	491.4	NA
	11/16/06	7:00	27	173	9327	172	181	9798	173	25347	1.5	726	497.4	6.0
	11/17/06	7:00	26	151	9492	165	152	9968	170	25517	1.5	556	497.4	NA
	11/18/06	7:00	26	0	9658	166	0	136	168	25685	NA	743	503.3	5.9
11/19/06	7:00	22	0	9772	114	0	252	116	25801	NA	627	503.3	NA	
24	11/20/06	7:00	22	0	9887	115	0	370	118	25919	NA	509	503.3	NA
	11/21/06	7:00	33	98	57	170	106	542	172	26091	1.4	731	509.2	5.9
	11/22/06	7:00	32	79	77	20	78	707	165	26256	1.4	566	509.2	NA
	11/23/06	7:00	28	61	322	245	0	811	104	26360	NA	798	515.2	6.0
	11/24/06	6:46	21	60	396	74	76	885	74	26434	1.4	724	515.2	NA
	11/25/06	7:04	24	62	476	80	87	962	77	26511	1.4	826	521.0	5.8
11/26/06	7:00	24	61	555	79	0	1043	81	26592	NA	745	521.0	NA	

US EPA Arsenic Demonstration Project at Sandusky, MI - Daily System Operation

Week No.	Date	Time	12.5% Cl ₂ Usage lb	Inlet Flow			Effluent Flow				Head Loss ft H ₂ O	Backwash		
				Flow rate gpm	Meter kgal	Daily Flow kgal	Flow rate gpm	Meter kgal	Daily Flow kgal	Cum. Flow kgal		Elapsed Volume kgal	Cum. Volume kgal	Kgal/event kgal
25	11/27/06	7:15	24	60	634	79	80	1121	78	26670	1.4	667	521.0	NA
	11/28/06	7:05	30	189	795	161	192	1286	165	26835	1.4	738	521.0	NA
	11/29/06	7:11	32	78	947	152	82	1440	154	26989	1.4	584	527.0	6.0
	11/30/06	7:05	29	83	1101	154	79	1595	155	27144	1.4	751	532.9	5.9
	12/01/06	7:12	32	80	1261	160	98	1759	164	27308	1.4	587	532.9	NA
	12/02/06	7:16	34	82	1413	152	89	1911	152	27460	1.4	754	538.8	5.9
	12/03/06	7:11	31	80	1533	120	82	2034	123	27583	1.4	631	538.8	NA
26	12/04/06	7:00	28	80	1634	101	70	2137	103	27686	1.5	528	538.8	NA
	12/05/06	7:00	31	82	1793	159	83	2298	161	27847	1.5	367	538.8	NA
	12/06/06	7:02	28	269	1969	176	278	2478	180	28027	1.6	187	538.8	NA
	12/07/06	7:04	27	154	2139	170	160	2649	171	28198	1.5	736	544.7	5.9
	12/08/06	7:22	28	0	2320	181	0	2834	185	28383	NA	551	544.7	NA
	12/09/06	7:00	25	0	2476	156	0	2990	156	28539	NA	742	550.6	5.9
	12/10/06	7:00	24	0	2609	133	0	3127	137	28676	NA	606	550.6	NA
27	12/11/06	6:51	23	155	2739	130	154	3260	133	28809	1.5	473	550.6	NA
	12/12/06	6:58	31	154	2931	192	157	3455	195	29004	1.5	722	556.6	6.0
	12/13/06	7:00	30	177	3132	201	176	3660	205	29209	1.5	517	556.6	NA
	12/14/06	6:59	32	0	3327	195	0	3857	197	29406	NA	718	562.5	5.9

Note 1: Unit 1 backwashes Monday, Wednesday, and Friday w/ air wash at 60-70 scfm.

Note 2: Unit 1 inlet valve throttled to allow 66-75% of flow to Unit 1 and 25-33% of flow to Unit 2 when both units operating until 09/19/06. Afterwards, Unit 1: 100% during day, 50% at night; Unit 2: 50% at night only.

Note 3: Blower operates once/week to keep air diffuser grid from plugging.

NA = not available; NR = no reading taken.

Highlighted columns indicate calculated values.

APPENDIX B
ANALYTICAL DATA TABLES

Analytical Results from Long-Term Sampling at Sandusky, MI

Sampling Date		06/22/06 - Well 1			06/28/06 - Well 1			07/05/06 - Well 1			07/12/06 ^(e) - Well 3			07/18/06 - Well 3			07/25/06 - Well 3		
Sampling Location		IN	AD	TT	IN	AD	TT	IN	AD	TT	IN	AD	TT	IN	AD	TT	IN	AD	TT
Parameter	Unit																		
Alkalinity	mg/L ^(a)	297	297	297	293	297	293	297	302	302	302	302	302	311	307	307	312	317	308
Ammonia (as N)	mg/L	0.1	0.1	0.1	-	-	-	-	-	-	-	-	-	0.4	0.3	0.3	-	-	-
Fluoride	mg/L	0.7	0.7	0.7	-	-	-	-	-	-	-	-	-	1.5	1.4	1.6	-	-	-
Sulfate	mg/L	87	89	89	-	-	-	-	-	-	-	-	-	102	107	102	-	-	-
Nitrate (as N)	mg/L	<0.05	<0.05	<0.05	-	-	-	-	-	-	-	-	-	<0.05	<0.05	<0.05	-	-	-
P (total)	µg/L ^(b)	<10	<10	<10	<10	<10	<10	<10	<10	<10	<10	<10	<10	<10	<10	<10	<10	<10	<10
Silica (as SiO ₂)	mg/L	11.7	11.6	12.1	12.0	12.9	13.8	11.6	11.9	11.9	12.2	11.9	12.4	11.3	11.2	11.4	12.5	12.4	12.3
Turbidity	NTU	13.0	1.3	0.2	10.0	1.1	1.7	9.9	1.1	1.0	13.0	1.2	0.6	16.0	0.8	0.3	16.0	1.4	0.5
TOC	mg/L	NA ^(c)	NA ^(c)	NA ^(c)	-	-	-	-	-	-	-	-	-	<1.0	1.1	1.0	-	-	-
pH	S.U.	7.7	7.7	7.6	7.3	7.2	7.3	7.3	7.1	7.1	7.3	7.2	7.2	7.2	7.1	7.1	7.3	7.3	7.3
Temperature	°C	11.8	11.5	13.0	13.3	12.0	13.5	12.3	12.0	13.0	12.3	12.0	12.6	11.9	12.6	12.5	12.4	11.4	12.1
DO	mg/L	1.8	2.4	2.3	2.8	3.7	5.6	1.8	2.0	2.0	1.7	2.6	3.1	1.4	2.6	2.8	3.7	4.2	3.9
ORP	mV	298	387	431	406	499	535	291	530	566	287	487	484	272	484	366	306	380	418
Free Chlorine	mg/L	-	0.2	0.1	-	0.2	0.2	-	0.3	0.2	-	1.4	0.4	-	0.4	0.3	-	1.7	3.1
Total Chlorine	mg/L	-	NA ^(d)	NA ^(d)	-	NA ^(d)	NA ^(d)	-	NA ^(d)	NA ^(d)	-	3.5	4.7	-	3.3	3.4	-	3.2	3.5
Total Hardness	mg/L ^(a)	375	384	407	-	-	-	-	-	-	-	-	-	378	407	402	-	-	-
Ca Hardness	mg/L ^(a)	247	252	267	-	-	-	-	-	-	-	-	-	262	286	283	-	-	-
Mg Hardness	mg/L ^(a)	128	132	140	-	-	-	-	-	-	-	-	-	115	121	119	-	-	-
As (total)	µg/L	7.6	7.6	1.2	7.3	7.4	1.4	8.1	10.4	5.5	8.9	10.0	5.6	10.6	10.6	1.6	15.3	21.2	1.6
As (soluble)	µg/L	-	-	-	-	-	-	-	-	-	-	-	-	-	-	-	-	-	-
As (particulate)	µg/L	7.3	1.3	0.9	-	-	-	-	-	-	-	-	-	10.4	1.6	1.4	-	-	-
As(III)	µg/L	0.2	6.3	0.3	-	-	-	-	-	-	-	-	-	0.2	9.0	0.2	-	-	-
As(V)	µg/L	6.0	0.3	0.3	-	-	-	-	-	-	-	-	-	9.8	0.6	0.6	-	-	-
Fe (total)	µg/L	1.3	1.0	0.6	-	-	-	-	-	-	-	-	-	0.6	1.0	0.7	-	-	-
Fe (soluble)	µg/L	689	694	<25	576	617	35	712	1,023	523	869	912	472	962	977	<25	1,156	1,785	<25
Mn (total)	µg/L	688	<25	<25	-	-	-	-	-	-	-	-	-	990	<25	<25	-	-	-
Mn (soluble)	µg/L	25.2	25.0	13.5	22.2	23.0	12.7	24.3	29.4	21.0	26.3	26.3	20.5	29.2	29.3	14.5	30.6	35.6	10.7
		-	-	-	-	-	-	-	-	-	-	-	-	-	-	-	-	-	-
		25.1	10.7	13.0	-	-	-	-	-	-	-	-	-	30.1	11.2	14.3	-	-	-

(a) As CaCO₃. (b) As P. (c) Sample failed laboratory QA/QC check. (d) Test reagent not available for measurement. (e) Switched to Well No. 3 on 07/10/06. Water quality measurements taken on 07/10/06.

Analytical Results from Long-Term Sampling at Sandusky, MI (continued)

Sampling Date		08/01/06 ^(c) - Well 1			08/08/06 - Well 1			08/15/06 ^(d) - Well 1			08/22/06 - Well 1			08/29/06 - Well 1			09/06/06 ^(e) - Well 1		
Sampling Location	Parameter	IN	AD	TT	IN	AD	TT	IN	AD	TT	IN	AD	TT	IN	AD	TT	IN	AD	TT
	Unit																		
Alkalinity	mg/L ^(a)	299	295	295	302	307	307	307	312	337	331	324	333	320	315	324	326	335	335
		-	-	-	-	-	-	-	-	-	-	-	-	293	326	337	-	-	-
Ammonia (as N)	mg/L	-	-	-	-	-	-	0.3	0.2	0.2	-	-	-	-	-	-	-	-	-
Fluoride	mg/L	-	-	-	-	-	-	3.4	1.8	1.9	-	-	-	-	-	-	-	-	-
Sulfate	mg/L	-	-	-	-	-	-	93	94	94	-	-	-	-	-	-	-	-	-
Nitrate (as N)	mg/L	-	-	-	-	-	-	<0.05	<0.05	<0.05	-	-	-	-	-	-	-	-	-
P (total)	µg/L ^(b)	<10	<10	<10	<10	<10	<10	<10	<10	<10	<10	<10	<10	<10	<10	<10	22.1	19.3	<10
		-	-	-	-	-	-	-	-	-	-	-	-	<10	<10	<10	-	-	-
Silica (as SiO ₂)	mg/L	13.3	13.9	11.4	12.7	12.1	11.8	12.3	12.0	12.0	11.5	11.3	11.6	11.8	11.3	11.7	11.3	11.7	11.6
		-	-	-	-	-	-	-	-	-	-	-	-	11.2	11.7	11.4	-	-	-
Turbidity	NTU	10.0	0.7	0.3	9.2	0.8	0.2	7.9	0.9	0.1	7.8	0.8	0.2	7.7	0.6	0.2	11.0	9.9 ^(g)	0.5
		-	-	-	-	-	-	-	-	-	-	-	-	8.3	0.9	0.5	-	-	-
TOC	mg/L	-	-	-	-	-	-	1.1	1.1	1.1	-	-	-	-	-	-	-	-	-
pH	S.U.	7.3	7.2	7.2	7.2	7.1	7.2	7.3	7.2	7.3	7.2	7.2	7.2	7.3	7.3	7.3	7.1	7.2	7.2
Temperature	°C	12.6	12.0	12.1	12.3	12.1	12.3	11.8	11.6	11.7	12.5	11.7	11.9	12.1	11.9	16.2	12.0	12.0	11.8
DO	mg/L	0.8	2.6	2.4	1.5	2.0	2.7	1.0	2.7	2.9	1.7	2.5	2.4	1.8	3.1	2.9	2.3	2.8	2.7
ORP	mV	248	305	303	3 ^(h)	447	468	301	498	489	331	552	513	290	498	474	291	437	453
Free Chlorine	mg/L	-	0.5	0.5	-	0.5	0.5	-	2.3	2.0	-	0.3	0.3	-	1.4	0.4	-	0.4	3.1
Total Chlorine	mg/L	-	3.7	3.7	-	4.0	3.9	-	3.7	3.4	-	4.6	4.3	-	4.0	3.8	-	3.8	3.6
Total Hardness	mg/L ^(a)	-	-	-	-	-	-	392	424	411	-	-	-	-	-	-	-	-	-
Ca Hardness	mg/L ^(a)	-	-	-	-	-	-	257	277	282	-	-	-	-	-	-	-	-	-
Mg Hardness	mg/L ^(a)	-	-	-	-	-	-	135	148	129	-	-	-	-	-	-	-	-	-
As (total)	µg/L	10.3	10.6	1.7	11.8	11.5	1.7	10.0	9.4	2.0	10.4	10.8	1.6	8.5	8.7	1.2	23.5	21.6	4.6
		-	-	-	-	-	-	-	-	-	-	-	-	8.1	9.0	1.1	-	-	-
As (soluble)	µg/L	-	-	-	-	-	-	8.7	2.5	2.0	-	-	-	-	-	-	-	-	-
As (particulate)	µg/L	-	-	-	-	-	-	1.3	6.9	<0.1	-	-	-	-	-	-	-	-	-
As(III)	µg/L	-	-	-	-	-	-	7.5	0.8	0.8	-	-	-	-	-	-	-	-	-
As(V)	µg/L	-	-	-	-	-	-	1.2	1.6	1.2	-	-	-	-	-	-	-	-	-
Fe (total)	µg/L	757	755	<25	795	755	<25	841	789	<25	691	619	<25	708	724	<25	1,941	1,951	182
		-	-	-	-	-	-	-	-	-	-	-	-	707	724	<25	-	-	-
Fe (soluble)	µg/L	-	-	-	-	-	-	651	<25	<25	-	-	-	-	-	-	-	-	-

Analytical Results from Long-Term Sampling at Sandusky, MI (continued)

Sampling Date		08/01/06 ^(c) - Well 1			08/08/06 - Well 1			08/15/06 ^(d) - Well 1			08/22/06 - Well 1			08/29/06 - Well 1			09/06/06 ^(e) - Well 1		
Sampling Location	Parameter	IN	AD	TT	IN	AD	TT	IN	AD	TT	IN	AD	TT	IN	AD	TT	IN	AD	TT
	Unit																		
Mn (total)	µg/L	27.0	26.9	9.7	25.9	26.2	10.2	24.6	25.5	2.6	24.5	25.0	8.0	26.1	26.1	7.8	26.7	29.3	7.2
		-	-	-	-	-	-	-	-	-	-	-	-	25.4	25.7	8.0	-	-	-
Mn (soluble)	µg/L	-	-	-	-	-	-	26.3	10.2	2.6	-	-	-	-	-	-	-	-	-

(c) Resumed Well No. 1 operation on 07/28/06. (d) Water quality measurements taken on 08/16/06. (e) Water quality measurements taken on 09/05/06.

(a) As CaCO₃. (b) As P.

(f) Possible recording error. (g) Reanalysis indicated similar result.

Analytical Results from Long-Term Sampling at Sandusky, MI (continued)

Sampling Date		09/14/06 ^(c) - Well 1			09/19/06 - Well 1			09/27/06 ^(d) - Well 1			10/03/06 - Well 1			10/11/06 - Well 1			10/17/06 - Well 6		
Sampling Location Parameter Unit		IN	AD	TT	IN	AD	TT	IN	AD	TT	IN	AD	TT	IN	AD	TT	IN	AD	TT
Alkalinity	mg/L ^(a)	316	314	323	324	317	320	319	331	321	315	315	310	327	323	325	339	324	337
		-	-	-	-	-	-	-	-	-	-	-	-	-	-	-	-	-	-
Ammonia (as N)	mg/L	0.3	0.1	0.1	-	-	-	-	-	-	-	-	-	0.4	0.3	0.4	-	-	-
Fluoride	mg/L	0.6	0.6	0.6	-	-	-	-	-	-	-	-	-	0.6	0.5	0.5	-	-	-
Sulfate	mg/L	91	93	76	-	-	-	-	-	-	-	-	-	95	97	96	-	-	-
Nitrate (as N)	mg/L	<0.05	<0.05	<0.05	-	-	-	-	-	-	-	-	-	<0.05	<0.05	<0.05	-	-	-
P (total)	µg/L ^(b)	<10	<10	<10	<10	<10	<10	27.0	29.7	25.4	<10	<10	<10	<10	<10	<10	<10	<10	<10
		-	-	-	-	-	-	-	-	-	<10	-	-	-	-	-	-	-	-
Silica (as SiO ₂)	mg/L	12.3	11.8	11.4	12.3	12.2	12.1	11.4	11.8	12.1	12.1	11.8	11.5	11.4	11.4	10.0	12.2	11.6	11.3
		-	-	-	-	-	-	-	-	-	-	-	-	-	-	-	-	-	-
Turbidity	NTU	9.4	1.4	0.9	7.8	0.7	0.1	8.7	0.9	0.1	9.2	0.8	0.3	10.0	1.3	0.3	3.0	1.5	0.9
		-	-	-	-	-	-	-	-	-	-	-	-	-	-	-	-	-	-
TOC	mg/L	1.1	1.1	<1.0	-	-	-	-	-	-	-	-	-	1.1	1.1	1.0	-	-	-
pH	S.U.	7.3	7.3	7.2	7.2	7.3	7.3	7.1	7.3	7.3	7.0	7.2	7.2	7.0	7.2	7.2	7.3	7.4	7.4
Temperature	°C	12.6	11.6	11.6	12.0	11.3	11.5	11.8	11.5	11.7	11.9	11.2	11.3	11.6	11.0	11.2	11.3	11.2	11.2
DO	mg/L	1.9	2.4	2.6	1.5	2.8	3.6	1.8	2.9	3.0	1.9	3.2	3.2	2.0	3.2	2.7	1.8	3.3	3.2
ORP	mV	281	311	309	265	301	292	317	299	301	305	306	300	317	307	301	283	292	292
Free Chlorine	mg/L	-	1.4	0.3	-	0.4	0.9	-	0.7	0.1	-	0.2	0.2	-	0.9	1.9	-	0.4	0.3
Total Chlorine	mg/L	-	3.8	4.1	-	4.1	4.1	-	2.9	2.6	-	2.9	2.9	-	2.0	2.0	-	1.9	1.3
Total Hardness	mg/L ^(a)	387	377	379	-	-	-	-	-	-	-	-	-	396	400	408	-	-	-
Ca Hardness	mg/L ^(a)	254	250	252	-	-	-	-	-	-	-	-	-	278	276	281	-	-	-
Mg Hardness	mg/L ^(a)	133	126	127	-	-	-	-	-	-	-	-	-	118	124	127	-	-	-
As (total)	µg/L	9.6	7.7	1.0	7.5	7.5	1.2	11.8	12.7	6.3	10.5	11.0	1.7	11.6	9.1	1.9	10.2	10.1	1.9
		-	-	-	-	-	-	-	-	-	-	-	-	-	-	-	-	-	-
As (soluble)	µg/L	8.3	1.3	1.1	-	-	-	-	-	-	-	-	-	8.1	2.2	1.9	-	-	-
As (particulate)	µg/L	1.4	6.3	<0.1	-	-	-	-	-	-	-	-	-	3.5	6.9	<0.1	-	-	-
As(III)	µg/L	7.4	<0.1	<0.1	-	-	-	-	-	-	-	-	-	7.5	1.0	1.0	-	-	-
As(V)	µg/L	0.8	1.2	1.0	-	-	-	-	-	-	-	-	-	0.6	1.2	0.9	-	-	-
Fe (total)	µg/L	789	691	<25	697	698	<25	732	854	<25	625	633	<25	1,202	735	<25	242	239	<25
		-	-	-	-	-	-	-	-	-	-	-	-	-	-	-	-	-	-
Fe (soluble)	µg/L	610	<25	<25	-	-	-	-	-	-	-	-	-	680	<25	<25	-	-	-
Mn (total)	µg/L	23.4	22.8	3.4	26.1	25.0	7.0	25.8	27.0	2.0	23.5	24.1	1.1	26.5	26.2	20.8	23.2	24.1	0.4

Analytical Results from Long-Term Sampling at Sandusky, MI (continued)

Sampling Date		09/14/06 ^(c) - Well 1			09/19/06 - Well 1			09/27/06 ^(d) - Well 1			10/03/06 - Well 1			10/11/06 - Well 1			10/17/06 - Well 6		
Sampling Location	Parameter	IN	AD	TT	IN	AD	TT	IN	AD	TT	IN	AD	TT	IN	AD	TT	IN	AD	TT
	Unit	-	-	-	-	-	-	-	-	-	-	-	-	-	-	-	-	-	-
Mn (soluble)	µg/L	23.5	6.3	3.5	-	-	-	-	-	-	-	-	-	26.5	18.8	20.8	-	-	-

(c) Water quality measurements taken on 09/12/06. (d) Water quality measurements taken on

(a) As CaCO₃. (b) As P. 09/28/06.

Analytical Results from Long-Term Sampling at Sandusky, MI (continued)

Sampling Date		10/24/06 - Well 1			11/01/06 ^(c) - Well 1			11/07/06 - Well 1			11/16/06 - Well 1			11/28/06 - Wells 3 & 6			12/06/06 - Well 1		
Sampling Location	Parameter Unit	IN	AD	TT	IN	AD	TT	IN	AD	TT	IN	AD	TT	IN	AD	TT	IN	AD	TT
Alkalinity	mg/L ^(a)	333	320	322	320	320	322	324	315	320	327	334	332	350	350	344	321	323	321
		-	-	-	-	-	-	-	-	-	-	-	-	346	350	346	-	-	-
Ammonia (as N)	mg/L	-	-	-	-	-	-	0.3	0.3	0.3	-	-	-	-	-	-	0.3	0.2	0.2
Fluoride	mg/L	-	-	-	-	-	-	0.7	0.6	0.7	-	-	-	-	-	-	0.7	0.6	0.7
Sulfate	mg/L	-	-	-	-	-	-	105	106	101	-	-	-	-	-	-	95	91	93
Nitrate (as N)	mg/L	-	-	-	-	-	-	<0.05	<0.05	<0.05	-	-	-	-	-	-	<0.05	<0.05	<0.05
P (total)	µg/L ^(b)	<10	<10	<10	<10	<10	<10	<10	<10	<10	<10	<10	<10	<10	<10	<10	<10	<10	<10
		-	-	-	-	-	-	-	-	-	-	-	-	<10	<10	<10	-	-	-
Silica (as SiO ₂)	mg/L	12.3	12.2	11.6	11.3	11.5	11.5	11.5	11.8	10.9	11.2	11.7	11.1	11.7	11.5	11.5	12.0	11.5	11.8
		-	-	-	-	-	-	-	-	-	-	-	-	11.6	11.2	11.1	-	-	-
Turbidity	NTU	9.7	0.9	0.3	11.0	1.1	0.7	11.0	1.1	0.5	6.0	1.1	0.4	2.1	1.5	0.3	12.0	1.9	0.9
		-	-	-	-	-	-	-	-	-	-	-	-	2.2	1.6	0.4	-	-	-
TOC	mg/L	-	-	-	-	-	-	-	-	-	-	-	-	-	-	-	<1.0 ^(e)	1.0 ^(e)	<1.0 ^(e)
pH	S.U.	7.0	7.3	7.2	7.0	7.2	7.1	7.1	7.2	7.2	7.0	7.0	7.1	7.2	7.2	7.1	7.1	7.2	7.1
Temperature	°C	11.3	11.0	11.1	11.9	11.2	11.2	12.4	11.4	11.8	12.2	11.8	11.9	13.0	13.1	12.1	11.5	11.2	11.2
DO	mg/L	2.0	2.7	2.9	1.7	2.7	2.6	1.9	2.7	2.4	2.6	2.8	3.0	2.9	3.2	3.2	2.5	2.9	2.8
ORP	mV	291	294	293	285	321	311	329	316	314	265	351	315	258	286	301	268	318	291
Free Chlorine	mg/L	-	0.3	0.2	-	0.9	2.5	-	0.3	0.2	-	0.9	0.2	-	0.3	0.3	-	0.2	0.2
Total Chlorine	mg/L	-	2.9	2.9	-	2.6	2.6	-	2.9	2.7	-	2.8	2.7	-	2.8	3.3	-	3.3	3.3
Total Hardness	mg/L ^(a)	-	-	-	-	-	-	436	431	432	-	-	-	-	-	-	397	385	389
Ca Hardness	mg/L ^(a)	-	-	-	-	-	-	300	297	295	-	-	-	-	-	-	263	254	253
Mg Hardness	mg/L ^(a)	-	-	-	-	-	-	136	134	138	-	-	-	-	-	-	133	131	137
As (total)	µg/L	14.1	13.5	2.7	9.6	9.2	1.5	18.3	11.2	3.0	10.5	11.0	3.0	9.5	9.2	1.8	10.5	10.6	2.2
		-	-	-	-	-	-	-	-	-	-	-	-	9.6	9.2	1.9	-	-	-
As (soluble)	µg/L	-	-	-	-	-	-	9.5	3.4	2.9	-	-	-	-	-	-	9.7	2.1	2.1
As (particulate)	µg/L	-	-	-	-	-	-	8.7	7.8	<0.1	-	-	-	-	-	-	0.8	8.5	0.1
As(III)	µg/L	-	-	-	-	-	-	7.8	2.1	2.1	-	-	-	-	-	-	8.5	0.6	0.6
As(V)	µg/L	-	-	-	-	-	-	1.8	1.3	0.8	-	-	-	-	-	-	1.2	1.5	1.5
Fe (total)	µg/L	754	759	<25	789	804	<25	3,214 ^(d)	1,277	<25	667	641	<25	236	240	<25	851	862	<25
		-	-	-	-	-	-	-	-	-	-	-	-	245	245	<25	-	-	-
Fe (soluble)	µg/L	-	-	-	-	-	-	763	<25	<25	-	-	-	-	-	-	827	<25	<25

Analytical Results from Long-Term Sampling at Sandusky, MI (continued)

Sampling Date		10/24/06 - Well 1			11/01/06 ^(c) - Well 1			11/07/06 - Well 1			11/16/06 - Well 1			11/28/06 - Wells 3 & 6			12/06/06 - Well 1		
Sampling Location	Parameter Unit	IN	AD	TT	IN	AD	TT	IN	AD	TT	IN	AD	TT	IN	AD	TT	IN	AD	TT
Mn (total)	μg/L	25.9	25.7	0.4	24.3	24.4	2.4	28.5	28.1	10.0	24.5	24.3	10.3	21.7	21.1	<0.1	27.1	27.3	0.9
		-	-	-	-	-	-	-	-	-	-	-	-	21.6	21.4	<0.1	-	-	-
Mn (soluble)	μg/L	-	-	-	-	-	-	26.6	11.2	10.1	-	-	-	-	-	-	29.2	11.2	2.1

(a) As CaCO₃. (b) As P. (c) Water quality measurements taken on 10/31/06. (d) Reanalysis indicated similar result. (e) Sample analyzed outside of hold time.

Analytical Results from Long-Term Sampling at Sandusky, MI (continued)

Sampling Date		12/12/06 - Well 1		
Sampling Location		IN	AD	TT
Parameter	Unit			
Alkalinity	mg/L ^(a)	299 -	313 -	301 -
Ammonia (as N)	mg/L	-	-	-
Fluoride	mg/L	-	-	-
Sulfate	mg/L	-	-	-
Nitrate (as N)	mg/L	-	-	-
P (total)	µg/L ^(b)	<10 -	<10 -	<10 -
Silica (as SiO ₂)	mg/L	11.4 -	11.2 -	11.3 -
Turbidity	NTU	11.0 -	0.5 -	<0.1 -
TOC	mg/L	-	-	-
pH	S.U.	7.2	7.2	7.2
Temperature	°C	12.2	11.4	11.2
DO	mg/L	1.8	2.7	2.9
ORP	mV	255	284	490
Free Chlorine	mg/L	-	2.0	0.2
Total Chlorine	mg/L	-	2.9	2.9
Total Hardness	mg/L ^(a)	-	-	-
Ca Hardness	mg/L ^(a)	-	-	-
Mg Hardness	mg/L ^(a)	-	-	-
As (total)	µg/L	9.8 -	10.1 -	2.2 -
As (soluble)	µg/L	-	-	-
As (particulate)	µg/L	-	-	-
As(III)	µg/L	-	-	-
As(V)	µg/L	-	-	-
Fe (total)	µg/L	777 -	788 -	<25 -
Fe (soluble)	µg/L	-	-	-
Mn (total)	µg/L	23.6 -	24.7 -	7.2 -
Mn (soluble)	µg/L	-	-	-

(a) As CaCO₃. (b) As P.