



U.S. Department  
of Transportation  
**Federal Aviation  
Administration**

# Advisory Circular

Consolidated file includes Change 1

---

**Subject:** Surface Drainage Design

**Date:** 9/29/2006

**AC No:** 150/5320-5C

**Initiated by:** AAS-100

---

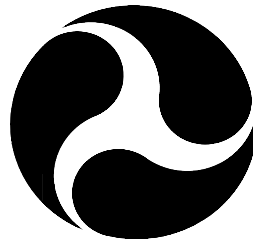
- 1. Purpose.** This Advisory Circular (AC) provides guidance for engineers, airport managers, and the public in the design and maintenance of airport surface drainage systems.
- 2. Cancellation.** This AC cancels AC 150/5320-5B, *Airport Drainage*, dated July 1, 1970.
- 3. Background.** The Federal Aviation Administration (FAA) evaluated options for revising the airport drainage manual and decided it would be beneficial to participate in the cooperative effort undertaken by the Department of Defense (DOD). This effort combines existing surface drainage topics covered in different agency manuals into one Unified Facilities Criteria (UFC) document. The resulting manual/advisory circular will serve as the design and analysis standard for surface drainage for DOD and FAA. The current techniques and practices have been evaluated in order to take advantage of recent advances in the field of drainage engineering, changes in drainage technology, national regulations, and local requirements.
- 4. Application.** FAA recommends the information and procedures contained in the manuals for use by airports as appropriate.

David L. Bennett  
Director of Airport Safety and Standards

# **UNIFIED FACILITIES CRITERIA (UFC)**

---

## **SURFACE DRAINAGE DESIGN**



U.S. Department of Transportation  
**Federal Aviation Administration**

**APPROVED FOR PUBLIC RELEASE; DISTRIBUTION UNLIMITED**

**UNIFIED FACILITIES CRITERIA (UFC)**  
**SURFACE DRAINAGE DESIGN<sup>1</sup>**

Any copyrighted material included in this UFC is identified at its point of use. Use of the copyrighted material apart from this UFC must have the permission of the copyright holder.

U.S. ARMY CORPS OF ENGINEERS (Preparing Activity)

NAVAL FACILITIES ENGINEERING COMMAND

AIR FORCE CIVIL ENGINEER SUPPORT AGENCY

Record of Changes (changes are indicated by \1\ ... /1/)

<b>Change No.</b>	<b>Date</b>	<b>Location</b>

<sup>1</sup>This UFC supersedes TM 5-820-1/AFM 88-5, Chap 1, dated August 1987; TM 5-820-2/AFM 88-5, Chap 2, dated March 1979; TM 5-820-3/AFM 88-5, Chap 3, dated June 1991; TM 5-820-4/AFM 88-5, Chap 4, dated October 1983; TM 5-852-7/AFM 88-19, Chap 7, dated April 1981; NAVFAC DM 21.06, dated April 1986; EI 02C202, dated October 1995.

The format of this document does not conform to UFC 1-300-01.

## FOREWORD

The Unified Facilities Criteria (UFC) system is prescribed by Military Standard (MIL-STD) 3007 and provides planning, design, construction, sustainment, restoration, and modernization criteria, and applies to the Military Departments, the Defense Agencies, and the Department of Defense (DOD) Field Activities in accordance with [USD\(AT&L\) Memorandum](#) dated 29 May 2002. UFC will be used for all DOD projects and work for other customers where appropriate.

UFC are living documents and will be periodically reviewed, updated, and made available to users as part of the Services' responsibility for providing technical criteria for military construction. Headquarters, U.S. Army Corps of Engineers (HQUSACE), Naval Facilities Engineering Command (NAVFAC), and Headquarters Air Force Civil Engineer Support Agency (HQ AFCESA) are responsible for administration of the UFC system. Defense agencies should contact the preparing service for document interpretation and improvements. Technical content of UFC is the responsibility of the cognizant DOD working group. Recommended changes with supporting rationale should be sent to the respective service proponent office by the following electronic form: [Criteria Change Request \(CCR\)](#). The form is also accessible from the Internet site listed below.

UFC are effective upon issuance and are distributed only in electronic media from the following sources:

- Whole Building Design Guide web site DOD page: (<http://dod.wbdg.org/>)

Hard copies of UFC printed from electronic media should be checked against the current electronic version prior to use to ensure that they are current.

### AUTHORIZED BY:

---

DONALD L. BASHAM, P.E.  
Chief, Engineering and Construction  
U.S. Army Corps of Engineers

---

Dr. JAMES W. WRIGHT, P.E.  
Chief Engineer  
Naval Facilities Engineering Command

---

KATHLEEN I. FERGUSON, P.E.  
The Deputy Civil Engineer  
DCS/Installations & Logistics  
Department of the Air Force

---

Dr. GET W. MOY, P.E.  
Director, Installations Requirements and  
Management  
Office of the Deputy Under Secretary of  
Defense (Installations and Environment)



**UNIFIED FACILITIES CRITERIA (UFC)  
NEW DOCUMENT SUMMARY SHEET**

**Document:** UFC 3-230-01/AC 150/5320-5C

**Description:** UFC 3-230-01/AC 150/5320-5C provides comprehensive and practical guidance to the Tri-service community and Federal Aviation Administration (FAA) for the design of storm drainage systems associated with transportation facilities. Criteria are provided for the design of storm drainage systems which collect, convey, and discharge stormwater on and around pavements and other transportation facilities.

**Reasons for Document:**

- Previous criteria associated with this topic were outdated and did not take advantage of recent developments in the field of hydrologic engineering.
- Multiple documents covering various topics on the subject matter were in circulation and this document provides a consolidated and comprehensive guide for all users.
- Many new environmental practices have been developed and were not addressed in previous criteria.
- User feedback indicated that published criteria from multiple documents was often confusing and contradicting.

**Impact:** There are negligible cost impacts; however, these benefits should be realized:

- Providing one location for criteria associated with storm drainage will allow users to be more efficient and effective when applying the procedures and principles contained in this document.
- The updated criteria in this document are considered standard practice and will allow users to take advantage of concepts and methods which are widely understood and accepted throughout the industry today.

## CONTENTS

	Page
CHAPTER 1 INTRODUCTION	
Paragraph 1-1	PURPOSE ..... 1
1-2	SCOPE ..... 1
1-3	REFERENCES..... 1
1-4	UNITS OF MEASUREMNET ..... 1
1-5	APPLICABILITY ..... 1
1-5.1	Previous Standards..... 1
1-5.2	Applicability Within DOD ..... 1
1-5.3	Design Objectives ..... 1
1-5.4	Waivers to Criteria..... 2
1-6	GENERAL INVESTIGATIONS ..... 2
1-7	ENVIRONMENTAL CONSIDERATIONS ..... 3
1-7.1	National Environmental Policy..... 3
1-7.2	Federal Guidelines ..... 3
1-7.3	Regulatory Considerations ..... 3
1-7.4	Federal Regulations ..... 4
1-7.5	State Regulations..... 5
1-7.6	Local Laws ..... 7
1-7.7	U.S. Army Environmental Quality Program ..... 8
1-7.8	U.S. Air Force Environmental Quality Program..... 8
1-7.9	U.S. Navy Environmental Quality Program ..... 8
1-7.10	FAA Environmental Quality Program ..... 8
1-7.11	Environmental Impact Analysis ..... 8
1-7.12	Environmental Effects of Surface Drainage Systems..... 8
1-7.13	Discharge Permits..... 9
1-7.14	Effects of Drainage Facilities on Fish ..... 9
CHAPTER 2 SURFACE HYDROLOGY	
Paragraph 2-1	PURPOSE AND SCOPE..... 10
2-2	HYDROLOGIC CRITERIA ..... 10
2-2.1	Design Objectives ..... 10
2-2.2	Degree of Drainage Required ..... 10
2-2.3	Surface Runoff from Design Storm ..... 10
2-2.4	Design Storm Frequency ..... 10
2-2.5	Surface Runoff from Storms Exceeding Design Storm ..... 11
2-2.6	Reliability of Operation ..... 12
2-2.7	Environmental Impact ..... 12
2-2.8	Maintenance..... 12
2-2.9	Future Expansion ..... 12
2-3	HYDROLOGIC METHODS AND PROCEDURES ..... 12

2-3.1	Rainfall (Precipitation) .....	12
2-3.2	Determination of Peak Flow Rates.....	15
2-3.3	USGS Regression Equations.....	25
2-3.4	SCS TR-55 Peak Flow Method .....	28
2.4	DEVELOPMENT OF DESIGN HYDROGRAPHS .....	32
2-4.1	SCS Tabular Hydrograph.....	32
2-4.2	SCS Synthetic Unit Hydrograph (UH) .....	36

### CHAPTER 3 PAVEMENT SURFACE DRAINAGE

Paragraph 3-1	OVERVIEW.....	40
3-2	DESIGN FREQUENCY AND SPREAD.....	40
3-2.1	Selection of Design Frequency and Design Spread.....	40
3-2.2	Selection of Check Storm and Spread .....	41
3-3	SURFACE DRAINAGE .....	41
3-3.1	Longitudinal Slope.....	41
3-3.2	Cross (Transverse) Slope .....	42
3-3.3	Curbs and Gutters.....	43
3-3.4	Roadside and Median Channels .....	44
3-4	FLOW IN GUTTERS .....	45
3-4.1	Capacity Relationship .....	45
3-4.2	Conventional Curb and Gutter Sections.....	46
3-4.3	Shallow Swale Sections .....	53
3-4.4	Flow in Sag Vertical Curves .....	60
3-4.5	Gutter Flow Time.....	60
3-5	DRAINAGE INLET DESIGN.....	62
3-5.1	Inlet Types .....	63
3-5.2	Characteristics and Uses of Inlets.....	64
3-5.3	Inlet Capacity .....	64
3-5.4	Interception Capacity of Inlets on Grade .....	73
3-5.5	Interception Capacity of Inlets in Sag Locations.....	86
3-5.6	Inlet Locations.....	94
3-5.7	Median, Embankment, and Bridge Inlets .....	102
3-6	GRATE TYPE SELECTION CONSIDERATIONS .....	111

### CHAPTER 4 CULVERT DESIGN

Paragraph 4-1	PURPOSE.....	113
4-2	FISH PASSAGE CONSIDERATIONS.....	115
4-2.1	General .....	115
4-2.2	High Inverts.....	115
4-2.3	High Velocities in Culverts.....	115
4-2.4	Undersized or Failed Culverts .....	116
4-2.5	Erosion Along Drainageways or at Outlets.....	116
4-2.6	Channel Filling .....	116

4-2.7	Culvert Installation.....	116
4-2.8	Control of Icing.....	116
4-3	DESIGN STORM .....	116
4-4	DESIGN .....	116
4-4.1	Hydraulic Design Data for Culverts .....	117
4-4.2	Headwalls and Endwalls .....	151
4-4.3	Erosion Control at Outlets .....	161
4-4.4	Vehicular Safety and Hydraulically Efficient Drainage Practice .....	175
4-5	OUTLET PROTECTION DESIGN EXAMPLE .....	176

## CHAPTER 5 CHANNEL DESIGN

Paragraph 5-1	OPEN CHANNEL FLOW .....	186
5-1.1	Flow Resistance.....	186
5-1.2	Stable Channel Design .....	192
5-2	DESIGN PARAMETERS.....	197
5-2.1	Discharge Frequency .....	197
5-2.2	Channel Geometry .....	197
5-2.3	Channel Slope.....	197
5-2.4	Freeboard .....	197
5-2.5	Shear Stress .....	199

## CHAPTER 6 STORM DRAIN DESIGN

Paragraph 6-1	PURPOSE AND SCOPE.....	202
6-2	DESIGN PROCEDURES FOR THE DRAINAGE SYSTEM ...	202
6-2.1	Grading .....	202
6-2.2	Classification of Storm Drains .....	202
6-2.3	Hydraulics of Storm Drainage Systems.....	203
6-2.4	Design Guidelines and Considerations .....	212
6-3	PRELIMINARY DESIGN PROCEDURE .....	216
6-3.1	Step 1.....	216
6-3.2	Step 2.....	221
6-3.3	Step 3.....	221
6-3.4	Step 4.....	221
6-3.5	Step 5.....	222
6-3.6	Step 6.....	222
6-4	ENERGY GRADE LINE EVALUATION PROCEDURE .....	222

## CHAPTER 7 DRAINAGE STRUCTURES

Paragraph 7-1	GENERAL.....	231
7-2	INLETS .....	231
7-2.1	Configuration.....	231

7-2.2	Area Inlets.....	232
7-3	MANHOLES.....	235
7-3.1	Configuration.....	235
7-3.2	Chamber and Access Shaft.....	236
7-3.3	Frames and Covers.....	236
7-3.4	Channels and Benches.....	240
7-3.5	Manhole Depth.....	240
7-3.6	Location and Spacing.....	241
7-3.7	Settlement of Manholes.....	241
7-4	JUNCTION CHAMBERS.....	242
7-5	MISCELLANEOUS STRUCTURES.....	242
7-5.1	Chutes.....	242
7-5.2	Security Fencing.....	242
7-5.3	Fuel/Water Separators.....	245
7-5.4	Outlet Energy Dissipators.....	246
7-5.5	Drop Structures and Check Dams.....	247
7-5.6	Transitions.....	247
7-5.7	Flow Splitters.....	247
7-5.8	Siphons.....	248
7-5.9	Flap Gates.....	249
7-6	DESIGN FEATURES.....	250
7-6.1	Grates.....	250
7-6.2	Ladders.....	251
7-6.3	Steps.....	254
7-7	SPECIAL DESIGN CONSIDERATIONS FOR AIRFIELDS.....	254
7-7.1	Overview.....	254
7-7.2	Recommended Design Parameters.....	254

## CHAPTER 8 STORM WATER CONTROL FACILITIES

Paragraph 8-1	GENERAL.....	257
8-1.1	Storage and Detention/Retention Benefits.....	257
8-1.2	Design Objectives.....	258
8-2	ISSUES RELATED TO STORM WATER QUANTITY CONTROL FACILITIES.....	258
8-2.1	Release Timing.....	258
8-2.2	Safety.....	259
8-2.3	Maintenance.....	260
8-3	STORAGE FACILITY TYPES.....	261
8-3.1	Detention Facilities.....	261
8-3.2	Retention Facilities.....	262
8-3.3	Wet Pond Facilities.....	262
8-3.4	Infiltration Facilities.....	263

CHAPTER 9 PIPE SELECTION, BEDDING AND BACKFILL

Paragraph 9-1	GENERAL .....	264
9-1.1	Pipe Selection .....	264
9-1.2	Selection of <i>n</i> Values .....	264
9-1.3	Restricted Use of Bituminous-Coated Pipe .....	264
9-1.4	Classes of Bedding and Installation .....	265
9-1.5	Strength of Pipe .....	266
9-1.6	Rigid Pipe.....	266
9-1.7	Flexible Pipe.....	282
9-1.8	Bedding of Pipe (Culverts and Storm Drains) .....	282
9-2	FROST CONDITION CONSIDERATIONS.....	282
9-3	INFILTRATION OF FINE SOILS THROUGH DRAINAGE PIPE JOINTS .....	284
9-4	MINIMUM AND MAXIMUM COVER FOR AIRFIELDS .....	285
9-5	MINIMUM AND MAXIMUM COVER FOR ROADWAYS .....	286

CHAPTER 10 GUIDELINES FOR DESIGN IN THE ARTIC AND SUBARTIC

Paragraph 10-1	GENERAL .....	288
10-2	ICING .....	288
10-2.1	Description .....	288
10-2.2	Types .....	288
10-2.3	Natural Factors Conducive to Icing Formation .....	290
10-2.4	Effects of Human Activities on Icing.....	290
10-2.5	Methods of Counteracting Icing.....	291
10-3	GUIDELINES FOR DESIGN OF STORM DRAINS IN THE ARCTIC AND SUBARCTIC.....	297
10-4	GRADING .....	299
10-5	TEMPORARY STORAGE .....	299
10-6	MATERIALS.....	299
10-7	MAINTENANCE .....	299
10-8	JOINTING .....	299
10-9	END PROTECTION .....	299
10-10	ANCHORAGE AND BUOYANCY .....	300
10-11	DEBRIS AND ICING CONTROL.....	300
10-12	TIDAL AND FLOOD EFFECTS.....	300
10-13	INSTALLATION.....	300

CHAPTER 11 WATER QUALITY CONSIDERATIONS

Paragraph 11-1	GENERAL .....	301
11-2	GENERAL BMP SELECTION GUIDANCE .....	301
11-3	ESTIMATING POLLUTANT LOADS.....	304
11-4	EXTENDED DETENTION DRY PONDS.....	304

11-5	WET PONDS .....	304
11-6	INFILTRATION/EXFILTRATION TRENCHES .....	304
11-7	INFILTRATION BASINS .....	305
11-8	SAND FILTERS .....	305
11-9	WATER QUALITY INLETS .....	305
11-10	VEGETATIVE PRACTICES .....	305
11-11	ULTRA-URBAN BMPs .....	305
11-12	TEMPORARY EROSION AND SEDIMENT CONTROL PRACTICES.....	306

CHAPTER 12 DESIGN COMPUTER PROGRAMS

Paragraph	12-1	STORM WATER MANAGEMENT PROGRAMS .....	307
	12-2	DRIP (DRAINAGE REQUIREMENT IN PAVEMENTS).....	307
	12-3	CANDE-89 (CULVERT ANALYSIS AND DESIGN) .....	307
	12-4	MODBERG.....	307
	12-5	DDSOFT (DRAINAGE DESIGN SOFTWARE).....	307
	12-6	NDSOFT (NORMAL DEPTH SOFTWARE).....	307
	12-7	PIPECAR.....	308
	12-8	VISUAL URBAN (HY-22) URBAN DRAINAGE DESIGN PROGRAMS .....	308
	12-9	ADDITIONAL SOFTWARE.....	308
	12-9.1	HYDRAIN .....	309
	12-9.2	HYDRA.....	310
	12-9.3	WSPRO.....	311
	12-9.4	HYDRO .....	311
	12-9.5	HY8 .....	312
	12-9.6	HYCHL .....	312
	12-9.7	NFF .....	313
	12-9.8	HYEQT .....	313
	12-9.9	TR-55 .....	313
	12-9.10	TR-20 .....	314
	12-9.11	HMS .....	315
	12-9.12	HEC-RAS .....	316
	12-9.13	SWMM.....	317
	12-10	HYDRAULIC TOOLBOX (HY-TB) .....	318
	12-10.1	HY12 .....	318
	12-10.2	HY15 .....	318
	12-10.3	BASIN.....	318
	12-10.4	SCOUR .....	318
	12-11	URBAN DRAINAGE DESIGN PROGRAMS.....	319
	12-11.1	Manning's Equation .....	319
	12-11.2	HEC-22.....	319
	12-11.3	Stormwater Management .....	319
	12-12	DR3M .....	319

12-12.1	Rainfall-Excess Components .....	319
12-12.2	Impervious Surfaces.....	320
12-12.3	Routing.....	320
12-12.4	Model Versatility .....	320
12-12.5	Urban Basin Planning.....	320
12-12.6	Usability.....	320
12-13	EVALUATION OF WATER QUALITY.....	320
12-14	SOFTWARE AVAILABILITY.....	321
GLOSSARY	.....	324
APPENDIX A	REFERENCES.....	328
APPENDIX B	LIST OF CHARTS.....	334
APPENDIX C	LIST OF SYMBOLS .....	385
APPENDIX D	BIBLIOGRAPHY .....	390
APPENDIX E	WAIVER PROCESSING PROCEDURES FOR DOD .....	398
APPENDIX F	WAIVER PROCESSING PROCEDURES FOR FAA .....	402
INDEX	.....	406

**FIGURES**

<u>Figure</u>	<u>Title</u>	
2-1	Example IDF Curve .....	13
2-2	SCS 24-hr Rainfall Distribution.....	14
2-3	Approximate Geographic Areas for SCS Rainfall Distributions.....	14
2-4	Dimensionless Curvilinear SCS Synthetic Unit Hydrograph and Equivalent Triangular Hydrograph.....	37
2-5	Example: The Triangular Unit Hydrograph .....	39
3-1	Typical Gutter Sections .....	44
3-2	Conveyance–Spread Curves for a Composite Gutter Section.....	49
3-3	Classes of Storm Drain Inlets .....	63
3-4	P-1-7/8 and P-1-7/8 x 4 Grate (Same as P-1-7/8 Grate Without 3/8-in. Transverse Rods).....	67
3-5	P-1-1/8 Grate.....	68
3-6	Curved Vane Grate.....	69
3-7	45-Degree 2-1/4 and 45-Degree 3-1/4 Tilt-bar Grates.....	70
3-8	30-Degree 3-1/4 Tilt-bar Grates .....	71



3-9	Reticuline Grate.....	72
3-10	Depressed Curb-opening Inlet.....	80
3-11	Definition of Depth.....	87
3-12	Curb-Opening Inlets.....	92
3-13	Inlet Spacing Computation Sheet.....	97
3-14	Example of Flanking Inlets.....	100
3-15	Median Drop Inlet.....	103
3-16	Embankment Inlet and Downdrain.....	111
4-1	Inlet Control.....	118
4-2	Headwater Depth for Concrete Pipe Culverts with Inlet Control.....	119
4-3	Headwater Depth for Oval Concrete Pipe Culverts Long Axis Vertical with Inlet Control.....	120
4-4	Headwater Depth for Oval Concrete Pipe Culverts Long Axis Horizontal with Inlet Control.....	121
4-5	Headwater Depth for Corrugated Metal Pipe Culverts with Inlet Control.....	122
4-6	Headwater Depth for Structural Plate and Standard Corrugated Metal Pipe-Arch Culverts with Inlet Control.....	123
4-7	Headwater Depth for Box Culverts with Inlet Control.....	124
4-8	Headwater Depth for Corrugated Metal Pipe Culverts with Tapered Inlet Inlet Control.....	125
4-9	Headwater Depth for Circular Pipe Culverts with Beveled Ring Inlet Control.....	126
4-10	Outlet Control.....	127
4-11	Head for Circular Pipe Culverts Flowing Full, $n = 0.012$ .....	130
4-12	Head for Oval Circular Pipe Culverts Long Axis Horizontal or Vertical Flowing Full, $n = 0.012$ .....	131
4-13	Head for Circular Pipe Culverts Flowing Full, $n = 0.024$ .....	132
4-14	Head for Circular Pipe Culverts Flowing Full, $n = 0.0328$ to $0.0302$ .....	133
4-15	Head for Standard Corrugated Metal Pipe-Arch Culverts Flowing Full, $n = 0.024$ .....	134
4-16	Head for Field-Bolted Structural Plate Pipe-Arch Culverts 18 in. Corner Radius Flowing Full, $n = 0.0327$ to $0.0306$ .....	135
4-17	Head for Concrete Box Culverts Flowing Full, $n = 0.012$ .....	136
4-18	Tailwater Elevation at or Above Top of Culvert.....	137
4-19	Tailwater Below the Top of the Culvert.....	137
4-20	Circular Pipe Critical Depth.....	139
4-21	Oval Concrete Pipe Long Axis Horizontal Critical Depth.....	140
4-22	Oval Concrete Pipe Long Axis Vertical Critical Depth.....	141
4-23	Standard Corrugated Metal Pipe-Arch Critical Depth.....	142
4-24	Structural Plate Pipe-Arch Critical Depth.....	143
4-25	Critical Depth Rectangular Section.....	144
4-26	Culvert Design Form.....	146
4-27	Culvert Headwalls and Wingwalls.....	152
4-28	Types of Scour at Storm Drain and Culvert Outlets.....	154

4-29	Square Culvert Froude Number.....	155
4-30	Predicted Scour Depth vs. Observed Scour Depth.....	156
4-31	Predicted Scour Width vs. Observed Scour Width .....	157
4-32	Predicted Scour Length vs. Observed Scour Length.....	158
4-33	Predicted Scour Volume vs. Observed Scour Volume .....	159
4-34	Dimensionless Scour Hole Geometry for Minimum Tailwater.....	160
4-35	Dimensionless Scour Hole Geometry for Maximum Tailwater.....	160
4-36	Recommended Size of Protective Stone .....	162
4-37	Length of Stone Protection, Horizontal Blanket .....	163
4-38	Recommended Configuration of Riprap Blanket Subject to Minimum and Maximum Tailwaters.....	164
4-39	Preformed Scour Hole .....	165
4-40	Culvert Outlet Erosion Protection, Lined Channel Expansion.....	166
4-41	Maximum Permissible Discharge for Lined Channel Expansions.....	166
4-42	Flared Outlet Transition .....	167
4-43	Stilling Well .....	169
4-44	U.S. Bureau of Reclamation Impact Basin .....	170
4-45	Saint Anthony Falls Stilling Basin .....	171
4-46	Design Chart for SAF Stilling Basin .....	172
4-47	Recommended Riprap Sizes .....	174
4-48	Scour Hole Riprap Sizes .....	175
5-1	Distribution of Shear Stress.....	193
5-2	Shear Stress Distribution in Channel Bends.....	195
5-3	Channel Geometries.....	198
6-1	Storm Drain Capacity Sensitivity .....	206
6-2	Hydraulic and Energy Grade Lines in Pipe Flow .....	210
6-3	Preliminary Storm Drain Computation Sheet.....	220
6-4	Energy and Hydraulic Grade Line Illustration .....	223
6-5	Energy Grade Line Computation Sheet – Table A.....	225
6-6	Energy Grade Line Computation Sheet – Table B.....	226
7-1	Inlet Structures .....	232
7-2	Typical Inlet Design for Storm Drainage Systems .....	233
7-3	Repair Area Inlets.....	234
7-4	Standard Storm Drain Manhole .....	237
7-5	Standard Precast Manholes .....	238
7-6	Junction Details for Large Pipes .....	238
7-7	Typical Manhole Configurations .....	239
7-8	“Tee” Manhole for Large Storm Drains .....	240
7-9	Efficient Channel and Bench Configurations .....	243
7-10	Details of Typical Drainage Chute .....	244
7-11	Outlet Security Barrier .....	245
7-12	Transitions to Avoid Obstruction.....	248
7-13	Twin-Barrel Siphon .....	249
7-14	Examples of Typical Inlet Grates .....	252
7-15	Examples of Inlet Design .....	253

7-16	Type A – Bicycle Gear Configuration.....	255
7-17	Type B – Tricycle Gear Configuration.....	255
7-18	Type C – Tricycle Gear Configuration .....	256
8-1	Hydrograph Schematic.....	257
8-2	Example of a Cumulative Hydrograph with and without Detention .....	259
9-1	Three Main Classes of Conduits.....	266
9-2	Free-Body Conduit Diagrams .....	267
9-3	Trench Beddings for Circular Pipe.....	268
9-4	Beddings for Positive Projecting Conduits.....	269
9-5	Installation Conditions that Influence Loads on Underground Conduits.....	269
10-1	Typical Cross Section of a Frost Belt Installation.....	296
10-2	Earth Embankments with Impervious Barriers.....	297

**TABLES**

<u>Table</u>	<u>Title</u>	
2-1	Runoff Coefficients for Rational Formula.....	16
2-2	Manning’s Roughness Coefficient ( <i>n</i> ) for Overland Sheet Flow .....	19
2-3	Intercept Coefficients for Velocity vs. Slope Relationship of Equation 2-4.....	20
2-4	Values of Manning’s Coefficient ( <i>n</i> ) for Channels and Pipes.....	21
2-5	Nationwide Urban Equations Developed by the USGS .....	26
2-6	Runoff Curve Numbers for Urban Areas (Average Watershed Condition, $I_a = 0.2S_R$ ) .....	29
2-7	Adjustment Factor ( $F_p$ ) for Pond and Swamp Areas that are Spread Throughout the Watershed .....	30
2-8	Tabular Hydrograph Unit Discharges for Type II Rainfall Distributions .....	33
2-9	Subarea and Composite Hydrographs .....	36
3-1	Manning’s <i>n</i> for Street and Pavement Gutters.....	46
3-2	Spread at Average Velocity in a Reach of Triangular Gutter .....	61
3-3	Average Debris Handling Efficiencies of Grates Tested.....	73
3-4	Grate Efficiency and Capacity Summary .....	79
3-5	Comparison of Inlet Interception Capacities.....	86
3-6	Distance to Flanking Inlets in a Sag Vertical Curve Using Depth at Curb Criteria.....	102
3-7	Grate Ranking with Respect to Bicycle and Pedestrian Safety .....	112
4-1	Entrance Loss Coefficients, Outlet Control, Full or Partly Full $H_e = K_e \frac{V^2}{2g}$ Entrance Head Loss, .....	128
5-1	Manning’s <i>n</i> for Natural Stream Channels (Surface Width at Flood Stage Less than 100 ft).....	187

5-2	Manning's Roughness Coefficients for Lined Channels .....	187
5-3	Classification of Vegetal Covers as to Degree of Retardance .....	188
5-4	Manning's $n$ Relationships for Vegetal Degree of Retardance .....	189
5-5	Permissible Shear Stresses for Lining Materials .....	199
6-1	Manning's Coefficients for Storm Drain Conduits .....	205
6-2	Increase in Capacity of Alternate Conduit Shapes Based on a Circular Pipe with the Same Height.....	207
6-3	Frequencies for Coincidental Occurrence .....	212
6-4	Minimum Pipe Slopes to Ensure 3.0 ft/s Velocity in Storm Drains Flowing Full .....	216
7-1	Manhole Spacing Criteria .....	241
7-2	Transition Design Criteria .....	248
9-1	Suggested Maximum Cover Requirements for Concrete Pipe, Reinforced Concrete, H-20 Highway Loading .....	270
9-2	Suggested Maximum Cover Requirements for Corrugated Aluminum Alloy Pipe, Riveted, Helical, or Welded Fabrication 2.66-in. Spacing, 0.5-in.-Deep Corrugations, H-20 Highway Loading.....	271
9-3	Suggested Maximum Cover Requirements for Corrugated Steel Pipe, 2.66-in. Spacing, 0.5-in.-Deep Corrugations .....	272
9-4	Suggested Maximum Cover Requirements for Structural Plate Aluminum Alloy Pipe, 9-in. Spacing, 2.5-in Corrugations .....	273
9-5	Suggested Maximum Cover Requirements for Corrugated Steel Pipe, 5-inch Span, 1-inch-Deep Corrugations .....	274
9-6	Suggested Maximum Cover Requirements for Structural Plate Steel Pipe, 6-in. Span, 2-in.-Deep Corrugations .....	275
9-7	Suggested Maximum Cover Requirements for Corrugated Steel Pipe, 3-in. Span, 1-in. Corrugations .....	277
9-8	Suggested Guidelines for Minimum Cover .....	278
9-9	Minimum Depth of Cover in Feet for Pipe Under Flexible Pavement (Part 1) .....	279
9-9	Minimum Depth of Cover in Feet for Pipe Under Flexible Pavement (Part 2) .....	280
9-9	Minimum Depth of Cover in Feet for Pipe Under Flexible Pavement (Part 3) .....	281
11-1	BMP Selection Criteria .....	302
11-2	Pollutant Removal Comparison for Various Urban BMP Designs.....	303
12-1	Software Versus Capabilities Matrix .....	309
12-2	Software Program Contact Information .....	321

## CHAPTER 1

### INTRODUCTION

1-1 **PURPOSE.** This document establishes general concepts and procedures for the hydrologic design of surface structures for the U.S. Army, Navy, Air Force, Marine Corps, and Federal Aviation Administration (FAA).

1-2 **SCOPE.** This manual prescribes the hydrologic design criteria to be used for transportation facilities and other areas.

1-3 **REFERENCES.** Appendix A contains a list of references used in this UFC. Appendix D is a bibliography that lists publications that are considered relevant to this subject and that offer additional information on various topics.

1-4 **UNITS OF MEASUREMENT.** The unit of measurement system in this document is the inch-pound (IP). In some cases, International System of Units (SI) measurements may be the governing critical values because of applicable codes, accepted standards, industry practices, or other considerations.

1-5 **APPLICABILITY.** Criteria in this manual pertain to all Department of Defense (DOD) military facilities in the United States, its territories, trusts, and possessions, and unless otherwise noted, to DOD facilities overseas on which the United States has vested base rights. For DOD facilities overseas, if written agreement exists between host nation and DOD that requires application of either North Atlantic Treaty Organization (NATO), International Civil Aviation Organization (ICAO), or other standards, those standards shall apply as stipulated in the agreement.

1-5.1 **Previous Standards.** The criteria in this manual are not intended to apply to existing facilities constructed under previous standards; however, when existing facilities are modified or new facilities are constructed, they must conform to the criteria established in this manual unless waived.

1-5.2 **Applicability Within DOD.** This document covers a wide range of topics in the areas of surface drainage and serves as the standard for several agencies responsible for hydrologic design for transportation facilities and other areas. The intended use of the facility under design may differ between agencies and in some cases dictates the need for separate standards. In special cases in which more than one standard is presented, or the standard does not apply to all agencies, special care has been given to clearly identify the relevant audience. Any user of this manual should pay close attention to the relevance of each topic to the intended agency.

#### 1-5.3 **Design Objectives**

1-5.3.1 The objective of storm drainage design is to provide for safe passage of vehicles or operation of the facility during the design storm event. The drainage system

is designed to collect storm water runoff from the pavement surface and adjacent areas, convey it along and through the adjacent areas, and discharge it to an adequate receiving body without causing adverse on- or off-site impacts.

1-5.3.2 Storm water collection systems must be designed to provide adequate surface drainage. Traffic safety is intimately related to surface drainage. Rapid removal of storm water from the pavement minimizes the conditions which can result in the hazards of hydroplaning. Surface drainage is a function of transverse and longitudinal pavement slope, pavement roughness, inlet spacing, and inlet capacity.

1-5.3.3 The objective of storm water conveyance systems (e.g., storm drain piping, ditches and channels, pumps) is to provide an efficient mechanism for conveying design flows from inlet locations to the discharge point without surcharging inlets or otherwise causing surface flooding. Erosion potential must also be considered in the design of open channels or ditches used for storm water conveyance.

1-5.3.4 The design of appropriate discharge facilities for storm water collection and conveyance systems includes consideration of storm water quantity and quality. Local, state, and/or Federal regulations often control the allowable quantity and quality of storm water discharges. To meet these regulatory requirements, storm drainage systems will usually require detention or retention basins, and/or other best management practices (BMPs) for the control of discharge quantity and quality.

1-5.4 **Waivers to Criteria.** Each DOD service component is responsible for setting administrative procedures necessary to process and grant formal waivers. Waivers to the criteria contained in this manual shall be in accordance with Appendix E.

1-6 **GENERAL INVESTIGATIONS.** An on-site investigation of the system site and tributary area is a prerequisite for study of drainage requirements. Information regarding capacity, elevations, and condition of existing drains will be obtained. Topography, size and shape of drainage area, and extent and type of development; profiles, cross sections, and roughness data on pertinent existing streams and watercourses; and location of possible ponding areas will be determined. Thorough knowledge of climatic conditions and precipitation characteristics is essential. Adequate information regarding soil conditions, including types, permeability, vegetative cover, depth to and movement of subsurface water, and depth of frost will be secured. Outfall and downstream flow conditions, including high-water occurrences and frequencies, also must be determined. The effect of base drainage construction on local interests' facilities and local requirements that will affect the design of the drainage works will be evaluated. Where diversion of runoff is proposed, particular effort will be made to avoid resultant downstream conditions leading to unfavorable public relations, costly litigations, or damage claims. Any agreements needed to obtain drainage easements and/or avoid interference with water rights will be determined at the time of design and consummated prior to initiation of construction. Possible adverse effects on water quality due to disposal of drainage in waterways involved in water supply systems will be evaluated.

## 1-7 ENVIRONMENTAL CONSIDERATIONS

1-7.1 **National Environmental Policy.** The National Environmental Policy Act of 1969 (NEPA), approved 1 January 1970, sets forth the policy of the Federal Government, in cooperation with state and local governments and other concerned public and private organizations, to protect and restore environmental quality. The Act (Public Law [PL] 91-190) states, in part, that Federal agencies have a continuing responsibility to use all practicable means, consistent with other essential considerations of national policy, to create and maintain conditions under which man and nature can exist in productive harmony. Federal plans, functions, and programs are to be improved and coordinated to (1) preserve the environment for future generations, (2) assure safe, healthful, productive, and aesthetically pleasing surroundings for all, (3) attain the widest beneficial uses of the environment without degradation, risk to health or safety or other undesirable consequences, ...and (4) enhance the quality of renewable resources and approach the maximum attainable recycling of depletable resources. All Federal agencies, in response to NEPA, must be concerned not just with the impact of their activities on technical and economic considerations but also on the environment.

1-7.2 **Federal Guidelines.** Storm drainage design is an integral component in the design of transportation facilities. Drainage design for transportation facilities must strive to maintain compatibility and minimize interference with existing drainage patterns, control flooding of the pavement surface for design flood events, and minimize potential environmental impacts from facility-related storm water runoff. To meet these goals, the planning and coordination of storm drainage systems must begin in the early planning phases of transportation projects. Federal goals for sustainability are outlined in the Environmental Protection Agency's (EPA) *Federal Guide for Green Construction Specs*.

System planning, prior to commencement of design, is essential to the successful development of a final storm drainage design. Successful system planning will result in a final system design that evolves smoothly through the preliminary and final design stages of the transportation project.

1-7.3 **Regulatory Considerations.** The regulatory environment related to drainage design is ever changing and continues to grow in complexity. Engineers responsible for the planning and design of drainage facilities must be familiar with Federal, state, and local regulations, laws, and ordinances that may impact the design of storm drain systems. A detailed discussion of the legal aspects of highway drainage design, including a thorough review of applicable laws and regulations, is included in the American Association of State Highway and Transportation Officials' (AASHTO) *Highway Drainage Guidelines*, Volume V, and *Model Drainage Manual*, Chapter 2. Some of the more significant Federal, state, and local regulations affecting drainage design are summarized in paragraphs 1-7.4 through 1-7.6.

1-7.4 **Federal Regulations.** The following Federal laws may affect the design of storm drainage systems. The highway drainage engineer should be familiar with these laws and any associated regulatory procedures.

1-7.4.1 The Fish and Wildlife Act of 1956 (*Title 16 United States Code* [USC] Section 742a, et seq.), the Migratory Game-Fish Act (16 USC § 760c-760g), and the Fish and Wildlife Coordination Act (16 USC § 661-666c) express the concern of Congress with the quality of the aquatic environment as it affects the conservation, improvement and enjoyment of fish and wildlife resources. The Fish and Wildlife Service's role in the permit review process is to review and comment on the effects of a proposal on fish and wildlife resources. Storm drainage design may impact streams or other channels which fall under the authority of these acts.

1-7.4.2 NEPA (42 USC § 4321-4347) declares the national policy to promote efforts which will prevent or eliminate damage to the environment and biosphere, stimulate the health and welfare of man, and to enrich the understanding of the ecological systems and natural resources important to the nation. NEPA and its implementing guidelines from the Council on Environmental Quality and the Federal Highway Administration (FHWA) affect highway drainage design as it relates to impacts on water quality and ecological systems.

1-7.4.3 Section 401 of the Federal Water Pollution Control Act Amendments of 1972 (FWPCA) (PL 92-500, 86 Stat. 816, 33 USC § 1344) prohibits discharges from point sources unless covered by a National Pollutant Discharge Elimination System (NPDES) permit. These permits are issued under authority of Section 402 of the Act, and must include the more stringent of either technology-based standards or water-quality based standards. The NPDES program regulations are found at Title 40, Code of Federal Regulations, Parts 122-125 (40 CFR 122-125). These regulations govern how the EPA and authorized states write NPDES permits by outlining procedures on how permits shall be issued, what conditions are to be included, and how the permits should be enforced.

1-7.4.4 Section 402p of the FWPCA (PL 92-500, 86 Stat. 816, 33 USC § 1344) requires the EPA to establish final regulations governing storm water discharge permit application requirements under the NPDES program. The permit application requirements include storm water discharges associated with industrial activities. Highway construction and maintenance are classified as industrial activities.

1-7.4.5 The Water Quality Act of 1987 (PL 100-4), an amendment of Section 402p of the FWPCA, provides a comprehensive framework for the EPA to develop a phased approach to regulating storm water discharges under the NPDES program for storm water discharges associated with industrial activity (including construction activities). The Act clarified that permits for discharges of storm water associated with industrial activity must meet all of the applicable provisions of Section 402 and Section 301, including technology and water quality-based standards. The classes of diffuse sources of pollution include urban runoff, construction activities, separate storm drains, waste disposal activities, and resource extraction operations, which all correlate well with categories of discharges covered by the NPDES storm water program.

1-7.4.6 Section 404 of the FWPCA (PL 92-500, 86 Stat. 816, 33 USC § 1344) prohibits the unauthorized discharge of dredged or fill material in navigable waters. The



instrument of authorization is termed a permit, and the Secretary of the Army, acting through the Chief of Engineers, U.S. Army Corps of Engineers, has responsibility for the administration of the regulatory program. The definition of navigable waters includes all coastal waters, navigable waters of the United States to their headwaters, streams tributary to navigable waters of the United States to their headwaters, inland lakes used for recreation or other purposes that may be interstate in nature, and wetlands contiguous or adjacent to the above waters. A water quality certification is also required for these activities.

1-7.4.7 The Coastal Zone Management Act of 1972 (PL 92-583, amended by PL 94-310; 86 Stat. 1280, 16 USC § 145, et seq.) declares a national policy to preserve, protect, develop, and restore or enhance the resources of the nation's coastal zone, and to assist states in establishing management programs to achieve wise use of land and water resources, giving full consideration to ecological, cultural, historic, and aesthetic values as well as to the needs of economic development. The development of highway storm drainage systems in coastal areas must comply with this act in accordance with state coastal zone management programs.

1-7.4.8 The Coastal Zone Act Reauthorization Amendments of 1990 (CZARA) specifically charged state coastal programs (administered under Federal authority by the National Oceanic and Atmospheric Administration [NOAA]), and state nonpoint source programs (administered under Federal authority by the EPA), to address nonpoint source pollution issues affecting coastal water quality. The guidance specifies economically achievable management measures to control the addition of pollutants to coastal waters for sources of nonpoint pollution through the application of the best available nonpoint pollution control practices, technologies, processes, siting criteria, operating methods, or other alternatives.

1-7.4.9 The Safe Water Drinking Act of 1974, as amended, includes provisions for requiring protection of surface water discharges in areas designated as sole or principal source aquifers. Mitigation of activities that may contaminate the aquifer (including highway runoff) are typically required to assure Federal funding of the project, which may be withheld if harm to the aquifer occurs.

1-7.5 **State Regulations.** In addition to complying with the Federal laws cited in paragraphs 1-7.1 through 1-7.4.9, the design of storm drainage systems must also comply with state laws and regulations. State drainage law is derived from both common and statutory law. A summary of applicable state drainage laws originating from common law, or court-made law, and statutory law follow. Note that this is a generalized summary of common state drainage law. Drainage engineers should become familiar with the application of these legal principles in their states.

1-7.5.1 The civil law rule of natural drainage is based upon the perpetuation of natural drainage. A frequently quoted statement of this law is:

. . . every landowner must bear the burden of receiving upon his land the surface water naturally falling upon land above it and naturally

flowing to it therefrom, and he has the corresponding right to have the surface water naturally falling upon his land or naturally coming upon it, flow freely therefrom upon the lower land adjoining, as it would flow under natural conditions. From these rights and burdens, the principle follows that he has a lawful right to complain of others, who, by interfering with natural conditions, cause such surface water to be discharged in greater quantity or in a different manner upon his land, than would occur under natural conditions. . . . (Heier v. Krull. 160 Cal 441 (1911))

This rule is inherently strict, and as a result has been modified to some degree in many states.

1-7.5.2 The reasonable use rule states that the possessor of land incurs liability only when his harmful interference with the flow of surface waters is unreasonable. Under this rule, a possessor of land is legally privileged to make a reasonable use of his land even though the flow of surface waters is altered thereby and causes some harm to others. The possessor of land incurs liability, however, when his harmful interference with the flow of surface waters is unreasonable.

1-7.5.3 Stream water rules are founded on a common law maxim that states that "water runs and ought to run as it is by natural law accustomed to run." Thus, as a general rule, any interference with the flow of a natural watercourse to the damage of another will result in liability. Surface waters from highways are often discharged into the most convenient watercourse. The right is unquestioned if those waters were naturally tributary to the watercourse and unchallenged if the watercourse has adequate capacity; however, if all or part of the surface waters has been diverted from another watershed to a small watercourse, any lower owner may complain and recover for ensuing damage.

1-7.5.4 Eminent domain is a statutory law giving public agencies the right to take private property for public use. This right can be exercised as a means to acquire the right to discharge highway drainage across adjoining lands when this right may otherwise be restricted. Whenever the right of eminent domain is exercised, a requirement of just compensation for property taken or damaged must be met.

1-7.5.5 Agricultural drainage laws have been adopted in some states. These laws provide for the establishment, improvement, and maintenance of ditch systems. Drainage engineers may have to take into consideration agricultural laws that may or may not permit irrigation waste water to drain into the highway right-of-way. If the drainage of irrigated agricultural lands into roadside ditches is permitted, excess irrigation water may have to be provided for in the design of the highway drainage system.

1-7.5.6 Environmental quality acts have been enacted by many states to promote the enhancement and maintenance of the quality of life. Hydraulic engineers should be familiar with these statutes.

1-7.6 **Local Laws.** Many governmental subdivisions have adopted ordinances and codes that impact drainage design. These include regulations for erosion control, BMPs, and storm water detention.

1-7.6.1 Erosion control regulations set forth practices, procedures, and objectives for controlling erosion from construction sites. Cities, counties, or other government subdivisions commonly have erosion control manuals that provide guidance for meeting local requirements. Erosion control measures are typically installed to control erosion during construction periods, and are often designed to function as a part of the highway drainage system. Additionally, erosion control practices may be required by the regulations governing storm water discharge requirements under the NPDES program. These erosion and sediment control ordinances set forth enforceable practices, procedures, and objectives for developers and contractors to control sedimentation and erosion by setting specific requirements that may include adherence to limits of clearing and grading, time limit or seasonal requirements for construction activities to take place, stabilization of the soil, and structural measures around the perimeter of the construction site.

1-7.6.2 BMP regulations set forth practices, procedures, and objectives for controlling storm water quality in urbanizing areas. Many urban city or county government bodies have implemented BMP design procedures and standards as a part of their land development regulations. The design and implementation of appropriate BMPs for controlling storm water runoff quality in these areas must be a part of the overall design of highway storm drainage systems. Additionally, the NPDES permit program for storm water management addresses construction site runoff by the use of self-designed storm water pollution prevention plans. These plans are based upon three main types of BMPs: those that prevent erosion, others that prevent the mixing of pollutants from the construction site with storm water, and those that trap pollutants before they can be discharged. All three of these BMPs are designed to prevent, or at least control, the pollution of storm water before it has a chance to affect receiving streams.

1-7.6.3 Storm water detention regulations set forth practices, procedures, and objectives for controlling storm water quantity through the use of detention basins or other controlling facilities. The purpose of these facilities is to limit increases in the amount of runoff resulting from land development activities. In some areas, detention facilities may be required as a part of the highway storm drainage system. Detention and retention basins must generally meet design criteria to control the more frequent storms and to safely pass larger storm events. Storm water management may also include other measures to reduce the rate of runoff from a developed site, such as maximizing the amount of runoff that infiltrates back into the ground.

1-7.7 **U.S. Army Environmental Quality Program.** Army Regulation (AR) 200-1, outlines the Army's fundamental environmental policies, management of its programs, and its various types of activities, one of which, water resources management, includes minimizing soil erosion and attendant pollution caused by rapid runoff into streams and rivers. The overall goal is to "plan, initiate, and carry out all actions and programs in a manner that will minimize or avoid adverse effects on the quality of the human

environment without impairment of the Army mission.” A primary objective is to eliminate the discharge of pollutants produced by Army activities. Provision of suitable surface drainage facilities is necessary in meeting this objective.

1-7.8 **U.S. Air Force Environmental Quality Program.** Air Force policy directive (AFPD) 32-70 enunciates Air Force policy in compliance with NEPA executive orders and DOD directives. Procedures outlined in AFPD 32-70 are similar to those described for Army installations. Air Force instruction (AFI) 32-7061 establishes 32 CFR 989 as the controlling document on environmental assessments and statements for Air Force facilities.

1-7.9 **U.S. Navy Environmental Quality Program.** The Navy's Environmental Quality Initiative (EQI) is a comprehensive initiative focused on maximizing the use of pollution prevention to achieve and maintain compliance with environmental regulations. The EQI is a fundamental part of the Navy environmental strategy called AIMM to SCORE – Assess, Implement, Manage and Measure to achieve Sustained Compliance and Operational Readiness through Environmental Excellence.

1-7.10 **FAA Environmental Handbook.** FAA Order 5050.4 provides instructions and guidance for preparing and processing the environmental assessments, findings of no significant impact (FONSI), and environmental impact statements (EIS) for airport development proposals and other airport actions as required by various laws and regulations.

1-7.11 **Environmental Impact Analysis.** A comprehensive reference, *Handbook for Environmental Impact Analysis*, was issued in September of 1974. This document, prepared by the U.S. Army Corps of Engineers Construction Engineering Research Laboratory (CERL), presents recommended procedures for use by Army personnel in preparing and processing environmental impact assessments (EIA) and EIS. The procedures list step-by-step actions considered necessary to comply with requirements of NEPA and subsequent guidelines. These require that all Federal agencies use a systematic and disciplinary approach to incorporate environmental considerations into their decision making process.

1-7.12 **Environmental Effects of Surface Drainage Systems.** Such facilities in the arctic or subarctic could have either beneficial or adverse environmental impacts affecting water, land, ecology, and socioeconomic (human and economic) considerations. Despite low population density and minimal development, the fragile nature of the ecology in the arctic and subarctic has attracted the attention of environmental groups interested in protecting these unique assets. Effects on surrounding land and vegetation may cause changes in various conditions in the existing environment, such as surface water quantity and quality, groundwater levels and quality, drainage areas, animal and aquatic life, and land use. Proposed systems may also have social impacts on the community, requiring relocation of military and public activities, open space, recreational activities, community activities, and quality of life. Environmental attributes related to water could include such items as erosion, aquifer yield, flood potential, flow or temperature variations (the latter affecting

permafrost levels and ice jams), biochemical oxygen demand, and content of dissolved oxygen, dissolved solids, nutrients, and coliform organisms. These are among many possible attributes to be considered in evaluating environmental impacts, both beneficial and adverse, including effects on surface water and groundwater. Various methods are explained for presenting and summing up the impact of these effects on the environment.

1-7.13 **Discharge Permits.** The Federal pollution abatement program requires regulatory permits for all discharges of pollutants from point sources (such as pipelines, channels, or ditches) into navigable waters or their tributaries. This requirement does *not* extend to discharges from separate storm sewers except where the storm sewers receive industrial, municipal, and agricultural wastes or runoff, or where the storm water discharge has been identified as a significant contributor of pollution by the EPA regional administrator, the state water pollution control agency, or an interstate agency. Federal installations, while cooperating with and furnishing information to state agencies, do not apply for or secure state permits for discharges into navigable waters.

1-7.14 **Effects of Drainage Facilities on Fish.** In many locations, natural drainage channels are environmentally important to preserve fish resources. Culverts, ditches, and other drainage structures constructed along or tributary to these fish streams must be designed to minimize adverse environmental effects. Culvert hazards to fish include high inverts, excessive velocities, undersized culverts, stream degradation, failed or damaged culverts that create obstructions, erosion and siltation at outlets, blockage by icing, and seasonal timing and methods of drainage construction. Consult Federal and state fish and wildlife agencies for guidance on probable effects and possible expedients to mitigate them. Give special concern to anticipated conditions during fish migration season. More information is located in Chapter 4.

## CHAPTER 2

### SURFACE HYDROLOGY

2-1 **PURPOSE AND SCOPE.** This chapter presents explanations and examples to give a better understanding of problems in the design of drainage facilities, and outlines convenient methods of estimating design capacities for drainage facilities.

2-2 **HYDROLOGIC CRITERIA.** The Rational Method, developed over 100 years ago, is widely used for estimating design runoff from urban areas. The Rational Formula, popular because of its simplicity in application, is suited mainly to sizing culverts, storm drains, or channels to accommodate drainage from small areas, generally less than 200 acres. Selection of appropriate values of runoff coefficients in the formula depends on the experience of the designers and the designers' knowledge of local rainfall-runoff relationships. United States Geological Survey (USGS) regression equations and National Resources Conservation Service (NRCS) techniques appropriate for surface drainage design are also included in this chapter.

2-2.1 **Design Objectives.** The design capacity of surface drainage systems should economically drain the facilities with due consideration of the mission and importance of the particular facility and environmental impacts.

2-2.2 **Degree of Drainage Required.** The degree of protection to be provided by the drain system depends largely on the importance of the facility as determined by the type and volume of traffic to be accommodated, the necessity for uninterrupted service, and similar factors. Although the degree of protection should increase with the importance of the facility, minimum requirements must be adequate to avoid hazards to operation. One severe accident chargeable to inadequate drainage can offset any difference between the cost of reasonably adequate and inadequate drainage facilities. In some cases, one can justify use of design storm frequencies appreciably higher than minimum criteria in order to protect important facilities. In some designs, portions of the drainage system have been based on as high as a 50-year (yr) design frequency to reduce likelihood of flooding a facility essential to operations and to prevent loss of life.

2-2.3 **Surface Runoff from Design Storm.** Surface runoff from the selected design storm will be disposed of without damage to facilities, undue saturation of the subsoil, or significant interruption of normal traffic. In addition, certain facilities may have restrictions on surface storage of water due to the potential attraction of waterfowl. For more information on waterfowl hazards, refer to Air Force pamphlet (AFPAM) 91-212 or Advisory Circular (AC) 150/5200-33.

2-2.4 **Design Storm Frequency**

2-2.4.1 **DOD Airfields and Heliports.** For airfields and heliports, a minimum of a 2-yr storm event is required unless a waiver is obtained. This event shall have no encroachment of runoff on taxiway and runway pavements (including paved shoulders).

It should be noted that after this design storm frequency is specified, computations must be made to determine the critical duration of rainfall required to produce the maximum rate of runoff for each area. This will depend primarily on the slope and length of overland flow. Another important aspect of the design is minimizing ponding during rain events. Ponding is the accumulation of water around an inlet structure during a rain event. Typically, ponding will be limited around the apron inlets such that it does not exceed 4 inches (in.).

**2-2.4.2 Federal Aviation Administration.** For airports, it is recommended that the 5-yr storm event be used with no encroachment of runoff on taxiway and runway pavements (including paved shoulders). The damage or inconvenience that may be caused by storms greater than the 5-yr event may not warrant the increased cost of a drainage system large enough to accommodate that storm. The calculation of and provision for the storage of water or ponding between runways, taxiways, and aprons should usually be considered as a safety factor for temporary accommodation of runoff from storm return periods longer than 5 years. Ponding or storage of water of more than a temporary nature may be acceptable on the airport site other than between runways, taxiways, and aprons. Such temporary storage may indeed be essential because of limitations in offsite outfalls. An additional design consideration is the ponding of water around an inlet structure on an apron during a rain event. Typically, ponding will be limited around an apron inlet such that it does not exceed 4 inches.

**2-2.4.3 Areas Other Than Airfields.** For such developed portions of military installations as roadways, administrative, industrial, and housing areas, the design storm will normally be based on rainfall of 10-yr frequency. Potential damage or operational requirements may warrant a more severe criterion; in certain storage and recreational areas, a lesser criterion may be appropriate. (With concurrence of the using service, a lesser criterion may also be employed in regions where storms of an appreciable magnitude are infrequent and either damages or operational capabilities are such that large expenditures for drainage are not justified.)

An additional design consideration is the spread of water around inlets. Spread is the width of water on the paved surface measured perpendicular to the curb face. More information on limitations of spread can be found in Chapter 3.

**2-2.5 Surface Runoff from Storms Exceeding Design Storm.** The design storm frequency alone is not a reliable criterion of the adequacy of storm drain facilities. It is advisable to investigate the probable consequences of storms more severe and less frequent than the design storm before making final decisions regarding the adequacy of proposed drain-inlet capacities. Surface runoff from storms greater than the design storm will be disposed of with the minimum damage to the airfield or heliport. The center 50 percent of runways; the center 50 percent of taxiways serving these runways; and helipad surfaces along the centerline should be free from ponding resulting from storms of a 10-yr frequency and intensity determined by the geographic location. For areas other than airfields and heliports, check with the appropriate local regulatory agency for guidance on design storm requirements.

2-2.6 **Reliability of Operation.** The drainage system will have the maximum reliability of operation practicable under all conditions, with due consideration given to abnormal requirements such as debris and annual periods of snowmelt and ice jam breakup.

2-2.7 **Environmental Impact.** Drainage facilities will be constructed with minimal impact on the environment.

2-2.8 **Maintenance.** The drainage system will require minimum maintenance, and that maintenance will be accomplished quickly and economically. Particular reliance will be placed on maintenance of drainage components serving operational facilities.

2-2.9 **Future Expansion.** Future expansion of drainage facilities will be feasible with the minimum of expense and interruption to normal traffic.

2-3 **HYDROLOGIC METHODS AND PROCEDURES.** This section provides an overview of hydrologic methods and procedures commonly used in drainage design. These methods include: the Rational Method, the Soil Conservation Service (SCS) Technical Release 55 (TR-55) method, and the USGS regression equations. Much of the information contained in this section was condensed from the FHWA Hydraulic Engineering Circular No. 22 (HEC-22). The presentation here is intended to provide the reader with an introduction to the methods and procedures, their data requirements, and their limitations. Most of these procedures can be applied using commonly available computer programs. Chapter 12 of this manual contains information on available computer programs.

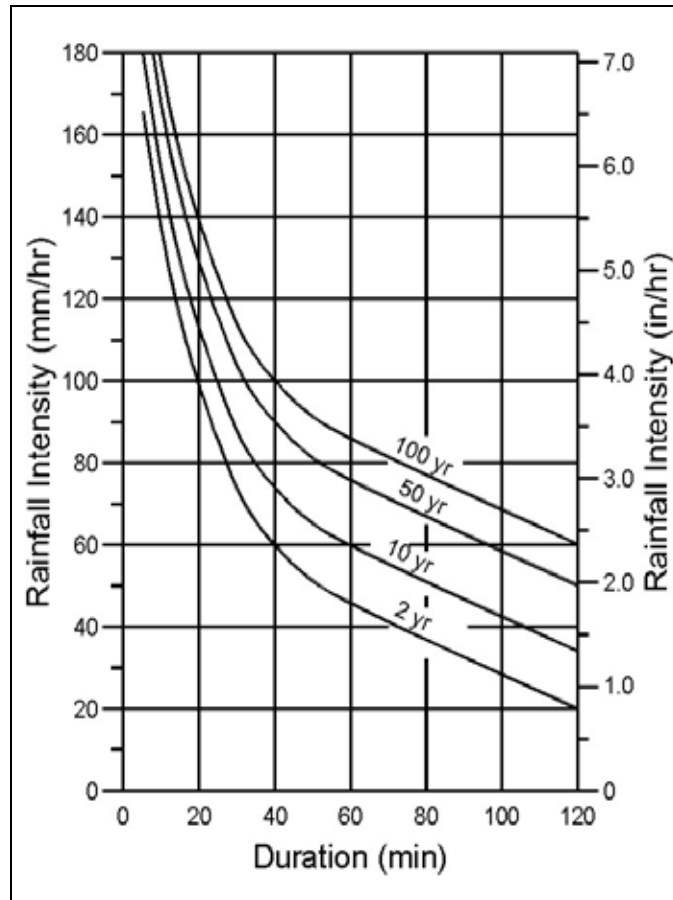
2-3.1 **Rainfall (Precipitation).** Rainfall, along with watershed characteristics, determines the flood flows upon which storm drainage design is based. In this section, we will describe the constant rainfall and the synthetic rainfall techniques.

2-3.1.1 **Constant Rainfall Intensity.** Although rainfall intensity varies during precipitation events, many of the procedures used to derive peak flow are based on an assumed constant rainfall intensity. Intensity is defined as the rate of rainfall and is typically given in units of inches per hour (in/hr).

Intensity-duration-frequency curves (IDF curves) have been developed for many jurisdictions throughout the United States through frequency analysis of rainfall events for thousands of rainfall gages. The IDF curve provides a summary of a site's rainfall characteristics by relating storm duration and exceedance probability (frequency) to rainfall intensity (assumed constant over the duration). Figure 2-1 illustrates an example IDF curve. To interpret an IDF curve, find the rainfall duration along the X-axis, go vertically up the graph until reaching the proper return period, then go horizontally to the left and read the intensity off of the Y-axis. Regional IDF curves are available in most state or local highway agency drainage manuals. If the IDF curves are not available, the designer needs to develop them on a project-by-project basis.



Figure 2-1. Example IDF Curve



2-3.1.2 **Synthetic Rainfall Events.** Drainage design is usually based on synthetic rather than actual rainfall events. The SCS 24-hour (hr) rainfall distributions are the most widely used synthetic hyetographs. These rainfall distributions were developed by the U.S. Department of Agriculture SCS, which is now known as NRCS. The SCS 24-hr distributions incorporate the intensity-duration relationship for the design return period. This approach is based on the assumption that the maximum rainfall for any duration within the 24-hr duration should have the same return period. For example, a 10-yr, 24-hr design storm would contain the 10-yr rainfall depths for all durations up to 24 hours as derived from IDF curves. SCS developed four synthetic 24-hr rainfall distributions as shown in Figure 2-2; approximate geographic boundaries for each storm distribution are shown in Figure 2-3.

Figure 2-2. SCS 24-hr Rainfall Distribution

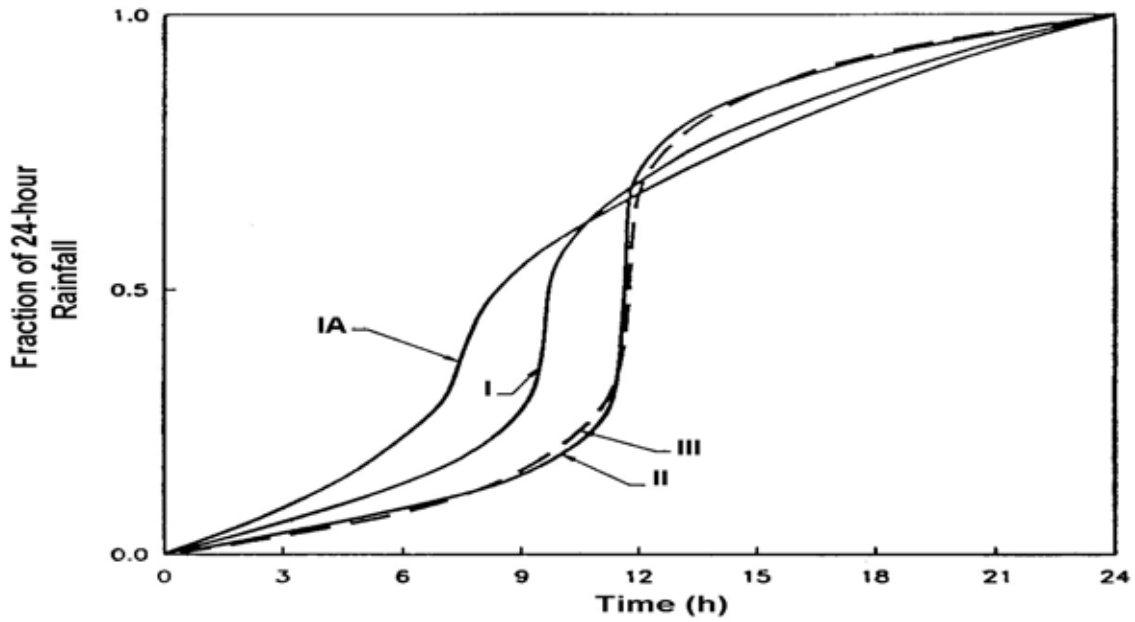
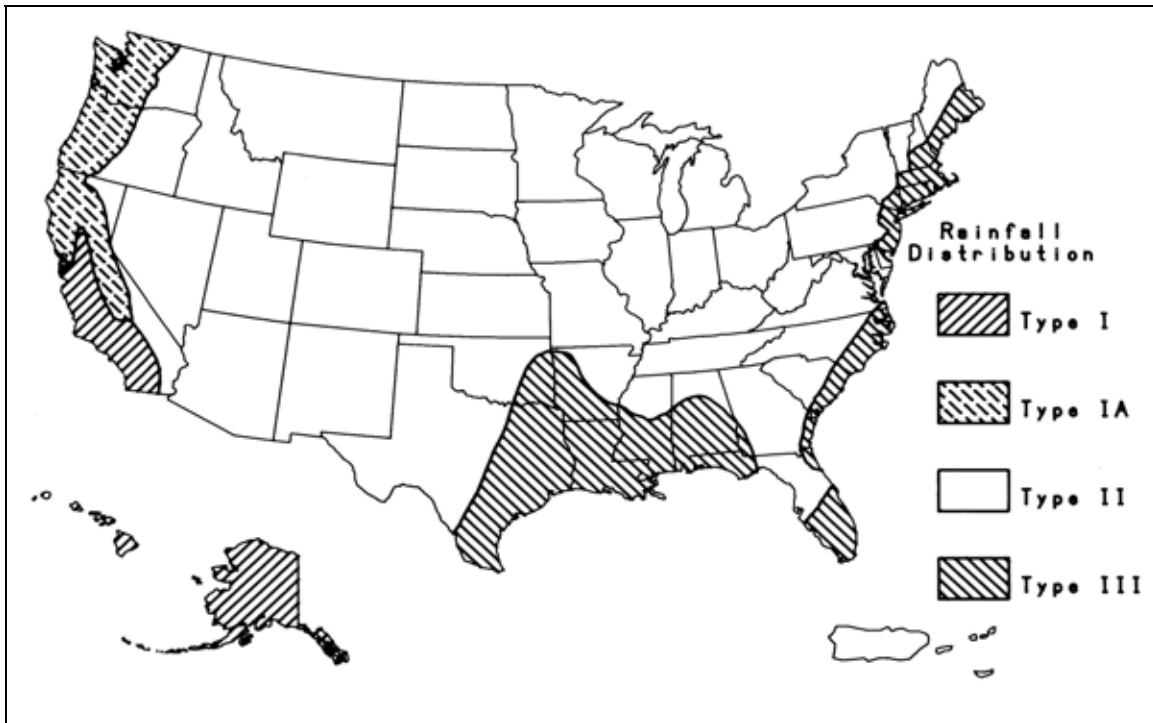


Figure 2-3. Approximate Geographic Areas for SCS Rainfall Distributions



Although the SCS distributions shown do not agree exactly with IDF curves for all locations in the region for which they are intended, the differences are within the

accuracy limits of the rainfall depths from the Weather Bureau's rainfall frequency atlases.

**2-3.2 Determination of Peak Flow Rates.** Peak flows are generally adequate for design and analysis of conveyance systems such as storm drains or open channels; however, if the design or analysis must include flood routing (e.g., storage basins or complex conveyance networks), a flood hydrograph is required. This section discusses three methods, the Rational Method, the SCS TR-55 method, and the USGS regression equations, that are used to derive peak flows for both gaged and ungaged sites. Each method can be used to develop a peak discharge. The drainage area of the project usually dictates which of these methods should be used. The Rational Method is the most commonly used method, but due to its assumptions, it is limited to drainage areas smaller than 200 acres. For drainage areas up to 2000 acres, the SCS TR-55 method is commonly used. Due to the way in which the regression equations were developed, they are usually not appropriate for very small areas, but each set of equations has its own limitations and those should be understood before the equations are applied. The regression equations are often used to compute the discharges for larger areas such as those necessary for culvert design.

**2-3.2.1 Rational Method.** One of the most commonly used equations for the calculation of peak flow from small areas is the Rational Formula, given as Equation 2-1:

$$Q = CIA \tag{2-1}$$

where:

$Q$  = flow, ft<sup>3</sup>/s

$C$  = dimensionless runoff coefficient representing the characteristics of the watershed

$I$  = rainfall intensity, in/hr

$A$  = drainage area, hectares, acres

**2-3.2.1.1 Assumptions.** Assumptions inherent in the Rational Formula are that:

- Peak flow occurs when the entire watershed is contributing to the flow.
- Rainfall intensity is the same over the entire drainage area.
- Rainfall intensity is uniform over a time duration equal to the time of concentration ( $t_c$ ). The time of concentration is the time required for water to travel from the hydraulically most remote point of the basin to the point of interest.

- The frequency of the computed peak flow is the same as that of the rainfall intensity, i.e., the 10-yr rainfall intensity is assumed to produce the 10-yr peak flow.
- The coefficient of runoff is the same for all storms of all recurrence probabilities.

2-3.2.1.2 **Limitations.** Because of the inherent assumptions, the Rational Formula should be applied only to drainage areas smaller than 200 acres.

2-3.2.2 **Runoff Coefficient**

2-3.2.2.1 The runoff coefficient, *C*, in Equation 2-1 is a function of the ground cover and a host of other hydrologic abstractions. It relates the estimated peak discharge to a theoretical maximum of 100 percent runoff. Typical values for *C* are given in Table 2-1. If the basin contains varying amounts of different land cover or other abstractions, a composite coefficient can be calculated through area weighing using Equation 2-2:

$$\text{weighted } C = \frac{\sum(C_x A_x)}{A_{total}} \tag{2-2}$$

where:

*x* = subscript designating values for incremental areas with consistent land cover

**Table 2-1. Runoff Coefficients for Rational Formula**

Type of Drainage Area	Runoff Coefficient, <i>C</i> *
<b>Business:</b>	
Downtown areas	0.70 - 0.95
Neighborhood areas	0.50 - 0.70
<b>Residential:</b>	
Single-family areas	0.30 - 0.50
Multi-units, detached	0.40 - 0.60
Multi-units, attached	0.60 - 0.75
Suburban	0.25 - 0.40
Apartment dwelling areas	0.50 - 0.70
<b>Industrial:</b>	
Light areas	0.50 - 0.80
Heavy areas	0.60 - 0.90
Parks, cemeteries	0.10 - 0.25
Playgrounds	0.20 - 0.40
Railroad yard areas	0.20 - 0.40
Unimproved areas	0.10 - 0.30

Type of Drainage Area	Runoff Coefficient, C*
Lawns:	
Sandy soil, flat, 2 percent	0.05 - 0.10
Sandy soil, average, 2 to 7 percent	0.10 - 0.15
Sandy soil, steep, 7 percent	0.15 - 0.20
Heavy soil, flat, 2 percent	0.13 - 0.17
Heavy soil, average, 2 to 7 percent	0.18 - 0.22
Heavy soil, steep, 7 percent	0.25 - 0.35
Streets:	
Asphaltic	0.70 - 0.95
Concrete	0.80 - 0.95
Brick	0.70 - 0.85
Drives and walks	0.75 - 0.85
Roofs	0.75 - 0.95
*Higher values are usually appropriate for steeply sloped areas and longer return periods because infiltration and other losses have a proportionally smaller effect on runoff in these cases.	

2-3.2.2.2 Example 2-1 illustrates the calculation of the runoff coefficient, C, using area weighing.

Example 2-1

*Given:* These existing and proposed land uses:

Existing conditions (unimproved):

Land Use	Area, acres	Runoff Coefficient, C
Unimproved Grass	22.1	0.25
Grass	21.2	0.22
Total =	43.3	

Proposed conditions (improved):

Land Use	Area, acres	Runoff Coefficient, C
Paved	5.4	0.90
Lawn	1.6	0.15
Unimproved Grass	18.6	0.25
Grass	17.7	0.22
Total =	43.3	

*Find:* Weighted runoff coefficient, C, for the existing and proposed conditions.

*Solution:*

Step 1. Determine weighted C for existing (unimproved) conditions using Equation 2-2.

$$\text{weighted } C = \frac{\sum(C_x A_x)}{A}$$

$$\text{weighted } C = \frac{[(22.1)(0.25) + (21.2)(0.22)]}{(43.3)}$$

$$\text{weighted } C = 0.235$$

Step 2. Determine weighted C for proposed (improved) conditions using Equation 2-2.

$$\text{weighted } C = \frac{[(5.4)(0.90) + (1.6)(0.15) + (18.6)(0.25) + (17.7)(0.22)]}{(43.3)}$$

$$\text{weighted } C = 0.315$$

**2-3.2.3 Rainfall Intensity.** Rainfall intensity, duration, and frequency curves are necessary to use the Rational Method. Regional IDF curves are available in most state and local highway agency manuals and are also available from NOAA. If the IDF curves are not available, they should be developed.

**2-3.2.4 Time of Concentration.** A number of methods can be used to estimate time of concentration,  $t_c$ , some of which are intended to calculate the flow velocity within individual segments of the flow path (e.g., shallow concentrated flow, open channel flow, etc.). The time of concentration can be calculated as the sum of the travel times within the various consecutive flow segments. For additional discussion on establishing the time of concentration for inlets and drainage systems, see Chapters 3 and 6 of this manual.

**2-3.2.4.1 Sheet Flow Travel Time.** Sheet flow is the shallow mass of runoff on a planar surface with a uniform depth across the sloping surface. This usually occurs at the headwater of streams over relatively short distances, rarely more than about 400 feet (ft), and possibly less than 80 ft. Sheet flow is commonly estimated with a version of the kinematic wave equation, a derivative of Manning's equation, shown as Equation 2-3:

$$T_{ti} = \frac{K_c}{I^{0.4}} \left( \frac{nL}{\sqrt{S}} \right)^{0.6} \quad (2-3)$$

where:

- $T_{if}$  = sheet flow travel time, minutes (min)
- $n$  = roughness coefficient (see Table 2-2)
- $L$  = flow length, ft
- $I$  = rainfall intensity, in/hr
- $S$  = surface slope, feet per feet (ft/ft)
- $K_c$  = empirical coefficient equal to 0.933

**Table 2-2. Manning's Roughness Coefficient ( $n$ ) for Overland Sheet Flow**

Surface Description	$n$
Smooth asphalt	0.011
Smooth concrete	0.012
Ordinary concrete lining	0.013
Good wood	0.014
Brick with cement mortar	0.014
Vitrified clay	0.015
Cast iron	0.015
Corrugated metal pipe	0.024
Cement rubble surface	0.024
Fallow (no residue)	0.05
Cultivated soils	
Residue cover < 20 percent	0.06
Residue cover > 20 percent	0.17
Range (natural)	0.13
Grass	
Short grass prairie	0.15
Dense grasses	0.24
Bermuda grass	0.41
Woods*	
Light underbrush	0.40
Dense underbrush	0.80
*When selecting $n$ , consider cover to a height of about 1.2 inches. This is only part of the plant cover that will obstruct sheet flow.	

Since the rainfall intensity value,  $I$ , depends on  $t_{ij}$  and  $t_{ij}$  is not initially known, the computation of  $t_{ij}$  is an iterative process. An initial estimate of  $t_{ij}$  is assumed and used to obtain  $I$  from the IDF curve for the locality. The  $t_{ij}$  is then computed from Equation 2-3 and used to check the initial value of  $t_{ij}$ . If they are not the same, the process is repeated until two successive  $t_{ij}$  estimates are the same.

**2-3.2.4.2 Shallow Concentrated Flow Velocity.** After short distances of at most 300 ft, sheet flow tends to concentrate in rills and then gullies of increasing proportions. Such flow is usually referred to as shallow concentrated flow. The velocity of such flow can be estimated using a relationship between velocity and slope as shown in Equation 2-4:

$$V = (3.28)kS_p^{0.5} \tag{2-4}$$

where:

$V$  = velocity, ft/s

$k$  = intercept coefficient (see Table 2-3)

$S_p$  = slope, percent

**Table 2-3. Intercept Coefficients for Velocity vs. Slope Relationship of Equation 2-4**

Land Cover/Flow Regime	$k$
Forest with heavy ground litter; hay meadow (overland flow)	0.076
Trash fallow or minimum tillage cultivation; contour or strip cropped; woodland (overland flow)	0.152
Short grass pasture (overland flow)	0.213
Cultivated straight row (overland flow)	0.274
Nearly bare and untilled (overland flow); alluvial fans in western mountain regions	0.305
Grassed waterway (shallow concentrated flow)	0.457
Unpaved (shallow concentrated flow)	0.491
Paved area (shallow concentrated flow); small upland gullies	0.619

**2-3.2.4.3 Open Channel and Pipe Flow Velocity.** Flow in gullies empties into channels or pipes. Open channels are assumed to begin where either the blue stream line shows on USGS quadrangle sheets or the channel is visible on aerial photographs. Cross-section geometry and roughness should be obtained for all channel reaches in the watershed. Manning's equation can be used to estimate average flow velocities in pipes and open channels as follows:



$$V = \frac{1.49}{n} R^{2/3} S^{1/2} \quad (2-5)$$

where:

$n$  = roughness coefficient (see Table 2-4)

$V$  = velocity, ft/s

$R$  = hydraulic radius (defined as the flow area divided by the wetted perimeter),  
ft

$S$  = slope, ft/ft

**Table 2-4. Values of Manning's Coefficient ( $n$ ) for Channels and Pipes**

Conduit Material	Manning's $n^*$
<b>Closed Conduits</b>	
Brick	0.013 - 0.017
Cast iron pipe	
Cement-lined and seal coated	0.011 - 0.015
Concrete (monolithic)	0.012 - 0.014
Concrete pipe	0.011 - 0.015
Corrugated-metal pipe – 0.5 in. by 2.5 in. corrugations	
Plain	0.022 - 0.026
Paved invert	0.018 - 0.022
Spun asphalt lines	0.011 - 0.015
Plastic pipe (smooth)	0.011 - 0.015
Vitrified clay	
Pipes	0.011 - 0.015
Liner plates	0.013 - 0.017
<b>Open Channels</b>	
Lined channels	
Asphalt	0.013 - 0.017
Brick	0.012 - 0.018
Concrete	0.011 - 0.020
Rubble or riprap	0.020 - 0.035
Vegetal	0.030 - 0.400
Excavated or dredged	
Earth, straight and uniform	0.020 - 0.030
Earth, winding, fairly uniform	0.025 - 0.040

Conduit Material	Manning's $n^*$
Rock	0.030 - 0.045
Unmaintained	0.050 - 0.140
Natural channels (minor streams, top width at flood stage < 100 ft)	
Fairly regular section	0.030 - 0.070
Irregular section with pools	0.040 - 0.100
*Lower values are usually for well-constructed and maintained (smoother) pipes and channels.	

For a circular pipe flowing full, the hydraulic radius is one-fourth of the diameter. For a wide rectangular channel ( $W > 10 d$ ), the hydraulic radius is approximately equal to the depth. The travel time is then calculated as follows:

$$T_{ti} = \frac{L}{60V} \quad (2-6)$$

where:

$T_{ti}$  = travel time for segment i, min

$L$  = flow length for segment i, ft

$V$  = velocity for segment i, ft/s

### Example 2-2

*Given:* These flow path characteristics:

<u>Flow Segment</u>	<u>Length (ft)</u>	<u>Slope (ft/ft)</u>	<u>Segment Description</u>
1 (sheet flow)	223	0.005	Bermuda grass
2 (shallow conduit)	259	0.006	Grassed waterway
3 (flow in conduit)	479	0.008	15-in concrete pipe

*Find:* Time of concentration,  $t_c$ , for the area.

*Solution:*

Step 1. Calculate time of concentration for each segment.

#### **Segment 1**

Obtain Manning's  $n$  roughness coefficient from Table 2-2:  $n = 0.41$

Determine the sheet flow travel time using Equation 2-3:

$$T_{ti} = \frac{K_c}{l^{0.4}} \left( \frac{nL}{\sqrt{S}} \right)^{0.6}$$

Since the rainfall intensity value,  $l$ , is being sought and is also in the equation, an iterative approach must be used. From experience, estimate a time of concentration and read a rainfall intensity from the appropriate IDF curve. In this example, try a time of concentration of 30 min and read from the IDF curve in Figure 2-1 an intensity of 3.4 in/hr. Now use Equation 2-3 to see how good the 30-min estimate was.

First, solve the equation in terms of  $l$ .

$$T_{ti1} = \left[ \frac{0.933}{(l)^{0.4}} \right] \left[ \frac{(0.41)(223)}{(0.005)^{0.5}} \right]^{0.6} = \frac{(68.68)}{l^{0.4}}$$

Inserting 3.4 in/hr for  $l$ , the result is 42.1 min. Since 42.1 is greater than the assumed 30 min, try the intensity for 42 min from Figure 2-1, which is 2.8 in/hr.

Using 2.8 in/hr, the result is 45.4 min. Repeat the process with 2.7 in/hr for 45 min and the result is a time of 46.2. This value is close to the 45.2 min.

Use 46 min for segment 1.

## Segment 2

Obtain the intercept coefficient,  $k$ , from Table 2-3:  $k = 0.457$  and  $K_c = 3.281$

Determine the concentrated flow velocity from Equation 2-4:

$$V = 3.28kS_p^{0.5} = (3.28)(0.457)(0.6)^{0.5} = 1.16 \text{ ft/s}$$

Determine the travel time from Equation 2-6:

$$T_{ti2} = \frac{L}{(60V)} = \frac{259}{[(60)(1.16)]} = 3.7 \text{ min}$$

**Segment 3**

Obtain Manning's  $n$  roughness coefficient from Table 2-4:  $n = 0.011$

Determine the pipe flow velocity from Equation 2-5 (assuming full flow)

$$V = (1.49/0.011)(1.25/4)^{0.67} (0.008)^{0.5} = 5.58 \text{ ft/s}$$

Determine the travel time from Equation 2-6:

$$T_{i3} = \frac{L}{(60V)} = \frac{479}{[(60)(5.58)]} = 1.4 \text{ min}$$

Step 2. Determine the total travel time by summing the individual travel times:

$$t_c = T_{i1} + T_{i2} + T_{i3} = 46.0 + 3.7 + 1.4 = 51.1 \text{ min} \quad \text{Use 51 min}$$

Example 2-3

*Given:* Land use conditions from Example 2-1 and the following times of concentration:

Condition	Time of concentration $t_c$ (min)	Weighted C (from Example 2-1)
Existing condition (unimproved)	88	0.235
Proposed condition (improved)	66	0.315

Area = 43.36 acres

*Find:* The 10-yr peak flow using the Rational Formula and the IDF curve shown in Figure 2-1.

*Solution:*

Step 1. Determine the rainfall intensity,  $I$ , from the 10-yr IDF curve for each time of concentration.

Existing condition (unimproved) 1.9 in/hr

Proposed condition (improved) 2.3 in/hr

Step 2. Determine peak flow rate,  $Q$ .

Existing condition (unimproved):

$$\begin{aligned} Q &= CIA \\ &= (0.235)(1.9)(43.3) \end{aligned}$$

$$= 19.3 \text{ ft}^3/\text{s}$$

Proposed condition (improved):

$$\begin{aligned} Q &= CIA \\ &= (0.315)(2.3)(43.3) \\ &= 31.4 \text{ ft}^3/\text{s} \end{aligned}$$

2-3.3 **USGS Regression Equations.** Regression equations are commonly used for estimating peak flows at ungaged sites or sites with limited data. The USGS has developed and compiled regional regression equations that are included in a computer program called the National Flood Frequency program (NFF). NFF allows quick and easy estimation of peak flows throughout the United States. All the USGS regression equations were developed using dependent variables in English units. Local equations may be available to provide better correspondence to local hydrology than the regional equations found in NFF. For more information on NFF, refer to paragraph 12-10.7.

2-3.3.1 **Rural Equations.** The rural equations are based on watershed and climatic characteristics within specific regions of each state that can be obtained from topographic maps, rainfall reports, and atlases. These regression equations are generally of the following form:

$$RQ_T = aA^b B^c C^d \quad (2-7)$$

where:

$$\begin{aligned} RQ_T &= \text{T-year rural peak flow} \\ a &= \text{regression constant} \\ b,c,d &= \text{regression coefficients} \\ A,B,C &= \text{basin characteristics} \end{aligned}$$

Through a series of studies conducted by the USGS, state highway, and other agencies, rural equations have been developed for all states. The NFF program described in Chapter 12 is a companion software package to implement these equations. These equations should not be used where dams and other hydrologic modifications have a significant effect on peak flows. Many other limitations are presented in USGS documents.

2-3.3.2 **Urban Equations.** Rural peak flow can be converted to urban peak flows with the seven-parameter nationwide urban regression equations developed by the USGS. These equations are shown in Table 2-5. A three-parameter equation has also been developed, but the seven-parameter equation is implemented in NFF. The urban equations are based on urban runoff data from 269 basins in 56 cities and 31 states.

These equations have been thoroughly tested and proven to give reasonable estimates of peak flows having recurrence intervals between 2 and 500 years. Subsequent testing at 78 additional sites in the southeastern United States verified the adequacy of the equations. While these regression equations have been verified, errors may still be approximately 35 to 50 percent when compared to field measurements. More information can be found in the USGS publication, *Flood Characteristics of Urban Watersheds in the United States*.

**Table 2-5. Nationwide Urban Equations Developed by the USGS**

Equation	Chapter Equation Number
$UQ_2 = 2.35 A_s^{.41} SL^{.17} (RI_2 + 3)^{2.04} (ST + 8)^{-.65} (13 - BDF)^{-.32} IA_s^{.15} RQ_2^{.47}$	(2-8)
$UQ_5 = 2.70 A_s^{.35} SL^{.16} (RI_2 + 3)^{1.86} (ST + 8)^{-.59} (13 - BDF)^{-.31} IA_s^{.11} RQ_5^{.54}$	(2-9)
$UQ_{10} = 2.99 A_s^{.32} SL^{.15} (RI_2 + 3)^{1.75} (ST + 8)^{-.57} (13 - BDF)^{-.30} IA_s^{.09} RQ_{10}^{.58}$	(2-10)
$UQ_{25} = 2.78 A_s^{.31} SL^{.15} (RI_2 + 3)^{1.76} (ST + 8)^{-.55} (13 - BDF)^{-.29} IA_s^{.07} RQ_{25}^{.60}$	(2-11)
$UQ_{50} = 2.67 A_s^{.29} SL^{.15} (RI_2 + 3)^{1.74} (ST + 8)^{-.53} (13 - BDF)^{-.28} IA_s^{.06} RQ_{50}^{.62}$	(2-12)
$UQ_{100} = 2.50 A_s^{.29} SL^{.15} (RI_2 + 3)^{1.76} (ST + 8)^{-.52} (13 - BDF)^{-.28} IA_s^{.06} RQ_{100}^{.63}$	(2-13)
$UQ_{500} = 2.27 A_s^{.29} SL^{.16} (RI_2 + 3)^{1.86} (ST + 8)^{-.54} (13 - BDF)^{-.27} IA_s^{.05} RQ_{500}^{.63}$	(2-14)
<p>where:</p> <ul style="list-style-type: none"> <li><math>UQ_T</math> = Urban peak discharge for T-year recurrence interval, ft<sup>3</sup>/s</li> <li><math>A_s</math> = Contributing drainage area, mi<sup>2</sup></li> <li><math>SL</math> = Main channel slope (measured between points that are 10 and 85 percent of main channel length upstream of site), ft/mi</li> <li><math>RI_2</math> = Rainfall intensity for 2-hr, 2-yr recurrence, in/hr</li> <li><math>ST</math> = Basin storage (percentage of basin occupied by lakes, reservoirs, swamps, and wetlands), percent</li> <li><math>BDF</math> = Basin development factor (provides a measure of the hydraulic efficiency of the basin (see description in paragraph 2-3.3.2)</li> <li><math>IA</math> = Percentage of basin occupied by impervious surfaces</li> <li><math>RQ_T</math> = T-year rural peak flow</li> </ul>	

The basin development factor (BDF) is a highly significant parameter in the urban equations and provides a measure of the efficiency of the drainage basin and the extent of urbanization. It can be determined from drainage maps and field inspection of

the basin. The basin is first divided into upper, middle, and lower thirds. Within each third of the basin, four characteristics must be evaluated and assigned a code of 0 or 1. The four characteristics are: channel improvements; channel lining (prevalence of impervious surface lining); storm drains or storm sewers; and curb and gutter streets.

With the curb and gutter characteristic, at least 50 percent of the partial basin must be urbanized or improved with respect to an individual characteristic to be assigned a code of 1. With four characteristics being evaluated for each third of the basin, complete development would yield a BDF of 12.

#### Example 2-4

*Given:* The following site characteristics:

- The site is located in Tulsa, Oklahoma.
- The drainage area is 3 square miles (mi<sup>2</sup>)
- The mean annual precipitation is 38 in.
- Urban parameters (see Table 2-5 for parameter definition):

$$SL = 53 \text{ ft/mi}$$

$$RI2 = 2.2 \text{ in/hr (see National Weather Service Technical Paper 40)}$$

$$ST = 5$$

$$BDF = 7$$

$$IA = 35$$

*Find:* The 2-yr urban peak flow.

*Solution:*

Step 1. Calculate the rural peak flow from the appropriate regional equation.

From Water-Resources Investigations Report 94-4002, the rural regression equation for Tulsa, Oklahoma, is:

$$RQ2 = 0.368A_s^{.59} P^{1.84} = 0.368(3)^{.59} (38)^{1.84} = 568 \text{ ft}^3 / \text{s}$$

Step 2. Calculate the urban peak flow using Equation 2-8.

$$UQ2 = 2.35A_s^{.41} SL^{.17} (RI2 + 3)^{2.04} (ST + 8)^{.65} (13 - BDF)^{.32} IA_s^{.15} RQ2^{.47}$$

$$UQ2 = 2.35(3)^{.41} (53)^{.17} (2.2 + 3)^{2.04} (5 + 8)^{.65} (13 - 7)^{.32} (35)^{.15} (568)^{.47} = 747 \text{ ft}^3 / \text{s}$$

2-3.4 **SCS TR-55 Peak Flow Method.** The SCS (now known as NRCS) peak flow method calculates peak flow as a function of drainage basin area, potential watershed storage, and the time of concentration. An easy to use graphical approach to this method can be found in the TR-55 publication. While some equations are presented in this UFC, graphs, charts, and figures that easily solve the equations are found in TR-55. This rainfall-runoff relationship separates total rainfall into direct runoff, retention, and initial abstraction to yield the following equation for rainfall runoff:

$$Q_D = \frac{(P - 0.2S_R)^2}{P + 0.8S_R} \quad (2-15)$$

where:

$Q_D$  = depth of direct runoff, in.

$P$  = depth of 24-hr precipitation, in. This information is available in most highway agency drainage manuals by multiplying the 24-hr rainfall intensity by 24 hr.

$S_R$  = retention, in.

2-3.4.1 Empirical studies found that  $S_R$  is related to soil type, land cover, and the antecedent moisture condition of the basin. These are represented by the runoff curve number,  $CN$ , which is used to estimate  $S_R$  with this equation:

$$S_R = \left[ \frac{1000}{CN} - 10 \right] \quad (2-16)$$

where:

$CN$  = Curve number, listed in Table 2-6 for different land uses and hydrologic soil types. This table assumes average antecedent moisture conditions. For multiple land use/soil type combinations within a basin, use area weighing (see Example 2-1). Soil maps are generally available through the local jurisdiction or the NRCS. Soils are grouped into categories A through D based on soil characteristics. Soil Group A includes pervious sandy soils, while Soil Group D includes non-pervious rocks and clays. A complete description is provided in TR-55.

2-3.4.2 Peak flow is then estimated with Equation 2-17:

$$q_p = q_u A_k Q_D \quad (2-17)$$

where:

$q_p$  = peak flow, ft<sup>3</sup>/s



$q_u$  = unit peak flow,  $\text{ft}^3/\text{s}/\text{mi}^2/\text{in}$ .

$A_k$  = basin area,  $\text{mi}^2$

$Q_D$  = runoff depth, in.

The unit peak flow,  $q_u$ , is calculated with the equations or graphical methods presented in TR-55.

2-3.4.3 The concept of initial abstraction is important to the TR-55 method and can be calculated with the following equation:

$$I_a = 0.2S_R \tag{2-18}$$

$I_a$  = initial abstraction, in.

**Table 2-6. Runoff Curve Numbers for Urban Areas  
(Average Watershed Condition,  $I_a = 0.2S_R$ )**

Land Use Description		Curve Numbers for Hydrologic Soil Group			
		A	B	C	D
Fully developed urban areas (vegetation established)					
Lawns, open spaces, parks, golf courses, cemeteries, etc.					
Good condition: grass cover on 75 percent or more of the area		39	61	74	80
Fair condition: grass cover on 50 to 75 percent of the area		49	69	79	84
Poor condition: grass cover on 50 percent or less of the area		68	79	86	89
Paved parking lots, roofs, driveways, etc. (excluding right-of-way)					
Streets and roads		98	98	98	98
Paved with curbs and storm sewers (excluding right-of-way)		98	98	98	98
Gravel (including right-of-way)		76	85	89	91
Dirt (including right-of-way)		72	82	87	89
Paved with open ditches (including right-of-way)		83	89	92	93
	Average % impervious				
Commercial and business areas	85	89	92	94	95
Industrial districts	72	81	88	91	93
Row houses, town houses, and residential with lot sizes 0.125 acre or less	65	77	85	90	92
Residential: average lot size					
0.25 acre	38	61	75	83	87
0.33 acre	30	57	72	81	86
0.50 acre	25	54	70	80	85

Land Use Description		Curve Numbers for Hydrologic Soil Group			
		A	B	C	D
1 acre	20	51	68	79	84
2 acres	12	46	65	77	82
Developing urban areas (no vegetation established)					
Newly graded area		77	86	91	94
Western desert urban areas:					
Natural desert landscaping (pervious area only)		63	77	85	88
Artificial desert landscaping (impervious weed barrier, desert shrub with 1 to 2 in. sand or gravel mulch and basin borders)		96	96	96	96
Cultivated agricultural land					
Fallow					
Straight row or bare soil		77	86	91	94
Conservation tillage - Poor		76	85	90	93
Conservation tillage - Good		74	83	88	90

2-3.4.4 When ponding or swampy areas occur in a basin, considerable runoff may be retained in temporary storage. The peak flow should be reduced to reflect the storage with Equation 2-19:

$$q_a = q_p F_p \quad (2-19)$$

where:

$q_a$  = adjusted peak flow, ft<sup>3</sup>/s

$F_p$  = adjustment factor, listed in Table 2-7

**Table 2-7. Adjustment Factor ( $F_p$ ) for Pond and Swamp Areas that are Spread Throughout the Watershed**

Area of Pond or Swamp (percent)	$F_p$
0.0	1.00
0.2	0.97
1.0	0.87
3.0	0.75
5.0	0.72

This method has a number of limitations that can have an impact on the accuracy of estimated peak flows:

- The basin should have fairly homogeneous *CN* values.

- The  $CN$  should be 40 or greater.
- The  $t_c$  should be between 0.1 and 10 hr.
- $I_a/P$  should be between 0.1 and 0.5.
- The basin should have one main channel or branches with nearly equal times of concentration.
- Neither channel nor reservoir routing can be incorporated.
- $F_p$  is applied only for ponds and swamps that are not in the  $t_c$  flow path.

Example 2-5

*Given:* These physical and hydrologic conditions:

- 1.27 mi<sup>2</sup> of fair condition open space and 1.08 mi<sup>2</sup> of paved surface (airfield)
- Negligible pond and swamp land
- Hydrologic soil type C
- Average antecedent moisture conditions
- Time of concentration is 0.8 hr.
- 24-hour, Type II rainfall distribution, 10-yr rainfall of 2.8 in.

*Find:* The 10-yr peak flow using the TR-55 peak flow method.

*Solution:*

Step 1 Calculate the composite  $CN$  using Table 2-6 and Equation 2-2.

$$CN = \sum \frac{(CN_x A_x)}{A} = \frac{[1.27(79) + 1.08(98)]}{(1.27 + 1.08)} = 88$$

Step 2. Calculate the retention,  $S_R$ , using Equation 2-16.

$$S_R = \left( \frac{1000}{CN} - 10 \right) = \left[ \left( \frac{1000}{88} \right) - 10 \right] = 1.36 \text{ in.}$$

Step 3. Calculate the depth of direct runoff,  $Q_D$ , using Equation 2-15.

$$Q_D = \frac{(P - 0.2S_R)^2}{(P + 0.8S_R)} = \frac{[2.8 - 0.2(1.36)]^2}{[2.8 + 0.8(1.36)]} = 1.64 \text{ in.}$$

$Q_D$  is direct runoff, which means the amount of rainfall available for runoff after losses. Using the direct runoff value and the chart for unit peak discharge found in Chapter 4 of TR-55, the peak discharge can be calculated.

Step 4. Determine  $I_a/P$  from  $I_a = 0.2S_R$ .

$$I_a = 0.2(1.36) = 0.272$$

$$\frac{I_a}{P} = \frac{0.272}{2.8} = 0.097 \text{ say } 0.10$$

Step 5. Calculate peak flow using Equation 2-17.

$$q_p = q_u A_k Q_D = (410)(2.35)(1.64) = \underline{1580 \text{ ft}^3 / \text{s}}$$

2-4 **DEVELOPMENT OF DESIGN HYDROGRAPHS.** This section discusses methods used to develop a design hydrograph. Hydrograph methods can be computationally involved, so computer programs such as HEC-RAS and HMS (Hydrologic Modeling System), TR-20 (based on SCS Technical Release 20), TR-55, and HYDRAIN are used almost exclusively to generate runoff hydrographs. Hydrographic analysis is performed when flow routing is important, such as in the design of storm water detention, other water quality facilities, and pump stations. Hydrographs can also be used to evaluate flow routing through large storm drainage systems to more precisely reflect flow peaking conditions in each segment of complex systems. See Chapter 12 of this UFC for more information on computer programs for analysis of urban hydrology and hydraulics. HEC-22 contains additional information on hydrographic methods.

2-4.1 **SCS Tabular Hydrograph.** The SCS developed a tabular method that is used to estimate partial composite flood hydrographs at any point in a watershed. This method is generally applicable to small, nonhomogeneous areas that may be beyond the limitations of the Rational Method. It is applicable for estimating the effects of land use change in a portion of the watershed as well as estimating the effects of proposed structures.

2-4.1.1 The SCS tabular hydrograph method is based on a series of unit discharge hydrographs expressed in cubic feet of discharge per second per square mile of watershed per in. of runoff. A series of these unit discharge hydrographs are provided in TR-55 for a range of subarea times of concentration ( $T_c$ ) from 0.1 to 2 hr, and reach travel times ( $T_{tr}$ ) from 0 to 3 hr. One such tabulation is provided in Table 2-8.

Table 2-8. Tabular Hydrograph Unit Discharges for Type II Rainfall Distributions (English Units)

Tabular hydrograph unit discharges (csm/in) for type II rainfall distributions (Taken from SCS TR-55 Manual)

TRVL TIME (HR)	11.0	11.3	11.6	11.9	12.0	12.1	12.2	12.3	12.4	12.5	12.6	12.7	12.8	13.0	13.2	13.4	13.6	13.8	14.0	14.3	14.6	15.0	15.5	16.0	16.5	17.0	17.5	18.0	19.0	20.0	22.0	26.0
IA/P = 0.10      * * * TC = 0.5 HR * * *																																
0.0	17	23	32	57	94	170	308	467	529	507	402	297	226	140	96	74	61	53	47	41	36	32	29	26	23	21	20	19	16	14	12	0
.10	16	22	30	51	80	140	252	395	484	499	434	343	265	162	108	80	65	55	49	42	36	33	29	26	23	21	20	19	16	14	12	0
.20	14	19	25	38	47	69	116	207	332	434	477	449	378	238	149	101	77	62	53	45	39	34	30	27	24	22	20	19	17	14	12	0
.30	13	18	24	35	43	60	97	170	278	382	446	448	401	270	171	114	83	66	56	46	40	34	31	27	24	22	20	19	17	15	12	0
.40	12	15	21	29	33	40	53	83	141	233	332	408	434	361	243	157	107	79	64	51	43	36	32	28	25	22	21	20	17	15	12	0
.50	11	15	20	28	31	37	48	71	118	194	286	367	412	378	271	178	119	86	68	53	44	37	32	29	25	23	21	20	17	15	12	0
.75	9	11	14	19	21	24	27	31	37	49	74	118	182	319	374	328	244	169	117	76	56	43	35	31	28	25	22	21	18	16	12	1
1.0	7	9	12	16	17	19	21	24	27	32	40	55	83	188	309	359	322	245	172	102	68	49	38	32	29	26	23	21	19	16	12	1
1.5	5	7	8	11	12	13	14	15	17	19	21	23	27	43	89	175	269	322	309	225	140	77	49	38	32	29	25	23	20	17	13	5
2.0	3	4	6	7	8	8	9	10	10	11	12	14	15	18	23	35	65	123	202	297	280	181	88	52	39	33	29	26	21	19	14	10
2.5	2	3	4	5	5	6	6	7	7	8	9	9	10	12	15	18	24	36	66	150	244	278	171	87	52	39	33	29	23	20	15	11
3.0	1	1	2	3	3	4	4	4	5	5	6	6	7	8	9	11	13	16	20	37	86	198	263	182	96	56	40	33	26	21	16	11
IA/P = 0.30      * * * TC = 0.5 HR * * *																																
0.0	0	0	0	1	9	53	157	314	433	439	379	299	237	159	118	95	81	71	65	56	50	46	42	38	34	31	30	28	25	22	19	0
.10	0	0	0	0	1	6	37	117	248	372	416	391	330	218	150	113	92	79	70	60	53	47	43	39	35	32	30	29	26	22	19	0
.20	0	0	0	0	1	4	26	87	194	313	382	388	349	244	167	122	97	82	72	62	54	48	43	39	35	32	30	29	26	22	19	0
.30	0	0	0	0	0	3	19	64	151	259	341	372	316	223	156	117	94	80	67	58	50	45	41	36	33	31	29	26	23	19	0	
.40	0	0	0	0	0	2	13	47	116	211	298	354	328	245	172	127	100	83	69	59	51	45	41	37	33	31	29	26	23	19	0	
.50	0	0	0	0	0	0	0	1	9	34	89	170	255	341	303	225	161	120	96	76	64	54	47	42	38	34	31	30	27	24	19	0
.75	0	0	0	0	0	0	0	1	4	14	41	89	152	270	305	268	207	155	118	87	70	57	48	44	39	35	32	30	27	24	19	0
1.0	0	0	0	0	0	0	0	0	0	2	7	22	98	212	295	285	237	181	120	88	67	53	46	42	38	34	31	28	25	19	2	
1.5	0	0	0	0	0	0	0	0	0	0	0	0	0	5	30	95	183	249	265	217	152	96	66	53	46	41	37	34	30	26	20	8
2.0	0	0	0	0	0	0	0	0	0	0	0	0	0	0	0	3	18	59	125	221	245	182	105	69	54	47	42	38	32	28	22	16
2.5	0	0	0	0	0	0	0	0	0	0	0	0	0	0	0	1	5	21	84	174	230	172	103	69	54	46	42	34	30	23	18	
3.0	0	0	0	0	0	0	0	0	0	0	0	0	0	0	0	0	1	13	56	157	217	163	101	68	53	46	37	31	25	18		
IA/P = 0.50      * * * TC = 0.5 HR * * *																																
0.0	0	0	0	0	0	2	26	89	170	217	229	200	179	144	119	104	93	85	78	70	64	59	55	51	46	43	41	40	36	32	28	0
.10	0	0	0	0	0	0	1	18	65	135	190	216	205	170	137	115	101	91	83	74	67	61	56	52	47	44	42	40	36	32	28	0
.20	0	0	0	0	0	0	1	12	47	106	162	198	203	178	145	121	105	94	85	76	68	61	57	52	48	44	42	40	37	32	28	0
.30	0	0	0	0	0	0	0	1	8	34	82	135	177	194	168	139	117	102	92	80	71	63	58	54	49	45	43	41	37	33	28	0
.40	0	0	0	0	0	0	0	6	25	63	111	155	189	174	146	122	106	94	82	73	64	58	54	50	45	43	41	37	33	28	0	
.50	0	0	0	0	0	0	0	4	18	48	90	133	184	177	152	128	110	97	84	74	65	59	55	50	45	43	41	38	33	28	0	
.75	0	0	0	0	0	0	0	1	7	22	47	80	142	169	164	144	124	108	91	79	68	61	56	51	47	44	42	38	34	28	0	
1.0	0	0	0	0	0	0	0	0	0	1	3	11	51	112	155	166	154	134	109	91	76	65	59	54	49	45	43	39	35	28	2	
1.5	0	0	0	0	0	0	0	0	0	0	0	0	2	16	50	97	136	154	145	121	95	75	64	58	54	49	45	41	37	29	10	
2.0	0	0	0	0	0	0	0	0	0	0	0	0	0	0	4	18	47	86	134	146	125	94	75	64	58	53	49	42	39	31	21	
2.5	0	0	0	0	0	0	0	0	0	0	0	0	0	0	0	3	11	44	95	140	127	97	77	65	58	54	45	41	33	26		
3.0	0	0	0	0	0	0	0	0	0	0	0	0	0	0	0	1	7	29	86	135	122	95	76	65	58	49	43	35	27			

RAINFALL TYPE = II      \* \* \* TC = 0.5 HR \* \* \*

Copied from TR-55<sup>(13)</sup>

2-4.1.2 The hydrograph ordinates for a specific time are determined by multiplying the runoff depth, the subarea, and the tabular hydrograph unit discharge value for that time as determined from the tables. See Equation 2-20:

$$q = q_t A Q_D \quad (2-20)$$

where:

- $q$  = hydrograph ordinate for a specific time, ft<sup>3</sup>/s
- $q_t$  = tabular hydrograph unit discharge from appropriate table, ft<sup>3</sup>/s/mi<sup>2</sup>/in
- $A$  = sub-basin drainage area, mi<sup>2</sup>
- $Q_D$  = runoff depth, in.

2-4.1.3 The TR-55 publication provides a detailed description of the tabular hydrograph method. In developing the tabular hydrograph, the watershed is divided into homogeneous subareas. Input parameters required for the procedure include: (1) the 24-hr rainfall amount, in., (2) an appropriate rainfall distribution (I, IA, II, or III), (3) the runoff curve number, CN, (4) the time of concentration,  $T_c$ , (5) the travel time,  $T_{ti}$ , and (6) the drainage area, mi<sup>2</sup>, for each subarea. The 24-hr rainfall amount, rainfall distribution, and the runoff curve number are used in Equations 2-15 and 2-16 to determine the runoff depth in each subarea. The product of the runoff depth times drainage is multiplied times each tabular hydrograph value to determine the final hydrograph ordinate for a particular subarea. Subarea hydrographs are then added to determine the final hydrograph at a particular point in the watershed. Example 2-6 provides an illustration of the use of the tabular hydrograph method.

2-4.1.4 These assumptions and limitations are inherent in the tabular method:

- The total area should be less than 2000 acres. Typically, subareas are far smaller than this because the subareas should have fairly homogeneous land use.
- The travel time,  $T_{ti}$ , is less than or equal to 3 hr.
- The time of concentration,  $t_c$ , for any given subarea is less than or equal to 2 hr.
- The drainage areas of individual subareas differ by less than a factor of 5.

#### Example 2-6

*Given:* A watershed with three subareas. Subareas 1 and 2 both drain into Subarea 3. Consider the basin data for the three subareas:

<u>Subarea</u>	<u>Area (mi<sup>2</sup>)</u>	<u>t<sub>c</sub> (hr)</u>	<u>T<sub>ti</sub> (hr)</u>	<u>CN</u>
1	0.386	0.5	---	75
2	0.193	0.5	---	65
3	0.927	0.5	0.20	70

A time of concentration,  $t_c$ , of 0.5 hr, an  $I_a/P$  value of 0.10, and a Type II storm distribution are assumed for convenience in all three subareas. The travel time applies to the reach for the corresponding area; therefore, the travel time,  $T_{ti}$ , in Subarea 3 will apply to the tabular hydrographs routed from Subareas 1 and 2.

*Find:* The outlet hydrograph for a 5.9-in. storm.

*Solution:*

Step 1. Calculate the retention for each of the subareas using Equation 2-16.

$$S_R = \left( \frac{1000}{CN} - 10 \right)$$

$$\text{Subarea 1.} \quad S_R = \left( \frac{1000}{75} - 10 \right) = 3.33 \text{ in.}$$

$$\text{Subarea 2.} \quad S_R = \left( \frac{1000}{65} - 10 \right) = 5.38 \text{ in.}$$

$$\text{Subarea 3.} \quad S_R = \left( \frac{1000}{70} - 10 \right) = 4.29 \text{ in.}$$

Step 2. Calculate the depth of runoff for each of the subareas using Equation 2-15.

$$Q_D = \frac{(P - 0.2S_R)^2}{P + 0.8S_R}$$

$$\text{Subarea 1.} \quad Q_D = \frac{[5.9 - 0.2(85)]^2}{[5.9 + 0.8(85)]} = 3.2 \text{ in.}$$

$$\text{Subarea 2.} \quad Q_D = \frac{[5.9 - 0.2(137)]^2}{[5.9 + 0.8(137)]} = 2.28 \text{ in.}$$

Subarea 3. 
$$Q_D = \frac{[5.9 - 0.2(109)]^2}{[5.9 + 0.8(109)]} = 2.72 \text{ in.}$$

Step 3. Calculate ordinate values using Equation 2-20:  $q = q_t A Q_D$ .

Multiply the appropriate tabular hydrograph values ( $q_t$ ) from Table 2-8 by the subarea areas ( $A$ ) and runoff depths ( $Q$ ) and sum the values for each time to give the composite hydrograph at the end of Subarea 3. For example, the hydrograph flow contributed from Subarea 1 ( $t_c = 0.5$  hr,  $T_{ti} = 0.20$  hr) at 12.0 hr is calculated as the product of the tabular value, the area, and the runoff depth, or 47 (0.386)3.2 = 58 ft<sup>3</sup>/s.

Table 2-9 lists the subarea and composite hydrographs. Please note that this example does not use every hydrograph time ordinate.

**Table 2-9. Subarea and Composite Hydrographs**

Subarea	Flow at Specified Time (ft <sup>3</sup> /s)										
	11 (hr)	12 (hr)	12.2 (hr)	12.4 (hr)	12.5 (hr)	12.6 (hr)	12.8 (hr)	13 (hr)	14 (hr)	16 (hr)	20 (hr)
1	17	58	143	410	536	584	466	294	65	33	17
2	6	21	51	146	191	210	166	105	23	12	6
3	43	238	778	1337	1281	1016	571	354	119	66	35
Total	66	317	972	1893	2008	1815	1203	753	207	111	58

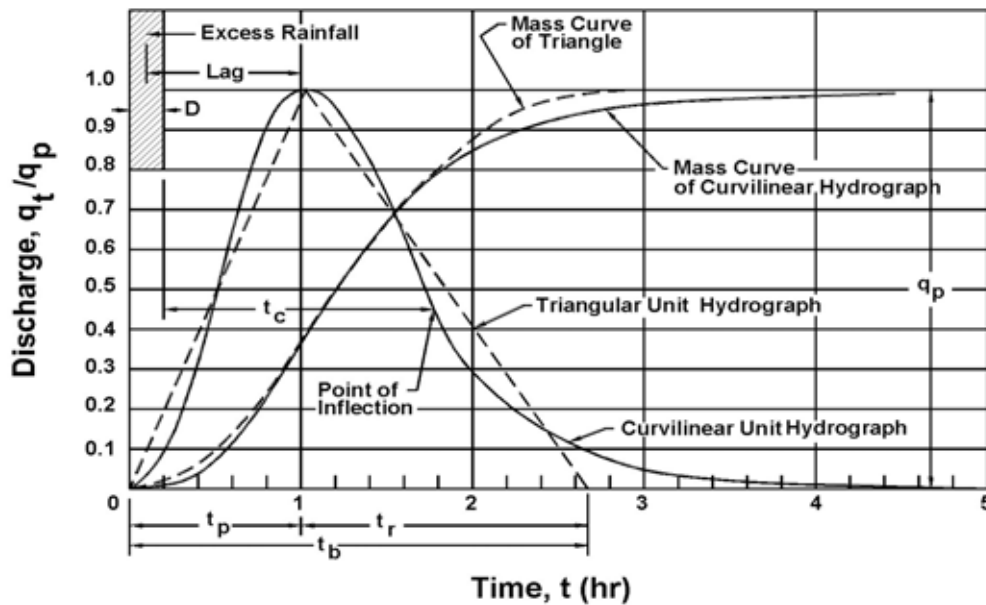
2-4.2 **SCS Synthetic Unit Hydrograph (UH).** The SCS developed a synthetic UH procedure that has been widely used in conservation and flood control work. The UH used by this method is based upon an analysis of a large number of natural UHs from a broad cross section of geographic locations and hydrologic regions.

2-4.2.1 This method is easy to apply. The only parameters that need to be determined are the peak discharge and the time to peak ( $t_p$ ). A standard UH is constructed using these two parameters.

2-4.2.2 For the development of the SCS UH, the curvilinear UH is approximated by a triangular UH that has similar characteristics. Figure 2-4 shows a comparison of the two dimensionless UHs. Even though the time base ( $t_b$ ) of the triangular UH is 8/3 of the time to peak,  $t_p$ , and the  $t_b$  of the curvilinear UH is five times the  $t_p$ , the area under the two UH types is the same.



Figure 2-4. Dimensionless Curvilinear SCS Synthetic Unit Hydrograph and Equivalent Triangular Hydrograph



2-4.2.3 The area under a hydrograph equals the volume of direct runoff,  $Q_D$ , which is 1 inch for a UH. The peak flow is calculated using Equation 2-21:

$$q_p = \frac{K_c A_k Q_D}{t_p} \quad (2-21)$$

where:

$q_p$  = peak flow,  $\text{ft}^3/\text{s}$

$A_k$  = drainage area,  $\text{mi}^2$

$Q_D$  = volume of direct runoff (= 1 for unit hydrograph), in.

$t_p$  = time to peak, hr

$K_c$  = 483.5

2-4.2.4 The constant 483.5 reflects a UH that has 3/8 of its area under the rising limb. For mountainous watersheds, the fraction could be expected to be greater than 3/8, and therefore the constant may be near 603.5. For flat, swampy areas, the constant may be on the order of 301.7.

Time to peak,  $t_p$ , can be expressed in terms of time of concentration,  $t_c$ , as in Equation 2-22:

$$t_p = \frac{2}{3} t_c \quad (2-22)$$

Expressing  $q_p$  in terms of  $t_c$  rather than  $t_p$  yields:

$$q_p = \frac{K_c A_k Q_D}{t_c} \quad (2-23)$$

where  $K_c = 725.25$

### Example 2-7

*Given:* The following watershed conditions:

- The watershed is commercially developed.
- Watershed area = 0.463 mi<sup>2</sup>
- Time of concentration,  $t_c$ , = 1.34 hr
- $Q_D = 1.0$  in.

*Find:* The triangular SCS UH.

*Solution:*

Step 1. Calculate peak flow using Equation 2-23.

$$\begin{aligned} q_p &= \frac{K_c A_k Q_D}{t_c} \\ &= \frac{725.25 (0.463) (1.0)}{1.34} \\ &= 250.59 \text{ ft}^3/\text{s} \end{aligned}$$

Step 2. Calculate the time to peak,  $t_p$ , using Equation 2-22.

$$t_p = \frac{2}{3} t_c = \frac{2}{3} (1.34) = 0.893 \text{ hr}$$

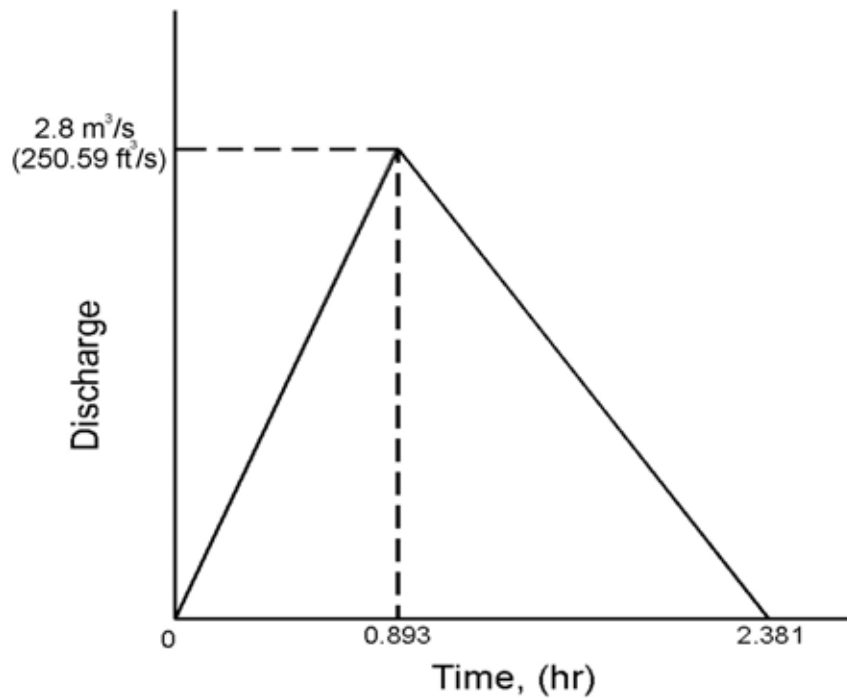
Step 3. Calculate the time base,  $t_b$ , of the UH.

Step 4. Draw the resulting triangular UH (see Figure 2-5).

$$t_b = \frac{8}{3}(0.893) = 2.38 \text{ hr}$$

**NOTE:** The curvilinear SCS UH is more commonly used and is incorporated into many computer programs.

**Figure 2-5. Example: The Triangular Unit Hydrograph**



## CHAPTER 3

### PAVEMENT SURFACE DRAINAGE

3-1 **OVERVIEW.** Effective drainage of pavements is essential to the maintenance of the service level and to traffic safety. Water on the pavement can interrupt traffic, reduce skid resistance, increase potential for hydroplaning, limit visibility due to splash and spray, and cause difficulty in steering a vehicle when the wheels encounter puddles.

Pavement drainage requires consideration of surface drainage, gutter flow, and inlet capacity. The design of these elements is dependent on storm frequency and the allowable spread of storm water on the pavement surface. This chapter presents design guidance for the design of these elements. Most of the information presented here is taken directly from the FHWA's HEC-22 and AASHTO's *Model Drainage Manual*. The charts referenced throughout this chapter can be found in the HEC-22.

3-2 **DESIGN FREQUENCY AND SPREAD.** Two of the more significant variables considered in the design of pavement drainage are the frequency of the design runoff event and the allowable spread of water on the pavement. A related consideration is the use of an event of lesser frequency to check the drainage design.

Spread and design frequency are not independent. The implications of the use of a criterion for spread of one-half of a traffic lane are considerably different for one design frequency than for a lesser frequency. It also has different implications for a low-traffic, low-speed roadway than for a higher classification roadway or airport runways. These subjects are central to the issue of pavement drainage and important to highway and runway safety.

#### 3-2.1 Selection of Design Frequency and Design Spread

3-2.1.1 The objective of storm drainage design is to provide for safe passage of vehicles during the design storm event. The design of a drainage system for a curbed pavement section is to collect runoff in the gutter and convey it to pavement inlets in a manner that provides reasonable safety for traffic and pedestrians at a reasonable cost. As spread increases, the risks of traffic accidents and delays, and the nuisance and possible hazard to pedestrian traffic increase.

3-2.1.2 The allowable spread for airfields, runways, taxiways, and aprons was defined in Chapter 2, section 2-2.4, Design Storm Frequency.

3-2.1.3 Spread on traffic lanes can be tolerated to greater widths where traffic volumes and speeds are low. Spreads of one-half of a traffic lane are usually considered a minimum type design for DOD roads.

3-2.1.4 The selection of design criteria for intermediate types of facilities may be the most difficult. For example, some arterials with relatively high traffic volumes and

speeds may not have shoulders that will convey the design runoff without encroaching on the traffic lanes. In these instances, an assessment of the relative risks and costs of various design spreads may be helpful in selecting appropriate design criteria.

3-2.1.5 The recommended design frequency for depressed sections and underpasses where ponded water can be removed only through the storm drainage system is a 50-yr frequency event. The use of a lesser frequency event, such as a 100-yr storm, to assess hazards at critical locations where water can pond to appreciable depths is commonly referred to as a check storm or check event.

### 3-2.2 Selection of Check Storm and Spread

3-2.2.1 A check storm should be used any time runoff could cause unacceptable flooding during less frequent events. Also, inlets should always be evaluated for a check storm when a series of inlets terminates at a sag vertical curve where ponding to hazardous depths could occur.

3-2.2.2 The frequency selected for the check storm should be based on the same considerations used to select the design storm, i.e., the consequences of spread exceeding that chosen for design and the potential for ponding. Where no significant ponding can occur, check storms are usually unnecessary.

3-2.2.3 Criteria for spread during the check event are: (1) one lane open to traffic during the check storm event, and (2) one lane free of water during the check storm event. These criteria differ substantively, but each sets a standard by which the design can be evaluated.

3-3 **SURFACE DRAINAGE.** When rain falls on a sloped pavement surface, it forms a thin film of water that increases in thickness as it flows to the edge of the pavement. Factors that influence the depth of water on the pavement include the length of flow path, surface texture, surface slope, and rainfall intensity. As the depth of water on the pavement increases, the potential for vehicular hydroplaning increases. For the purposes of highway drainage, this section provides information on hydroplaning and design guidance for these drainage elements:

- Longitudinal pavement slope
- Cross or transverse pavement slope
- Curb and gutter design
- Roadside and median ditches

Note that the guidance for transverse and longitudinal slopes for military airfields is in UFC 3-260-01 and for FAA facilities, AC 150/5300-13.

3-3.1 **Longitudinal Slope.** Experience has shown that the recommended minimum values of roadway longitudinal slope given in the AASHTO Green Book, *A Policy on*

*Geometric Design of Highways and Streets*, will provide safe, acceptable pavement drainage. In addition, follow these general guidelines:

- A minimum longitudinal gradient is more important for a curbed pavement than for an uncurbed pavement since the water is constrained by the curb. However, flat gradients on uncurbed pavements can lead to a spread problem if vegetation is allowed to build up along the pavement edge.
- Desirable gutter grades should not be less than 0.5 percent for curbed pavements, with an absolute minimum of 0.3 percent. Minimum grades can be maintained in very flat terrain by use of a rolling profile, or by warping the cross slope to achieve rolling gutter profiles.
- To provide adequate drainage in sag vertical curves, a minimum slope of 0.3 percent should occur within 50 ft of the low point of the curve. This is accomplished where the length of the curve in feet divided by the algebraic difference in grades in percent ( $K$ ) is equal to or less than 167. This is represented as:

$$K = \frac{L}{G_2 - G_1} \quad (3-1)$$

where:

$K$  = vertical curve constant, ft/percent

$L$  = horizontal length of curve, ft

$G_i$  = grade of roadway, percent

3-3.2 **Cross (Transverse) Slope.** An acceptable range of roadway cross slopes is specified in UFC 3-250-01FA. These cross slopes are a compromise between the need for reasonably steep cross slopes for drainage and relatively flat cross slopes for driver comfort and safety. These cross slopes represent standard practice.

3-3.2.1 Cross slopes of 2 percent have little effect on driver effort in steering or on friction demand for vehicle stability. Use of a cross slope steeper than 2 percent on pavements with a central crown line is not desirable. In areas of intense rainfall, a somewhat steeper cross slope (2.5 percent) may be used to facilitate drainage.

3-3.2.2 Additional guidelines related to cross slope are:

- Although not widely encouraged, inside lanes can be sloped toward the median if conditions warrant.
- Median areas should not be drained across travel lanes.

- The number and length of flat pavement sections in cross slope transition areas should be minimized. Consideration should be given to increasing cross slopes in sag vertical curves, crest vertical curves, and in sections of flat longitudinal grades.
- Shoulders should be sloped to drain away from the pavement, except with raised, narrow medians and superelevations.

3-3.3 **Curbs and Gutters.** Curbs are normally used at the outside edge of pavements for low-speed, highway facilities, and in some instances adjacent to shoulders on moderate to high-speed facilities. They serve several purposes:

- They contain the surface runoff within the roadway and away from adjacent properties.
- They prevent erosion on fill slopes.
- They provide pavement delineation.
- They enable the orderly development of property adjacent to the roadway.

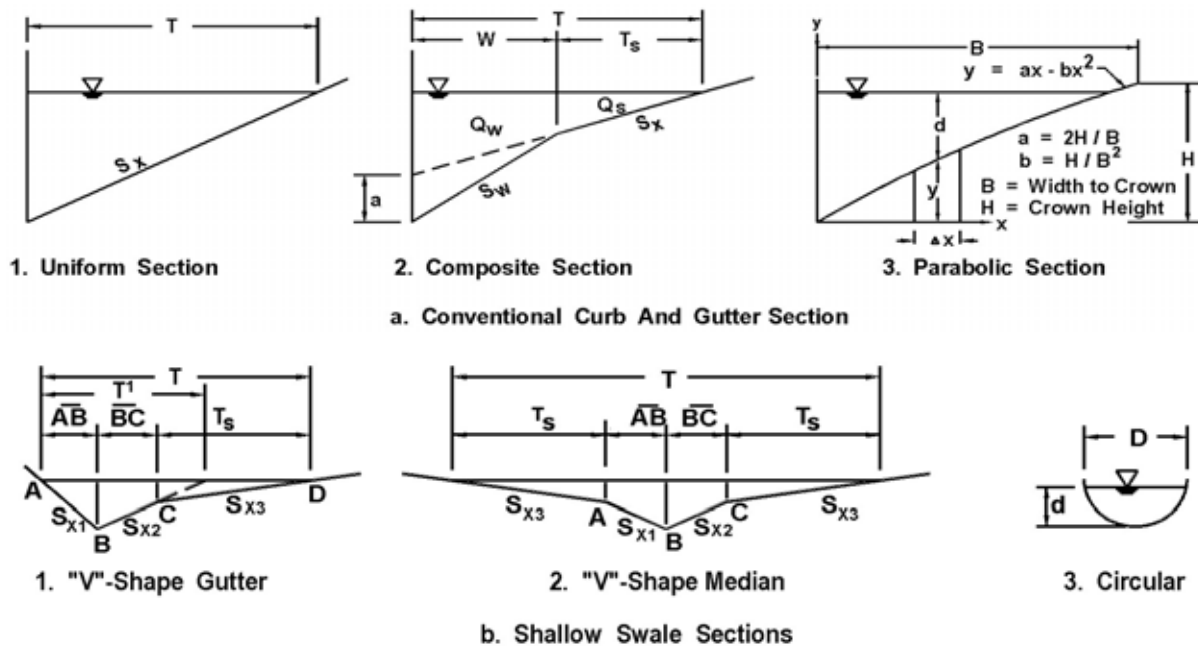
3-3.3.1 Gutters formed in combination with curbs are available in 12- through 39-in. widths. Gutter cross slopes may be the same as that of the pavement or may be designed with a steeper cross slope, usually 1 in./ft steeper than the shoulder or parking lane (if used). AASHTO geometric guidelines state that an 8 percent slope is a common maximum cross slope.

3-3.3.2 A curb and gutter combination forms a triangular channel that can convey runoff equal to or less than the design flow without interruption of the traffic. When a design flow occurs, there is a spread or widening of the conveyed water surface. The water spreads to include not only the gutter width, but also parking lanes or shoulders and portions of the traveled surface.

3-3.3.3 In general, curbs and gutters are not permitted to interrupt surface runoff along a taxiway or runway. The runoff must be allowed unimpeded travel transversely off the runway and then directly by the shortest route across the turf to the area inlets. Inlets spaced throughout the paved apron construction must be placed at proper intervals and in well-drained depressed locations.

3-3.3.4 Spread is what concerns the hydraulic engineer in curb and gutter flow. The distance of the spread,  $T$ , is measured perpendicular to the curb face to the extent of the water on the roadway and is shown in Figure 3-1. Limiting this width becomes a very important design criterion and will be discussed in detail in section 3-4.

Figure 3-1. Typical Gutter Sections



3-3.3.5 Where practical, runoff from cut slopes and other areas draining toward the roadway should be intercepted before it reaches the highway. By doing so, the deposition of sediment and other debris on the roadway as well as the amount of water that must be carried in the gutter section will be minimized. Where curbs are not needed for traffic control, shallow ditch sections at the edge of the roadway pavement or shoulder offer advantages over curbed sections by providing less of a hazard to traffic than a near-vertical curb and by providing hydraulic capacity that is not dependent on spread on the pavement. These ditch sections are particularly appropriate where curbs have historically been used to prevent water from eroding fill slopes.

### 3-3.4 Roadside and Median Channels

3-3.4.1 Roadside channels are commonly used with uncurbed roadway sections to convey runoff from the highway pavement and from areas that drain toward the highway. Due to right-of-way limitations, roadside channels cannot be used on most urban arterials.

3-3.4.2 They can be used in cut sections, depressed sections, and other locations where sufficient right-of-way is available and driveways or intersections are infrequent.

3-3.4.3 To prevent drainage from the median areas from running across the travel lanes, slope median areas and inside shoulders to a center swale. This design is particularly important for high speed facilities and for facilities with more than two lanes of traffic in each direction.



3-4 **FLOW IN GUTTERS.** A pavement gutter is defined as a section of pavement adjacent to the roadway that conveys water during a storm runoff event. It may include a portion or all of a travel lane. As illustrated in Figure 3-1, gutter sections can be categorized as conventional or shallow swale type. Conventional curb and gutter sections usually have a triangular shape, with the curb forming the near-vertical leg of the triangle. Conventional gutters may have a straight cross slope (Figure 3-1, a.1), a composite cross slope where the gutter slope varies from the pavement cross slope (Figure 3-1, a.2), or a parabolic section (Figure 3-1, a.3). Shallow swale gutters typically have V-shaped or circular sections as illustrated in Figure 3-1, b.1, b.2, and b.3, respectively, and are often used in paved median areas on roadways with inverted crowns.

### 3-4.1 Capacity Relationship

3-4.1.1 Gutter flow calculations are necessary to establish the spread of water on the shoulder, parking lane, or pavement section. A modification of Manning's equation can be used for computing flow in triangular channels. The modification is necessary because the hydraulic radius in the equation does not adequately describe the gutter cross section, particularly where the top width of the water surface may be more than 40 times the depth at the curb. To compute gutter flow, Manning's equation is integrated for an increment of width across the section. The resulting equation is:

$$Q = \frac{0.56}{n} S_x^{1.67} S_L^{0.5} T^{2.67} \quad (3-2)$$

or in terms of T

$$T = \left( \frac{Qn}{0.56 S_x^{1.67} S_L^{0.5}} \right)^{0.375} \quad (3-2)$$

where:

$n$  = Manning's coefficient (Table 3-1)

$Q$  = flow rate, ft<sup>3</sup>/s

$T$  = width of flow (spread), ft

$S_x$  = cross slope, ft/ft

$S_L$  = longitudinal slope, ft/ft

Equation 3-2 neglects the resistance of the curb face since this resistance is negligible.

**Table 3-1. Manning's  $n$  for Street and Pavement Gutters**

Type of Gutter or Pavement	Manning's $n$
Concrete gutter, troweled finish	0.012
Asphalt Pavement: Smooth texture	0.013
Rough texture	0.016
Concrete gutter-asphalt pavement: Smooth	0.013
Rough	0.015
Concrete pavement: Float finish	0.014
Broom finish	0.016
For gutters with small slope, where sediment may accumulate, increase above values of $n$ by	0.02
Reference: U.S. Department of Transportation (USDOT), FHWA, Hydraulic Design Series No. 3 (HDS-3)	

3-4.1.2 Spread on the pavement and flow depth at the curb are often used as criteria for spacing pavement drainage inlets. Charts 1A and 1B in Appendix B are nomographs for solving Equation 3-2. These charts can be used for either criterion with the relationship:

$$d = TS_x \quad (3-3)$$

where:

$$d = \text{depth of flow, ft}$$

Chart 1 can be used for a direct solution of gutter flow where Manning's  $n$  value is 0.016. For other values of  $n$ , divide the value of  $Q_n$  by  $n$ . Instructions for use and an example problem solution are provided on the chart.

**3-4.2 Conventional Curb and Gutter Sections.** Conventional gutters begin at the inside base of the curb and usually extend from the curb face toward the roadway centerline a distance of 1.0 to 3.0 ft. As illustrated in Figure 3-1, gutters can have uniform, composite, or curved sections. Uniform gutter sections have a cross-slope that is equal to the cross-slope of the shoulder or travel lane adjacent to the gutter. Gutters having composite sections are depressed in relation to the adjacent pavement slope. That is, the paved gutter has a cross-slope that is steeper than that of the adjacent pavement. This concept is illustrated in Example 3-1. Curved gutter sections are sometimes found along older city streets or highways with curved pavement sections. Procedures for computing the capacity of curb and gutter sections follow.

3-4.2.1 **Conventional Gutters of Uniform Cross Slope.** The nomograph in Chart 1 solves Equation 3-2 for gutters having triangular cross sections. Example 3-1 illustrates its use for the analysis of conventional gutters with a uniform cross slope.

Example 3-1

*Given:* Gutter section illustrated in Figure 3-1 a.1.

$$S_L = 0.010 \text{ ft/ft}$$

$$S_x = 0.020 \text{ ft/ft}$$

$$n = 0.016$$

*Find:* (1) Spread at a flow of 1.8 ft<sup>3</sup>/s

(2) Gutter flow at a spread of 8.2 ft

*Solution (1):*

Step 1. *Compute the spread, T, using Equation 3-2 or Chart 1.*

$$T = \left[ \frac{(Q_n)}{\{(0.56)S_x^{1.67} S_L^{0.5}\}} \right]^{0.375}$$

$$T = \left[ \frac{(1.8)(0.016)}{\{(0.56)(0.020)^{1.67} (0.010)^{0.5}\}} \right]^{0.375}$$

$$T = 9.0 \text{ ft}$$

*Solution (2):*

Step 1. *Using Equation 3-2 or Chart 1 with T = 8.2 ft and the information given above, determine Q<sub>n</sub>.*

$$Q_n = (0.56)S_x^{1.67} S_L^{0.5} T^{2.67}$$

$$Q_n = (0.56)(0.020)^{1.67} (0.010)^{0.5} (8.2)^{2.67}$$

$$Q_n = 0.22 \text{ ft}^3/\text{s}$$

Step 2. Compute  $Q$  from  $Q_n$  determined in Step 1.

$$Q = \frac{Q_n}{n}$$

$$Q = \frac{0.22}{.016}$$

$$Q = 1.4 \text{ ft}^3/\text{s}$$

3-4.2.2 **Composite Gutter Sections.** The design of composite gutter sections requires consideration of flow in the depressed segment of the gutter,  $Q_w$ . Equation 3-4, displayed graphically as Chart 2 in Appendix B, is provided for use with Equations 3-5 and 3-6 and Chart 1 to determine the flow in a width of gutter in a composite cross section,  $W$ , less than the total spread,  $T$ . The procedure for analyzing composite gutter sections is demonstrated in Example 3-2.

$$E_o = \frac{1}{\left[ 1 + \frac{\left( \frac{S_w}{S_x} \right)}{\left( 1 + \frac{\left( \frac{S_w}{S_x} \right)^{2.67}}{\left( \frac{T}{W} - 1 \right)} \right) - 1 \right]} \quad (3-4)$$

$$Q_w = Q - Q_s \quad (3-5)$$

$$Q = \frac{Q_s}{(1 - E_o)} \quad (3-6)$$

where:

$Q_w$  = flow rate in the depressed section of the gutter,  $\text{ft}^3/\text{s}$

$Q$  = gutter flow rate,  $\text{ft}^3/\text{s}$

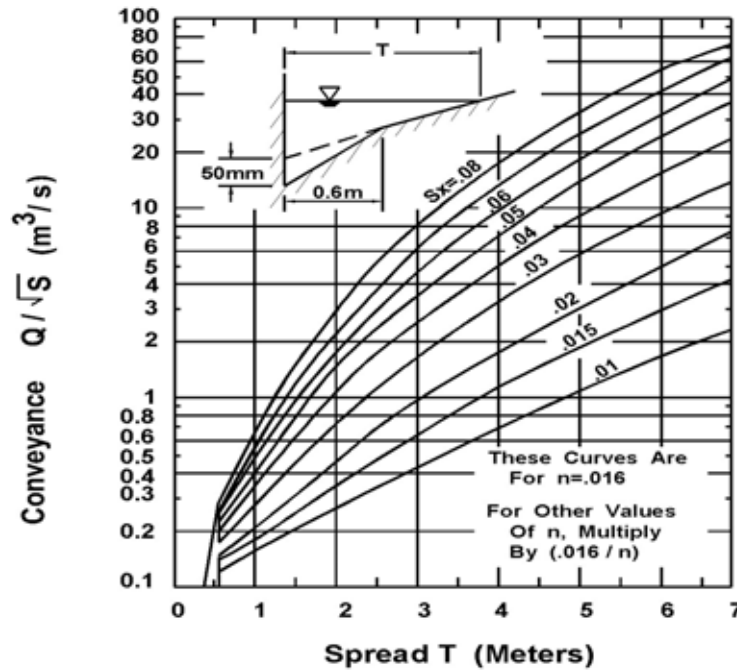
$Q_s$  = flow capacity of the gutter section above the depressed section,  $\text{ft}^3/\text{s}$

$E_o$  = ratio of flow in a chosen width (usually the width of a grate) to total gutter flow ( $Q_w/Q$ )

$$S_w = S_x + a/W \text{ (Figure 3-1 a.2)}$$

Figure 3-2 illustrates a design chart for a composite gutter with a 2-ft wide gutter section with a 2-in. depression at the curb that begins at the projection of the uniform cross slope at the curb face. A series of charts similar to Figure 3-2 for "typical" gutter configurations could be developed.

**Figure 3-2. Conveyance-Spread Curves for a Composite Gutter Section**



Example 3-2

*Given:* Gutter section illustrated in Figure 3-1 a.2 with these dimensions:

- $W = 2 \text{ ft}$
- $S_L = 0.010 \text{ ft/ft}$
- $S_x = 0.020 \text{ ft/ft}$
- $n = 0.016$

Gutter depression,  $a = 2 \text{ in.}$

*Find:* (1) Gutter flow at a spread of 8.2 ft

(2) Spread at a flow of 4.2 ft<sup>3</sup>/s

*Solution (1):*

Step 1. Compute the cross slope of the depressed gutter,  $S_w$ , and the width of spread from the junction of the gutter and the road to the limit of the spread,  $T_s$ .

$$S_w = (a/W) + S_x$$

$$S_w = \frac{[(2)/(12)]}{(2)} + (0.020)$$

$$= 0.103 \text{ ft/ft}$$

$$T_s = T - W = 8.2 - 2.0$$

$$T_s = 6.2 \text{ ft}$$

Step 2. From Equation 3-2 or Chart 1 (using  $T_s$ ):

$$Q_s n = (0.56) S_x^{1.67} S_L^{0.5} T_s^{2.67}$$

$$Q_s n = (0.56)(0.02)^{1.67} (0.01)^{0.5} (6.2)^{2.67}$$

$$Q_s n = 0.011 \text{ ft}^3/\text{s}, \text{ and}$$

$$Q_s = \frac{(Q_s n)}{n} = \frac{0.011}{0.016}$$

$$Q_s = 0.69 \text{ ft}^3/\text{s}$$

Step 3. Determine the gutter flow,  $Q$ , using Equation 3-4 or Chart 2.

$$\frac{T}{W} = \frac{8.2}{2.0} = 4.10$$

$$\frac{S_w}{S_x} = \frac{0.103}{0.020} = 5.15$$

$$E_o = \frac{1}{\left[ 1 + \frac{\left( \frac{S_w}{S_x} \right)}{\left( 1 + \frac{\left( \frac{S_w}{S_x} \right)^{2.67}}{\left( \frac{T}{W} - 1 \right)} \right)} \right]} - 1$$

$$E_o = \frac{1}{\left[ 1 + \frac{(5.15)}{\left( 1 + \frac{(5.15)^{2.67}}{(4.10 - 1)} \right)} \right]} - 1$$

$$E_o = 0.70$$

or from Chart 2, for  $\frac{W}{T} = \frac{2.0}{8.2} = 0.24$

$$E_o = \frac{Q_w}{Q} = 0.70$$

$$Q = \frac{Q_s}{(1 - E_o)}$$

$$Q = \frac{0.69}{(1 - 0.70)}$$

$$Q = 2.3 \text{ ft}^3/\text{s}$$

*Solution (2):*

Since the spread cannot be determined by a direct solution, an iterative approach must be used.

Step 1. Try  $Q_s = 1.4 \text{ ft}^3/\text{s}$ .

Step 2. Compute  $Q_w$ .

$$Q_w = Q - Q_s = 4.2 - 1.4$$

$$Q_w = 2.8 \text{ ft}^3/\text{s}$$

Step 3. Using Equation 3-4 or from Chart 2, determine the  $W/T$  ratio.

$$E_o = \frac{Q_w}{Q} = \frac{2.8}{4.2} = 0.67$$

$$\frac{S_w}{S_x} = \frac{0.103}{0.020} = 5.15$$

$$\frac{W}{T} = 0.23 \text{ from Chart 2}$$

Step 4. Compute the spread based on the assumed  $Q_s$ .

$$T = \frac{W}{\left(\frac{W}{T}\right)} = \frac{2.0}{.23}$$

$$T = 8.7 \text{ ft}$$

Step 5. Compute the  $T_s$  based on the assumed  $Q_s$ .

$$T_s = T - W = 8.7 - 2.0 = 6.7 \text{ ft}$$

Step 6. Use Equation 3-2 or Chart 1 to determine the  $Q_s$  for the computed  $T_s$ .

$$Q_s n = (0.56) S_x^{1.67} S_L^{0.5} T_s^{2.67}$$

$$Q_s n = (0.56)(0.02)^{1.67} (0.01)^{0.5} (6.7)^{2.67}$$

$$Q_s n = 0.0131 \text{ ft}^3/\text{s}$$

$$Q_s = \frac{Q_s n}{n} = \frac{0.0131}{0.016}$$

$$Q_s = 0.82 \text{ ft}^3/\text{s}$$

Step 7. Compare the computed  $Q_s$  with the assumed  $Q_s$ .

$$Q_s \text{ assumed} = 1.4 > 0.82 = Q_s \text{ computed. Not close, try again.}$$

Step 8. Try a new assumed  $Q_s$  and repeat Steps 2 through 7.



$$\text{Assume } Q_s = 1.9 \text{ ft}^3/\text{s}$$

$$Q_w = 4.2 - 1.9 = 2.3 \text{ ft}^3/\text{s}$$

$$E_o = \frac{Q_w}{Q} = \frac{2.3}{4.2} = 0.55$$

$$\frac{S_w}{S_x} = 5.15$$

$$\frac{W}{T} = 0.18$$

$$T = \frac{2.0}{0.18} = 11.1 \text{ ft}$$

$$T_s = 11.1 - 2.0 = 9.1 \text{ ft}$$

$$Q_s n = 0.30 \text{ ft}^3/\text{s}$$

$$Q_s = \frac{0.30}{0.016} = 1.85 \text{ ft}^3/\text{s}$$

$Q_s$  assumed = 1.9 ft<sup>3</sup>/s close to 1.85 ft<sup>3</sup>/s =  $Q_s$  computed

### 3-4.3 Shallow Swale Sections

3-4.3.1 **Runoff Control.** Where curbs are not needed for traffic control, a small swale section of circular or V shape may be used to convey runoff from the pavement. As an example, the control of pavement runoff on fills may be needed to protect the embankment from erosion. Small swale sections may have sufficient capacity to convey the flow to a location suitable for interception.

3-4.3.2 **V-sections.** Chart 1 can be used to compute the flow in a shallow V-shaped section. When using Chart 1 for V-shaped channels, the cross slope,  $S_x$ , is determined by Equation 3-7:

$$S_x = \frac{S_{x1} S_{x2}}{(S_{x1} + S_{x2})} \quad (3-7)$$

Example 3-3 demonstrates the use of Chart 1 to analyze a V-shaped shoulder gutter. Analysis of a V-shaped gutter resulting from a roadway with an inverted crown section is illustrated in Example 3-4.

Example 3-3

Given: V-shaped roadside gutter (Figure 3-1 b.1.) with these characteristics:

$$S_L = 0.01 \qquad S_{x1} = 0.25$$

$$n = 0.016 \qquad S_{x2} = 0.04$$

$$BC = 2.0 \text{ ft} \qquad S_{x3} = 0.02$$

Find: Spread at a flow of 1.77 ft<sup>3</sup>/s

Solution:

Step 1. Calculate  $S_x$  using Equation 3-7 assuming all flow is contained entirely in the V-shaped gutter section defined by  $S_{x1}$  and  $S_{x2}$ .

$$S_x = \frac{S_{x1} S_{x2}}{(S_{x1} + S_{x2})} = \frac{(0.25)(0.04)}{(0.25 + 0.04)}$$

$$S_x = 0.0345$$

Step 2. Using Equation 3-2 or Chart 1, find the hypothetical spread,  $T'$ , assuming all flow is contained entirely in the V-shaped gutter.

$$T' = \left[ \frac{(Qn)}{(0.56 S_x^{1.67} S_L^{0.5})} \right]^{0.375}$$

$$T' = \left[ \frac{(1.77)(0.016)}{\{(0.56)(0.0345)^{1.67} (0.01)^{0.5}\}} \right]^{0.375}$$

$$T' = 6.4 \text{ ft}$$

Step 3. To determine if  $T'$  is within  $S_{x1}$  and  $S_{x2}$ , compute the depth at point B in the V-shaped gutter knowing  $\overline{BC}$  and  $S_{x2}$ . Then, knowing the depth at B, compute the distance  $\overline{AB}$ .

$$d_B = \overline{BC} S_{x2} = (2)(0.04) = 0.08 \text{ ft}$$

$$\overline{AB} = \frac{d_B}{S_{x1}} = \frac{(0.08)}{(0.25)} = 0.32 \text{ ft}$$

$$\overline{AC} = \overline{AB} + \overline{BC} = 0.32 + 2.0 = 2.32 \text{ ft}$$

Because 2.32 ft is less than  $T'$ , it is clear that the spread falls outside the V-shaped gutter section. An iterative solution technique must be used to solve for the section spread,  $T$ , as illustrated in the following steps.

Step 4. Solve for the depth at point C,  $d_c$ , and compute an initial estimate of the spread.

$$T_{\overline{BD}} \text{ along } \overline{BD}$$

$$d_c = d_B - \overline{BC}(S_{x2})$$

From the geometry of the triangle formed by the gutter, an initial estimate for  $d_B$  is determined as:

$$\left(\frac{d_B}{0.25}\right) + \left(\frac{d_B}{0.04}\right) = 6.4 \text{ ft}$$

$$d_B = 0.22 \text{ ft}$$

$$d_c = 0.22 - (2.0)(0.04) = 0.14 \text{ ft}$$

$$T_s = \frac{d_c}{S_{x3}} = \frac{0.14}{0.02} = 7 \text{ ft}$$

$$T_{\overline{BD}} = T_s + \overline{BC} = 7 + 2 = 9 \text{ ft}$$

Step 5. Using a spread along  $\overline{BD}$  equal to 9.0 ft, develop a weighted slope for  $S_{x2}$  and  $S_{x3}$ .

2.0 ft at  $S_{x2}$  (0.04) and 7.0 ft at  $S_{x3}$  (0.02)

$$\frac{(2.0)(0.04) + (7.0)(0.02)}{9.05} = 0.024$$

Using this slope along with  $S_{x1}$ , find  $S_x$  using Equation 3-7.

$$S_x = \frac{S_{x1}S_{x2}}{(S_{x1} + S_{x2})}$$

$$= \frac{(0.25)(0.024)}{(0.25 + 0.024)} = 0.022$$

Step 6. Using Equation 3-2 or Chart 1, compute the gutter spread using the composite cross slope,  $S_x$ .

$$T = \left[ \frac{(Qn)}{(0.56S_x^{1.67} S_L^{0.5})} \right]^{0.375}$$

$$T = \left[ \frac{(1.77)(0.016)}{\{(0.56)(0.022)^{1.67} (0.01)^{0.5}\}} \right]^{0.375}$$

$$T = 8.5 \text{ ft}$$

This 8.5 ft is lower than the assumed value of 9.0 ft. Therefore, assume

$T_{\overline{BD}} = 8.3 \text{ ft}$  and repeat Step 5 and Step 6.

Step 5. 2.0 ft at  $S_{x2}$  (0.04) and 6.3 ft at  $S_{x3}$  (0.02)

$$\frac{(2.0)(0.04) + 6.3(0.02)}{(8.30)} = 0.0248$$

Using this slope along with  $S_{x1}$ , find  $S_x$  using Equation 3-7.

$$S = \frac{(0.25)(0.0248)}{(0.25 + 0.0248)} = 0.0226$$

Step 6. Using Equation 3-2 or Chart 1, compute the spread,  $T$ .

$$T = \left[ \frac{(Qn)}{(0.56S_x^{1.67} S_L^{0.5})} \right]^{0.375}$$

$$T = \left[ \frac{(1.77)(0.016)}{\{(0.56)(0.0226)^{1.67} (0.01)^{0.5}\}} \right]^{0.375}$$

$$T = 8.31 \text{ ft}$$

This value of  $T$  equals 8.31 ft. Because this value is close to the assumed value of 8.3 ft, it is acceptable.

#### Example 3-4

Given: V-shaped gutter as illustrated in Figure 3-1 b.2 with:

$$\overline{AB} = 3.28 \text{ ft}$$

$$\overline{BC} = 3.28 \text{ ft}$$

$$S_L = 0.01$$

$$n = 0.016$$

$$S_{x1} = S_{x2} = 0.25$$

$$S_{x3} = 0.04$$

Find: (1) Spread at a flow of 24.7 ft<sup>3</sup>/s

(2) Flow at a spread of 23.0 ft

Solution (1):

Step 1. Assume that the spread remains within middle "V" (A to C) and compute  $S_x$ .

$$S_x = \frac{(S_{x1} S_{x2})}{(S_{x1} + S_{x2})}$$

$$S_x = \frac{(0.25)(0.25)}{(0.25 + 0.25)}$$

$$S_x = 0.125$$

Step 2. From Equation 3-2 or Chart 1:

$$T = \left[ \frac{(Qn)}{\{(0.56)S_x^{1.67} S_L^{0.5}\}} \right]^{0.375}$$

$$T = \left[ \frac{(24.7)(0.016)}{\{(0.56)(0.125)^{1.67} (0.01)^{0.5}\}} \right]^{0.375}$$

$$T = 7.65 \text{ ft}$$

Since  $T$  is outside  $S_{x1}$  and  $S_{x2}$ , an iterative approach (as illustrated in Example 3-3) must be used to compute the spread.

Step 3. Treat one-half of the median gutter as a composite section and solve for  $T'$  equal to one-half of the total spread.

$$Q' \text{ for } T' = \frac{1}{2} Q = 0.5 (24.7) = 12.4 \text{ ft}^3/\text{s}$$

Step 4. Try  $Q'_s = 1.8 \text{ ft}^3/\text{s}$

$$Q'_w = Q' - Q'_s = 12.4 - 1.8 = 10.6 \text{ ft}^3/\text{s}$$

Step 5. Using Equation 3-4 or Chart 2, determine the  $W/T'$  ratio.

$$E'_o = \frac{Q'_w}{Q'} = \frac{10.6}{12.4} = 0.85$$

$$\frac{S_w}{S_x} = \frac{S_{x2}}{S_{x3}} = \frac{0.25}{0.04} = 6.25$$

$W/T' = 0.33$  from Chart 2

Step 6. Compute the spread based on the assumed  $Q'_s$ .

$$T' = \frac{W}{\left(\frac{W}{T'}\right)} = \frac{3.28}{0.22} = 9.94 \text{ ft}$$

Step 7. Compute  $T_s$  based on the assumed  $Q'_s$ .

$$T_s = T' - W = 9.94 - 3.28 = 6.66 \text{ ft}$$

Step 8. Use Equation 3-2 or Chart 1 to determine  $Q'_s$  for  $T_s$ .

$$Q'_s n = (0.56) S_{x3}^{1.67} S_L^{0.5} T_s^{2.67} = (0.56)(0.04)^{1.67} (0.01)^{0.5} (6.66)^{2.67}$$

$$Q'_s n = 0.041$$

$$Q'_s = \frac{0.041}{0.016} = 2.56 \text{ ft}^3/\text{s}$$

Step 9. Check the computed  $Q'_s$  with the assumed  $Q'_s$ .

$Q'_s$  assumed = 1.8 < 2.56 =  $Q'_s$  computed; therefore, try a new assumed  $Q'_s$  and repeat Steps 4 through 9.

Assume  $Q'_s = 0.04$

$$Q'_w = 12.0 \text{ ft}^3/\text{s}$$

$$E'_o = 0.97$$

$$\frac{S_w}{S_x} = 6.25$$

$$\frac{W}{T'} = 0.50 \text{ from Chart 2}$$

$$T' = 6.56 \text{ ft}$$

$$T_s = 1.0 \text{ ft}$$

$$Q_s n = 0.0062$$

$$Q_s = 0.39 \text{ ft}^3/\text{s}$$

$Q_s$  computed = 0.39. This is close to 0.40 =  $Q_s$  assumed; therefore, the solution is acceptable.

$$T = 2 T' = 2 (6.56) = 13.12 \text{ ft}$$

*Solution (2):*

Analyze in half-section using composite section techniques. Double the computed half-width flow rate to get the total discharge:

Step 1. Compute half-section top width

$$T' = \frac{T}{2} = \frac{23}{2} = 11.5 \text{ ft}$$

$$T_s = T' - 3.28 = 8.22 \text{ ft}$$

Step 2. From Equation 3-2 or Chart 1, determine  $Q$ .

$$Q_s n = (0.56) S_x^{1.67} S_L^{0.5} T_s^{2.67}$$

$$Q_s n = (0.56)(0.04)^{1.67} (0.01)^{0.5} (8.22)^{2.67}$$

$$Q_s n = 0.073$$

$$Q_s = \frac{0.073}{0.016} = 4.56 \text{ ft}^3/\text{s}$$

Step 3. Determine the flow in half-section using Equation 3-4 or Chart 2.

$$\frac{T'}{W} = \frac{11.5}{3.28} = 3.51$$

$$\frac{S_w}{S_x} = \frac{0.25}{0.04} = 6.25$$

$$E_o = \left[ \frac{1}{1 + \frac{\left(\frac{S_w}{S_x}\right)}{\left(1 + \frac{\left(\frac{S_w}{S_x}\right)}{\left(\frac{T}{W} - 1\right)}\right)^{2.67}} - 1} \right]$$

$$E_o = \left[ \frac{1}{1 + \frac{(6.25)}{\left(1 + \frac{(6.25)}{(3.5 - 3.28)}\right)^{2.67}} - 1} \right]$$

$$E_o = 0.814 = \frac{Q'_w}{Q} = 1 - \frac{Q'_s}{Q'}$$

$$Q' = \frac{Q'_s}{(1 - 0.814)} = \frac{4.56}{(1 - 0.814)}$$

$$Q' = 24.5 \text{ ft}^3/\text{s}$$

$$Q = 2 Q' = 2 (24.5) = 49 \text{ ft}^3/\text{s}$$

**3-4.4 Flow in Sag Vertical Curves.** As gutter flow approaches the low point in a sag vertical curve, the flow can exceed the allowable design spread values as a result of the continually decreasing gutter slope. The spread in these areas should be checked to ensure that it remains within allowable limits. If the computed spread exceeds design values, additional inlets should be provided to reduce the flow as it approaches the low point. Sag vertical curves and measures for reducing spread are discussed further in section 3-5.5.

**3-4.5 Gutter Flow Time.** The flow time in gutters is an important component of the time of concentration for the contributing drainage area to an inlet. To find the gutter flow component of the time of concentration, a method for estimating the average velocity in a reach of gutter is needed. The velocity in a gutter varies with the flow rate, and the flow rate varies with the distance along the gutter, i.e., both the velocity and flow rate in a gutter are spatially varied. The time of flow can be estimated by use of an average velocity obtained by integration of Manning's equation for the gutter section



with respect to time. The derivation of such a relationship for triangular channels is presented in Appendix C of HEC-22.

Table 3-2 and Chart 4 can be used to determine the average velocity in triangular gutter sections. In Table 3-2,  $T_1$  and  $T_2$  are the spread at the upstream and downstream ends of the gutter section, respectively.  $T_a$  is the spread at the average velocity. Chart 4 in Appendix B is a nomograph to solve Equation 3-13 for the velocity in a triangular channel with known cross slope, gutter slope, and spread.

**Table 3-2. Spread at Average Velocity in a Reach of Triangular Gutter**

$\frac{T_1}{T_2}$	0	0.1	0.2	0.3	0.4	0.5	0.6	0.7	0.8
$\frac{T_a}{T_2}$	0.65	0.66	0.68	0.70	0.74	0.77	0.82	0.86	0.90

$$V = \frac{1.11}{n} S_L^{0.5} S_x^{0.67} T^{0.67} \quad (3-8)$$

where:

$V$  = velocity in the triangular channel, ft/s

Example 3-5 illustrates the use of Table 3-2 and Chart 4 to determine the average gutter velocity.

Example 3-5

*Given:* A triangular gutter section with these characteristics:

$$T_1 = 3.28 \text{ ft}$$

$$T_2 = 9.84 \text{ ft}$$

$$S_L = 0.03 \text{ ft/ft}$$

$$S_x = 0.02 \text{ ft/ft}$$

$$n = 0.016$$

Inlet spacing is anticipated to be 330 ft.

*Find:* Time of flow in gutter

*Solution:*

Step 1. Compute the upstream to downstream spread ratio.

$$\frac{T_1}{T_2} = \frac{3.28}{9.84} = 0.33$$

Step 2. Determine the spread at average velocity, interpolating between values in Table 3-2.

$$\frac{(0.30 - 0.33)}{(0.3 - 0.4)} = \frac{X}{(0.74 - 0.70)}$$

$$X = 0.01$$

$$\frac{T_a}{T_2} = 7.65 \text{ ft}$$

$$= 0.71$$

$$T_a = (0.71)(9.84) = 6.99 \text{ ft}$$

Step 3. Using Equation 3-8 or Chart 4, determine the average velocity.

$$V_a = \frac{1.11}{n} S_L^{0.5} S_x^{0.67} T^{0.67}$$

$$V_a = \left[ \frac{1.11}{(0.016)} \right] (0.03)^{0.5} (0.02)^{0.67} (6.99)^{0.67}$$

$$V_a = 3.21 \text{ ft/s}$$

Step 4. Compute the travel time in the gutter.

$$T_{ti} = L/V = (330)/(3.21/(60)) = 1.7 \text{ min}$$

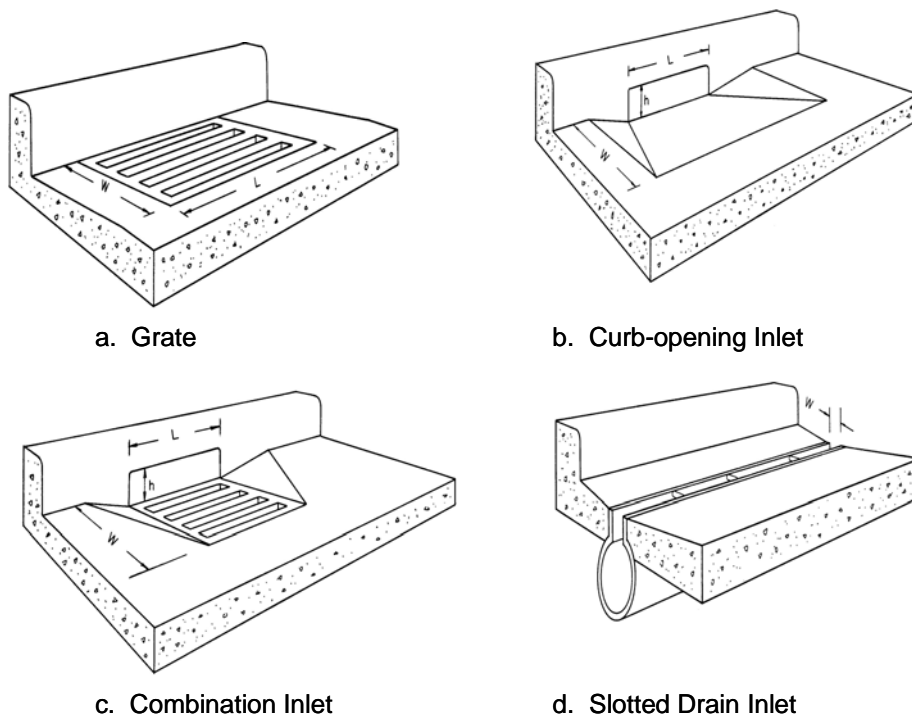
3-5 **DRAINAGE INLET DESIGN.** The hydraulic capacity of a storm drain inlet depends upon its geometry as well as the characteristics of the gutter flow. Inlet capacity governs both the rate of water removal from the gutter and the amount of water that can enter the storm drainage system. Inadequate inlet capacity or poor inlet location may cause flooding on the roadway resulting in a hazard to the traveling public.

3-5.1 **Inlet Types.** Storm drain inlets are used to collect runoff and discharge it to an underground storm drainage system. Inlets are typically located in gutter sections, paved medians, and roadside and median ditches. Inlets used for the drainage of highway surfaces can be divided into four classes:

- Grate inlets
- Curb-opening inlets
- Combination inlets
- Continuous inlets

Grate inlets consist of an opening in the gutter or ditch covered by a grate. Curb-opening inlets are vertical openings in the curb covered by a top slab. Slotted inlets, a form of continuous inlet, consist of a pipe cut along the longitudinal axis with bars perpendicular to the opening to maintain the slotted opening. Combination inlets consist of both a curb-opening inlet and a grate inlet placed in a side-by-side configuration, but the curb opening may be located in part upstream of the grate. Figure 3-3 illustrates each class of inlets. Continuous inlets may also be used with grates, and each type of inlet may be installed with or without a depression of the gutter.

**Figure 3-3. Classes of Storm Drain Inlets**



### 3-5.2 Characteristics and Uses of Inlets

3-5.2.1 **Grate Inlets.** As a class, grate inlets perform satisfactorily over a wide range of gutter grades. Grate inlets generally lose capacity with increase in grade, but to a lesser degree than curb-opening inlets. The principal advantage of grate inlets is that they are installed along the roadway where the water is flowing. Their principal disadvantage is that they may be clogged by floating trash or debris. For safety reasons, preference should be given to grate inlets where out-of-control vehicles might be involved. Additionally, where bicycle traffic occurs, grates should be bicycle safe.

3-5.2.2 **Curb-opening Inlets.** Curb-opening inlets are most effective on flatter slopes, in sags, and with flows that typically carry significant amounts of floating debris. The interception capacity of curb-opening inlets decreases as the gutter grade steepens. Consequently, the use of curb-opening inlets is recommended in sags and on grades less than 3 percent. Of course, they are bicycle safe as well.

3-5.2.3 **Combination Inlets.** Combination inlets provide the advantages of both curb-opening and grate inlets. This combination results in a high capacity inlet that offers the advantages of both grate and curb-opening inlets. When the curb-opening precedes the grate in a "sweeper" configuration, the curb-opening inlet acts as a trash interceptor during the initial phases of a storm. Used in a sag configuration, the sweeper inlet can have a curb opening on both sides of the grate. A complete discussion of combination inlets can be found in Chapter 4 of HEC-22.

3-5.2.4 **Continuous Inlets.** Continuous inlets can be used in areas where it is necessary to intercept sheet flow before it crosses onto a section of roadway. Their principal advantage is their ability to intercept flow over a wide section. A form of continuous inlet, slotted inlets are very susceptible to clogging from sediments and debris and are not recommended for use in environments where significant sediment or debris loads may be present. Continuous inlets on a longitudinal grade do have the same hydraulic capacity as curb openings when debris is not a factor. A complete discussion of continuous inlets can be found in Chapter 4 of HEC-22.

3-5.3 **Inlet Capacity.** Inlet interception capacity has been investigated by several agencies and manufacturers of grates. Hydraulic tests on grate inlets and slotted inlets included in this document were conducted by the Bureau of Reclamation for the FHWA. Four of the grates selected for testing were rated highest in bicycle safety tests, three have designs and bar spacing similar to those proven bicycle safe, and a parallel bar grate was used as a standard with which to compare the performance of others.

Figures 3-4 through 3-9 show the inlet grates for which design procedures were developed. For ease in identification, the following terms have been adopted:

- P-1-7/8                      Parallel bar grate with bar spacing 1.875 in. on center (Figure 3-4).

- P-1-7/8 x 4 Parallel bar grate with bar spacing 1.875 in. on center and 0.375-in. diameter lateral rods spaced at 4 in. on center (Figure 3-4).
- P-1-1/8 Parallel bar grate with 1.125 in. on center bar spacing (Figure 3-5)
- Curved Vane Curved vane grate with 3.25 in. longitudinal bar and 4.25 in. transverse bar spacing on center (Figure 3-6).
- 45°- 2-1/4 Tilt Bar 45-degree tilt-bar grate with 2.25 in. longitudinal bar and 4 in. transverse bar spacing on center (Figure 3-7).
- 45°- 3-1/4 Tilt Bar 45-degree tilt-bar grate with 3.25 in. longitudinal bar and 4 in. transverse bar spacing on center (Figure 3-7).
- 30°- 3-1/4 Tilt Bar 30-degree tilt-bar grate with 3.25 in. longitudinal bar and 4 in. transverse bar spacing on center (Figure 3-8).
- Reticuline "Honeycomb" pattern of lateral bars and longitudinal bearing bars (Figure 3-9).

### 3-5.3.1 Factors Affecting Inlet Interception Capacity and Efficiency on

**Continuous Grades.** Inlet interception capacity,  $Q_i$  is the flow intercepted by an inlet under a given set of conditions. The efficiency of an inlet,  $E$ , is the percent of total flow that the inlet will intercept for those conditions. The efficiency of an inlet changes with changes in cross slope, longitudinal slope, total gutter flow, and, to a lesser extent, pavement roughness. In mathematical form, efficiency,  $E$ , is defined by Equation 3-9:

$$E = \frac{Q_i}{Q} \quad (3-9)$$

where:

$E$  = inlet efficiency

$Q$  = total gutter flow, ft<sup>3</sup>/s

$Q_i$  = intercepted flow, ft<sup>3</sup>/s

Flow that is not intercepted by an inlet is termed carryover or bypass and is defined by Equation 3-10:

$$Q_b = Q - Q_i \quad (3-10)$$

where:

$Q_b$  = bypass flow, ft<sup>3</sup>/s

3-5.3.1.1 The interception capacity of all inlet configurations increases with increasing flow rates, and inlet efficiency generally decreases with increasing flow rates. Factors affecting gutter flow also affect inlet interception capacity. The depth of water next to the curb is the major factor in the interception capacity of both grate inlets and curb-opening inlets. The interception capacity of a grate inlet depends on the amount of water flowing over the grate, the size and configuration of the grate, and the velocity of flow in the gutter. The efficiency of a grate is dependent on the same factors and total flow in the gutter.

Figure 3-4. P-1-7/8 and P-1-7/8 x 4 Grates  
(Same as P-1-7/8 Grate Without 3/8-in. Transverse Rods)

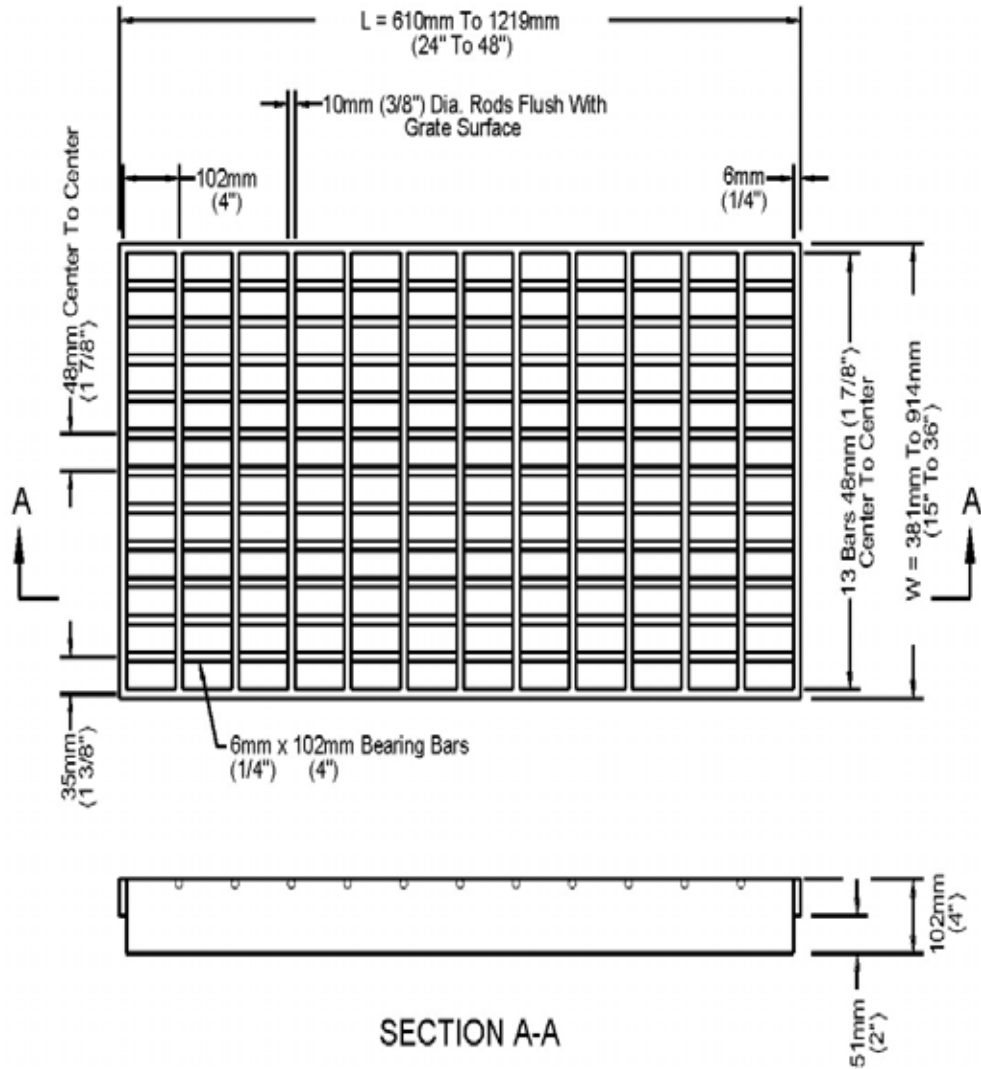


Figure 3-5. P-1-1/8 Grate

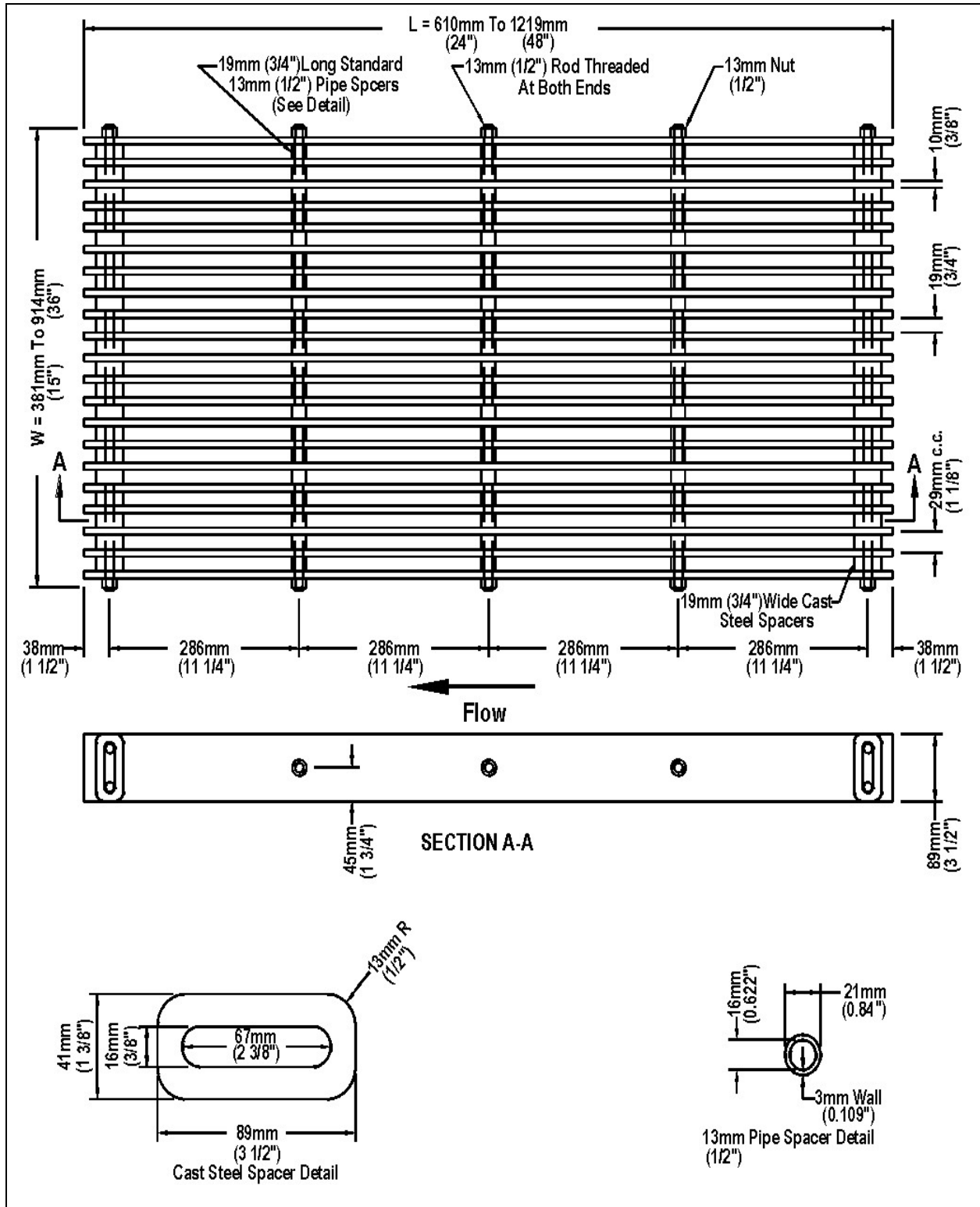




Figure 3-6. Curved Vane Grate

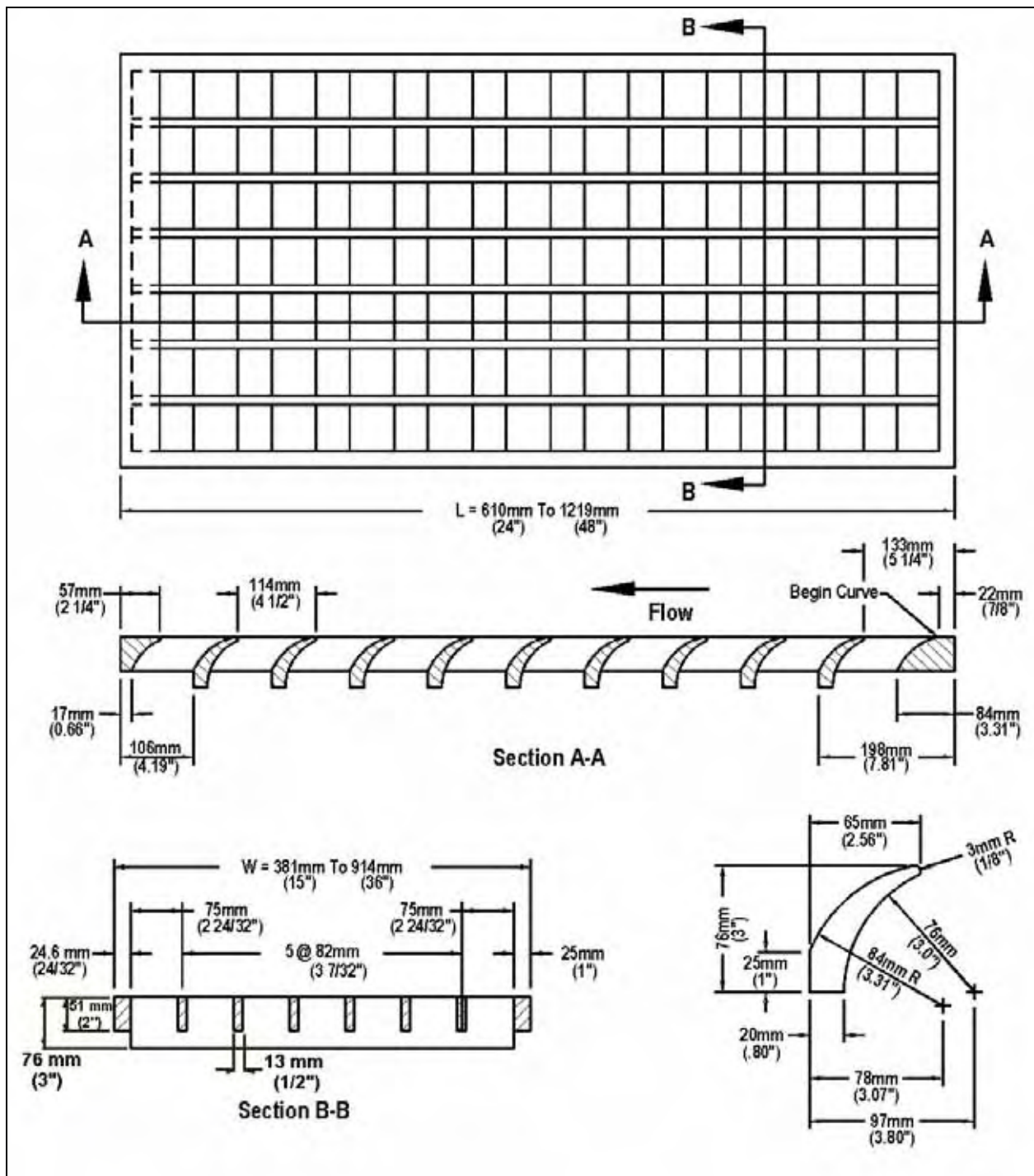


Figure 3-7. 45-Degree 2-1/4 and 45-Degree 3-1/4 Tilt-bar Grates

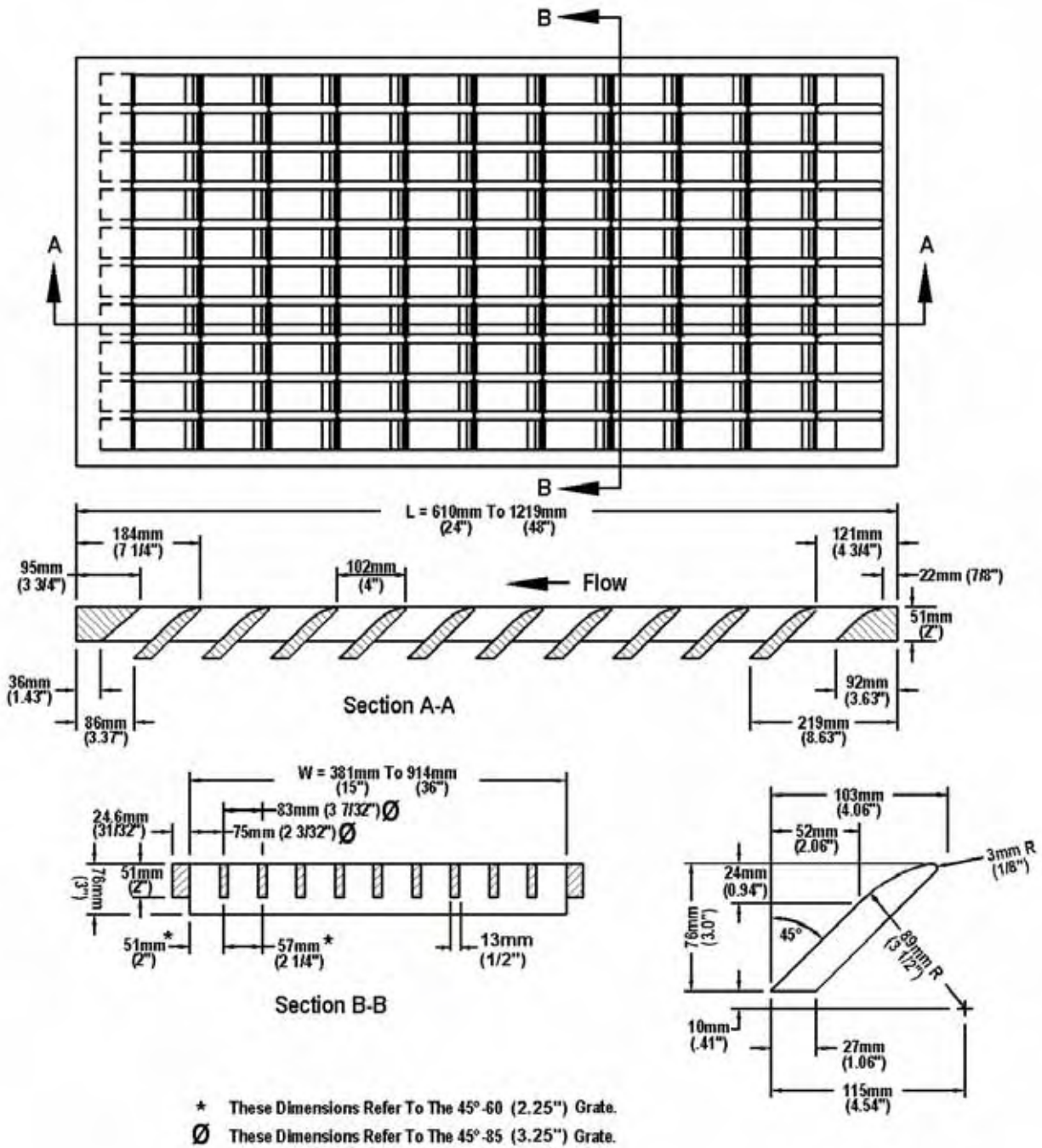
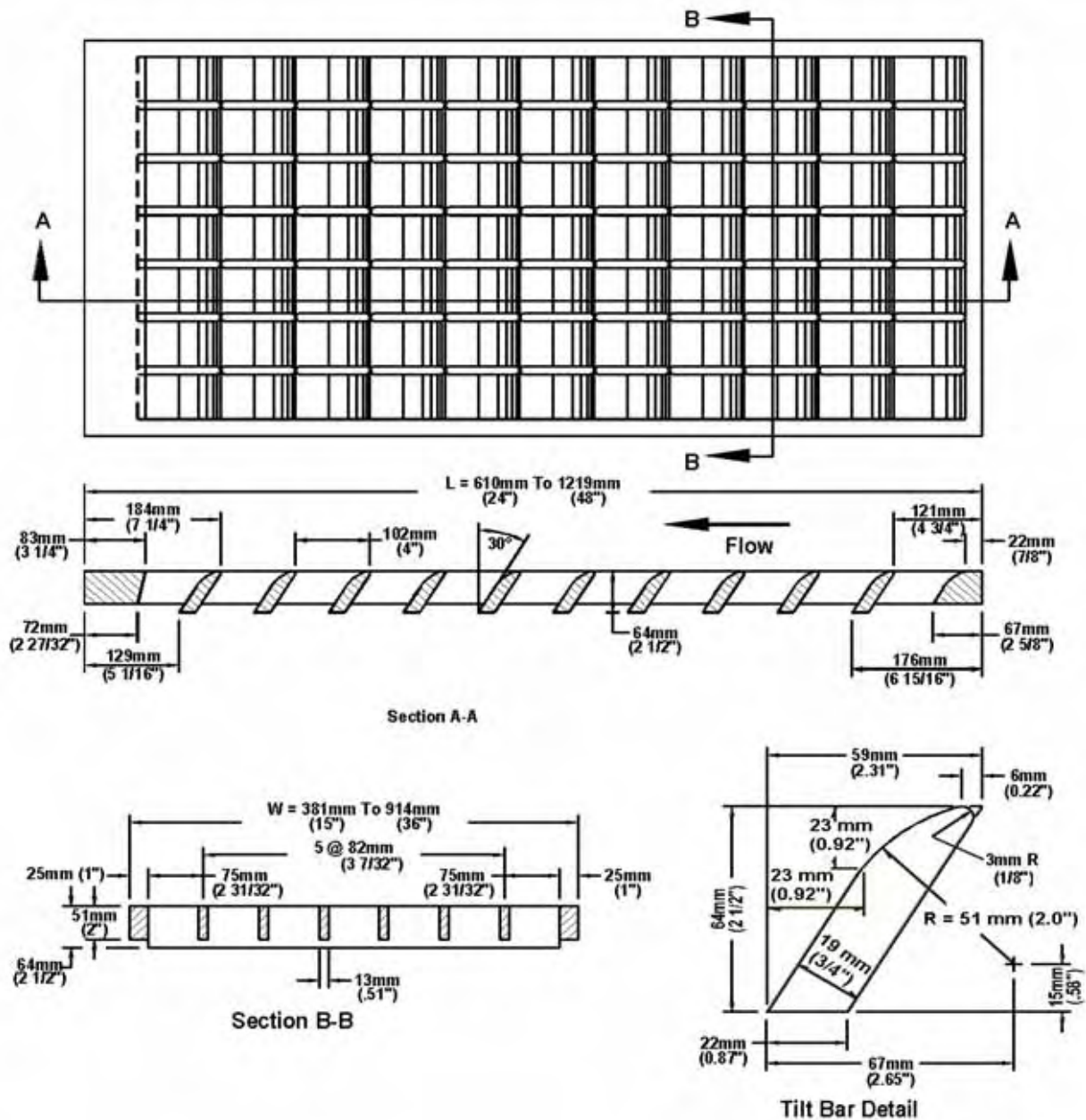


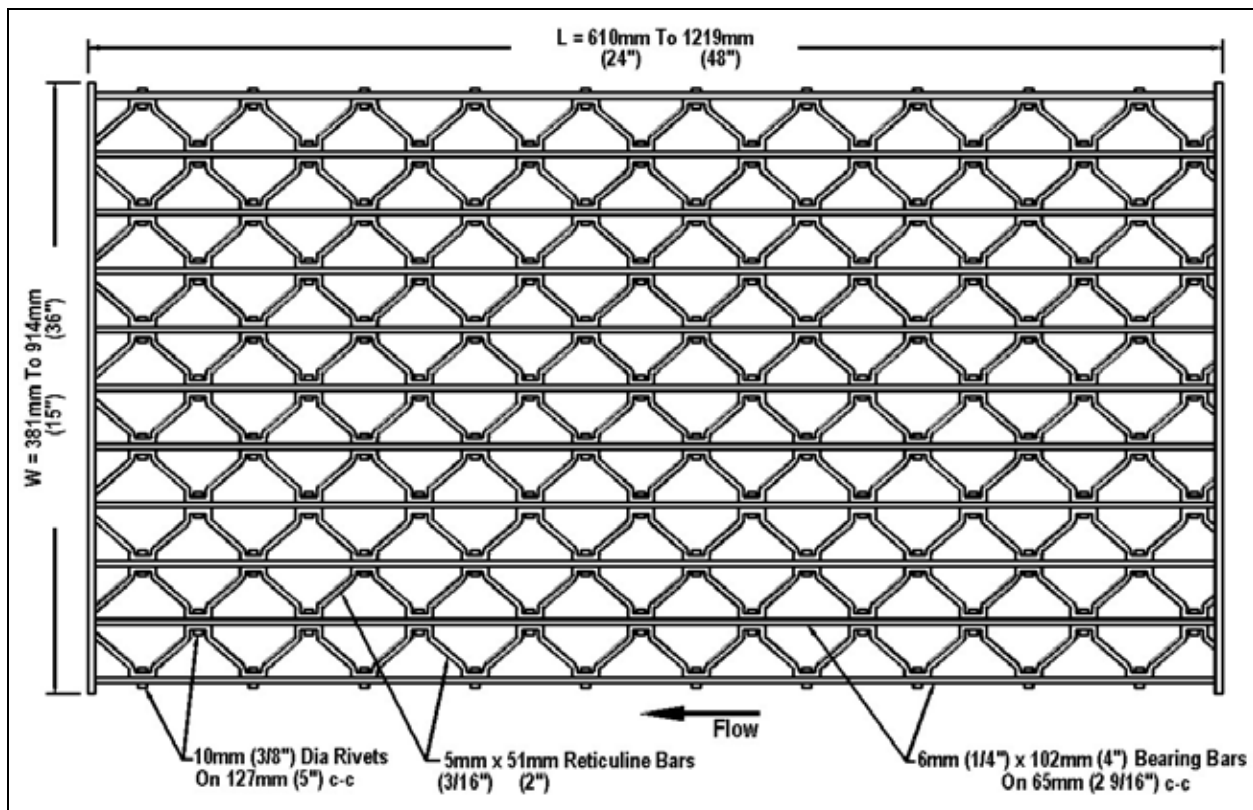
Figure 3-8. 30-Degree 3-1/4 Tilt-bar Grates



3-5.3.1.2 Interception capacity of a curb-opening inlet is largely dependent on flow depth at the curb and curb opening length. Flow depth at the curb and consequently, curb-opening inlet interception capacity and efficiency, is increased by the use of a local gutter depression at the curb opening or a continuously depressed gutter to increase the proportion of the total flow adjacent to the curb. Top slab supports placed flush with the curb line can substantially reduce the interception capacity of curb openings. Tests have shown that such supports reduce the effectiveness of openings downstream of the

support by as much as 50 percent and, if debris is caught at the support, interception by the downstream portion of the opening may be reduced to near zero. If intermediate top slab supports are used, they should be recessed several inches from the curb line and rounded in shape.

Figure 3-9. Reticuline Gate



3-5.3.1.3 Slotted inlets function in essentially the same manner as curb-opening inlets, i.e., as weirs with flow entering from the side. Interception capacity is dependent on flow depth and inlet length. Efficiency is dependent on flow depth, inlet length, and total gutter flow.

3-5.3.1.4 The interception capacity of an equal length combination inlet consisting of a grate placed alongside a curb opening on a grade does not differ materially from that of a grate only. Interception capacity and efficiency are dependent on the same factors that affect grate capacity and efficiency. A combination inlet consisting of a curb-opening inlet placed upstream of a grate inlet has a capacity equal to that of the curb-opening length upstream of the grate plus that of the grate, taking into account the reduced spread and depth of flow over the grate because of the interception by the curb opening. This inlet configuration has the added advantage of intercepting debris that might otherwise clog the grate and deflect water away from the inlet.

3-5.4 **Interception Capacity of Inlets on Grade.** Section 3-5.3.1 examines the factors that influence the interception capacity of inlets on grade. This section (3-5.4) introduces the design charts for inlets on grade (Appendix B) and procedures for using the charts for the various inlet configurations. Remember that for locally depressed inlets, the quantity of flow reaching the inlet would be dependent on the upstream gutter section geometry and not the depressed section geometry.

Charts for grate inlet interception are presented in Appendix B. The chart for frontal flow interception is based on test results that show that grates intercept all of the frontal flow until a velocity is reached at which water begins to splash over the grate. At velocities greater than "splash-over" velocity, grate efficiency in intercepting frontal flow is diminished. Grates also intercept a portion of the flow along the length of the grate, or the side flow. A chart is provided to determine side-flow interception.

One set of charts is provided for slotted inlets and curb-opening inlets because these inlets are both side-flow weirs. The equation developed for determining the length of inlet required for total interception fits the test data for both types of inlets.

3-5.4.1 **Grate Inlets.** Grates are effective highway pavement drainage inlets where clogging with debris is not a problem. Where clogging may be a problem, see Table 3-3's ranking of grates for susceptibility to clogging based on laboratory tests using simulated leaves. This table should be used for relative comparisons only.

**Table 3-3. Average Debris Handling Efficiencies of Grates Tested**

Rank	Grate	Longitudinal Slope	
		0.005	0.04
1	Curved Vane	46	61
2	30°- 85 Tilt Bar	44	55
3	45°- 85 Tilt Bar	43	48
4	P - 50	32	32
5	P - 50x100	18	28
6	45°- 60 Tilt Bar	16	23
7	Reticuline	12	16
8	P - 30	9	20

When the velocity approaching the grate is less than the "splash-over" velocity, the grate will intercept essentially all of the frontal flow. Conversely, when the gutter flow velocity exceeds the "splash-over" velocity for the grate, only part of the flow will be intercepted. A part of the flow along the side of the grate will be intercepted, dependent on the cross slope of the pavement, the length of the grate, and the flow velocity.

3-5.4.1.1 The ratio of frontal flow to total gutter flow,  $E_o$ , for a uniform cross slope is expressed by Equation 3-11:

$$E_o = \frac{Q_w}{Q} = 1 - \left(1 - \frac{W}{T}\right)^{2.67} \quad (3-11)$$

where:

$Q$  = total gutter flow, ft<sup>3</sup>/s

$Q_w$  = flow in width,  $W$ , ft<sup>3</sup>/s

$W$  = width of depressed gutter or grate, ft

$T$  = total spread of water, ft

Example 3-2 and Chart 2 provide solutions of  $E_o$  for either uniform cross slopes or composite gutter sections.

3-5.4.1.2 The ratio of side flow,  $Q_s$ , to total gutter flow is:

$$\frac{Q_s}{Q} = 1 - \frac{Q_w}{Q} = 1 - E_o \quad (3-12)$$

3-5.4.1.3 The ratio of frontal flow intercepted to total frontal flow,  $R_f$ , is expressed by Equation 3-13:

$$R_f = 1 - 0.09(V - V_o) \quad (3-13)$$

where:

$V$  = velocity of flow in the gutter, ft/s

$V_o$  = gutter velocity where splash-over first occurs, ft/s

**(NOTE:  $R_f$  cannot exceed 1.0.)**

This ratio is equivalent to frontal flow interception efficiency. Chart 5 provides a solution for Equation 3-13 that takes into account grate length, bar configuration, and gutter velocity at which splash-over occurs. The average gutter velocity (total gutter flow divided by the area of flow) is needed to use Chart 5. This velocity can also be obtained from Chart 4.

3-5.4.1.4 The ratio of side flow intercepted to total side flow,  $R_s$ , or side flow interception efficiency, is expressed by Equation 3-14. Chart 6 in Appendix B provides a solution to Equation 3-14.

$$R_s = \frac{1}{\left(1 + \frac{0.15V^{1.8}}{S_x L^{2.3}}\right)} \quad (3-14)$$

A deficiency in developing empirical equations and charts from experimental data is evident in Chart 6. The fact that a grate will intercept all or almost all of the side flow where the velocity is low and the spread only slightly exceeds the grate width is not reflected in the chart. Error due to this deficiency is very small. In fact, where velocities are high, side flow interception may be neglected without significant error.

3-5.4.1.5 The efficiency,  $E$ , of a grate is expressed as in Equation 3-15:

$$E = R_f E_o + R_s (1 - E_o) \quad (3-15)$$

The first term on the right side of Equation 3-15 is the ratio of intercepted frontal flow to total gutter flow, and the second term is the ratio of intercepted side flow to total side flow. The second term is insignificant with high velocities and short grates.

3-5.4.1.6 It is important to recognize that the frontal flow to total gutter flow ratio,  $E_o$ , for composite gutter sections assumes by definition a frontal flow width equal to the depressed gutter section width. The use of this ratio when determining a grate's efficiency requires that the grate width be equal to the width of the depressed gutter section,  $W$ . If a grate having a width less than  $W$  is specified, the gutter flow ratio,  $E_o$ , must be modified to accurately evaluate the grate's efficiency. Because an average velocity has been assumed for the entire width of gutter flow, the grate's frontal flow ratio,  $E_o$ , can be calculated by multiplying  $E_o$  by a flow area ratio. The area ratio is defined as the gutter flow area in a width equal to the grate width divided by the total flow area in the depressed gutter section. This adjustment is represented in Equation 3-15a:

$$E'_o = E_o \left( \frac{A'_w}{A_w} \right) \quad (3-15a)$$

where:

$E'_o$  = adjusted frontal flow area ratio for grates in composite cross sections

$A'_w$  = gutter flow area in a width equal to the grate width, ft<sup>2</sup>

$A_w$  = flow area in depressed gutter width, ft<sup>2</sup>

3-5.4.1.7 The interception capacity of a grate inlet on grade is equal to the efficiency of the grate multiplied by the total gutter flow as represented in Equation 3-16. Note that  $E'_o$  should be used in place of  $E_o$  in Equation 3-16 when appropriate.

$$Q_i = EQ = Q[R_f E_o + R_s (1 - E_o)] \quad (3-16)$$

3-5.4.1.8 The use of Chart 5 and Chart 6 is illustrated in the Examples 3-6 and 3-7.

Example 3-6

*Given:* The gutter section from Example 3-2 (illustrated in Figure 3-1 a.2) with:

$$T = 8.2 \text{ ft}$$

$$S_L = 0.010$$

$$S_x = 0.020$$

$$W = 2.0 \text{ ft}$$

$$n = 0.016$$

Continuous gutter depression,  $a = 2 \text{ in.}$  or  $0.167 \text{ ft}$

*Find:* The interception capacity of a curved vane grate 2 ft by 2 ft

*Solution:* From Example 3-2:

$$S_w = 0.103 \text{ ft/ft}$$

$$E_o = 0.70$$

$$Q = 2.3 \text{ ft}^3/\text{s}$$

Step 1. Compute the average gutter velocity.

$$V = \frac{Q}{A} = \frac{2.3}{A}$$

$$A = 0.5 T^2 S_x + 0.5 a W$$

$$A = 0.5(8.2)^2(0.02) + 0.5(0.167)(2.0)$$

$$A = 0.84 \text{ ft}^2$$

$$V = \frac{2.3}{0.84} = 2.74 \text{ ft/s}$$

Step 2. Determine the frontal flow efficiency using Chart 5.

$$R_f = 1.0$$



Step 3. Determine the side flow efficiency using Equation 3-14 or Chart 6.

$$R_s = \frac{1}{\left[ \frac{1 + (0.15V^{1.8})}{(S_x L^{2.3})} \right]}$$

$$R_s = \frac{1}{\left[ \frac{1 + (0.15)(2.74)^{1.8}}{(0.02)(2.0)^{2.3}} \right]}$$

$$R_s = 0.10$$

Step 4. Compute the interception capacity using Equation 3-16.

$$Q_i = Q [R_f E_o + R_s (1 - E_o)]$$

$$Q_i = (2.3) [(1.0)(0.70) + (0.10)(1 - 0.70)]$$

$$Q_i = 1.68 \text{ ft}^3/\text{s}$$

#### Example 3-7

*Given:* The gutter section illustrated in Figure 3-1 a.1 with:

$$T = 9.84 \text{ ft}$$

$$S_L = 0.04 \text{ ft/ft}$$

$$S_x = 0.025 \text{ ft/ft}$$

$$n = 0.016$$

Bicycle traffic not permitted.

*Find:* The interception capacity of the following grates:

- a. P-50: 2.0 ft x 2.0 ft
- b. Reticuline: 2.0 ft x 2.0 ft
- c. Grates in a. and b. with a length of 4.0 ft

*Solution:*

Step 1. Using Equation 3-2 or Chart 1, determine Q.

$$Q = \left( \frac{0.56}{n} \right) S_x^{1.67} S_L^{0.5} T^{2.67}$$

$$Q = \left\{ \frac{(0.56)}{(0.016)} \right\} (0.025)^{1.67} (0.04)^{0.5} (9.84)^{2.67}$$

$$Q = 6.62 \text{ ft}^3/\text{s}$$

Step 2. Determine  $E_o$  from Equation 3-4 or Chart 2.

$$\frac{W}{T} = \frac{2.0}{9.84}$$

$$= 0.2$$

$$E_o = \frac{Q_w}{Q}$$

$$E_o = 1 - \left( 1 - \frac{W}{T} \right)^{2.67}$$

$$= 1 - (1 - 0.2)^{2.67}$$

$$E_o = 0.45$$

Step 3. Using Equation 3-8 or Chart 4, compute the gutter flow velocity.

$$V = \left( \frac{1.11}{n} \right) S_L^{0.5} S_x^{0.67} T^{0.67}$$

$$V = \left\{ \frac{(1.11)}{(0.016)} \right\} (0.04)^{0.5} (0.025)^{0.67} (9.84)^{0.67}$$

$$V = 5.4 \text{ ft/s}$$

Step 4. Using Equation 3-13 or Chart 5, determine the frontal flow efficiency for each grate.

Using Equation 3-14 or Chart 6, determine the side flow efficiency for each grate.

Using Equation 3-16, compute the interception capacity of each grate.

Table 3-4 summarizes the results.

Table 3-4. Grate Efficiency and Capacity Summary

Grate	Size (width by length)	Frontal Flow Efficiency, $R_f$	Side Flow Efficiency, $R_s$	Interception Capacity, $Q_i$
P – 1-7/8	2.0 ft by 2.0 ft	1.0	0.036	3.21 ft <sup>3</sup> /s
Reticuline	2.0 ft by 2.0 ft	0.9	0.036	2.89 ft <sup>3</sup> /s
P – 1-7/8	2.0 ft by 4.0 ft	1.0	0.155	3.63 ft <sup>3</sup> /s
Reticuline	2.0 ft by 4.0 ft	1.0	0.155	3.63 ft <sup>3</sup> /s

**NOTE:** The P-1-7/8 parallel bar grate will intercept about 14 percent more flow than the reticuline grate, or 48 percent of the total flow as opposed to 42 percent for the reticuline grate. Increasing the length of the grates would not be cost effective because the increase in side flow interception is small.

3-5.4.2 **Curb-opening Inlets.** Curb-opening inlets are effective in the drainage of highway pavements where flow depth at the curb is sufficient for the inlet to perform efficiently, as discussed in section 3-5.3.1. Curb openings are less susceptible to clogging and offer little interference to traffic operation. They are a viable alternative to grates on flatter grades where grates would be in traffic lanes or would be hazardous for pedestrians or bicyclists.

3-5.4.2.1 Curb opening heights vary in dimension; however, a typical maximum height is approximately 4 to 6 inches. The length of the curb-opening inlet required for total interception of gutter flow on a pavement section with a uniform cross slope is expressed by Equation 3-17:

$$L_T = (0.6)Q^{0.42} S_L^{0.3} \left( \frac{1}{nS_x} \right)^{0.6} \quad (3-17)$$

where:

$L_T$  = curb opening length required to intercept 100 percent of the gutter flow, ft

$S_L$  = longitudinal slope

$Q$  = gutter flow, ft<sup>3</sup>/s

3-5.4.2.2 The efficiency of curb-opening inlets shorter than the length required for total interception is expressed by Equation 3-18:

$$E = 1 - \left( 1 - \frac{L}{L_T} \right)^{1.8} \quad (3-18)$$

where:

$$L = \text{curb opening length, ft}$$

Chart 7 is a nomograph for the solution of Equation 3-17, and Chart 8 provides a solution to Equation 3-18.

3-5.4.2.3 The length of inlet required for total interception by depressed curbing openings in depressed gutter sections can be found by the use of an equivalent cross slope,  $S_e$ , in Equation 3-17 in place of  $S_x$ .  $S_e$  can be computed using Equation 3-19.

$$S_e = S_x + S'_w E_o \quad (3-19)$$

where:

$S'_w$  = cross slope of the gutter measured from the cross slope of the pavement,  $S_x$ , ft/ft

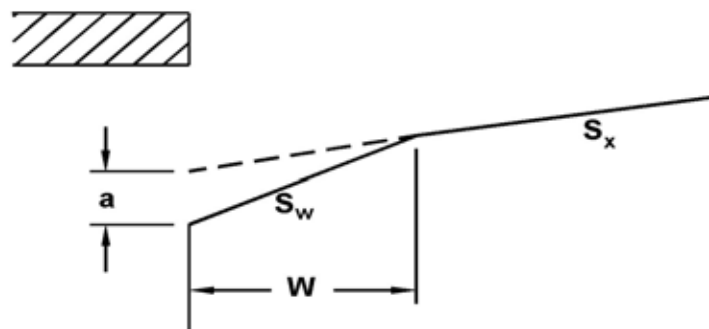
$$S'_w = \frac{a}{12 W}, \text{ for } W \text{ in ft, or } = S_w - S_x$$

$a$  = gutter depression, in.

$E_o$  = ratio of flow in the depressed section to total gutter flow determined by the gutter configuration upstream of the inlet

Figure 3-10 shows the depressed curb inlet for Equation 3-19.  $E_o$  is the same ratio as used to compute the frontal flow interception of a grate inlet.

**Figure 3-10. Depressed Curb-opening Inlet**



3-5.4.2.4 As seen from Chart 7, the length of the curb opening required for total interception can be significantly reduced by increasing the cross slope or the equivalent cross slope. The equivalent cross slope can be increased by use of a continuously depressed gutter section or a locally depressed gutter section.

Using the equivalent cross slope,  $S_e$ , Equation 3-17 becomes:

$$L_T = (0.6)Q^{0.42} S_L^{0.3} \left( \frac{1}{nS_e} \right)^{0.6} \quad (3-20)$$

3-5.4.2.5 Equation 3-18 is applicable with either straight cross slopes or composite cross slopes. Charts 7 and 8 are applicable to depressed curb-opening inlets using  $S_e$  rather than  $S_x$ .

3-5.4.2.6 Equation 3-19 uses the ratio,  $E_o$ , in the computation of the equivalent cross slope,  $S_e$ . Example 3-8a demonstrates the procedure to determine spread and then uses Chart 2 to determine  $E_o$ . Example 3-8b demonstrates the use of these relationships to design the length of a curb-opening inlet.

#### Example 3-8a

*Given:* A curb-opening inlet with the following characteristics:

$$S_L = 0.014 \text{ ft/ft}$$

$$S_x = 0.02 \text{ ft/ft}$$

$$Q = 1.77 \text{ ft}^3/\text{s}$$

$$n = 0.016$$

*Find:* The interception capacity of the following grates:

(1)  $Q_i$  for a 9.84 ft curb opening.

(2)  $Q_i$  for a depressed 9.84 ft curb-opening inlet with a continuously depressed curb section.

$$a = 1 \text{ in.}$$

$$W = 2 \text{ ft}$$

*Solution (1):*

Step 1. Determine the length of curb opening required for total interception of gutter flow using Equation 3-17 or Chart 7.

$$L_T = (0.6)Q^{0.42} S_L^{0.3} \left( \frac{1}{nS_x} \right)^{0.6}$$

$$L_T = (0.6)(1.77)^{0.42} (0.014)^{0.3} \left( \frac{1}{[(0.016)(0.02)]} \right)^{0.6}$$

$$L_T = 23.94 \text{ ft}$$

Step 2. Compute the curb-opening efficiency using Equation 3-18 or Chart 8.

$$\frac{L}{L_T} = \frac{9.84}{23.94} = 0.41$$

$$E = 1 - \left( 1 - \frac{L}{L_T} \right)^{1.8}$$

$$E = 1 - (1 - 0.41)^{1.8}$$

$$E = 0.61$$

Step 3. Compute the interception capacity.

$$Q_i = E Q$$

$$= (0.61)(1.77)$$

$$Q_i = 1.08 \text{ ft}^3/\text{s}$$

Solution (2):

Step 1. Use Equation 3-4 (Chart 2) and Equation 3-2 (Chart 1) to determine the  $W/T$  ratio.

Determine the spread,  $T$  (procedure from Example 3-2, Solution 2).

Assume  $Q_s = 0.64 \text{ ft}^3/\text{s}$

$$Q_w = Q - Q_s$$

$$= 1.77 - 0.64$$

$$= 1.13 \text{ ft}^3/\text{s}$$

$$E_o = \frac{Q_w}{Q}$$

$$= \frac{1.13}{1.77}$$

$$= 0.64$$

$$S_w = S_x + \frac{a}{W}$$

$$= 0.02 + \frac{0.83}{2.0}$$

$$S_w = 0.062$$

$$\frac{S_w}{S_x} = \frac{0.062}{0.02} = 3.1$$

Use Equation 3-4 or Chart 2 to determine  $W/T$ .

$$\frac{W}{T} = 0.24$$

$$T = \frac{W}{\left(\frac{W}{T}\right)}$$

$$= \frac{2.0}{0.24}$$

$$= 8.33 \text{ ft}$$

$$T_s = T - W$$

$$= 8.3 - 2.0$$

$$= 6.3 \text{ ft}$$

Use Equation 3-2 or Chart 1 to obtain  $Q_s$ .

$$Q_s = \left(\frac{0.56}{n}\right) S_x^{1.67} S_L^{0.5} T_s^{2.67}$$

$$Q_s = \left\{ \frac{(0.56)}{(0.016)} \right\} (0.02)^{1.67} (0.01)^{0.5} (6.3)^{2.67}$$

$$Q_s = 0.69 \text{ ft}^3/\text{s}, \text{ which is close to the } Q_s \text{ assumed value}$$

Step 2. Determine the efficiency of the curb opening.

$$S_e = S_x + S'_w E_o = S_x + \left(\frac{a}{W}\right) E_o$$

$$= 0.02 + \left[\frac{(0.083)}{(2.0)}\right] (0.164)$$

$$S_e = 0.047$$

Using Equation 3-20 or Chart 7:

$$L_T = (0.6)Q^{0.42} S_L^{0.3} \left(\frac{1}{nS_e}\right)^{0.6}$$

$$L_T = (0.6)(1.77)^{0.42} (0.01)^{0.3} \left[\frac{1}{((0.016)(0.047))}\right]^{0.6}$$

$$L_T = 14.34 \text{ ft}$$

Using Equation 3-18 or Chart 8 to obtain curb inlet efficiency:

$$\frac{L}{L_T} = \frac{9.84}{14.34} = 0.69$$

$$E = 1 - \left(1 - \frac{L}{L_T}\right)^{1.8}$$

$$E = 1 - (1 - 0.69)^{1.8}$$

$$E = 0.88$$

Step 3. Compute curb opening inflow using Equation 3-9.

$$Q_i = Q E$$

$$= (1.77)(0.88)$$

$$Q_i = 1.55 \text{ ft}^3/\text{s}$$

The depressed curb-opening inlet will intercept 1.5 times the flow intercepted by the undepressed curb opening.



Example 3-8b

Given: From Example 3-6:

$$S_L = 0.01 \text{ ft/ft}$$

$$S_x = 0.02 \text{ ft/ft}$$

$$T = 8.2 \text{ ft}$$

$$Q = 2.26 \text{ ft}^3/\text{s}$$

$$n = 0.016$$

$$W = 2.0 \text{ ft}$$

$$A = 2.0 \text{ in}$$

$$E_o = 0.70$$

Find: The minimum length of a locally depressed curb-opening inlet required to intercept 100 percent of the gutter flow.

Solution:

Step 1. Compute the composite cross slope for the gutter section using Equation 3-19.

$$S_e = S_x + S'_w E_o$$

$$S_e = 0.02 + \left(\frac{2/12}{0.6}\right)0.60$$

$$S_e = 0.07$$

Step 2. Compute the length of curb-opening inlet required from Equation 3-20.

$$L_T = (0.6)Q^{0.42}S_L^{0.3}\left(\frac{1}{nS_e}\right)^{0.6}$$

$$L_T = (0.6)(2.26)^{0.42}(0.01)^{0.3}\left[\frac{1}{(0.016)(0.07)}\right]^{0.6}$$

$$L_T = 12.5 \text{ ft}$$

3-5.4.2.7 The use of depressed inlets and combination inlets enhances the interception capacity of the inlet. Example 3-6 determined the interception capacity of a depressed

curved vane grate, 2 ft by 2 ft; Examples 3-8a and 3-8b for an undepressed curb-opening inlet with a length of 9.8 ft and a depressed curb-opening inlet with a length of 9.8 ft; and Example 3-10 for a combination of 2 ft by 2 ft depressed curve vane grate located at the downstream end of a 9.8-ft-long depressed curb-opening inlet. The geometries of the inlets and the gutter slopes were consistent in the examples, and Table 3-5 summarizes a comparison of the intercepted flow of the various configurations.

**Table 3-5. Comparison of Inlet Interception Capacities**

Inlet Type	Intercepted Flow, $Q_i$
Curved Vane - Depressed	1.2 ft <sup>3</sup> /s (Example 3-6)
Curb-Opening - Undepressed	1.1 ft <sup>3</sup> /s (Example 3-8a)
Curb-Opening - Depressed	1.59 ft <sup>3</sup> /s (Example 3-8b)
Combination - Depressed	1.76 ft <sup>3</sup> /s (Example 3-10)

Table 3-5 shows that the combination inlet intercepted approximately 100 percent of the total flow whereas the curved vane grate alone intercepted only 66 percent of the total flow. The depressed curb-opening inlet intercepted 90 percent of the total flow; however, if the curb-opening inlet was undepressed, it would have intercepted only 62 percent of the total flow.

**3-5.5 Interception Capacity of Inlets in Sag Locations.** Inlets in sag locations operate as weirs under low head conditions and as orifices at greater depths. Orifice flow begins at depths dependent on the grate size, the curb opening height, or the slot width of the inlet. At depths between those at which weir flow definitely prevails and those at which orifice flow prevails, flow is in a transition stage. At these depths, control is ill-defined and flow may fluctuate between weir and orifice control. Design procedures presented here are based on a conservative approach to estimating the capacity of inlets in sump locations.

The efficiency of inlets in passing debris is critical in sag locations because all runoff that enters the sag must be passed through the inlet. Total or partial clogging of inlets in these locations can result in hazardous ponded conditions. When a clogged inlet can lead to a hazardous condition (i.e., abnormally high depths of water such as at an underpass where there is no other avenue for the water to exit), extra precautions are recommended. Some of these include flanking inlets and combination inlets. Grate inlets alone are not recommended for use in sag locations because of the tendency of grates to become clogged. Combination inlets, flanking inlets, or curb-opening inlets are recommended for use in these locations. More information on flanking inlets can be found in section 3-5.6.3. If the depth of ponding is not hazardous even when the inlet is clogged, additional precautions may not be necessary.

**3-5.5.1 Grate Inlets in Sags.** A grate inlet in a sag location operates as a weir to depths dependent on the size of the grate and as an orifice at greater depths. Grates of

larger dimension will operate as weirs to greater depths than smaller grates. The capacity of grate inlets operating as weirs is:

$$Q_i = C_w P d^{1.5} \quad (3-21)$$

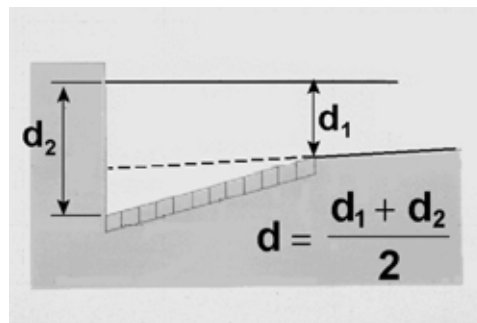
where:

$P$  = perimeter of the grate (ft) disregarding the side against the curb

$C_w$  = weir coefficient, 3.0

$d$  = average depth across the grate;  $0.5 (d_1 + d_2)$ , ft (Figure 3-11)

**Figure 3-11. Definition of Depth**



3-5.5.1.1 The capacity of a grate inlet operating as an orifice is:

$$Q_i = C_o A_g (2gd)^{0.5} \quad (3-22)$$

where:

$C_o$  = orifice coefficient, 0.67

$A_g$  = clear opening area of the grate,  $\text{ft}^2$

$g$  = acceleration due to gravity,  $32.16 \text{ ft/s}^2$

Use of Equation 3-22 requires the clear area of opening of the grate. Tests of three grates for the FHWA showed that for flat bar grates, such as the P-1-7/8 x 4 and P-1-1/8 grates, the clear opening is equal to the total area of the grate less the area occupied by longitudinal and lateral bars. The curved vane grate performed about 10 percent better than a grate with a net opening equal to the total area less the area of the bars projected on a horizontal plane. That is, the projected area of the bars in a curved vane grate is 68 percent of the total area of the grate, leaving a net opening of 32 percent; however, the grate performed as a grate with a net opening of 35 percent. Tilt-bar grates were not tested, but analysis of the results would indicate a net opening area of 34 percent for the 30-degree tilt-bar and zero for the 45-degree tilt-bar grate.

Obviously, the 45-degree tilt-bar grate would have greater than zero capacity. Tilt-bar and curved vane grates are not recommended for sump locations where there is a chance that operation would be as an orifice. Opening ratios for the grates are given on Chart 9 in Appendix B.

3-5.5.1.2 Chart 9 is a plot of Equations 3-21 and 3-22 for various grate sizes. The effects of grate size on the depth at which a grate operates as an orifice is apparent from the chart. Transition from weir to orifice flow results in interception capacity less than that computed by either the weir or the orifice equation. This capacity can be approximated by drawing a curve between the lines representing the perimeter and net area of the grate to be used.

Example 3-9 illustrates use of Equations 3-21 and 3-22 and Chart 9.

Example 3-9

*Given:* Under design storm conditions, a flow to the sag inlet is 6.71 ft<sup>3</sup>/s. Also:

$$S_x = 0.05 \text{ ft/ft}$$

$$n = 0.016$$

$$T_{allowable} = 9.84 \text{ ft}$$

*Find:* The grate size required and depth at curb for the sag inlet assuming 50 percent clogging where the width of the grate,  $W$ , is 2.0 ft.

*Solution:*

Step 1. Determine the required grate perimeter.

Depth at curb,  $d_2$ :

$$d_2 = T S_x = (9.84)(0.05)$$

$$d_2 = 0.49 \text{ ft}$$

Average depth over grate:

$$d = d_2 - \left(\frac{W}{2}\right) S_w$$

$$d = 0.49 - \left(\frac{2.0}{2}\right)(.05)$$

$$d = 0.445 \text{ ft}$$

From Equation 3-26 or Chart 9:

$$P = \frac{Q_i}{[C_w d^{1.5}]}$$

$$P = \frac{(6.71)}{[(3.0)(0.44)^{1.5}]}$$

$$P = 7.66 \text{ ft}$$

Some assumptions must be made regarding the nature of the clogging in order to compute the capacity of a partially clogged grate. If the area of a grate is 50 percent covered by debris so that the debris-covered portion does not contribute to interception, the effective perimeter will be reduced by a lesser amount than 50 percent. For example, if a 2 ft by 4 ft grate is clogged so that the effective width is 1 ft, then the calculation for the perimeter, P, is  $P = 1 + 4 + 1 = 6$  ft, rather than 7.66 ft, the total perimeter, or 3.83 ft, half of the total perimeter. The area of the opening would be reduced by 50 percent and the perimeter by 25 percent. Therefore, assuming 50 percent clogging along the length of the grate, a 4 ft by 4 ft, 2 ft by 6 ft, or a 3 ft by 5 ft grate would meet the requirements of a 7.66 ft perimeter 50 percent clogged.

Assuming 50 percent clogging along the grate length,

$$P_{\text{effective}} = 8.0 = (0.5)(2) W + L$$

$$\text{If } W = 2 \text{ ft, then } L > 5 \text{ ft}$$

$$\text{If } W = 3 \text{ ft, then } L \geq 5 \text{ ft}$$

Select a double 2 ft by 3 ft grate:

$$P_{\text{effective}} = (0.5)(2)(2.0) + (6)$$

$$P_{\text{effective}} = 8 \text{ ft}$$

Step 2. Check the depth of flow at the curb using Equation 3-21 or Chart 9.

$$d = \left[ \frac{Q}{(C_w P)} \right]^{0.67}$$

$$d = \left[ \frac{6.71}{(3.0)(8.0)} \right]^{0.67}$$

$$d = 0.43 \text{ ft}$$

*Conclusion:*

A double 2 ft by 3 ft grate 50 percent clogged is adequate to intercept the design storm flow at a spread that does not exceed design spread; however, the tendency of grate inlets to clog completely warrants consideration of a combination inlet or curb-opening inlet in a sag where ponding can occur, and flanking inlets in long flat vertical curves.

**3-5.5.2 Curb-opening Inlets.** The capacity of a curb-opening inlet in a sag depends on the water depth at the curb, the curb opening length, and the height of the curb opening. The inlet operates as a weir to depths equal to the curb opening height and as an orifice at depths greater than 1.4 times the opening height. At depths between 1.0 and 1.4 times the opening height, flow is in a transition stage.

**3-5.5.2.1** Spread on the pavement is the usual criterion for judging the adequacy of a pavement drainage inlet design. It is also convenient and practical in the laboratory to measure depth at the curb upstream of the inlet at the point of maximum spread on the pavement. Therefore, depth at the curb measurements from experiments coincide with the depth at the curb of interest to designers. The weir coefficient for a curb-opening inlet is less than the usual weir coefficient for several reasons, the most obvious of which is that depth measurements from experimental tests were not taken at the weir, and drawdown occurs between the point where measurements were made and the weir.

**3-5.5.2.2** The weir location for a depressed curb-opening inlet is at the edge of the gutter, and the effective weir length is dependent on the width of the depressed gutter and the length of the curb opening. The weir location for a curb-opening inlet that is not depressed is at the lip of the curb opening, and its length is equal to that of the inlet, as shown in Chart 10 of Appendix B.

**3-5.5.2.3** The equation for the interception capacity of a depressed curb-opening inlet operating as a weir is:

$$Q_i = C_w (L + 1.8 W) d^{1.5} \quad (3-23)$$

where:

$$C_w = 2.3$$

$$L = \text{length of curb opening, ft}$$

$$W = \text{lateral width of depression, ft}$$

$$d = \text{depth at curb measured from the normal cross slope, ft, i.e., } d = T S_x$$

**3-5.5.2.4** The weir equation is applicable to depths at the curb approximately equal to the height of the opening plus the depth of the depression. Thus, the limitation on the use of Equation 3-23 for a depressed curb-opening inlet is:

$$d \leq h + \frac{a}{12} \quad (3-24)$$

where:

$h$  = height of curb-opening inlet, ft

$a$  = depth of depression, in.

3-5.5.2.5 Experiments have not been conducted for curb-opening inlets with a continuously depressed gutter, but it is reasonable to expect that the effective weir length would be as great as that for an inlet in a local depression. Use of Equation 3-23 will yield conservative estimates of the interception capacity.

3-5.5.2.6 The weir equation for curb-opening inlets without depression becomes:

$$Q_i = C_w L d^{1.5} \quad (3-25)$$

Without depression of the gutter section, the weir coefficient,  $C_w$ , becomes 3.0. The depth limitation for operation as a weir becomes  $d \leq h$ .

3-5.5.2.7 At curb-opening lengths greater than 12 ft, Equation 3-25 for non-depressed inlets produces intercepted flows that exceed the values for depressed inlets computed using Equation 3-23. Since depressed inlets will perform at least as well as non-depressed inlets of the same length, Equation 3-25 should be used for all curb-opening inlets with lengths greater than 12 ft.

3-5.5.2.8 Curb-opening inlets operate as orifices at depths greater than approximately 1.4 times the opening height. The interception capacity can be computed by Equation 3-26a and Equation 3-26b. These equations are applicable to depressed and undepressed curb-opening inlets. The depth at the inlet includes any gutter depression.

$$Q_i = C_o h L (2 g d_o)^{0.5} \quad (3-26a)$$

or

$$Q_i = C_o A_g \left[ 2g \left( d_i - \frac{h}{2} \right) \right]^{0.5} \quad (3-26b)$$

where:

$C_o$  = orifice coefficient (0.67)

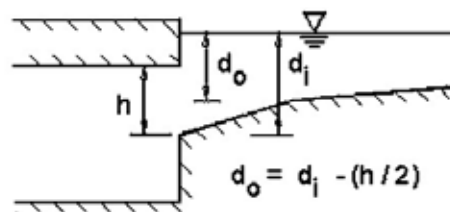
$d_o$  = effective head on the center of the orifice throat, ft

$L$  = length of orifice opening, ft

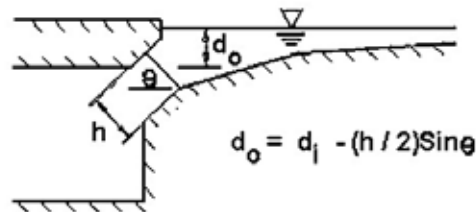
- $A_g$  = clear area of opening, ft<sup>2</sup>
- $d_i$  = depth at lip of curb opening, ft
- $h$  = height of curb-opening orifice, ft

The height of the orifice in Equation 3-26a and Equation 3-26b assumes a vertical orifice opening. As illustrated in Figure 3-12, other orifice throat locations can change the effective depth on the orifice and the dimension ( $d_i - h/2$ ). A limited throat width could reduce the capacity of the curb-opening inlet by causing the inlet to go into orifice flow at depths less than the height of the opening.

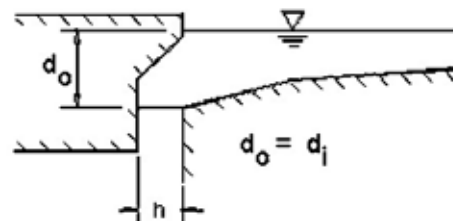
**Figure 3-12. Curb-opening Inlets**



**a. Horizontal Throat**



**b. Inclined Throat**



**c. Vertical Throat**



3-5.5.2.9 For curb-opening inlets with other than vertical faces (see Figure 3-12), Equation 3-26a can be used with:

$$h = \text{orifice throat width, ft}$$

$$d_o = \text{effective head on the center of the orifice throat, ft}$$

Chart 10 provides solutions for Equation 3-23 and Equation 3-26 for depressed curb-opening inlets, and Chart 11 provides solutions for Equation 3-25 and Equation 3-26 for curb-opening inlets without depression. Chart 12 is provided for use for curb openings with other than vertical orifice openings. Example 3-10 illustrates the use of Chart 11 and Chart 12.

#### Example 3-10

*Given:* Curb-opening inlet in a sump location with:

$$L = 8.2 \text{ ft}$$

$$h = 0.432 \text{ ft}$$

(1) Undepressed curb opening:

$$S_x = 0.02$$

$$T = 8.2 \text{ ft}$$

(2) Depressed curb opening:

$$S_x = 0.02$$

$$a = 1$$

$$W = 2 \text{ ft}$$

$$T = 8.2 \text{ ft}$$

*Find:*  $Q_i$

*Solution (1): Undepressed*

Step 1. Determine the depth at curb.

$$d = T S_x = (8.2)(0.02)$$

$$d = 0.16 \text{ ft}$$

$$d = 0.16 \text{ ft} \leq h = 0.43 \text{ ft, therefore weir flow controls}$$

Step 2. Use Equation 3-25 or Chart 11 to find  $Q_i$ .

$$Q_i = C_w L d^{1.5}$$

$$\begin{aligned} Q_i &= (3.0)(8.2)(0.16)^{1.5} \\ &= 1.6 \text{ ft}^3/\text{s} \end{aligned}$$

*Solution (2): Depressed*

Step 1. Determine the depth at curb,  $d_i$ .

$$d_i = d + a$$

$$d_i = S_x T + a$$

$$d_i = (0.02)(8.2) + 1/12$$

$$d_i = 0.25 \text{ ft}$$

$$d_i = 0.25 \text{ ft} < h = 0.43 \text{ ft, therefore weir flow controls}$$

Step 2. Determine the efficiency of the curb opening.

$$P = L + 1.8 W$$

$$P = 8.2 + (1.8)(2.0)$$

$$P = 11.8 \text{ ft}$$

$$Q_i = C_w (L + 1.8 W) d^{1.5}$$

$$\begin{aligned} Q_i &= (2.3)(11.8)(0.16)^{1.5} \\ &= 1.7 \text{ ft}^3/\text{s} \end{aligned}$$

The depressed curb-opening inlet has 10 percent more capacity than an inlet without depression.

**3-5.6 Inlet Locations.** The location of inlets is determined by geometric controls that require inlets at specific locations, the use and location of flanking inlets in sag vertical curves, and the criterion of spread on the pavement. In order to adequately design the location of the inlets for a given project, specific information is needed:

- A layout or plan sheet suitable for outlining drainage areas
- Road or runway profiles
- Typical cross sections

- Grading cross sections
- Superelevation diagrams
- Contour maps

3-5.6.1 **Geometric Controls.** In a number of locations, inlets may be necessary with little regard to the contributing drainage area. These locations should be marked on the plans prior to any computations regarding discharge, water spread, inlet capacity, or flow bypass. These are examples of such locations:

- At all low points in the gutter grade
- Immediately upstream of median breaks, entrance/exit ramp gores, cross walks, and street intersections, i.e., at any location where water could flow onto the travelway
- Immediately up grade of bridges (to prevent pavement drainage from flowing onto bridge decks)
- Immediately downstream of bridges (to intercept bridge deck drainage)
- Immediately up grade of cross slope reversals
- Immediately up grade from pedestrian cross walks
- At the end of channels in cut sections
- On side streets immediately up grade from intersections
- Behind curbs, shoulders, or sidewalks to drain low areas

In addition to these areas, runoff from areas draining towards the pavement should be intercepted by roadside channels or inlets before it reaches the roadway. This applies to drainage from cut slopes, side streets, and other areas alongside the pavement. Curbed pavement sections and pavement drainage inlets are inefficient means for handling extraneous drainage.

3-5.6.2 **Inlet Spacing on Continuous Grades.** Design spread is the criterion used for locating storm drain inlets between those required by geometric or other controls. The interception capacity of the upstream inlet will define the initial spread. As flow is contributed to the gutter section in the downstream direction, spread increases. The next downstream inlet is located at the point where the spread in the gutter reaches the design spread. Therefore, the spacing of inlets on a continuous grade is a function of the amount of upstream bypass flow, the tributary drainage area, and the gutter geometry.

3-5.6.2.1 For a continuous slope, the designer may establish the uniform design spacing between inlets of a given design if the drainage area consists of pavement only

or has reasonably uniform runoff characteristics and is rectangular in shape. In this case, the time of concentration is assumed to be the same for all inlets. The following procedure and example illustrate the effects of inlet efficiency on inlet spacing.

3-5.6.2.2 In order to design the location of inlets on a continuous grade, the computation sheet shown in Figure 3-13 may be used to document the analysis. A step-by-step procedure for the use of Figure 3-13 follows.

- Step 1. Complete the blanks at the top of the sheet to identify the job by state project number, route, date, and your initials.
- Step 2. Mark on a plan the location of inlets that are necessary even without considering any specific drainage area, such as the locations described in section 3-5.6.1.
- Step 3. Start at a high point, at one end of the job if possible, and work towards the low point. Then begin at the next high point and work backwards toward the same low point.
- Step 4. To begin the process, select a trial drainage area approximately 300 to 500 ft long below the high point and outline the area on the plan. Include any area that may drain over the curb, onto the roadway. However, where practical, drainage from large areas behind the curb should be intercepted before it reaches the roadway or gutter.
- Step 5. Col. 1 Describe the location of the proposed inlet by number (col. 1) and station (col. 2) and record this.  
Col. 2 Information in columns 1 and 2. Identify the curb and gutter type in Column 19.  
Col. 19 Remarks. A sketch of the cross section should be prepared.
- Step 6. Col. 3 Compute the drainage area (acres) outlined in Step 4 and record in Column 3.
- Step 7. Col. 4 Determine the runoff coefficient,  $C$ , for the drainage area. Select a  $C$  value provided in Table 2-1 or determine a weighted  $C$  value using Equation 3-2 and record the value in Column 4.
- Step 8. Col. 5 Compute the time of concentration,  $t_c$ , in minutes, for the first inlet and record it in Column 5. The  $t_c$  is the amount of time it takes for the water to flow from the most hydraulically remote point of the drainage area to the inlet, as discussed in Chapter 2. The minimum  $t_c$  is 5 minutes.

Figure 3-13. Inlet Spacing Computation Sheet

INLET SPACING COMPUTATION SHEET														Date _____ SP _____ ROUTE _____		Computed By: _____ Sheet __ of __		
INLET		GUTTER DISCHARGE Design Frequency _____					GUTTER DISCHARGE Allowable Spread _____						INLET DISCHARGE			RMK		
No.	Stat.	Drain. Area A ( ) (3)	Run-off Coeff. C (4)	Time of Conc. $t_c$ (min) (5)	Rain. Inten. I ( /hr) (6)	Q = CIA/K <sub>s</sub> ( <sup>3</sup> /s) (7)	Long. Slope S <sub>L</sub> ( / ) (8)	Cross Slope S <sub>i</sub> or S <sub>w</sub> ( / ) (9)	Prev. By-pass Flow ( <sup>3</sup> /s) (10)	Total Gutter Flow ( <sup>3</sup> /s) (11)	Depth d ( ) (12)	Grate or Gutter Width W ( ) (13)	Spread T ( ) (14)	W/T (15)	Inlet Type (16)	Intercept Flow Q <sub>i</sub> ( <sup>3</sup> /s) (17)	By-pass Flow Q <sub>b</sub> ( <sup>3</sup> /s) (18)	(19)

**UFC 3-230-01**  
**8/1/2006**

**AC 150/5320-5C**  
**9/29/2006**

- Step 9. Col. 6 Using the time of concentration,  $t_c$ , determine the rainfall intensity from the IDF curve for the design frequency. Enter the value in Column 6.
- Step 10. Col. 7 Calculate the flow in the gutter using Equation 3-1,  $Q = C/A$ . The flow is calculated by multiplying Column 3 times Column 4 times Column 6. Enter the flow value in Column 7.
- Step 11. Col. 8 From the roadway profile, enter in Column 8 the gutter longitudinal slope,  $S_L$ , at the inlet, taking into account any superelevation.
- Step 12. Col. 9 From the cross section, enter the cross slope,  $S_x$ , in Column 9 and the grate or gutter width,  $W$ , in Column 13.
- Step 13. Col. 11 For the first inlet in a series, enter the value from Column 7 into Column 11 since there was no previous bypass flow. Additionally, if the inlet is the first in a series, enter 0 into Column 10.
- Step 14. Col. 14 Determine the spread,  $T$ , by using Equations 3-2 and 3-4 or Chart 1 and Chart 2 and enter the value in Column 14. Also, determine the depth at the curb,  $d$ , by multiplying the spread by the appropriate cross slope, and enter the value in Column 12. Compare the calculated spread with the allowable spread as determined by the design criteria outlined in section 3.2. Additionally, compare the depth at the curb with the actual curb height in Column 19. If the calculated spread, Column 14, is near the allowable spread and the depth at the curb is less than the actual curb height, continue on to Step 15. Otherwise, expand or decrease the drainage area up to the first inlet to increase or decrease the spread, respectively. The drainage area can be expanded by increasing the length to the inlet, and it can be decreased by decreasing the distance to the inlet. Then, repeat Steps 6 through 14 until you obtain the appropriate values.
- Step 15. Col. 15 Calculate  $W/T$  and enter the value in Column 15.
- Step 16. Col. 16 Select the inlet type and dimensions and enter the values in Column 16.
- Step 17. Col. 17 Calculate the flow intercepted by the grate,  $Q_i$ , and enter the value in Column 17. Use Equations 3-11 and 3-8 or Chart 2 and Chart 4 to define the gutter flow. Use Chart 5 and Equation 3-14 or Chart 6 to define the flow intercepted by the grate. Use Equations 3-17 and 3-18 or Chart 7 and Chart 8 for curb-opening inlets. Finally, use Equation 3-16 to determine the intercepted flow.

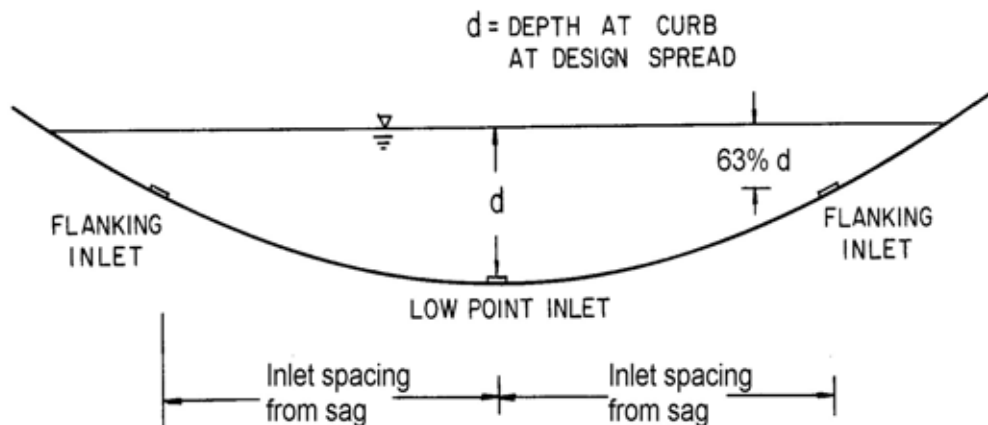
- Step 18. Col. 18 Determine the bypass flow,  $Q_b$ , and enter it into Column 18. The bypass flow is Column 11 minus Column 17.
- Step 19. Col. 1-4 Proceed to the next inlet down the grade. To begin the procedure, select a drainage area approximately 300 to 400 ft below the previous inlet for a first trial. Repeat Steps 5 through 7 considering only the area between the inlets.
- Step 20. Col. 5 Compute the time of concentration,  $t_c$ , for the next inlet based upon the area between the consecutive inlets and record this value in Column 5.
- Step 21. Col. 6 Determine the rainfall intensity from the IDF curve based on the time of concentration,  $t_c$ , determined in Step 20 and record the value in Column 6.
- Step 22. Col. 7 Determine the flow in the gutter by using Equation 3-1 and record the value in Column 7.
- Step 23. Col. 11 Record the value from Column 18 of the previous line into Column 10 of the current line. Determine the total gutter flow by adding Column 7 and Column 10 and record the value in Column 11.
- Step 24. Col. 12 Determine the spread and the depth at the curb as outlined in Step 14. Repeat Steps 18 through 24 until the spread and the depth at the curb are within the design criteria.
- Step 25. Col. 16 Select the inlet type and record it in Column 16.
- Step 26. Col. 17 Determine the intercepted flow in accordance with Step 17.
- Step 27. Col. 18 Calculate the bypass flow by subtracting Column 17 from Column 11. This completes the spacing design for the inlet.
- Step 28. Repeat Steps 19 through 27 for each subsequent inlet down to the low point. HEC-22 provides an example that illustrates the use of this procedure and Figure 3-13.

For inlet spacing in areas with changing grades, the spacing will vary as the grade changes. If the grade becomes flatter, inlets may be spaced at closer intervals because the spread will exceed the allowable spread. Conversely, for an increase in slope, the inlet spacing will become longer because of increased capacity in the gutter sections. Additionally, individual transportation agencies may limit spacing due to maintenance constraints.



3-5.6.3 **Flanking Inlets.** As explained in section 3-5.6.2, inlets should always be located at the low or sag points in the gutter profile. In addition, it is good engineering practice to place flanking inlets on each side of the low point inlet when in a depressed area that has no outlet except through the system. This is illustrated in Figure 3-14. The purpose of the flanking inlets is to act in relief of the inlet at the low point if it should become clogged or if the design spread is exceeded. For a complete explanation of the application of flanking inlets, see section 3-5.5. To summarize, flanking inlets should be used when the runoff entering the sag has only one exit location, i.e., the inlet in the bottom of the sag and the depth of ponding caused by clogging at the low point would cause a hazardous condition. An example would be a sag at an underpass. If the depth of ponding does not become too great and the runoff can exit over the curb, then flanking inlets may not be necessary.

**Figure 3-14. Example of Flanking Inlets**



Example 3-11

*Given:* A 500-ft (L) sag vertical curve at an underpass on a 4-lane divided highway with begin and end slopes of -2.5 percent and +2.5 percent respectively. The spread at design Q is not to exceed the shoulder width of 9.8 ft.

$$S_x = 0.02$$

*Find:* The location of the flanking inlets if located to function in relief of the inlet at the low point when the inlet at the low point is clogged.

*Solution:*

Step 1. Find the rate of vertical curvatures, *K*.

$$K = \frac{L}{(S_{end} - S_{beginning})}$$

$$K = \frac{500\text{ft}}{(2.5\% - (-2.5\%))}$$

$$K = 100 \text{ ft}$$

Step 2. Determine the depth at the curb at the design spread.

$$d = S_x T = (0.02)(9.84)$$

$$d = 0.2 \text{ ft}$$

Step 3. Determine the depth for the flanker locations.

$$d = \begin{array}{l} \text{63 percent of depth over the inlet at the bottom of the sag (see} \\ \text{Figure 3-14)} \end{array}$$

$$= 0.63 (0.2)$$

$$= 0.13 \text{ ft}$$

Step 4. For use with Table 3-6:

$$d = 0.20 - 0.13 = 0.07 \text{ ft}$$

$$X = \text{distance from sag point, } (200dK)^{0.5}$$

$$= \{(200)(0.07)(100)\}^{0.5}$$

$$= 37.4 \text{ ft}$$

The inlet spacing is 37.4 ft from the sag point.

3-5.6.3.1 Flanking inlets can be located so they will function before water spread exceeds the allowable spread at the sump location. The flanking inlets should be located so that they will receive all of the flow when the primary inlet at the bottom of the sag is clogged. They should do this without exceeding the allowable spread at the bottom of the sag. If the flanking inlets are the same dimension as the primary inlet, they will each intercept one-half the design flow when they are located so that the depth of ponding at the flanking inlets is 63 percent of the depth of ponding at the low point. If the flanking inlets are not the same size as the primary inlet, it will be necessary to either develop a new factor or do a trial and error solution using assumed depths with the weir equation to determine the capacity of the flanking inlet at the given depths.

3-5.6.3.2 Table 3-6 shows the spacing required for various depth at curb criteria and vertical curve lengths defined by  $K = L / (G_2 - G_1)$ , where  $L$  is the length of the vertical curve in feet and  $G_1$  and  $G_2$  are the approach grades in percent. The AASHTO policy on geometrics specifies maximum  $K$  values for various design speeds and a maximum  $K$  of 167 considering drainage. The use of Table 3-6 is illustrated in Example 3-11.

**Table 3-6. Distance to Flanking Inlets in a Sag Vertical Curve  
Using Depth at Curb Criteria**

d (ft)	K (ft/percent)									
	20	30	40	50	70	90	110	130	160	167
0.1	20	24	28	32	37	42	47	51	57	58
0.2	28	35	40	45	53	60	66	72	80	82
0.3	35	42	49	55	65	73	81	88	98	100
0.4	40	49	57	63	75	85	94	102	113	116
0.5	45	55	63	71	84	95	105	114	126	129
0.6	49	60	69	77	92	104	115	125	139	142
0.7	53	65	75	84	99	112	124	135	150	153
0.8	57	69	80	89	106	120	133	144	160	163

NOTES: 1.  $X = (200dK)^{0.5}$ , where X = distance from sag point  
2.  $d = Y - Y_f$ , where Y = depth of ponding and  $Y_f$  = depth at the flanker inlet  
3. Drainage maximum K = 167

3-5.6.3.3 Example problem solutions in section 3-5.5 illustrate the total interception capacity of inlets in sag locations. Except where inlets become clogged, spread on low gradient approaches to the low point is a more stringent criterion for design than the interception capacity of the sag inlet. AASHTO recommends that a gradient of 0.3 percent be maintained within 50 ft of the level point in order to provide for adequate drainage. It is considered advisable to use spread on the pavement at a gradient comparable to that recommended by the AASHTO Committee on Design to evaluate the location and excessive spread in the sag curve. Standard inlet locations may need to be adjusted to avoid excessive spread in the sag curve. Inlets may be needed between the flankers and the ends of the curves also. For major sag points, the flanking inlets are added as a safety factor, and are not considered as intercepting flow to reduce the bypass flow to the sag point. They are installed to assist the sag point inlet in the event of clogging.

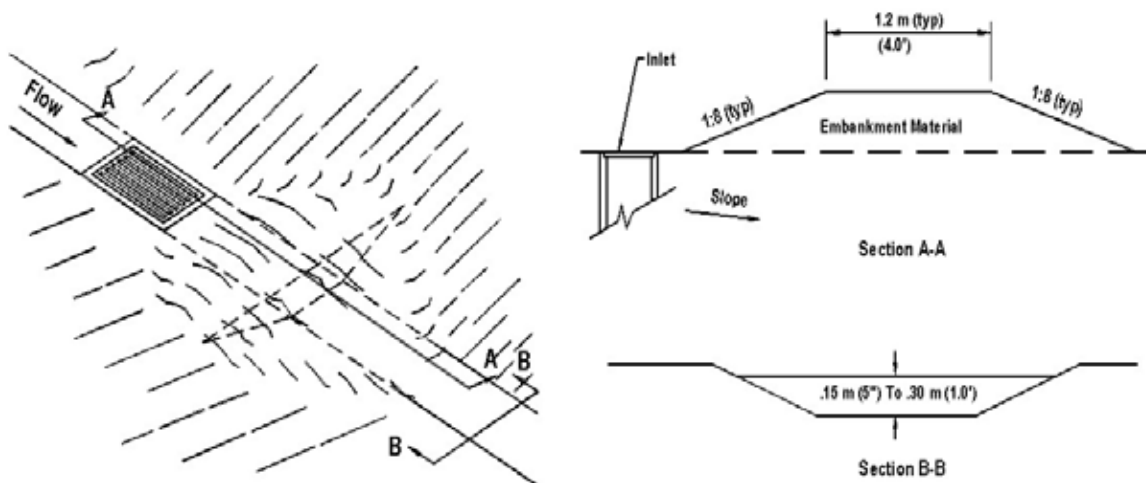
**3-5.7 Median, Embankment, and Bridge Inlets.** Flow in median and roadside ditches is discussed briefly in Chapter 5 and in the FHWA's HEC-15 and HDS-4. It is sometimes necessary to place inlets in medians at intervals to remove water that could cause erosion. Inlets are sometimes used in roadside ditches at the intersection of cut and fill slopes to prevent erosion downstream of cut sections.

Where adequate vegetative cover can be established on embankment slopes to prevent erosion, it is preferable to allow storm water to discharge down the slope with as little concentration of flow as practicable. Where storm water must be collected with curbs or swales, inlets are used to receive the water and discharge it through chutes, sod or riprap swales, or pipe downdrains.

Bridge deck drainage is similar to roadway drainage, and deck drainage inlets are similar in purpose to roadway inlets.

**3-5.7.1 Median and Roadside Ditch Inlets.** Median and roadside ditches may be drained by drop inlets similar to those used for pavement drainage, by pipe culverts under one roadway, or by cross drainage culverts that are not continuous across the median. Figure 3-15 illustrates a traffic-safe median inlet. Inlets, pipes, and discontinuous cross drainage culverts should be designed not to detract from a safe roadside. Drop inlets should be flush with the ditch bottom, and traffic-safe bar grates should be placed on the ends of pipes used to drain medians that would be a hazard to errant vehicles, although this may cause a plugging potential. Cross-drainage structures should be continuous across the median unless the median width makes this impractical.

**Figure 3-15. Median Drop Inlet**



**3-5.7.1.1** Ditches tend to erode at drop inlets; paving around the inlets helps to prevent erosion and may increase the interception capacity of the inlet marginally by acceleration of the flow.

**3-5.7.1.2** Pipe drains for medians operate as culverts and generally require more water depth to intercept median flow than drop inlets. No test results are available on which to base design procedures for estimating the effects of placing grates on culvert inlets; however, little effect is expected.

**3-5.7.1.3** The interception capacity of drop inlets in median ditches on continuous grades can be estimated by use of Chart 14 and Chart 15 in Appendix B to estimate flow depth and the ratio of frontal flow to total flow in the ditch.

3-5.7.1.4 Chart 14 is the solution to Manning's equation for channels of various side slopes. Manning's equation for open channels is:

$$Q = \frac{1.486}{n} AR^{0.67} S_L^{0.5} \quad (3-27)$$

where:

$Q$  = discharge rate, ft<sup>3</sup>/s

$n$  = hydraulic resistance variable

$A$  = cross-sectional area of flow, ft<sup>2</sup>

$R$  = hydraulic radius = area/wetted perimeter, ft

$S_L$  = bed slope, ft/ft

3-5.7.1.5 For the trapezoidal channel cross section shown on Chart 14, Manning's equation becomes:

$$Q = \frac{1.486}{n} (B + zd^2) \left( \frac{B + zd^2}{B + 2d\sqrt{z^2 + 1}} \right)^{0.67} S_L^{0.5} \quad (3-28)$$

where:

$B$  = bottom width, ft

$z$  = horizontal distance of the side slope to a rise of 1 ft vertical, ft

Equation 3-28 is a trial and error solution to Chart 14.

3-5.7.1.6 Chart 15 is the ratio of frontal flow to total flow in a trapezoidal channel. This is expressed as:

$$E_o = \frac{W}{(B + dz)} \quad (3-29)$$

3-5.7.1.7 Chart 5 and Chart 6 are used to estimate the ratios of frontal and side flow intercepted by the grate-to-total flow.

3-5.7.1.8 Small dikes downstream of drop inlets (Figure 3-15) can be provided to impede bypass flow in an attempt to cause complete interception of the approach flow. The dikes usually need not be more than a few inches high and should have traffic safe slopes. The height of dike required for complete interception on continuous grades or the depth of ponding in sag vertical curves can be computed by use of Chart 9. The effective perimeter of a grate in an open channel with a dike should be taken as

$2(L + W)$  since one side of the grate is not adjacent to a curb. Use of Chart 9 is illustrated in section 3-5.5.1.2.

3-5.7.1.9 The following examples illustrate the use of Chart 14 and Chart 15 for drop inlets in ditches on continuous grade.

Example 3-12

*Given:* A median ditch with these characteristics:

$$B = 3.9 \text{ ft}$$

$$n = 0.03$$

$$z = 6$$

$$S = 0.02$$

The flow in the median ditch is to be intercepted by a drop inlet with a 2 ft by 2 ft P-50 parallel bar grate; there is no dike downstream of the inlet.

$$Q = 9.9 \text{ ft}^3/\text{s}$$

*Find:* The intercepted and bypassed flows ( $Q_i$  and  $Q_b$ )

*Solution:*

Step 1. Compute the ratio of frontal to total flow in a trapezoidal channel.

$$Q_n = (9.9)(0.03)$$

$$Q_n = 0.30 \text{ ft}^3/\text{s}$$

From Chart 13:

$$\frac{d}{B} = 0.12$$

$$d = (B) \left( \frac{d}{B} \right)$$

$$= (0.12)(3.9)$$

$$= 0.467 \text{ ft}$$

Using Equation 3-29 or Chart 15:

$$\begin{aligned} E_o &= \frac{W}{(B + dz)} \\ &= \frac{2.0}{[3.9 + (0.47)(6)]} \\ &= 0.30 \end{aligned}$$

Step 2. Compute the frontal flow efficiency.

$$\begin{aligned} V &= \frac{Q}{A} \\ A &= (0.47)[(6)(0.47) + 3.9] \\ A &= 3.18 \text{ ft}^2 \\ V &= \frac{9.9}{3.18} \\ &= 3.11 \text{ ft/s} \end{aligned}$$

From Chart 5,  $R_f = 1.0$

Step 3. Compute the side flow efficiency.

Since the ditch bottom is wider than the grate and has no cross slope, use the least cross slope available on Chart 6 or use Equation 3-14 to solve for  $R_s$ .

Using Equation 3-14 or Chart 6:

$$\begin{aligned} R_s &= \frac{1}{\left(1 + \frac{0.15V^{1.8}}{S_x L^{2.3}}\right)} \\ R_s &= \frac{1}{\left(1 + \frac{(0.15)(3.11)^{1.8}}{(0.01)(2.0)^{2.3}}\right)} \\ &= 0.04 \end{aligned}$$

Step 4. Compute the total efficiency.

$$\begin{aligned} E &= E_o R_f + R_s (1 - E_o) \\ E &= (0.30)(1.0) + (0.04)(1 - 0.30) \end{aligned}$$

$$= 0.33$$

Step 5. Compute the interception and bypass flow.

$$Q_i = E Q$$

$$Q_i = (0.33)(9.9)$$

$$Q_i = 3.27 \text{ ft}^3/\text{s}$$

$$Q_b = Q - Q_i$$

$$Q_b = (9.9) - (3.27)$$

$$Q_b = 6.63 \text{ ft}^3/\text{s}$$

In the above example, a P-1-7/8 inlet would intercept about 33 percent of the flow in a 3.9-ft bottom ditch on a continuous grade.

For grate widths equal to the bottom width of the ditch, use Chart 6 by substituting ditch side slopes for values of  $S_x$ , as illustrated in Example 3-13.

### Example 3-13

*Given:* A median ditch with these characteristics:

$$Q = 9.9 \text{ ft}^3/\text{s}$$

$$W = 2 \text{ ft}$$

$$z = 6$$

$$S = 0.03 \text{ ft/ft}$$

$$B = 2 \text{ ft}$$

$$n = 0.03$$

$$S_x = 0.17 \text{ ft/ft}$$

The flow in the median ditch is to be intercepted by a drop inlet with a 2 ft by 2 ft P-1-7/8 parallel bar grate. There is no dike downstream of the inlet.

*Find:* The intercepted and bypassed flows ( $Q_i$  and  $Q_b$ ).

*Solution:*

Step 1. Compute the ratio of frontal to total flow in a trapezoidal channel.

$$Q_n = (9.9)(0.03)$$



$$Q_n = 0.30 \text{ ft}^3/\text{s}$$

From Chart 14:

$$\frac{d}{B} = 0.25$$

$$\begin{aligned} d &= (0.25)(2.0) \\ &= 0.50 \text{ ft} \end{aligned}$$

Using Equation 3-29 or Chart 15:

$$\begin{aligned} E_o &= \frac{W}{(B + dz)} \\ &= \frac{2.0}{[2.0 + (0.5)(6)]} \\ &= 0.40 \end{aligned}$$

Step 2. Compute the frontal flow efficiency.

$$V = \frac{Q}{A}$$

$$A = (0.5)[(6)(0.5) + 2.0]$$

$$A = 2.5 \text{ ft}^2$$

$$V = \frac{9.9}{2.5}$$

$$= 4.0 \text{ ft/s}$$

From Chart 5,  $R_f = 1.0$

Step 3. Compute the side flow efficiency.

Using Equation 3-14 or Chart 6:

$$R_s = \frac{1}{\left(1 + \frac{0.15V^{1.8}}{S_x L^{2.3}}\right)}$$

$$R_s = \frac{1}{\left(1 + \frac{(0.15)(4.0)^{1.8}}{(0.17)(2.0)^{2.3}}\right)}$$
$$= 0.32$$

Step 4. Compute the total efficiency.

$$E = E_o R_f + R_s(1 - E_o)$$
$$E = (0.40)(1.0) + (0.32)(1 - 0.40)$$
$$= 0.59$$

Step 5. Compute the interception and bypass flow.

$$Q_i = E Q$$
$$Q_i = (0.59)(9.9)$$
$$Q_i = 5.83 \text{ ft}^3/\text{s}$$
$$Q_b = Q - Q_i$$
$$Q_b = (9.9) - (5.83)$$
$$Q_b = 4.07 \text{ ft}^3/\text{s}$$

The height of dike downstream of a drop inlet required for total interception is illustrated by Example 3-14.

#### Example 3-14

*Given:* Data from Example 3-13.

*Find:* The required height of a berm to be located downstream of the grate inlet to cause total interception of the ditch flow.

Solution:

$$P = 2(L + W)$$
$$P = 2(2.0 + 2.0)$$
$$= 8.0 \text{ ft}$$

Using Equation 3-21 or Chart 9:

$$d = \left[ \frac{Q_i}{(C_w P)} \right]^{0.67}$$

$$d = \left[ \frac{(9.9)}{\{(3.0)(8.0)\}} \right]^{0.67}$$

$$d = 0.55 \text{ ft}$$

A dike will need to have a minimum height of 0.55 ft for total interception. Due to the initial velocity of the water that may provide adequate momentum to carry the flow over the dike, an additional 0.5 ft may be added to the height of the dike to ensure complete interception of the flow.

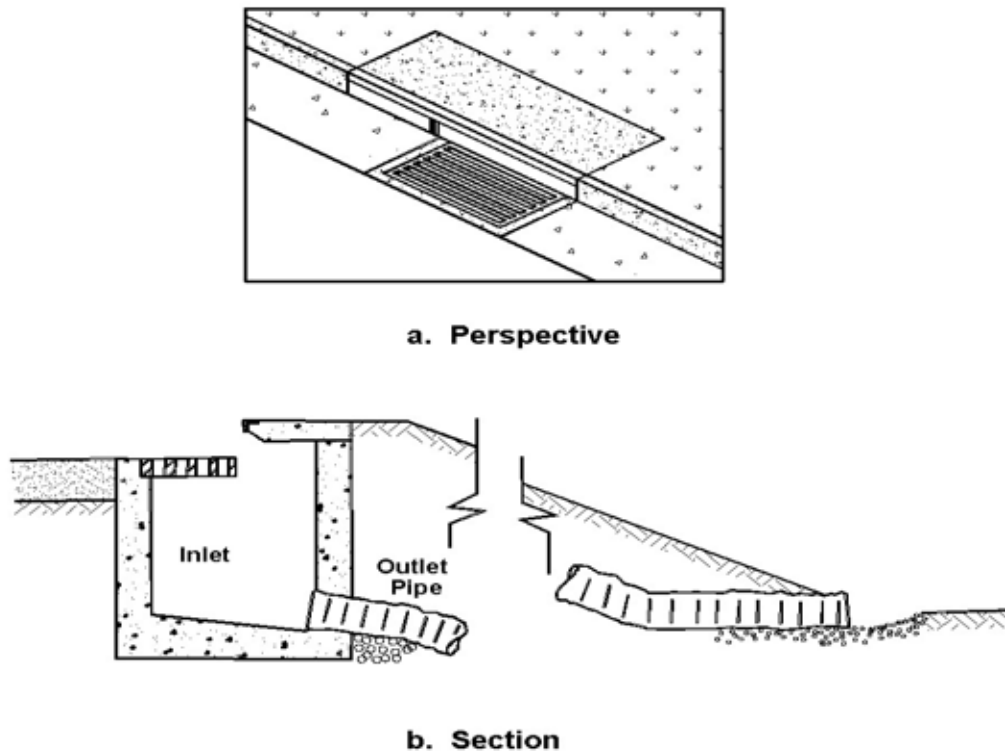
**3-5.7.2 Embankment Inlets.** Drainage inlets are often needed to collect runoff from pavements in order to prevent erosion of fill slopes or to intercept water upgrade or downgrade of bridges. Inlets used at these locations differ from other pavement drainage inlets in three respects. First, the economies that can be achieved by system design are often not possible because a series of inlets is not used; second, total or near total interception is sometimes necessary in order to limit the bypass flow from running onto a bridge deck; and third, a closed storm drainage system is often not available to dispose of the intercepted flow, and the means for disposal must be provided at each inlet. Intercepted flow is usually discharged into open chutes or pipe downdrains that terminate at the toe of the fill slope.

**3-5.7.2.1** Example problem solutions in other sections of this UFC illustrate by inference the difficulty in providing for near total interception on grade. Grate inlets intercept little more than the flow conveyed by the gutter width occupied by the grate. Combination curb-opening and grate inlets can be designed to intercept total flow if the length of curb opening upstream of the grate is sufficient to reduce spread in the gutter to the width of the grate used. Depressing the curb opening would significantly reduce the length of inlet required. Perhaps the most practical inlets or procedure for use where near total interception is necessary are sweeper inlets, increase in grate width, and slotted inlets of sufficient length to intercept 85 to 100 percent of the gutter flow. Design charts and procedures in section 3-5.4 are applicable to the design of inlets on embankments. Figure 3-16 illustrates a combination inlet and downdrain.

**3-5.7.2.2** Downdrains or chutes used to convey intercepted flow from inlets to the toe of the fill slope may be open or closed chutes. Pipe downdrains are preferable because the flow is confined and cannot cause erosion along the sides. Pipes can be covered to reduce or eliminate interference with maintenance operations on the fill slopes. Open chutes are often damaged by erosion from water splashing over the sides of the chute due to oscillation in the flow and from spill over the sides at bends in the chute. Erosion at the ends of downdrains or chutes can be a problem if not anticipated. The end of the device may be placed low enough to prevent damage by undercutting due to erosion.

Well-graded gravel or rock can be used to control the potential for erosion at the outlet of the structure; however, some transportation agencies install an elbow or a "tee" at the end of the downdrains to redirect the flow and prevent erosion. See the FHWA's HEC-14 for additional information on energy dissipator designs.

**Figure 3-16. Embankment Inlet and Downdrain**



3-6 **GRATE TYPE SELECTION CONSIDERATIONS.** Grate type selection should consider such factors as hydraulic efficiency, debris handling characteristics, pedestrian and bicycle safety, and loading conditions. Relative costs will also influence grate type selection.

3-6.1 Charts 5, 6, and 9 illustrate the relative hydraulic efficiencies of the various grate types explained here. The parallel bar grate (P-1-7/8) is hydraulically superior to all others but is not considered bicycle safe. The curved vane and the P-1-1/8 grates have good hydraulic characteristics with high velocity flows. The other grates tested are hydraulically effective at lower velocities.

3-6.2 Debris-handling capabilities of various grates are reflected in Table 3-3. The table shows a clear difference in efficiency between the grates with the 3.25-in. longitudinal bar spacing and those with smaller spacings. The efficiencies shown in the table are suitable for comparisons between the grate designs tested, but should not be taken as an indication of field performance since the testing procedure used did not

simulate actual field conditions. Some local transportation agencies have developed factors for use of debris-handling characteristics with specific inlet configurations.

3-6.3 Table 3-7 ranks grate styles according to relative bicycle and pedestrian safety. The bicycle safety ratings were based on a subjective test program performed by the FHWA; however, all the grates are considered bicycle and pedestrian safe except the P-1-7/8. In recent years with the introduction of very narrow racing bicycle tires, some concern has been expressed about the P-1-1/8 grate. Exercise caution when using it in bicycle areas.

3-6.4 Grate loading conditions must also be considered when determining an appropriate grate type. Grates in traffic areas must be able to withstand traffic loads; conversely, grates draining yard areas usually do not need to be as rigid.

**Table 3-7. Grate Ranking with Respect to Bicycle and Pedestrian Safety**

Rank	Grate Style
1	P-1-7/8 x 4
2	Reticuline
3	P-1-1/8
4	45° - 3-1/4 Tilt Bar
5	45° - 2-1/4 Tilt Bar
6	Curved Vane
7	30° - 3-1/4 Tilt Bar

## CHAPTER 4

### CULVERT DESIGN

4-1 **PURPOSE.** This chapter discusses the hydraulic design of culverts. Though it is fairly easy to perform culvert design using the charts and nomographs from this chapter, it is still highly recommended that the designer obtain a copy of the FHWA's HY-8 culvert analysis software from the FHWA Web site. The HY-8 program is easy and quick to use and provides accurate answers using the equations shown on the charts and nomographs.

A drainage culvert is defined as any structure under a pavement with a clear opening of 20 feet or less measured along the center of the pavement. Culverts are used to convey flow through an embankment or past some other type of flow obstruction. Culverts are constructed from a variety of materials and are available in many different shapes and configurations. Culvert hydraulics and diagrams, charts, coefficients, and related information useful in the design of culverts are shown later in this chapter.

4-1.1 Culverts are generally of circular, oval, elliptical, arch, or box cross section and may be of single or multiple construction, the choice depending on available headroom and economy. Culvert materials for permanent-type installations include plain concrete, reinforced concrete, corrugated metal, and plastic. Concrete culverts may be either precast or cast in place, and corrugated metal culverts may have either annular or helical corrugations and be constructed of steel or aluminum. For the metal culverts, different kinds of coatings and linings are available for improvement of durability and hydraulic characteristics. The design of economical culverts involves consideration of many factors relating to requirements of hydrology, hydraulics, physical environment, imposed exterior loads, construction, and maintenance. With the design discharge and general layout determined, the design requires detailed consideration of such hydraulic factors as shape and slope of approach and exit channels, allowable head at entrance (and ponding capacity, if appreciable), tailwater levels, hydraulic and energy grade lines, and erosion potential. A selection from possible alternative designs may depend on practical considerations such as minimum acceptable size, available materials, local experience concerning corrosion and erosion, and construction and maintenance aspects. If two or more alternative designs involving competitive materials of equivalent merit appear to be about equal in estimated cost, plans will be developed to permit contractor's options or alternate bids, so that the least construction cost will result.

4-1.2 Culvert pipe is available in many sizes depending on the material type and configuration. Pipe manufacturers provide pipe and culvert manuals and handbooks that describe their products. See Chapter 9 of this UFC for allowable pipe sizes and fill heights. Designs for extra large sizes or for special shapes or structural requirements may be submitted by manufacturers for approval and fabrication. Short culverts under sidewalks (not entrances or driveways) may be as small as 8 in. in diameter if placed to be comparatively free from accumulation of debris or ice. In general, pipe diameters or

pipe-arch rises should be not less than 18 inches. A diameter or pipe-arch of not less than 24 in. should be used in areas where windblown materials such as weeds and sand may tend to block the waterway. Within these ranges of sizes, structural requirements may limit the maximum size that can be used for a specific installation.

4-1.3 The capacity of a culvert is determined by its ability to admit, convey, and discharge water under specified conditions of potential and kinetic energy upstream and downstream. The hydraulic design of a culvert for a specified design discharge involves selection of a type and size, determination of the position of hydraulic control, and hydraulic computations to determine whether acceptable headwater depths (HW/D) and outfall conditions will result. In considering what degree of detailed refinement is appropriate in selecting culvert sizes, the relative accuracy of the estimated design discharge should be taken into account. Hydraulic computations will be carried out by standard methods based on pressure, energy, momentum, and loss considerations. Appropriate formulas, coefficients, and charts for culvert design are provided later in this chapter. The FHWA's Hydraulic Design Series No. 5 (HDS-5) should be consulted for detailed information regarding culvert design practice.

4-1.4 Rounding or beveling the entrance in any way will increase the capacity of a culvert for every design condition. Some degree of entrance improvement should always be considered for incorporation in design. A headwall will improve entrance flow over that of a projecting culvert. A headwall is particularly desirable as a cutoff to prevent saturation, sloughing, and/or erosion of the embankment. Provisions for drainage should be made over the center of the headwall to prevent scouring along the sides of the walls. A mitered entrance conforming to the fill slope produces a little improvement in efficiency over that of the straight, sharp-edged, projecting inlet, but may be structurally unsafe due to uplift forces. Both types of inlets tend to inhibit the culvert from flowing full when the inlet is submerged. The most efficient entrances incorporate such geometric features as elliptical arcs, circular arcs, tapers, and parabolic drop-down curves. In general, elaborate inlet designs for culverts are justifiable only in unusual circumstances.

4-1.5 Outlets and endwalls must be protected against undermining, bottom scour, damaging lateral erosion, and degradation of the downstream channel. The presence of tailwater higher than the culvert crown will affect culvert performance and may require protection of the adjacent embankment against wave or eddy scour. Endwalls (outfall headwalls) and wingwalls should be used where practical, and wingwalls should flare 1 on 8 from 1 diameter width to that required for the formation of a hydraulic jump and the establishment of a Froude number in the exit channel that will ensure stability. Two general types of channel instability can develop downstream of a culvert: gully scour or a localized erosion referred to as a scour hole. Gully scour is to be expected when the Froude number of flow in the channel exceeds that required for stability. Erosion of this type may be considerable depending upon the location of the stable channel section relative to that of the outlet in both the vertical and downstream directions. A scour hole can be expected downstream of an outlet even if the downstream channel is stable. The severity of damage depends upon the conditions existing or created at the outlet. More

information on erosion protection is provided at the end of this chapter. In addition, the FHWA's HEC-14 is highly recommended for this topic.

4-1.6 In the design and construction of any drainage system it is necessary to consider the minimum and maximum earth cover allowable in the underground conduits to be placed under both flexible and rigid pavements. Minimum-maximum cover requirements for various pipe and culverts is provided in Chapter 9 of this UFC. The cover depths recommended are valid for average bedding and backfill conditions. Deviations from these conditions may result in significant minimum cover requirements.

4-1.7 Infiltration of fine-grained soils into drainage pipelines through joint openings is one of the major causes of ineffective drainage facilities. This is particularly a problem along pipes on relatively steep slopes such as those encountered with broken-back culverts. Infiltration of backfill and subgrade material can be controlled by watertight flexible joint materials in rigid pipe and with watertight coupling bands in flexible pipe. The results of laboratory research concerning soil infiltration through pipe joints and the effectiveness of gasketing tapes for waterproofing joints and seams are available. More information on watertight joints can be found in Chapter 9.

4-2 **FISH PASSAGE CONSIDERATIONS.** While the need for fish passage rarely occurs on DOD projects, this section provides some general fish passage guidance.

4-2.1 **General.** When it is determined that fish are present and fish passage must be accommodated, several design items must be considered. Consult a local fisheries biologist prior to making any of the design accommodations noted in paragraphs 4-2.2 through 4-2.8.

4-2.2 **High Inverts.** Fish passage is impossible when the culvert outlet is set too high, exceeding jumping ability of the fish and creating a spill velocity exceeding the swimming capability of the fish. Causes can be survey or design error, improper installation, or unexpected degradation of the downstream channel after culvert installation.

4-2.3 **High Velocities in Culverts.** These prevent fish from swimming upstream. Factors affecting velocity include the culvert's area, shape, slope, and internal roughness, and inlet and outlet conditions. Some increases in velocity result from the increased slope due to the culvert alignment being straight in lieu of the natural stream's meander, reduced surface roughness of the pipe, and a reduction in the cross-sectional area due to the pipe. Tailwater elevation, the water level in the downstream channel at the culvert outlet, should be based on the type of fish present. This minimum should be set with due consideration to recommendations of local fishery biologists.

Countersinking or partially burying a culvert will allow the natural stream material to be sustained throughout the length of the culvert. Enlarged, countersunk pipes have been effective for passing fish through a culvert.



4-2.4 **Undersized or Failed Culverts.** These can cause overtopping and washout of an embankment and destroy a fish resource by release of large amounts of sediment and debris.

4-2.5 **Erosion Along Drainageways or at Outlets.** Additional sediment from uncontrolled erosion can adversely affect fish. Causes can be high velocities, high inverts, undersized culverts, inadequate bank protection, and lack of suitable culvert endwalls.

4-2.6 **Channel Filling.** Covering an extensive reach of stream bottom decreases the area most suitable for spawning, depleting renewal of stocks. Proper biological input in siting and designing drainageways will avoid this problem.

4-2.7 **Culvert Installation.** Scheduling culvert excavation, channel diversion, and channel crossings by equipment should avoid times of the year that are critical to the fish cycle.

4-2.8 **Control of Icing.** Thawing devices such as electrical cables or steam lines, essential to any design where there is ice buildup, should be in operation to assure freedom from ice blockages during the spring migration period.

#### 4-3 **DESIGN STORM**

4-3.1 The design of culverts will be based on the design storm frequencies defined in Chapter 2, section 2-2.5. The headwater depth for the design storm shall not exceed 1.25 or the local requirement. Examples of conditions where greater than the design storm frequency may be used are areas of steep slope in which overflows would cause severe erosion damage; high road fills that impound large quantities of water; and primary diversion structures, important bridges, and critical facilities where uninterrupted operation is imperative.

4-3.2 Protection of facilities against flood flows originating from areas exterior to the facility will normally be based on local design requirements but not less than the 10-yr event. Operational requirements, cost-benefit considerations, and the nature and consequences of flood damage resulting from the failure of protective works shall also be considered. Justification for the selected design storm will be presented, and, if appropriate, comparative costs and damages for alternative designs should be included.

4-4 **DESIGN.** Improper design and careless construction of various drainage structures may render facilities ineffective and unsafe. Consequently, the necessity of applying basic hydraulic principles to the design of all drainage structures must be emphasized. Care should be given to both preliminary field surveys that establish control elevations and to the construction of the various hydraulic structures in strict accordance with proper and approved design procedures. A successful drainage system requires the coordination of both the field and design engineers.

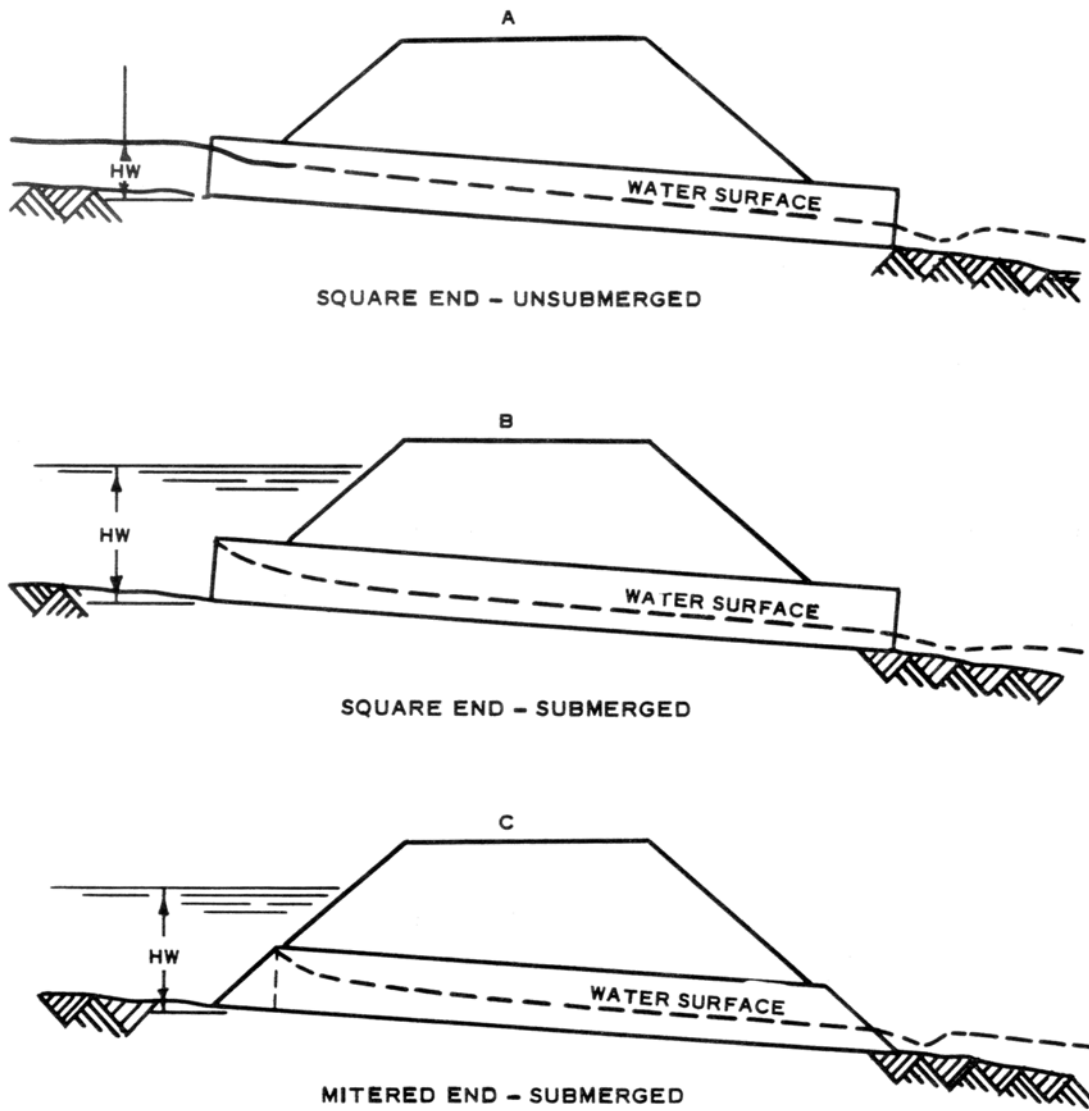
#### 4-4.1 Hydraulic Design Data for Culverts

4-4.1.1 **General.** This section presents diagrams, charts, coefficients, and related information useful in the design of culverts. The information has been obtained largely from the U.S. Department of Transportation (USDOT), Federal Highway Administration (FHWA), and supplemented or modified as appropriate by information from various other sources and as required for consistency with design practice of the U.S. Army Corps of Engineers.

4-4.1.2 **Culvert Flow.** Laboratory tests and field observations show two major types of culvert flow: flow with inlet control and flow with outlet control. Under inlet control, the cross-sectional area of the culvert barrel, the inlet geometry, and the amount of headwater (HW) or ponding at the entrance are of primary importance. Outlet control involves the additional consideration of the elevation of the tailwater in the outlet channel and the slope, roughness, and length of the culvert barrel. The type of flow or the location of the control is dependent on the quantity of flow, roughness of the culvert barrel, type of inlet, flow pattern in the approach channel, and other factors. In some instances, the flow control changes with varying discharges, and occasionally the control fluctuates from inlet control to outlet control and vice versa for the same discharge. Thus, the design of culverts should consider both types of flow and should be based on the more adverse flow condition anticipated.

4-4.1.3 **Inlet Control.** The discharge capacity of a culvert is controlled at the culvert entrance by the depth of headwater and the entrance geometry, including the area, slope, and type of inlet edge. Types of inlet-controlled flow for unsubmerged and submerged entrances are shown at A and B in Figure 4-1. A mitered entrance (C, Figure 4-1) produces little improvement in efficiency over that of the straight, sharp-edged, projecting inlet. Both types of inlets tend to inhibit the culvert from flowing full when the inlet is submerged. With inlet control, the roughness and length of the culvert barrel and outlet conditions (including depths of tailwater) are not factors in determining culvert capacity. The effect of the barrel slope on inlet-control flow in conventional culverts is negligible. Nomographs for determining culvert capacity for inlet control were developed by the Division of Hydraulic Research, Bureau of Public Roads (see the FHWA's HDS-1). These nomographs (Figures 4-2 through 4-9) give headwater-discharge relations for most conventional culverts flowing with inlet control. Nomographs for other culvert shapes are provided in HDS-5.

Figure 4-1. Inlet Control



U. S. Army Corps of Engineers

Figure 4-2. Headwater Depth for Concrete Pipe Culverts with Inlet Control

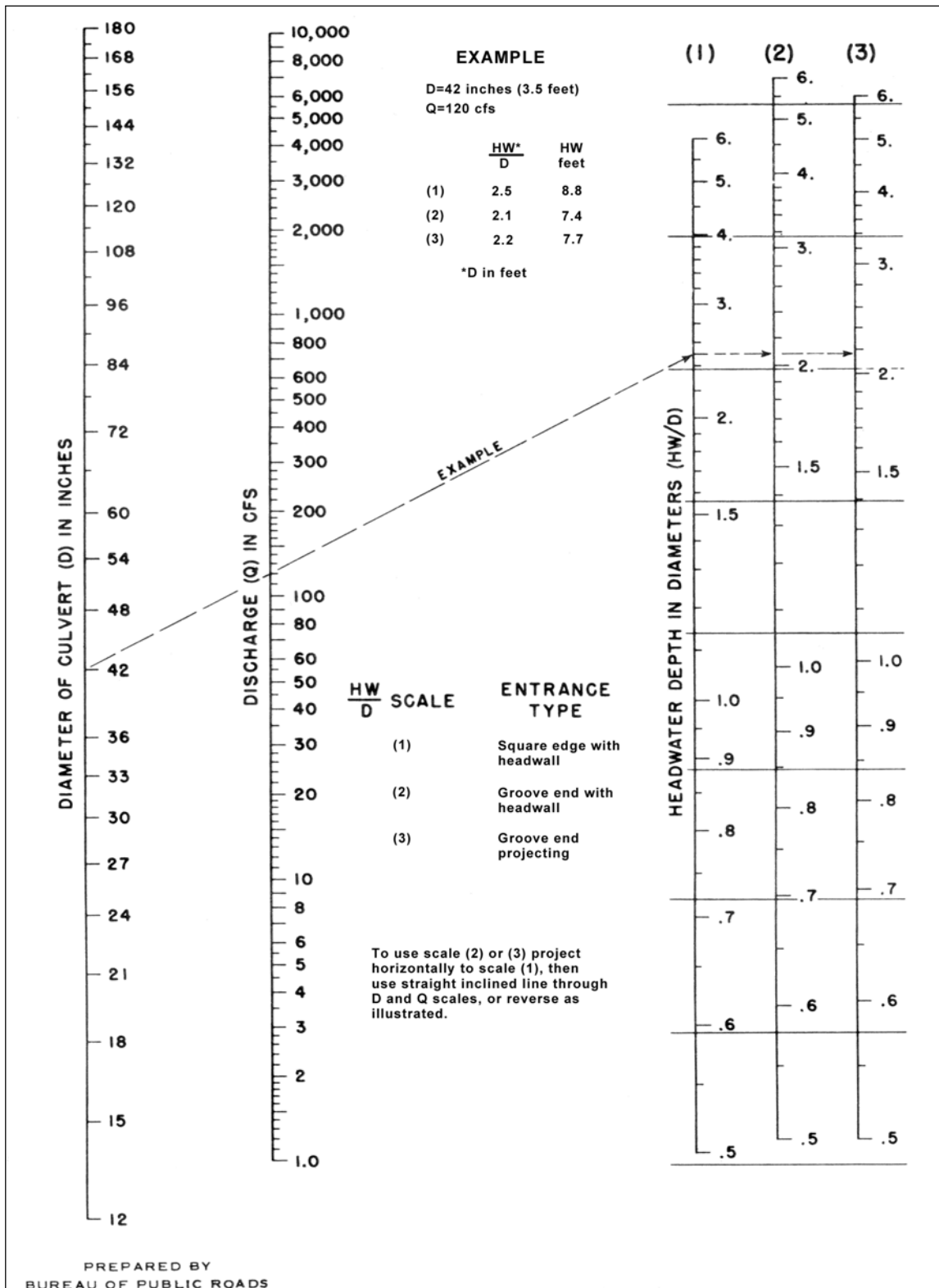


Figure 4-3. Headwater Depth for Oval Concrete Pipe Culverts Long Axis Vertical with Inlet Control

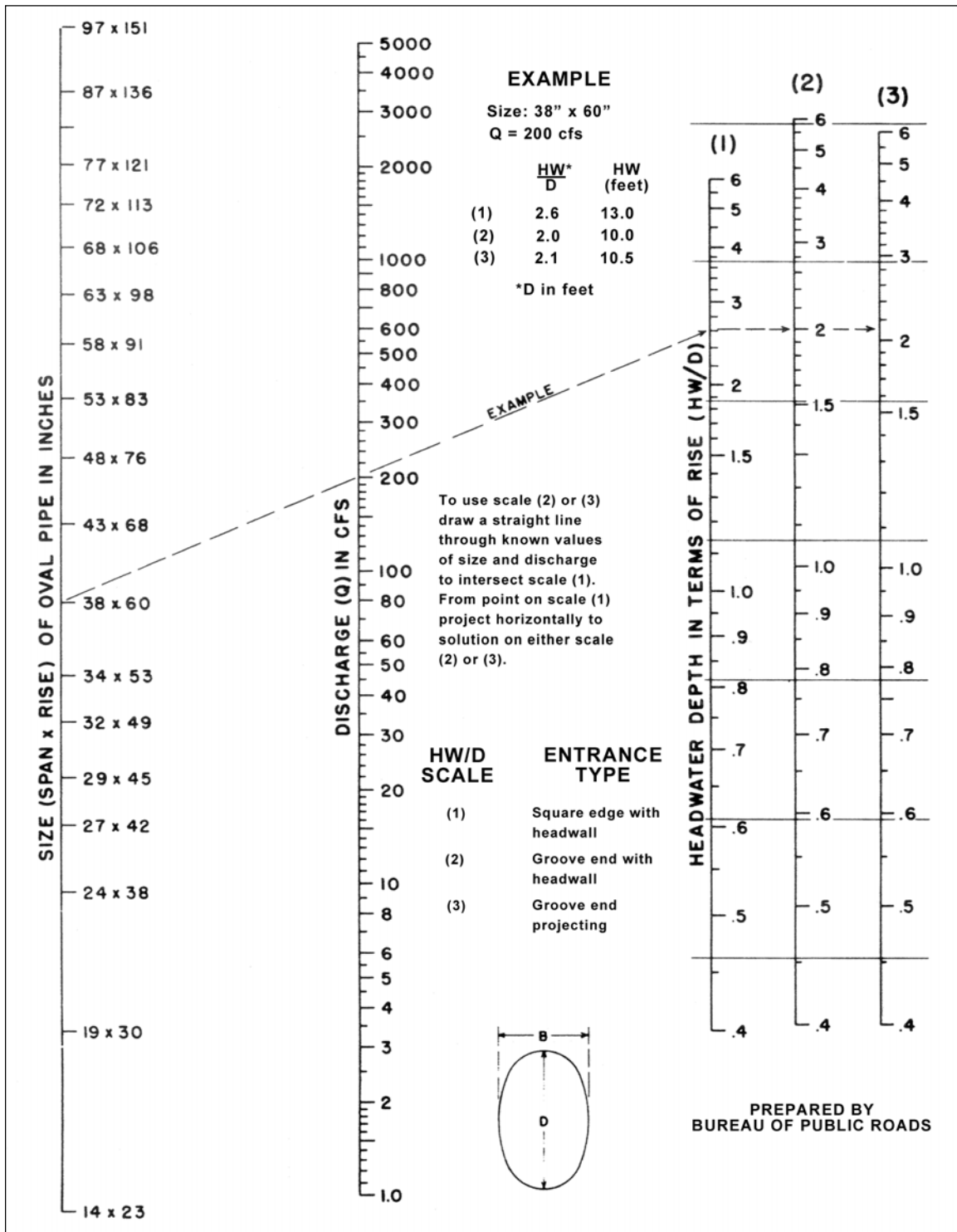


Figure 4-4. Headwater Depth for Oval Concrete Pipe Culverts Long Axis Horizontal with Inlet Control

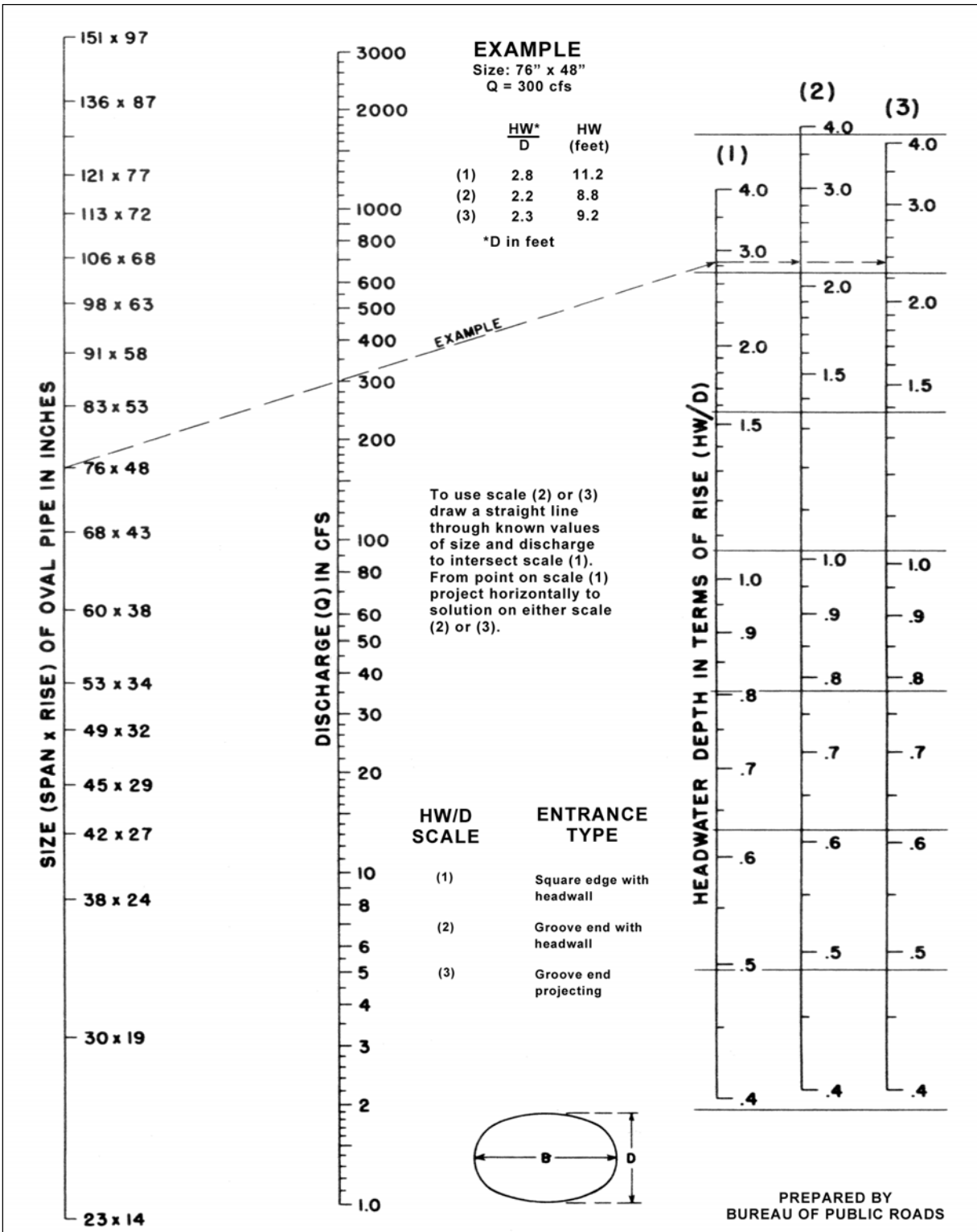


Figure 4-5. Headwater Depth for Corrugated Metal Pipe Culverts with Inlet Control

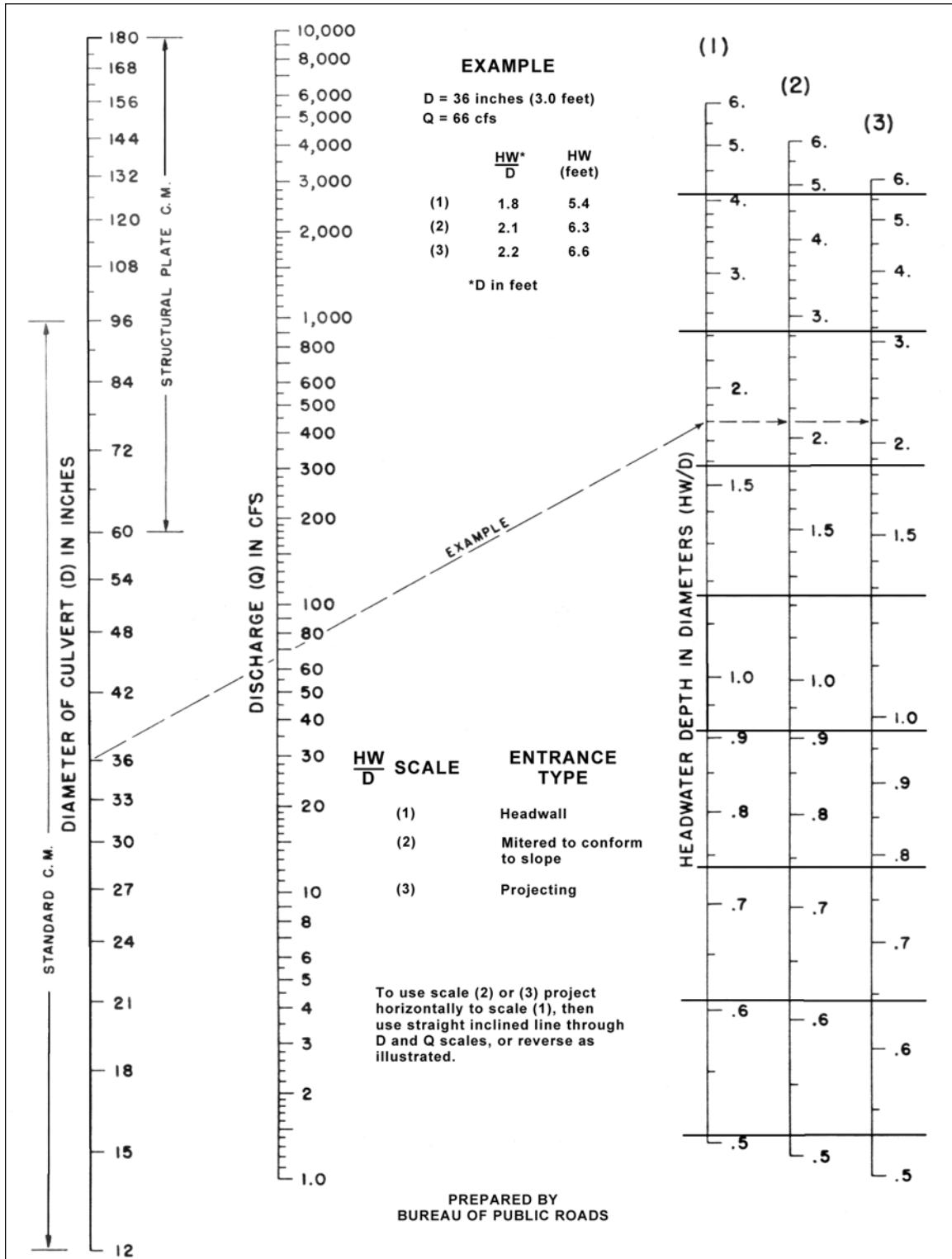


Figure 4-6. Headwater Depth for Structural Plate and Standard Corrugated Metal Pipe-Arch Culverts with Inlet Control

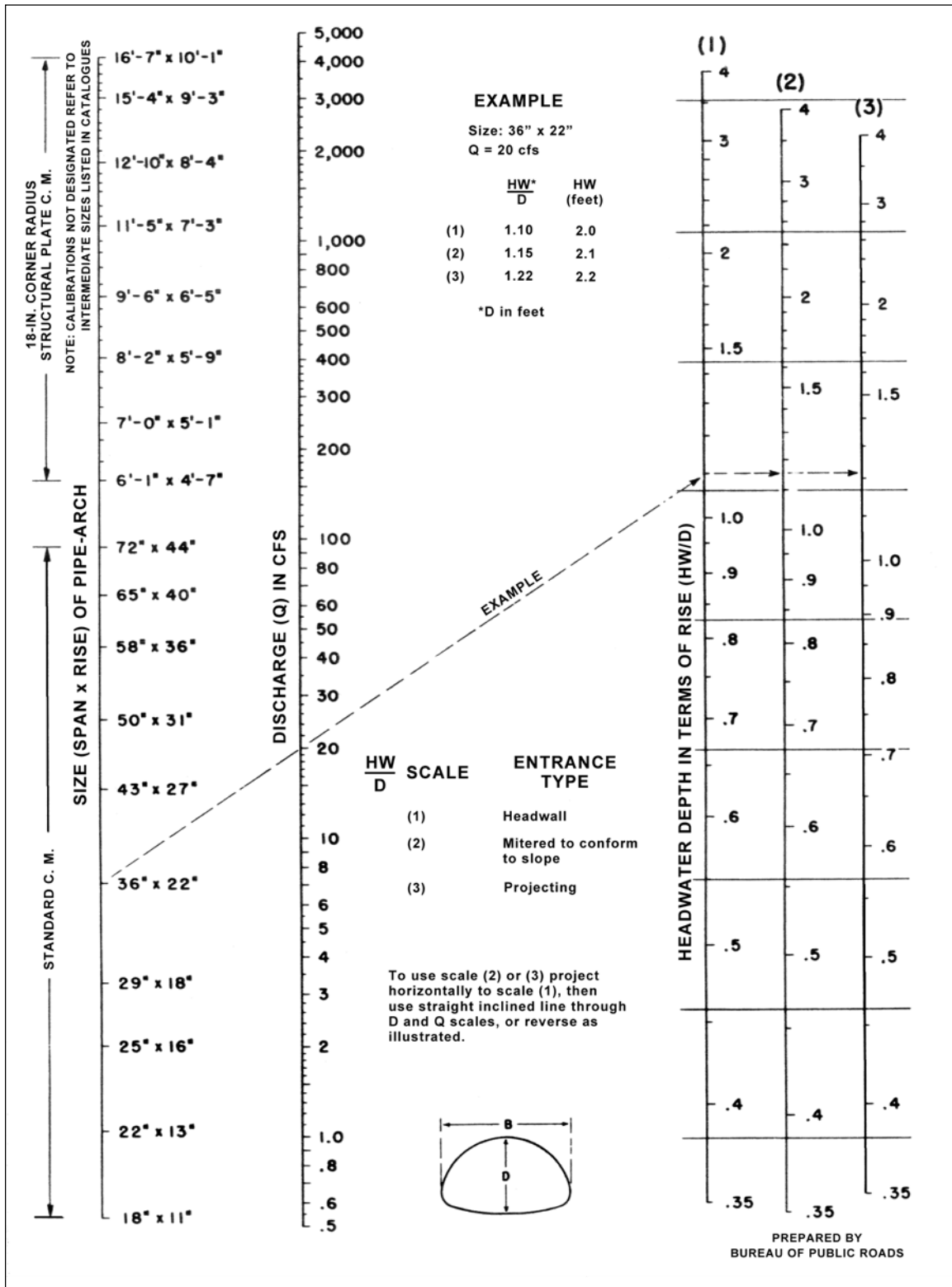




Figure 4-7. Headwater Depth for Box Culverts with Inlet Control

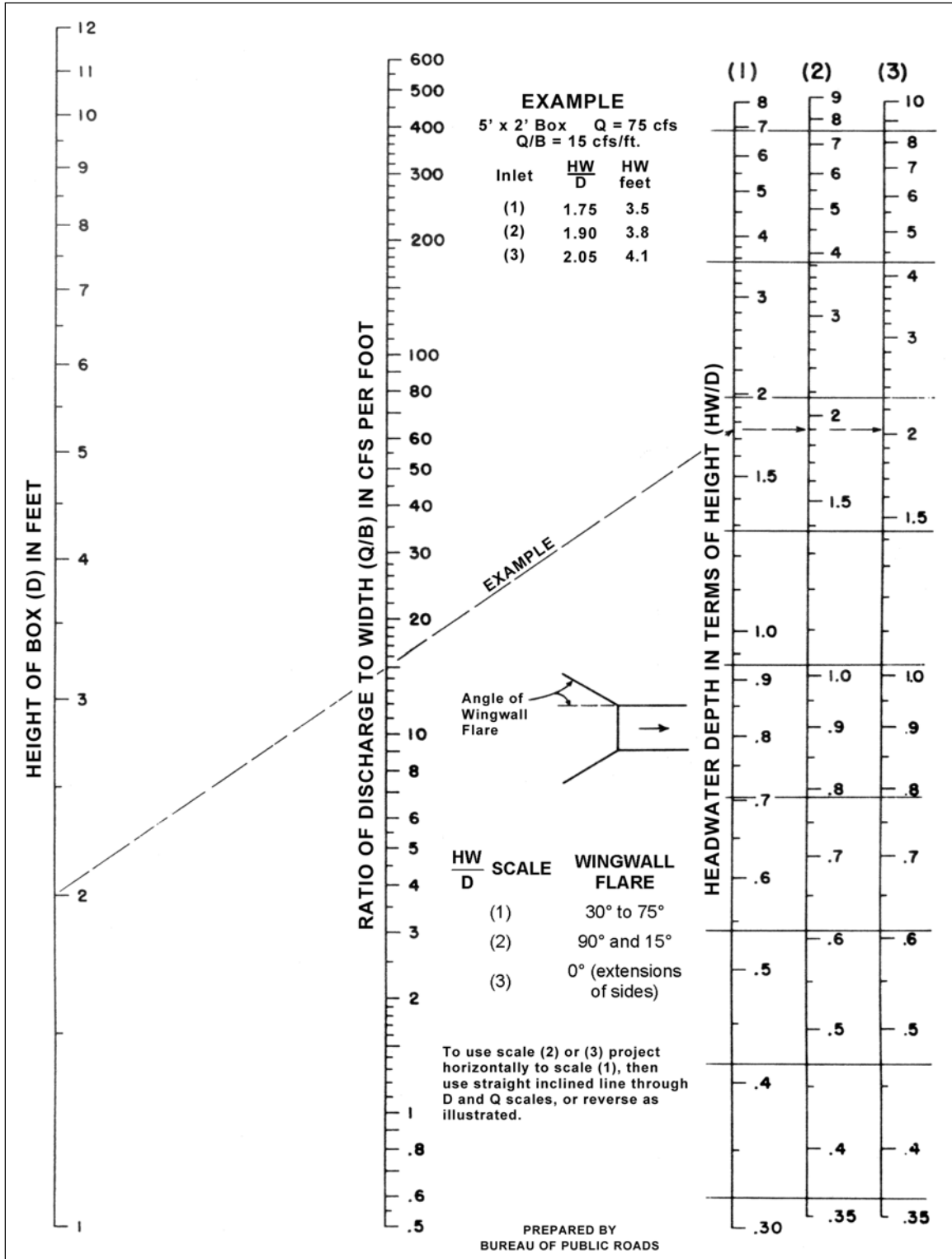


Figure 4-8. Headwater Depth for Corrugated Metal Pipe Culverts with Tapered Inlet Inlet Control

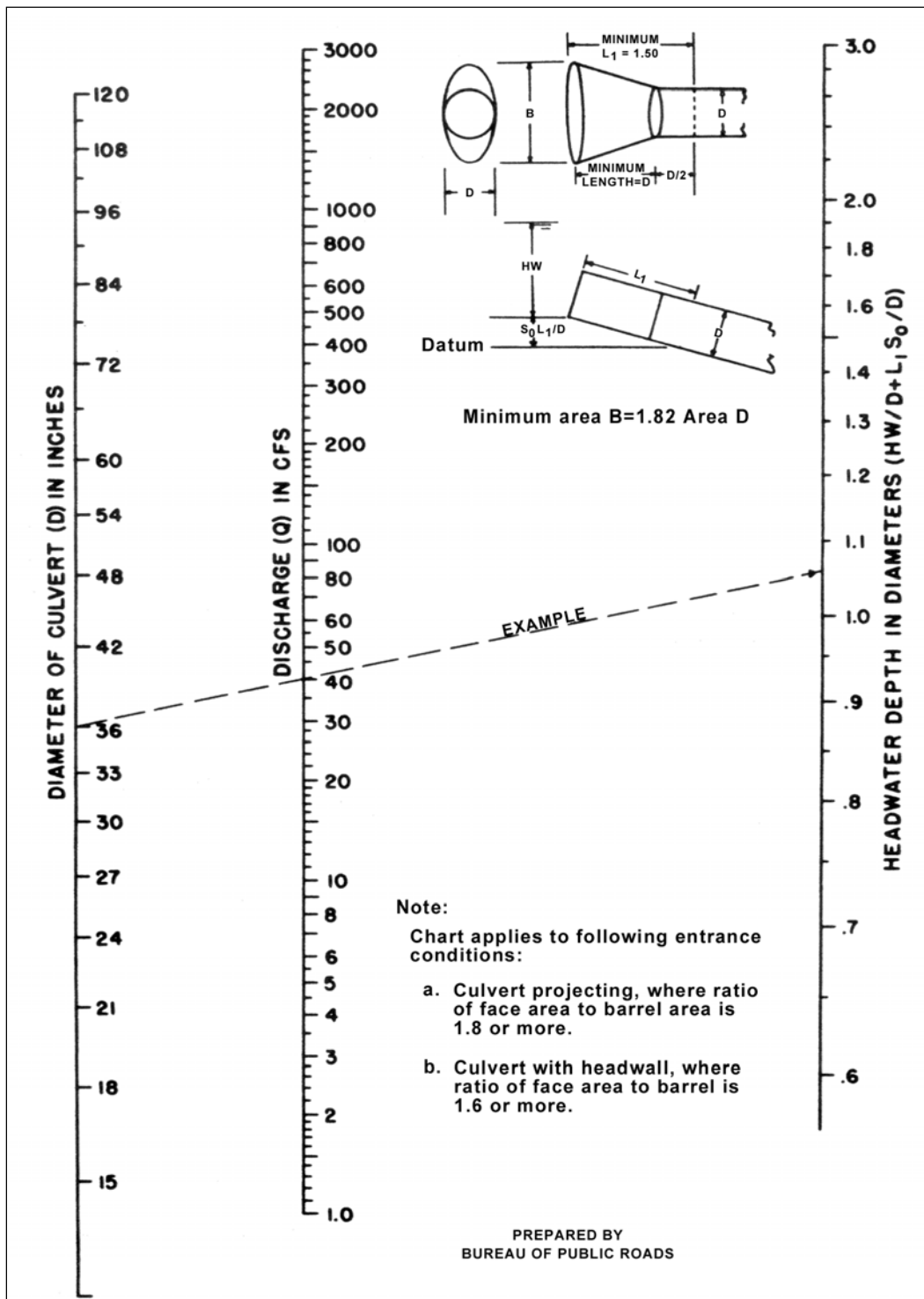
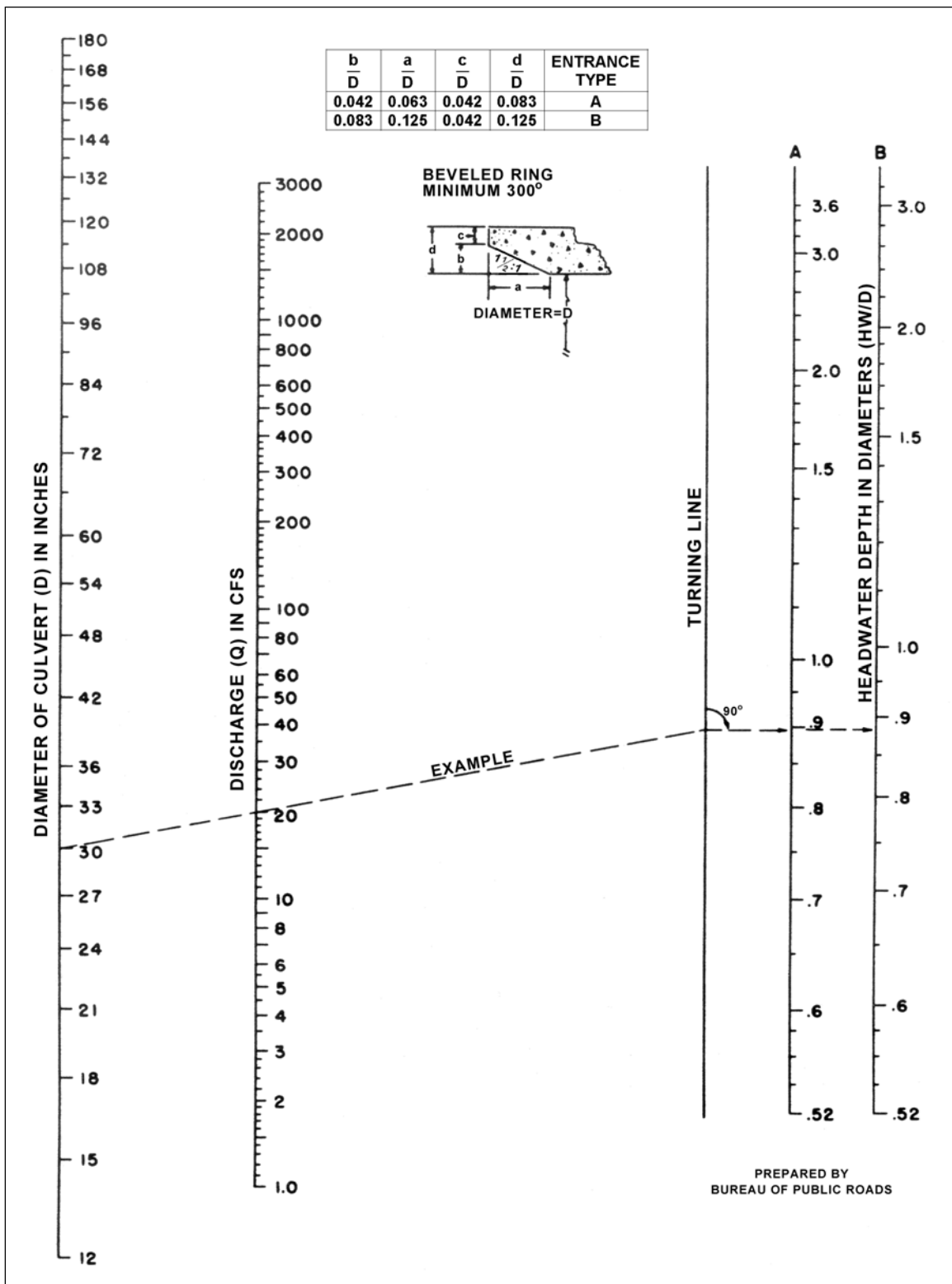
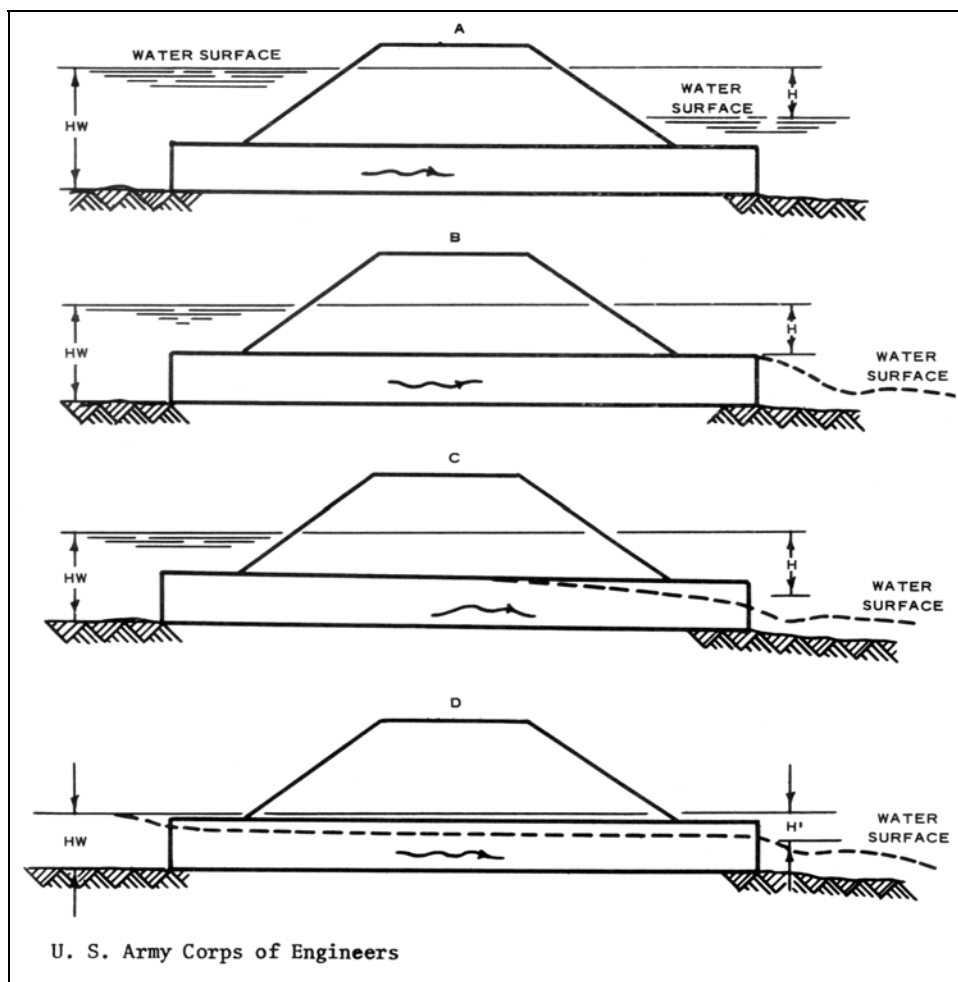


Figure 4-9. Headwater Depth for Circular Pipe Culverts with Beveled Ring Inlet Control



4-4.1.4 **Outlet Control.** Culverts flowing with outlet control can flow with the culvert barrel full or partially full for part of the barrel length or for all of it (Figure 4-10). If the entire barrel is filled (both cross section and length) with water, the culvert is said to be in full flow or flowing full (Figure 4-10, A and B). The other two common types of outlet-control flow are shown in Figure 4-10, C and D. The procedure given for outlet-control flow does not give an exact solution for a free-water-surface condition throughout the barrel length shown in Figure 4-10, D. An approximate solution is given for this case when the headwater,  $HW$ , is equal to or greater than  $0.75D$ , where  $D$  is the height of the culvert barrel. The head,  $H$ , required to pass a given quantity of water through a culvert flowing full with control at the outlet is made up of three major parts.

Figure 4-10. Outlet Control



4-4.1.4.1 These three parts are usually expressed in feet of water and include a velocity head, an entrance loss, and a friction loss. The velocity head (the kinetic energy of the water in the culvert barrel) equals  $\frac{V^2}{2g}$ . The entrance loss varies with the type or

design of the culvert inlet and is expressed as a coefficient times the velocity head, or  $K_e \frac{V^2}{2g}$ . Values of  $K_e$  for various types of culvert entrances are given in Table 4-1. The friction loss,  $H_f$ , is the energy required to overcome the roughness of the culvert barrel and is usually expressed in terms of Manning's  $n$  (Table 6-1) and Equation 4-1:

$$H_f = \left( \frac{29n^2L}{R^{1.333}} \right) \left( \frac{V^2}{2g} \right) \quad (4-1)$$

**Table 4-1. Entrance Loss Coefficients, Outlet Control, Full or Partly Full**

**Entrance Head Loss,  $H_e = K_e \frac{V^2}{2g}$  \***

Type of Structure and Design of Entrance	Coefficient, $K_e$
Pipe, Concrete	
Projecting from fill, socket end (groove-end)	0.2
Projecting from fill, square-cut end	0.5
Headwall or headwall and wingwalls	
Socket end of pipe (groove-end)	0.2
Square-edge	0.5
Rounded (radius = 0.083 barrel dimension)	0.2
Mitered to conform to fill slope	0.7
**End section conforming to fill slope	0.5
Beveled edges, 33.7-degree or 45-degree bevels	0.2
Side- or sloped-tapered inlet	0.2
Pipe, or Pipe-Arch, Corrugated Metal	
Projecting from fill (no headwall)	0.9
Headwall or headwall and wingwalls, square-edge	0.5
Mitered to conform to fill slope, paved or unpaved slope	0.7
**End section conforming to fill slope	0.5
Beveled edges, 33.7-degree or 45-degree bevels	0.2
Side- or slope-tapered inlet	0.2
Box, Reinforced Concrete	
Headwall parallel to embankment (no wingwalls)	
Square-edged on 3 edges	0.5
Rounded on 3 edges to radius of 0.083 barrel dimension, or beveled edges on 3 sides	0.2
Wingwalls at 30 degrees to 75 degrees to barrel	
Square-edged at crown	0.4
Crown edge rounded to radius of 0.083 barrel dimension, or beveled top edge	0.2

Type of Structure and Design of Entrance	Coefficient, $K_e$
Wingwalls at 10 degrees to 25 degrees to barrel	
Square-edged at crown	0.7
Wingwalls parallel (extension of sides)	
Square-edged at crown	0.7
Side- or slope-tapered inlet	0.2
* Table developed by the U.S. Army Corps of Engineers	
** <b>NOTE:</b> Made of either metal or concrete, these end sections are commonly available from manufacturers. From limited hydraulic tests, they are equivalent in operation to a headwall in both inlet and outlet control. Some end sections, incorporating a closed taper in their design, have a superior hydraulic performance. These latter sections can be designed using the information given for the beveled inlet.	

4-4.1.4.2 Adding the three terms and simplifying, yields for full pipe, outlet control flow Equation 4-2:

$$H = \left( 1 + K_e + \frac{29n^2L}{R^{1.333}} \right) \left( \frac{V^2}{2g} \right) \quad (4-2)$$

This equation can be solved readily by the use of the full-flow nomographs, Figures 4-11 through 4-17. The equations shown on these nomographs are the same as Equation 4-1 but expressed in a different form. Each nomograph is drawn for a single value of  $n$  as noted in the respective figure. These nomographs may be used for other values of  $n$  by modifying the culvert length as explained later in this chapter in the section describing the use of the outlet-control nomographs. The value of  $H$  (head, ft) must be measured from some "control" elevation at the outlet that is dependent on the rate of discharge or the elevation of the water surface of the tailwater. For simplicity, a value  $h_o$  is used as the distance in feet from the culvert invert (flow line) at the outlet to the control elevation. Equation 4-3 is used to compute headwater in reference to the inlet invert:

$$HW = h_o + H - LS_o \quad (4-3)$$

Figure 4-11. Head for Circular Pipe Culverts Flowing Full,  $n = 0.012$

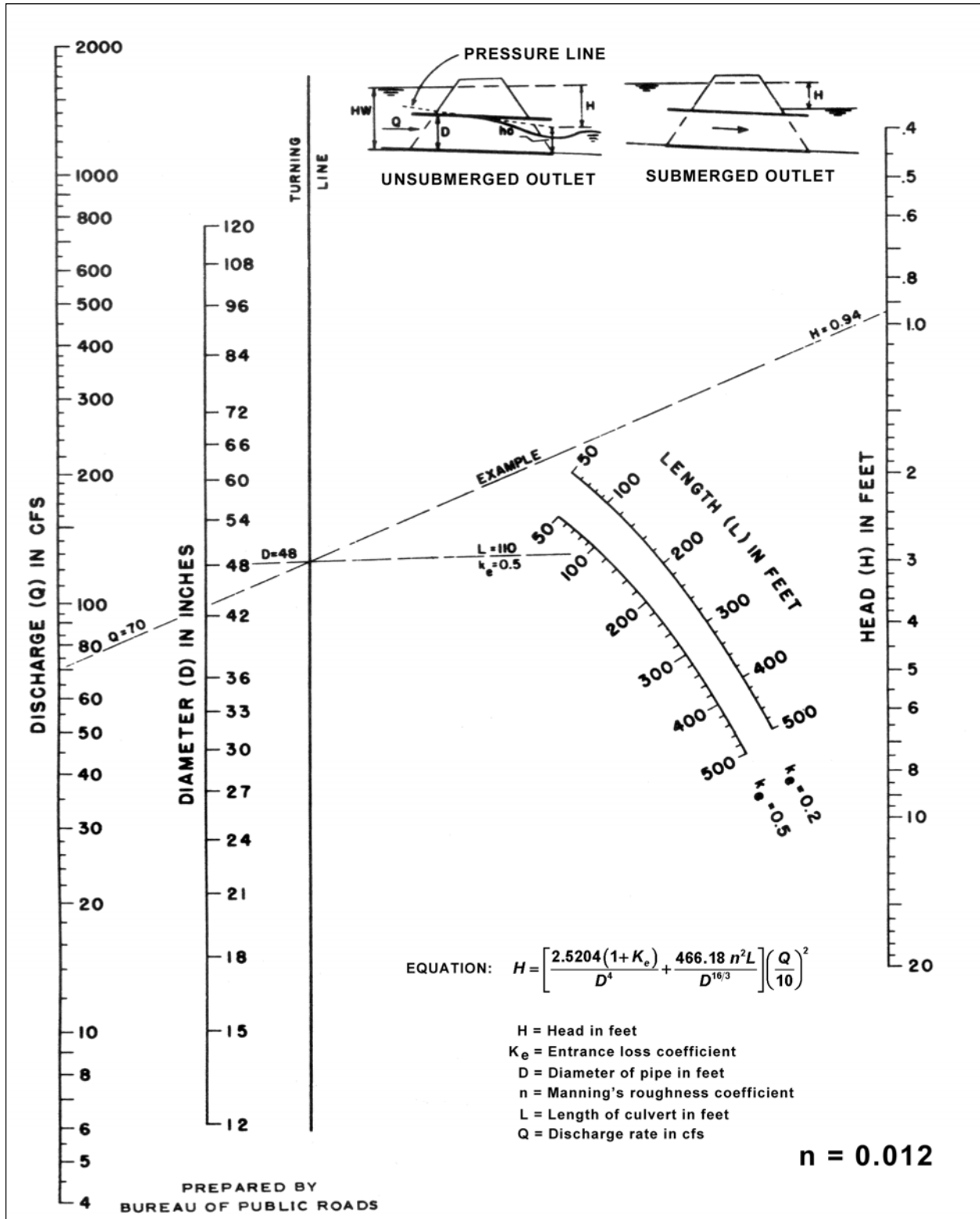


Figure 4-12. Head for Oval Circular Pipe Culverts Long Axis Horizontal or Vertical Flowing Full,  $n = 0.012$

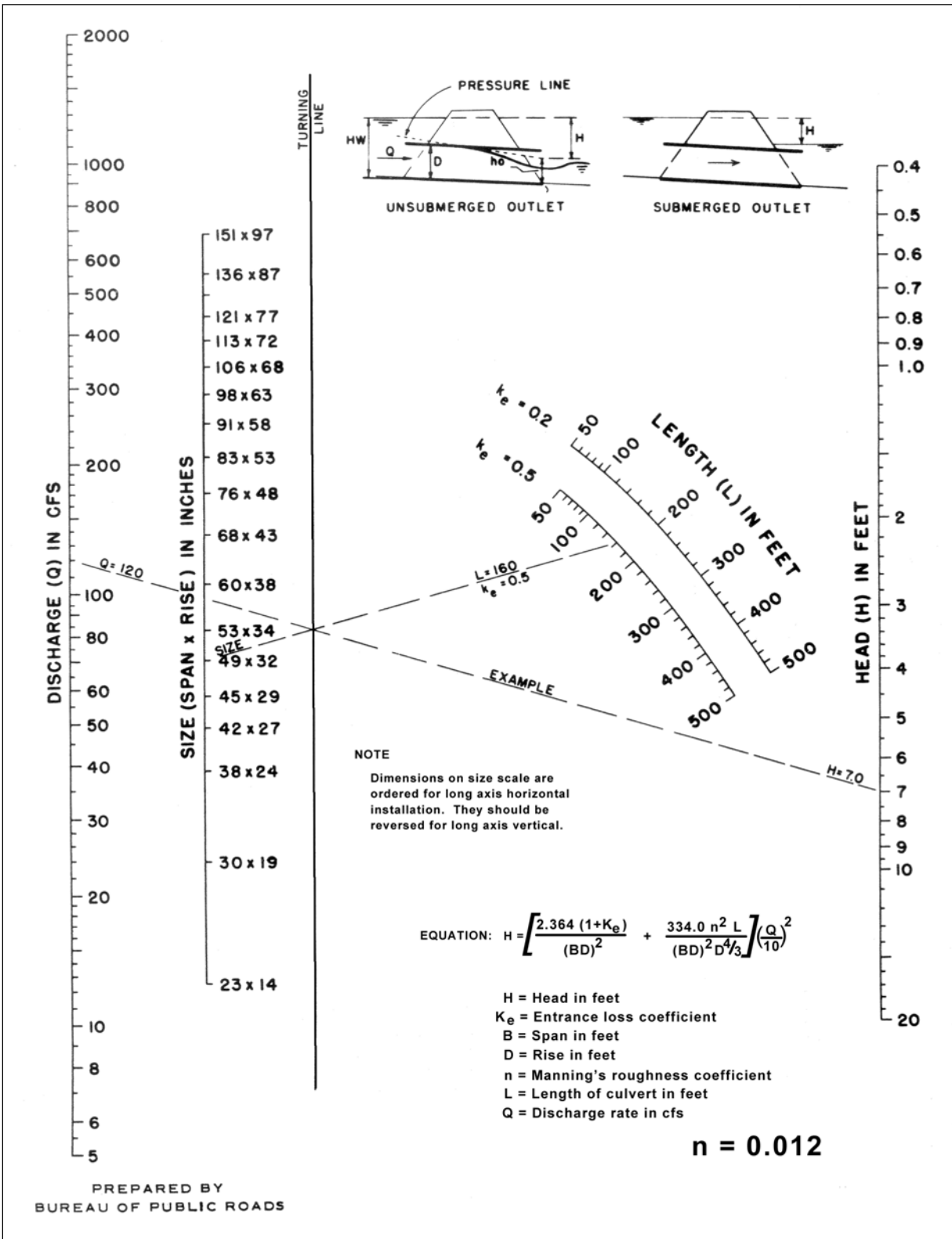




Figure 4-13. Head for Circular Pipe Culverts Flowing Full,  $n = 0.024$

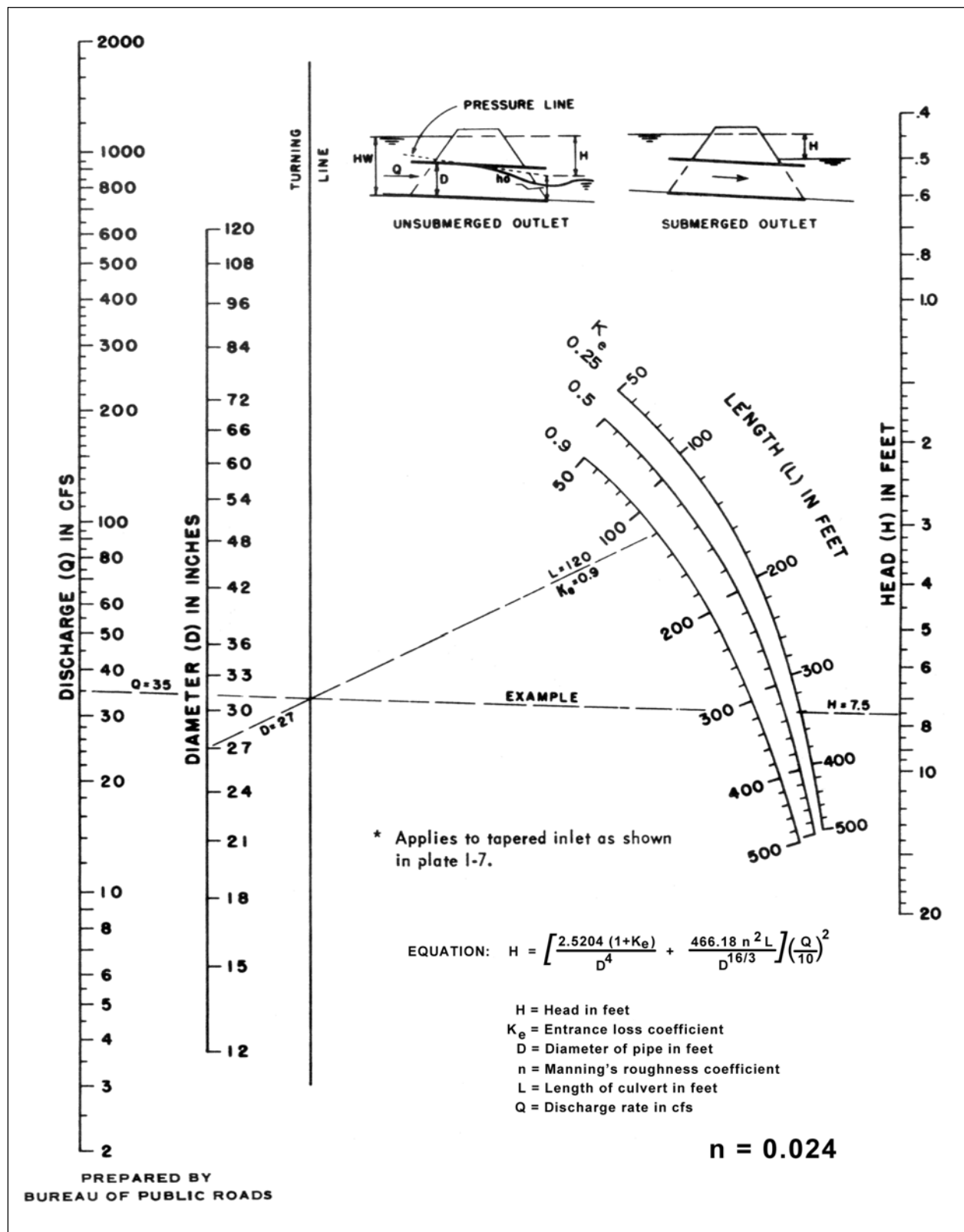


Figure 4-14. Head for Circular Pipe Culverts Flowing Full,  $n = 0.0328$  to  $0.0302$

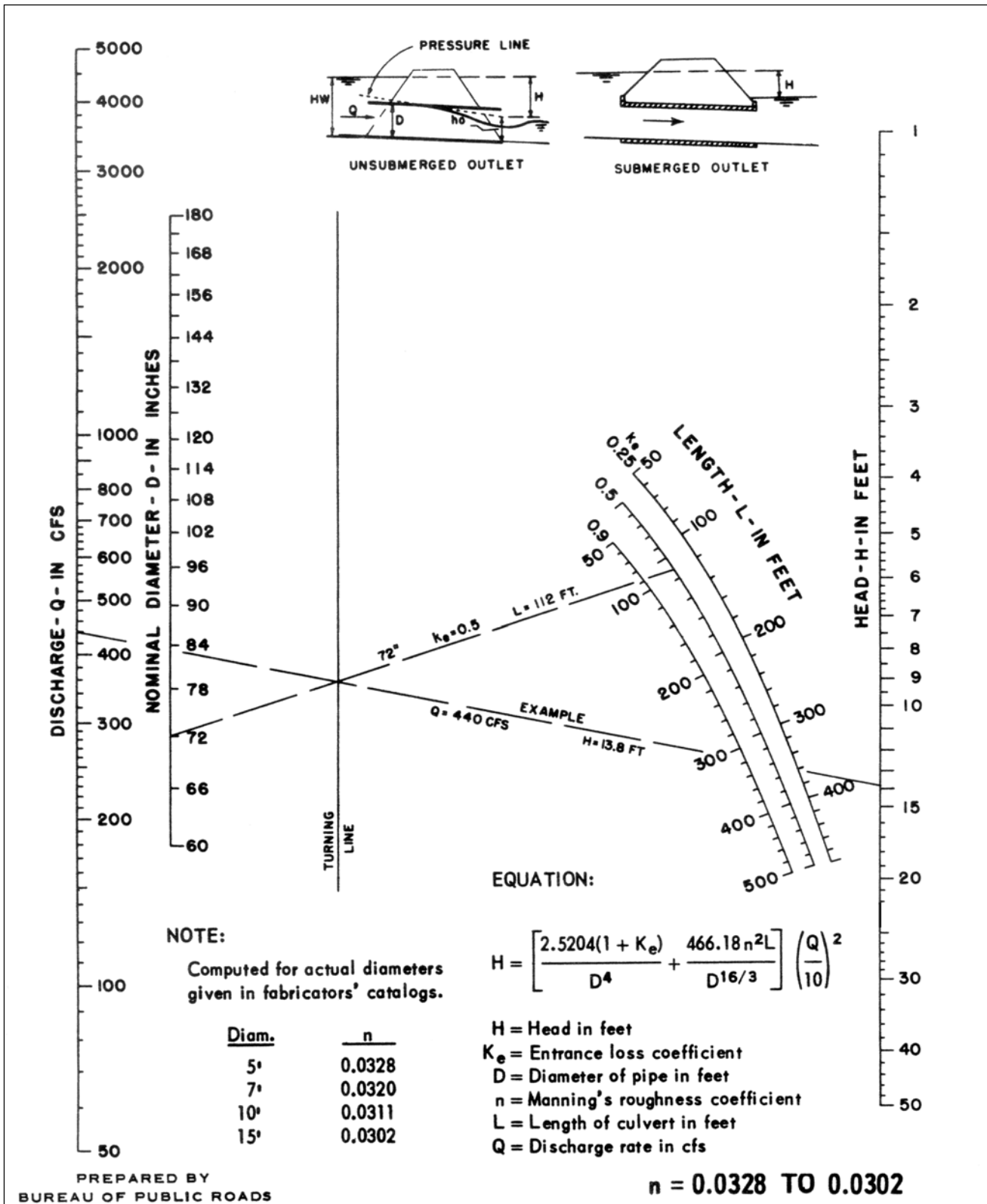


Figure 4-15. Head for Standard Corrugated Metal Pipe-Arch Culverts Flowing Full,  $n = 0.024$

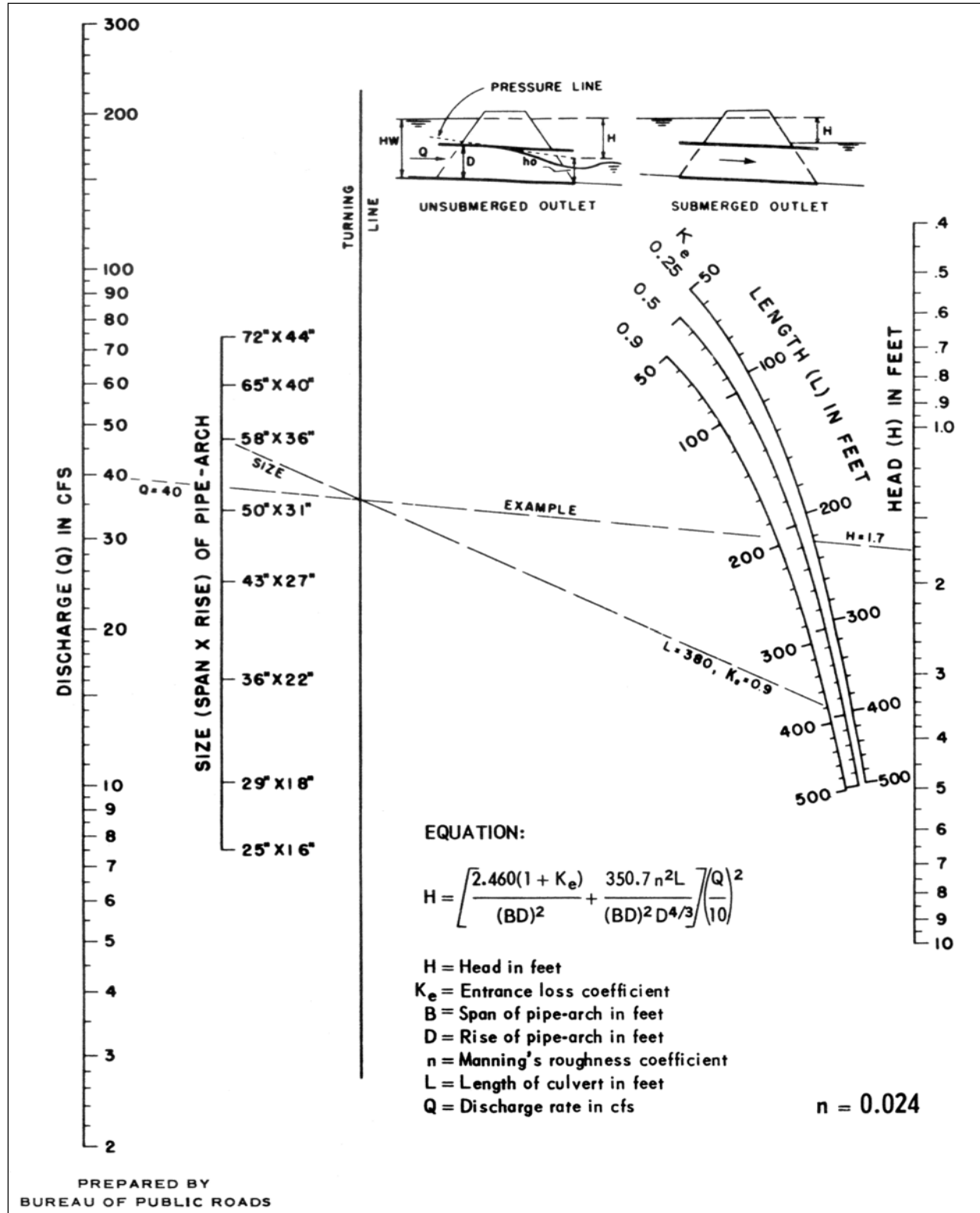


Figure 4-16. Head for Field-Bolted Structural Plate Pipe-Arch Culverts 18 in. Corner Radius Flowing Full,  $n = 0.0327$  to  $0.0306$

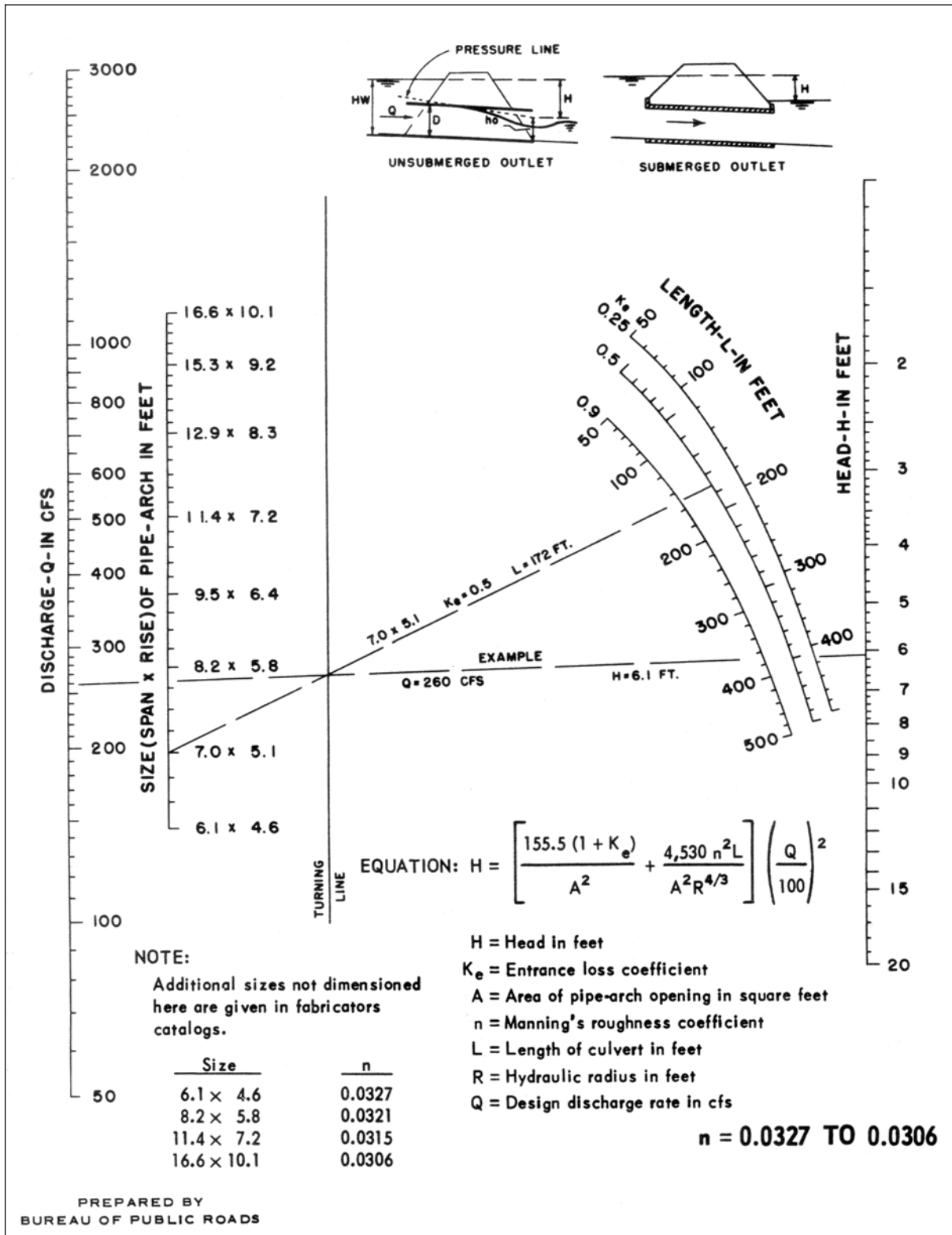
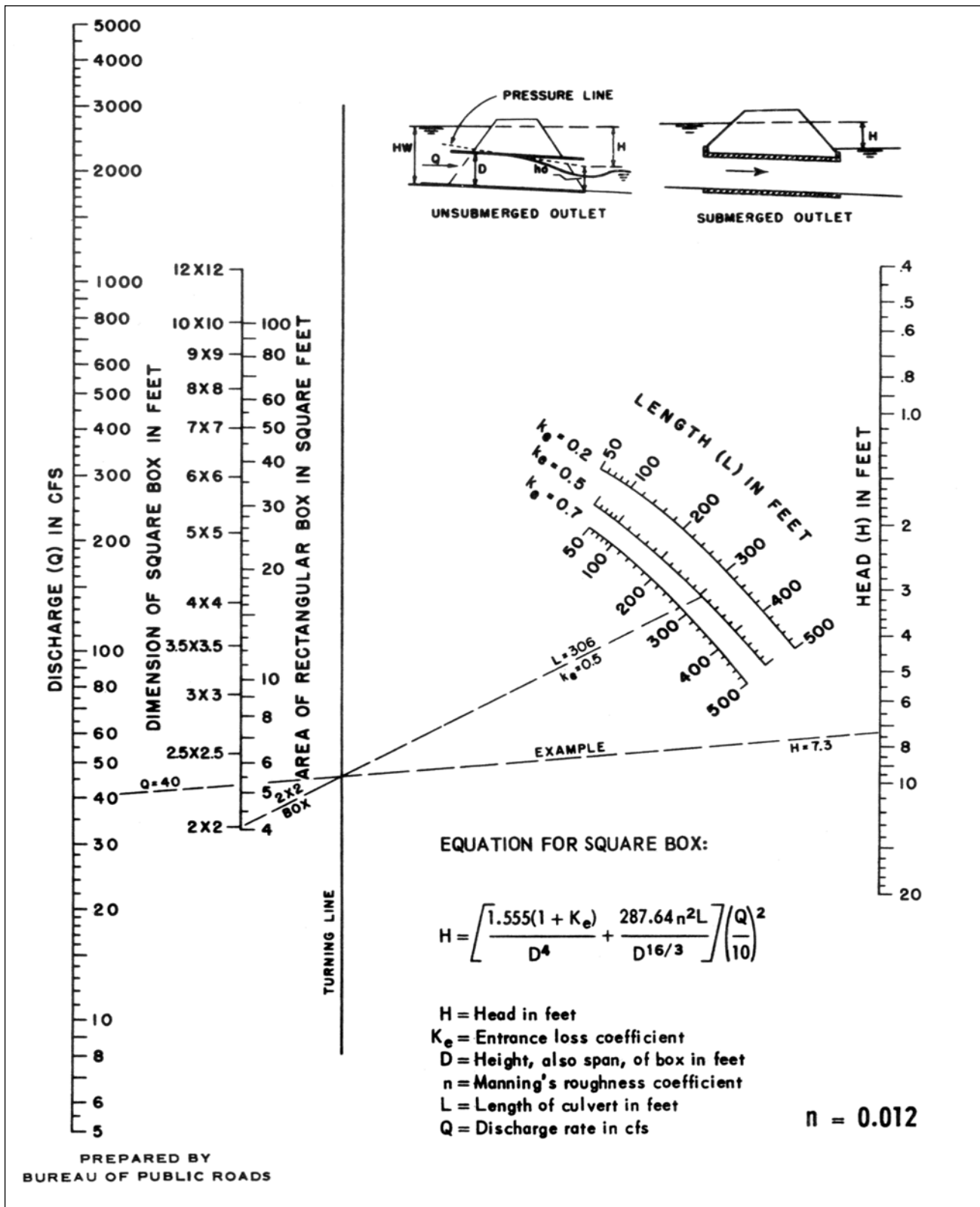


Figure 4-17. Head for Concrete Box Culverts Flowing Full,  $n = 0.012$



4-4.1.5 Tailwater Elevation at or Above the Top of the Culvert Barrel Outlet (Figure 4-10, A). The tailwater (TW) depth is equal to  $h_o$ , and the relation of headwater to other terms in Equation 4-3 is illustrated in Figure 4-18.

Figure 4-18. Tailwater Elevation at or Above the Top of the Culvert

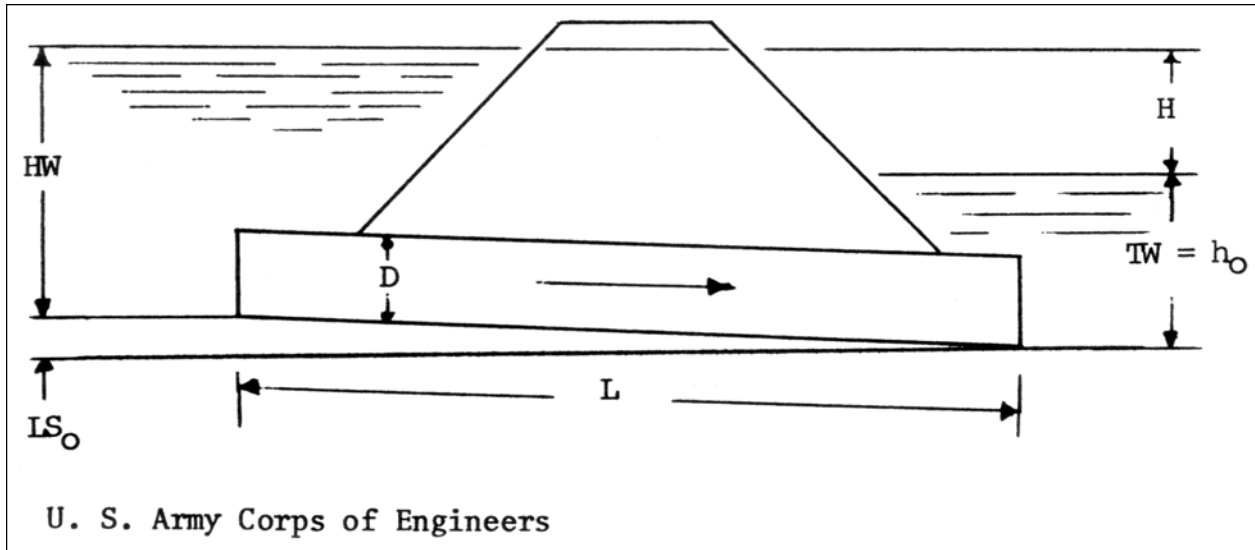
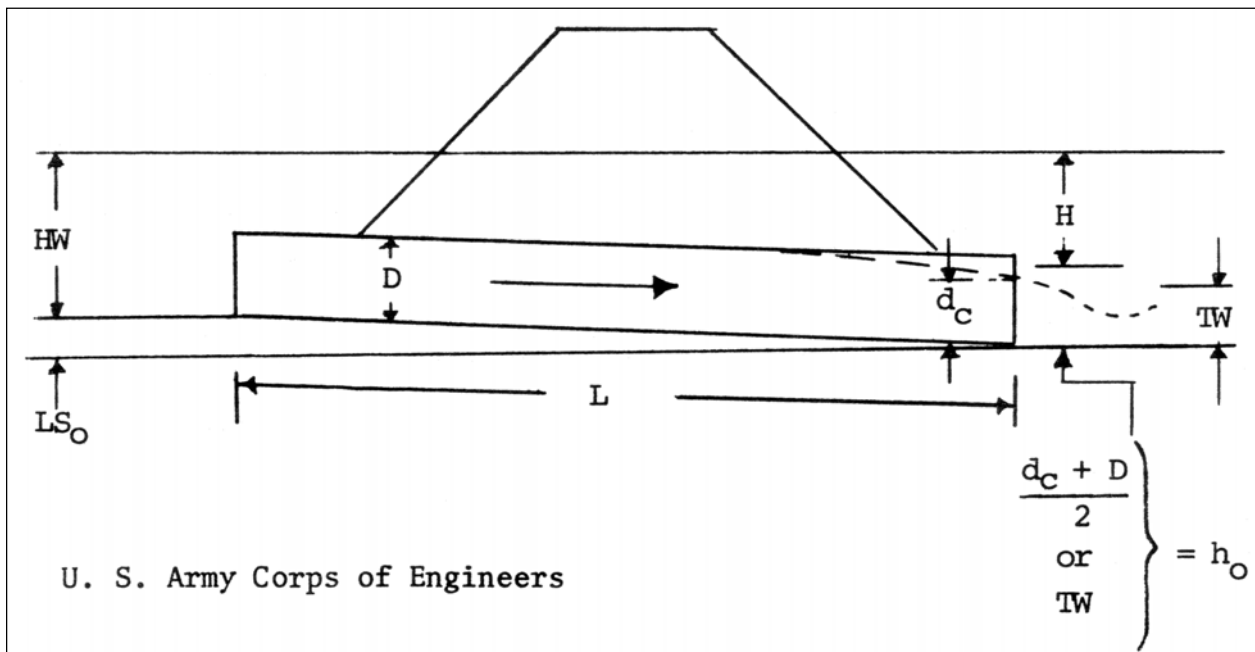


Figure 4-19. Tailwater Below the Top of the Culvert



4-4.1.6 **Tailwater Elevation Below the Top or Crown of the Culvert Barrel Outlet.**

Figure 4-10, B, C, and D are three common types of flow for outlet control with this low TW condition (Figure 4-19). In these cases,  $h_o$  is found by comparing two values, TW

depth in the outlet channel and  $\frac{d_c + D}{2}$ , and setting  $h_o$  equal to the larger value. The

fraction  $\frac{d_c + D}{2}$  is a simplified means of computing  $h_o$  when the TW is low and the

discharge does not fill the culvert barrel at the outlet. In this fraction,  $d_c$  is critical depth as determined from Figures 4-20 through 4-25, and  $D$  is the culvert height. The value of  $d_c$  should never exceed  $D$ , making the upper limit of this fraction equal to  $D$ . Figure 4-21 shows the terms of Equation 4-3 for the cases discussed above. Equation 4-3 gives accurate answers if the culvert flows full for a part of the barrel length as illustrated by Figure 4-25. This condition of flow will exist if the headwater, as determined by Equation 4-3, is equal to or greater than the quantity:

$$HW \geq D + (1 + K_e) \frac{V^2}{2g} \quad (4-4)$$

4-4.1.6.1 If the headwater drops below this point, the water surface will be free throughout the culvert barrel as in Figure 4-10, D, and Equation 4-3 will yield answers with some error since the only correct method of finding headwater in this case is by a backwater computation starting at the culvert outlet. Equation 4-3 will give answers of sufficient accuracy for design purposes, however, if the headwater is limited to values greater than  $0.75D$ . For lower headwaters, backwater calculations are required to obtain accurate headwater elevations.

4-4.1.6.2 The depth of TW is important in determining the hydraulic capacity of culverts flowing with outlet control. In many cases, the downstream channel is of considerable width and the depth of water in the natural channel is less than the height of water in the outlet end of the culvert barrel, making the tailwater ineffective as a control. There are instances, however, where the downstream water-surface elevation is controlled by a downstream obstruction or backwater from another stream. A field inspection of all major culvert locations should be made to evaluate downstream controls and determine water stages.

4-4.1.6.3 An approximation of the normal depth of flow in a natural stream (outlet channel) can be made by using Manning's equation,  $V = \frac{1.486}{n} R^{2/3} S^{1/2}$ , if the channel is reasonably uniform in cross section, slope, and roughness. Values of  $n$  for natural streams in Manning's formula are given in Table 5-1. Chart 14 of Appendix B provides the solution to Manning's equation for various channels. This chart could be used to quickly estimate the tailwater depth downstream of the culvert. If the water surface in the outlet channel is established by downstream controls, other means must be found to determine the tailwater elevation. Sometimes this necessitates studying the stage-discharge relation of another stream into which the stream in question flows or securing data on reservoir elevations if a storage dam is involved.

Figure 4-20. Circular Pipe Critical Depth

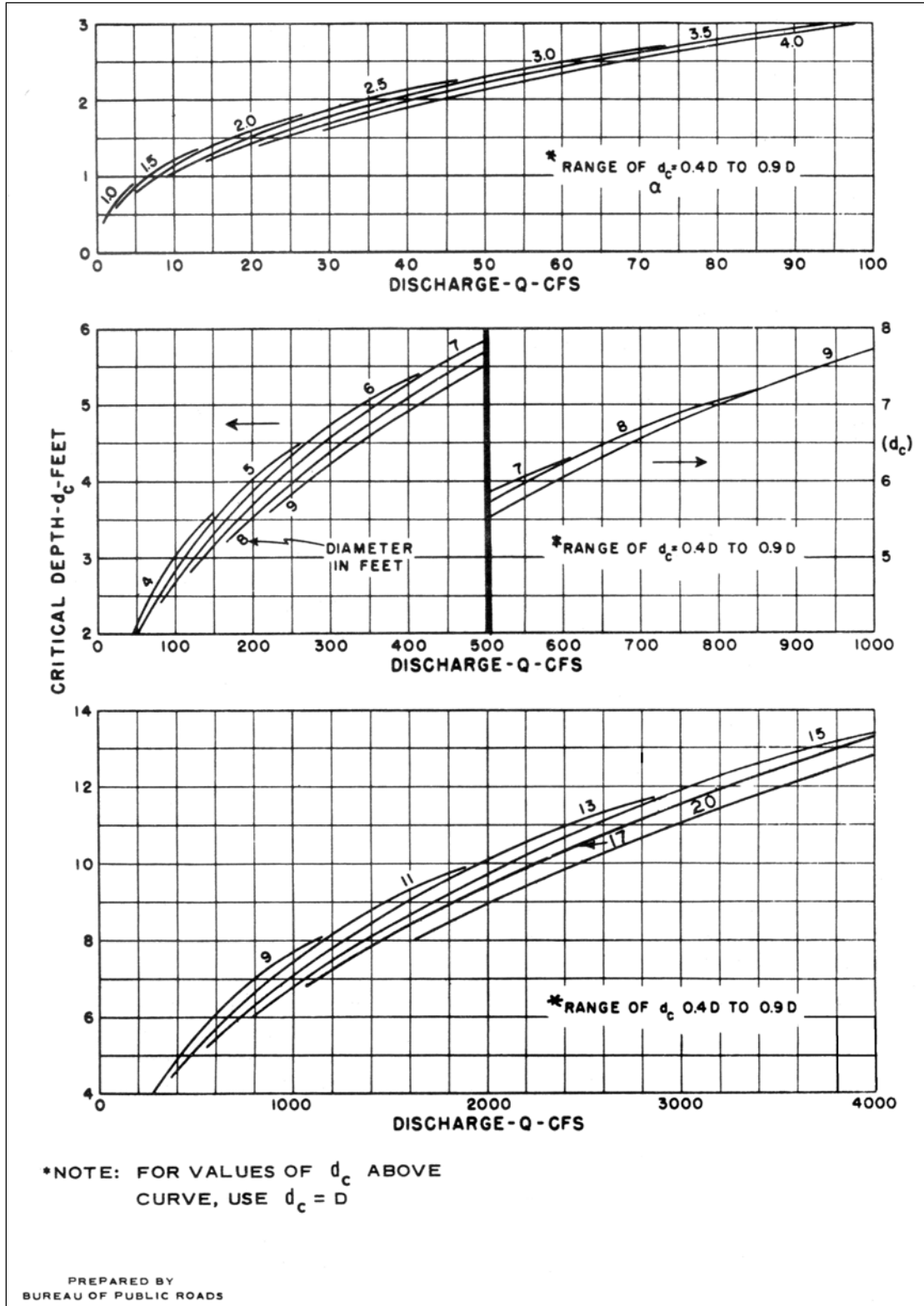




Figure 4-21. Oval Concrete Pipe Long Axis Horizontal Critical Depth

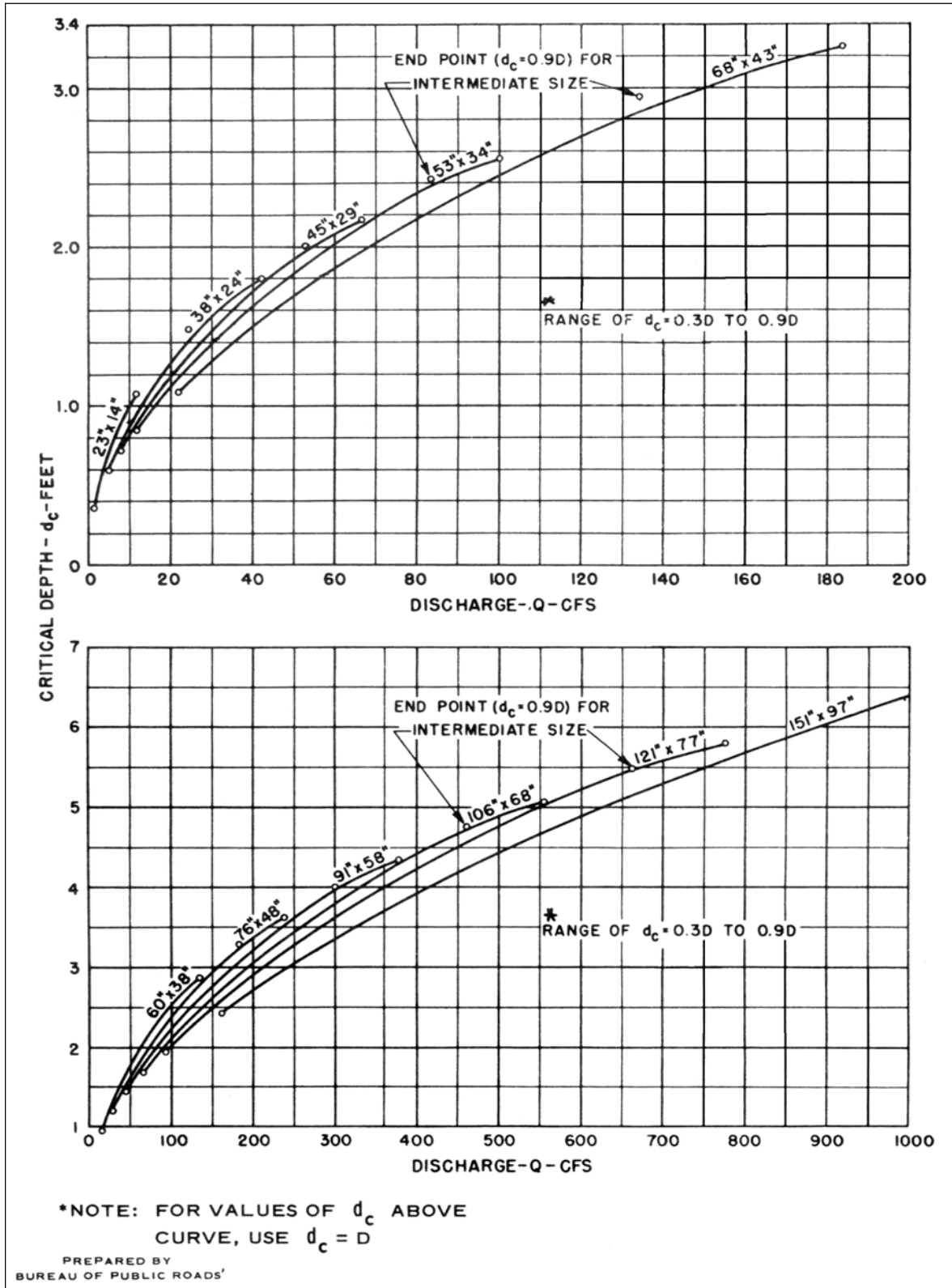


Figure 4-22. Oval Concrete Pipe Long Axis Vertical Critical Depth

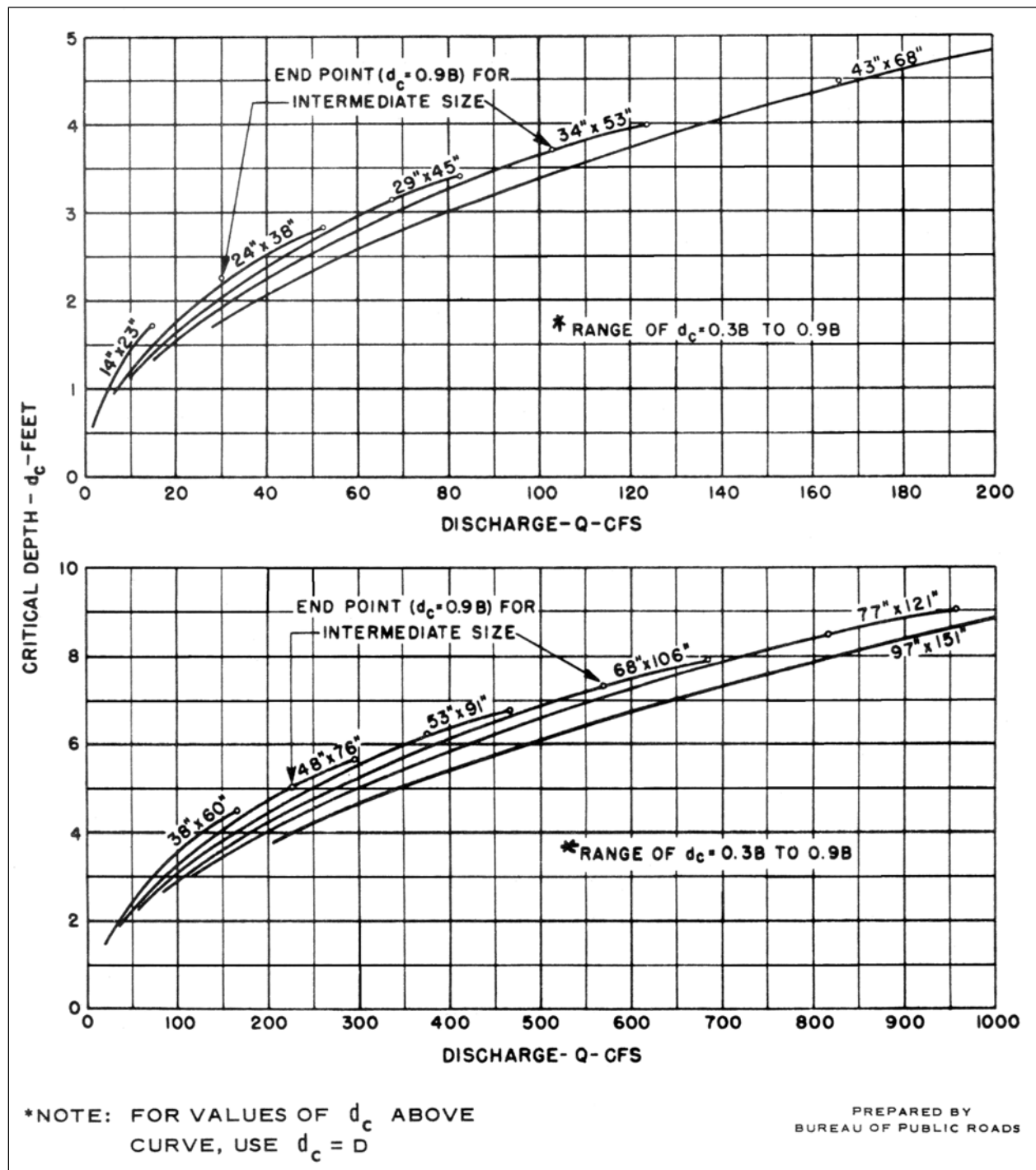


Figure 4-23. Standard Corrugated Metal Pipe-Arch Critical Depth

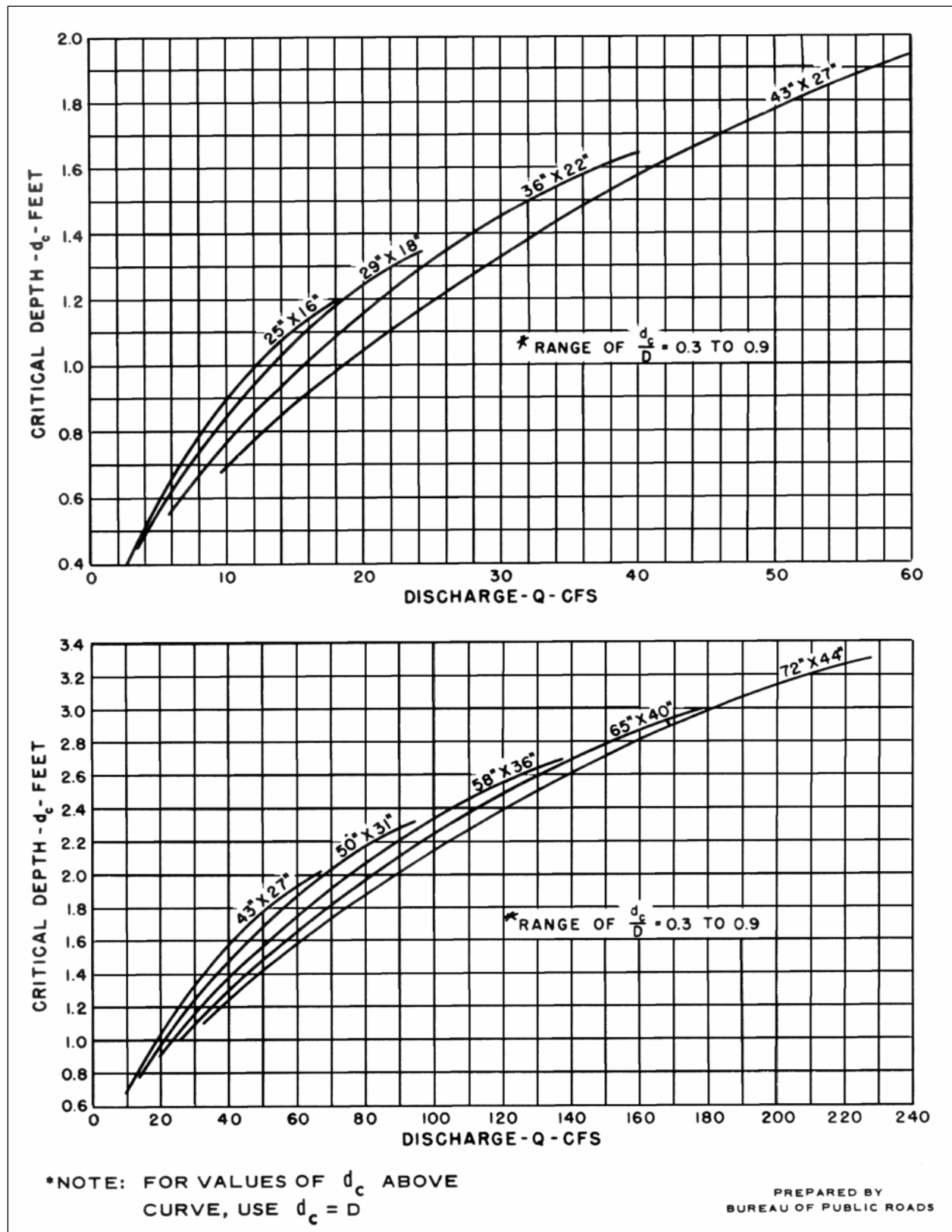


Figure 4-24. Structural Plate Pipe-Arch Critical Depth

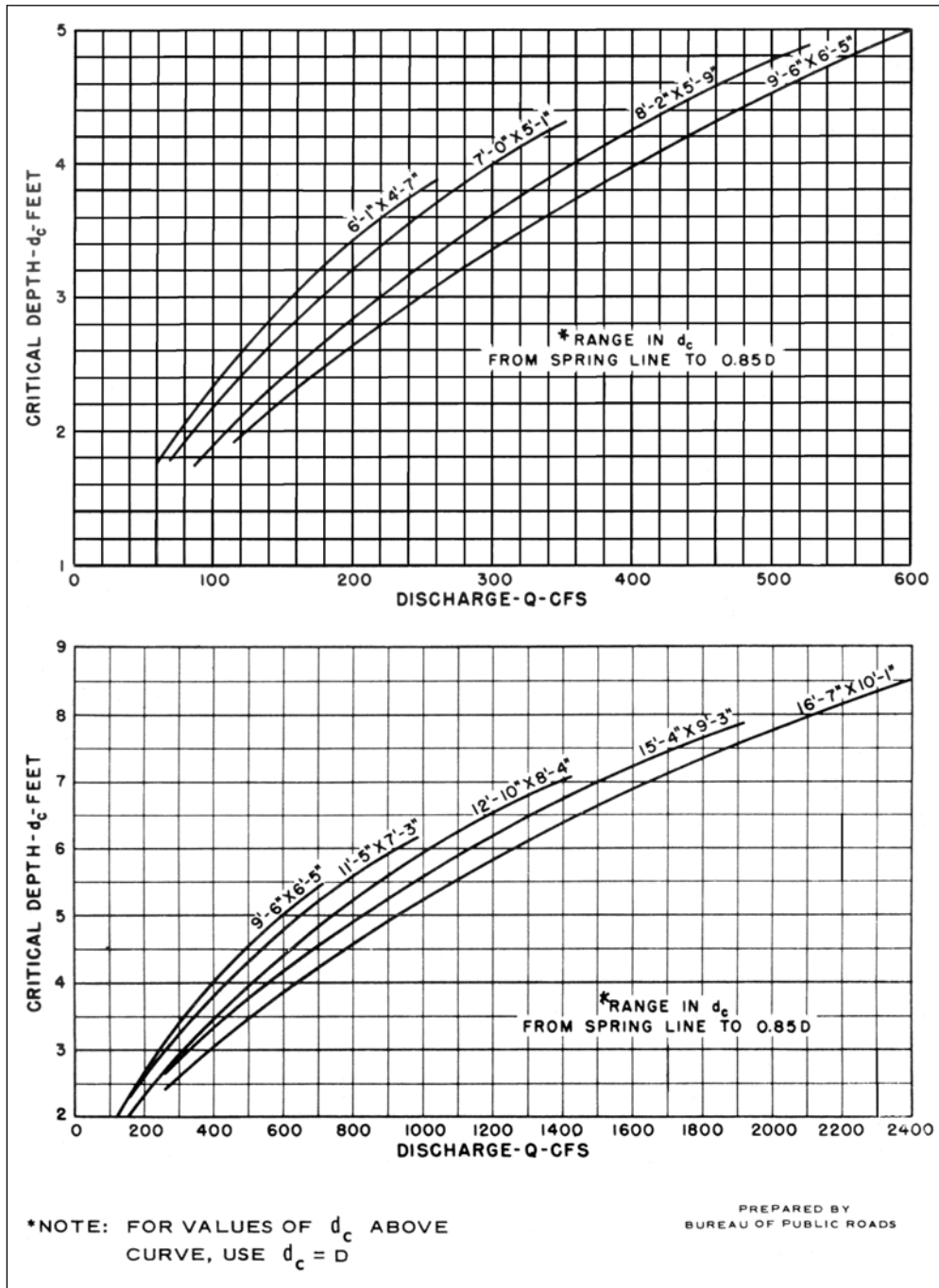
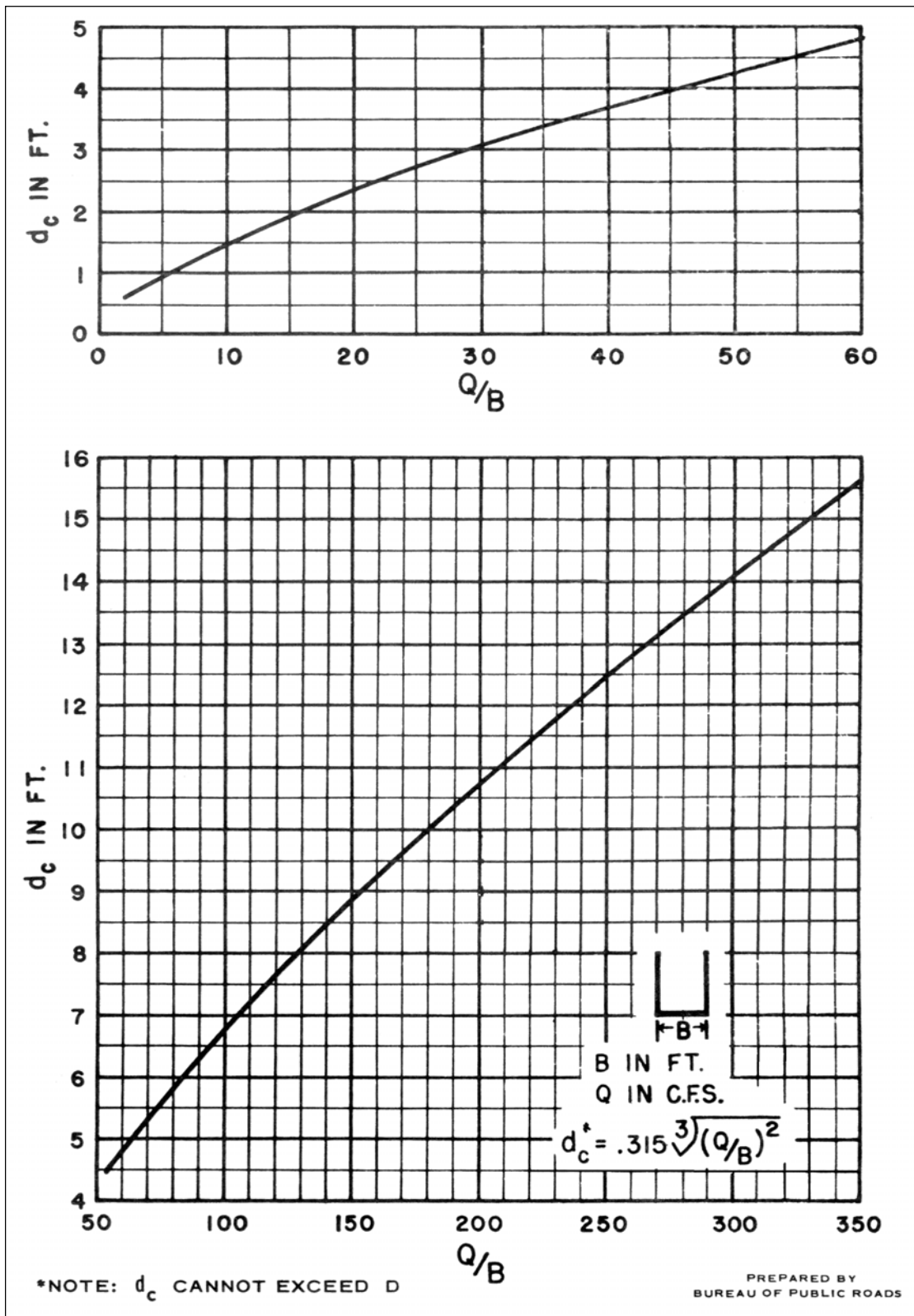


Figure 4-25. Critical Depth Rectangular Section



#### 4-4.1.7 Procedure for Selection of Culvert Size

4-4.1.7.1 Using the Culvert Design Form (Figure 4-26) as a guide, perform the steps in paragraph 4-4.1.7.2 to design a culvert. Evaluate both inlet and outlet control conditions.

4-4.1.7.2 Select the culvert size by following these steps:

- a. Step 1: List the given data.
  - (1) Design discharge,  $Q$ , in  $\text{ft}^3/\text{s}$ .
  - (2) Approximate length of the culvert, in feet.
  - (3) Allowable headwater depth, in feet, which is the vertical distance from the culvert invert (flow line) at entrance to the water-surface elevation permissible in the approach channel upstream from the culvert.
  - (4) Type of culvert, including barrel material, barrel cross-sectional shape, and entrance type.
  - (5) Slope of the culvert. (If the grade is given in percent, convert it to slope in feet per foot.)
  - (6) Allowable outlet velocity (if scour or fish passage are issues).
- b. Step 2: Determine a trial culvert size.
  - (1) Refer to the inlet-control nomograph (Figures 4-2 through 4-9) for the selected culvert type.
  - (2) Using an  $\frac{HW}{D}$  of approximately 1.25 and the scale for the entrance type to be used, find a trial-size culvert by following the instructions for the use of these nomographs. If there are reasons for less or greater relative depth of headwater in a particular case, another value of  $\frac{HW}{D}$  may be used for this trial selection.
  - (3) If the trial size for the culverts is obviously too large because of limited height of embankment or availability of size, try a  $\frac{HW}{D}$  value or multiple culverts by dividing the discharge equally for the number of culverts used. Raising the embankment height or using pipe-arch and box culverts with width greater than height should be considered. Selection should be based on an economic analysis.

Figure 4-26: Culvert Design Form

PROJECT : _____		STATION : _____		<b>CULVERT DESIGN FORM</b>													
SHEET _____ OF _____		DESIGNER / DATE : _____ / _____		REVIEWER / DATE : _____ / _____													
<p style="text-align: center;"><u>HYDROLOGICAL DATA</u></p> <p>SEE ADD'L SHTS. <input type="checkbox"/> METHOD: _____</p> <p><input type="checkbox"/> DRAINAGE AREA: _____ <input type="checkbox"/> STREAM SLOPE: _____</p> <p><input type="checkbox"/> CHANNEL SHAPE: _____</p> <p><input type="checkbox"/> ROUTING: _____ <input type="checkbox"/> OTHER: _____</p> <p style="text-align: center;"><u>DESIGN FLOWS/TAIWATER</u></p> <table style="width:100%; border-collapse: collapse;"> <tr> <td style="width: 33%; text-align: center;">R.I. (YEARS)</td> <td style="width: 33%; text-align: center;">FLOW (cfs)</td> <td style="width: 33%; text-align: center;">TW (ft)</td> </tr> <tr> <td style="text-align: center;">_____</td> <td style="text-align: center;">_____</td> <td style="text-align: center;">_____</td> </tr> </table>			R.I. (YEARS)	FLOW (cfs)	TW (ft)	_____	_____	_____	<p style="text-align: right;">ROADWAY ELEVATION : _____ (ft)</p> <p style="text-align: center;"><math>S = S_0 - \text{FALL} / L_a</math></p> <p style="text-align: center;"><math>S = \text{_____}</math></p> <p style="text-align: center;"><math>L_a = \text{_____}</math></p>								
R.I. (YEARS)	FLOW (cfs)	TW (ft)															
_____	_____	_____															
<u>CULVERT DESCRIPTION:</u> MATERIAL - SHAPE - SIZE - ENTRANCE		TOTAL FLOW Q (cfs)	FLOW PER BARREL Q/N (1)	<u>HEADWATER CALCULATIONS</u>								CONTROL HEADWATER ELEVATION	OUTLET VELOCITY	COMMENTS			
				<u>INLET CONTROL</u>				<u>OUTLET CONTROL</u>									
				HW <sub>i</sub> /D (2)	HW <sub>i</sub>	FALL (3)	EL <sub>hi</sub> (4)	TW (5)	$d_c$	$\frac{d_c + D}{2}$	$h_o$ (6)	$k_o$	H (7)	EL <sub>ho</sub> (8)			
<u>TECHNICAL FOOTNOTES:</u>				(4) $EL_{hi} = HW_i + EL_i$ (INVERT OF INLET CONTROL SECTION)				(6) $h_o = TW$ or $(d_c + D) / 2$ (WHICHEVER IS GREATER)				(7) $H = \left[ 1 + k_o + (29 n^2 L) / R L^{33} \right] v^2 / 2g$					
(1) USE Q/NB FOR BOX CULVERTS				(5) TW BASED ON DOWN STREAM CONTROL OR FLOW DEPTH IN CHANNEL.				(8) $EL_{ho} = EL_o + H + h_o$									
(2) $HW_i / D = HW / D$ OR $HW_i / D$ FROM DESIGN CHARTS																	
(3) $FALL = HW_i - (EL_{hd} - EL_{sf})$ ; FALL IS ZERO FOR CULVERTS ON GRADE																	
<u>SUBSCRIPT DEFINITIONS:</u>			<u>COMMENTS / DISCUSSION:</u>					<u>CULVERT BARREL SELECTED:</u>									
a. APPROXIMATE f. CULVERT FACE hd. DESIGN HEADWATER hi. HEADWATER IN INLET CONTROL ho. HEADWATER IN OUTLET CONTROL i. INLET CONTROL SECTION o. OUTLET sf. STREAMBED AT CULVERT FACE tw. TAILWATER								SIZE : _____ SHAPE : _____ MATERIAL : _____ ENTRANCE : _____									

- c. Step 3: Find the headwater depth for the trial-size culvert.
- (1) Determine and record the headwater depth by use of the appropriate inlet-control nomograph (Figures 4-2 through 4-9). Tailwater conditions are to be neglected in this determination. Headwater in this case is found by simply multiplying  $\frac{HW}{D}$  obtained from the nomograph by  $D$ .
  - (2) Compute and record the headwater for outlet control using these instructions:
    - (a) Approximate the depth of the tailwater for the design flood condition in the outlet channel. The tailwater depth may also be due to backwater caused by another stream or some control downstream.
    - (b) For tailwater depths equal to or above the depth of the culvert at the outlet, set the tailwater equal to  $h_o$  and find the headwater by the following equation:

$$HW = h_o + H - S_oL$$

$H$  is estimated from the outlet control nomographs (Figures 4-11 through 4-17).

- (c) For tailwater elevations below the crown of the culvert at the outlet, use the following equation to find the headwater:

$$HW = h_o + H - S_oL$$

where  $h_o = \frac{d_c + D}{2}$  or TW, whichever is greater. When  $d_c$

(Figures 4-20 through 4-25) exceeds the height of the culvert,  $h_o$  should be set equal to  $D$ . Again,  $H$  is estimated from the outlet control nomographs (Figures 4-11 through 4-17).

- (3) Compare the headwater determined from the inlet control and outlet control computations. The higher headwater governs and indicates the flow control existing under the given conditions.
- (4) Compare the higher headwater with that allowable at the site. If headwater is greater than allowable, repeat the procedure using a larger culvert. If headwater is less than allowable, repeat the procedure to investigate the possibility of using a smaller size.



- d. Step 4: Check the outlet velocities for the selected size.
- (1) If outlet control governs in Step 3(2)c, outlet velocity equals  $\frac{Q}{A}$ , where  $A$  is the cross-sectional area of flow at the outlet. If  $d_c$  or TW is less than the height of the culvert barrel, use a cross-sectional area corresponding to  $d_c$  or TW depth, whichever gives the greater area of flow. The total barrel area is used when the tailwater exceeds the top of the barrel.
  - (2) If inlet control governs in Step 3(2)c, outlet velocity can be assumed to equal normal velocity in open-channel flow as computed by Manning's equation for the barrel size, roughness, and slope of the selected culvert. The FHWA's HDS-3 contains many charts that can be used to estimate the normal depth exiting a culvert. Both circular and box shapes are represented in HDS-3.
- e. Step 5: Try a culvert of another type or shape and determine the size and headwater by the same procedure.
- f. Step 6: Record the final selection of culvert with size, type, outlet velocity, required headwater, and economic justification on the Culvert Design Form (Figure 4-26).

#### 4-4.1.8 Instructions for Using the Inlet-Control Nomographs (Figures 4-2 through 4-9)

##### 4-4.1.8.1 To determine headwater:

- a. Connect with a straight edge the given culvert diameter or height,  $D$ , and the discharge,  $Q$ , or  $\frac{Q}{B}$  for box culverts; mark the intersection of the straight edge on  $\frac{HW}{D}$  scale 1.
- b. If  $\frac{HW}{D}$  scale 1 represents the entrance type used, read  $\frac{HW}{D}$  on scale 1. If some other entrance type is used, extend the point of intersection ((a) above) horizontally to scale 2 or 3 and read  $\frac{HW}{D}$ .
- c. Compute the headwater by multiplying  $\frac{HW}{D}$  by  $D$ .

4-4.1.8.2 To determine the culvert size:

- a. Given an  $\frac{HW}{D}$  value, locate  $\frac{HW}{D}$  on the scale for the appropriate entrance type. If scale 2 or 3 is used, extend  $\frac{HW}{D}$  point horizontally to scale 1.
- b. Connect the point on  $\frac{HW}{D}$  scale 1 ((a) above) to the given discharge and read the required diameter, height, or size of the culvert.

4-4.1.8.3 To determine the discharge:

- a. Given  $HW$  and  $D$ , locate  $\frac{HW}{D}$  on the scale for the appropriate entrance type. Continue as in paragraph 4-4.1.8.2, step (a).
- b. Connect the point on  $\frac{HW}{D}$  scale 1 ((a) above) and the size of the culvert on the left scale and determine  $Q$  or  $\frac{Q}{B}$  on the discharge scale.
- c. If  $\frac{Q}{B}$  is determined, multiply  $B$  to find  $Q$ .

4-4.1.9 **Instructions for Using the Outlet-Control Nomographs.** Figures 4-11 through 4-17 are nomographs to solve for the head when culverts flow full with outlet control. They are also used in approximating the head for some partially full flow conditions with outlet control. These nomographs do not give a complete solution for finding headwater.

- a. Locate the appropriate nomograph for the selected type of culvert.
- b. Begin finding the nomograph solution by locating a starting point on the length scale. To locate the proper starting point on the length scale, follow these instructions:
  - (1) If the  $n$  value of the nomograph corresponds to that of the culvert being used, find the proper  $K_e$  from Table 4-1, and on the appropriate nomograph, locate the starting point on the length curve for the  $K_e$ . If a  $K_e$  curve is not shown for the selected  $K_e$ , go to step 2, below. If the  $n$  value for the selected culvert differs from that of the nomograph, see step 3, below.
  - (2) For the  $n$  of the nomograph and a  $K_e$  intermediate between the given scales, connect the given length on adjacent scales by a straight line

and select a point on this line spaced between the two chart scales in proportion to the  $K_e$  values.

- (3) For a different value of roughness coefficient,  $n_1$ , than that of the chart  $n$ , use the length scales shown with an adjusted length,  $L_1$ , calculated by the formula:

$$L_1 = L \left( \frac{n_1}{n} \right)^2 \quad (4-5)$$

where:  $L_1$  = adjusted culvert length

$L$  = actual culvert length

$n_1$  = desired  $n$  value

$n$  =  $n$  value from the outlet control chart

- c. Using a straight edge, connect the point on the length scale to the size of the culvert barrel and mark the point of crossing on the "turning line."
- d. Pivot the straight edge on this point on the turning line and connect the given discharge rate. Read the head in feet on the head scale. For values beyond the limit of the chart scales, find  $H$  by solving the equation given in the nomograph or by using the FHWA's HY-8 computer program.

4-4.1.9.1 Table 4-1 is used to find the  $n$  value for the selected culvert.

4-4.1.9.2 To use the box-culvert nomograph (Figure 4-17) for full flow for other than square boxes:

- a. Compute the cross-sectional area of the rectangular box.

**NOTE:** The area scale on the nomograph is calculated for barrel cross sections with span  $B$  twice the height  $D$ ; its close correspondence with the area of square boxes assures that it may be used for all sections intermediate between square and  $B = 2D$  or  $B = 2/3D$ . For other box proportions, use the equation shown in the nomograph for more accurate results.

- b. Connect the proper point on the length scale to the barrel area and mark the point on the turning line.
- c. Pivot the straight edge on this point on the turning line and connect the given discharge rate. Read the head in feet on the head scale.

#### 4-4.2 Headwalls and Endwalls

4-4.2.1 The normal functions of a headwall or wingwall are to recess the inflow or outflow end of the culvert barrel into the fill slope to improve entrance flow conditions, to anchor the pipe and to prevent disjuncting caused by excessive pressures, to control erosion and scour resulting from excessive velocities and turbulences, and to prevent adjacent soil from sloughing into the waterway opening.

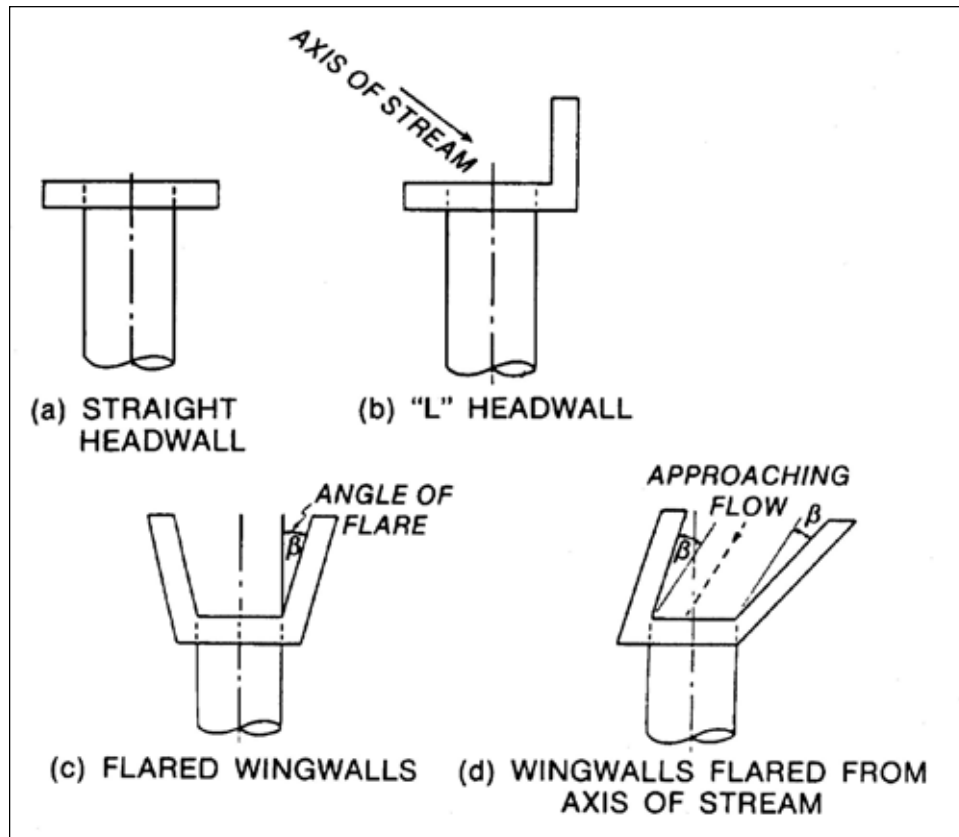
4-4.2.2 Headwalls are particularly desirable as a cutoff to prevent saturation sloughing, piping, and erosion of the embankment. Provisions for drainage should be made over the center of the headwall to prevent scouring along the sides of the walls.

4-4.2.3 Whether or not a headwall is desirable depends on the expected flow conditions and the embankment stability. Erosion protection such as riprap or sacked concrete with a sand-cement ratio of 9:1 may be required around the culvert entrance if a headwall is not used.

4-4.2.4 In the design of headwalls, some degree of entrance improvement should always be considered. The most efficient entrances would incorporate one or more of such geometric features as elliptical arcs, circular arcs, tapers, and parabolic drop-down curves. Elaborate inlet design for a culvert would be justifiable only in unusual circumstances. The rounding or beveling of the entrance in almost any way will increase the culvert capacity for every design condition. These types of improvements provide a reduction in the loss of energy at the entrance for little or no additional cost.

4-4.2.5 Entrance structures (headwalls and wingwalls) protect the embankment from erosion and, if properly designed, may improve the hydraulic characteristics of the culvert. The height of these structures should be kept to the minimum that is consistent with hydraulic, geometric, and structural requirements. Several entrance structures are shown in Figure 4-27. Straight headwalls (Figure 4-27a) are used for low to moderate approach velocity, light drift (small floating debris), broad or undefined approach channels, or small defined channels entering culverts with little change in alignment. The "L" headwall (Figure 4-27b) is used if an abrupt change in flow direction is necessary with low to moderate velocities; however, before an "L" headwall is considered, all efforts should be made to align the culvert with the natural stream. The change in flow direction often causes debris and sediment problems. Winged headwalls or wingwalls (Figure 4-27c) are used for channels with moderate velocity and medium floating debris. Wingwalls are most effective when set flush with the edges of the culvert barrel, aligned with the stream axis (Figure 4-27d), and placed at a flare angle of 18 to 45 degrees. Warped wingwalls (not shown) are used for well-defined channels with high-velocity flow and a free water surface. They are used primarily with box culverts. Warped headwalls are hydraulically efficient because they form a gradual transition from a trapezoidal channel to the barrel. The use of a drop-down apron in conjunction with these wingwalls may be particularly advantageous.

Figure 4-27. Culvert Headwalls and Wingwalls



4-4.2.6 Headwalls are normally constructed of plain or reinforced concrete or of masonry and usually consist of either a straight headwall or a headwall with wingwalls, apron, and cutoff wall, as required by local conditions. Definite design criteria applicable to all conditions cannot be formulated, but certain features require careful consideration to ensure an efficient headwall structure:

- Most culverts outfall into a waterway of relatively large cross section; only moderate tailwater is present, and except for local acceleration, if the culvert effluent freely drops, the downstream velocities gradually diminish. In such situations, the primary problem is usually not one of hydraulics but the protection of the outfall against undermining bottom scour, damaging lateral erosion, and perhaps degrading the downstream channel. The presence of tailwater higher than the culvert crown will affect the culvert performance and may possibly require protection of the adjacent embankment against wave or eddy scour. In any event, a determination must be made about downstream control, its relative permanence, and tailwater conditions likely to result. Endwalls (outfall headwalls) and wingwalls will not be used unless justifiable as an integral part of outfall energy dissipators or erosion protection works, or for reasons such as right-of-way restrictions and occasionally aesthetics.

- The system will fail if there is inadequate endwall protection. Usually the end sections are damaged first, thus causing flow obstruction and progressive undercutting during high runoff periods, which causes washout of the structure. For corrugated metal (pipe or arch) culvert installations, the use of prefabricated end sections may prove desirable and economically feasible. When a metal culvert outfall projects from an embankment fill at a substantial height above natural ground, either a cantilevered free outfall pipe or a pipe downspout will probably be required. In either case, the need for additional erosion protection requires consideration.

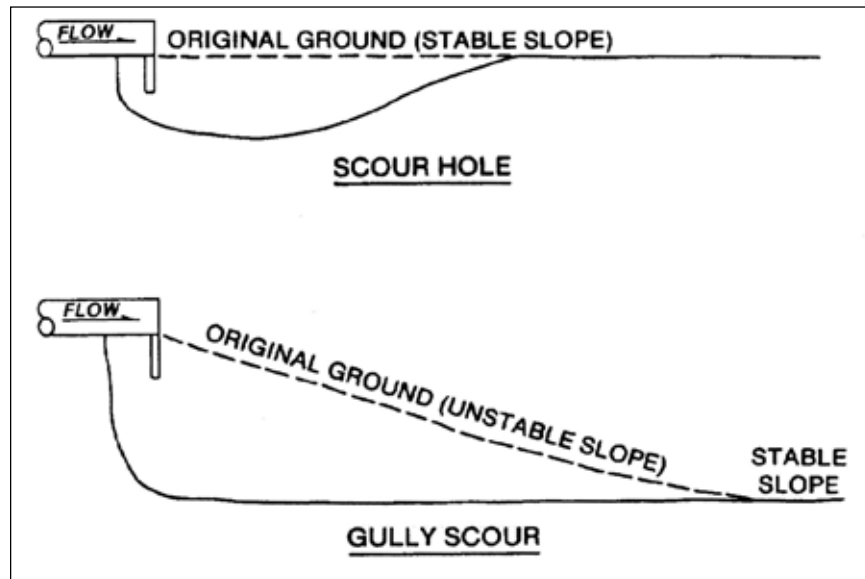
4-4.2.7 Headwalls and endwalls incorporating various designs of energy dissipators, flared transitions, and erosion protection for culvert outfalls are explained in detail in subsequent sections of this chapter.

4-4.2.8 Headwalls or endwalls will be adequate to withstand soil and hydrostatic pressures. In areas of seasonal freezing, the structure will also be designed to preclude detrimental heave or lateral displacement caused by frost action. The most satisfactory method of preventing such damage is to restrict frost penetration beneath and behind the wall to non-frost-susceptible materials. Positive drainage behind the wall is also essential. Criteria for determining the depth of backfill behind walls are given in UFC 3-220-03FA.

4-4.2.9 The headwalls or endwalls will be large enough to preclude the partial or complete stoppage of the drain by sloughing of the adjacent soil. This can best be accomplished by a straight headwall or by wingwalls. Typical erosion problems result from uncontrolled local inflow around the endwalls. The recommended preventive for this type of failure is the construction of a berm behind the endwall (outfall headwall) to intercept local inflow and direct it properly to protected outlets such as field inlets and paved or sodded chutes that will conduct the water into the outfall channel. The proper use of solid sodding will often provide adequate headwall and channel protection.

4-4.2.10 In general, two types of channel instability can develop downstream from storm sewer and culvert outlets: gully scour or a localized erosion termed a scour hole. Distinction between the two conditions can be made by comparing the original or existing slope of the channel or drainage basin downstream of the outlet relative to that required for stability as illustrated in Figure 4-28.

Figure 4-28. Types of Scour at Storm Drain and Culvert Outlets



4-4.2.10.1 Gully scour is to be expected when the Froude number of flow ( $F = V/(gy)^{0.5}$  where  $F$  is the Froude Number,  $g$  is  $32.3 \text{ ft/s}^2$ , and  $y$  is the depth of water in the channel) in the channel exceeds that required for stability. It begins at a control point downstream where the channel is stable and it progresses upstream. If sufficient differential in elevation exists between the outlet and the section of stable channel, the outlet structure will be completely undermined. The primary cause of gully scour is the practice of siting outlets high, with or without energy dissipators relative to a stable downstream grade in order to reduce quantities of pipe and excavation. Erosion of this type may be extensive, depending upon the location of the stable channel section relative to that of the outlet in both the vertical and downstream directions. To prevent gully erosion, outlets and energy dissipators should be located at sites where the slope of the downstream channel or drainage basin is naturally moderate enough to remain stable under the anticipated conditions, or else it should be controlled by ditch checks, drop structures, and/or other means to a point where a naturally stable slope and cross section exist. Design of stable open channels is discussed later in this UFC.

4-4.2.10.2 A scour hole or localized erosion can occur downstream of an outlet even if the downstream channel is stable. The severity of damage to be anticipated depends upon the conditions existing or created at the outlet. In many situations, flow conditions can produce scour resulting in embankment erosion as well as structural damage to the apron, endwall, and culvert.

4-4.2.10.3 Empirical equations have been developed for estimating the extent of the anticipated scour hole in sand. These equations are based on knowledge of the design discharge, the culvert diameter, and the duration and Froude number of the design flow at the culvert outlet; however, the relationship between the Froude number of flow at the culvert outlet and a discharge parameter, or  $Q/D_o^{5/2}$ , can be calculated for any shape of

outlet, and this discharge parameter is just as representative of flow conditions as is the Froude number. The relationship between the two parameters for partial and full pipe flow in square culverts is shown in Figure 4-29. Since the discharge parameter is easier to calculate and is suitable for application purposes, the original data were reanalyzed in terms of discharge parameter for estimating the extent of localized scour to be anticipated downstream of culvert and storm drain outlets. The equations for the maximum depth, width, length, and volume of scour and comparisons of predicted and observed values are shown in Figures 4-30 through 4-33. Minimum and maximum tailwater depths are defined as those less than  $0.5D_o$  and equal to or greater than  $0.5D_o$ , respectively. Dimensionless profiles along the center lines of the scour holes to be anticipated with minimum and maximum tailwaters are presented in Figure 4-34 and Figure 4-35. Dimensionless cross sections of the scour hole at a distance of 0.4 of the maximum length of scour downstream of the culvert outlet for all tailwater conditions are also shown in Figure 4-34 and Figure 4-35.

Figure 4-29. Square Culvert Froude Number

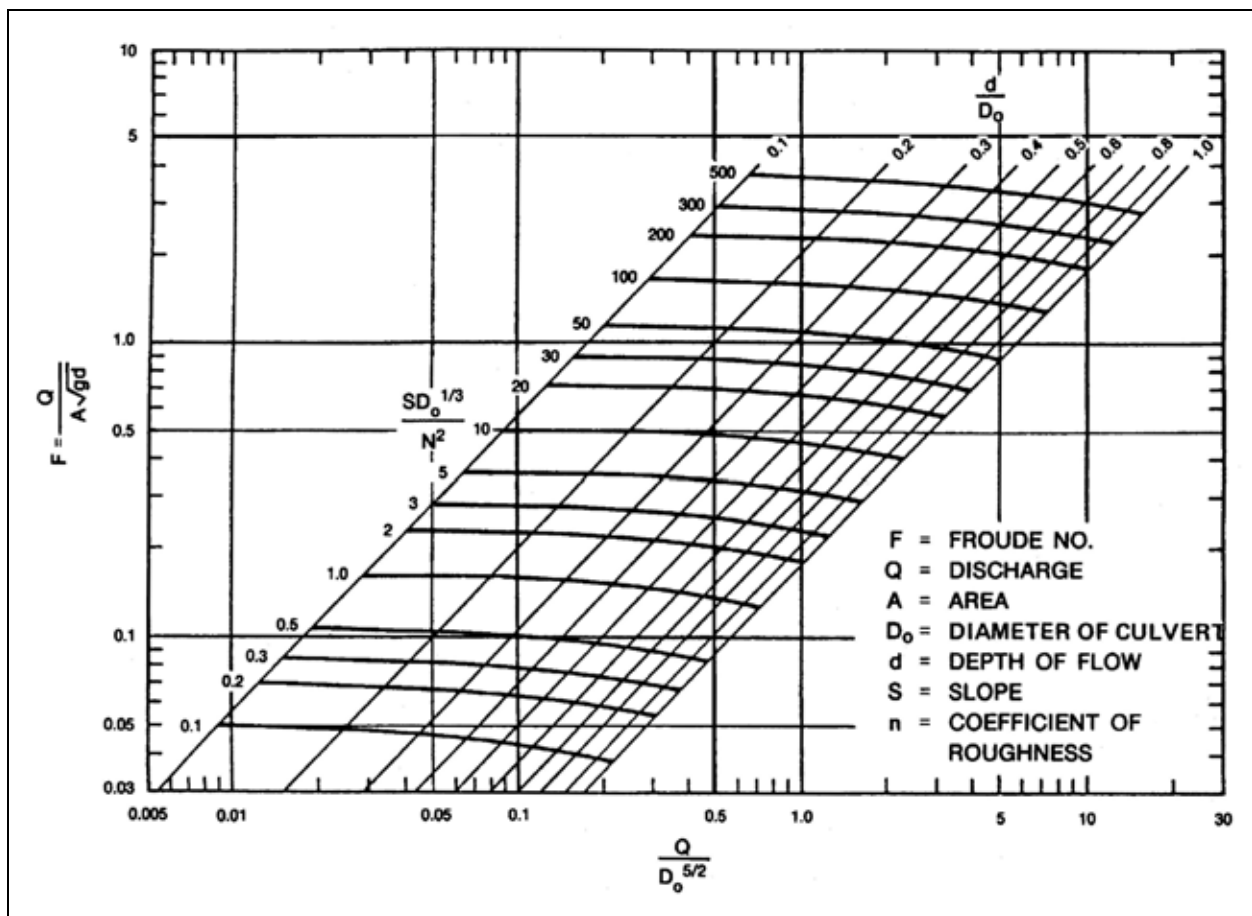




Figure 4-30. Predicted Scour Depth vs. Observed Scour Depth

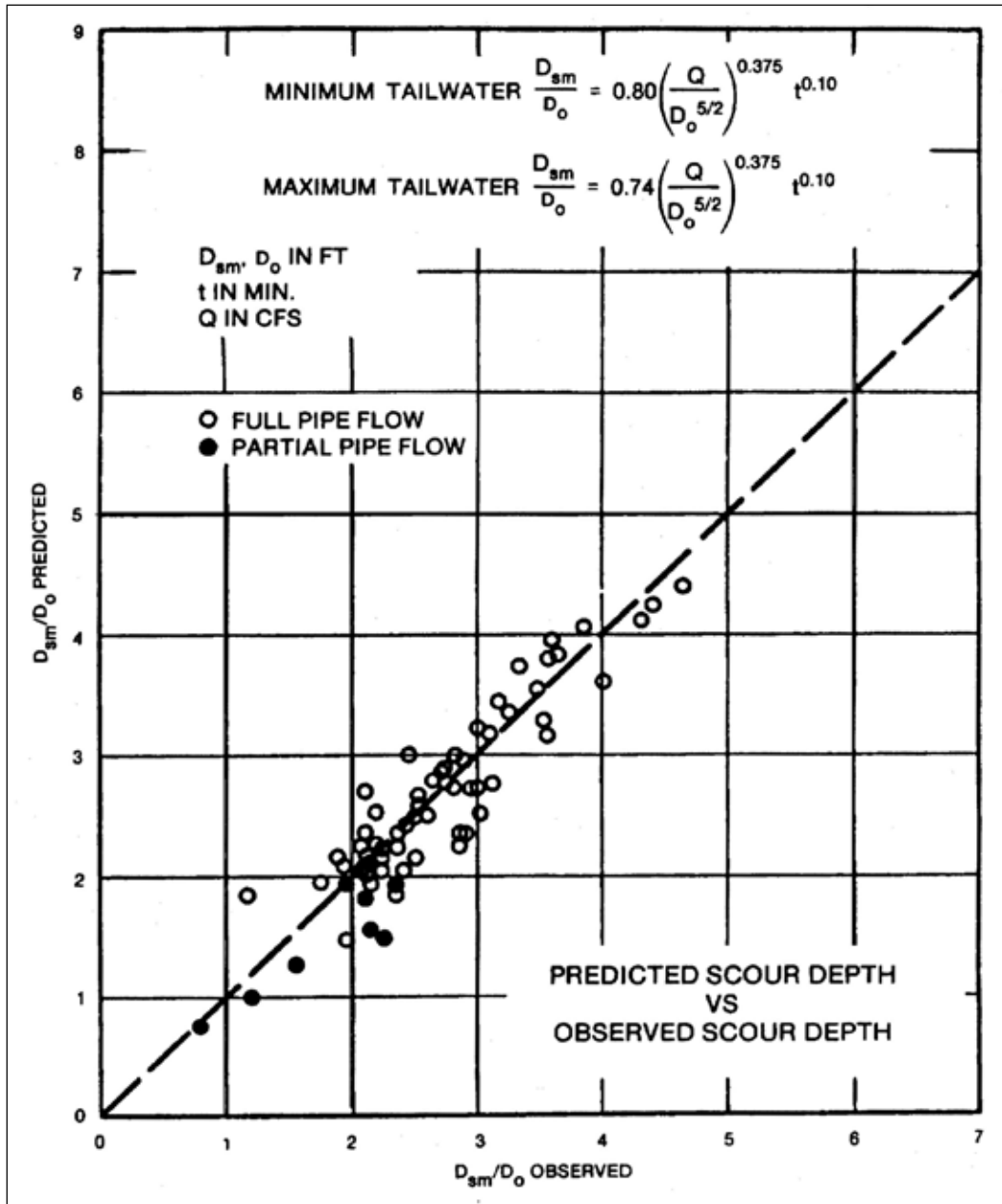


Figure 4-31. Predicted Scour Width vs. Observed Scour Width

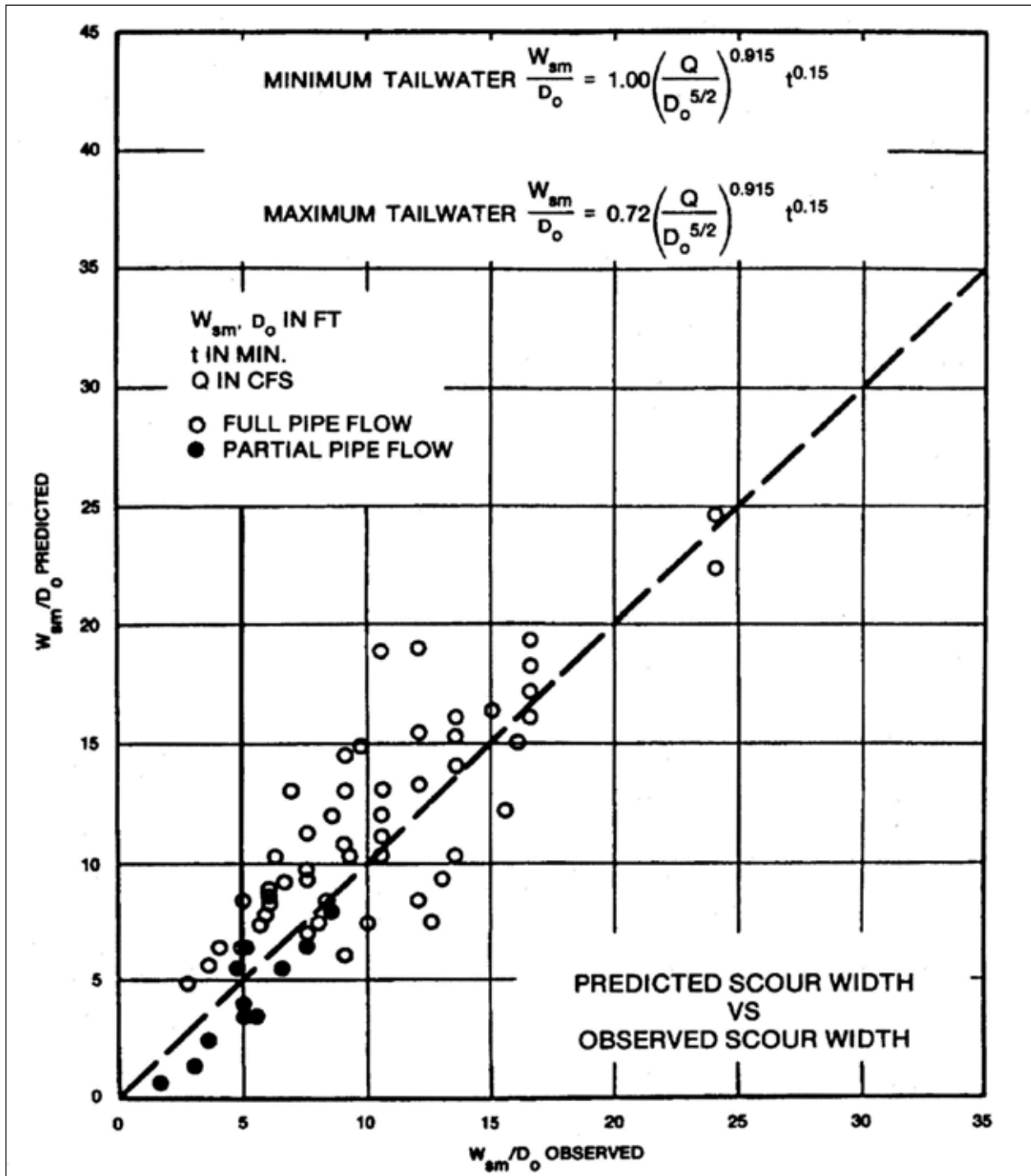


Figure 4-32. Predicted Scour Length vs. Observed Scour Length

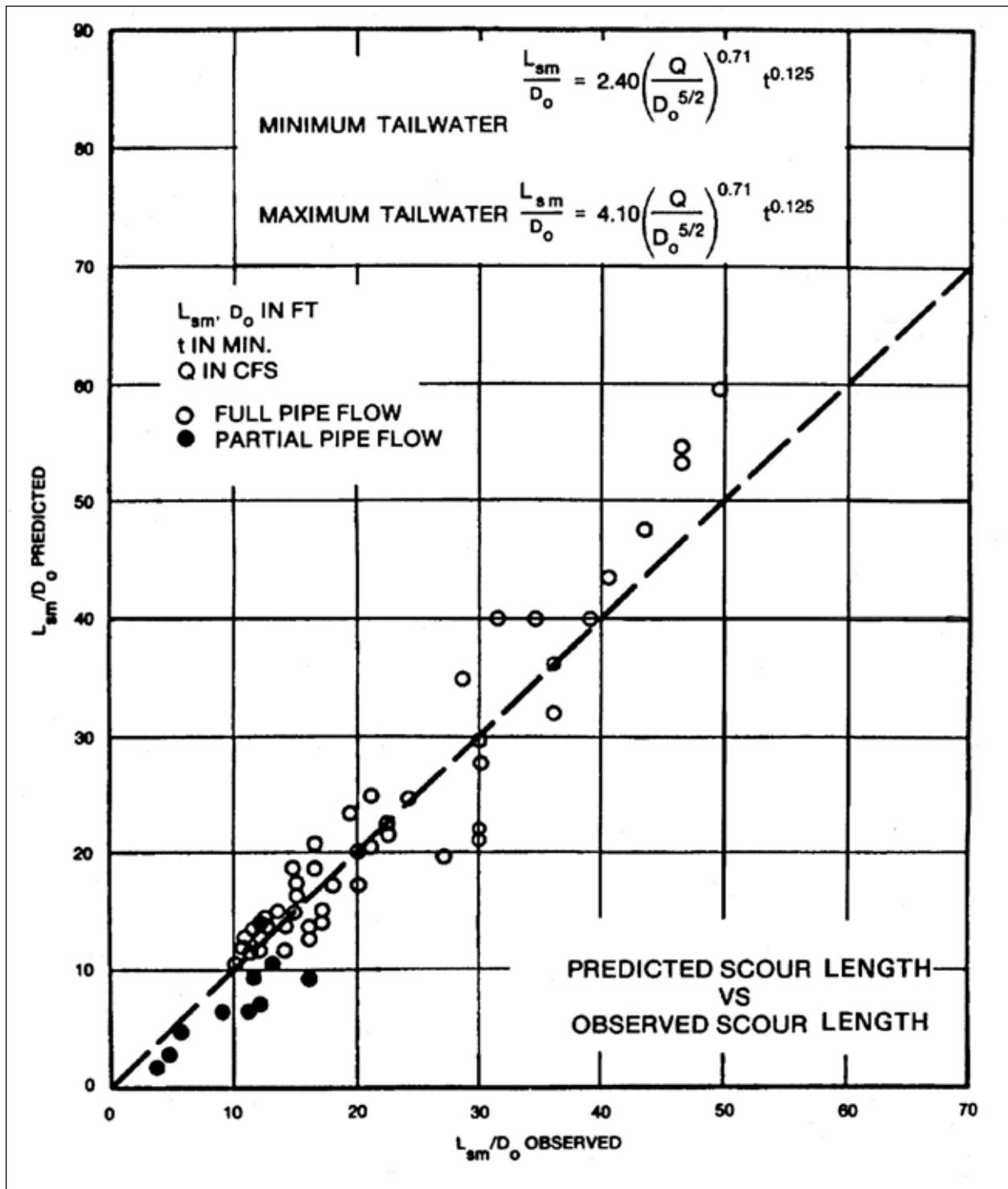


Figure 4-33. Predicted Scour Volume vs. Observed Scour Volume

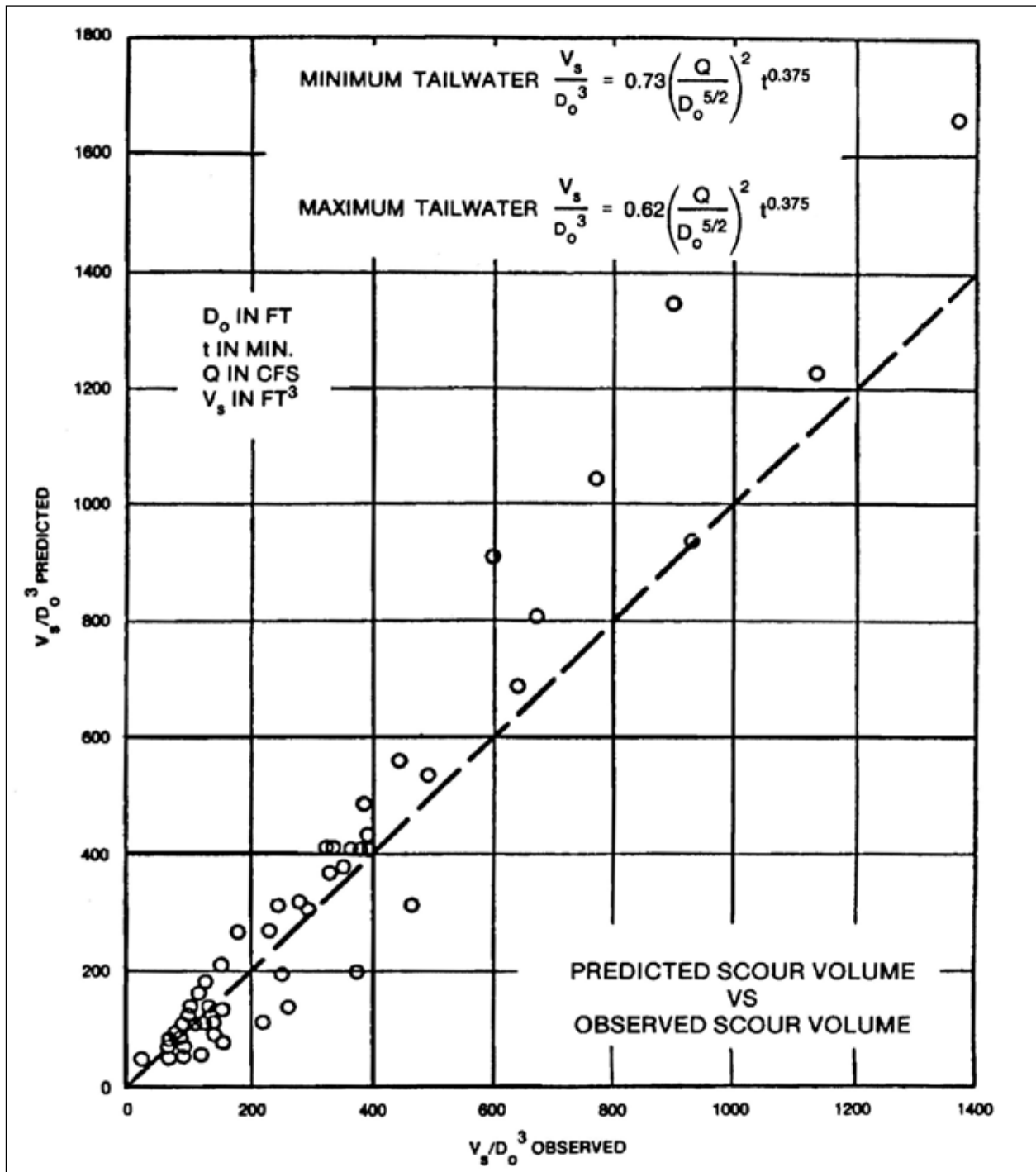


Figure 4-34. Dimensionless Scour Hole Geometry for Minimum Tailwater

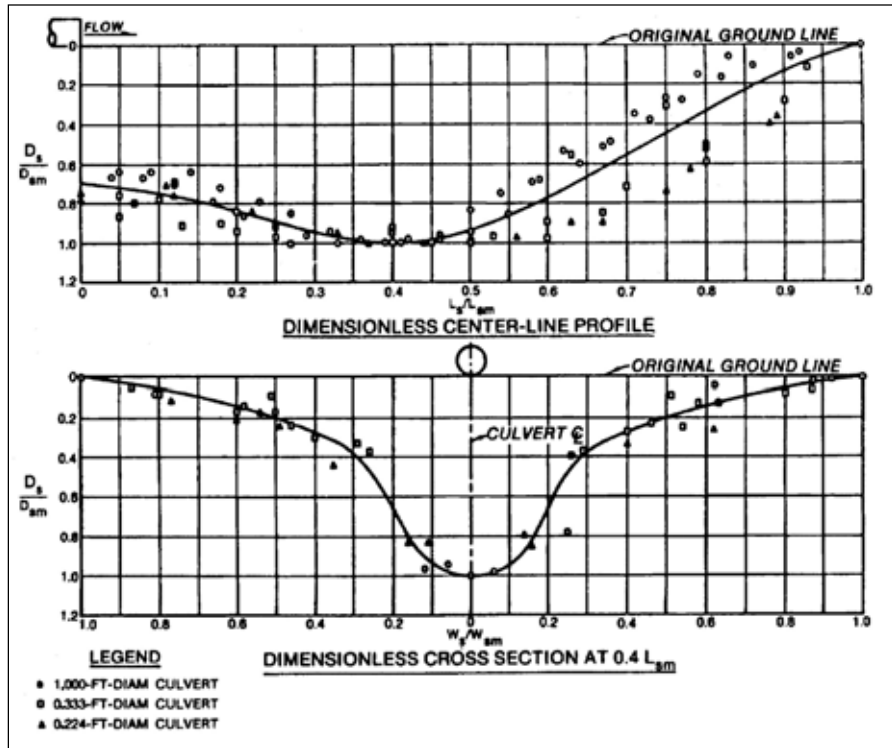
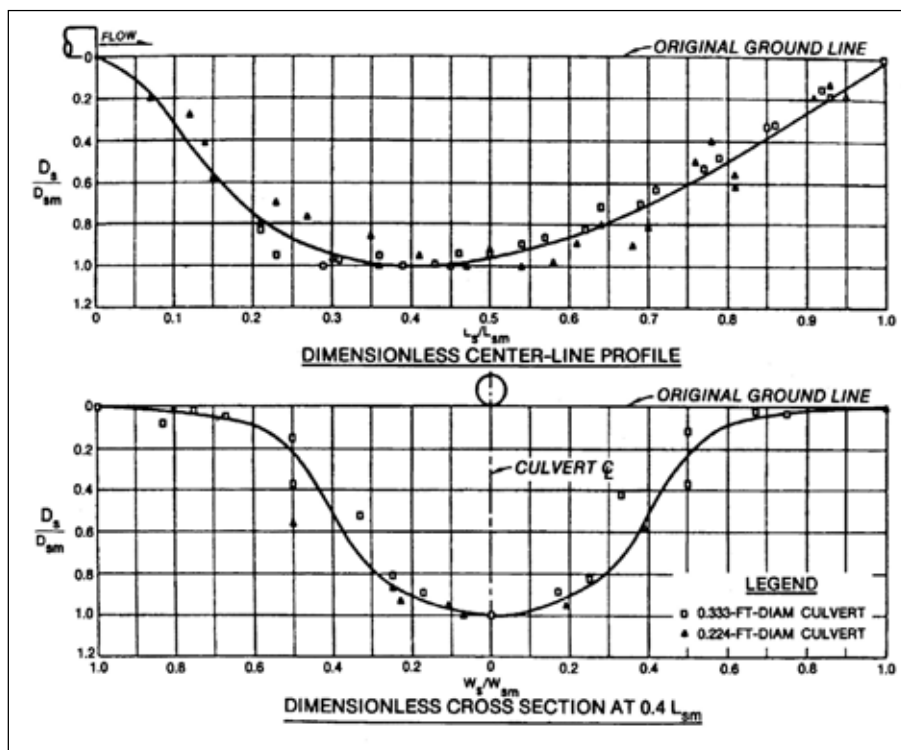


Figure 4-35. Dimensionless Scour Hole Geometry for Maximum Tailwater



4-4.3 **Erosion Control at Outlets.** There are various methods of preventing scour and erosion at outlets and protecting the structure from undermining. Some of these methods will be explained in subsequent paragraphs. For a complete description of scour at the outlet of culverts and the design of energy dissipators, refer to the FHWA's HEC-14. It has charts, nomographs, and tables necessary for estimating scour holes and the design of energy dissipators. In addition, the HY-8 culvert evaluation software, also available from the FHWA, uses the techniques discussed in HEC-14 to perform scour hole calculations and energy dissipator designs. HEC-14 and HY-8 are highly recommended for energy dissipater design.

4-4.3.1 In some situations, placement of riprap at the end of the outlet may be sufficient to protect the structure. The average size of stone ( $d_{50}$ ) and configuration of a horizontal blanket of riprap at outlet invert elevation required to control or prevent localized scour downstream of an outlet can be estimated using the information in Figures 4-36 to 4-38. For a given design discharge, culvert dimensions, and tailwater depth relative to the outlet invert, the minimum average size of stone ( $d_{50}$ ) for a horizontal blanket of protection can be determined using data in Figure 4-36. The length of stone protection (LSP) can be determined by the relations shown in Figure 4-37. The recommended configuration of the blanket is shown in Figure 4-38.

Figure 4-36. Recommended Size of Protective Stone

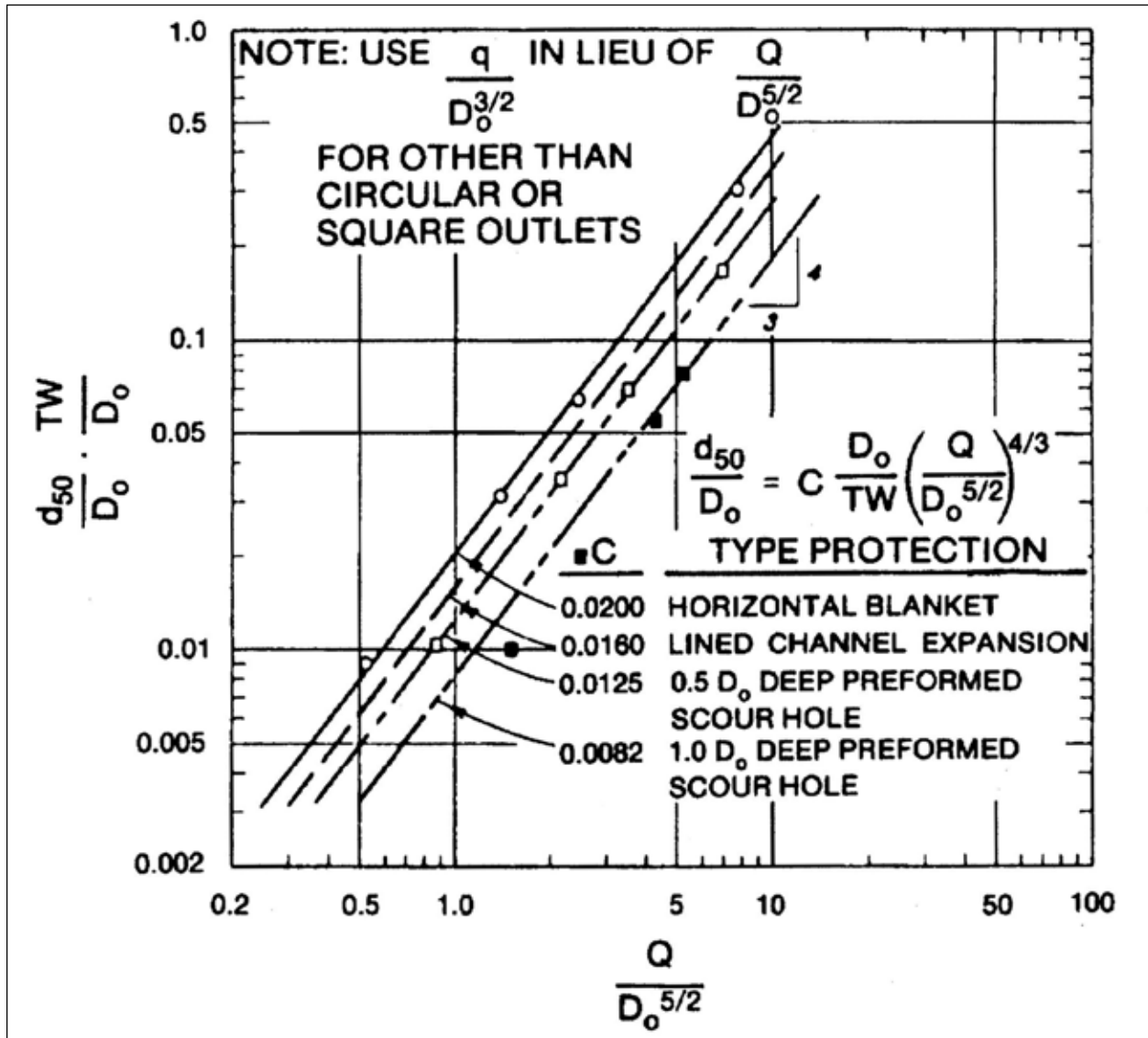


Figure 4-37. Length of Stone Protection, Horizontal Blanket

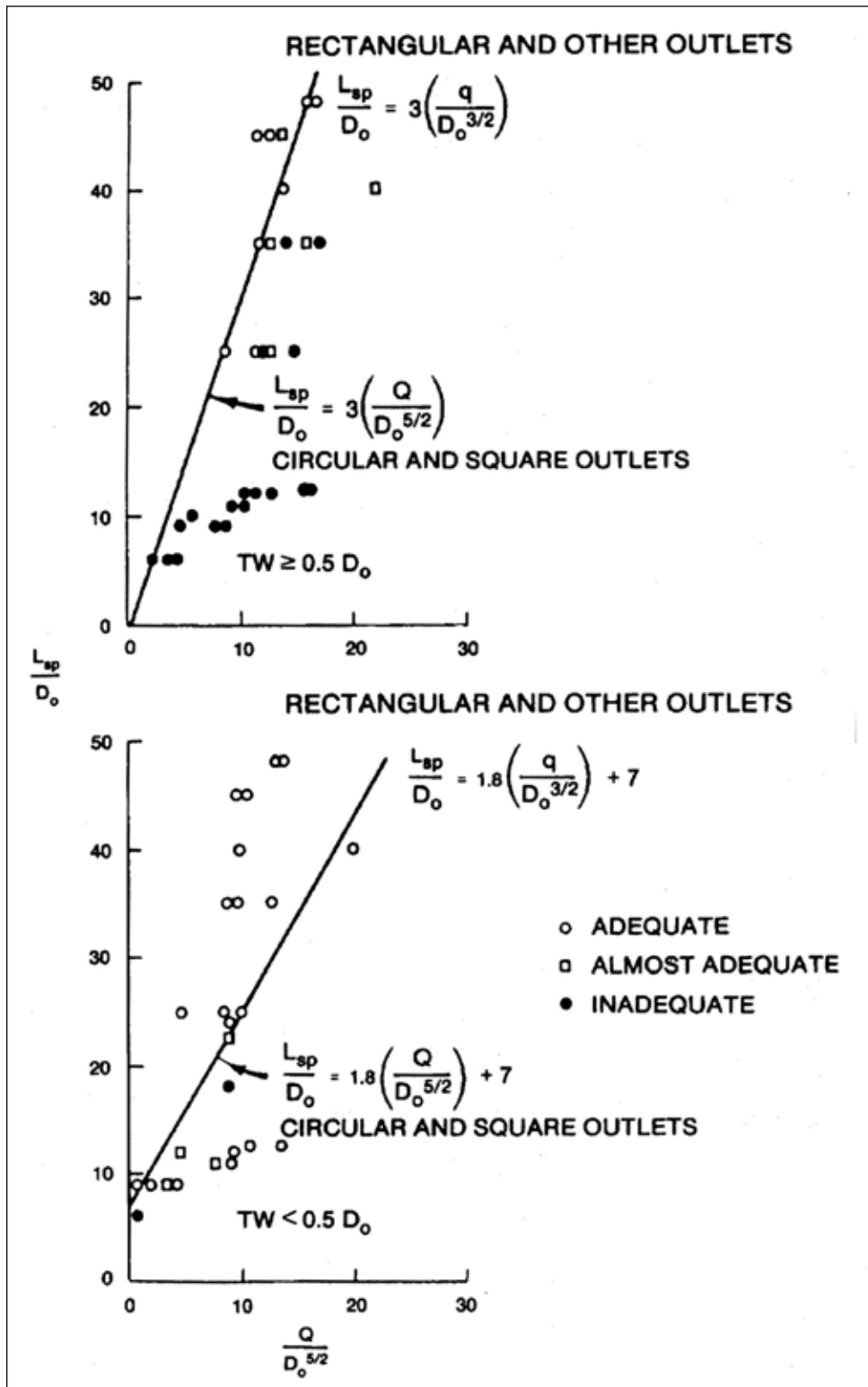
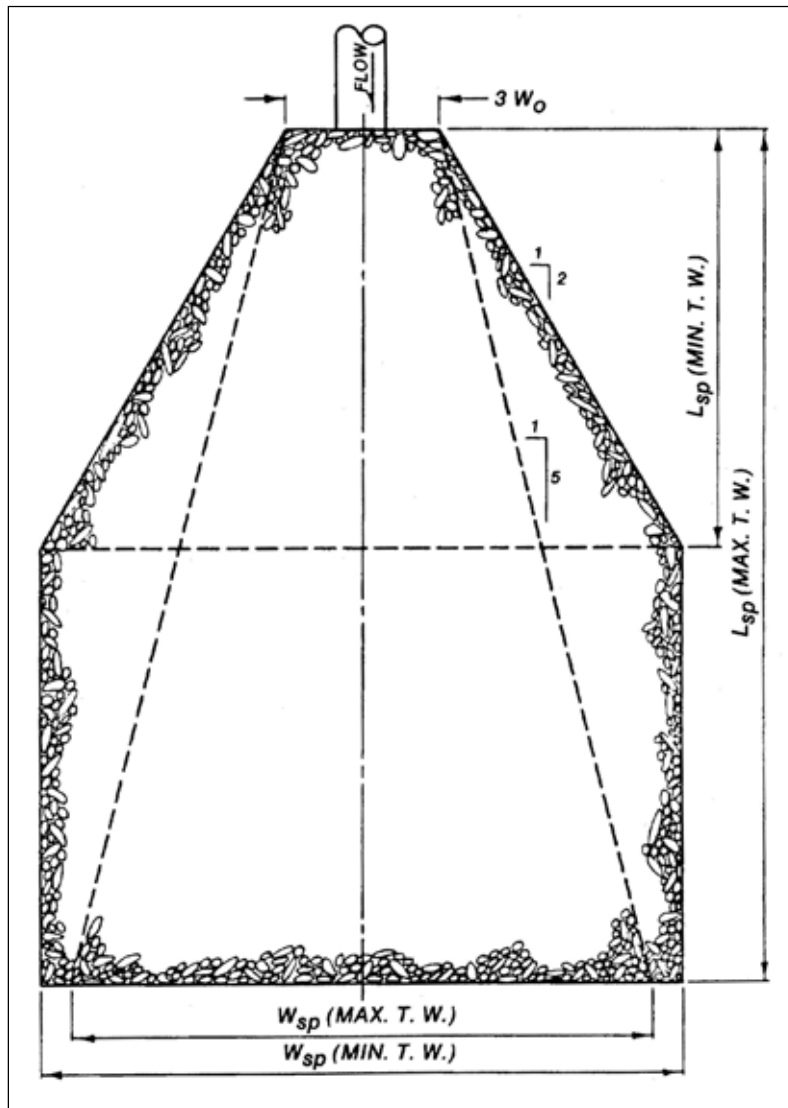


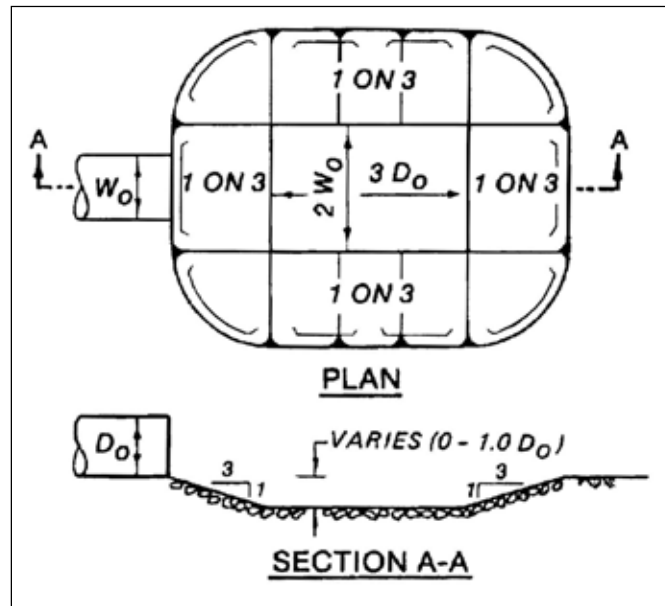


Figure 4-38. Recommended Configuration of Riprap Blanket Subject to Minimum and Maximum Tailwaters



4-4.3.2 The relative advantage of providing both vertical and lateral expansion downstream of an outlet to permit dissipation of excess kinetic energy in turbulence, rather than direct attack of the boundaries, is shown in Figure 4-36. Figure 4-36 indicates that the required size of stone may be reduced considerably if a riprap-lined, preformed scour hole is provided instead of a horizontal blanket at an elevation essentially the same as the outlet invert. Details of a scheme of riprap protection termed "preformed scour hole lined with riprap" are shown in Figure 4-39.

Figure 4-39. Preformed Scour Hole



4-4.3.3 Three ways in which riprap can fail are movement of the individual stones by a combination of velocity and turbulence, movement of the natural bed material through the riprap, resulting in slumping of the blanket, and undercutting and raveling of the riprap by scour at the end of the blanket; therefore, in design, consideration must be given to the selection of adequately sized stone, use of an adequately graded riprap or provision of a filter blanket, and proper treatment of the end of the blanket.

4-4.3.4 Expanding and lining the channel downstream from a square or rectangular outlet for erosion control is usually accomplished using rip rap as shown in Figure 4-40. Figure 4-41 can be used to determine the thickness of the riprap lining. The effectiveness of the lined channel expansion relative to the other schemes of riprap protection described previously is shown in Figure 4-36.

Figure 4-40. Culvert Outlet Erosion Protection, Lined Channel Expansion

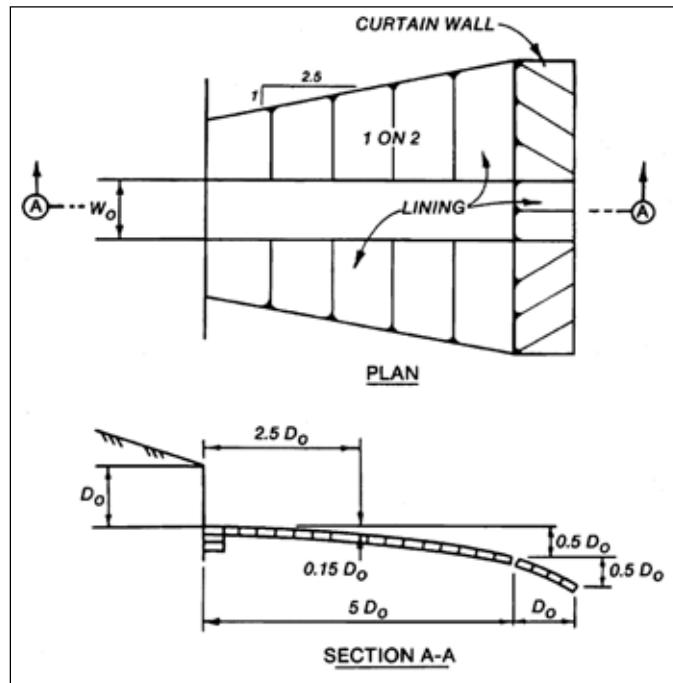
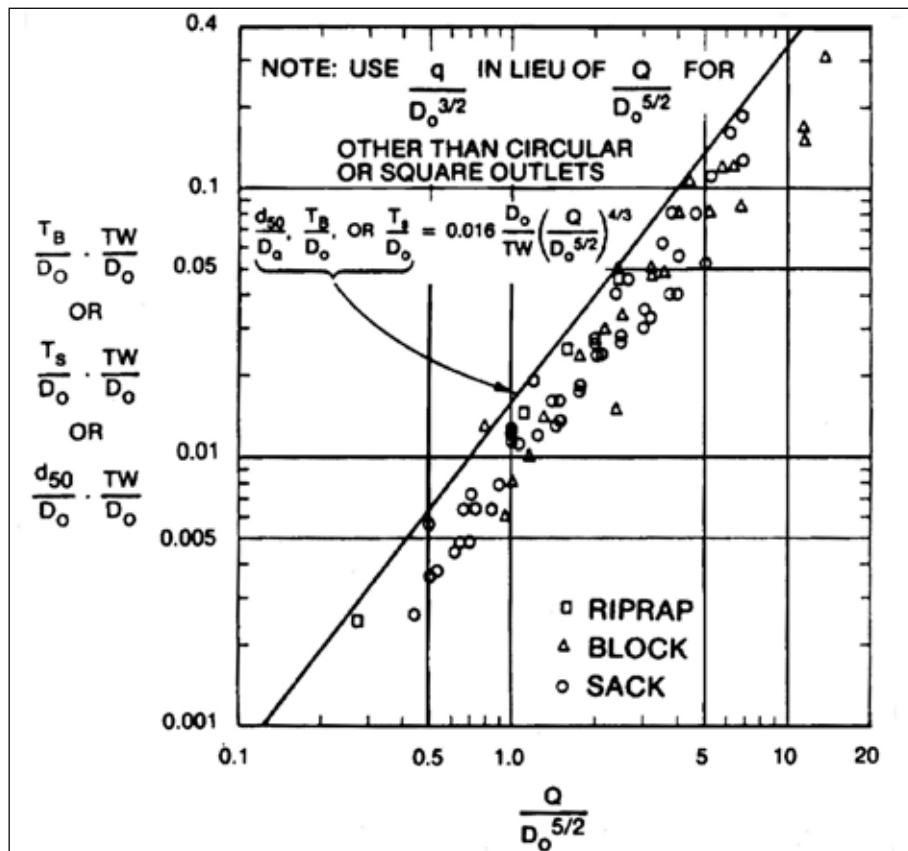


Figure 4-41. Maximum Permissible Discharge for Lined Channel Expansions



4-4.3.5 The maximum discharge parameters,  $Q/D_o^{5/2}$  or  $q/D_o^{3/2}$ , of various schemes of protection can be calculated based on the information in paragraph 4-4.3.4; comparisons relative to the cost of each type of protection can then be made to determine the most practical design for providing effective drainage and erosion control facilities for a given site. In some conditions, the design discharge and economical size of the conduit will result in a value of the discharge parameter greater than the maximum value permissible, thus requiring some form of energy dissipator.

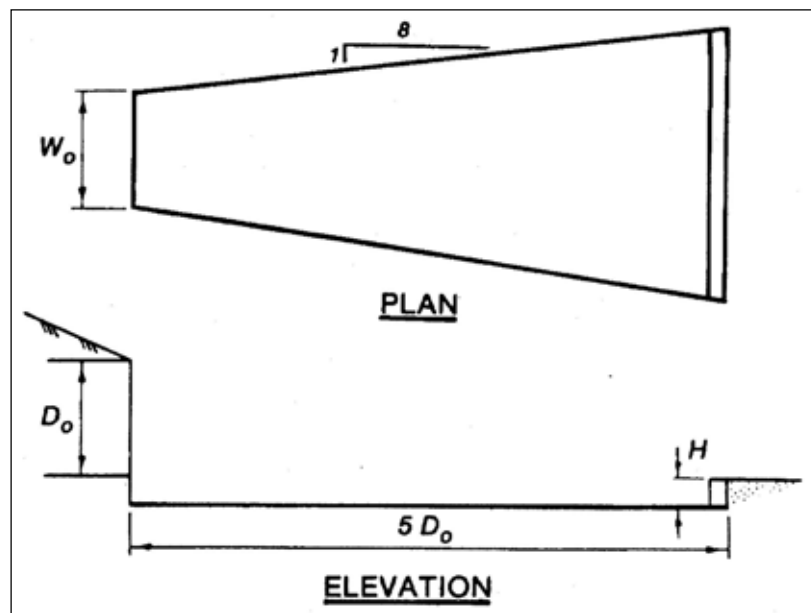
4-4.3.6 The simplest form of energy dissipator is the flared outlet transition. Protection is provided to the local area covered by the apron, and a portion of the kinetic energy of flow is reduced or converted to potential energy by hydraulic resistance provided by the apron. A typical flared outlet transition is shown in Figure 4-42. The flare angle of the walls should be 1 on 8. The length of transition needed for a given discharge conduit size and tailwater situation with the apron at the same elevation as the outlet invert ( $H = 0$ ) can be calculated by these equations:

$$\frac{L}{D_o} = 0.30 \left( \frac{D_o}{TW} \right)^2 \left( \frac{Q}{D_o^{5/2}} \right)^{2.5(TW/D_o)^{1/3}} \quad \text{Circular and square outlets} \quad (4-6)$$

$$\frac{L}{D_o} = 0.30 \left( \frac{D_o}{TW} \right)^2 \left( \frac{q}{D_o^{3/2}} \right)^{2.5(TW/D_o)^{1/3}} \quad \text{Rectangular and other shaped outlets} \quad (4-7)$$

Recessing the apron and providing an end sill will not significantly improve energy dissipation.

**Figure 4-42. Flared Outlet Transition**



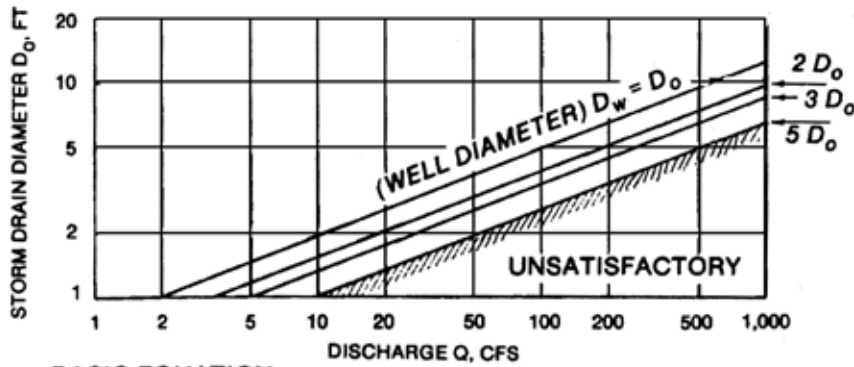
4-4.3.7 The flared transition is satisfactory only for low values of  $Q/D_o^{5/2}$  or  $q/D_o^{3/2}$ , as at culvert outlets. With higher values, however, as at storm drain outlets, other types of energy dissipators will be required. Design criteria for three types of laboratory-tested energy dissipators are presented in Figures 4-43 to 4-45. Each type has advantages and limitations. Selection of the optimum type and size is dependent upon local tailwater conditions, maximum expected discharge, and economic considerations.

4-4.3.8 The stilling well shown in Figure 4-43 consists of a vertical section of circular pipe affixed to the outlet end of a storm sewer. The recommended depth of the well below the invert of the incoming pipe is dependent on the slope and diameter of the incoming pipe and can be determined from the plot in Figure 4-43. The recommended height above the invert of the incoming pipe is two times the diameter of the incoming pipe. The required well diameter can be determined from the equation in Figure 4-43. The top of the well should be located at the elevation of the invert of a stable channel or drainage basin. The area adjacent to the well may be protected by riprap or paving. Energy dissipation does not require maintaining a specified tailwater depth in the vicinity of the outlet. Use of the stilling well is not recommended with  $Q/D_o^{5/2}$  greater than 10.

4-4.3.9 The U.S. Bureau of Reclamation (USBR) impact energy dissipator shown in Figure 4-44 is an efficient stilling device even with deficient tailwater. Energy dissipation is accomplished by the impact of the entering jet on the vertically hanging baffle and by the eddies that are formed following impact on the baffle. Excessive tailwater causes flow over the top of the baffle and should be avoided. The basin width required for good energy dissipation for a given storm drain diameter and discharge can be calculated from the information in Figure 4-44. The other dimensions of the energy dissipator are a function of the basin width as shown in Figure 4-44. This basin can be used with  $Q/D_o^{5/2}$  ratios up to 21.

4-4.3.10 The Saint Anthony Falls (SAF) stilling basin shown in Figure 4-45 is a hydraulic jump energy dissipator. To function satisfactorily, this basin must have sufficient tailwater to cause a hydraulic jump to form. Design equations for determining the dimensions of the structure in terms of the square of the Froude number of flow entering the dissipator are shown in this figure. Figure 4-46 is a design chart based on these equations. The width of basin required for good energy dissipation can be calculated from the equation in Figure 4-45. Tests used to develop this equation were limited to basin widths of three times the diameter of the outlet, but other model tests indicate that this equation also applies to ratios greater than the maximum shown in Figure 4-45. However, outlet portal velocities exceeding 60 ft/s are not recommended for design containing chute blocks. Parallel basin sidewalls are recommended for best performance. Transition sidewalls from the outlet to the basin should not flare more than 1 on 8.

Figure 4-43. Stilling Well

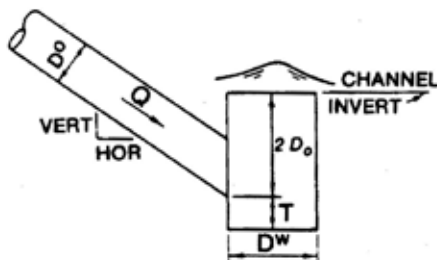
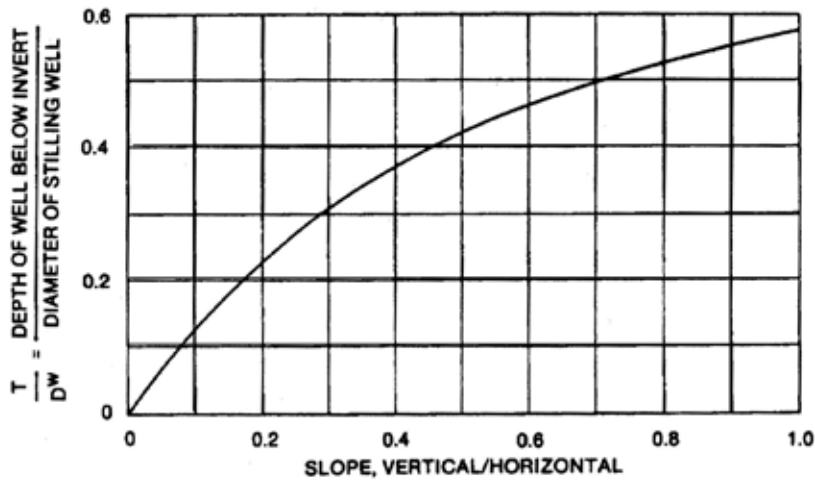


**BASIC EQUATION**

$$\frac{D_w}{D_o} = 0.53 \left( \frac{Q}{D_o^{5/2}} \right) \text{ FOR } \frac{Q}{D_o^{5/2}} \leq 10$$

WHERE:

- $D_w$  = STILLING WELL DIAMETER, FT
- $D_o$  = DRAIN DIAMETER, FT
- $Q$  = DESIGN DISCHARGE, CFS



**ELEVATION**

Figure 4-44. U.S. Bureau of Reclamation Impact Basin

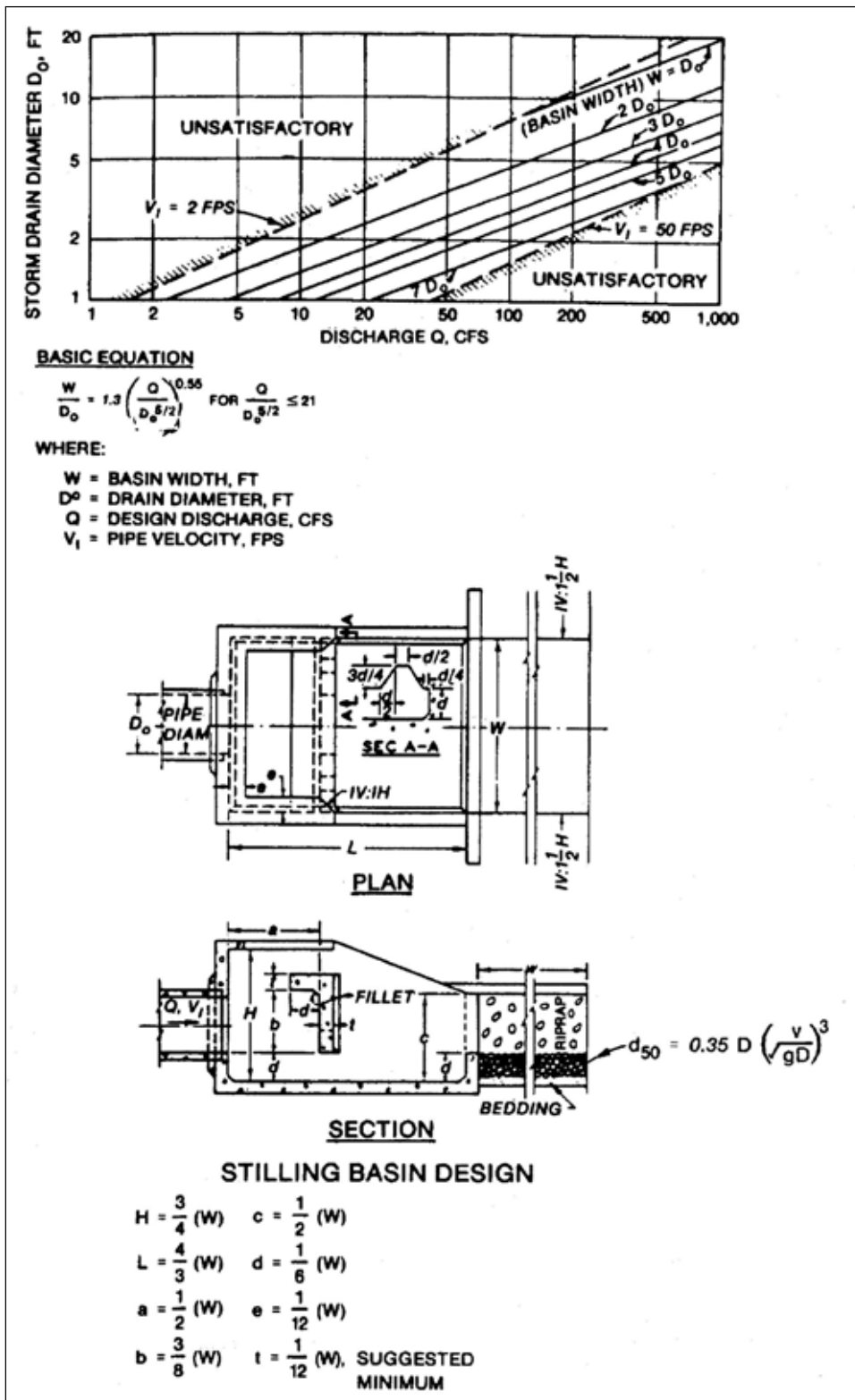


Figure 4-45. Saint Anthony Falls Stilling Basin

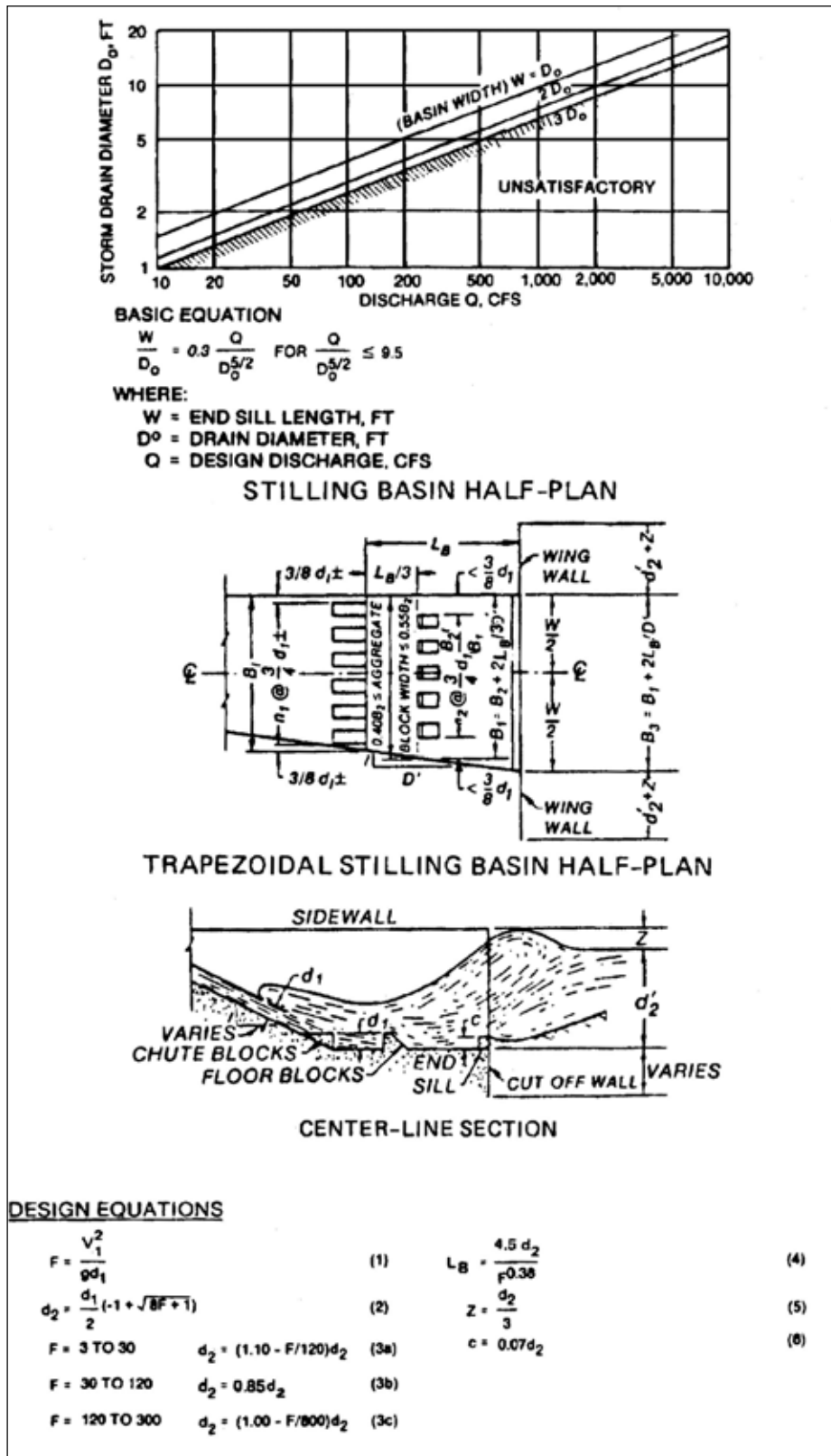
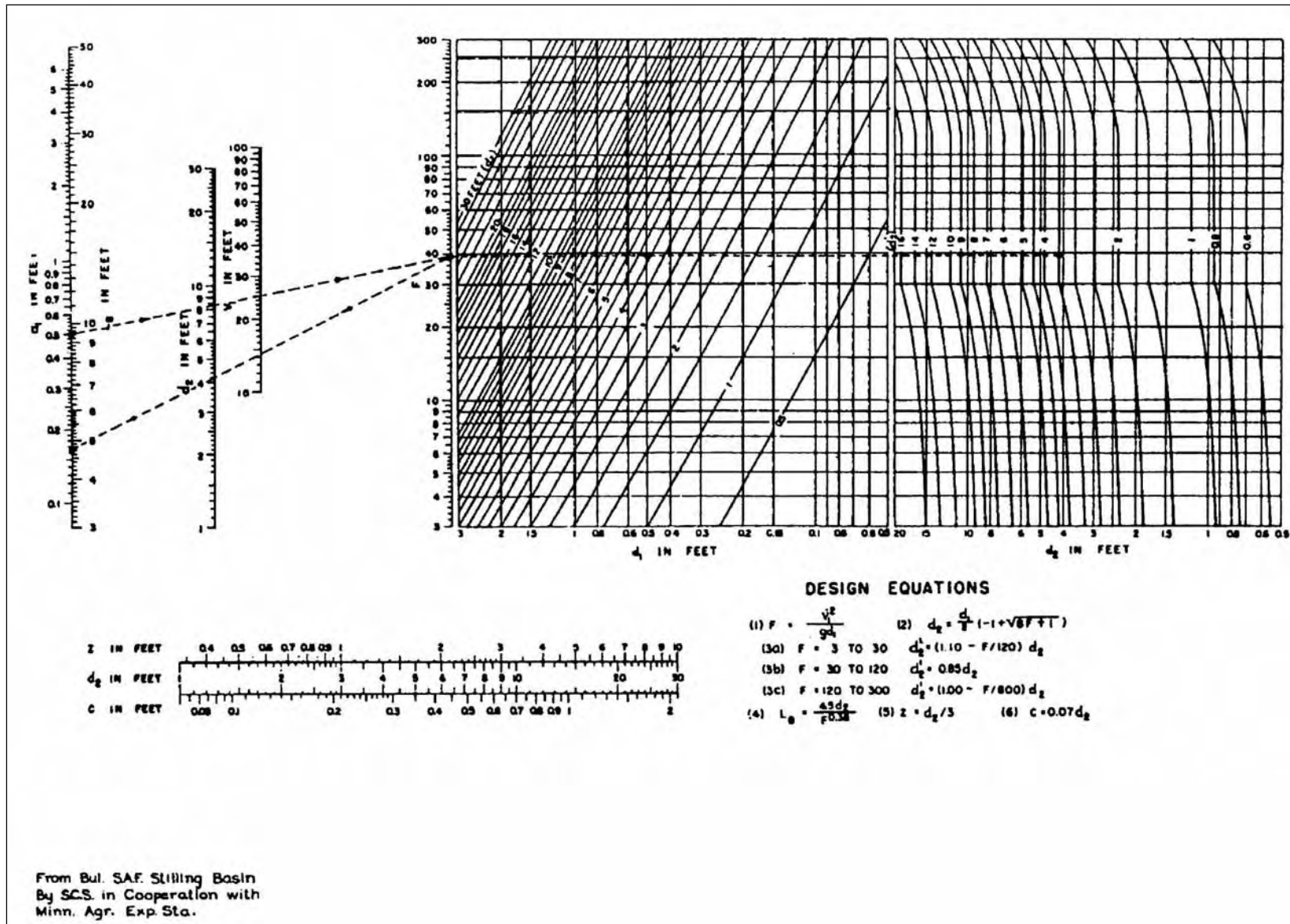




Figure 4-46. Design Chart for SAF  
Stilling Basin



4-4.3.11 Riprap will be required downstream from the energy dissipators described in this chapter. The size of the stone can be estimated by this equation:

$$d_{50} = D \left( \frac{V}{\sqrt{gD}} \right)^3 \quad \text{or} \quad F = (d_{50} / D)^{1/3} \quad (4-8)$$

This equation is also to be used for riprap subject to direct attack or adjacent to hydraulic structures such as inlets, confluences, and energy dissipators, where turbulence levels are high. The riprap should extend downstream for a distance approximately 10 times the theoretical depth of flow required for a hydraulic jump.

4-4.3.12 Smaller riprap sizes can be used to control channel erosion. Equation 4-9 is to be used for riprap on the banks of a straight channel where flows are relatively quiet and parallel to the banks.

- Trapezoidal channels

$$d_{50} = .035D \left( \frac{V}{\sqrt{gD}} \right)^3 \quad \text{or} \quad F = 1.42 (d_{50} / D)^{1/3} \quad (4-9)$$

- Equation 4-10 is to be used for riprap at the outlets of pipes or culverts where no preformed scour holes are made.
- Wide channel bottom or horizontal scour hole

$$d_{50} = 0.15D \left( \frac{V}{\sqrt{gD}} \right)^3 \quad \text{or} \quad F = 1.88 (d_{50} / D)^{1/3} \quad (4-10)$$

- $\frac{1}{2} D$  deep scour hole

$$d_{50} = 0.09D \left( \frac{V}{\sqrt{gD}} \right)^3 \quad \text{or} \quad F = 2.23 (d_{50} / D)^{1/3} \quad (4-11)$$

- $D$  deep scour hole

$$d_{50} = 0.055D \left( \frac{V}{\sqrt{gD}} \right)^3 \quad \text{or} \quad F = 2.63 (d_{50} / D)^{1/3} \quad (4-12)$$

- These relationships are shown in Figures 4-47 and 4-48.

Figure 4-47. Recommended Riprap Sizes

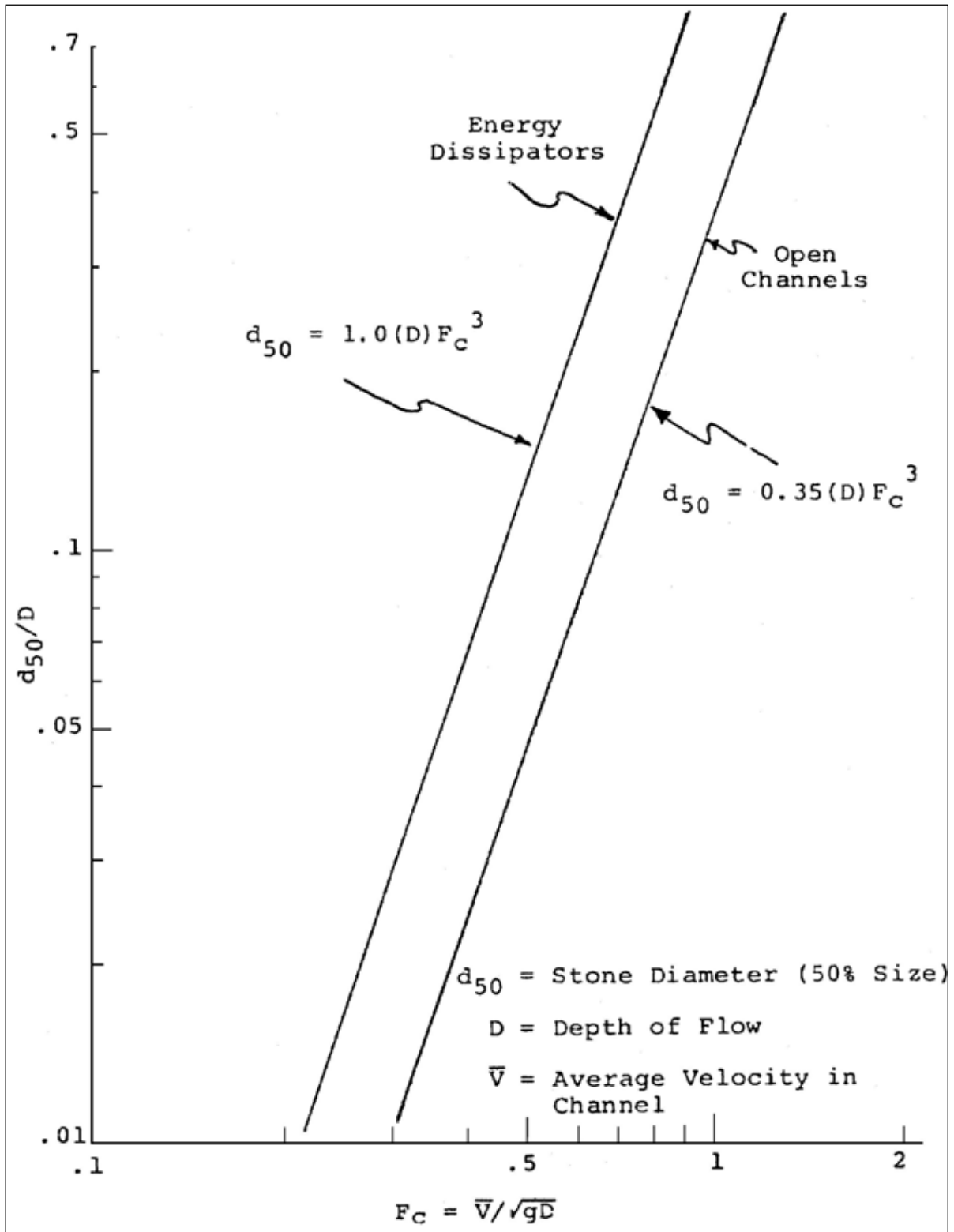
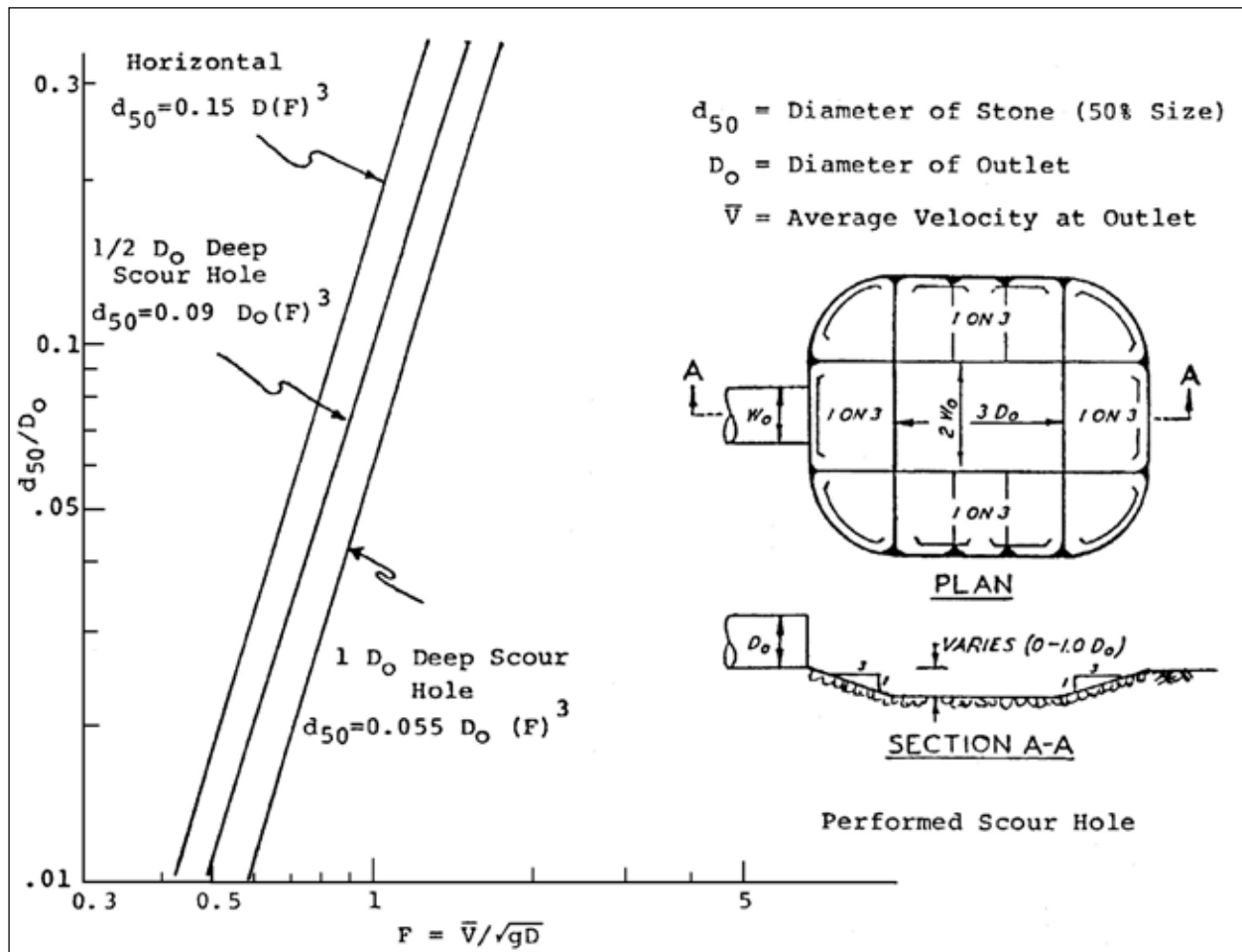


Figure 4-48. Scour Hole Riprap Sizes



4-4.3.13 User-friendly computer programs are available to assist the designer with many of the design problems discussed in this chapter. More information on available computer programs is located in Chapter 12 of this UFC.

#### 4-4.4 Vehicular Safety and Hydraulically Efficient Drainage Practice

4-4.4.1 Some drainage structures are potentially hazardous and, if located in the path of an errant vehicle, can substantially increase the probability of an accident. Inlets should be flush with the ground, or should present no obstacle to a vehicle that is out of control. End structures or culverts should be placed outside the designated recovery area wherever possible. If grates are necessary to cover culvert inlets, take care to design the grate so that the inlet will not clog during periods of high water. Where curb inlet systems are used, setbacks should be minimal and grates should be designed for hydraulic efficiency and safe passage of vehicles. Hazardous channels or energy dissipating devices should be located outside the designated recovery area, or adequate guardrail protection should be provided.

4-4.4.2 It is necessary to emphasize that liberties should not be taken with the hydraulic design of drainage structures to make them safer unless it is clear that their function and efficiency will not be impaired by the changes. Even minor changes at culvert inlets can seriously disrupt hydraulic performance.

#### 4-5 OUTLET PROTECTION DESIGN EXAMPLES

4-5.1 This section contains examples of recommended application to estimate the extent of scour in a cohesionless soil and alternative schemes of protection required to prevent local scour.

4-5.2 Circular and rectangular outlets with equivalent cross-sectional areas that will be subjected to a range of discharges for a duration of 1 hr are used with these parameters:

- Dimensions of rectangular outlet =  $W_o = 10$  ft,  $D_o = 5$  ft
- Diameter of circular outlet,  $D_o = 8$  ft
- Range of discharge,  $Q = 362$  to  $1,086$  ft<sup>3</sup>/s
- Discharge parameter for rectangular culvert,  $q/D_o^{3/2} = 3.2$  to  $9.7$
- Discharge parameter for circular culvert,  $Q/D_o^{5/2} = 2$  to  $6$
- Duration of runoff event,  $t = 60$  min
- Maximum tailwater elevation =  $6.4$  ft above outlet invert ( $> 0.5 D_o$ )
- Minimum tailwater elevation =  $2.0$  ft above outlet invert ( $< 0.5 D_o$ )

4-5.2.1 **Example 4-1.** Determine the maximum depth of scour for minimum and maximum flow conditions for the culverts specified in paragraphs 4-5.2.1.1 and 4-5.2.1.2.

4-5.2.1.1 **Rectangular Culvert.** See Figure 4-30.

- Minimum Tailwater

$$\frac{D_{sm}}{D_o} = 0.80 \left( \frac{q}{D_o^{3/2}} \right)^{0.375} t^{0.10}$$

$$D_{sm} = 0.80 (3.2 \text{ to } 9.7)^{0.375} (60)^{0.1} (5) = 9.3 \text{ ft to } 14.0 \text{ ft}$$

- Maximum Tailwater

$$\frac{D_{sm}}{D_o} = 0.74 \left( \frac{q}{D_o^{3/2}} \right)^{0.375} t^{0.10}$$

$$D_{sm} = 0.74 (3.2 \text{ to } 9.7)^{0.375} (60)^{0.1} (5) = 8.6 \text{ ft to } 13.0 \text{ ft}$$

4-5.2.1.2 **Circular Culvert.** See Figure 4-30.

- Minimum Tailwater

$$\frac{D_{sm}}{D_o} = 0.80 \left( \frac{Q}{D_o^{5/2}} \right)^{0.375} t^{0.10}$$

$$D_{sm} = 0.80 (2 \text{ to } 6)^{0.375} (60)^{0.1} (8) = 12.5 \text{ ft to } 18.9 \text{ ft}$$

- Maximum Tailwater

$$\frac{D_{sm}}{D_o} = 0.74 \left( \frac{q}{D_o^{5/2}} \right)^{0.375} t^{0.1}$$

$$D_{sm} = 0.74 (2 \text{ to } 6)^{0.375} (60)^{0.1} (8) = 11.6 \text{ ft to } 17.5 \text{ ft}$$

4-5.2.2 **Example 4-2.** Determine the maximum width of scour for minimum and maximum flow conditions for the culverts specified in paragraphs 4-5.2.2.1 and 4-5.2.2.2.

4-5.2.2.1 **Rectangular Culvert.** See Figure 4-31.

- Minimum Tailwater

$$\frac{W_{sm}}{D_o} = 1.00 \left( \frac{q}{D_o^{3/2}} \right)^{0.915} t^{0.15}$$

$$W_{sm} = 1.00 (3.2 \text{ to } 9.7)^{0.915} (60)^{0.15} (5) = 27 \text{ ft to } 74 \text{ ft}$$

$$W_{smr} = W_{sm} + \frac{W_o}{2} - \frac{D_o}{2} = (27 \text{ to } 74) + \frac{10}{2} - \frac{5}{2} = 29.5 \text{ ft to } 76.5 \text{ ft}$$

- Maximum Tailwater

$$\frac{W_{sm}}{D_o} = 0.72 \left( \frac{q}{D_o^{3/2}} \right)^{0.915} t^{0.15}$$

$$W_{sm} = 0.72 (3.2 \text{ to } 9.7)^{0.915} (60)^{0.015} = 19 \text{ ft to } 53 \text{ ft}$$

$$W_{smr} = W_{sm} + \frac{W_o}{2} - \frac{D_o}{2} = (19 \text{ to } 53) + \frac{10}{2} - \frac{5}{2} = 21.5 \text{ ft to } 55.5 \text{ ft}$$

4-5.2.2.2 **Circular Culvert.** See Figure 4-31.

- Minimum Tailwater

$$\frac{W_{sm}}{D_o} = 1.00 \left( \frac{Q}{D_o^{5/2}} \right)^{0.915} t^{0.15}$$

$$W_{sm} = 1.00 (2 \text{ to } 6)^{0.915} (60)^{0.15} (8) = 28 \text{ ft to } 76 \text{ ft}$$

- Maximum Tailwater

$$\frac{W_{sm}}{D_o} = 0.72 \left( \frac{Q}{D_o^{5/2}} \right)^{0.915} t^{0.15}$$

$$W_{sm} = 0.72 (2 \text{ to } 6)^{0.915} (60)^{0.15} (8) = 20 \text{ ft to } 55 \text{ ft}$$

4-5.2.3 **Example 4-3.** Determine the maximum length of scour for minimum and maximum flow conditions for the culverts specified in paragraphs 4-5.2.3.1 and 4-5.2.3.2.

4-5.2.3.1 **Rectangular Culvert** (see Figure 4-32)

- Minimum Tailwater

$$\frac{L_{sm}}{D_o} = 2.40 \left( \frac{q}{D_o^{3/2}} \right)^{0.71} t^{0.125}$$

$$L_{sm} = 2.4 (3.2 \text{ to } 9.7)^{0.71} (60)^{0.125} (5) = 46 \text{ ft to } 101 \text{ ft}$$

- Maximum Tailwater

$$\frac{L_{sm}}{D_o} = 4.10 \left( \frac{q}{D_o^{3/2}} \right)^{0.71} t^{0.125}$$

$$L_{sm} = 4.10 (3.2 \text{ to } 9.7)^{0.71} (60)^{0.125} (5) = 78 \text{ ft to } 171 \text{ ft}$$

4-5.2.3.2 **Circular Culvert.** See Figure 4-32.

- Minimum Tailwater

$$\frac{L_{sm}}{D_o} = 2.40 \left( \frac{Q}{D_o^{5/2}} \right)^{0.71} t^{0.125}$$

$$L_{sm} = 2.4 (2 \text{ to } 6)^{0.71} (60)^{0.125} (8) = 52 \text{ ft to } 114 \text{ ft}$$

- Maximum Tailwater

$$\frac{L_{sm}}{D_o} = 4.10 \left( \frac{Q}{D_o^{5/2}} \right)^{0.71} t^{0.125}$$

$$L_{sm} = 4.10 (2 \text{ to } 6)^{0.71} (60)^{0.125} (8) = 90 \text{ ft to } 195 \text{ ft}$$

4-5.2.4 **Example 4-4.** Determine the profile and cross section of scour for maximum discharge and minimum tailwater conditions (see Figure 4-34):

<b>Circular Culvert</b>											
For $L_{sm} = 114 \text{ ft}$ and $D_{sm} = 18.9 \text{ ft}$											
$L_s/L_{sm}$	0.0	0.1	0.2	0.3	0.4	0.5	0.6	0.7	0.8	0.9	1.0
$L$	0.0	11.4	22.8	34.2	45.6	57.0	68.4	79.8	91.2	102.6	114.0
$D_s/D_{sm}$	0.7	0.75	0.85	0.95	1.0	0.95	0.75	0.55	0.33	0.15	0.0
$D_s$	13.2	14.2	16.1	18.0	18.9	18.0	14.2	10.4	6.3	2.9	0.0
For $W_{sm} = 76 \text{ ft}$ and $D_{sm} = 18.9 \text{ ft}$											
$W_s/W_{sm}$	0.0		0.2		0.4		0.6		0.8		1.0
$W_s$	0.0		15.2		30.4		45.6		60.8		76.0
$D_s/D_{sm}$	1.0		0.67		0.27		0.15		0.05		0.0
$D_s$	18.9		12.6		5.1		2.8		0.95		0.0



<b>Rectangular Culvert</b>											
For $L_{sm} = 101$ ft and $D_{sm} = 14.0$ ft											
$L_s/L_{sm}$	0.0	0.1	0.2	0.3	0.4	0.5	0.6	0.7	0.8	0.9	1.0
$L$	0.0	10.1	20.2	30.3	40.4	50.5	60.6	70.7	80.8	90.9	101.0
$D_s/D_{sm}$	0.7	0.75	0.85	0.95	1.0	0.95	0.75	0.55	0.33	0.15	0.0
$D_s$	9.8	10.5	11.9	13.3	14.0	13.3	10.5	7.7	4.6	2.1	0.0
For $W_{sm} = 74$ ft and $D_{sm} = 14.0$ ft											
$W_s/W_{sm}$	0.0		0.2		0.4		0.6		0.8		1.0
$W_s$	0.0		14.8		29.6		44.4		59.2		74.0
$D_s/D_{sm}$	1.0		0.67		0.27		0.15		0.05		0.0
$D_s$	14.0		9.38		3.78		2.10		0.70		0.0
$W_{sr} = W_s$ $W_s + \frac{W_o}{2} - \frac{D_o}{2}$	0-2.5		17.3		32.1		46.9		61.7		76.5

4-5.2.5 **Example 4-5.** Determine the depth and width of the cutoff wall for the culverts specified in paragraphs 4-5.2.5.1 and 4-5.2.5.2.

4-5.2.5.1 **Rectangular Culvert.** The maximum depth and width of scour equals 14 ft and 76.5 ft.

- From Figure 4-34, depth of cutoff wall =  $0.7 (D_{sm}) = 0.7 (14) = 9.8$  ft
- From Figure 4-34, width of cutoff wall =  $2 (W_{smr}) = 2 (76.5) = 153$  ft

4-5.2.5.2 **Circular Culvert.** The maximum depth and width of scour equals 18.9 ft and 76.0 ft.

- From Figure 4-34, depth of cutoff wall =  $0.7 (D_{sm}) = 0.7 (18.9) = 13.2$  ft
- From Figure 4-34, width of cutoff wall =  $2 (W_{sm}) = 2 (76) = 152$  ft

**NOTE:** The depth of the cutoff wall may be varied with width in accordance with the cross section of the scour hole at the location of the maximum depth of scour. See Figures 4-34 and 4-35.

4-5.2.6 **Example 4-6.** Determine the size and extent of the horizontal blanket of riprap for the culverts specified in paragraphs 4-5.2.6.1 and 4-5.2.6.2.

#### 4-5.2.6.1 Rectangular Culvert

- Minimum Tailwater

$$\text{From Figure 4 - 36, } \frac{d_{50}}{D_o} = 0.020 \frac{D_o}{TW} \frac{q}{D_o^{3/2}}^{4/3}$$

$$d_{50} = 0.020 (5/2) (3.2 \text{ to } 9.7)^{4/3} (5) = 1.2 \text{ ft to } 5.2 \text{ ft}$$

$$\text{From Figure 4 - 37, } \frac{L_{sp}}{D_o} = 1.8 \frac{q}{D_o^{3/2}} + 7$$

$$L_{sp} = [1.8 (3.2 \text{ to } 9.7) + 7] 5 = 64 \text{ ft to } 122 \text{ ft}$$

- Maximum Tailwater

$$\frac{d_{50}}{D_o} = 0.020 \frac{D_o}{TW} \left( \frac{q}{D_o^{3/2}} \right)^{4/3}$$

$$d_{50} = 0.020 (5/6.4) (3.2 \text{ to } 9.7)^{4/3} (5) = 0.37 \text{ ft to } 0.76 \text{ ft}$$

$$\frac{L_{sp}}{D_o} = 3 \left( \frac{q}{D_o^{3/2}} \right)$$

$$L_{sp} = 3 (3.2 \text{ to } 9.7) 5 = 48 \text{ ft to } 145 \text{ ft}$$

#### 4-5.2.6.2 Circular Culvert

- Minimum Tailwater

$$\frac{d_{50}}{D_o} = 0.020 \frac{D_o}{TW} \left( \frac{Q}{D_o^{5/2}} \right)^{4/3}$$

$$d_{50} = 0.020 (8/2) (2 \text{ to } 6)^{4/3} (8) = 1.6 \text{ ft to } 7.0 \text{ ft}$$

$$\frac{L_{sp}}{D_o} = 1.8 \left( \frac{Q}{D_o^{5/2}} \right) + 7$$

$$L_{sp} = 1.8 (2 \text{ to } 6) + 7 \quad 8 = 85 \text{ ft to } 142 \text{ ft}$$

- Maximum Tailwater

$$\frac{d_{50}}{D_o} = 0.020 \frac{D_o}{TW} \left( \frac{Q}{D_o^{5/2}} \right)^{4/3}$$

$$d_{50} = 0.020 (8/6.4) (2 \text{ to } 6)^{4/3} (8) = 0.50 \text{ ft to } 2.18 \text{ ft}$$

$$\frac{L_{sp}}{D_o} = 3 \left( \frac{Q}{D_o^{5/2}} \right)$$

$$L_{sp} = 3 (2 \text{ to } 6) \quad 8 = 48 \text{ ft to } 144 \text{ ft}$$

Use Figure 4-38 to determine the recommended configuration of a horizontal blanket of riprap subject to minimum and maximum tailwaters.

4-5.2.7 **Example 4-7.** Determine the size and geometry of riprap-lined preformed scour holes 0.5- and 1.0- $D_o$  deep for minimum tailwater conditions for the culverts specified in paragraphs 4-5.2.7.1 and 4-5.2.7.2.

4-5.2.7.1 **Rectangular Culvert.** See Figure 4-36.

- 0.5- $D_o$ -Deep Riprap-Lined Preformed Scour Hole

$$\frac{d_{50}}{D_o} = 0.0125 \frac{D_o}{TW} \left( \frac{q}{D_o^{3/2}} \right)^{4/3}$$

$$d_{50} = 0.0125 (5/2) (3.2 \text{ to } 9.7)^{4/3} (5) = 0.73 \text{ ft to } 3.2 \text{ ft}$$

- 1.0- $D_o$ -Deep Riprap-Lined Preformed Scour Hole

$$\frac{d_{50}}{D_o} = 0.0082 \frac{D_o}{TW} \left( \frac{q}{D_o^{3/2}} \right)^{4/3}$$

$$d_{50} = 0.0082 (5/2) (3.2 \text{ to } 9.7)^{4/3} (5) = 0.48 \text{ ft to } 2.1 \text{ ft}$$

#### 4-5.2.7.2 Circular Culvert

- 0.5- $D_o$ -Deep Riprap-Lined Preformed Scour Hole

$$\frac{d_{50}}{D_o} = 0.0125 \frac{D_o}{TW} \left( \frac{Q}{D_o^{5/2}} \right)^{4/3}$$

$$d_{50} = 0.0125 (8/2) (2 \text{ to } 6)^{4/3} (8) = 1.0 \text{ ft to } 4.4 \text{ ft}$$

- 1.0- $D_o$ -Deep Riprap-Lined Preformed Scour Hole

$$\frac{d_{50}}{D_o} = 0.0082 \frac{D_o}{TW} \left( \frac{Q}{D_o^{5/2}} \right)^{4/3}$$

$$d_{50} = 0.0082 (8/2) (2 \text{ to } 6)^{4/3} (8) = 0.66 \text{ ft to } 2.9 \text{ ft}$$

- See Figure 4-24 for geometry.

4-5.2.8 **Example 4-8.** Determine the size and geometry of a riprap-lined channel expansion for minimum tailwaters for the culverts specified in paragraphs 4-5.2.8.1 and 4-5.2.8.2 (see Figure 4-41).

#### 4-5.2.8.1 Rectangular Culvert

$$\frac{d_{50}}{D_o} = 0.016 \frac{D_o}{TW} \left( \frac{q}{D_o^{3/2}} \right)^{4/3}$$

$$d_{50} = 0.016 (5/2) (3.2 \text{ to } 9.7)^{4/3} (5) = 0.94 \text{ ft to } 4.1 \text{ ft}$$

#### 4-5.2.8.2 Circular Culvert

$$\frac{d_{50}}{D_o} = 0.016 \frac{D_o}{TW} \left( \frac{Q}{D_o^{5/2}} \right)^{4/3}$$

$$d_{50} = 0.016 (8/2) (2 \text{ to } 6)^{4/3} (8) = 1.29 \text{ ft to } 5.6 \text{ ft}$$

- See Figure 4-40 for geometry.

4-5.2.9 **Example 4-9.** Determine the length and geometry of a flared outlet transition for minimum tailwaters for the culverts specified in paragraphs 4-5.2.9.1 and 4-5.2.9.2.

#### 4-5.2.9.1 Rectangular Culvert

$$\frac{L}{D_o} = 0.30 \left( \frac{D_o}{TW} \right)^2 \left( \frac{q}{D_o^{3/2}} \right)^{2.5(TW/D_o)^{1/3}}$$

$$L = 0.3 (5/2)^2 (3.2 \text{ to } 9.7)^{2.5(2/5)^{1/3}} 5 = 80 \text{ ft to } 616 \text{ ft}$$

#### 4-5.2.9.2 Circular Culvert

$$\frac{L}{D_o} = \left[ 0.30 \left( \frac{D_o}{TW} \right)^2 \left( \frac{Q}{D_o^{5/2}} \right)^{2.5(TW/D_o)^{1/3}} \right]$$

$$L = \left[ 0.3 (8/2)^2 (2 \text{ to } 6)^{2.5(2/8)^{1/3}} \right] 8 = 114 \text{ ft to } 645 \text{ ft}$$

- See Figure 4-42 for geometric details. These equations were developed for H equals 0 or horizontal apron at outlet invert elevation without an end sill.

4-5.2.10 **Example 4-10.** Determine the diameter of the stilling well required downstream of the 8-ft-diameter outlet:

- From Figure 4-43:

$$\frac{D_w}{D_o} = 0.53 \left( \frac{Q}{D_o^{5/2}} \right)^{1.0}$$

$$D_w = 0.53 (2 \text{ to } 6) 8 = 8.5 \text{ ft to } 25.4 \text{ ft}$$

- See Figure 4-43 for additional dimensions.

4-5.2.11 **Example 4-11.** Determine the width of a USBR Type VI basin required downstream of the 8-ft-diameter outlet:

- From Figure 4-44:

$$\frac{W_{VI}}{D_o} = 1.30 \left( \frac{Q}{D_o^{5/2}} \right)^{0.55}$$

$$W_{VI} = \left[ 1.3 (2 \text{ to } 6)^{0.55} \right] 8 = 15.2 \text{ ft to } 27.9 \text{ ft}$$

- See Figure 4-44 for additional dimensions.

4-5.2.12 **Example 4-12.** Determine the width of the SAF basin required downstream of the 8-ft-diameter outlet:

- From Figure 4-45:

$$\frac{W_{SAF}}{D_o} = 0.30 \left( \frac{Q}{D_o^{5/2}} \right)^{1.0}$$

$$W_{SAF} = 0.30 (2 \text{ to } 6) 8 = 4.8 \text{ ft to } 14.4 \text{ ft}$$

- See Figure 4-45 for additional dimensions.

4-5.2.13 **Example 4-13.** Determine the size of riprap required downstream of an 8-ft-diameter culvert and a 14.4-ft-wide SAF basin with a discharge of 1,086 ft<sup>3</sup>/s:

$$q = \frac{Q}{W_{SAF}} = \frac{1086}{14.4} = 75 \text{ ft}^3/\text{s}/\text{ft}$$

$$V_1 = \frac{Q}{A} = \frac{1086}{0.785(8)^2} = 21.6 \text{ ft/s}$$

$$d_1 = \frac{q}{V_1} = \frac{75}{21.6} = 3.5 \text{ ft}$$

$$d_2 = 8.4 \text{ ft (from conjugate depth relations)}$$

- Minimum Tailwater Required For A Hydraulic Jump = 0.90 (8.4) = 7.6 ft

$$d_{50} = D \left( \frac{V}{\sqrt{gD}} \right)^3$$

$$V = \frac{q}{D} = \frac{75}{7.6} = 9.9 \text{ ft/s}$$

$$d_{50} = 1.0 \left[ \frac{9.9}{\sqrt{32.2(7.6)}} \right]^3 7.6$$

$$d_{50} = 1.9 \text{ ft}$$

## CHAPTER 5

### CHANNEL DESIGN

5-1 **OPEN CHANNEL FLOW.** Roadside and median channels are open-channel systems that collect and convey storm water from the pavement surface, roadside, and median areas. These channels may outlet to a storm drain piping system via a drop inlet, to a detention or retention basin or other storage component, or to an outfall channel. Roadside and median channels are normally trapezoidal in cross section and are lined with grass or other protective lining.

The design and analysis of roadside and median channels follow the basic principles of open channel flow. Summaries of several important open channel flow concepts and relationships are presented in many hydraulic engineering texts and in the FHWA's HEC-22 manual.

5-1.1 **Flow Resistance.** The depth of flow in a channel of given geometry and longitudinal slope is primarily a function of the channel's resistance to flow or roughness. This depth is called the normal depth and is computed from Manning's equation for "V" combined with the continuity equation,  $Q = VA$ . The combined equation, often referred to as Manning's equation, is:

$$Q = \frac{1.486AR^{0.67}S_o^{0.5}}{n} \quad (5-1)$$

where:

$Q$  = discharge rate, ft<sup>3</sup>/s

$A$  = cross-sectional flow area, ft<sup>2</sup>

$R$  = hydraulic radius,  $\frac{A}{P}$ , ft

$P$  = wetted perimeter, ft

$S_o$  = energy grade line slope, ft/ft

$n$  = Manning's roughness coefficient

Nomograph solutions to Manning's equation for triangular and trapezoidal channels are presented in Appendix B and are also available in many other texts.

5-1.1.1 The selection of an appropriate Manning's  $n$  value for design purposes is often based on observation and experience. Manning's  $n$  values are also known to vary with flow depth. Table 5-1 provides Manning's  $n$  values for natural channels; Table 5-2 provides a tabulation of Manning's  $n$  values for various channel lining materials.

**Table 5-1. Manning's *n* for Natural Stream Channels  
(Surface Width at Flood Stage Less than 100 ft)**

Stream Channel Characteristics	<i>n</i> Value
Fairly regular section:	
Some grass and weeds, little or no brush.....	0.030-0.035
Dense growth of weeds, depth of flow materially greater than weed height .....	0.035-0.05
Some weeds, light brush on banks.....	0.035-0.05
Some weeds, heavy brush on banks.....	0.05-0.07
Some weeds, dense willows on banks .....	0.06-0.08
For trees within the channel with branches submerged at high stage, increase all above values by.....	0.01-0.02
Irregular sections with pools, slight channel meander: increase these values approximately .....	0.01-0.02
Mountain streams, no vegetation in channel, banks usually steep, trees and brush along banks submerged at high stage:	
Bottom of gravel, cobbles, and few boulders.....	0.04-0.05
Bottom of cobbles, with large boulders.....	0.05-0.07

**Table 5-2. Manning's Roughness Coefficients for Lined Channels\*\***

Lining Category	Lining Type	<i>n</i> Value for Given Depth Ranges		
		0 - 0.5 ft	0.5 - 2.0 ft	> 2.0 ft
Rigid	Concrete	0.015	0.013	0.013
	Grouted Riprap	0.040	0.030	0.028
	Stone Masonry	0.042	0.032	0.030
	Soil Element	0.025	0.022	0.020
	Asphalt	0.018	0.016	0.016
Unlined	Bare Soil	0.023	0.020	0.020
	Rock Cut	0.045	0.035	0.025
Temporary*	Woven Paper Net	0.016	0.015	0.015
	Jute Net	0.028	0.022	0.019
	Fiberglass Roving	0.028	0.021	0.019
	Straw with Net	0.065	0.033	0.025
	Curled Wood Mat	0.066	0.035	0.028
	Synthetic Mat	0.036	0.025	0.021



Lining Category	Lining Type	n Value for Given Depth Ranges		
		0 - 0.5 ft	0.5 - 2.0 ft	> 2.0 ft
Gravel Riprap	1 in. D <sub>50</sub>	0.044	0.033	0.030
	2 in. D <sub>50</sub>	0.066	0.041	0.034
Rock Riprap	6 in. D <sub>50</sub>	0.104	0.069	0.035
	12 in. D <sub>50</sub>	--	0.078	0,040

**NOTE:** Values listed are representative values for the respective depth ranges. Manning's roughness coefficients, *n*, vary with the flow depth.  
 \* Some "temporary" linings become permanent when buried.  
 \*\* Table reproduced from FHWA HEC-15

5-1.1.2 Manning's roughness coefficient for vegetative and other linings varies significantly depending on the amount of submergence. The classification of vegetal covers by degree of retardance is provided in Table 5-3. Table 5-4 provides a list of Manning's *n* relationships for five classes of vegetation defined by their degree of retardance.

**Table 5-3. Classification of Vegetal Covers as to Degree of Retardance\***

Retardance Class	Cover	Condition
A	Weeping lovegrass	Excellent stand, tall, average 2.5 ft
	Yellow bluestem	Excellent stand, tall, average 3.0 ft
	Ischaemum	
B	Kudzu	Very dense growth, uncut
	Bermuda grass	Good stand, tall, average 1.0 ft
	Native grass mixture (Little bluestem, bluestem, blue gamma, and other long and short midwest grasses)	Good stand, unmowed
	Weeping lovegrass	Good stand, tall, average 2.0 ft
	Lespedeza sericea	Good stand, not woody, tall, average 1.6 ft
	Alfalfa	Good stand, uncut, average 0.91 ft
	Weeping lovegrass	Good stand, unmowed, average 1.1 ft
	Kudzu	Dense growth, uncut
Blue gamma	Good stand, uncut, average 1.1 ft	

Retardance Class	Cover	Condition
C	Crabgrass Bermuda grass Common lespedeza Grass-legume mixture—summer (orchard grass, redtop Italian ryegrass, and common lespedeza) Centipede grass Kentucky bluegrass	Fair stand, uncut, average 0.8 to 4.0 ft Good stand, mowed, average 0.5 ft Good stand, uncut, average 0.91 ft Good stand, uncut, average 0.5 to 1.5 ft  Very dense cover, average 0.5 ft Good stand, headed, average. 0.5 to 1.0 ft
D	Bermuda grass Common lespedeza Buffalo grass Grass-legume mixture—fall, spring (orchard grass, redtop, Italian ryegrass, and common lespedeza) Lespedeza sericea	Good stand, cut to 0.2 ft Excellent stand, uncut, average 0.4 ft Good stand, uncut, average 0.3 to 0.5 ft Good stand, uncut, average 0.3 to 0.4 ft  After cutting to 0.2-ft height, very good stand before cutting
E	Bermuda grass Bermuda grass	Good stand, cut to average 0.1 ft Burned stubble
<p><b>NOTE:</b> These covers have been tested in experimental channels. The covers were green and generally uniform.</p> <p>*Table reproduced from FHWA HEC-15</p>		

**Table 5-4. Manning's *n* Relationships for Vegetal Degree of Retardance**

Retardance Class	Manning's <i>n</i> Equation*	Chapter Equation Number
A	$\frac{R^{1/6}}{[15.8 + 19.97 \log(R^{1.4} S_o^{0.4})]}$	5-2
B	$\frac{R^{1/6}}{[23.0 + 19.97 \log(R^{1.4} S_o^{0.4})]}$	5-3
C	$\frac{R^{1/6}}{[30.2 + 19.97 \log(R^{1.4} S_o^{0.4})]}$	5-4
D	$\frac{R^{1/6}}{[34.6 + 19.97 \log(R^{1.4} S_o^{0.4})]}$	5-5
E	$\frac{R^{1/6}}{[37.7 + 19.97 \log(R^{1.4} S_o^{0.4})]}$	5-6
<p>* Equations are valid for flows less than 50 ft<sup>3</sup>/s. Nomograph solutions for these equations are in FHWA HEC-15.</p>		

### 5-1.1.3 Example 5-1

*Given:* A trapezoidal channel (as shown in Figure 5-3) with these characteristics:

- $S_o = 0.01$
- $B = 2.62$  ft
- $z = 3$
- $d = 1.64$  ft

*Find:* The channel capacity and flow velocity for these channel linings:

- (1) Riprap with a median aggregate diameter,  $d_{50} = 6$  in.
- (2) A good stand of buffalo grass, uncut, 3 to 6 in.

#### 5-1.1.3.1 Solution 1: Riprap

Step 1. Determine the channel parameters. From Table 5-1:

$$n = 0.069$$

$$\begin{aligned} A &= Bd + 2(1/2)(d)(zd) \\ &= Bd + zd^2 \\ &= (2.62)(1.64) + (3)(1.64)^2 \\ &= 12.4 \text{ ft}^2 \end{aligned}$$

$$\begin{aligned} P &= B + 2[(zd)^2 + d^2]^{1/2} \\ &= B + 2d(z^2 + 1)^{0.5} \\ &= (2.62) + (2)(1.64) + (3^2 + 1)^{0.5} \\ &= 13.0 \text{ ft} \end{aligned}$$

$$\begin{aligned} R &= \frac{A}{P} \\ &= \frac{12.4}{13.0} \\ &= 0.95 \text{ ft} \end{aligned}$$

Step 2. Compute the flow capacity.

$$\begin{aligned}Q_n &= 1.49AR^{0.67}S_o^{0.5} \\ &= (1.49)(12.4)(0.95)^{0.67}(0.01)^{0.5} \\ &= 1.79 \text{ ft}^3/\text{s}\end{aligned}$$

$$\begin{aligned}Q &= \frac{Qn}{n} \\ &= \frac{1.79}{0.069} \\ &= 25.9 \text{ ft}^3/\text{s}\end{aligned}$$

Step 3. Compute the flow velocity.

$$\begin{aligned}V &= \frac{Q}{A} \\ &= \frac{25.9}{12.4} \\ &= 2.1 \text{ ft/s}\end{aligned}$$

#### 5-1.1.3.2 **Solution 2: Buffalo Grass**

Step 1. Determine the roughness. Use these characteristics:

- Degree of retardance from Table 5-3
- Retardance Class D
- From paragraph 5-1.1.3.1, solution 1, step 1:  $R = 0.95$  ft
- Roughness coefficient,  $n$ , from Table 5-4

$$n = \frac{R^{0.167}}{34.6 + 19.97 \log[(R)^{1.4} (S_o)^{0.4}]}$$

$$n = \frac{(0.95)^{0.167}}{34.6 + 19.97 \log[(0.95)^{1.4} (0.01)^{0.4}]}$$

$$n = 0.055$$

Step 2. Compute the flow capacity. Use these values from step 1:

$$Q_n = 1.79 \text{ ft}^3/\text{s}$$

$$Q = \frac{Q_n}{n}$$

$$= \frac{1.79}{0.55}$$

$$= 32.5 \text{ ft}^3/\text{s}$$

Step 3. Compute the flow velocity.

$$V = \frac{Q}{A}$$

$$= \frac{32.5}{12.4}$$

$$= 2.62 \text{ ft/s}$$

5-1.2 **Stable Channel Design.** HEC-15 provides a detailed presentation of stable channel design concepts related to the design of roadside and median channels. This section provides a brief summary of significant concepts.

5-1.2.1 Stable channel design concepts provide a means of evaluating and defining channel configurations that will perform within acceptable limits of stability. For most highway drainage channels, bank instability and lateral migration cannot be tolerated. Stability is achieved when the material forming the channel boundary effectively resists the erosive forces of the flow. Principles of rigid boundary hydraulics can be applied to evaluate this type of system.

5-1.2.2 Both velocity and tractive force methods have been applied to the determination of channel stability. Permissible velocity procedures are empirical in nature, and have been used to design numerous channels in the United States and throughout the world. However, tractive force methods consider actual physical processes occurring at the channel boundary and represent a more realistic model of the detachment and erosion processes.

5-1.2.3 The hydrodynamic force created by water flowing in a channel causes a shear stress on the channel bottom. The bed material, in turn, resists this shear stress by developing a tractive force. Tractive force theory states that the flow-induced shear stress should not produce a force greater than the tractive resisting force of the bed material. This tractive resisting force of the bed material creates the permissible or critical shear stress of the bed material. In a uniform flow, the shear stress is equal to the effective component of the gravitational force acting on the body of water parallel to

the channel bottom. The average shear stress is equal to:

$$\tau = \gamma RS \tag{5-7}$$

where:

$\tau$  = average shear stress, lb/ft<sup>2</sup>

$\gamma$  = unit weight of water, 62.4 lb/ft<sup>3</sup> (at 15.6 °C (60 °F))

$R$  = hydraulic radius, ft

$S$  = average bed slope or energy slope, ft/ft

5-1.2.4 The maximum shear stress for a straight channel occurs on the channel bed and is less than or equal to the shear stress at maximum depth. The maximum shear stress is computed as follows:

$$\tau_d = \gamma d S \tag{5-8}$$

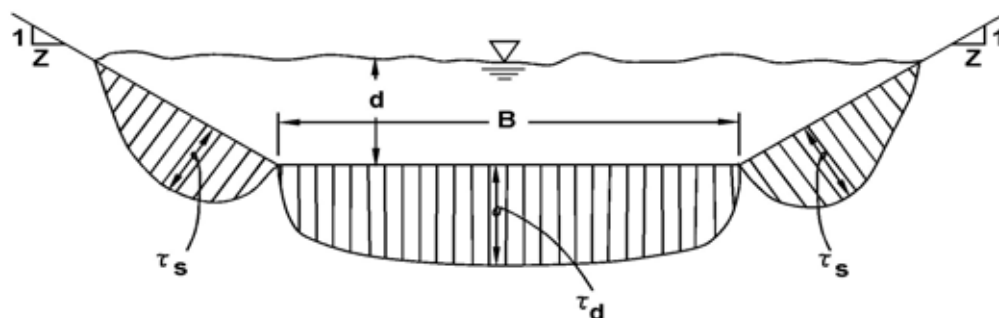
where:

$\tau_d$  = maximum shear stress, lb/ft<sup>2</sup>

$d$  = maximum depth of flow, ft

5-1.2.5 Shear stress in channels is not uniformly distributed along the wetted perimeter of a channel. A typical distribution of shear stress in a trapezoidal channel tends toward zero at the corners with a maximum on the bed of the channel at its centerline, and the maximum for the side slopes occurs around the lower third of the slope, as illustrated in Figure 5-1.

**Figure 5-1. Distribution of Shear Stress**



5-1.2.6 For trapezoidal channels lined with gravel or riprap having side slopes steeper than 3:1, side slope stability must also be considered. This analysis is performed by

comparing the tractive force ratio between side slopes and channel bottom with the ratio of shear stresses exerted on the channel sides and bottom. The ratio of shear stresses on the sides and bottom of a trapezoidal channel,  $K_1$ , is given in Chart 17 of Appendix B and the tractive force ratio,  $K_2$ , is given in Chart 18. The angle of repose,  $\theta$ , for different rock shapes and sizes is provided in Chart 19. The required rock size for the side slopes is found using the following equation:

$$(d_{50})_{sides} = \frac{K_1}{K_2} (d_{50})_{bottom} \quad (5-9)$$

where:

$d_{50}$  = mean riprap size, ft

$K_1$  = ratio of shear stresses on the sides and bottom of a trapezoidal channel

$K_2$  = ratio of tractive force on the sides and bottom of a trapezoidal channel

5-1.2.6.1 Flow around bends also creates secondary currents, which impose higher shear stresses on the channel sides and bottom compared to straight reaches. Areas of high shear stress in bends are illustrated in Figure 5-2. The maximum shear stress in a bend is a function of the ratio of channel curvature to bottom width. This ratio increases as the bend becomes sharper and the maximum shear stress in the bend increases. The bend shear stress can be computed using this relationship:

$$\tau_b = K_b \tau_d \quad (5-10)$$

where:

$\tau_b$  = bend shear stress, lb/ft<sup>2</sup>

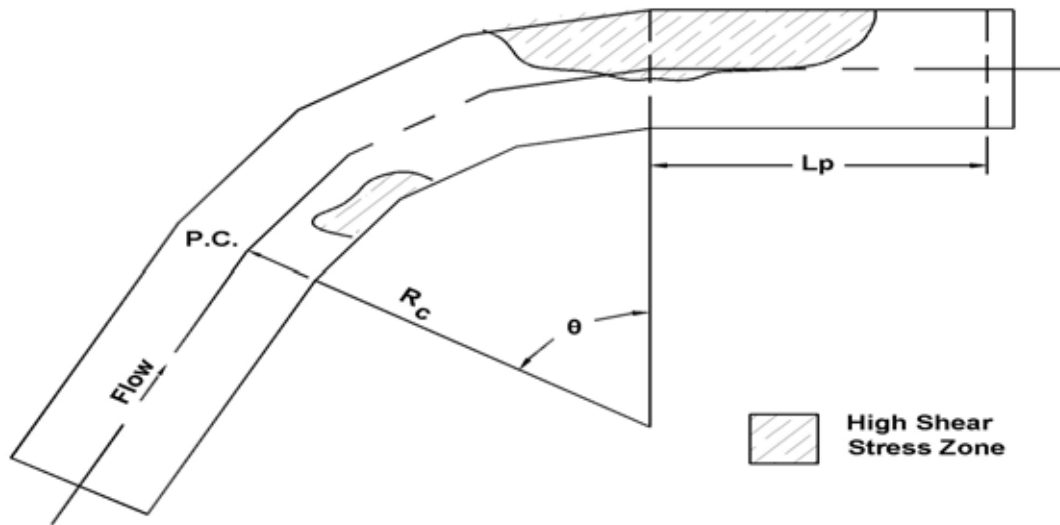
$K_b$  = function of  $R_c/B$  (see Chart 21, HEC-22)

$R_c$  = radius to the centerline of the channel, ft

$B$  = bottom width of channel, ft

$\tau_d$  = maximum channel shear stress, lb/ft<sup>2</sup>

Figure 5-2. Shear Stress Distribution in Channel Bends



5-1.2.6.2 The increased shear stress produced by the bend persists downstream of the bend a distance,  $p$ , as shown in Figure 5-2. This distance can be computed using this relationship:

$$L_p = \frac{0.604R^{7/6}}{n_b} \quad (5-11)$$

where:

$L_p$  = length of protection (length of increased shear stress due to the bend) downstream of the point of tangency, ft

$n_b$  = Manning's roughness in the channel bend

$R$  = hydraulic radius, ft

### 5-1.2.6.3 Example 5-2

*Given:* A trapezoidal channel with these characteristics:

$$S_o = 0.01 \text{ ft/ft}$$

$$B = 3.0 \text{ ft}$$

$$z = 3$$

Lining = A good stand of buffalo grass 3 to 6 in. high. From Example 5-1, Solution 2,  $n = 0.055$ .



The channel reach consists of a straight section and a 90-degree bend with a centerline radius of 14.8 ft. The design discharge is 28.2 ft<sup>3</sup>/s.

*Find:* The maximum shear stress in the straight reach and in the bend.

*Solution:*

Step 1. Compute the channel parameters.

$$\begin{aligned}Q_n &= (28.2)(0.055) \\ &= 1.555 \text{ ft}^3/\text{s}\end{aligned}$$

From (Chart 14A):

$$\begin{aligned}d/B &= 0.49 \\ d &= B d/B \\ &= (3.0)(0.49) \\ &= 1.47 \text{ ft}\end{aligned}$$

Step 2. Compute the maximum shear stress in the straight reach.

$$\begin{aligned}\tau_d &= \gamma d S \\ &= (62.5)(1.47)(0.01) \\ &= 0.92 \text{ lb/ft}^2\end{aligned}$$

Step 3. Compute the shear stress in the bend.

$$\begin{aligned}\frac{R_c}{B} &= \frac{(14.8)}{(3.0)} \\ &= 4.93\end{aligned}$$

From Chart 21 (HEC-22):

$$K_b = 1.55$$

Using Equation 5-10:

$$\begin{aligned}\tau_b &= K_b \tau_d \\ &= (1.55)(0.92) \\ &= 1.43 \text{ lb/ft}^2\end{aligned}$$

5-2 **DESIGN PARAMETERS.** Parameters required for the design of roadside and median channels include discharge frequency, channel geometry, channel slope, vegetation type, freeboard, and shear stress. This section provides criteria relative to the selection or computation of these design elements.

5-2.1 **Discharge Frequency.** Roadside and median drainage channels are typically designed to carry 5- to 10-yr design flows; however, when designing temporary channel linings, a lower return period can be used. Usually a 2-yr return period is appropriate for the design of temporary linings.

5-2.2 **Channel Geometry.** Most drainage channels are trapezoidal. Several typical shapes with equations for determining channel properties are illustrated in Figure 5-3. The channel depth, bottom width, and top width must be selected to provide the necessary flow area. Chart 22 of Appendix B provides a nomograph solution for determining channel properties for trapezoidal channels.

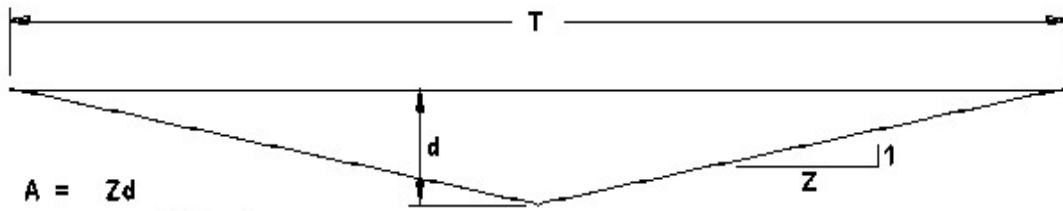
Channel side slopes for triangular or trapezoidal channels should not exceed the angle of repose of the soil and/or lining material, and should generally be 1V:3H or flatter. In areas where traffic safety may be of concern, channel side slopes should be 1V:4H or flatter.

Design of roadside and median channels should be integrated with the geometric and pavement design to ensure proper consideration of safety and pavement drainage needs.

5-2.3 **Channel Slope.** Channel bottom slopes are generally dictated by the road profile or other constraints. However, if channel stability conditions warrant, it may be feasible to adjust the channel gradient slightly to achieve a more stable condition. Channel gradients greater than 2 percent may require the use of flexible linings to maintain stability. Most flexible lining materials are suitable for protecting channel gradients of up to 10 percent, with the exception of some grasses. Linings such as riprap and wire-enclosed riprap are more suitable for protecting very steep channels with gradients in excess of 10 percent. Rigid linings, such as concrete paving, are highly susceptible to failure from structural instability due to such occurrences as overtopping, freeze thaw cycles, swelling, and excessive soil pore water pressure.

5-2.4 **Freeboard.** The freeboard of a channel is the vertical distance from the water surface to the top of the channel. The importance of this factor depends on the consequence of overflow of the channel bank. At a minimum the freeboard should be sufficient to prevent waves, superelevation changes, or fluctuations in water surface from overflowing the sides. In a permanent roadside or median channel, about 0.5 ft of freeboard is generally considered adequate. For temporary channels no freeboard is necessary. However, a steep gradient channel should have a freeboard height equal to the flow depth to compensate for the large variations in flow caused by waves, splashing, and surging.

Figure 5-3. Channel Geometries

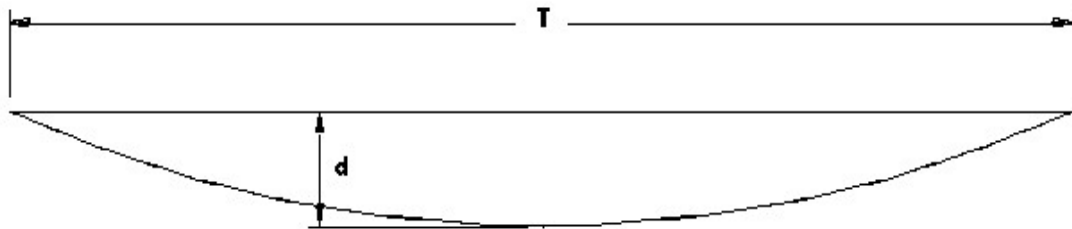


$$A = Zd$$

$$P = 2d\sqrt{Z^2 + 1}$$

$$T = 2dZ$$

### V - Shape

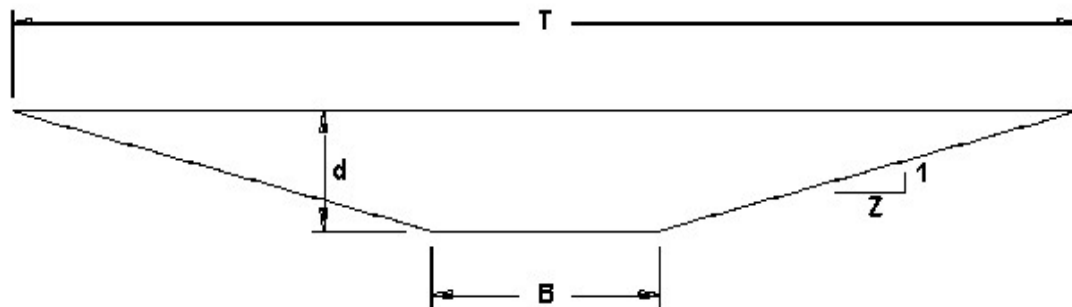


$$A = \frac{2}{3} Td$$

$$P = \frac{1}{2} \sqrt{16d^2 + T^2} + \left(\frac{T^2}{8d}\right) \ln_e \left(\frac{4d + \sqrt{16d^2 + T^2}}{T}\right)$$

$$T = 1.5 \frac{A}{D}$$

### Parabolic



$$A = Bd + Zd^2$$

$$P = B + 2d\sqrt{Z^2 + 1}$$

$$T = b + 2dZ$$

### Trapezoidal

5-2.5 **Shear Stress.** The permissible or critical shear stress in a channel defines the force required to initiate movement of the channel bed or lining material. Table 5-5 shows permissible shear stress values for manufactured, vegetative, and riprap channel lining. The permissible shear stress for non-cohesive soils is a function of mean diameter of the channel material as shown in Chart 23 of Appendix B. For larger stone sizes not shown in Chart 23 and rock riprap, the permissible shear stress is given by the following equation:

$$\tau_p = 4.0D_{50} \quad (5-12)$$

where:

$\tau_p$  = permissible shear stress, lb/ft<sup>2</sup>

$d_{50}$  = mean riprap size, ft

For cohesive materials, the plasticity index provides a good guide for determining the permissible shear stress as illustrated in Chart 24 of Appendix B.

**Table 5-5. Permissible Shear Stresses for Lining Materials\*\***

Lining Category	Lining Type	Permissible Unit Shear Stress, lb/ft <sup>2</sup>
Temporary*	Woven Paper Net	0.15
	Jute Net	0.45
	Fiberglass Roving:	
	Single	0.60
	Double	0.85
	Straw with Net	1.45
	Curled Wood Mat	1.55
	Synthetic Mat	2.00
Vegetative	Class A	3.70
	Class B	2.10
	Class C	1.00
	Class D	0.60
	Class E	0.35
Gravel Riprap	1 in.	0.33
	2 in.	0.67
Rock Riprap	6 in.	2.00
	12 in.	4.00

Lining Category	Lining Type	Permissible Unit Shear Stress, lb/ft <sup>2</sup>
Bare Soil	Non-cohesive	
	Cohesive	
*Some "temporary" linings become permanent when buried. **Table reproduced from HEC-15		

### 5-2.5.1 Example 5-3

*Given:* The channel section and flow conditions in Example 5-2, paragraph 5-1.2.6.3.

*Find:* Determine if a good stand of buffalo grass (Class D degree of retardance) will provide an adequate lining for this channel.

*Solution:*

Step 1. Determine the permissible shear stress.

From Table 5-4:

$$\tau_p = 0.60 \text{ lb/ft}^2$$

Step 2. Compare  $\tau_p$  with the maximum shear stress in the straight section,  $\tau_d$ , and with the shear stress in the bend,  $\tau_b$ .

$$\tau_d = 0.92 \text{ lb/ft}^2$$

$$\tau_b = 1.43 \text{ lb/ft}^2$$

$$\tau_p = 0.60 < \tau_d = 0.92$$

$$\tau_p = 0.60 < \tau_b = 1.43$$

### 5-2.5.2 Example 5-4

*Given:* The channel section and flow conditions in Example 5-2 (paragraph 5-1.2.6.3) and Example 5-3 (paragraph 5-2.5.1).

*Find:* Determine the length of increased shear stress downstream of the point of tangency of the 90-degree bend.

*Solution:*

Step 1. Determine the flow depth and hydraulic radius.

Assume that the flow depth and hydraulic radius in the bend will be approximately the same as those in the straight reach.

From Example 5-2:

$$d = 1.47 \text{ ft}$$

$$\begin{aligned} \text{with } d/B &= 1.47/3.0 \\ &= 0.49 \end{aligned}$$

From Chart 22:

$$R/d = 0.61$$

$$\begin{aligned} R &= d R/d \\ &= (1.47)(0.61) \\ &= 0.90 \text{ ft} \end{aligned}$$

Step 2. Determine the channel roughness in the bend.

From Example 5-2:

$$n = 0.055$$

Step 3. Determine length of increased shear stress.

Using Equation 5-11:

$$\begin{aligned} L_p &= \frac{0.604R^{7/6}}{n_b} \\ &= \frac{0.604(0.90)^{7/6}}{(0.055)} \\ &= 9.7 \text{ ft} \end{aligned}$$

Since the permissible shear stress,  $\tau_p$ , was less than the actual shear stress in the bend,  $\tau_b$ , an adequate lining material would have to be installed throughout the bend plus the length,  $L_p$ , downstream of the point of tangency of the curve.

## CHAPTER 6

### STORM DRAIN DESIGN

6-1 **PURPOSE AND SCOPE.** A storm drain is that portion of the drainage system that receives surface water through inlets and conveys the water through conduits to an outfall. It is composed of different lengths and sizes of pipe or conduit connected by appurtenant structures. A section of conduit connecting one inlet or appurtenant structure to another is termed a "segment" or "run." The storm drain conduit is most often a circular pipe, but it can also be a box or other enclosed conduit shape. Appurtenant structures include inlet structures (excluding the actual inlet opening), access holes, junction chambers, and other miscellaneous structures. Generalized design considerations for these structures are presented in Chapter 7. The computation of energy losses through these structures is described in detail in HEC-22, Chapter 7.

6-2 **DESIGN PROCEDURES FOR THE DRAINAGE SYSTEM.** Design storm runoff must be efficiently removed to avoid interruption of operations during or following storms and to prevent temporary or permanent damage to pavement subgrades. Removal is accomplished by a drainage system unique to each site. Drainage systems will vary in design and extent depending upon local soil conditions and topography; size of the physical facility; vegetation cover or its absence; the anticipated presence or absence of ponding; and most importantly, upon local storm intensity and frequency patterns. The drainage system should function with a minimum of maintenance difficulties and expense and should be adaptable to future expansion. Open channels or natural water courses are permitted only at the periphery of an airfield or heliport facility and must be well removed from the landing strips and traffic areas. Provisions for subsurface pavement drainage, the requirements for which are provided in UFC 3-250-01FA or UFC 3-260-01, may necessitate careful consideration. Subdrains are used to drain the base material, lower the water table, or drain perched water tables. Fluctuations of the water table must be considered in the initial design of the facility. A detailed step-by-step design procedure starts in section 6-3.

6-2.1 **Grading.** Proper grading is the most important single factor contributing to the success of the drainage system. Development of grading and drainage plans must be fully coordinated. Specific grading criteria for airfields can be found in UFC 3-260-01 for DOD and AC 150/5300-13 for FAA.

6-2.2 **Classification of Storm Drains.** Storm drains may be classified in two groups, primary and auxiliary.

6-2.2.1 **Primary Drains.** Primary drains consist of main drains and laterals that have sufficient capacity to accommodate the project design storm, either with or without supplementary storage in ponding basins above the drain inlets. To lessen construction requirements for drainage facilities, maximum use of ponding consistent with operational and grading requirements will be considered. The location and elevation of the drain inlets are determined in the development of the grading plans.

6-2.2.2 **Auxiliary Drains.** Auxiliary drains normally consist of any type or size drains provided to facilitate the removal of storm runoff but lacking sufficient capacity to remove the project design storm without excessive flooding or overflow. Auxiliary storm drains may be used in certain airfields to provide positive drainage of long flat swales located adjacent to runways or in unpaved adjacent areas. During less frequent storms of high intensity, excess runoff should flow overland to the primary drain system or other suitable outlet with a minimum of erosion. An auxiliary drain may also be installed to convey runoff from pavement gutters wherever a gutter capacity of less than design discharge is provided.

6-2.3 **Hydraulics of Storm Drainage Systems.** Hydraulic design of storm drainage systems requires an understanding of basic hydrologic and hydraulic concepts and principles. Hydrologic concepts were discussed earlier in this UFC. Important hydraulic principles include flow classification, conservation of mass, conservation of momentum, and conservation of energy. These elements are discussed in hydraulic texts. The following sections assume a basic understanding of these topics.

6-2.3.1 **Flow Type Assumptions.** The design procedures presented here assume that flow within each storm drain segment is steady and uniform. This means that the discharge and flow depth in each segment are assumed to be constant with respect to time and distance. Also, since storm drain conduits are typically prismatic, the average velocity throughout a segment is considered constant.

In actual storm drainage systems, the flow at each inlet is variable, and flow conditions are not truly steady or uniform; however, since the usual hydrologic methods employed in storm drain design are based on computed peak discharges at the beginning of each run, it is conservative to design using the steady uniform flow assumption.

6-2.3.2 **Open Channel vs. Pressure Flow.** Two design philosophies exist for sizing storm drains under the steady uniform flow assumption. The first is referred to as open channel or gravity flow design. To maintain open channel flow, the segment must be sized so that the water surface within the conduit remains open to atmospheric pressure. For open channel flow, flow energy is derived from the flow velocity (kinetic energy), depth (pressure), and elevation (potential energy). If the water surface throughout the conduit is to be maintained at atmospheric pressure, the flow depth must be less than the height of the conduit.

6-2.3.2.1 Pressure flow design requires that the flow in the conduit be at a pressure greater than atmospheric. Under this condition, there is no exposed flow surface within the conduit. In pressure flow, flow energy is again derived from the flow velocity, depth, and elevation. The significant difference here is that the pressure head will be above the top of the conduit, and will not equal the depth of flow in the conduit. In this case, the pressure head rises to a level represented by the hydraulic grade line. A detailed explanation of the hydraulic grade line is presented later in this chapter.



6-2.3.2.2 The question of whether open channel or pressure flow should control design has been debated. For a given flow rate, design based on open channel flow requires larger conduit sizes than those sized based on pressure flow. While it may be more expensive to construct storm drainage systems designed based on open channel flow, this design procedure provides a margin of safety by providing additional headroom in the conduit to accommodate an increase in flow above the design discharge. This factor of safety is often desirable since the methods of runoff estimation are not exact, and once placed, storm drains are difficult and expensive to replace.

6-2.3.2.3 There may be situations in which pressure flow design is desirable, however. For example, on some projects, there may be adequate headroom between the conduit and inlet/access hole elevations to tolerate pressure flow. In such a case, a significant cost savings may be realized over the cost of a system designed to maintain open channel flow. Also, in some cases it may be necessary to use an existing system that must be placed under pressure flow to accommodate the proposed design flow rates. In instances such as these, making a cursory hydraulic and economic analysis of a storm drain using both design methods before making a final selection may be advantageous.

6-2.3.2.4 Under most ordinary conditions, it is recommended that storm drains be sized based on a gravity flow criteria at flow full or near full. Designing for full flow is a conservative assumption since the peak flow actually occurs at 93 percent of full flow. However, the designer should maintain an awareness that pressure flow design may be justified in certain instances. When pressure flow is allowed, special emphasis should be placed on the proper design of the joints so that they are able to withstand the pressure flow.

6-2.3.3 **Hydraulic Capacity.** The hydraulic capacity of a storm drain is controlled by its size, shape, slope, and friction resistance. Several flow friction formulas have been advanced that define the relationship between flow capacity and these parameters. The most widely used formula for gravity and pressure flow in storm drains is Manning's equation.

6-2.3.3.1 Manning's equation was introduced in Chapter 3 for computing gutter capacity and the capacity for roadside and median channels. For circular storm drains flowing full, Manning's equation becomes:

$$V = \frac{0.59}{n} D^{0.67} S_o^{0.5} \quad Q = \frac{0.46}{n} D^{2.67} S_o^{0.5} \quad (6-1)$$

where:

$V$  = mean velocity, ft/s

$Q$  = rate of flow, ft<sup>3</sup>/s

$n$  = Manning's coefficient (Table 6-1)

$D$  = storm drain diameter, ft

$S_o$  = slope of the hydraulic grade line, ft/ft

6-2.3.3.2 A nomograph solution of Manning's equation for full flow in circular conduits is presented in Chart 25 of Appendix B. Representative values of the Manning's coefficient for various storm drain materials are provided in Table 6-1. Remember that the values in the table are for new pipe tested in a laboratory. Actual field values for culverts may vary depending on the effect of abrasion, corrosion, deflection, and joint conditions.

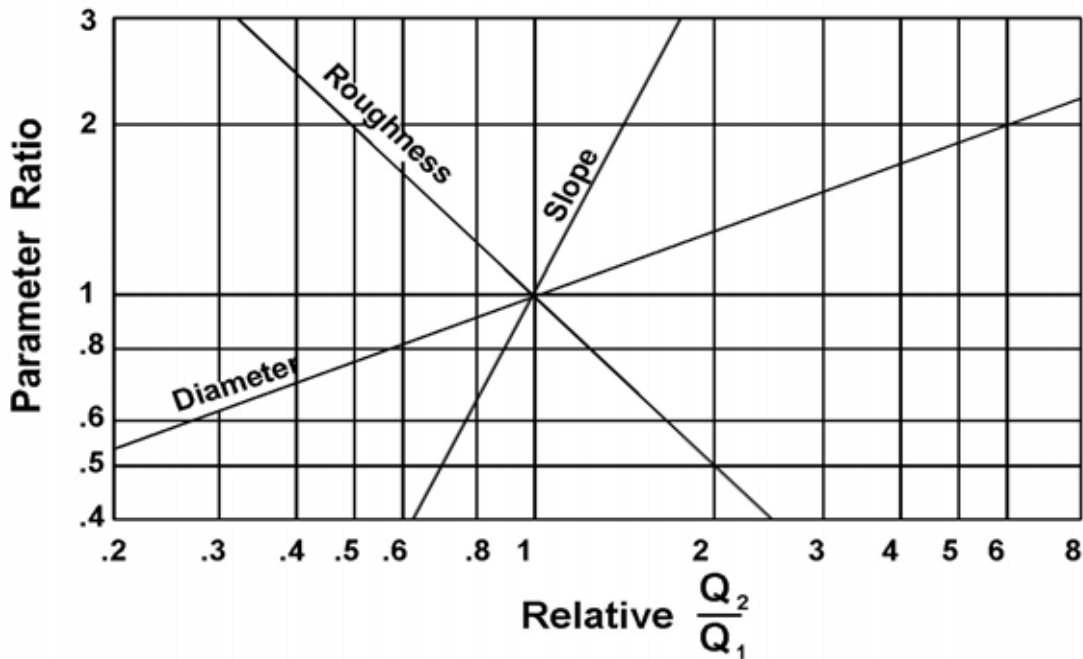
**Table 6-1. Manning's Coefficients for Storm Drain Conduits**

Type of Pipe	Roughness or Corrugation	Manning's $n^*$
Concrete Pipe	Smooth	0.010-0.011
Concrete Boxes	Smooth	0.012-0.015
Spiral Rib Metal Pipe	Smooth	0.012-0.013
Corrugated Metal Pipe, Pipe-Arch, and Box (Annular or Helical Corrugations — see HDS-5, Manning's $n$ varies with barrel size)	2.66 by 0.5 in. Annular	0.022-0.027
	2.66 by 0.5 in. Helical	0.011-0.023
	6 by 1 in. Helical	0.022-0.025
	5 by 1 in.	0.025-0.026
	3 by 1 in.	0.027-0.028
	6 by 2 in. Structural Plate	0.033-0.035
	9 by 2.5 in. Structural Plate	0.033-0.037
Corrugated Polyethylene	Smooth	0.009-0.015
Corrugated Polyethylene	Corrugated	0.018-0.025
Polyvinyl chloride (PVC)	Smooth	0.009-0.011
* <b>NOTE:</b> The Manning's $n$ values in this table were obtained in the laboratory and are supported by the provided reference. Actual field values for storm drains may vary depending on the effect of abrasion, corrosion, deflection, and joint conditions.		

6-2.3.3.3 Figure 6-1 illustrates storm drain capacity sensitivity to the parameters in Manning's equation. This figure can be used to study the effect changes in individual parameters will have on storm drain capacity. For example, if the diameter of a storm

drain is doubled, its capacity will be increased by a factor of 6.0; if the slope is doubled, the capacity is increased by a factor of 1.4; however, if the roughness is doubled, the pipe capacity will be reduced by 50 percent.

**Figure 6-1. Storm Drain Capacity Sensitivity**



6-2.3.3.4 The hydraulic elements graph in Chart 26 of Appendix B is provided to assist in the solution of the Manning's equation for part-full flow in storm drains. The hydraulic elements chart shows the relative flow conditions at different depths in a circular pipe and illustrates the following important points:

- Peak flow occurs at 93 percent of the height of the pipe. This means that if the pipe is designed for full flow, the design will be slightly conservative.
- The velocity in a pipe flowing half-full is the same as the velocity for full flow.
- Flow velocities for flow depths greater than half-full are greater than velocities at full flow.
- As the depth of flow drops below half-full, the flow velocity drops off rapidly.

6-2.3.3.5 The shape of a storm drain conduit also influences its capacity. Although most storm drain conduits are circular, a significant increase in capacity can be realized by using an alternate shape. Table 6-2 provides a tabular listing of the increase in capacity that can be achieved using alternate conduit shapes that have the same height as the original circular shape, but have a different cross-sectional area. Although these alternate shapes are generally more expensive than circular shapes, their use can be justified in some instances based on their increased capacity.

**Table 6-2. Increase in Capacity of Alternate Conduit Shapes Based on a Circular Pipe with the Same Height**

Shape	Area (Percent Increase)	Conveyance (Percent Increase)
Circular		
Oval	63	87
Arch	57	78
Box ( $B = D$ )	27	27

In addition to the nomograph in Chart 25 of Appendix B, numerous charts have been developed for conduits with specific shapes, roughness, and sizes.

**6-2.3.3.5 Example 6-1**

*Given:*  $Q = 17.6 \text{ ft}^3/\text{s}$

$S_o = 0.015 \text{ ft/ft}$

*Find:* The pipe diameter needed to convey the indicated design flow. Consider use of both concrete and helical corrugated metal pipes.

*Solution:*

Step 1. Concrete Pipe. Using Equation 6-1 or Chart 25 with  $n = 0.013$  for concrete:

$$D = \left[ \frac{(Qn)}{(0.46S_o^{0.5})} \right]^{0.375}$$

$$D = \left[ \frac{(17.6)(0.013)}{\{(0.46)(0.015)^{0.5}\}} \right]^{0.375}$$

$$D = 1.69 \text{ ft} = 20.3 \text{ in}$$

Use  $D = 21$  in diameter standard pipe size.

Step 2. Helical Corrugated Metal Pipe. Using Equation 6-1 or Chart 25:

Assume  $n = 0.017$

$$D = \left[ \frac{(Qn)}{(0.46S_o^{0.5})} \right]^{0.375}$$

$$D = \left[ \frac{(17.6)(0.017)}{\{(0.46)(0.015)^{0.5}\}} \right]^{0.375}$$

$$D = 1.87 \text{ ft} = 20.3 \text{ in}$$

Use  $D = 24$  in. diameter standard size. (**NOTE:** The  $n$  value for 24 in. = 0.017. The pipe size and  $n$  value must coincide as shown in Table 6-1.)

### 6-2.3.3.6 Example 6-2

*Given:* The concrete and helical corrugated metal pipes in Example 6-1.

*Find:* The full flow pipe capacity and velocity.

*Solution:* Use Equation 6-1 or Chart 25.

Step 1. Concrete pipe:

$$Q = \left( \frac{0.46}{n} D^{2.67} S_o^{0.5} \right)$$

$$Q = \frac{(0.46)}{(0.013)} (1.75)^{2.67} (0.015)^{0.5}$$

$$Q = 19.3 \text{ ft}^3/\text{s}$$

Step 2. Helical corrugated metal pipe:

$$Q = \left( \frac{0.46}{n} D^{2.67} S_o^{0.5} \right)$$

$$Q = \frac{(0.46)}{(0.017)} (2.0)^{2.67} (0.015)^{0.5}$$

$$Q = 21.1 \text{ ft}^3/\text{s}$$

$$V = \left( \frac{0.59}{n} D^{0.67} S_o^{0.5} \right)$$

$$V = \frac{(0.59)}{(0.017)} (2.05)^{0.67} (0.015)^{0.5}$$

$$V = 6.8 \text{ ft/s}$$

6-2.3.4 **Energy Grade Line/Hydraulic Grade Line.** The energy grade line (EGL) is an imaginary line that represents the total energy along a channel or conduit carrying water. Total energy includes elevation head, velocity head, and pressure head. The calculation of the EGL for the full length of the system is critical to the evaluation of a storm drain. To develop the EGL, it is necessary to calculate all of the losses through the system. The energy equation states that the energy head at any cross section must equal that in any other downstream section plus the intervening losses. The intervening losses are typically classified as either friction losses or form losses. The friction losses can be calculated using Manning's equation. Form losses are typically calculated by multiplying the velocity head by a loss coefficient,  $K$ . Various tables and calculations exist for developing the value of  $K$  depending on the structure being evaluated for loss. Knowing the location of the EGL is critical to understanding and estimating the location of the hydraulic grade line (HGL).

6-2.3.4.1 The HGL is a line coinciding with the level of flowing water at any point along an open channel. In closed conduits flowing under pressure, the HGL is the level to which water would rise in a vertical tube at any point along the pipe. The HGL is used to aid the designer in determining the acceptability of a proposed storm drainage system by establishing the elevation to which water will rise when the system is operating under design conditions.

6-2.3.4.2 The HGL, a measure of flow energy, is determined by subtracting the velocity head ( $V^2/2g$ ) from the EGL. Energy concepts can be applied to pipe flow as well as open channel flow. Figure 6-2 illustrates the EGLs and HGLs for open channel and pressure flow in pipes.

6-2.3.4.3 When water is flowing through the pipe and there is a space of air between the top of the water and the inside of the pipe, the flow is considered as open channel flow and the HGL is at the water surface. When the pipe is flowing full under pressure flow, the HGL will be above the crown of the pipe. When the flow in the pipe just reaches the point where the pipe is flowing full, this condition is between open channel flow and pressure flow. At this condition, the pipe is under gravity full flow and the flow is influenced by the resistance of the total circumference of the pipe. Under gravity full flow, the HGL coincides with the crown of the pipe.

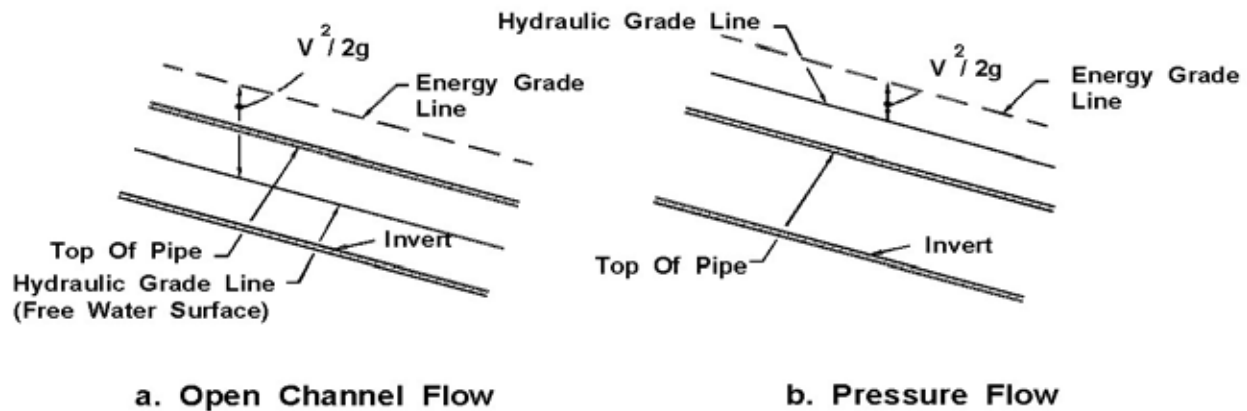


Figure 6-2. Hydraulic and Energy Grade Lines in Pipe Flow

6-2.3.4.4 Inlet surcharging and possible access hole lid displacement can occur if the HGL rises above the ground surface. A design based on open channel conditions must be planned carefully as well, including evaluation of the potential for excessive and inadvertent flooding created when a storm event larger than the design storm pressurizes the system. As hydraulic calculations are performed, frequent verification of the existence of the desired flow condition should be made. Often storm drainage systems can alternate between pressure and open channel flow conditions from one section to another.

6-2.3.4.5 A detailed procedure for evaluating the EGL and the HGL for storm drainage systems is presented later in this chapter.

6-2.3.5 **Storm Drain Outfalls.** All storm drains have an outlet where flow from the storm drainage system is discharged. The discharge point can be a natural river or stream, an existing storm drainage system, or a channel that is either existing or proposed for the purpose of conveying the storm water away from the highway. The procedure for calculating the EGL through a storm drainage system begins at the outfall; therefore, consideration of outfall conditions is an important part of storm drain design.

6-2.3.5.1 Several aspects of outfall design must be given serious consideration. These include the flowline or invert (inside bottom) elevation of the proposed storm drain outlet, tailwater elevations, the need for energy dissipation, and the orientation of the outlet structure.

6-2.3.5.2 The flowline or invert elevation of the proposed outlet should be equal to or higher than the flowline of the outfall. If not, the water may need to be pumped or otherwise lifted to the elevation of the outfall.

6-2.3.5.3 The tailwater depth or elevation in the storm drain outfall must be considered carefully. Evaluation of the HGL for a storm drainage system begins at the system

outfall with the tailwater elevation. For most design applications, the tailwater will either be above the crown of the outlet or between the crown and critical depth of the outlet. The tailwater may also occur between the critical depth and the invert of the outlet; however, the starting point for the HGL determination should be either the design tailwater elevation or the average of the critical depth and the height of the storm drain conduit,  $(dc + D)/2$ , whichever is greater.

6-2.3.5.4 An exception to this rule would be for a very large outfall with low tailwater where a water surface profile calculation would be appropriate to determine the location where the water surface will intersect the top of the barrel and full flow calculations can begin. In this case, the downstream water surface elevation would be based on critical depth or the design tailwater elevation, whichever is highest.

6-2.3.5.5 If the outfall channel is a river or stream, it may be necessary to consider the joint or coincidental probability of two hydrologic events occurring at the same time to adequately determine the elevation of the tailwater in the receiving stream. The relative independence of the discharge from the storm drainage system can be qualitatively evaluated by a comparison of the drainage area of the receiving stream to the area of the storm drainage system. For example, if the storm drainage system has a drainage area much smaller than that of the receiving stream, the peak discharge from the storm drainage system may be out of phase with the peak discharge from the receiving watershed.

Table 6-3 provides a comparison of discharge frequencies for coincidental occurrence for a 10- and 100-yr design storm. This table can be used to establish an appropriate design tailwater elevation for a storm drainage system based on the expected coincident storm frequency on the outfall channel. For example, if the receiving stream has a drainage area of 500 acres and the storm drainage system has a drainage area of 5 acres, the ratio of receiving area to storm drainage area is 500 to 5, which equals 100 to 1. From Table 6-3 and considering a 10-yr design storm occurring over both areas, the flow rate in the main stream will be equal to that of a 5-yr storm when the drainage system flow rate reaches its 10-yr peak flow at the outfall. Conversely, when the flow rate in the main channel reaches its 10-yr peak flow rate, the flow rate from the storm drainage system will have fallen to the 5-yr peak flow rate discharge. This is because the drainage areas are different sizes, and the time to peak for each drainage area is different.

6-2.3.5.6 There may be instances in which an excessive tailwater causes flow to back up the storm drainage system and out of inlets and access holes, creating unexpected and perhaps hazardous flooding conditions. The potential for this should be considered. Flap gates placed at the outlet can sometimes alleviate this condition; otherwise, it may be necessary to isolate the storm drain from the outfall by using a pump station.

6-2.3.5.7 Energy dissipation may be required to protect the storm drain outlet. Protection is usually required at the outlet to prevent erosion of the outfall bed and banks. Riprap aprons or energy dissipators should be provided if high velocities are expected. See HEC-14 for guidance with designing an appropriate dissipator.



**Table 6-3. Frequencies for Coincidental Occurrence**

Area Ratio	Frequencies for Coincidental Occurrence			
	10-Year Design		100-Year Design	
	Main Stream	Tributary	Main Stream	Tributary
10,000 to 1	1	10	2	100
	10	1	100	2
1,000 to 1	2	10	10	100
	10	2	100	10
100 to 1	5	10	25	100
	10	5	100	25
10 to 1	10	10	50	100
	10	10	100	50
1 to 1	10	10	100	100
	10	10	100	100

6-2.3.5.8 The orientation of the outfall is another important design consideration. Where practical, the outlet of the storm drain should be positioned in the outfall channel so that it is pointed in a downstream direction. This will reduce turbulence and the potential for excessive erosion. If the outfall structure cannot be oriented in a downstream direction, the potential for outlet scour must be considered. For example, where a storm drain outfall discharges perpendicular to the direction of flow of the receiving channel, care must be taken to avoid erosion on the opposite channel bank. If erosion potential exists, a channel bank lining of riprap or other suitable material should be installed on the bank. Alternatively, an energy dissipator structure could be used at the storm drain outlet.

6-2.3.6 **Energy Losses.** Prior to computing the HGL, estimate all energy losses in pipe runs and junctions. In addition to the principal energy involved in overcoming the friction in each conduit run, energy (or head) is required to overcome changes in momentum or turbulence at outlets, inlets, bends, transitions, junctions, and access holes. The calculation of these losses is extremely important when designing the storm drain. If the storm drain design does not account for energy losses, the performance of the storm drain system is uncertain. HEC-22 has a comprehensive description of all of the energy losses and includes an example problem that demonstrates the application of some of these relationships. Refer to Chapter 7 of HEC-22.

6-2.4 **Design Guidelines and Considerations.** Design criteria and considerations describe the limiting factors that qualify an acceptable design. Several of these factors, including design and check storm frequency, time of concentration and discharge determination, allowable high water at inlets and access holes, minimum flow velocities,

minimum pipe grades, and alignment, are explained in paragraphs 6-2.4.1 through 6-2.4.2.5.

**6-2.4.1 Design Storm Frequency.** The storm drain conduit is one of the most expensive and permanent elements within storm drainage systems. Storm drains normally remain in use longer than any other system elements. Once a storm drain is installed, increasing the capacity or repairing the line is very expensive. Consequently, the design flood frequency for projected hydrologic conditions should be selected to meet the need of the proposed facility both now and well into the future.

6-2.4.1.1 The design storm frequencies for DOD airfields and heliports, areas other than airfields, and FAA facilities are given in Chapter 2 of this UFC; however, exercise caution in selecting an appropriate storm frequency. Consider traffic volume, type and use of roadway, speed limit, flood damage potential, and the needs of the local community.

6-2.4.1.2 The highway community recommends designing storm drains that drain sag points where runoff can be removed only through the storm drainage system for a minimum 50-year frequency storm. The inlet at the sag point as well as the storm drain pipe leading from the sag point must be sized to accommodate this additional runoff. This can be done by computing the bypass occurring at each inlet during a 50-year rainfall and accumulating it at the sag point. Another method would be to design the upstream system for a 50-year design to minimize the bypass to the sag point. Evaluate each case on its own merits and assess the risk and impacts of flooding a sag point.

6-2.4.1.3 Following the initial design of a storm drainage system, it is prudent to evaluate the system using a higher check storm. Check storms are also explained in Chapter 2. Often for roadway design, a 100-year frequency storm is recommended for the check storm. The check storm is used to evaluate the performance of the storm drainage system and determine if the major drainage system is adequate to handle the flooding from a storm of this magnitude. Again, review local criteria.

**6-2.4.2 Time of Concentration and Discharge.** The rate of discharge at any point in the storm drainage system is not the sum of the inlet flow rates of all inlets above the section of interest. It is generally less than this total. The Rational Method is the most common means of determining design discharges for storm drain design. The time of concentration is very influential in determining the design discharge using the Rational Method. The time of concentration is the period required for water to travel from the most hydraulically distant point of the watershed to the point of interest. The designer is usually concerned with two different times of concentration: one for inlet spacing and the other for pipe sizing. The time of concentration for inlet spacing is the time required for water to flow from the hydraulically most distant point of the unique drainage area contributing only to that inlet. Typically, this is the sum of the times required for water to travel overland to the pavement gutter and along the length of the gutter between inlets. If the total time of concentration to the upstream inlet is less than 5 minutes, a minimum time of concentration of 5 minutes is used as the duration of rainfall. The time of

concentration for each successive inlet should be determined independently in the same manner as was used for the first inlet.

6-2.4.2.1 The time of concentration for pipe sizing is the time required for water to travel from the most hydraulically distant point in the total contributing watershed to the design point. Typically, this time consists of two components: (1) the time for overland and gutter flow to reach the first inlet, and (2) the time to flow through the storm drainage system to the point of interest.

6-2.4.2.2 The flow path with the longest time of concentration to the point of interest in the storm drainage system will usually define the duration used in selecting the intensity value in the Rational Method. Exceptions to the general application of the Rational Equation exist. For example, a small, relatively impervious area within a larger drainage area may have an independent discharge higher than that of the total area. This anomaly may occur because of the high runoff coefficient (*C* value) and high intensity resulting from a short time of concentration. If an exception does exist, it can generally be classified as one of two exception scenarios.

6-2.4.2.3 The first exception occurs when a highly impervious section exists at the most downstream area of a watershed and the total upstream area flows through the lower impervious area. When this occurs, two separate calculations should be made.

- First, calculate the runoff from the total drainage area with its weighted *C* value and the intensity associated with the longest time of concentration.
- Second, calculate the runoff using only the smaller, less pervious area. The typical procedure would be followed using the *C* value for the small less pervious area and the intensity associated with the shorter time of concentration.

Compare the results of these two calculations and use the largest value of discharge for design.

6-2.4.2.4 The second exception exists when a smaller, less pervious area is tributary to the larger primary watershed. When this occurs, two sets of calculations should also be made.

- First, calculate the runoff from the total drainage area with its weighted *C* value and the intensity associated with the longest time of concentration.
- Second, calculate the runoff to consider how much discharge from the larger primary area is contributing at the same time as the peak from the smaller, less pervious tributary area. When the small area is discharging, some discharge from the larger primary area is also contributing to the total discharge. In this calculation, use the intensity associated with the time of concentration from the smaller, less pervious area. The portion of the larger primary area to be considered is determined by this equation:

$$A_c = A \frac{t_{c1}}{t_{c2}} \quad (6-2)$$

$A_c$  is the most downstream part of the larger primary area that will contribute to the discharge during the time of concentration associated with the smaller, less pervious area.  $A$  is the area of the larger primary area,  $t_{c1}$  is the time of concentration of the smaller, less pervious tributary area, and  $t_{c2}$  is the time of concentration associated with the larger primary area as is used in the first calculation. The  $C$  value to be used in this computation should be the weighted  $C$  value that results from combining  $C$  values of the smaller, less pervious tributary area and the area  $A_c$ . The area to be used in the Rational Method is the area of the less pervious area plus  $A_c$ . This second calculation should be considered only when the less pervious area is tributary to the area with the longer time of concentration and is at or near the downstream end of the total drainage area.

6-2.4.2.5 Finally, compare the results of these calculations and use the largest value of discharge for design.

6-2.4.3 **Maximum Highwater.** Maximum highwater is the maximum allowable elevation of the water surface (HGL) at any given point along a storm drain. These points include inlets, access holes, or any place where there is access from the storm drain to the ground surface. The maximum highwater at any point should not interfere with the intended functioning of an inlet opening or reach an access hole cover. Maximum allowable highwater levels should be established along the storm drainage system prior to initiating hydraulic evaluations.

6-2.4.4 **Minimum Velocity and Grades.** It is desirable to maintain a self-cleaning velocity in the storm drain to prevent deposition of sediments and subsequent loss of capacity. For this reason, storm drains should be designed to maintain full-flow pipe velocities of 3 ft/s or greater. A review of the hydraulic elements in Chart 26 (Appendix B) indicates that this criteria results in a minimum flow velocity of 2 ft/s at a flow depth equal to 25 percent of the pipe diameter. Minimum slopes required for a velocity of 3 ft/s can be computed using the form of Manning's formula in Equation 6-3. Alternately, use values in Table 6-4.

$$S = 2.67 \left( \frac{nV}{D^{0.67}} \right)^2 \quad (6-3)$$

where:

$D$  = in feet when using Equation 6-3

**Table 6-4. Minimum Pipe Slopes to Ensure 3.0 ft/s Velocity in Storm Drains Flowing Full**

Pipe Size, in.	Full Pipe Flow, ft <sup>3</sup> /s	Minimum Slopes, ft/ft		
		<i>n</i> = 0.012	<i>n</i> = 0.013	<i>n</i> = 0.024
8	1.1	0.0064	0.0075	0.0256
10	1.6	0.0048	0.0056	0.0190
12	2.4	0.0037	0.0044	0.0149
15	3.7	0.0028	0.0032	0.0111
18	5.3	0.0022	0.0026	0.0087
21	7.2	0.0018	0.0021	0.0071
24	9.4	0.0015	0.0017	0.0059
27	11.9	0.0013	0.0015	0.0051
30	14.7	0.0011	0.0013	0.0044
33	17.8	0.0010	0.0011	0.0039
36	21.2	0.0009	0.0010	0.0034
42	28.9	0.0007	0.0008	0.0028
48	37.7	0.0006	0.0007	0.0023
54	47.7	0.0005	0.0006	0.0020
60	58.9	0.0004	0.0005	0.0017
66	71.3	0.0004	0.0005	0.0015
72	84.8	0.0003	0.0004	0.0014

6-3 **PRELIMINARY DESIGN PROCEDURE.** The preliminary design of storm drains can be accomplished by using the following steps and the storm drain computation sheet in Figure 6-3. This procedure assumes that each storm drain will be initially designed to flow full under gravity conditions. The designer must recognize that when the steps in this section are complete, the design is only preliminary. Final design is accomplished after the EGL and HGL computations have been completed.

6-3.1 **Step 1.** Prepare a working plan layout and profile of the storm drainage system establishing the following design information:

a. Location of Storm Drains

(1) Preliminary Layout. Prepare a preliminary map (scale 1 in. = 200 ft or larger) showing the outlines of roadways, runways, taxiways, and parking aprons. Contours should represent approximately the finished grade for

the airfield, heliport, or roadway facility. Details of grading, including ponding basins around primary drain inlets, need not be shown more accurately than with 1-ft contour intervals.

(2) Profiles. Plot profiles of all roadways, or runways, taxiways, and aprons so that elevations controlling the grading of intermediate areas may be determined readily at any point.

b. Direction of Flow. Avoid drainage patterns consisting of closely spaced interior inlets in pavements with intervening ridges for airfields. Such grading may cause taxiing problems, including bumping or scraping of wing tanks. Crowned sections are the standard cross sections for roadways, runways, taxiways, and safety areas. Crowned sections generally slope each way from the center line of the runway on a transverse grade to the pavement. Although crowned grading patterns result in the most economical drainage, adjacent pavements, topographic considerations, or other matters may necessitate other pavement grading.

c. Location of Access Holes and Other Structures

(1) Drain Outlets. Consider the limiting grade elevations and feasible channels for the collection and disposition of the storm runoff. Select the most suitable locations for outlets of drains serving various portions of the field. Then select a tentative layout for primary storm drains. The most economical and most efficient design is generally obtained by maintaining the steepest hydraulic gradient attainable in the main drain and maintaining approximately equal lateral length on each side of the main drain.

(2) Cross-sectional Profiles of Intermediate Areas. Assume the location of cross-sectional profiles of intermediate areas. Plot data showing controlling elevations and indicate the tentatively selected locations for inlets by means of vertical lines. See Chapter 3 for guidance on the preliminary location of inlets. To facilitate a comparison of the elevations of intermediate areas with those of paved areas, projections of roadways, runways, taxiways, or aprons for limited distances should be shown on the profiles. Generally, one cross-sectional profile should follow each line of the underground storm drain system. Other profiles should pass through each of the inlets at approximately right angles to paved roadways, runways, taxiways, or aprons.

(3) Correlation of the Controlling Elevations and Limiting Grades. Begin at points corresponding to the controlling elevations, such as the edges of runways, and sketch the ground profile from the given points to the respective drain inlets. Make the grades conform to the limiting slopes. Review the tentative grading and inlet elevations and make such

adjustments in the locations of drain inlets and in grading details as necessary to obtain the most satisfactory general plan.

- d. Number or Label Assigned to Each Structure
- e. Location of All Existing Utilities (e.g., water, sewer, gas, underground cables)

(1) Trial Drainage Layouts. Several trial drainage layouts will be necessary before the most economical system can be selected. The first consideration will be the tentative layout serving all of the depressed areas in which overland flow will accumulate. The inlet structures will be located, during the initial step, at the lowest points within the field areas. The pipelines will be shown next. Each of the inlet structures will be connected to the field pipelines, which in turn will be connected to the major outfalls.

(2) Rechecking of Finished Contours. Before proceeding further, recheck the finished contours to determine whether the surface flow is away from the paved areas, that the flow is not directed across them, that no field structures fall within the paved areas (except in aprons), that possible ponding areas are not adjacent to pavement edges, and that surface water will not have to travel excessively long distances to flow into the inlets. If there is a long, gradually sloping swale between a runway and its parallel taxiway (in which the longitudinal grade, for instance, is all in one direction), additional inlets should be placed at regular intervals down this swale. Should this be required, ridges may be provided to protect the area around the inlet, prevent bypassing, and facilitate the entry of the water into the structure. If the ridge area is within the runway safety area, the grades and grade changes will need to conform to the limitations established for runway safety areas in other pertinent publications.

(3) Maximum Spread and Ponding. Estimate the maximum elevation of storage permissible in the various ponding areas and check the elevations against the profiles. Ponding requirements for airfields and heliports are provided in Chapter 2. Scale the distances from the respective drain inlets to the point where the elevation of maximum permissible ponding intersects the ground line, transfer the scaled distances to the map prepared in (1) above, and sketch a line through the plotted points to represent the boundary of the maximum ponding area during the design storm. Criteria for allowable width of spread for roadways is provided in Chapter 3.

(4) Ditches. A system of extensive peripheral ditches may become an integral part of the drainage system. Ditch size and function are variable. Some ditches carry the outfall away from the pipe system and drainage areas into the natural drainage channels or into existing water courses. Others receive outfall flow from the airport site or adjacent terrain. Open

ditches are subject to erosion if their gradients are steep and if the volume of flow is large. When necessary, the ditches may be turfed, sodded, stabilized, or lined to control erosion. A complete explanation of median drainage can be found in Chapter 3. Stable channel design is detailed in Chapter 5.

(5) Study of the Contiguous Areas. After the storm drain system has been tentatively laid out and before the actual computations have been started, the areas contiguous to the graded portion of the airport that may contribute surface flow upon it should again be studied. A system of open channels, intercepting ditches, or storm drains should be designed where necessary to intercept this storm flow and conduct it away from the facility to convenient outfalls. A study of the soil profiles will assist in locating porous strata that may be conducting subsurface water into the airport. If this condition exists, the subsurface water should be intercepted and diverted.



**Figure 6-3. Preliminary Storm Drain Computation Sheet**

COMPUTED BY \_\_\_\_\_ DATE \_\_\_\_\_  
 CHECKED BY \_\_\_\_\_ DATE \_\_\_\_\_  
 PAGE \_\_\_\_\_ OF \_\_\_\_\_

ROUTE \_\_\_\_\_  
 SECTION \_\_\_\_\_  
 COUNTY \_\_\_\_\_

STR. ID		LENGTH	DRAINAGE AREA		RUNOFF COEFF. "C"	"AREA" X "C"		TIME OF CONCENTRATION		RAIN "I"	RUNOFF "Q"	PIPE DIA.	Q FULL	VELOCITY		SEC TIME	INVERT ELEV.		CROWN DROP	SLOPE
FROM	TO	( )	INC ( )	TOTAL ( )		INC. ( )	TOTAL ( )	INLET (min)	SYSTEM (min)	( /hr)	( <sup>3</sup> /s)	( )	( <sup>3</sup> /s)	FULL ( /s)	DESIGN ( /s)	(min)	U/S ( )	D/S ( )	( )	( / )
(1)	(2)	(3)	(4)	(5)	(6)	(7)	(8)	(9)	(10)	(11)	(12)	(13)	(14)	(15)	(16)	(17)	(18)	(19)	(20)	(21)

6-3.2 **Step 2.** Determine the following hydrologic parameters for the drainage areas tributary to each inlet to the storm drainage system. Use the completed grading plan as a guide and sketch the boundaries of specific drainage areas tributary to their respective drain inlets. Compute the area of paved and unpaved areas tributary to the respective inlets.

- Drainage areas
- Runoff coefficients
- Travel time

6-3.3 **Step 3.** Using the information generated in Steps 1 and 2, complete the following information on the design form for each run of pipe starting with the upstream-most storm drain run:

- FROM and TO stations, Columns 1 and 2.
- LENGTH of run, Column 3.
- INC. drainage area, Column 4. The incremental drainage area tributary to the inlet at the upstream end of the storm drain run under consideration.
- RUNOFF COEFF. "C," Column 6. The runoff coefficient for the drainage area tributary to the inlet at the upstream end of the storm drain run under consideration. In some cases, a composite runoff coefficient will need to be computed.

6-3.4 **Step 4.** Using the information from Step 3, compute this information:

- TOTAL area, Column 5. Add the incremental area in Column 4 to the previous section's total area and place this value in Column 5.
- INC. "AREA" X "C," Column 7. Multiply the drainage area in Column 4 by the runoff coefficient in Column 6. Put the product,  $CA$ , in Column 7.
- TOTAL "AREA" X "C," Column 8. Add the value in Column 7 to the value in Column 8 for the previous storm drain run, and put this value in Column 8.
- RAIN "I," Column 11. Using the larger of the two times of concentration in Columns 9 and 10, and an IDF curve, determine the rainfall intensity,  $I$ , and place this value in Column 11.
- RUNOFF "Q," Column 12. Calculate the discharge as the product of Columns 8 and 11. Place this value in Column 12.

- SLOPE, Column 21. Place the pipe slope value in Column 21. The pipe slope will be approximately the slope of the finished roadway. The slope can be modified as needed.
- PIPE DIA., Column 13. Size the pipe using relationships and charts presented in Chapter 4 to convey the discharge by varying the slope and pipe size as necessary. The storm drain should be sized as close as possible to a full gravity flow. Since most calculated sizes will not be available, a nominal size will be used. The designer will decide whether to go to the next larger size and have part-full flow or whether to go to the next smaller size and have pressure flow.
- Q (CAPACITY) FULL, Column 14. Compute the full flow capacity of the selected pipe using Equation 6-1, and put this information in Column 14.
- VELOCITY, Columns 15 (FULL) and 16 (DESIGN). Compute the full flow and design flow velocities (if different) in the conduit and place these values in Columns 15 and 16. If the pipe is flowing full, the velocities can be determined from  $V = Q/A$ , Equation 6-1, or Chart 25 (Appendix B). If the pipe is not flowing full, the velocity can be determined from Chart 26.
- SEC (SECTION) TIME, Column 17. Calculate the travel time in the pipe section by dividing the pipe length (Column 3) by the design flow velocity (Column 16). Place this value in Column 17.
- CROWN DROP, Column 20. Calculate an approximate crown drop at the structure to off-set potential structure energy losses using Equation 7-9 of HEC-22.
- INVERT ELEV., Columns 18 and 19. Compute the pipe inverts at the upper (U/S) and lower (D/S) ends of this section of pipe, including any pipe size changes that occurred along the section.

6-3.5 **Step 5.** Repeat steps 3 and 4 for all pipe runs to the storm drain outlet. Use equations and nomographs to accomplish the design effort.

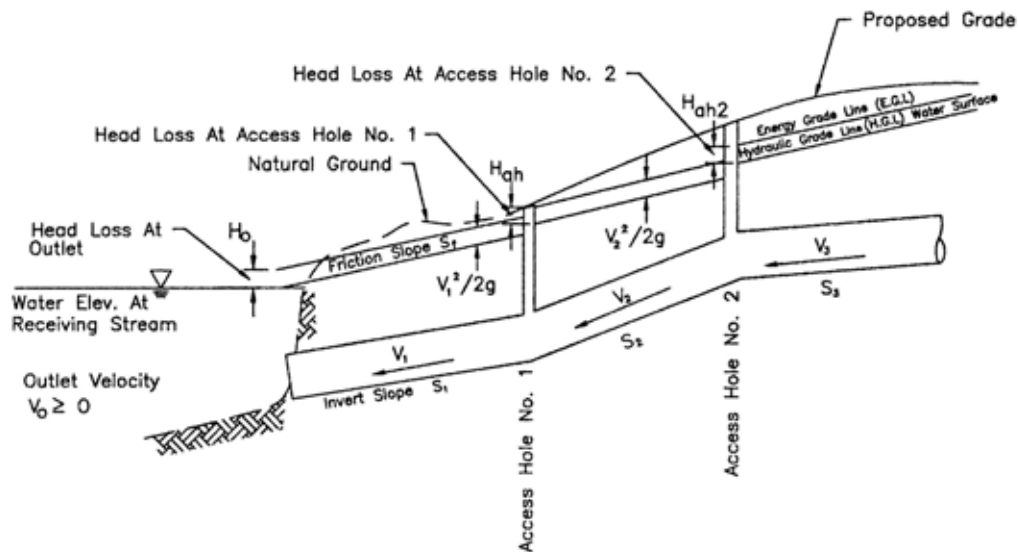
6-3.6 **Step 6.** Check the design by calculating the EGL and HGL as described in section 6-4.

An example of storm drain sizing and layout is provided in Chapter 7 of HEC-22.

6-4 **ENERGY GRADE LINE EVALUATION PROCEDURE.** This section presents a step-by-step procedure for manual calculation of the EGL and the HGL using the energy loss method. For most storm drainage systems, computer methods such as HYDRA are the most efficient means of evaluating the EGL and HGL; however, it is important that the designer understand the analysis process to better interpret the output from computer-generated storm drain designs.

6-4.1 Figure 6-4 provides a sketch illustrating the use of the two grade lines in developing a storm drainage system. The step-by-step procedure in paragraph 6-4.3 can be used to manually compute the EGL and HGL. The computation tables in Figure 6-5 and Figure 6-6 can be used to document this procedure.

**Figure 6-4. Energy and Hydraulic Grade Line Illustration**



6-4.2 Before beginning the computational steps in the procedure, it is important to understand the organization of data on the form. In general, a line will contain the information on a specific structure and the line downstream from the structure. As the table is started, the first two lines may be unique. The first line will contain information about the outlet conditions. This may be a pool elevation or information on a known downstream system. The second line will be used to define the conditions right at the end of the last conduit. Following these first two lines, the procedure becomes more general. A single line on the computation sheet is used for each junction or structure and its associated outlet pipe. For example, data for the first structure immediately upstream of the outflow pipe and the outflow pipe would be tabulated in the third full line of the computation sheet (lines may be skipped on the form for clarity).

Table A (Figure 6-5) is used to calculate the HGL and EGL elevations, while table B (Figure 6-6) is used to calculate the pipe losses and structure losses. Values obtained in Table B are transferred to Table A for use during the design procedure. In the description of the computation procedures, a column number will be followed by a letter A or B to indicate the appropriate table to be used.

6-4.3 EGL computations begin at the outfall and are worked upstream, taking each junction into consideration. Many storm drain systems are designed to function in a subcritical flow regime. In subcritical flow, pipe and access hole losses are summed to determine the upstream EGL levels. If supercritical flow occurs, pipe and access losses

are not carried upstream. When a storm drain section is identified as being supercritical, the designer should advance to the next upstream pipe section to determine its flow regime. This process continues until the storm drain system returns to a subcritical flow regime. Again, HEC-22 includes a complete example that works through these steps.

**NOTE:** In the EGL computational procedure, values obtained in Table B are transferred to Table A for use during the design procedure. **In the step-by-step description, a column number will be followed by a letter A or B to indicate the appropriate table to be used.**

6-4.3.1 **Step 1.** The first line of Table A includes information on the system beyond the end of the conduit system. Define this as the stream, pool, existing system, etc., in Column 1A. Determine the EGL and HGL for the downstream receiving system. If this is a natural body of water, the HGL will be at the water surface. The EGL will also be at the water surface if no velocity is assumed or will be a velocity head above the HGL if there is a velocity in the water body. If the new system is being connected to an existing storm drain system, the EGL and the HGL will be that of the receiving system. Enter the HGL in Column 14A and the EGL in Column 10A of the first line on the computation sheet.

6-4.3.2 **Step 2.** Identify the structure number at the outfall (this may be just the end of the conduit, but it needs a structure number), the top of conduit (TOC) elevation at the outfall end, and the surface elevation at the outfall end of the conduit. Place these values in Columns 1A, 15A, and 16A, respectively. Also, add the structure number in Column 1B.

6-4.3.3 **Step 3.** Determine the EGL just upstream of the structure identified in Step 2. Two different cases exist when the conduit is flowing full:

- Case 1: If the tailwater at the conduit outlet is greater than  $(d_c + D)/2$ , the EGL will be the TW elevation plus the velocity head for the conduit flow conditions.
- Case 2: If the tailwater at the conduit outlet is less than  $(d_c + D)/2$ , the EGL will be the HGL plus the velocity head for the conduit flow conditions. The equivalent HGL, EHGL, will be the invert plus  $(d_c + D)/2$ .

The velocity head needed in either Case 1 or 2 will be calculated in the next steps, so it may be helpful to complete Step 4 and work Step 5 to the point where velocity head (Column 7A) is determined and then come back and finish this step. Enter the EGL in Column 13A.

**NOTE:** The values for  $d_c$  for circular pipes can be determined from Chart 27. Charts for other conduits or other geometric shapes can be found in HDS-5. Note that the value of  $d_c$  cannot be greater than the height of the conduit.

Figure 6-5. Energy Grade Line Computation Sheet - Table A

COMPUTED BY \_\_\_\_\_ DATE \_\_\_\_\_  
 CHECKED BY \_\_\_\_\_ DATE \_\_\_\_\_  
 PAGE \_\_\_\_\_ OF \_\_\_\_\_  
 INITIAL TAILWATER ELEV. \_\_\_\_\_ ROUTE \_\_\_\_\_  
 SECTION \_\_\_\_\_  
 COUNTY \_\_\_\_\_

Str. ID	D	Q	L	V	d	d <sub>c</sub>	V <sup>2</sup> /2g	S <sub>r</sub>	Total Pipe Loss (table B)	EGL <sub>o</sub>	K (table B)	K(V <sup>2</sup> /2g)	EGL <sub>i</sub>	HGL	U/S TOC	Surf. Elev.
(1)	(2)	( <sup>3</sup> /s) (3)	(4)	( /s) (5)	(6a)	(6b)	(7)	( / ) (8)	(9)	(10)	(11)	(12)	(13)	(14)	(15)	(16)

Figure 6-6. Energy Grade Line Computation Sheet - Table B

COMPUTED BY \_\_\_\_\_  
CHECKED BY \_\_\_\_\_  
PAGE \_\_\_\_\_

DATE \_\_\_\_\_  
DATE \_\_\_\_\_  
OF \_\_\_\_\_

ROUTE \_\_\_\_\_  
SECTION \_\_\_\_\_  
COUNTY \_\_\_\_\_

Str. ID (1)	Pipe Losses ( )						Structure Losses ( )								
	H <sub>f</sub> (2)	h <sub>b</sub> (3)	H <sub>s</sub> (4)	H <sub>e</sub> (5)	H <sub>f</sub> (6)	Total (7)	d <sub>aho</sub> (8)	K <sub>o</sub> (9)	C <sub>D</sub> (10)	C <sub>d</sub> (11)	C <sub>Q</sub> (12)	C <sub>p</sub> (13)	C <sub>B</sub> (14)	K (15)	

6-4.3.4 **Step 4.** Identify the structure for the junction immediately upstream of the outflow conduit (for the first conduit) or immediately upstream of the last structure (if working with subsequent lines) and enter this value in Column 1A and Column 1B of the next line on the computation sheets. Enter the conduit diameter ( $D$ ) in Column 2A, the design discharge ( $Q$ ) in Column 3A, and the conduit length ( $L$ ) in Column 4A.

6-4.3.5 **Step 5.** If the barrel flows full, enter the full flow velocity from continuity in Column 5A and the velocity head ( $V^2/2g$ ) in Column 7A. Put “full” in Column 6a and not applicable (n/a) in Column 6b of Table A. Continue with Step 6. If the barrel flows only partially full, continue with Step 5A.

**NOTE:** If the pipe is flowing full because of high tailwater or because the pipe has reached its capacity for the existing conditions, the velocity will be computed based on continuity using the design flow and the full cross-sectional area. Do not use the full flow velocity determined in Column 15 of the Preliminary Storm Drain Computation Sheet (Figure 6-3) for part-full flow conditions. For part-full conditions defined in Step 5, the calculations in the preliminary form may be helpful. Actual flow velocities need to be used in the EGL and HGL calculations.

6-4.3.5.1 **Step 5A.** Part-full flow: Using the hydraulic elements graph in Chart 26 with the ratio of part-full to full flow (values from the Preliminary Storm Drain Computation Sheet, Figure 6-3), compute the depth and velocity of flow in the conduit. Enter these values in Column 6a and 5, respectively, of Table A. Compute the velocity head ( $V^2/2g$ ) and place in Column 7A.

6-4.3.5.2 **Step 5B.** Compute the critical depth for the conduit using Chart 27. (If the conduit is not circular, see HDS-5 for additional charts.) Enter this value in Column 6b of Table A.

6-4.3.5.3 **Step 5C.** Compare the flow depth in Column 6a (Table A) with the critical depth in Column 6b (Table A) to determine the flow state in the conduit. If the flow depth in Column 6a is greater than the critical depth in Column 6b, the flow is subcritical; continue with Step 6. If the flow depth in Column 6a is less than or equal to the critical depth in Column 6b, the flow is supercritical; continue with Step 5D. In either case, remember that the EGL must be higher upstream for flow to occur. If after checking for super critical flow in the upstream section of pipe, ensure that the EGL is higher in the pipe than in the structure.

6-4.3.5.4 **Step 5D.** Pipe losses in a supercritical pipe section are not carried upstream. Therefore, enter a zero (0) in Column 7B for this structure.

6-4.3.5.5 **Step 5E.** Enter the structure ID for the next upstream structure on the next line in Column 1A and Column 1B. Enter the pipe diameter ( $D$ ), discharge ( $Q$ ), and conduit length ( $L$ ) in Columns 2A, 3A, and 4A, respectively, of the same line.

**NOTE:** After a downstream pipe has been determined to flow in supercritical flow, it is necessary to check each succeeding upstream pipe for the type of flow. This is done by



calculating normal depth and critical depth for each pipe. If normal depth is less than the diameter of the pipe, the flow will be open channel flow and the critical depth calculation can be used to determine whether the flow is sub or supercritical. If the flow line elevation through an access hole drops enough that the invert of the upstream pipe is not inundated by the flow in the downstream pipe, the designer goes back to Column 1A and begins a new design as if the downstream section did not exist.

6-4.3.5.6 **Step 5F.** Compute the normal depth for the conduit using Chart 26 and the critical depth using Chart 27. (If the conduit is not circular, see HDS-5 for additional charts.) Enter these values in Columns 6a and 6b of Table A.

6-4.3.5.7 **Step 5G.** If the pipe barrel flows full, enter the full flow velocity from continuity in Column 5A and the velocity head ( $V^2/2g$ ) in Column 7A. Go to Step 3, Case 2 to determine the EGL at the outlet end of the pipe. Put this value in Column 10A and go to Step 6. For part-full flow, continue with Step 5H.

6-4.3.5.8 **Step 5H.** Part-full Flow: Compute the velocity of flow in the conduit and enter this value in Column 5A. Compute the velocity head ( $V^2/2g$ ) and place the value in Column 7A.

6-4.3.5.9 **Step 5I.** Compare the flow depth in Column 6a with the critical depth in Column 6b to determine the flow state in the conduit. If the flow depth in Column 6a is greater than the critical depth in Column 6b, the flow is subcritical; continue with Step 5J. If the flow depth in Column 6a is less than or equal to the critical depth in Column 6b, the flow is supercritical; continue with Step 5K.

6-4.3.5.10 **Step 5J.** Subcritical Flow Upstream: Compute the EGL at the outlet of the structure ( $EGL_o$ ) at the outlet of the previous structure as the outlet invert plus the sum of the outlet pipe flow depth and the velocity head. Place this value in Column 10A of the appropriate structure and go to Step 9.

6-4.3.5.11 **Step 5K.** Supercritical Flow Upstream: Access hole losses do not apply when the flow in two successive pipes is supercritical. Place zeros (0) in Columns 11A, 12A, and 15B of the intermediate structure (previous line). The HGL at the structure is equal to the pipe invert elevation plus the flow depth. Check the invert elevations and the flow depths both upstream and downstream of the structure to determine where the highest HGL exists. The highest value should be placed in Column 14A of the previous structure line. Perform Steps 20 and 21 and then repeat Steps 5E through 5K until the flow regime returns to subcritical. If the next upstream structure is end-of-line, skip to Step 10B and then perform Steps 20, 21, and 24.

6-4.3.6 **Step 6.** Compute the friction slope ( $S_f$ ) for the pipe:  $S_f = H_f / L = [Q n / (0.46 D^{2.67})]^2$

Enter this value in Column 8A of the current line. This equation assumes full flow in the outlet pipe. If full flow does not exist, set the friction slope equal to the pipe slope.

6-4.3.7 **Step 7.** Compute the friction loss ( $H_f$ ) by multiplying the length ( $L$ ) in Column 4A by the friction slope ( $S_f$ ) in Column 8A and enter this value in Column 2B. Compute other losses along the pipe run such as bend losses ( $h_o$ ), transition contraction ( $H_c$ ) and expansion ( $H_e$ ) losses, and junction losses ( $H_j$ ) using Equations 7-5 through 7-8 of HEC-22 and place the values in Columns 3B, 4B, 5B, and 6B, respectively. Add the values in 2B, 3B, 4B, 5B, and 6B and place the total in Columns 7B and 9A.

6-4.3.8 **Step 8.** Compute the EGL value at the outlet of the structure ( $EGL_o$ ) as the EGL for an inflow pipe ( $EGL_i$ ) elevation from the previous structure (Column 13A) plus the total pipe losses (Column 9A). Enter the  $EGL_o$  value in Column 10A.

6-4.3.9 **Step 9.** Estimate the depth of water in the access hole (estimated as the depth from the outlet pipe invert to the HGL in the pipe at the outlet). It is computed as  $EGL_o$  (Column 10A) minus the pipe velocity head in Column 7A minus the pipe invert elevation (from the Preliminary Storm Drain Computation Sheet, Figure 6-3). Enter this value in Column 8B. If supercritical flow exists in this structure, leave this value blank and skip to Step 5E.

6-4.3.10 **Step 10.** If the inflow storm drain invert is submerged by the water level in the access hole, compute access hole losses using Equation 7-10 and Equation 7-11 of HEC-22. Start by computing the initial structure head loss coefficient ( $K_o$ ) based on the relative access hole size. Enter this value in Column 9B. Continue with Step 11. If the inflow storm drain invert is not submerged by the water level in the access hole, compute the head in the access hole using culvert techniques from HDS-5:

6-4.3.10.1 **Step 10A.** If the structure outflow pipe is flowing full or partially full under outlet control, compute the access hole loss by setting  $K$  in Equation 7-10 to  $K_e$  as reported in Table 7-5b of HEC-22. Enter this value in Columns 15B and 11A and continue with Step 17. Add a note on Table A indicating that this is a drop structure.

6-4.3.10.2 **Step 10B.** If the outflow pipe functions under inlet control, compute the depth in the access hole (HGL) using Chart 28 or 29 (Appendix B). If the storm conduit shape is other than circular, select the appropriate inlet control nomograph from HDS-5. Add these values to the access hole invert to determine the HGL. Since the velocity in the access hole is negligible, the EGL and HGL are the same. Enter the HGL in Column 14A and the EGL in Column 13A. Add a note on Table A indicating that this is a drop structure. Go to Step 20.

6-4.3.11 **Step 11.** Using Equation 7-13 of HEC-22, compute the correction factor for pipe diameter ( $C_D$ ) and enter this value in Column 10B. Note, this factor is only significant in cases where the  $d_{ahd}/D_o$  ratio is greater than 3.2.

6-4.3.12 **Step 12.** Using Equation 7-14 of HEC-22, compute the correction factor for flow depth ( $C_d$ ) and enter this value in Column 11B. Note, this factor is only significant in cases where the  $d_{ahd}/D_o$  ratio is less than 3.2.

6-4.3.13 **Step 13.** Using Equation 7-15 of HEC-22, compute the correction factor for relative flow ( $C_Q$ ) and enter this value in Column 12B. This factor equals 1.0 if there are less than 3 pipes at the structure.

6-4.3.14 **Step 14.** Using Equation 7-16 of HEC-22, compute the correction factor for plunging flow ( $C_P$ ) and enter this value in Column 13B. This factor equals 1.0 if there is no plunging flow. This correction factor is only applied when  $h > d_{aho}$ .

6-4.3.15 **Step 15.** Enter in Column 14B the correction factor for benching ( $C_B$ ) as determined from Table 7-6 of HEC-22. Linear interpolation between the two columns of values will most likely be necessary.

6-4.3.16 **Step 16.** Using Equation 7-11 of HEC-22, compute the value of  $K$  and enter this value in Columns 15B and 11A.

6-4.3.17 **Step 17.** Compute the total access hole loss ( $H_{ah}$ ) by multiplying the  $K$  value in Column 11A by the velocity head in Column 7A. Enter this value in Column 12A.

6-4.3.18 **Step 18.** Compute  $EGL_i$  at the structure by adding the structure losses in Column 12A to the  $EGL_o$  value in Column 10A. Enter this value in Column 13A.

6-4.3.19 **Step 19.** Compute the HGL at the structure by subtracting the velocity head in Column 7A from the  $EGL_i$  value in Column 13A. Enter this value in Column 14A.

6-4.3.20 **Step 20.** Determine the top of conduit (TOC) value for the inflow pipe (using information from the Preliminary Storm Drain Computation Sheet, Figure 6-3) and enter this value in Column 15A.

6-4.3.21 **Step 21.** Enter the ground surface, top of grate elevation, or other high water limits at the structure in Column 16A. If the HGL value in Column 14A exceeds the limiting elevation, design modifications will be required.

6-4.3.22 **Step 22.** Enter the structure ID for the next upstream structure in Columns 1A and 1B of the next line. When starting a new branch line, skip to Step 24.

6-4.3.23 **Step 23.** Continue to determine the EGL through the system by repeating Steps 4 through 23. (Begin with Step 2 if working with a drop structure. This begins the design process again as if there were no system downstream from the drop structure.)

6-4.3.24 **Step 24.** When starting a new branch line, enter the structure ID for the branch structure in Columns 1A and 1B of a new line. Transfer the values from Columns 2A through 10A and 2B to 7B associated with this structure on the main branch run to the corresponding columns for the branch line. If flow in the main storm drain at the branch point is subcritical, continue with Step 9; if it is supercritical, continue with Step 5E.

## CHAPTER 7

### DRAINAGE STRUCTURES

7-1 **GENERAL.** Certain appurtenant structures are essential to the proper functioning of every storm drainage system. These structures include inlet structures, manholes, and junction chambers. Other miscellaneous appurtenances include transitions, flow splitters, siphons, and flap gates.

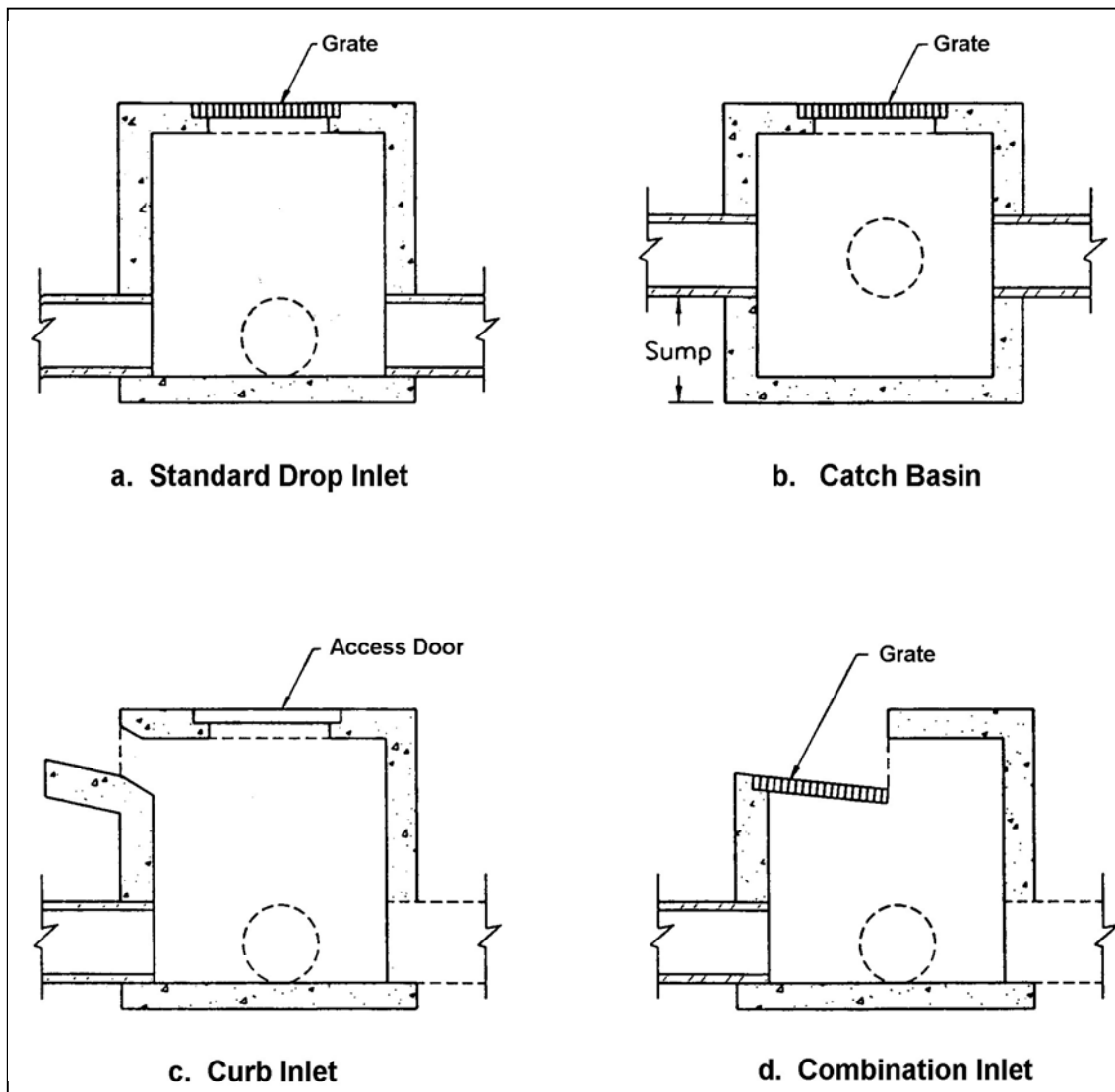
Many agencies have developed their own design standards for commonly used structures; therefore, it is to be expected that many variations will be found in the design of even the simplest structures. The information in this chapter is limited to a general description of these structures with special emphasis on the features considered essential to good design.

7-2 **INLETS.** The primary function of an inlet structure is to allow surface water to enter the storm drainage system. As a secondary function, inlet structures also serve as access points for cleaning and inspection. The materials most commonly used for inlet construction are cast-in-place concrete and pre-cast concrete. The structures must ensure efficient drainage of design storm runoff to avoid interruption of operations during or following storms and to prevent temporary or permanent damage to pavement subgrades. The material, including the slotted drain corrugated metal pipe to handle surface flow (if employed), should be strong enough to withstand the loads to which it will be subjected.

7-2.1 **Configuration.** Inlets are structures with inlet openings to receive surface water. Figure 7-1 illustrates several typical inlet structures, including a standard drop inlet (area inlet), catch basin, curb inlet, and combination inlet. The hydraulic design of surface inlets is covered in detail in Chapter 3.

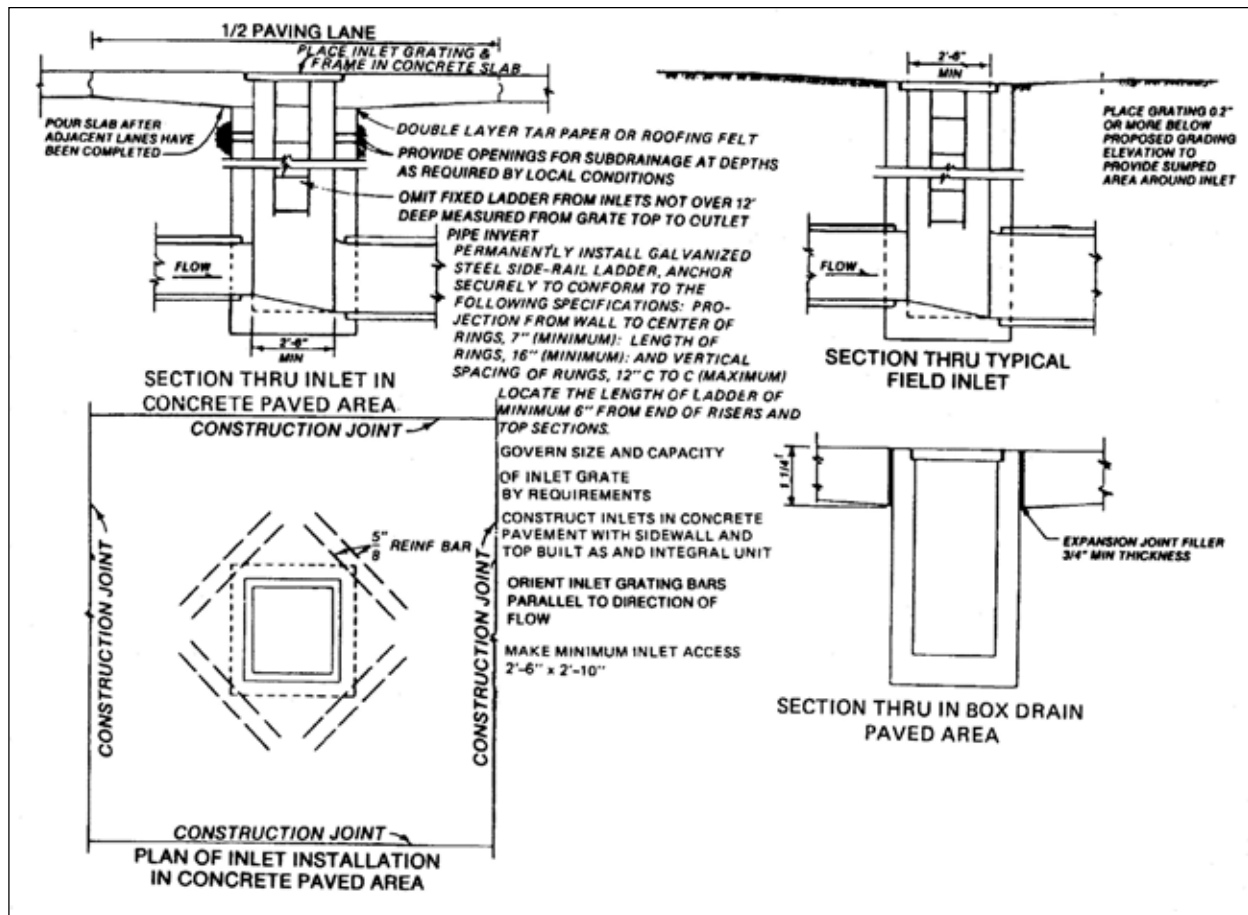
The catch basin, illustrated in Figure 7-1, b, is a special type of inlet structure designed to retain sediment and debris transported by storm water into the storm drainage system. Catch basins include a sump for the collection of sediment and debris. Catch basin sumps require periodic cleaning to be effective and may become an odor and mosquito nuisance if not properly maintained; however, in areas where site constraints dictate that storm drains be placed on relatively flat slopes, and where a strict maintenance plan is followed, catch basins can be used to collect sediment and debris but are ineffective in reducing other pollutant loadings. Additional information regarding the removal of pollutants from storm water can be found in Chapter 11.

Figure 7-1. Inlet Structures



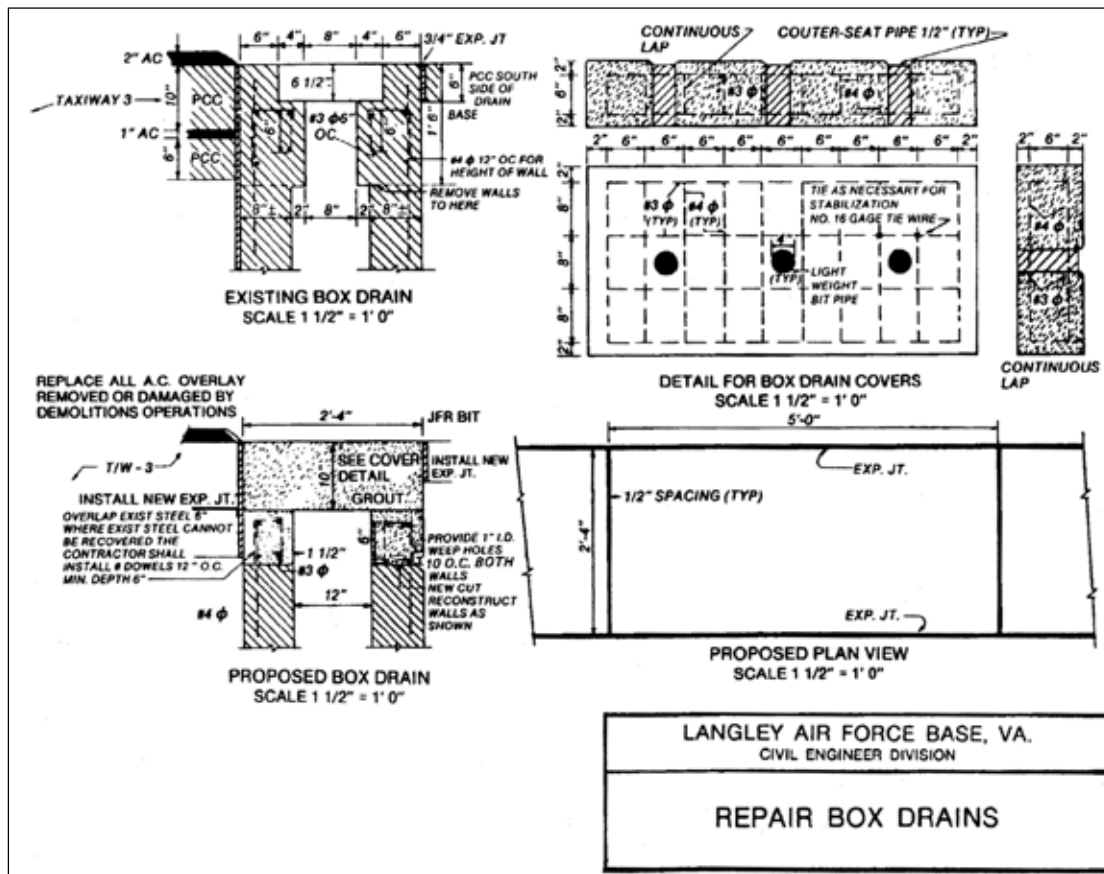
7-2.2 **Area Inlets.** Where area inlets are used within paved areas to remove surface drainage, a continuous-type grating, generally covering the entire drain, is used to permit water to enter directly into the drain. Certain general requirements are illustrated by the typical section through an area inlet in a paved area shown in Figure 7-2. The walls of the box drain will extend to the surface of the pavement. The pavement will have a free thickened edge at the drain. An approved expansion-joint filler covering the entire surface of the thickened edge of the pavement will be installed at all joints between the pavement and box drain. A 0.75-in. thick filler is usually sufficient, but thicker fillers may be required. Grating for area inlets can be built of steel, cast iron, or reinforced concrete with adequate strength to withstand anticipated loadings. Where two or more area inlets are adjacent, they will be interconnected to provide equalization of flow and optimum hydraulic capacity.

Figure 7-2. Typical Inlet Design for Storm Drainage Systems



7-2.2.1 A number of area inlets similar to those shown in Figure 7-2 have failed structurally at several installations. Causes of failure are the inability of the drain walls to resist the movement of the abutting pavement under seasonal expansion and contraction, the general tendency of the slope pavement to make an expansion movement toward the drain wall while the thickened edge is restrained from moving away from the drain, and the infiltration of detritus into joints. Figure 7-3 indicates a successful box drain in use at Langley Air Force Base. The design provides for the top of the box drain wall to terminate at the bottom of the abutting pavement. A typical drain cover is a 10-in. thick reinforced concrete slab with inserted lightweight circular pipes used for the grating openings. While only 4-in. diameter holes have been indicated in the figure, additional holes may be used to provide egress for the storm runoff. The design may also be used to repair existing area inlets that have failed.

Figure 7-3. Repair Area Inlets



7-2.2.2 Inlet drainage structures, particularly area inlets, have been known to settle at rates different from the adjacent pavement, causing depressions that permit pavement failure should the subgrade deteriorate. Construction specifications requiring careful backfilling around inlets will help prevent the differential settling rates.

7-2.2.3 Inlet structures are located at the upstream end and at intermediate points along a storm drain line. Inlet spacing is controlled by the geometry of the site, inlet opening capacity, and tributary drainage magnitude. Inlet placement is generally a trial and error procedure that attempts to produce the most economical and hydraulically effective system.

Certain general rules apply to inlet placement:

- An inlet is required at the uppermost point in a gutter section where gutter capacity criteria are violated. This point is established by moving the inlet and thus changing the drainage area until the tributary flow equals the gutter capacity. Successive inlets are spaced by locating the point where the sum of the bypassing flow and the flow from the additional contributing area exceed the gutter capacity. Chapter 3 contains information regarding inlet spacing procedures.

- Inlets are normally used at intersections to prevent street cross flow that could cause pedestrian or vehicular hazards. It is desirable to intercept 100 percent of any potential street cross flow under these conditions. Intersection inlets should be placed on tangent curb sections near corners.
- Inlets are also required where the street cross slope begins to superelevate. The purpose of these inlets is also to reduce the traffic hazard from street cross flow. Sheet flow across the pavement at these locations is particularly susceptible to icing.
- Inlets should also be located at any point where side drainage enters streets and may overload gutter capacity. Where possible, these side drainage inlets should be located to intercept side drainage before it enters the street.
- Inlets should be placed at all low points in the gutter grade and at median breaks.
- Inlets are also used upstream of bridges to prevent pavement drainage from flowing onto the bridge decks, and downstream of bridges to intercept drainage from the bridge.
- As a matter of general practice, inlets should not be located within driveway areas.

7-3 **MANHOLES.** The primary function of a manhole is to provide convenient access to the storm drainage system for inspection and maintenance. As secondary functions, manholes also serve as flow junctions, and can provide ventilation and pressure relief for storm drainage systems. It is noted that inlet structures can also serve as manholes and should be used in lieu of manholes where possible so that the benefit of extra storm water interception is achieved at minimal additional cost.

Like the materials used for storm drain inlets, the materials most commonly used for manhole construction are pre-cast concrete and cast-in-place concrete. In most areas, pre-cast concrete manhole sections are commonly used due to their availability and competitive cost. They can be obtained with cast-in-place steps at the desired locations, and special transition sections are available to reduce the diameter of the manhole at the top to accommodate the frame and cover. The transition sections are usually eccentric, with one side vertical to accommodate access steps. Pre-cast bottoms are also available in some locations.

7-3.1 **Configuration.** Typical manhole and junction box construction is shown in Figures 7-4 through 7-7. Where storm drains are too large to reasonably accommodate the typical structure configurations illustrated in Figure 7-7, a vertical riser connected to the storm drain with a commercial "tee" unit is often used. Such a configuration is illustrated in Figure 7-8. As illustrated in Figure 7-7, the design elements of a manhole include the bottom chamber and access shaft, the ladder, and the manhole bottom. The design elements of a manhole are examined in paragraphs 7-3.2 through 7-3.7.



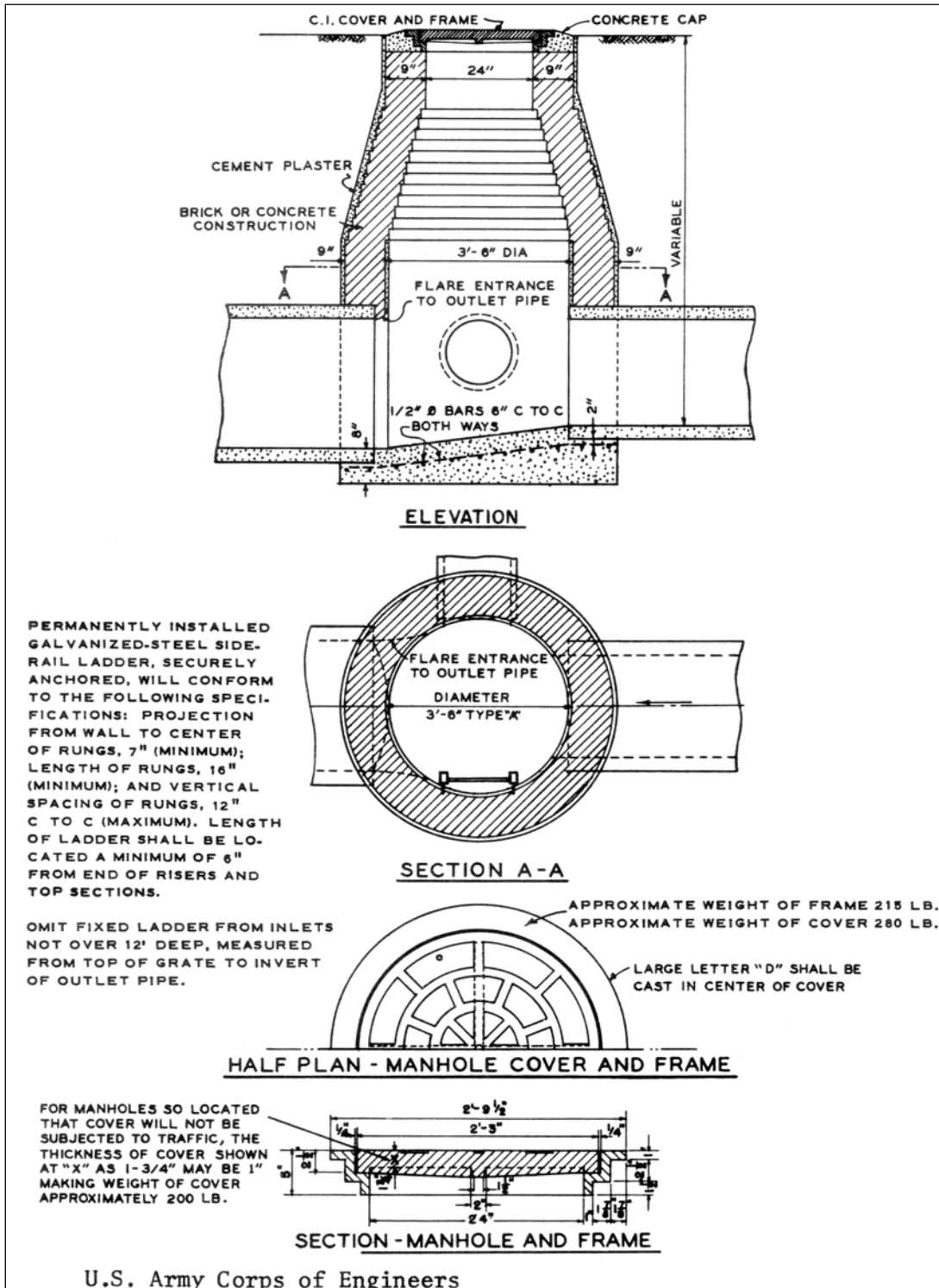
7-3.2 **Chamber and Access Shaft.** Most manholes are circular, with the inside dimension of the bottom chamber being sufficient to perform inspection and cleaning operations without difficulty. A minimum inside diameter of 4 ft has been adopted widely, with a 5-ft diameter manhole being used for larger diameter storm drains. The access shaft (cone) tapers to a cast-iron frame that provides a minimum clear opening usually specified as 22 to 24 inches. It is common practice to maintain a constant diameter bottom chamber up to a conical section a short distance below the top, as shown in Figure 7-7, a. It has also become common practice to use eccentric cones for the access shaft, especially in precast manholes. This provides a vertical side for the steps (Figure 7-7, b), which makes the manhole much easier to access.

Another design option maintains the bottom chamber diameter to a height sufficient for a good working space, then tapers to 3 ft as shown in Figure 7-7, c. The cast iron frame in this case has a broad base to rest on the 3-ft diameter access shaft. Still another design uses a removable, flat, reinforced concrete slab instead of a cone, as shown in Figure 7-7, d. As illustrated in Figure 7-7, the access shaft can be centered over the manhole or offset to one side. Certain guidelines apply:

- For manholes with chambers 3 ft or less in diameter, the access shaft can be centered over the axis of the manhole.
- For manholes with chambers 4 ft or greater in diameter, the access shaft should be offset and made tangent to one side of the manhole for better location of the manhole steps.
- For manholes with chambers greater than 4 ft in diameter, where laterals enter from both sides of the manhole, the offset should be toward the side of the smaller lateral.
- The manhole should be oriented so the workers enter it while facing traffic if traffic exists.

7-3.3 **Frames and Covers.** Manhole frames and covers are designed to provide adequate strength to support superimposed loads, provide a good fit between cover and frame, and maintain provisions for opening while providing resistance to unauthorized opening (primarily from children). Additional information specific to airfields is located at the end of this chapter. In addition, to differentiate storm drain manholes from those on sanitary sewers, communication conduits, or other underground utilities, it is good practice to have the words "STORM DRAIN" or equivalent cast into the top surface of the covers. Most agencies maintain frame and cover standards for their systems. Special considerations for aircraft loading are provided at the end of this chapter.

Figure 7-4. Standard Storm Drain Manhole



U.S. Army Corps of Engineers

Figure 7-5. Standard Precast Manholes

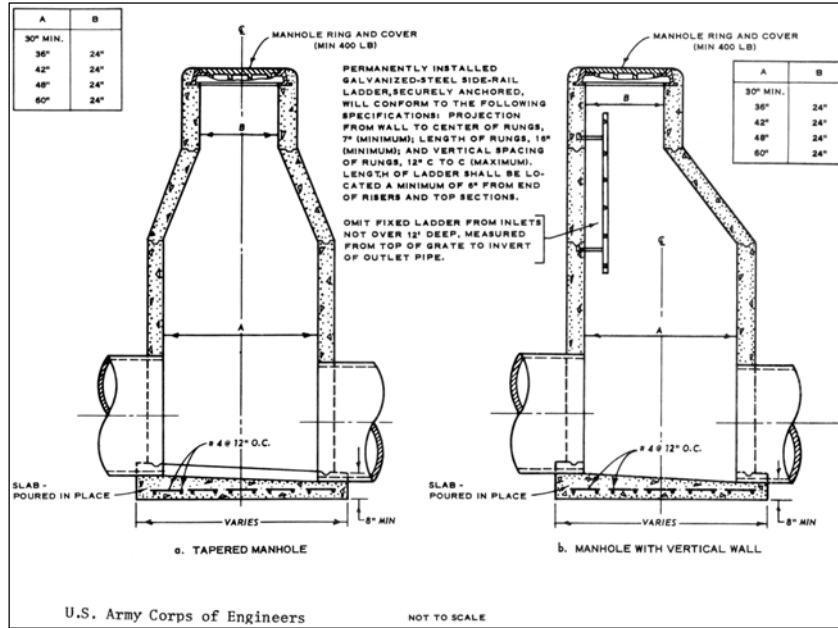


Figure 7-6. Junction Details for Large Pipes

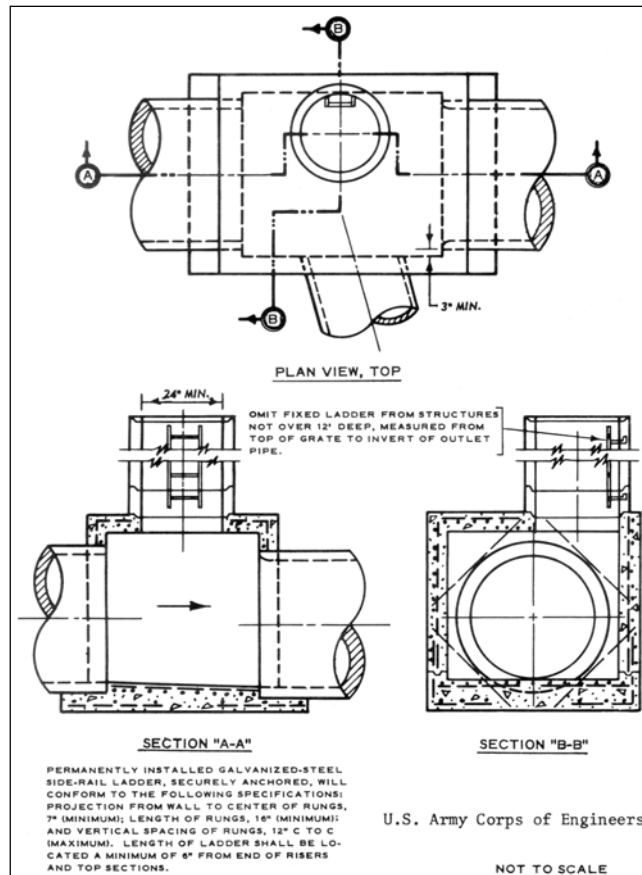


Figure 7-7. Typical Manhole Configurations

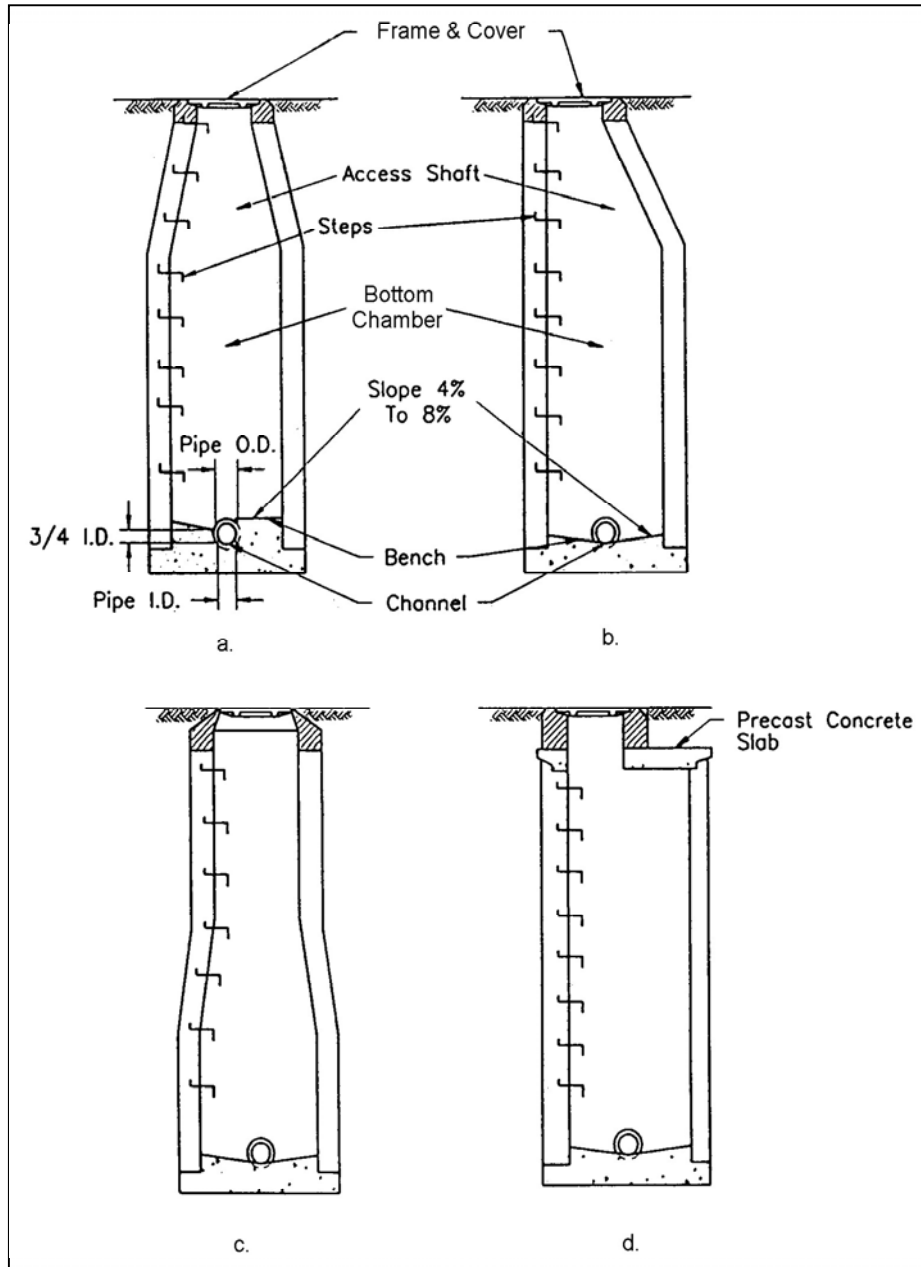
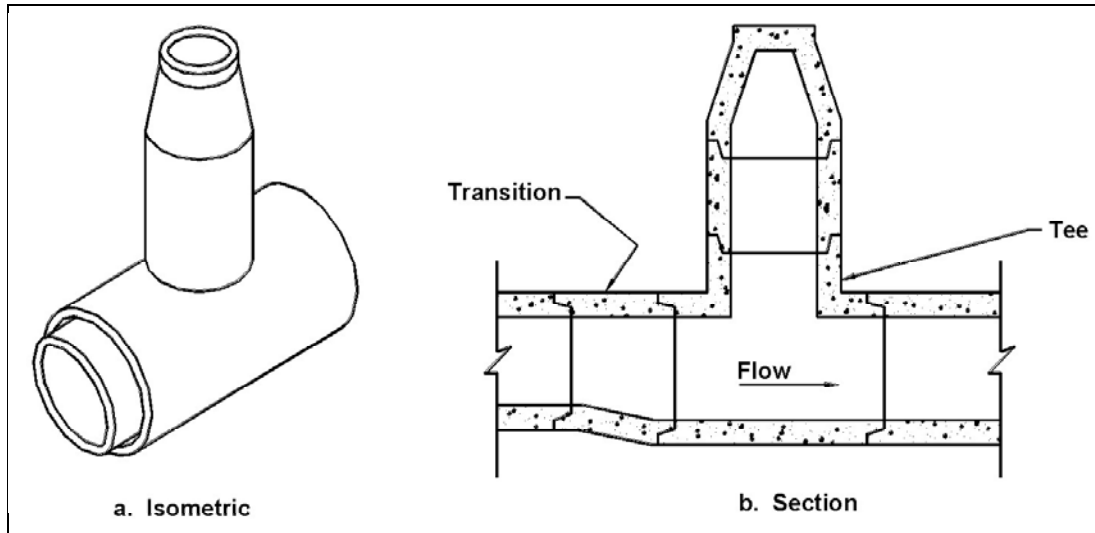


Figure 7-8. "Tee" Manhole for Large Storm Drains



If the HGL could rise above the ground surface at a manhole site, special consideration must be given to the design of the manhole frame and cover. The cover must be secured so that it remains in place during peak flooding periods, avoiding a manhole "blowout." A blowout is caused when the HGL rises in elevation higher than the manhole cover and forces the lid to explode off. Manhole covers should be bolted or secured in place with a locking mechanism if blowout conditions are possible.

**7-3.4 Channels and Benches.** Flow channels and benches are illustrated in Figure 7-7. The purpose of the flow channel is to provide a smooth, continuous conduit for the flow and to eliminate unnecessary turbulence in the manhole by reducing energy losses. The elevated bottom of the manhole on either side of the flow channel is called the bench. The purpose of a bench is to increase the hydraulic efficiency of the manhole.

In the design of manholes, benched bottoms are not common. Benching is used only when the HGL is relatively flat and there is no appreciable head available. Typically, the slopes of storm drain systems do not require benches to hold the HGL in the correct place. Where the HGL is not of consequence, avoid the extra expense of adding benches.

For the design of the inflow and outflow pipe invert elevations, the pipes should be set so the top of the outlet pipe is below the top of the inlet pipe by the amount of loss in the manhole. This practice is often referred to as "hanging the pipe on the hydraulic grade line."

**7-3.5 Manhole Depth.** The depth required for a manhole will be dictated by the storm drain profile and surface topography. Common manhole depths range from 5 to

13 ft. Manholes that are shallower or deeper than this may require special consideration.

Irregular surface topography sometimes results in shallow manholes. If the depth to the invert is only 2 to 3 ft, all maintenance operations can be conducted from the surface; however, maintenance activities are not comfortable from the surface, even at shallow depths. It is recommended that the manhole width be of the same size as that for greater depths. Typical manhole widths are 4 to 5 ft. For shallow manholes, use of an extra large cover with a 30- or 36-in. opening will enable a worker to stand in the manhole for maintenance operations.

Deep manholes must be carefully designed to withstand soil pressure loads. If the manhole is to extend very far below the water table, it must also be designed to withstand the associated hydrostatic pressure or excessive seepage may occur. Since long portable ladders would be cumbersome and dangerous, access must be provided with either steps or built-in ladders.

7-3.6 **Location and Spacing.** Manhole location and spacing criteria have been developed in response to storm drain maintenance requirements. Spacing criteria are typically established based on a local agency's past experience and maintenance equipment limitations. At a minimum, manholes should be located at specific points:

- Where two or more storm drains converge
- Where pipe sizes change
- Where a change in alignment occurs
- Where a change in grade occurs

In addition, manholes may be located at intermediate points along straight runs of storm drain in accordance with the criteria outlined in Table 7-1; however, individual transportation agencies may have limitations on spacing of manholes due to maintenance constraints.

**Table 7-1. Manhole Spacing Criteria**

Pipe Size, in.	Suggested Maximum Spacing, ft
12 – 24	300
27 – 36	400
42 – 54	500
60 and up	1000

7-3.7 **Settlement of Manholes.** Failure of joints between sections of concrete pipe in the vicinity of large concrete manholes indicates that the manhole has settled at a

different rate than that of the connecting pipe. Flexible joints should be required for all joints between sections of rigid pipe in the vicinity of large manholes, e.g., 3 to 5 joints along all pipe entering or leaving the manhole.

**7-4 JUNCTION CHAMBERS.** A junction chamber is a specially designed underground chamber used to join two or more large storm drain conduits. This type of structure is usually required where storm drains are larger than the size that can be accommodated by standard manholes. For smaller diameter storm drains, manholes are typically used instead of junction chambers. Junction chambers by definition do not need to extend to the ground surface and can be completely buried; however, it is recommended that riser structures be used to provide for surface access and/or to intercept surface runoff.

Materials commonly used for junction chamber construction include pre-cast concrete and cast-in-place concrete. On storm drains constructed of corrugated steel, the junction chambers are sometimes made of the same material.

To minimize flow turbulence in junction boxes, flow channels and benches are typically built into the bottom of the chambers. Figure 7-9 illustrates several efficient junction channel and bench geometries. Where junction chambers are used as access points for the storm drain system, their location should adhere to the spacing criteria outlined in section 7-3.6.

## **7-5 MISCELLANEOUS STRUCTURES**

**7-5.1 Chutes.** A chute is a steep, open channel that provides a method of discharging accumulated surface runoff over fills and embankments. A typical design is shown in Figure 7-10.

**7-5.2 Security Fencing.** When a conduit or channel passes through or beneath a security fence and forms an opening greater than 96 square inches (in<sup>2</sup>) in area, a security barrier must be installed. Barriers are usually of bars, grillwork, or chain-link screens. Parallel bars used to prevent access will be spaced not more than 6 in. apart and will be of sufficient strength to preclude bending by hand after assembly.

**7-5.2.1** Where fences enclose maximum security areas such as exclusion and restricted areas, drainage channels, ditches, and equalizers will, wherever possible, be carried under the fence in one or more pipes having an internal diameter of not more than 10 in. Where the volume of flow is such that the multipipe arrangement is not feasible, the conduit or culvert will be protected by a security grill composed of 0.75-in. diameter rods or 0.50-in. bars spaced not more than 6 in. on center, set and welded in an internal frame. Where rods or bars exceed 18 in. in length, suitable spacer bars will be provided at not more than 18 in. on center, welded at all intersections. Security grills will be located inside the protected area. Where the grill is on the downstream end of the culvert, the grill will be hinged to facilitate cleaning and provided with a latch and padlock, and a debris catcher will be installed in the upstream end of the conduit or culvert. Elsewhere the grill will be permanently attached to the culvert.

Security regulations normally require the guard to inspect such grills at least once every shift. For culverts in rough terrain, steps will be provided to the grill to facilitate inspection and cleaning.

**Figure 7-9. Efficient Channel and Bench Configurations**

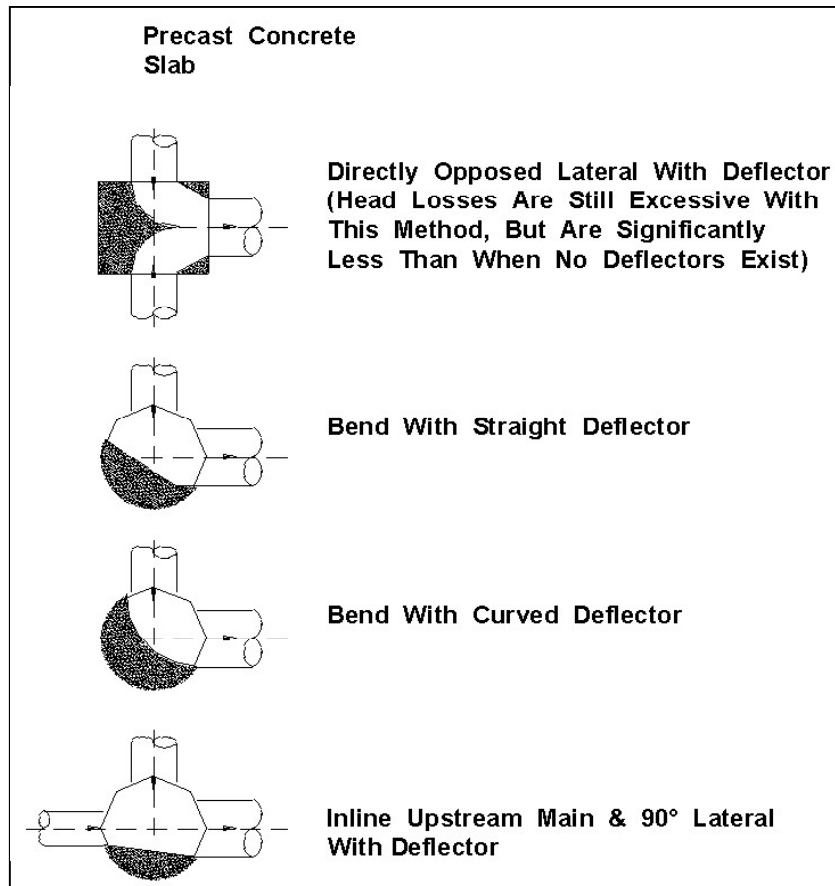
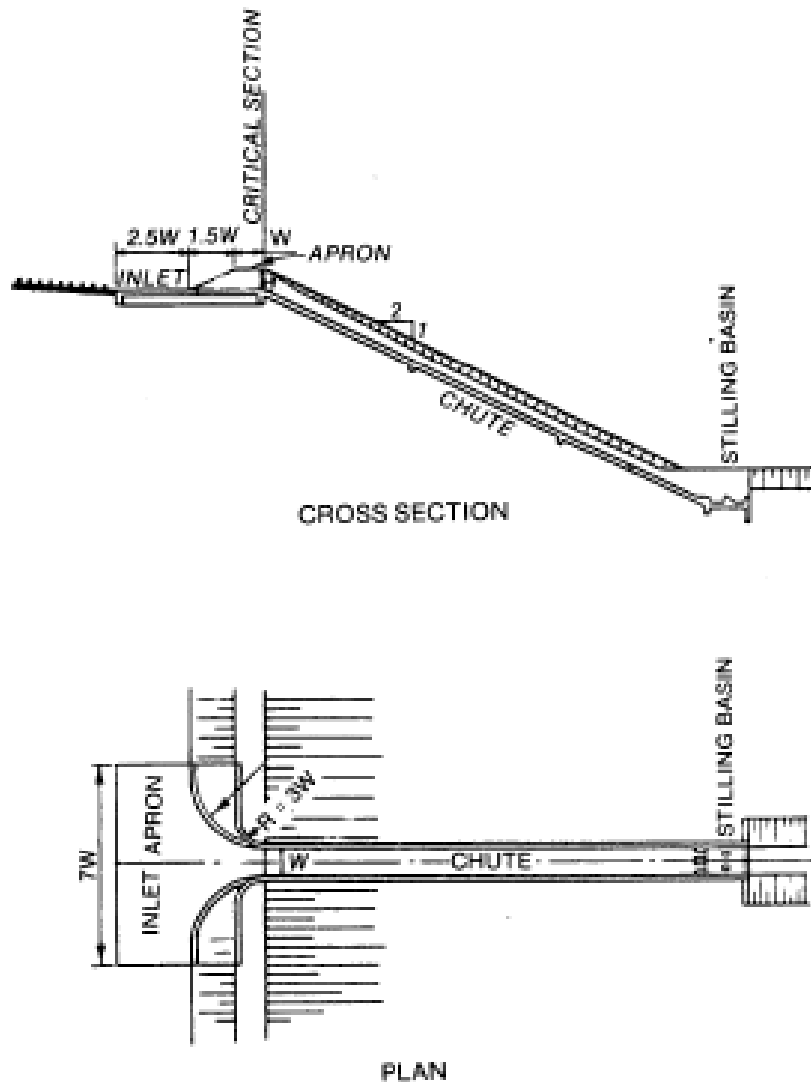




Figure 7-10. Details of a Typical Drainage Chute



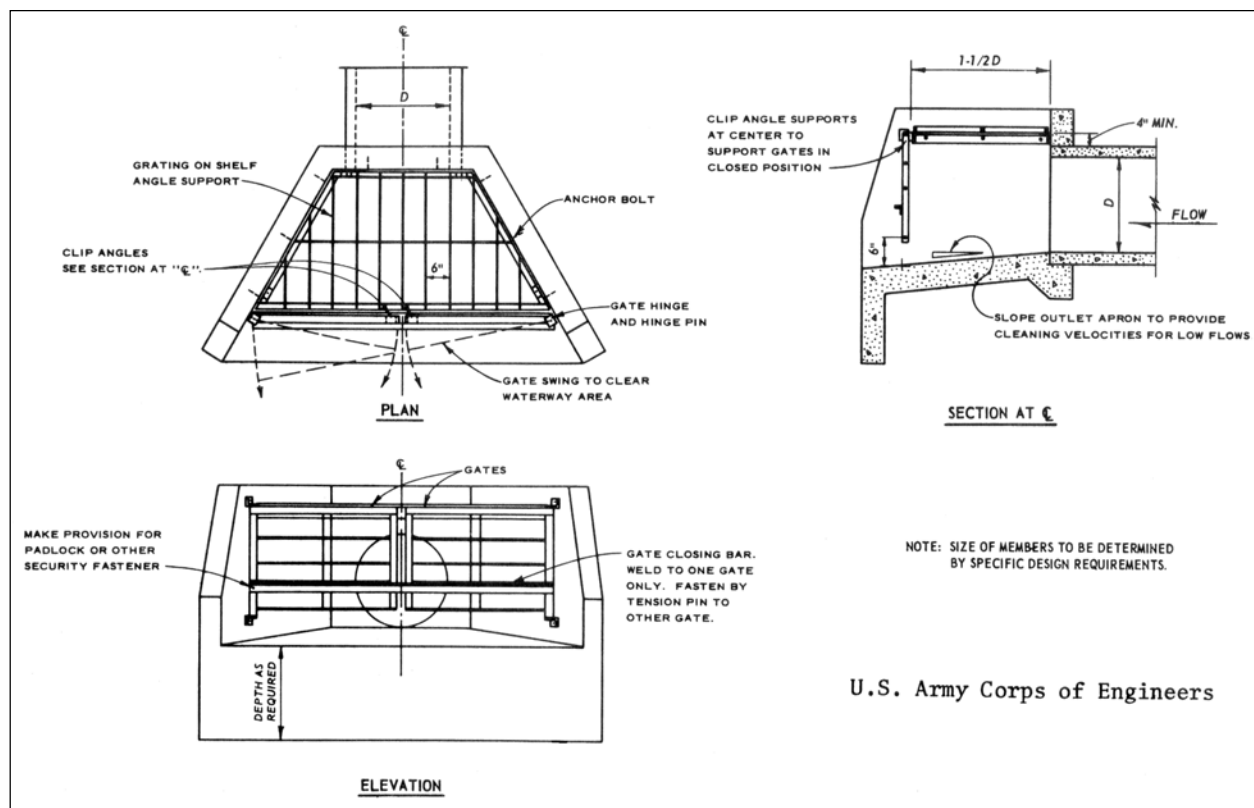
7-5.2.2 For culverts and storm drains, barriers at the intakes would be preferable to barriers at the outlets because of the relative ease of debris removal; however, barriers at the outfalls are usually essential. In these cases, consideration should be given to placing debris interceptors at the inlets. Bars constituting a barrier should be placed in a horizontal position, and the number of vertical members should be limited to minimize clogging; the total clear area should be at least twice the area of the conduit or larger under severe debris conditions. For large conduits, an elaborate cage-like structure may be required. Provisions to facilitate cleaning during or immediately after heavy runoff should be made. Figure 7-11 shows a typical barrier for the outlet of a pipe drain. Note that a 6-in. underclearance is provided to permit passage of normal bedload material, and that the apron between the conduit outlet and the barrier is placed on a slope to

minimize deposition of sediment on the apron during ordinary flow. Erosion protection, where required, is placed immediately downstream from the barrier.

7-5.2.3 If manholes must be located in the immediate vicinity of a security fence, their covers must be fastened to prevent unauthorized opening.

7-5.2.4 Open channels may present special problems due to the relatively large size of the waterway and the possible requirements for passage of large floating debris. For such channels, a barrier should be provided that can be unfastened and opened or lifted during periods of heavy runoff or when clogged. The barrier is hinged at the top and an empty tank is welded to it at the bottom to serve as a float. Open channels or swales that drain relatively small areas and with flows that carry only minor quantities of debris may be secured merely by extending the fence down to a concrete sill set into the sides and across the bottom of the channel.

Figure 7-11. Outlet Security Barrier



7-5.3 **Fuel/Water Separators.** Fuel/water separators should be installed where there is an oil/water separation problem. The most common location for these units is in areas that contain vehicle washracks. Details on the selection and design of oil/water separators can be found in Army Engineering Technical Letter (ETL) 1110-3-466.

7-5.4 **Outlet Energy Dissipators.** Most drainage systems are designed to operate under normal free outfall conditions. Tailwater conditions are generally absent; however, it is possible for a discharge resulting from a drainage system to possess kinetic energy in excess of that which normally occurs in waterways. To reduce the kinetic energy and thereby reduce downstream scour, outfalls may sometimes be required to reduce streambed scour. Scour may occur in the streambed if discharge velocities exceed the critical velocities of the streambed material. Studies of local materials must be made prior to a decision to install energy dissipation devices. Protection against scour may be provided by plain outlets, transitions, and stilling basins. Plain outlets provide no protective works and depend on natural material to resist erosion. Transitions provide little or no dissipation of energy themselves, but by spreading the effluent jet to approximately the flow cross-section of the natural channel, the energy is greatly reduced prior to releasing the effluent into the outlet channel. Stilling basins dissipate the high kinetic energy of flow by a hydraulic jump or other means. Riprap may be required at any of the three types of outfalls.

#### 7-5.4.1 **Plain Type**

- If the discharge channel is in rock or a material highly resistant to erosion, no special erosion protection is required; however, since flow from the culvert will spread with a resultant drop in water surface and increase in velocity, this type of outlet should be used without riprap only if the material in the outlet channel can withstand velocities approximately 1.5 times the velocity in the culvert. At such an outlet, side erosion due to eddy action or turbulence is more likely to prove troublesome than is bottom scour.
- Cantilevered culvert outlets may be used to discharge a free-falling jet onto the bed of the outlet channel. A plunge pool will be developed, the depth and size of which will depend on the energy of the falling jet at the tailwater and the erodibility of the bed material.

7-5.4.2 **Transition Type.** Endwalls (outfall headwalls) serve the dual purpose of retaining the embankment and limiting the outlet transition boundary. Erosion of embankment toes usually can be traced to eddy attack at the ends of such walls. A flared transition is very effective if proportioned so that eddies induced by the effluent jet do not continue beyond the end of the wall or overtop a sloped wall. A guideline is that the product of velocity and flare angle should not exceed 150. That is, if effluent velocity is 5 ft/s, each wingwall may flare 30 degrees; but if velocity is 15 ft/s, the flare should not exceed 10 degrees. Unless wingwalls can be anchored on a stable foundation, a paved apron between the wingwalls is required. Take special care in design of the structure to preclude undermining. A newly excavated channel may be expected to degrade, and proper allowance for this action should be included in establishing the apron elevation and the depth of the cutoff wall. Warped endwalls provide excellent transitions because they result in the release of flow in a trapezoidal section, which generally approximates the cross section of the outlet channel. If a warped transition is placed at the end of a curved section below a culvert, the transition is made at the end of the curved section to minimize the possibility of overtopping due to superelevation of

the water surface. A paved apron is required with warped endwalls. Usually riprap is required at the end of a transition-type outlet.

**7-5.4.3 Improved Channels.** Improved channels, especially the paved ones, commonly carry water at velocities higher than those prevailing in the natural channels into which they discharge. Often riprap will suffice for dissipation of excess energy. A cutoff wall may be required at the end of a paved channel to preclude undermining. In extreme cases, a flared transition, stilling basin, or impact device may be required.

**7-5.5 Drop Structures and Check Dams.** Drop structures and check dams are designed to check channel erosion by controlling the effective gradient and to provide for abrupt changes in channel gradient by means of a vertical drop. These structures also provide satisfactory means for discharging accumulated surface runoff over fills with heights not exceeding approximately 5 ft and over embankments higher than 5 ft, provided the end sill of the drop structure extends beyond the toe of the embankment. The check dam is a modification of the drop structure used for erosion control in small channels where a less elaborate structure is permissible.

**7-5.6 Transitions.** In storm drainage systems, transitions from one pipe size to another typically occur in manholes or junction chambers; however, there are times when transitions may be required at other locations within the storm drainage system. A typical example is illustrated in Figure 7-12, where a rectangular pipe transition is used to avoid an obstruction. Commercially available transition sections are also available for circular pipes. These transitions can be used upstream of "tee"-type manholes in large storm drains, as illustrated in Figure 7-12. Providing a smooth, gradual transition to minimize head losses is the most significant consideration in the design of transition sections. Table 7-2 provides design criteria for transition sections.

**7-5.7 Flow Splitters.** A flow splitter is a special structure designed to divide a single flow and divert the parts into two or more downstream channels. Flow splitters are constructed similar to junction boxes except that with flow splitters, flows from a single large storm drain are split into several smaller storm drains.

The design of flow splitters must minimize head loss and potential debris problems. Hydraulic disturbances at the point of flow division result in unavoidable head losses. These losses may be reduced by the inclusion of proper flow deflectors in the design of the structure. Hydraulic disturbances within flow splitters often result in regions of flow velocity reduction. These reductions can cause deposition of material suspended in the storm water flow. In addition, the smaller pipes may not be large enough to carry some of the debris being passed by the large pipe. In some cases, flow splitters can become maintenance intensive; therefore, their use should be judiciously controlled, and when used, positive maintenance access must be provided.

Figure 7-12. Transitions to Avoid Obstruction

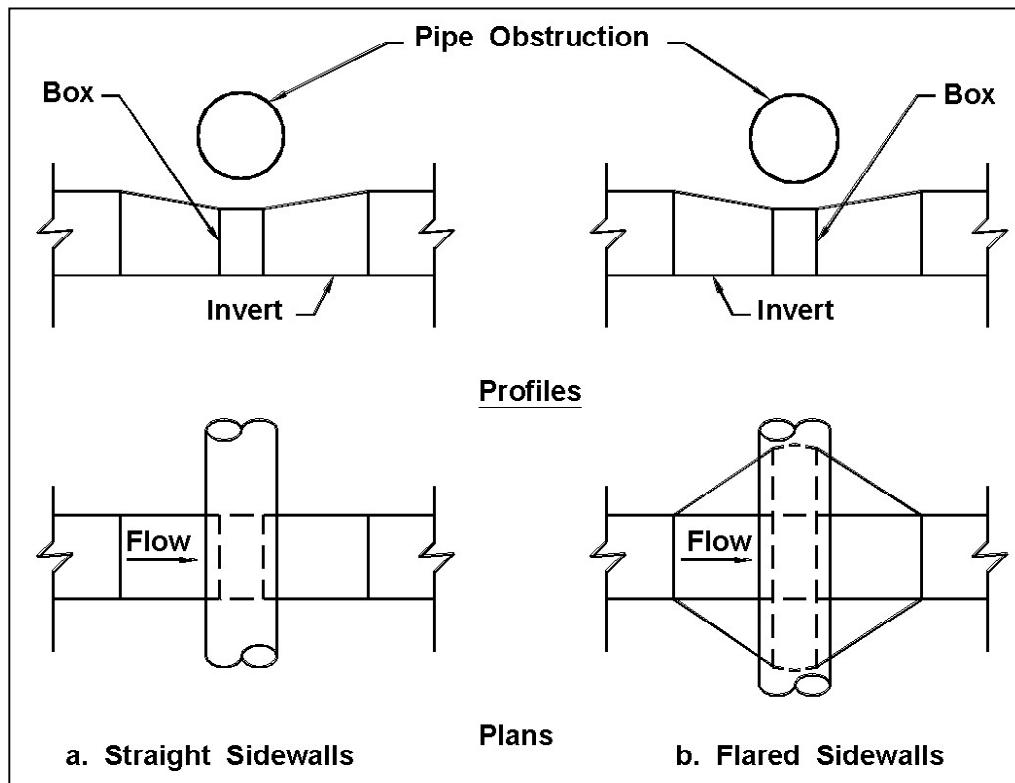
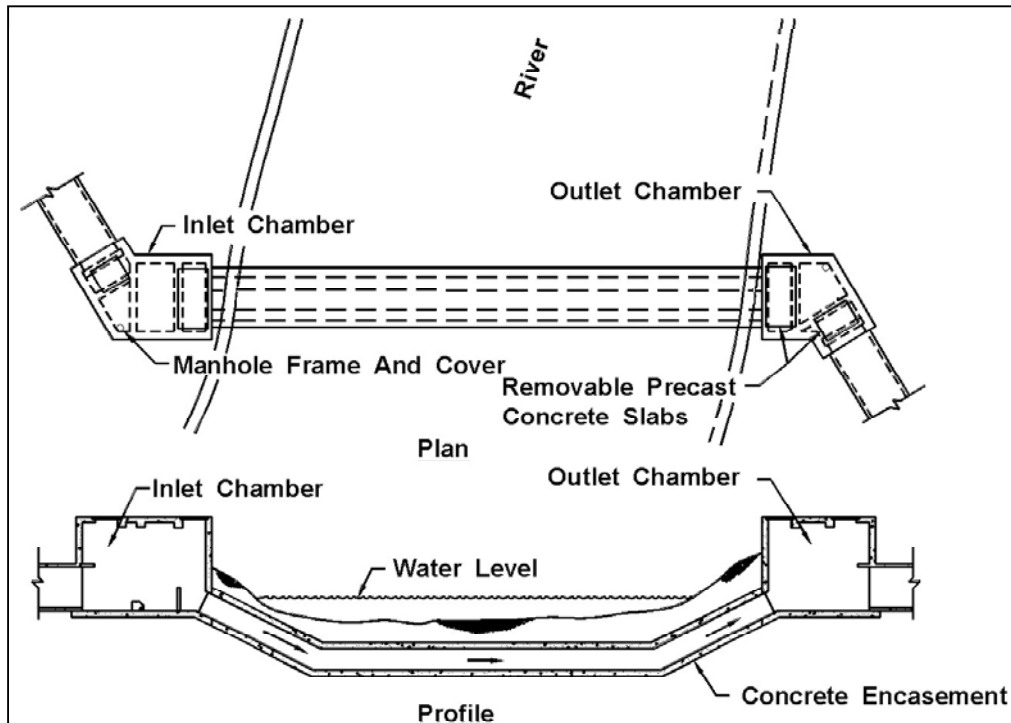


Table 7-2. Transition Design Criteria

Type	Flow Condition	
	$V < 20 \text{ ft/s}$	$V > 20 \text{ ft/s}$
Expansion	Straight Walls Ratio - 5:1 to 10:1	Straight Walls Ratio - 10:1 to 20:1
Contraction	Straight Walls Ratio - 5:1 to 10:1	Straight Walls Ratio - 10:1 to 20:1

7-5.8 **Siphons.** In practice, the term "siphon" refers to an inverted siphon or depressed pipe that would stand full even without any flow. Its purpose is to carry the flow under an obstruction such as a stream or depressed highway and to regain as much elevation as possible after the obstruction has been passed. Siphons can consist of single or multiple barrels; however, AASHTO recommends a minimum of two barrels. Figure 7-13 illustrates a twin-barrel siphon.

Figure 7-13. Twin-Barrel Siphon



Certain considerations are important to the efficient design of siphons:

- Self flushing velocities should be provided under a wide range of flows.
- Hydraulic losses should be minimized.
- Provisions for cleaning should be provided.
- Sharp bends should be avoided.
- The rising portion of the siphon should not be steep enough to make it difficult to flush deposits. (Some agencies limit the rising slope to 15 percent.)
- There should be no change in pipe diameter along the length of the siphon.
- Provisions for drainage should be considered.

7-5.9 **Flap Gates.** Flap gates are installed at or near storm drain outlets for the purpose of preventing back-flooding of the drainage system at high tides or high stages in the receiving streams. A small differential pressure on the back of the gate will open it, allowing discharge in the desired direction. When water on the front side of the gate rises above that on the back side, the gate closes to prevent backflow. Flap gates are typically made of cast iron, rubber, or steel, and are available for round, square, and rectangular openings and in various designs and sizes.

Maintenance is a necessary consideration with the use of flap gates. In storm drain systems that are known to carry significant volumes of suspended sediment and/or floating debris, flapgates can act as skimmers and cause brush and trash to collect between the flap and seat. The reduction of flow velocity behind a flap gate may also cause sediment deposition in the storm drain near the outlet. Flap gate installations require regular inspection and removal of accumulated sediment and debris.

In addition, for those drainage structures that have a flap gate mounted on a pipe projecting into a stream, the gate must be protected from damage by floating logs or ice during high flows. In these instances, protection must be provided on the upstream side of the gate.

## 7-6 DESIGN FEATURES

7-6.1 **Grates.** Grating elevations for area inlets must be carefully coordinated with the base or airport grading plan. Each inlet must be located at an elevation that will ensure interception of surface runoff. Increased overland velocities immediately adjacent to field inlet openings may result in erosion unless protective measures are taken. A solid sod annular ring varying from 3 to 10 ft around the inlet reduces erosion if suitable turf is established and maintained on the adjacent drainage area. Prior to the establishment of turf on the adjacent area, silt may deposit in a paved apron around the perimeter or deposit in the sod ring, thereby diverting flow from the inlet. In lieu of a sod ring, a paved apron around the perimeter of a grated inlet may be beneficial in preventing erosion and differential settlement of the inlet and the adjacent area as well as facilitating mowing operations.

7-6.1.1 Drainage structures in non-paved areas should be designed so that the grating does not extend above the ground level. The tops of such structures should permit unobstructed use of the area by equipment and facilitate collection of surface runoff.

7-6.1.2 An area inlet in a ponded area operates as a weir under low head situations. At higher heads, however, the grating acts as an orifice. A complete description of grates acting under weir and orifice flow is provided in Chapter 3.

7-6.1.3 Typically a grated inlet in a sloping gutter will intercept all the flow approaching the gross width of the grate opening. The size and spacing of the bars of grated inlets are influenced by the traffic and safety requirements of the local area; nevertheless, in the interest of hydraulic capacity and maintenance requirements, it is desirable that the openings be made as large as traffic and safety requirements will permit. To prevent possible clogging by debris, safety factors are required and are addressed in Chapter 3.

7-6.1.4 Grates may be made of cast iron, steel, or ductile iron; however, cast iron grates may not be used in areas where grates may be subjected to wheel loads. Reinforced concrete grates, with circular openings, may be designed for box drains. Inlet grating and frames must be designed to withstand aircraft wheel loads of the

largest aircraft using or expected to use the facility. As design loads vary, the grates should be carefully checked for load-carrying capacities. Selection of grates and frames will depend upon capacity, strength, anchoring, or the requirement for single or multiple grates. The suggested design of typical metal grates and inlets is shown in Figures 7-14 and 7-15.

7-6.1.5 Commercially manufactured grates and frames for airport loadings have been designed specifically for airport loadings from 50 to 250 lb/in<sup>2</sup>. Hold-down devices have also been designed and are manufactured to prevent grate displacement by aircraft traffic. If manufactured grates are used, the vendor must certify the design load capacity. All grates to be used under loaded conditions should be delivered without paintings or coatings to allow for inspection of cracks and other imperfections prior to installation.

7-6.1.6 For rigid concrete pavements, grates may be protected by expansion joints around the inlet frames. Construction joints, which match or are equal to the normal spacing of joints, may be required around the drainage structure. The slab around the drainage structure should include steel reinforcements to control cracking outwardly from each corner of the inlet.

7-6.2 **Ladders.** Adequate ladders should be provided to assure that rapid entrance and egress may be made by personnel during an inspection of facilities. Ladder rungs should be checked periodically since they are often lost in the course of regular inspection and maintenance work. Fixed ladders will be provided depending on the depth of the structures. DOD projects require ladders on all structures over 12 ft in depth. Access to manhole and junction boxes without fixed ladders will be by portable ladders.



Figure 7-14. Examples of Typical Inlet Grates

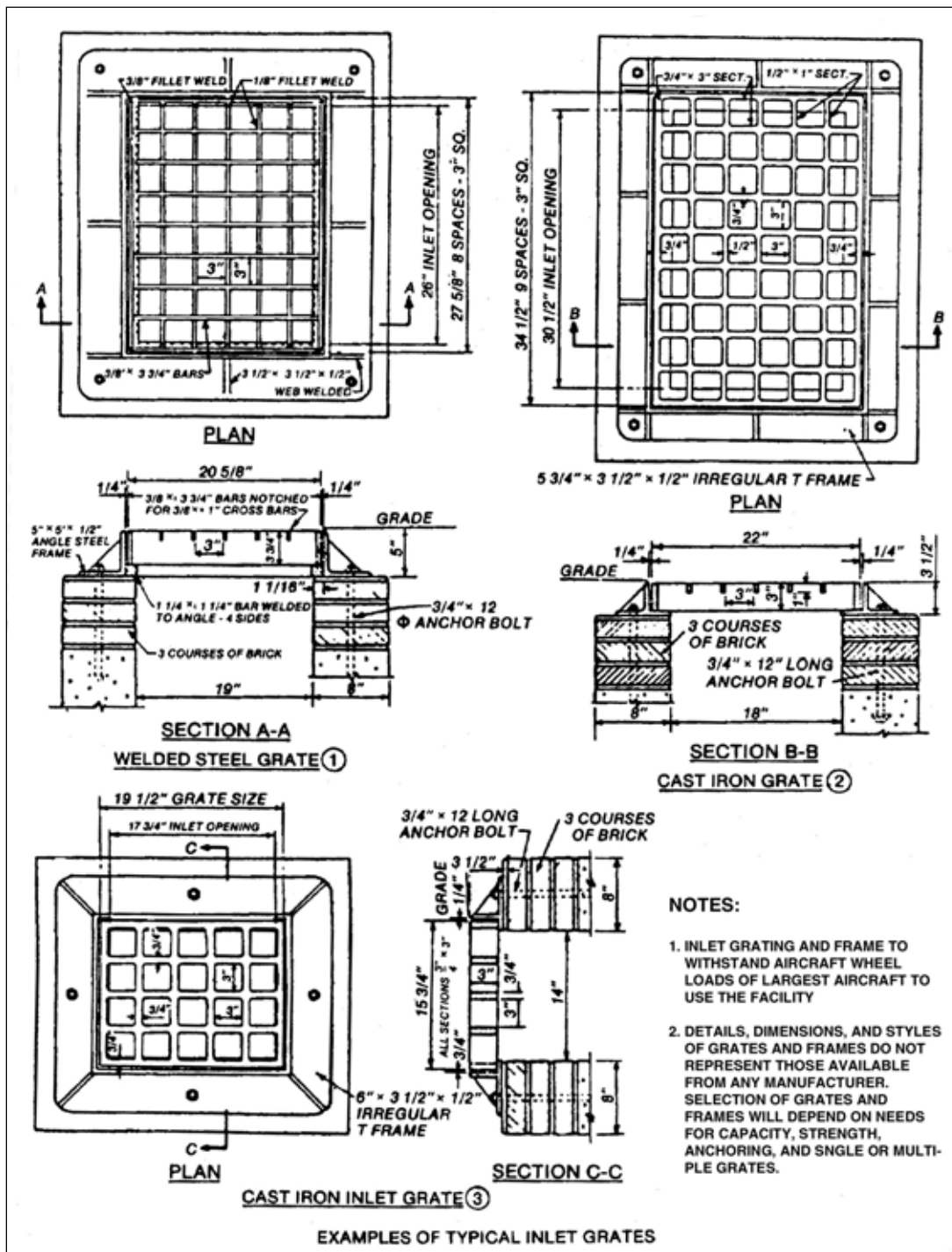
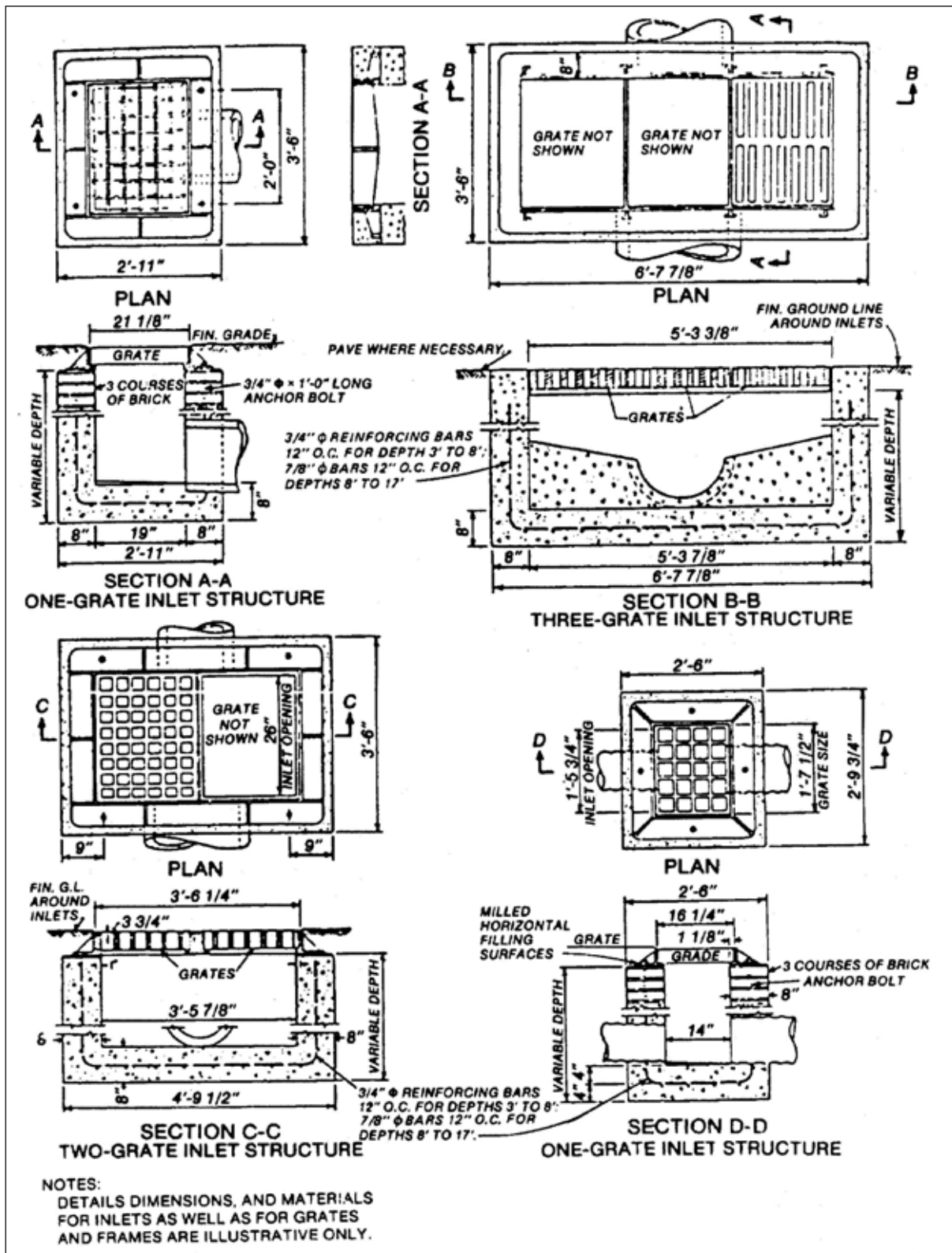


Figure 7-15. Examples of Inlet Design



7-6.3 **Steps.** Steps are intended to provide a means of convenient access to manholes. Where access steps are provided, each step should be designed to comply with Occupational Safety and Health Administration (OSHA) requirements. The steps should be corrosion resistant. Steps coated with neoprene or epoxy or steps fabricated from rust-resistant material such as stainless steel or aluminum coated with bituminous paint are preferable. Steps made from reinforcing steel are absolutely unacceptable.

Note that some agencies have abandoned the use of manhole steps in favor of having maintenance personnel supply their own ladders. Reasons for this include danger from rust-damaged steps and the desire to restrict access. In addition, DOD does not recommend the use of steps on any structure.

## 7-7 SPECIAL DESIGN CONSIDERATIONS FOR AIRFIELDS

7-7.1 **Overview.** Structures built in connection with airport drainage are similar to those used in conventional construction, but these structures must be capable of supporting the heaviest design aircraft wheel load. Although standard-type structures are usually adequate for roads, special structures will be needed occasionally.

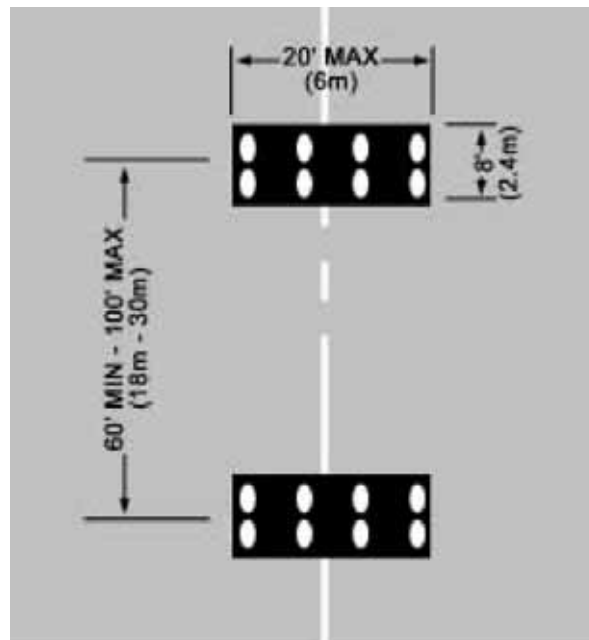
Future heavy aircraft may increase point loadings on some structures (e.g., manhole covers), while on other structures the entire aircraft weight may be imposed on a deck span, pier, or footing (e.g., overpasses). Strengthening of drainage structures after the initial construction may prove extremely difficult, costly, and time consuming.

### 7-7.2 Recommended Design Parameters

7-7.2.1 **Structural Considerations.** For many drainage structures, the design load is highly dependent upon the aircraft gear configuration. While the exact gear configuration of future heavy aircraft is unknown, three basic gear configurations will be used to design for future heavy loads: Type A – Bicycle; Type B – Tricycle; and Type C – Tricycle. The three basic gear configurations for future heavy aircraft come from FAA AC 150/5320-6D. For a given aircraft gross weight, each of the three basic gear configurations will be used in the design of each drainage component. Then, for each drainage component, the basic gear configuration that results in the most conservative design will be selected as the design gear configuration for that component. For purposes of design, each of the three basic configurations contains two wheel groups of eight wheels each (sixteen wheels per aircraft). Each wheel group occupies an area of 20 ft by either 6 ft or 8 ft, with each wheel group supporting one-half of the aircraft gross weight. Wheel prints are uniformly spaced within each of the respective wheel groups. Nose gears are not considered in the design, except as they occur in the static load.

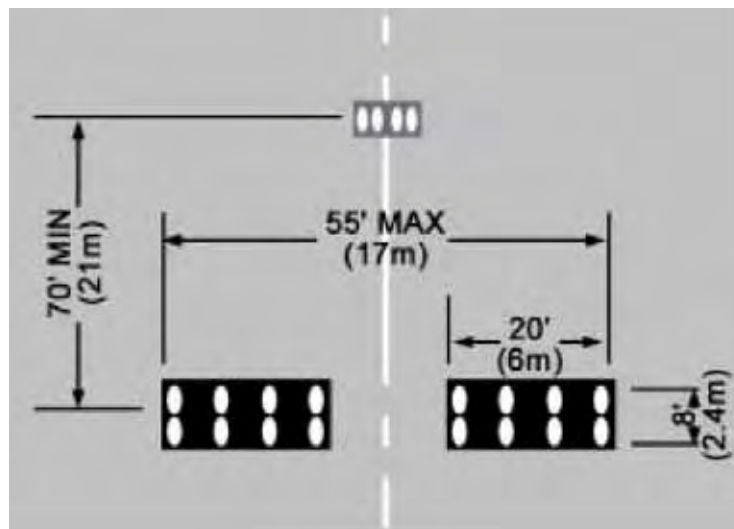
7-7.2.1.1 **Type A – Bicycle.** The Type A – Bicycle configuration (Figure 7-16) consists of two wheel groups located along a single line parallel to the primary aircraft axis (i.e., parallel to the line of travel), but with the major axis of each wheel group oriented perpendicular to the primary aircraft axis.

Figure 7-16. Type A – Bicycle Gear Configuration



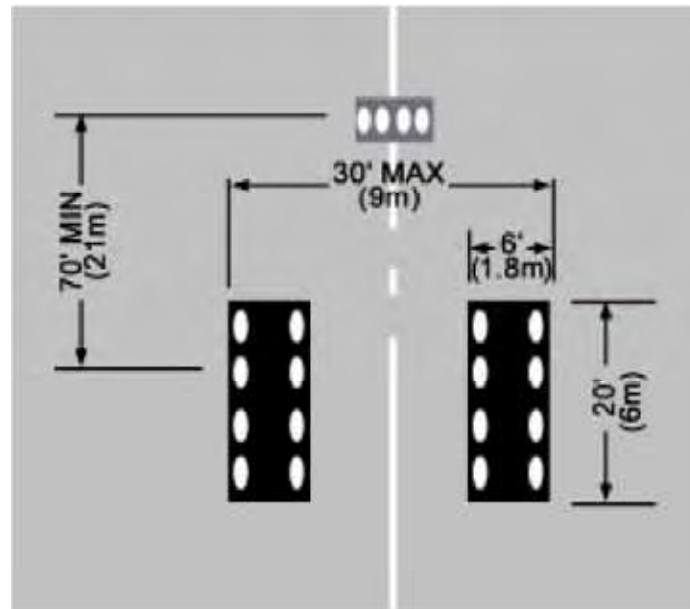
7-7.2.1.2 **Type B – Tricycle.** The Type B – Tricycle configuration (Figure 7-17) includes a nose gear and has wheel groups whose major axes are coincident and perpendicular to the major aircraft axis.

Figure 7-17. Type B – Tricycle Gear Configuration



7-7.2.1.3 **Type C – Tricycle.** The Type C – Tricycle configuration (Figure 7-18) includes a nose gear and has wheel groups whose major axes are parallel to, and equidistant from, the principal aircraft axis.

Figure 7-18. Type C – Tricycle Gear Configuration



7-7.2.2 **Loads.** All loads discussed in this UFC are to be considered as dead load (DL) plus live loads (LL). The design of structures subject to direct wheel loads should also anticipate braking loads as high as 0.7 g (for no-slip brakes).

7-7.2.3 **Direct Loading.** Decks and covers subject to direct heavy aircraft loading, such as manhole covers, inlet grates, utility tunnel roofs, and bridges, should be designed for these loadings:

7-7.2.3.1 Manhole covers for 100-kip wheel loads with tire pressure of 250 lb/in<sup>2</sup>.

7-7.2.3.2 For spans of 2 ft or less in the least direction, apply a uniform live load of 250 lb/in<sup>2</sup>.

7-7.2.3.3 For spans greater than 2 ft in the least direction, the design will be based on the number of wheels that will fit the span. Wheel loads of 50 to 75 kip should be considered.

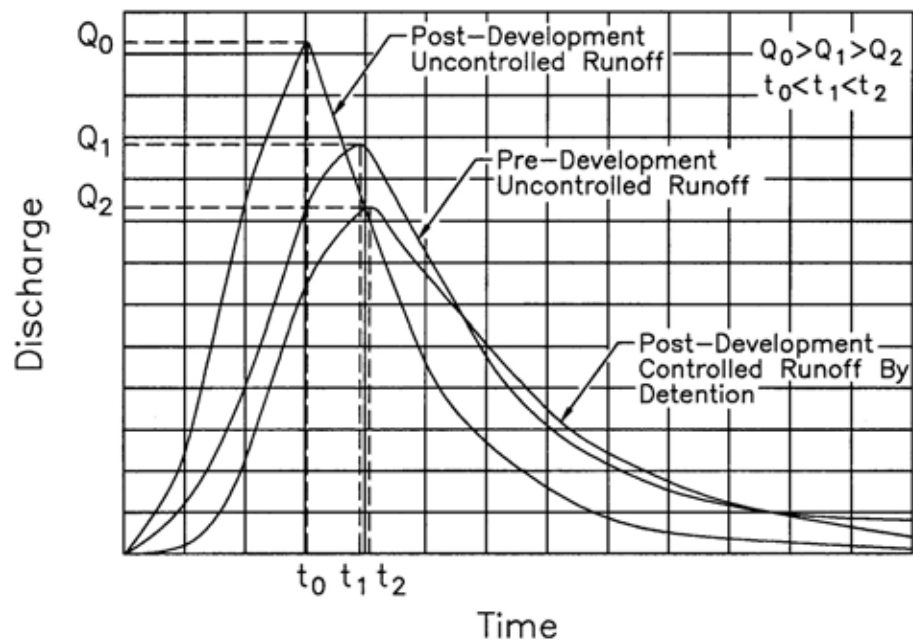
7-7.2.3.4 For structures that will be required to support both in-line and directional traffic lanes such as diagonal taxiways or apron taxi routes, load transfer at expansion joints will not be considered in the design process; however, if specific knowledge about the long-term load transfer characteristics of a particular feature supports the use of load transfer in the design of a particular drainage structure, then an exception is allowed and load transfer will be considered.

## CHAPTER 8

### STORM WATER CONTROL FACILITIES

8-1 **GENERAL.** Many land development activities, including the construction of roads and airports, convert natural pervious areas to impervious areas. These activities cause increased runoff because infiltration is reduced, the surface is usually smoother, allowing more rapid drainage, and depression storage is usually reduced. In addition, natural drainage systems are often replaced by lined channels, storm drains, and curb-and-gutter systems. These man-made systems produce an increase in runoff volume and peak discharge as well as a reduction in the time to peak of the runoff hydrograph. This concept is illustrated by the hydrograph in Figure 8-1.

Figure 8-1. Hydrograph Schematic



8-1.1 **Storage and Detention/Retention Benefits.** The temporary storage or detention/retention of excess storm water runoff as a means of controlling the quantity and quality of storm water releases is a fundamental principle in storm water management and a necessary element of many storm drainage systems. Previous concepts that called for the rapid removal of storm water runoff from developed areas, usually by downstream channelization, are now being combined with methods for storing storm water runoff to prevent overloading of existing downstream drainage systems. The storage of storm water can reduce the frequency and extent of downstream flooding, soil erosion, sedimentation, and water pollution. Detention/retention facilities also have been used to reduce the costs of large storm drainage systems by reducing the required size for downstream storm drain conveyance systems. The use of detention/retention facilities can reduce the peak

discharge from a given watershed, as shown in Figure 8-1. The reduced post-development runoff hydrograph is typically designed so that the peak flow is equal to or less than the pre-developed runoff peak flow rate. Additionally, the volume of the post-development hydrograph is the same as the volume of the reduced post-development runoff hydrograph. Specific design criteria, detailed design guidance, and example problems that address storm water management are provided in Chapter 8 of HEC-22.

## 8-1.2 Design Objectives

8-1.2.1 One of the fundamental objectives of storm water management is to maintain the peak runoff rate from a developing area at or below the pre-development rate to control flooding, soil erosion, sedimentation, and pollution. Design criteria related to pollution control are presented in Chapter 11.

8-1.2.2 Specific design criteria for peak flow attenuation are typically established by local government bodies. Some jurisdictions also require that flow volume be controlled to pre-development levels as well. Controlling flow volume is only practical when site conditions permit infiltration. To compensate for the increase in flow volume, some jurisdictions require that the peak post-development flow be reduced to below pre-development levels.

8-1.2.3 When storm water management first became common, most detention/retention facilities were designed for control of runoff from only a single storm frequency. Typically, 2-year, 10-year, or 100-year storms were selected as the controlling criteria. However, single storm criteria have been found rather ineffective since such a design may provide little control of other storms. For example, design for the control of frequent storms (low return periods) provides little attenuation of less frequent but much larger storm events. Similarly, design for less frequent large storms provides little attenuation for the more frequent smaller storms. Some jurisdictions now enforce multiple-storm regulatory criteria that dictate that multiple storm frequencies be attenuated in a single design. A common criteria would be to regulate the 2-year, 10-year, and 100-year events.

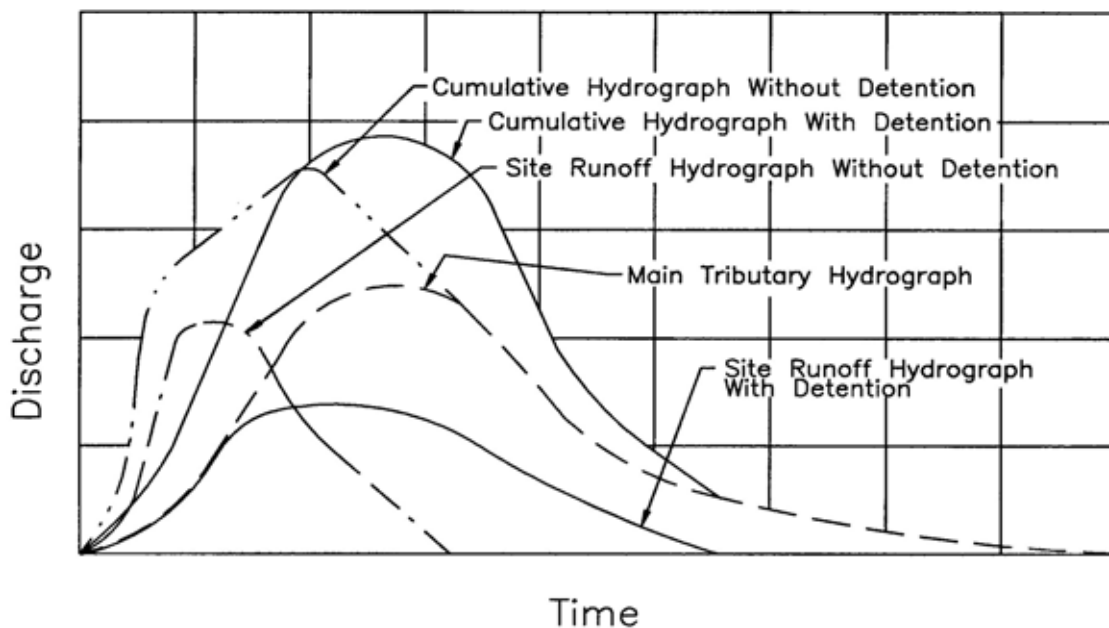
## 8-2 ISSUES RELATED TO STORM WATER QUANTITY CONTROL

**FACILITIES.** Three potential problem areas are associated with the design of storm water quantity control facilities, and these problem areas must be considered during design. They are release timing, safety, and maintenance.

8-2.1 **Release Timing.** The timing of releases from storm water control facilities can be critical to the proper functioning of overall storm water systems. As illustrated in Figure 8-1, storm water quantity control structures reduce the peak discharge and increase the duration of flow events. Though this is the desired result for flow tributary to an individual storm water control facility, this shifting of flow peak times and durations in some instances can cause adverse effects downstream.

For example, where the drainage area being controlled is in a downstream portion of a larger watershed, delaying the peak and extending the recession limb of the hydrograph may result in a higher peak on the main channel. As illustrated in Figure 8-2, this can occur if the reduced peak on the controlled tributary watershed is delayed in such a way that it reaches the main stream at or near the time of its peak. On occasions, it has also been observed that in locations where multiple detention facilities have been installed within developing watersheds, downstream storm flooding problems continue to be noticed. In both of these cases, the natural timing characteristics of the watershed are not being considered, and are not being duplicated by the uncoordinated use of randomly located detention facilities. It is critical that release timing be considered in the analysis of storm water control facilities to ensure the desired result.

**Figure 8-2. Example of a Cumulative Hydrograph with and without Detention**



## 8-2.2 Safety

8-2.2.1 In the design of water quantity control facilities, it is important to consider the possibility that people may be attracted to the site, regardless of whether or not the site or structure is intended for their use. It is important to design and construct inflow and outflow structures with safety in mind. Considerations for promoting safety include preventing public trespass, providing emergency escape aids, and eliminating other hazards.

8-2.2.2 Removable, hydraulically-efficient grates and bars may be considered for all inlet and outlet pipes, particularly if they connect with an underground storm drain system and/or they present a safety hazard. Fences may be needed to enclose ponds.



8-2.2.3 Where active recreation areas are incorporated into a detention basin, very mild bottom slopes should be used along the periphery of the storage pond. Ideally, detention basins should be located away from busy streets and intersections. Outflow structures should be designed to limit flow velocities at points where people could be drawn into the discharge stream. Persons who enter a detention pond or basin during periods when storm water is being discharged may be at risk. The force of the currents may push a person into an outflow structure or may hold a victim under the water where a bottom discharge is used. Several design precautions intended to improve safety are addressed in other storm water publications.

8-2.2.4 In the case of airfields, give special consideration to the attraction of wildlife to the facility. Waterfowl, in particular, create a significant safety hazard to aircraft and therefore must be considered during the design phase. For more information on waterfowl hazards, refer to AFPAM 91-212 or AC 150/5200-33.

8-2.3 **Maintenance.** Storm water management facilities must be properly maintained if they are to function as intended over a long period of time. Certain types of maintenance tasks should be performed periodically to ensure that storm water management facilities function properly:

- Inspections: Storm water storage facilities should be inspected periodically for the first few months after construction and on an annual basis thereafter. In addition, these facilities should be inspected during and after major storm events to ensure that the inlet and outlet structures are still functioning as designed, and that no damage or clogging has occurred.
- Mowing: Impoundments should be mowed at least twice a year to discourage woody growth and control weeds.
- Sediment, Debris and Litter Control: Accumulated sediment, debris, and litter should be removed from detention facilities at least twice a year. Particular attention should be given to removing sediment, debris, and trash around outlet structures to prevent clogging of the control device.
- Nuisance Control: Standing water or soggy conditions within the lower stage of a storage facility can create nuisance conditions such as odors, insects, and weeds. Allowance for positive drainage during design will minimize these problems. Additional control can be provided by periodic inspection and debris removal, and by ensuring that outlet structures are kept free of debris and trash.
- Structural Repairs and Replacement: Inlet and outlet devices and standpipe or riser structures have been known to deteriorate with time, and may have to be replaced. The actual life of a structural component will depend on individual, site-specific criteria, such as soil conditions.

8-3 **STORAGE FACILITY TYPES.** Storm water quantity control facilities can be classified by function as either detention or retention facilities. The primary function of detention is to store and gradually release or attenuate storm water runoff by way of a control structure or other release mechanism. True retention facilities provide for storage of storm water runoff, and release via evaporation and infiltration only. Retention facilities that provide for slow release of storm water over an extended period of several days or more are referred to as extended detention facilities.

#### 8-3.1 **Detention Facilities**

8-3.1.1 The detention concept is most often employed in highway and municipal storm water management plans to limit the peak outflow rate to that which existed from the same watershed before development for a specific range of flood frequencies. Detention storage may be provided at one or more locations and may be both above or below ground. These locations may exist as impoundments, collection and conveyance facilities, underground tanks, and on-site facilities such as parking lots, pavements, and basins. The facility may have a permanent pool, known as a wet pond. Wet ponds are typically used where pollutant control is important. Detention ponds are the most common type of storage facility used for controlling storm water runoff peak discharges. The majority of these are dry ponds that release all the runoff temporarily detained during a storm.

8-3.1.2 Detention facilities should be provided only where they are shown to be beneficial by hydrologic, hydraulic, and cost analysis. Additionally, some detention facilities may be required by ordinances and should be constructed as deemed appropriate by the governing agency. Specific design guidance and criteria for detention storage apply:

- Design rainfall frequency, intensity, and duration must be consistent with applicable standards and local requirements.
- The facility's outlet structure must limit the maximum outflow to allowable release rates. The maximum release rate may be a function of existing or developed runoff rates, downstream channel capacity, potential flooding conditions, and/or local ordinances.
- The size, shape, and depth of a detention facility must provide sufficient volume to satisfy the project's storage requirements. This is best determined by routing the inflow hydrograph through the facility. HEC-22, Chapter 8, outlines techniques that can be used to estimate an initial storage volume, and provides an explanation of storage routing techniques.
- An auxiliary outlet must be provided to allow overflow that may result from excessive inflow or clogging of the main outlet. This outlet should be positioned such that overflows will follow a predetermined route. Preferably, such overflows should discharge into open channels, swales, or other approved storage or conveyance features.

- The system must be designed to release excess storm water expeditiously to ensure that the entire storage volume is available for subsequent storms and to minimize hazards. A dry pond, which is a facility with no permanent pool, may need a paved low flow channel to ensure complete removal of water and to aid in nuisance control.
- The facility must satisfy Federal and state statutes and recognize local ordinances. Some of these statutes are the Federal Water Pollution Control Act, the Water Quality Act, and other Federal, state, and local regulations.
- Access must be provided for maintenance.
- If the facility will be an "attractive nuisance" or is not considered reasonably safe, it may have to be fenced and/or signed.

### 8-3.2 Retention Facilities

8-3.2.1 Retention facilities as defined here include extended detention facilities, infiltration basins, and swales. In addition to storm water storage, retention may be used for water supply, recreation, pollutant removal, aesthetics, and/or groundwater recharge. As explained in Chapter 11, infiltration facilities provide significant water quality benefits, and although groundwater recharge is not a primary goal of highway storm water management, the use of infiltration basins and/or swales can provide this secondary benefit.

8-3.2.2 Retention facilities are typically designed to provide the dual functions of storm water quantity and quality control. These facilities may be provided at one or more locations and may be either above or below ground. These locations may exist as impoundments, collection and conveyance facilities (swales or perforated conduits), and on-site facilities such as parking lots and roadways using pervious pavements.

8-3.2.3 Design criteria for retention facilities are the same as those for detention facilities except that it may not be necessary to remove all runoff after each storm. Additional criteria should be applied, however. See paragraphs 8-3.3 and 8-3.4 for this criteria.

### 8-3.3 Wet Pond Facilities

- Wet pond facilities must provide sufficient depth and volume below the normal pool level for any desired multiple use activity.
- Shoreline protection should be provided where erosion from wave action is expected.
- The design should include a provision for lowering the pool elevation or draining the basin for cleaning purposes, shoreline maintenance, and emergency operations.

- Any dike or dam must be designed with a safety factor commensurate with an earth dam and/or as set forth in state statutes.
- Safety benching should be considered below the permanent water line at the toe of steep slopes to guard against accidental drowning.

#### 8-3.4 **Infiltration Facilities**

- A pervious bottom is necessary to ensure sufficient infiltration capability to drain the basin in a reasonable amount of time so that it will have the capacity needed for another event.
- Because of the potential delay in draining the facility between events, it may be necessary to increase the emergency spillway capacity and/or the volume of impoundment.
- Detailed engineering geological studies are necessary to ensure that the infiltration facility will function as planned.
- Particulates from the inflow should be removed so they do not settle and preclude infiltration.

The FHWA's TS-80-218 is recommended for additional information on underground detention and retention facilities.

## CHAPTER 9

### PIPE SELECTION, BEDDING AND BACKFILL

9-1 **GENERAL.** A drainage pipe is defined as a structure (other than a bridge) to convey water through a trench or under a fill or some other obstruction. Materials for permanent-type installations include non-reinforced concrete, reinforced concrete, corrugated steel, plastic, corrugated aluminum alloy, and structural plate steel pipe.

#### 9-1.1 Pipe Selection

9-1.1.1 The selection of a suitable construction conduit will be governed by the availability and suitability of pipe materials for local conditions with due consideration of economic factors. It is desirable to permit alternates so that bids can be received with contractors' options for the different types of pipe suitable for a specific installation. Allowing alternates serves as a means of securing bidding competition. When alternate designs are advantageous, each system will be economically designed, taking advantage of full capacity, best slope, least depth, and proper strength and installation provisions for each material involved. Where field conditions dictate the use of one pipe material in preference to others, the reasons will be clearly presented in the design analysis.

9-1.1.2 Consider life cycle cost factors in selecting the type of pipe to be used in construction. The factors include strength under either maximum or minimum cover being provided, pipe bedding and backfill conditions, anticipated loadings, length of pipe sections, ease of installation, resistance to corrosive action by liquids carried or surrounding soil materials, suitability of jointing methods, provisions for expected deflection without adverse effect on the pipe structure or on the joints or overlying materials, and cost of maintenance. Although it is possible to obtain an acceptable pipe installation to meet design requirements by establishing special provisions for several possible materials, ordinarily only one or two alternates will economically meet the individual requirements for a proposed drainage system.

9-1.1.3 DOD has approved the use of plastic pipe for low volume roadway applications; however, it is not approved for use under any type of airfield pavement except for subsurface water collection and disposal.

9-1.2 **Selection of  $n$  Values.** Roughness should be considered when selecting pipe options. A designer is continually confronted with what coefficient of roughness,  $n$ , to use in a given situation. The question of whether  $n$  should be based on the new and ideal condition of a pipe or on an anticipated condition at a later date is difficult to answer. Sedimentation or paved pipe can affect the coefficient of roughness. Roughness coefficients for pipe are covered in Chapter 6.

9-1.3 **Restricted Use of Bituminous-Coated Pipe.** Corrugated metal pipe with any percentage of bituminous coating will not be installed where solvents can be

expected to enter the pipe. If corrugated steel is a pipe option where solvents are expected, polymeric coated corrugated steel pipe is recommended.

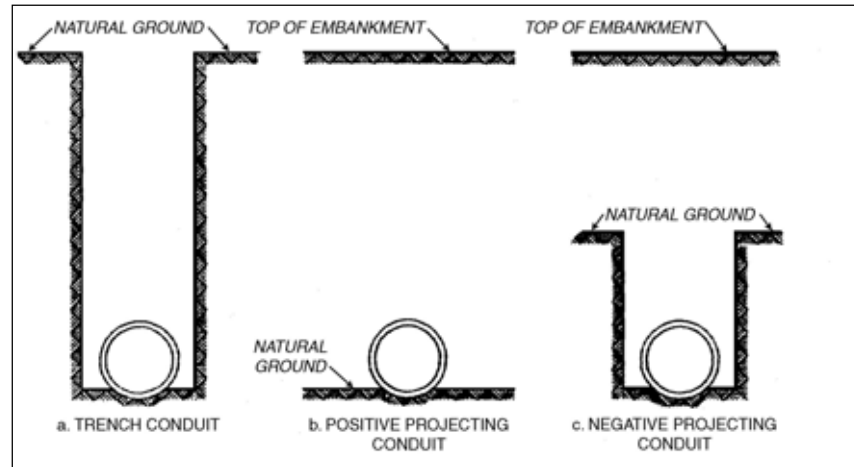
9-1.3.1 The selection of culvert materials to withstand deterioration from corrosion or abrasion will be based on these specific considerations:

9-1.3.1.1 Rigid or plastic pipes are preferable where industrial wastes, spilled petroleum products, or other substances harmful to bituminous paving and coating in corrugated metal pipe are apt to be present. Concrete pipe typically should not be used where soil is more acidic than pH 5.5 or where the fluid carried has a pH less than 5.5 or higher than 9.0. High density polyethylene (HDPE) pipe is unaffected by acidic or alkaline soil conditions. Concrete pipe can be engineered to perform very satisfactorily in the more severe acidic or alkaline environments. Type II or Type V cements should be used where soils and/or water have a moderate or high sulfate concentration, respectively. High-density concrete pipe is recommended when the culvert will be subject to tidal drainage and saltwater spray. Where highly corrosive substances are to be carried, the resistive qualities of vitrified clay pipe or plastic-lined concrete pipe should be considered.

9-1.3.1.2 Corrugated steel pipe will be galvanized and generally will be bituminous coated for permanent installations. Bituminous coating or polymeric coating is recommended for corrugated steel pipe subjected to stagnant water; where dense decaying vegetation is present to form organic acids; where there is continuous wetness or continuous flow; and in well-drained, normally dry, alkali soils. The polymeric-coated pipe is not damaged by spilled petroleum products or industrial wastes. Corrugated aluminum alloy pipe, fabricated in all of the shapes and sizes of the more familiar corrugated steel pipe, evidences corrosion resistance in clear granular materials even when subjected to sea water. Corrugated aluminum pipe will not be installed in soils that are highly acid (pH less than 5) or alkaline (pH greater than 9), or in metallic contact with other metals or metallic deposits, or where known corrosive conditions are present or where bacterial corrosion is known to exist. Similarly, this type pipe will not be installed in material classified as OH (organic clays of medium to high plasticity, organic silts) or OL (organic silts and organic silty clays of low plasticity) according to the Unified Soil Classification System (ASTM D2487-00). Although bituminous coatings can be applied to aluminum alloy pipe, such coatings do not afford adequate protection (bituminous adhesion is poor) under the aforementioned corrosive conditions. Suitable protective coatings for aluminum alloy have been developed but are not economically feasible for culverts or storm drains. When considering a coating for use, performance data from users in the area can be helpful. Performance history indicates various successes or failures of coatings and their probable cause, and such histories are available from local highway departments.

9-1.4 **Classes of Bedding and Installation.** Figures 9-1 through 9-4 indicate the classes of bedding for conduits. Figure 9- 5 is a schematic representation of the subdivision of classes of conduit installation that influence loads on underground conduits.

Figure 9-1. Three Main Classes of Conduits



9-1.5 **Strength of Pipe.** Pipe shall be considered of ample strength when it meets the conditions specified for the loads indicated in Tables 9-1 through 9-7. When railway or vehicular wheel loads or loads due to heavy construction equipment (live loads, LL) impose heavier loads, or when the earth (or dead loads, DL) vary materially from those normally encountered, these tables cannot be used for pipe installation design and separate analyses must be made. The suggested minimum and maximum cover shown in the tables pertain to pipe installations in which the backfill material is compacted to at least 90 percent of ASTM D1557 or AASHTO T99 density (100 percent for cohesionless sands and gravels). This does not modify requirements for any greater degree of compaction specified for other reasons. It is emphasized that proper bedding, backfilling, compaction, and prevention of infiltration of backfill material into pipe are important not only to the pipe, but also to protect overlying and nearby structures. When in doubt about minimum and maximum cover for local conditions, a separate cover analysis must be performed.

9-1.6 **Rigid Pipe.** Tables 9-1 and 9-2 indicate maximum and minimum cover for trench conduits employing pipe and concrete pipe. If positive projecting conduits are employed, they are installed in shallow bedding with a part of the conduit projecting above the surface of the natural ground and then covered with an embankment. Due allowance will be made in amounts of minimum and maximum cover for positive projecting conduits. Table 9-8 suggests guidelines for minimum cover to protect the pipe during construction and the minimum finished height of cover.

Figure 9-2. Free-Body Conduit Diagrams

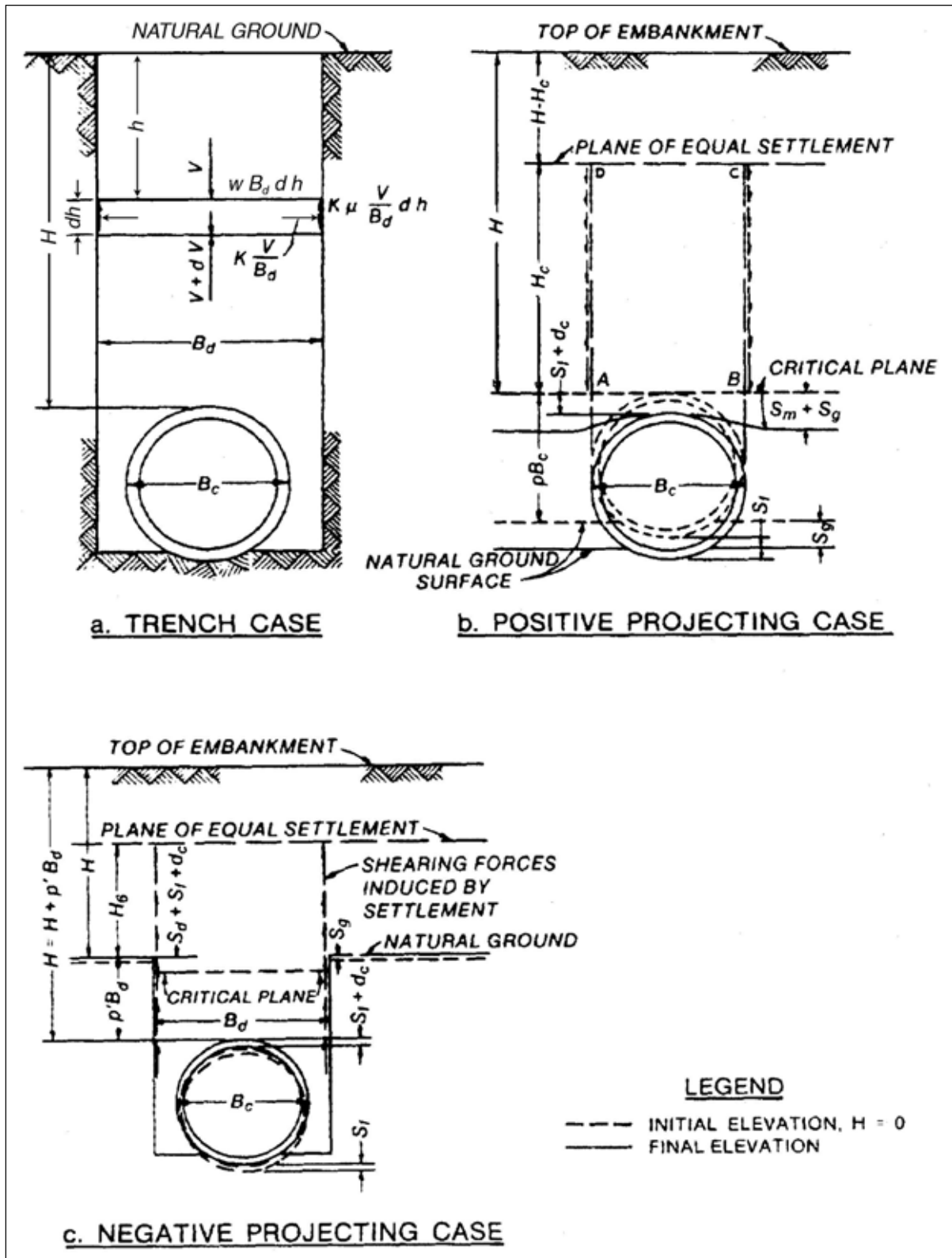




Figure 9-3. Trench Beddings for Circular Pipe

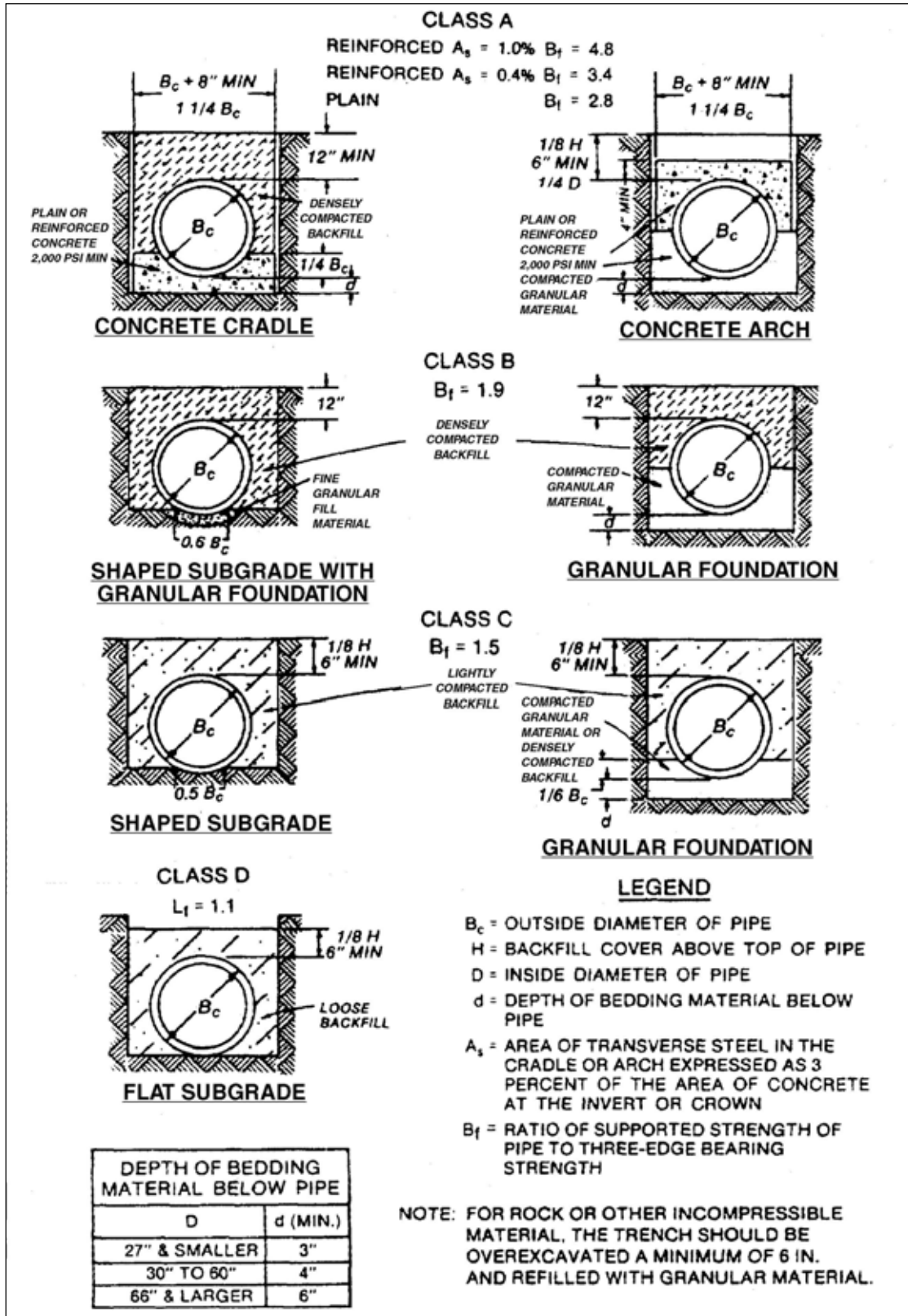


Figure 9-4. Beddings for Positive Projecting Conduits

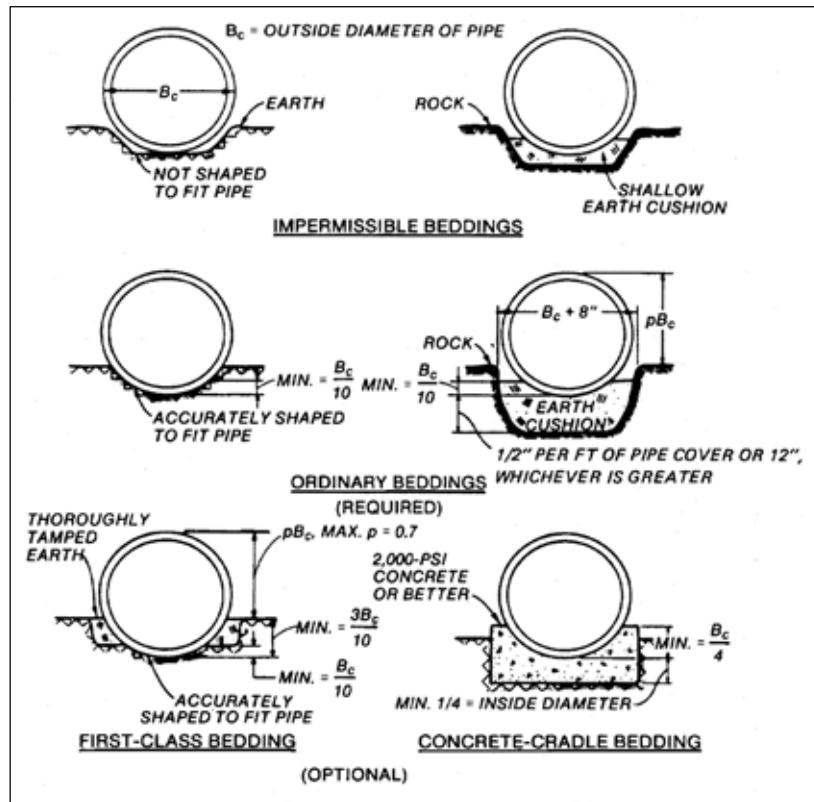
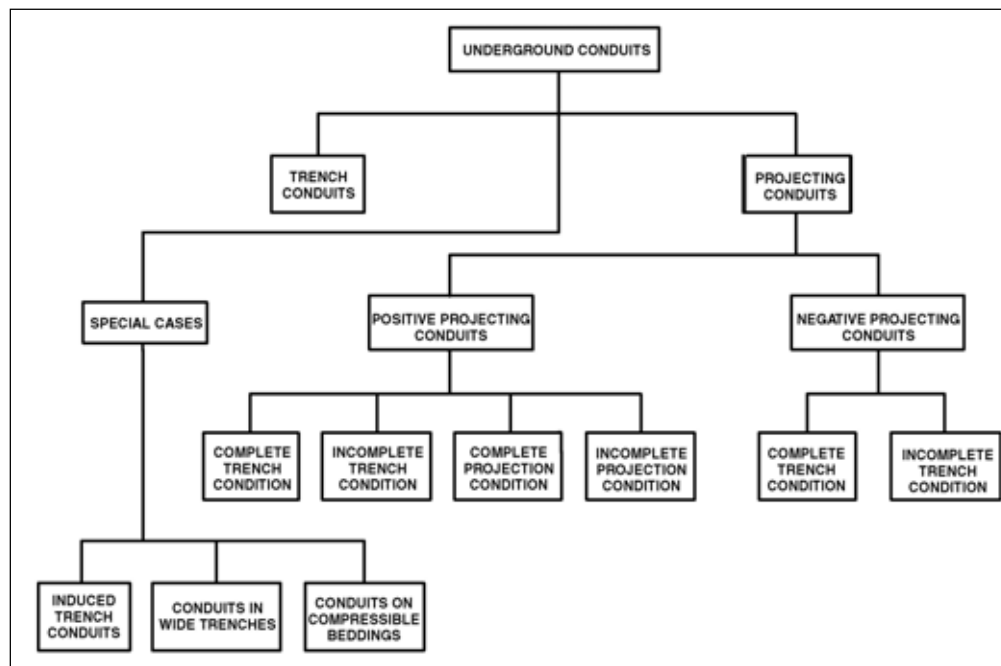


Figure 9-5. Installation Conditions that Influence Loads on Underground Conduits



**Table 9-1. Suggested Maximum Cover Requirements for Concrete Pipe, Reinforced Concrete, H-20 Highway Loading\***

Diameter, in.	Suggested Maximum Cover Above Top of Pipe, ft				
	Circular Section				
	Class				
	1500	2000	2500	3000	3750
12	9	13	16	19	24
24	10	13	17	19	24
36	10	13	17	20	25
48	10	13	17	20	25
60	10	14	17	20	25
72	10	14	17	20	25
84	11	14	17	21	24
108	11	14	17	21	26
Non-reinforced Concrete					
Diameter, in.	Suggested Maximum Cover Above Top of Pipe, ft				
	Circular Section				
	I	II		III	
12	14	14		17	
24	13	13		14	
36	9	12		12	

\*Source: U.S. Army Corps of Engineers

Notes:

1. The suggested values shown are for average conditions and are to be considered as guidelines only for dead load plus H-20 live load.
2. Soil conditions, trench width, and bedding conditions vary widely throughout varying climatic and geographical areas.
3. Calculations to determine maximum cover should be made for all individual pipe and culvert installations underlying roads, streets, and open storage areas subject to H-20 live loads. Cooper E-80 railway loadings should be independently made.
4. Cover depths are measured from the bottom of the subbase of pavements, or the top of unsurfaced areas, to the top of the pipe.
5. Calculations to determine maximum cover for Cooper E-80 railway loadings are measured from the bottom of the tie to the top of the pipe.
6. "D" loads listed for the various classes of reinforced-concrete pipe are the minimum required 3-edge test loads to produce ultimate failure in pounds per linear foot of interval pipe diameter.
7. Each diameter pipe in each class designation of non-reinforced concrete has a different D-load value that increases with wall thickness.
8. If pipe produced by a manufacturer exceeds the strength requirements established by indicated standards, cover depths may be adjusted accordingly.
9. See Table 9-9 for suggested minimum cover requirements.

**Table 9-2. Suggested Maximum Cover Requirements for Corrugated Aluminum Alloy Pipe, Riveted, Helical, or Welded Fabrication 2.66-in. Spacing, 0.5-in.-Deep Corrugations, H-20 Highway Loading\***

Diameter, in.	Suggested Maximum Cover Above Top of Pipe, ft									
	Circular Section					Vertically Elongated Section				
	Thickness, in.					Thickness, in.				
	.060	.075	.105	.135	.164	.060	.075	.105	.135	.164
12	50	50	86	90	93					
15	40	40	69	72	74					
18	33	33	57	60	62					
24	25	25	43	45	46					
30	20	20	34	36	37					
36	16	16	28	30	31					
42	16	16	28	30	31			50	52	53
48			28	30	31			43	45	47
54			28	30	31					
60				30	31					
66					31					
72					31					

\*Source: U.S. Army Corps of Engineers

Notes:

1. Corrugated aluminum alloy pipe will conform to the requirements of ASTM B745/B745M.
2. The suggested values shown are for average conditions and are guidelines only for dead load plus H-20 live load. Cooper E-80 railway loadings should be independently made.
3. Soil conditions, trench width, and bedding conditions vary widely throughout varying climatic and geographical areas.
4. Calculations to determine maximum cover should be made for all individual pipe and culvert installations underlying roads, streets, and open storage areas subject to H-20 live loads.
5. Cover depths are measured from the bottom of the subbase of pavements, or the top of unsurfaced areas, to the top of the pipe.
6. Calculations to determine maximum cover for Cooper E-80 railway loadings are measured from the bottom of the tie to the top of the pipe.
7. Vertical elongation will be accomplished by shop fabrication and will usually be 5 percent of the pipe diameter.
8. See Table 9-9 for suggested minimum cover requirements.

**Table 9-3. Suggested Maximum Cover Requirements for Corrugated Steel Pipe, 2.66-in. Spacing, 0.5-in.-Deep Corrugations\***

H-20 Highway Loading						
Suggested Maximum Cover Above Top of Pipe, ft						
Diameter, in.	Helical – Thickness, in.					
	.052	.064	.079	.109	.138	.168
12	170	213	266	372		
15	136	170	212	298		
18	113	142	173	212		
21	97	121	139	164		
24	85	106	120	137	155	
27	75	94	109	120	133	
30	68	85	101	110	119	
36	56	71	88	98	103	
42	48	60	76	92	95	99
48		53	66	88	91	93
54			59	82	88	90
60				74	86	87
66					85	86
72					79	85
78						84
84						75

\*Source: U.S. Army Corps of Engineers

Notes:

1. Corrugated steel pipe will conform to the requirements of ASTM A760/A760M-01a, ASTM A761/A761M-04, ASTM A762/A762M-00, and ASTM A849-00.
2. The suggested maximum heights of cover shown in the tables are calculated on the basis of the current AASHTO *Standard Specifications for Highway Bridges* and are based on circular pipe.
3. Soil conditions, trench width, and bedding conditions vary widely throughout varying climatic and geographical areas.
4. Calculations to determine maximum cover should be made for all individual pipe and culvert installations underlying roads, streets, and open storage areas subject to H-20 live loads. Cooper E-80 railway loadings should be independently made.
5. Cover depths are measured from the bottom of the subbase of pavements, or the top of unsurfaced areas, to the top of the pipe.
6. Calculations to determine maximum cover for Cooper E-80 railway loadings are measured from the bottom of the tie to the top of the pipe.
7. If pipe produced by a manufacturer exceeds the strength requirements established by indicated standards, then cover depths may be adjusted accordingly.
8. See Table 9-9 for suggested minimum cover requirements.

**Table 9-4. Suggested Maximum Cover Requirements for Structural Plate Aluminum Alloy Pipe, 9-in. Spacing, 2.5-in. Corrugations\***

<b>H-20 Highway Loading</b>							
<b>Diameter, in.</b>	<b>Suggested Maximum Cover Above Top of Pipe, ft</b>						
	<b>Circular Section</b>						
	<b>Thickness, in.</b>						
	<b>0.10</b>	<b>0.125</b>	<b>0.15</b>	<b>0.175</b>	<b>0.20</b>	<b>0.225</b>	<b>0.250</b>
72	24	32	41	48	55	61	64
84	20	27	35	41	47	52	55
96	18	24	30	36	41	45	50
108	16	21	27	32	37	40	44
120	14	19	24	29	33	36	40
132	13	17	22	26	30	33	36
144	12	16	20	24	27	30	33
156		14	18	22	25	28	30
168		13	17	20	23	26	28
180			16	19	22	24	26

\*Source: U.S. Army Corps of Engineers

Notes:

1. Structural plate aluminum alloy pipe will conform to the requirements of ASTM B745/B745M.
2. Soil conditions, trench width, and bedding conditions vary widely throughout varying climatic and geographical areas.
3. Calculations to determine maximum cover should be made for all individual pipe and culvert installations underlying roads, streets, and open storage areas subject to H-20 live loads. Cooper E-80 railway loadings should be independently made.
4. Cover depths are measured from the bottom of the subbase of pavements, or the top of unsurfaced areas, to the top of the pipe.
5. Calculations to determine maximum cover for Cooper E-80 railway loadings are measured from the bottom of the tie to the top of the pipe.
6. If pipe produced by a manufacturer exceeds the strength requirements established by indicated standards, cover depths may be adjusted accordingly.
7. See Table 9-9 for suggested minimum cover requirements.

**Table 9-5. Suggested Maximum Cover Requirements for Corrugated**

H-20 Highway Loading					
Diameter, in.	Suggested Maximum Cover Above Top of Pipe, ft				
	Helical—Thickness, in.				
	.064	.079	.109	.138	.168
48	54	68	95	122	132
54	48	60	84	109	117
60	43	54	76	98	107
66	39	49	69	89	101
72	36	45	63	81	96
78	33	41	58	75	92
84	31	38	54	70	85
90	29	36	50	65	80
96		34	47	61	75
102		32	44	57	70
108			42	54	66
114			40	51	63
120			38	49	60

\*Source: U.S. Army Corps of Engineers

Notes:

1. Corrugated steel pipe will conform to the requirements of ASTM A760/A760M-01a, ASTM A761/A761M-04, ASTM A762/A762M-00, and ASTM A849-00.
2. The suggested maximum heights of cover shown in the table are calculated on the basis of the current AASHTO *Standard Specifications for Highway Bridges* and are based on circular pipe.
3. Soil conditions, trench width, and bedding conditions vary widely throughout varying climatic and geographical areas.
4. Calculations to determine maximum cover should be made for all individual pipe and culvert installations underlying roads, streets, and open storage areas subject to H-20 live loads. Cooper E-80 railway loadings should be independently made.
5. Cover depths are measured from the bottom of the subbase of pavements, or the top of unsurfaced areas, to the top of the pipe.
6. Calculations to determine maximum cover for Cooper E-80 railway loadings are measured from the bottom of the tie to the top of the pipe.
7. If pipe produced by a manufacturer exceeds the strength requirements established by indicated standards, cover depths may be adjusted accordingly.
8. See Table 9-9 for suggested minimum cover requirements.

**Table 9-6. Suggested Maximum Cover Requirements for Structural Plate Steel Pipe, 6-in. Span, 2-in.-Deep Corrugations\***

H-20 Highway Loading							
Diameter, ft	Suggested Maximum Cover Above Top of Pipe, ft						
	Thickness, in.						
	.109	.138	.168	.188	.218	.249	.280
5.0	46	68	90	103	124	146	160
5.5	42	62	81	93	113	133	145
6.0	38	57	75	86	103	122	133
6.5	35	52	69	79	95	112	123
7.0	33	49	64	73	88	104	114
7.5	31	45	60	68	82	97	106
8.0	29	43	56	64	77	91	100
8.5	27	40	52	60	73	86	94
9.0	25	38	50	57	69	81	88
9.5	24	36	47	54	65	77	84
10.0	23	34	45	51	62	73	80
10.5	22	32	42	49	59	69	76
11.0	21	31	40	46	56	66	72
11.5	20	29	39	44	54	63	69
12.0	19	28	37	43	51	61	66
12.5	18	27	36	41	49	58	64
13.0	17	26	34	39	47	56	61
13.5	17	25	33	38	46	54	59
14.0	16	24	32	36	44	52	57
14.5	16	23	31	35	42	50	55
15.0	15	22	30	34	41	48	53
15.5	15	22	29	33	40	47	51
16.0		21	28	32	38	45	50
16.5		20	27	31	37	44	48
17.0		20	26	30	36	43	47
17.5		19	25	29	35	41	45
18.0			25	28	34	40	44
18.5			24	27	33	39	43
19.0			23	27	32	38	42
19.5			23	26	31	37	41
20.0				25	31	36	40
20.5				25	30	35	39
21.0					29	34	38
21.5					28	34	37
22.0					28	33	36
22.5					27	32	35
23.0						31	34
23.5						31	34
24.0						30	33
24.5							32
25.0							32
25.5							31

\*Source: U.S. Army Corps of Engineers



Notes:

1. Corrugated steel pipe will conform to the requirements of ASTM A760/A760M-01a, ASTM A761/A761M-04, ASTM A762/A762M-00, and ASTM A849-00.
2. The suggested maximum heights of cover shown in the table are calculated on the basis of the current AASHTO *Standard Specifications for Highway Bridges* and are based on circular pipe.
3. Soil conditions, trench width, and bedding conditions vary widely throughout varying climatic and geographical areas.
4. Calculations to determine maximum cover should be made for all individual pipe and culvert installations underlying roads, streets, and open storage areas subject to H-20 live loads. Cooper E-80 railway loadings should be independently made.
5. Cover depths are measured from the bottom of the subbase of pavements, or the top of unsurfaced areas, to the top of the pipe.
6. Calculations to determine maximum cover for Cooper E-80 railway loadings are measured from the bottom of the tie to the top of the pipe.
7. If pipe produced by a manufacturer exceeds the strength requirements established by indicated standards, cover depths may be adjusted accordingly.
8. See Table 9-9 for suggested minimum cover requirements.

**Table 9-7. Suggested Maximum Cover Requirements for Corrugated**

H-20 Highway Loading										
Diameter, in.	Suggested Maximum Cover Above Top of Pipe, ft									
	Riveted - Thickness, in.					Helical – Thickness, in.				
	.064	.079	.109	.138	.168	.064	.079	.109	.138	.168
36	53	66	98	117	130	81	101	142	178	201
42	45	56	84	101	112	69	87	122	142	157
48	39	49	73	88	98	61	76	107	122	132
54	35	44	65	78	87	54	67	95	110	117
60	31	39	58	70	78	48	61	85	102	107
66	28	36	53	64	71	44	55	77	97	101
72	26	33	49	58	65	40	50	71	92	96
78	24	30	45	54	60	37	47	65	84	93
84	22	28	42	50	56	34	43	61	78	91
90	21	26	39	47	52	32	40	57	73	89
96		24	36	44	49		38	53	69	84
102		23	34	41	46		35	50	64	79
108			32	39	43			47	61	75
114			30	37	41			45	58	71
120			29	35	39			42	55	67

\*Source: U.S. Army Corps of Engineers

Notes:

1. Corrugated steel pipe will conform to the requirements of ASTM A760/A760M-01a, ASTM A761/A761M-04, ASTM A762/A762M-00, and ASTM A849-00.
2. The suggested maximum heights of cover shown in the table are calculated on the basis of the current AASHTO *Standard Specifications for Highway Bridges* and are based on circular pipe.
3. Soil conditions, trench width, and bedding conditions vary widely throughout varying climatic and geographical areas.
4. Calculations to determine maximum cover should be made for all individual pipe and culvert installations underlying roads, streets, and open storage areas subject to H-20 live loads. Cooper E-80 railway loadings should be independently made.
5. Cover depths are measured from the bottom of the subbase of pavements, or the top of unsurfaced areas, to the top of the pipe.
6. Calculations to determine maximum cover for Cooper E-80 railway loadings are measured from the bottom of the tie to the top of the pipe.
7. If pipe produced by a manufacturer exceeds the strength requirements established by indicated standards, cover depths may be adjusted accordingly.
8. See Table 9-9 for suggested minimum cover requirements.

**Table 9-8. Suggested Guidelines for Minimum Cover\***

<b>H-20 Highway Loading</b>			
<b>Pipe</b>	<b>Minimum Cover to Protect Pipe</b>		<b>Minimum Finished Height of Cover (From Bottom of Subbase to Top of Pipe)</b>
	<b>Pipe Diameter, in.</b>	<b>Height of Cover During Construction, ft</b>	
Concrete Pipe Reinforced	12 to 108	Diameter/2 or 3.0 ft, whichever is greater	Diameter/2 or 2.0 ft, whichever is greater
Non-Reinforced	12 to 36	Diameter/2 or 3.0 ft, whichever is greater	Diameter/2 or 2.0 ft, whichever is greater
Corrugated Aluminum Pipe 2.66 in. by 0.5 in.	12 to 24 30 and over	1.5 ft Diameter	Diameter/2 or 1.0 ft, whichever is greater Diameter/2
Corrugated Steel Pipe 3 in. by 1 in.	12 to 30 36 and over	1.5 ft Diameter	Diameter/2 or 1.0 ft, whichever is greater Diameter/2
Structural Plate Aluminum Alloy Pipe 9 in. by 2.5 in.	72 and over	Diameter/2	Diameter/4
Structural Plate Steel 6 in. by 2 in.	60 and over	Diameter/2	Diameter/4

\*Source: U.S. Army Corps of Engineers

Notes:

1. All values shown above are for average conditions and are guidelines only.
2. Calculations should be made for minimum cover for all individual pipe installation for pipe underlying roads, streets, and open storage areas subject to H-20 live loads.
3. Calculations for minimum cover for all pipe installations should be made separately for all Cooper E-80 railroad live loading.
4. In seasonal frost areas, minimum pipe cover must meet requirements of Table 2-3 of UFC 3-230-16FA for protection of storm drains.
5. Pipe placed under rigid pavement will have minimum cover from the bottom of the subbase to the top of pipe of 1.0 ft for pipe up to 60 in. and greater than 1.0 ft for sizes above 60 in. if calculations so indicate.
6. Trench widths depend upon varying conditions of construction but may be as wide as is consistent with the space required to install the pipe and as deep as can be managed from practical construction methods.
7. Non-reinforced concrete pipe is available in sizes up to 36 in.
8. See Table 9-9 for suggested minimum cover requirements.

**Table 9-9. Minimum Depth of Cover in Feet for Pipe Under Flexible Pavement (Part 1)**

<b>CORRUGATED ALUMINUM 2 2/3" x 1/2" or 2" x 1/2" CORRUGATIONS</b>									
AIRCRAFT WHEEL LOAD—Up to 30,000 lb. single and up to 40,000 lb. dual									
Metal thickness (in.)	Pipe diameter (in.)								
	12	18	24	36	48	60	72	84	96
0.060.....	2.0	2.5	2.5						
0.075.....	1.5	2.0	2.5	2.5	3.0				
0.105.....		1.5	1.5	1.5	2.0	2.5	3.0		
0.135.....			1.0	1.0	1.5	1.5	1.5		
0.165.....					1.0	1.5	1.5	2.0	2.0

<b>CORRUGATED ALUMINUM 6" x 1" CORRUGATIONS</b>									
AIRCRAFT WHEEL LOAD—up to 30,000 lb. single and up to 40,000 lb. dual									
Metal thickness (in.)	Pipe diameter (in.)								
	36	48	60	72	84	96	108	120	
0.060.....	2.0	2.0	2.5	3.0					
0.075.....	1.0	1.5	2.0	2.5	3.5				
0.105.....	1.0	1.0	1.5	2.0	3.0	3.5			
0.135.....			1.5	2.0	2.5	3.0	3.5	4.0	
0.165.....					2.0	2.5	3.5	4.5	

<b>CORRUGATED ALUMINUM 2 2/3" x 1/2" or 2" x 1/2" CORRUGATIONS</b>									
AIRCRAFT WHEEL LOAD—40,000 lb. dual to 110,000 lb. dual									
Metal thickness (in.)	Pipe diameter (in.)								
	12	18	24	36	48	60	72	84	96
0.060.....	2.0	2.5	2.5						
0.075.....	1.5	2.0	2.5	2.5	3.0				
0.105.....		1.5	1.5	1.5	2.0	2.5	3.0		
0.135.....				1.5	1.5	2.0	2.5	3.0	
0.165.....					1.5	1.5	2.0	2.0	2.5

<b>CORRUGATED ALUMINUM 6" x 1" CORRUGATIONS</b>									
AIRCRAFT WHEEL LOAD—40,000 lb. dual to 110,000 lb. dual									
Metal thickness (in.)	Pipe diameter (in.)								
	36	48	60	72	84	96	108	120	
0.060.....	2.5	3.0	3.5	4.0					
0.075.....	1.5	2.0	2.5	3.0	4.0				
0.105.....	1.5	1.5	2.0	2.5	3.5	4.0			
0.135.....			2.0	2.5	3.0	3.5	4.5		
0.165.....					2.5	3.0	4.0	5.0	

<b>CORRUGATED ALUMINUM 2 2/3" x 1/2" or 2" x 1/2" CORRUGATIONS</b>									
AIRCRAFT WHEEL LOAD—110,000 lb. dual to 200,000 lb. dual; 190,000 lb. dt. to 350,000 lb. dt.; up to 750,000 lb. ddt. & 1,500,000 lb.									
Metal thickness (in.)	Pipe diameter (in.)								
	12	18	24	36	48	60	72	84	96
0.060.....	3.0	3.0	3.0						
0.075.....	3.0	3.0	3.0	3.5	5.0				
0.105.....		2.0	2.0	2.5	3.5	4.5			
0.135.....				2.0	3.0	4.0	4.5	5.5	
0.165.....					2.5	3.5	4.0	5.0	5.5

<b>CORRUGATED ALUMINUM 6" x 1" CORRUGATIONS</b>									
AIRCRAFT WHEEL LOAD—110,000 lb. d. to 200,000 lb. d.; 190,000 lb. dt. to 350,000 lb. dt.; up to 750,000 lb. ddt. & 1,500,000 lb.									
Metal thickness (in.)	Pipe diameter (in.)								
	36	48	60	72	84	96	108	120	
0.060.....	4.0	4.5	5.0	5.0					
0.075.....	3.0	3.5	3.5	4.0	4.0				
0.105.....	2.0	2.0	3.0	2.5	4.0	4.5			
0.135.....			2.5	3.0	3.5	4.0	5.0		
0.165.....					3.0	3.5	4.5	5.5	

<b>CLAY</b>									
AIRCRAFT WHEEL LOAD—up to 30,000 lb. single and up to 40,000 lb. dual									
Pipe type	Pipe diameter (in.)								
	6	10	12	15	18	21	24	30	36
Std. strength clay.....	2.0	2.5	2.5	2.5	2.5	2.5	2.5	2.5	2.5
Extra strength clay.....	2.0	2.0	2.0	2.0	2.0	2.0	2.0	2.0	2.0

<b>CLAY</b>									
AIRCRAFT WHEEL LOAD—40,000 lb. dual to 110,000 lb. dual									
Pipe type	Pipe diameter (in.)								
	6	10	12	15	18	21	24	30	36
Std. strength clay.....	4.0	5.5	6.0	6.0	6.0	6.0	6.0	6.0	6.0
Extra strength clay.....	2.0	3.5	3.5	3.5	3.5	3.5	3.5	3.5	3.5

<b>ASBESTOS CEMENT</b>									
AIRCRAFT WHEEL LOAD—up to 30,000 lb. single and up to 40,000 lb. dual									
Asbestos cement-class	Pipe diameter (in.)								
	6	10	12	16	18	24	30	36	42
1500.....	2.5	2.5	2.5	2.5					
2400.....	2.5	2.5	2.5	2.5	2.5	2.5			
3300.....	1.5	1.5	1.5	1.5	1.5	1.5	1.5		
4000.....		1.5	1.5	1.5	1.5	1.5	1.5	1.5	
5000.....			1.5	1.5	1.5	1.5	1.5	1.5	1.5
6000.....								1.0	1.0
7000.....								1.0	1.0

<b>ASBESTOS CEMENT</b>									
AIRCRAFT WHEEL LOAD—40,000 lb. dual to 110,000 lb. dual									
Asbestos cement-class	Pipe diameter (in.)								
	6	10	12	16	18	24	30	36	42
1500.....	5.5	5.5	5.5	5.5					
2400.....	6.0	6.0	6.0	6.0	6.0	6.0			
3300.....	3.5	3.5	3.5	3.5	3.5	3.5	3.5		
4000.....		3.5	3.5	3.5	3.5	3.5	3.5	3.5	
5000.....			3.5	3.5	3.5	3.5	3.5	3.5	3.5
6000.....								2.5	2.5
7000.....								2.5	2.5

**Table 9-9. Minimum Depth of Cover in Feet for Pipe Under Flexible Pavement (Part 2)**

<b>CORRUGATED STEEL 2 2/3" x 1 1/2" CORRUGATIONS</b>									
AIRCRAFT WHEEL LOAD—Up to 30,000 lb. single and up to 40,000 lb. dual									
Metal thickness (in.)	Pipe diameter (in.)								
	12	18	24	36	48	60	72	84	96
0.052.....	1.0	1.0	1.5	1.5					
0.064.....	1.0	1.0	1.0	1.5	1.5				
0.079.....	1.0	1.0	1.0	1.5	1.5	1.5			
0.109.....			1.0	1.0	1.0	1.0	1.5		
0.138.....				1.0	1.0	1.0	1.0	1.5	
0.168.....				1.0	1.0	1.0	1.0	1.5	1.5

<b>CORRUGATED STEEL 3" x 1" CORRUGATIONS</b>									
AIRCRAFT WHEEL LOAD—Up to 30,000 lb. single and up to 40,000 lb. dual									
Metal thickness (in.)	Pipe diameter (in.)								
	36	48	60	72	84	96	108	120	
0.052.....	1.5	2.0	2.0	2.0					
0.064.....	1.0	1.5	1.5	2.0	2.0	2.0			
0.079.....	1.0	1.0	1.5	1.5	2.0	2.0	2.0		
0.109.....	1.0	1.0	1.0	1.0	1.5	1.5	2.0	2.0	
0.138.....	1.0	1.0	1.0	1.0	1.0	1.5	2.0	2.0	2.0
0.168.....	1.0	1.0	1.0	1.0	1.0	1.5	2.0	2.0	2.0

<b>CORRUGATED STEEL 2 2/3" x 1 1/2" CORRUGATIONS</b>									
AIRCRAFT WHEEL LOAD—40,000 lb. dual to 110,000 lb. dual									
Metal thickness (in.)	Pipe diameter (in.)								
	12	18	24	36	48	60	72	84	96
0.052.....	1.5	2.0	2.0	2.5					
0.064.....	1.5	1.5	2.0	2.5	2.5				
0.079.....	1.5	1.5	2.0	2.5	2.5	2.5			
0.109.....			1.5	2.0	2.0	2.0	2.5		
0.138.....				2.0	2.0	2.0	2.0	2.5	
0.168.....				2.0	1.5	2.0	2.0	2.0	2.5

<b>CORRUGATED STEEL 3" x 1" CORRUGATIONS</b>									
AIRCRAFT WHEEL LOAD—40,000 lb. dual to 110,000 lb. dual									
Metal thickness (in.)	Pipe diameter (in.)								
	36	48	60	72	84	96	108	120	
0.052.....	2.5	3.0	3.0	3.0					
0.064.....	2.0	2.5	2.5	3.0	3.0	3.0			
0.079.....	1.5	2.0	2.5	2.5	3.0	3.0	3.0		
0.109.....	1.5	1.5	2.0	2.0	2.0	2.5	3.0	3.0	
0.138.....	1.5	1.5	1.5	2.0	2.0	2.0	2.5	3.0	3.0
0.168.....	1.5	1.5	1.5	1.5	2.0	2.0	2.0	2.5	2.5

<b>CORRUGATED STEEL 2 2/3" x 1 1/2" CORRUGATIONS</b>									
AIRCRAFT WHEEL LOAD—110,000 lb. dual to 200,000 lb. dual; 190,000 lb. dt. to 350,000 lb. dt.; up to 750,000 lb. ddt.									
Metal thickness (in.)	Pipe diameter (in.)								
	12	18	24	36	48	60	72	84	96
0.052.....	2.0	2.5	3.0	3.0					
0.064.....	2.0	2.5	2.5	3.0	3.0				
0.079.....	2.0	2.0	2.5	2.5	2.5	3.0			
0.109.....			2.0	2.5	2.5	2.5	3.0		
0.138.....				2.0	2.0	2.5	3.0	3.0	
0.168.....				2.0	2.0	2.5	3.0	3.0	3.0

<b>CORRUGATED STEEL 3" x 1" CORRUGATIONS</b>									
AIRCRAFT WHEEL LOAD—110,000 lb. dual to 200,000 lb. dual; 190,000 lb. dt. to 350,000 lb. dt.; up to 750,000 lb. ddt.									
Metal thickness (in.)	Pipe diameter (in.)								
	36	48	60	72	84	96	108	120	
0.052.....	3.0	3.5	3.5						
0.064.....	2.5	3.0	3.5	3.5	3.5				
0.079.....	2.0	2.5	3.0	3.0	3.5	3.5			
0.109.....	2.0	2.0	2.5	2.5	3.0	3.5	3.5	3.5	
0.138.....	2.0	2.0	2.0	2.5	3.0	3.0	3.0	3.5	3.5
0.168.....	2.0	2.0	2.0	2.0	2.5	2.5	3.0	3.0	3.0

<b>CORRUGATED STEEL 2 2/3" x 1 1/2" CORRUGATIONS</b>									
AIRCRAFT WHEEL LOAD—Up to 1,500,000 lb.									
Metal thickness (in.)	Pipe diameter (in.)								
	12	18	24	36	48	60	72	84	96
0.052.....	2.5	2.5	3.0	3.0					
0.064.....	2.5	2.5	2.5	3.0	3.0				
0.079.....	2.5	2.5	2.5	2.5	2.5	3.0			
0.109.....			2.5	2.5	2.5	2.5	3.0		
0.138.....				2.5	2.5	2.5	3.0	3.0	
0.168.....				2.5	2.5	2.5	3.0	3.0	3.0

<b>CORRUGATED STEEL 3" x 1" CORRUGATIONS</b>									
AIRCRAFT WHEEL LOAD—Up to 1,500,000 lb.									
Metal thickness (in.)	Pipe diameter (in.)								
	36	48	60	72	84	96	108	120	
0.052.....	3.0	3.5	3.5						
0.064.....	2.5	3.0	3.5	3.5	3.5				
0.079.....	2.5	2.5	3.0	3.0	3.5	3.5			
0.109.....	2.5	2.5	2.5	2.5	3.0	3.5	3.5	3.5	
0.138.....	2.5	2.5	2.5	2.5	3.0	3.0	3.0	3.5	3.5
0.168.....	2.5	2.5	2.5	2.5	2.5	2.5	3.0	3.0	3.0

<b>STRUCTURAL PLATE PIPE—3" x 2 1/2" CORR. FOR ALUMINUM; 6" x 2" CORRUGATIONS FOR STEEL</b>			
AIRCRAFT WHEEL LOAD—Up to 30,000 lb. s. or 40,000 lb. d.	AIRCRAFT WHEEL LOAD—40,000 lb. d. to 110,000 lb. d.	AIRCRAFT WHEEL LOAD—110 k.d. to 200 k.d.; 190 k d.t. to 350 k. d.t.; to 750 k. d.d.t.	AIRCRAFT WHEEL LOAD—Up to 1,500,000 lb.
Pipe dia. ÷8 but not less than 1.0'	Pipe dia ÷6 but not less than 1.5'	Pipe dia. ÷5 but not less than 2.0'	Pipe dia ÷4 but not less than 2.5'

**Table 9-9. Minimum Depth of Cover in Feet for Pipe Under Flexible Pavement (Part 3)**

NONREINFORCED CONCRETE																		
AIRCRAFT WHEEL LOAD—Up to 30,000 lb. single and up to 40,000 lb. dual									AIRCRAFT WHEEL LOAD—40,000 lb. dual to 110,000 lb. dual									
Pipe type	Pipe diameter (in.)								Pipe type	Pipe diameter (in.)								
	4	6	8	10	12	15	18	21		24	4	6	8	10	12	15	18	21
Std. strength	2.0	2.0	2.0	2.0	2.5	2.5	2.5	2.5	2.5	3.5	4.0	4.0	4.5	5.5	6.0	6.0	6.0	6.0
Extra strength	1.0	1.0	1.5	1.5	1.5	1.5	1.5	1.5	1.5	1.5	2.0	2.5	3.0	3.5	3.5	3.5	3.5	3.5

REINFORCED CONCRETE																				
AIRCRAFT WHEEL LOAD—Up to 30,000 lb. single and up to 40,000 lb. dual																				
Reinf. concrete 0.01" crack D-load	Pipe diameter (in.)																			
	12	15	18	21	24	27	30	33	36	42	48	54	60	72	84	96	108	120	132	144
800	2.0	2.0	2.0	2.0	2.0	2.0	2.0	2.0	1.5	1.5	1.5	1.0	1.0	1.0	1.0	1.0	1.0	1.0	1.0	1.0
1000	2.0	2.0	2.0	2.0	2.0	2.0	2.0	2.0	1.5	1.5	1.5	1.0	1.0	1.0	1.0	1.0	1.0	1.0	1.0	1.0
1350	1.5	1.5	1.5	1.5	1.5	1.5	1.5	1.5	1.5	1.0	1.0	1.0	1.0	1.0	1.0	1.0	1.0	1.0	1.0	1.0
2000	1.0	1.0	1.0	1.0	1.0	1.0	1.0	1.0	1.0	1.0	1.0	1.0	1.0	1.0	1.0	1.0	1.0	1.0	1.0	1.0
3000	1.0	1.0	1.0	1.0	1.0	1.0	1.0	1.0	1.0	1.0	1.0	1.0	1.0	1.0	1.0	1.0	1.0	1.0	1.0	1.0
AIRCRAFT WHEEL LOAD—40,000 lb. dual to 110,000 lb. dual																				
Reinf. concrete 0.01" crack D-load	Pipe diameter (in.)																			
	12	15	18	21	24	27	30	33	36	42	48	54	60	72	84	96	108	120	132	144
800	5.5	5.5	5.5	5.5	5.5	5.0	5.0	5.0	4.5	4.5	4.0	4.0	3.5	3.0	2.5	2.0	1.5	1.5	1.5	1.0
1000	4.0	4.0	4.0	4.0	3.5	3.5	3.5	3.5	3.0	3.0	2.5	2.0	2.0	1.5	1.0	1.0	1.0	1.0	1.0	1.0
1350	3.0	3.0	2.5	2.5	2.5	2.0	2.0	2.0	1.5	1.5	1.5	1.0	1.0	1.0	1.0	1.0	1.0	1.0	1.0	1.0
2000	2.0	2.0	1.5	1.5	1.5	1.5	1.5	1.0	1.0	1.0	1.0	1.0	1.0	1.0	1.0	1.0	1.0	1.0	1.0	1.0
3000	2.0	2.0	1.5	1.5	1.5	1.5	1.5	1.0	1.0	1.0	1.0	1.0	1.0	1.0	1.0	1.0	1.0	1.0	1.0	1.0
AIRCRAFT WHEEL LOAD—110,000 lb. dual to 200,000 lb. dual; 190,000 lb. dual tandem to 350,000 lb. dual tandem; up to 750,000 lb. d.d.t.																				
Reinf. concrete 0.01" crack D-load	Pipe diameter (in.)																			
	12	15	18	21	24	27	30	33	36	42	48	54	60	72	84	96	108	120	132	144
800	7.0	7.0	7.0	7.0	7.0	6.5	6.5	6.5	6.0	6.0	6.0	6.0	6.0	6.0	6.0	5.5	5.5	5.0	4.5	4.0
1000	4.0	4.0	4.0	4.0	4.0	4.0	3.5	3.5	3.5	3.5	3.0	2.5	2.0	2.0	2.0	2.5	2.5	2.0	2.0	1.5
1350	3.0	3.0	2.5	2.5	2.0	2.0	2.0	2.0	2.0	1.5	1.5	1.0	1.0	1.0	1.5	1.5	1.0	1.0	1.0	1.0
2000	3.0	3.0	2.5	2.5	2.0	2.0	2.0	2.0	2.0	1.5	1.5	1.0	1.0	1.0	1.5	1.5	1.0	1.0	1.0	1.0
3000	3.0	3.0	2.5	2.5	2.0	2.0	2.0	2.0	2.0	1.5	1.5	1.0	1.0	1.0	1.5	1.5	1.0	1.0	1.0	1.0
AIRCRAFT WHEEL LOAD—Up to 1,500,000 lb.																				
Reinf. concrete 0.01" crack D-load	Pipe diameter (in.)																			
	12	15	18	21	24	27	30	33	36	42	48	54	60	72	84	96	108	120	132	144
2000	7.0	7.0	7.0	7.0	7.0	6.5	6.5	6.5	6.0	6.0	6.0	6.0	6.0	6.0	6.0	6.0	6.0	6.0	6.0	6.0
3000	4.0	4.0	4.0	4.0	4.0	4.0	3.5	3.5	3.5	3.5	3.0	3.0	3.0	3.0	3.0	3.0	3.0	3.0	3.0	3.0

- Cover depths are measured from top of flexible pavement, however, provide at least 1 foot between bottom of pavement structure and top of pipe.
- The types of pipe shown are available in intermediate sizes, such as 6", 8", 15", 27", 33", etc.
- For pipe installation in turfed areas use cover depths shown for 30,000 pound single; 40,000 pound dual.
- Cover depths shown do not provide for freezing conditions. Usually the pipe invert should be below maximum frost penetration.
- Blanks in tables indicate that pipe will not meet strength requirements.
- Minimum cover depths shown for flexible pipe are based on use of excellent backfill.
- Minimum cover depths shown for rigid pipe are based on use of class B bedding.
- Minimum cover requirements for concrete arch or elliptical pipe may be taken from tables for reinforced concrete circular pipe, providing the outside horizontal span of the arch or elliptical pipe is matched to outside diameter of the circular pipe (assumes that classes of the pipes are the same).
- Pipe cover requirements for "up to 1,500,000 pounds" are theoretical as gear configuration is not known.

**RIGID PAVEMENT**

For all types and sizes of pipe use 1.5 foot as minimum cover under rigid pavement (measure from bottom of slab, providing pipe is kept below subbase course). Rigid pipe for loads categorized as "up to 1,500,000 lb." must, however, be either class IV or class V reinforced concrete.

9-1.7 **Flexible Pipe.** Suggested maximum cover for trench and positive projecting conduits are indicated in Tables 9-3 through 9-7 for corrugated aluminum alloy pipe, corrugated steel pipe, structural plate aluminum alloy pipe, plastic, and structural plate steel pipe. Conditions other than those stated in the tables, particularly other loading conditions, will be compensated for as necessary. For unusual installation conditions, a detailed analysis will be made so that ample safeguards for the pipe will be provided with regard to strength and resistance to deflection due to loads. Determinations for deflections of flexible pipe should be made if necessary. For heavy live loads and heavy loads due to considerable depth of cover, it is desirable that a selected material, preferably bank-run gravel or crushed stone where economically available, be used for backfill adjacent to the pipe. Table 9-8 suggests guidelines for minimum cover to protect the pipe during construction and the minimum finished height of cover. ASTM D2321-04e1 provides standards for the installation of plastic pipe.

9-1.8 **Bedding of Pipe (Culverts and Storm Drains).** The contact between a pipe and the foundation on which it rests is the pipe bedding. It has an important influence on the supporting strength of the pipe. For drainpipes at military installations, the method of bedding shown in Figure 9-3 is generally satisfactory for both trench and positive projecting (embankment) installations. Some designs standardize and classify various types of bedding for the shaping of the foundation, use of granular material, use of concrete, and similar special requirements. Although such refinement is not considered necessary, at least for standardized cover requirements, select, fine granular material can be used as an aid in shaping the bedding, particularly where foundation conditions are difficult. Also, where economically available, granular materials can be used to good advantage for backfill adjacent to the pipe. When culverts or storm drains are to be installed in unstable or yielding soils, under great heights of fill, or where pipe will be subjected to very heavy live loads, a method of bedding can be used in which the pipe is set in plain or reinforced concrete of suitable thickness extending upward on each side of the pipe. In some instances, the pipe may be totally encased in concrete or concrete may be placed along the side and over the top of the pipe (top or arch encasement) after proper bedding and partial backfilling. Pipe manufacturers will be helpful in recommending type and specific requirements for encased, partially encased, or specially reinforced pipe in connection with design for complex conditions.

Figures 9-1, 9-2, 9-3, and 9-4 indicate the three main types of rigid conduit burial, the free-body conduit diagrams, trench beddings for circular pipe, and beddings for positive projecting conduits, respectively. Figure 9-5 is a schematic representation of the subdivision of classes of conduit installation that influences loads on underground conduits.

9-2 **FROST CONDITION CONSIDERATIONS.** The detrimental effects of heaving of frost-susceptible soils around and under storm drains and culverts are principal considerations in the design of drainage systems in seasonal frost areas. In such areas, water freezing within the drainage system, except icing at inlets, is of secondary importance provided the hydraulic design assures minimum velocity flow.

9-2.1. Drains, culverts, and other utilities under pavements on frost-susceptible subgrades are frequently locations of detrimental differential surface heaving. Heaving causes pavement distress and loss of smoothness because of abrupt differences in the rate and magnitude of heave of the frozen materials. Heaving of frost-susceptible soils under drains and culverts can also result in pipe displacement with consequent loss of alignment, joint failures, and in extreme cases, pipe breakage. Placing drains and culverts beneath pavements should be minimized to the extent possible. When this is unavoidable, to obtain maximum uniformity the pipes should be installed before the base course is placed. The practice of excavating through base courses to lay drain pipes and other conduits is unsatisfactory because attaining uniformity between the compacted trench backfill and the adjacent material is almost impossible.

9-2.2 No special measures are required to prevent heave in non-frost-susceptible subgrades. In frost-susceptible subgrades where the highest groundwater table is 5 ft or more below the maximum depth of frost penetration, the centerline of the pipe should be placed at or below the depth of maximum frost penetration. Where the highest groundwater table is less than 5 ft below the depth of maximum frost penetration and the pipe diameter is 18 in. or more, one of these measures should be taken:

- Place the centerline of the pipe at or below the depth of maximum frost penetration, and backfill around the pipe with a highly free-draining non-frost-susceptible material.
- Place the centerline of the pipe one-third diameter below the depth of maximum frost penetration.

9-2.3 To prevent water from freezing in the pipe, the invert of the pipe should be placed at or below the depth of maximum frost penetration. In arctic and subarctic areas, it may not be feasible economically to provide sufficient depth of cover to prevent freezing of water in subdrains; also, in the arctic, no residual thaw layer may exist between the depth of seasonal frost penetration and the surface of permafrost. Subdrains in such areas may be blocked with ice during the spring thawing period; however, subdrains will function normally the rest of the time. Water freezing in culverts also presents a serious problem in arctic and subarctic regions. The number of such structures should be held to a minimum and should be designed based on twice the normal design capacity. Thawing devices should be provided in all culverts up to 48 in. in diameter. Large-diameter culverts are usually cleaned manually immediately prior to the spring thaw. Drainage requirements for arctic and subarctic regions are presented in Chapter 10.

9-2.4 These design notes should be considered for installations located in seasonal frost areas:

- Note 1. The cover requirement for traffic loads will apply when such depth exceeds that necessary for frost protection.
- Note 2. Sufficient granular backfill will be placed beneath inlets and outlets to restrict frost penetration to nonheaving materials.



- Note 3. Design of short pipes with exposed ends, such as culverts under roads, will consider local icing experience. If necessary, larger pipe will be provided to compensate for icing.
- Note 4. The depth of frost penetration in well-drained, granular, non-frost-susceptible soil beneath pavements kept free of snow and ice will be determined from data in the appropriate UFC for pavement design. In all cases, estimates of frost penetration will be based on the design freezing index, which is defined as the average air-freezing index of the three coldest winters in a 30-yr period, or the air-freezing index for the coldest winter in the past 10-yr period if 30 years of records are unavailable. Additional design support can be obtained from the PCASE computer program.
- Note 5. Under traffic areas, and particularly where frost condition pavement design is based on reduced subgrade strength, gradual transitions between frost-susceptible subgrade materials and non-frost-susceptible trench backfill will be provided within the depth of frost penetration to prevent detrimental differential surface heave.

9-3 **INFILTRATION OF FINE SOILS THROUGH DRAINAGE PIPE JOINTS.** For DOD facilities, watertight joints are recommended under airfield pavements.

9-3.1 Infiltration of fine-grained soils into drainage pipelines through joint openings is one of the major causes of ineffective drainage facilities. This is a serious problem along pipes on relatively steep slopes such as those encountered with broken-back culverts or stilling wells or when the pipe operates under pressure flow conditions. Infiltration is not confined to non-cohesive soils. Dispersive soils have a tendency to slake and flow into drainage lines.

9-3.2 Infiltration, prevalent when the HGL (e.g., water table) is at or above the pipeline, occurs in joints of rigid pipelines and in joints and seams of flexible pipe unless these are made watertight. Watertight jointing is especially necessary in culverts and storm drains placed on steep slopes to prevent infiltration and/or leakage and piping that normally results in the progressive erosion of the embankments and loss of downstream energy dissipators and pipe sections.

9-3.3 Culverts and storm drains placed on steep slopes should be large enough and properly vented so that full pipe flow can never occur. This maintains the hydraulic gradient above the pipe invert but below crown of the pipe, thereby reducing the tendency for infiltration of soil water through joints. Pipes on steep slopes may tend to prime and flow full periodically because of entrance or outlet condition effects until the hydraulic or pressure gradient is lowered enough to cause venting or loss of prime at either the inlet or outlet. The alternating increase and reduction of pressure relative to atmospheric pressure is considered a primary cause of severe piping and infiltration. A vertical riser should be provided upstream of or at the change in slope to provide sufficient venting for establishment of partial flow and stabilization of the pressure

gradient in the portion of pipe on the steep slope. The riser may also be equipped with an inlet and used simultaneously to collect runoff from a berm or adjacent area.

9-3.4 Infiltration of backfill and subgrade material can be controlled by watertight flexible joint materials in rigid pipe and with watertight coupling bands in flexible pipe. Successful flexible watertight joints have been obtained in rigid pipelines with rubber gaskets installed in close-tolerance tongue-and-groove joints and factory-installed plastic gaskets installed on bell-and-spigot pipe. Bell-and-spigot joints caulked with oakum or other similar rope-type caulking materials and sealed with hot-poured joint compound have also been successful. Metal pipe seams may require welding, and the rivet heads may have to be ground to lessen interference with gaskets. Several kinds of connecting bands are adequate both hydraulically and structurally for joining corrugated metal pipes on steep slopes.

9-3.5 A conclusive infiltration test will be required for each section of pipeline involving watertight joints, and installation of flexible watertight joints will conform closely to manufacturers' recommendations. Although system layouts presently recommended are considered adequate, particular care should be exercised to provide a layout of subdrains that does not require water to travel appreciable distances through the base course due to impervious subgrade material or barriers. Pervious base courses with a minimum thickness of about 6 in. with provisions for drainage should be provided beneath pavements constructed on fine-grained subgrades and subject to perched water table conditions. Base courses containing more than 10 percent fines cannot be drained and remain saturated continuously.

#### 9-4 **MINIMUM AND MAXIMUM COVER FOR AIRFIELDS**

9-4.1 Heliport and airport layout will typically include underground conduits that pass under runways, taxiways, aprons, helipads, and other hardstands. In the design and construction of the drainage system, it will be necessary to consider both minimum and maximum earth cover allowable in the underground conduits to be placed under both flexible and rigid pavements as well as beneath unsurfaced airfields and medium-duty landing-mat-surfaced fields. Underground conduits are subject to two principal types of loads: dead loads (DL) caused by embankment or trench backfill plus superimposed stationary surface loads, uniform or concentrated; and live or moving loads (LL), including impact. FAA cover tables shall be used for all airfields' pipe cover requirements. These tables are included in this UFC as Table 9-9. Cover depths are valid for the specified loads and conditions, including average bedding and backfill. Deviations from these loads and conditions significantly affect the allowable maximum and minimum cover, requiring a separate design calculation.

9-4.2 Drainage systems should be designed to provide the greatest possible capacity to serve the planned pavement configuration. Additions to or replacements of drainage lines following initial construction are both costly and disrupting to aircraft traffic.

## 9-5 MINIMUM AND MAXIMUM COVER FOR ROADWAYS

9-5.1 In the design and construction of the drainage system, it will be necessary to consider both minimum and maximum earth cover allowable on the underground conduits to be placed under both flexible and rigid pavements. Underground conduits are subject to two principal types of loads: DL, caused by embankment or trench backfill plus superimposed stationary surface loads, uniform or concentrated; and LL, including impact. LL assume increasing importance with decreasing fill height.

9-5.2 AASHTO *Standard Specifications for Highway Bridges* should be used for all H-20 highway loading analyses. The American Railway Engineering and Maintenance of Way Association (AREMA) *Manual for Railway Engineering* should be used for all Cooper's E-80 railway loadings. Appropriate pipe manufacturer design manuals should be used for maximum cover analyses.

9-5.3 Drainage systems should be designed to provide an ultimate capacity sufficient to serve the planned installation. Addition to, or replacement of, drainage lines following initial construction is costly.

9-5.4 Investigations of in-place drainage and erosion control facilities at fifty military installations were made during the period of 1966 to 1972. The age of the facilities varied from one to more than thirty years. The study revealed that buried conduits and associated storm drainage facilities installed from the early 1940s until the mid-1960s appeared to be in good to excellent structural condition; however, many installations reported failures of buried conduits during construction. Note, therefore, that minimum conduit cover requirements are not always adequate during construction. When construction equipment, which may be heavier than LL for which the conduit has been designed, is operated over or near an already in-place underground conduit, it is the responsibility of the contractor to provide any additional cover during construction to avoid damage to the conduit. Major improvements in the design and construction of buried conduits in the two decades include, among other items, increased strength of buried pipes and conduits, increased compaction requirements, and revised minimum cover tables.

9-5.5 The necessary minimum cover in certain instances may determine pipe grades. A safe minimum cover design requires consideration of a number of factors, including selection of conduit material, construction conditions and specifications, selection of pavement design, selection of backfill material and compaction, and the method of bedding underground conduits. Emphasis on these factors must be carried from the design stage through the development of final plans and specifications.

9-5.6 Tables 9-1 through 9-6 identify certain suggested cover requirements for storm drains and culverts. These suggested requirements should be considered as guidelines only. Cover requirements have been formulated for reinforced and non-reinforced concrete pipe, corrugated aluminum alloy pipe, corrugated steel pipe, structural plate aluminum alloy pipe, and structural plate steel pipe. The different sizes and materials of conduit and pipe have been selected to allow the reader to be aware of

the many and varied items that are commercially available for construction purposes. The cover depths listed are suggested only for average bedding and backfill conditions. Deviations from average conditions may result in significant minimum cover requirements, and separate cover analyses must be made in each instance of a deviation from average conditions. Specific bedding, backfill, and trench widths may be required in certain locations; each condition deviating from the average condition should be analyzed separately. Where warranted by design analysis, the suggested maximum cover may be exceeded.

9-5.7 As a minimum, pipe in non-paved areas shall be designed for expected maintenance equipment.

## CHAPTER 10

### GUIDELINES FOR DESIGN IN THE ARCTIC AND SUBARCTIC

10-1 **GENERAL.** The design criteria provided in this UFC are generally applicable to arctic and subarctic regions; however, the general information in this chapter on icings and special design considerations for arctic and subarctic conditions are applicable.

The arctic is the northern region in which the mean temperature for the warmest month is less than 50 degrees Fahrenheit (F) and the mean annual temperature is below 32 degrees F. In general, the arctic coincides with the tundra region north of the limit of trees.

The subarctic is the region adjacent to the arctic in which the mean temperature for the coldest month is below 32 degrees F, the mean temperature for the warmest month is above 50 degrees F, and in which there are fewer than 4 months with a mean temperature above 50 degrees F. In general, the subarctic land areas coincide with the circumpolar belt of dominant coniferous forests.

#### 10-2 **ICING**

10-2.1 **Description.** The term "icing" (sometimes misnamed "glaciering") applies to a surface ice mass formed by the freezing of successive sheets of water, the source of which may be a river or stream, a spring, or seepage from the ground. When icing occurs at or near airfields, heliports, roadways, or railroads, the drainage structures and channels gradually fill with ice, which may spread over pavements or structures, endangering and disrupting traffic and operations. Ice must be removed from pavements or structures and drainage facilities must be cleared to avoid or limit the re-forming of icing. Obstruction of flow through drainage facilities—culverts, bridges, pipelines, or channels—can lead to washout of pavement embankments or undermining of structures. The spring thaw period is most critical in this regard. Prevention or control of icing at or near drainage structures and the related effects on pavements and other facilities are key considerations of drainage design and maintenance in the arctic and subarctic. Because icing can occur throughout both seasonal frost and permafrost areas, they are a widespread cause of recurring operational and maintenance problems. Drainage designs based only on conventional criteria will not fulfill the abnormal hydraulic conveyance requirements of icing-prone regions and will be subject to troublesome maintenance problems. Special design and maintenance concepts, based mainly on field experience under similar situations, are required.

10-2.2 **Types.** Icing is classed conveniently as river or stream icing, ground icing, or spring icing, although sometimes it is difficult to assign a specific type to a particular situation. There are three general types of icing:

10-2.2.1 **River or Stream Icing.** River or stream icing occurs more commonly on shallow streams with large width/depth ratios. Braided or meandering channels are

more prone to icing formation than well defined single channels. River or stream icing normally begins to develop soon after normal ice cover forms on a stream surface, usually during October to December. The icing begins with the appearance of unfrozen water on the surface of the normal ice cover. This water may originate from cracks in the ice cover, from seepage through unfrozen portions of soil forming the channel banks, from adjacent springs that usually discharge into the channel, or other sources. This water, flowing in sheets of an inch or less in thickness to a foot or more, freezes in a layer. Each overflow event is followed by another, with new flow atop the previously frozen sheet, the icing growing higher layer upon layer with its boundaries extending laterally according to the topography. River icing may grow for only part of the winter or throughout the period of below-freezing temperatures. Icing behavior usually varies a little year by year, depending on availability of the feeding water. An icing surface is typically flat but can be gently terraced, with each step marking the frozen edge of a thin overflow layer. Occasionally ice mounds form and develop cracks that provide outlets for the confined water forming the mounds. The water flows out, continuing the growth of the icing for a limited period. Smaller icing is typically confined to the stream or drainage channel; larger icing may spread over floodplains or pavements. With the onset of the spring thawing season, runoff cuts channels through the icing to the streambed. Channels are widened by thawing, collapse of the ice forming the sides, and erosion. Depending on the size of the icing and its geographic location, its remnants may last only until May or June, or in colder regions remnants may last all summer. In extreme locations, they never completely melt and are known as perennial icing. River or stream icing occurring at culverts is objectionable in that fish migration is obstructed.

10-2.2.2 **Ground Icing.** Unlike river or stream icing, ground icing, while developing on certain topographic features, does not have clearly defined areas of activity. These icings are commonly referred to as seepage icings, due to the way their feed waters appear on the ground surface. Seepage icings may develop on nearly level ground or at points of contact of two different types of relief (such as at the base of a slope) or as encrustations on slopes. Ground icing begins to form at different times of the year depending on the sources and modes of discharge of the feeding waters. Where water seeps from the ground often or continuously, icing may begin to form in September or October, in which case it might also be termed a spring icing. Those forming where water does not usually issue from the ground typically begin to form in November or December, or even later in the winter. A characteristic of ground icing is that its development begins with unfrozen water appearing on the ground surface or with the saturation and subsequent freezing of snow on the ground. This water may seep from the soil or from fractures in the bedrock, or it may travel along the roots of vegetation, or it may issue from frost-induced cracks in the ground. As the seepage flows are exposed to the cold atmosphere, they freeze. Additional seepages follow repeatedly onto the icing surface and also freeze, building up successive thin ice layers, seldom over an inch thick. Ground icings may grow during the winter, being extremely sensitive to weather and local hydrologic conditions of the winter and its preceding seasons. Normally ground icings are limited in size as compared with stream spring icing since their source of supply is limited. Some rapid growth may occur with the advent of thawing weather. When general thawing occurs, the ground icing will slowly waste

away. This disintegration is unlike that of stream icings, in which sizable runoff streams can rapidly erode icing.

10-2.2.3 **Spring Icing.** Springs found in a variety of topographic situations sustain continuous discharge, leading to early winter formation of icing, usually prior to ground icing. Spring outlets typically remain fixed in location and continue to grow throughout the winter, ultimately reaching a larger size than ground icing. A flow of 1 ft<sup>3</sup>/min can create a 1-ft-deep icing covering an acre in one month. Spring icings melt away slowly on all sides, and these icings are also eroded by spring water channel flow.

10-2.3 **Natural Factors Conducive to Icing Formation.** Certain natural factors are conducive to icing:

10-2.3.1 A rainy season prior to freeze-up producing an abundance of groundwater in the annual frost zone of the soil or in the ground above the permafrost.

10-2.3.2 Low air temperatures and little snow during the first half of the winter, i.e., through January. Early heavy snow minimizes the occurrence of icing.

10-2.3.3 Nearness of an impervious horizon such as the permafrost table to the ground surface.

10-2.3.4 Heavy snow depth accumulations during the latter part of winter.

10-2.4 **Effects of Human Activities on Icing.** Airfields and heliports, by altering the natural physical environment, have profound effects on icing. The widespread clearing of vegetative cover, cutting and filling of soil, excavation of rock, and provisions for drainage, for example, greatly affect the natural thermal regime of the ground and the hydrologic regimes of both groundwater and surface water. Some of the effects are discussed in paragraphs 10-2.4.1 to 10-2.4.6.

10-2.4.1 Removal of vegetation and organic soil, with their typically higher insulation values than those of the construction materials replacing them, results in increased seasonal frost penetration. This may create or aggravate nearby damming of groundwater flow and cause icing. Airfield and heliport pavement areas, kept clear of snow, lack its insulating value and are subject to deeper seasonal frost penetration, causing icing.

10-2.4.2 Cut faces may intersect the water table, and fill sections may block natural drainage channels. Construction compaction operations can reduce permeability of natural soils, blocking natural discharge openings.

10-2.4.3 In cut sections, water comes into contact with the cold atmosphere, forming ground icing where none occurred prior to the construction. Icing grows on the cut face, fills the adjacent drainage ditches with ice, and eventually reaches the pavement surface. In these conditions, deep snow on the slope and ditch insulates seepage from the cut face. Seepage water passes under the snow without freezing and reaches the

snow-free pavement where it is sufficiently exposed to freeze. This type of man-made icing is the most common and troublesome type along pavements.

10-2.4.4 Snowplowing and snow storage greatly affect the location and extent of icing by changing insulation values and damming seepage waters.

10-2.4.5 Channel realignment and grading into wider, more shallow sections, commonly done in airfield and heliport construction, renders the stream more susceptible to high heat losses, extensive freezing, and formation of icing.

10-2.4.6 Drainage designers customarily size hydraulic structures to accommodate runoff from a specified design storm. In the arctic and subarctic, the size of hydraulic structures based solely on these well-founded hydrologic principles will usually result in inadequate capacity, which will contribute or intensify icing formation. Culverts, small bridges, storm drains, and inlets designed to accommodate peak design discharges are usually much too small to accommodate icing volumes before becoming completely blocked by ice. Once the drainage openings become blocked, icing upstream from the affected structures grows markedly. The inadequacy of drainage facilities, both in capacity and number, because of failure to accommodate icing, leads to more serious effects of icing on engineering works.

10-2.5 **Methods of Counteracting Icing.** Several techniques are available for avoiding, controlling, or preventing icing. Although sound in principle, the methods are often applied without adequate understanding of the icing problems, leading to unsuccessful or poor results. Selection of a particular method from the many that might be applied for the given set of conditions is based principally on economics. One must use a systems approach considering costs of installation plus costs of operation and maintenance, energy conservation, and environmental impact. Where feasible, methods requiring no fuel or electrical energy output or little or no service by maintenance personnel are preferred. The techniques for dealing with icings fall into two categories: *avoidance and control* and *prevention*.

10-2.5.1 **Methods of Icing Avoidance and Control.** These methods deal with the effects of the icing at the location being protected, so that the type of icing (river or stream, ground, or spring) is of little significance. There are several methods of icing avoidance and control:

10-2.5.1.1 **Change of Location.** Site facilities where icings do not occur. This is an economic consideration that is difficult to resolve in siting an airfield because of its extensive area, grading, and lateral clearance requirements.

10-2.5.1.2 **Raising the Grade.** This will deter or postpone icing formation but is costly and depends on the availability of ample fill. There is also the threat of embankment washouts resulting from ice-blocked facilities, and the possibility of objectionable seepage effects.



10-2.5.1.3 **More and Larger Drainage Structures.** Susceptibility to icing problems can be reduced by providing more and larger drainage facilities. Openings as much as 2 or 3 times as large as those required by conventional hydraulic design criteria will accommodate sizable icing volumes without encroaching on design flows. Culverts with large vertical dimensions, or small bridges in lieu of culverts, are advantageous. Provision for adequate drainage channels and conduits will facilitate diversion of meltwater runoff from icings, protecting the installation from washouts.

10-2.5.1.4 **Storage Space.** This can be provided as a ponding basin or by shifting a cut face further back from the airfield or heliport. There, an icing can grow in an area where it will not encroach on operational facilities.

10-2.5.1.5 **Dams, Dikes, or Barriers.** Known also as ice fences, these are used often to limit the horizontal extent of icings. Permanent barriers of earth, logs, or lumber may be built between the source of the icing and the area to be protected. Temporary barriers may be erected of snow embankments, movable wooden fencing, corrugated metal, burlap, plastic sheeting, or expedient lumber construction. In some situations, a second or even third fence is required above the first as the icing grows higher.

10-2.5.1.6 **Culvert Closures.** To prevent a culvert being filled with snow and ice, which requires a laborious spring clearing operation, closures are sometimes placed over the culvert ends in the fall. These closures can be of rocks that will permit minor flows prior to freeze-up.

10-2.5.1.7 **Staggered (or Stacked) Culverts.** This involves placement of two (or more) culverts, one at the usual location at the base of the fill, the other(s) higher in the fill. When the lower culvert becomes blocked by an icing accumulation, the higher ones carry initial spring runoff over the icing. As the spring thaw progresses, the lower one becomes cleared, eventually carrying the entire flow. In cases where there is limited height, the second culvert is placed to the side with its invert at a slightly higher elevation. The ponding area available for icing accumulations must be large enough to store an entire winter's ice without having the icing reach the upper culverts or the elevation of the area being protected.

10-2.5.1.8 **Heat.** Icing is commonly controlled by the application of heat in any of several ways, the objective being not to prevent icing but to establish and maintain thawed channels through it to minimize its growth and to pass spring runoff.

10-2.5.1.9 **Steam.** This method, common in North America, is used to thaw culvert openings and to thaw channels into icing for collecting icing feed water or early spring runoff. Steam, generated in truck-mounted boilers, is conducted through hoses to portable steam lances, or through hoses temporarily attached to permanently installed thaw pipes supported inside the tops of the culverts. Thaw pipes of 0.375- to 2-in. diameter have been used. The thaw pipe is terminated by a vertical riser at each end of the culvert, extending high enough to permit access above accumulated ice and snow. The pipe is filled with antifreeze, with the risers capped when not in use.

10-2.5.1.10 **Fuel Oil Heaters.** These heaters, known as firepots, are in common use. They consist of a 55-gallon oil drum equipped with an oil burner unit (railroads often use coal or charcoal as fuel). The drum, fed from a nearby fuel supply, is usually suspended from a tripod at the upstream end of the culvert. A continuous fire maintains a thaw pit in the icing. Fuel consumption varies, averaging about 30 gallons per day. Water, flowing over the icing, enters the pit where it receives heat, passes through the culvert, ideally without refreezing before it flows beyond the area to be protected. While firepots are simple devices, they are inefficient energy sources due to loss of most heat to the atmosphere rather than to the water or icing. Firepots are in decreasing favor due to their high maintenance requirements and the difficulty in preventing the theft of the fuel in remote locations.

10-2.5.1.11 **Electrical Heating.** Use of insulated heating cables to heat culverts is a recent adaptation successfully used where electrical power is available or, in important locations, where small generating stations are feasible. Heating cables have been used, not to prevent icing but to create and maintain a thawed tunnel-like opening in an icing to minimize its growth and to provide for spring runoff. Cable can be strung in the fall within the culvert and, in some cases, along its upstream drainageway, and removed in the spring. Cable can also be installed permanently in a small diameter metal pipe inside the culvert or buried at shallow depth under a drainage ditch or channel. Common heat output is 40 to 50 watts/lineal feet, with minimum heat lost to the atmosphere. A tunnel approximately 2 to 3 ft wide and 4 to 5 ft high is achieved by later winter. Electrical heating requires much less attention by maintenance personnel than steam thawing.

10-2.5.1.12 **Breaking and Removing Accumulated Ice.** This common technique, whether by manual or mechanical equipment, should be practiced only as an expedient or emergency measure. The timing of such operations, like that for the following two methods, critically limits their effectiveness.

10-2.5.1.13 **Blasting.** This has a twofold objective: the physical removal of ice and the fracturing of ice to provide paths for water flow deep in the icing. This flow can enlarge openings and still remain protected from the atmosphere and refreezing.

10-2.5.1.14 **Deicing Chemicals.** Chemicals such as sodium or calcium chloride are sometimes used to prevent refreezing of a drainage facility once it has been freed of ice by other means. A common practice is to place a burlap bag containing the salt at a culvert inlet, allowing the compound to be dissolved slowly by the flow, with the solution lowering the freezing point of the water. Objections are the detrimental effects on fish and wildlife, vegetation, and other downstream water uses and the corrosive effects on metal pipe.

10-2.5.2 **Methods of Icing Prevention.** These preventive techniques are best classified according to the general type of icing:

#### 10-2.5.2.1 River or Stream Icing

- **Channel Modification.** Straightening and deepening a channel can prevent icing, although frequent maintenance is usually required to counteract the stream's tendency to resume its natural configuration by erosion and deposition. Rock-fill gabions have been used to create a deep, narrow channel for low winter discharges. Such deepened channels permit formation of ice cover to normal thickness while providing adequate space beneath for flow. Deepening at riffles, rapids, or drop structures is especially important because icing is more likely to form in these shallow areas.
- **Insulation of Critical Sections.** River or stream icing may be prevented by insulating critical sections of the stream where high heat losses cause excessive thickening of the normal ice cover, constricting or completely blocking flow and resulting in icing formation. These sections may be located under a bridge or taxiway or at riffles or rapids. The insulation, which may be placed on the initial ice cover, may consist of soil, snow, brush, peat, sawdust, or other material, typically 1 to 2 feet thick. Another method is to cover the stream before ice forms, using logs, timber, or corrugated metal as a support for insulating material, later augmented by snowfall. Insulating covers, while beneficial in lessening heat losses from the stream, must be removed each spring before annual freshets. They may also be washed downstream to become obstructions if high water occurs prior to cover removal.
- **Frost Belts.** Known also as "permafrost belts," these are addressed further in paragraph 10-2.5.2.2, Ground Icing. A frost belt is essentially a ditch or cleared strip of land upstream or upslope from the icing problem area. If organic soil and vegetative cover are removed and the area is kept clear of snow during the first half of the winter, deep seasonal frost will act as a dam to water seeping through the ground, forcing it to the surface where it will form an icing upstream or upslope from the belt. In applying this technique to a drainage channel, a belt is formed by periodically cutting transversely into the ice to cause the bottom of the ice cover to lower and merge with the bed. In this way, the icing is induced to form away from the bridge or culvert entrance being protected.

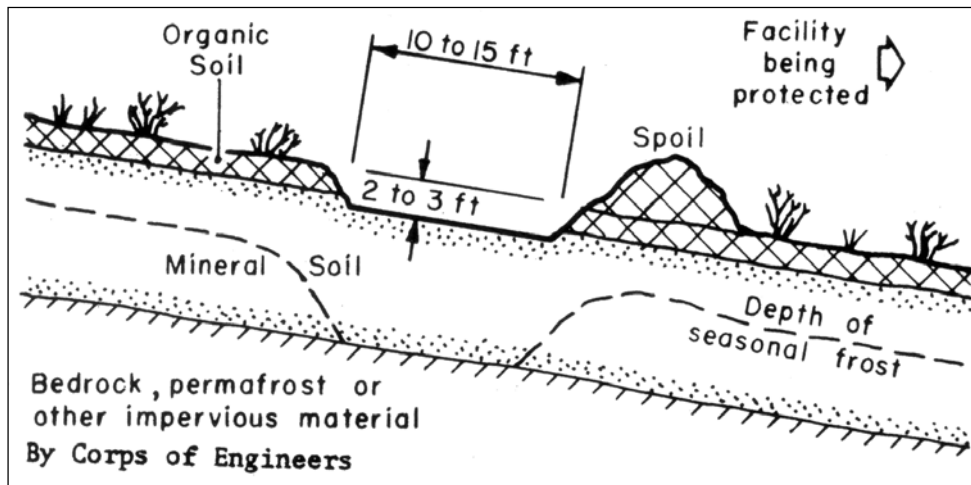
10-2.5.2.2 **Ground Icing.** The most successful methods of preventing ground icing involve drainage. Other procedures depend on preventing formation in one location by inducing formation elsewhere. There are several principal methods:

- **Surface Drainage.** This may be accomplished by a network of ditches located to drain the soil surface in the region of icing development. Ideally these ditches will be sited in compliance with airfield/heliport lateral safety clearance criteria and be narrow and deep enough to drain the soil to an appreciable depth and to expose only a small surface area to heat loss to the atmosphere. In some cases, these drainage ditches are covered and

insulated to maintain flow in winter. Open ditches can be as narrow as 1 ft or, if insulated, approximately 3 ft wide by 3 ft deep.

- **Insulation of the Ground.** In some cases, ground icings can be prevented by insulating the ground in areas where deep seasonal frost penetration forms a dam, blocking groundwater flow. Insulating material may be snow, soil, brush, or peat. This technique may merely shift the location where an impervious frost dam occurs. It is essential that the insulation of the ground extend under the pavement being protected to assure that groundwater flow is maintained past it. Otherwise, seasonal frost penetration under a snow-free airfield pavement would act as a frost dam and cause an icing to form upslope from the area. Suitable insulation materials for pavements are available and have been used effectively.
  
- **Permanent-type Frost Belts.** Successful use of frost belts requires careful siting, planning, and maintenance. Frost belts may be either permanent or seasonal. The permanent-type belt, as mentioned in paragraph 10-2.5.2.1 for control of river or stream icing, is a strip of land cleared of organic soil and vegetation, extending across a slope normal to the direction of seepage flow. Seasonal frost beneath this belt, merging with or approaching some impervious base, causes an icing to form upslope from the belt location. The belt must be long enough to prevent the icing from extending around the ends of the belt and approaching the airfield or other area being protected. Such a belt is usually approximately 2 to 3 ft deep and 10 to 15 ft wide. Spoil from the excavation is placed as a low ridge on the downslope side of the belt (Figure 10-1). The shape of the frost belt depends on the topography; often it is slightly convex downslope, or made of two straight segments meeting at an angle of 160 to 170 degrees on the upslope side of the belt. Sometimes more than one belt is necessary, with the belts arranged parallel to each other with their spacing depending on the channel slope. Permanent frost belts require attention to avoid degradation of the permafrost table underneath because the insulation of the ground has been reduced by removing the organic soil and vegetative cover. After a few years, the permafrost table may lower so much that the seasonal frost penetration in the winter will not reach it. In such a case, seepage flow in the soil is not stopped at the belt, and an icing does not develop at the belt but occurs instead downslope at the airfield or other facility intended to be protected. This can be avoided by covering the belt area in the spring with an insulating material and removing it in the fall before the onset of winter frosts. The belt must be kept clear of snow through the first half of the winter to permit rapid and deep seasonal frost penetration.

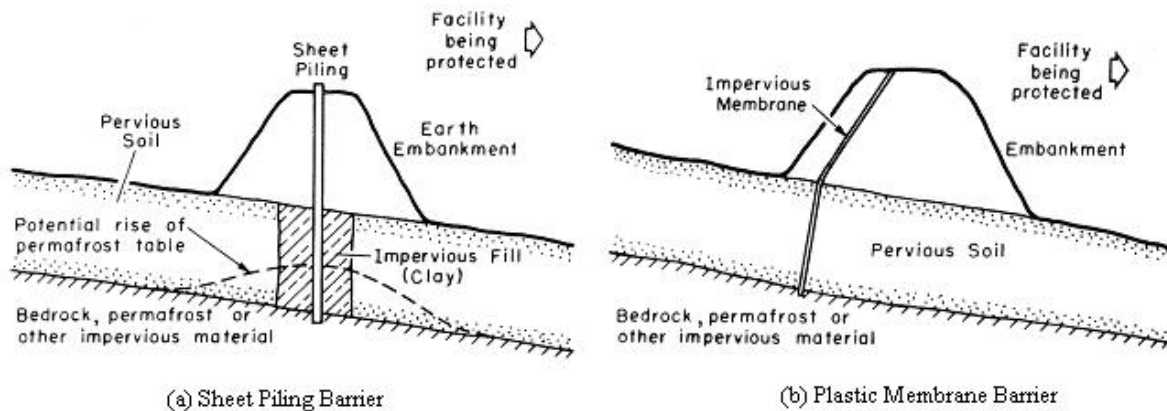
Figure 10-1. Typical Cross Section of a Frost Belt Installation



- **Seasonal-type Frost Belts.** Seasonal-type frost belts are free from most maintenance requirements associated with the permanent type and are much simpler and more economical to construct. Instead of preparing a ditch in the ground, one merely clears a strip of snow at the desired belt location and keeps it free of snow during the first half of the winter. The cleared snow is piled downslope of the belt, forming a ridge. The chief advantage of the seasonal belt is that it is less likely to degrade the underlying permafrost. This objective can be further assured by relocating the belt upslope or downslope in successive winters. A disadvantage of the seasonal belt is that seasonal frost penetrates below it more slowly because of the high specific heat of the wet organic soil and the insulation afforded by the vegetation left in place. It therefore takes longer for a frost dam to form and stop the flow of seepage water. This may permit formation of some icing at the downslope protected area early in the winter before the seasonal frost belt attains full effectiveness. Frost belts have not been widely accepted because of neglect in placement of summer insulation and priority attention to snow removal from pavements rather than from frost belt areas in the winter. Frost belts are much easier to maintain in locations where the impervious base that restricts groundwater flow is other than permafrost and thus is not subject to degradation.
- **Earth Embankments and Impervious Barriers.** Ground icing formation can also be prevented by use of earth embankments combined with impervious barriers to groundwater flow. These are placed well away from the area to be protected and function similarly to frost belts by damming seepage flow through the soil, causing it to rise to the ground surface where it freezes to form an icing. In southern permafrost zones where permafrost is close to freezing temperatures, embankments may cause the permafrost to melt, leading to subsidence. Methods of developing the impervious

barrier include trenching across the slope down to the impervious stratum, filling the trench with clay and then driving a row of sheet piling through it extending several feet above the surface to aid in ponding (Figure 10-2a). Other expedients include use of plastic membrane instead of piling (Figure 10-2b) or burial or horizontal air duct pipe (12 to 18 in.), usually located 4 to 6 ft below the bottom of the embankment. Vertical air shafts from the horizontal ducts permit cold winter air to permeate the system, removing heat from the ground and freezing the soil beneath the embankment to create an impervious barrier. The vertical air shafts are sealed in the summer to prevent excessive thawing in the soil. A problem that has arisen in some duct installations is that if they are not completely watertight, infiltrated water will freeze in the duct, causing an obstruction that is typically difficult to clear. Because this type installation would obstruct seepage flow year-round rather than just in winter, gated openings must be provided to allow accumulated water to flow downslope during the summer. The openings are closed all winter to ensure that the icing will form upslope from the embankment. An innovation is the use of a steel mesh grid with apertures 8 to 32 in<sup>2</sup>. These permit water passage when the air is warm, but gradually freeze until a blockage forms in subfreezing weather. Grids must be removed in the summer to avoid debris accumulation.

**Figure 10-2. Earth Embankments with Impervious Barriers**



By Corps of Engineers

10-3 **GUIDELINES FOR DESIGN OF STORM DRAINS IN THE ARCTIC AND SUBARCTIC.** Certain principles used in design are particularly applicable to drainage facilities in arctic and subarctic regions. The planner should be cognizant of several features related to drainage to assure a successful design:

10-3.1 Sites should be selected in areas where cuts, or the placement or base course fills, will not intercept or block existing natural drainageways or subsurface drainageways. Adequate provision should be made for the changed drainage conditions.

10-3.2 Areas with fine-grained, frost-susceptible soils should be avoided if possible. In arctic and subarctic regions, most soils are of single grain structure with only a very small percentage of clay. Since the cohesive forces between grain particles are very small, the material erodes easily. Fine-grained soil profiles may also contain large numbers of ice lenses and wedges when frozen.

10-3.3 If the upper surface of the permafrost layer is deep, design features of a drainage system can be similar to those used in frost regions of the continental United States if due provisions are made for lower temperatures.

10-3.4 The avoidance, control, and prevention of icing are addressed in section 10-2.

10-3.5 The flow of water in a drainage channel accelerates the thawing of frozen soil and bedrock. This may cause the surface of the permafrost to dip considerably beneath streams or channels that convey water, and may result in the thaw of ice such as that contained in rock fissures and cracks. The latter could develop subsurface drainage channels in bedrock. Bank sloughing and significant changes in channels become prominent. Sloughing is often manifested by wide cracks paralleling the ditches. For this reason, drainage ditches should be located as far as practicable from runway and road shoulders and critical structures.

10-3.6 In many subarctic regions, freezing drainage channels of drifted snow and ice become a significant problem before breakup each spring. In these areas, it is advantageous to have ditch shapes and slopes sufficiently wide and flat to accommodate heavy snow-moving equipment. In other locations where flow continues year-round, narrow, deep ditches are preferable to lessen the amount of exposed water surface and avoid icing.

10-3.7 Large cut sections should be avoided in planning the drainage layout. Thawed zones or water-bearing strata may be encountered and later cause serious icing. Vegetative cover in permafrost areas should be preserved to the maximum degree practicable; where disturbed, it should be restored as soon as construction permits.

10-3.8 Fine-grained soils immediately above a receding frost zone are very unstable; consequently, much sliding and caving is to be expected on unprotected ditch side slopes in such soils.

10-3.9 Locating ditches over areas where permafrost lies on a steep slope should be avoided if possible. Slides may occur because of thawing and consequent wetting of the soil at the interface between frozen and unfrozen ground.

10-3.10 Provisions should be made for removal and disposal or storage of snow and ice, with due consideration to control of snowmelt water. Drainage maintenance facilities should include heavy snow-removal equipment and electric cables with energy sources or a steam boiler with accessories for thawing structures that become clogged with ice.

Pipes or cables for this purpose are often fastened inside the upper portions of culverts prior to their placement.

10-3.11 Usually inlets to closed conduits should be sealed before freeze-up and opened prior to breakup each spring.

10-4 **GRADING.** Proper grading is a very important factor contributing to the success of any drainage system. The development of grading and drainage plans must be coordinated most carefully. In arctic and subarctic regions, the need for elimination of soft, soggy areas cannot be overemphasized.

10-5 **TEMPORARY STORAGE.** Trunk drains and laterals should have sufficient capacity to accommodate the project design runoff. Supplementary detention ponds upslope from drain inlets should not be considered in drainage designs for airfields or heliports in the arctic and subarctic. Plans and schedules should be formulated in sufficient detail to avoid flooding even during the time of actual construction.

10-6 **MATERIALS.** Selection of suitable types of drainage materials for specific projects will be based on design requirements—hydraulic, structural, and durability—and economics for the specific drainage installation. In the arctic and subarctic, the flexible, thin-walled pipe materials—corrugated metal (galvanized steel or clad aluminum alloy)—have been most widely used for drainage applications because of their availability, weight and transportability considerations, relative ease of installation, and dependability of jointing. Heavier rigid-type pipe, reinforced and nonreinforced concrete, particularly with recently developed, flexible, gasketed joints, and the newer types of plastic pipe are used under certain conditions in the subarctic.

10-7 **MAINTENANCE.** Access for maintenance equipment and personnel is necessary for major drainage channels, debris control barriers, and icing control installations. Structures should be inspected periodically, particularly before fall freeze-up and after annual spring thaw breakup periods.

10-8 **JOINTING.** Disjointing, leakage, or failure in pipe joints can occur, especially where drainage lines are subject to movement caused by backfill settlement, live loads (LL), or frost action. Flexible, watertight joint pipe is available for use in such situations. Most watertight joints rely on the use of close-tolerance pipe ends connected over a closely fitting gasket.

10-9 **END PROTECTION.** End structures, factory-made or constructed in the field, are attached to the ends of storm drains or culverts to provide structural stability, hold the fill, reduce erosion, and improve hydraulic characteristics. A drain projecting beyond the slope of an airfield or roadway embankment is a hazard and is subject to damage or failure caused by ice, drift, or the current. Drain ends can be mitered to fit embankment slopes or provided with prefabricated, flared end sections. Headwalls and wingwalls to contain pipe ends are often constructed, usually of concrete, to meet the several design requirements, including provision of weight to offset uplift or buoyancy and to inhibit piping. Headwalls or wingwalls should be oriented or skewed to fit the



drain line for maximum hydraulic efficiency and to lessen icing formation and drift or debris accumulation. The effect of pipeline entrance design on the hydraulic efficiency of drainage systems is examined in Chapter 4. A properly shaped culvert entrance can be an important factor in reducing ponding at an inlet that can wash out an airfield or roadway embankment.

10-10      **ANCHORAGE AND BUOYANCY.** Forces on a drain line inlet during high flows, especially during spring breakup, are variable and unpredictable. Currents and vortexes cause scour, which can undermine a drainage structure and erode or fail embankments. These conditions are accentuated in the arctic and subarctic by accumulated ice and debris. Corrugated metal pipe sections, because they are thin-walled and flexible, are particularly vulnerable to entrance distortion or failure. Ends can be protected by providing secure heavy anchorage. This could be a concrete or grouted rock endwall or slope pavement. Rigid-type pipe with its shorter sections is subject to disjuncting if undermined by scour unless provided with steel tiebars to prevent movement and separation. Buoyant forces must be determined for possible conditions such as blockage of a drainage line end by ice or debris, flow around the outside of a pipe, or, in coastal locations, tidal effects. These forces must be counteracted by adequately weighting the line, tying it down, or providing vents. Catastrophic drainage failures have resulted from failure to safeguard against such occurrences, even in temporary situations during construction.

10-11      **DEBRIS AND ICING CONTROL.** It is essential to control debris and icing to achieve desired hydraulic and structural performance and to avoid damages and operational interruption from flooding and uncontrolled icing. The debris problem can be solved by providing a structure large enough to pass the material or by retaining it at a convenient adequate storage and removal location upstream from the drainage structure.

10-12      **TIDAL AND FLOOD EFFECTS.** Airfields, with their requirements for large level areas, are often sited on coastal or alluvial floodplains where their drainage systems are subject to tidal and stream flood effects. In arctic and subarctic regions, ice jam and spring break-up dynamic forces and flood heights create major problems, including stream migration, which can adversely affect airfield embankments and protective levees, degrade permafrost, and shift or block drainage outlets. Stream meander control is difficult and costly, especially in the arctic. Flap gates may be required to prevent backflow into drainage systems, a situation particularly undesirable in tidal or brackish water locations due to corrosive action on drainage pipelines. These gates require a high level of maintenance to assure their operation despite ice, debris, sand, or silt accumulation.

10-13      **INSTALLATION.** Pipe construction in the arctic and subarctic, as in other regions, requires shaped bedding and systematic, layer-by-layer backfilling and compaction, and maintaining equal heights of fill along both sides of the pipe. Many culvert and storm drain failures during construction are caused by operating equipment too close to the pipe, failure to remove large projecting stones from backfill near the pipe, or inadequate caution in handling frozen backfill material.

## CHAPTER 11

### WATER QUALITY CONSIDERATIONS

11-1 **GENERAL.** The objective of this chapter is to provide an overview of water quality practices used in developed areas. The purpose of a best management practice (BMP) is to mitigate the adverse impacts of development activity. BMPs can be employed for storm water control benefits and/or pollutant removal capabilities. Several BMP options are available and should be considered carefully based on site-specific conditions and the overall management objectives of the watershed. Regulatory control for water quality practices is driven by National Pollution Discharge Elimination System (NPDES) requirements under such programs as the Clean Water Act. These requirements were addressed in Chapter 1 of this UFC. Water quality practices may not be required depending on local ordinances and regulations in specific project locations.

This chapter provides a brief introduction to the kinds of BMPs that have been used historically to provide water quality benefits. Tables 11-1 and 11-2 provide brief information on the selection criteria and the pollutant removal capabilities of the various BMP options. It is beyond the scope of this document to provide procedures for estimating pollutant loading or for the detailed design of the BMPs. Section 11-11 includes information and references for developing technologies referred to as "Ultra-Urban" technologies. For more information about the design of the BMPs, refer to HEC-22.

#### 11-2 **GENERAL BMP SELECTION GUIDANCE**

11-2.1 Several factors are involved in determining the suitability of a particular BMP. They include physical conditions at the site, the watershed area served, and storm water and water quality objectives. Table 11-1 presents a matrix that shows site selection criteria for BMPs. A dot indicates that a BMP is feasible. The site selection restrictions for each BMP are also indicated. Be aware that the "Area Served" criteria presented in Table 11-1, and at other locations throughout this chapter, should not be taken as a strict limitation. They are suggested rules of thumb based primarily on pollutant removal effectiveness and cost effectiveness of typical facilities as reported in the literature. In terms of water quality benefit, Table 11-2 provides a comparative analysis of pollutant removal for various BMP designs. Generally, BMPs provide high pollutant removal for non-soluble particulate pollutants, such as suspended sediment and trace metals. Much lower rates are achieved for soluble pollutants such as phosphorus and nitrogen.

11-2.2 An important parameter in BMP design is the runoff volume treated. This volume is often referred to as the first-flush volume or the water quality volume (WQV). This initial flush of runoff is known to carry the most significant non-point pollutant loads. Definitions for this first flush or WQV vary. The most common definitions are (a) the first 0.5 in. of runoff per acre of impervious area, (b) the first 0.5 in. of runoff per acre of catchment area, and (c) the first 1.0 in. of runoff per acre of catchment area.

Table 11-1. BMP Selection Criteria\*

Best Management Practices (BMPs)	Area Served (ha)					Soil Type and Minimum Infiltration Rate (mm/hr)							Other Restrictions					
	0-2	2-4	4-12	12-20	20+	Loamy Sand	Sandy Loam	Sandy Loam	Silt Loam	Sandy Clay	Silty Clay	Silty Clay	Sandy Clay	Silty Clay	Ground-water Table (m)	Slope (%)	Prox. to Wells (m)	Normal Depth Range (m)
						210	61	26	13	7	4	2	1	1				
Biofiltration	•	•						•	•	•	•	•			0.3 - 0.6	<4		
Infiltration Trench	•	•				•	•	•	•						0.6 - 1.2	<20	> 30	0.6 - 1.8
Infiltration Basin		•	•	•		•	•	•	•						0.6 - 1.2	<20	> 30	0.6 - 1.8
Grassed Swales (with Check Dams)	•	•	•			•	•	•	•	•					0.3 - 0.6	< 5		0.15 - 0.6
Filter Strips	•					•	•	•	•	•					0.3 - 0.6	<20		
Water Quality Inlet	•					•	•	•	•	•	•	•	•	•				
Detention Ponds			•	•	•	•	•	•	•	•	•	•	•					
Retention Ponds			•	•	•		•	•	•	•	•	•	•					
Extended Detention/Retention Ponds			•	•	•	•	•	•	•	•	•	•						
Detention/Retention With Wetland Bottoms			•	•	•	•	•	•	•	•	•							

\* Source: HEC-22

Table 11-2. Pollutant Removal Comparison for Various Urban BMP Designs\*

BMP/design		Pollutant removal efficiency (%)						Overall Removal Capability
		Suspended Sediment	Total Phosphorus	Total Nitrogen	Oxygen Demand	Trace Metals	Bacteria	
Extended detention pond	Design 1	60 - 80	20 - 40	20 - 40	20 - 40	40 - 60	Unknown	Moderate
	Design 2	80 - 100	40 - 60	20 - 40	40 - 60	60 - 80	Unknown	Moderate
	Design 3	80 - 100	60 - 80	40 - 60	40 - 60	60 - 80	Unknown	High
Wet pond	Design 4	60 - 80	40 - 60	20 - 40	20 - 40	20 - 40	Unknown	Moderate
	Design 5	60 - 80	40 - 60	20 - 40	20 - 40	60 - 80	Unknown	Moderate
	Design 6	80 - 100	60 - 80	40 - 60	40 - 60	60 - 80	Unknown	High
Infiltration trench	Design 7	60 - 80	40 - 60	40 - 60	60 - 80	60 - 80	60 - 80	Moderate
	Design 8	80 - 100	40 - 60	40 - 60	60 - 80	80 - 100	60 - 80	High
	Design 9	80 - 100	60 - 80	60 - 80	80 - 100	80 - 100	80 - 100	High
Infiltration basin	Design 7	60 - 80	40 - 60	40 - 60	60 - 80	40 - 60	60 - 80	Moderate
	Design 8	80 - 100	40 - 60	40 - 60	60 - 80	80 - 100	60 - 80	High
	Design 9	80 - 100	60 - 80	60 - 80	80 - 100	80 - 100	80 - 100	High
Porous pavement	Design 7	40 - 60	60 - 80	40 - 60	60 - 80	40 - 60	60 - 80	Moderate
	Design 8	80 - 100	60 - 80	60 - 80	60 - 80	80 - 100	80 - 100	High
	Design 9	80 - 100	60 - 80	60 - 80	80 - 100	80 - 100	80 - 100	High
Water quality inlet	Design 10	0 - 20	Unknown	Unknown	Unknown	Unknown	Unknown	Low
Filter strip	Design 11	20 - 40	0 - 20	0 - 20	0 - 20	20 - 40	Unknown	Low
	Design 12	80 - 100	40 - 60	40 - 60	40 - 60	80 - 100	Unknown	Moderate
Grassed swale	Design 13	0 - 20	0 - 20	0 - 20	0 - 20	0 - 20	Unknown	Low
	Design 14	20 - 40	20 - 40	20 - 40	20 - 40	0 - 20	Unknown	Low

**Design 1:** First-flush runoff volume detained for 6-12 h. **Design 2:** Runoff volume produced by 25 mm (1.0 in), detained 24 h. **Design 3:** As in Design 2, but with shallow marsh in bottom stage. **Design 4:** Permanent pool equal to 13 mm (0.5 in) storage per impervious hectare (acre). **Design 5:** Permanent pool equal to 2.5 (Vr); where Vr = mean storm runoff. **Design 6:** Permanent pool equal to 4.0 (Vr); approx. 2 weeks retention. **Design 7:** Facility exfiltrates first-flush; 13 mm (0.5 in) runoff/imper. hectare (acre). **Design 8:** Facility exfiltrates 25-mm (1-in) runoff volume per imper. hectare (acre). **Design 9:** Facility exfiltrates all runoff, up to the 2-yr design storm. **Design 10:** 11 m<sup>3</sup>(400 ft<sup>3</sup>) wet storage per imper. hectare (acre). **Design 11:** 6-m (20-ft) wide turf strip. **Design 12:** 30-m (100-ft) wide forested strip, with level spreader. **Design 13:** High-slope swales with no check dams. **Design 14:** Low-gradient swales with check dams.

\* Source: HEC-22

In general terms, the greater the volume treated, the better the pollutant removal efficiency; however, treating volumes in excess of 1.0 in. per acre of catchment area results in only minor improvements in pollutant removal efficiency.

### 11-3 ESTIMATING POLLUTANT LOADS

11-3.1 To predict the impact of development activities in a watershed, pollutant loadings can be estimated for both pre- and post-development scenarios. Several methods and models are currently available that employ algorithms for pollutant loading estimation. The Simple Method is an aptly named empirical method that is intended for use on sites of less than 1 mi<sup>2</sup>. It assumes that an average pollutant concentration is multiplied by the average runoff to yield an average loading estimate.

11-3.2 The FHWA has developed a computer model that deals with the characterization of storm water runoff pollutant loads from highways. Impacts to receiving water, specifically lakes and streams, are predicted from the estimated loadings. More detail on the estimating procedures can be found in the 4-volume FHWA report, *Pollutant Loadings and Impacts from Highway Stormwater Runoff*.

11-3.3 Several other comprehensive storm water management models have the ability to generate pollutant loads and the fate and transport of the pollutants:

- Storm Water Management Model (SWMM)
- Storage, Treatment, Overflow, Runoff Model (STORM)
- Hydrologic Simulation Program, Fortran (HSPF)
- Virginia Storm Model (VAST)

11-4 **EXTENDED DETENTION DRY PONDS.** Extended detention dry ponds are depressed basins that temporarily store a portion of storm water runoff following a storm event. Water is typically stored for up to 48 hours following a storm by means of a hydraulic control structure to restrict outlet discharge. The extended detention of the storm water provides an opportunity for urban pollutants carried by the flow to settle out.

11-5 **WET PONDS.** A wet pond, or retention pond, serves the dual purpose of controlling the volume of storm water runoff and treating the runoff for pollutant removal. Wet ponds are designed to store a permanent pool during dry weather. These ponds are an attractive BMP alternative because the permanent pool can have aesthetic value and can be used for recreational purposes and as an emergency water supply. Pollutant removal in wet ponds is accomplished through gravity settling, biological stabilization of solubles, and infiltration.

11-6 **INFILTRATION/EXFILTRATION TRENCHES.** Infiltration trenches are shallow excavations that have been backfilled with a coarse stone media. An infiltration trench forms an underground reservoir that collects runoff and either exfiltrates it to the subsoil or diverts it to an outflow facility. The trenches primarily serve as a BMP that provides moderate to high removal of fine particulates and soluble pollutants, but also

are employed to reduce peak flows to pre-development levels. Use of an infiltration trench is feasible only when soils are permeable and the seasonal groundwater table is below the bottom of the trench.

11-7        **INFILTRATION BASINS.** An infiltration basin is an excavated area that impounds storm water flow and gradually exfiltrates it through the basin floor. Infiltration basins are similar in appearance and construction to conventional dry ponds; however, the detained runoff is exfiltrated through permeable soils beneath the basin, removing both fine and soluble pollutants. Infiltration basins can be designed as combined exfiltration/detention facilities or as simple infiltration basins.

11-8        **SAND FILTERS.** Sand filters provide storm water treatment for first flush runoff. The runoff is filtered through a sand bed before being returned to a stream or channel. Sand filters are generally used in urban areas and are particularly useful for groundwater protection where infiltration into soils is not feasible.

11-9        **WATER QUALITY INLETS.** Water quality inlets are pre-cast storm drain inlets that remove sediment, oil and grease, and large particulates from parking lot runoff before it reaches storm drainage systems or infiltration BMPs. As three-stage underground retention systems designed to settle out grit and absorbed hydrocarbons, they are commonly known as oil and grit separators. Water quality inlets typically serve highway storm drainage facilities adjacent to commercial sites where large amounts of vehicle wastes are generated, such as gas stations, vehicle repair facilities, and loading areas. These inlets may be used to pretreat runoff before it enters an underground filter system.

11-10       **VEGETATIVE PRACTICES.** Several types of vegetative BMPs can be applied to convey and filter runoff:

- Grassed swales
- Filter strips
- Wetlands

Vegetative practices are non-structural BMPs and are significantly less costly than structural controls. They are commonly used in conjunction with structural BMPs, particularly as a means of pre-treating runoff before it is transferred to a location for retention, detention, storage, or discharge.

#### 11-11        **ULTRA-URBAN BMPs**

11-11.1     The relative merits of traditional storm water control measures in the context of existing developed communities have become an important issue. The EPA Phase II storm water regulations (National Pollutant Discharge Elimination System Stormwater Program), the safety of public water supplies, and the threat to endangered aquatic species have intensified interest in identifying innovative approaches for protecting source and receiving water quality. Also, additional drivers for innovation are the implementation of Section 6217g of the Coastal Zone Act Reauthorization Amendments (CZARA), state coastal nonpoint source management programs, and the desire of many

local watershed committees to improve and restore degraded streams as part of their watershed restoration priorities submitted to EPA by states as requested by the Clean Water Action Plan. Comprehensive storm water regulations, space limitations, hardened infrastructure, high urban land values, limitations of traditional BMPs, and the increase in urban runoff pollutant loads over the last decade have spurred the development of a new class of products and technologies. These non-traditional methods of capturing runoff contaminants before they reach surface and groundwater have been labeled in many circles as "ultra-urban" technologies.

11-11.2 Ultra-urban storm water technologies have an appeal that historical methods of storm water management do not have in developed areas. They are particularly suited to retrofit applications in the normal course of urban renewal, community revitalization, and redevelopment, as well as new urban development. These engineered devices are typically structural and are made on a production line in a factory. They may be designed to handle a range of pollutant and water quality conditions in highly urbanized areas. Some ultra-urban storm water controls have small footprints and may be literally dropped into the urban infrastructure or integrated into the streetscape of both private and public sector property. Others may be installed beneath parking lots and garages or on rooftops. Still others are designed to remove pollutants before they are flushed into urban runoff collection systems.

11-11.3 The Civil Engineering Research Foundation's (CERF) Environmental Technology Evaluation Center (EvTEC) has developed a Web site focusing on new and innovative storm water control technologies: <http://www.cerf.org>

These are two of EvTEC's ongoing evaluations:

- Stormwater Best Management Practices (BMPs) Verification Program: <http://www.cerf.org/evtec/eval/wsdot2.htm>
- Low-Cost Stormwater BMP Study

11-12 **TEMPORARY EROSION AND SEDIMENT CONTROL PRACTICES.** Most states have erosion and sedimentation (E&S) control regulations for land disturbance activities. The purpose of E&S measures is to reduce erosive runoff velocity and to filter the sediment created by the land disturbance. Temporary E&S controls are applied during the construction process and consist of structural and/or vegetative practices. The control measures are usually removed after final site stabilization unless they prove to be necessary for permanent stabilization. A few of these practices are listed here (for more information on these practices, see HEC-22):

- |                               |                         |
|-------------------------------|-------------------------|
| ▪ Mulching                    | ▪ Silt fence            |
| ▪ Temporary/permanent seeding | ▪ Brush barrier         |
| ▪ Sediment basins             | ▪ Diversion dike        |
| ▪ Check dams                  | ▪ Temporary slope drain |

## CHAPTER 12

### DESIGN COMPUTER PROGRAMS

12-1 **STORM WATER MANAGEMENT PROGRAMS.** In developed areas, planners, designers, and operators of storm water drainage systems are often required to determine quantities of storm water runoff and evaluate its quality as an important component in the overall condition of an area or watershed. Two computer models designed principally for urban areas are available. These are STORM, developed by the Hydrologic Engineering Center of the U.S. Army Corps of Engineers, and SWMM, developed for the EPA.

12-2 **DRIP (DRAINAGE REQUIREMENT IN PAVEMENTS).** DRIP is a Windows® computer program developed by the FHWA for pavement subsurface drainage design.

12-3 **CANDE-89 (CULVERT ANALYSIS AND DESIGN).** CANDE-89 is a software program used for the structural analysis and design of buried culverts and other soil-structure systems. A variety of buried structures are considered, including corrugated steel and aluminum pipes, long span metal structures, reinforced concrete pipe, concrete box culverts, and structural plastic pipes. The CANDE methodology incorporates the soil mass with the structure into an incremental static, plane-strain boundary value problem. The program is available from the Center for Microcomputers in Transportation (*McTrans*) Web site:

<http://www-mctrans.ce.ufl.edu>

12-4 **MODBERG.** ModBerg calculates the maximum depth of frost penetration for a given location. This program is available from the PCASE Downloads Page of the Tri-Service Transportation Technology Transfer Website Portal:

<https://transportation.wes.army.mil/triservice/pcase/downloads.aspx>

12-5 **DDSOFT (DRAINAGE DESIGN SOFTWARE).** Based on the Rational Formula and Manning's equation, DDSOFT determines the size and bed slope of a drainage channel or storm sewer. The program works with channels of 4 different shapes (i.e., vertical curb, triangular, rectangular, and trapezoidal) and 1 sewer shape (i.e., circular). The program is available from this Web site:

<http://www.ntu.edu.sg/home/cswong/software.htm>

12-6 **NDSOFT (NORMAL DEPTH SOFTWARE).** Based on Manning's equation, NDSOFT determines the normal depth in a drainage channel. It works with channels of 5 different shapes (i.e., vertical curb, triangular, rectangular, trapezoidal, and circular). Further, the program can also determine the size of a circular sewer based on the normal depth under the full-flow condition. The program is available from this Web site:



<http://www.ntu.edu.sg/home/cswong/software.htm>

12-7      **PIPECAR.** PIPECAR is a program for structural analysis and design of circular and horizontal reinforced concrete pipe. Load analysis includes pipe weight, soil weight, internal fluid load, LL, and internal pressures up to 50 ft of head. The program is available for download from the Hydraulics Engineering page of the Federal Highway Administration Web site:

<http://www.fhwa.dot.gov/engineering/hydraulics/software/softwaredetail.cfm>

12-8      **VISUAL URBAN (HY-22) URBAN DRAINAGE DESIGN PROGRAMS.** These programs perform tasks in highway pavements drainage, open channel flow characteristics, critical depth calculations, development of stage-storage relationships, and reservoir routing. The software is available for download from the Hydraulics Engineering page of the Federal Highway Administration Web site:

<http://www.fhwa.dot.gov/engineering/hydraulics/software/softwaredetail.cfm>

12-9      **ADDITIONAL SOFTWARE.** Several software packages are available that provide quick and precise analysis of urban hydrology and hydraulics. The software programs reviewed in this chapter are public sector programs that incorporate many of the procedures discussed in this UFC. These modeling packages are reviewed:

- HYDRAIN
- HYDRA
- WSPRO
- HYDRO
- HY8
- HYCHL
- NFF
- HYEQT
- TR-55
- TR-20
- HMS
- HEC-RAS
- SWMM
- PSRM-QUAL
- Hydraulic Toolbox (HY-TB)
- HY22 Urban Drainage Design Programs
- DR3M

Table 12-1 presents a software versus capabilities matrix for these software packages. Some of the models have a single capability, such as hydrologic analysis, while other packages offer a variety of analysis and design options.

Table 12-1. Software vs. Capabilities Matrix

	Storm Drains	Hydrology	Water Surface Profiles	Culverts	Roadside/ Median Channels	Water Quality	Pavement Drainage	Pond Routing	BMP Evaluation	Metric Version
HYDRAIN	•	•	•	•	•		•	•		•
TR-55		•								
TR-20		•						•		
HMS		•						•		•
SWMM	•	•				•	•	•	•	•
PSRM-QUAL	•	•				•	•	•	*	
DR3M	•	•					•	•		
HY-TB	•				•		•			
Urban Drainage	•				•		•	•		•
Evaluation of Water Quality						•			•	

\*To be added in a future update.

Many private and public domain software products are available for the analysis and design of various components of storm drain systems. These products range from simple computational tools for specific components of the storm drain system to complex programs that can analyze complete storm drain systems using interactive graphical interfaces. The computer hardware and software industry is a rapidly changing industry in which new and more advanced applications software is developed each year. This chapter is limited to a review of public sector software. For public sector software, user support is minimal or nonexistent if the software is obtained directly from the Government. Private vendors sell many of these packages and may offer user support.

12-9.1 **HYDRAIN.** HYDRAIN is an integrated computer software system consisting of hydraulic and hydrologic analysis programs. The system manages engineering computations and data associated with these subprograms:

- HYDRA - Storm Drain and Sanitary Sewer Design and Analysis
- WSPRO - Open Channel Water Surface Analysis, Bridge Hydraulics, Scour
- HYDRO - Design Event versus Return Period Hydrology
- HYCLV - Culvert Design and Analysis
- HY8 - FHWA Culvert Analysis and Design
- HYCHL - Flexible and Rigid Channel Lining Design and Analysis
- HYEQT - Equation Program
- NFF - USGS National Flood Frequency Program

12-9.1.1 HYDRAIN is a versatile hydrologic and hydraulic software package. The subprograms within the system offer a variety of analysis and design option tools. The HYDRAIN programs are embedded within a system shell that allows for quick and easy access to each module. File operations, access to program editors, and other Disk Operating System (DOS) utilities can be performed through the input shell.

12-9.1.2 Data entry for most programs within the system is done through the command line editor. The editor is equipped with short and long helps to aid the user. The user supplies the input data for the subprogram within one input file. If the subprogram is run from within the HYDRAIN environment, the input file may be modified without leaving HYDRAIN by using the built-in editor. This feature minimizes the time required for data modification and job resubmission.

12-9.1.3 HY8 and HYCHL are interactive programs. In other words, these programs access a series of menus that ask the user for specific input.

12-9.1.4 HYDRAIN can handle almost all aspects of storm drain design in a highway context. It is applicable to analysis of simple hydrologic situations and design or analysis of simple and complex hydraulic systems. HYDRAIN is easy to use, providing a full screen input editor and extensive help messages.

12-9.2 **HYDRA.** HYDRA (HighwaY Storm DRainage) is a storm drain and sanitary sewer analysis and design program. Originally developed in 1975, the program ran on mainframe computer systems. HYDRA provides hydraulic engineers a means of accurately, easily, and quickly designing and analyzing storm, sanitary, or combined collection systems. Of HYDRA's many features, these are particularly useful:

12-9.2.1 **Operational Modes.** HYDRA operates in two modes: design and analysis. In the analysis mode, HYDRA analyzes a drainage system given user-supplied specifications. In the design mode, HYDRA can "free design" its own drainage system based on design criteria supplied by the user.

12-9.2.2 **System Types.** In either the design or the analysis mode, HYDRA can work with 3 possible types of systems: (1) storm drain systems, (2) sanitary (sewer) systems, and (3) combined (storm and sanitary) sewer systems.

12-9.2.3 **Hydraulic Analysis Features.** Two options are available to HYDRA users: the calculation of the HGL through a system and the simulation of a system under pressurized (surcharged) flow conditions.

12-9.2.4 **Storm Flow Simulation Methods.** HYDRA is capable of simulating storm flow based on either the Rational Method for peak flow simulation or user-supplied hydrographic simulation.

12-9.2.5 **Detention Basin Routing.** HYDRA will design or analyze a detention pond by routing a hydrograph with the storage-indication method.

12-9.2.6 **Planning.** HYDRA can be used for determining the most practical alternatives for unloading an existing overloaded storm drain and for formulating master plans to allow for the orderly growth of these systems.

12-9.2.7 **Drainage Systems Size.** HYDRA has a data handling algorithm especially designed to accept a drainage system of any realistically conceivable design, including complicated branching systems.

12-9.2.8 **Infiltration/Inflow Analysis.** HYDRA can account for undesirable inputs, such as infiltration in sanitary sewer systems.

12-9.2.9 **Cost Estimation.** HYDRA's cost estimation capabilities include consideration of de-watering, traffic control, sheeting, shrinkage of backfill, costs of borrow, bedding costs, surface restoration, rock excavation, pipe zone costs, and more. HYDRA is also sufficiently flexible to allow cost criteria to be varied for any segment of pipe in a system. Ground profiles, either upstream or downstream from any specified point along the system, can also be accepted for consideration in cost estimation.

12-9.3 **WSPRO.** WSPRO (Water Surface PROfile) is a water surface profile computation program originally developed by the USGS for the FHWA. Water surface profile computations are made with the standard step method in the absence of bridges. The majority of water surface profile computations are now performed by HEC-RAS, which is described in paragraph 12-10.12.

12-9.4 **HYDRO.** HYDRO is a hydrologic analysis program based on the FHWA's HDS-2. It combines existing approaches for rainfall runoff analysis into one system. HYDRO generates point estimates or a single design event. It is not a continuous simulation model. HYDRO uses the probabilistic distribution of natural events such as rainfall or stream flow as a controlling variable. HYDRO can be considered a computer-based subset of HDS-2.

12-9.4.1 HYDRO capabilities are divided into three major hydrological categories: rainfall analysis, IDF curve generation, and flow analysis. HYDRO's rainfall analysis features allow the user to investigate steady-state (rainfall intensity) and dynamic (hyetograph) rainfall conditions. Both the rainfall analysis and IDF curve generation are a function of frequency, geographic location, and duration of the storm event.

- **Rainfall Analysis.** HYDRO can internally calculate rainfall intensities for any site in the continental United States. This rainfall is a single peak rainfall. HYDRO can also be used to create a triangular hyetograph.
- **IDF Curves.** IDF curves can be created using the internal intensity databases. The curves will show, for a user-provided frequency, the duration versus intensity for any location in the continental United States. The frequency can be any whole number between 2 and 100 yr and the duration can extend from 5 min to 24 hr of rainfall duration.

- **Peak Flow Methods.** HYDRO implements three peak flow methods: the Rational Method; user-supplied regression equations; and the Log-Pearson Type III method. Each of these methods produces a single peak flow value or steady state of low-flow value.
- **Hydrograph Method.** HYDRO can combine the peak flow with the dimensionless hydrograph to handle hydrographic or dynamic flow conditions. HYDRO includes two dimensionless hydrograph methods: the USGS nationwide urban method and the semi-arid method.

12-9.5     **HY8.** HY8 is an interactive BASIC program that allows the user to investigate the hydraulic performance of a culvert system. A culvert system is composed of the actual hydraulic structure or structures as well as hydrological inputs, storage and routing considerations, and energy dissipation devices and strategies.

12-9.5.1   HY8 automates the methods presented in HDS-5, HEC-14, HDS-2, and information published by pipe manufacturers pertaining to the culvert sizes and materials.

12-9.5.2   HY8 is composed of four different program modules: Culvert Analysis and Design, Hydrograph Generation, Hydrograph Routing, and Energy Dissipation.

- **Culvert Analysis and Design.** Culvert hydraulics can be determined for circular, rectangular, elliptical, arch, and user-defined geometry. HY8 can analyze as many as six parallel culvert systems simultaneously, each having different inlets, inlet elevations, outlets, outlet elevations, lengths, materials, and cross-sectional shape characteristics.
- **Hydrograph Generation/Routing.** Storm hydrographs can be generated to be used singly or as input into culvert routing analyses. The generated hydrograph, along with the culvert data, can be used by HY8 to calculate storage and outflow hydrograph characteristics. The routing is performed by application of the storage indication (modified Puls) method.
- **Energy Dissipation.** HY8 can also design and analyze energy dissipation structures at the outlet of a culvert. Options include external dissipators, internal dissipators, and estimating scour hole geometry.

12-9.6     **HYCHL.** HYCHL is a channel lining analysis and design program. The basis for program algorithms are the FHWA's HEC-15 and HEC-11. The program performs several options and analyses:

12-9.6.1   **Stability Analysis.** HYCHL can analyze drainage channels for stability given design flow and channel conditions (i.e., slope, shape, and lining type).

12-9.6.2   **Maximum Discharge.** The maximum discharge a particular channel lining can convey can be calculated based on the permissible shear stress of the lining.

12-9.6.3 **Multiple Lining Types.** Depending on channel function, material availability, costs, aesthetics, and desired service life, a designer may choose from a variety of lining types, whether single or composite. HYCHL can perform analysis on rigid or flexible linings. Rigid linings in HYCHL include concrete, grouted riprap, stone masonry, soil cement, and asphalt. Flexible linings include a variety of temporary and permanent lining types. Permanent flexible linings include vegetation, riprap, and gabions. Riprap-lined channels can be designed or analyzed as irregular or regular channel shapes. Temporary linings include woven paper, jute mesh, fiberglass roving, straw with net, curled wood mat, synthetic mat, and bare soil (unlined).

12-9.6.4 **Alternative Channel Shapes.** Channel cross sections available in HYCHL include trapezoidal, parabolic, triangular, triangular with rounded bottom, and irregular (user-defined) shapes.

12-9.6.5 **Constant on Variable Channel Inflow.** HYCHL can evaluate the performance of channel linings using a design flow that is assumed to be either a constant for the entire channel length or a variable inflow. The variable lineal flow results in an increasing discharge with channel length.

12-9.7 **NFF.** The USGS, in cooperation with the FHWA and the Federal Emergency Management Agency, has compiled all the current statewide and metropolitan-wide regression equations into a microcomputer program, the National Flood Frequency (NFF) program. NFF summarizes techniques for estimating flood-peak discharges and associated flood hydrographs for a given recurrence interval or exceedence probability for unregulated rural and urban watersheds. NFF includes both the regression equations for rural watersheds in each state and the nationwide regression equations for urban watersheds, and it generates rural and urban frequency functions and hydrographs.

12-9.8 **HYEQT.** The HYDRAIN equation program (HYEQT) is an application program that allows a user to input and solve regression equations for solving peak flow (or any other formula of interest). This program can be used instead of the NFF program to allow for modification of the USGS regression equations. These equations provide estimates that engineers and hydrologists can use for planning and design applications.

12-9.9 **TR-55.** TR-55 is a hydrology program that implements SCS methods for calculating time of concentration, peak flows, hydrographs, and detention basin storage volumes. It is applicable to urban drainage situations where detailed hydrograph routing procedures are not warranted. The program, now compatible with Windows™ operating systems, incorporates the procedures outlined in Technical Release 55 (TR-55). TR-55 contains simplified procedures to calculate storm runoff volume, peak rate of discharge, hydrographs, and storage volumes required for storm water reservoirs. The procedures are applicable in small urbanizing watersheds in the United States.

TR-55 is extremely easy to use, with interactive menus that prompt the user for specific inputs. Several screens of input are normally required before an analysis

can proceed. Help screens assist the user in successfully performing an analysis. These are some of the options and analyses included in TR-55:

12-9.9.1 **Estimating Runoff.** TR-55 employs the SCS Runoff Curve Number Method or the Graphical Peak Discharge Method to estimate peak discharges in a rural or urban watershed.

12-9.9.2 **Time of Concentration and Travel Time.** TR-55 computes travel time for sheet flow, shallow concentrated flow, and open-channel flow. Travel time for sheet flow is estimated using Manning's kinematic solution. Travel time in open channels is evaluated by applying Manning's equation.

12-9.9.3 **Tabular Hydrograph Method.** The Tabular Hydrograph method can develop partial composite flood hydrographs at any point in a watershed by dividing the watershed into homogeneous subareas.

12-9.9.4 **Storage Volume for Detention Basins.** TR-55 can also estimate detention basin storage volume.

12-9.10 **TR-20.** TR-20, based on SCS Technical Release 20, is a comprehensive hydrology program that implements SCS methods for generating and routing runoff hydrographs in a multibasin watershed. The program provides for hydrographic analyses of a watershed under present conditions and various combinations of land cover/use and structural or channel modifications using single rainfall events. Output consists of runoff peaks and/or flood hydrographs, their time of occurrence, and water surface elevations at any desired cross section or structure. Subarea surface runoff hydrographs are developed from storm rainfall using an SCS dimensionless unit hydrograph (UH), drainage areas, times of concentration, and SCS runoff curve numbers. Hydrographs can be developed, routed, added, stored, diverted, or divided to convey floodwater from the headwaters to the watershed outlet. TR-20 is applicable only to larger watersheds where detailed hydrograph routing is warranted. These are some of the options and analyses employed by TR-20:

12-9.10.1 **Runoff Volume.** A mass curve of runoff is developed for each subwatershed. The runoff curve number (CN), rainfall volume, and rainfall distribution are the input variables needed to determine the mass curve. CNs are determined by the user for each subwatershed based on soil, land use, and hydrologic condition information. The runoff volume is computed using the SCS runoff equation. The program can develop and route the runoff from as many as nine different rainfall distributions and ten different storms for each rainfall distribution. Runoff depths and durations will be developed and routed for a rainfall distribution defined in either dimensionless units or actual time units.

12-9.10.2 **Hydrograph Development.** An incremental UH is developed for each subwatershed. The UH time increment is calculated as a function of the time of concentration. The incremental runoff volume is determined for each time increment. The composite flood hydrograph is computed by summing the incremental hydrograph

ordinates. A maximum of 300 ordinates (discharge values) can be stored for any composite flood hydrograph. The peak flow value of the composite flood hydrograph is computed by a separate routine that utilizes the Gregory-Newton forward difference formula for fitting a second degree polynomial through the 3 largest consecutive hydrograph values saved at the main time increment. In multiple peaked hydrographs, up to ten peaks may be computed.

12-9.10.3 **Reservoir Routing.** The composite flood hydrograph is routed through a reservoir using the storage indication method. The program can route a hydrograph through up to 99 structures and an unlimited number of variations for each structure.

12-9.10.4 **Reach Routing.** The composite flood hydrograph is routed through a valley reach using a modified Attenuation-Kinematic (Att-Kin) method. TR-20 can route through up to 200 stream reaches and an unlimited number of channel modifications for each reach.

12-9.11 **HMS.** HMS is a flood hydrograph package developed by the U.S. Army Corps of Engineers. The HMS model, like TR-20, is designed to simulate the surface runoff response of a river basin to precipitation by representing the basin as an interconnected system of hydrologic and hydraulic components. Each component models an aspect of the precipitation-runoff process within a portion of the basin. A component may represent a surface runoff entity, a stream channel, or a reservoir. Representation of a component requires a set of parameters that specify the particular characteristics of the component and mathematical relations that describe the physical processes. The result of the modeling process is the computation of streamflow hydrographs at desired locations in the river basin. It is applicable to only larger watersheds where detailed hydrograph routing is warranted.

Simulating a river basin as a group of subareas interconnected through channel routing reaches and confluences, HMS performs hydrologic calculations on a user-specified time step for a single storm (soil moisture recovery during dry spells is not included). HMS is used to generate discharge, not water surface elevations (although it does calculate normal depth). The HEC-RAS model is typically used in conjunction with HMS to determine water surface profiles through detailed hydraulic computations. These are the major components and characteristics of HMS:

12-9.11.1 **Precipitation.** A precipitation hyetograph is used as input for all runoff calculations. Precipitation data for an observed event can be user-supplied or synthetic storms can be used. Snowfall and snowmelt can also be considered.

12-9.11.2 **Hydrographs.** There are three synthetic UH methods in the HMS model, including the Clark UH, the Snyder UH, and the SCS dimensionless UH. User-defined UHs can be entered directly.

12-9.11.3 **Flood Routing.** Flood routing can be computed by a variety of methods, including Muskingum, Muskingum-Cunge, kinematic wave, modified Puls, working R and D, and level-pool reservoir routing.



12-9.11.4 **Flood Damage/Flood Control System Optimization.** The reservoir component of the HMS model is employed in a stream network model to simulate dam failure. HMS also has a flood control system optimization option which is used to determine optimal sizes for the flood loss mitigation measures in a river basin flood control plan.

HMS was first developed in 1968 and has undergone several revisions over the years. New capabilities of the most recent version include database management interfaces and a graphics program that allows plots of information stored in the HMS database. In addition, a user-friendly input program is available to help first-time users of HMS. The program helps the user to assemble the correct sequence of records for an HMS input file.

12-9.12 **HEC-RAS.** HEC-RAS is an integrated system of software designed for interactive use in a multi-tasking environment. The system is comprised of a graphical user interface (GUI), separate hydraulic analysis components, data storage and management capabilities, and graphics and reporting facilities.

The HEC-RAS system contains three one-dimensional hydraulic analysis components for: (1) steady flow water surface profile computations; (2) unsteady flow simulation; and (3) movable boundary sediment transport computations. A key element is that all three components will use a common geometric data representation and common geometric and hydraulic computation routines. In addition to the three hydraulic analysis components, the system contains several hydraulic design features that can be invoked once the basic water surface profiles are computed. HEC-RAS can also perform water temperature analyses in river systems.

These are HEC-RAS' current capabilities:

- **Geometric Features:** bridge hydraulics – extensive; culverts (nine types); multiple open (bridges & culverts); inline structures – gates and weirs; lateral structures – gates, weirs, culverts, and rating curves; pressurized conduits; storage/ponding areas; hydraulic connections between storage areas; pump stations; floating ice; levees; extensive data import and export; and GIS connections.
- **Analysis Features:** steady flow profiles; unsteady flow simulations; FEMA floodway encroachments; split flow optimization; sediment transport capacity and bridge scour; dam and levee breaching; navigation dam operations; channel modifications; mixed flow regime; and extensive calibration features.
- **Graphical Output Capabilities:** water surface profile plots; cross sections; rating curves; stage and flow hydrographs; generalized profile plot of any variable (i.e., velocity); a three dimensional view of the river system; graphical animations; and plotting of more than 250 output variables at every cross section per profile.

- Tabular Output: detailed output tables for XS and all structures; summary output tables; and user defined output.
- Documentation: extensive manuals (user's manual, hydraulic reference manual, and applications guide); online help system; and example data sets

12-9.13 **SWMM.** The Storm Water Management Model (SWMM), developed by the EPA, is a comprehensive mathematical model for simulation of urban runoff quantity and quality in storm and combined sewer systems. The model simulates all aspects of the urban hydrologic and quality cycles, including surface runoff, transport through the drainage network, storage and treatment, and receiving water effects.

12-9.13.1 SWMM simulates real storm events on the basis of rainfall (hyetograph) and other meteorological inputs and system (catchment, conveyance, storage/treatment) characterization to predict outcomes in the form of quantity and quality values. The model is structured to perform runoff computations, transport and rate functions, and water quality and cost computations.

12-9.13.2 SWMM is made up of many different components or "blocks" that perform various functions. Those blocks are: Runoff, Transport, Storage/Treatment, EXTRAN, and five other "service" blocks related to data preparation.

- Runoff Block. The runoff portion of SWMM can simulate both the quantity and quality of runoff from a drainage basin and the routing of flows and contaminants to the major sewer lines. Drainage basins are represented by an aggregate of idealized subcatchments and gutters or pipes. The program accepts an arbitrary rainfall or snowfall hyetograph and makes a step-by-step accounting of snow melt, infiltration losses, impervious areas, surface detention, overland flow, channel flow, and the constituents washed into inlets, leading to the calculation of inlet hydrographs and pollutographs.
- Transport Block. Routing is performed by SWMM in the transport "block" portion of the program. Both quantity and quality parameters are routed through a sewer system. Quantity routing follows a kinematic wave approach. Up to four contaminants can be routed. Storage routing is accomplished by the modified Puls method.
- Storage/Treatment Block. The storage/treatment block simulates the routing of flows and pollutants through a dry or wet weather storage/treatment plant containing up to five units or processes. Each unit may be modeled as having detention or non-detention characteristics, and may be linked in a variety of configurations. Sludge handling may also be modeled using one or more units.
- EXTRAN Block. EXTRAN is a hydraulic flow routing model for open channel and/or closed conduit systems. The EXTRAN block receives hydrograph input at specific nodal locations by interface file transfer from an upstream block (e.g., the Runoff Block) and/or by direct user input. The model

performs dynamic routing of storm water flows throughout the major storm drainage system to the points of outfall to the receiving water system. The program will simulate branched or looped networks, backwater due to tidal or nontidal conditions, free-surface flow, pressure flow or surcharge, flow reversals, flow transfer by weirs, orifices and pumping facilities, and storage at on- or off-line facilities. Types of channels that can be simulated include circular, rectangular, trapezoidal, parabolic, natural channels, and others. Simulation output takes the form of water-surface elevations and discharge at selected system locations.

12-9.13.3 SWMM is a very complicated model with many features. Initial model setup is difficult due to extensive data requirements. Data assembly and preparation can require multiple man-months for a large catchment or urban area. The model is frequently updated, with new releases on a biannual basis (approximately). Updated user's manuals and test cases are documented in published EPA reports.

12-9.13.4 SWMM can handle almost all aspects of hydrology, runoff water quality, and hydraulics of an urban drainage system. It is applicable to only the largest and most complex storm drain systems where extremely detailed hydrology or water quality analysis is required. SWMM is very difficult to use and requires extensive input data.

12-10 **HYDRAULIC TOOLBOX (HY-TB).** Hydraulic Toolbox is a collection of four hydraulics programs written in BASIC. They are HY12, HY15, BASIN, and SCOUR. Hydraulic Toolbox evaluates gutter and inlet hydraulics, flexible channel lining design, riprap stilling basin design, and culvert outlet scour. It is applicable to analysis of any these drainage components on an individual basis but is not a tool for modeling hydraulic systems.

12-10.1 **HY12.** HY12 uses the design procedures of HEC-12. The program analyzes the flow in gutters and the interception capacity of grate inlets, curb-opening inlets, slotted drain inlets, and combination inlets on continuous grades and in sags. Both uniform and composite cross-slopes can be analyzed.

12-10.2 **HY15.** The HY15 program applies the methodologies in HEC-15. HY15 analyzes the hydraulic performance of flexible and concrete channel linings for trapezoidal or triangular channels in straight reaches. The design procedures are based on the concept of maximum permissible tractive force, where channel lining stability is determined by comparing the hydraulic forces exerted on the lining with the maximum permissible shear stress a particular lining can sustain.

12-10.3 **BASIN.** BASIN is a riprap design program that analyzes the adequacy of riprap-lined basins at the outlet of culverts.

12-10.4 **SCOUR.** The SCOUR program provides estimates of the scour at the outlet of culverts in terms of depth, width, length, and volume.

The programs in this package are simple and easy to use. Input screens prompt the user for all necessary information to perform an analysis, but there is no on-

line user help. Although no supporting documentation exists, related references to the methodologies should provide an adequate theoretical basis for proper application.

12-11      **URBAN DRAINAGE DESIGN PROGRAMS.** The Urban Drainage Design software is a collection of three hydraulic programs written in BASIC. It includes: (1) Manning's equation for various channel shapes, (2) HEC-22 (Storm Drain Design), and (3) Stormwater Management. Urban Drainage Design software evaluates normal depth flow conditions, gutter and inlet hydraulics, and storm water management pond hydrograph routing. Like the Hydraulic Toolbox, this software is applicable to the analysis of individual drainage components, not to modeling hydraulic systems.

12-11.1    **Manning's Equation.** The Manning's equation program computes flow through circular, trapezoidal, and triangular channel shapes. Open-channel flow is solved by application of the Manning's equation. Critical depths are also computed by this program.

12-11.2    **HEC-22.** This is a pavement drainage program which applies the principles of HEC-22. The program allows for analysis of gutter flow, grates, curb openings, combination inlets, inlets in a sump, and median and side ditches. Both uniform and composite cross slopes can be analyzed.

12-11.3    **Stormwater Management.** This program provides options for computing stage-storage curves for circular pipes, trapezoidal basins, irregular basins, and rectangular basins. There is also an option for reservoir routing using the Storage Indication method. Reservoir routing is one of the main applications of this software.

The programs in this package are basic, straightforward hydraulics computation algorithms that are quick and easy to apply. The programs are menu-driven, prompting the user for all necessary data. Although no supporting documentation exists, related references to the methodologies should provide an adequate theoretical basis for proper application.

12-12      **DR3M.** The Distributed Routing Rainfall-Runoff Model (DR3M), developed by the USGS, is a watershed model for routing storm runoff through a branched system of pipes and/or natural channels. The model provides detailed simulation of storm runoff periods and a daily soil-moisture accounting between storms. Drainage basins are represented as sets of overland-flow, channel, and reservoir segments that together describe the drainage features of the basin. The kinematic wave theory is used for routing flows over contributing overland-flow areas and through channel networks. A set of model segments can be arranged into a network that will represent many complex drainage basins. The model is intended primarily for application to urban watersheds.

12-12.1    **Rainfall-Excess Components.** The rainfall-excess components of the model are more complex than the runoff methods discussed in this UFC, and include soil-moisture accounting, pervious area rainfall excess, impervious area rainfall excess, and parameter optimization. The soil-moisture accounting component determines the effect of antecedent conditions on infiltration. Soil moisture is modeled as a dual storage

system, one representing the antecedent base-moisture storage, and the other representing the upper-zone storage caused by infiltration into a saturated moisture storage. Pervious-area rainfall excess is determined as a function of the point potential infiltration. In the model, point potential infiltration is computed using the Green-Ampt equation.

12-12.2 **Impervious Surfaces.** Two types of impervious surfaces are considered by the model. The first type, effective impervious surfaces, are those impervious areas that are directly connected to the channel drainage system. Roofs that drain into driveways, streets, and paved parking lots that drain onto streets are examples of effective impervious surfaces. The second type, noneffective impervious surfaces, are those impervious areas that drain to pervious areas. An example of this type would be a roof that drains onto a lawn.

12-12.3 **Routing.** DR3M has the capability to perform routing calculations through application of the kinematic wave theory. The model approximates the complex topography and geometry of a watershed as a set of segments that jointly describe the drainage features of a basin. There are four types of segments: overland-flow segments, channel segments, reservoir segments, and nodal segments.

12-12.4 **Model Versatility.** DR3M can be used for a wide variety of applications. A set of model segments can be arranged easily into a network that will represent simple or complex drainage basins. The model can be applied to drainage basins ranging from tens of hectares to several square kilometers but not to exceed 25 km<sup>2</sup>.

12-12.5 **Urban Basin Planning.** DR3M can be used for urban basin planning purposes by its determination of the hydrologic effects of different development configurations. Examples of this type of application include assessing the effects of increased impervious cover, detention ponds, or culverts on runoff volumes and peak flows.

12-12.6 **Usability.** DR3M is a comprehensive drainage system simulation tool. It is applicable to analysis of both simple and complex hydraulic systems. DR3M has menu driven input screens and help messages available to the user through ANNIE (Interactive Hydrologic Analyses and Data Management, a USGS water resources applications program), but the model is complex and requires extensive input data. DR3M, like SWMM, should be considered only for the most complex hydrologic and hydraulic systems.

## 12-13 **EVALUATION OF WATER QUALITY**

12-13.1 The Synoptic Rainfall Data Analysis Program (SYNOP) water quality program is the computer implementation of FHWA/RD-88-006-9. This software characterizes runoff water quality and estimates impacts to streams and lakes. The user defines the site characteristics and the pollutant target concentrations. The model then determines the expected runoff concentration given a user-defined exceedence probability (50th percentile is the site median concentration that is the default setting).

The default concentrations included in the model are based on extensive monitoring data: 993 storm events at 31 highway sites in 11 states. After determining the expected runoff concentration, the model performs impact analysis for the stream (dilution modeling) or lake (Vollenweider model of phosphorus concentration only). If the computed concentration exceeds the target, the user can evaluate load reductions with these controls: grass channel, overland flow, wet ponds, and infiltration.

12-13.2 This software is simple and easy to use. Input screens prompt the user for all necessary information. Documentation for the software is adequate, while documentation for the underlying procedures is extensive (see the FHWA reports).

12-13.3 The FHWA highway pollutant loading model estimates the highway runoff load for a number of different pollutants, evaluates the impacts of pollutant load on a receiving stream or lake, and can estimate the water quality improvements with various BMPs. The model is based on a number of simplifying assumptions, but is generally applicable to water quality evaluation for all but the most environmentally sensitive highway projects.

12-14 **SOFTWARE AVAILABILITY.** Table 12-2 lists where some of the models summarized in this chapter may be obtained.

**Table 12-2. Software Program Contact Information**

Software Model	Contact Information
HYDRAIN	<p>McTrans University of Florida PO Box 116585 Gainesville, Florida 32611-6585 (800) 226-1013 <a href="http://www-mctrans.ce.ufl.edu/">http://www-mctrans.ce.ufl.edu/</a></p>
TR-55	<p>Natural Resources Conservation Service National Water and Climate Center 1201 Lloyd Blvd., Suite 802 Portland, Oregon 97232-1274 (503) 414-3031 <a href="http://www.wcc.nrcs.usda.gov/hydro/">http://www.wcc.nrcs.usda.gov/hydro/</a></p>
TR-20	<p>Natural Resources Conservation Service National Water and Climate Center 1201 Lloyd Blvd., Suite 802 Portland, Oregon 97232-1274 (503) 414-3031 <a href="http://www.wcc.nrcs.usda.gov/hydro/">http://www.wcc.nrcs.usda.gov/hydro/</a></p>

Software Model	Contact Information
HMS	U.S. Army Corps of Engineers Hydrologic Engineering Center 609 Second Street Davis, California 95616 (530) 756-1104 <a href="http://www.hec.usace.army.mil/">http://www.hec.usace.army.mil/</a>
HEC-RAS	U.S. Army Corps of Engineers Hydrologic Engineering Center 609 Second Street Davis, California 95616 (530) 756-1104 <a href="http://www.hec.usace.army.mil/">http://www.hec.usace.army.mil/</a>
SWMM	National Technical Information Service U.S. Department of Commerce 5285 Port Royal Road Springfield, Virginia 22161 (800) 553-6847 <a href="http://www.ntis.gov/index.asp">http://www.ntis.gov/index.asp</a> Or U.S. Environmental Protection Agency Urban Watershed Management Branch 2890 Woodbridge Ave. MS104 Edison, New Jersey 08837 (732) 321-6635 <a href="http://www.epa.gov/ednrmrl/models/swmm/index.htm">http://www.epa.gov/ednrmrl/models/swmm/index.htm</a>
Hydraulic Toolbox	McTrans University of Florida PO Box 116585 Gainesville, Florida 32611-6585 (800) 226-1013 <a href="http://www-mctrans.ce.ufl.edu/">http://www-mctrans.ce.ufl.edu/</a>
Urban Drainage Design	McTrans University of Florida PO Box 116585 Gainesville, Florida 32611-6585 (800) 226-1013 <a href="http://www-mctrans.ce.ufl.edu/">http://www-mctrans.ce.ufl.edu/</a>

Software Model	Contact Information
DR3M	United States Department of the Interior U.S. Geological Survey Hydrologic Analysis Software Support Program 437 National Center Reston, Virginia 20192 <a href="http://water.usgs.gov/software/dr3m.html">http://water.usgs.gov/software/dr3m.html</a>



## GLOSSARY

### Abbreviations and Acronyms

**AASHTO**—American Association of State Highway and Transportation Officials  
**AC**—Advisory Circular  
**AFI**—Air Force instruction  
**AFPAM**—Air Force pamphlet  
**AFPD**—Air Force policy directive  
**AFR**—Air Force regulation  
**AIMM to SCORE**—Assess, Implement, Manage, and Measure to Achieve Sustained Compliance and Operational Readiness through Environmental Excellence  
**AR**—Army Regulation  
**AREMA**—American Railway Engineering and Maintenance of Way Association  
**ASTM**—American Society for Testing and Materials  
**ATT-Kin**—attenuation-kinematic  
**AT&A**—air traffic and airspace  
**AT&L**—Acquisition, Technology, and Logistics  
**BDF**—basin development factor  
**BMP**—best management practice  
**CANDE-89**—Culvert Analysis and Design software  
**CCR**—Criteria Change Request  
**CERF**—Civil Engineering Research Foundation  
**CERL**—Construction Engineering Research Laboratory  
**CFR**—Code of Federal Regulations  
**CNO/CMC**—Chief of Naval Operations/Command Master Chief  
**CORPS**—Con conversationally-Oriented Real-Time Programming System  
**CZARA**—Coastal Zone Act Reauthorization Amendments  
**Dia.**—diameter  
**DDSOFT**—Drainage Design Software  
**DEH**—Director of Engineering and Housing  
**DL**—dead load  
**DM**—Design Manual  
**DOD**—Department of Defense  
**DOS**—disk operating system  
**DRIP**—Drainage Requirement In Pavements  
**DR3M**—Distributed Routing Rainfall-Runoff Model  
**EGL**—energy grade line  
**EHGL**—equivalent hydraulic grade line  
**EIA**—Environmental Impact Assessment  
**EIS**—Environmental Impact Statement  
**EPA**—Environmental Protection Agency  
**EQI**—Environmental Quality Initiative  
**ETL**—Engineering Technical Letter  
**EvTEC**—Environmental Technology Evaluation Center

**EXTRAN**—Extended Transport Module  
**E&S**—erosion and sedimentation  
**F**—Fahrenheit  
**FAA**—Federal Aviation Administration  
**FONSI**—finding of no significant impact  
**ft**—feet  
**ft/ft**—feet per foot  
**ft/s**—feet per second  
**ft/s<sup>2</sup>**—feet per cubic second  
**ft<sup>2</sup>**—square feet  
**ft<sup>3</sup>/min**—cubic feet per minute  
**ft<sup>3</sup>/s**—cubic feet per second  
**ft<sup>3</sup>/s/mi<sup>2</sup>/in**—cubic feet per second per square miles per in  
**FHWA**—Federal Highway Administration  
**FWPCA**—Federal Water Pollution Control Act  
**gal**—gallons  
**gal/day**—gallons per day  
**GUI**—graphical user interface  
**H**—head  
**HDPE**—high density polyethylene  
**HDS**—Hydraulic Design Series  
**HEC**—Hydrologic Engineering Circular  
**HEC-RAS**—Hydrologic Engineering Center River Analysis System  
**HGL**—hydraulic grade line  
**HMS**—Hydrologic Modeling System  
**HQ AFCESA**—Headquarters Air Force Civil Engineer Support Agency  
**HQ USACE**—Headquarters U.S. Army Corps of Engineers  
**hr**—hour  
**HSPF**—Hydrological Simulation Program – Fortran  
**HW**—headwater  
**HW/D**—headwater depth  
**HYCHL**—flexible and rigid channel lining design and analysis software  
**HYCLV**—culvert design and analysis software  
**HYDRA**—storm drain and sanitary sewer design and analysis software  
**HYDRAIN**—integrated drainage design software  
**HYDRO**—design event versus return period hydrologic analysis software  
**HYEQT**—flow equation program  
**HY-TB**—Hydraulic Toolbox  
**HY8**—FHWA culvert analysis and design software  
**ICAO**—International Civil Aviation Organization  
**IDF**—Intensity Duration Frequency  
**IFR**—instrument flight rules  
**in**—inches  
**in<sup>2</sup>**—square inches  
**in/ft**—inch per foot

**in/hr**—inches per hour  
**IP**—inch-pound  
**lb/ft<sup>2</sup>**—pounds per square foot  
**lb/in<sup>2</sup>**—pounds per square inch  
**LL**—live load  
**LSP**—length of stone protection  
**m**—meter  
**MACOM**—major command (Army)  
**MAJCOM**—major command  
**McTrans**—Center for Microcomputers in Transportation  
**mi<sup>2</sup>**—square miles  
**MIL-STD**—Military Standard  
**min**—minutes  
**mm**—millimeter  
**mm/hr**—millimeters per hour  
**MODBERG**—frost penetration calculation program  
**m<sup>3</sup>/s**—cubic miles per second  
**NATO**—North Atlantic Treaty Organization  
**NAVAID**—navigational aid  
**NAVAIR**—Naval Air Systems Command  
**NAVFAC**—Naval Facilities Engineering Command  
**NAVFACENGCOM**—Naval Facilities Engineering Command  
**NDSOFT**—Normal Depth Software  
**NEPA**—National Environmental Policy Act  
**NFF**—National Flood Frequency  
**NOAA**—National Oceanic and Atmospheric Administration  
**NPDES**—National Pollutant Discharge Elimination System  
**NRCS**—National Resources Conservation Service  
**O.C.**—on center  
**OH**—Organic clays of medium to high plasticity, organic silts  
**OL**—Organic silts and organic silty clays of low plasticity  
**OLS**—optical lighting system  
**OSHA**—Occupational Safety and Health Administration  
**PAPI**—precision approach path indicator  
**PCASE**—Pavement-Transportation Computer Assisted Structural Engineering  
**PIPECAR**—Pipe Culvert Analysis and Reinforcing Design  
**PL**—Public Law  
**PSI**—pounds per square inch  
**PVC**—polyvinyl chloride  
**R**—radius  
**SAF**—Saint Anthony Falls  
**SCS**—Soil Conservation Service  
**SI**—International System of Units  
**sq mi**—square miles  
**STORM**—Storage, Treatment, Overflow Runoff Model

**SWMM**—Storm Water Management Model  
**SYNOP**—Synoptic Rainfall Data Analysis Program  
**TM**—Technical Manual  
**TOC**—top of conduit  
**TR**—Technical Release  
**TS**—Technical Standard  
**TSMCX**—USACE Transportation Systems Center  
**TW**—tailwater  
**UFC**—Unified Facilities Criteria  
**UH**—unit hydrograph  
**U.S.**—United States  
**USAASA**—U.S. Army Aeronautical Services Agency  
**USAAVNC**—U.S. Army Aviation Center  
**USASC**—U.S. Army Safety Center  
**USATCA**—U.S. Army Training Center, Armor  
**USBR**—United States Bureau of Reclamation  
**USC**—United States Code  
**USD**—Under Secretary of Defense  
**USDOT**—United States Department of Transportation  
**USGS**—United States Geological Survey  
**v.**—versus  
**VASI**—visual approach slope indicator  
**VAST**—Virginia Storm Model  
**VFR**—visual flight rules  
**vs.**—versus  
**WQV**—water quality volume  
**WSPRO**—water surface profile (open channel water surface analysis) software  
**yr**—year

## APPENDIX A

### REFERENCES

#### GOVERNMENT PUBLICATIONS:

1. U.S. Department of Agriculture

Natural Resources Conservation  
Service (formerly Soil Conservation  
Service)  
P.O. Box 2890  
Washington, DC 20013  
Internet site: <http://www.nrcs.usda.gov/>

TR-20, Project Formulation Hydrology

TR-55, Urban Hydrology for Small  
Watersheds

2. U.S. Department of Commerce

DOC/NOAA/National Weather Service  
Office of Hydrologic Development,  
Hydrometeorological Design Studies  
Center, W/OHD13  
1325 East-West Highway  
Silver Spring, MD 20910-3283  
Internet site:  
<http://www.nws.noaa.gov/oh/hdsc/>

Technical Paper 40, Rainfall Frequency  
Atlas of the United States for Durations  
from 30 minutes to 24 Hours and Return  
Periods from 1 to 100 Years (1961)

3. U.S. Department of Defense

Department of the Air Force  
Air Force e-Publishing  
Internet site:  
<http://www.e-publishing.af.mil/>

AFI 32-7061, The Environmental Impact  
Analysis Process

AFPAM 91-212, Bird/Wildlife Aircraft Strike  
Hazard (BASH) Management Techniques

AFPD 32-70, Environmental Quality

Department of the Army  
Corps of Engineers (USACE)  
Engineering and Construction Division  
Directorate of Military Programs  
Washington, DC 20314-1000

AR 200-1, Environmental Protection and Enhancement

ETL 1110-3-466, Selection and Design of Oil/Water Separators at Army Facilities

Technical Report E-59, Handbook for Environmental Impact Analysis

Department of the Navy  
Standardization Documents Order Desk  
700 Robbins Avenue, Bldg. 4D  
Philadelphia, PA 19111-5094

NAVFACINST 11010.44E, Shore Facilities Planning Manual

NAVFAC P-272, Definitive Designs for Naval Shore Facilities

Unified Facilities Criteria  
Internet site:  
[http://65.204.17.188/report/doc\\_ufc.html](http://65.204.17.188/report/doc_ufc.html)

UFC 3-220-03FA, Design: Soils and Geology Procedures for Foundation Design of Buildings and Other Structures (Except Hydraulic Structures)

UFC 3-230-16FA, Design: Drainage and Erosion Control Structures for Airfields and Heliports

UFC 3-250-01FA, Design: Pavement Design for Roads, Streets, Walks and Open Storage Areas

UFC 3-260-01, Design: Airfield and Heliport Planning and Design

#### 4. U.S. Department of the Interior

United States Geological Survey  
Publications Warehouse  
Internet site:  
<http://infotrek.er.usgs.gov/pubs/>

Report No. 2207, Flood Characteristics of Urban Watersheds in the United States

Water-Resources Investigations Report 94-4002, Nationwide Summary of U.S. Geological Survey Regional Regression Equations for Estimating Magnitude and Frequency of Floods for Ungaged Sites, 1993

5. U.S. Department of Transportation

Federal Aviation Administration  
800 Independence Avenue, SW  
Washington, DC 20591  
Internet site: <http://www.faa.gov/>

Order 5050.4, Airport Environmental Handbook

Order 5300.1F, Modifications to Agency Airport Design, Construction, and Equipment Standards

AC 150/5200-33, Hazardous Wildlife Attractants on or near Airports

AC 150/5300-13, Airport Design

AC 150/5320-6D, Airport Pavement Design and Evaluation

Federal Highway Administration  
400 Seventh Street, SW  
Washington, DC 20590  
Internet site: <http://www.fhwa.dot.gov/>

FHWA/RD-88-006-9, Pollutant Loadings and Impacts from Highway Stormwater Runoff, Vol. I – Vol. IV

HDS-1, Hydraulics of Bridge Waterways

HDS-3, Design Charts for Open-Channel Flow

HDS-4, Introduction to Highway Hydraulics

HDS-5, Hydraulic Design of Highway Culverts

HEC-14, Hydraulic Design of Energy Dissipators for Culverts and Channels

HEC-15, Design of Roadside Channels with Flexible Linings

HEC-22, Urban Drainage Design Manual

TS-80-218, Underground Disposal of Storm Water Runoff, Design Guidelines Manual

6. Public Laws, United States Code, and Code of Federal Regulations  
U.S. Government Printing Office  
732 N. Capitol Street, NW  
Washington, DC 20401  
Internet site: <http://www.gpoaccess.gov/>

Coastal Zone Act Reauthorization Amendments of 1990, Section 6217g, PL 101-508, 16 USC § 1455b, November 5, 1990

Coastal Zone Management Act of 1972, PL 92-583, amended by PL 94-310, 16 USC § 1451-1464, October 27, 1972

Environmental Impact Analysis Process (EIAP), 32 CFR 989

Federal Water Pollution Control Act (Clean Water Act), 33 USC § 1251-1387, October 18, 1972, as amended

Fish and Wildlife Act of 1956, 16 USC § 742a-742j, August 8, 1956

Fish and Wildlife Coordination Act, 16 USC § 661-666c, January 3, 1995

Migratory Game-Fish Act, 16 USC § 760c-760g, January 19, 2004

National Environmental Policy Act of 1969, (NEPA), Public Law 91-190, 42 USC § 4321-4347, January 1, 1970

Safe Water Drinking Act of 1974, as amended, PL 93-523, 42 USC § 300f-300j-26, December 16, 1974

Section 301 of the Federal Water Pollution Control Act Amendments of 1972, PL 92-500, 33 USC § 1344, October 18, 1972

Section 401 of the Federal Water Pollution Control Act Amendments of 1972, PL 92-500, 33 USC § 1344, October 18, 1972

Section 402 of the Federal Water Pollution Control Act Amendments of 1972, PL 92-500, 33 USC § 1344, October 18, 1972



Section 404 of the Federal Water Pollution Control Act Amendments of 1972, PL 92-500, 33 USC § 1344, October 18, 1972

Water Quality Act of 1987, PL 100-4, 33 USC § 1251-1387, February 4, 1987

7. U.S. Environmental Protection Agency  
Ariel Rios Building  
1200 Pennsylvania Avenue, N.W.  
Washington, DC 20460  
Internet site: <http://www.epa.gov/>

Federal Guide for Green Construction Specs, draft

#### NON-GOVERNMENT PUBLICATIONS:

1. AASHTO  
444 North Capitol Street N.W.  
Suite 249  
Washington, DC 20001  
Internet site: <http://www.aashto.org/>

Highway Drainage Guidelines, Volume V

Model Drainage Manual, Chapter 2

Policy on Geometric Design of Highways and Streets

T99, Moisture-Density Relations of Soils Using a 2.5 kg (5.5 lb) Rammer and a 305 mm (12 in.) Drop

2. AREMA  
8201 Corporate Drive, Suite 1125  
Landover, MD 20785  
Internet site: <http://www.arena.org/>

Manual for Railway Engineering

3. ASTM International  
100 Barr Harbor Drive  
PO Box C700  
West Conshohocken, PA, 19428-2959  
Internet site: <http://www.astm.org/>

A760/A760M-01a, Standard Specification for Corrugated Steel Pipe, Metallic-Coated for Sewers and Drains

A761/A761M-04, Standard Specification for Corrugated Steel Structural Plate, Zinc-Coated, for Field-Bolted Pipe, Pipe-Arches, and Arches

A762/A762M-00, Standard Specification for Corrugated Steel Pipe, Polymer Precoated for Sewers and Drains

A849-00, Standard Specification for Post-Applied Coatings, Pavings, and Linings for Corrugated Steel Sewer and Drainage Pipe

B745/B745M, Standard Specification for Corrugated Aluminum Pipe for Sewers and Drains

D1557-02e1, Standard Test Methods for Laboratory Compaction Characteristics of Soil Using Modified Effort

D2321-04e1, Standard Practice for Underground Installation of Thermoplastic Pipe for Sewers and Other Gravity-Flow Applications

D2487-00, Standard Classification of Soils for Engineering Purposes (Unified Soil Classification System)

HB-17, Standard Specifications for Highway Bridges

APPENDIX B

LIST OF CHARTS

Chart	Description .....	Page
1A, 1B	Flow in triangular gutter sections .....	335, 336
2A, 2B	Ratio of frontal flow to total gutter flow .....	337, 338
3A, 3B	Conveyance in circular channels .....	339, 340
4A, 4B	Velocity in triangular gutter sections .....	341, 342
5A, 5B	Grate inlet frontal flow interception efficiency .....	343, 344
6A, 6B	Grate inlet side flow interception efficiency .....	345, 346
7A, 7B	Curb-opening and slotted drain inlet length for total interception .....	347, 348
8A, 8B	Curb-opening and slotted drain inlet interception efficiency .....	349, 350
9A, 9B	Grate inlet capacity in sump conditions .....	351, 352
10A, 10B	Depressed curb-opening inlet in sump locations .....	353, 354
11A, 11B	Undepressed curb-opening inlet in sump locations .....	355, 356
12A, 12B	Curb-opening inlet orifice capacity for inclined and vertical orifice throats .....	357, 358
13A, 13B	Slotted drain inlet capacity in sump locations .....	359, 360
14A, 14B	Solution of Manning's equation for channels of various side slopes .....	361, 362
15A, 15B	Ratio of frontal flow to total flow in a trapezoidal channel .....	363, 364
16	Manning's n versus relative roughness for selected lining types .....	365
17	Channel side shear stress to bottom shear stress ratio, $K_1$ .....	366
18	Tractive force ratio, $K_2$ .....	367
19	Angle of repose of riprap in terms of mean size and shape of stone .....	368
20A, 20B	Protection length, $L_p$ , downstream of channel bend .....	369, 370
21	$K_b$ factor for maximum shear stress on channel bends .....	371
22	Geometric design chart for trapezoidal channels .....	372
23	Permissible shear stress for non-cohesive soils .....	373
24	Permissible shear stress for cohesive soils .....	374
25A, 25B	Solution of Manning's formula for flow in storm drains .....	375, 376
26	Hydraulic elements chart .....	377
26	(Rotated) Hydraulic elements chart .....	378
27A, 27B	Critical depth in circular pipes .....	379, 380
28A, 28B	Headwater depth for concrete pipe culverts with inlet control .....	381, 382
29A, 29B	Headwater depth for c.m. pipe culverts with inlet control .....	383, 384

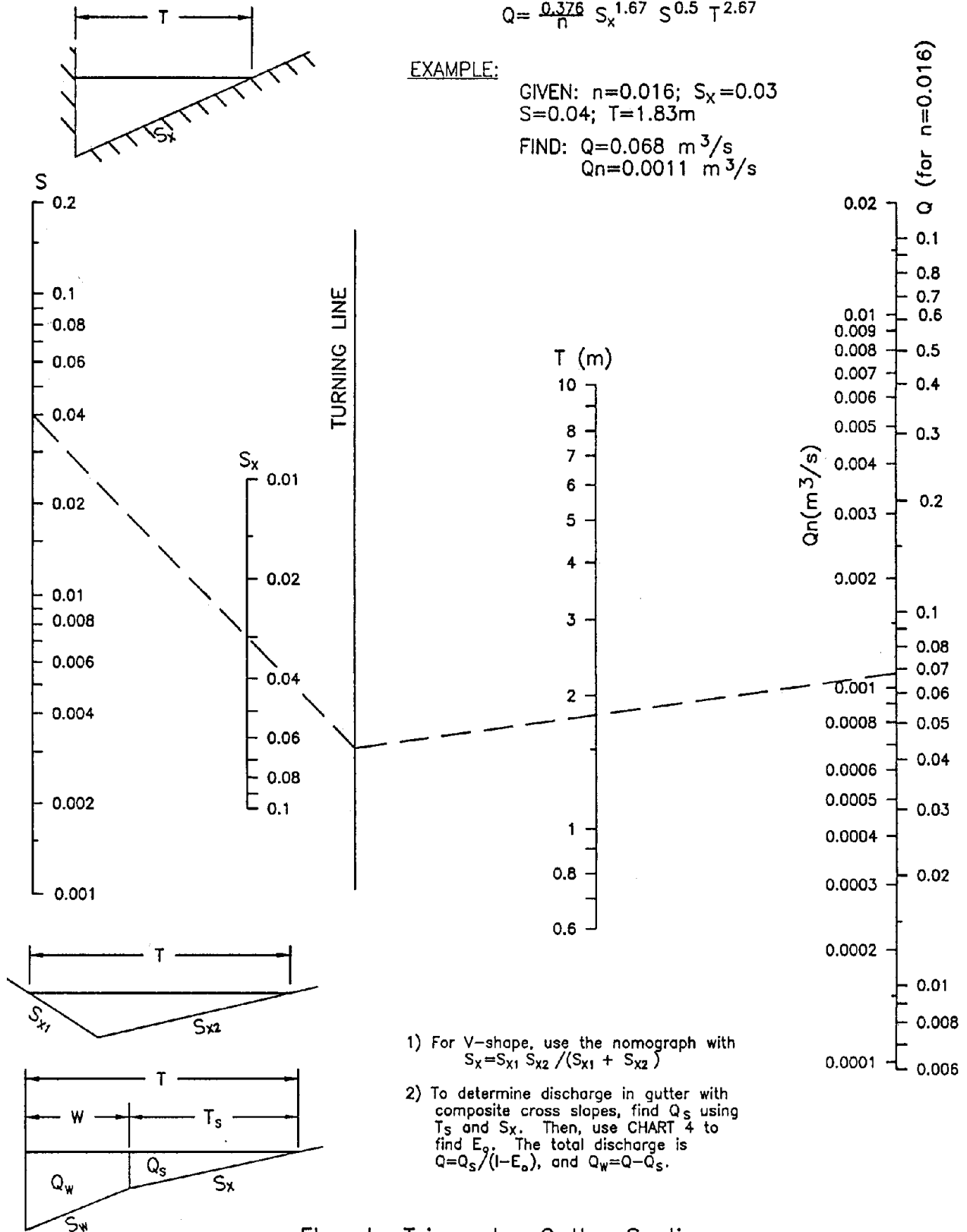
# CHART 1A

$$Q = \frac{0.376}{n} S_x^{1.67} S^{0.5} T^{2.67}$$

**EXAMPLE:**

GIVEN:  $n=0.016$ ;  $S_x=0.03$   
 $S=0.04$ ;  $T=1.83\text{m}$

FIND:  $Q=0.068 \text{ m}^3/\text{s}$   
 $Qn=0.0011 \text{ m}^3/\text{s}$



1) For V-shape, use the nomograph with  $S_x = S_{x1} S_{x2} / (S_{x1} + S_{x2})$

2) To determine discharge in gutter with composite cross slopes, find  $Q_s$  using  $T_s$  and  $S_x$ . Then, use CHART 4 to find  $E_o$ . The total discharge is  $Q = Q_s / (1 - E_o)$ , and  $Q_w = Q - Q_s$ .

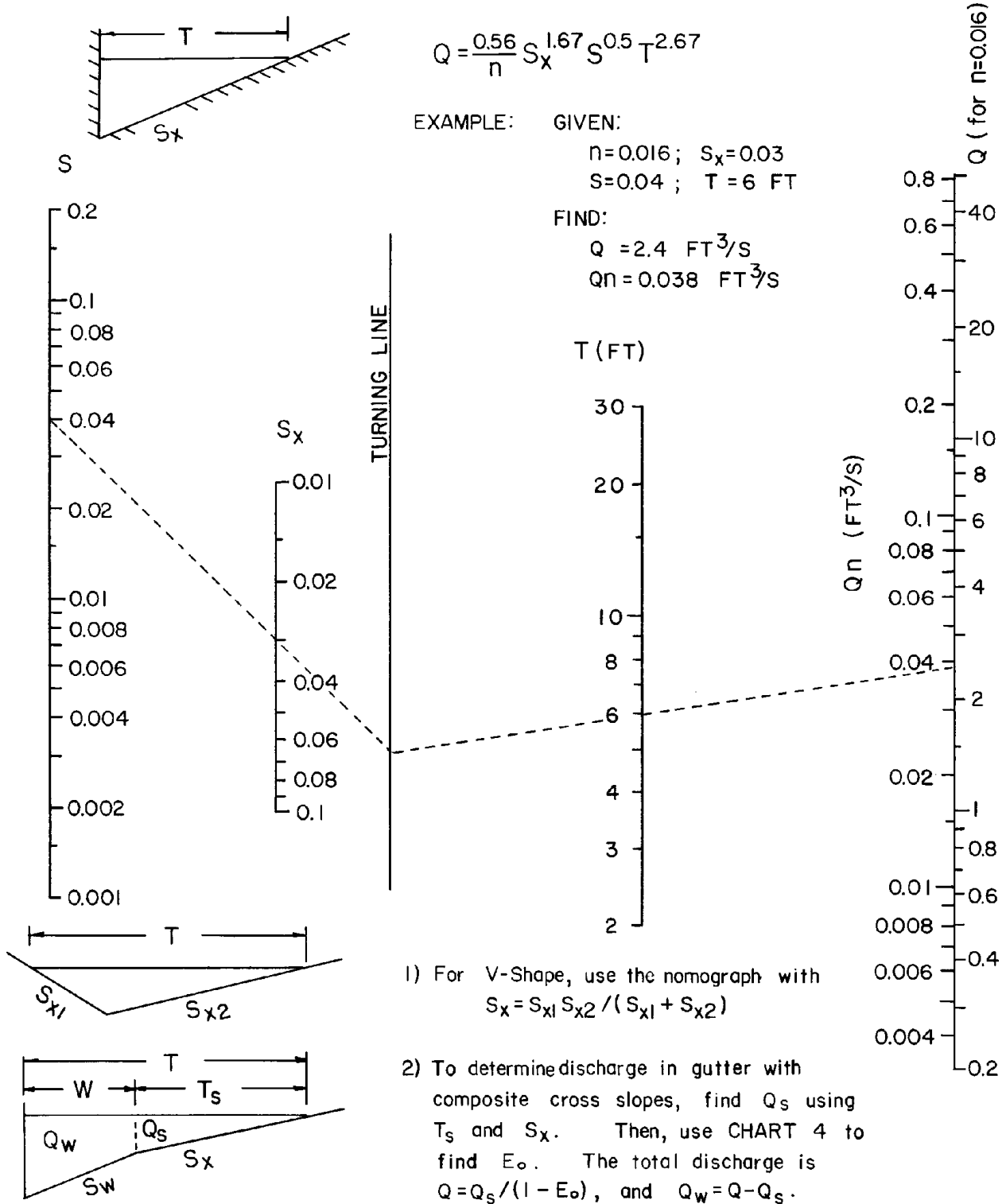
Flow In Triangular Gutter Sections

**CHART 1B**

$$Q = \frac{0.56}{n} S_x^{1.67} S^{0.5} T^{2.67}$$

EXAMPLE: GIVEN:  
 $n = 0.016$ ;  $S_x = 0.03$   
 $S = 0.04$ ;  $T = 6$  FT

FIND:  
 $Q = 2.4$  FT<sup>3</sup>/S  
 $Qn = 0.038$  FT<sup>3</sup>/S

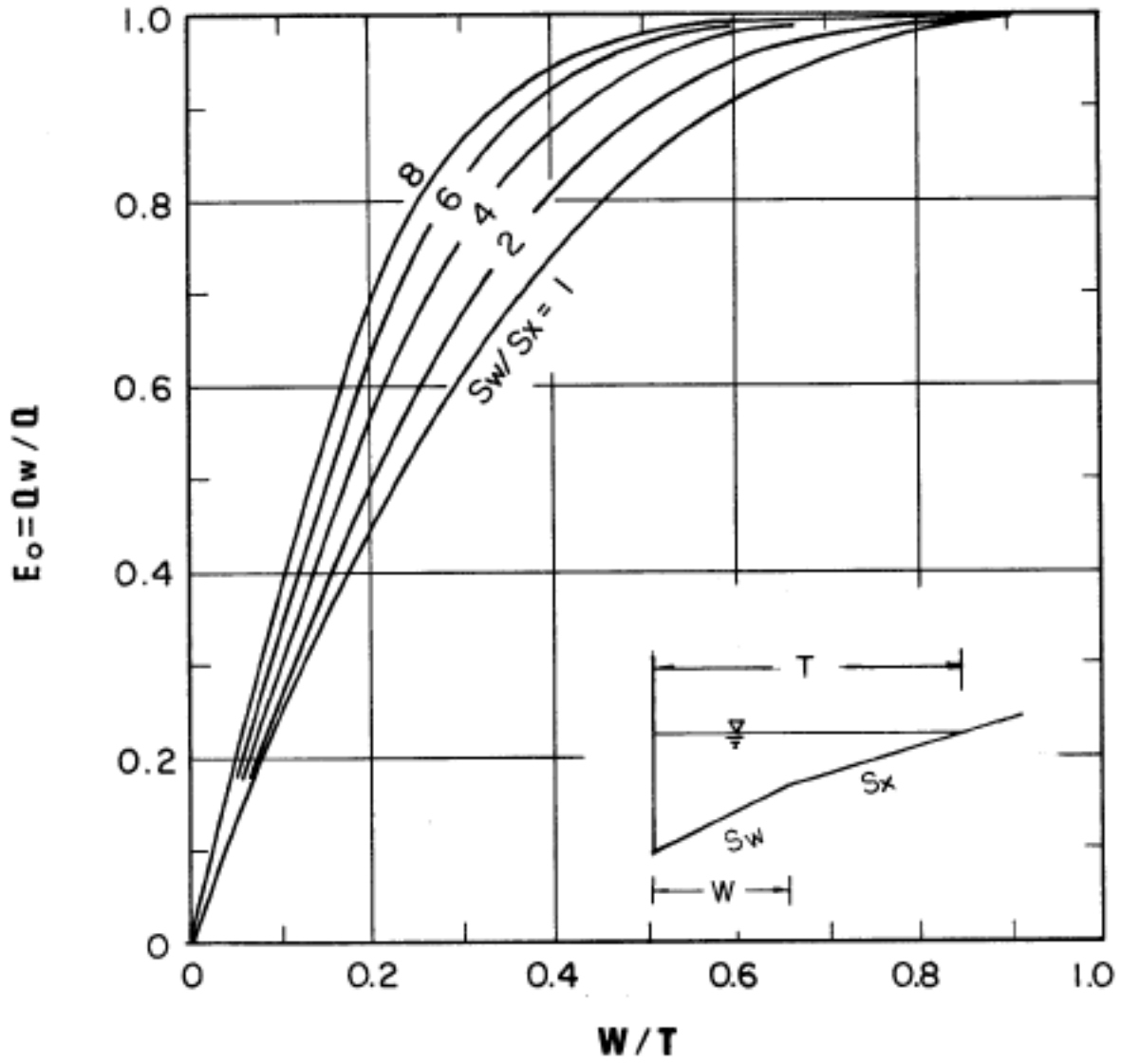


1) For V-Shape, use the nomograph with  
 $S_x = S_{x1} S_{x2} / (S_{x1} + S_{x2})$

2) To determine discharge in gutter with composite cross slopes, find  $Q_s$  using  $T_s$  and  $S_x$ . Then, use CHART 4 to find  $E_o$ . The total discharge is  $Q = Q_s / (1 - E_o)$ , and  $Q_w = Q - Q_s$ .

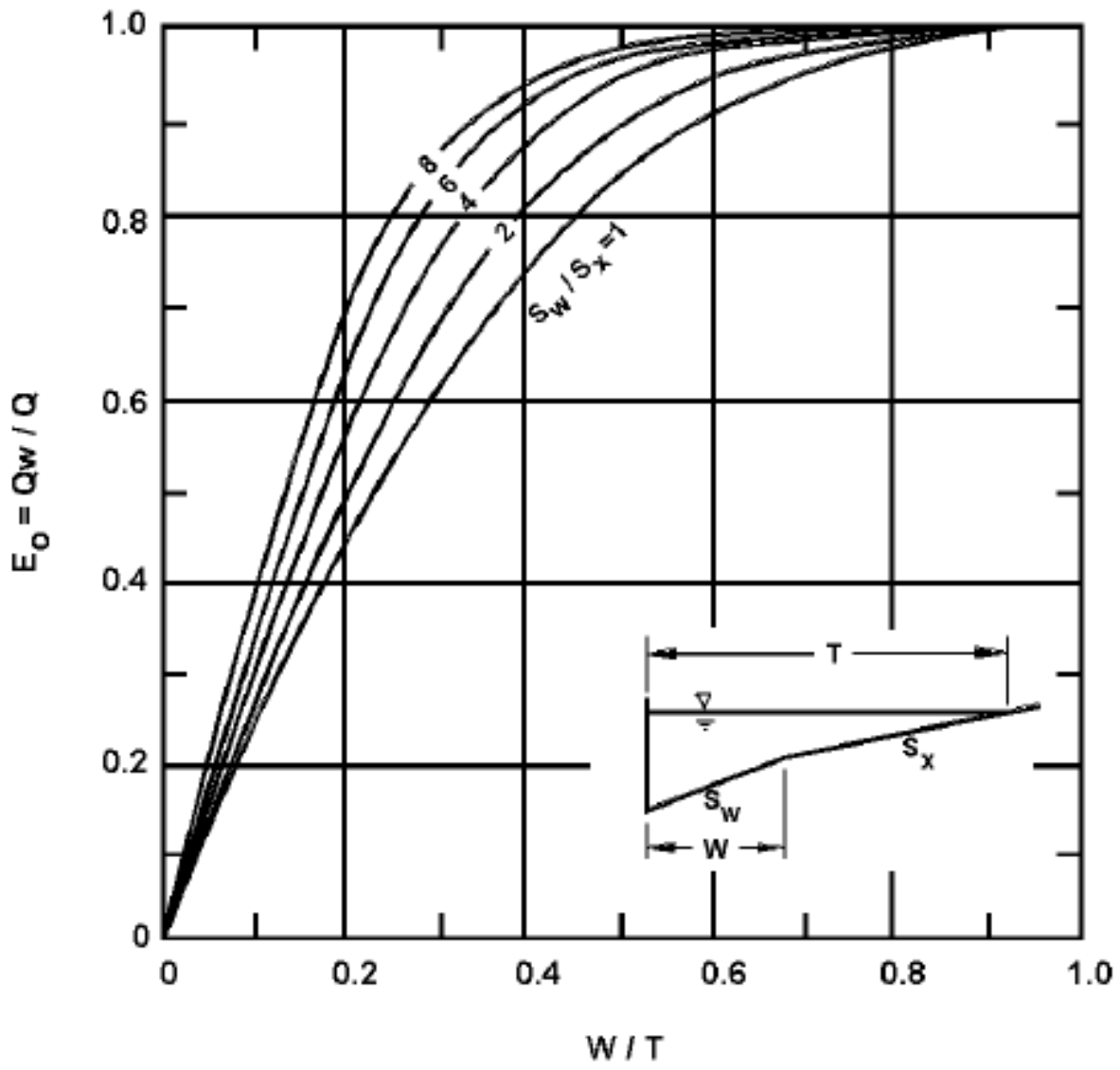
Flow in Triangular Gutter Sections - English Units

CHART 2A



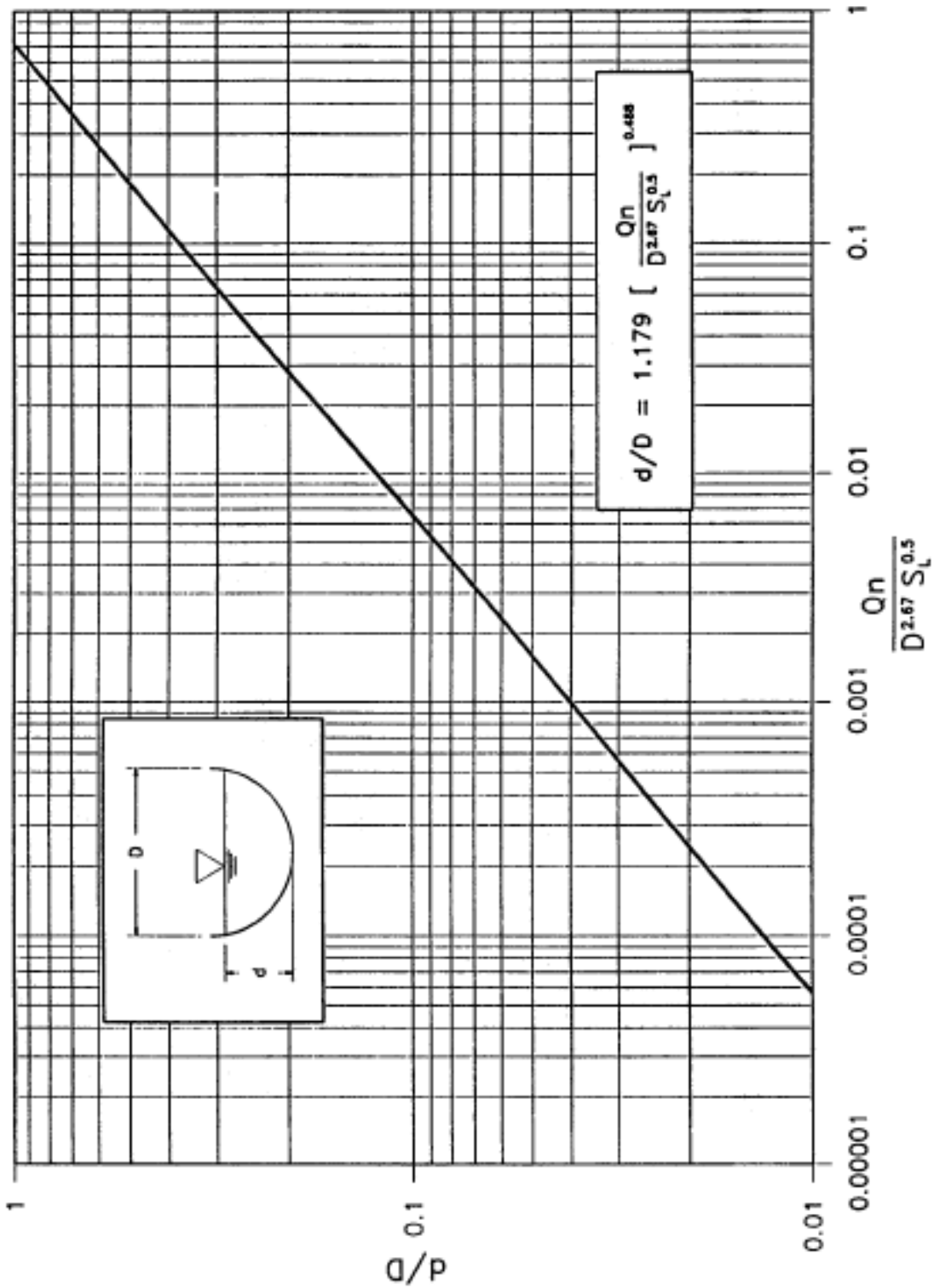
Ratio of frontal flow to total gutter flow.

CHART 2B



Ratio of Frontal Flow to Total Gutter Flow

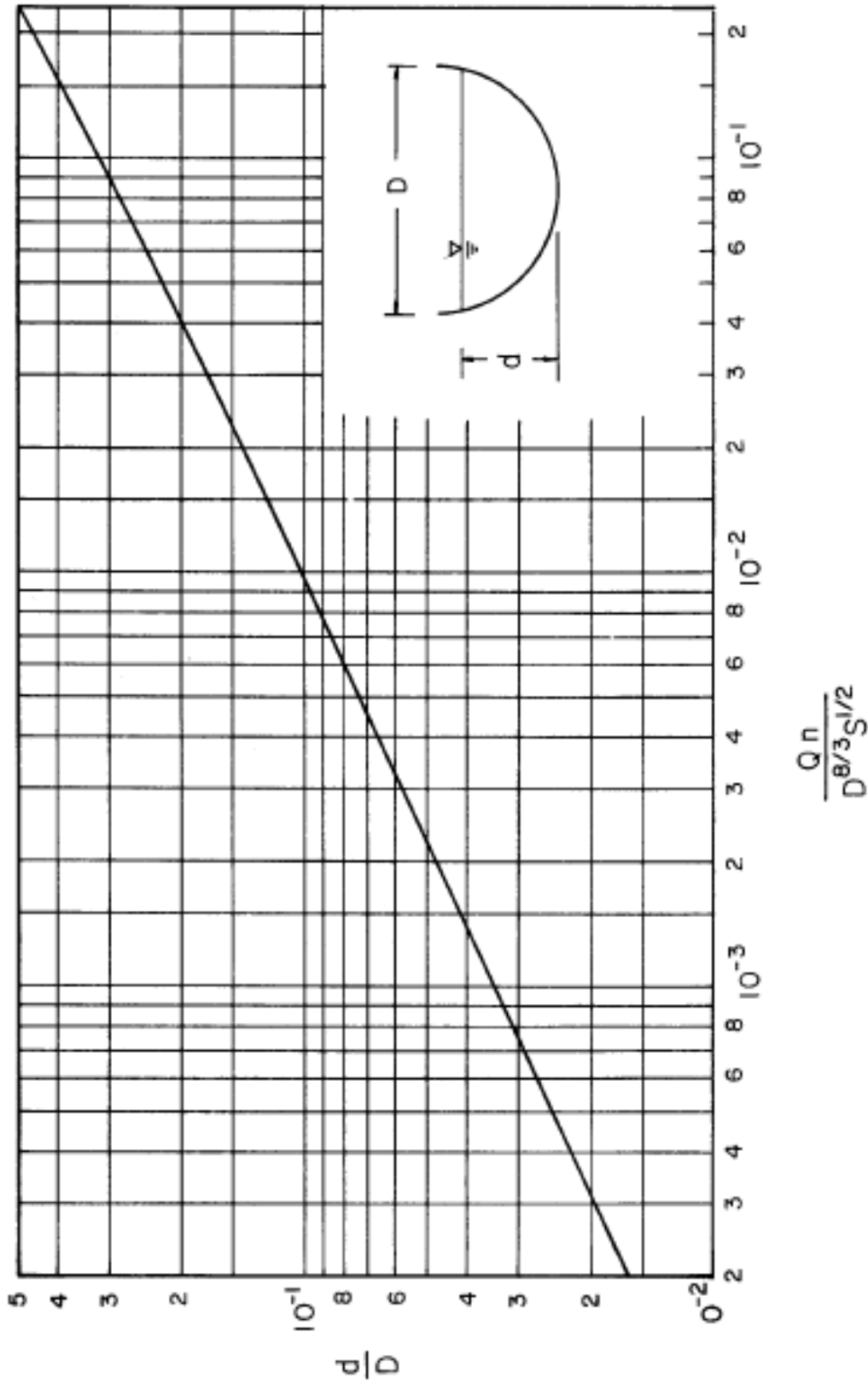
CHART 3A



Conveyance In Circular Channels.

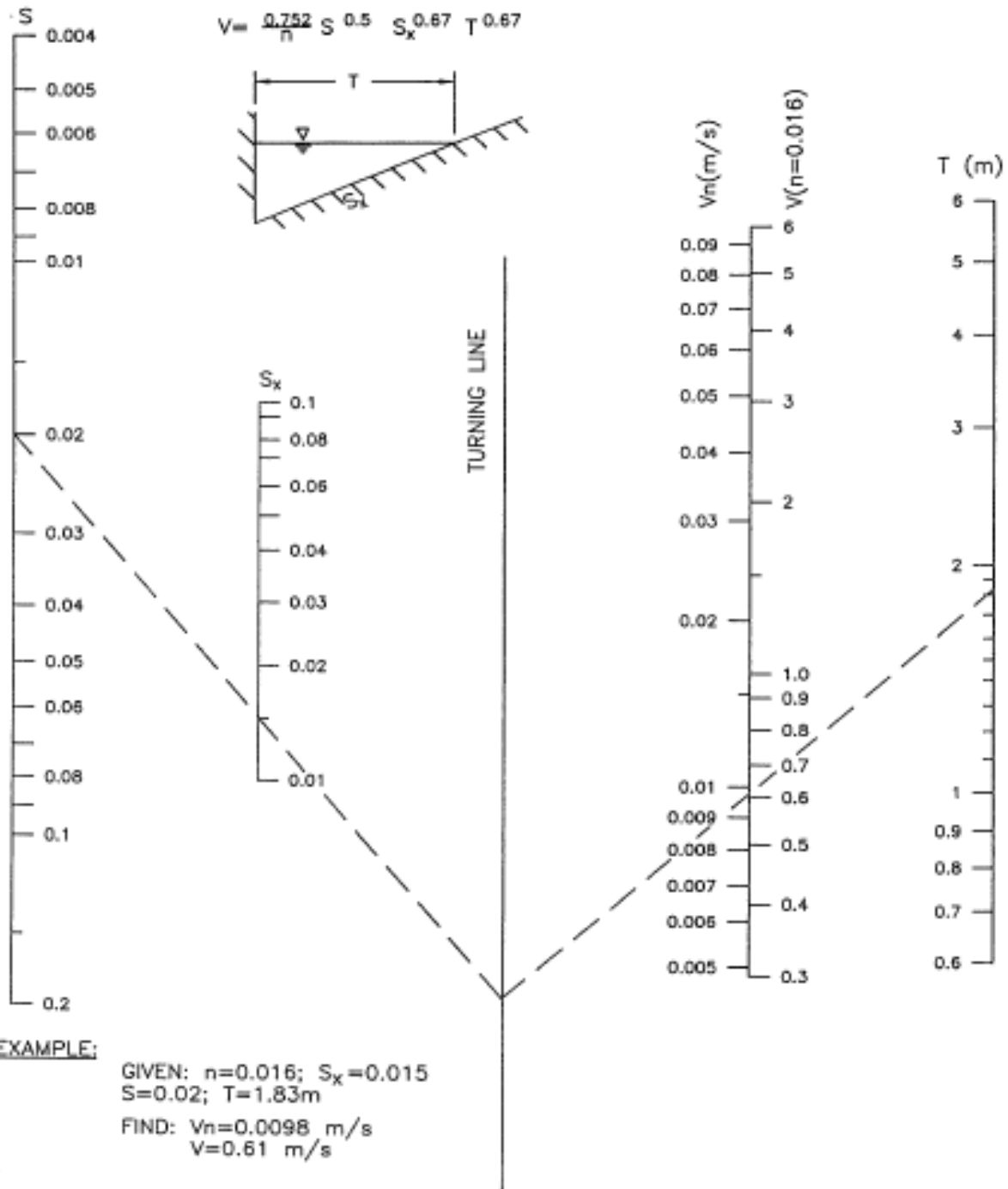


CHART 3B



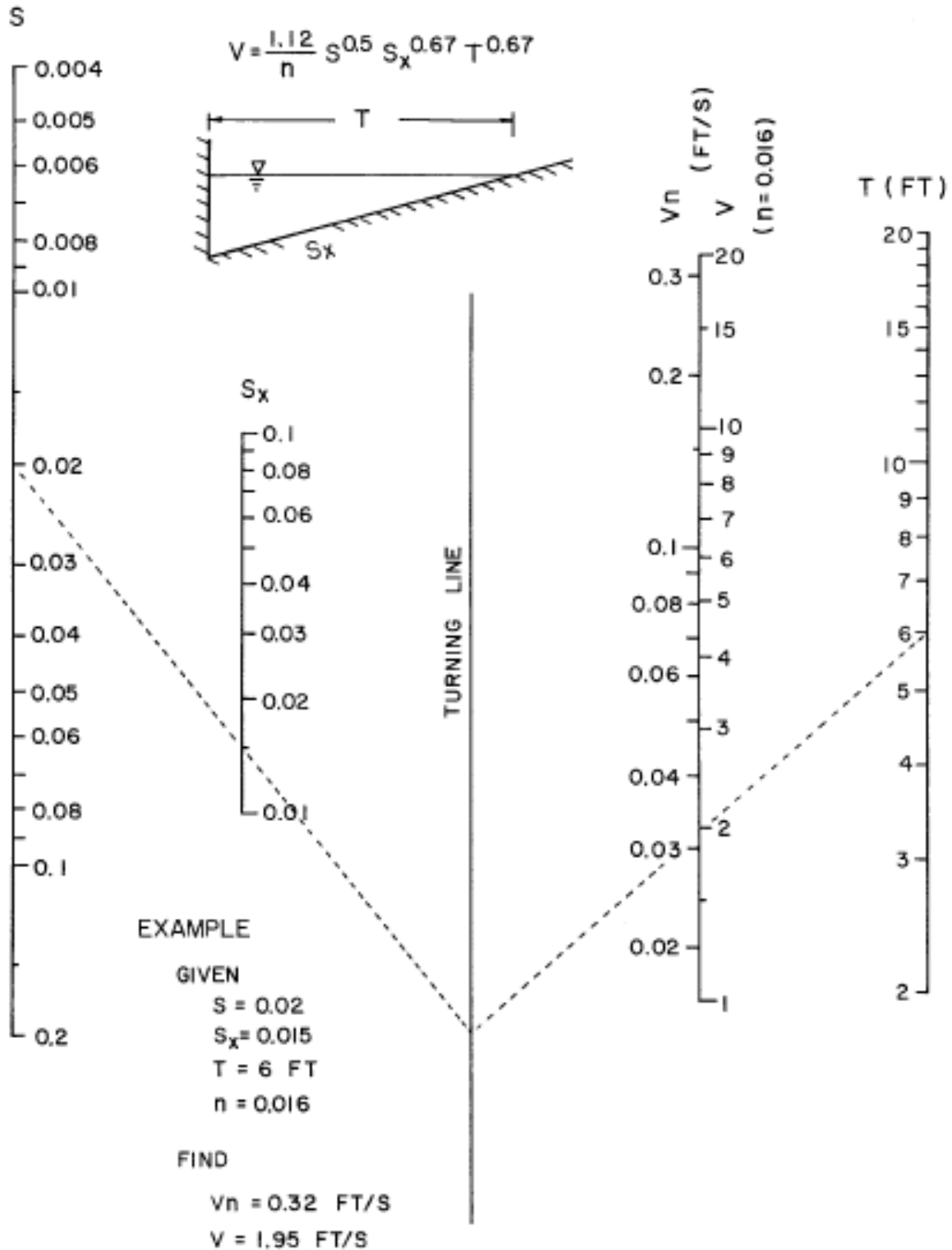
Conveyance in Circular Channels - English Units

CHART 4A



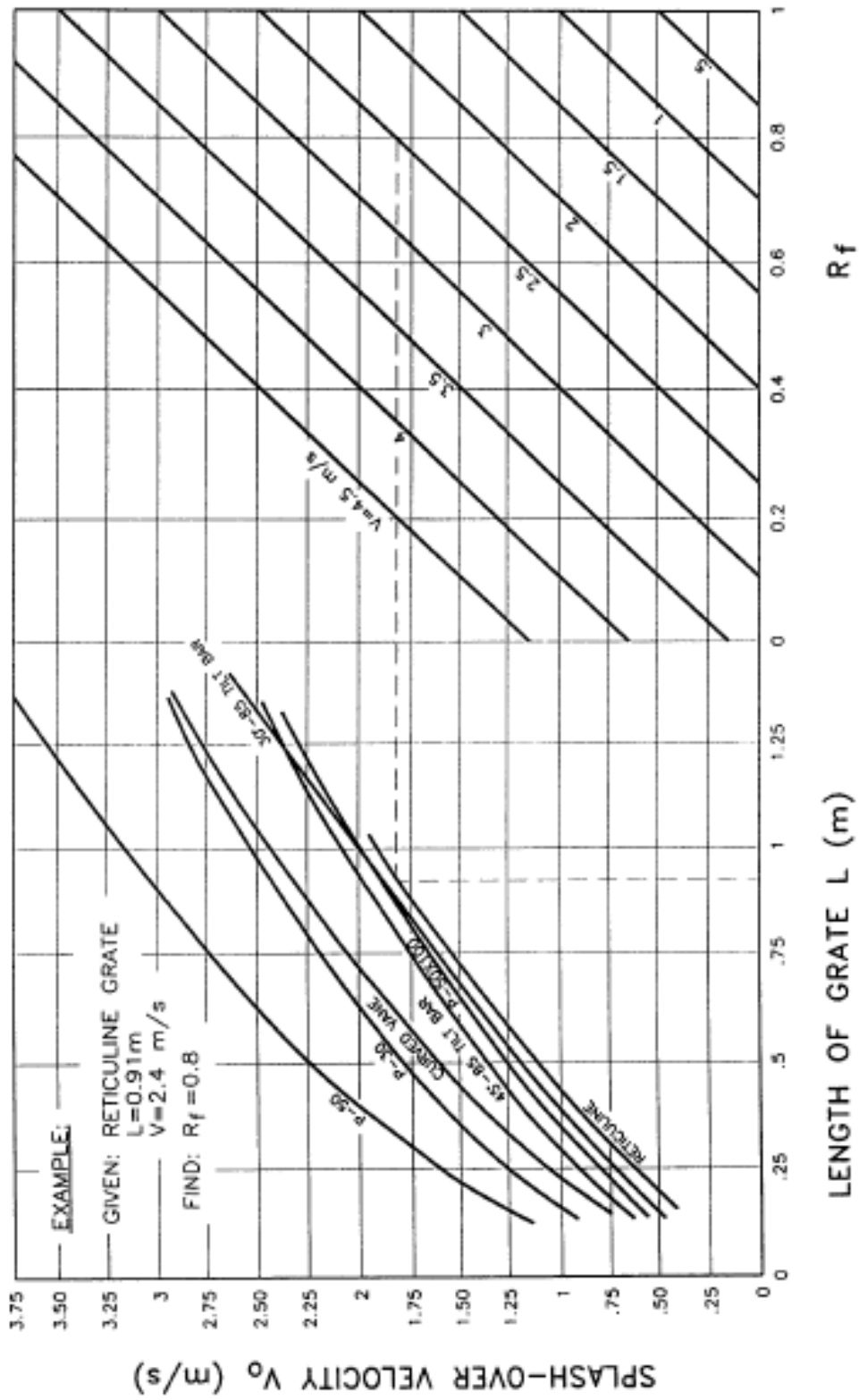
Velocity in Triangular Gutter Sections

CHART 4B



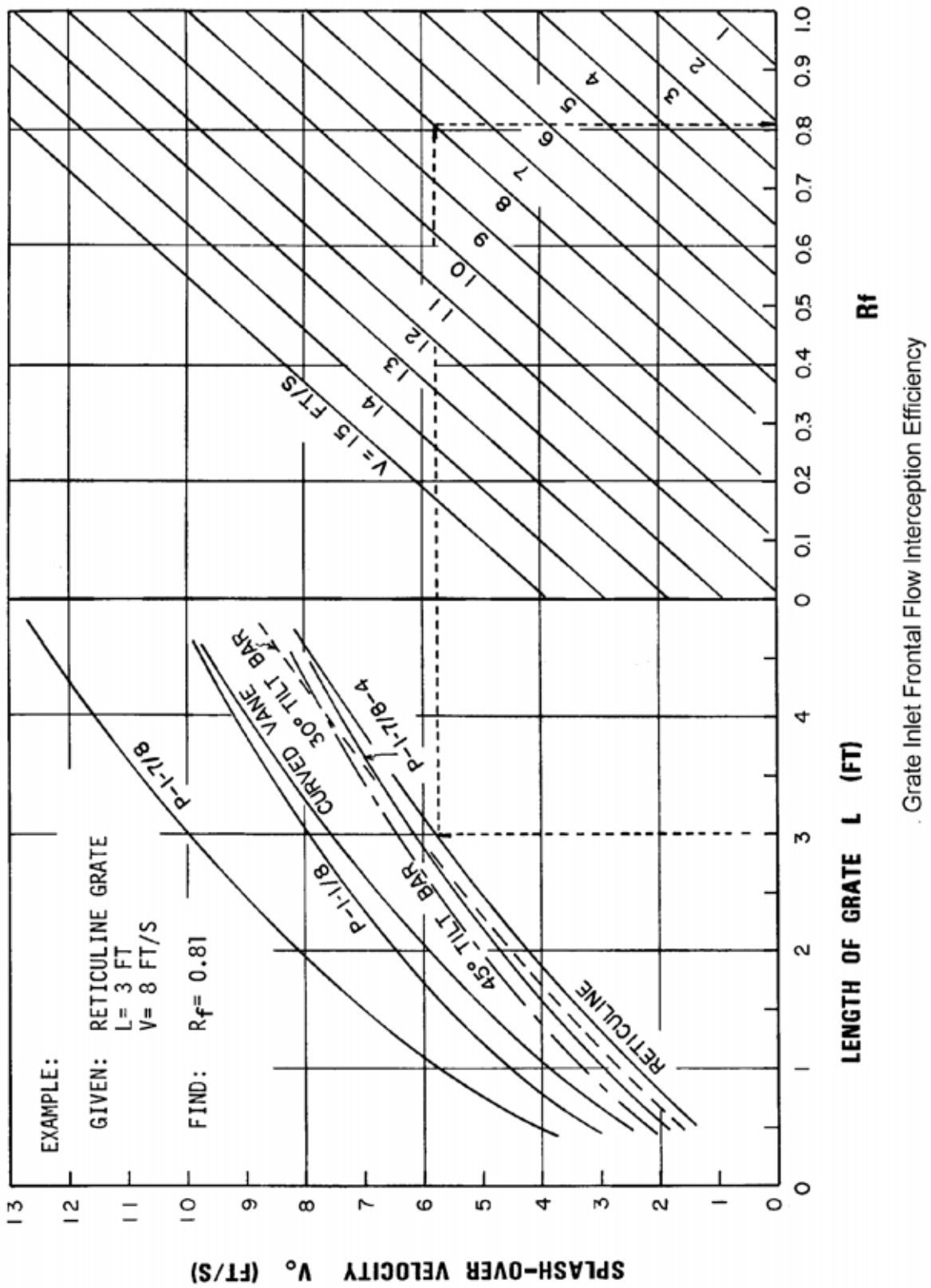
Velocity in Triangular Gutter Sections - English Units

CHART 5A

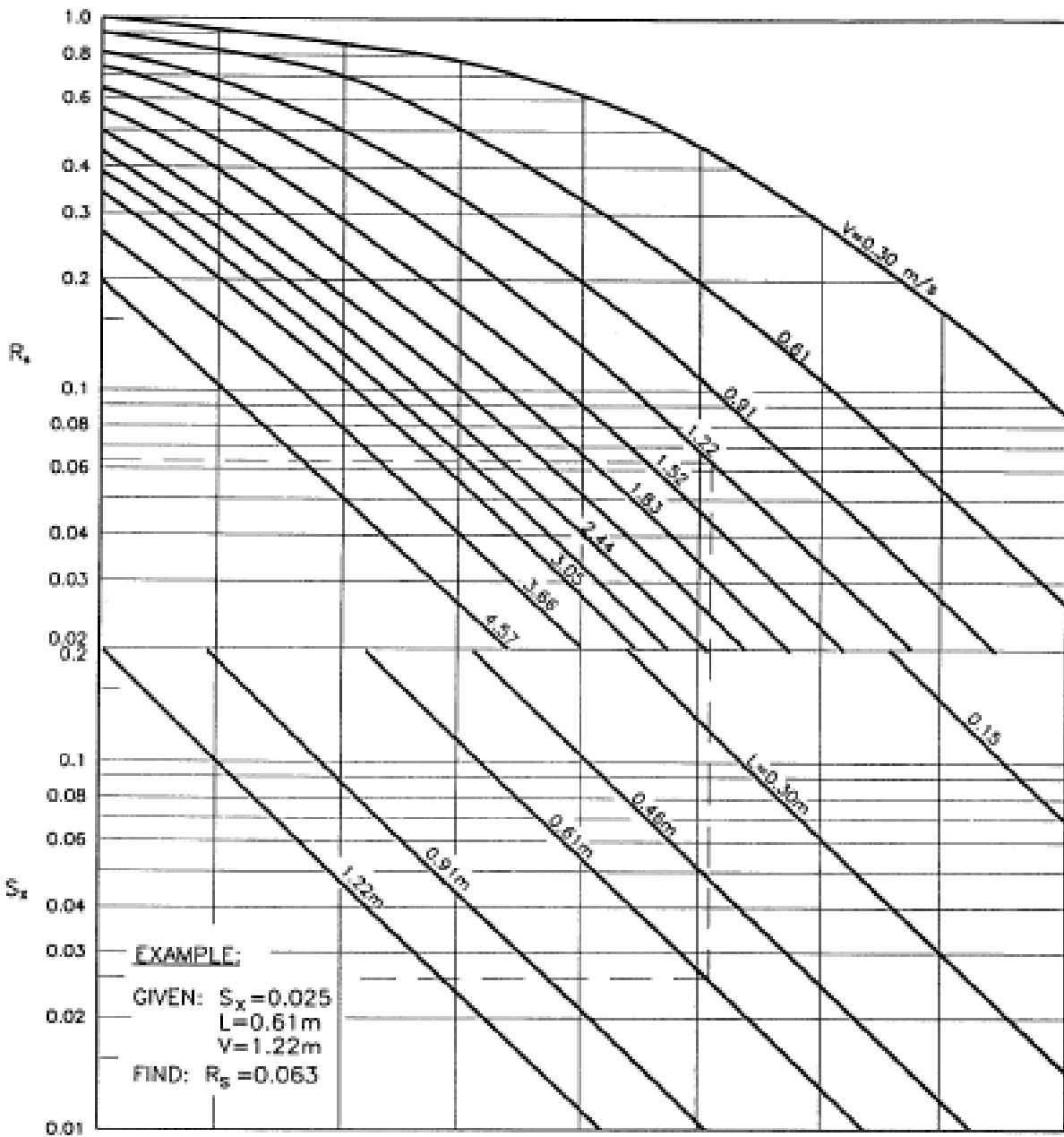


Grate Inlet Frontal Flow Interception Efficiency

CHART 5B

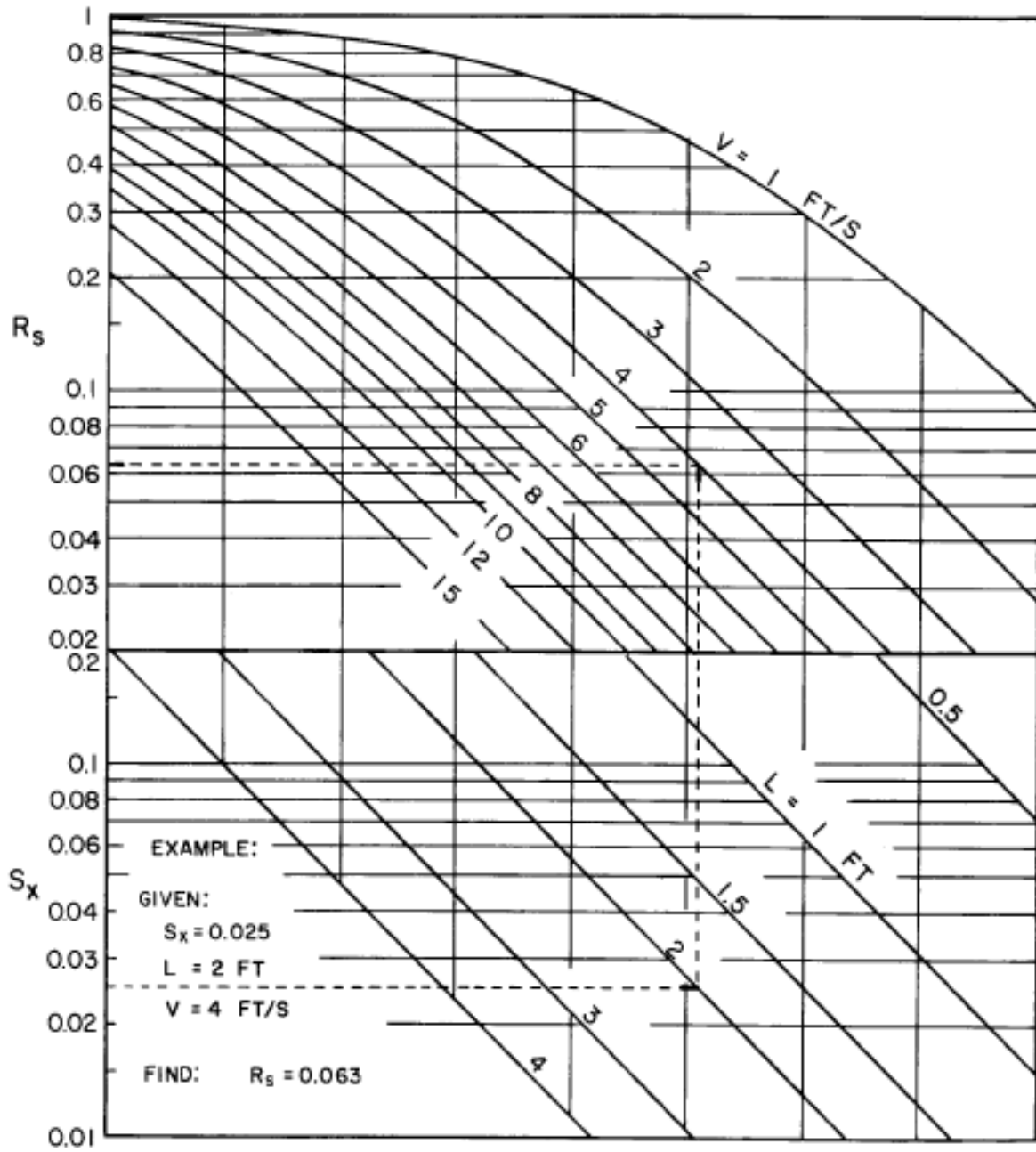


### CHART 6A



Grate Inlet Side Flow Intercept Efficiency.

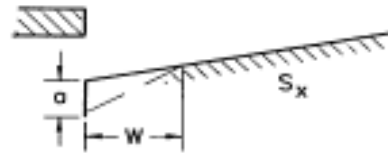
### CHART 6B



Grate Inlet Side Flow Intercept Efficiency

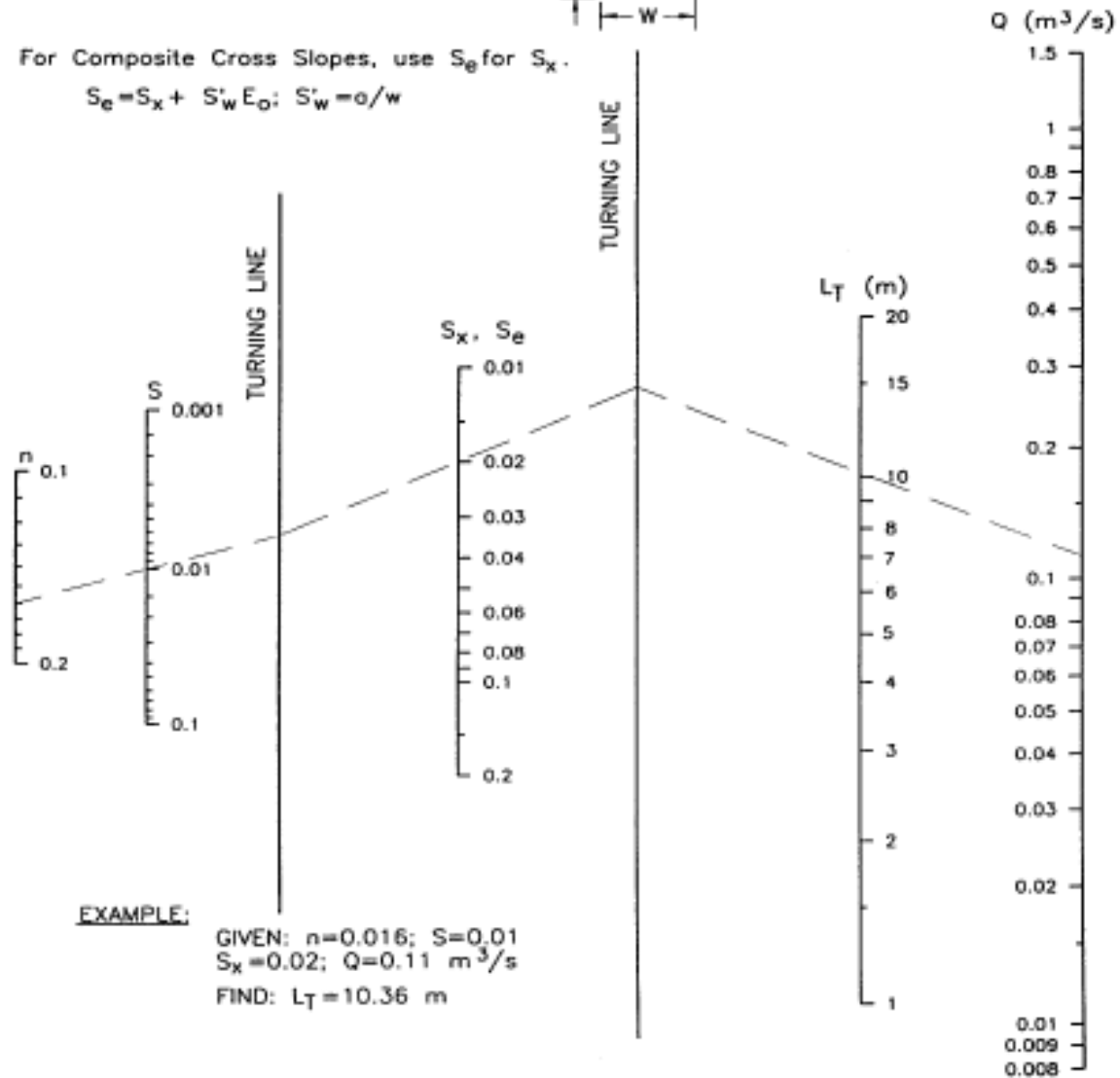
CHART 7A

$$L_T = 0.817 Q^{0.42} S^{0.3} (1/nS_x)^{0.6}$$



For Composite Cross Slopes, use  $S_e$  for  $S_x$ .

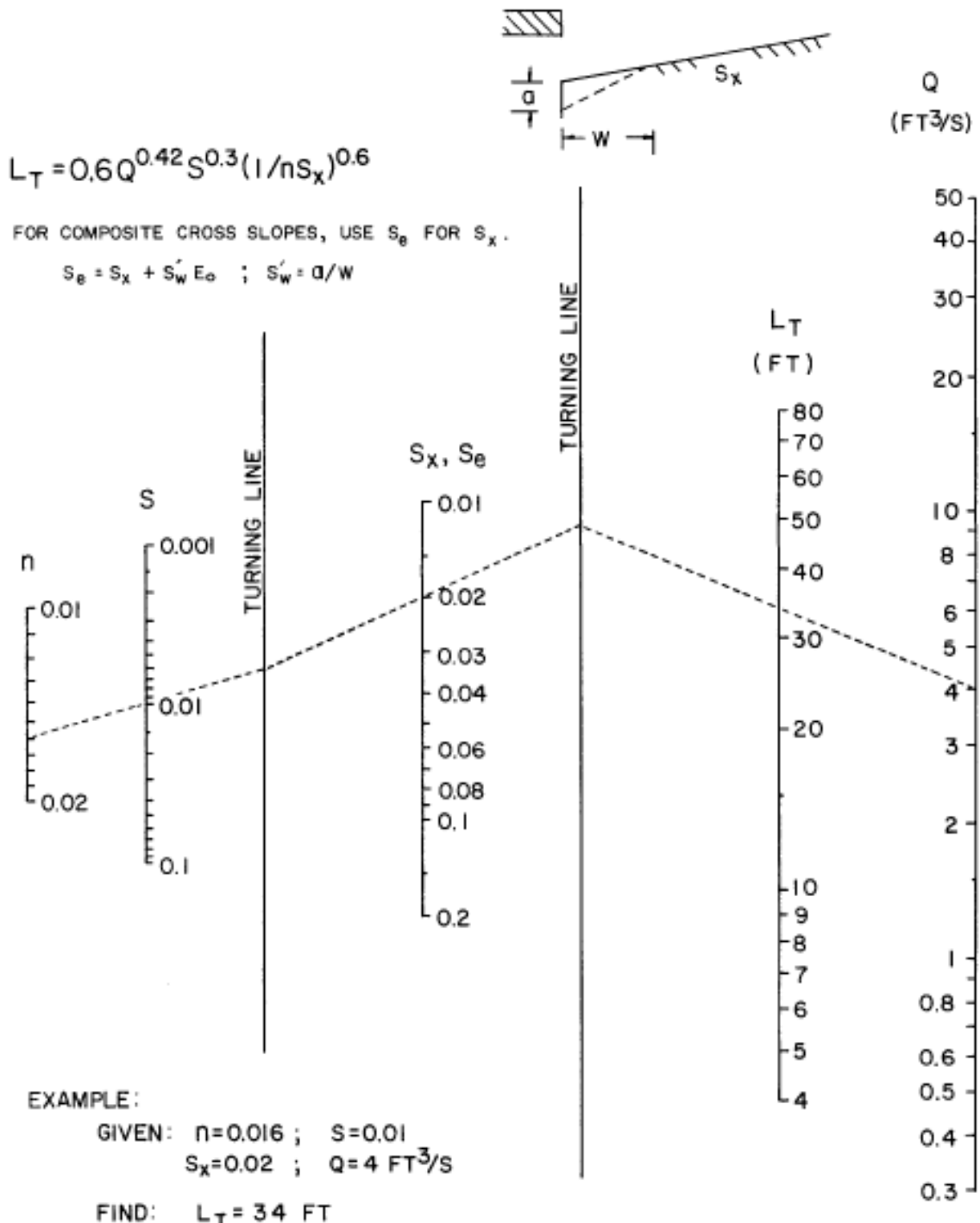
$$S_e = S_x + S'_w E_o; S'_w = a/w$$



Curb Opening & Slotted Drain Inlet Length for Total Interception

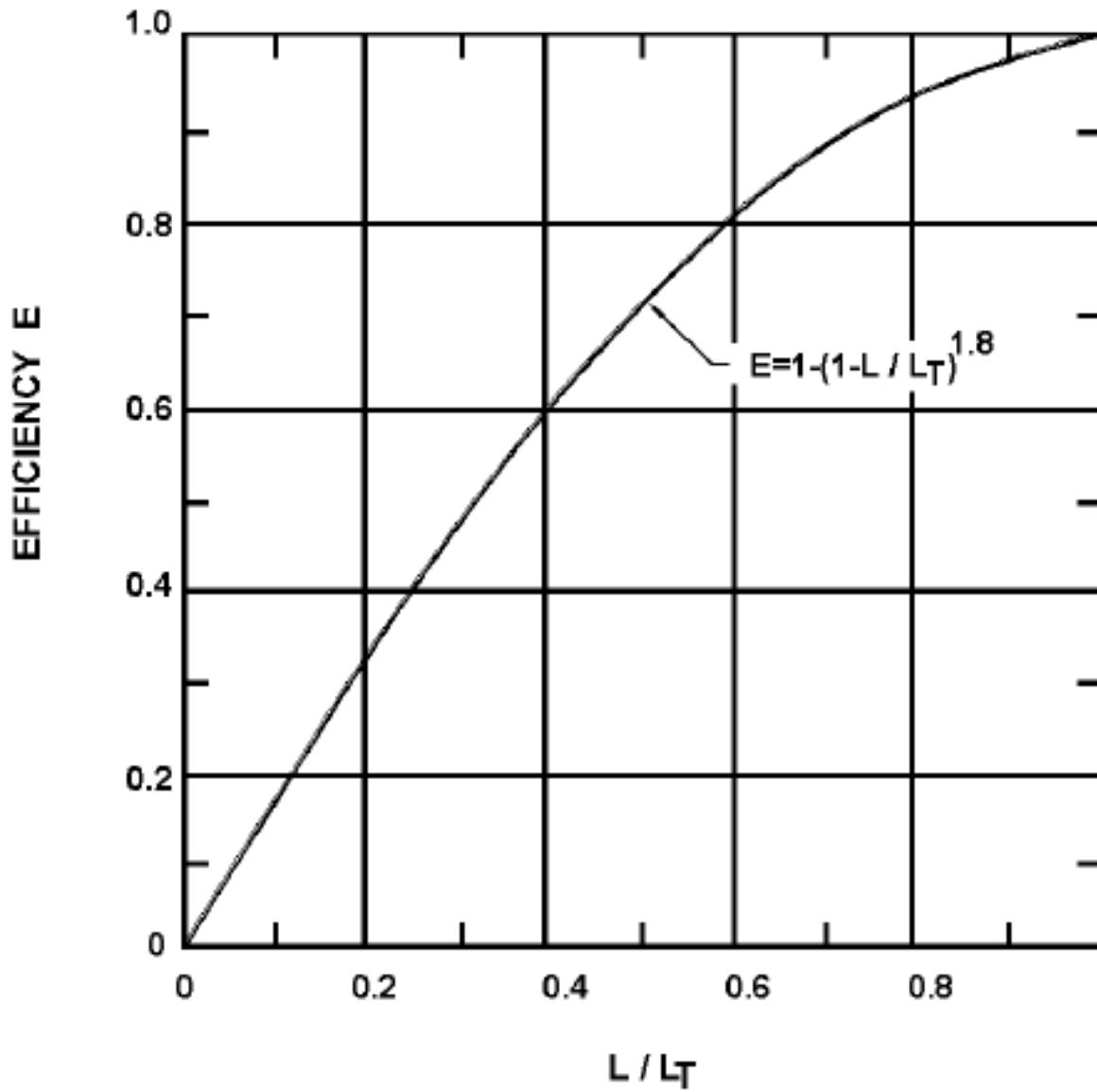


CHART 7B

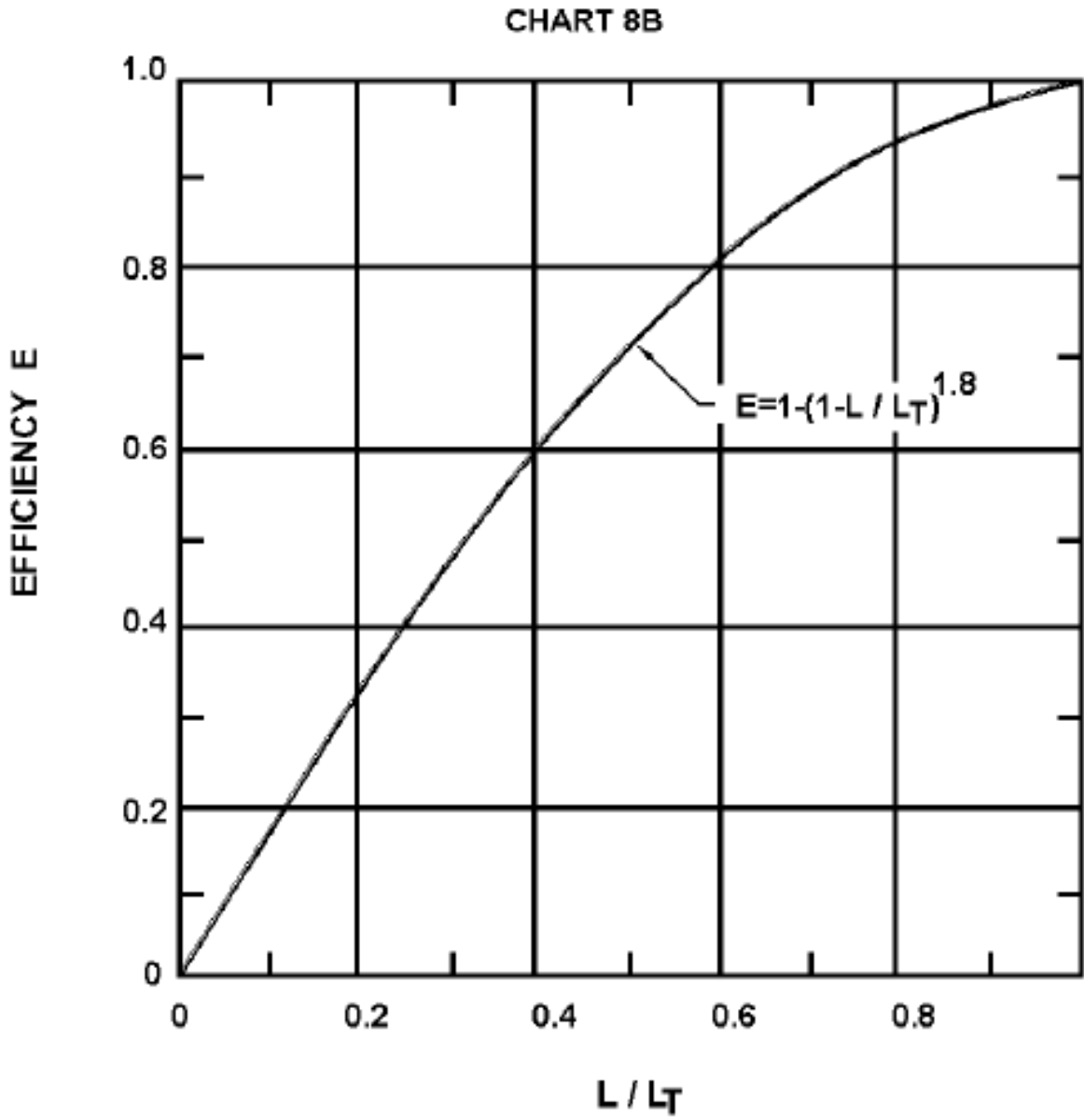


Curb-opening & Slotted Drain Inlet Length for Total Interception - English Units

CHART 8A

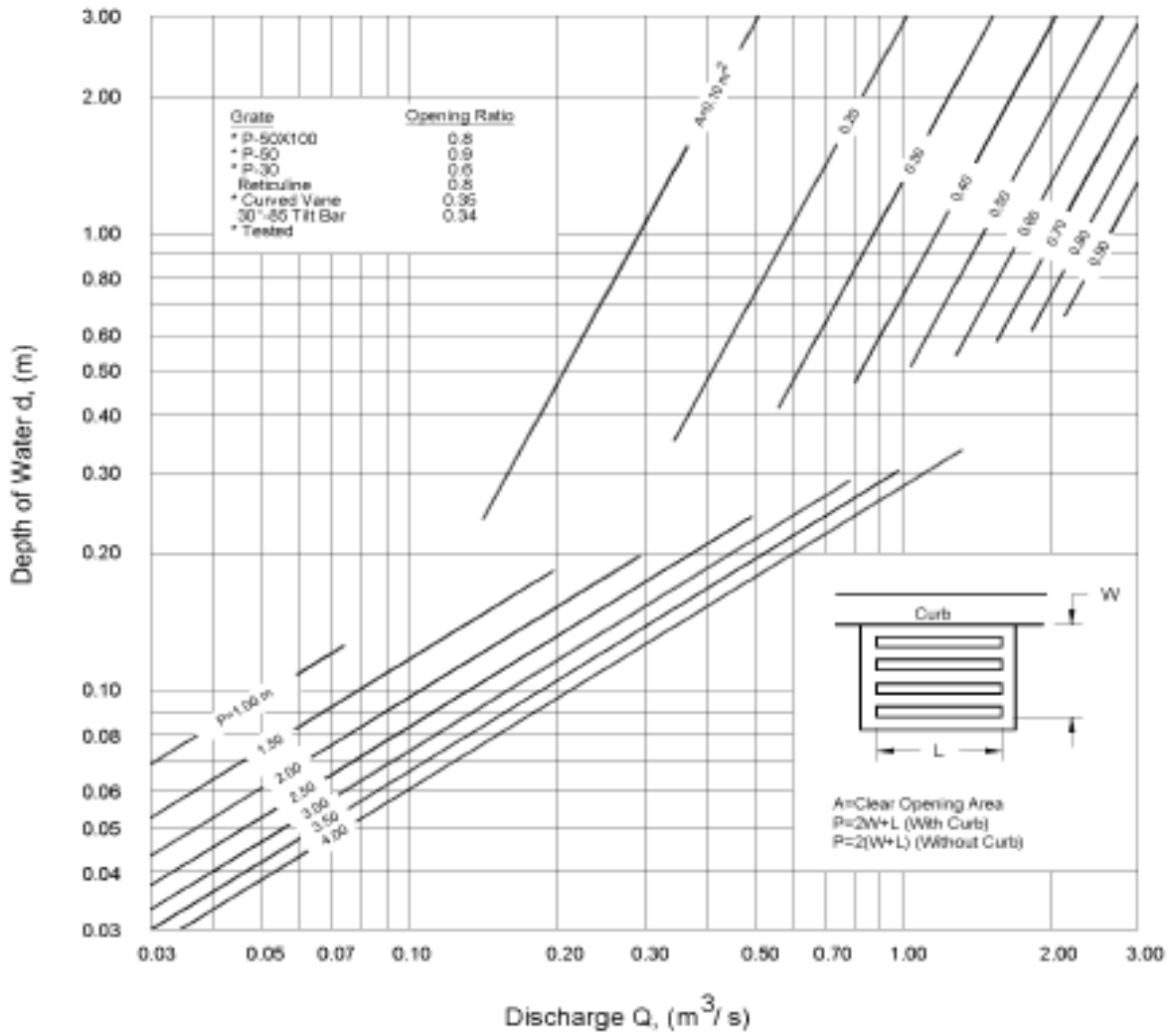


Curb-opening and Slotted Drain Inlet Interception Efficiency.



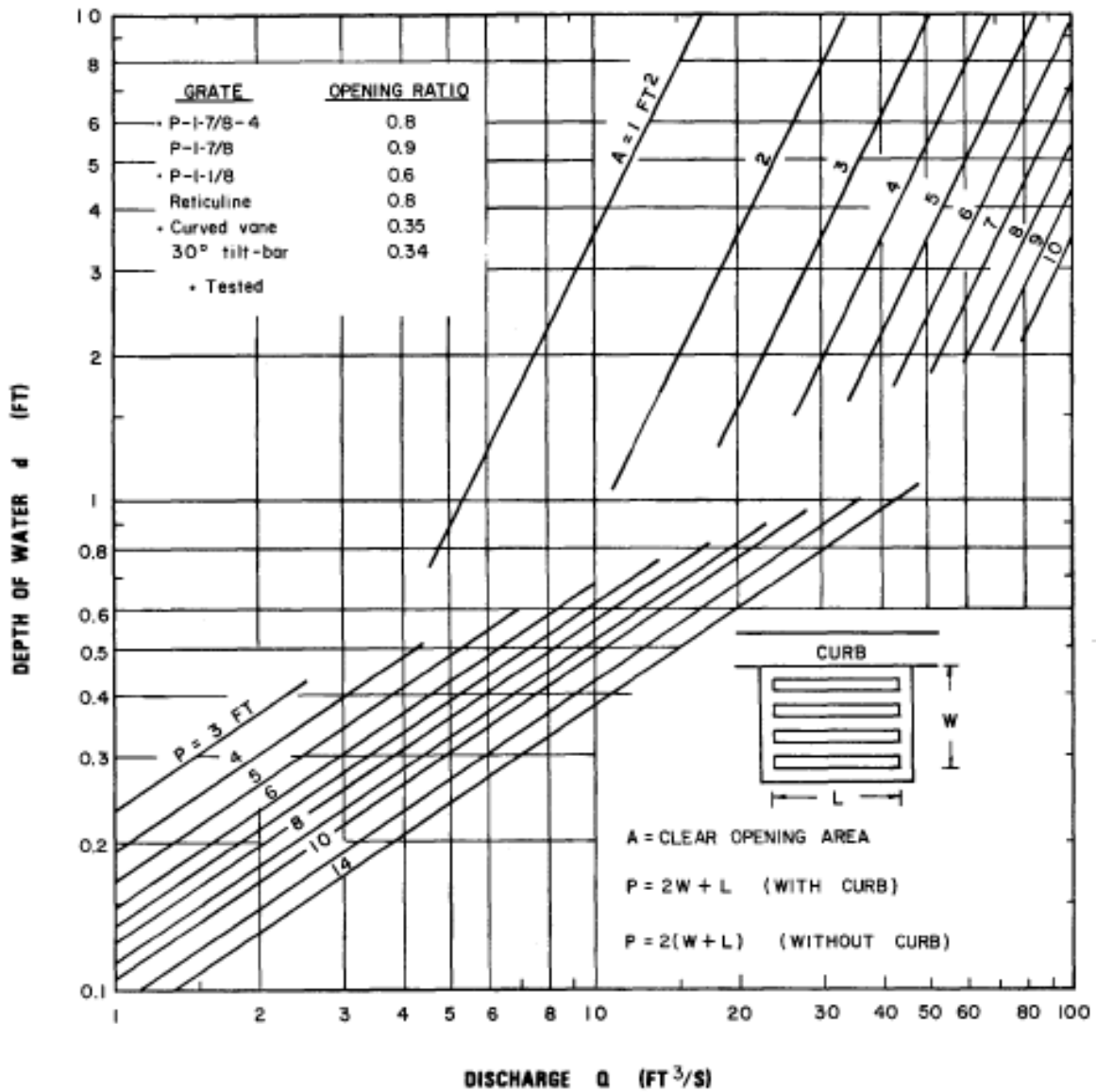
Curb-opening and Slotted Drain Inlet Interception Efficiency.

### CHART 9A



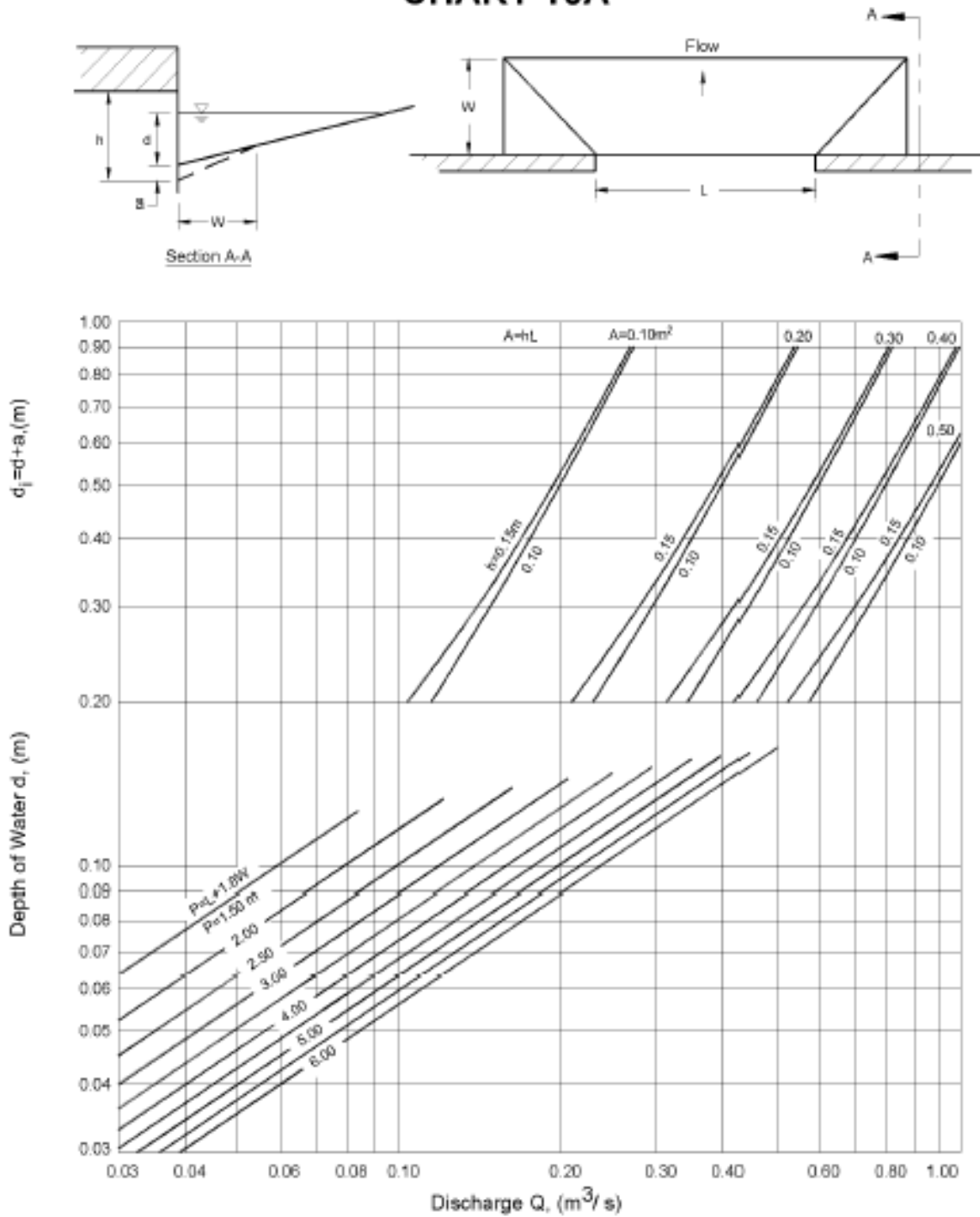
Grate Inlet Capacity in Sump Conditions.

### CHART 9B



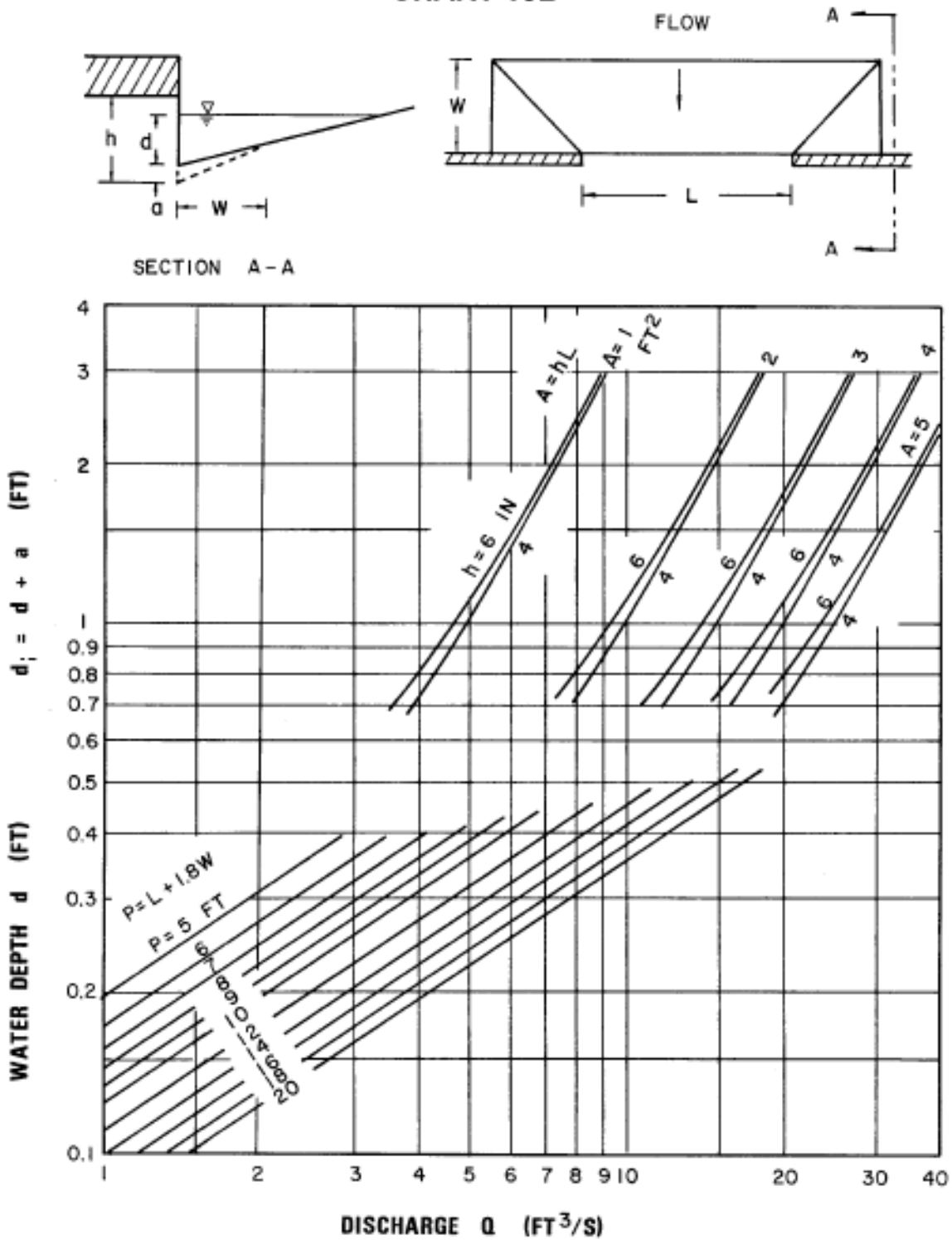
Grate Inlet Capacity in Sump Conditions - English Units

### CHART 10A



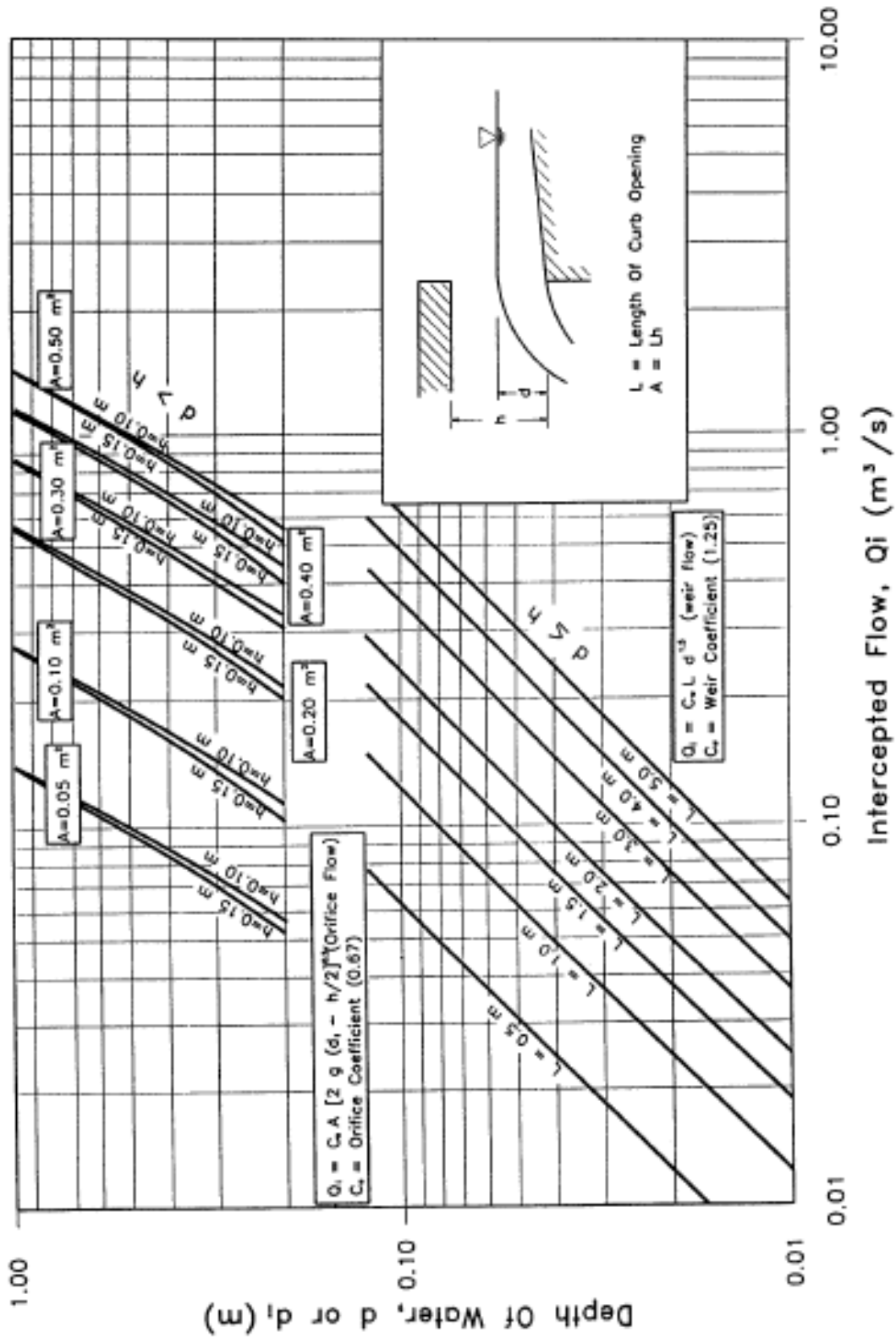
Depressed Curb-opening Inlet Capacity in Sump Locations

CHART 10B



Depressed Curb-opening Inlet Capacity in Sump Locations - English Units

### CHART 11A



Undepressed Curb Opening Inlet Capacity in Sump Conditions



CHART 11B

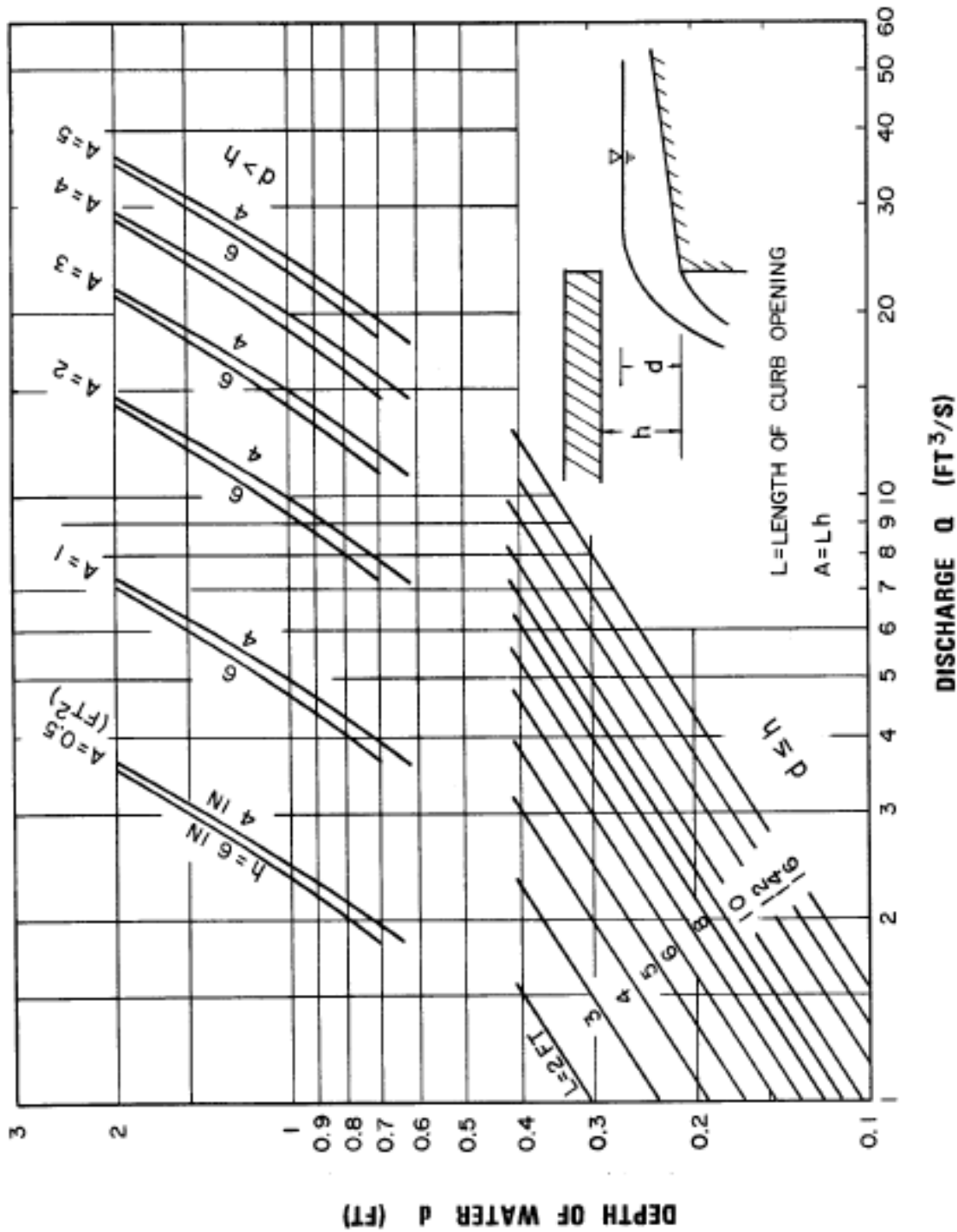
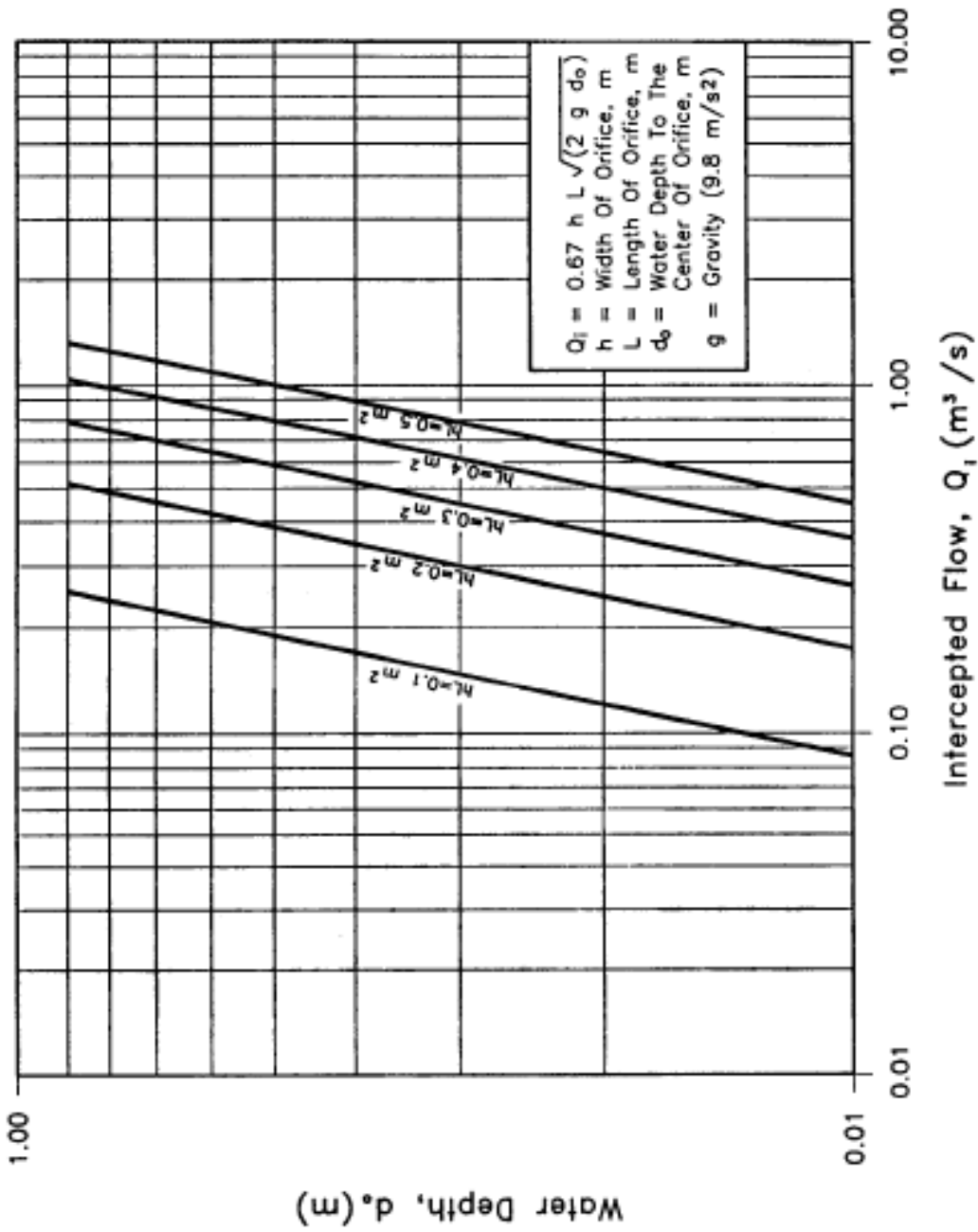
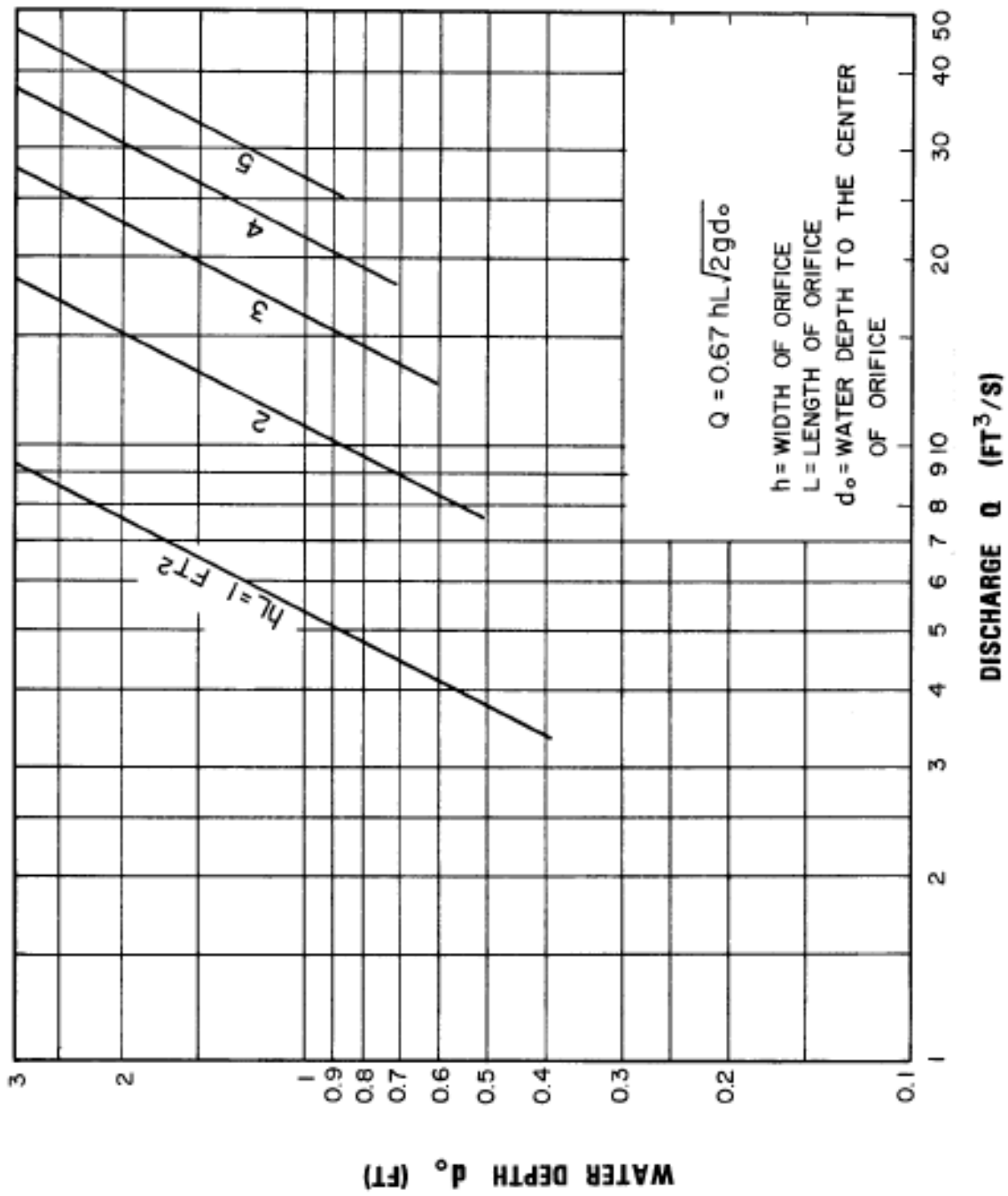


CHART 12A



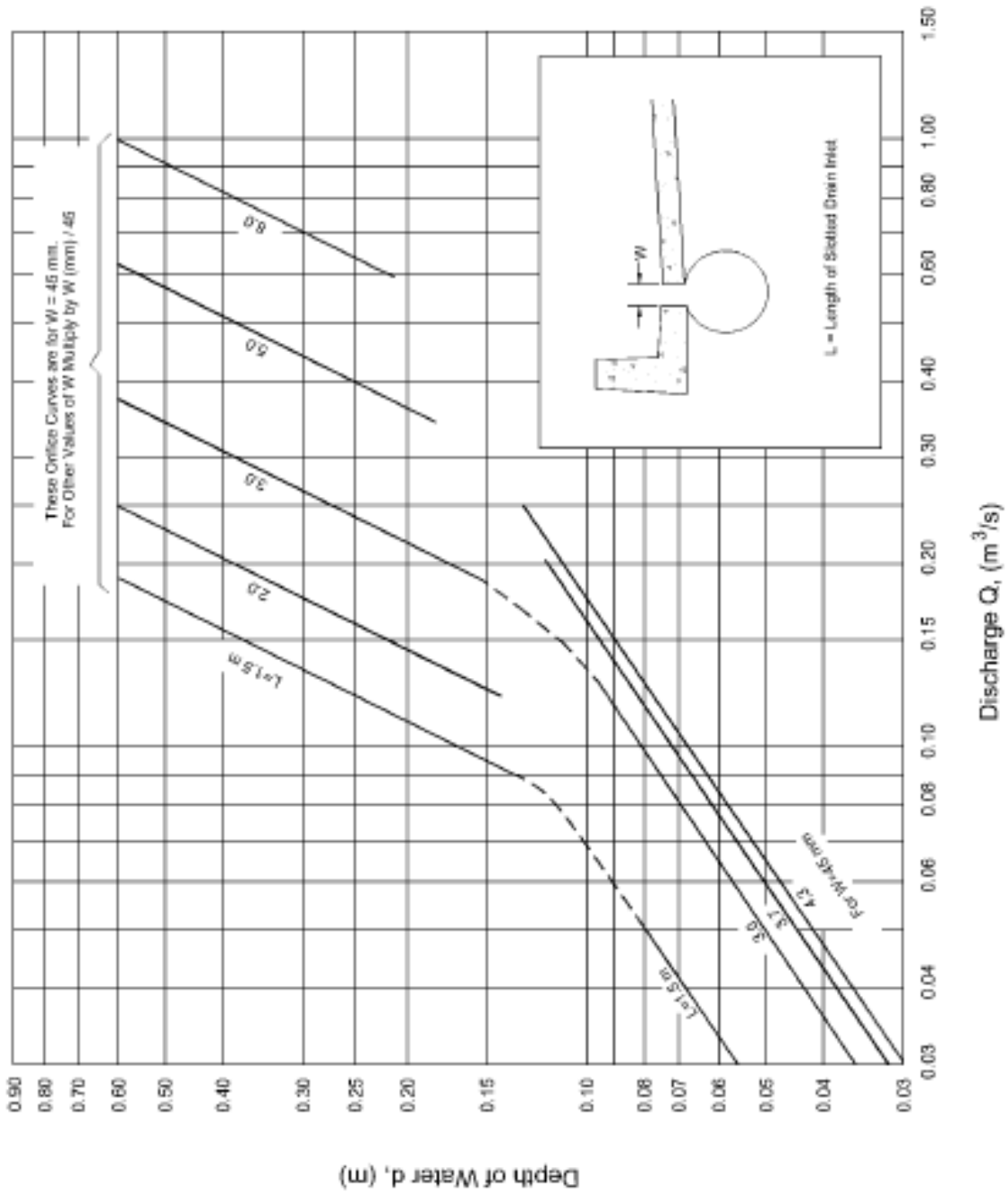
Curb Opening Inlet Orifice Capacity  
For Inclined And Vertical Orifice Throats.

CHART 12B



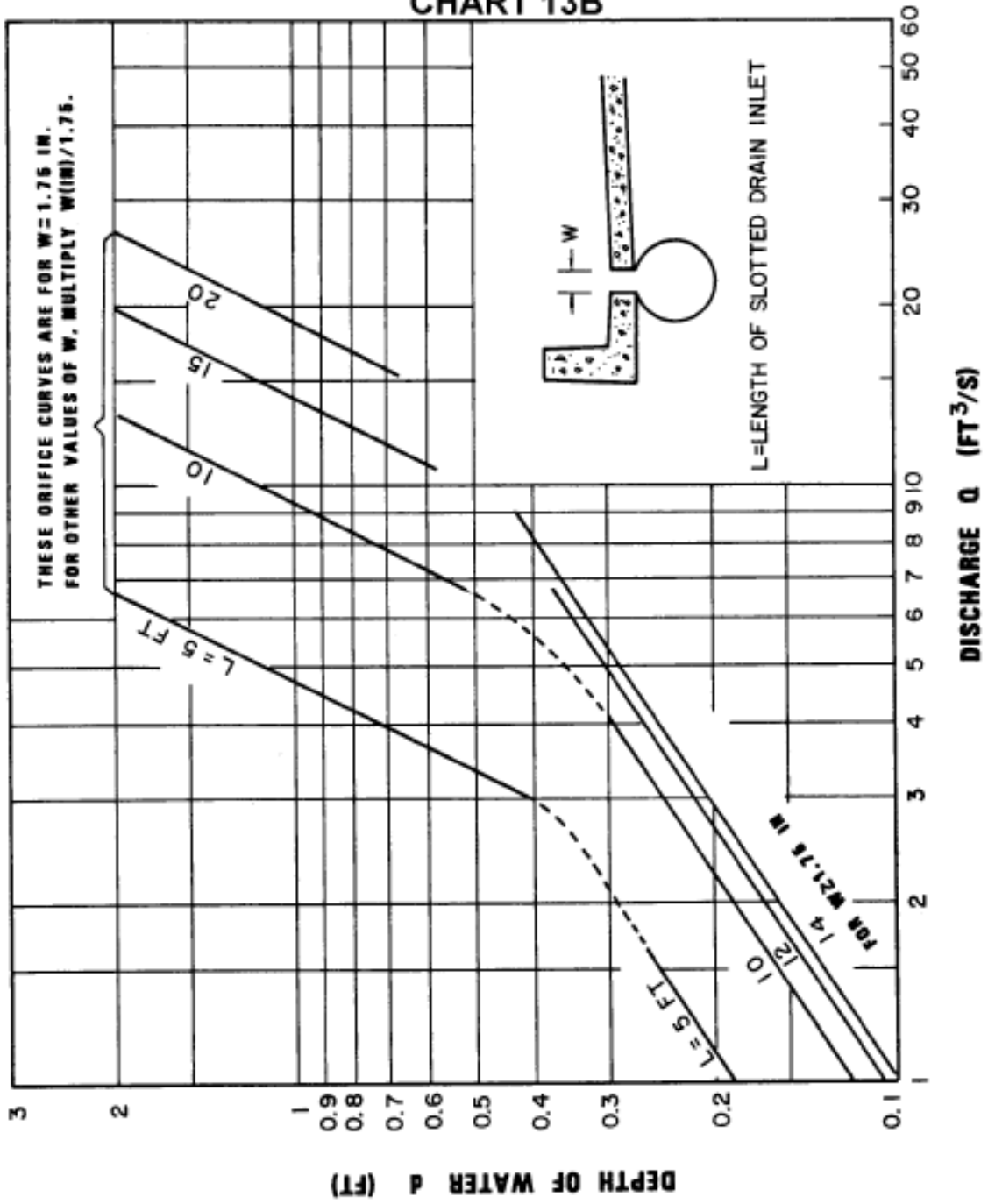
Curb-opening Inlet Orifice Capacity for Inclined and Vertical Orifice Throats - English Units

### CHART 13A



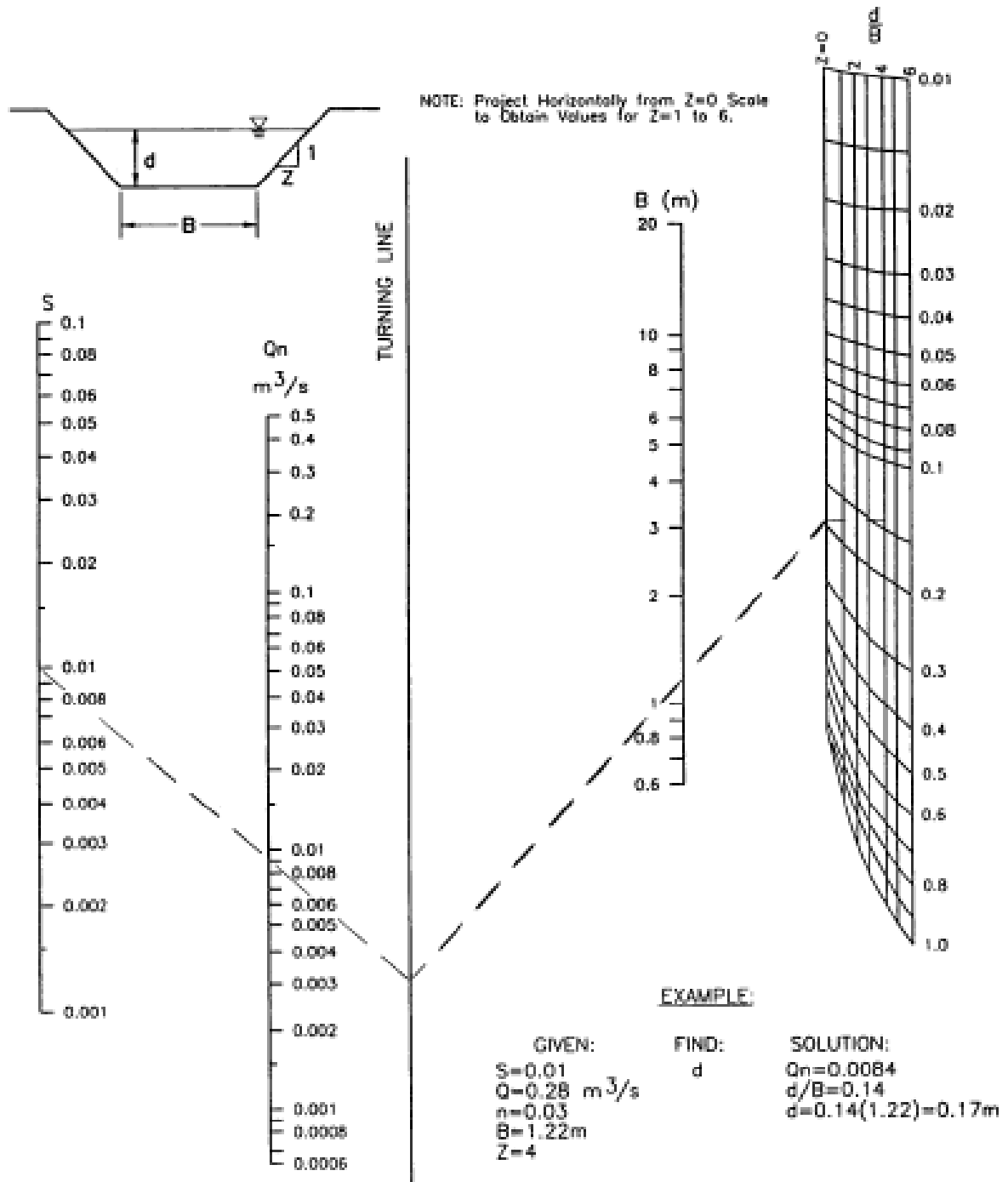
Slotted Drain Inlet Capacity in Sump Locations.

CHART 13B



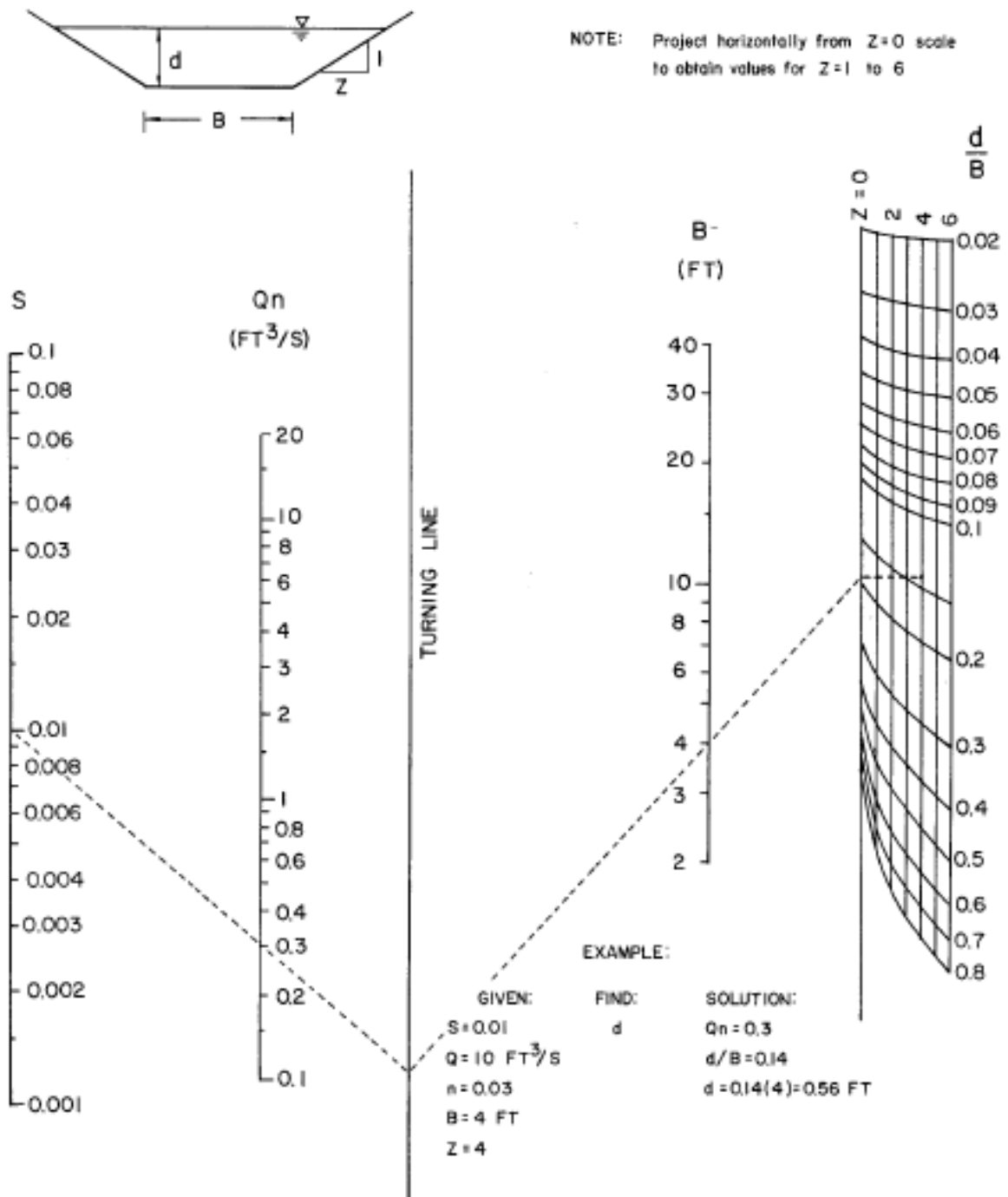
Slotted Drain Inlet Capacity in Sump Locations - English Units

CHART 14A



Solution to Manning's Equation for Channels of Various Side Slopes.

CHART 14B



Solution to Manning's Equation for Channels of Various Side Slopes - English Units

### CHART 15A

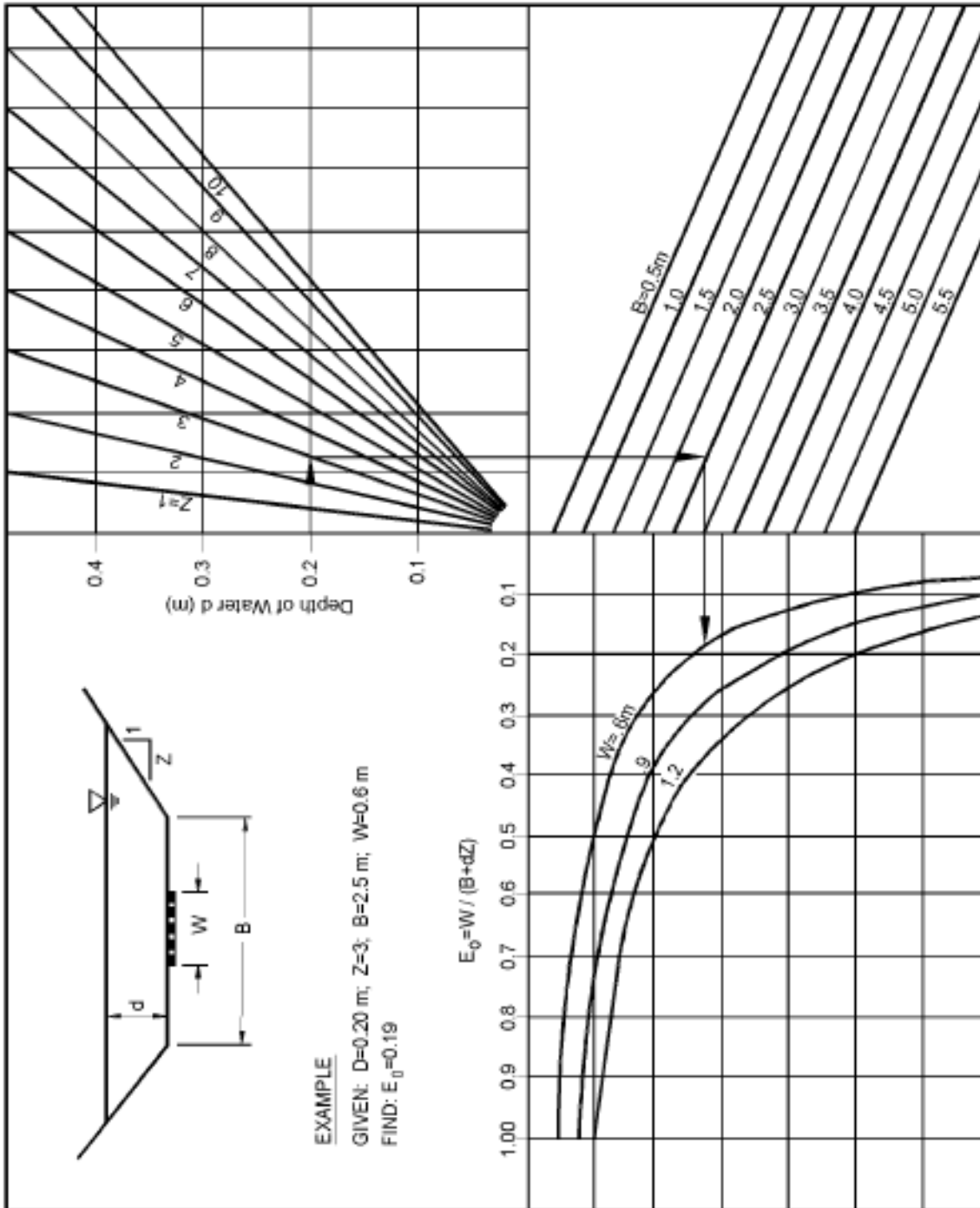




CHART 15B

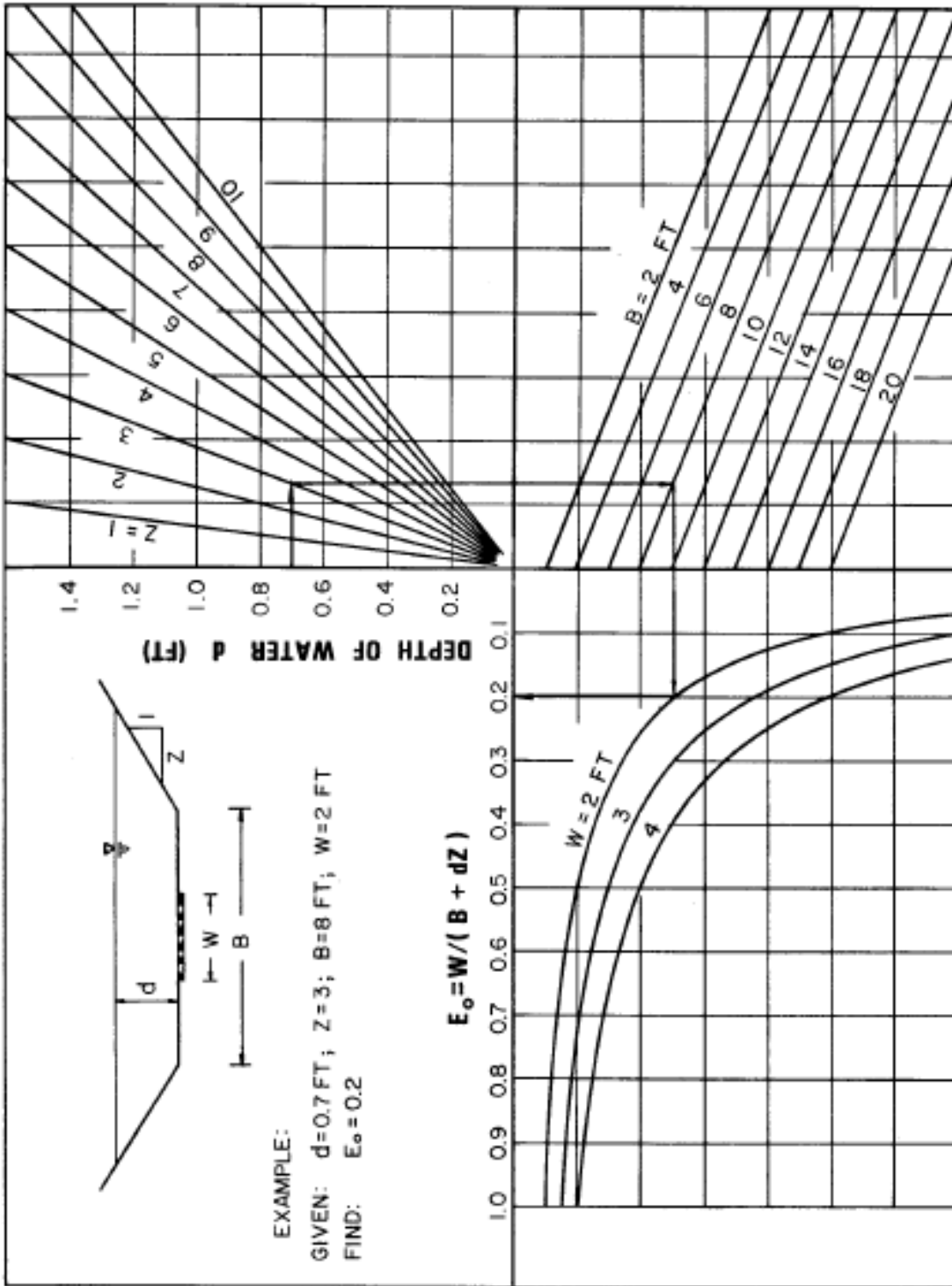
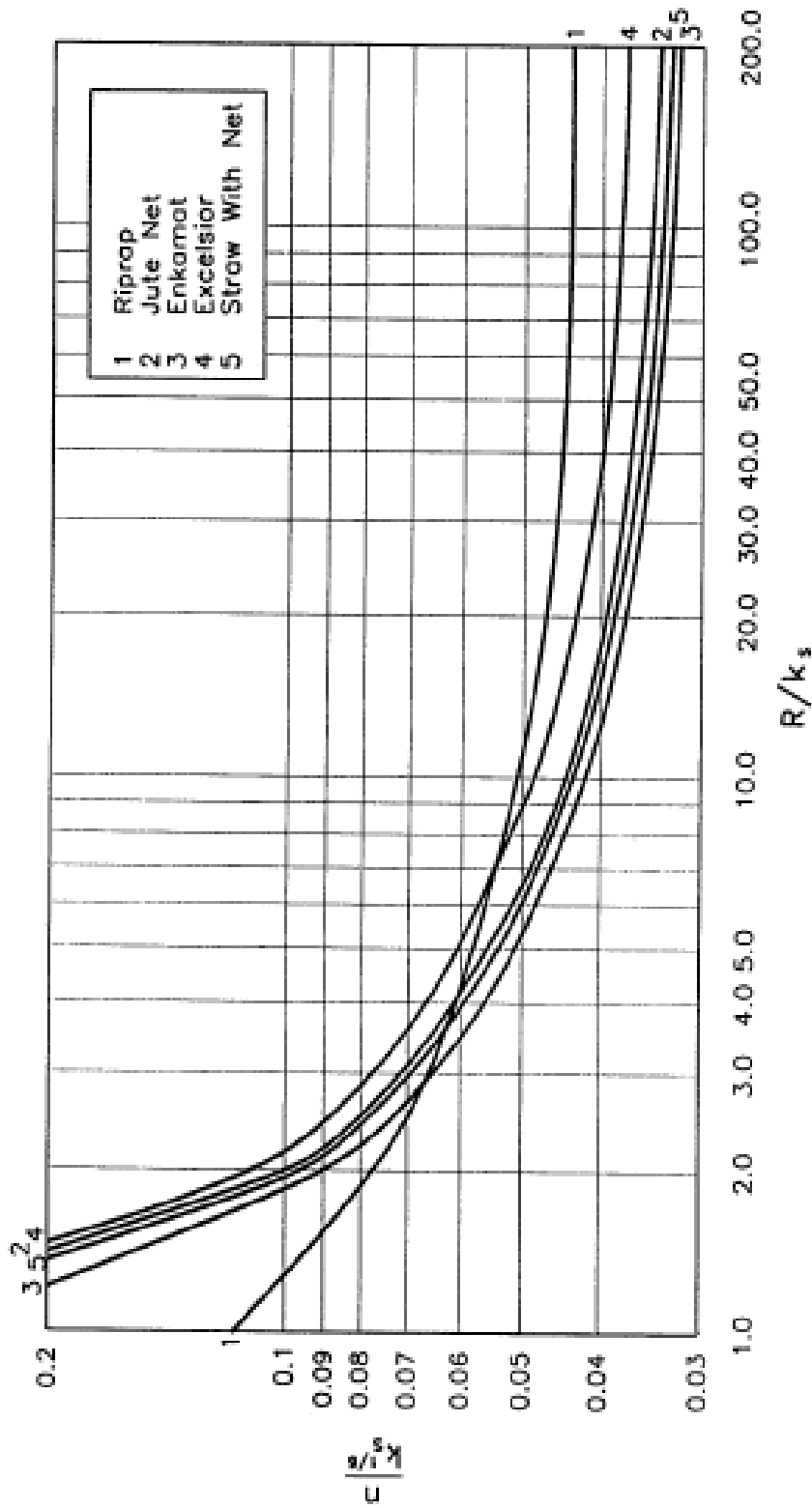
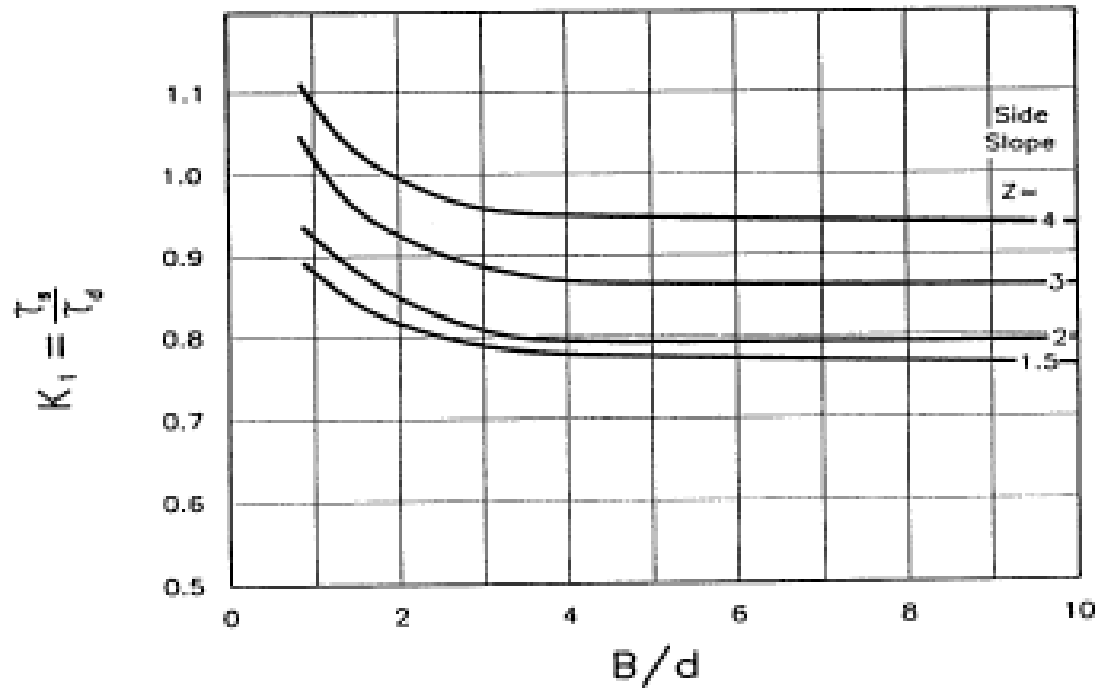


CHART 16



Manning's n Versus Relative Roughness  
For Selected Lining Types

### CHART 17



Channel Side Shear Stress To Bottom Shear Stress Ratio,  $K_1$ .

### CHART 18

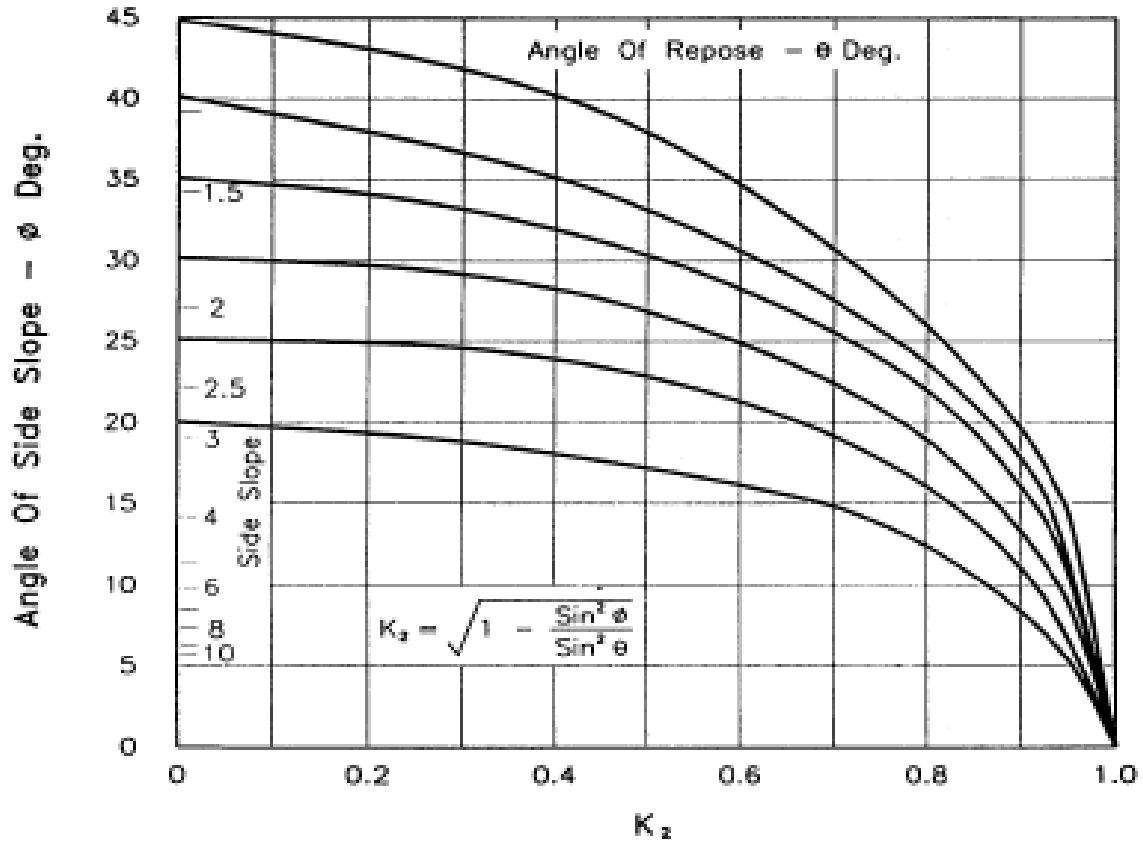
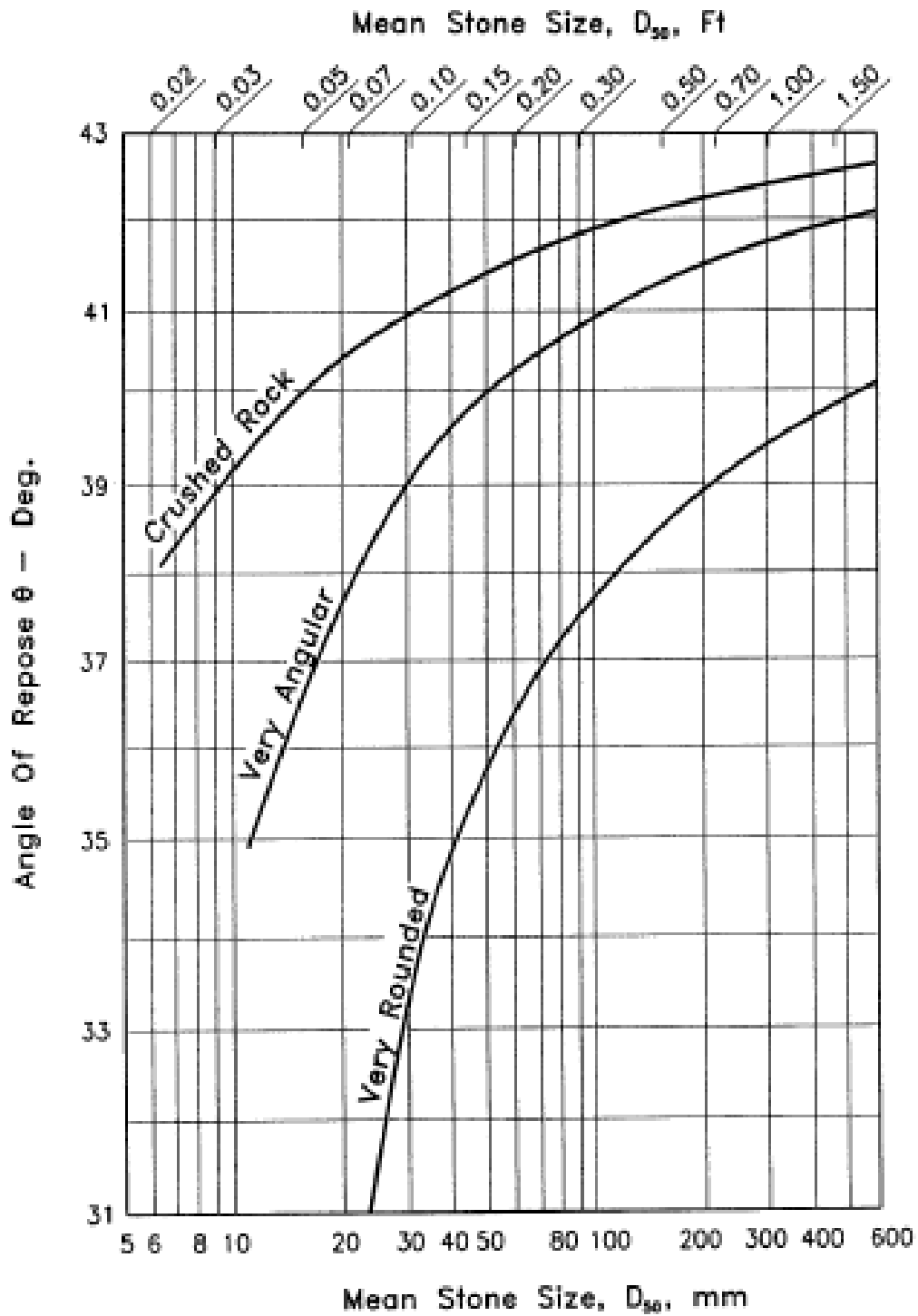


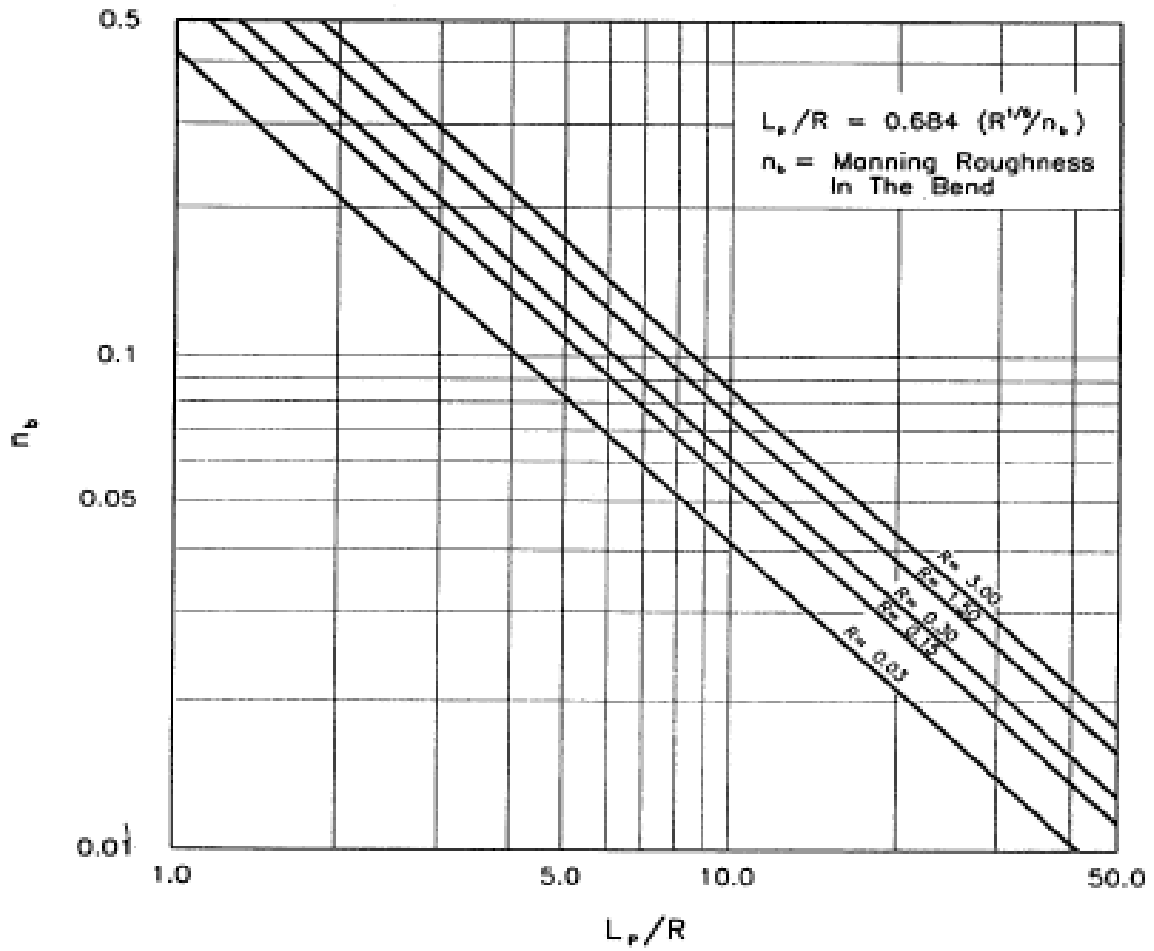
Chart 18. Tractive Force Ratio,  $K_2$ .

### CHART 19



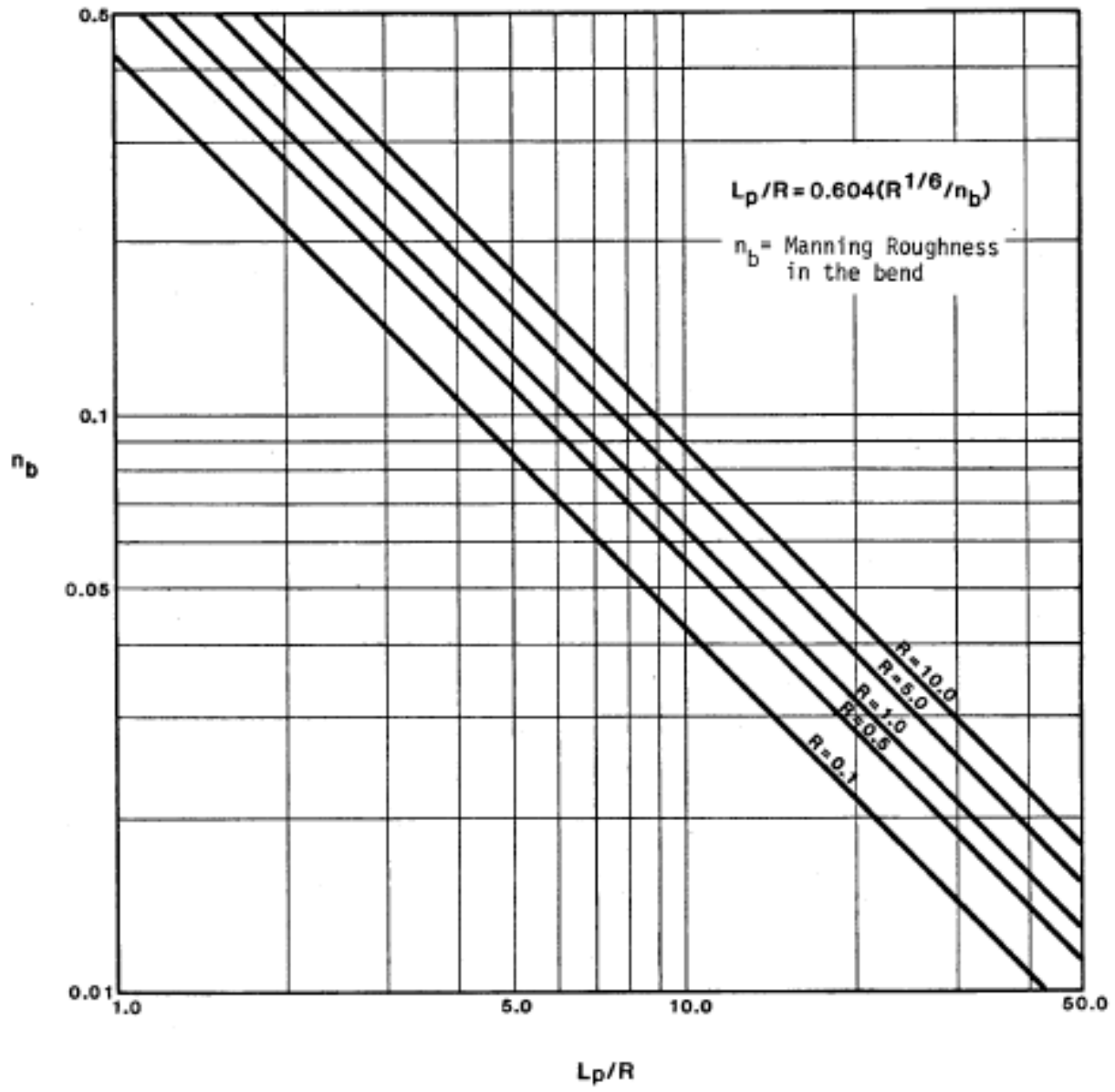
Angle Of Repose Of Riprap In Terms Of Mean Size  
And Shape Of Stone.

### CHART 20A



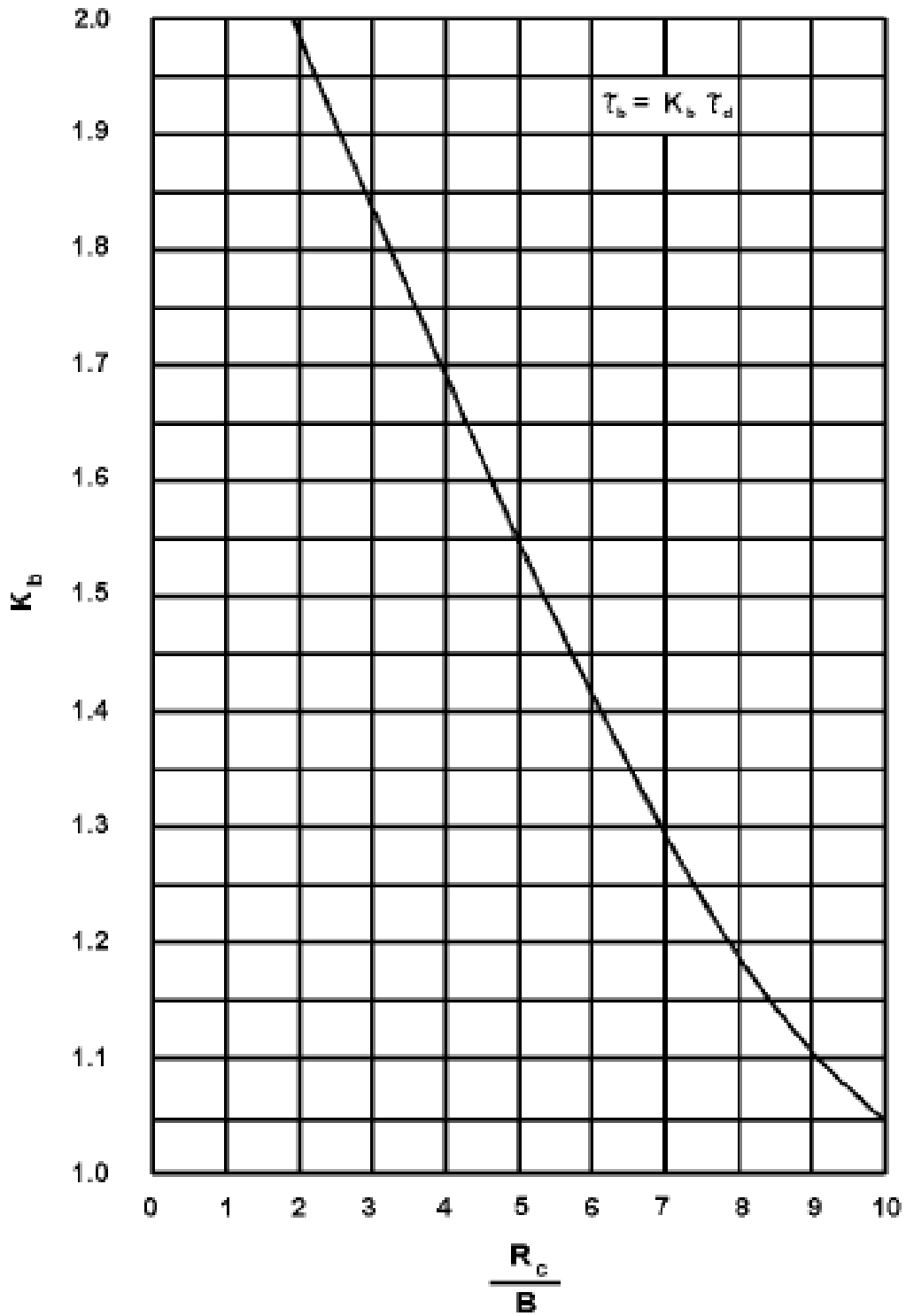
Protection Length,  $L_p$ , Downstream Of Channel Bend (11)

CHART 20B



Protection Length,  $L_p$ , Downstream of Channel Bend<sup>(1)</sup> - English Units

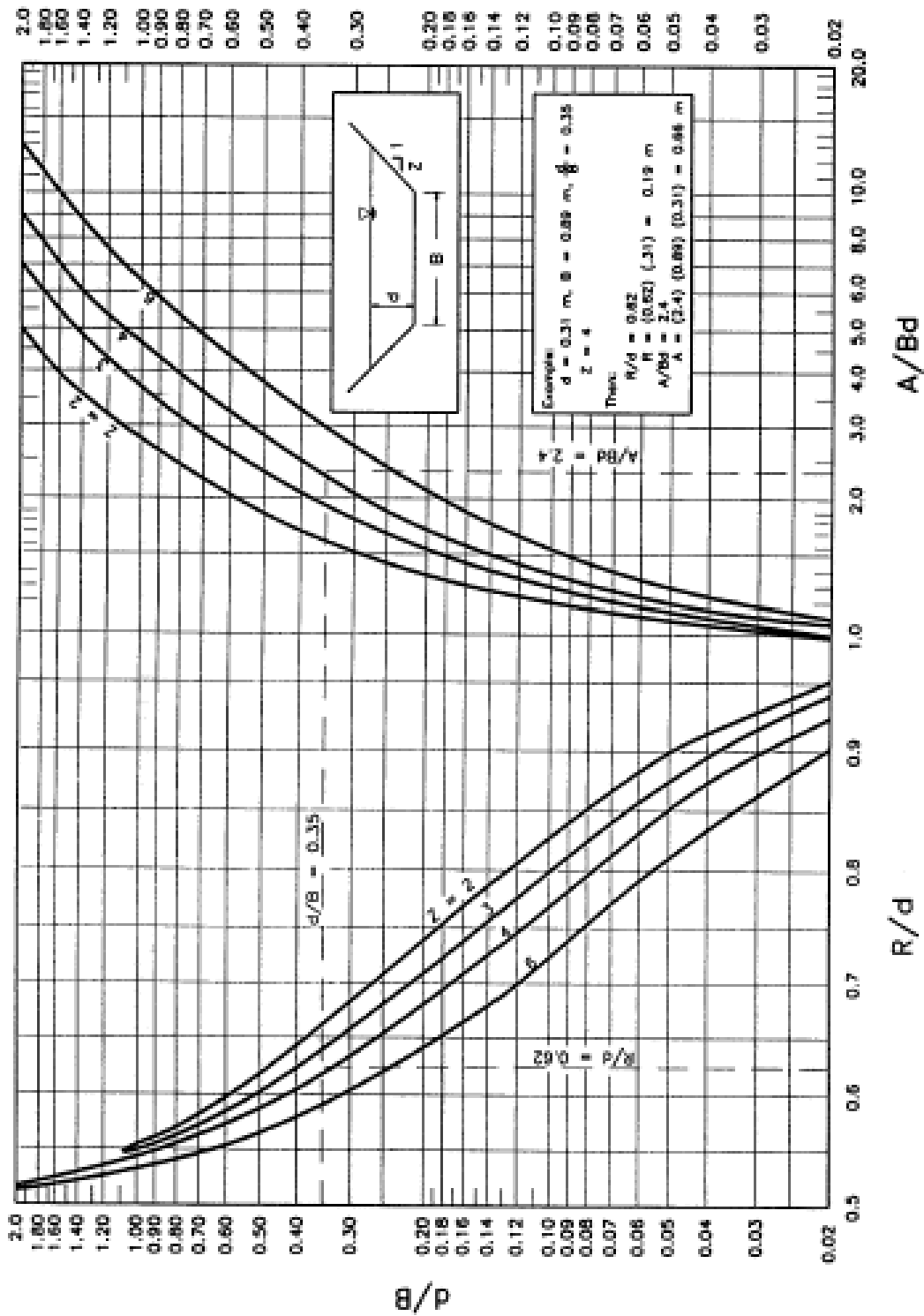
CHART 21



**$K_b$  Factor For Maximum Shear Stress  
On Channel Bends. (12)**

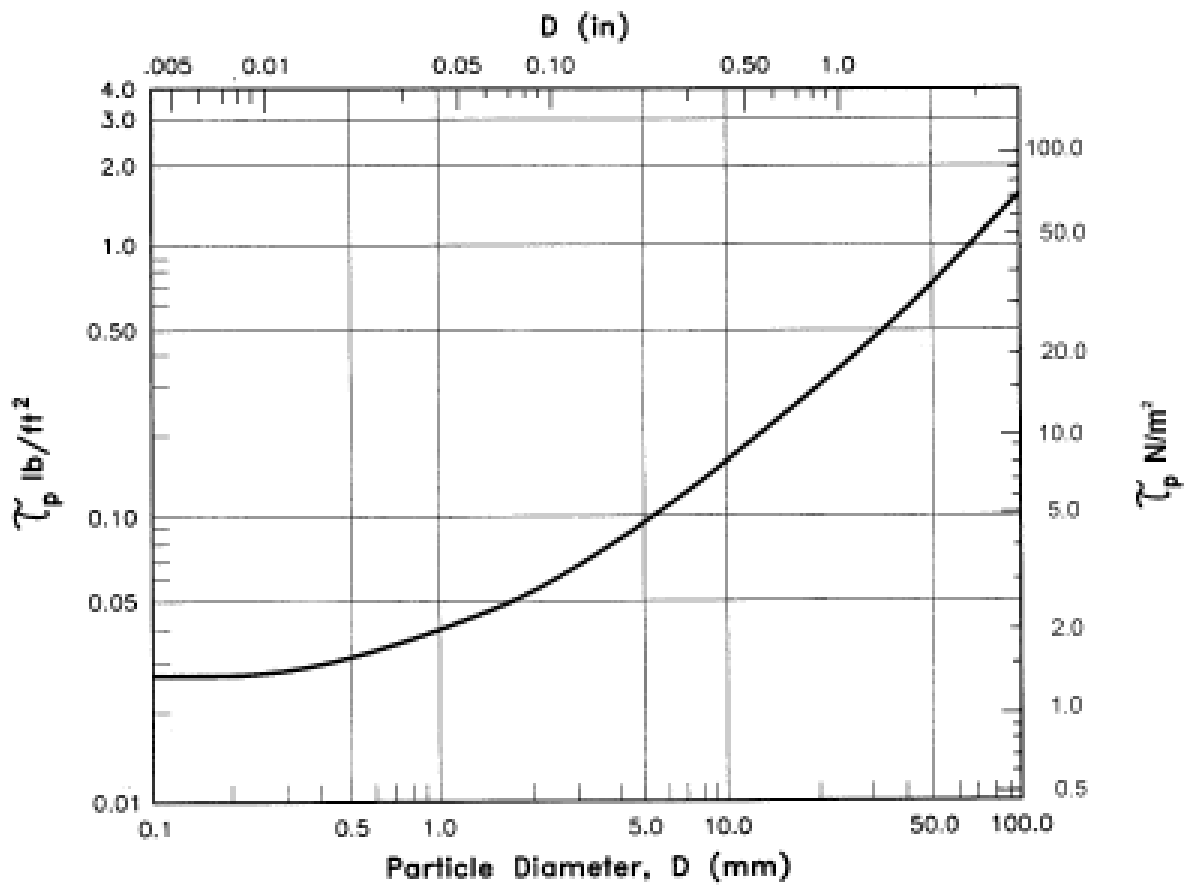


CHART 22



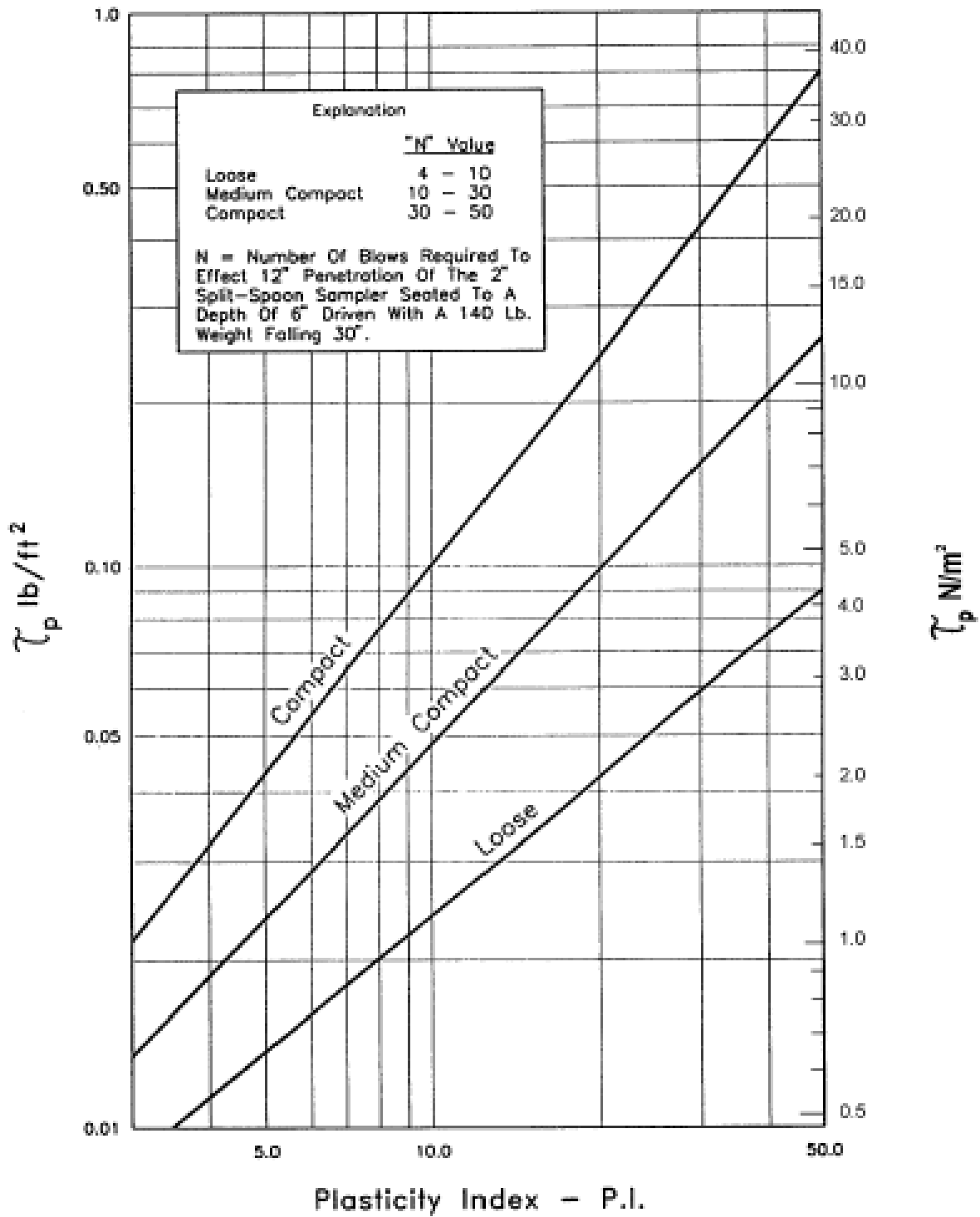
Geometric Design Chart For Trapezoidal Channels.

### CHART 23



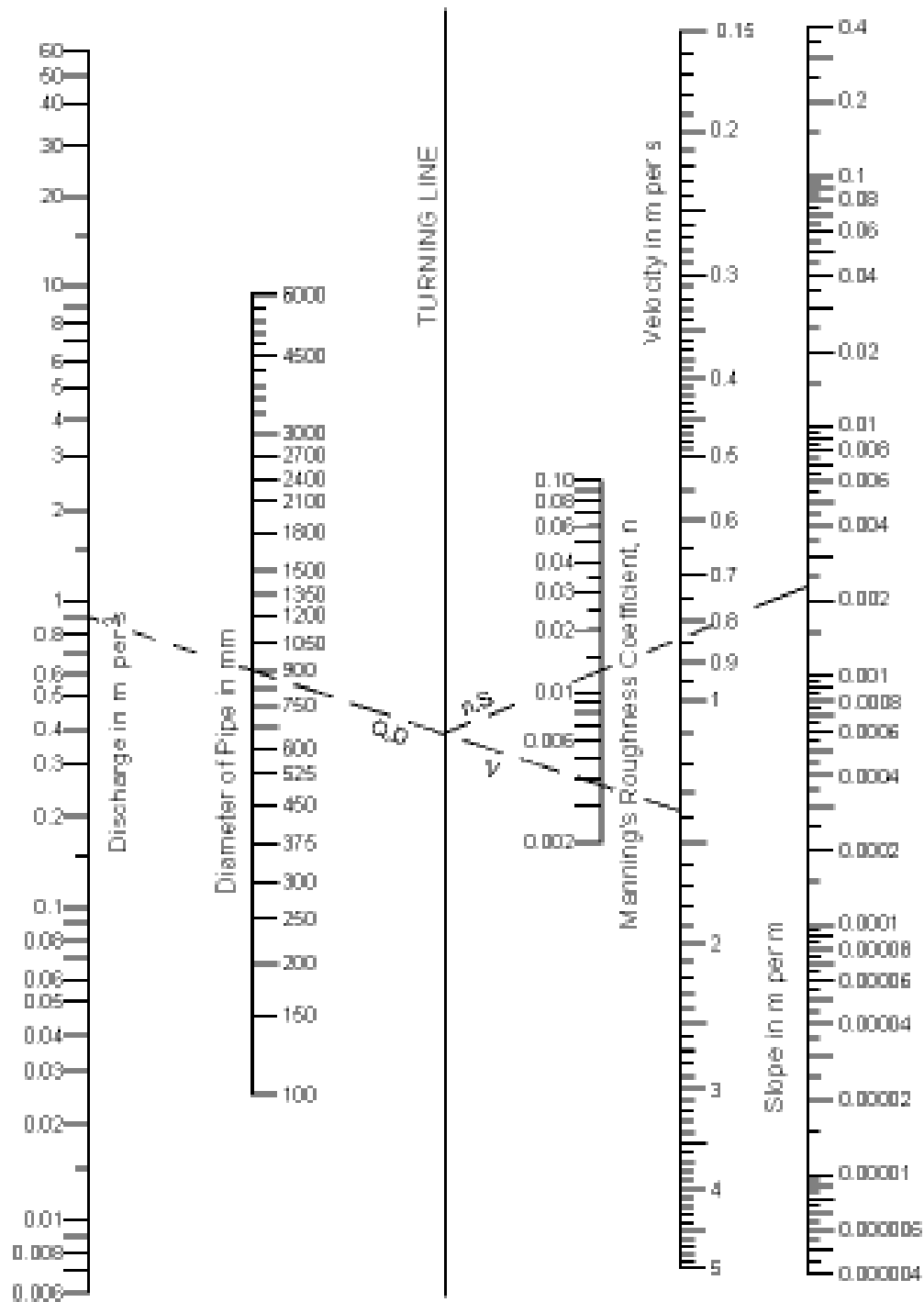
Permissible Shear Stress For Non-cohesive Soils. (After 15)

CHART 24



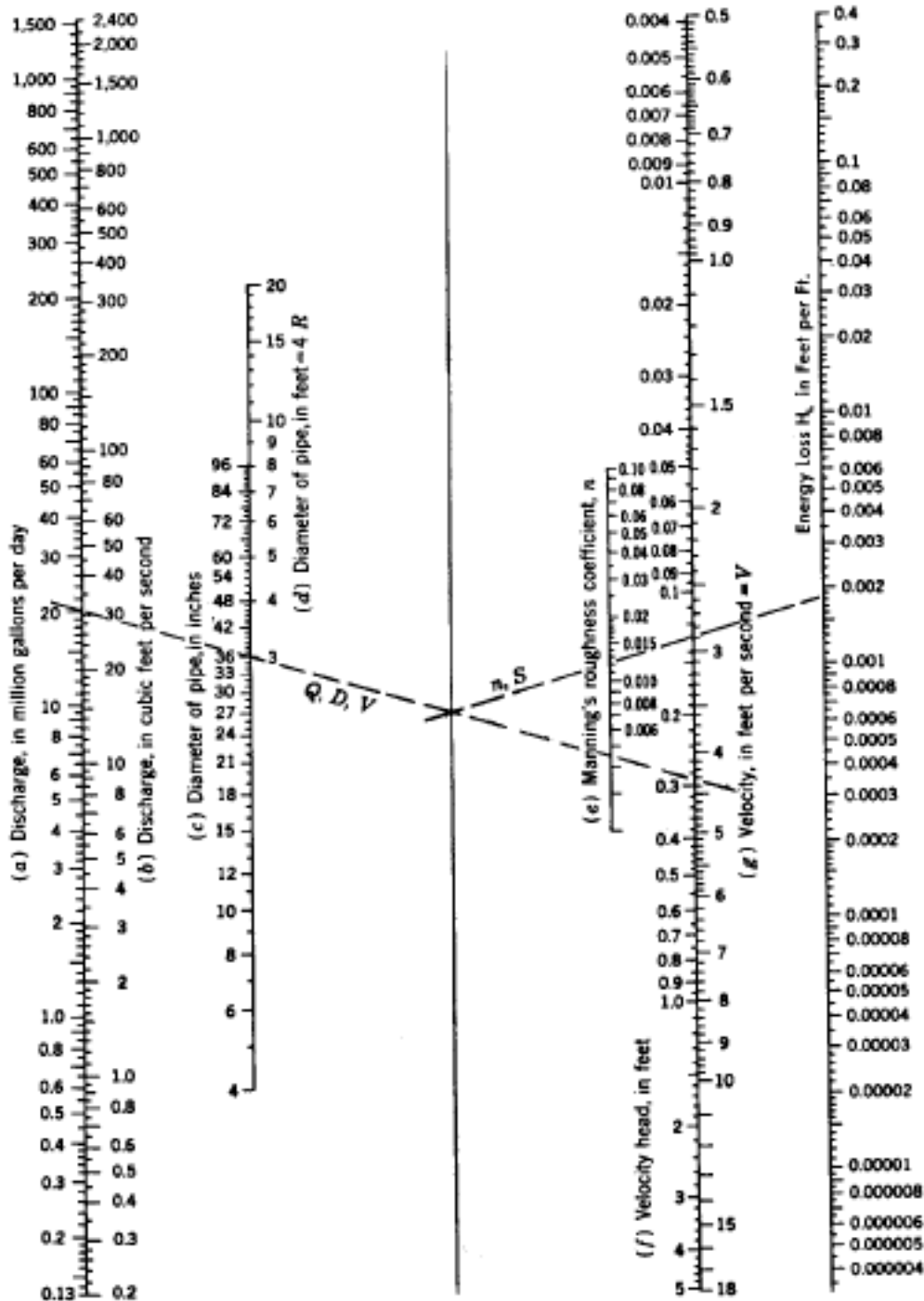
Permissible Shear Stress For Cohesive Soils.

# CHART 25A



Solution of Manning's Equation for flow in Storm Drains.

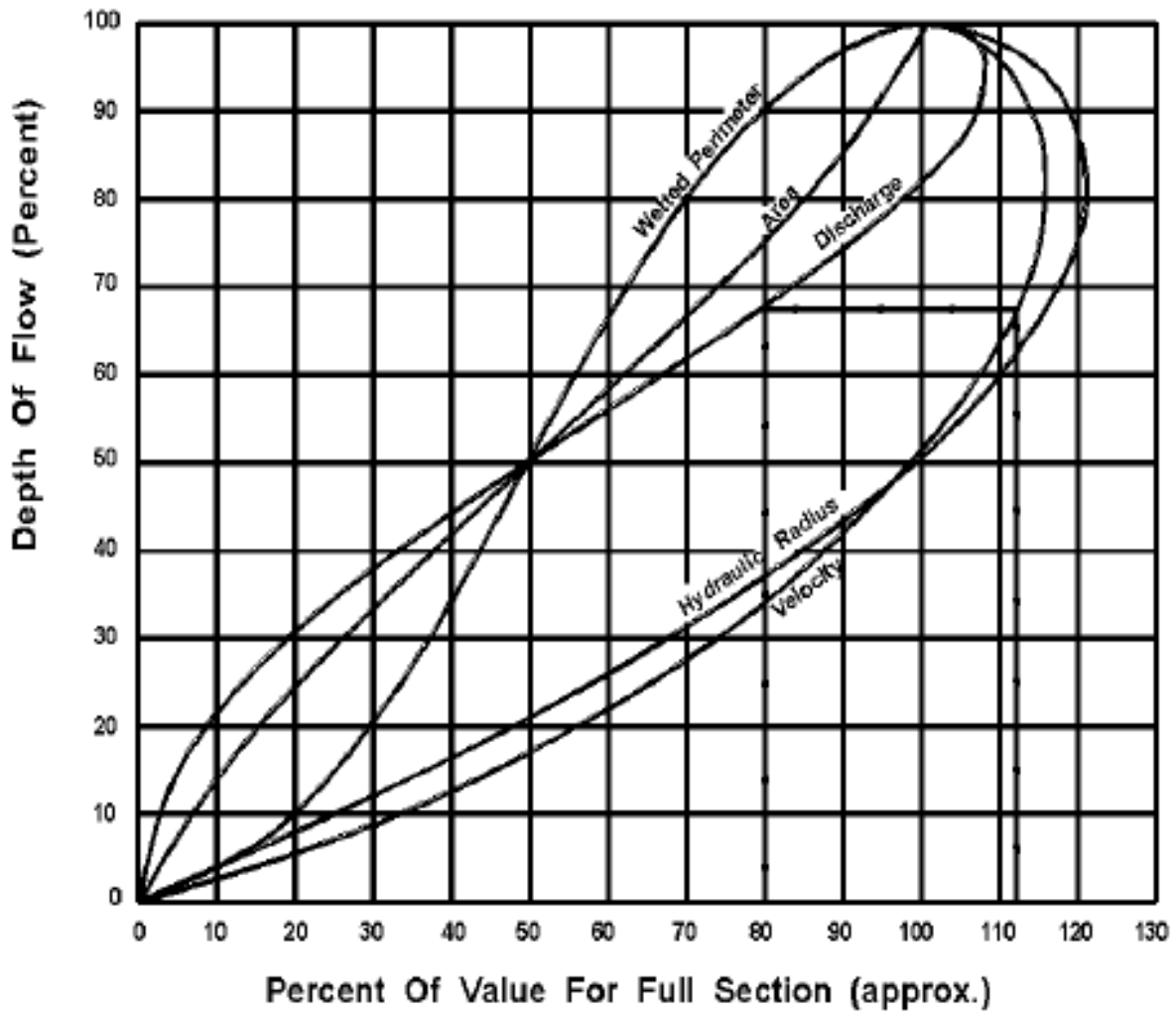
CHART 25B



Alignment chart for energy loss in pipes, for Manning's formula.  
Note: Use chart for flow computations,  $H_e = S$

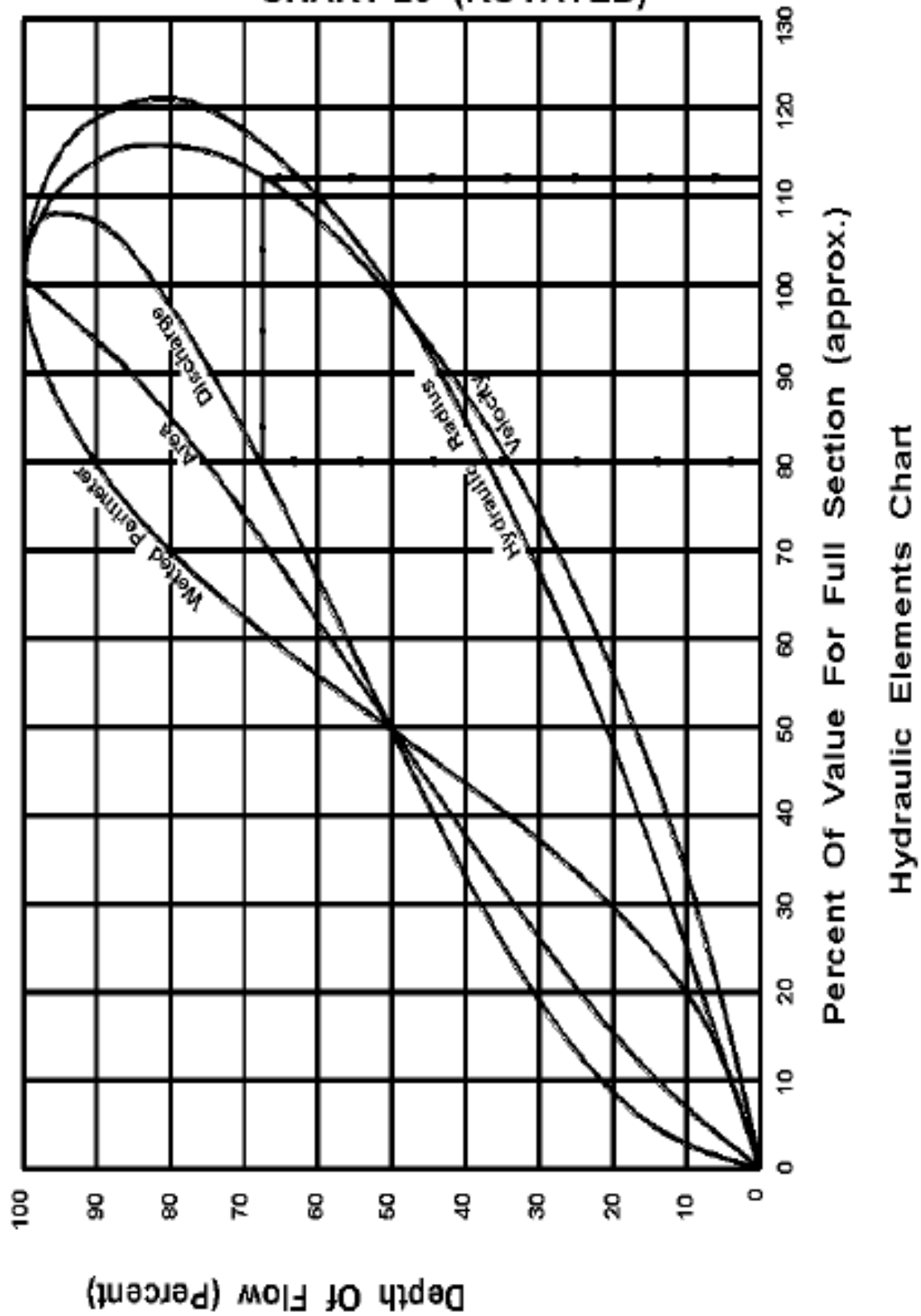
Solution of Manning's Equation for Flow in Storm Drains - English Units  
(Taken from "Modern Sewer Design" by American Iron and Steel Institute)

### CHART 26



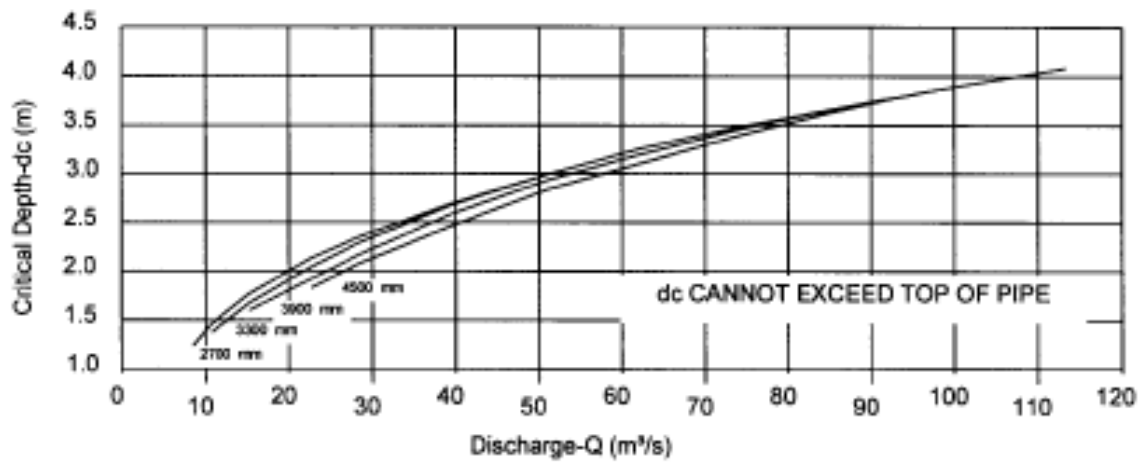
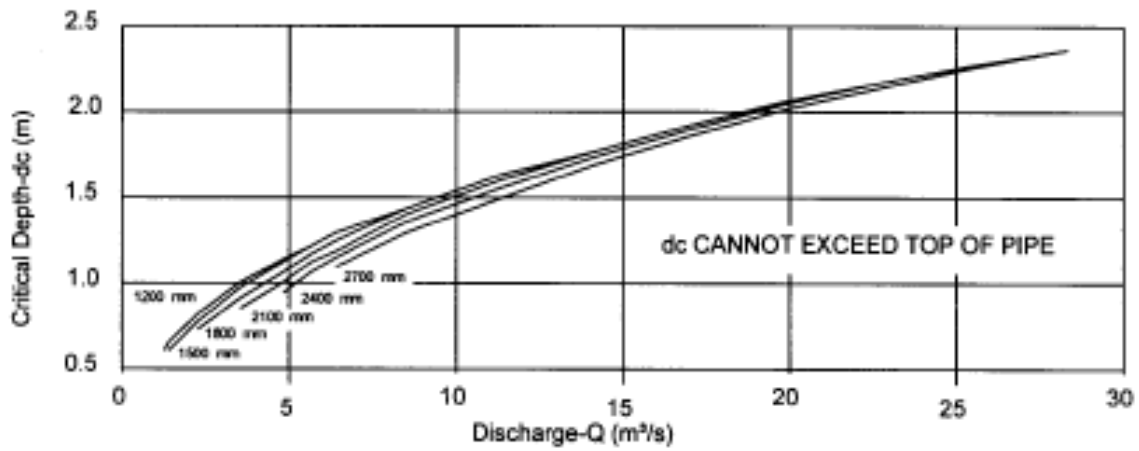
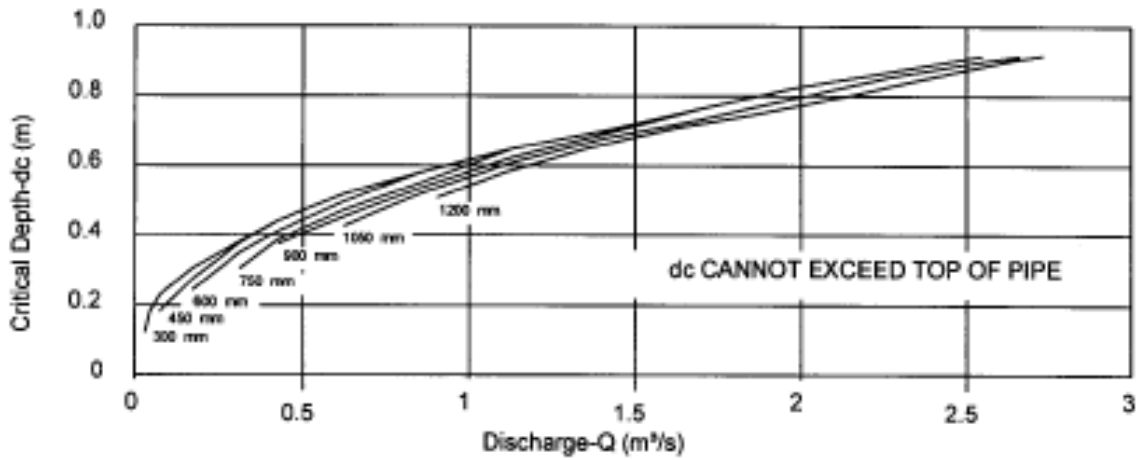
Hydraulic Elements Chart

CHART 26- (ROTATED)



Hydraulic Elements Chart

### CHART 27A

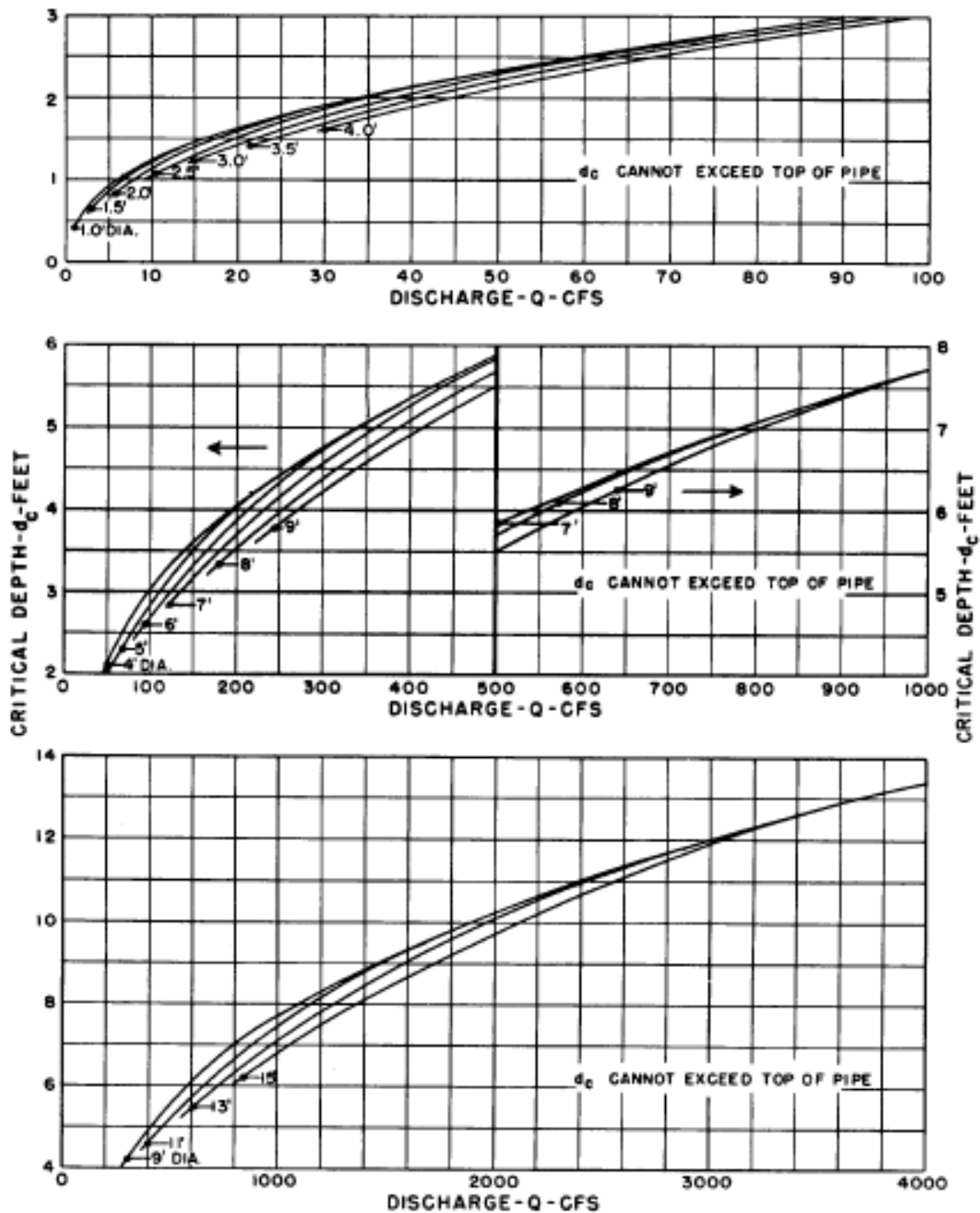


Adapted from Bureau of Public Roads

**Critical Depth-Circular Pipe**



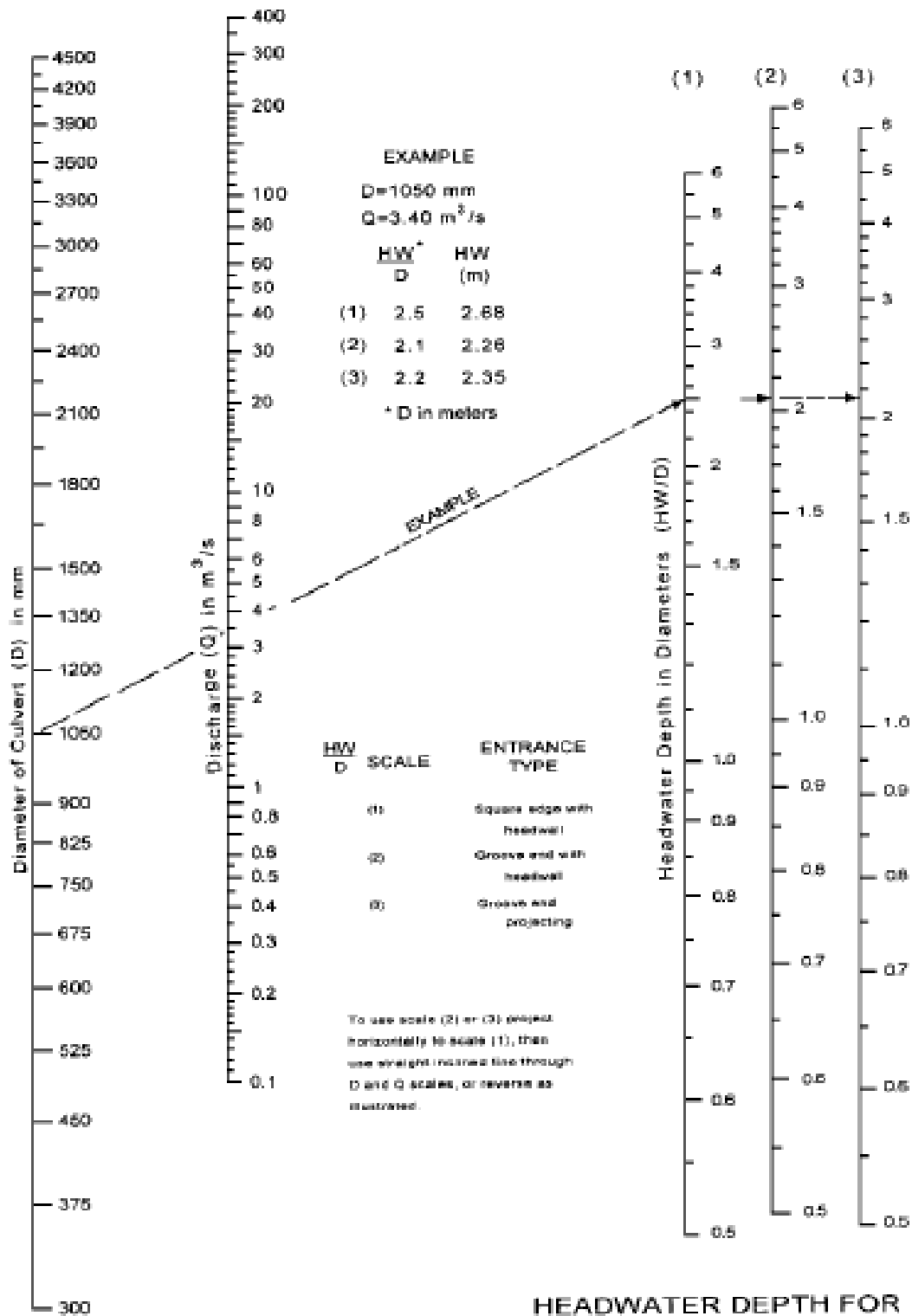
### CHART 27B



BUREAU OF PUBLIC ROADS  
JAN. 1964

Chart 27B. Critical Depth in Circular Pipe - English Units

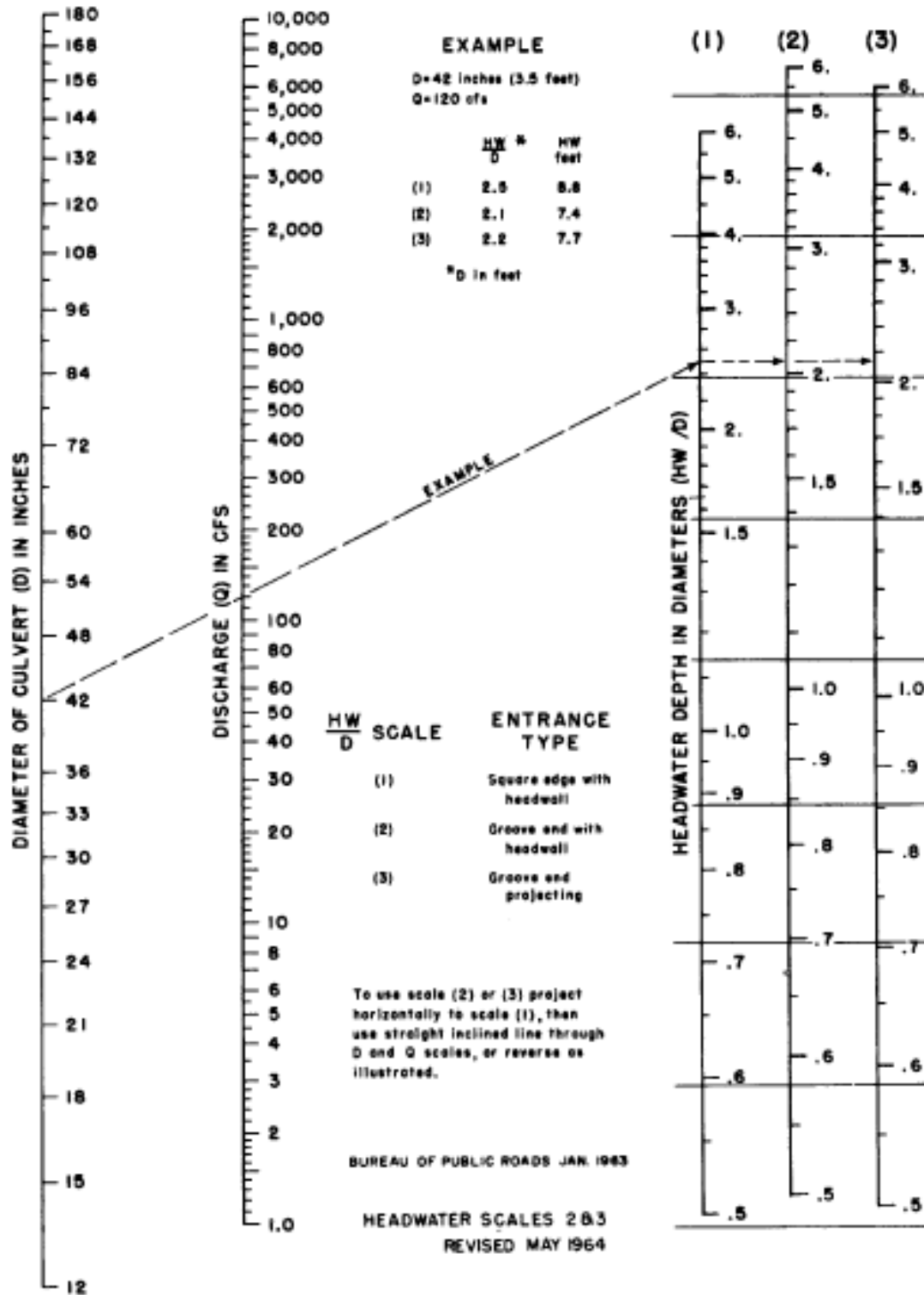
### CHART 28A



Adapted from Bureau of Public Roads Jan. 1963

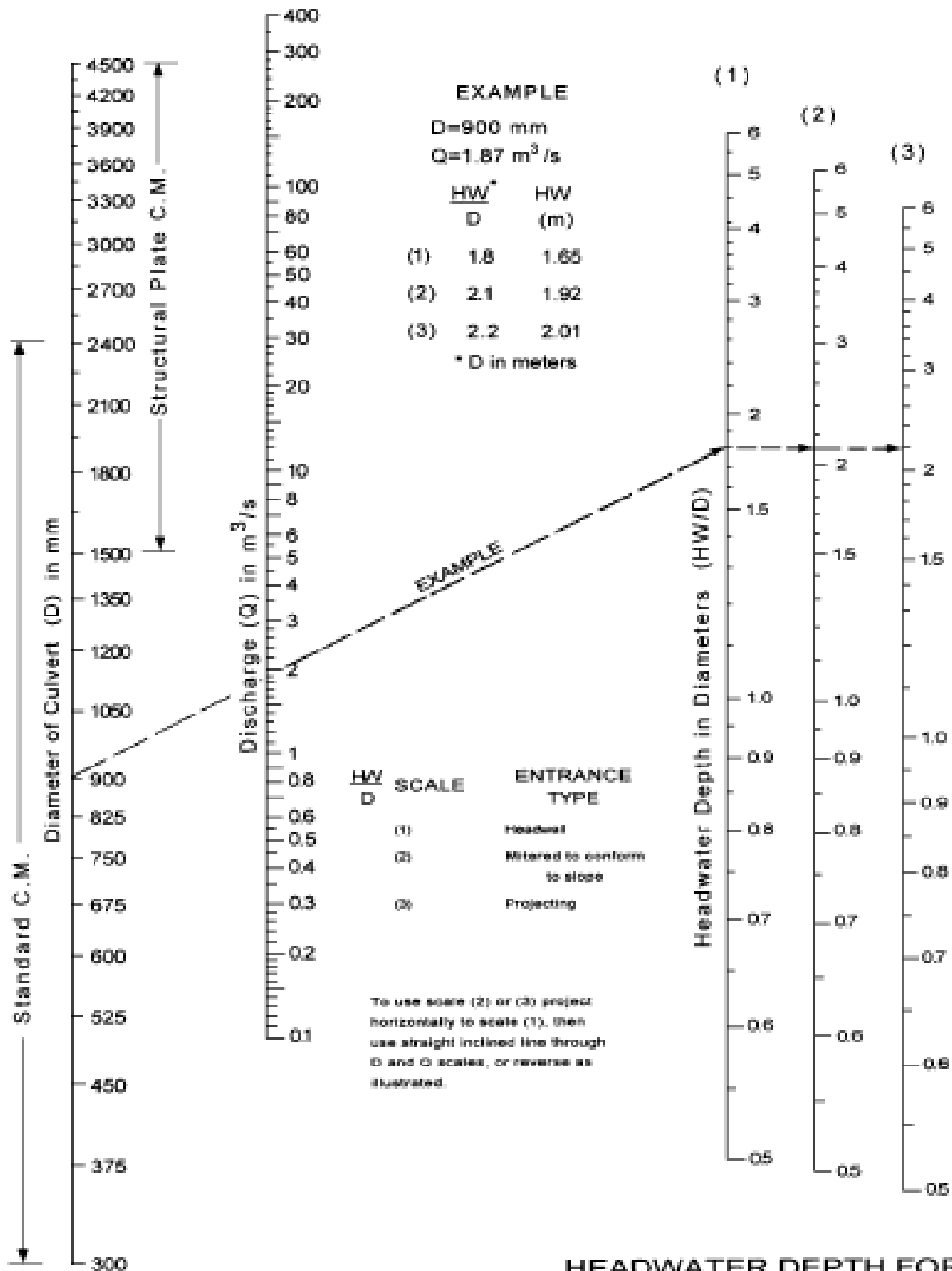
**HEADWATER DEPTH FOR CONCRETE PIPE CULVERTS WITH INLET CONTROL**

### CHART 28B



Headwater Water Depth for Concrete Pipe Culverts with Inlet Control - English Units

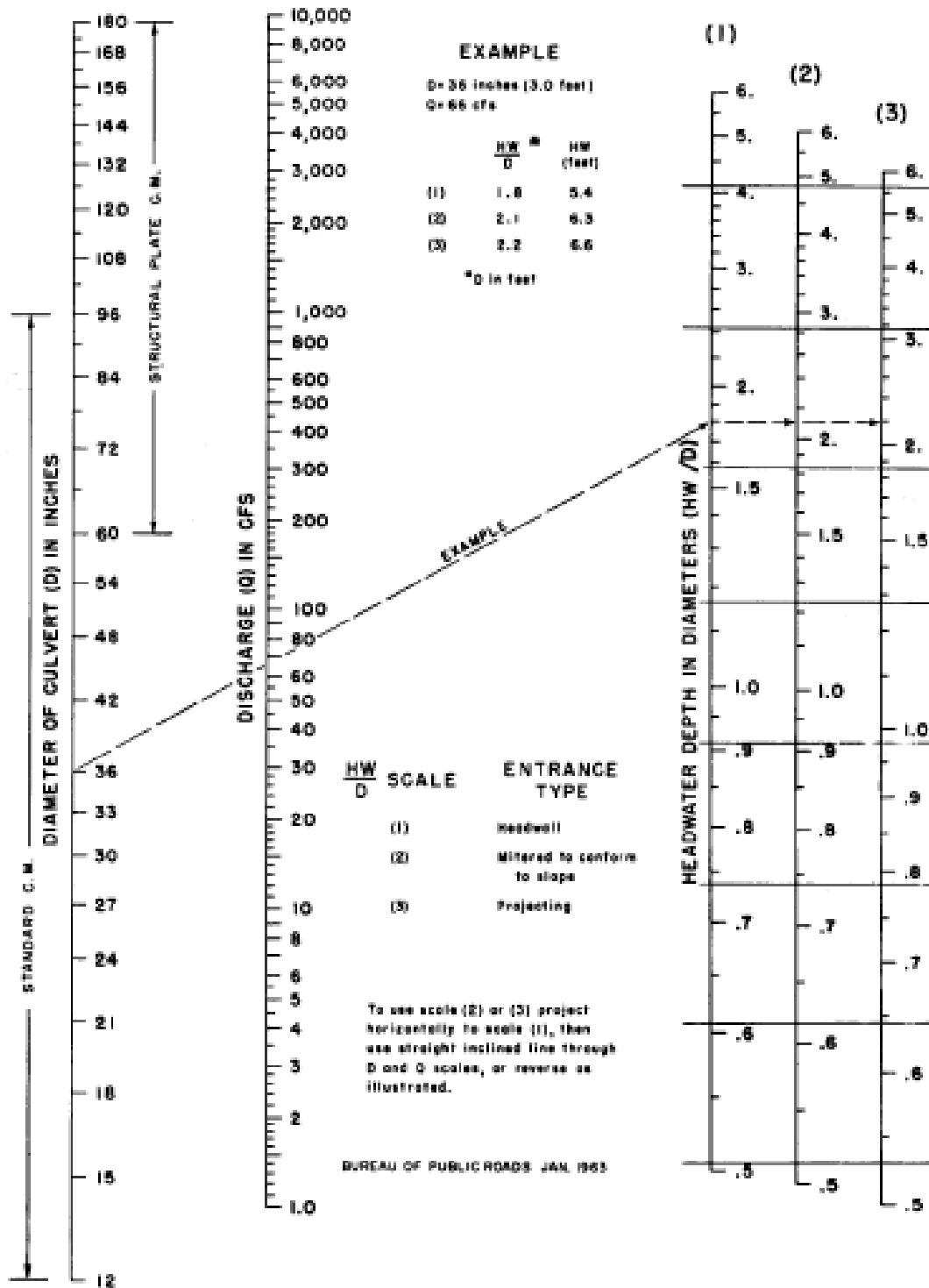
### CHART 29A



**HEADWATER DEPTH FOR  
C.M. PIPE CULVERTS  
WITH INLET CONTROL**

Adapted from  
Bureau of Public Roads Jan. 1953

### CHART 29B



Headwater Depth for C. M. Pipe Culverts with Inlet Control - English Units

APPENDIX C

LIST OF SYMBOLS

Symbol	Description	Units, English
a	Regression constant	--
a	Gutter depression	in.
A	Cross sectional area of flow	ft <sup>2</sup>
A	Drainage area	acres
A	Sub-basin drainage area	mi <sup>2</sup>
A <sub>c</sub>	The most downstream part of the larger primary area that will contribute to the discharge during the time of concentration associated with the smaller, less pervious area	acres
A <sub>g</sub>	Clear opening area of the grate	ft <sup>2</sup>
A <sub>k</sub>	Basin area	sq mi
A <sub>s</sub>	Contributing drainage area	sq mi
A <sub>w</sub>	Flow area in depressed gutter width	ft <sup>2</sup>
A' <sub>w</sub>	Gutter flow area in a width equal to the grate width	ft <sup>2</sup>
A,B,C	Basin characteristics	--
B	Bottom width of channel	ft
b, c, d	Regression coefficients	--
C	Dimensionless runoff coefficient	--
C <sub>o</sub>	Orifice coefficient	--
C <sub>w</sub>	Weir coefficient	--
CN	Curve number	--
d	Depth of flow	ft
d	Average depth across the grate: 0.5 (d <sub>1</sub> + d <sub>2</sub> ),	ft
d	Depth at curb measured from the normal cross slope, (d=T S <sub>x</sub> )	ft
D	Culvert height or diameter	ft
d <sub>B</sub>	Depth at point B of a V shaped gutter	ft
d <sub>C</sub>	Depth at point C of a V shaped gutter	ft
d <sub>c</sub>	Critical depth	ft
d <sub>i</sub>	Depth at lip of curb opening	ft
d <sub>o</sub>	Effective head on the center of the orifice throat	ft

Symbol	Description	Units, English
$d_2$	Depth at curb	--
$d_{50}$	Average riprap size	ft
$D_{50}$	Average riprap size	ft
E	Inlet efficiency	percent
$EGL_i$	EGL at the inlet end	
$EGL_o$	EGL at the outlet end	
$E_o$	Ratio of flow in a chosen width (usually the width of a grate) to total gutter flow ( $Q_w/Q$ )	--
$E'_o$	Adjusted frontal flow area ratio for grates in composite cross sections	--
F	Froude number	--
$F_p$	Adjustment factor for pond and swamp areas	--
g	Acceleration due to gravity	32.16 ft/s <sup>2</sup>
$G_i$	Grade of roadway	percent
$G_1$	Approach grade	percent
$G_2$	Approach grade	percent
h	Height of curb-opening inlet or orifice	ft
h	Orifice throat width	ft
H	Head (above weir crest excluding velocity head)	ft
$H_f$	Friction loss	ft
$h_o$	Head measured as the distance from the culvert invert (flow line) at the outlet to the control elevation	ft
I	Rainfall intensity	in/hr
IA	Percent of basin occupied by impervious surfaces	percent
$I_a$	Initial abstraction	in
k	Intercept coefficient (Table 2-3)	--
K	Vertical curve constant, rate of vertical curvatures	ft/ percent
$K_c$	Empirical coefficient equal to .933	--
$K_e$	Entrance loss coefficient	--
L	Curb opening length	ft
L	Flow length	ft
L	Horizontal length of curve	ft
L	Actual culvert length	--
$L_T$	Curb opening length required to intercept 100 percent of the gutter flow	ft

Symbol	Description	Units, English
$L_1$	Adjusted culvert length	--
$n$	Hydraulic resistance variable	--
$n$	Manning's roughness coefficient	--
$n_1$	Desired $n$ value	--
$P$	Depth of 24-hr precipitation	in
$P$	Perimeter of the grate disregarding the side against the curb	ft
$q$	Hydrograph ordinate for a specific time	ft <sup>3</sup> /s
$Q$	Flow	ft <sup>3</sup> /s
$Q'$	One half the total flow	--
$q_a$	Adjusted peak flow	ft <sup>3</sup> /s
$q_p$	Peak flow	ft <sup>3</sup> /s
$q_t$	Tabular hydrograph unit discharge from appropriate table (SCS TR-55 manual)	ft <sup>3</sup> /s/mi <sup>2</sup> /in
$q_u$	Unit peak flow	ft <sup>3</sup> /s/mi <sup>2</sup> /in
$Q_b$	Bypass flow	ft <sup>3</sup> /s
$Q_D$	Depth of direct runoff	in
$Q_i$	Intercepted flow, interception flow capacity, inflow, flow capacity	ft <sup>3</sup> /s
$Q_s$	Flow capacity of the gutter section above the depressed section	ft <sup>3</sup> /s
$Q_w$	Flow rate in the depressed section of the gutter	ft <sup>3</sup> /s
$R$	Hydraulic radius (flow area divided by the wetted perimeter)	ft
$RI_2$	Rainfall intensity for 2-hr, 2-yr recurrence	in/hr
$RQ_T$	T-year rural peak flow	ft <sup>3</sup> /s
$R_f$	Ratio of frontal flow intercepted to total frontal flow	--
$R_s$	Ratio of side flow intercepted to total side flow	--
$S$	Surface slope	ft/ft
$SL$	Main channel slope (measured between points that are 10 and 85 percent of the main channel length upstream of the site)	ft/mi
$S_L$	Longitudinal slope	ft/ft
$ST$	Basin storage (percentage of basin occupied by lakes, reservoirs, swamps, and wetlands)	percent
$S_e$	Equivalent cross slope	ft/ft



Symbol	Description	Units, English
$S_p$	Slope	percent
$S_R$	Retention	in
$S_w$	Cross slope of the depressed gutter	ft/ft
$S'_w$	Cross slope of the gutter measured from the cross slope of the pavement, $S_x$	ft/ft
$S_x$	Cross slope	ft/ft
$t$	Time	--
$t_b$	Time base	hr
$t_c$	Time of concentration	hr
$t_{c1}$	Time of concentration of the smaller, less pervious tributary area	hr
$t_{c2}$	Time of concentration associated with the larger primary area	hr
$t_p$	Time to peak	hr or s
$T$	Distance of the spread, width of flow (spread)	ft
$T'$	Hypothetical spread	ft
$T'$	One half the total spread	ft
$T_a$	Spread at the average velocity in a triangular gutter	ft
$T_s$	Width of spread from the junction of the gutter and the road to the limit of the spread	--
$T_{ti}$	Travel time	min
$T_{ti1}$	Segment 1, sheet flow, travel time	min
$T_{ti2}$	Segment 2, shallow concentration flow, travel time	min
$T_{ti3}$	Segment 3, conduit flow, travel time	min
$T_1$	Spread at the upstream end of the triangular gutter section	ft
$T_2$	Spread at the downstream end of the triangular gutter section	ft
$UQ_T$	Urban peak discharge for T-year recurrence interval	ft <sup>3</sup> /s
$V$	Velocity, frontal flow efficiency	ft/s
$V_a$	Average velocity	ft
$V_o$	Gutter velocity where splash-over first occurs	ft/s
$W$	Width of gutter, width of grate	ft
$x$	Subscript designating values for incremental areas with consistent land cover	--
$X$	Distance from sag point	--

Symbol	Description	Units, English
y	Depth of water in the channel	--
Y	Depth of ponding	--
Y <sub>f</sub>	Depth at the flanking inlet	--
z	Horizontal distance of the side slope to a rise of 1 ft. vertical	ft
<	Less than	--
≤	Equal to or less than	--
>	Greater than	--
≥	Equal to or greater than	--
=	Equals	--
%	Percent	--
°	Degree	--
Φ	Diameter	--

## APPENDIX D

### BIBLIOGRAPHY

- A Policy on Design of Urban Highways and Arterial Streets, American Association of State Highway Officials, 1973.
- Ables, J. H., Jr., "Divide Cut Drainage Structures, Tennessee-Tombigbee Waterway, Mississippi and Alabama," Technical Report H-76-18, U. S. Army Engineer Waterways Experiment Station, Vicksburg, Mississippi, 1976.
- American Association of State Highway and Transportation Officials, Guidelines for the Hydraulic Design of Culverts, Task Force on Hydrology and Hydraulics, 1975.
- Baker, R. F., Byrd, L. C., and Mickle, D. C., Handbook of Highway Engineering, Van Nostrand Reinhold, New York, 1974.
- Bauer, W. J., and Beck, E. J., Spillways and Stream-Bed Protection Work, Section 20, Handbook of Applied Hydraulics, ed. By C. V. Davis and K. E. Sorensen, McGraw-Hill, New York, 1969.
- Baumgardner, R. H. 1998. "Overview of Pavement Drainage Systems for Concrete Pavements." Proceedings of the International Symposium on Subdrainage in Roadway Pavements and Subdrains. Grenada, Spain.
- Baumgardner, R. H. and Mathis, D. M., "Experimental Project No. 12, Concrete Pavement Drainage Rehabilitation, State of the Practice," Federal Highway Administration, Pavement Division and Demonstration Projects Division, Washington, DC 20590, April 1989.
- Beichley, C. L., Hydraulic Design of Stilling Basin for Pipe or Channel Outlets, Research Report No. 24, U. S. Department of the Interior, Bureau of Reclamation, 1971.
- \_\_\_\_\_ Research Study on Stilling Basins, Energy Dissipators, and Associated Appurtenances, Progress Report No. XIII, Section 14, Modification of Section 6 (Stilling Basin for Pipe or Open Channel Outlets-Basin VI), Report HYD-572, U. S. Department of the Interior, Bureau of Reclamation, 1969.
- Bhowmik, N. C., Stilling Basin Design for Low Froude Numbers, Journal of the Hydraulics Division, ASCE, Vol. 101, No. HY7, 1975.
- Blaisell, F. W., Hydraulics of Closed Conduit Spillways, Technical Papers No. 12 and 18, Series B, University of Minnesota, Hydraulic Laboratory, St. Anthony Falls, Parts I-VII, 1958.
- Bohan, J. P., Erosion and Riprap Requirements at Culvert and Storm-Drain Outlets, Research Report H-70-2, U. S. Army Engineer Waterways Experiment Station, Vicksburg, Mississippi, 1970.

- Bruce, J. P., Atlas of Rainfall Intensity-Duration Frequency Data for Canada, Department of Transportation, Meteorological Branch, Climatological Studies No. 8, 1968.
- Burgi, P. H., Hydraulic Design of Vertical Stilling Wells, Journal of the Hydraulics Division, ASCE, Vol. 101, No. HY7, 1975.
- Calhoun, C. C., Jr., Evaluation of Gasketing Tapes for Waterproofing Structural-Plate Joints and Seams, Technical Report No. 3-779, U. S. Army Engineer Waterways Experiment Station, Vicksburg, Mississippi, 1967.
- \_\_\_\_\_ and Ulery, H. H., Jr., Development of Minimum Pipe-Cover Requirements for C-5A and Other Aircraft Loadings, Miscellaneous Paper S-73-65, U. S. Army Engineer Waterways Experiment Station, Vicksburg, Mississippi, 1973.
- Cedergren, H. R. 1974. Methodology and Effectiveness of Drainage Systems for Airfield Pavements. Technical Report C-13. Champaign, IL: Construction Engineering Research Laboratory.
- Chief, Administration of Hydrometeorological Services, USSR, Atlas of World Water Balance. (In Russian with English Translation of Table of Contents; Large Maps of Continents Showing Annual Precipitation, Distribution of Precipitation, Runoff Coefficients, etc., 1974)
- Chow, V. T. (ed.), Handbook of Applied Hydrology, McGraw-Hill, New York, 1964.
- Chow, V. T., Hydrologic Determination of Waterway Areas for Design of Drainage Structures in Small Drainage Areas, University of Illinois Engineering Experiment Station Bulletin No. 462, 1962.
- Christopher, B. R., and V. C. McGuffey. 1997. Pavement Subsurface Drainage System. NCHRP Synthesis 239. Washington, DC: TRB, National Science Foundation.
- Cold Regions Research and Engineering Laboratory (CRREL), Hanover, NH 03755, Carey, K. L., Icing Developed from Surface Water and Ground Water. CRREL Monograph 11-D3, 1973.
- Concrete Pipe Design Manual, American Concrete Pipe Association, 1974.
- Crovetti, J. A., and Dempsey, B. J., "Pavement Subbases," University of Illinois Report UILU-ENG-91-2005, May 1991.
- Daleiden, J. F. 1998. Video Inspection of Highway Edgedrain Systems. Report FHWA-SA-98-044. Washington, DC: Federal Highway Administration.

Dempsey, B. J., "Performance of Prefabricated Geocomposite Subdrainage System in an Airport Runway," Federal Aviation Administration Report DOT/FAA/RD93/23, October 1993.

Department of the Army Technical Manual TM 5-820-1, Surface Drainage Facilities for Airfields and Heliports, 1977.

Department of the Army Technical Manual TM 5-820-2, Drainage and Erosion Control-Subsurface Drainage Facilities for Airfields, 1977.

EI 02C202, Subsurface Drainage.

ERES Consultants. 1999. Pavement Subsurface Drainage Design. Participant's Manual. Washington, DC: National Highway Institute, FHWA.

ETL 1110-3-435, Engineering and Design, Drainage Layers for Pavements.

Federal Highway Administration. 1992. Drainable Pavement Systems-Participant Notebook. Report FHWA-SA-92-008. Washington, DC: Federal Highway Administration.

Federal Highway Administration. 1995. Drainage Requirements in Pavements (DRIP) User's Manual. Contact No. DTFH 61-95-C-00008. Washington, DC: Federal Highway Administration.

Federal Highway Administration, "Subsurface Pavement Drainage," FHWA Technical Paper 9001, October 1990.

Federal Highway Administration, "Geotextile Design and Construction Guidelines," Federal Highway Administration, Washington, DC, Publication No. FHWA-89-002, May 1989.

Federal Highway Administration, "Geotextile Specifications for Highway Applications," Federal Highway Administration, Washington, DC, Publication No. FHWA-89-TS-026, February 1989.

Fletcher, B. P., and Grace, J. L., Jr., Evaluation of Flared Outlet Transitions, Research Report H-72-1, U. S. Army Engineer Waterways Experiment Station, Vicksburg, Mississippi, 1972.

\_\_\_\_\_ and Grace, J. L., Jr., Practical Guidance for Design of Lined Channel Expansions at Culvert Outlets, Technical Report H-74-9, U. S. Army Engineer Waterways Experiment Station, Vicksburg, Mississippi, 1974.

\_\_\_\_\_ and Grace, J. L., Jr., Practical Guidance for Estimating and Controlling Erosion at Culvert Outlets, Miscellaneous Paper H-72-5, U. S. Army Engineer Waterways Experiment Station, Vicksburg, Mississippi, 1972.

- \_\_\_\_\_ Grace, J. L., Jr., and Pickering, C. A., Evaluation of Three Energy Dissipators for Storm-Drain Outlets, Research Report H-71-1, U. S. Army Engineer Waterways Experiment Station, Vicksburg, Mississippi, 1971.
- \_\_\_\_\_ Calhoun, C. C., Jr., and Brown, D. N., Drainage and Erosion Control Facilities Field Performance Investigation, Miscellaneous Papers H-73-6, U. S. Army Engineer Waterways Experiment Station, Vicksburg, Mississippi, 1973.
- Gaskin, D. A. and Stanley, L. E., Application of Electrical Energy to Culvert Icing Problems, A Laboratory Study, CRREL Technical Report 248, 1974.
- Hall, K. T., M. I. Darter, T. E. Hoerner, and L. Khazanovich. 1996. LTPP DATA ANALYSIS – Phase I: Validation of Guidelines for k-Value Selection and Concrete Pavement Performance Prediction. Report FHWA-RD-96-198. McLean, VA: Federal Highway Administration.
- Handbook of Drainage and Construction Products, Armco Drainage and Metal Products, Inc., Ohio, 1967.
- Handbook of Steel Drainage and Highway Construction Products, American Iron and Steel Institute, New York, 1983.
- Hathway, G. A., Design of Drainage Facilities for Military Airfields. Trans., America Society of Civil Engineers, Vol. 110, pp. 697-730, 1945.
- Hite, J. E., "South Fork Tillatobu Creek Drop Structures, Mississippi," Technical Report H-82-22, U. S. Army Engineer Waterways Experiment Station, Vicksburg, Mississippi, 1982.
- Hogue, D. W., Temperatures of North America, Quartermaster Research and Development Center, Environmental Protection Research Division, Natick, MA. Research Study Report RER-9, 1957.
- Horton, R. E., "The Interpretation and Application of Runoff Plat Experiments with Reference to Soil Erosion Problems," Proceedings, Volume 3, Soil Science Society, Madison, Wis., 1938.
- Hydraulic Engineering Center, U.S. Army Corps of Engineers, Davis, C. A., Urban Storm Water Runoff (Storm), Generalized Computer Program, May 1974 Metcalf and Eddy, Inc., University of Florida, Gainesville, and Water Resources Engineers, Inc., Walnut Creek, CA, Storm Water Management Model, Vol. I, Final Report. 11024DOC 07/71, Report for EPA, 1971.
- Industrial Fabrics Association International (IFAI). 1997. Geotechnical Fabrics Report Specifier's Guide. Lenexa, KS: Industrial Fabrics Association International.

Keeley, J. W., Soil Erosion Studies in Oklahoma; Part I, Water Erosion in Narrow Ditches and Channels; Part II, Erosion Control Devices for Ditches and Channels, U. S. Bureau of Public Roads, Oklahoma Division, Oklahoma, 1961.

\_\_\_\_\_ Soil Erosion Studies in Oklahoma; Part III, Culvert Outlet Conditions and Downstream Channel Stability, U. S. Bureau of Public Roads, Oklahoma City, Oklahoma, 1963.

\_\_\_\_\_ Soil Sedimentation Studies in Oklahoma; Deposition in Culverts and Channels, Federal Highway Division, Oklahoma City, Oklahoma, 1967.

King, H. W., and Brater, E. F., Handbook of Hydraulics, McGraw-Hill Book Company, Inc., New York, 1963.

Koerner, R. M., G. R. Koerner, A. K. Fahim, and R. F. Wilson-Fahmy. 1994. Long-Term Performance of Geosynthetics in Drainage Applications. NCHRP Report 367. Washington, DC: TRB, National Science Foundation.

Kozlov, George S., "Improved Drainage and Frost Action Criteria for New Jersey Pavement Design, Volume III, Road Surface Drainage Design, Construction and Maintenance Guide for Pavements," Division of Research and Demonstration, New Jersey Department of Transportation, Final Report, March 1984.

Morris, H. M. and Wiggert, J. M., Applied Hydraulics in Engineering, 2nd ed., Ronald Press Company, New York, 1971.

Moulton, L. K. 1982. Highway Subsurface Drainage. Report FHWA-TS-80-224. Washington, DC: Federal Highway Administration.

Murphy, T. E., Control of Scour at Hydraulic Structures, Miscellaneous Paper H-71-5, U. S. Army Engineer Waterways Experiment Station, Vicksburg, Mississippi, 1971.

Neill, C. R., Mean-Velocity Criterion for Scour of Coarse Uniform Bed-Material, Proceedings of the 12th Congress of International Association for Hydraulic Research, Vol. 3, pp. 46-54, 1967.

Nettles, E. H., and Compton, J. R., Laboratory Investigation of Soil Infiltration Through Pipe Joints, Technical Report No. 3-781, U. S. Army Engineer Waterways Experiment Station, Vicksburg, Mississippi, 1967.

Paguette, R. J., Ashford, N., and Wright, P. H., Transportation Engineering, New York: Ronald Press Company, 1972.

Parish, R. P., Fish vs. Culvert Design. Alberta Hydrotechnical Seminar, Edmonton, Canada, 1976.

Ritter, L. J., Jr., and Paquette, R. J., Highway Engineering, New York: Ronald Press Company, 1967.

- Sawyer, S. 1995. Establishment of Underdrain Maintenance Procedure. Report FHWA/OK 95(04). Final Report. Oklahoma City, OK: Federal Highway Administration.
- Scheer, A. C., Large Culvert Studies in Montana, Department of Civil Engineering and Engineering Mechanics, Montana State University, Missoula, Montana, 1968.
- Schilling, M. C., Culvert Outlet Protection Design: Computer Program Documentation, National Technical Information Service, Springfield, Virginia, AS PB-232 795, 1974.
- Sewer Manual For Corrugated Steel Pipe, National Corrugated Steel Pipe Association, Illinois, 1978.
- Signore, J. M. and B. J. Dempsey. 1998. Accelerated Testing of Separation Layers for Open-Graded Drainage Layers. Final Report. Project C960014. Springfield, IL: Illinois Department of Transportation.
- Silberman, E., and Dahlin, W. Q., Friction Factors for Helical Corrugated Aluminum Pipe, Project Report No. 112, University of Minnesota, St. Anthony Falls Hydraulic Laboratory, 1969.
- Stevens, M. A., Simmons, D. B., and Watts, F. J., Riprapped Basins for Culvert Outfalls, Highway Research Record, No. 373, 1971.
- Straub, L. G. and Johnson, L. A., Field Reconnaissance Report, Part II, Translation of Selected Topics, University of Minnesota, St. Anthony Falls Hydraulic Laboratory for CRREL (ACFEL), 1950.
- TM 5-820-2/AFM 88-5, Drainage and Erosion Control Subsurface Drainage Facilities for Airfield Pavements.
- Transportation Research Board, National Research Council. Erosion Control on Highway Construction. National Cooperative Highway Research Program, Synthesis of Highway Practice 18, 1973.
- Transportation Research Board, National Research Council. Roadway Design in Seasonal Frost Areas. National Cooperative Highway Research Program, Synthesis of Highway Practice 26, 1975.
- Turner, H. O, Jr., "Santa Ana River Drop Structures, California," Technical Report in preparation, U. S. Army Engineer Waterways Experiment Station, Vicksburg, Mississippi.
- U.S. Army Engineer Waterways Experiment Station, Erosion and Riprap Requirements at Culvert and Stem-Drain Outlets, by J. P. Bohan, Research Report H-70-2, 1970.



- U.S. Army Engineer Waterways Experiment Station, Evaluation of Three Energy Dissipators for Stem-Drain Outlets, by J. L. Grace and G. A. Pickering, Research Report H-71-1, 1971.
- U.S. Army Engineer Waterways Experiment Station, Practical Guidance for Estimating and Controlling Erosion at Culvert Outlets, by B. P. Fletcher and J. L. Grace, Jr., Miscellaneous Paper H-72-5, 1972.
- U.S. Department of Agriculture, Friction Factors for Helical Corrugated Pipe, by C. E. Rice, ARS 41-119, 1966.
- U.S. Department of the Interior, Bureau of Reclamation, Hydraulic Design of Stilling Basin for Pipe or Channel Outlets, by G. L. Beickley, Research Report No. 24, 1971.
- U. S. Department of Transportation, Federal Aviation Administration, Airport Drainage, AC 150/5320-SB, Washington, D. C., 1970.
- U.S. Department of Transportation, Federal Highway Administration, Hydraulic Design of Improved Inlets for Culverts, Hydraulic Engineering Circular No. 13, August 1972.
- U.S. Weather Bureau (National Weather Service, NOAA), Probable Maximum Precipitation and Rainfall Frequency Data for Alaska. Technical Paper 47, 1963.
- Viessman, W., Jr., Knapp, J. W., Lewis, G. L., and Harbaugh, T. E., Introduction to Hydrology, 2nd Edition, New York: TEP, 1977.
- Wilson, C., Climatology of the Cold Regions, CRREL Monograph I-A3am 1967, and I-A3b, 1969.
- Witczak, M. W., E. J. Yoder. 1975. Principles of Pavement Design. Second Edition. New York, NY: John Wiley & Sons, Inc.
- Wyatt, T., W. Barker, and J. Hall. 1998. Drainage Requirements in Pavements, Microcomputer Program. Washington, DC: Federal Highway Administration.
- Wyatt, T., W. Barker and J. Hall. 1998. Drainage Requirements in Pavements, User Manual. Report FHWA-SA-96-070. Washington, DC: Federal Highway Administration.
- Yen, B. C. and Ying-Chang Liou, Hydraulic Resistance in Alluvial Channels, Research Report No. 22, University of Illinois Water Research Center, Urbana, Illinois, 1969.
- Yu, H. T., L. Khazanovich, S. P. Rao, H. Ali, M. I. Darter, and H. Von Quintus. 1999. Guidelines for Subsurface Drainage. Final Report. NCHRP Project 1-34. Washington, DC: TRB, National Science Foundation.

**UFC 3-230-01**  
**8/1/2006**

**AC 150/5320-5C**  
**9/29/2006**

Yu, U. S. and McNoun, J. S., Runoff from Impervious Surfaces, Contract Report No. 2-66, U.S. Army Engineer Waterways Experiment Station, Vicksburg, Miss., 1963.

## APPENDIX E

### WAIVER PROCESSING PROCEDURES FOR DOD

#### E-1 ARMY

#### E-1.1 Waiver Procedures:

E-1.1.1 **Installation.** The installation's design agent, aviation representative (safety officer, operations officer, and/or air traffic and airspace [AT&A] officer) and DEH master planner will:

E-1.1.1.1 Jointly prepare/initiate waiver requests.

E-1.1.1.2 Submit requests through the installation to the major command (MACOM).

E-1.1.1.3 Maintain a complete record of all waivers requested and their disposition (approved or disapproved). A list of waivers to be requested and those approved for a project should also be included in the project design analysis prepared by the design agent, aviation representative, or DEH master planner.

#### E-1.1.2 The MACOM will:

E-1.1.2.1 Ensure that all required coordination has been accomplished.

E-1.1.2.2 Ensure that the type of waiver requested is clearly identified as either "Temporary" or "Permanent." "Permanent" waivers are required where no further mitigative actions are intended or necessary. "Temporary" waivers are for a specified period during which additional actions to mitigate the situation must be initiated to fully comply with criteria or to obtain a permanent waiver. Follow-up inspections will be necessary to ensure that mitigative actions proposed for each temporary waiver granted have been accomplished.

E-1.1.2.3 Review waiver requests and forward all viable requests to U. S. Army Aeronautical Services Agency (USAASA) for action. To expedite the waiver process, MACOMs are urged to simultaneously forward copies of the request to:

E-1.1.2.3.1 Commander, U. S. Army Aeronautical Services Agency (USAASA),  
ATTN: ATAS-AI, 9325 Gunston Road, Suite N319, Fort Belvoir, VA 22060-5582.

E-1.1.2.3.2 Commander, U.S. Army Safety Center (USASC), ATTN: CSSC-SPC,  
Bldg. 4905, 5th Ave., Fort Rucker, AL 36362-5363.

E-1.1.2.3.3 Commander, U. S. Army Aviation Center (USAAVNC), ATTN: ATZQ-ATC-  
AT, Fort Rucker, AL 36362-5265.

E-1.1.2.3.4 Director, USACE Transportation Systems Center (TSMCX), ATTN:  
CENWO-ED-TX, 215 N 17th St., Omaha, NE 68102.

E-1.1.3 **USAASA.** USAASA is responsible for coordinating these reviews for the waiver request:

E-1.1.3.1 Air traffic control assessment by USATCA.

E-1.1.3.2 Safety and risk assessment by USASC.

E-1.1.3.3 Technical engineering review by TSMCX.

E-1.1.3.4 From these reviews, USAASA formulates a consolidated position and makes the final determination on all waiver requests and is responsible for all waiver actions for Army operational airfield/airspace criteria.

E-1.2 **Contents of Waiver Requests.** Each request must contain this information:

E-1.2.1 Reference to the specific standard and/or criterion to be waived by publication, paragraph, and page.

E-1.2.2 Complete justification for noncompliance with the airfield/airspace criteria and/or design standards. Demonstrate that noncompliance will provide an acceptable level of safety, economics, durability, and quality for meeting the Army mission. This includes reference to special studies made to support the decision. Specific justification for waivers to criteria and allowances must be included:

E-1.2.2.1 When specific site conditions (physical and functional constraints) make compliance with existing criteria impractical and/or unsafe. Some examples are the need to provide hangar space for all aircraft because of recurring adverse weather conditions; the need to expand hangar space closer to and within the runway clearances due to lack of land; and maintaining fixed-wing Class A clearances when support of Class B fixed-wing aircraft operations are over 10 percent of the airfield operations.

E-1.2.2.2 When deviation(s) from criteria fall within a reasonable margin of safety and do not impair construction or long range facility requirements. An example is locating security fencing around and within established clearance areas.

E-1.2.2.3 When construction that does not conform to criteria is the only alternative to meet mission requirements. Evidence of analysis and efforts taken to follow criteria and standards must be documented and referenced.

E-1.2.3 The rationale for the waiver request, including specific impacts on the assigned mission, safety, and/or environment.

E-1.3 **Additional Requirements:**

E-1.3.1 **Operational Factors.** Include information on the existing and/or proposed operational factors used in the assessment:

E-1.3.1.1 Mission urgency.

E-1.3.1.2 All aircraft by type and operational characteristics.

E-1.3.1.3 Density of aircraft operations at each air operational facility.

E-1.3.1.4 Facility capability (visual flight rules [VFR] or instrument flight rules [IFR]).

E-1.3.1.5 Use of self-powered parking versus manual parking.

E-1.3.1.6 Safety of operations (risk management).

E-1.3.1.7 Existing navigational aids (NAVAIDS).

E-1.3.2 **Documentation.** Record all alternatives considered, their consequences, necessary mitigative efforts, and evidence of coordination.

E-2 **AIR FORCE**

E-2.1 **Waivers to Criteria and Standards.** Waivers to criteria and standards in this publication must be approved by the major command (MAJCOM) pavements engineer.

E-2.2 **Waiver Procedure.** The design agent or, if designed by the Air Force, the base pavements engineer, prepares a Request for Waiver for each project. The request must contain a complete listing of all deviations from criteria and standards, including justification. If the base civil engineer concurs, the request is forwarded to the MAJCOM pavements engineer for consideration.

E-3 **NAVY AND MARINE CORPS**

E-3.1 **Applicability:**

E-3.1.1 **Use of Criteria.** The criteria in this manual apply to Navy and Marine Corps aviation facilities located in the United States, its territories, trusts, and possessions. Where a Navy or Marine Corps aviation facility is a tenant on a civil airport, use these criteria to the extent practicable; otherwise, FAA criteria apply. Where a Navy or Marine Corps aviation facility is host to a civilian airport, these criteria will apply. Apply these standards to the extent practical at overseas locations where the Navy and Marine Corps have vested base rights. While the criteria in this manual are not intended for use in a theater-of-operations situation, they may be used as a guideline where prolonged use is anticipated and no other standard has been designated.

E-3.1.2 **Criteria at Existing Facilities.** The criteria will be used for planning new aviation facilities and new airfield pavements at existing aviation facilities (exception: primary surface width for Class B runways). Existing aviation facilities have been developed using previous standards that may not conform to the criteria herein. Safety clearances at existing aviation facilities need not be upgraded solely for the purpose of conforming to this criteria; however, at existing aviation facilities where few structures have been constructed in accordance with previous safety clearances, it may be feasible to apply the revised standards herein.

E-3.2 **Approval.** Approval from Headquarters Naval Facilities Engineering Command (NAVFACENGCOC) must be obtained prior to revising safety clearances at existing airfield pavements to conform with these new standards. NAVFACENGCOC will coordinate the approval with the Naval Air Systems Command and Chief of Naval Operations/Command Master Chief (CNO/CMC) as required.

E-3.3 **Obtaining a Waiver.** Once safety clearances have been established for an aviation facility, there may be occasions where it is not feasible to meet the designated standards. In these cases, a waiver must be obtained from the Naval Air Systems Command (NAVAIR). The waiver and its relation to the site approval process is defined in NAVFACINST 11010.44E, *Shore Facilities Planning Manual*.

E-3.4 **Exemptions from Waiver.** Certain navigational and operational aids usually are sited in violation of airspace safety clearances in order to operate effectively. The aids listed in paragraphs E-3.4.1 to E-3.4.8 are within this group and require no waiver from NAVAIR, provided they are sited in accordance with NAVFAC P-272, *Definitive Designs for Naval Shore Facilities*, and/or the NAVFAC Design Manuals (DM series):

E-3.4.1 Approach lighting systems.

E-3.4.2 Visual approach slope indicator (VASI) systems and precision approach path indicators (PAPI).

E-3.4.3 Permanent optical lighting systems (OLS), portable OLS, and Fresnel lens equipment.

E-3.4.4 Runway distance markers.

E-3.4.5 Arresting gear systems, including signs.

E-3.4.6 Taxiway guidance, holding, and orientation signs.

E-3.4.7 All beacons and obstruction lights.

E-3.4.8 Arming and de-arming pads.

## APPENDIX F

### WAIVER PROCESSING PROCEDURES FOR FAA

**ORDER**

U.S. DEPARTMENT OF TRANSPORTATION  
FEDERAL AVIATION ADMINISTRATION

5300.1F

6/30/00

#### SUBJ: MODIFICATIONS TO AGENCY AIRPORT DESIGN, CONSTRUCTION, AND EQUIPMENT STANDARDS

**1. PURPOSE.** This Order establishes approval level for modifications to standards applicable to airport design, construction and equipment procurement projects.

**2. DISTRIBUTION.** This Order is distributed to division level in the Offices of Airport Planning and Programming, Airport Safety and Standards, Air Traffic, Airway Facilities, and Flight Standards Services; to the division level in the regional Airports, Air Traffic, Airway Facilities, and Flight Standards Divisions; and to all Airport District and Field Offices.

**3. CANCELLATION.** Order 5300.1E, *Approval Level for Modification of Agency Airport Design and Construction Standards*, dated 10/22/91, is canceled.

#### **4. DEFINITIONS.**

**a.** "Modification to standards" means any change to FAA standards, other than dimensional standards for runway safety areas, applicable to an airport design, construction, or equipment procurement project that results in lower costs, greater efficiency, or is necessary to accommodate an unusual local condition on a specific project, when adopted on a case-by-case basis.

**b.** Regional or State standards are alternative standards that may be used within the subject Region or State for airport development projects without further documentation.

**c.** "Materials standards" are those standards that apply to the procurement or approval of materials.

**d.** "Construction standards as they relate to materials" are those standards that apply to installation methods and tolerances.

**5. EXEMPTIONS.** Exemptions from 14 CFR Part 139, *Certification and Operations: Land Airports Serving Certain Air Carriers* (Part 139) are not covered by this Order.

**6. BACKGROUND.** Various laws and regulations require conformance with current FAA standards, as detailed below. Modifications to national standards may be considered for a specific project where unusual conditions preclude compliance with national airport design, construction, materials, or equipment standards.

**a. Airport and Airway Improvement Act.** The Airport and Airway Improvement Act (The Act), recodified at 49 USC 47105(b)(3) states in part, "An application for a project grant under this subchapter may propose airport development only if the development complies with standards the Secretary prescribes or approves, including standards for site location, airport layout, site preparation, paving, lighting, and safety of approaches."

**b. Airport Improvement Program.** To carry out the intent of the Act, one of the standard grant assurances requires airport sponsors to "...carry out the project in accordance with policies, standards, and specifications approved by the Secretary, including but not limited to, the advisory circulars listed in the Current FAA Advisory Circulars for AIP Projects, ... and in accordance with applicable state policies, standards, and specifications approved by the Secretary." In addition, Order 5100.38, *AIP Handbook*, paragraph 35, provides that "... a sponsor is required to comply with all appropriate technical guidelines incorporated into identified AC's; and these standards become mandatory for the project being funded. Standards in effect on the date of allocation of AIP funds to a project apply to that project. Standards which become effective after the date of allocation may be applied to the project by mutual agreement between the FAA and the sponsor."

**c. Passenger Facility Charges.** 14 CFR Part 158, *Passenger Facility Charges*, Appendix A requires, "The public agency hereby assures and certifies, with respect to this project that: ...It will carry out the project in accordance with FAA airport design, construction, and equipment standards and specifications contained in advisory circulars current on the date of project approval."

Distribution: A-W(PP/AS/AT/AF/FS)-2; A-X(AS/AT/AF/FS)-2;  
A-FAS-1(STD)

Initiated by: AAS-100

5300.1F

6/30/00

**d. Runway Safety Areas.** Part 139, paragraph 139.309, requires runway safety areas to conform to current standards if construction, reconstruction, or significant expansion began on or after January 1, 1988 *to the extent practicable*. Regional Airports Division Managers are required to make a Runway Safety Area determination in accordance with FAA Order 5200.8, *Runway Safety Area Program*, for each runway at federally obligated airports and airports certificated under Part 139 within their geographic purview. Modifications to Standards are *not* issued for nonstandard runway safety areas.

**7. POLICY.** A standard policy for modifications to standards ensures uniformity in the application of standards.

**a.** Modifications to materials standards shall be made only when locally available materials cannot meet the requirements of that standard, and are subject to the limitations of paragraph 10.

**b.** Modifications to construction methods standards shall be made only when they will result in cost savings and/or greater efficiency, and are subject to the limitations of paragraph 10.

**c.** Modifications to equipment standards or airport design standards shall be made only when justified by unusual local conditions.

**d.** Modifications to the general provisions of AC 150/5370-10, *Standards for Specifying Construction of Airports*, should be made only to make them consistent with local laws and regulations.

**8. REQUESTS FOR MODIFICATIONS TO STANDARDS.** An airport sponsor's request for a modification to standards shall be submitted to the appropriate FAA Airports Regional or District Office, and shall contain the following:

**a.** A list of standards affected and the basis for the request as allowed in paragraph 7 above.

**b.** A description of the proposed modification.

**c.** A discussion of viable alternatives for accommodating the unusual conditions, and

**d.** Assurance that:

**(1)** modifications to materials, construction or equipment standards will provide a product that will meet FAA standards for acceptance and that the finished product

will perform for its intended design life, based on historical data, or

**(2)** modifications to airport design standards will provide an acceptable level of safety, and

**(3)** modification is necessary to conform to local laws and regulations (if applicable).

## 9. PROCESSING OF REQUESTS.

**a.** Each FAA Regional or Airports District Office will maintain a file of approved modifications to standards associated with each airport. The file will contain a log that identifies the standard affected and the action date. The file will also contain each request received, the documented evaluation of the request, and a copy of the letter of approval. A table listing nonstandard conditions, including modifications to layout or dimensional standards, should be incorporated into the ALP. This table should reflect the dates of approval letters and identify associated airspace review case numbers.

**b.** Requests will be evaluated by the receiving office to determine if a modification to standards is appropriate, and if so, the proper level of approval as determined under sections 10-13 of this order.

**(1)** Those requiring headquarters approval will be forwarded to the Director of Airport Safety and Standards, AAS-1, and shall include the following:

**(a)** A reference to the project and location.

**(b)** The rationale for using a new method or material, documentation to show successful use on construction projects, and a copy of the proposed specification.

**(c)** A recommendation by the Regional Office for approval or disapproval.

**(d)** Approval or disapproval of Regional requests will be forwarded by AAS-1 within 30 days of receipt.

**(2)** Information copies of modifications to standards approved at the regional level shall be provided to AAS-1.

**(3)** Notify AAS-1, in writing, when methods or materials contained in Engineering Briefs are used on a project.

**c.** Modifications which may impact existing or future aircraft operations, instrument flight procedures, navigational aids, or facilities associated with instrument



6/30/00

5300.1F

procedures will be coordinated as necessary with the regional National Airspace System Implementation Center, and Flight Standards, Air Traffic, and Airways Facilities Divisions.

**d.** Each Headquarters Division will update a central database of modifications to standards. This database will be used to track trends that indicate needs for changes to national standards.

**e. Approval Letters.** Approval letters should contain the following for each modification:

- (1) reference to the standard modified,
- (2) a description of the approved modification,
- (3) the justification for the modification,
- (4) the effective period of the modification, if appropriate, and
- (5) a statement that the modification is subject to review if conditions originally justifying the modification change.

**10. REGIONAL APPROVAL.** Modifications listed below may be approved by Regional Division Managers. This authority may be redelegated.

**a.** Modifications to airport design and equipment standards, and construction standards as they relate to materials (except as provided in paragraph 11 below) may be approved on a case-by-case basis when the modification will provide an acceptable level of safety and provide an economically feasible alternative.

**b.** Modifications to construction methods and materials specifications previously approved by AAS-1 for use within a region may be approved on a case-by-case basis without further review by AAS-1. Those determined to be appropriate for national use will be issued by AAS-1 as an Engineering Brief and may also be approved on a case-by-case basis without further review by AAS-1.

**c.** Modifications to the general provisions of AC 150/5370-10 may be approved if necessary to make them consistent with local laws and regulations.

**11. HEADQUARTERS APPROVAL.** The Director of Airport Safety and Standards, AAS-1 (or designee), specifically reserves approval authority for modifications to standards in the following areas:

**a.** Standards for siting navigational or lighting aids that are common to the facilities and equipment program.

**b.** Standards for marking, lighting and signs on airport runways, taxiways and aprons.

**c.** Equipment specifications listed in AC 150/5345-53, *Airport Lighting Equipment Certification Program*.

**d.** Construction methods and materials specifications for which AAS-1 has not previously approved a modification for use within the subject Region.

**e.** Criteria used to control the quality or determine the acceptability of materials and finished products.

(1) Quality control criteria include all the tests performed to determine if adjustments to operations are necessary to stay within specification limits. They include the following: aggregate gradation within tolerance for subbase, base, and surface courses; asphalt content for bituminous mixes; and slump and air content for concrete mixes.

(2) Acceptance testing includes all criteria and the tests performed to determine acceptability of the material or finished product and includes the following: density and thickness for subgrade, subbase, base courses, and bituminous pavement; flexural strength and thickness for concrete pavement; surface tolerances for subbase, base, and surface courses and the use of a nuclear gauge for density acceptance in lieu of cores or borings.

**f.** Additions to requirements for Airport Layout Plans contained in Appendix 7 of AC 150/5300-13, *Airport Design*.

**g.** Standards for transfer of electronic data in Appendix 15 of AC 150/5300-13.

## 12. REGIONAL STANDARDS.

**a.** Alternative standards may be adopted by an FAA Regional Office as "regional standards." The authority to adopt such standards is the same as the authority to approve modifications to the affected standards on a case-by-case basis in paragraph 10 above.

**b.** Information copies of regional standards approved at the regional level will be provided to AAS-1, with a recommendation for adoption as national standards, if appropriate.

**c.** Requests for headquarters approval of regional standards must include adequate justification.

**d.** Regional standards must be updated when changes to national standards are issued.

5300.1F

6/30/00

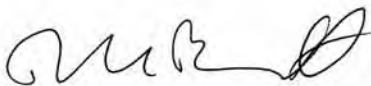
**13. STATE STANDARDS.**

a. State standards may be developed for airports that are not primary airports, in accordance with 49 USC 47105(c), and AC 150/5100-13A, *Development of State Standards for Nonprimary Airports*. State highway specifications may be permitted for airfield pavement construction at nonprimary airports in accordance with 49 USC 47114(d)(5) as amended by P.L. 106-181(April 2000). For all other airports, the FAA

standards shall be used, except as modified in accordance with this Order.

b. The Director of Airport Safety and Standards, AAS-1 (or designee), specifically reserves approval authority for State standards.

c. Standards developed under this section must be updated periodically and reflect FAA standards where applicable.



David L. Bennett  
Director of Airport Safety and Standards

## APPENDIX G

### DESIGN OF SUBSURFACE PAVEMENT DRAINAGE SYSTEMS

#### G-1 INTRODUCTION

**G-1.1 Purpose.** This chapter provides guidance for the design and construction of subsurface drainage facilities for airfield runways, taxiways, and aprons.

**G-1.2 Scope.** The criteria within this chapter apply to paved runways, taxiways, and aprons. The criteria is limited to situations where the water can be drained from the pavement structure by gravity flow and is mainly concerned with elimination of water that enters the pavement through the surface.

**G-1.3 Definitions.** Several terms in this chapter have a unique usage within the chapter or may not be in common usage. Paragraphs G-1.3.1 through G-1.3.16 define these terms.

**G-1.3.1 Apparent Opening Size (AOS).** The AOS is a measure of the opening size of a geotextile. AOS is the sieve number corresponding to the sieve size at which 95 percent of the single-size glass beads pass the geotextile ( $O_{95}$ ) when tested in accordance with ASTM D 4751.

**G-1.3.2 Coefficient of Permeability ( $k$ ).** The coefficient of permeability is a measure of the rate at which water passes through a unit area of material in a given amount of time under a unit hydraulic gradient.

**G-1.3.3 Choke Stone.** A choke stone is a small-size stone used to stabilize the surface of an open-graded material (OGM). For a choke stone to be effective, the ratio of  $d_{15}$  of the coarse aggregate to the  $d_{15}$  of the choke stone must be less than 5, and the ratio of the  $d_{50}$  of the coarse aggregate to  $d_{50}$  of the choke stone must be greater than 2.

**G-1.3.4 Drainage Layer.** A drainage layer is a layer in the pavement structure that is specifically designed to allow rapid horizontal drainage of water from the pavement structure. The layer is also considered to be a structural component of the pavement and may serve as part of the base or subbase.

**G-1.3.5 Effective Porosity.** The effective porosity is defined as the ratio of the volume of voids that will drain under the influence of gravity to the total volume of a unit of aggregate. The difference between the porosity and the effective porosity is the amount of water that will be held by the aggregate. For materials such as the rapid draining material (RDM) and OGM, the water held by the aggregate will be small; thus, the difference between the porosity and effective porosity will be small (less than 10 percent). The effective porosity may be estimated by computing the porosity from the unit dry weight of the aggregate and the specific gravity of the solids, which then should be reduced by 5 percent to allow for water retention in the aggregate.

**G-1.3.6 Geocomposite Edge Drain.** A geocomposite edge drain is a manufactured product using geotextiles, geogrids, geonets, and/or geomembranes in laminated or

composite form, which can be used as an edge drain in place of trench-pipe construction.

**G-1.3.7 Geotextile.** A geotextile is a permeable textile used in geotechnical projects. For this AC, geotextile will refer to a nonwoven needle punch fabric that meets the requirements of the AOS, grab strength, and puncture strength specified for the particular application.

**G-1.3.8 Hazen's Effective Particle Diameter.** The Hazen's effective particle diameter is the particle size, in millimeters, that corresponds to 10 percent passing on the grain-size distribution curve. This parameter is one of the major parameters in determining the permeability of a soil.

**G-1.3.9 Open-Graded Material (OGM).** An OGM is a granular material having a very high permeability (greater than 1,500 m/day (5,000 ft/day)) which may be used for a drainage layer. Such a material will normally require stabilization for construction stability or for structural strength to serve as a base in a flexible pavement.

**G-1.3.10 Pavement Structure.** Pavement structure is the combination of subbase, base, and surface layers constructed on a subgrade.

**G-1.3.11 Permeable Base.** An open-graded, granular material with most of the fines removed (e.g., less than 10 percent passing the No. 16 sieve) to provide high permeability 305 m/day (1,000 ft/day or more) for use in a drainage layer.

**G-1.3.12 Porosity.** Porosity refers to the volume of voids in a material and is expressed as the ratio of the volume of voids to the total volume.

**G-1.3.13 Rapid Draining Material (RDM).** A granular material having a sufficiently high permeability (300 to 1,500 m/day (1,000 to 5,000 ft/day)) to serve as a drainage layer and also having the stability to support construction equipment and the structural strength to serve as a base and/or a subbase.

**G-1.3.14 Separation Layer.** A separation layer is a layer provided directly beneath the drainage layer to prevent fines from infiltration or pumping into the drainage layer and to provide a working platform for construction and compaction of the drainage layer.

**G-1.3.15 Stabilization.** Stabilization refers to either mechanically or chemically stabilizing the drainage layer to increase the stability and strength to withstand construction traffic and/or design traffic. Mechanical stabilization is accomplished by the use of a choke stone and compaction. Chemical stabilization is accomplished by the use of either portland cement or asphalt.

**G-1.3.16 Subsurface Drainage.** The process of collecting and removing water from the pavement structure. Subsurface drainage systems are categorized by function: those that drain surface infiltration water and those that control groundwater.

**G-1.4 Bibliography.** In recent years, subsurface drainage has received increasing attention, particularly in the area of highway design. A number of studies have been

conducted by state highway agencies and by the Federal Highway Administration that have resulted in a large number of publications on the subject of subsurface drainage. Appendix A provides a list of publications that contain information pertaining to the design of subsurface drainage for pavements.

**G-1.5 Effects of Subsurface Water.** Water has a detrimental effect on pavement performance, primarily by either weakening subsurface materials or eroding material by free water movement. For flexible pavements, the weakening of the base, subbase, or subgrade when saturated with water is one of the main causes of pavement failures. In rigid pavement, free water, trapped between the concrete surface and an impermeable layer directly beneath the concrete, moves due to pressure caused by loadings. This movement of water (referred to as pumping) erodes the subsurface material, creating voids under the concrete surface. In frost areas, subsurface water will contribute to frost damage by heaving during freezing and loss of subgrade support during thawing. Poor subsurface drainage can also contribute to secondary damage such as “D” cracking or swelling of subsurface materials.

**G-1.6 Traffic Effects.** The type, speed, and volume of traffic will influence the criteria used in the design of pavement drainage systems. For rigid pavements, pumping is greatly increased as the volume and speed of the traffic increases. For flexible pavements, the buildup of pore pressures as a result of high-volume, high-speed traffic is a primary cause of the weakening of the pavement structure. For these reasons, the criteria for a subsurface under airfield runways and taxiways will be more stringent than for airfield parking aprons or other pavements that have low-volume and low-speed traffic.

**G-1.7 Sources of Water.** The two types of water to be considered are water from infiltration and subterranean water. Infiltration is the most important source of water and is the source of most concern in this document. Subterranean water is important in frost areas and areas of very high water table or areas of artesian water. In many areas, perched water may develop under pavements due to a reduced rate of evaporation of the water from the surface. In frost areas, free water collects under the surface by freeze/thaw action.

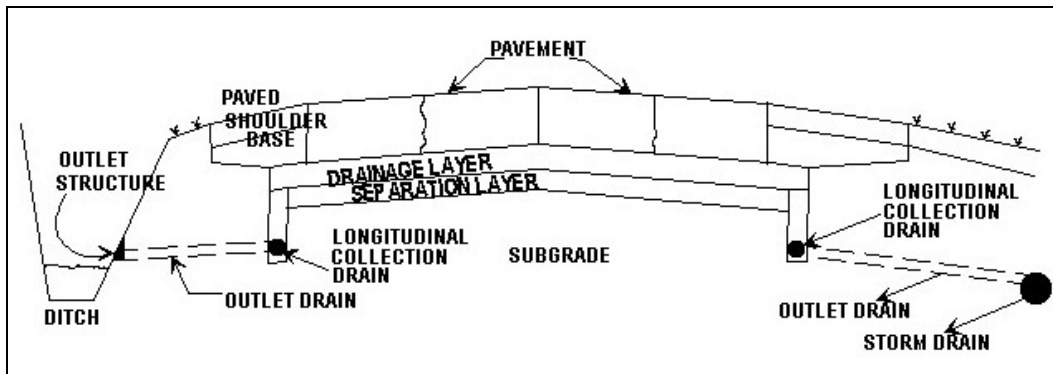
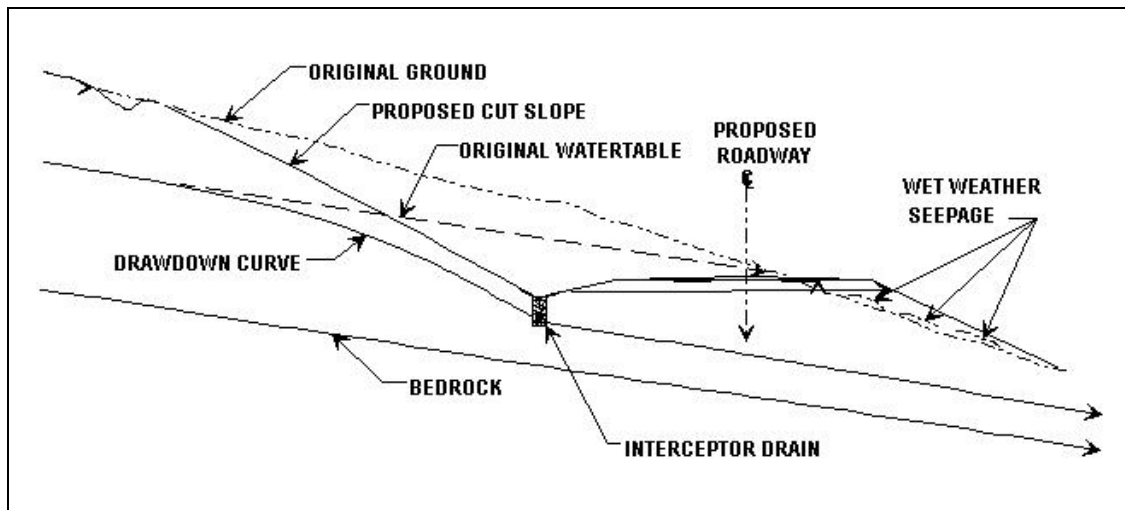
**G-1.7.1 Infiltration.** Infiltration is surface water that enters the pavement from the surface through cracks or joints in the pavement, through the joint between the pavement and shoulder, through pores in the pavement, and through shoulders and adjacent areas. Since surface infiltration is the principal source of water, it is the source needing greatest control measures. Groundwater tables rise and fall depending upon the relation between infiltration, absorption, evaporation, and groundwater flow. Seasonal fluctuations are normal because of differences in the amount of precipitation and maybe relatively large in some localities. Prolonged drought or wet periods will cause large fluctuations in the groundwater level.

**G-1.7.2 Subterranean Water.** Subterranean water can be a source of water from a high water table, capillary forces, artesian pressure, and freeze-thaw action. This source of water is particularly important in areas of frost action when large volumes of water can be drawn into the pavement structure during the formation of ice lenses. For large paved areas, the evaporation from the surface is greatly reduced, which causes

saturation of the pavement structure by capillary forces. Also, if impervious layers exist beneath the pavement, perched water can be present or develop from water entering the pavement through infiltration. This perched water then becomes a subterranean source of water. In general, the presence of near surface subterranean water must be identified during soil exploration, and drainage facilities must be designed to mitigate the influence of such water.

**G-1.7.3 Freeze-Thaw.** Freeze–thaw action can result in large amounts of water being drawn into the pavement structure. In freeze-thaw conditions, water flows to the freeze front by capillary action. Repeated cycles of freeze-thaw result in the growth of ice lenses that can cause heave in the pavement structure. It is not uncommon to note heaves in soils as great as 60 percent; under laboratory conditions, heaves of as much as 300 percent have been recorded. The formation of ice lenses in the pavement structure has two very detrimental effects on the pavement. One effect is that the formation of the ice lenses causes a loss of density of the pavement materials, resulting in strength loss. A second effect is that thawing of the ice results in a large volume of free water that must be drained from the pavement. Because thawing usually occurs simultaneously from both the top and bottom of the pavement structure, the free water can be trapped within the pavement structure. Providing adequate drainage will minimize pumping and promote the restoration of pavement strength. In the design of subdrain systems in frost areas, free water in both the upper and lower sections of the pavement must be considered.

**G-1.7.4 Classification of Subdrain Facilities.** Subdrain facilities can be categorized into two functional categories: those that control infiltration, and those that control groundwater. An infiltration control system is designed to intercept and remove water that enters the pavement from precipitation or surface flow. An important function of this system is to keep water from being trapped between impermeable layers. A groundwater control system is designed to reduce water movement into subgrades and pavement sections by controlling the flow of groundwater or by lowering the water table. Often, subdrains are required to perform both functions, and the two subdrain functions can be combined into a single subdrain system. Figures G-1 and G-2 illustrate examples of infiltration and groundwater control systems, respectively.

**Figure G-1. Collector Drain to Remove Infiltration Water****Figure G-2. Collector Drain to Intercept Seepage and Lower the Groundwater Table**

**G-1.8 Subsurface Drainage Requirements.** Determining the subsurface soil properties and water condition is a prerequisite for the satisfactory design of a subsurface drainage system. Field explorations and borings made in connection with the project design should include certain investigations pertinent to subsurface drainage. A topographic map of the proposed area and the surrounding vicinity should be prepared; the map should indicate all streams, ditches, wells, and natural reservoirs. Analyzing aerial photographs of the areas selected for construction may furnish valuable information on general soil and groundwater conditions. An aerial photograph presents a graphic record of the extent, boundaries, and surface features of soil patterns occurring at the surface of the ground. The presence of vegetation, the slopes of a valley, the colorless monotony of sand plains, the farming patterns, the drainage pattern, gullies, eroded lands, and evidences of human works are revealed in detail by aerial photographs. The use of aerial photographs may supplement both the detail and knowledge gained in topographic survey and ground explorations. The sampling and exploratory work can be made more rapid and effective after an analysis of aerial

photographs has developed the general soil features. The location and depth of permanent and perched groundwater tables may be sufficiently shallow to influence the design. The season of the year and rainfall cycle will measurably affect the depth to the water table. In many locations, information may be obtained from residents of the surrounding areas regarding the behavior of wells and springs and other evidences of subsurface water. The soil properties investigated for other purposes in connection with the design will supply information that can be used for the design of the drainage system. It may be necessary to supplement these explorations at locations of subsurface drainage structures and in areas where soil information is incomplete for design of the drainage system.

**G-1.9 Laboratory Tests.** The design of subsurface drainage structures requires knowledge of these soil properties: strength, compressibility, swell and dispersion characteristics, the in situ and compacted unit dry weights, the coefficient of permeability, the in situ water content, specific gravity, grain-size distribution, and the effective void ratio. These soil properties may be satisfactorily determined by experienced soil technicians through laboratory tests. The final selected soil properties for design purposes may be expressed as a range, one extreme representing a maximum value and the other a minimum value. The true value should be between these two extremes, but it may approach or equal one or the other, depending on the variation within a soil stratum.

**G-1.10 Drainage of Water from Soil.** The quantity of water removed by a drain will vary depending on the type of soil and location of the drain with respect to the groundwater table. All of the water contained in a given specimen cannot be removed by gravity flow because water retained as thin films adhering to the soil particles and held in the voids by capillarity will not drain. Consequently, to determine the volume of water that can be removed from a soil in a given time, the effective porosity as well as the permeability must be known. Limited effective porosity test data for well-graded base-course materials, such as bank-run sands and gravels, indicate a value for effective porosity of not more than 0.15. Uniformly graded soils such as medium coarse sands, may have an effective porosity of not more than 0.25. Open-graded aggregate used for drainage layers will have an effective porosity of between 0.25 and 0.35.

## G-2 PRINCIPLES OF PAVEMENT DRAINAGE

**G-2.1 Flow of Water through Soils.** The flow of water through soils is expressed by Darcy's empirical law, which states that the velocity of flow ( $v$ ) is directly proportional to the hydraulic gradient ( $i$ ). This law can be expressed as:

$$v = k \cdot i \quad (G-1)$$

Where  $k$  is the coefficient of proportionality known as the coefficient-of-permeability. Equation G-1 can be expanded to obtain the rate of flow through an area of soil ( $A$ ). The equation for the rate of flow ( $Q$ ) is:

$$Q = k \cdot i \cdot A \quad (G-2)$$



According to Darcy's law, the velocity of flow and the quantity of discharge through a porous media are directly proportional to the hydraulic gradient. For this condition to be true, flow must be laminar or non-turbulent. Investigations have indicated that Darcy's law is valid for a wide range of soils and hydraulic gradients; however, in developing criteria for subsurface drainage, liberal margins have been applied to allow for turbulent flow. The criteria and uncertainty depend heavily on the permeability of the soils in the pavement structure. It is therefore useful to examine the influence of various factors on the permeability of soils. In examining permeability of soils in regard to pavement drainage, the materials of most concern are base and subbase aggregate and aggregate used as drainage layers.

## **G-2.2 Factors Affecting Permeability**

**G-2.2.1 Coefficient of Permeability.** The value of permeability depends primarily on the characteristics of the permeable materials, but it is also a function of the properties of the fluid. An equation (after Taylor) demonstrating the influence of the soil and pore fluid properties on permeability was developed based on flow through porous media similar to flow through a bundle of capillary tubes. This equation is given here as Equation G-3:

$$k = D_s^2 \cdot C \cdot \left( \frac{\gamma \cdot e^3}{\mu \cdot (1-e)} \right) \quad (\text{G-3})$$

where

- $k$  = the coefficient of permeability
- $D_s$  = Hazen's effective particle diameter
- $C$  = shape factor
- $\gamma$  = unit weight of pore fluid
- $\mu$  = viscosity of pore fluid
- $e$  = void ratio

**G-2.2.2 Effect of Pore Fluid and Temperature.** In the design of subsurface drainage systems for pavements, the primary pore fluid of concern is water. Therefore, when permeability is mentioned in this chapter, water is assumed to be the pore fluid. Equation G-3 indicates that the permeability is directly proportional to the unit weight of water and inversely proportional to the viscosity. The unit weight of water is essentially constant, but the viscosity of water will vary with temperature. Over the widest range of temperatures ordinarily encountered in seepage problems, viscosity varies about 100 percent. Although this variation seems large, it can be insignificant when considered in the context of the variations that can occur with changes in material properties.

**G-2.2.3 Effect of Grain Size and Void Ratio.** It is logical that the smaller the grain size the smaller the voids that constitute the flow channels, and hence, the lower the permeability. Equation G-3 suggests that permeability varies with the square of the effective particle diameter and the cube of the void ratio. Since for the most part the void

ratio is a function of the material gradation, the influence of effective particle diameter will be magnified. Consider that according to Equation G-3, when the effective particle size increases from 0.075 mm (No. 200) to 1.18 mm (No. 16), the permeability would increase by a factor of approximately 250. Assuming the increase in effective particle size would result in an increase in the void ratio by a minimum of 2 times, the permeability due to the increase in void ratio would be by a factor of 8. Thus the total increase in permeability due to the increase in the effective particle size and increase in void ratio would be by a factor of approximately 2000.

Also, the shape of the void spaces has a marked influence on the permeability. As a consequence, the relationships between grain size, void ratio, and permeability are complex. Intuition and experimental test data suggest that the finer particles in a soil have the most influence on permeability. The coefficient of permeability of sand and gravel materials, graded between limits usually specified for pavement bases and subbases, depends principally upon the percentage by weight of particles passing the 0.075 mm (No. 200) sieve. Table G-1 provides estimates of the permeability for these materials for various amounts of material finer than the 0.075 mm (No. 200) sieve.

**Table G-1. Coefficient of Permeability for Sand and Gravel Materials  
(Coefficient of 55)**

Percent by Weight Passing 0.075 mm (No. 200) Sieve	Permeability for Remolded Samples	
	mm/sec	ft/min
3	$5 \times 10^{-1}$	$10^{-1}$
5	$5 \times 10^{-2}$	$10^{-2}$
10	$5 \times 10^{-3}$	$10^{-3}$
15	$5 \times 10^{-4}$	$10^{-4}$
20	$5 \times 10^{-5}$	$10^{-5}$

Figure G-3. Permeability Test Data (from Lambe and Whitman, with permission)

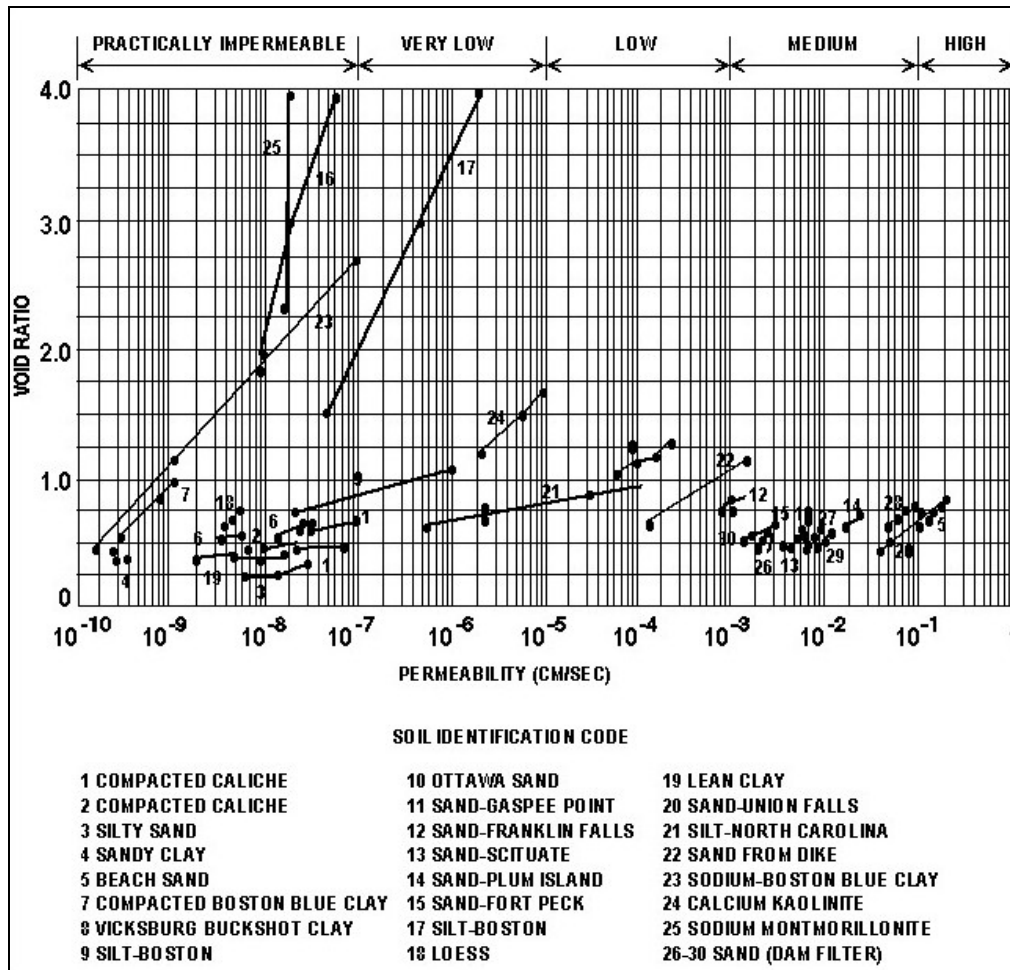


Figure G-3 presents the permeability for different soils as a function of the void ratio. The amount of water that can be contained in a soil will directly relate to the void ratio. Not all water contained in a soil can be drained by gravity flow because water retained as thin films adhering to the soil particles and held by capillarity will not drain. Consequently, to determine the volume of water that can be removed from a soil, the effective porosity ( $n_e$ ) must be known. The effective porosity is defined as the ratio of the volume of the voids that can be drained under gravity flow to the total volume of soil, and can be expressed mathematically as

$$n_e = 1 - \frac{\gamma_d}{G_s \cdot \gamma_w} (1 + G_s \cdot W_e) \tag{G-4}$$

where

- $\gamma_d$  = dry density of the soil
- $G_s$  = specific gravity of solids

- $\gamma_w$  = unit weight of water  
 $W_e$  = effective water content (after the soil has drained) expressed as a decimal fraction relative to dry weight

Limited effective porosity test data for well-graded, base-course materials, such as bank-run sands and gravels, indicate a value for effective porosity of not more than 0.15. Uniformly graded medium or coarse sands may have an effective porosity of not more than 0.25, while for a uniformly graded aggregate such as would be used in a drainage layer, the effective porosity may be above 0.25.

**G-2.2.5 Effect of Structure and Stratification.** Generally, in situ soils show a certain amount of stratification or a heterogeneous structure. Water-deposited soils usually exhibit a series of horizontal layers that vary in grain-size distribution and permeability, and generally these deposits are more permeable in the horizontal than in the vertical direction. In pavement construction, the subgrade, subbase, and base materials are placed and compacted in horizontal layers, which results in having a different permeability in the vertical direction than in the horizontal direction. The vertical drainage of water from a pavement can be disrupted by a single relatively impermeable layer. For most pavements, the subgrades have a very low permeability compared to the base and subbase materials. Therefore, water in the pavement structure can best be removed by horizontal flow. For a layered pavement system, the effective horizontal permeability is obtained from a weighted average of the layer permeability by the formula

$$k = \frac{(k_1 \cdot d_1 + k_2 \cdot d_2 + k_3 \cdot d_3 + \dots)}{(d_1 + d_2 + d_3 + \dots)} \quad (\text{G-5})$$

where

- $k$  = the effective horizontal permeability  
 $k_1, k_2, k_3 \dots$  = the coefficients of horizontal permeability of individual layers  
 $d_1, d_2, d_3 \dots$  = the thicknesses of the individual layers

When a drainage layer is employed in the pavement section, the permeability of the drainage material will likely be several orders of magnitude greater than that of the other materials in the section. Since water flow is proportional to permeability, the flow of water from the pavement section can be computed based only on the characteristics of the drainage layer.

**G-2.3 Quantity and Rate of Subsurface Flow.** Water flowing from the pavement section may come from infiltration through the pavement surface and groundwater. Normally groundwater flows into collector drains from the subgrade and will be an insignificant flow compared to the flow coming from infiltration. The computation of the groundwater flow is beyond the scope of this manual; should it be necessary to compute the groundwater flow, consult a textbook on groundwater flow. The volume of infiltration water flow from the pavement will depend on factors such as the type and condition of the surface, the length and intensity of rainfall, the properties of the drainage layer, the hydraulic gradient, the time allowed for drainage, and the drained

area. In the design of the subsurface drainage system, all of these factors must be considered.

**G-2.3.1 Effects of Pavement Surface.** The type and condition of the pavement surface will have considerable influence on the volume of water entering the pavement structure. In the design of surface drainage facilities, all rain falling on paved surfaces is assumed to be runoff. For new, well designed and constructed pavements, the assumption of 100 percent runoff is probably a good, conservative assumption for the design of surface drainage facilities. For design of the subsurface drainage facilities, the design should be based on the infiltration rate for a deteriorated pavement. Studies have shown that for badly deteriorated pavements, well over 50 percent of the rainfall can flow through the pavement surface. For well maintained pavements, the infiltration rate will be greatly reduced such that the run off will approach 100 percent.

**G-2.3.2 Effects of Rainfall.** It is only logical that the volume of water entering the pavement will be directly proportional to the intensity and length of the rainfall. Relatively low-intensity rainfalls can be used for designing the subsurface drainage facilities because high-intensity rainfalls do not greatly increase the adverse effect of water on pavement performance. The excess rainfall would, once the base and subbase were saturated, run off as surface drainage. For this reason, a seemingly non-conservative design rainfall can be selected.

**G-2.3.3 Capacity of Drainage Layers.** If water enters the pavement structure at a greater rate than the discharge rate, the pavement structure becomes saturated. The design of horizontal drainage layers for the pavement structure is based, in part, on the drainage layer serving as a reservoir for the excess water entering the pavement. The capacity of the drainage layer as a reservoir is a function of the storage capacity of the drainage layer plus the amount of water that drains from the layer during a rain event. The storage capacity of the drainage layer will be a function of the effective porosity of the drainage material and the thickness of the drainage layer. The storage capacity of the drainage layer,  $q_s$ , in terms of depth of water per unit area is computed by Equation G-6:

$$q_s = n_e \cdot h \quad (\text{G-6})$$

where

$n_e$  = the effective porosity

$h$  = the thickness of the drainage layer

In the equation, the dimensions of  $q_s$  will be the same as the dimensions of  $h$ . If it is assumed that not all the water will be drained from the drainage layer, then the storage capacity will be reduced by the amount of water in the layer at the start of the rain event. The criterion for design of the drainage layer calls for 85 percent of the water to be drained from the drainage layer within 24 hours; therefore, it is conservatively assumed that only 85 percent of the storage volume will be available at the beginning of a rain event. To account for the possibility of water in the layer at the beginning of a rain event, Equation G-6 is modified to be

$$q_s = 0.85 \cdot n_e \cdot h \quad (\text{G-7})$$

The amount of water ( $q_d$ ) that will drain from the drainage layer during the rain event may be estimated using Equation G-8:

$$q_d = \frac{t \cdot k \cdot i \cdot h}{2 \cdot L} \quad (\text{G-8})$$

where

- $t$  = duration of the rain event
- $L$  = length of the drain path
- $k$  = permeability of the drainage layer
- $i$  = slope of the drainage layer
- $h$  = thickness of the drainage layer

**G-2.3.3.1** In these equations, the dimensions of  $q_s$ ,  $q_d$ ,  $t$ ,  $k$ ,  $h$ , and  $L$  should be consistent. The total capacity ( $q$ ) of the drainage layer will be the sum of  $q_s$  and  $q_d$ , resulting in this equation for the capacity:

$$q = (0.85 \cdot n_e \cdot h) + \left( \frac{t \cdot k \cdot i \cdot h}{2 \cdot L} \right) \quad (\text{G-9})$$

**G-2.3.3.2** Knowing the water entering the pavement, Equation G-9 can be used to estimate the thickness of the drainage layer such that the drainage layer will have the capacity for a given design rain event. For most situations, the amount of water draining from the drainage layer will be small compared to the storage capacity. Therefore, in most cases, Equation G-7 can be used in estimating the thickness required for the drainage layer.

**G-2.3.4 Time for Drainage.** The water should be drained from the base and subbase layers as rapidly as possible. The time for drainage of these layers is a function of the effective porosity, the length of the drainage path, the thickness of the layers, the slope of the drainage path, and the permeability of the layers. Past criterion has specified that the base and subbase obtain a degree of 50 percent drainage within 10 days. The equation for computing the time for 50 percent drainage is

$$T_{50} = \frac{(n_e \cdot D^2)}{(2 \cdot k \cdot H_o)} \quad (\text{G-10})$$

where

- $T_{50}$  = time for 50 percent drainage
- $n_e$  = effective porosity of the soil
- $k$  = coefficient of permeability
- $D$ ,  $H_o$ , and  $H$  = base and subbase geometry dimensions (illustrated in Figure G-4)

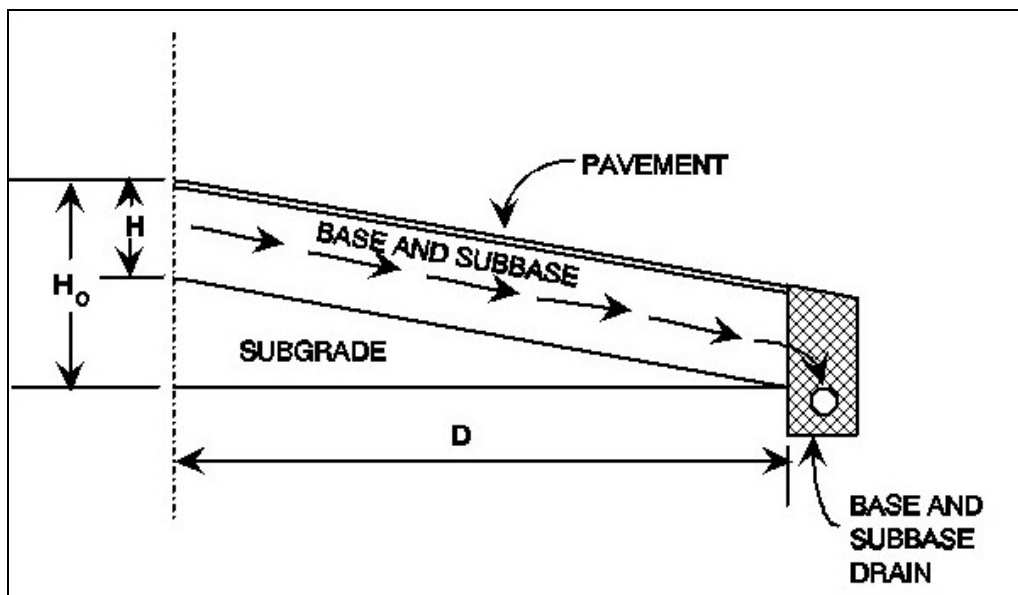
The dimensions of time  $k$ ,  $H_o$ ,  $H$ , and  $D$  must be consistent. If in Figure G-4 the thickness of the drainage layer is small compared to the length of the drainage path, the slope of the drainage path ( $i$ ) can represent the value of  $\left(\frac{H_o}{D}\right)$  and Equation G-10 can be written as

$$T_{50} = \frac{n_e \cdot D}{2 \cdot i \cdot k} \quad (\text{G-11})$$

Experience has shown that base and subbase materials, when compacted to densities required in pavement construction, seldom have sufficient permeability to meet the 10-day drainage criterion. In such pavements, the base and subbase materials become saturated, causing a reduced pavement life. When a drainage layer is incorporated into the pavement structure to improve pavement drainage, the criterion for design of the drainage layer is that the drainage layer must reach a degree of drainage of 85 percent within 24 hours. The time for 85 percent drainage is approximately twice the time for 50 percent drainage. The time for 85 percent drainage ( $T_{85}$ ) is computed by

$$T_{85} = \frac{n_e \cdot D}{i \cdot k} \quad (\text{G-12})$$

**Figure G-4. Pavement Geometry for Computation of Time for Drainage**



**G-2.3.5 Length and Slope of the Drainage Path.** As can be seen in Equation G-10, the time for drainage is a function of the square of the length of the drainage path. For this reason and the fact that for most pavement designs the length of the drainage path can be controlled, the drainage path length is an important parameter in the design of the drainage system. The length of the drainage path ( $L$ ) may be computed from this equation:

$$L = \frac{L_t \cdot \sqrt{i_t^2 + i_e^2}}{i_t} \quad (\text{G-13})$$

where

$L_t$  = the length of the transverse slope of the drainage layer

$i_t$  = the transverse slope of the drainage layer

$i_e$  = the longitudinal slope of the drainage layer

The slope of the drainage path ( $i$ ) is a function of the transverse slope and the longitudinal slope of the drainage layer and is computed by Equation G-14:

$$i = \sqrt{i_t^2 + i_e^2} \quad (\text{G-14})$$

**G-2.3.6 Rate of Flow.** The edge drains for pavements having drainage layers must be designed to handle the maximum rate of flow from the drainage layer. This maximum rate of flow will be obtained when the drainage layer is flowing full and may be estimated using Equation G-2.

## G-2.4 Use of Drainage Layers

**G-2.4.1 Purpose of Drainage Layers.** Special drainage layers may be used to promote horizontal drainage of water from pavements, prevent the buildup of hydrostatic water pressure, and facilitate the drainage of water generated by cycles of freeze-thaw.

**G-2.4.2 Placement of Drainage Layers.** In rigid pavements, the drainage layer will generally be placed directly beneath the concrete slab. In this location, the drainage layer will intercept water entering through cracks and joints and permit rapid drainage of the water away from the bottom of the concrete slab. In flexible pavements, the drainage layer will normally be placed beneath the dense graded aggregate base (DGA). Placing the drainage layer beneath the base will reduce the stresses on the drainage layer to an acceptable level and drainage will be provided for the base course.

**G-2.4.3 Permeability Requirements for the Drainage Layer.** The material for drainage layers in pavements must be of sufficient permeability to provide rapid drainage and to rapidly dissipate water pressure in addition to providing sufficient strength and stability to withstand load-induced stresses. There is a trade-off between strength or stability and permeability; therefore, the material for the drainage layers should have the minimum permeability for the required drainage application. For most applications, a material with a permeability of 300 m/day (1,000 ft/day) will provide sufficient drainage.

## G-2.5 Use of Filters

**G-2.5.1 Purpose of Filters in Pavement Structures.** The purpose of filters in pavement structures is to prevent the movement of soil (piping) yet allow the flow of



water from one material to another. The need for a filter is dictated by the existence of water flow from a fine grain material to a coarse grain material generating a potential for piping of the fine grain material. The principal location in the pavement structure for a flow from a fine grain material into a coarse grain material is where water flows from the base, subbase, or subgrade into the coarse aggregate surrounding the drain pipe. Thus, the principal use of a filter in a pavement system will be in preventing piping into the drain pipe. Although rare, the possibility exists for hydrostatic head forcing a flow of water upward from the subbase or subgrade into the pavement drainage layer. For such a condition, it would be necessary to design a filter to separate the drainage layer from the finer material.

**G-2.5.2 Piping Criteria.** The criteria for preventing movement of particles from the soil or granular material to be drained into the drainage material are:

$$\frac{15 \text{ percent size of drainage or filter material}}{85 \text{ percent size of material to be drained}} \leq 5$$

and

$$\frac{50 \text{ percent size of drainage or filter material}}{50 \text{ percent size of material to be drained}} \leq 25$$

These criteria will be used when protecting all soils except clays without sand or silt particles. For these soils, the 15 percent size of drainage or filter material may be as great as 0.4 mm and the  $d_{50}$  criteria may be disregarded.

**G-2.5.3 Permeability Requirements.** To assure that the filter material is sufficiently permeable to permit passage of water without hydrostatic pressure buildup, this requirement should be met:

$$\frac{15 \text{ percent size of filter material}}{15 \text{ percent size of material to be drained}} \geq 5$$

## **G-2.6 Use of Separation Layers**

**G-2.6.1 Purpose of Separation Layers.** When drainage layers are used in pavement systems, the drainage layers must be separated from fine grain subgrade materials to prevent penetration of the drainage material into the subgrade or pumping of fines from the subgrade into the drainage layer. The separation layer is different from a filter in that there is no requirement, except during frost thaw, to protect against water flowing from the subgrade through the layer into the drainage layer.

**G-2.6.2 Requirements for Separation Layers.** The main requirements of the separation layer are that the material for the separation layer have sufficient strength to prevent the coarse aggregate of the drainage layer from being pushed into the fine material of the subgrade and that the material have sufficient permeability to prevent buildup of hydrostatic pressure in the subgrade. To satisfy the strength requirements, the material of the separation layer should have a minimum CBR of 50. To allow for release of hydrostatic pressure in the subgrade, the separation layer should have a

permeability greater than that of the subgrade. This would not normally be a problem because the permeability of subgrades are orders of magnitude less than the permeability of a 50 CBR material, but to ensure sufficient permeability, the permeability requirements of a filter would apply.

## **G-2.7 Use of Geotextiles**

**G-2.7.1 Purpose of Geotextiles.** Geotextiles (engineering fabrics) may be used to replace either the filter or the separation layer. The principal use of geotextiles is for the filter around the pipe for the edge drain. Although geotextiles can be used as a replacement for the separation layer, a geotextile adds no structure strength to the pavement; therefore, this practice is not recommended.

**G-2.7.2 Requirements of Geotextiles for Filters.** When geotextiles are to serve as a filter lining the edge drain trench, the most important function of the filter is to keep fines from entering the edge drain system. For pavement systems having drainage layers, there is little requirement for water flow through the fabric; therefore, for most applications, it is better to have a heavier fabric than would normally be used as a filter. Since drainage layers have a very high permeability, geotextile fabric should never be placed between the drainage layer and the edge drain. The permeability of geotextiles is governed by the size of the openings in the fabric, which is specified in terms of the AOS in millimeters. For use as a filter for the trench of the edge drain, the geotextile should always have an AOS that is equal to or less than 0.212 mm. For geotextiles used as filters with drains installed to intercept groundwater flow in subsurface aquifers, the geotextile should be selected based on criteria similar to the criteria used to design a granular filter.

**G-2.7.3 Requirements for Geotextiles Used for Separation.** Geotextiles used as separation layers beneath drainage layers should be selected based primarily on survivability of the geotextiles, with slightly less emphasis placed on the AOS. When a geotextile is used as a separation layer, the geotextile's survivability should be rated very high by the rating scheme in AASHTO M 28890, *Standard Specification for Geotextiles, Asphalt Retention, and Area Change of Paving Engineering Fabrics*. This would ensure survival of the geotextile under the stress of traffic during the life of the pavement. To ensure that fines will not pump into the drainage layer yet allow water flow to prevent hydrostatic pressure, the AOS of the geotextile must be equal to or less than 0.212 mm and also equal to or greater than 0.125 mm.

**G-3 DESIGN OF THE PAVEMENT SUBSURFACE DRAINAGE SYSTEM.** The design methodology contained in this chapter is for the design of a pavement subsurface drainage system for the rapid removal of surface infiltration water and water generated by freeze-thaw action. Although the primary emphasis will be on removing water from under the pavement, on occasion the system will also serve as an interceptor drain for groundwater.

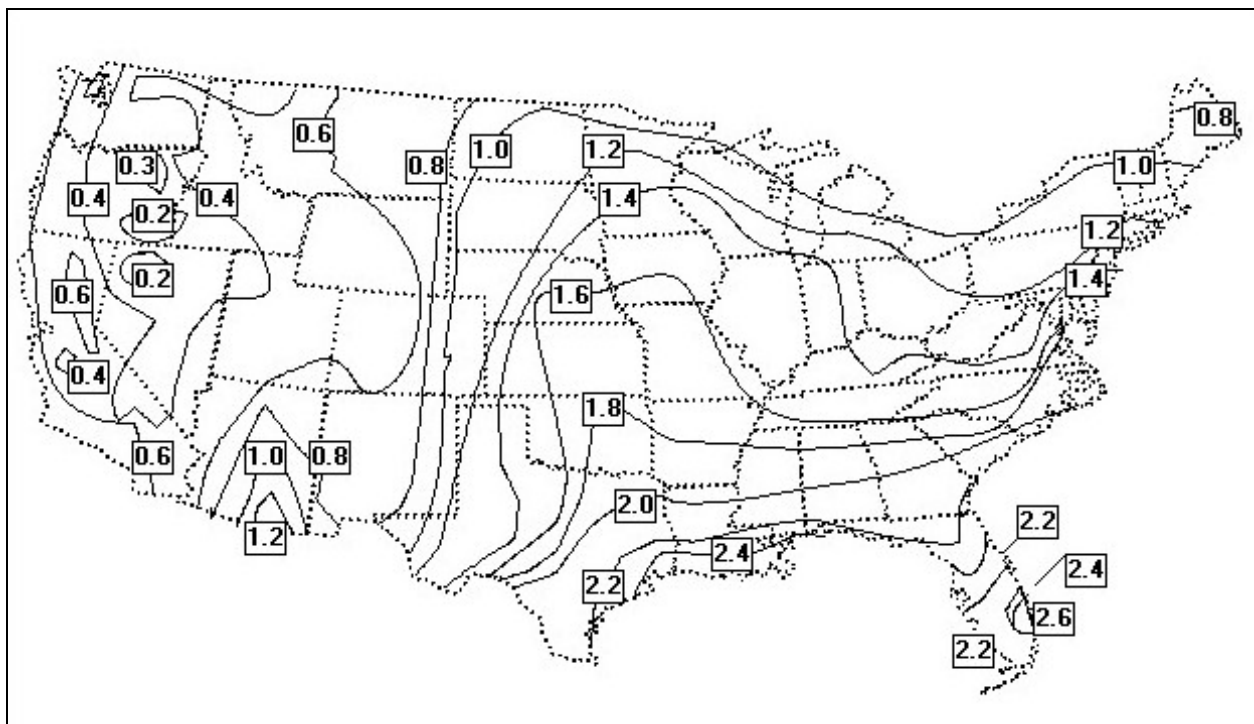
**G-3.1 Methods.** For most pavement structures, water is to be removed by a special drainage layer that allows the rapid horizontal drainage of water. The drainage layer must be designed to handle surface infiltration from a design storm and withstand the stress of traffic. A separation layer must be provided to prevent intrusion of fines

from the subgrade or subbase into the drainage layer and facilitate construction of the drainage layer. The drainage layer should feed into a collection system consisting of trenches with a drain pipe, backfill, and filter. The collection system must be designed to maintain progressively greater outflow capabilities in the direction of flow. The outlet for the subsurface drains should be properly located or protected to prevent backflow from the surface drainage system. Some pavements may not require a drainage system because the subgrade may have sufficient permeability for the water to drain vertically into the subgrade. In addition, some pavements designed for very light traffic may not justify the expense of a subsurface drainage system. Even for pavements designed for very light traffic, care must be taken to ensure that base and subbase material are free draining and that water will be not trapped in the pavement structure. For pavement without collection systems, the base and subbase must daylight at the shoulders.

**G-3.2 Design Prerequisites.** For the satisfactory design of a subsurface drainage system, the designer must have an understanding of environmental conditions, subsurface soil properties, and groundwater conditions.

**G-3.2.1 Environmental Conditions.** Temperature and rainfall data applicable to the local area should be obtained and studied. The depth of frost penetration is an important factor in the design of a subsurface drainage system. For most areas, the approximate depth of frost penetration can be determined by referring to AC 150/5320-6. Rainfall data are used to determine the volume of water to be handled by the subsurface drainage system. The data can be obtained from local weather stations, by using Figure G-5, or from the web at <http://www.weather.gov/oh/hdsc/currentpf.htm>.

**Figure G-5. Design Storm Index, 1-Hour Rainfall Intensity-Frequency Data for the Continental United States Excluding Alaska**



**G-3.2.2 Subsurface Soil Properties.** In most cases, the soil properties investigated for other purposes in connection with the pavement design will supply information that can be used for the design of the subsurface drainage system. The two properties of most interest are the coefficient of permeability and the frost susceptibility of the pavement materials.

**G-3.2.3 Coefficient of Permeability.** Knowing the coefficient of permeability of the existing subsurface soils is essential for determining if special horizontal drainage layers are necessary in the pavement. For pavements having subgrades with a high coefficient of permeability, the water entering the pavement will drain vertically and therefore horizontal drainage layers will not be required. For pavements having subgrades with a low coefficient of permeability, the water entering the pavement must be drained horizontally to the collector system or to edge drains.

**G-3.2.4 Frost-Susceptible Soils.** Soils susceptible to frost action are those that have the potential of ice formation when the soil is subjected to freezing conditions with water available. Ice formation takes place at successive levels as freezing temperatures penetrate into the ground. Soils possessing a high capillary rate and low cohesive nature act as a wick in feeding water to ice lenses. Soils are categorized according to their degree of frost susceptibility as shown in Table G-2. Because a large volume of free water is generated during the thaw of ice lenses, horizontal drainage layers are required to permit the escape of the water from the pavement structure and thus facilitate restoring the pavement strength.

**Table G-2. Frost-Susceptible Soils**

Typical Soil			
Frost Group	Type of Soil	Percent Finer than 0.02 mm by Weight	Types Under Unified Soil Classification System
F1	Gravelly soils	6-10	GW-GM, GP-GM, GW-GC, GP-GC
F2	(a) Gravelly soils (b) Sands	3-20 6-15	GM, GC, GM-GC SM, SC, SW-SM, SP-SM, SW-SC, SP-SC, SM-SC
F3	(a) Gravelly soils (b) Sands, except very fine silty sands (c) Clays (PI > 12)	> 20 > 15 --	GM, GC, GM-GC SM, SC, SM-SC CL, CH, ML-CL
F4	(a) Silts (b) Very fine sands (c) Clays (PI < 12) (d) Varved clays and other fine grained, with banded sediments	-- > 15 -- --	ML, MH, ML-CL SM, SC, SM-SC CL, ML-CL CL or CH layered ML, MH, SM, SC SM-SC or ML-CL

**G-3.2.5 Sources for Data.** From the field explorations made in connection with the project design, include a topographic map of the proposed pavement facility and surrounding vicinity indicating all streams, ditches, wells, and natural reservoirs. Analyze aerial photographs for information on general soil and groundwater conditions. Borings taken during the soil exploration should provide depth to water tables and subgrade soil types. Obtain typical values of permeability for subgrade soils from Figure G-3. Although the value of permeability determined from Figure G-3 must be considered as an estimate only, the value should be sufficiently accurate to determine if subsurface drainage is required for the pavement. For the permeability of granular materials, determine estimates of the permeability from these equations:

$$k = \frac{217.5 \cdot (D_{10})^{1.478} \cdot (n)^{6.654}}{(P_{200})^{0.597}} \text{ in mm/sec} \quad (\text{G-15})$$

or

$$k = \frac{(6.214 \times 10^5) \cdot (D_{10})^{1.478} \cdot (n)^{6.654}}{(P_{200})^{0.597}} \text{ in ft/day} \quad (\text{G-16})$$

where

- $n$  = porosity =  $1 - \frac{\gamma_d}{\gamma_w \cdot G}$
- $G$  = specific gravity of solids (assumed 2.7)
- $\gamma_d$  = dry density of material
- $\gamma_w$  = density of water
- $D_{10}$  = effective grain size at 10 percent passing in mm
- $P_{200}$  = percent passing 0.075 mm (No. 200) sieve

For the most part, the permeability values needed for design of the drainage layer will be assigned based on the gradation of the drainage material. In some cases, laboratory permeability tests may be necessary; however, use caution and be aware that the permeability of very open granular materials is very sensitive to test methods, methods of compaction, and gradation of the sample. Because of this, use conservative drainage layer permeability values for design.

### **G-3.3 Criteria for Subsurface Drainage Systems**

**G-3.3.1 Criteria for Requiring a Subsurface Drainage System.** Not all pavements will require a subsurface drainage system, either because the subgrade is sufficiently permeable to allow water to drain vertically into the subgrade or because the pavement structure does not justify the expense of a subsurface drainage system. For pavements in nonfrost areas and having a subgrade with permeability greater than 6 m/day (20 ft/day), one can assume that the vertical drainage will be sufficient such that no

drainage system is required. In addition to this exemption for the requirement for drainage systems, flexible pavements that are in nonfrost areas and that have a total thickness of structure above the subgrade of 200 mm (8 in.) or less are not required to have a drainage system. All pavements not meeting these criteria are required to have a subsurface drainage system. Even if a pavement meets the exemption requirements, conduct a drainage analysis for possible benefits for including the drainage system. For rigid pavements in particular, take care to ensure that water is drained rapidly from the bottom of the slab and that the material directly beneath the concrete slab is not susceptible to pumping.

**G-3.3.2 Design Water Inflow.** Design the subsurface drainage of the pavement to handle infiltrated water from a design storm of 1-hour duration at an expected return frequency of 2 years. The design storm index for the continental United States can be obtained from Figure G-5. The inflow is determined by multiplying the design storm index ( $R$ ) times an infiltration coefficient ( $F$ ). The infiltration coefficient will vary over the life of the pavement depending on the type of pavement, surface drainage, pavement maintenance, and the structural condition of the pavement. Since determining a precise value of the infiltration coefficient for a particular pavement is very difficult, a value of 0.5 may be assumed for design.

**G-3.3.3 Length and Slope of the Drainage Path.** The length of the drainage path is measured along the slope of the drainage layer from the crest of the slope to where the water will exit the drainage layer. In simple terms, the length of the drainage path is the maximum distance water will travel in the drainage layer. The length of the drainage path ( $L$ ) in meters (feet) may be computed using Equation G-13, and the slope ( $i$ ) of the drainage path may be computed using Equation G-14.

**G-3.3.4 Thickness of the Drainage Layer.** The thickness of the drainage layer is computed such that the capacity of the drainage layer will be equal to or greater than the infiltration from the design storm. When the length of the drainage path ( $L$ ) is in meters (feet), the design storm index ( $R$ ) is in meters/hour (feet/hour), the permeability of the drainage layer ( $k$ ) is in meters/hour (feet/hour), and the length of the design storm ( $t$ ) is in hours, the equation for computing the thickness ( $H$ ) in meters (feet) is

$$H = \frac{2 \cdot F \cdot R \cdot L \cdot t}{(1.7 \cdot n_e \cdot L) + (k \cdot i \cdot t)} \quad (\text{G-17})$$

The effective porosity ( $n_e$ ), the infiltration coefficient ( $F$ ), and the slope of the drainage path ( $i$ ) are non-dimensional. If the term ( $k \cdot i \cdot t$ ) is small compared to the term ( $1.7 \cdot n_e \cdot L$ ), which would be the case for long drainage paths, i.e., for drainage paths longer than approximately 6 m (20 ft), then the required thickness of the drainage layer can be estimated by deleting the term ( $k \cdot i \cdot t$ ) from Equation G-17 or

$$H = \frac{F \cdot R}{0.85 \cdot n_e} \quad (\text{G-18})$$

where the units are the same as in Equation G-17.

**G-3.3.5 Drainage Criteria.** The subsurface drainage criteria for airfield runways and taxiways require that, should the drainage layer become saturated, it should be capable of attaining 85 percent drainage within 24 hours. For airfield parking aprons and other pavement areas receiving only low-volume, low-speed traffic, the time for 85 percent drainage is 10 days. The time for 85 percent drainage is computed by the equation

$$T_{85} = \frac{n_e \cdot L}{i \cdot k} \quad (\text{G-19})$$

where the dimensions of  $T_{85}$  will be in days when  $L$  is in meters (feet) and  $k$  is in meters/day (feet/day). The time of drainage may be adjusted by changing the drainage material, the length of the drainage path, or the slope of the drainage path. Changing the drainage material will change both the effective porosity and the permeability, but the effective porosity will change, at the most, by a factor of 3, whereas the permeability may change by several orders of magnitude. Thus, providing a more open drainage material would decrease the time for drainage, but more open materials are less stable and more susceptible to rutting. It is therefore desirable to keep the drainage material as dense as possible. The drainage layer of a pavement is usually placed parallel to the surface; therefore, in most cases, the slope of the drainage path is governed by the geometry of the pavement surface. For large paved areas such as airfield apron areas, the time for drainage is best controlled by designing the collection system to minimize the length of the drainage path. For edge drains along airfield taxiways and runways, it may be difficult to reduce the length of the drainage path without resorting to placing drains under the pavement. Pavements having long longitudinal slopes may require transverse collector drains to prevent long drainage paths. Thus, designing the subsurface drainage system to meet the criteria for time of drainage involves matching the type of drainage material with the drainage path length and slope.

### **G-3.4 Placement of Subsurface Drainage Systems**

**G-3.4.1 Rigid Pavements.** In the case of rigid pavements, the drainage layer, if required, should be placed directly beneath the concrete slab. In the structural design of the concrete slab, the drainage layer along with any granular separation layer is considered a base layer, and structural benefit may be realized from the layers.

**G-3.4.2 Flexible Pavements.** In the case of flexible pavements, the drainage layer should be placed either directly beneath the surface layer or beneath a graded, crushed aggregate base course. If the required thickness of the granular subbase is equal to or greater than the thickness of the drainage layer plus the thickness of the separation layer, the drainage layer is placed beneath the graded, crushed aggregate base. Where the total thickness of the pavement structure is less than 300 mm (12 in.), the drainage layer may be placed directly beneath the surface layer and the drainage layer used as a base. When the drainage layer is placed beneath an unbound aggregate base, take care to limit the material passing the 0.075 mm (No. 200) sieve in the aggregate base to 8 percent or less.

**G-3.4.3 Separation Layer.** The drainage layer must be protected from contamination of fines from the underlying layers by a separation layer placed directly

beneath the drainage layer. In most cases, the separation layer should be a graded aggregate material meeting the requirements of a 50 CBR subbase and can, in fact, be considered as part of the subbase. For design situations where a firm foundation already exists and thickness of the separation layer is not needed in the structure for protection of the subgrade, a filter fabric may be substituted for the granular separation layer. In frost areas, the separation layer should be NFS and, in fact, some materials used as non-susceptible fill may qualify as a separation layer.

### **G-3.5 Material Properties**

**G-3.5.1 For Drainage Layers.** The material for a drainage layer should be a hard, durable crushed aggregate to withstand degradation under construction traffic as well as in-service traffic. The gradation of the material should be such that the material has sufficient stability for the operation of construction equipment. While it is desirable for strength and stability to have the well-graded aggregate, the permeability of the material must be maintained. For most drainage layers, the drainage materials should have a minimum permeability of 300 m/day (1,000 ft/day). Two materials, an RDM and an OGM, have been identified for use in drainage layers. The RDM is a material that has a sufficiently high permeability (300 m/day (1,000 ft/day) to 1,500 m/day (5,000 ft/day)) to serve as a drainage layer and that also has the stability to support construction equipment and the structural strength to serve as a base and/or a subbase. The OGM is a material that has a very high permeability (greater than 1,500 m/day (5,000 ft/day)) and that can be used for a drainage layer. The OGM will normally require stabilization for construction stability and/or for structural strength to serve as a base in a flexible pavement. Gradation limits for the two materials are given in Table G-3, and the design properties are given in Table G-4. The gradations given in Table G-3 provide very wide bands, and it is possible to produce gradations within these bands that may not be sufficiently stable for construction without the use of chemical stabilization. Table G-5 provides the gradation specifications for three aggregate materials, each of which will meet the criteria for stability. These gradations were developed to produce the maximum density given maximum aggregate sizes of 1.5 in., 1 in., and 0.75 in., and a maximum of 4 percent passing the number 16 sieve. For drainage layer thicknesses less than 6 in., gradations number 1 or 2 may be used. For drainage layers 6 in. or more in thickness, any of the three gradations may be used, but the gradations with larger aggregates will produce the more stable aggregate. Each of the gradations would produce a drainage layer with a permeability of approximately 1000 ft/day.

**Table G-3. Gradations of Materials for Drainage Layers and Choke Stone**

<b>Drainage Layer Material</b>			
<b>Sieve Designation (mm)</b>	<b>Rapid Draining Material</b>	<b>Open-Graded Material</b>	<b>Choke Stone</b>
38.0 (1-1/2 in.)	100	100	100
25.0 (1 in.)	70-100	95-100	100
19.0 (3/4 in.)	55-100	--	100



Drainage Layer Material			
Sieve Designation (mm)	Rapid Draining Material	Open-Graded Material	Choke Stone
12.5 (1/2 in.)	40-80	25-80	100
9.5 (3/8 in.)	30-65	--	80-100
4.75 (No. 4)	G-50	0-10	G-100
2.4 (No. 8)	0-25	0-5	5-40
1.2 (No. 16)	0-5	--	0-10

**Table G-4. Properties of Materials for Drainage Layers**

Property	Rapid Draining Material	Open-Graded Material
Permeability in m/sec (ft/day)	300-1,500 (1,000-5,000)	> 1,500 (> 5,000)
Effective Porosity	0.25	0.32
Percent Fractured Faces (Corps of Engineers method)	90 percent for 80 CBR 75 percent for 50 CBR	90 percent for 80 CBR 75 percent for 50 CBR
C <sub>v</sub>	> 3.5	--
LA Abrasion	< 40	< 40

Note: C<sub>v</sub> is the uniformity coefficient = D60/D10.

**Table G-5. Material Gradations for Drainage Layer**

Sieve Size	Gradation #1 ¾ inch max.		Gradation #2 1 inch max.		Gradation #3 1½ inch max	
	Percent Passing	Tolerance	Percent Passing	Tolerance	Percent Passing	Tolerance
1 ½ in (37.0 mm)					100	-5
1 in (25 mm)			100	-5	79	±8
¾ in (19 mm)	100	-5	85	±8	66	±8
½ in (12.5 mm)	78	±8	65	±8	52	±8
3/8 in (9.5 mm)	63	±8	53	±8	42	±8

Sieve Size	Gradation #1 ¾ inch max.		Gradation #2 1 inch max.		Gradation #3 1½ inch max	
	Percent Passing	Tolerance	Percent Passing	Tolerance	Percent Passing	Tolerance
No. 4 (4.75mm)	38	±8	32	±6	25	±6
No. 8 (2.36 mm)	19	±6	16	±6	12	±4
No. 16 (1.18 mm)	2	±2	2	±2	2	±2

**G-3.5.2 Aggregate for Separation Layer.** The separation layer serves to prevent fines from infiltrating or pumping into the drainage layer and to provide a working platform for construction and compaction of the drainage layer. The material for the separation layer should be a graded aggregate with a 50 CBR maximum except that the maximum aggregate size should not be greater than 0.25 the thickness of the separation layer. The permeability of the separation layer should be greater than the permeability of the subgrade, but the material should not be so open as to permit pumping of fines into the separation layer. To prevent pumping of fines, the ratio of  $d_{15}$  of the separation layer to  $d_{85}$  of the subgrade must be equal to or less than 5. The material property requirements for the separation layer are given in Table G-6.

**Table G-6 Criteria for Granular Separation Layer**

Maximum Aggregate Size	Lesser of 50 mm (2 in.) or 0.25 of layer thickness
Maximum CBR	50
Maximum Percent Passing 2.00 mm (No. 10)	50
Maximum Percent Passing 0.075 mm (No. 200)	15
Maximum Liquid Limit	25
Maximum Plasticity Index	5
$d_{15}$ of Separation Layer to $d_{85}$ of Subgrade	≤ 5

**G-3.5.3 Filter Fabric for Separation Layer.** Although filter fabric provides protection against pumping, it does not provide extra stability for compaction of the drainage layer; therefore, fabric should be selected only when the subgrade provides adequate support for compaction of the drainage layer. The important characteristics of the fabric are strength for surviving construction and traffic loads, and AOS to prevent pumping of fines into the drainage layer. Filter fabric for separation should be a nonwoven needle punch fabric having a minimum grab strength in accordance with ASTM D-4632 of 0.8 Kilonewtons (kN) (180 lbs) at 50% elongation and a minimum puncture strength

in accordance with ASTM D-4833 of 0.35 kN (80 lbs). The AOS for the filter fabric is determined from Table G-7.

**Table G-7. Criteria for Filter Fabric to be Used as a Separation Layer**

Soil Type	Criteria	ASTM Test Method
Soil with 50% or Less Passing No. 200 Sieve	AOS (mm) < 0.6 mm Greater than No. 30 sieve	D-4751
Soil with Greater Than 50% Passing No. 200 Sieve	AOS (mm) < 0.297 Greater than No. 50 sieve	D-4751

**G-4 STABILIZATION OF DRAINAGE LAYER.** Stabilization of OGM is normally required for stability and strength and for preventing degradation of the aggregate in handling and compaction. Stabilization may also be used when high-quality crushed aggregate is not available, and on occasions when stabilization of RDM is necessary. Stabilization may be accomplished mechanically by use of a choke stone or by the use of a binder such as asphalt or portland cement.

**G-4.1 Choke Stone Stabilization.** A choke stone is a small-size stone used to stabilize the surface of an OGM. The choke stone should be a hard, durable, crushed aggregate having 90 percent fractured faces. The ratio of  $d_{15}$  of the coarse aggregate to the  $d_{15}$  of the choke stone must be less than 5, and the ratio of the  $d_{50}$  of the coarse aggregate to  $d_{50}$  of the choke stone must be greater than 2. The gradation range for acceptable choke stone is given in Table G-3. Normally, ASTM No. 8 or No. 9 stone will meet the requirements of a choke stone for the OGM.

**G-4.2 Asphalt Stabilization.** Stabilization of the drainage material with asphalt is accomplished by using only enough asphalt as is required to coat the aggregate. Take care so that the voids are not filled by excess asphalt. The asphalt grade used for stabilization should be AC20 or higher. For stabilization of OGM, 2 to 2.5 percent asphalt by weight should be sufficient to coat the aggregate. Higher rates of application may be necessary when stabilization of less open aggregate such as RDM is necessary.

**G-4.3 Cement Stabilization.** As with asphalt stabilization, portland cement stabilization is accomplished by using only enough cement paste to coat the aggregate, and care should be taken so that the voids are not filled by excess paste. The amount of portland cement required should be approximately  $170 \text{ kg/m}^3$  (2 bags per cubic yard) depending on the gradation of the aggregate. The water-cement ratio should be just sufficient to provide a paste that will adequately coat the aggregate.

## **G-5 CONSTRUCTION OF THE DRAINAGE LAYER**

**G-5.1 Experience.** Construction of drainage layers can present problems in handling, placement, and compaction. If the drainage material does not have adequate stability, major problems can develop in the placement of the surface layer above the

drainage layer. Experience with highly permeable bases (drainage layers) both by the United States Army Corps of Engineers (USACE) and various state departments of transportation indicates that pavements containing such layers can be constructed without undue difficulties if necessary precautions are taken. The key to successful construction of the drainage layers is the training and experience of the construction personnel. Prior to the start of construction, the construction personnel should be taught how to handle and place the drainage material. Placing test strips is recommended for training construction personnel.

**G-5.2 Placement of the Drainage Layer.** The material for the drainage layer must be placed to prevent segregation and to obtain a layer of uniform thickness. The materials for the drainage layer will require extra care in stockpiling and handling. Placement of the RDM and OGM is best accomplished using an AC paver. To ensure good compaction, the maximum lift thickness should be no greater than 150 mm (6 in.). If choke stone is used to stabilize the surface of the OGM, place the choke stone after compaction of the final lift of OGM. Spread the choke stone in a thin layer no thicker than 10 mm (0.5 in.) using a spreader box or paver. Work the choke stone into the surface of the OGM by using a vibratory roller and by wetting. The choke stone remaining on the surface should not migrate into the OGM by the action of water or traffic.

**G-5.3 Compaction.** Compaction is a key element in the successful construction of the drainage layer. Compaction control normally used in pavement construction is not appropriate for materials such as the RDM and OGM. It is therefore necessary to specify compaction techniques and level of effort instead of the properties of the end product. It will be important to place the drainage material in relatively thin lifts of 150 mm (6 in.) or less and to have a good, firm foundation beneath the drainage material. The recommended method of determining the required compaction effort is to construct a test section and closely monitor the aggregate during compaction to determine when crushing of the aggregate appears excessive. Experience has indicated that sufficient compaction can be obtained by 6 passes or fewer of a vibratory roller loaded at approximately 9 metric tons (10 short tons). Material not being stabilized with asphalt or cement should be kept moist during compaction. Asphalt stabilized material for drainage layers must be compacted at a slightly lower temperature than a dense-graded asphalt material. In most cases, it will be necessary to allow an asphalt stabilized material to cool to less than 93 degrees Celsius (200 degrees Fahrenheit) before beginning compaction.

**G-5.4 Protection after Compaction.** After compaction, protect the drainage layer from contamination by fines from construction traffic and from the flow of surface water. The surface layer should be placed as soon as possible after placement of the drainage layer. Also, take precautions to protect the drainage layer from disturbance by construction equipment. Only tracked asphalt pavers should be allowed for paving over any RDM or OGM that has not been stabilized. Drivers should avoid rapid acceleration, hard braking, or sharp turning on the completed drainage layer. Although curing of cement-stabilized drainage layers is not critical, efforts should be made at curing until the surface layer is placed.

**G-5.5 Proof Rolling.** For airfields with runways over 1,524 m (5,000 ft), proof rolling is recommended on the graded, crushed-aggregate base even when the base is used over a drainage layer. Proof rolling the separation layer prior to placing the drainage layer is recommended. It is recommended that the proof rolling be accomplished using a rubber-tired roller load to provide a minimum tire force of 89 kN (20,000 lbs) and inflated to at least 620 kPa (90 lb/in.<sup>2</sup>). A minimum of 6 coverages should be applied, where a coverage is the application of one tire print over each point in the surface of the designated area. During proof rolling, action of the separation layer must be monitored for any sign of excessive movement or pumping that would indicate soft spots in the separation layer or the subgrade. Since the successful placement of the drainage layer depends on the stability of the separation layer, all weak spots must be removed and replaced with stable material. All replaced material must meet the appropriate material and construction specifications and upon replacement according to the appropriate specification, proof rolling as specified in this paragraph is recommended.

## **G-6 COLLECTOR DRAINS**

**G-6.1 Design Flow.** Provide collector drains to collect and transport water from under the pavement. For pavements having drainage layers, collector drains are mandatory. The collector system should have the capacity to handle the water from the drainage layer plus water from other sources. The amount of water entering the collector system from the drainage layer is computed assuming the drainage layer is flowing full. Thus, the volume of water ( $Q$ ) in cubic millimeters per second per meter (cubic feet per day per foot) of length of collector pipe (assuming the drainage layer is only on one side of the collector) would be

$$Q = 1000 \cdot H \cdot i \cdot k \text{ in cubic mm per second per meter} \quad (\text{G-20})$$

or

$$Q = H \cdot i \cdot k \text{ in cubic ft per day per foot} \quad (\text{G-21})$$

where

- $H$  = thickness of the drainage layer, mm (ft)
- $i$  = slope of the drainage layer
- $k$  = permeability of the material in the drainage layer, mm/sec (ft/day)

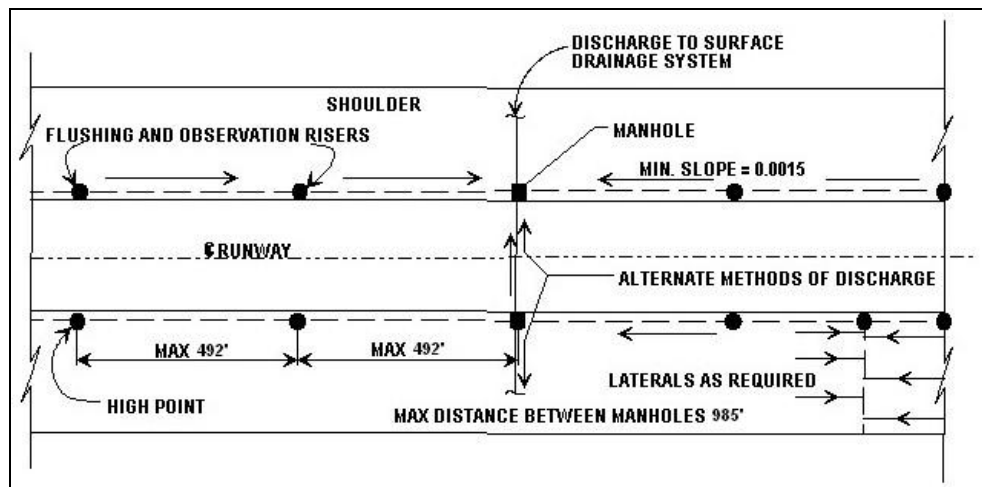
If the collector system has water entering from both sides, the volume of water entering the collector would be twice that given by Equation G-20.

## **G-6.2 Design of Collector Drains**

**G-6.2.1 Drainage System Layout.** The collector drains are normally placed along the shoulder of the pavement as illustrated in Figure G-8. The system will consist of the drain pipe, flushing and observation risers, manholes, discharge laterals, filter fabric, and trench backfill. Since placing subsurface drains under pavements may result in differential settlement or heave, avoid this when possible. The drainage system for large

areas of pavement may require placement of subsurface drains under the pavement. For these cases, place the subsurface drains to avoid high traffic areas. In areas of extreme cold temperatures and heavy snow buildup, place laterals to reduce the probability that they will become clogged with ice or snow. Also, in areas of extreme cold temperatures, placing the collector drains below the depth of frost penetration may not be possible; therefore, the collector pipe may be filled with ice while thawing is occurring near the surface. For this case, make provisions to drain the upper portion of the pavement either by daylighting the drainage layer or providing special laterals to drain the drainage layer.

**Figure G-8. Plan View of Subsurface Drainage System**



**G-6.2.2 Collector Pipe.** The collector pipe may be perforated flexible, acrylonitrile butadiene styrene (ABS), corrugated polyethylene (CPE), or smooth, rigid polyvinyl chloride pipe (PVC). Pipe should conform to the appropriate AASHTO specification. Most state highway agencies use either CPE or PVC. For CPE pipe, AASHTO specification M 252 is suggested, while for PVC pipe, AASHTO specification M 278 is recommended. Though asphalt-stabilized material is not recommended as backfill around pipe, if it is to be used, the pipe should be PVC 90 degrees Celsius electrical plastic conduit EPC-40 or EPC-80 conforming to the requirements of National Electrical Manufacturers Association (NEMA) Specification TC-2. Geocomposite edge drains (strip drains) may be used in special situations, but only with the approval of a modification to standards (FAA Order 5100.1) by AAS-100. Geocomposite edge drains should be considered only for pavements without a drainage layer.

**G-6.2.3 Pipe Size and Slopes.** The pipe must be sized, according to Equation G-22 or G-23, to have a capacity sufficient to collect the peak flow from under the pavement. Equations G-22 and G-23 are Manning equations for computing the capacity of a full-flowing circular drain. The equation for flow ( $Q$ ) in cubic feet per second is

$$Q = \frac{1.486}{n} \cdot (A) \cdot \left[ \frac{d}{4} \right]^{2/3} \cdot (s^{1/2}) \quad (\text{G-22})$$

where

- $n$  = coefficient of roughness for the pipe
- $A$  = area of the pipe, ft<sup>2</sup>
- $d$  = pipe diameter, ft
- $s$  = slope of the pipe invert

For metric units, the equation for flow in cubic meters per second is

$$Q = \frac{1.0}{n} \cdot (A) \cdot \left[ \frac{d}{4} \right]^{2/3} \cdot (s^{1/2}) \quad (\text{G-23})$$

where

- $n$  and  $s$  are as defined in Equation G-22
- $A$  = pipe area, m<sup>2</sup>
- $d$  = pipe diameter, m

The coefficient of roughness for different pipe types can be obtained from Table G-8. Except for long intercepting lines and extremely severe groundwater conditions, 150-mm (6-in.) diameter drains should be satisfactory for most subsurface drainage installations. The minimum size pipe recommended for all collector drains is 150-mm (6-in.) diameter. The recommended minimum slope for subdrains is 0.15 percent.

**Table G-8. Coefficient of Roughness for Different Types of Pipe**

Type of Pipe	Coefficient of Roughness, $n$
Clay, concrete, smooth-wall plastic, and asbestos-cement	0.013
Bituminous-coated, non-coated corrugated metal pipe or corrugated metal pipe	0.024

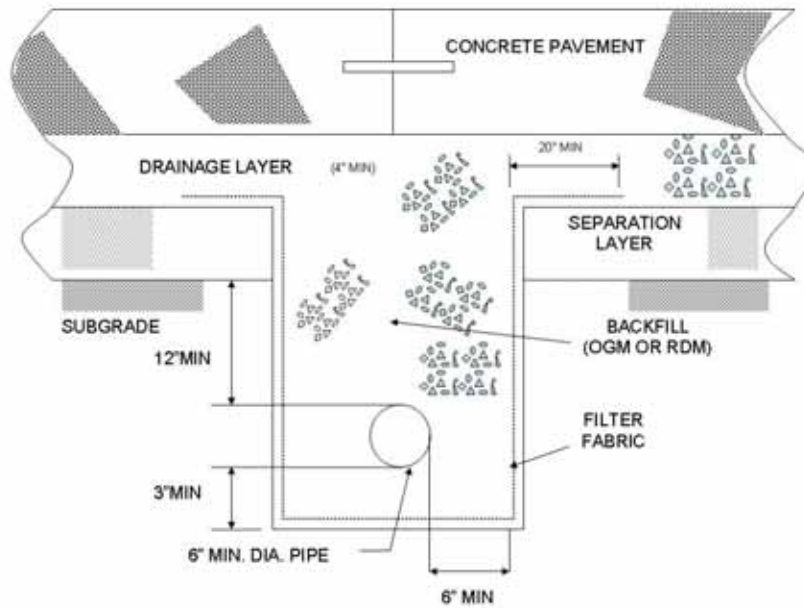
**G-6.3 Placement of the Drainage Layer and Collector Drains.** In general, the drainage layer is placed below the concrete surface for a rigid pavement and below the base course for a flexible pavement. Typical designs details for placement of the drainage layer and the collector drains in non-frost areas are given in Figures G-9a, G-10a, G-11a, and G-12a. In most cases, the trench for the collector drains should be wide enough to provide 150 mm (6 in.) of clearance on each side of the pipe. The depth of the trench must be sufficient to provide a minimum 300 mm (12 in.) from the top of the pavement subgrade to the center of the pipe, plus 80 mm (3 in.) of clearance beneath the pipe. In frost areas, use extra care in placing subsurface drains. The typical

design details for placement of the drainage layer and the collector drains for frost areas are given in Figures G-9b, G-9c, G-10b, G-11b, G-11c, and G-12b details (cross slopes varies in accordance with AC 150/5300-13). For F3 and F4 subgrades, always place a collector pipe such that there will be positive drainage for the drainage layer and any NFS fill. If possible, place the drains below the depth of frost penetration. For many locations, placing the drains below the depth of frost penetration will not be economically feasible and therefore the drains and backfill will be subject to freezing. In areas where the depth of frost penetration is greater than 1.2 m (4 ft) below the bottom of the drainage layer, the pipe need not be located deeper than 1.2 m (4 ft) from the bottom of the drainage layer. Because differential frost heave will cause pavement problems in frost areas, the sides of the trench must be sloped not steeper than 1 vertical on 10 horizontal for the depth of frost penetration. At the edge of the pavement where the pavement will not be subject to traffic, the sides of the trench may be sloped at a slope of 1 vertical on 4 horizontal. The sloping of the trench sides is not required for the parts of the trench in NFS materials or for F1 or S1 soils unless the pavement over the trench is subjected to high-speed traffic.

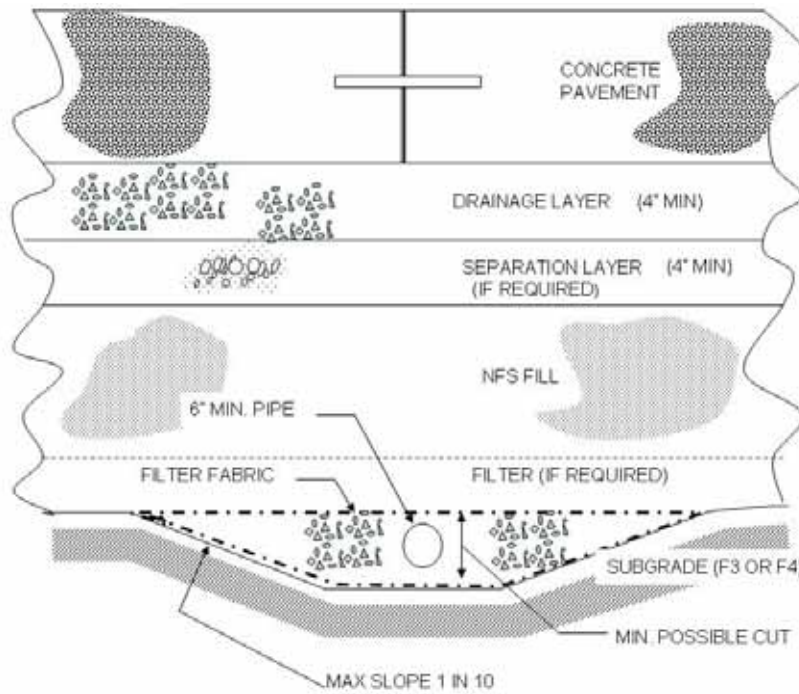
The placement of collector drains under the interior portion of a pavement in frost areas is a special case where the collector drain is not directly connected to the drainage layer by an OGM or an RDM. This case is illustrated in figures G-9b, G-9c, G-11b, and G-11c. The interior designs are based on the premise that NFS fill will have sufficient permeability to allow vertical drainage of the drainage layer into the collector pipes. Another premise is that the filter fabric will have sufficient area as not to impede the flow of water from the NFS fill to the collector pipe. The exception to the minimum requirement for the depth of the collector pipe below the surface of the subgrade is the interior case in a frost area for an F3 or F4 subgrade when the collector pipe is above the depth of frost penetration. For this case, keep the depth of the pipe below the surface of the subgrade to a minimum.



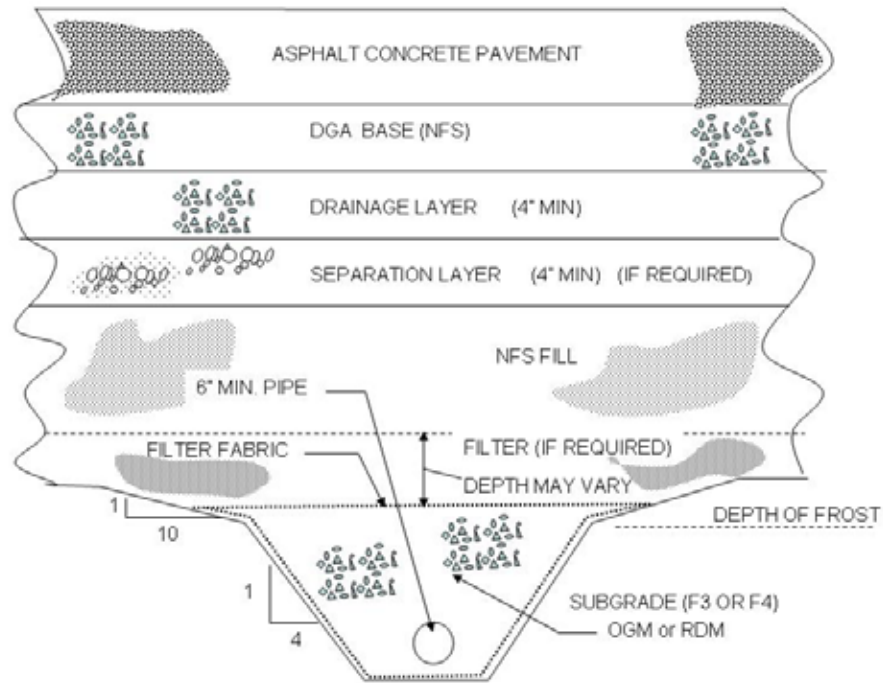
**Figure G-9a. Typical Interior Subdrain Detail for Rigid Pavement (Non-Frost Areas)**



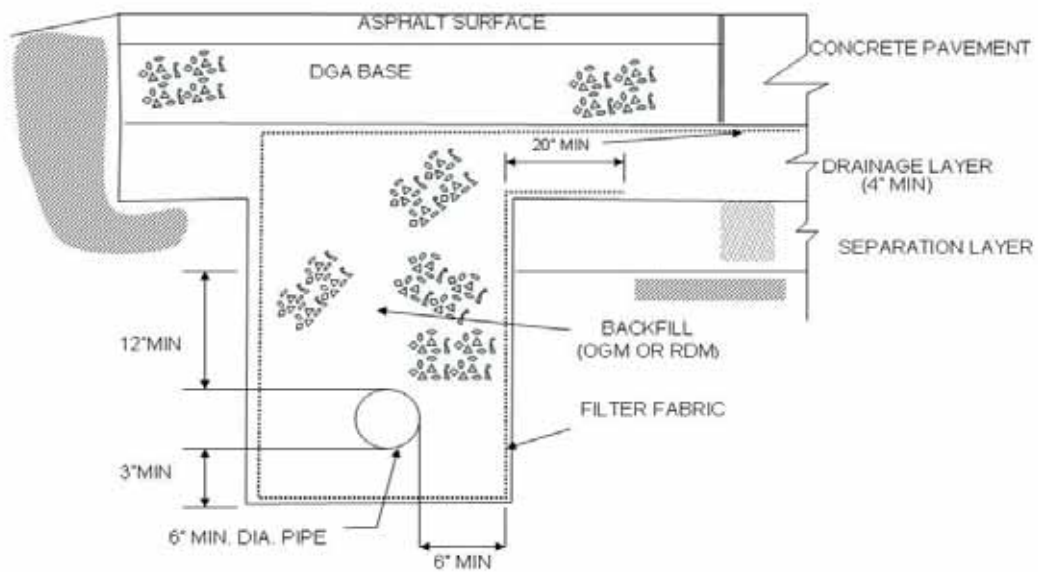
**Figure G-9b. Typical Interior Subdrain for Rigid Pavement (Frost Areas, Depth of Frost > Depth to Pipe)**



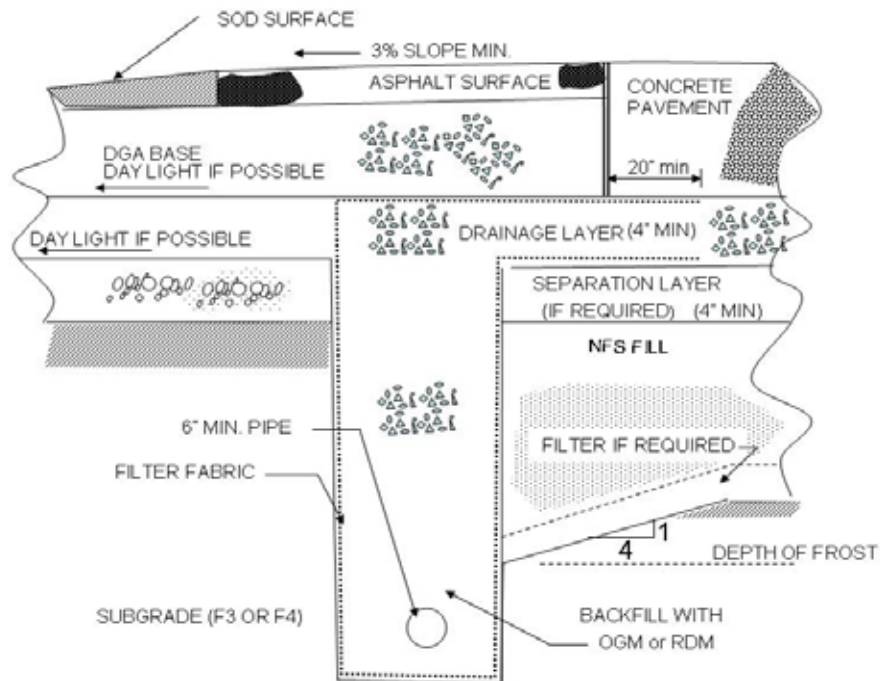
**Figure G-9c. Typical Interior Subdrain for Rigid Pavement  
(Frost Areas, Depth of Frost < Depth to Pipe)**



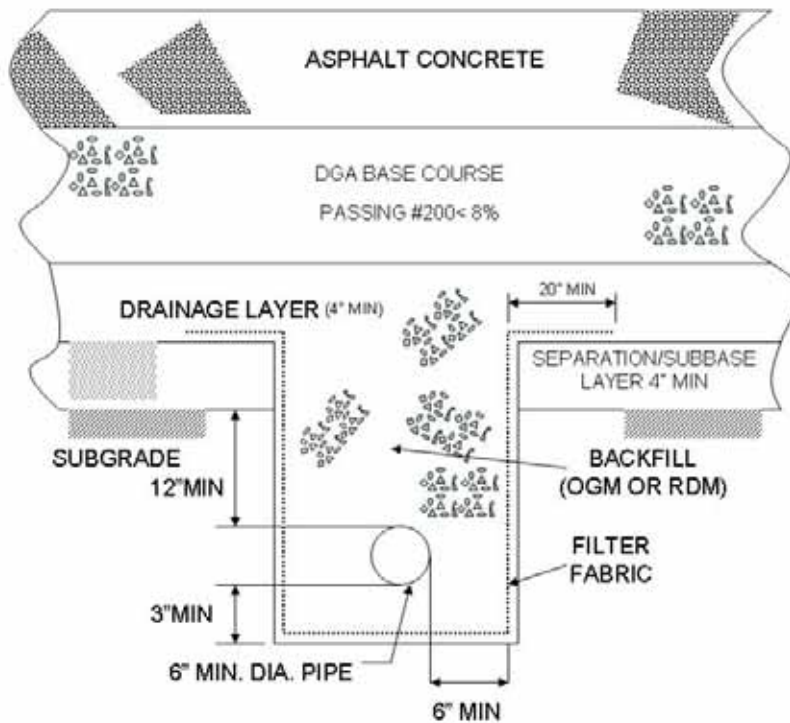
**Figure G-10a. Typical Edge Subdrain Detail for Rigid Pavement  
(Non-Frost Areas)**



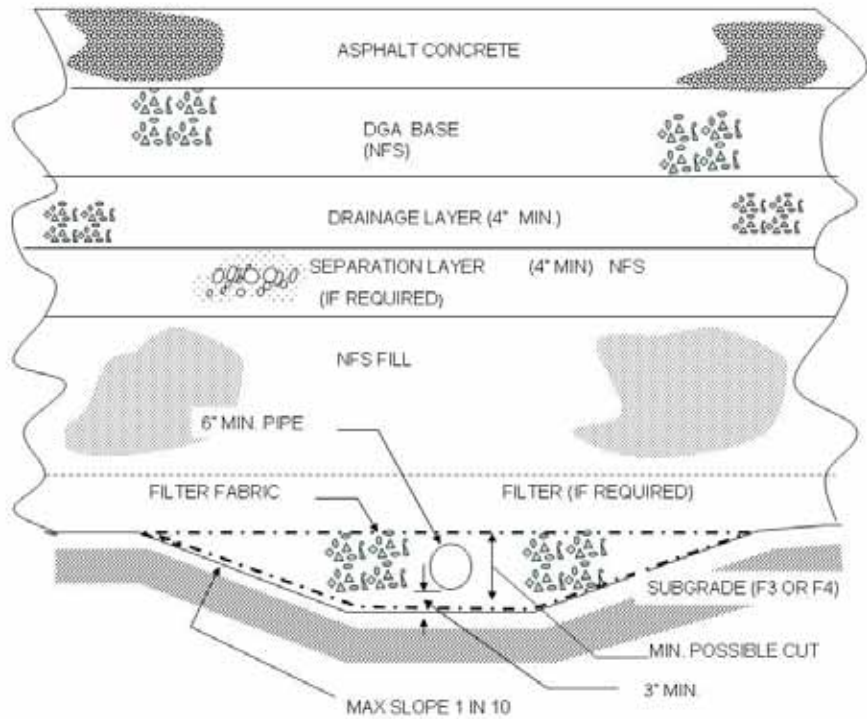
**Figure G-10b. Typical Edge Subdrain Detail for Rigid Pavement (Frost Areas)**



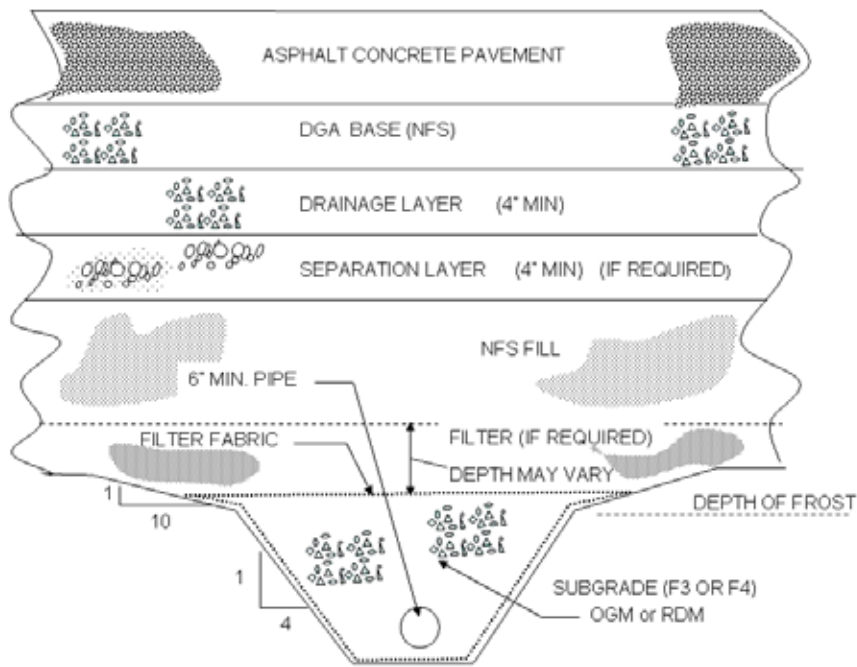
**Figure G-11a. Typical Interior Subdrain Detail for Flexible Pavement (Non-Frost Areas)**



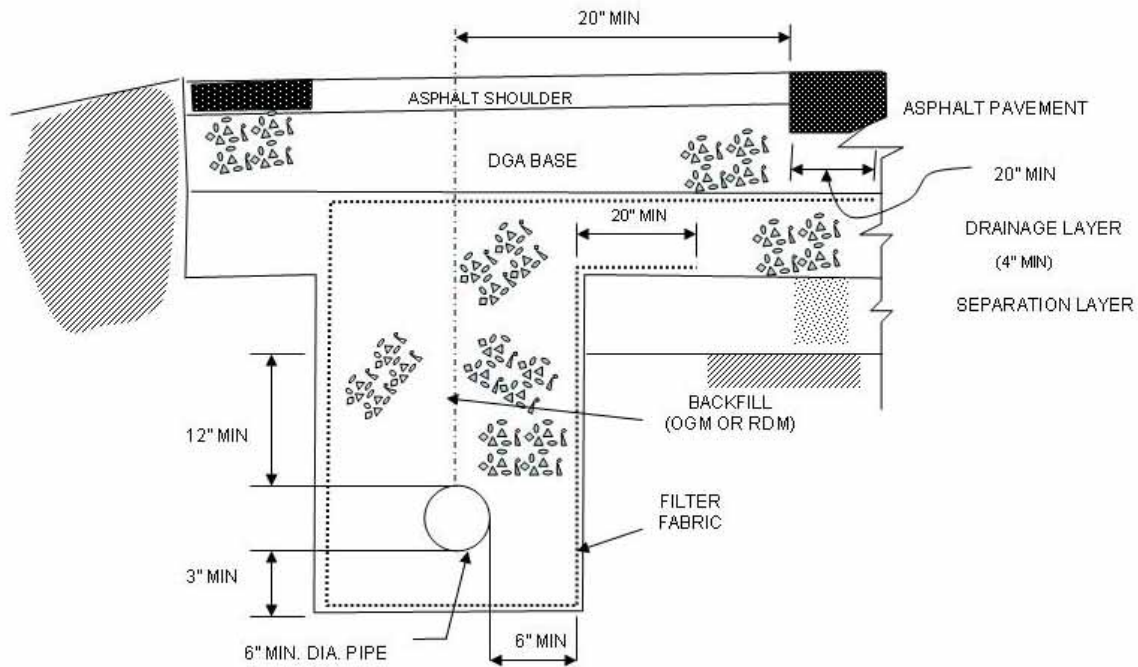
**Figure G-11b. Typical Interior Subdrain Detail for Flexible Pavement  
(Frost Areas, Depth of Frost > Depth of Pipe)**



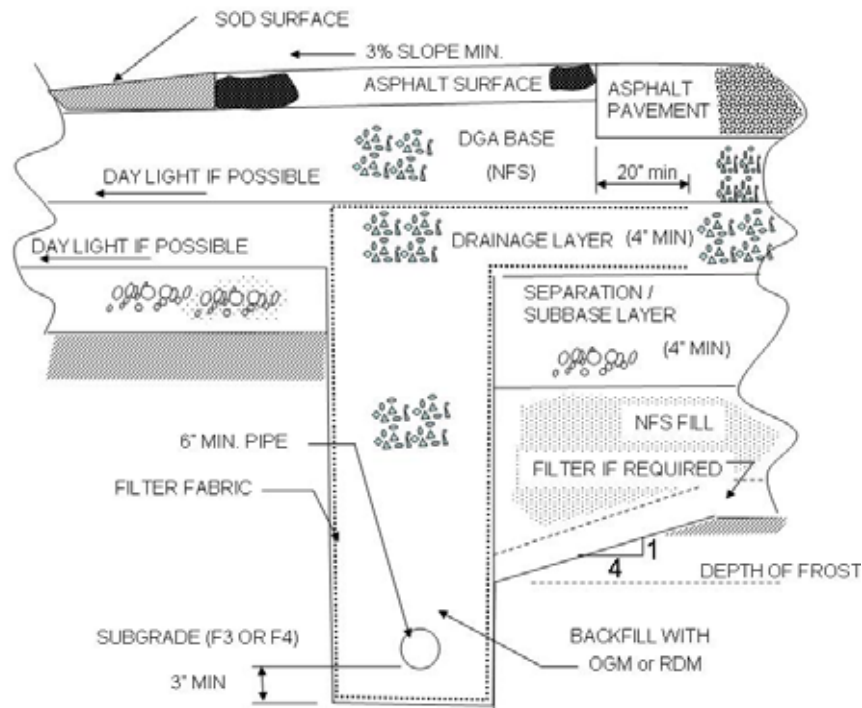
**Figure G-11c. Typical Interior Subdrain Detail for Flexible Pavement  
(Frost Areas, Depth of Frost < Depth of Pipe)**



**Figure G-12a. Typical Edge Subdrain Detail for Flexible Pavement (Non-Frost Areas)**



**Figure G-12b. Typical Edge Subdrain Detail for Flexible Pavement (Frost Areas)**



**G-6.3.1 Backfill.** The trench should be backfilled with a permeable material to rapidly convey water to the drainage pipe. The backfill material may be an OGM, RDM, or other uniformly graded aggregate. A minimum of 80 mm (3 in.) of aggregate should



be placed beneath the drainage pipe. Proper compaction or chemical stabilization of the backfill is necessary to prevent settlement of the fill. In placing the backfill, compact it in lifts not exceeding 300 mm (6 in.). When using geocomposites in place of pipe, placing the geocomposites against the material to be drained should keep the backfill from conveying water. For this reason, the backfill for the geocomposites will not require the high permeability required for the backfill around the pipe drains; however, since the backfill for the geocomposites will be against the side of the trench, the backfill should meet the requirements of a granular filter.

**G-6.3.2 Geotextiles in the Trench.** Line the trench with a geotextile filter fabric as shown in Figures G-9 through G-12, which provide the typical. The filter fabric should be placed to separate the permeable backfill of the trench from the subgrade or subbase materials, but it must not impede the flow of water from the drainage layer to the drain pipe. The filter fabric must also protect from the infiltration of fines from any surface layers. This is particularly important for drains placed outside the pavement area where surface water can enter the drain through a soil surface. The filter fabric for the trench should be a nonwoven needle punch fabric meeting the criteria in Table G-9.

**Table G-9. Criteria for Fabrics Used in Trench Construction**

Soil or Fabric Characteristic	ASTM Test Method	Criteria
Soil with 50% or Less Passing No. 200 Sieve	D 4751	AOS < 0.6 mm (Sieve No. 30)
Soil with Greater Than 50% Passing No. 200 Sieve	D 4751	AOS < 0.297 mm (Sieve No. 50)
Minimum Grab Strength in kN (lbs) at 50% Elongation	D 4632	0.6 (130)
Minimum Puncture Strength in kN (lbs)	D 4833	0.25 (55)

**G-6.3.3 Trench Cap.** Edge drains placed outside of a paved area should be capped with a layer of low-permeability material, such as an asphalt-stabilized surface, to reduce the infiltration of surface water into the subsurface drainage system. If the area above the edge drain is to be sod surfaced, a filter layer will be required between the drain layer and sod.

#### **G-6.4 Lateral Outlet Pipe**

**G-6.4.1 Design.** The lateral outlet pipe provides a means of getting water out of the edge drains and of cleaning and inspecting the system. Edge drains should be provided with lateral outlet pipes spaced at intervals (90 to 150 m) (300 to 500 ft) along the edge drains and at the low point of all vertical curves. To facilitate drain cleanout, the outlet pipes should be placed at approximately a 45-degree angle from the direction of flow in the collector drain. The lateral pipe should be a metal or rigid solid-walled pipe and should be equipped with an outlet structure. A 3-percent slope from the edge drain to the outlet structure is recommended. Where possible, outlet pipes should, be connected

to existing storm drains or inlets to reduce outlet maintenance. For a lateral pipe flowing to a ditch, the invert of the outlet pipe should be a minimum of 150 mm (6 in.) above the 2-year design flow in the ditch. To prevent piping, the trench for the outlet pipes must be backfilled with a material of low permeability, or provided with a cutoff wall or diaphragm. Dual outlets are recommended for maintenance considerations, as shown in Figure G-13. The dual outlet system allows sections of collector drains to be flushed to clear any debris material blocking the free flow of water. Note these additional recommended design details for drainage outlets:

(a) Provide dual outlets with large-radius bends, as shown in Figure G-14.

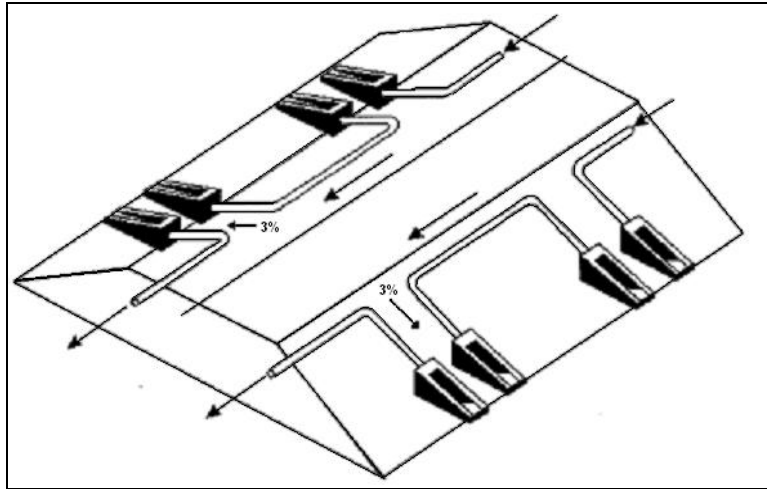
(b) Use rigid walls, not perforated pipes. For pipe drains, use the same diameter pipe as the collector drains. For prefabricated, geocomposite drains, 102-mm to 152-mm- (4-in. to 6-in.-) diameter pipe should provide adequate hydraulic capacity. The flow capacity of the outlets must be greater than that of the collector drains. In general, because of the greater slope provided for outlet pipes, the hydraulic capacity is not a problem.

(c) Place the discharge end of the outlet pipe at least 150 mm (6 in.) above the G-year design flow in the drainage ditch (Figure G-15). This requirement applies even if the outlet is discharging into storm drain inlets.

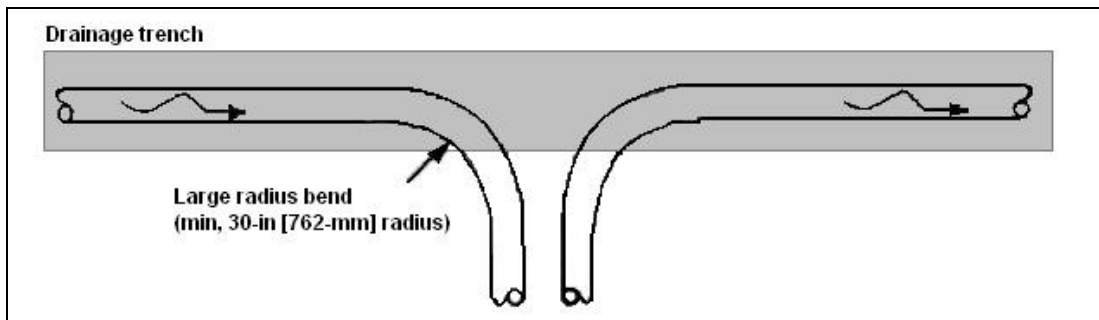
(d) In frost areas, give special attention to the placement of the outlet pipes so they do not become clogged with ice or snow.

**G-6.4.2 Outfall for Outlet Pipe.** The outfall for the outlet pipe should be provided with a headwall to protect the outlet pipe from damage, prevent slope erosion, and facilitate the location of outlet pipes. Headwalls should be placed flush with the slope so that mowing operations are not impaired. Easily removable rodent screens should be installed at the pipe outlet. The headwall may be precast or cast in place. Figure G-16 is an example of a design for a headwall.

**Figure G-13. Schematic of Dual Outlet System Layout (Baumgardner 1998)**



**Figure G-14. Illustration of Large-Radius Bends Recommended for Drainage Outlet**



**Figure G-15. Recommended Outlet Design Detail**

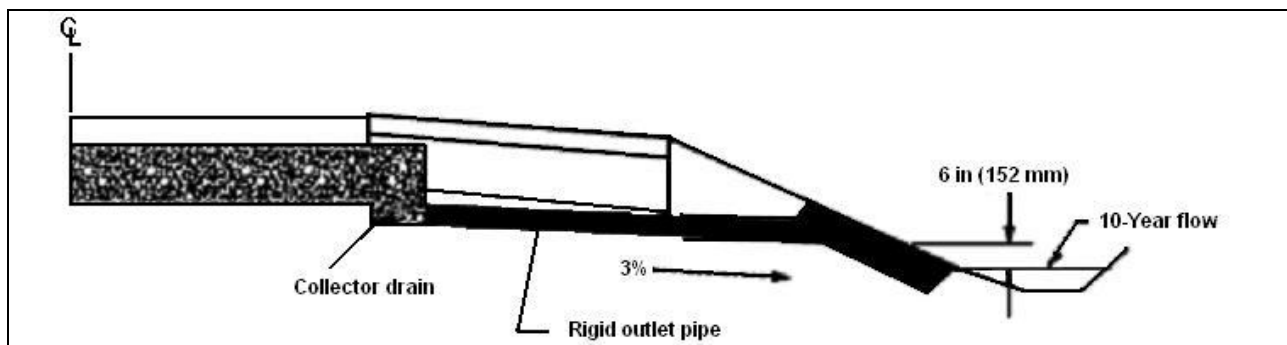
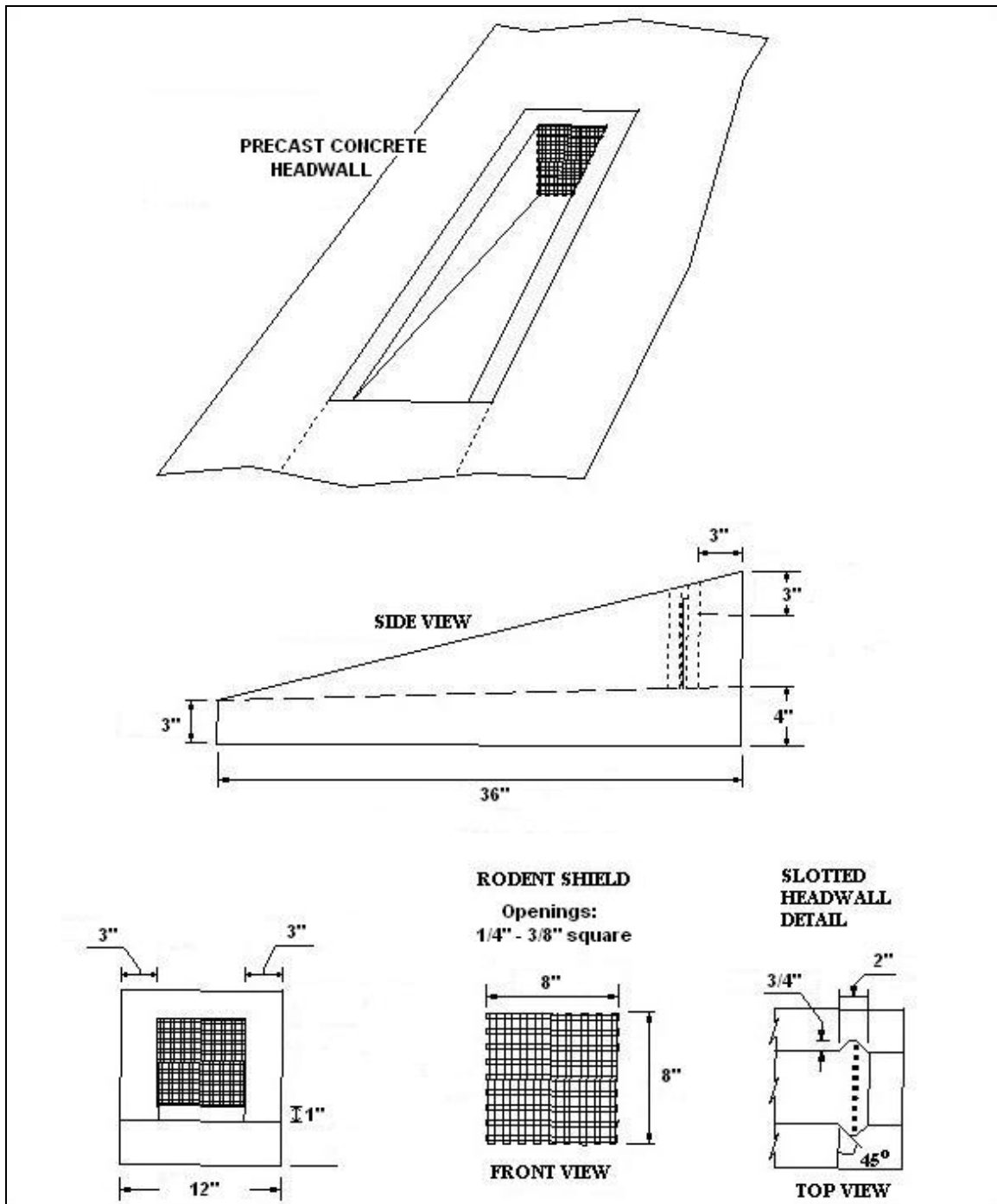




Figure G-16. Example Design for a Headwall



**G-6.4.3 Reference Markers.** Although not a requirement, reference markers are recommended for the outlets to facilitate maintenance and/or observation. A simple, flexible marker post or marking on the shoulder will suffice to mark the outlet.

**G-6.5 Cross Drains.** Cross drains may be required at locations where flow in the drainage layer is blocked, for steep longitudinal grades, or at the bottom of vertical

curves. For example, cross drains may be required where pavements abut building foundations, at bridge approach slabs, or where drainage layers abut impermeable bases.

**G-6.6 Manholes and Observation.** Manholes, observation basins, and risers are installed on subsurface drainage systems for access to the system to observe its operation and to flush or rod the pipe for cleaning. When required, manholes on subgrade pipe drains should be located at intervals of not over 300 m (1,000 ft) with one flushing riser located between manholes and at dead ends. Manholes should be provided at principal junction points of several drains. Typical details of construction are provided in Chapter 4.

**G-7 MAINTENANCE OF SUBSURFACE DRAINAGE SYSTEMS.** Commitment to maintenance is as important as providing subsurface drainage systems. In fact, an improperly maintained drainage system can cause more damage to the pavement structure than if no drainage were provided at all. Poor maintenance leads to clogged or silted outlets and edge-drain pipes, missing rodent screens, excessive growth of vegetation blocking outlet pipes and openings on daylighted bases, and growth of vegetation in side ditches. These problems can potentially cause backing up of water within the pavement system, thereby defeating the purpose of providing the drainage system. Therefore, inspections and maintenance of subsurface drainage systems should be made an integral part of the policy of any agency installing these systems. The inspection process comprises of two parts: (a) visual inspection, and (b) video inspection.

**G-7.1 Visual Inspection.** The visual inspection process includes these items:

**G-7.1.1** Evaluation of external drainage-related features, including measuring ditch depths and checking for crushed outlets, excessive vegetative growth, clogged and debris-filled daylighted openings, condition of headwalls, presence of erosion, and missing rodent screens. This operation should be performed at least once a year.

**G-7.1.2** Pavement condition evaluation to check for moisture-related pavement distresses such as pumping, faulting, and D-cracking in PCC pavements and fatigue cracking and AC stripping in AC pavements. This operation could be either a full-scale PCI survey or a brief overview survey, depending on agency needs. The recommended frequency for this activity is once every 2 years.

**G-7.2 Video Inspection.** Video inspections play a vital role in monitoring in-service drainage systems. The video inspection process can be used to check for clogged drains due to silting and intrusion of surrounding soil as well as for any problems with the drainage system such as ruptured pipes and broken connections. Video inspections should be carried out on an as-needed basis whenever there is evidence of drainage-related problems. Table G-10 provides a detailed list of equipment used in a Federal Highway Administration (FHWA) study (Daleiden 1998). A video inspection system typically consists of a camera head, a long, flexible probe mounted on a frame for inserting the camera head into the pipe, and a data acquisition unit fitted with a video screen and a video recorder. This system can be used to detect and correct any construction problems before a project is accepted. The construction-related

problems that are easily detected using video equipment include crushed or ruptured drainage pipes, improper connections between drainage pipes, and problems with the connection between the outlet pipe and headwall.

**Table G-10. Equipment Description or FHWA Video Inspection Study (Daleiden 1998)**

<p><b>Camera:</b> The camera is a Pearpoint flexiprobe high-resolution, high-sensitivity, waterproof color video camera engineered to inspect pipes 76 to 150 mm (3 to 6 in.) in diameter. The flexiprobe light head and camera has a physical size of 71 mm (2.8 in.) and is capable of negotiating 102-mm by 102-mm (4-in. by 4-in.) plastic tees. The light head incorporates 6 high-intensity lights. This lighting provides the ability to obtain a “true” color picture of the entire surface periphery of a pipe. The camera includes a detachable hard plastic ball that centers the camera during pipe inspections.</p>
<p><b>Camera Control Unit</b> The portable color control unit includes a built-in 203-mm (8-in.) color monitor and controls including remote iris, focus, video input/output, audio in with built-in speaker, and light level intensity control. Two VCR input/output jacks are provided for video recording as well as tape playback verification through the built-in monitor.</p>
<p><b>Metal Coiler and Push Rod With Counter:</b> The portable coiler contains 150 mm (6 in.) of integrated semi-rigid push rod, gold and rhodium slip rings, electro-mechanical cable counter, and electrical cable. The integrated push rod/electrical cable consists of a special epoxy glass reinforced rod with polypropylene sheathing material, which will allow for lengthy inspections due to the semi-rigid nature of this system.</p>
<p><b>Video Cassette Recorder:</b> The video cassette recorder is a high-quality four-head industrial grade VHS recorder with audio dubbing, still frame, and slow speed capabilities.</p>
<p><b>Generator:</b> A compact portable generator capable of providing 650 watts at 115 volts to power the inspection equipment.</p>
<p><b>Molded Transportation Case:</b> A molded transportation case, specifically built for air transportation, encases the control unit, camera, and videocassette recorder.</p>
<p><b>Color Video Printer:</b> A video printer is incorporated into the system to allow the technician to obtain color prints of pipe anomalies or areas of interest.</p>

## **G-7.2 Maintenance Guidelines**

**G-7.2.1 Collector Drains and Outlets.** The collector drains and outlets should be flushed periodically with high-pressure water jets to loosen and remove any sediment that has built up within the system. The key to this operation is having the appropriate outlet details that facilitate the process, such as the dual headwall system shown in Figure G-13. The area around the outlet pipes should be kept mowed to prevent any

buildup of water. Missing rodent screens and outlet markers, and damaged pipes and headwalls need to be either repaired or replaced.

**G-7.2.2 Daylighted Systems.** Routine removal of roadside debris and vegetation clogging the daylighted openings of a permeable or dense-graded base is very important for maintaining the functionality of these systems.

**G-7.2.3 Drainage Ditches.** Drainage ditches should be kept mowed to prevent excessive vegetative growth. Debris and silt deposited at the bottom of the ditch should be cleaned periodically to maintain the ditch line and to prevent water from backing up into the pavement system.

## INDEX

- access hole lid displacement, 210
- adjustment factor ( $F_p$ ), 30
- airport drainage systems
  - design load, 254
  - recommended design parameters, 254
  - special design considerations, 254
- allowable spread, 40
- anchorage and buoyancy, 300
- applicability, 1
- appurtenant structures, 231
  - check dams, 247
  - chutes, 242
  - drop structures, 247
  - flap gates, 249
  - flow splitters, 247
  - fuel/water separators, 245
  - inlets, 231
  - junction chambers, 242
  - manholes, 235
  - outlet energy dissipators, 246
  - security fencing, 242, 245
  - siphons, 248
  - transitions, 247
- arctic and subarctic drainage systems, 297
- area inlets, 232
  - failure, 233
  - settling rates, 234
- auxiliary drains, 203
- barriers, 244, 245
- basin development factor, 26
- BDF, 26
- bedding for conduits, 265
- bends
  - shear stresses, 194, 195
- best management practices (BMPs), 2, 301
  - design
    - runoff volume treated, 301
    - selection guidance, 301
- box-culvert nomograph, 150
- catch basins, 231
- cellular blocks, 165
- channel design, 186
- channel instability, 153
- channels
  - erosion
    - riprap to control, 173
  - geometry, 197
  - improved, 247
  - instability, 114
  - lining materials, 186
  - slope, 197
  - stability, 192
- check dams, 247
- check storm, 41
- chutes, 110
  - closed, 110
  - open, 110
- composite gutter sections, 48
- computer programs, 12, 32, 39, 175
  - ANNIE, 320
  - BASIN, 318
  - CANDE-89, 307
  - DDSoft, 307
  - DR3M, 319, 320, 323
  - DRIP, 307

- HEC-RAS, 32, 316, 317, 322
- HMS, 32, 315, 322
- HSPF, 304
- HY12, 318
- HY15, 318
- HY8, 309, 310, 312
- HY-8, 161
- HYCHL, 309, 310, 312
- HYCLV, 309
- HYDRA, 222, 309, 310
- HYDRAIN, 32, 309, 310, 312, 321
- Hydraulic Toolbox (HY-TB), 318, 322
- HYDRO, 309, 311
- HYEQT, 309, 313
- ModBerg, 307
- NDSOFT, 307
- NFF, 309, 313
- PIPECAR, 308
- SCOUR, 318
- STORM, 304
- SWMM, 304, 317, 318, 320, 322
- TR-20, 32, 314, 315, 321
- TR-55, 32, 313, 321
- Urban Drainage Design, 319, 322
- urban hydrology and hydraulics, 308
- VAST, 304
- Visual Urban (HY-22) Urban Drainage Design, 308
- WSPRO, 309, 311
- constant rainfall intensity, 12
- cover
  - minimum and maximum for airfields, 285
  - minimum and maximum for roadways, 286
  - requirements, 115
  - storm drains and culverts, 286
- cross (transverse) slope, 42
- cross-drainage structures, 103
- culverts
  - beveled entrance, 114
  - broken-back, 115, 284
  - capacity, 114
  - construction types, 113
  - culvert pipe, 113
  - design procedure, 145
  - flow types, 117
  - hydraulic design data for, 117
  - hydraulic design of, 113
  - inlet control, 117
  - materials, 113
  - mitered entrance, 114
  - outlet control, 117, 127, 138
  - rounded entrance, 114
- curb and gutter flow spread, 43
- curbs
  - disadvantages, 44
  - use, 43
- curbs and gutters, 43
- curved vane grates, 111
- dead loads, 256, 266
- degree of protection, 10
- design capacity, 10
- design discharge
  - Rational Method, 213
  - time of concentration, 213
- design frequency and spread, 40
- design objectives, 1
- design storm frequencies, 116, 213
  - headwater depth, 116
  - higher than minimum, 10
  - sag points, 213

- Design Storm Frequencies
  - areas other than airfields, 11
  - DOD airfields and heliports, 10
  - FAA, 11
- design storm frequency, 213
- detention facilities, 261
  - design guidance and criteria, 261, 262
- detention/retention facilities, 257, 258
- direct loading
  - design requirements, 256
- discharge frequencies, 197, 211
- downdrains, 110
- drainage culvert
  - definition, 113
- drainage inlet design, 62
- drainage pipe
  - definition, 264
- drainage pipelines
  - infiltration, 115
- drainage structures
  - vehicular safety, 175
- drainage system design
  - frost condition considerations, 282, 283, 284
  - grading, 202, 299
  - procedures, 202
- drop inlets, 103
- drop structures, 247
- end structure protection, 299
- endwalls, 114, 152, 153, 246
- energy dissipators, 111, 167
  - designs, 161
  - flared outlet transition, 167, 168
  - hydraulic jump, 168
  - riprap use with, 173
  - Saint Anthony Falls (SAF) stilling basin, 168
  - stilling well, 168
  - USBR impact energy dissipator, 168
- energy grade line (EGL)
  - definition, 209
  - manual calculation
    - energy loss method, 222
- energy loss method, 222
- environmental considerations
  - Air Force environmental quality program, 8
  - Army environmental quality program, 8
  - discharge permits, 9
  - effects of surface drainage systems, 8
  - environmental impact analysis, 8
  - FAA environmental quality program, 8
  - Federal guidelines, 3
  - Federal regulations, 4
  - local laws, 7
  - Navy environmental quality program, 8
  - NEPA, 3, 4
  - regulatory considerations, 3
  - state regulations, 5
- Equations
  - 2-1, 15
  - 2-10, 26
  - 2-11, 26
  - 2-12, 26
  - 2-13, 26
  - 2-14, 26
  - 2-15, 28
  - 2-16, 28
  - 2-17, 28
  - 2-18, 29
  - 2-19, 30
  - 2-2, 16

2-20, 34	3-4, 48
2-21, 37	3-5, 48
2-22, 38	3-6, 48
2-23, 38	3-7, 53
2-3, 18	3-8, 61
2-4, 20	3-9, 65
2-5, 21	4-1, 128
2-6, 22	4-10, 173
2-7, 25	4-11, 173
2-8, 26	4-12, 173
2-9, 26	4-2, 129
3-1, 42	4-3, 129
3-10, 65	4-4, 138
3-11, 74	4-5, 150
3-12, 74	4-6, 167
3-13, 74	4-7, 167
3-14, 75	4-8, 173
3-15, 75	4-9, 173
3-15a, 75	5-1, 186
3-16, 75	5-10, 194
3-17, 79	5-11, 195
3-18, 79	5-12, 199
3-19, 80	5-2, 189
3-2, 45	5-3, 189
3-20, 81	5-4, 189
3-21, 87	5-5, 189
3-22, 87	5-6, 189
3-23, 90	5-7, 193
3-24, 91	5-8, 193
3-25, 91	5-9, 194
3-26a, 91	6-1, 204
3-26b, 91	6-2, 215
3-27, 104	6-3, 215
3-28, 104	erosion, 114
3-29, 104	control at outlets, 161
3-3, 46	protection, 115



erosion and sedimentation (E&S) control regulations, 306	4-8, 183 4-9, 183
estimating pollutant loads, 304	5-1, 190
Examples	5-2, 195
2-1, 17	5-3, 200
2-2, 22	5-4, 200
2-3, 24	6-1, 207
2-4, 27	6-2, 208
2-5, 31	extended detention dry ponds, 304
2-6, 34	fish passage considerations, 115
2-7, 38	flanking inlets, 100, 101
3-1, 47	flap gates, 211, 231, 249
3-10, 93	flexible pipe, 282
3-11, 100	flow
3-12, 105	in gutters, 45
3-13, 107	resistance, 186
3-14, 109	splitters, 231, 247
3-2, 49	flow friction formulas, 204
3-3, 54	flowline, 210
3-4, 56	freeboard, 197
3-5, 61	fuel/water separators, 245
3-6, 76	gear configurations, 254, 255
3-7, 77	general investigations, 2
3-8a, 81	geometric controls, 95
3-8b, 85	grading, 202
3-9, 88	grates, 250
4-1, 176	30°- 3-1/4 tilt bar, 65
4-10, 184	45°- 2-1/4 tilt bar, 65
4-11, 184	45°- 3-1/4 tilt bar, 65
4-12, 185	curved vane, 65
4-13, 185	efficiency, 73, 111
4-2, 177	for airport loadings, 251
4-3, 178	loading conditions, 112
4-4, 179	materials, 250
4-5, 180	P-1-1/8, 65, 111
4-6, 181	P-1-7/8, 64, 112
4-7, 182	

- P-1-7/8 x 4, 65
- parallel bar, 111
- protection of, 251
- reticuline, 65
- type selection, 111
- gravity flow, 203
- gully scour, 114, 153, 154
- gutters
  - composite sections, 48
  - conventional, 46
  - dimensions, 43
  - flow, 40, 45
  - flow calculations, 45
  - flow time, 60
- headwalls, 114, 151
  - advantages of, 151
  - construction of, 152
  - design of, 151
- headwalls and endwalls, 151, 153
- headwalls and wingwalls, 151
- heaving, 283
- HEC-RAS, 311, 315
- hydraulic grade line (HGL)
  - definition, 209
  - manual calculation
    - energy loss method, 222
- hydraulic jump, 246
- hydrologic methods
  - Rational Method, 12, 15
  - regression equations
    - USGS, 12
- hydrologic methods
  - TR-55, 12
- hydrologic methods
  - TR-55, 15
- hydrologic methods
- TR-55, 328
- icing, 288
  - debris and icing control, 300
  - description, 288
  - effects of human activities on, 290
  - ground icing, 289, 294
  - methods of counteracting, 291
  - methods of prevention, 293
  - natural factors conducive to, 290
  - river or stream icing, 289, 294
  - spring icing, 290
  - types, 288
- IDF curves, 12, 13
  - regional, 18
- infiltration, 115, 284
  - basins, 262, 305
  - control, 285
  - facilities, 262, 263
  - required testing, 285
- infiltration/exfiltration trenches, 304
- inlets
  - capacity, 40
  - catch basins, 231
  - combination inlets, 63, 64, 110
  - continuous inlets, 63, 64
  - curb-opening inlets, 63, 64, 79
  - embankment inlets, 110
  - grate inlets, 63, 64, 73, 110
  - inlet-control nomographs, 117, 148
  - interception capacity, 64, 71
    - factors affecting, 65
  - locations, 94
  - median and roadside ditch inlets, 103
  - median, embankment, and bridge, 102
  - on embankments, 110
  - placement, 234

- slotted inlets, 63, 72
- spacing, 234
- spacing on continuous grades, 95
- surcharging, 210
- sweeper inlets, 110
- types, 63
- water quality, 305
- interception capacity
  - combination inlets, 72
  - curb-opening inlets in sag locations, 90
  - grate inlets, 73
  - grate inlets in sag locations, 86
  - inlets in sag locations, 86
  - inlets on grade, 73
  - slotted inlets, 72
- invert elevation, 210
- jointing, 299
- kinematic wave equation, 18
- ladders, 251
- length of stone protection (LSP), 161
- live loads, 256, 266
- longitudinal slope, 41
- manholes, 235
  - chamber and access shaft, 236
  - channels and benches, 240
  - configuration, 235
  - depth, 240, 241
  - frames and covers, 236, 240
  - ladders, 251
  - location and spacing, 241
  - settlement, 241
  - steps, 254
- Manning's equation, 18, 20, 45, 60, 103, 138, 148, 186, 204, 205, 206, 209, 307, 314, 319, 334
- maximum highwater
  - definition, 215
  - minimum velocity and grades, 215
- NFF, 25, 313
- NOAA, 5, 18, 396
- NRCS, 13, 28
  - peak flow method, 28, 31
- open channel flow, 186, 203
- outfall design, 210
- outfall headwalls, 246
- outlets
  - energy dissipators, 246
    - riprap, 246
    - stilling basins, 246
  - outlet control, 127
  - outlet-control nomographs, 149
  - protection design example, 176
  - protection of, 114
- paved apron, 247
- peak flow
  - attenuation, 258
  - rates
    - derivation methods, 15
- pipe
  - bedding, 282
  - downdrains, 110
  - drains, 103
  - installation
    - arctic and subarctic, 300
  - selection, 264, 265
    - arctic and subarctic, 299
  - bituminous-coated pipe restrictions, 264
  - life cycle cost factors, 264
  - plastic pipe
    - DOD restrictions, 264
  - roughness, 264
- pipestrength, 266

- plain outlets, 246
- ponding, 117
- pressure flow, 203
- primary drains, 202
- Rational Formula, 10, 15, 16, 24, 307
- Rational Method, 10, 15, 18, 32, 310, 312
  - exceptions to application, 214
- regression equations, 312, 313
  - regional, 25
  - rural, 25
  - urban, 25
  - USGS, 10, 15, 25
- Regression Equations
  - urban, 26
  - USGS, 26
- release timing, 258, 259
- retention facilities, 261, 262
  - definition, 262
  - design guidance and criteria, 262
- retention ponds, 304
- rigid pipe, 266
- riprap, 161, 173, 247
  - aprons, 211
  - failure, 165
  - size of stone, 161, 164, 165
- roadside and median channels, 44
  - design parameters, 197
    - channel geometry, 197
    - channel slope, 197
    - discharge frequency, 197
    - freeboard, 197
    - shear stress, 199
- runoff coefficient, 16
- sack revetment, 165
- sag points
  - design storm frequency, 213
- sag vertical curves
  - flow in, 60
- Saint Anthony Falls (SAF) stilling basin, 168
- sand filters, 305
- scour, 114, 246
  - estimating the extent of, 176
  - preventing local scour, 176
  - scour holes, 114, 153, 154, 155
- scour holes
  - calculations, 161
- SCS
  - peak flow method, 28, 31
  - tabular hydrograph method, 32
- secondary currents, 194
- shallow ditch sections, 44
- shear stress, 192, 193
  - bends, 194, 195
  - distribution of, 193
  - permissible, 199
- sheet flow, 18
- side slope stability, 193
- Simple Method, 304
- siphons, 231, 249
  - definition, 248
- stable channel design, 192, 193
  - concepts, 192
- stilling wells, 168, 284
- storage facility types, 261
- storm drain
  - arctic and subarctic guidelines, 297
  - auxiliary drains, 203
  - classification, 202
  - computation sheet, 216
  - conduit, 202
  - conduit shapes, 206
  - design, 202

- check storms, 213
- energy grade line (EGL), 209
- energy losses, 212
- hydraulic capacity, 204
  - conduit shape, 206
  - Manning's equation, 204, 205
- hydraulic grade line (HGL), 209, 210
- open channel flow, 203
- open channel flow advantages, 204
- outfall conditions, 210
- outfall orientation, 212
- preliminary design procedure, 216
- pressure flow, 203
- pressure flow advantages, 204
- Rational Method, 213
- maintenance, 299
- outfalls, 210
- primary drains, 202
- system
  - design procedures, 202
  - flow type assumptions, 203
  - grading, 202
  - hydraulics, 203
- storm water
  - control facilities, 257
- storm water management, 257
  - models, 304
    - HSPF, 304
    - STORM, 304
    - SWMM, 304
    - VAST, 304
  - peak runoff rate, 258
  - programs, 307
- storm water quantity control facilities, 258
  - maintenance, 260
  - release timing, 258
  - safety, 259, 260
- storm water runoff
  - detention/retention facilities, 257, 258
  - storage, 257, 299
- surface drainage, 40, 41
- surface runoff, 10, 11
- swales, 262
- synthetic rainfall, 12, 13
- tailwater depth, 210
- tidal and flood effects, 300
- time of concentration, 18, 60
  - definition, 213
  - inlet spacing, 213
  - pipe sizing, 214
- tractive force theory, 192
- transitions, 246, 247
- triangular gutter sections, 61
- ultra-urban BMPs, 305
- units of measurement, 1
- USBR impact energy dissipator, 168
- USGS
  - regression equations, 10, 12, 15, 25, 26
- vegetal covers
  - degree of retardance, 188
- vegetative practices, 305
- vehicular safety
  - drainage structures, 175
  - hydraulically efficient drainage practice, 175
- waiver procedures
  - Air Force, 400
  - Army, 398
  - Navy and Marine Corps, 400
- waivers, 2
- warped endwalls, 246

**UFC 3-230-01**  
**8/1/2006**

**AC 150/5320-5C**  
**9/29/2006**

water quality practices  
    overview, 301  
waterfowl hazards, 10, 260  
watertight joints, 115, 284

DOD facilities, 284  
wet ponds, 304  
    facilities, 262  
wingwalls, 114, 152, 246