



U.S. General Services Administration
Public Buildings Service
Office of the Chief Architect

November 1, 2006

This version of the "GSA Building Information Modeling Guide Series 02 - Spatial Program Validation" is identified as Version 0.90 to indicate its provisional status. With its publication the GSA BIM Guide, for the first time, becomes available for public review and comment. As its provisional status denotes, however, it will continue to serve as the basis for further development, pilot validation, and professional editing. All readers of this provisional guide are encouraged to submit feedback to the National 3D-4D-BIM Program. Updated versions will continue to be issued to address and incorporate on-going feedback in an open, collaborative process.

Currently, "GSA Building Information Modeling Guide Series 01 - Overview," version 0.90 is also available for review and comment.

For further information about GSA's National 3D-4D-BIM Program, additional BIM Guide Series, or to submit comments or questions, please visit <http://www.gsa.gov/bim>

The National 3D-4D-BIM Program
Office of the Chief Architect
Public Buildings Service
U.S. General Services Administration
1800 F Street NW, Suite 3341
Washington, DC 20405



GSA Building Information Modeling Guide Series

02 - GSA BIM Guide For Spatial Program Validation

Appendices

Version 0.90 – November 1, 2006

Office of the Chief Architect (OCA)
Public Buildings Service (PBS)
United States General Services Administration (GSA)



COPYRIGHT © 2006 BY
General Services Administration
Public Buildings Service
Office of the Chief Architect

If you would like to contact the authors, please write to:

The National 3D-4D-BIM Program
Office of the Chief Architect
Public Buildings Service
U.S. General Services Administration
1800 F Street NW, Suite 3341
Washington, DC 20405



table of contents

Appendices

appendix a: bim-authoring app. information	3
A.1 Validation of Five BIM-Authoring Applications	3
A.1.1 General Guidelines for Creating a Spatial Program BIM	3
A.2 Modeling Tips and Techniques	8
A.2.1 Modeling Spaces	8
A.2.2 Manipulating Spaces	8
A.2.3 Columns and Shafts in Spaces	8
A.2.4 Creating Generic Types	8
A.3 Inputting GSA Spatial Program BIM Requirements	34
A.3.1 Entering Spatial Data	34
A.3.2 Area Calculations	34
A.3.3 Adding Additional Space Descriptions	34
A.4 Handling Project Models	51
A.4.1 Working with BIM models	51
A.4.2 Installing/Enabling IFC BIM Import/Export	51
A.4.3 Saving/Exporting IFC BIMs	51
A.4.4 Optimizing File Sizes	51
A.5 For Further Information	62
A.5.1 Contact Information	62
appendix b: bim-analysis application information	65
Solibri Model Checker	65



appendix c: naming conventions	73
C.1 Established Space Names from Spatial Data Mgmt's (SDM) CAFM DBs	73
C.2 Floor Naming Conventions	75
appendix d: glossary of acronyms	76

appendix a: bim-authoring app. information

A.1 Validation of Five BIM-Authoring Applications

OCA has developed a “GSA Concept Design View” of the requirements for spatial data management. The GSA Concept Design View is a model view of the IFC (Industry Foundation Classes) BIM modeling standard that was developed and published by the IAI (International Alliance for Interoperability). The GSA Concept Design View of IFC is supported by Autodesk Revit and Architectural Desktop, Bentley Architecture, Graphisoft ArchiCAD, and Onuma Planning System. These applications have gone through four rounds of validation testing using a GSA test case building.

Currently, OCA is in the process of implementing pilot projects (10 completed and 10+ ongoing) across the U.S. in conjunction with participating A/E teams, construction managers, contractors, technology consultants, and software developers.

Following are specific instructions and recommendations on how certain functions can best be performed when using various BIM-authoring tools. At OCA’s request, the information provided specific to each authoring tool has been confirmed or provided by the vendor.

A.1.1 General Guidelines for Creating a Spatial Program BIM

This section provides an overview/executive summary of each BIM-authoring application product.

Autodesk ADT + Inopso IFC Utility

A.1.1: With the exception of the required GSA spatial program non-graphic data, which needs to be attached to spaces modeled in Autodesk Architectural Desktop, there are no suggested practices for Modeling Buildings for the GSA that differs from the existing body of knowledge for applying ADT to any building-modeling project. The following sections detail some GSA-specific ADT recommendations for dealing with spaces, areas, and using ADT property sets for the entry of the GSA spatial program non-graphic data.

Refer to online documentation and tutorials for detailed guidance on the specifics of creating a BIM model using Autodesk Architectural Desktop. It is also strongly recommended that you leverage all of the avenues available to assist in your implementation of Autodesk Architectural Desktop. These avenues are outlined in section A.5.1.

Autodesk Revit

A.1.1: With the exception of the required GSA spatial program non-graphic data, which needs to be attached to rooms modeled in Autodesk Revit, there are no suggested practices for Modeling Buildings for the GSA that differs from the existing body of knowledge for applying Revit to any building-modeling project. The following sections detail some GSA-specific Autodesk Revit Building recommendations for dealing with rooms, areas, and using Revit Schedule keys to automate the entry of the GSA spatial program non-graphic data.

Refer to Revit online documentation and tutorials for detailed guidance on the specifics of creating a BIM model using Autodesk Revit. It is also strongly recommended that you leverage all of the avenues available to assist in your implementation of Autodesk Revit. These avenues are outlined in section A.5.1.

Bentley Architecture

Please contact Bentley Architecture for more information.

Graphisoft Archicad

A.1.1: Graphisoft's Archicad® offers a different approach to your workflow process, which gives you more control over your design, while maintaining accuracy and efficiency in documentation. While you raise walls, lay floors, add doors and windows, build stairs, and construct roofs, this Building Information Authoring Tool creates a central database of 3D model data. From this, you can extract all the information needed to completely describe your design: complete plans, sections and elevations, architectural and construction details, Bills of Quantities, window/door/finish schedules, renderings, animations, and virtual reality scenes. That means while you are designing, Archicad is creating all the project documentation. In addition, unlike designing in 2D software, the Virtual Building™ approach means that you can make changes at any time while maintaining the integrity of your documents, without risking costly errors or costing you productivity.

Archicad's Virtual Building: stores all the information about the building in a central database; changes made in one view are updated in all others, including floor plans, sections/elevations, 3D models, and bills of material. Archicad's intelligent building elements like doors, windows, and columns understand and react to their environment. This accelerates work, makes the management of the project easier, and allows you to design instead of draft. Even while working from drafted lines, arcs, and splines, you can create intelligent building elements. You can design and edit the model in 3D, view and navigate in real time to check the design, and hold interactive design sessions with clients. Virtual reality presentations and animations can be generated directly in Archicad. Construction documents and files are derived automatically from the Virtual Building model.

Graphisoft's support of the IFC protocol allows architects, structural engineers, HVAC engineers, cost estimators, developers, facility managers, and contractors to share the key description of an entire facility. The following entities are currently supported with IFC 2x2: Beam, Building, Building Storey, Project, Building Element Proxy, Column, Door, Distribution Element, Flow Controller, Flow Fitting, Flow Segment, Flow Terminal, Flow Storage Device, Ramp Flight, Roof, Flow Treatment Device,

Railing, Wall, Ramp, Footing, Furnishing Element, Grid, Group, Opening Element, Pile, Plate, Site, Slab (Floor, and Roof) Space, Space Boundary, Stair, Stair Flight, Wall Standard Case, and Window. Graphisoft's Archicad automatically generates virtually all of the information necessary for the user to accurately create the information necessary to document a building information model.

Additional information may be found on-line at <http://www.graphisoft.com> or <http://www.graphisoft.com/ftp/techsupport/documentation/IFC/References/whitepaper.pdf>

ONUMA

A.1.1: The Onuma Planning System (OPS™) is designed to enable A/Es to take any available data regarding project requirements and quickly start producing a BIM that aligns with GSA space standards. For example, if a user only has a database table with program requirements that lists Space Names and Area, OPS is able to read this minimal information and automatically generate a series of blocks as an initial, preliminary BIM. The user can then study rearranging and planning the blocks, stacking floor levels, and other massing analysis to make strides towards a final architectural solution. If additional spatial data based on GSA standards were available (i.e., GSA STAR Space Type) this would also be captured by the planning system. As more information becomes available over the course of the project, the user can use OPS to keep track of this data. The intent is to give users flexibility in incorporating nearly any level of available data and still start producing a BIM.

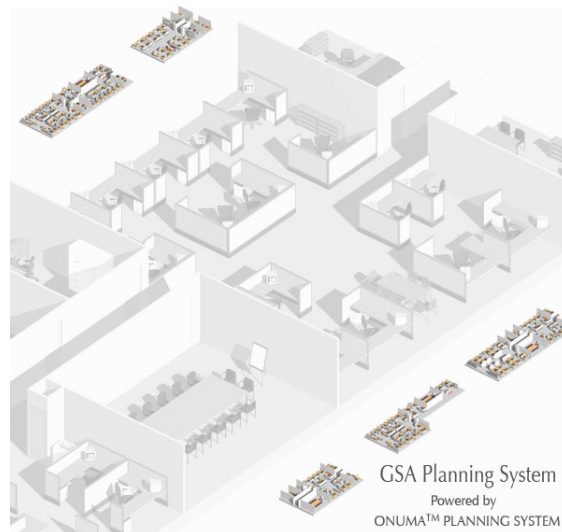

Figure 1:

When spaces are created in OPS, the database automatically starts to track the number of spaces and its square footage. Also, any equipment or furniture that is placed in the space is tracked. This information can be used later for cost studies that are available in the reports.

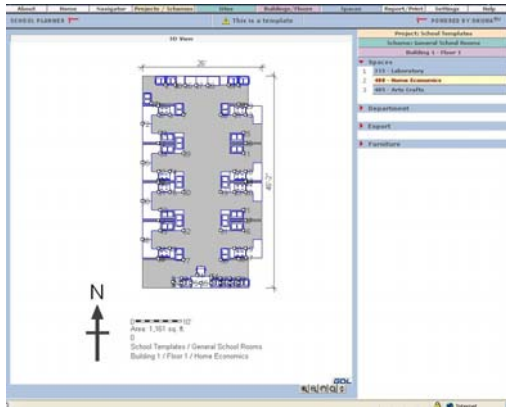

Figure 2:

Space Settings Matrix														
Space Name	Space Number	Capacity	Occupancy	Space Height	Space Elevation	GSA Space Type	GSA Space Category	Security Zone	Preservation Zone	Privacy Zone	Project Specific Zone	Occupant Organisation code	Occupant Sub-Organisation Code	Occupant Billing ID
GROUND FLOOR														
1 CLOSET	1316	0	0	10'	0'	INS	01	Restricted	Renovation	Non-Public		6900		
2 OFFICE	1504	0	0	10'	0'	TTO	01	Restricted	Renovation	Public		4715		DC0052331
3 LOBBY	1001	0	0	10'	0'	CRH	02	Public	Restoration	Public		4715		DC0052331
4 MECH.	1207	0	0	10'	0'	MCH	02	Restricted	Renovation	Non-Public		4715		DC0052331
5 VEST.	1506	0	0	10'	0'	CRH	02	Restricted	Renovation	Public		4715		DC0052331
6 ELEC.	1319	0	0	10'	0'	MCH	02	Restricted	Renovation	Non-Public		6900		
7 TELE.	1318	0	0	10'	0'	MCH	02	Restricted	Renovation	Non-Public		6900		
8 ELEV. LOBBY	1321	0	0	10'	0'	CRH	02	Restricted	Renovation	Non-Public		6900		
9 VEST.	1509	0	0	10'	0'	CRH	02	Restricted	Renovation	Public		4715		DC0052331
10 VEST.	1510	0	0	10'	0'	CRH	02	Restricted	Renovation	Public		4715		DC0052331
11 TELE.	1004	0	0	10'	0'	MCH	02	Restricted	Renovation	Non-Public		4715		DC0052331

Figure 3:

OPS is also designed to allow users to create pre-set Template Spaces. If any of these templates are used, all the data that is pre-set becomes populated as a start point and is ready for further editing.

Users can also reclaim past work effort by “borrowing” spaces from past projects with similar spatial requirements.

OPS allow users a wide range of “start points.” Depending on the information available at the start of a project, the interoperability of OPS enables users to create a BIM from just a minimal amount of data in a variety of formats. Therefore, the creation of a BIM in OPS is not restricted to a linear process.

Many ways to start a Project in OPS

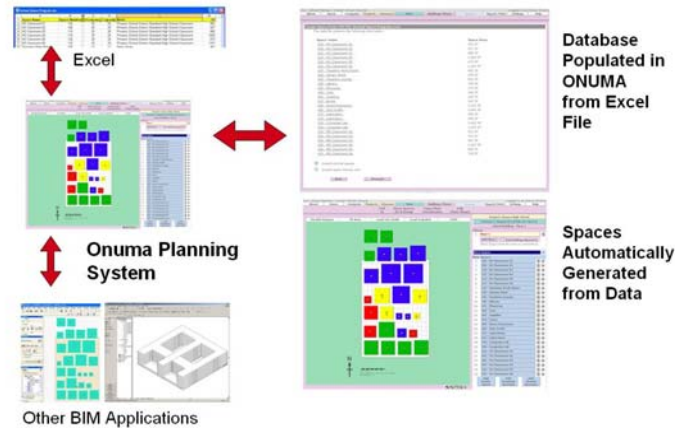

Figure 4:

The following steps shows a simple example of how one might generate a BIM in OPS

- 1) Gather all available project information (Excel, existing BIMs, etc)
- 2) Upload to OPS (using the CSV and IFC import capabilities)
- 3) Arrange spaces and create new spaces as needed
- 4) Output Reports showing the current status of the spatial program
- 5) Adjust Schemes based on the current project and the program requirements

The screenshot shows the 'Space Settings Matrix' window. It has a title bar with 'Space Settings Matrix' and 'All Buildings'. The window contains a table with two columns: 'Space Name' and 'Space Number'. The table lists the following spaces:

Space Name	Space Number
56 CLOSET	1022
57 STORAGE	1030
58 ENTRY VEST.	1019
59 ELEC.	1018
60 TELE.	1017
61 CORR.	1104
62 CLOSET	1201
63 OFFICE	1202
64 SUPPLY	1302
65 CORR.	1312
66 LOBBY	1023

At the bottom of the window, there is a 'Save Settings' button.

Figure 5:

A.2 Modeling Tips and Techniques

A.2.1 Modeling Spaces

The follow sections explain the recommended methods for modeling spaces to be exported as IFC Space (IfcSpace) objects.

A.2.2 Manipulating Spaces

When manipulating a space (e.g., resizing, copying, mirroring, and scaling) in a BIM-authoring application, the user must ensure that the Space Number is updated and correct so that each Space Number is unique. Vendor-specific instructions are presented below.

A.2.3 Columns and Shafts in Spaces

In some area calculations, columns and building services shafts shall be excluded. Effectively, this means that spaces surrounding large columns and shafts will be modeled as if they had holes or voids, from a space calculation point of view. This function is accomplished differently in each of the major BIM-authoring applications, as described in the following sections.

A.2.4 Creating Generic Types

In some instances, there will not be a tool available to create a particular IFC object. In these instances, the A/E should create a generic object and map this to the correct IFC object type. Instructions for doing this are described in the following sections.

Autodesk ADT + Inopso IFC Utility

A.2.1: In ADT, historically there have been two options for modeling Spaces. One method was to use the Space object while the other method was to use the Area object. Starting with ADT 2006, the functionality of spaces and areas has been merged into a single "Space object." The manner of creation is not relevant [i.e., a Space can be created using one of the automatic functions or it can be created manually (insert/polygonal)]. For legacy purposes, ADT 2006 still contains the separate Area object; however, for GSA related spatial program BIM modeling, the Space object must be used. The advantage of the new Space object (starting with ADT 2006) is that a single space can now store net, gross, and usable boundaries uniquely. As these are now stored with the Space object, property sets and space schedules can be set up to automatically extract net, gross, or useable areas directly from your ADT space model. By default, the usable and gross boundaries are turned off in ADT 2006. To take advantage of net, usable, and gross boundaries in a single Space object, you must go to the options dialog box and enable this as depicted in the following figure.

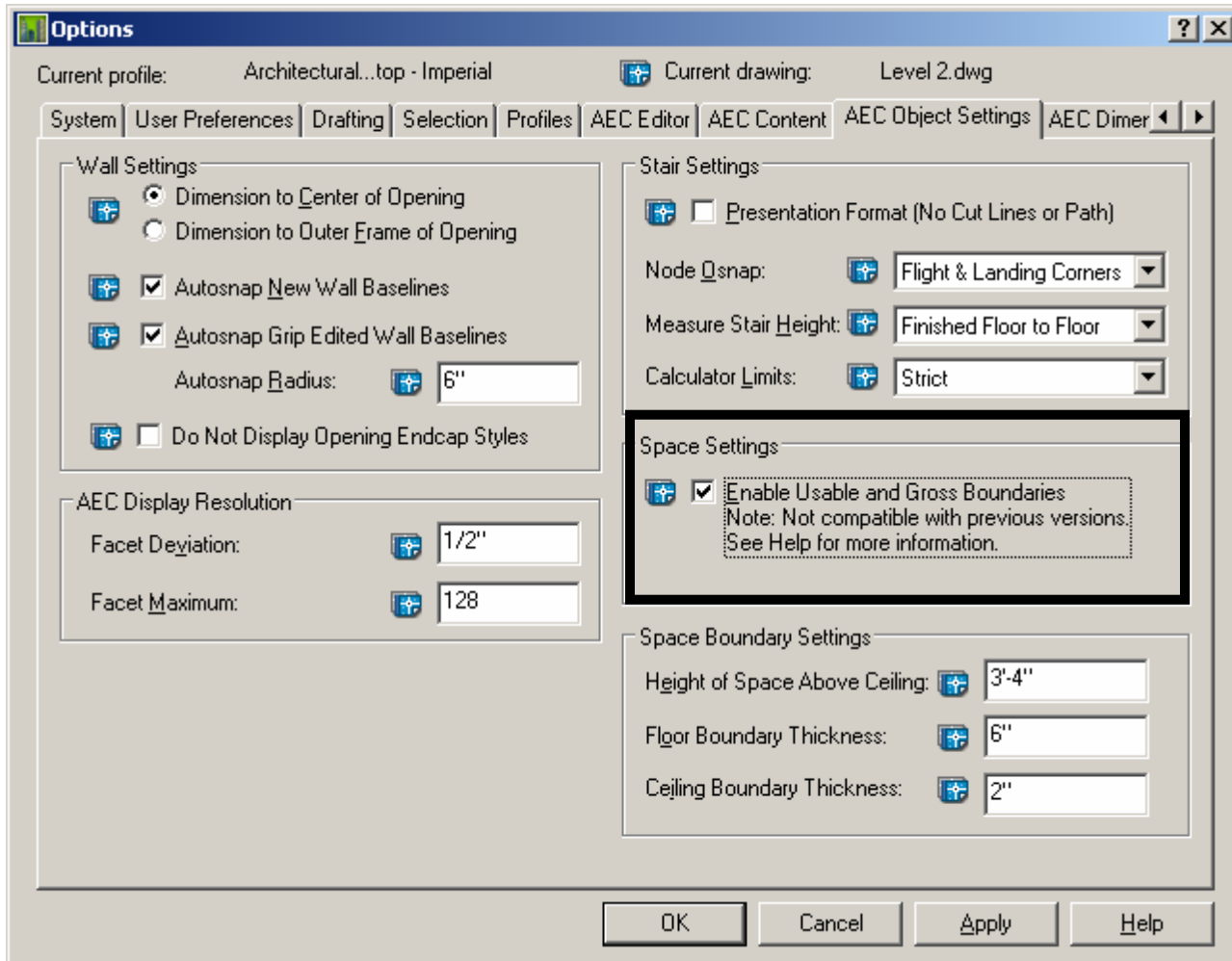

Figure 6:

A.2.2: Once enabled, you can select a space in ADT and toggle through the boundaries that you may want to edit. The image below depicts a single highlighted space in ADT 2006 with the separate grips for each of the net, useable, and gross boundaries.

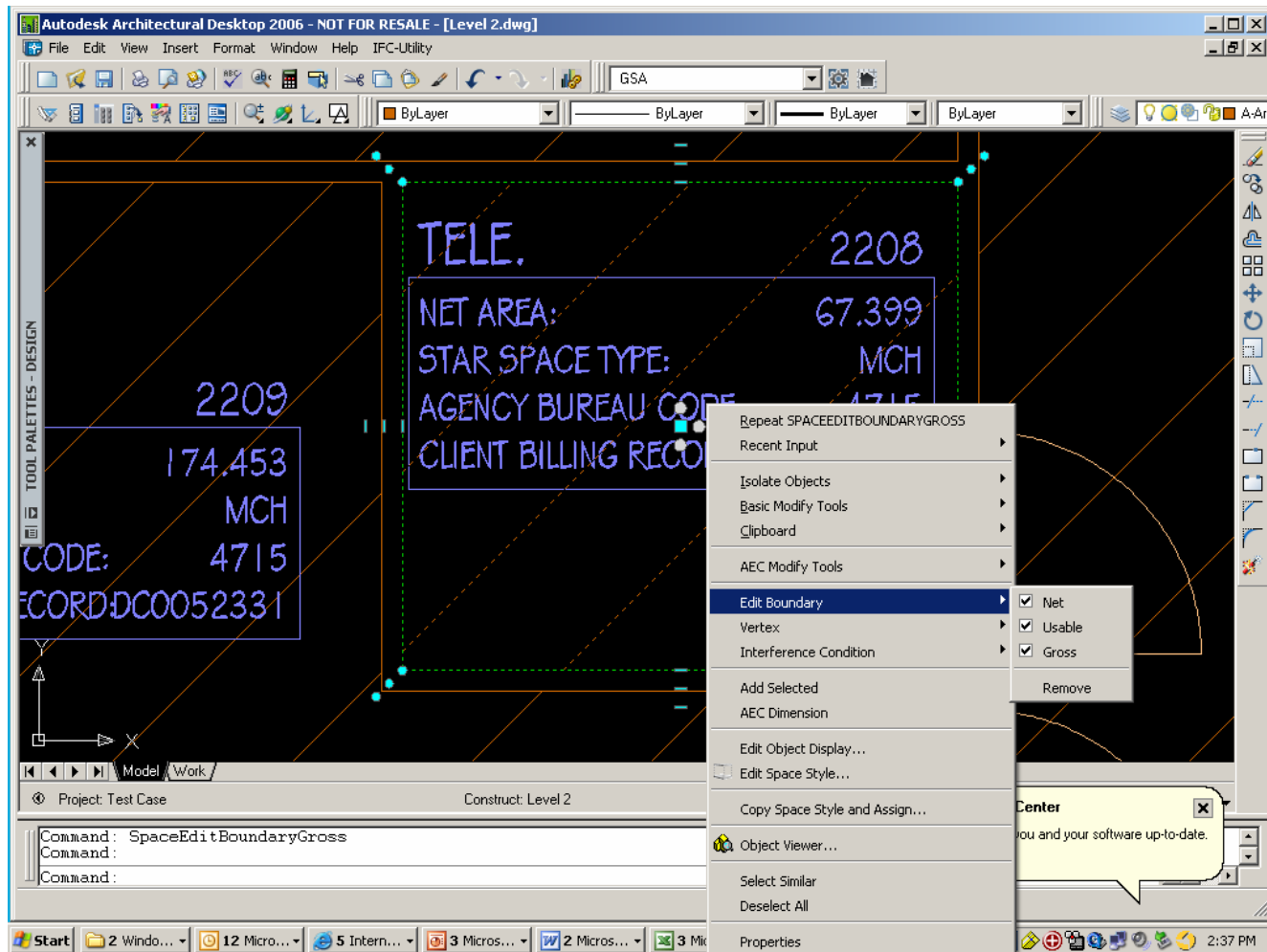

Figure 7:

Specific to these GSA Spatial BIM guidelines, a special set of custom property sets have been set up for ADT that correspond directly to the GSA-specific non-graphic data that needs to be classified in the spaces. These are available as templates that can be inserted into your project. Check with Autodesk and/or the GSA Office of the Chief Architect to obtain up-to-date ADT templates containing these GSA Spaces property sets. The property sets are associated with the spaces in ADT. An example of these is depicted in the screen shots below:

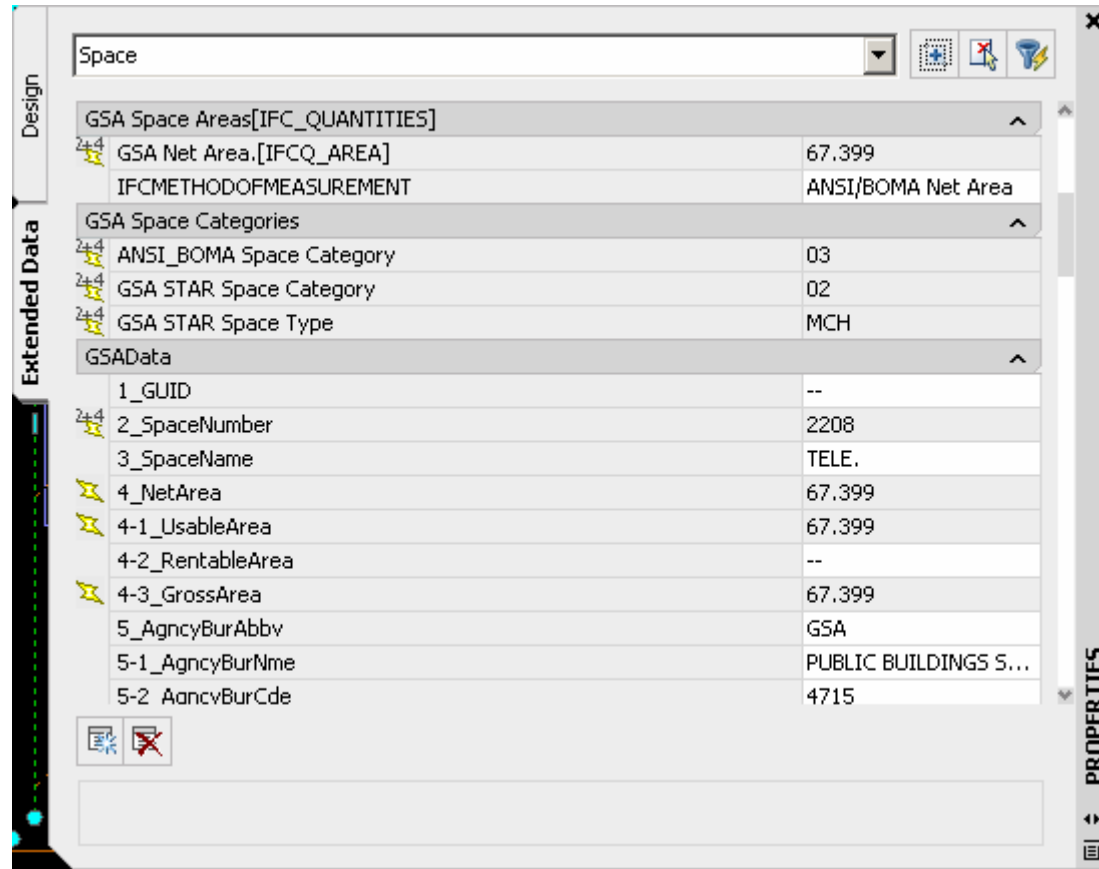

Figure 8:

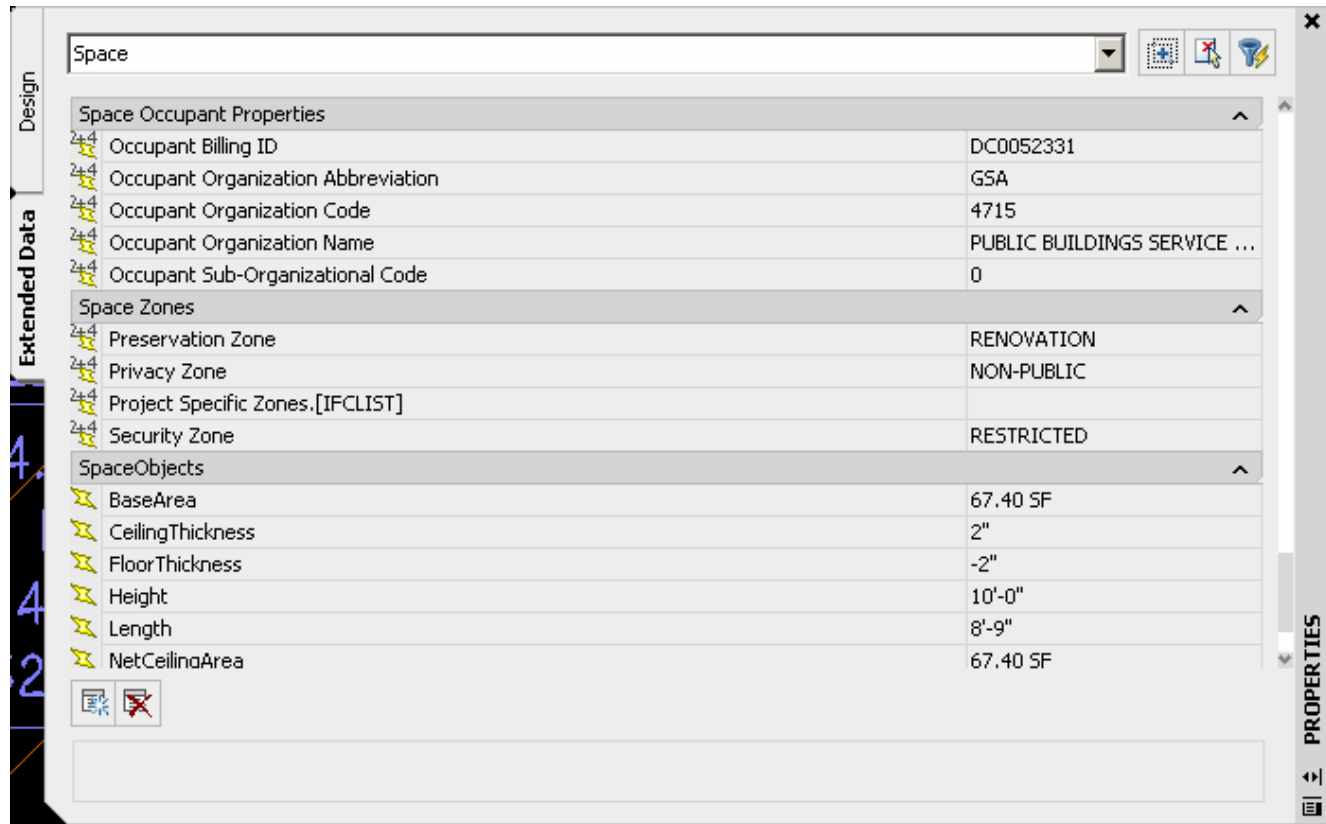

Figure 9:

A.2.3: Columns can be subtracted with the AEC Modify Tools, Subtract function.

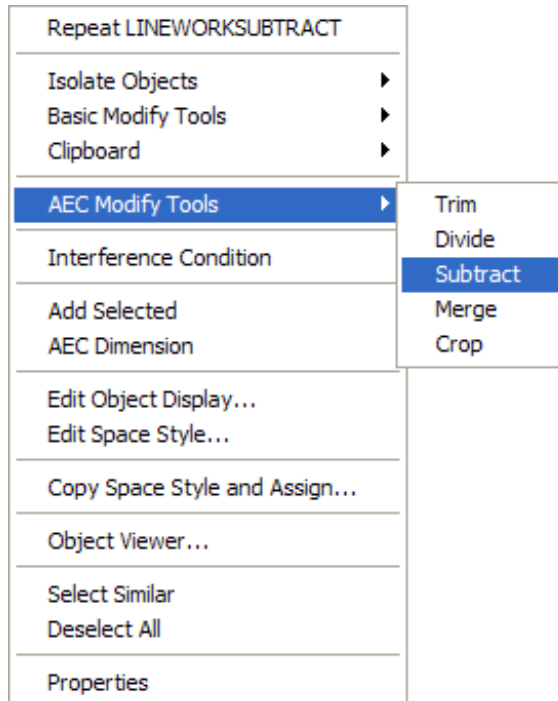

Figure 10:

A.2.4: Generic Types. Architectural Desktop has built in Building objects for all GSA required spatial BIM components and we do not anticipate that you would need create any “generic” object to represent any of the these required BIM components. If you do employ generic modeling for a component of a given building, you have the option to classify this generic object as a specific BIM object for IFC export using the INOPSO add on for ADT using Classify Entity As capability. An example is depicted below.

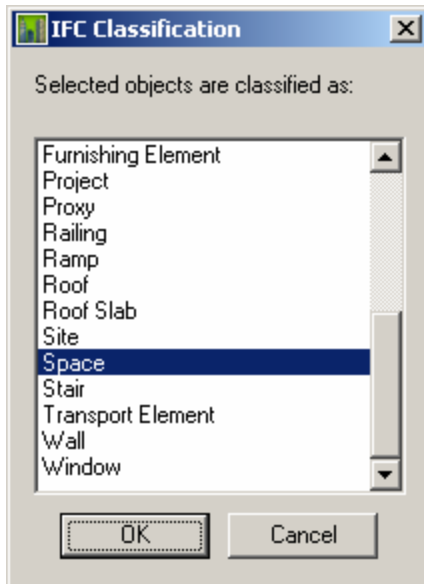

Figure 11:

Autodesk Revit

A.2.1: Autodesk Revit Building has a couple of methods for modeling spaces. These are rooms and areas. With both methods the resulting spaces are automatically generated and “parametrically” associated with the bounding elements, which can be walls or room separators. As the bounding elements are stretched, the associated spaces are updated including the associated room or area schedules with area and volumetric calculations.

Rooms

In Autodesk Revit Building, you create a room when you place room into a space whose boundary consists of either three or more room-bounding walls (a wall is room bounding if its room bounding parameter is selected) or three or more room separation lines. If the space is bounded by walls, the room area is calculated from the inside face of the walls.

Considerations when using Revit Rooms in the context of working with the GSA BIM guide recommendations:

- In the concept design phase, many details of the building may not be fully defined such as wall types and window specifications. The Revit rooms and resulting room schedules give you a very accurate and instantaneous method for determining if your design is meeting the space program requirements.
- In this concept design phase you also may not have all or your interior walls/partitions fully modeled yet or you may have the need to represent logical spaces within a large bounded room. In this case, you can use Revit Room separators to subdivide spaces in smaller functional groups. An example of this may be the security area within a lobby that may not be bound by any physical walls.
- Starting in Revit Building version 9, in addition to the room tag itself, specific room objects have been introduced.

Areas, Area Boundaries and Area Analysis

Autodesk Revit Building has an area analysis module. This area analysis module allows you to create area boundaries for defining useable space in buildings. You can create multiple area measurement schemes. By default, Revit Building creates two area schemes:

- **Gross Building:** Total constructed area of a building.
- **Rentable:** Area measurements based on the BOMA standard method for measuring floor area in office buildings.

You can define these areas boundaries by drawing them or by picking walls. Once created, these area boundaries get parametrically associated with their adjacent walls or room separators. Refer to the Autodesk Revit Building online help system including a tutorial for getting familiar with these area analysis tools. Once you create these discrete areas, you have the option to apply area rules to them based on an area type. If you change the area type, Revit Building will automatically change the area boundary line. For example, office area is measured at the wall centerline while exterior area is measured to the exterior wall face.

Considerations when using Revit Area Analysis tools in the context of working with the GSA BIM guide recommendations:

- The Revit Area types of Office Space, Building Common, Floor Area, and Major Vertical Penetration correspond directly to the ANSI/BOMA Categories listed in the PBS Business Assignment Guide for Office Space, Building Common, Floor Common, and Vertical Penetrations.
- For representing “Gross Building Area” there is an area type in Revit “Gross Building Area” which is any area inside the outer face of the buildings exterior walls.
- There is currently no area type in Revit that corresponds directly to the “PBS Specific” Category 5 listed in the PBS Business assignment guide.
- Depending on where you are in the design phase, you may want to wait until a later phase before you do an exhaustive area analysis scheme with Revit. In you are in concept design for example, you could get some very useful approximate rentable areas derived from formulas assigned to the Room schedule area reports.

A.2.2: No Revit Building specific instructions are required here. The introduction to this section is sufficient and applies to Revit. Note that when copy and pasting rooms, Revit Building will not duplicate the room number.

A.2.3: In Autodesk Revit Building when calculating area from either rooms or areas, the area of a column is not automatically subtracted. For GSA net area calculations, these areas need to be subtracted from the area of the room. Starting with Revit Building 9.0 an option has been added to exclude columns and shafts from the area calculations.

If you want Revit to subtract out the area of a column when it reports area in a room or area schedule, click on the column, and select properties and make sure that it is classified as “room bounding” as depicted below.

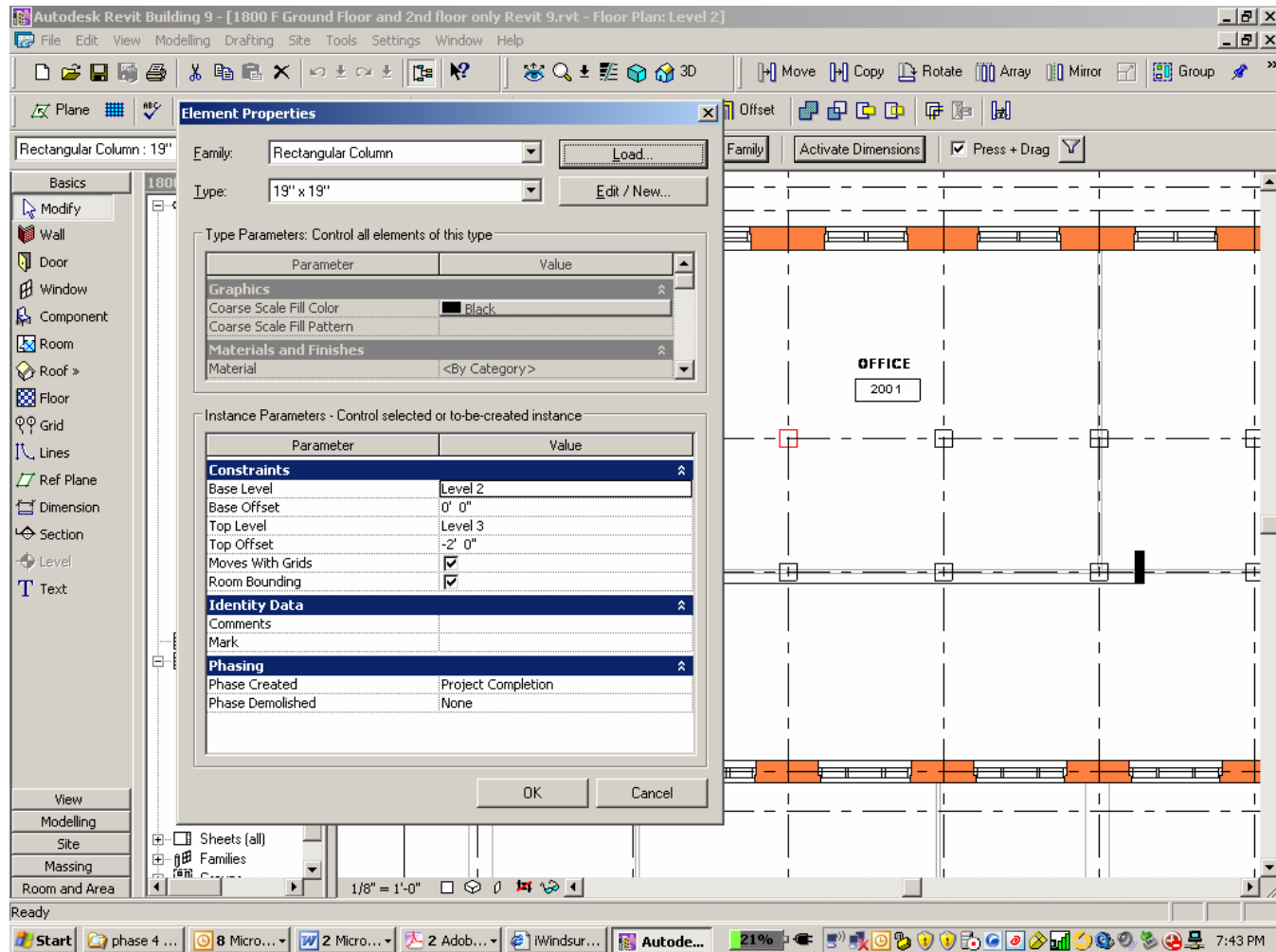

Figure 12:

A.2.4: Please contact Autodesk Revit for more information.

Bentley Architecture

A.2.1: Bentley Architecture provides a complete set of tools to create, edit, label, and manage information related to spaces.

These tools create a 2D space polygon in the Bentley Architecture file. When spaces are exported to the IFC format, they are converted to 3D volumetric descriptions of a uniform height based on the ceiling height associated with each space.

Please refer to the Bentley BIM to GSA IFC Resource Kit for complete documentation.

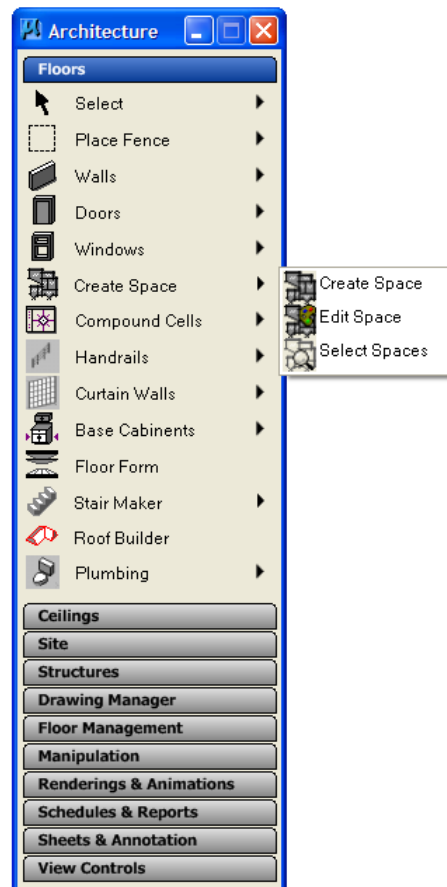

Figure 13:

A.2.2: Bentley Architecture allows spaces to be copied using the standard MicroStation commands like copy element. Using copy will also copy all of the space attribute values from the source of the copy. These attribute values may be modified as required by selecting the Bentley Architecture Edit Space command as shown at right.

Please refer to the Bentley BIM to GSA IFC Resource Kit for complete documentation.

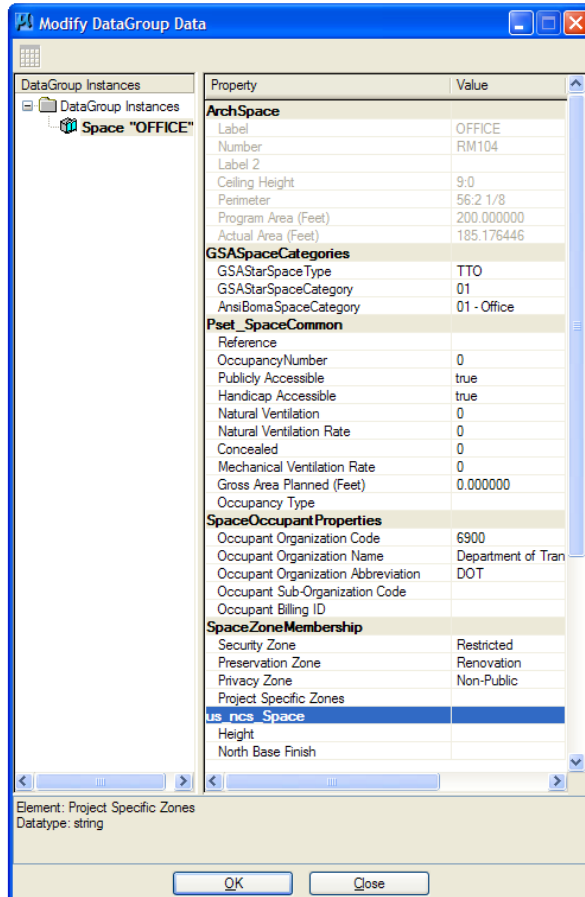

Figure 14:

Bentley Architecture allows spaces to be mirrored using the standard MicroStation commands like mirror element. If mirror copy element is selected, the command will also copy all of the space attribute values from the source space of the mirror copy. These attribute values may be modified as required by selecting the Bentley Architecture Edit Space command as shown below.

Please refer to the Bentley BIM to GSA IFC Resource Kit for complete documentation.

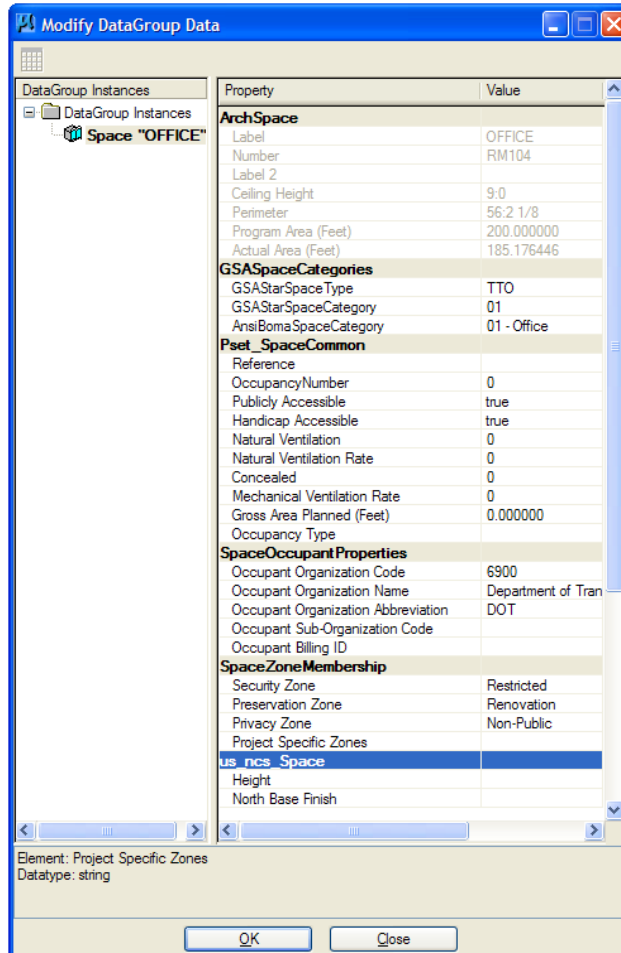

Figure 15:

A.2.3: Bentley Architecture allows spaces to be created with excluded areas or holes using the Create Space command in the Flood mode. The command allows areas of exclusion or holes to be filtered by their by area as show in the dialog below. Setting this value to 0.0 as shown below will result in all areas of exclusion or holes to be excluded from the resultant space.

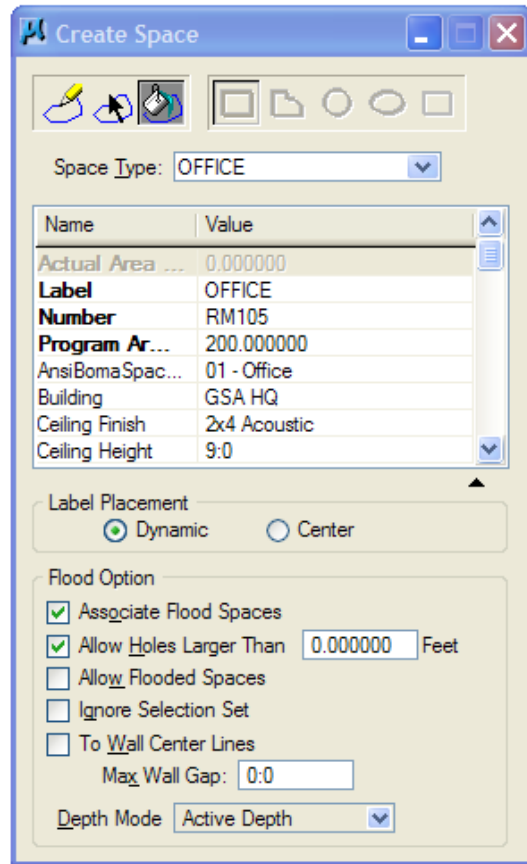

Figure 16:

A.2.4: Please contact Bentley Architecture for more information.

Graphisoft Archicad

A.2.1: In Archicad, spaces shall be created using the Zone tool. When using the, Zone_Stamp_GSA_3 to create the zones, all instances of such spaces will be correctly exported to IFC BIM format, including the standard space properties defined for the IFC BIM. Additional information can be found through your local reseller or on line at <http://www.graphisoft.com/support/ifc> and in the Graphisoft IFC Guide available from <http://www.graphisoft.com/support/ifc/downloads/>

A.2.2: Instructions for manipulating the Zones in Archicad can be found in the help menu, the on-line training guides or by contacting your local reseller. To insure that you have unique ID's for each Zone you may create an interactive schedule that lists the Zones and all required fields. Space Numbers, Names and all other information can be managed from the schedule. When the Zone elements are edited in the schedule, you can be assured they are updated throughout the Virtual Building database. Instructions for creating an interactive schedule may be found in the help menu, the on-line training guide or by contacting your local reseller.

After making a copy of a zone, the user must select the copy and edit the "Zone ID" field found under "Listing and Labeling" under the "Zone Selection Settings."

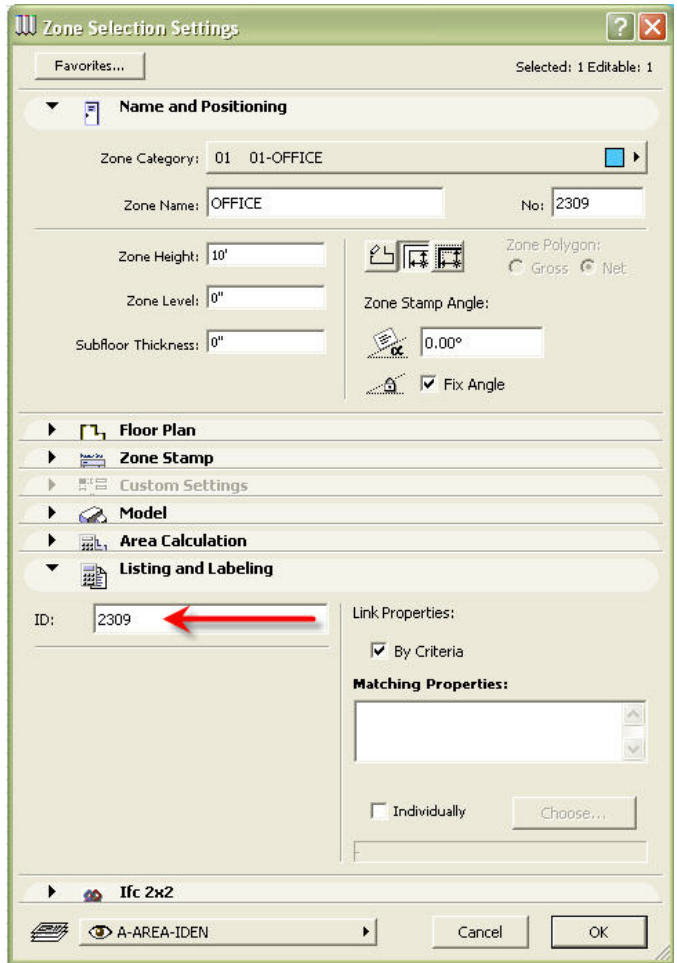

Figure 17:



Figure 18:

Changing the Zone Name or Number (No.) may not create a unique instance of the Zone and the generated schedules will reflect the duplication. The "Zone ID" may also be edited in the interactive schedule and changes applied to the model prior to export as an IFC BIM file.

A.2.3: When a space is created with the automatic zone creation method, the existing columns are automatically excluded from the space area. If the space is created with the manual method or when columns are placed after the Zone, holes for the columns must be created manually. This may be done by first selecting the zone, then selecting the Zone Tool and drawing a polygon around each column.

Note: You must have the First Geometry method selected to edit an existing Zone element



Figure 19:

Note: If the space measurement requires that some columns shall be included in the space area and the zone has been created automatically, then the polygons surrounding the columns shall be removed. This is achieved with the Zone Tool. First, select the zone, and then click on one of the points around the column opening. Select the move node option from the pet pallet and drag the polygon points together.

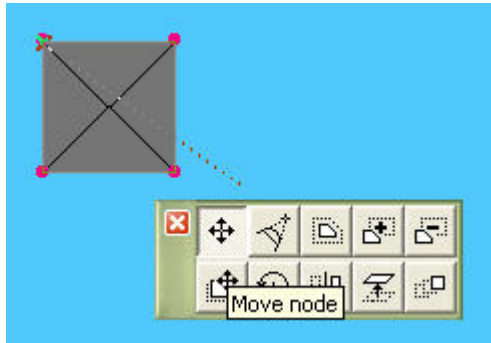

Figure 20:

When all of the nodes have been dragged to one point, the polygon, and thus the opening disappears.

A.2.4: A full description of managing the IFC file type can be found at www.graphisoft.com under IFC Support in the download section or by contacting your local reseller.

ONUMA

A.2.1: All spaces created in OPS can be output as IFC Spaces without additional set up.

There are 3 ways to add spaces.

- 1) Add Empty Space
- 2) Add Template Space(s)
- 3) Add Shared Spaces(s)

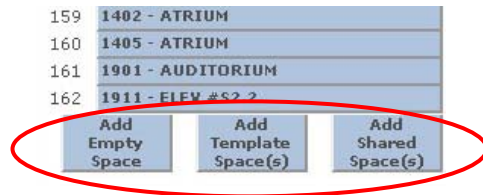

Figure 21:

Method 1: Add Empty Space

Click on button *Add Empty Space*.

A brand new "blank" space will be added to the Scheme.

This space will not have any furniture or equipment populated in the space.

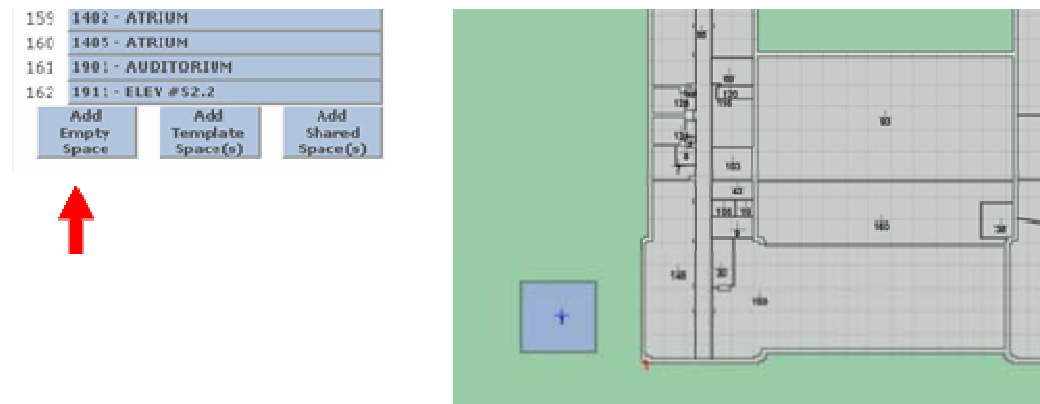

Figure 22:

Method 2: Add Template Space(s)

Click on button *Add Template Space(s)*. A *Modulet* window will pop up.

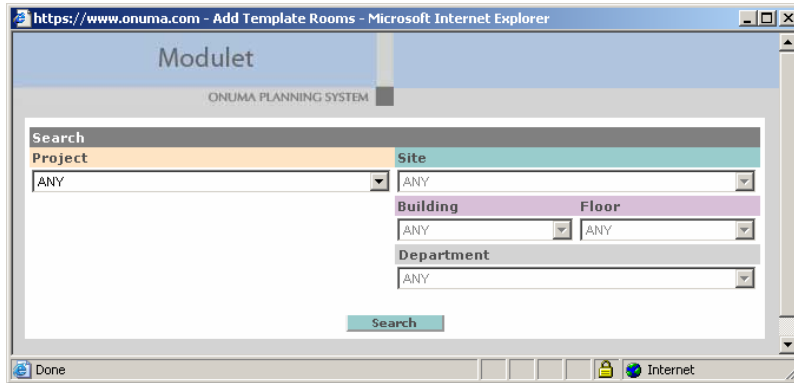

Figure 23:

This feature in OPS enables a user to populate their scheme with Template Spaces that are provided in OPS or created by the user in other buildings, schemes, and projects.

Method 3: Add Shared Space(s)

Click on button *Add Template Space(s)*. A *Modulet* window will pop up.

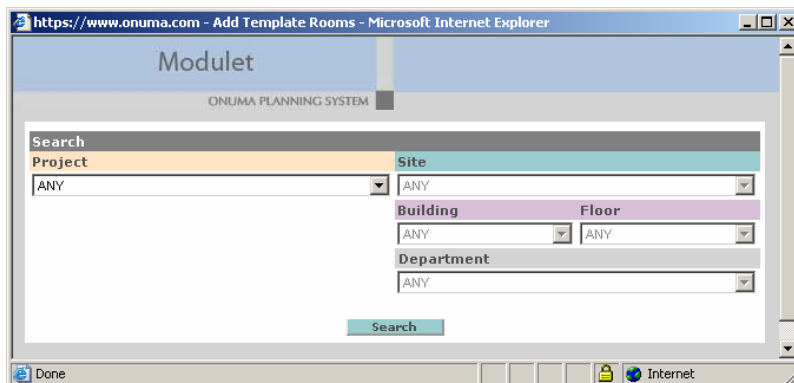

Figure 24:

This feature in OPS is extended to allow users to leverage Spaces that have been developed by other users who have elected to “Share” particular schemes they have worked on. This is particularly effective in teamwork environments where several people can benefit from the work effort a one person.

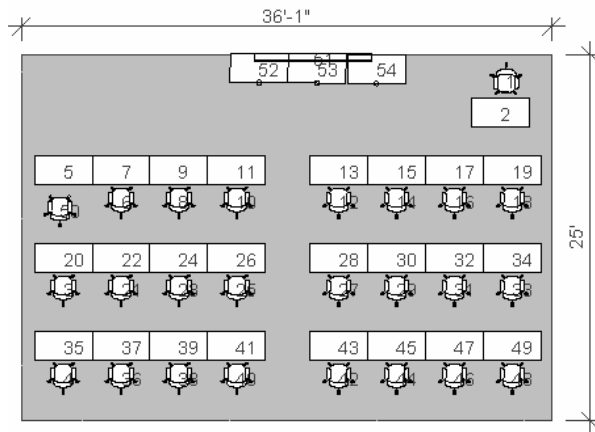

Figure 25:

Furniture	
Show Furniture Numbers:	<input checked="" type="checkbox"/>
1 Chair Console	<input type="checkbox"/>
2 Desk Mod Sys 1 Ped	<input type="checkbox"/>
3 Chair Console	<input type="checkbox"/>
4 Chair Console	<input type="checkbox"/>
5 Desk Mod Sys 1 Ped	<input type="checkbox"/>
6 Chair Console	<input type="checkbox"/>
7 Desk Mod Sys 1 Ped	<input type="checkbox"/>
8 Chair Console	<input type="checkbox"/>
9 Desk Mod Sys 1 Ped	<input type="checkbox"/>
10 Chair Console	<input type="checkbox"/>
11 Desk Mod Sys 1 Ped	<input type="checkbox"/>
12 Chair Console	<input type="checkbox"/>
13 Desk Mod Sys 1 Ped	<input type="checkbox"/>
14 Chair Console	<input type="checkbox"/>
15 Desk Mod Sys 1 Ped	<input type="checkbox"/>
16 Chair Console	<input type="checkbox"/>
17 Desk Mod Sys 1 Ped	<input type="checkbox"/>
18 Chair Console	<input type="checkbox"/>
19 Desk Mod Sys 1 Ped	<input type="checkbox"/>

Figure 26:

In addition to adding spaces, this method will transfer the associated data such as furniture and equipment from the original spaces. This way, a user can quickly populate a building with spaces that match requirements.

A.2.2: Manipulating Spaces. Much of the space manipulations in OPS are achieved through a series of pulldown commands and simple “clicking and dragging.”

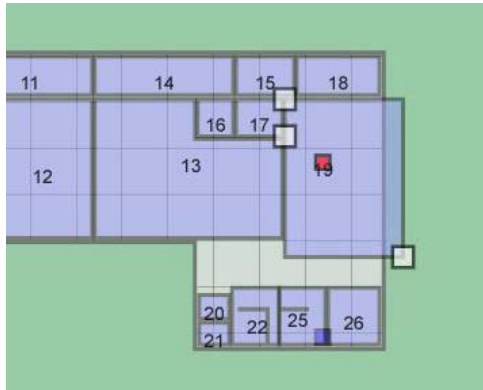

Figure 27:

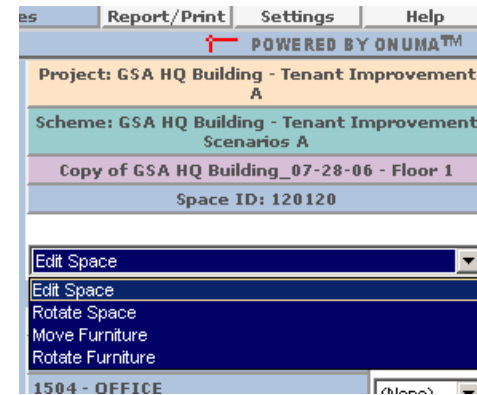

Figure 28:

Users can change the shape of a space and the size, move furniture, and add new furniture and equipment. Square spaces can be changed to L shaped, U Shaped or user defined shapes.

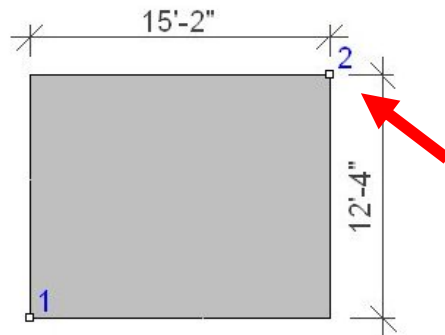

Figure 29:

“Grips” are used to adjust the size of the Space. Dimensions will dynamically update as the geometry and area of the space are also updated.

Copying Spaces

Spaces are copied by clicking the *Add Template Space(s)* or *Add Shared Space(s)* in OPS. In addition to being able to copy Spaces within the current project OPS can query and leverage all Spaces within any other projects that the user has inputted into OPS.

The Modulet is used to navigate through the list of projects. The user can then select the space(s) to copy over into the current project. The user can then use the *Space Settings Matrix* to re-number the new space(s).

NOTE: Since ONUMA operates as a web-enabled model server, users can leverage spaces in ANY project that they imported into ONUMA in a networked environment; users can also share Projects and Schemas, further increasing the availability of spaces that can be copied into a project.

Space Settings Matrix

Space Name	Space Number	Capacity
Floor 1		
1 Office	107	0
2 Manager's Office	102	0
3 Mechanical	104	0
4 Stair 2	103	0
5 Elevator	105	0
6 Storage	106	0
7 Stair 1	108	0
8 Lobby	101	0
9 Office	109	0

Copy spaces using the Modulet

The database in ONUMA will keep track of all Spaces that are added or deleted from the project. The Space Settings Matrix is used to edit room numbers.

Figure 30:

Mirroring Spaces

Any space added in OPS can be mirrored. The mirrored spaces will export to IFC correctly.

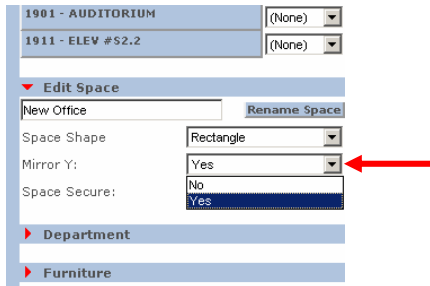

Figure 31:

Unique Space Numbers

OPS will warn users of any duplicated Space Numbers. As the design progresses and develops, the importance of avoiding to have duplicate Space Numbers increases.

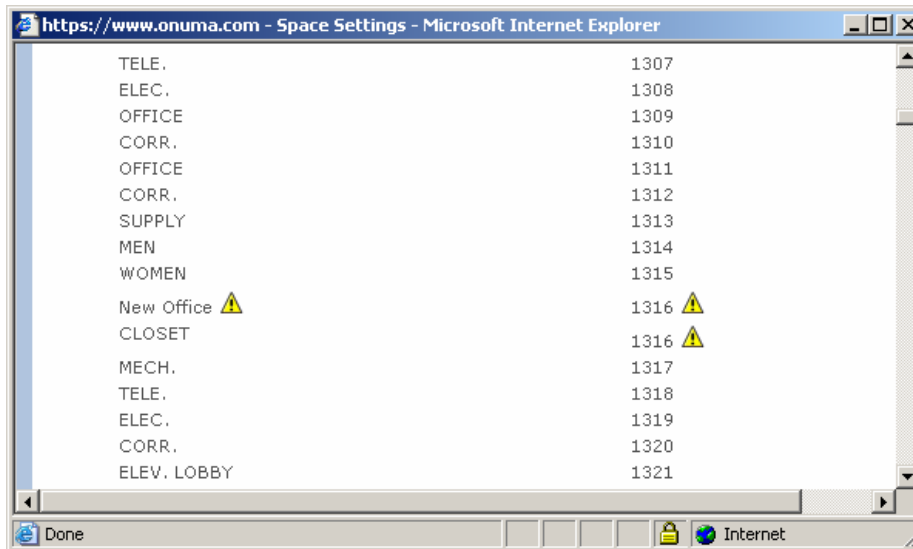

Figure 32:

OPS will also warn users of space names that do not match GSA standard naming conventions. In early planning studies when importing a list of spaces into OPS from an Excel file, the system can automatically flag non standard spaces and give the user the option to rename them to match GSA standards. In later stages of design if an existing IFC model is imported from BIM Applications, OPS can also flag and check for inconsistencies.

A.2.3: In addition to OPS being a web-enabled tool that allows users to create BIM from scratch it is also set up to import and export to other BIM desktop applications such as ArchiCAD and Revit. Each of the other BIM applications has slightly different strategies for working with columns and shafts as they relate to space. OPS for example reads space data from the ArchiCAD Zone tool and places it in IFC Properties to define column spaces. This area of the column is then subtracted from the space area in the data and reports.

The way to work with column data also varies depending on what stage the project is in. A conceptual project is much different from a built model. A conceptual model may or may not have columns in spaces, as it could start from area requirements. The BIM for a conceptual model in OPS can include columns in the spaces. An as built model that could have been started in BIM Desktop applications that have precise definitions of columns in spaces is a different process. In this case, the area of the columns if reported in the BIM Desktop application can be imported into OPS and tracked as the area of the column. As OPS imports as built BIMs that have columns, the data for columns is tracked.

Although OPS is more focused on the data related to the spaces with respect to planning and less on the physical modeling of all detailed components of a building, it will capture all the spatial data generated from other IFC compliant that took items such as columns and shafts into consideration. This is an example of how although OPS does not require its users to get down to detailed modelings in the tool, the tool can still leverage the detailed and accurate data.

A.2.4: OPS comes with a library of objects to be used for typical architectural projects. In the event the library does not contain a specific object that is needed for a project, users can create a generic object that would serve as a “placeholder” in the model as well as a mechanism to capture data relevant to that particular Component or object.



Figure 33:

A.3 Inputting GSA Spatial Program BIM Requirements

A.3.1 Entering Spatial Data

The information content of a BIM is very dependent on the BIM-authoring application being used. The figure below defines Space Number and Space Name for each specific BIM-authoring application:

Description	Sample Data	Autodesk ADT	Autodesk Revit	Bentley Architecture	Graphisoft ArchiCAD	Onuma Planning	IFC 2X2
Space Number	8006	Number	Number	Number	No.	Space Number	IfcSpace.Name
Space Name	OFFICE	Name	Name	Name	Zone Name	Space Name	IfcSpace.LongName

Figure 34:

A.3.2 Area Calculations

BIM-authoring tool vendor for instructions on performing area calculations according to the rules of the ANSI/BOMA Standard and the PBS Business Assignment Guide are:

A.3.3 Adding Additional Space Descriptions

Some A/Es may want to use more detailed descriptions for the space in addition to the required Space Name category (i.e., in addition to the Space Name "OFFICE," A/Es may also want to say "Program Director's Office"). The follow section describes how to input more detailed space descriptions with the BIM-authoring application:

Autodesk ADT + Inopso IFC Utility

A.3.1: The required GSA Spatial data is associated with the ADT spaces via the use of property sets as referred to and depicted in section A.2.1. The data is entered and associated with these spaces by clicking and selecting the Space object and right clicking and invoking the “ADT/AutoCAD” properties window. Specific to the property for space number, an example ADT property set has been set up that automatically puts the floor number as a prefix to the room/space name. This helps in automating the required space name numbering in cases where a given floor is an exact duplicate of an existing floor.

A.3.2: The Standard Net Area for spaces is provided by ADT and can be redirected to the relating GSA area properties. In addition, optionally users can choose to modify the useable boundaries of the spaces to conform to the ANSI/BOMA standard method of measuring space.

A.3.3: The space name and number properties associated with the ADT spaces are reserved for the GSA Spatial requirements are exported to the required IFC file. In those cases where a given project needs more site specific naming or numbers you can add you own ADT property set for this purpose.

Autodesk Revit

A.3.1: An Autodesk Revit room schedule can be set up so that all of the GSA “approved” room names get presented to the end user as a scroll box in either the room schedule or in the element properties window (for more information on this capability go to: www.autodesk.com/gov-gsa-bim).

The same holds true for the GSA specific space data fields (specified in Section 3: Space and Zones of this document) that need to be associated with the spaces/rooms. The GSA-specific space properties can be implemented in Revit Building using some custom project parameters. Also with the Revit Building Schedule Key capability, many of the required GSA space data properties can be automatically selected and/or populated. In the example below the Revit room number “2001” is selected and the element properties window for this room presents a scroll bar for the end user to “dial” in a room name.

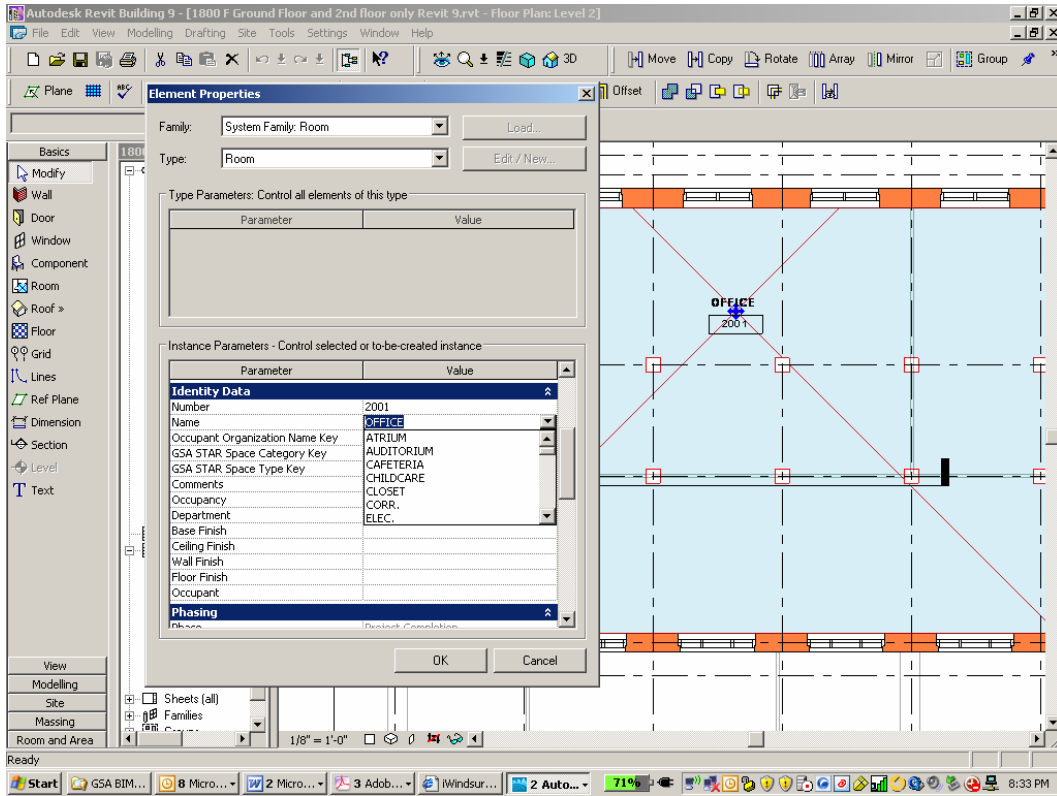

Figure 35:

The screenshot below shows GSA spatial properties implemented in Autodesk Revit Building as project parameters. In this example, the GSA STAR Space Type value is “dialed” in from a list that was created in a schedule key.

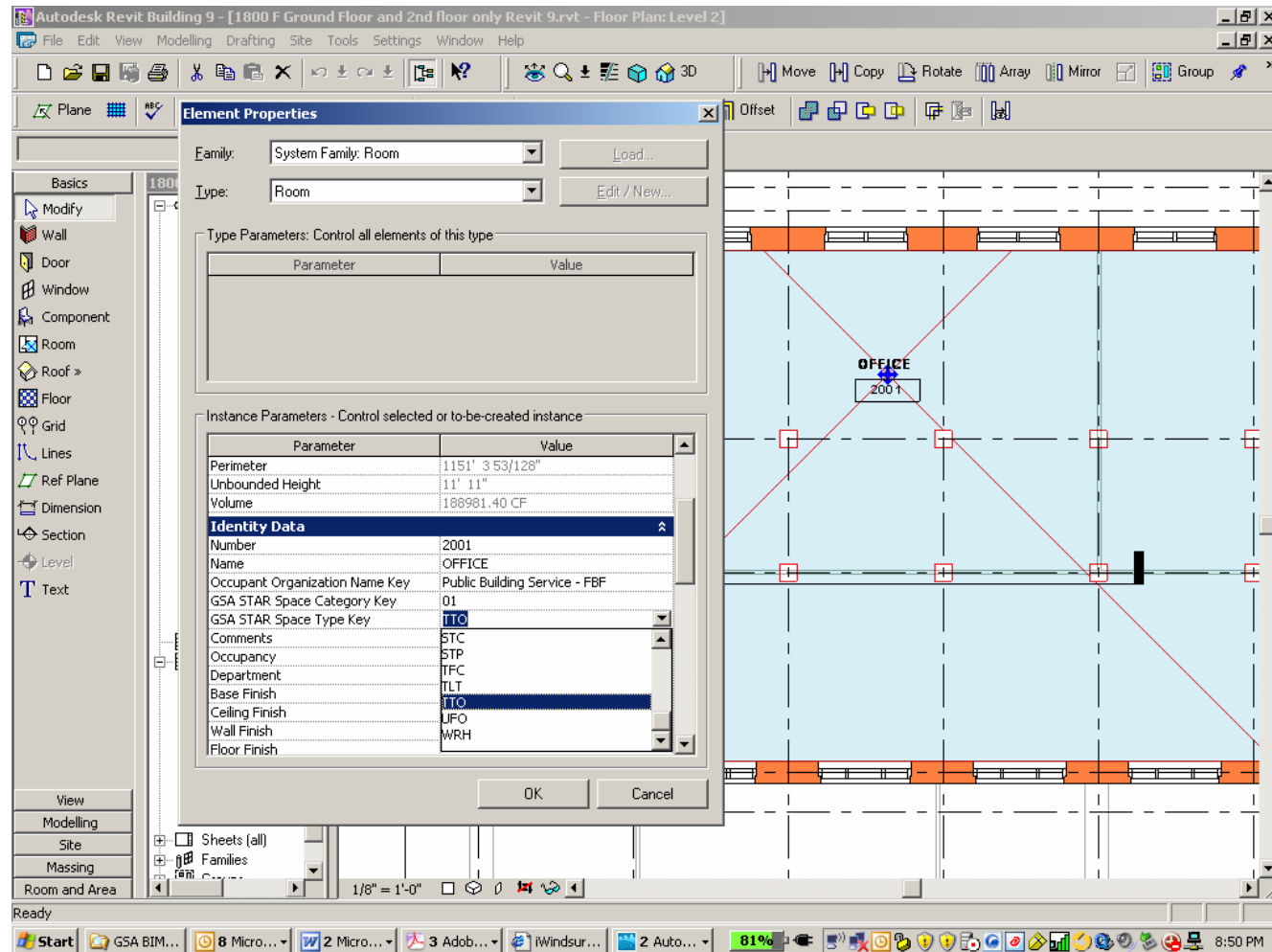

Figure 36:

Example of a Revit Schedule key that can be implemented for GSA STAR Space Type

GSA STAR Space Type Key Table			
Key Name	GSA Star Space Type	Star Space Type Desc	ANSIBOMA Space Category
ADP	ADP	Automated Data Processing	01 - Office
ANT	ANT	Antennas	02 - Building Common
AUD	AUD	Auditorium	01 - Office
CFT	CFT	Conference/Training	01 - Office
CLD	CLD	Child Care	01 - Office
CON	CON	Construction	05 - PBS Specific
CRH	CRH	Circulation Horizontal	03 - Floor Common
CRJ	CRJ	Courtrooms/Judiciary	01 - Office
CRV	CRV	Circulation Vertical	04 - Vertical Penetration
CST	CST	Custodial	02 - Building Common
FDS	FDS	Food Service	01 - Office
FIT	FIT	Fitness Center	01 - Office
HUT	HUT	Health Unit	01 - Office
INS	INS	Light Industrial	01 - Office
JCC	JCC	Judges Chambers, US Courts	01 - Office
JHR	JHR	Judicial Hearing Room	01 - Office
LAB	LAB	Laboratory	01 - Office
LND	LND	Land	05 - PBS Specific
MCH	MCH	Mechanical	02 - Building Common
PTL	PTL	Private Toilet	01 - Office
QRR	QRR	Quarters & Residence	01 - Office
STC	STC	Structurally Changed	01 - Office
STP	STP	Structured Parking	05 - PBS Specific
TFC	TFC	Tenant Floor Cut	01 - Office
TLT	TLT	Toilet	03 - Floor Common
TTO	TTO	Total Office	01 - Office
UFO	UFO	Unsuitable for Occupancy	05 - PBS Specific
WRH	WRH	Warehouse	01 - Office

Figure 37:

Screenshot below shows all of the GSA required space properties added to the room element data as Revit project parameters. Values that are “grayed out” were automatically populated by dialing in schedule key data. From the example above dialing in the GSA STAR Space type “TTO” automatically populated the corresponding values for ANSI/BOMA Space Category (01 -Office) and Star Space Type Description (Total Office).

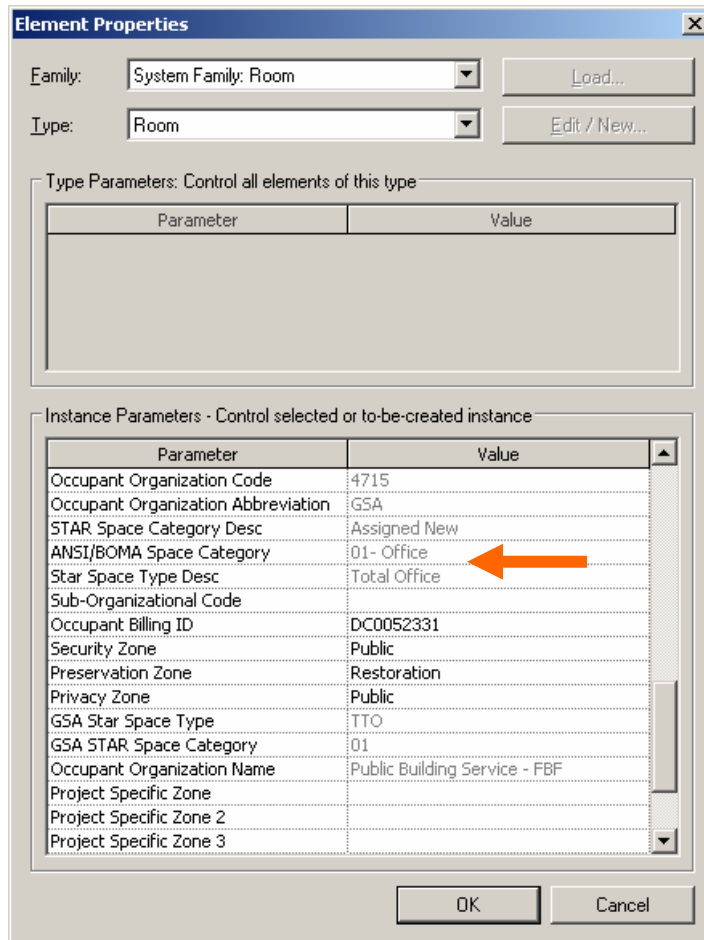

Figure 38:

A.3.2: For an explanation of how Revit can be used to model ANSI/BOMA spaces refer to previous section A.2.1.

A.3.3: In applying Autodesk Revit Building to model rooms/spaces in compliance with these GSA Spatial BIM program guidelines, it is important that the name associated with the room's identity data be reserved for the list of approved room names per the GSA assignment guide. The "built-in" room name in Revit Building is what is used to identify the room when exported to the IFC file. There will be cases on projects where you will want to use more building and/or occupant specific names for the rooms. In these cases, you should leverage the other built in room fields of department and occupant or create your own custom project parameter.

Bentley Architecture

Bentley Architecture provides the ability to assign attribute information to spaces as they are created. As shown in the chart above, GSA "Space Name" ("Office" in the example below) should be used as the Bentley Architecture Space "Label", GSA "Space Number" ("RM103" in the example below) should be used as the Bentley Architecture "Number".

The Bentley BIM to GSA IFC Resource Kit provides a Bentley Architecture workspace specific for the GSA to provide menu selections for GSA approved space types and other data fields.

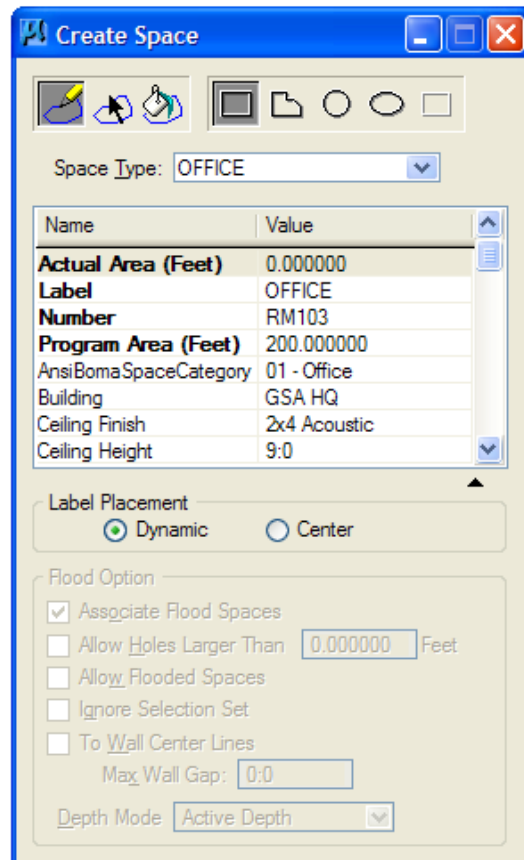

Figure 39:

Please refer to the Bentley BIM to GSA IFC Resource Kit for complete documentation.

A.3.2: Bentley Architecture provides tools to define space according to ANSI/BOMA Standard and the PBS Business Assignment Guide. The Bentley Architecture “DataGroup Explorer” facilitates the quick review of area calculation to the room level and management of space related information.

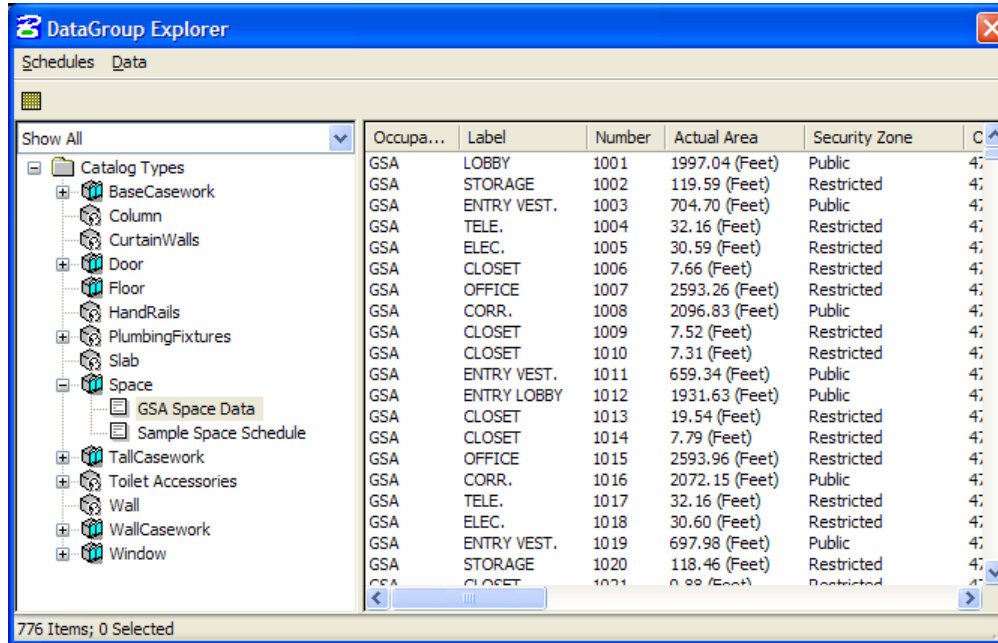

Figure 40:

Graphisoft Archicad

The following guidelines provide instructions on how to enter this data for each space:

A.3.1: Entering additional Spatial Data requires step A.3.3. Open the settings for the Zone to enter the Zone Selection Settings. In the given field type in the Zone Name as well as the Zone Identification No.

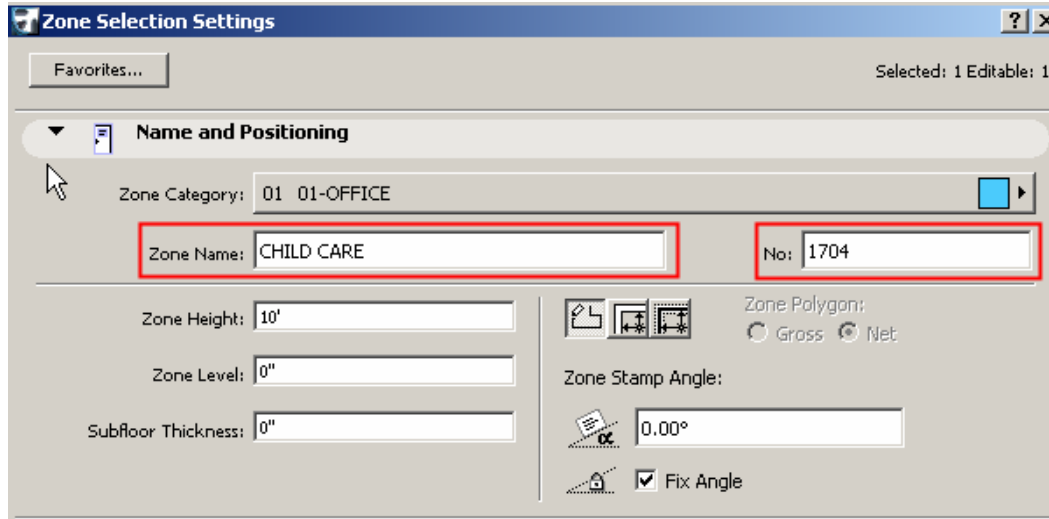

Figure 41:

For additional input of information, you must open the 'GSA Properties' in the Zone Settings. Here you will find a number of sections. You can select the given lines and enter the required data next to the property names.

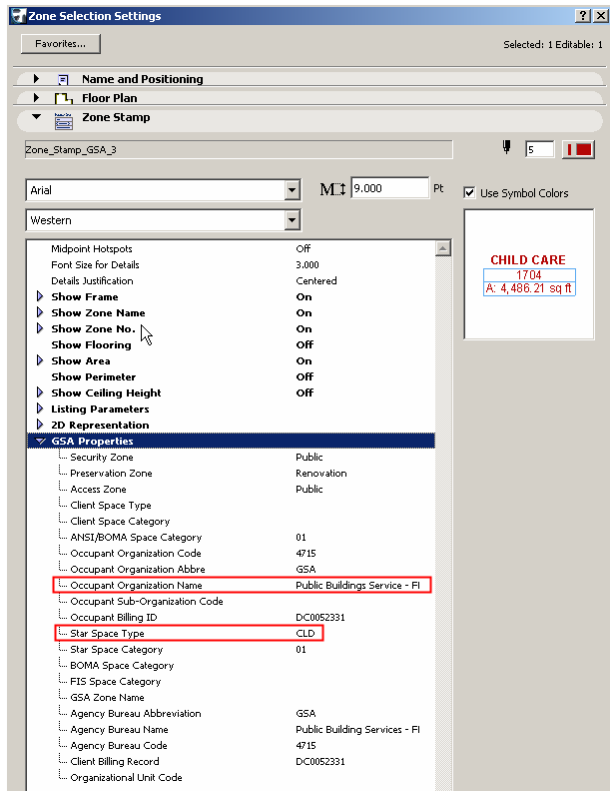

Figure 42:

A.3.2: In Archicad, users may populate information to the Zone Stamp used with the Zone Tool. In the Zone Settings , select the Zone_Stamp_GSA_3 . For additional information on the Zone Stamp, refer to the help menu in Archicad.

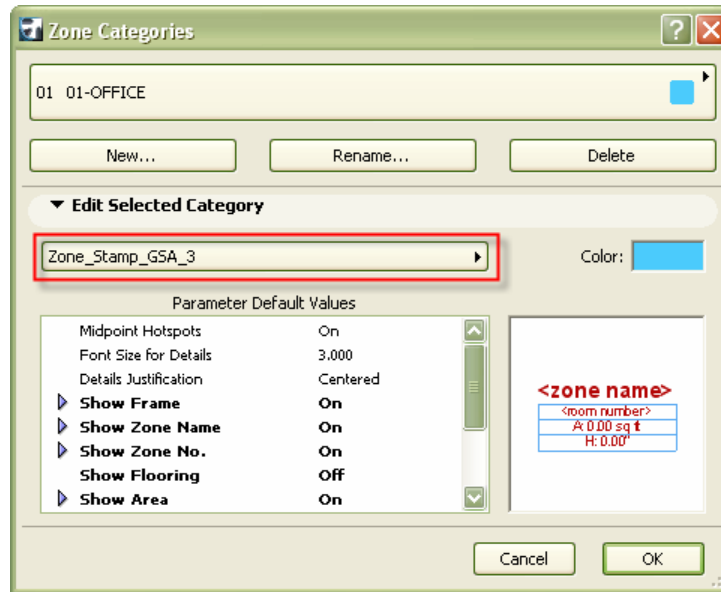

Figure 43:

The fields of the Zone Stamp may be populated from the Zone Selection Settings.

As listed above:

The Space Number is listed in the field for No:.

The Space Name is listed in the field for Zone Name.

A.3.3: Additional information may be listed in the Zone Category as well as in the Zone Attributes found in the IFC 2x2 settings available from the Zone Tool Settings dialogue.

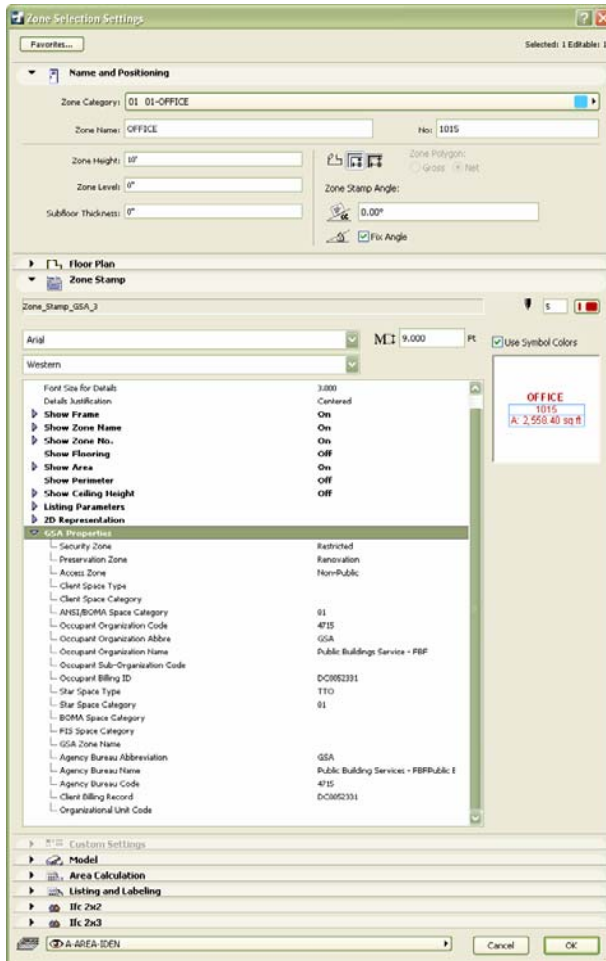

Figure 44:

For additional information on the Zone Selection Settings, refer to the help menu in Archicad.

For more information on displaying these settings, reference the “Tool Settings Dialog Boxes” under “Work Environments” from the help menu in Archicad.

A.3.2: Area Calculations can be scheduled using the Interactive Schedule function in Archicad.

Archicad’s interactive Element Schedule function allows you to automatically generate schedules of any information found in the Virtual Building. These Element Schedules not only displays quantities and other parameters but also make it editable. This makes it possible to manage data throughout a project.

ONUMA

A.3.1: Space Settings Matrix. Click on the *Settings* button. Go to the *Space Settings* and then click *Space Settings Matrix*. A pop up window will display showing categories of data attributes to edit. Check the boxes "Generic Space Info," "GSA Space Categories," "GSA Space Occupants". This will launch a matrix that will allow these attributes to be edited.

The screenshot shows the ONUMA interface for editing space settings. On the left, a filter menu titled 'Please set the filter for the settings page' allows users to select floors and departments. Under 'Attributes', several categories are checked: 'Generic Space Info' (Space Number, Capacity, Occupancy, Space Height, Space Elevation), 'USCG Space Info' (Space Code, USCG Land Ofc, USCG Site Number, USCG Group Ofc), 'Metric Space Info' (MDI, SVT, FCI), 'GSA Space Categories' (GSA STAR Space Type, GSA STAR Space Category), 'GSA Space Zones' (Security Zone, Preservation Zone, Privacy Zone, Project Specific Zone), and 'GSA Space Occupants' (Occupant Organisation Code, Occupant Sub-Organizational Code, Occupant Billing ID). A blue arrow points from this menu to the 'Space Settings Matrix' window on the right. This window displays a table of space settings for the 7th floor, with columns for Space Name, Space Number, Capacity, Occupancy, Space Height, Space Elevation, GSA Space Type, GSA Space Category, Occupant Organisation code, Occupant Sub-Organisation Code, and Occupant Billing ID. The table lists 11 spaces, including MECH, PIPE SHAFT, ELEV #S3.1, MEN, ELEV #S3.2, STAR #1.1, STAR #3.2, STAR #5.2, and PIPE SHAFT. A 'Save Settings' button is located at the bottom of the matrix.

Space Name	Space Number	Capacity	Occupancy	Space Height	Space Elevation	GSA Space Type	GSA Space Category	Occupant Organisation code	Occupant Sub-Organisation Code	Occupant Billing ID
7TH FLOOR										
1 MECH	7317	0	0	10'	0'	MCH	02	4715		DC0052331
2 PIPE SHAFT	7931	0	0	12'	0'	CRV	10			
3 ELEV #S3.1	7921	0	0	12'	0'	CRV	10	4715		DC0052331
4 MEN	7204	0	0	10'	0'	TLT	02	4715		DC0052331
5 MEN	7109	0	0	10'	0'	TLT	02	4731		DC0080235
6 ELEV #S3.2	7920	0	0	12'	0'	CRV	10	4715		DC0052331
7 STAR #1.1	7901	0	0	12'	0'	CRV	10	4715		DC0052331
8 STAR #3.2	7905	0	0	12'	0'	CRV	10	4715		DC0052331
9 STAR #5.2	7907	0	0	12'	0'	CRV	10	4731		DC0080235
10 PIPE SHAFT	7934	0	0	12'	0'	CRV	10			
11 PIPE SHAFT	7933	0	0	12'	0'	CRV	10			

Figure 45:

A.3.2: There is various output Reports that provide area calculations. OPS is also very flexible at providing this area calculation in conjunction with any other data relating to the spaces that have been inputted. For example, it is easy for a user to review the Space Name and Number along with the area calculation and any other data field the user wishes to review at the same time.

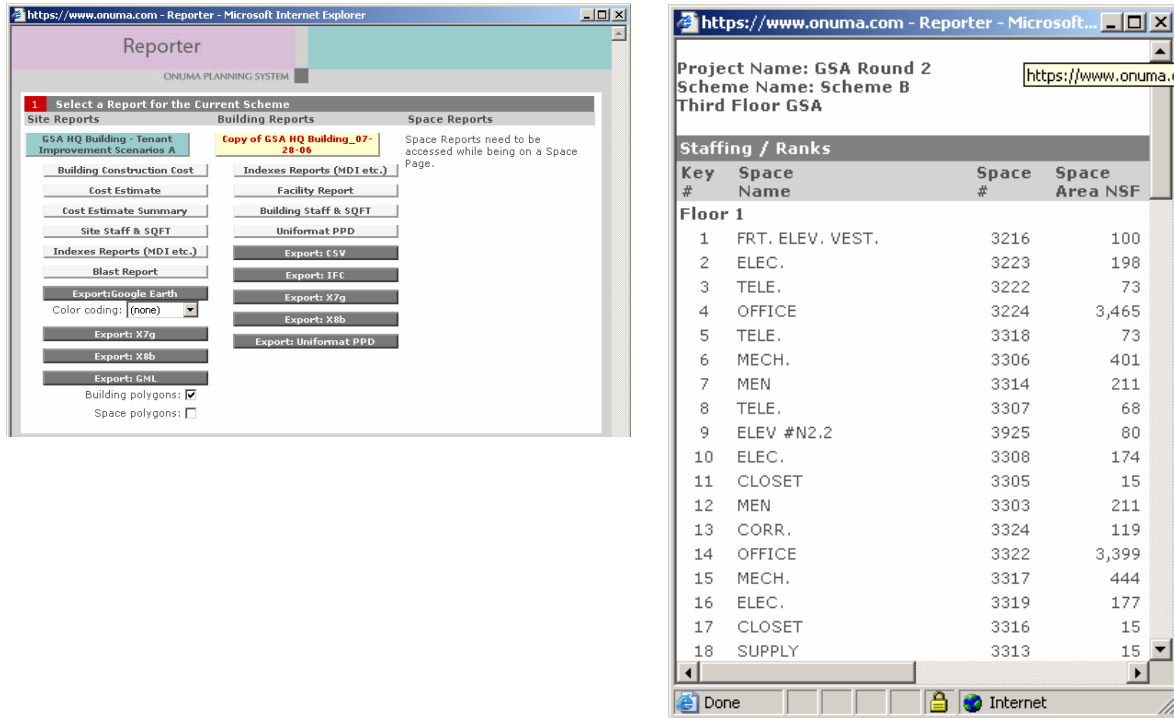

Figure 46:

A.3.3: The Space Settings Matrix will provide a *Detailed Description* column. This will allow users to add a more descriptive name for a space or note for the Space.

The screenshot shows a web browser window titled "Settings" with a URL of "https://www.onuma.com - Space Settings Matrix - Microsoft Internet Explorer". The page has a navigation menu with tabs for "Admin Settings", "General Settings", "Site Settings", "Building Settings", and "Space Settings". Under "Space Settings", there are sub-tabs for "Space Settings", "Space Settings Matrix", and "Department Relocation". The "Space Settings Matrix" tab is active, displaying a table with the following columns: Space Name, Space Number, Capacity, Occupancy, Space Code, USCG Land Opfac, USCG Site Number, USCG Group Opfac, GSA Space Type, GSA Space Category, Security Zone, Preservation Zone, Privacy Zone, Project Specific Zone, Occupant Organisation code, Occupant Sub-Organisation Code, and Occupant Billing ID. The table lists 11 spaces on Floor 1, including CLOSET, OFFICE, VEST., ELEC., TELE., and ELEV. LOBBY, with their respective settings for capacity, occupancy, and various organizational codes.

Space Name	Space Number	Capacity	Occupancy	Space Code	USCG Land Opfac	USCG Site Number	USCG Group Opfac	GSA Space Type	GSA Space Category	Security Zone	Preservation Zone	Privacy Zone	Project Specific Zone	Occupant Organisation code	Occupant Sub-Organisation Code	Occupant Billing ID
1 CLOSET	1516	0	0	003				INS	01	Restricted	Renovation	Non-Public		6900		
2 OFFICE	1504	0	0	003				TTO	01	Restricted	Renovation	Public		4715		DC0052331
3 CLOSET	1502	0	0	003				INS	01	Restricted	Renovation	Public		4715		DC0052331
4 CLOSET	1505	0	0	003				INS	01	Restricted	Renovation	Public		4715		DC0052331
5 VEST.	1506	0	0	003				CRH	02	Restricted	Renovation	Public		4715		DC0052331
6 ELEC.	1319	0	0	003				MCH	02	Restricted	Renovation	Non-Public		6900		
7 TELE.	1318	0	0	003				MCH	02	Restricted	Renovation	Non-Public		6900		
8 ELEV. LOBBY	1321	0	0	003				CRH	02	Restricted	Renovation	Non-Public		6900		
9 VEST.	1509	0	0	003				CRH	02	Restricted	Renovation	Public		4715		DC0052331
10 VEST.	1510	0	0	003				CRH	02	Restricted	Renovation	Public		4715		DC0052331
11 TELE.	1004	0	0	003				MCH	02	Restricted	Renovation	Non-Public		4715		DC0052331

Figure 47:

A.4 Handling Project Models

A.4.1 Working with BIM models

This section provides an overview to working with BIM models. This section discusses general guidelines on setting up and managing models across the A/E project team. More information is available from each vendor below.

A.4.2 Installing/Enabling IFC BIM Import/Export

Some BIM-authoring applications include IFC BIM import/export as part of the product; while in others, it is available as a separate module. More information is available from each vendor below.

A.4.3 Saving/Exporting IFC BIMs

BIM-authoring applications have different ways to store (export) an IFC BIM file. Either there is a separate tool for this purpose or the BIM-authoring application's Save As command is used to select the appropriate IFC BIM version.

A.4.4 Optimizing File Sizes

Particularly for large projects, the BIM files may become very large and difficult to manipulate. This section describes how to optimize the IFC BIM files in order to submit them to GSA.

Autodesk ADT + Inopso IFC Utility

A.4.1: In Architectural Desktop, which is based on AutoCAD, the complete BIM model is assembled using the AutoCAD external reference file capability. For example, in our testing and validation model for this BIM guide, each floor was modeled in a separate DWG files and the master building model was assembly by referencing in DWG files for floors one through 7. The Architectural Desktop product automates this process and sets up a multiple user-editing environment using a feature called the "Project Navigator." Although it is not absolutely required to create a GSA compliant BIM model with ADT, it is recommended that your design team get proper training on the use of the Project Navigator, which can automate the management of all of the individual dwg and BIM constructs that constitute the complete BIM model.

A.4.2: See <http://www.inopso.com> to learn how to install and export IFC BIM files.

A.4.3: To prepare the model for export read the documentation (Command: User documentation in the Gtslfc2xUtility pull-down menu), especially for classifying drawings as buildings, sites, and storeys and for initializing the elements of a drawing before export.

The Export IFC 2x/2x2 command in the GtsIfc2xUtility pull-down menu is used to save the IFC BIM file. The same menu also has an Import IFC 2x(2) and other IFC BIM file functions.

In order to fully support GSA features IFC2x2 export has to be used.

Usually the model is composed of several floors, with each modeled into separate files. Floors are combined into a building model in the project's View partition. Before saving, all of the floor files are opened and they are classified one-by-one as floor drawings (Classify Drawing As... Story). Finally, the drawing where the model is combined as a whole building is opened and it is classified as a building (Classify Drawing As... Building). These procedures are needed only for the first Save.

Finally, the Initialize Objects for Export function can be executed to make sure all of the IFC data is written into the BIM. After this step, the model is ready to be saved into an IFC BIM file.

Autodesk Revit

A.4.1: In contrast with BIM software applications (like Autodesk's Architectural Desktop for example) Autodesk Revit Building employees the concept a single building model. In many cases a given concept design deliverable could be housed in a single Revit rvt file, which helps to minimize the data management challenges. You will however have team members who will all be working on and editing portions of your single BIM model at the same time. It is critical that your team gets proper training and implementation advice on the best practices for using Revit's concept of work sets for a multiple user environment. Leverage the contact information in section A.5.1 for getting this type of help for Autodesk Revit as best practices on work sets are beyond the scope of this document. .

There will also be cases where the project is complex or you are working with Structural and MEP consultants who will be submitting their respective rvt files for linking into your Architectural model. On a per project basis, it is critical that you deploy some kind of project collaboration portal to keep track of and manage all of your RVT files, derived files like DWG, DWF, and other files associated with the project. This is especially true if your team members are spread out among multiple offices and geographies. If your team or owner is not already using a project collaboration solution for your project, Autodesk and our partners can help advise you on finding a solution that would fit the demands of your project.

A.4.2: Autodesk's Revit Building has an IFC export capability directly in the software. Documentation on options for this export including element mapping is included in the online help system for Autodesk Revit. The online help can be accessed via a Revit 9.x download by visiting: <http://usa.autodesk.com/adsk/servlet/item?siteID=123112&id=7142518>

A.4.3: Autodesk's Revit Building has an IFC export capability directly in the software. Documentation on options for this export including element mapping is included in the online help system for Autodesk Revit.

A.4.4: At Autodesk with every new release of Revit, we strive to make performance improvements including optimizing the size of exported IFC files. Short of our built in optimization, the best strategy for minimizing the size of the exported IFC file is to put forth best efforts to minimize your Revit Model sizes. A large component of this is to not “over-model” and to use Autodesk published best practices when creating your own customer content with Autodesk Revit Family editor. Also on very large buildings, it may be more pragmatic to break the model into smaller rvt files and link them together.

Bentley Architecture

Please contact Bentley Architecture for more information.

Graphisoft Archicad

A.4.1: Graphisoft’s Archicad embraces the entire building industry and manages the entire information life cycle of buildings. Unlike a simple 3D model on a computer, the Virtual Building contains a great deal more information about the building's materials and characteristics. A 3D digital database tracks all elements that make up a building. This information can include surface area and volume; thermal properties; room descriptions; price; specific product information; window, door and finish schedules; and more. This information is available for all professionals connected to the building industry - architects and residential designers, interior designers, real estate agents, facility managers, contractors, engineers and clients. Further information on BIM best practices can be found through your local reseller or on-line at www.graphisoft.com. You can also find further reading material at http://www.graphisoft.com/support/ifc/References/ifc_int.html.

A.4.2: Archicad provides the most comprehensive support to users for IFC model based sharing of data. Add-ons are provided for releases IFC 1.5.1, IFC 2.0, IFC 2x and release IFC 2x2. Short introductions to the different versions of IFC are available at <http://www.graphisoft.com/support/ifc/References>

The latest version of the IFC translator for both Macintosh and Windows Operating systems as well as previous versions of the IFC translator may be downloaded from: <http://www.graphisoft.com/support/ifc/downloads/public/>

A.4.3: After loading the IFC add-on, you may save an IFC file from an Archicad Virtual Building file. Select File->Save As and select IFC 2x2 as the file format

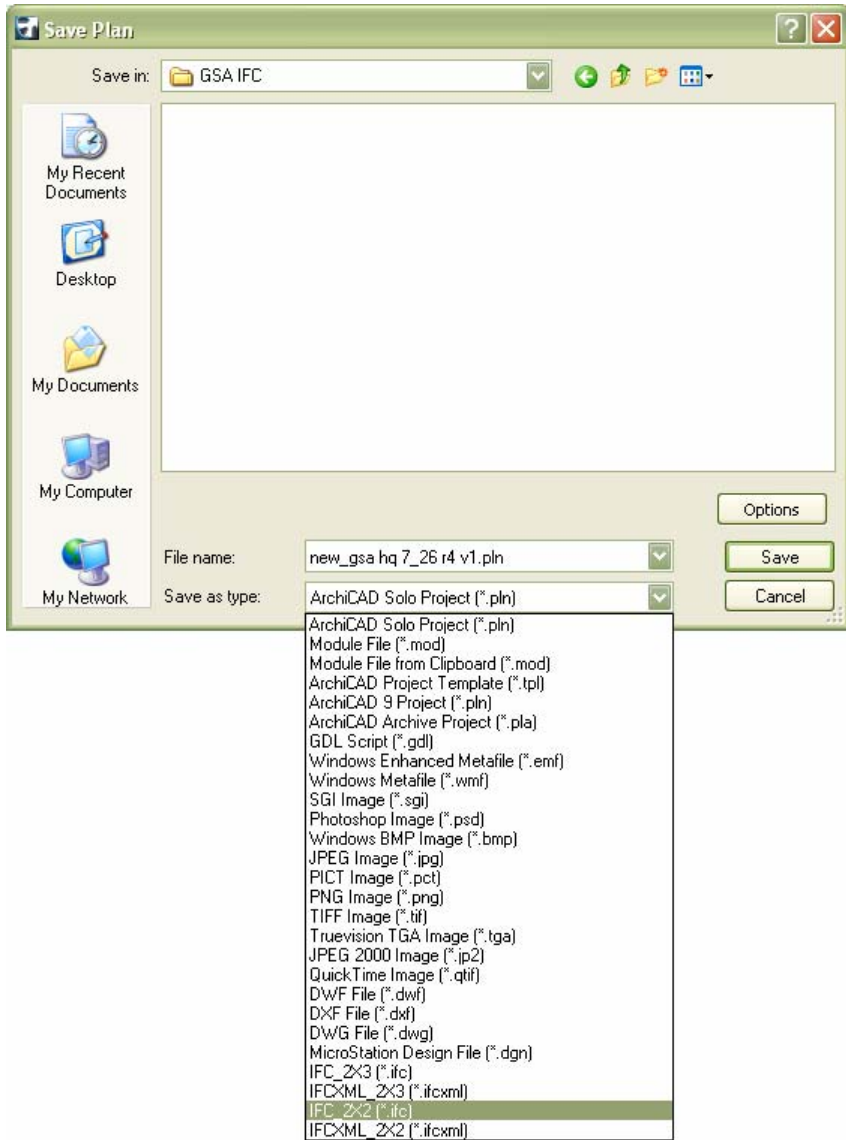

Figure 48:

A dialogue will open allowing you to modify all of the Export settings during the Save process.

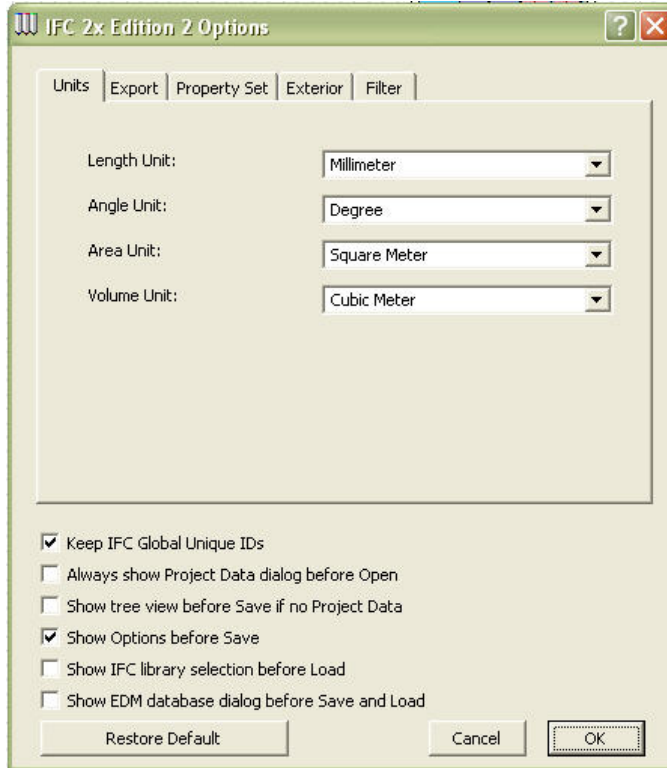

Figure 49:

You may also access these settings from the pulldown menu in Archicad.

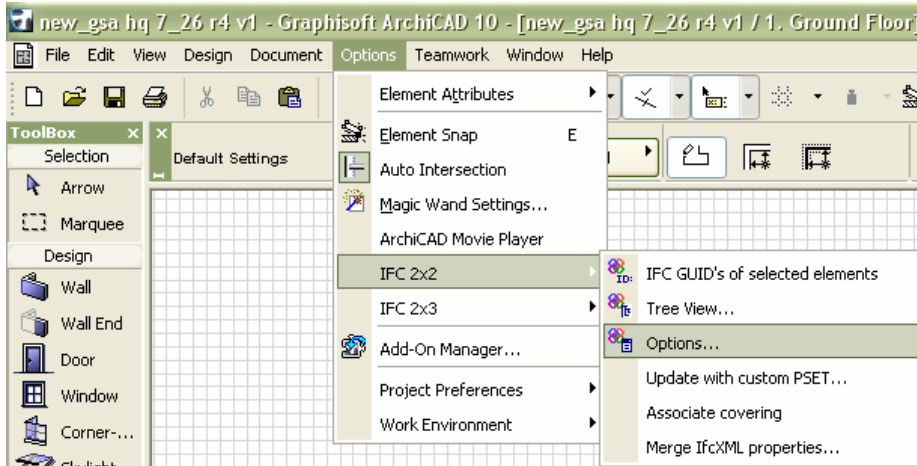

Figure 50:

When exporting the project using the Zone_Stamp_GSA_3 you will need to select a Property Set. This property set will allow additional parameters in the Zone_Stamp_GSA_3.GSM. to be properly mapped to IFC properties and quantities. By selecting and enabling the config_ifc2x2_GSAspace.xml file, you will insure correct data exchange from Archicad. Additional information can be found on line or through your local Archicad reseller.

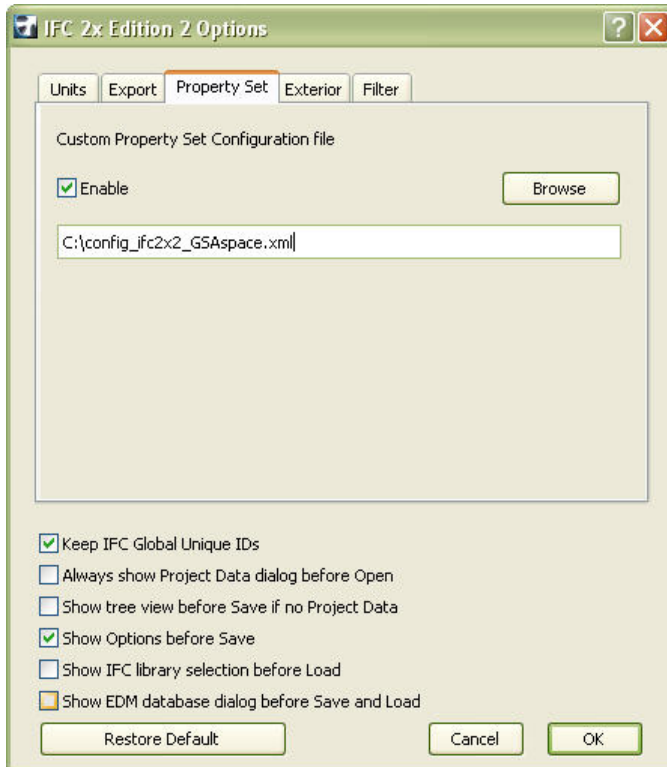

Figure 51:

A.4.4: After the export of the IFC 2x2 file there are a number of options to optimize the file size. One option for reducing the IFC file to an acceptable file size is to use the IFC Optimizer from Solibri. This application can be found at: <http://www.solibri.com>. The optimized IFC 2x2 file can also be zipped to supplement the compressing process with any industry standard compressing application.

ONUMA

A.4.1: In addition to traditional BIM capabilities for a single project, OPS serves as a multi-featured BIM Web Portal. You can find the following features in OPS.

- Manages BIMs on interoperable standards and protocols that allows queries into multiple or individual models.
- Web services are used to connect available data on multiple servers and databases.
- Allows viewing of models from the level of an entire campus or base, to individual buildings, to specific rooms, down to furniture and equipment inventory.
- In a multiple-user, real-time environment, users can combine partial BIMs or export IFCs or GML of the queried results to desktop BIM applications.
- Through a system of templates and shared projects, users can reclaim past work effort and maintain a level of consistency for projects.

A.4.2: OPS is a web-enabled tool that simply runs from a web browser. No special software or plug-ins are required to implement IFC export. IFC export comes standard with OPS. GSA Specific IFC settings are preconfigured in the OPS IFC. Users have the ability to view and edit GSA Specific IFC data directly in OPS prior to exporting to IFC.

A.4.3: There are two main methods to output an IFC file from OPS.

Method 1:

This method should be used if a user wishes to quickly generate an IFC file without having to “open” the project. From the list of Projects and Schemes, click the button *Export*.

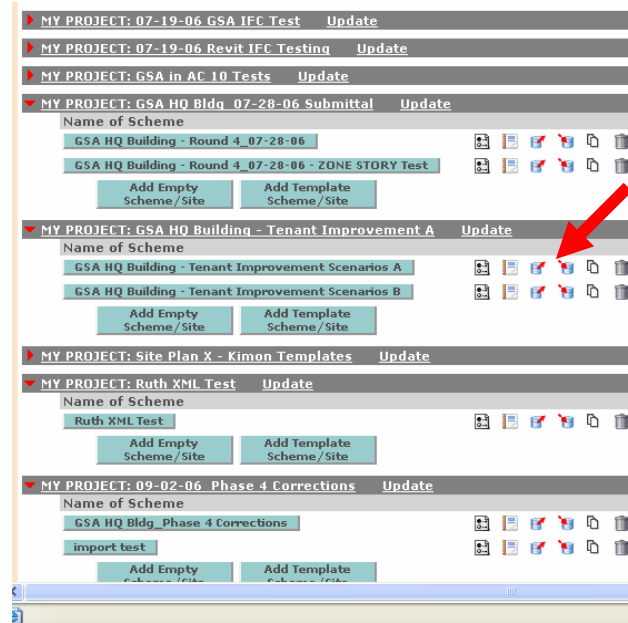

Figure 52:

Note: Saving out a typical IFC file from OPS usually takes about 30 seconds. For a larger building such as the GSA HQ (used in the test case), it takes about 1 minute to export and is 3MB in size.

With this interface, a user can quickly generate IFC files of multiple buildings without opening up the file itself.

The UI is a snapshot of how access to the database and export of IFC files can happen at an entire portfolio level down to individual building level.

An *Exporter* window will then pop up. Once a building is selected, select "IFC" in the pulldown.

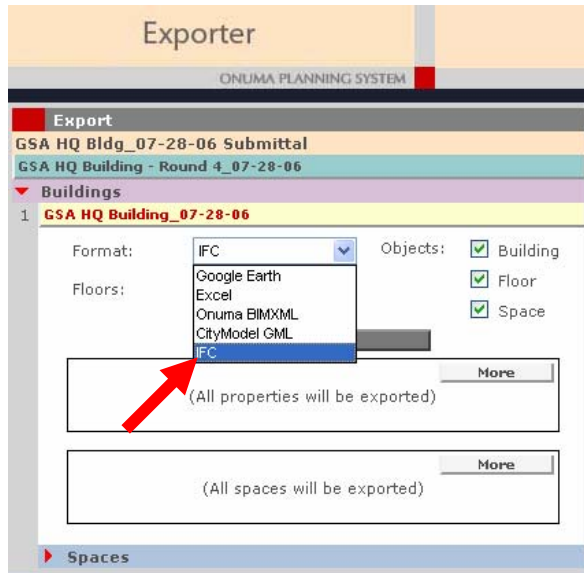

Figure 53:

Method 2:

This method should be used if a user already has a project opened.

Click on the button *Export*. This button will display the *Exporter* pop up window.

Select "*IFC*" in the pulldown and then click the button *Export* (similar to Method 1)

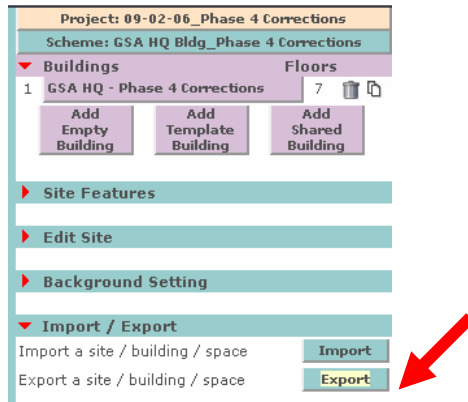

Figure 54:

A.4.4: As stated in the previous section, the IFC file sizes from OPS are very small and export very rapidly. However, all future versions of OPS will continue to strive towards optimizing all IFC outputs.

A.5 For Further Information

A.5.1 Contact Information

Below is the company information for each contributing vendor, including information about how to contact each company for responses to any questions or comments:

Autodesk ADT + Inopso IFC Utility

The Inopso IFC Utility is a third-party extension compatible with ADT 2004 through ADT 2006. It is available for download at www.inopso.com.

Autodesk Architectural Desktop

We realize that software applications such as Autodesk's Architectural Desktop are on relatively rapid technological development cycles. At the time of this writing, these best practices recommendations on using ADT were based on Architectural Desktop 2006. For this reason, it is important for Architect and Engineering firms to keep up to date on the current state of this technology and the emerging knowledge base of best practices in applying the Autodesk Architectural Desktop technology to GSA Federal Building projects.

Avenues for this include:

- Visiting www.autodesk.com/gov-gsa-bim
- Your local Autodesk Authorized Architectural Desktop reseller
- The latest Product and Best Practices information available on www.autodesk.com
- Autodesk Architectural Desktop Product Support and eLearning available to you with your Autodesk Subscription contract
- Autodesk Consulting Programs for Implementing Architectural Desktop
- The Autodesk Building Solutions government team
- The GSA Public Building Service Office of the Chief Architect

Prior to embarking on your first GSA BIM project using Autodesk Architectural Desktop, it is strongly recommended that you get in touch with the GSA Office of the Chief Architect and/or an Autodesk Building Solutions Government Specialist who will be able arrange appropriate up to date guidance on applying this technology. This will include getting you access to up to date ADT templates that have been set up specifically for GSA BIM Guide Space program validation.

Autodesk Revit

We realize that Building Information Modeling software applications such as Autodesk's Revit Building are on relatively rapid technological development cycles. At the time of this writing, these best practices recommendations on using Revit Building were based on Revit Building 9.0. For this reason, it is important for Architect and Engineering firms to keep up to date on the current state of this technology and the emerging knowledge base of best practices in applying the Autodesk Revit technology to GSA Federal Building projects.

Avenues for this include:

- Visiting www.autodesk.com/gov-gsa-bim
- Your local Autodesk Authorized Revit Building reseller
- The latest Product and Best Practices information available on www.autodesk.com
- Autodesk Revit Building Product Support and eLearning available to you with your Autodesk Subscription contract
- Autodesk Consulting Programs for Implementing Revit Building
- The Autodesk Building Solutions government team
- The GSA Public Building Service Office of the Chief Architect

Prior to embarking on your first GSA BIM project using Autodesk Revit, it is strongly recommended that you get in touch with the GSA Office of the Chief Architect and/or an Autodesk Building Solutions Government Specialist who will be able arrange appropriate up to date guidance on applying this technology. This will include getting you access to up to date Revit templates that have been set up specifically for GSA BIM Guide Space program validation.

Bentley Architecture

The Bentley BIM-to-GSA IFC Resource Kit may be obtained by Bentley SELECT users at <http://www.bentley.com> via direct download or CD-ROM via ground shipment.

Bentley Professional Services is available to provide project coaching to implement GSA's BIM requirements and to provide best practices for efficient use of Bentley Architecture.

Information about Bentley's BIM solutions and services can be accessed at <http://www.bentley.com/BIM>.

Graphisoft Archicad

The IFC concept is based on the idea of objects (or elements in Archicad terms) brought together in an integrated model (Archicad's Virtual Building). These objects are defined to support the whole lifecycle of facility development from inception through design, documentation and construction, then facility management and finally demolition and/or disposal.

IFC is available to all participants in the construction industry, for use globally, including use by all construction industry software vendors. IFC offers a higher-level "common language" for the sharing of intelligent objects between disciplines across the building lifecycle.

Additional information and support for both Windows and Macintosh systems may be found by contacting your local reseller or by contacting Technical support. Additional documentation can be found at www.graphisoft.com/products/ifc.

ONUMA

Onuma, Inc is a team of architects and programmers integrating design and construction with software and processes that radically increase accuracy and efficiency in the cradle to grave life cycle of the built environment. Antiquated methods in architecture have not kept pace with emerging technologies, resulting in construction waste and inefficiencies. Interoperable standards have reduced these inefficiencies.

ONUMA revolutionizes architecture by using integrated solutions built on open standards.

- We use software that is interoperable
- We take ownership of our own data
- We enable our clients to take ownership and become better stewards of their own data
- When interoperable software does not exist, we build solutions to meet needs

See <http://onuma.com/plan> for additional information about this product.

appendix b: bim-analysis application information

Solibri Model Checker

Solibri Model Checker (SMC) analyzes Building Information Models for integrity and quality. The system offers easy-to-use visualization with intuitive walk-through functionality. With a single mouse click, the system examines the building model and reveals potential flaws and weaknesses in the design. These analyses include checking spaces that overlap with other spaces or walls, and whether or not the space area is bounded by the inside faces of the surrounding walls.

Additionally, this technology has incorporated rules derived from the GSA BIM Guide to calculate and visualize the various area measurements defined in this Guide.

SMC imports standard IFC files as certified by IAI and IFC file extensions similar to what has been defined in this Guide. The following examples show how SMC works. This shows also how the information, once modeled according to this Guide, can be utilized in many down stream applications.

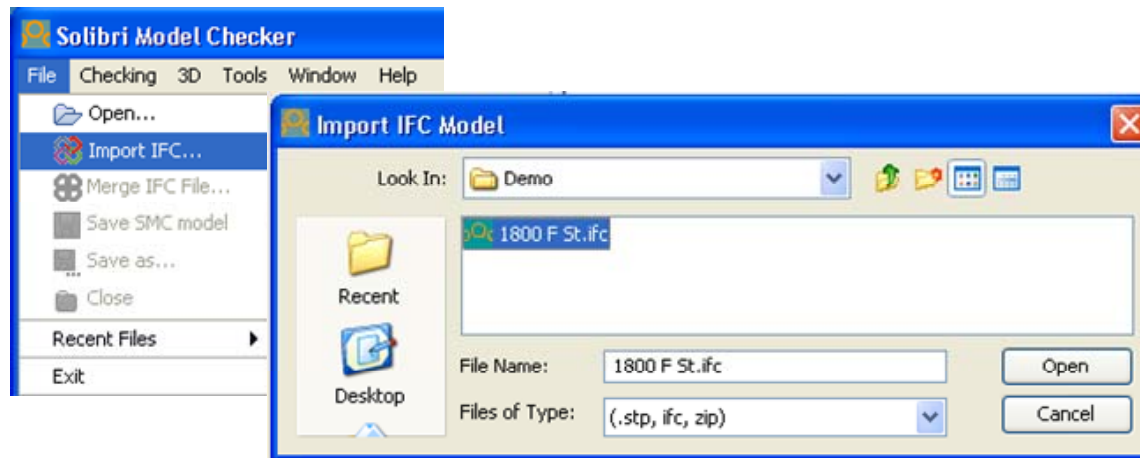

Figure 55: IFC Import to Solibri Model Checker. If there are several IFC files to import, the user can select multiple files and Solibri Model Checker will merge them.

Info (A) Space.0.150 : OFFICE[1403]

GSA Space Areas GSA Space Categories IfcElementQuantity
 Identification Location Quantities Relations ANSI/BOMA Properties
 Space Occupant Properties Space Zones

Property	Value
Occupant Billing ID	DC0052331
Occupant Organization Abbreviation	GSA
Occupant Organization Code	4715
Occupant Organization Name	Public Buildings Service - FBF
Occupant Sub-Organization Code	

Figure 56: GSA's additional properties as they appear in the space components display on SMC's side.

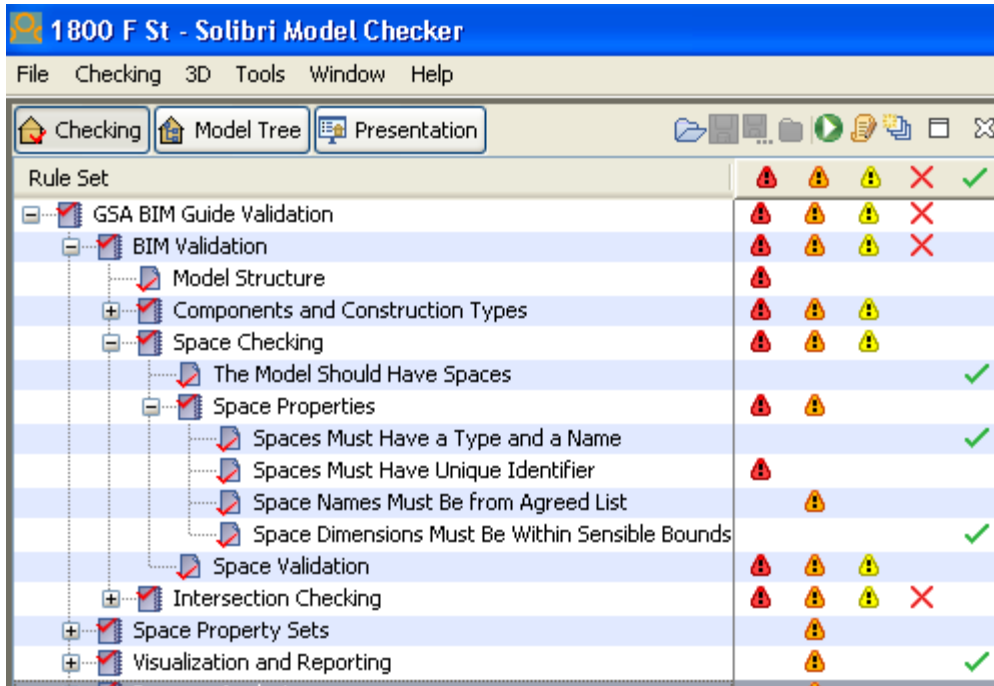

Figure 57: Solibri Model Checker uses rules to check the requirements (e.g., compliance of the BIM Guide). Severity of the problems found is indicated with color codes.

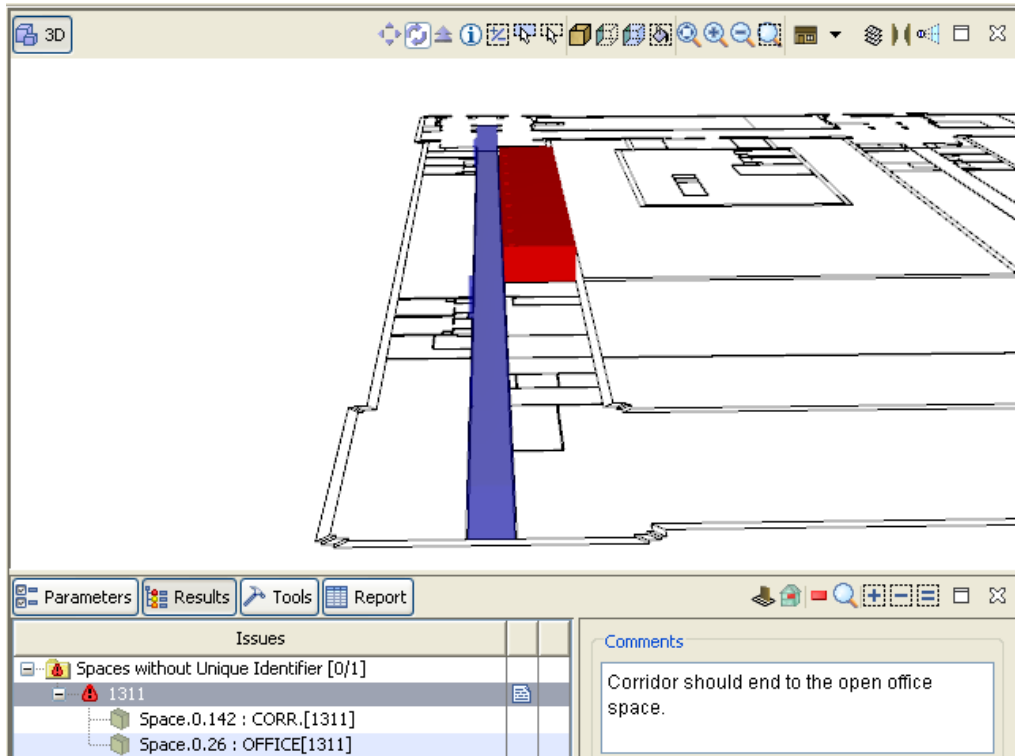

Figure 58: Space names should be unique in the model. The figure below shows two spaces having the same space number. The problem is visualized and the user can decide whether this should be fixed.

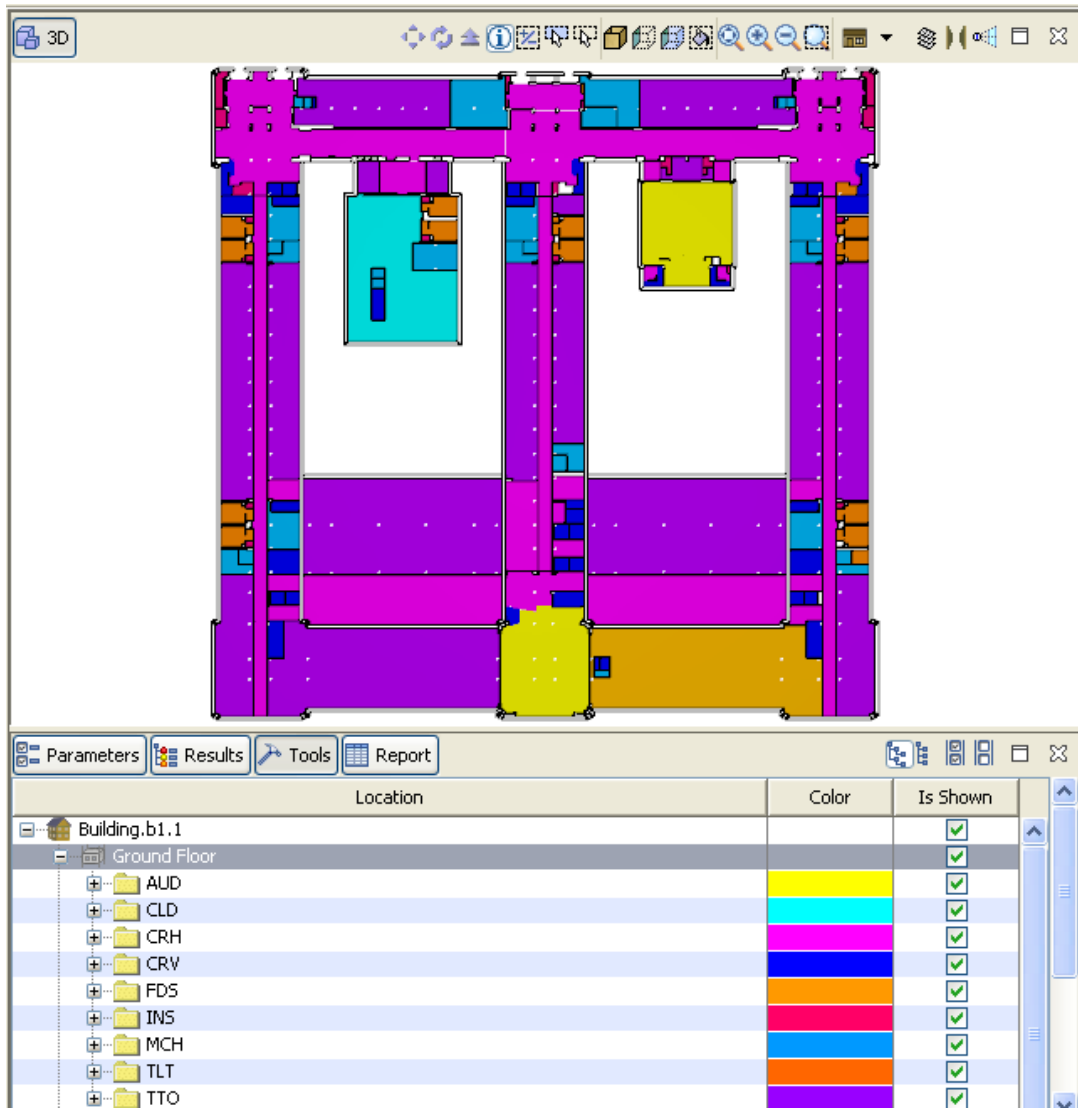

Figure 59: The stacking plan is visualized automatically by utilizing the information passed via the IFC file. Related area calculations are under "Report" tab.

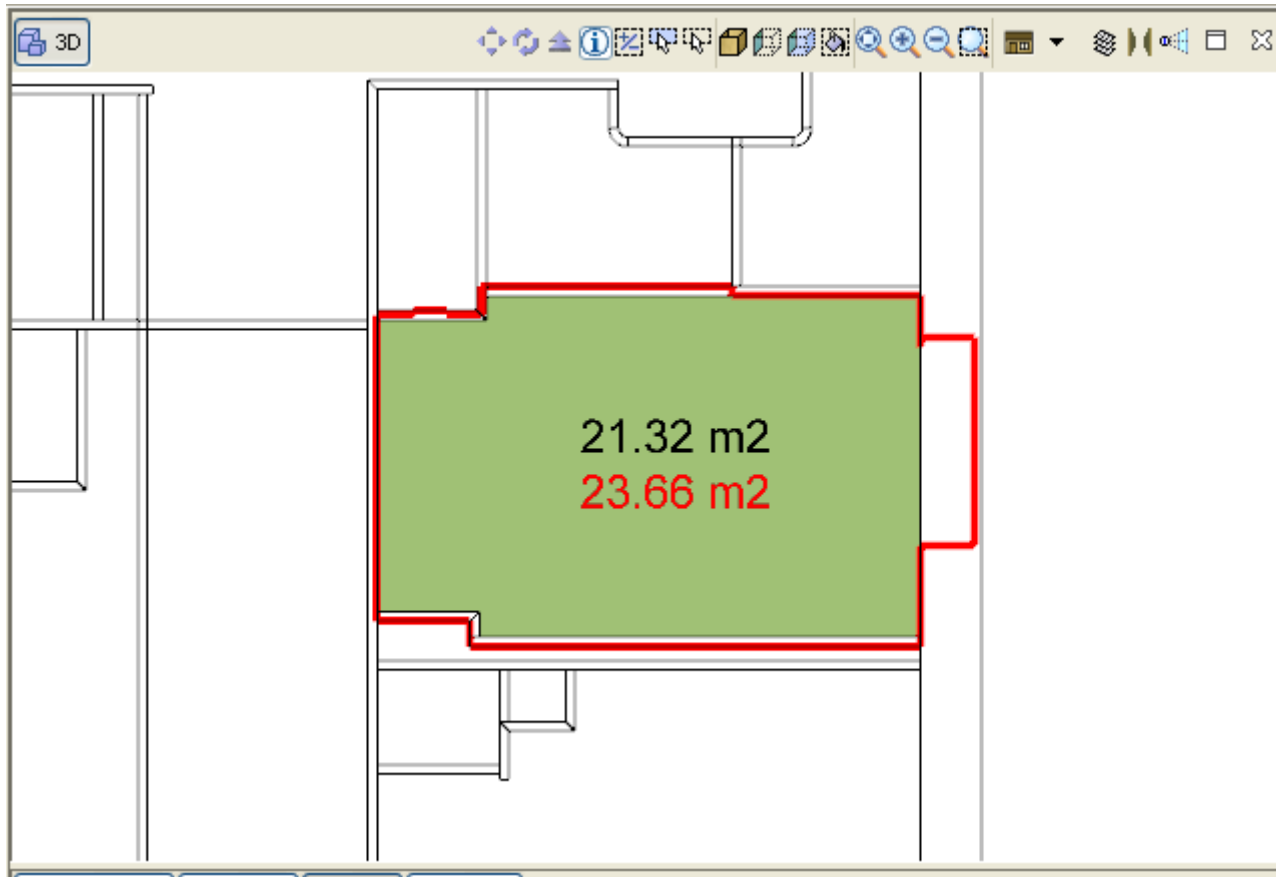

Figure 60: ANSI/BOMA Usable Area calculations are done using ANSI/BOMA measurement rules and PBS Assignment Guide instructions. The red line visualizes how the measurement is calculated. The red number is the usable area and black number is GSA Net Area as defined in this document.

Space Number	Space Name	ANSI/BOMA S...	Net Area	Usable Area
1001	LOBBY	03 - Floor Com...	177.81 m2	186.91 m2
1002	STORAGE	01 - Office	10.12 m2	12.04 m2
1003	ENTRY VEST.	03 - Floor Com...	65.24 m2	73.73 m2
1004	TELE.	02 - Building Co...	2.63 m2	3.01 m2
1005	ELEC.	02 - Building Co...	2.82 m2	3.25 m2
1006	CLOSET	01 - Office	0.64 m2	0.95 m2
1007	OFFICE	01 - Office	237.53 m2	247.39 m2
1008	CORR.	03 - Floor Com...	201.25 m2	222.61 m2
1009	CLOSET	03 - Floor Com...	0.64 m2	0.91 m2
1010	CLOSET	01 - Office	0.68 m2	0.71 m2
1011	ENTRY VEST.	03 - Floor Com...	63.41 m2	68.24 m2
1012	ENTRY LOBBY	03 - Floor Com...	178.76 m2	186.91 m2
1013	CLOSET	01 - Office	1.88 m2	2.09 m2
1014	CLOSET	01 - Office	0.72 m2	0.75 m2
1015	OFFICE	01 - Office	237.57 m2	247.95 m2
1016	CORR.	03 - Floor Com...	190.84 m2	209.95 m2
1017	TELE.	02 - Building Co...	3.06 m2	3.55 m2

Figure 61: Space area table showing GSA Net Area and ANSI/BOMA Usable area in the whole building.

Usable Building Common Area	Floor Usable Area	USF/GSF	Floor Common Area	Floor R/U	Basic Rentable Office Area
638.19 m ²	6,774.03 m ²	64%	3,373.56 m ²	1.5	9,191.57
421.07 m ²	6,848.51 m ²	82%	1,109.36 m ²	1.16	7,468.58
421.06 m ²	6,848.42 m ²	82%	1,109.48 m ²	1.16	7,468.64
420.95 m ²	6,848.46 m ²	82%	1,109.66 m ²	1.16	7,468.96
421.12 m ²	6,870.36 m ²	82%	1,087.43 m ²	1.16	7,470.02
421.08 m ²	6,870.32 m ²	82%	1,087.89 m ²	1.16	7,470.44
421.08 m ²	6,870.09 m ²	82%	1,088.08 m ²	1.16	7,470.40
3,164.56 m ²	47,930.20 m ²	79%	9,965.46 m ²	-	54,008.62

Efficiency Ratios

Figure 62: The information in the IFC file also enables efficiency ratio calculations.

appendix c: naming conventions

C.1 Established Space Names from Spatial Data Mgmt's (SDM) CAFM DBs

(*) not included in any versions of PBS Business Assignment Guide

(**) not included in the May 2005 version of PBS Business Assignment Guide

AQUARIUM **	ENTRY VEST.	LOG	STAIR 4
ATM **	EQUIPMENT ROOM	MAIL ROOM	STAIR 5
ATRIUM **	ESCALATOR	MECHANICAL	STAIR 6
ATTIC SPACE **	EVIDENCE	MEN	STAIR 7
AUDITORIUM	EXAM	OFFICE	STAIR A
BARBER SHOP	EXERCISE ROOM	OPEN OFFICE	STAIR B
BLDG. MGR. OFFICE	FILES/STORAGE	OPEN TO BELOW	STAIR C
BOX LOBBY	FILE/SUPPLY	PARKING	STAIR D
BREAK AREA	FILES	PEDESTRIAN WALKWAY	STAIR E
BREAK ROOM	FIRING RANGE	PIPE SHAFT*	STAIR F
CAFETERIA	FPS CONTROL ROOM	PRIMARY CANOPY	STAIR G
CANOPY	FREIGHT ELEVATOR	PRINT ROOM	STORAGE
CHILD CARE	FRT. ELEV. VEST.	RAMP	STORAGE/SUPPLY
CLASSROOM	FTS SWITCH ROOM	RECEPTION	SUPPLY
CLOSET	FULL SERVICE CNTR.	RESIDENCE	SWITCH ROOM
COMPUTER	FURRING	RETAIL	TELEPHONE
CONFERENCE	GARAGE	ROBING AREA	TELLER
CONSTRUCTION	HEARING	ROBING ROOM	TOILET
CONTROL BOOTH	HLDG. CELL	ROOF 1	TOTAL GROSS
COPY	HUB ROOM	ROOF 2	TRAINING
COPY/FILE	HUB/TELECOMM.	ROOF 3	TRUCK PRIMARY
COPY/STORAGE	IMPOUND LOT	ROOF 4	TV STUDIO
CORRIDOR	INTERVIEW	ROOF 5	VAULT
COURTROOM	JUDGES CHAMBER	ROOF 6	VENDING
CREDIT UNION	JURY ASSEMBLY **	ROOF 7 (ETC.)	VERT. PEN.
CUSTODIAL	JURY ROOM **	SALLY PORT	VESTIBULE
DUMB WAITER	KENNEL **	SECONDARY INSP. CANOPY **	WAITING
ELECTRICAL	KITCHEN **	SECURITY*	WAREHOUSE
ELEVATOR LOBBY	LABORATORY	SHOP **	WEIGHT ROOM
ELEV. VEST. **	LAW CLERK	SNACK BAR **	WET AREA
ELEVATOR	LIBRARY	STAIR	WOMEN
ELEVATOR PIT **	LOADING DOCK	STAIR 1	WORK ROOM
ELEVATORS **	LOBBY	STAIR 2	
ENTRY LOBBY	LOCKERS	STAIR 3	

Figure 63:

Further abbreviation of some of the approved space names may be necessary to display them properly. In such cases, it is essential that a convention be strictly followed, so that the names will remain machine-readable. Following is a list of approved abbreviations for words within approved space names. Additional abbreviations shall be coordinated with OCA and GSA regional project teams.

GENERIC MAPPERS		
BUILDING	BLDG	BLDG.
CAFETERIA	CAFÉ	
CONFERENCE	CONF	CONF.
CORRIDOR	CORR.	
CUSTODIAL	CUST.	
ELECTRICAL	ELEC.	
ELEVATOR LOBBY	ELEV. LOBBY	
EQUIPMENT ROOM	EQUIP. ROOM	
FILES/STORAGE	FILE/STORAGE	
FREIGHT ELEVATOR	FREIGHT ELEV.	
FULL SERVICE CNTR.	FULL SERV. CNTR.	
HUB/TELECOMM.	HUB/TELE.	
MANAGER	MGR	MGR.
MECHANICAL	MECH.	
ROOM	RM	RM.
TELEPHONE	TELE.	
VESTIBULE	VEST.	

Figure 64: Established abbreviations for space names

C.2 Floor Naming Conventions

Floor number must be unique for each building. The floor number shall be the same as the floor number indicated on the drawing titleblock and file name. The floor numbers (as defined in the Region 3 CAD Deliverables Policy) are:

01 - 99	First to 99 th floor
GF	Ground Floor
LT	Loft
M1, M2, M3...	Mezzanine 1, 2, 3...
P1, P2, P3...	Penthouse 1, 2, 3... and Parking 1, 2, 3... If a building has both, start penthouse numbering where parking leaves off to avoid redundant file names
B1, B2, B3...	Basement 1, 2, 3...
L1, L2, L3...	Lower Level 1, 2, 3...
R1, R2, R3...	Roof Level 1, 2, 3...
SB	Sub-Basement

Figure 65:

appendix d: glossary of acronyms

Following are the acronyms and abbreviations used in this Guide with their full names:

2-D	Two-dimensional
3-D	Three-dimensional
A/E	Architect/Engineer
AEC	Architecture-Engineering-Construction
ANSI	American National Standards Institute
BIM	Building Information Model or Building Information Modeling
BOMA	Building Owners and Managers Association
CAD	Computer Aided Drafting
FAR	Federal Acquisition Regulation
GSA	General Services Administration
GSAR	General Services Acquisition Regulation
GUID	Global Unique Identifier
HVAC	Heating, Ventilating and Air Conditioning
IAI	International Alliance for Interoperability
IFC	Industry Foundation Classes
IFC BIMs	Building Information Models compatible with IFC data standard
IFX	IFC-XML (See XML below.)
ISO	International Standards Organization
OCA	Office of the Chief Architect
PBS	Public Buildings Service
P-100	Facilities Standards for the Public Buildings Service
XML	Extensible Markup Language
XYZ	3-D spatial coordinates

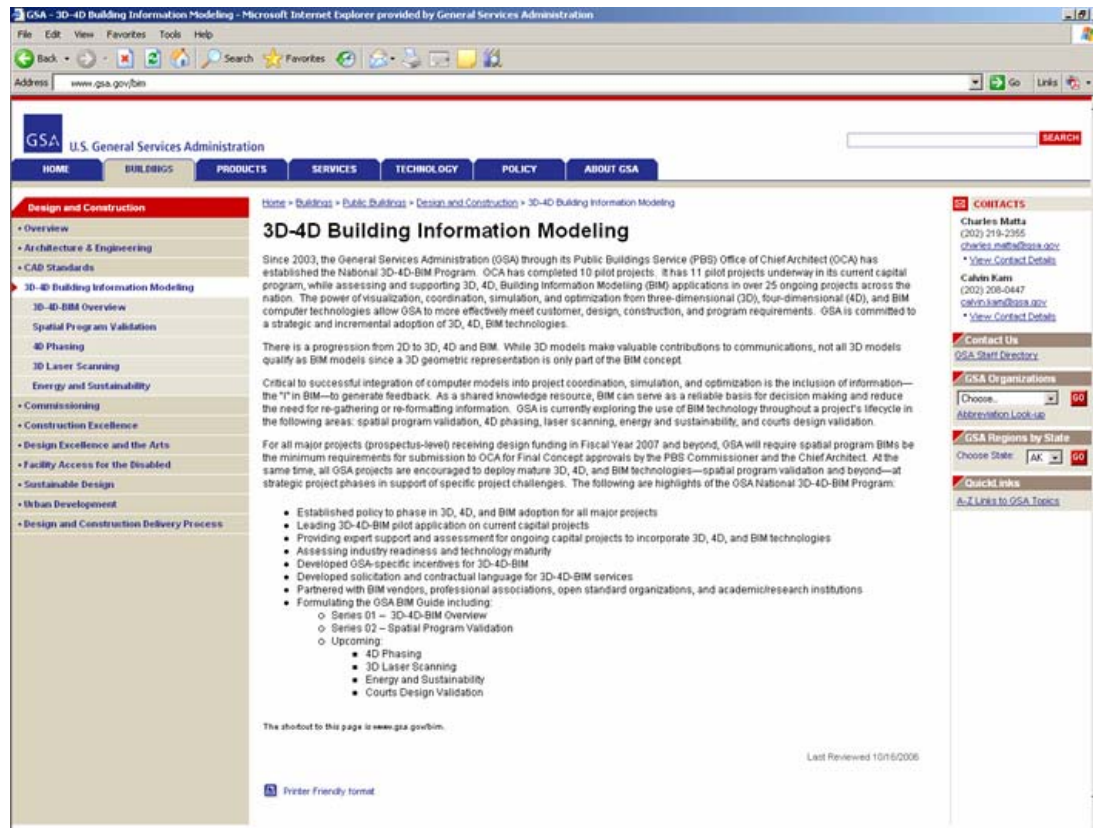

For further information about this GSA BIM Guide Volume on Spatial Program Validation or to submit comments or questions, please visit <http://www.gsa.gov/bim> or contact:

The National 3D-4D-BIM Program
 Office of the Chief Architect
 Public Buildings Service
 U.S. General Services Administration
 1800 F Street NW Suite 3341
 Washington, DC 20405