



U.S. General Services Administration
Public Buildings Service
Office of the Chief Architect

May 2007

This version of the *GSA Building Information Modeling Guide Series: 03 - GSA BIM Guide for 3D Imaging* is identified as Version 0.20 to indicate its provisional status. With its publication, the GSA BIM (Building Information Model) Guide, for the first time, becomes available for public review and comment. As its provisional status denotes, however, it will continue to serve as the basis for further development, pilot validation, and professional editing. All readers of this provisional guide are encouraged to submit feedback to the National 3D-4D-BIM Program. Updated versions will continue to be issued to address and incorporate on-going feedback in an open, collaborative process.

Currently, *GSA Building Information Modeling Guide Series: 01 - Overview of GSA's National 3D-4D-BIM Program* and *Series: 02 - Spatial Program Validation* are also available for review and comment.

For further information about GSA's National 3D-4D-BIM Program, additional BIM Guide Series, or to submit comments or questions, visit the National 3D-4D-BIM webpage at <http://www.gsa.gov/bim>.

The National 3D-4D-BIM Program
Office of the Chief Architect
Public Buildings Service
U.S. General Services Administration
1800 F Street NW, Suite 3341
Washington, DC 20405

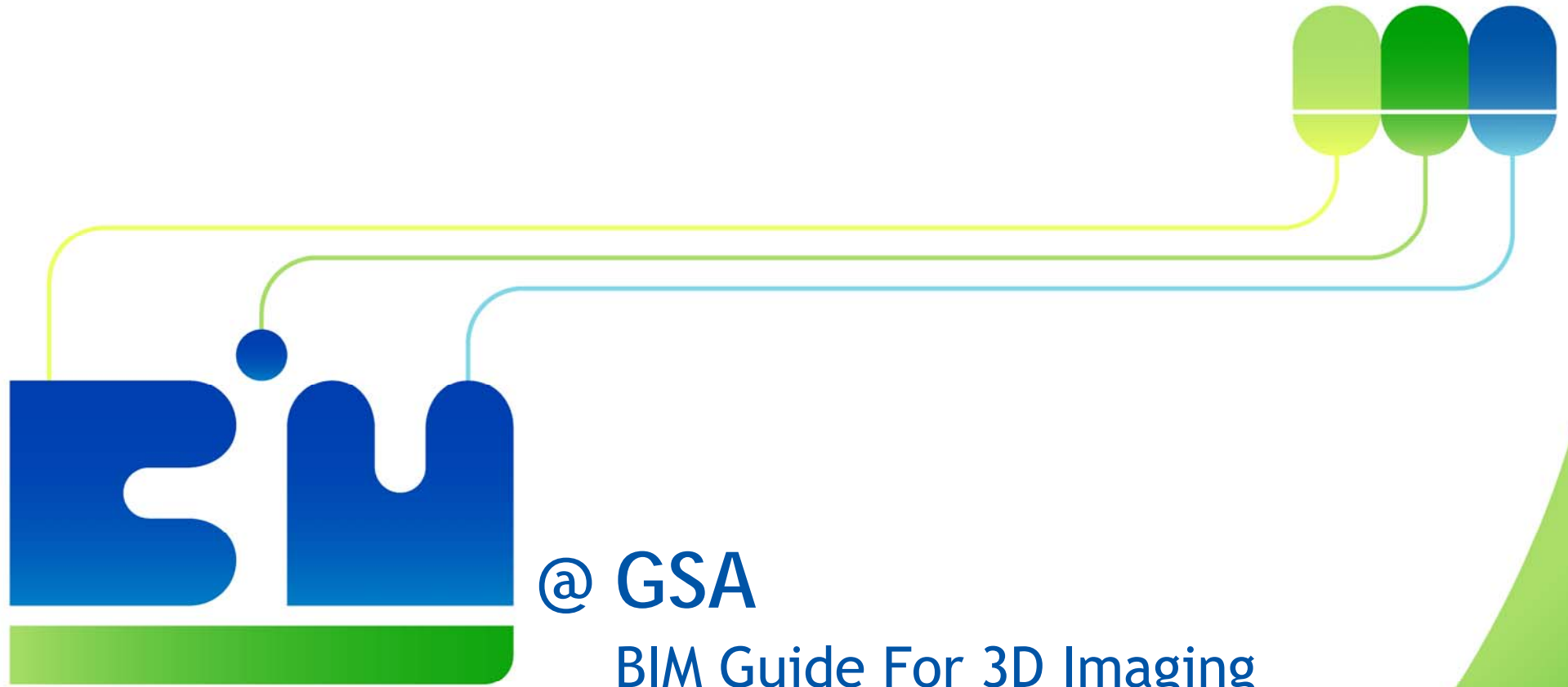

@ GSA

BIM Guide For 3D Imaging



Version 0.20 - May 2007

COPYRIGHT © 2007 BY
General Services Administration

If you would like to contact the authors, please write to:

The National 3D-4D-BIM Program
Office of the Chief Architect
Public Buildings Service
U.S. General Services Administration
1800 F Street NW, Suite 3341
Washington, DC 20405



table of contents

3d imaging

- executive summary iv
- section 1: introduction v
 - 1.1. What is 3D Imaging v
 - 1.2. 3D Imaging vs. Alternative Methods xi
 - 1.3. Benefits of 3D Imaging xi
 - 1.4. Sources of Error xii
 - 1.4.1. Calibration xii
 - 1.4.2. Field survey xii
 - 1.4.3. Scanning xii
 - 1.4.5. Registration xiii
 - 1.4.6. Modelingxiv
- section 2: solicitation phase 2
 - 2.1. Background and Project Description2
 - 2.1.1. Potential challenges3
 - 2.2. Objectives3
 - 2.2.1. Primary3
 - 2.2.2. Secondary4
 - 2.3. Deliverable Specifications4
 - 2.3.1. Scan Plan5
 - 2.3.2. Modeling Plan6
 - 2.3.3. Quality Control6

2.4.	Types of Deliverables from 3D Data	7
2.5.	Resolution Requirements.....	24
2.5.1.	Specific feature requirements	24
2.6.	Data.....	25
2.6.1.	Data Security and Ownership.....	25
2.6.2.	Special requirements	25
2.7.	Terminology	26
	section 3: evaluation phase	28
3.1.	Equipment Calibration.....	28
3.1.1.	3D imaging instruments	28
3.1.2.	Survey instruments.....	28
3.2.	Scan procedures	28
3.2.1.	Registration	29
3.3.	Data.....	30
3.4.	Control network	30
3.5.	Deliverables	30
3.5.1.	Point Cloud.....	31
3.5.2.	2D Drawings, Plans.....	32
3.5.3.	3D CAD Models.....	33
3.6.	Quality Control.....	34
3.7.	Personnel and training.....	34
	section 4: project management	37
4.1.	Coordination issues unique to GSA	37
4.2.	Project Schedule	37
4.2.1.	Solicitation	38



- 4.2.2. Planning..... 39
- 4.2.3. Execution 39
- 4.2.4. Factors Affecting Project Schedule 39
- 4.3. GSA 3D Imaging Applications 40
- 4.4. Information Management and Delivery 40
- 4.5. 3D Imaging Targets..... 41
- 4.6. Environmental Conditions..... 41
- appendix a: terminology and references 43
- A.1. Terminology 43
- A.2. References..... 47
- acknowledgements 48



executive summary

This BIM Guide Series on 3D Imaging is intended for incorporation by reference in Public Buildings Service (PBS) contracts for new construction and major modernization projects that require documentation of as-built conditions. As such, GSA Project Executives, the PBS Project Managers, and Contracting Officers administering the contracts are its primary audience. The Guide has been prepared to assist the project teams in contracting for and ensuring quality in 3D imaging contracts. It provides guidelines for the solicitation of 3D imaging services and evaluation criteria to ensure that the specified requirements for the deliverables are met.

This Guide is also of general interest to other members of the project teams, including PBS staff, customer agencies, and contracted parties such as designer consultants, construction managers, construction and design-build contractors. In addition, software solution providers will find this Guide of interest, in particular, those who offer 3D imaging services and software applications.

section 1: introduction

Private sector industries such as aerospace, automobile, and petroleum have been using 3D imaging for several years. The benefits of determining the spatial environment and as-built conditions have played a key role in reducing costs and delivering a higher quality engineering effort. 3D imaging has also become more prevalent in the architectural/engineering/construction (AEC) industry in pursuit of similar results. Federal institutions using 3D imaging technologies include the Department of Defense, U.S. and State Departments of Transportations, U.S. General Services Administration, U.S. Geological Society, U.S. Army Corps of Engineers, U.S. Secret Service, and the Federal Bureau of Investigation.

GSA has implemented 3D imaging technology as part of many projects to date. Applications include: documenting historic structures and architectural features, identifying construction discrepancies of aging buildings, determining above ceiling conditions prior to the construction phase, and as-built conditions of entire federal campuses. Results and best practices extracted from continuing projects will be incorporated into this Guide on an ongoing basis.

1.1. What is 3D Imaging

3D imaging refers to the practice of using 3D imaging systems to measure or to capture existing conditions in the built or natural environment. 3D imaging systems are instruments that are used to rapidly measure (typically on the order of thousands of measurements per second or faster) the range and bearing to and/or the 3D coordinates of points on an object or within a region of interest (Figures 1 and 2). Most current instruments use light in the visible to near infrared spectrum. Examples of 3D imaging systems are laser scanners [also known as laser radars, LADARs (laser detection and ranging), or LIDARS (light detection and ranging)], triangulation-based systems such as those using pattern projectors or lasers, and other systems based on interferometry [as used to this Guide, an interferometer is an optical instrument that measures distances based on the interference phenomena between a reference wave and the reflected wave]. In general, the information gathered by a 3D imaging system, in addition to polar $[(r, \theta, \varphi)$ - range, azimuth angle, elevation angle] or Cartesian (x, y, z) coordinates, can also include return pulse intensity and color associated with each coordinate (Figure 2). The measurements are made without physical contact between the instrument and the object, and the surfaces of objects to be measured do not require any special surface finish (although specular surfaces such as mirrors or highly reflective materials are problematic). The maximum ranges of 3D imaging systems vary from under 10 m to over a kilometer (a several feet to over half a mile), and measurement errors vary from sub-millimeter level to centimeter level (thousandths of an inch to tenths of inches) - with greater errors more often associated with the longer range instruments.

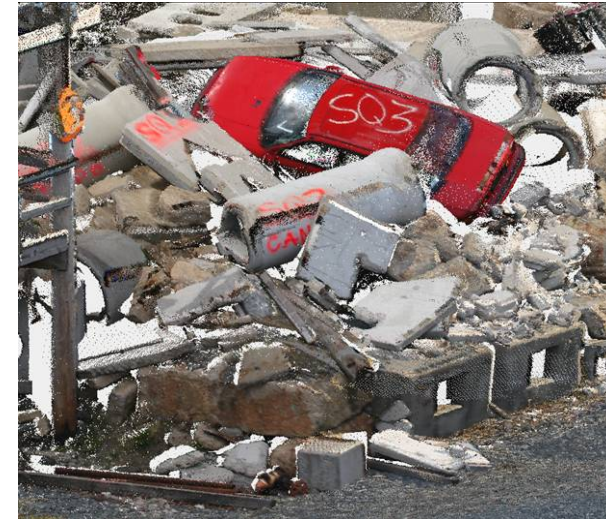

Zoomed-in
view

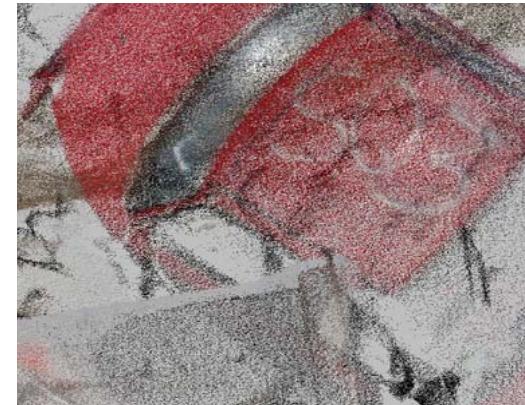

Figure 1: Digital photo of a mock disaster site - Compare to the point cloud image shown in Figure 2. (Courtesy of NIST)

Figure 2: Point cloud of the mock disaster site shown in Figure 1 with color information. The white patches indicate no data regions. (Courtesy of NIST)

The technology for 3D imaging systems has been around since the 1970s. However, it has only been in the past decade that the use of 3D imaging systems has become more prevalent and accepted. The applications for 3D imaging cover the spectrum from industrial metrology to remote sensing. These applications include creating 3D models (e.g., as-builts, inventory, maintenance, visualization), surveying and mapping, reverse engineering, quality control, autonomous vehicle navigation, collision avoidance,

object and target recognition, forensics, historic preservation/archaeology, disaster reconnaissance, space exploration (docking of space craft and assessing damage to the exterior of space shuttle), and forest management. Some of these applications are shown in Figure 3. The applications in this Guide will focus on those from ground-based 3D imaging systems and those related to imaging of constructed facilities.



a. Autonomous vehicle navigation, collision avoidance (Courtesy of NIST)



b. Manufacturing inspection and quality control (Courtesy of Boeing)



c. 3D models, as-builts, as-is documentation, historical preservation. (Courtesy of Riegler)

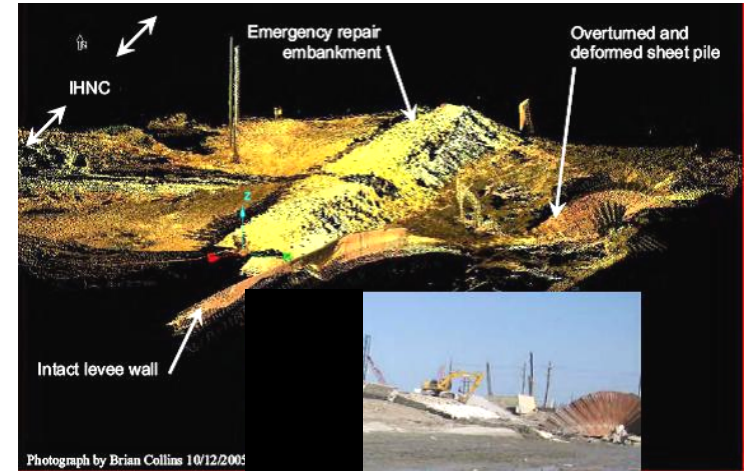

Hurricane Katrina, 2005

d. Disaster reconnaissance. (Courtesy of Brian Collins and Robert Kayen, USGS)

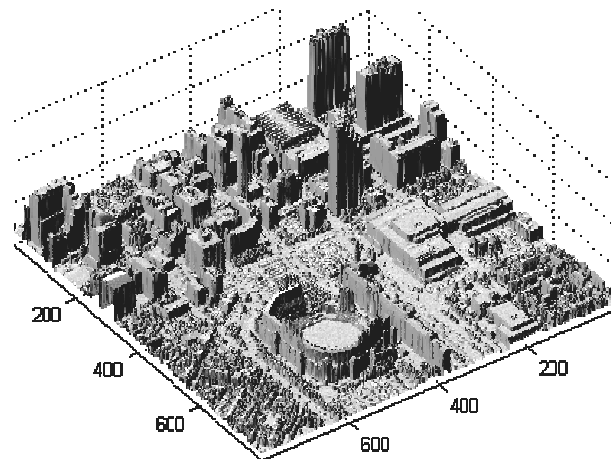

Downtown Baltimore, MD

e. Urban planning, route planning. (Courtesy of Jeff Turner, Ft. Belvoir)

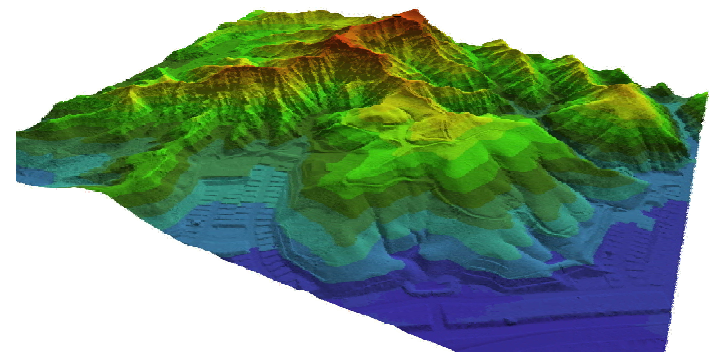

Santa Clarita, CA

f. Terrain mapping, surveying, bathymetry, coastal erosion. (Courtesy of Airborne 1)

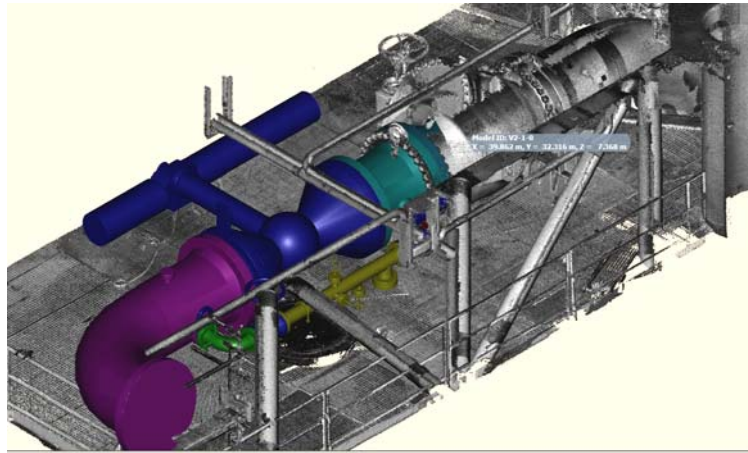

g. Interference checking, retrofits/revamps, reverse engineering, decommissioning. Courtesy of Quantapoint.

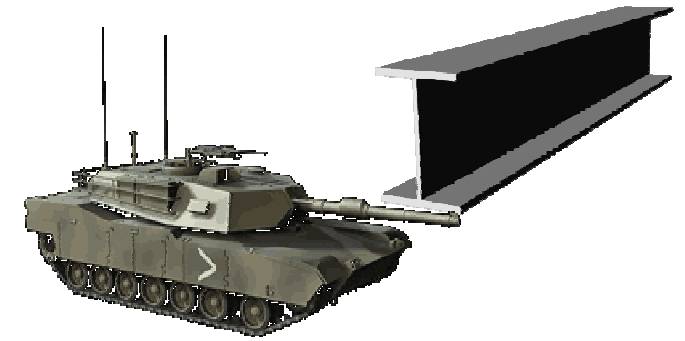

gunpoint-3d.com

h. Object recognition

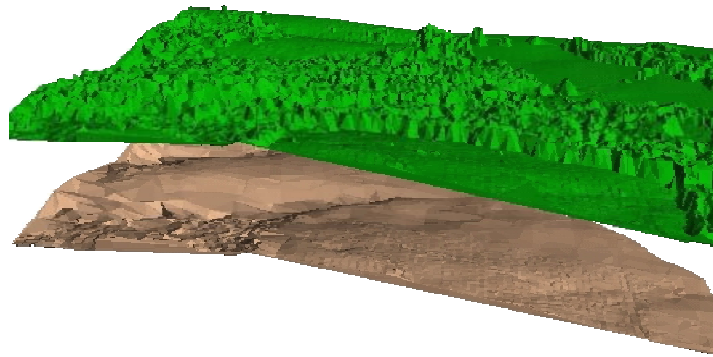

i. Forest biomass determination, flood plain, and wetland analysis

Figure 3: Examples of 3D Imaging Applications

In general, a 3D imaging system is either a pulsed time-of-flight or phased-based system used to obtain 3D information of a scene. 3D imaging systems are line of sight (LOS) instruments, i.e., objects will cast “shadows” representing regions of missing data (Figure 4) along the LOS of the instrument. Scenes are often scanned from several positions to capture occluded regions. Each

scan generates a point cloud (Figures 2 and 4), which may consist of millions of data points. The time to acquire the data is dependent on the field of regard, point density, desired accuracy, and instrument. The field of regard and point density are user specified parameters that are set prior to starting data collection. The field of regard is the angular (horizontal and vertical) coverage of a scene [e.g., 100° (horizontal) x 60° (vertical)]. The point density is specified by the angular increment or by a point spacing at a given distance. Some systems have the capability of averaging measurements. That is, measuring the same point several times (the number of times is usually user specified) and reporting the average value as the measured value (the other measurements are not reported). This capability reduces the noise in the data and if the instrument were calibrated, gives a better estimate of the true value. However, the time to acquire the data will increase due to the acquisition of multiple measurements. The method used to point or steer the beam varies with instrument (e.g., encoders, rotating mirrors) and affects the speed of data acquisition.

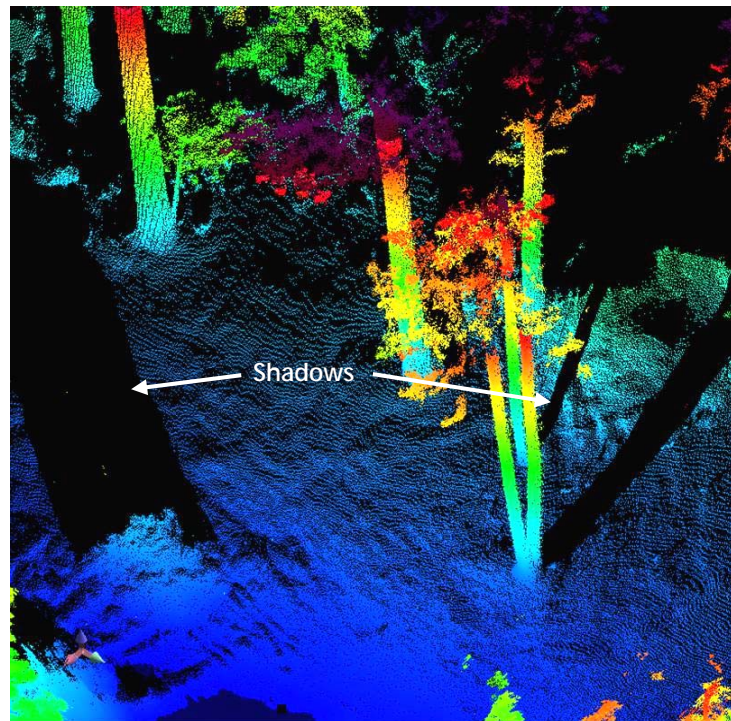

Figure 4: Point cloud showing some examples of shadows - regions with no data. (Courtesy of NIST)

The point clouds can be used without processing or can be post-processed to generate 2D drawings and 3D models or to extract other information.

1.2. 3D Imaging vs. Alternative Methods

The economic decision to use 3D imaging systems versus other methods depends on several factors. A good discussion on this topic may be found in Greaves and Jenkins [2004] and their findings are summarized in this section.

The first obvious factor is cost - what is the cost of the alternative? Although not an exclusive consideration, cost should obviously be a large component in the decision process.

For jobs involving simple geometries and readily accessible work sites, 3D imaging systems may not be the best choice. However, even if the alternative is less costly, 3D imaging may still be a better alternative depending on the expected use of the information.

In some situations, the use of 3D imaging systems for documenting existing conditions may be a viable alternative if:

- A high level of detail is required for complex geometries and/or congested areas. For example, if the objective is to document the existing conditions in a process plant with many pipes and objects so that it is possible to locate all pipes and objects, then using a 3D imaging system to get the data would be more viable than traditional survey methods which gather data one point at a time.
- Competing methods introduce safety risks - e.g., exposure to road traffic or toxic environments.
- Areas may be inaccessible or there is limited space - e.g., overheads and mechanical spaces.

1.3. Benefits of 3D Imaging

A major benefit of 3D imaging systems is the ability to capture existing conditions more completely and with a higher level of detail than most manual methods. Additionally, ranges can be measured to non-cooperative (i.e., non-specialized) targets, objects, or surfaces. These capabilities can result in [Greaves and Jenkins, 2004]:

- Increased accuracy and reduced variance in engineering and construction bids
- Reduced errors and rework
- Improved responsiveness to project changes
- Schedule reduction
- Increased worker safety
- Quality control
- 3D visualization

3D visualization is at times essential in explaining and understanding complex or complicated conditions.

1.4. Sources of Error

All measurements contain errors. Even measurements from a calibrated instrument are subject to random fluctuations or “noise”. Besides random errors, systematic errors will cause incorrect measurements unless corrected (e.g., applying a correction factor to the measurements). These errors, systematic and random, can originate from the instrument, operator, and/or environmental conditions. The processes that can introduce errors to the 3D imaging measurements or to the end-product of 3D imaging data are briefly described in the following sections.

1.4.1. Calibration

Errors from an improperly calibrated instrument are systematic errors and result in an offset or bias in the measurements. This offset may be constant, linear, nonlinear, or periodic. The offset may be determined by an accredited test facility, the manufacturer of the instrument, or by a user following a formal/standard test method. If a manufacturer performs the calibration, the manufacturer can change hardware settings and alignment of instrument parameters to optimal levels to eliminate or reduce the error. In the other cases, a correction factor is often applied to the measurements to reduce the calibration error.

1.4.2. Field survey

Field survey errors can arise from instrument error, environmental conditions, and operator error. Instrument error has a systematic component (calibration error - see section 1.4.1) and a random component (instrument noise). Random errors include pointing error, centering error, leveling error, and reading error. Correction factors can be applied to the measurements to account for the varying environmental conditions (temperature, humidity, and barometric pressure). Intrinsic to operator error is operator skill. Operator error includes blunders such as measuring the wrong target and transposing two numbers. Other operator errors are less obvious but can increase the error in the resulting data. Examples include poor geometry choice for target placement and instrument location, or failure to select proper instrument parameters (such as scan density) for the desired deliverable.

1.4.3. Scanning

Measurement errors from scanning can come from a variety of sources. Measurements are affected by the scanned object’s surface characteristics. Most 3D imaging systems have problems measuring a highly reflective or specular object or surface (e.g., mirror, reflective material used for road signage). More measurement noise and the higher likelihood of obtaining no measurement are associated with lower reflectivity (darker) surfaces and objects. The material of the object also affects measurements - problems can arise when measuring glass, plastics, machined metals and marble [Godin, et al. 2001]. In the case of marble, some lasers penetrate the marble resulting in biased measurements.

Increased measurement noise also occurs when scanning objects at oblique angles. This noise increases as the angle increases. Spurious measurements can also be obtained when scanning across edges where the laser beam is split by the edge and when scanning into the sun.

Environmental and ambient factors also contribute to scanning error. The thermal expansion of an object affects the measurements. Some examples are 1) scanning a pipe when it is hot and when it is cold and 2) scanning a wall heated by the afternoon sun and scanning the same wall at night. The measurements in these situations can be significantly different and can cause errors in registration and fitting. Temperature gradients will also affect measurements. For example, an asphalt road heated by the summer sun will result in a temperature gradient near the road surface. Windy conditions can affect measurements by causing movement or vibration of the instrument or the structure on which the instrument is stationed.

An operator's skills are another source of error. These skills include knowledge of the instrument (e.g., limitations of the instrument), proper instrument set-up, and experience (e.g., recognizing potential problems and sources of error, optimal instrument locations).

1.4.5. Registration

Registration is required to transform two or more scans of the same object or scene obtained from different locations with one instrument or two or more scans obtained from different instruments, so that they have a common reference frame (Figures 5 and 6). Registration can be performed by 1) using targets, 2) setting the scanner over a point with known coordinates (a control point) and back sighting to another known point to measure the orientation (the z-axis is typically referenced to gravity through instrument leveling), or 3) by surface-to-surface or surface-to-point cloud matching. Currently, most registration is performed using targets - Method 1.

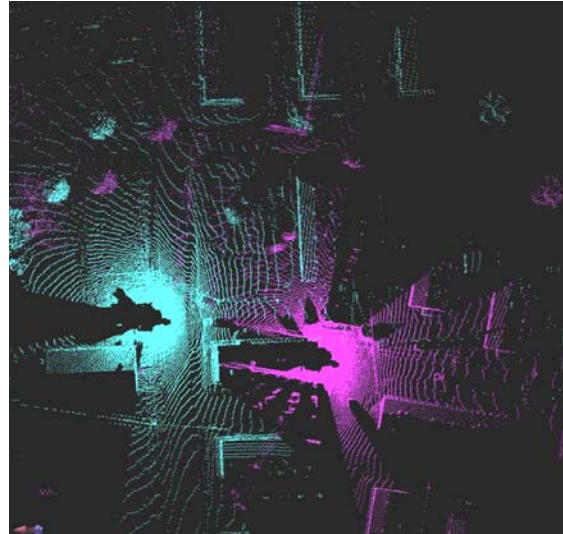

Figure 5: Two unregistered point clouds. (Courtesy of NIST)

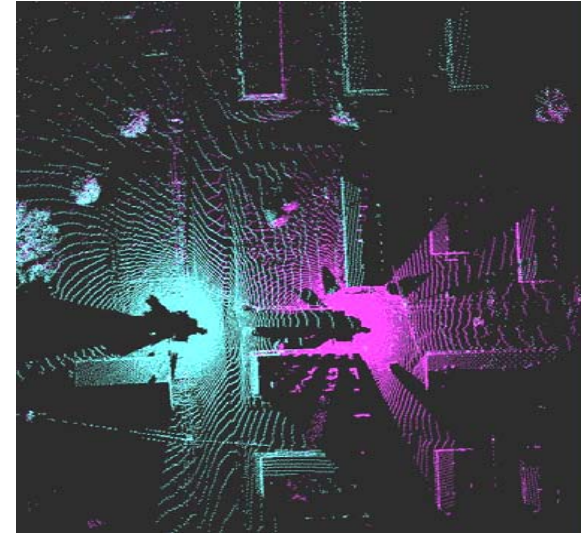

Figure 6: Registered point clouds. (Courtesy of NIST)

The registration error using Method 1 is dependent on how well the targets can be measured. In this case, the targets can either be specific artifacts placed in the scene such as spheres and planar targets or recognizable and distinct features in a scene. The use of the latter types of targets (e.g., object corners and edges) should be avoided as the chances of measuring the same exact point on an object from two locations and selecting these same two points for registration are low.

Another factor that can affect the registration error is the placement of the targets - targets should be evenly distributed throughout the work volume. The registration error using Method 2 is dependent on the accuracy of the control point, the error associated with positioning the instrument over the point, and the accuracy of the back sight measurement. Algorithms for registration using Method 3 are still mainly in the research and academic arena, though commercial packages are starting to incorporate their use.

1.4.6. Modeling

Many 3D imaging applications require some kind of modeling -- rendering of the scene in terms of surfaces, determining distances/volumes, or locating and identifying objects. The modeling process involves data editing (cleaning), segmentation, and fitting of geometric primitives (e.g., planes, spheres, cones, cylinders). Currently, most modeling is performed manually. Therefore, the main sources of modeling errors are data editing, operator errors, and errors due to the choice of fitting algorithm. It has been shown that an operator's qualifications can have a large impact on the quality of a 3D model [El-Hakim and Beraldin, 2007].



Another potential source of error can result by incorrectly inserting a duplicate model of a similar element. For example, all columns (Type A) on Floor 1 may have the same dimensions except for one (Type B) which was incorrectly constructed. In the modeling process, a model of Type A columns is created and duplicated for all columns on Floor 1 because the modeler incorrectly assumed that all columns were identical.



section 02: solicitation phase

section 2: solicitation phase

Identifying contexts and projects in which the benefits of 3D imaging can be exploited is a critical and essential first step. There are other technologies (e.g., photogrammetry) as well as traditional surveying methods that may offer better or more cost-effective alternatives depending on the scope of work and the anticipated deliverables.

2.1. Background and Project Description

First, the project team should clearly state the objectives for the 3D imaging project. It should identify the areas, surfaces, and objects which need to be imaged. A good understanding of the objectives (Section 2.2) is essential in helping the contractor design a scan plan (e.g., instrument locations, required resolutions) that maximizes the product deliverable while minimizing costs. Clear objectives will reduce future misunderstanding and need for re-work.

Exterior pictures of the building(s), from as many angles as possible, should be included in the solicitation as an appendix. If certain areas cannot be photographed or if the photos cannot be released to the public, a detailed narrative description of the area should be provided so that service providers can accurately conceptualize the environment, space limitations, and total area to be imaged.

For interior areas, the project team should identify all rooms and spaces to be imaged. Drawings (e.g., architectural, reflected ceiling) or sketches if available should be included in the solicitation. Should the layout of interior spaces be classified, describe in as much detail the approximate square footage, number of rooms, how the spaces are configured, and the placement of objects that would impact line of sight measurements.

It is important to note that capturing a comprehensive and complete overhead scan in any building is difficult and time consuming. It is almost impossible to capture 100 % of the overhead area in a scan without “shadows” (Figure 4). Project managers need to ensure that they allow access to as much of the ceiling as possible if they desire an accurate representation.

Areas of interest should be clearly identified and photos of these areas should be included in the solicitation. The type of features (e.g., cracks, architectural details) to be captured should be described in detail. The required resolution in areas of interest is often greater than for other areas and will generally result in longer scan times and higher costs.

A site visit for service providers will allow them to determine more accurately the work involved. The site visit will allow the service providers to determine the potential instrument locations, required data resolution to meet the specified objectives, and any technical difficulties that may be encountered.

2.1.1. Potential challenges

Potential challenges should be clearly identified in the solicitation. These challenges include:

- required security clearance of the 3D imaging crew
- accompaniment of the 3D imaging crew by security personnel
- obstructions caused by heavy vegetation or congested work spaces
- restricted access to certain areas
- restricted times that the 3D imaging crew can work

2.2. Objectives

2.2.1. Primary

A detailed description of the desired end use of the 3D data should be given in the solicitation. Past experience has shown that a qualified service provider who is well informed about a client's goals is the best resource for developing innovative, efficient, and cost-effective methods to achieve the desired project objectives (see Section 4.3). Thus, a concise and clear description of the project objective(s) should be provided in the solicitation.

A Project Definition Matrix similar to the one shown in Table 1 may be used to identify how the 3D imaging data will support the project objectives.

Table 1. Project Definition Matrix

PROJECT OBJECTIVES (see Section 4.3)	DATA				
	Generic Requirements (see Section 2.3)			AOI (Area of Interest) (see section 2.4)	Type (see section 2.4)
	Scan Plan	Post-Processing Plan	QC Report		
Urban Design	x	x	x	Level 1	Type 1 Type 3
Architectural Design	x	x	x	Level 2	Type 1 Type 2
Façade Restoration	x	x	x	Level 3	Type 1
Room Space Measurement	x	x	x	Level 2	Type 1
Maintenance/Damage Identification	x	x	x	Level 3	Type 1 Type 3
Historic Documentation	x	x	x	Level 1 Level 2	Type 1
Renovation	x	x	x	Level 2 Level 3	Type 1 Type 2
Above ceiling condition capture	x	x	x	Level 2	Type 1 Type 3

2.2.2. Secondary

A description of secondary objectives, if any, should be included in the solicitation. Secondary objectives include potential future applications of the 3D imaging data. The project team should keep in mind that if the resolution requirements for the secondary objectives are more stringent than those for the primary objective, then the project costs could potentially be skewed towards achieving the requirements of the secondary objectives.

2.3. Deliverable Specifications

The project team should specify the required units [e.g., U.S. customary units (English units), SI (International System of Units - metric)] for the deliverables.

2.3.1. Scan Plan

The scan plan should describe the general procedures used to obtain the spatial data. The procedures to achieve the specified tolerance of the deliverables should be described - especially at locations where a high level of detail is required. The procedures used to register the data should also be described.

Specifications of the 3D imaging system(s) used should be included in the scan plan.

Access to adjoining sites may be required if they provide preferable instrument locations. Optimal locations should:

- provide an unobstructed or less obstructed view
- enable the capture of a higher level of detail. For example, an instrument located at street level may not be able to capture the necessary level of detail of the upper stories of a building, or if the instrument has limited field of regard, it may not be able to image the upper stories at all. The roofs of adjacent buildings may provide better locations in these cases.
- provide a view that would not be possible otherwise

The responsibility of obtaining the required approvals/permits for access to adjoining sites should be stated in the solicitation.

2.3.1.1. Safety

If the 3D imaging system uses a laser, the system must be in compliance with the regulations for lasers and laser products issued by the Center for Devices and Radiological Health (CDRH) of the Food and Drug Administration. When using a laser 3D imaging system, the U. S. Department of Labor, Occupational Safety & Health Administration (OSHA) standards and regulations on exposure to laser hazards should be followed.

The service provider should provide GSA with documentation on whether the 3D imaging system(s) used are eye safe or not. Even if eye safe, the laser should not be viewed through optical devices (e.g., total stations, binoculars, camera). Therefore, information regarding the hazard should be posted, and personnel working around the site should be informed.

If the instrument(s) is not eye-safe, the service provider should describe the methods employed to ensure the safety of personnel working in the area to be imaged. Such methods include informing the tenants of the hazard and the mitigation measures taken, restricting access to the area, and posting warning/laser hazard signs around the site.

If required, the service provider should provide a safety plan. For example, if the instrument location is next to a roadway, the service provider should describe the safety precautions that will be taken for the safety of the work crew and the public, coordinate with local authorities (e.g., police, local/state transportation departments), and be responsible for getting the necessary permits or permission.

In all cases, it must be clear that the safety of the service provider's work crew is the responsibility of the service provider. The service provider is also required to have liability insurance.

2.3.2. Modeling Plan

Project managers should use good engineering judgment when setting a model's level of detail. The amount of time it takes to generate a model from 3D data is proportional to the level of detail. GSA's typical detail for exteriors is any feature greater than 2 in. in size. This requirement means that any assembly less than that size will not be modeled. Typical interior level of detail is 1 in. or greater. There are cases where a higher level of detail is required. Project managers should identify all areas, interior and exterior, that deviate from the GSA standard and require more detailed modeling.

2.3.3. Quality Control

The service provider is required to describe the methods to:

- ensure proper functioning of instruments (e.g., 3D imaging system, total station) used in the project
- verify that the deliverables are within the specified tolerances (e.g., point cloud, 2D drawings, 3D models)

If corrective actions are required, the responsibility of any cost associated with the corrective action should be specified in the solicitation. Examples of corrective actions include obtaining missing data and/or augmenting incomplete data, which would require going back to the site, and incorrect data due to a malfunctioning or improperly calibrated instrument.

2.3.3.1. Control network

Dimensional control is a primary concern when performing 3D imaging in the field. The likelihood of inadvertently introducing systematic errors into the data is very high should dimensional control measures be neglected. One highly recommended method of monitoring this is through the use of a control network. A control network is a network of permanently marked points with known coordinates that are recoverable throughout the life of a project and beyond. The service provider should describe procedures to establish the control network, control layout, and how the control network will be used.

2.4. Types of Deliverables from 3D Data

The deliverables are specified per the Deliverable Selection Matrix (DSM) (Table 2). The parameters in the DSM are defined below. Project managers should use good engineering judgment when specifying the tolerances and minimum artifact size (resolution) as tighter tolerances and higher resolutions increase scan times and costs.

Table 2: Deliverable Selection Matrix

Level of Detail	Area of Interest	Deliverable		Category	Tolerance mm (in)	Minimum Artifact Size (resolution) mm x mm (in x in)
		Type	Description			
Level 1	(Description)	3	Point cloud	Base	± 51 (± 2)	152 x 152 (6 x 6)
Level 2	2-A (Description)	1.3	Elevation	Base	± 13 (± ½)	25 x 25 (1 x 1)
		2.1	Surface model	Option	± 13 (± ½)	25 x 25 (1 x 1)
		3	Point cloud	Base	± 13 (± ½)	25 x 25 (1 x 1)
	2-B (Description)	1.3	Elevation	Base	± 13 (± ½)	25 x 25 (1 x 1)
		2.1	Surface model	Option	± 13 (± ½)	25 x 25 (1 x 1)
		3	Point cloud	Base	± 13 (± ½)	25 x 25 (1 x 1)
Level 3	3-A (Description)	1.3	Elevation	Base	± 6 (± ¼)	13 x 13 (½ x ½)
		3	Point cloud	Base	± 6 (± ¼)	13 x 13 (½ x ½)
	3-B (Description)	1.3	Elevation	Base	± 6 (± ¼)	13 x 13 (½ x ½)
		3	Point cloud	Base	± 6 (± ¼)	13 x 13 (½ x ½)
	3-C (Description)	1.3	Elevation	Base	± 6 (± ¼)	13 x 13 (½ x ½)
		3	Point cloud	Base	± 6 (± ¼)	13 x 13 (½ x ½)
Level 4	(Description)	2.1	Surface model	Base	± 3 (± 1/8)	13 x 13 (½ x ½)
		3	Point cloud	Base	± 3 (± 1/8)	13 x 13 (½ x ½)

- 1) Areas of Interest - A hierarchical system of scale in which each scan is registered per the following criteria:
 - Level 1: Total project area. Coordinate Frame: Local coordinate frame (coordinate frame used by the local jurisdiction) or the State Plane Coordinate Frame. The control network should be tied to this coordinate frame.

- Level 2: Subsection of Level 01 (e.g., building). Coordinate Frame: Local coordinate frame (coordinate frame used by the local jurisdiction) or project coordinate frame
- Level 3: Subsection of Level 02 (e.g., floor level). Coordinate Frame: Project coordinate frame or instrument coordinate frame.
- Level 4: Subsection of Level 03 (e.g., room or artifact). Coordinate Frame: Instrument coordinate frame.

There can be multiple Areas of Interest with common coordinate frames. For this, the following syntax applies: Level 1-A, Level 1-B, etc. Note that projects, particularly small projects, may only have one level of detail. For example, if the objective is to get a 2D plan of an office space, then Level of detail is Level 1 and the coordinate frame is the project coordinate frame. Another example is if the data can be obtained in one scan, then there is only one Level of detail, Level 1, and the coordinate frame is the instrument coordinate frame.

A control network is used for dimensional control and quality control (Sections 2.3.3.1 and 3.4). The control network is tied to a coordinate frame used by the local jurisdiction or a State Plane Coordinate Frame. A project coordinate frame is a coordinate frame that is established by a service provider and is used as a frame of reference for all the data obtained in the project. The project coordinate frame should be tied to the control network. An instrument coordinate frame is local to the instrument. The origin of the instrument coordinate frame is the instrument center. This schematic of the different frames is shown in Figure 7.

As discussed in Section 1.4.5, the process of registration introduces errors to the measurements with the errors increasing as the process is repeated. For example, two point clouds, A and B, are registered to the project coordinate frame to form a combined point cloud - point cloud C. The error in the distance between two points (both points from either point cloud A or B and not one from each) in point cloud C would be greater than the error between the same two points in point cloud A or point cloud B, respectively. This accumulation of error should be considered when setting tolerances - higher tolerance for a point cloud in Level 1 than for a point cloud in Level 3.

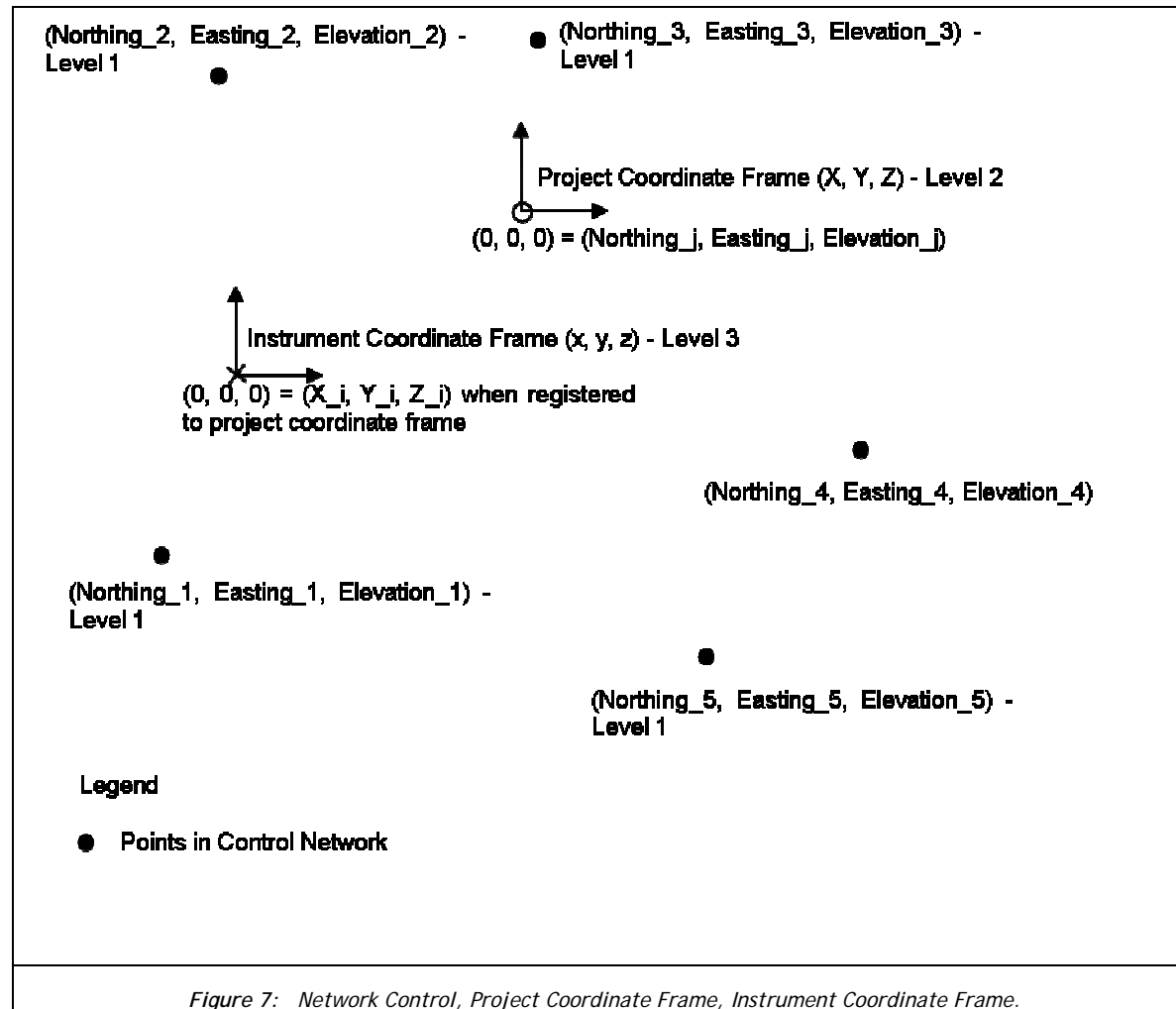

- 2) Deliverable Type - The service provider shall prepare and submit the deliverables in the formats listed below.
- Type 1 - 2D Drawings



The GSA PBS CAD (computer aided drawing) standards apply for all cases of this deliverable. The PBS CAD standards can be found at the public GSA website: <http://www.gsa.gov> (Home > Buildings > Public Buildings > Design and Construction > CAD Standards > CAD Standards Library).

- 1.1 Plans
- 1.2 Sections
- 1.3 Elevations (see Figures 8, 9, and 10)
- 1.4 Details (see Figures 11 and 12)

Submit two sets of large paper drawings < X” x Y” > to the COTR (Contracting Officer’s Technical Representative) and the regional representative of the project; submit two additional electronic copies of the same drawings in “.dwg” format.

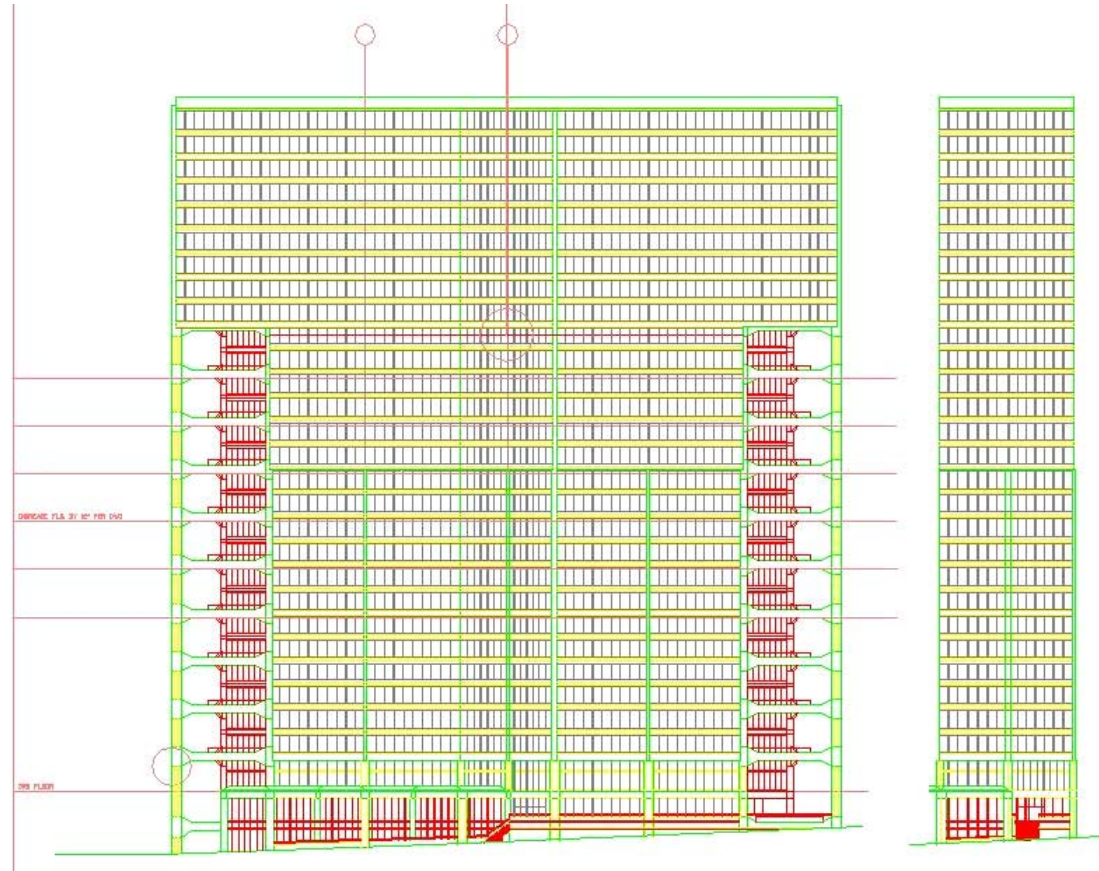

Figure 8: First example of an Elevation - high rise building. (Courtesy of Packer Engineering)

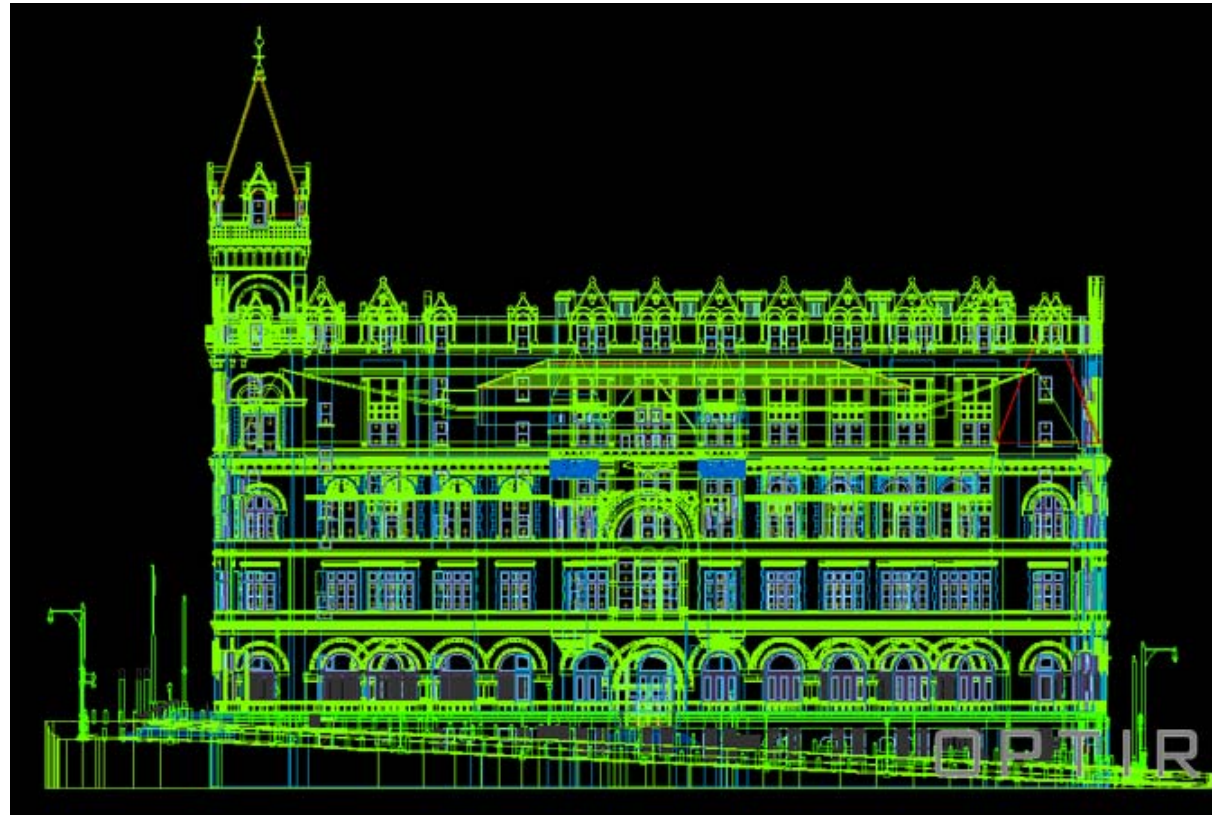

Figure 9: Second example of an Elevation - historic building. (Courtesy of Optira)

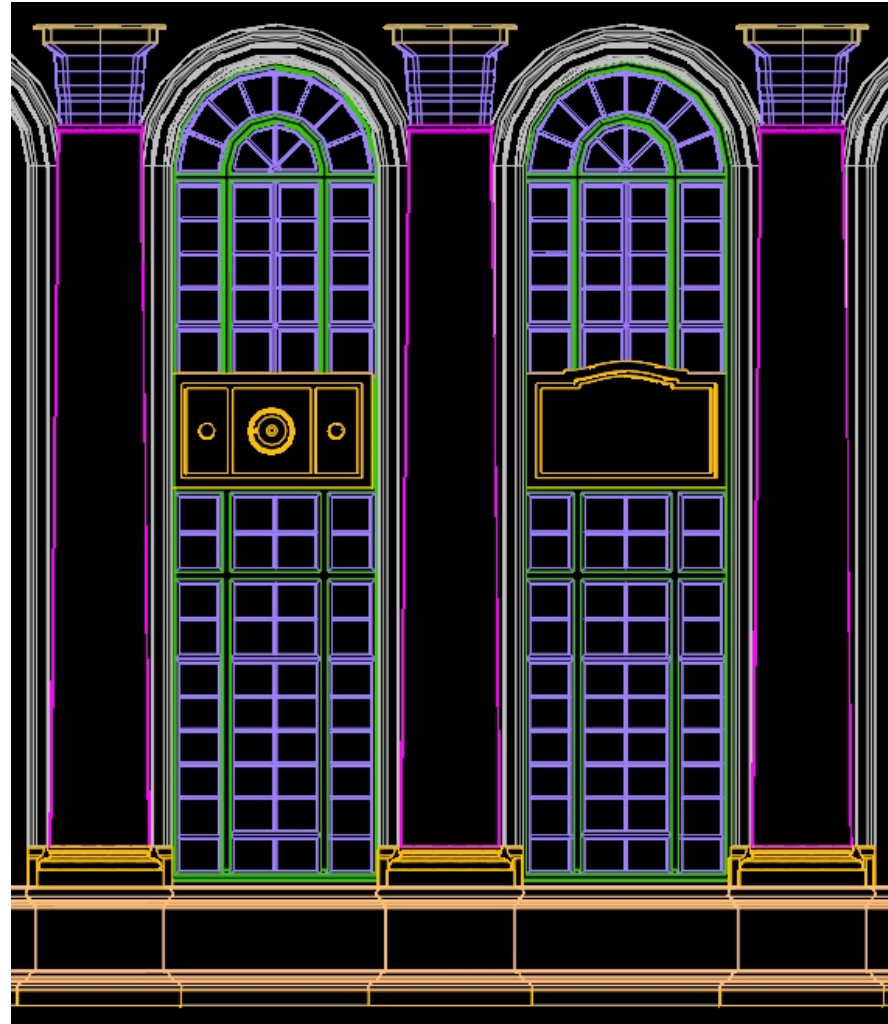

Figure 10: Third example of an Elevation. (Courtesy of Arcadis)



Figure 11: Details in a Point Cloud - historic building. (Courtesy of Optira)



Figure 12: Details in a 3D Model - historic building. (Courtesy of Optira)

- Type 2 - 3D Models
 - 2.1 Surface Model (see Figure 13)
 - 2.2 Object Model (see Figure 14)

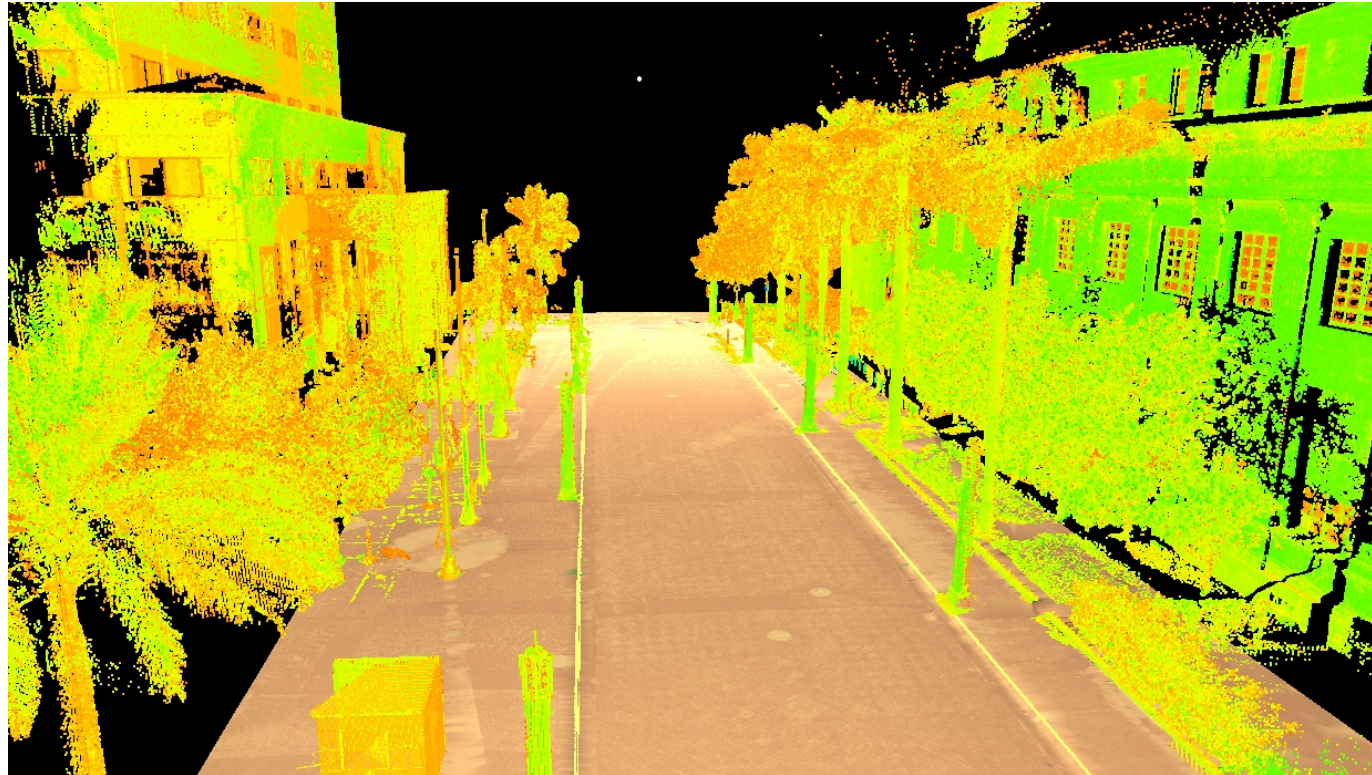

Figure 13: Example of a surface model - road surface. (Courtesy of Arcadis)

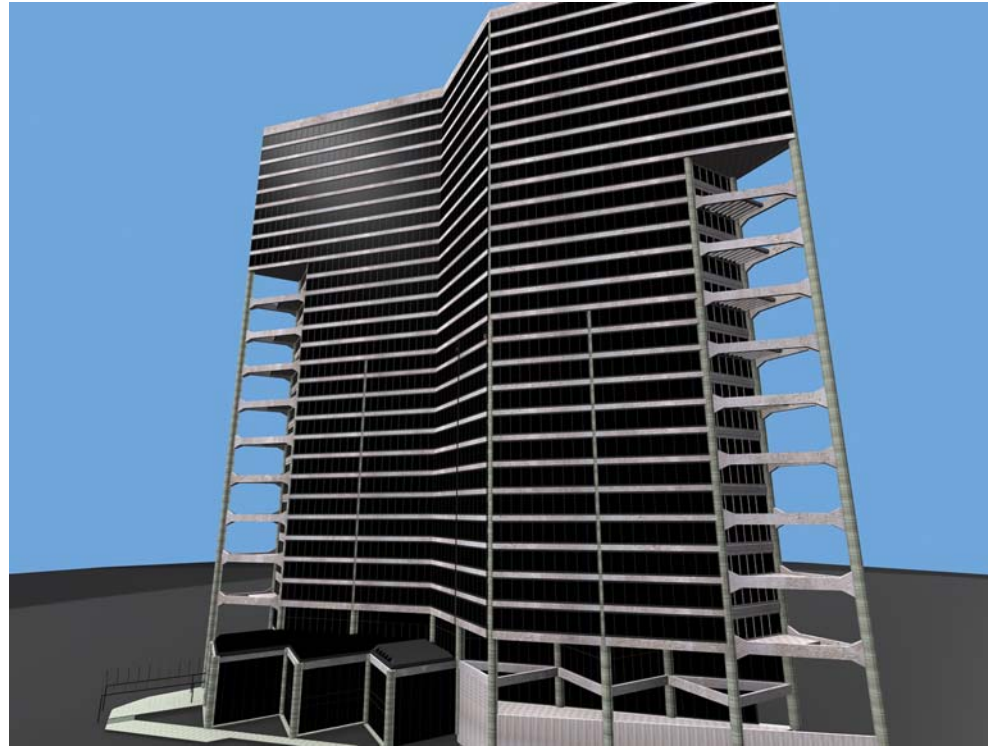

Figure 14: First example of a 3D object model - high rise building. (Courtesy of Packer Engineering)



Figure 15: Second example of a 3D object model. (Courtesy of Arcadis)

- Type 3 - Registered Scan Data
 - Registered point cloud (Figures 16, 17, and 18) either as:
 - one file containing all the transformed data
 - individual files (each scan is a separate file) with the transformation information included in the file

There is currently no standard format for 3D imaging data. One format for these data is ASCII: x, y, z, I, R, G, B (if intensity [I] and color [R, G, B] information are available). Other formats may be acceptable and are subject to negotiation and approval by the COTR. All point cloud and registered electronic data will be submitted in electronic format.

The registered point cloud data shall be reduced in size, to filter noise and redundant data to the maximum extent possible without compromising the accuracy and resolution of the model. Submitted media will become the property of the U.S. government upon delivery to the COTR.

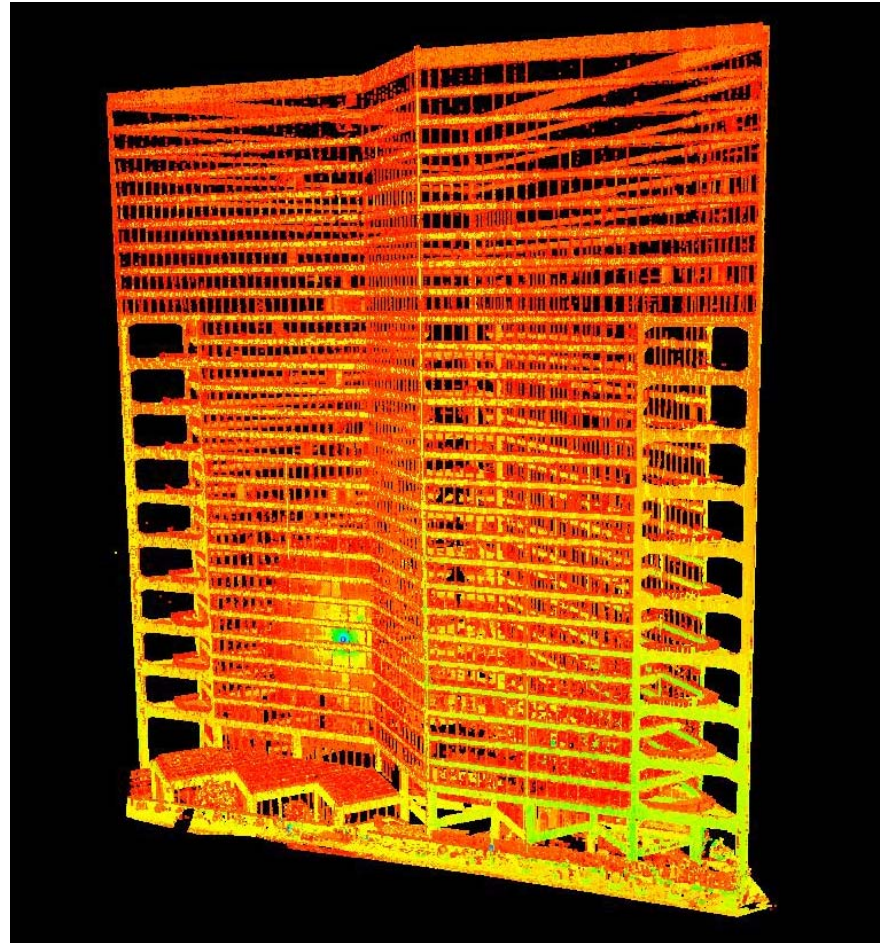

Figure 16: First example of a registered point cloud - high rise building. (Courtesy of Packer Engineering)



Figure 17: Second example of a registered point cloud - historic building. (Courtesy of Optira)

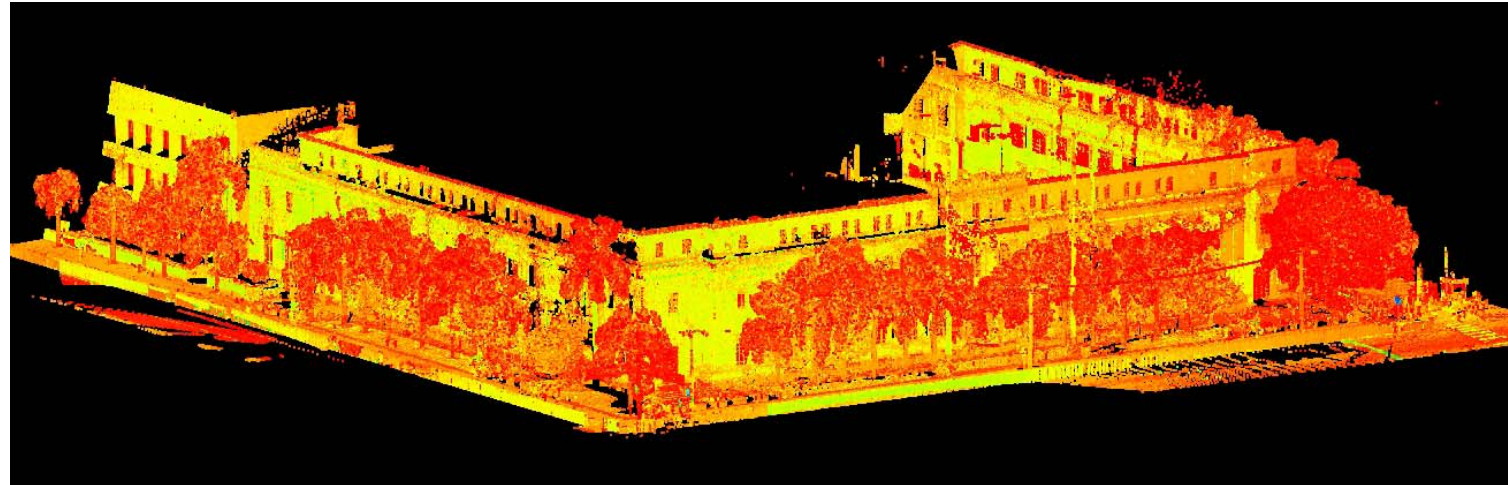

Figure 18: Third example of a registered point cloud. (Courtesy of Arcadis)

– Type 4 - Raw Scan Data

These data are the data from individual scans that have not been registered or filtered (Figures 19 and 20). The data is from a single scan as exported by the instrument software. Lacking a standard format, one format for these data is ASCII: x, y, z, I, R, G, B (if intensity [I] and color [R, G, B] information is available) - other formats may be acceptable and is subject to negotiation and approval by the COTR. At a minimum, the documentation for these files should contain the date of the scan, the location of the scan, the instrument used, and the instrument settings.

- Raw data for each scan in individual files. Raw data are data that are “as exported” from the 3D imaging system and are not processed in any way.
- Digital photographs
- A survey report of the control network, if used, is also required as well as a closure report of the scan registrations.

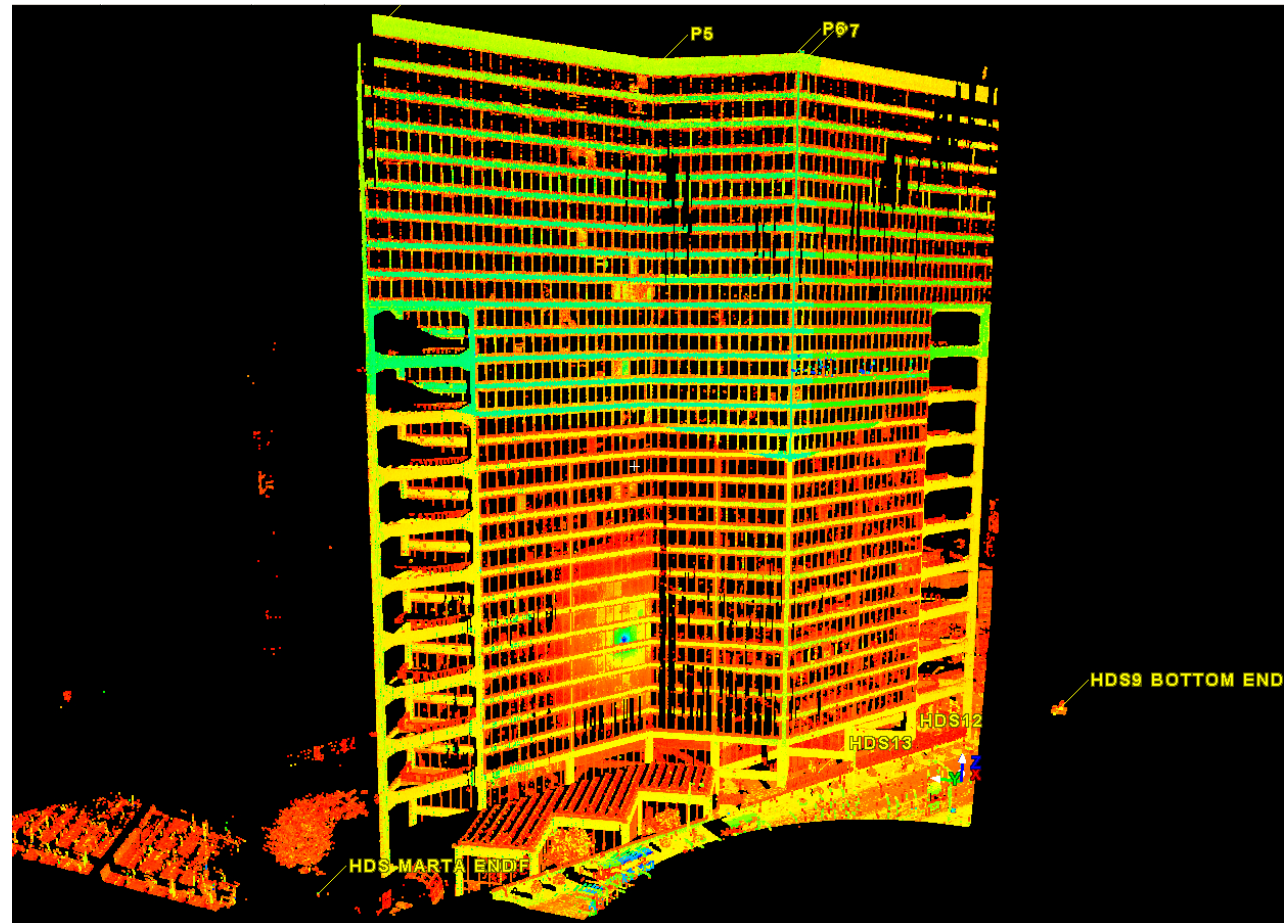

Figure 19: One example of raw scan data - unprocessed point cloud from a single instrument location of a high rise building.
(Courtesy of Packer Engineering)

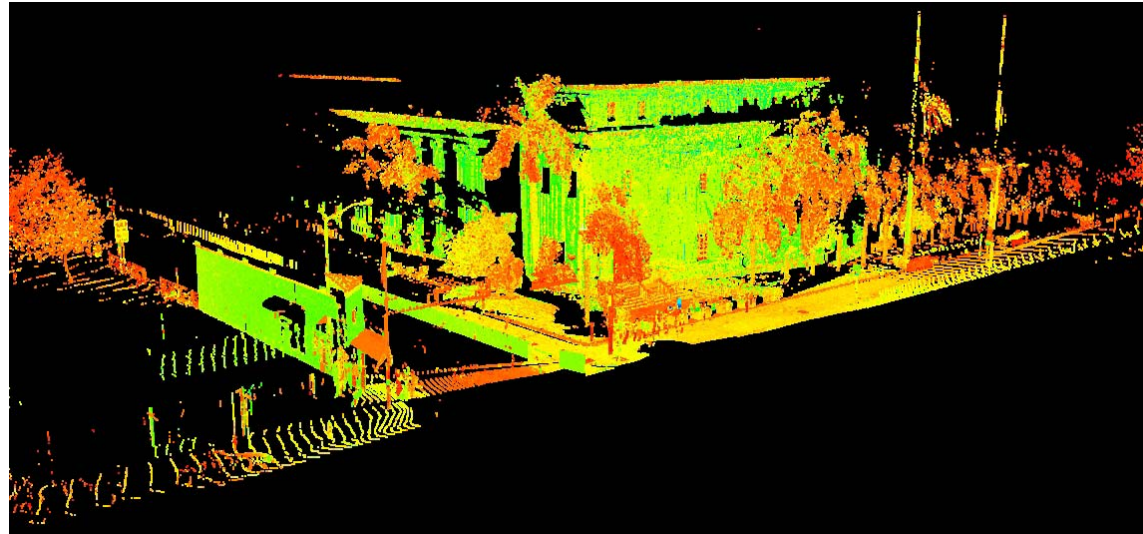

Figure 20: Second example of raw scan data - unprocessed point cloud from a single instrument location. (Courtesy of Arcadis)

- 3) Category - Refers to the requirement of either Base deliverables or Optional deliverables as determined by GSA COTR.
- 4) Tolerance - The allowable dimensional deviation from truth (truth being a measurement obtained by some other means - see Section 3.5), in the specified coordinate frame.
- 5) Minimum Artifact Size (resolution) - The dimensions of the smallest recognizable feature.

2.5. Resolution Requirements

2.5.1. Specific feature requirements

The project team shall make a matrix of required objects in the various portions of the deliverable. It is up to the service provider to ensure they establish a method of obtaining the 3D and other sensor data with sufficient resolution to extract the needed information.

2.6. Data

2.6.1. Data Security and Ownership

Frequently, questions regarding model and information ownership arise around technologies that promote interoperability. PBS shall have ownership of and rights to all data contained in BIMs and other deliverables developed and provided by the A/E in accordance with the applicable provisions of the A/E contract, including relevant clauses detailed under FAR 52.227 and GSA Order 3490.1.

All 3D, 4D, and Building Information Modeling-related information are considered to be Sensitive But Unclassified (SBU). SBU documents provided under contract are intended for use by authorized users only. In support of the contracted requirements, GSA will require vendors to exercise reasonable care when handling documents relating to SBU building information. Dissemination of any information provided for, generated by, and resulting from BIM projects is only allowed to authorized users. It is the responsibility of the person or firm disseminating the information to assure that the recipient is an authorized user and to keep records of recipients. Valid identification for non-Government users is required to receive SBU building information. For qualifying forms of identification, refer to GSA Order 3490.1.

The efforts required above shall continue throughout the entire term of the contract and for whatever specific time thereafter as may be necessary. Authorized users should store electronic information in a password protected (non-public) environment. Necessary record copies for legal purposes (such as those retained by the architect, engineer, or contractor) must be safeguarded against unauthorized use for the term of retention. Documents no longer needed shall be destroyed (such as after contract award, after completion of any appeals process or completion of the work). Destruction shall be done by burning or shredding hardcopy, and/or physically destroying CD's, deleting and removing files from the electronic recycling bins, and removing material from computer hard drives using a permanent erase utility or similar software. A Written Agreement of Disposal must be provided to the GSA upon contract completion.

For further detail, refer to GSA Order 3490.1, FAR 52.227, and other relevant data ownership and rights regulations.

For 3D imaging projects, GSA requires service providers to provide limited support after delivery of the data to ensure it is readable and free of conflicts. Should this information be unreadable or contain conflicts/discrepancies, the government should allow the 3D imaging service provider the opportunity to correct the data. It is recommended that a period of six to twelve months be allotted for post scanning support services. This will allow GSA project teams to ensure the deliverables meet the requirements and allow service providers time to help clarify, address, and/or resolve discrepancies.

2.6.2. Special requirements

Data backup - If needed, backup (e.g., daily, weekly) of data during the execution of the contract should be included in the solicitation or contract.



Data encryption - If required, data encryption should be included in the solicitation or contract.

2.7. Terminology

To avoid confusion as to the meaning of terms used in the contract, a list of terms should be included (e.g., as an appendix) in the solicitation. A list of terms and their suggested definitions are given in Appendix A.1.



section 03: evaluation phase

section 3: evaluation phase

To assist in the evaluation of submitted proposals for 3D imaging projects, the project team may want to bring in professionals who have expertise in surveying and 3D imaging.

3.1. Equipment Calibration

3.1.1. 3D imaging instruments

The 3D imaging instrument should be calibrated before the start of the project or should have been calibrated within the 12 months prior to the project start date. The calibration should be performed by the manufacturer of the instrument or by a qualified third party. The calibration should be performed using standard test procedures, if available.

Some instruments have a self-check process to determine if the instrument is within calibration. This capability provides the service provider a means of checking the instrument in the field. For instruments without the self-check capability and even for instruments with the capability, it is suggested that some field check be performed to ensure that instrument is functioning properly. The service provider should describe any field checks that will be performed.

3.1.2. Survey instruments

Any other survey instruments (e.g., theodolites, total stations, levels) that will be used in the project should also be calibrated before the start of the project or should have been calibrated within the 12 months prior to the project start date. The calibration should be performed by a qualified third party or the manufacturer of the instrument.

3.2. Scan procedures

The submission of a scan plan provides the project team with an understanding of how the service provider will approach the work, and will also help identify potential conflicts (such as building access). The review and acceptance of the scan plan by the project team does not obviate the provider from the responsibility of their specified deliverable in any way.

For the review of a scan plan, the project team is examining the provider's overall approach for good scan coverage (locations of instrument should provide good incidence angles and minimize shadows), methods of registering scan locations, and methods of maintaining dimensional control. In past GSA projects, the distance between scan locations have generally varied from 65 ft to 130 ft, though that rule of thumb may change as the instruments improve.

In general, the level of detail (resolution) that can be captured reduces with increasing distance from the 3D imaging system. This is because the point density reduces with distance, and the beam width increases with distance (beam divergence describes

how the beam width increases as a function of distance and is generally included in the instrument specifications). For example, if the beam width were 6 mm x 6 mm at 30 m (0.25 in x 0.25 in at 100 ft), then identifying a feature size less than 6 mm (0.25 in) would not be feasible with the instrument at this location. The instrument would have to be located closer to the feature or some other method should be used to achieve the desired resolution. Therefore, if a high level of detail is required in certain areas, the service provider should describe how the required level of detail will be achieved; for example, locate instrument closer to the area of interest and increase point density. For the situation when equal point density is possible for two locations and where one location is closer to the area of interest than the other, the location closer to the area of interest is preferred. If other methods are used to aid in achieving the required level of detail, then these methods (e.g., photogrammetry, edge detection algorithms, photographs, manual - visual) should be described.

At a minimum, the plan should include expected instrument locations identified in a photo(s), the area of coverage by the 3D imaging system (field of regard), the distances between scan locations, and preliminary target locations. Locations of points in the control network, if used, should also be identified.

3.2.1. Registration

Data registration is required to register two datasets (datasets from the same instrument obtained from different locations or datasets obtained from different instruments) so that they have a common coordinate frame or to register a dataset to another coordinate frame (e.g., global, project).

The most common method to register datasets involves the use of targets. These targets can be specific artifacts (e.g., spheres, planar targets) that are placed in area to be imaged so that they are visible from several different instrument locations. If a control network is used, the registration targets should be tied to the control network whenever possible. A minimum of three targets, visible in both scans, are required to register two scans. It is recommended that at least five common targets be used for redundancy in the event that there is a problem with the data for one or more of the targets. These targets should be evenly distributed throughout the volume of the scan region. For example, targets at the same elevation or in a line or close to each other would be poor choices of target locations.

Targets other than artifacts placed in a scene include distinguishable features such as building or room corners or the top of a pole. It is recommended that the use of these types of targets for registration be avoided and that specific artifacts inserted in a scene be used instead.

3.2.1.1. Registering Data from Different 3D Imaging Systems

If two or more 3D imaging systems are used in the project, the method used to register the data from these systems should be described. The use of two or more systems from the same manufacturer would likely not create problems even if different instrument models were used. However, if systems from different manufacturers were used, the compatibility of the exported data could be an issue. These issues include importing the data from one software package into the other and registering the datasets - can the software provided with the instrument from one manufacturer recognize the target data obtained from an instrument from another manufacturer as targets? The solution of these issues should be described in the scan plan.

3.3. Data

If two or more 3D imaging systems are used in the project, any compatibility issues between the exported data for the different systems should be identified. Any problems arising from the data incompatibility should be described and potential solutions should be proposed. For example, Instrument 1 obtains x,y,z and intensity data and Instrument 2 obtains x, y, z, intensity, and color data. If the software used to display the data is associated with Instrument 1, the color information from Instrument 2 may not be displayed. Other internal data specific to the instruments may also be lost in the export process.

If a third party software is used to process the data, the service provider should state if the software can import the native format of the instrument(s) used in the project.

As mentioned in Section 1.1, the amount of data obtained by a 3D imaging system can be an issue as the number of points can easily exceed 100 million. The ability to manipulate and display the point clouds may be an issue. This issue will become moot with the advancement of PC technology.

3.4. Control network

A control network must be of an order of accuracy higher than what it is being used for. The accuracy standards used to establish the control network should, at a minimum, conform to those for a Third-order, Class I Survey (FGDC-STD-007.4-2000). It is recommended that each point in the network be referenced to at least two, preferably three, surrounding permanent objects or points by measurement of angle, distance, and height.

The control network is mainly used to check the accuracy of the deliverables (e.g., point cloud, 3D models). The distance between any two points in the control network would be considered as truth and would be compared to the distance between the same two points in, for example, the point cloud, 2D drawing, or 3D model. Acceptance or rejection would be based on a pre-defined criteria.

The control network can also be used as a field check of the 3D imaging system to determine if the instrument is functioning within the instrument's specifications.

3.5. Deliverables

As alluded to in earlier sections, in addition to the instrument error, the specified tolerance for acceptance or rejection of a deliverable should consider the frame of reference used (Section 2.4 - discussion of Area of Interest) and modeling error (Section 1.4.6). At this time, the uncertainty of a point in a point cloud and errors from registration and modeling cannot be quantified empirically; thus, the determination of whether a deliverable meets the specification relies heavily on making physical measurements and comparing these measurements to "truth".

“True” distances are distances obtained from the control network, independent measurements, and/or artifact dimensions. The control network and independent measurements can either be obtained by the service provider or by an independent licensed surveyor hired by GSA.

“Calculated” distances are distances obtained from the deliverables, for example, point cloud, 2D models, plans, and 3D models. The difference between the calculated distance and the true distance is the distance error. Acceptance or rejection of a deliverable would depend on the error bounds specified in the solicitation or contract. For example, for a 3D model, if X % of the errors were less than or equal to Y mm, then the 3D model is acceptable. Where

- X ranges from 70 to 100 and is specified in the contract
- Y depends on the specified tolerance (different levels of Y may be set for different levels of detail) and is specified in the contract

It is important to remember that ALL measurements have errors. The reported measurement from the deliverables should be within the uncertainty of the secondary measurement system.

3.5.1. Point Cloud

Several methods may be used to evaluate the point cloud integrity:

- Control network: As described in Section 3.4, comparison of the distances between points on the control network and the same points in the point cloud.
- Independent measurements: Comparison of distances between distinguishable features in a point cloud to corresponding distances obtained using another method (e.g., total station). This method requires fitting primitives such as planes, lines, spheres and independently obtained measurements.
- Use of an artifact: The artifact should be of known length (e.g., ball bar, see Figure 21) placed within an area of interest, and scanned with the same settings used to capture the scene. The length of the artifact as obtained using the 3D imaging system would be compared to the known length of the artifact. This comparison would give an indication of the accuracy of the measured values.



Figure 21: 3 m ball bar with 2 SMRs (Spherically Mounted Retroreflectors) on the ends of the bar. (Courtesy of NIST)

A disadvantage of using an artifact is that the artifact will generally not be the same scale as the other objects in the project. For practical purposes, the length of the artifact would generally be about 10 ft while the dimensions of the structures would generally be much larger.

The selection of the number of distances to check will be pre-determined by GSA. The distances to be checked should be selected at random and should be representative of distances that are interest (e.g., clear distance between columns, window widths, room dimensions).

3.5.2. 2D Drawings, Plans

Evaluation of the accuracy of 2D drawings or plans would mainly rely on comparing the distances as reported in the 2D drawing or plans with the corresponding distances obtained through independent means using an instrument with higher or similar accuracy to the 3D imaging system.

As with evaluating point cloud integrity, the selection of the number of distances to check will be pre-determined by GSA. The distances to be checked would be selected at random should be representative of distances that are interest (e.g., room dimensions).

3.5.3. 3D CAD Models

3.5.3.1. *Geometric Integrity*

Evaluation of the accuracy of 3D CAD models relies mainly on the comparison of the distances obtained from the 3D CAD model with the corresponding distances obtained through independent means using an instrument with higher or similar accuracy to the 3D imaging system. Some suggested measurements to check are:

- horizontal distances (e.g., wall width, column spacing)
- vertical distances (e.g., wall height, building height)
- diagonal distances (e.g., wall corner to wall corner)
- angle between two planes in the model (e.g., corner of a room)
- verticality (e.g., verticality of a column or wall)

Other types of measurements that can be used for comparisons are column widths (circular columns, if available, would be preferable as most of the other measurements are of planar surfaces), door/window width, and pipe widths.

The number of distances to be checked will be pre-determined by GSA. The distances and locations to be checked would be selected at random and should be representative of distances that are of interest (e.g., clear distance between columns, room dimensions).

3.5.3.2. *Resolution*

A method to check if the specified resolution is achieved is by manual checking. If the specification requires identification of cracks of a specified minimum size, then checking the existence of actual cracks with the reported cracks would verify if the resolution was achieved or not.

Another method to determine if the specified resolution would be achievable based solely on the point cloud data is to measure the point spacing between the points in the area of interest. If the point spacing is larger than the required resolution, then achieving the specified resolution may be problematic unless other data or information are available from other sources. This method may not be possible if the point cloud is very dense thus making the determination of the point spacing very difficult.

3.6. Quality Control

Most 3D imaging software products provides quality reports that identify the fidelity of the scans and the registration. Service providers should at a minimum provide a narrative report that proves the accuracy of their work and the accuracy of the control network, if used. The contents of this report should include the quality report from the 3D imaging software.

Past GSA 3D imaging service providers have utilized two measures to help reduce errors in data. The first is to independently measure the locations of targets and key points in order to verify and correct raw scan data. The other measure used in the past is to scan targets twice, at the beginning and end of each scan operation, in order to ensure the scanning equipment has not moved during the scan.

It is also very important that the quality control plan describe the methods that will be used in the field to check that all necessary data is captured (e.g., no data missing for critical areas, too many shadows) and that the required resolution can be extracted from the 3D data. The field checks should include, at a minimum, viewing of the data to ensure that there is good coverage and comparison of random measurements (measurements from point cloud vs. same measurements using another method) of typical sections or key features. These checks will help reduce:

- the need to return to the job site at a later time to obtain missing data or to augment insufficient data
- project delays due to the missing or insufficient data
- incidences of not being able to produce a deliverable due to bad or no data

The occurrence of these checks should also be specified (e.g., at each instrument location prior to moving to the next instrument location, at the end of each day).

3.7. Personnel and training

There are currently no requirements in terms of licensing of 3D imaging service providers. Therefore, the experience of the service provider is critical. Service provider experience can be assessed by:

- work on previous projects of similar magnitude - for large projects, past experience not only speaks to the service provider's ability to manage large projects but also the ability to handle large datasets
- accuracy achieved on previous projects
- training in the use of the hardware and software - familiarity with and understanding of the hardware and software are crucial for efficient work processes and in recognizing and resolving problems
- references from past projects



Post-processing of 3D imaging data and the generation of 2D drawings and 3D models from these data are time intensive tasks and require specific expertise. Determining a service provider's experience in this area is as important as ascertaining his/her expertise in data collection.



section 04: project management

section 4: project management

A GSA project manager's role has changed somewhat for 3D imaging projects. The key to a successful contract, 3D imaging or any other, is proper specification of the deliverables as well as communication and coordination with tenant activities. Additional duties include early and thorough project design and planning, educating tenants, ensuring security is in place when needed, and timely transfer of acceptable and readable models and drawings. Project managers should recognize the diverse group of tenants and officials being affected by 3D imaging services. He or she shall ensure all service provider access requirements are met and security is acceptable to all tenants. Project managers should review this guide to better understand 3D imaging services and what is required.

4.1. Coordination issues unique to GSA

GSA maintains and operates facilities with a wide range of tenants. The operational requirements of these tenants are paramount to facility maintenance or upgrades. The most detrimental obstacle to a 3D imaging service provider is having access denied once notice to proceed is given. Any restricted access and any cleared access areas should be clearly communicated to the service providers and tenants. Many tenants, such as the U.S. Courts, U.S. Marshals, Bureau of Prisons, FBI, Drug Enforcement Administration (DEA), and U.S. Attorneys offices in GSA facilities may require longer advance notice (e.g., required background checks of work crew) and approval for 3D imaging service providers to enter their premises.

In many cases, education and communications with the affected tenants should be pursued by the government to alleviate coordination and security issues. GSA project teams should take proactive roles in assisting the 3D imaging service provider to coordinate with the tenants. Notices of upcoming work should be given to tenant liaisons in sufficient advance so that the tenants can make any preparations if needed. Additional coordination in person with key tenants should be planned during scope development.

After-hours work is a viable option to avoid disruption of daily operations. However, the added costs of security guards during this time and on weekends are typically chargeable to project funds. If after-hours work is anticipated during project planning, the costs of employing security guards, if necessary, should be taken into consideration. Project managers should allot time in the contract to help the service provider meet the required completion date. If at all possible, project managers shall identify requirements for after-hours work during project programming.

4.2. Project Schedule

Most 3D imaging project consists of three major phases: procurement, planning, and execution. A possible timeline for 3D imaging project is shown in Figure 22.

3D Imaging Project Timeline

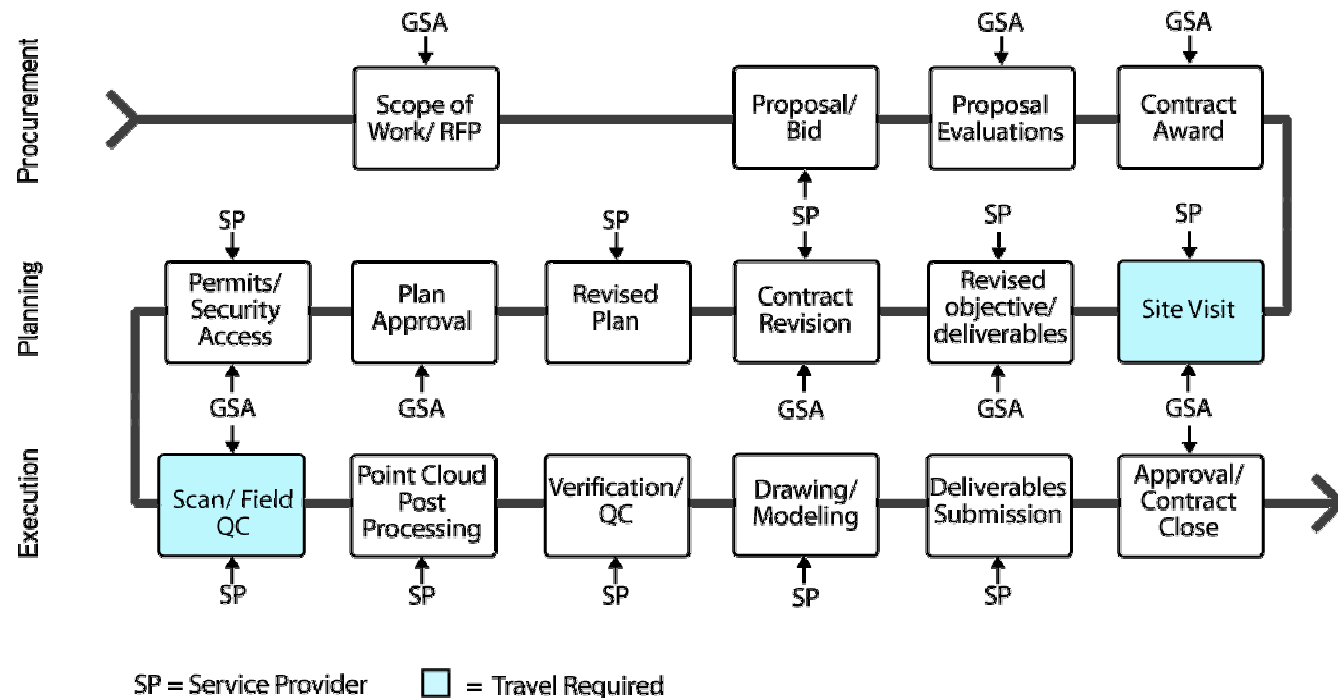

Figure 22: 3D Imaging Project Timeline.

4.2.1. Solicitation

This length of this phase is approximately 1 to 2 months. The solicitation phase begins with the generation of a request for proposal (RFP) which includes a statement of work (SOW) - see Section 3 for issues/considerations when preparing the SOW. A very critical part of the development of the SOW is defining the objectives and the deliverables of the project (Section 2). This is important as changes to the work effort and deliverables after the award of the contract may require another round of RFP. The determination of the deliverables should include not only the type and required tolerances but how the deliverables will be evaluated as being acceptable to GSA.

The generation and distribution of the RFP should be in accordance with GSA procurement requirements. Adequate time must be allocated for service providers to develop their bids as this requires development of scan, post processing, and quality control plans. For large projects, a site visit may be beneficial as this would allow potential service providers to generate a more detailed plan and thus a more accurate bid. Proposal evaluations are conducted per the criteria listed in the SOW.

4.2.2. Planning

This phase involves approximately 1 to 2 months of effort. If the scope or deliverables have changed since the award of the contract, then a revised SOW must be drafted (Caution: this may require another round of RFP be conducted based on the new SOW). Based on the revised SOW, revisions of the scan, model, and/or quality control plans may be necessary and these should be re-submitted by the service provider.

The planning phase should initiate with an on-site meeting. This meeting should include the GSA representatives, contracted service providers and the team that will ultimately be using the 3D imaging data, such as the contracted architecture or engineering firm (If the A/E firm has not yet been contracted, then special provisions need to be implemented in their contract dictating the use of 3D imaging data). Objectives must be defined clearly in this meeting and be vetted by all parties so that the service provider can revise the plan, if needed, in order to furnish the deliverables in the most efficient manner. A site walkthrough must identify all potential obstacles (e.g., vegetation, structures, traffic, surface finish) that could occur during the field work. Permissions and site access should also be discussed at this time.

All required permissions need to be obtained and coordination with local authorities, if necessary, should occur during this phase.

4.2.3. Execution

The execution phase entails about 2 to 6 months of effort. This phase includes field work which involves acquisition of data and often includes some registration of scans in the field to determine any missing data. The second part to execution is data post-processing (e.g., registration, editing, cleaning of data, fitting, modeling, exporting data into required formats) to obtain the required deliverables. In most cases, the post-processing tasks are more time intensive than the field work.

4.2.4. Factors Affecting Project Schedule

The time estimates in Section 4.2 are based on previous projects involving several multi-story buildings. There are many factors which affect the length and cost of a project, for example:

- size of the project (e.g., single building vs. 25 buildings) affects all phases
- specified tolerances and resolution
 - tighter tolerances and higher resolutions increase time and cost
 - affects field work and post-processing
- security/site access

- limited access, restricted work times, accompaniment of work crew by security personnel will increase time and cost
- affects field work
- required deliverables
 - any modeling will increase the time and cost
 - affects post-processing
- skill of the service provider - mainly affects field work and post-processing
- change in scope of work - affects field work and/or post-processing
- weather - affects field work

4.3. GSA 3D Imaging Applications

As mentioned in Section 2.2.1, clear objectives and how the data will be used, are critical in ensuring that the project manager gets what is required in a cost effective manner. Some example objectives of previous GSA 3D imaging projects are:

- Repair and restoration of a historic building façade. The 3D imaging data was used to provide 2D CAD elevations and section profiles, 3D geometric models, and/or 3D building information models to document as-built conditions. The data will also be used to assist in developing architectural and engineering restoration and renovation designs.
- Generation of 2D CAD and/or elevations of building exteriors where none exists. There was also a need to document representative as-built conditions due to deficiencies in the original construction. The 3D imaging data will be used to analyze beam deflections and enable designers to develop potential retrofit measures.
- Provide a facility plan to map and link several buildings in a BIM site model. Visualization of data in 3D will greatly aid in the development of physical security and force protection models.
- Document mechanical, electrical, plumbing (MEP)/above ceiling conditions. The 3D imaging data was used to develop a reflected ceiling plan.
- Document roof patterns.
- Document deformation or current assessment of existing structures.

4.4. Information Management and Delivery

Information management in 3D imaging contracts is critical, especially when large facilities with multiple floors are involved. Terabytes of information are typical for large buildings and/or high definition scans. Service providers also develop intricate labeling and documentation procedures during the scanning process. They should explain these procedures and labeling upon

submission of the electronic deliverables. Project managers should negotiate the best medium of data transfer during the contract negotiation phase. Project managers should also consider taking partial delivery of information (e.g., by floors or sections of facilities) during the contract if they feel this is beneficial to the contract.

4.5. 3D Imaging Targets

Targets are commonly used in 3D imaging projects to register scans and to tie in to the control network. These targets vary in types (planar or 3D), size, and material. Magnetized targets are commonly used as they can easily be positioned on ferrous surfaces. Planar stick-on targets are also used. At a minimum, targets need to be left in place for the duration of the scan and in some situations, targets need to be left in place overnight or for several days. It is important to inform security and other facility personnel that targets are not to be disturbed and should remain in place unless removed by the service provider. Moving or removing the targets can invalidate data and require rework. Conversely, service providers should make every attempt to minimize the time targets need to be left in place and remove targets when they are no longer necessary. If the spaces are occupied during the operation, project managers should inform tenants not to remove or block the targets.

4.6. Environmental Conditions

As described in Section 1.4.3, environmental conditions can affect the measurements. These effects are not unique to 3D imaging systems as the environmental conditions will have similar effects on traditional survey instruments or other metrology instruments. However, since the scan time can be on the order of tens of minutes compared to less than a second for survey instruments (single point measurement), the data will be noisier. For example, windy conditions can cause the instrument as well as objects in the scene to move, and the chances of stray objects (e.g., leaf, bird, trash) appearing in the scene causing outliers are greater.

As mentioned in Section 1.4.3, thermal expansion of objects could cause errors in registration and fitting. An example of such an occurrence would be two sides of a building measured on a hot sunny afternoon and the remaining two sides of the building measured at night or on another day when it was cooler. This situation may be unavoidable as the field work often spans several days if not weeks. The project manager should be cognizant of these sources of errors.



appendix a: terminology and references

appendix a: terminology and references

A.1. Terminology

accuracy of measurement, n--closeness of the agreement between the result of a measurement and a true value of the measurand. (VIM¹ 3.5)

Discussion--“Accuracy” is a qualitative concept.

*Discussion--*The term “precision” should not be used for “accuracy.”

bias, n--systematic error and is the difference between the average or expected value of a distribution and the true value. (adapted from the NIST/SEMATECH e-Handbook)

*Discussion--*In metrology, the difference between precision and accuracy is that measures of precision are not affected by bias, whereas accuracy measures degrade as bias increases.

control points², n-- visible or inferable reference points common to both an independent source and the product itself (point-cloud).

*Discussion--*An example of an inferable reference point is the center of a sphere, while not visible, it can be obtained by processing suitable data. Control points are sometimes referred to as fiduciarities.

*Discussion--*Control points may be used to:

- Register two or more point clouds.
- Infer the accuracy of the derived output from a 3D imaging system. Example: Control points are designated in a scan region and the locations of these control points (reference locations) are obtained by an instrument of higher accuracy than the 3D imaging system used. The distances (reference distances) between any two of these control points can be calculated using the reference locations. Similarly, the distances (measured distances) between corresponding control points in the point cloud or model can also be calculated using the data obtained by the 3D imaging system. The differences between the measured and reference distances or the errors may be used to infer the accuracy of the point cloud or model. However, the errors are only known at the control points and may or may not be representative of the entire point cloud or model.

¹ VIM is an acronym for the International Vocabulary of Basic and General Terms in Metrology standard.

² The proposed definition is being considered by ASTM E57.01, Terminology Subcommittee and has not been approved yet.

error (of measurement), n --result of a measurement minus a true value of the measurand. (VIM 3.10)

field of regard (FOR)³, n -- maximum horizontal and vertical angular extents of an area of interest that can be measured by a 3D imaging system as a result of scanning or reorienting the instrument's primary receiving axis (see Figure 22).

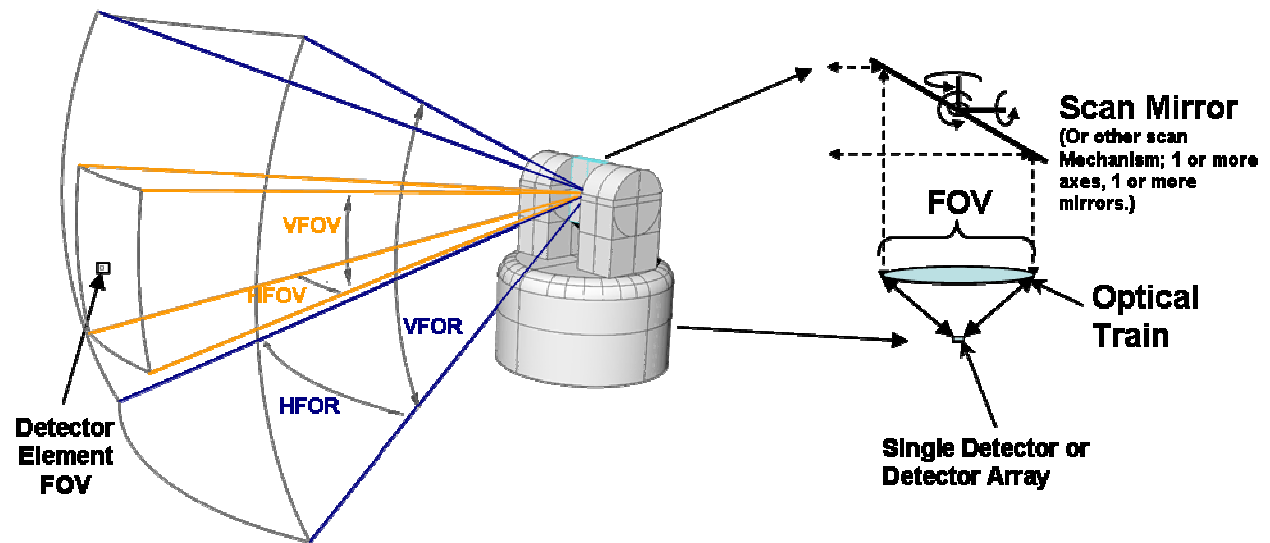

Figure 23: Schematic illustrating field of regard (FOR) and field of view (FOV) for a 3D imaging system with mechanical scanning

Discussion--For a system with no mechanical scanning of the instrument's primary receiving axis, the FOR equals the FOV.

Discussion--The reference to "scanning" accounts for the fact that some instruments use external motors and/or moving mirrors to physically move the instrument's primary receiving axis to increase the measured area.

³ See footnote 1.

Discussion--The units for field of regard (FOR) may be any angular measure (e.g., degrees, radians). The definitions horizontal field of regard (HFOR) and vertical field of regard (VFOR) can also be used.

Discussion--The term “field of regard” is preferred over the term “total field of view” to avoid confusion with “field of view”.

Related term: field of view (FOV)

field of view (FOV)⁴, n--maximum horizontal and vertical angular extents of an area of interest that can be measured by one or more detectors in a 3D imaging system, without scanning or reorienting the instrument’s primary receiving axis (see Figure 22).

Discussion--This definition applies to any 3D imaging system, whether the system has a single detector or an array of detectors in its focal plane. Single pixel detector systems can only measure one object point at a time, so the FOV of a single pixel detector system is frequently scanned mechanically for 3D imaging applications. Systems with arrays of detectors measure multiple object points simultaneously. The FOV of systems with a detector array can also be scanned mechanically.

Discussion--The reference to “scanning” accounts for the fact that some instruments use external motors and/or moving mirrors to physically move the instrument’s primary receiving axis to increase the field of view - see field of regard.

Discussion--In an optical range sensor system, the receiving instrument defines the field of view as the area that is visible through the instrument when the optical head of the instrument is not moving. The reference to “repositioning” accounts for the fact that some instruments use external motors and/or moving mirrors to physically move the principal optical axis of the instrument to increase the “total field of view”; a metric for these types of systems is provided elsewhere - see “field of regard”.

Discussion--The units for field of view (FOV) may be any angular measure (e.g., degrees, radians). The definitions horizontal field of view (HFOV) and vertical field of view (VFOV) can also be used.

Discussion--The term “field of regard” is preferred over the term “total field of view” to avoid confusion with “field of view”.

Related term: field of regard (FOR)

point cloud⁵, n—a collection of data points in 3D space (frequently in the hundreds of thousands), for example as obtained using a 3D imaging system.

⁴ See footnote 1.

⁵ See footnote 1.

Discussion--The distance between points is generally non-uniform and hence all three coordinates (Cartesian or spherical) for each point must be specifically encoded.

precision, *n*--the variability of a measurement process around its average value. (NIST/SEMATECH e-Handbook)

registration⁶, *n*--the process of determining transformations and applying them to a set of coordinates to transform that set from one coordinate system into a fixed one so that points that are common will have the same coordinates in the transformed fixed system.

Discussion--the process of determining the transformations often involves the minimization of an error function, such as the minimization of the distance between two sets of coordinates.

Discussion--Registration is required when two or more sets of coordinate data (e.g., point cloud, surveyed points, or reference points from a CAD model) are obtained with each set having its own frame of reference. For example, often two point clouds obtained by a 3D imaging system from different locations must be registered so that they have a common coordinate system.

Discussion--For static ground-based 3D imaging systems, the transformations are often rigid body transformations which implies that the distances between points within a data set do not change after applying transformations (rotations and translations).

Discussion--Examples of the registration process can include target-to-target, cloud-to-cloud, and cloud-to-model.

3D imaging system⁷, *n*--a non-contact instrument that is used to measure the range and bearing to and/or the 3D coordinates of points on an object or within a region of interest.

Discussion--Examples of a 3D imaging system are laser scanners (also known as LADARs or LIDARs or laser radars), optical range cameras (also known as flash LADARs or 3D range cameras), triangulation-based systems such as those using pattern projectors or lasers, and other systems based on interferometry.

Discussion--In general, the information gathered by a 3D imaging system is a collection of *n*-tuples, where in addition to spherical or Cartesian coordinates, each *n*-tuple can also include return pulse intensity, color, time stamp, identifier, polarization, etc.

⁶ See footnote 1.

⁷ Reprinted, with permission from E2544-07 Standard Terminology for Three-Dimensional (3-D) Imaging Systems, copyright ASTM International, 100 Barr Harbor Drive, West Conshohocken, PA 19428.

A.2. References

ASTM E 2544-07, “Terminology for 3D Imaging Systems,” ASTM International (to be published).

El-Hakim, S. F. and Beraldin, J.-A., “Sensor Integration and Visualization,” Chapter 10 in “Applications of 3D Measurements from Images,” edited by J. Fryer, A. Mitchell and J. Chandler, Whittles Publishing, UK, 2007.

Federal Geographic Data Committee, “Geospatial Positioning Accuracy Standards, Part 4: Standards for A/E/C and Facility Management ,” FGDC-STD-007.4-2002.

Godin, G., Rioux, M., Beraldin, J.-A., Levoy, M., Cournoyer, L., Blais, F., “An assessment of laser range measurement on marble surfaces,” 5th Conf. on Optical 3D Measurement Techniques, Wien, Austria, Oct. 1-4, 2001, pp 49-56.

Greaves, T. and Jenkins, B. [2004], “Capturing Existing Conditions with Terrestrial Laser Scanning: A Report on Opportunities, Challenges and Best Practices for Owners, Operators, Engineers/Construction Contractors and Surveyors of Built Assets and Civil Infrastructure,” Spar Point Research LLC, Danvers, MA.

International Organization for Standardization, International Vocabulary of Basic and General Terms in Metrology, 1993.

National Institute of Standards and Technology (NIST), <http://www.itl.nist.gov/div898/handbook/>.



acknowledgements

The development of this provisional version of the PBS Building Information Modeling Guide has been a collaborative effort among a cadre of very knowledgeable consultants, working with a number of PBS associates in the Office of the Chief Architect and the different GSA regions. Significant contributors are listed below:

GSA Public Buildings Service

- Charles Matta, FAIA
Director, Center for Federal Buildings and Modernizations
Office of the Chief Architect
- Calvin Kam, Ph.D.
National 3D-4D-BIM Program Manager, Center for Federal Buildings and Modernizations
Office of the Chief Architect

GSA Consultants

- Alan Lytle
Leader, Construction Metrology and Automation Group
National Institute of Standards and Technology
- Gerry Cheok
Research Civil Engineer
National Institute of Standards and Technology
- Jordan Brandt
Harvard University
- Ivan Panushev
Harvard University
- Eric Haun
Stanford University



3D-4D Building Information Modeling

Since 2003, the General Services Administration (GSA) through its Public Buildings Service (PBS) Office of Chief Architect (OCA) has established the National 3D-4D-BIM Program. OCA has completed 10 pilot projects. It has 11 pilot projects underway in its current capital program, while assessing and supporting 3D, 4D, Building Information Modeling (BIM) applications in over 25 ongoing projects across the nation. The power of visualization, coordination, simulation, and optimization from three-dimensional (3D), four-dimensional (4D), and BIM computer technologies allow GSA to more effectively meet customer, design, construction, and program requirements. GSA is committed to a strategic and incremental adoption of 3D, 4D, BIM technologies.

There is a progression from 2D to 3D, 4D and BIM. While 3D models make valuable contributions to communications, not all 3D models qualify as BIM models since a 3D geometric representation is only part of the BIM concept.

Critical to successful integration of computer models into project coordination, simulation, and optimization is the inclusion of information—the “I” in BIM—to generate feedback. As a shared knowledge resource, BIM can serve as a reliable basis for decision making and reduce the need for re-gathering or re-formatting information. GSA is currently exploring the use of BIM technology throughout a project’s lifecycle in the following areas: spatial program validation, 4D phasing, laser scanning, energy and sustainability, and courts design validation.

For all major projects (prospectus-level) receiving design funding in Fiscal Year 2007 and beyond, GSA will require spatial program BIMs be the minimum requirements for submission to OCA for Final Concept approvals by the PBS Commissioner and the Chief Architect. At the same time, all GSA projects are encouraged to deploy mature 3D, 4D, and BIM technologies—spatial program validation and beyond—at strategic project phases in support of specific project challenges. The following are highlights of the GSA National 3D-4D-BIM Program:

- Established policy to phase in 3D, 4D, and BIM adoption for all major projects
- Leading 3D-4D-BIM pilot application on current capital projects
- Providing expert support and assessment for ongoing capital projects to incorporate 3D, 4D, and BIM technologies
- Assessing industry readiness and technology maturity
- Developed GSA-specific incentives for 3D-4D-BIM
- Developed solicitation and contractual language for 3D-4D-BIM services
- Partnered with BIM vendors, professional associations, open standard organizations, and academic/research institutions
- Formulating the GSA BIM Guide including:
 - Series 01 – 3D-4D-BIM Overview
 - Series 02 – Spatial Program Validation
 - Upcoming:
 - 4D Phasing
 - 3D Laser Scanning
 - Energy and Sustainability
 - Courts Design Validation

The shortcut to this page is www.gsa.gov/bim.

Last Reviewed 10/16/2006

Printer Friendly format

For further information about this *GSA BIM Guide Series 03 - BIM Guide For 3D Imaging* or to submit comments or questions, please visit the National 3D-4D-BIM webpage at <http://www.gsa.gov/bim> or contact:

The National 3D-4D-BIM Program
Office of the Chief Architect
Public Buildings Service
U.S. General Services Administration
1800 F Street NW Suite 3341
Washington, DC 20405