

National Weather Service  
Observing Handbook No. 2



# Cooperative Station Observations

Observing Systems Branch  
Office of Systems Operations

Silver Spring, Md.  
July 1989

**U.S. DEPARTMENT OF COMMERCE**  
Robert Mosbacher, Secretary

**National Oceanic and Atmospheric Administration**  
William E. Evans, Under Secretary and Administrator

**National Weather Service**  
Elbert W. Friday, Jr., Director

This Handbook supersedes "Substation Observation Handbook No. 2," 1970

First Edition, 1989

Office of Systems Operations

Observing Systems Branch

Silver Spring, Maryland

## PREFACE

John Companius Holm's weather records, taken without the benefit of instruments in 1644 and 1645, were the earliest known observations in the United States. Subsequently such famous personages as George Washington, Thomas Jefferson, and Benjamin Franklin maintained weather records spanning many years.

The first extensive network of cooperative stations was set up in the 1890's as the result of an act of Congress in 1890 that established the Weather Bureau. Today, there are over 11,000 volunteer cooperative observers scattered over the 50 states, taking observations seven days a week throughout the year.

The above observers regularly and conscientiously contribute their time so that their observations can provide the vital information needed to define the climate in their areas. The records are also used constantly to answer questions and guide the actions of public agencies, agricultural and commercial organizations, and individuals. Their records also form a basis for preparedness for national and local emergencies, such as flooding.

## TABLE OF CONTENTS

1. COOPERATIVE WEATHER OBSERVER PROGRAM .....	1
1.1 PURPOSE OF HANDBOOK .....	1
1.2 DEFINITION OF COOPERATIVE STATION .....	1
1.3 TYPES OF STATIONS .....	1
1.3.1 PRECIPITATION .....	1
1.3.2 AIR TEMPERATURE .....	1
1.3.3 RIVER STAGE .....	1
1.3.4 EVAPORATION AND WIND MOVEMENT .....	2
1.3.5 SOIL TEMPERATURE .....	2
1.3.6 AGRICULTURAL DATA .....	2
1.3.7 ATMOSPHERIC PHENOMENA .....	2
1.3.8 FLASH FLOODING .....	2
1.3.9 ROAD HAZARDS .....	2
1.4 ESTABLISHING, MAINTAINING, AND INSPECTING STATIONS .....	3
1.4.1 MAINTENANCE .....	3
1.4.2 REQUESTING SUPPLIES .....	3
1.4.3 REPORTING DEFECTIVE INSTRUMENTS .....	4
1.5 PREFERRED TIME FOR TAKING OBSERVATIONS .....	4
1.5.1 RESETTING INSTRUMENTS .....	4
1.6 FORMS .....	4
1.6.1 LEGIBILITY .....	4
1.6.2 DISPOSITION OF RECORDS .....	5
2. PRECIPITATION .....	6
2.1 INTRODUCTION .....	6
2.1.1 PRECIPITATION GAGES .....	6
2.1.2 EXPOSURE OF GAGES .....	6
2.2 TYPES OF PRECIPITATION GAGES .....	8

2.2.1	EIGHT-INCH NONRECORDING GAGE . . . . .	8
2.2.1.1	INSTALLATION AND MAINTENANCE . . . . .	9
2.2.2	FOUR-INCH NONRECORDING GAGE . . . . .	9
2.2.3	WEIGHING-TYPE RECORDING GAGE . . . . .	9
2.2.4	UNIVERSAL GAGE . . . . .	10
2.2.4.1	CALIBRATION AND EQUIPMENT PROBLEMS . . . . .	11
2.2.4.2	GAINING ACCESS TO BUCKET AND CHART MECHANISM . . . . .	11
2.2.4.3	PREPARATION OF CHARTS . . . . .	11
2.2.4.4	INSTALLING AND REMOVING CHARTS . . . . .	11
2.2.4.5	CHANGING CHARTS ON GAGES WITH LARGE INSPECTION DOORS . . . . .	12
2.2.4.6	CHANGING CHARTS ON GAGES WITH SMALL INSPECTION DOORS . . . . .	13
2.2.4.7	COMPLETING THE CHARTS . . . . .	13
2.2.5	BELFORT (FISCHER & PORTER) PUNCH TAPE GAGE . . . . .	14
2.2.5.1	OPERATION AND MAINTENANCE . . . . .	14
2.2.5.2	SETTING THE TAPE TO THE CORRECT TIME . . . . .	16
2.2.6	WINTER OPERATION . . . . .	17
2.2.7	ROUTINE MAINTENANCE . . . . .	18
2.3	HOW TO MEASURE RAINFALL . . . . .	18
2.3.1	BELFORT GAGE . . . . .	18
2.3.2	UNIVERSAL GAGE . . . . .	18
2.3.3	FOUR-INCH NONRECORDING GAGE . . . . .	18
2.3.4	EIGHT-INCH NONRECORDING GAGE . . . . .	18
2.4	MEASURING THE WATER EQUIVALENT OF SNOWFALL . . . . .	19
2.4.1	OBTAINING CORE SAMPLES OF SNOW . . . . .	20
2.5	MEASURING THE DEPTH OF FROZEN PRECIPITATION . . . . .	20
2.5.1	DEFINITION . . . . .	20
2.5.2	MEASURING WITH A MEASURING STICK . . . . .	21
2.5.3	MEASURING NEW SNOW FALLING ON TOP OF OLD SNOW . . . . .	21
2.5.4	SNOW BOARDS . . . . .	21
2.5.5	SNOW STAKES . . . . .	22
2.6	KEEPING AND MAILING RECORDS . . . . .	22
2.6.1	PURPOSE . . . . .	22
2.6.2	WS FORM B-82 (FORMERLY WS FORM F-7), "OFFICIAL WEATHER OBSERVER'S RECORD . . . . .	23
2.6.3	WS FORM B-91, "RECORD OF RIVER AND CLIMATOLOGICAL OBSERVATIONS . . . . .	23

2.7 REAL-TIME RECORDING OF PRECIPITATION, TEMPERATURES, AND HAZARDOUS WEATHER EVENTS .....	24
3. AIR TEMPERATURE .....	26
3.1 DEFINITIONS .....	26
3.2 TYPES OF THERMOMETERS .....	26
3.3 INSTRUMENT SHELTERS .....	26
3.3.1 SHELTER PLACEMENT .....	27
3.3.2 SHELTER MAINTENANCE .....	28
3.4 LIQUID-IN-GLASS MAXIMUM AND MINIMUM THERMOMETERS .....	28
3.4.1 MAXIMUM THERMOMETER—HOW IT WORKS .....	28
3.4.2 MINIMUM THERMOMETER—HOW IT WORKS .....	28
3.4.3 MOUNTING AND MAINTAINING THE THERMOMETER SUPPORT .....	29
3.4.4 MOUNTING THE THERMOMETERS .....	30
3.4.5 HOW TO READ AND RECORD TEMPERATURES .....	30
3.4.5.1 READING AND SETTING THE MAXIMUM THERMOMETER .....	31
3.4.5.2 READING AND SETTING THE MINIMUM THERMOMETER .....	32
3.4.5.3 READING THE CURRENT TEMPERATURE .....	33
3.4.6 CORRECTING THERMOMETER ERRORS .....	33
3.4.6.1 CORRECTING MAXIMUM THERMOMETERS .....	33
3.4.6.2 CORRECTING MINIMUM THERMOMETERS .....	34
3.5 MAXIMUM/MINIMUM TEMPERATURE SYSTEM (MMTS) .....	35
3.5.1 INITIAL CHECKOUT OF INSTRUMENT .....	36
3.5.2 CALIBRATION .....	37
3.5.3 OPERATION .....	37
3.5.4 IDENTIFYING AND CORRECTING ERRONEOUS MAXIMUM AND MINIMUM TEMPERATURES .....	37
3.5.5 "HELP" AND BLINKING DISPLAYS .....	38
3.5.6 ENTRY OF TEMPERATURE READINGS ON WS FORM B-91 .....	38
3.5.7 COMMON ERRORS TO AVOID .....	38
4. RIVER STAGES AND RELATED PRECIPITATION OBSERVATIONS .....	40
4.1 INTRODUCTION .....	40
4.2 STAFF RIVER GAGE .....	40

4.3	WIRE WEIGHT GAGE .....	41
4.4	PROFILE GAGE .....	42
4.5	RIVER GAGE LOCATION .....	43
4.6	RELOCATING RIVER GAGES .....	43
4.7	TIMES OF RIVER STAGE AND PRECIPITATION OBSERVATIONS .....	43
4.8	WHEN TO REPORT .....	44
4.9	WHAT TO REPORT .....	44
4.10	REPORT FORMS .....	45
5.	EVAPORATION STATION OBSERVATIONS .....	45
5.1	INTRODUCTION .....	46
5.2	SETTING UP THE OBSERVING SITE .....	46
5.2.1	EXPOSURE OF EQUIPMENT .....	46
5.2.2	PLOT LAYOUT .....	47
5.2.3	ENCLOSURE .....	47
5.3	EVAPORATION EQUIPMENT .....	47
5.3.1	EVAPORATION PAN .....	48
5.3.1.1	INSTALLATION .....	48
5.3.1.2	MAINTENANCE .....	49
5.3.1.3	CONTROL OF ALGAE .....	49
5.3.2	FIXED POINT GAGE .....	49
5.3.2.1	MEASURING THE AMOUNT OF EVAPORATION .....	50
5.3.3	WATER STORAGE TANK .....	52
5.3.4	ANEMOMETER .....	52
5.3.4.1	INSTALLATION .....	52
5.3.4.2	MAINTENANCE .....	52
5.3.4.3	WIND MOVEMENT READINGS .....	53
5.3.4.4	DATA FROM 5-DIGIT-COUNTER TYPE ANEMOMETERS .....	53
5.3.5	DRY- AND WET-BULB TEMPERATURES .....	54
5.3.5.1	TYPES OF PSYCHROMETERS .....	54
5.3.5.2	MAINTENANCE .....	54
5.3.5.3	MOISTENING THE WET-BULB .....	54
5.3.5.4	TAKING PSYCHROMETER OBSERVATIONS .....	56

5.3.6	WATER TEMPERATURES	56
5.3.6.1	INSTALLATION	57
5.3.6.1.1	FLOAT-MOUNTED THERMOMETER	57
5.3.6.1.2	SUBMERGED-MOUNT THERMOMETER	57
5.3.6.1.3	RECORDING THERMOMETERS	57
5.3.6.2	MAINTENANCE	57
5.3.6.3	ACCURACY CHECKS	58
5.3.6.3.1	REJOINING SEPARATED MERCURY COLUMNS	58
5.3.6.4	READING AND RESETTING THE SIX'S THERMOMETER	58
5.4	RECORDING OBSERVATIONS FROM EVAPORATION STATIONS	58
6.	SOIL TEMPERATURE STATIONS	60
6.1	INTRODUCTION	60
6.2	EXPOSURE AND PROTECTION OF EQUIPMENT	60
6.2.1	SIZE OF PLOT	60
6.3	MAINTENANCE OF PLOTS	60
6.3.1	SOD-COVERED PLOTS	60
6.3.2	NATURAL COVER	61
6.3.3	BARE SOIL	61
6.3.4	SNOW COVER	61
6.4	TYPES OF THERMOMETERS AND READINGS	61
6.4.1	INSTALLATION OF THERMOMETERS	62
6.5	SHELTERS	62
6.5.1	THERMOMETER HEAD SHELTERS	62
6.5.2	LOCATION OF SHELTER	63
6.5.3	REPLACING SOIL IN TRENCH	63
6.6	DEPTH OF SOIL TEMPERATURE MEASUREMENTS	63
6.7	OBSERVATIONS	63
6.7.1	TYPE AND FREQUENCY	64
6.7.2	TIME OF OBSERVATION	64
6.8	ENTRY OF READINGS ON PERMANENT RECORD FORMS	64



6.9	PALMER SOIL THERMOMETER .....	65
6.9.1	RESETTING MAXIMUM AND MINIMUM POINTERS .....	65
6.9.2	MAINTENANCE .....	65
6.9.2.1	LOOSE POINTERS .....	65
6.9.2.2	FROZEN POINTERS .....	66
6.9.2.3	MOISTURE IN THE HEAD .....	66
6.9.2.4	BROKEN COVER .....	66
6.9.3	CALIBRATION ERRORS .....	66
6.9.3.1	IN-PLACE CALIBRATION CHECKS .....	66
6.9.3.2	CALIBRATION OF PALMER MODEL 35B .....	67
6.9.3.3	SETTING THE CALIBRATION .....	67
7.	ATMOSPHERIC PHENOMENA .....	69
7.1	INTRODUCTION .....	69
7.2	TORNADOES, WATERSPOUTS AND FUNNEL CLOUDS .....	69
7.2.1	TORNADO .....	69
7.2.2	FUNNEL CLOUD .....	70
7.2.3	WATERSPOUT .....	70
7.3	THUNDERSTORM .....	70
7.4	DAMAGING WINDS, SQUALLS, AND GUSTS .....	70
7.5	HYDROMETEORS .....	70
7.5.1	FORMS OF PRECIPITATION .....	71
7.5.2	HYDROMETEORS OTHER THAN PRECIPITATION .....	73
7.6	LITHOMETEORS .....	74
7.6.1	DRY HAZE .....	74
7.6.2	SMOKE .....	75
7.6.3	DUST .....	75
7.6.4	BLOWING SAND .....	75
7.7	ELECTROMETEORS .....	75
7.7.1	AURORA .....	75
7.7.2	THUNDER .....	76
7.7.3	LIGHTNING .....	76
7.8	LUMINOUS METEORS .....	76
7.8.1	HALO PHENOMENA .....	76
7.8.2	CORONA .....	76

7.8.3	RAINBOW	77
7.8.4	FOG BOW	77
7.9	REPORTING AND RECORDING ATMOSPHERIC PHENOMENA	77
7.9.1	REAL-TIME REPORTING	77
7.9.1.1	REPORTING TORNADOES AND FUNNEL CLOUDS	77
7.9.1.2	REPORTING OTHER PHENOMENA	77
7.9.2	RECORDING ATMOSPHERIC PHENOMENA	78
7.9.2.1	TORNADOES, WATERSPOUTS, AND FUNNEL CLOUDS	78
7.9.2.2	THUNDERSTORMS	78
7.9.2.3	OTHER PHENOMENA	78
8.	FLASH FLOODING	79
8.1	INTRODUCTION	79
8.2	AREAS MOST SUBJECT TO FLASH FLOODING	79
8.3	FLASH FLOOD WARNINGS	79
8.3.1	ROLE OF COOPERATIVE OBSERVERS	80
8.4	SUPPLEMENTAL PRECIPITATION SURVEYS	80
8.4.1	PURPOSE OF SURVEYS	80
8.4.2	HOW THE COOPERATIVE OBSERVER CAN HELP	80
9.	MISCELLANEOUS FORMS	82
9.1	INTRODUCTION	82
9.2	WS FORM B-18: PUNCHED TAPE MAILING LABEL	82
9.3	WS FORM B-44: COOPERATIVE STATION REPORT	82
9.4	WS FORM F-54: METROPOLITAN NETWORK MONTHLY REPORT	82

## FIGURES

1.1.	WS Form B-27—Substation Supply Request	
	Cooperative Station Supply Request	3
2.1	Wind Shield	7
2.2	Snow Tower	7

2.3	Eight-Inch Nonrecording Gage, Assembled	8
2.4	Eight-Inch Nonrecording Gage, Unassembled	8
2.5	Four-Inch Nonrecording Gage	9
2.6	Belfort (Fischer & Porter) Recording Gage	10
2.7	Universal Recording Gage	10
2.8	Belfort Recorder—Front View with Cover Removed	16
2.9	Snow Board	22
2.10	WS Form B-82—Official Weather Observer a Record	23
2.11	WS Form B-91—Record of River and Climatological Observations	24
3.1	Liquid-in-Glass Maximum and Minimum Thermometers	26
3.2	MMTS Outdoor Shelter with Indoor Digital Readout	27
3.3	Medium-Sized Instrument Shelter	27
3.4	Liquid-in-Glass Maximum Thermometer	28
3.5	Index on Minimum Thermometer	29
3.6	Supports for Maximum and Minimum Thermometers	29
3.8	Reading and Setting Thermometers	31
3.8	Reading Thermometers	32
3.9	Maximum Thermometer in Reading and Whirling Position	33
3.10	Maximum Thermometer Before and After Whirling	33
3.11	Minimum Thermometer in Vertical Position during Resetting of Index	34
3.12	Joining the Alcohol Column—Tapping Method	35
3.13	Joining Alcohol Column—Centrifugal Force Method	36
3.14	MMTS Display Panel Showing "HELP"	37
3.15	WS Form B-91 Showing Correct Procedures for Recording Maximum and Minimum Temperatures	39
4.1	Staff River Gage	41
4.2	Staff River Gage Installation	41
4.3	Wire Weight Gage	42
5.1	Evaporation Station Sites	46
5.2	Evaporation Plot Layout	47
5.3	Evaporation Pan	48
5.4	Stilling Well, Fixed Point Gage, and Measuring Tube	50
5.5	Evaporation Measurements	51
5.6	5-Digit, 3-Cup Anemometer	52
5.7	Psychrometer with Fan	55
5.8	Sling Psychrometer	55
5.9	Six's Water Thermometer, Submerged-Mount	56
5.10	WS Form B-92 (formerly WS Form E-22) Record of Evaporation and Climatological Observations	59
6.1	Installation of Soil Thermometers	63
6.2	Palmer Soil Thermometer	65
7.1	Winds Associated with a Tornado	69
7.2	Glaze	72
7.3	Road Hazard Caused by Glaze	72
7.4	Closeup View of Hail	73
7.5	Hail Accumulated on the Ground, having Damaged Crops	73
9.1	WS Form B-18A Punched Tape Mailing Label	82
9.2	WS Form F-54 Metropolitan Network Monthly Report	83

## SECTION 1: COOPERATIVE WEATHER OBSERVER PROGRAM

### 1.1 PURPOSE OF HANDBOOK

The purpose of this handbook is to provide guidelines for taking and reporting observations at cooperative stations. The instructions pertain to the exposure, operation, and maintenance of instruments and equipment used by the observer. Instructions also cover taking and reporting observations.

### 1.2 DEFINITION OF COOPERATIVE STATION

A cooperative station is a station at which observations are taken or other services rendered by private citizens, institutions (such as utilities and television stations), etc. Services rendered usually consist of taking instrumental or visual observations and transmitting reports.

The equipment used may be owned by the NWS, by an individual company, or by another governmental agency.

### 1.3 TYPES OF STATIONS

Although the majority of cooperative stations record precipitation amounts and maximum and minimum temperatures, there are several other types of stations. For example, one station may record precipitation only, while another station may record precipitation, temperature, and evaporation. One or more of the following parameters may be reported.

- |                    |                          |
|--------------------|--------------------------|
| a) Precipitation   | f) Soil temperature      |
| b) Air temperature | g) Agricultural data     |
| c) River stage     | h) Atmospheric phenomena |
| d) Evaporation     | I) Flash flooding        |
| e) Wind movement   | j) Road hazards          |

#### 1.3.1 PRECIPITATION

Measurements are made of the amount of rainfall, depth of snow, and other forms of precipitation. Records are kept of the character, type, and time of occurrence. Each station is normally furnished with a nonrecording or a weighing-type recording gage.

#### 1.3.2 AIR TEMPERATURE

Observations of the current air temperature, and of maximum and minimum temperatures between observations, are taken and recorded daily. The stations are provided with maximum and minimum thermometers and an instrument shelter for housing the thermometers, or a maximum-minimum temperature system (MMTS).

#### 1.3.3 RIVER STAGE

Daily observations of river stages are taken. These stations generally also record precipitation, weather conditions, depth of snow or ice, and status of the river (rising or falling).

## COOPERATIVE WEATHER OBSERVER PROGRAM

Each station is normally furnished with a river gage appropriate for the station.

### 1.3.4 EVAPORATION AND WIND MOVEMENT

Daily Measurements are made of the amount of evaporation from an open, freely exposed pan. Measurements are made of wind movement over the pan, temperature of the water, and at some stations, wet- and dry-bulb temperatures of the air. The stations are provided with:

- a) An evaporation pan and measuring apparatus (stilling well and gage).
- b) An anemometer and, when required, a wet- and dry-bulb psychrometer and storage tank.

### 1.3.5 SOIL TEMPERATURE

Selected stations record the soil temperature daily. The stations are provided with thermometers or sensing elements located in and under undisturbed bare or grass-covered soil at selected depths.

### 1.3.6 AGRICULTURAL DATA

At selected stations, observers forward weekly reports containing the effect of weather on crops and a description of current farming operations in the locality.

### 1.3.7 ATMOSPHERIC PHENOMENA

Weather occurrences such as rain, cloud cover, hail, and thunderstorms are considered to be atmospheric phenomena. Phenomena of severe enough nature to threaten life and property are usually reported when they take place, rather than waiting to report them at the scheduled time of observation.

### 1.3.8 FLASH FLOODING

In areas where flash flooding may occur, observations of the conditions which cause flash flooding are reported promptly. These conditions include heavy rainfall, river or creek stage, and the formation or breakup of ice jams.

### 1.3.9 ROAD HAZARDS

Road hazards are created by weather conditions such as drifting snow, flooding, and blowing dust or sand, and should be recorded.

## COOPERATIVE WEATHER OBSERVER PROGRAM

### 1.4 ESTABLISHING, MAINTAINING AND INSPECTING STATIONS

The NWS representative (i.e., your Cooperative Program Manager or service hydrologist) will be responsible for the installation of all furnished instruments. He will instruct the observer in techniques of weather observation, recording data, and caring for instruments and equipment. The NWS representative will visit the station periodically for reviews. He can then discuss problems with observing and recording weather data; also, for moving, inspecting, and maintaining the instruments and equipment.

#### 1.4.1 MAINTENANCE

Instruments and equipment furnished to the station should be maintained in accordance with instructions for each instrument. Instruments should not be moved or relocated without the approval of the NWS representative. If immediate action is necessary to prevent damage, notify the NWS representative promptly. The observer may install replacement parts unless otherwise indicated. Be sure to inform the NWS representative when the growth of vegetation, trees, shrubs, or other changes affect the exposure of instruments.

#### 1.4.2 REQUESTING SUPPLIES

Instruments, report forms, envelopes, and all other supplies will be furnished or ordered by the NWS representative. The observer should advise the NWS representative promptly when any forms, supplies, or services are needed. This may be done by letter or special card—WS Form B-27 (exhibit 1.1).

The image shows two forms side-by-side. The left form is a Business Reply Card from the U.S. Department of Commerce, National Oceanic & Atmospheric Administration, Silver Spring, Maryland. It includes a barcode, a 'NO POSTAGE NECESSARY IF MAILED IN THE UNITED STATES' stamp, and a 'BUSINESS REPLY CARD' stamp with 'FIRST CLASS PERMIT NO 1100 ROCKVILLE MD' and 'POSTAGE WILL BE PAID BY NATIONAL OCEANIC AND ATMOSPHERIC ADMINISTRATION'. The right form is WS Form B-27, Substation Supply Request, also from the U.S. Department of Commerce, NOAA, National Weather Service. It has a header with 'STATION NAME', 'STATION NUMBER', and 'DATE'. Below that is a line for 'OBSERVER'S SIGNATURE'. There are two checkboxes: 'PLEASE SEND THE SUPPLIES LISTED BELOW' and 'THIS STATION IS HAVING THE FOLLOWING DIFFICULTIES'. The bottom of the form is labeled 'WS FORM B-27 18-85' and 'SUBSTATION SUPPLY REQUEST NATIONAL WEATHER SERVICE'.

Exhibit 1.1: WS Form B-27—Substation Supply Request/  
Cooperative Station Supply Request

## COOPERATIVE WEATHER OBSERVER PROGRAM

### 1.4.3 REPORTING DEFECTIVE INSTRUMENTS

Damaged or defective Weather Service equipment and instruments should be reported to the NWS representative, who will then inform the observer about arranging for the repair or replacement of the equipment and/or instruments. The boxes and material in which thermometers, clocks, and other delicate instruments are packed in should be saved. They can be used when returning defective units. The units should be carefully packed in the same manner as they were received.

### 1.5 PREFERRED TIME FOR TAKING OBSERVATIONS

Observations at precipitation stations should be taken at 7 a.m. local time, although you may usually choose any time between 6 a.m. and 8 a.m. Be sure, however, to take observations at the same time every day throughout the year if at all possible. Continue observing at the same time whether standard or daylight savings time is in effect; i.e., convert from 7 a.m. standard time to 7 a.m. daylight saving time when the latter takes effect.

Evening observations are best for temperature stations (6 p.m. is the preferred time). Stations reporting both parameters should report at a time agreed to with the NWS representative. Unless otherwise directed, temperature and precipitation should be observed at the same time of day. Evaporation stations should observe all elements in the morning when the evaporation rate is normally lowest. If an evening observation time is established, it should be as late as possible.

#### 1.5.1 RESETTING INSTRUMENTS

Reset the maximum and minimum thermometers only once each 24 hours, immediately after they have been read. Nonrecording rain gages should be emptied after being read only once each 24 hours. Thermometers and gages should be reset only at the time of observation agreed to with the NWS representative. Instruments may be read at intermediate times, but they should not be reset.

### 1.6 FORMS

The National Weather Service (NWS) will furnish all forms you will need for recording weather data. The cover page for each pad of forms contains the reporting instructions. In the proper spaces, enter your station name (specified by your NWS representative), county, state, month and year, time of observation, etc.

#### 1.6.1 LEGIBILITY

Legible records are very important. A form that is difficult to read loses value. Use a sharp, medium-hard pencil and good carbon paper. Replace the carbon paper when it no longer makes a legible copy. Draw a line through (do not erase) erroneous entries and write the correct values above, below, or to the right or left of the line.

## **COOPERATIVE WEATHER OBSERVER PROGRAM**

### **1.6.2 DISPOSITION OF RECORDS**

Mail the original and first copy of the report promptly at the close of the period of record (usually monthly). Keep an additional carbon copy for at least two months, in case the copies you mail are not received. In some cases, the NWS representative may ask you to prepare additional copies.

The NWS will furnish postage-paid envelopes for mailing your records, ordering supplies, and reporting defective instruments and equipments.



## SECTION 2: PRECIPITATION

### 2.1 INTRODUCTION

There are two types of precipitation: liquid and solid. Liquid precipitation includes rain and drizzle. Since precipitation, by definition, falls to the ground, dew (which forms where it is found) is not precipitation. Solid precipitation includes snow, hail, ice pellets, etc. Precipitation is measured in terms of its depth:

- a) Liquid (including the water equivalent of solid precipitation which has melted) to the nearest hundredth of an inch, and
- b) Solid to the nearest tenth inch.

#### 2.1.1 PRECIPITATION GAGES

In its simplest form, a precipitation gage is an open-mouthed can with straight sides, installed with the open end upward and sides vertical. Precipitation gages are also called rain gages. Improved gages record the amount of precipitation falling per unit time on a chart (usually a punch tape or rotating drum). See section 2.2 below.

#### 2.1.2 EXPOSURE OF GAGES

The exposure of a rain gage is very important for obtaining accurate measurements. Gages should not be located close to isolated obstructions such as trees and buildings, which may deflect precipitation due to erratic turbulence. Gages should not be located in wide-open spaces or on elevated sites, such as tops of buildings, because of wind and the resulting turbulence problems. The best location is where the gage is uniformly protected in all directions, such as in an opening in a grove of trees. The height of the protection should not exceed twice its distance from the gage. As a general rule, the windier the gage location is, the greater the precipitation error will be.

Wind shields (exhibit 2.1) may be used to minimize the loss of precipitation. This loss is much greater during snowfall than rainfall, so shields are seldom installed at cooperative stations unless at least 20 percent of the annual precipitation falls in the form of snow.

In areas where heavy snowfall occurs; e.g., mountainous areas in the western U.S., gages are mounted on towers at a height considerably above the maximum level to which snow accumulates, at or somewhat below the level of tree tops. See exhibit 2.2.

Good exposures are not always permanent. Man-made alterations to the area and the growth of vegetation may change an excellent exposure to an unsatisfactory one in a very short time, necessitating the moving of precipitation gages to sites having better exposures.

## PRECIPITATION



Exhibit 2.1: Snow Tower

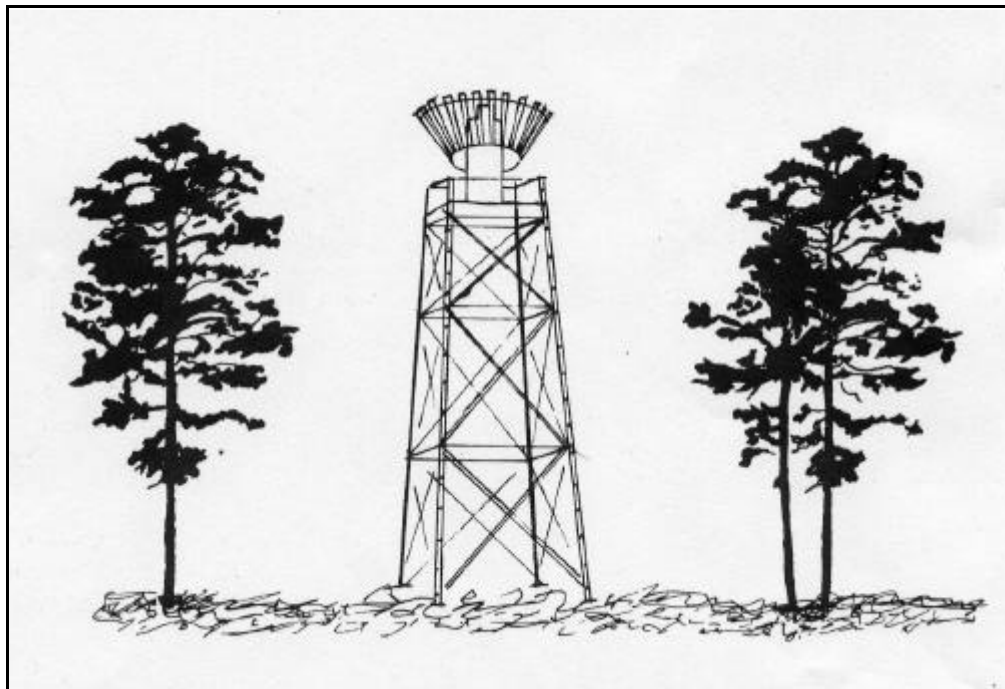

Exhibit 2.2: Snow Tower

## PRECIPITATION

### 2.2 TYPES OF PRECIPITATION GAGES

The specific types of gages now being used for measuring precipitation are:

- |                 |                                    |
|-----------------|------------------------------------|
| a) Nonrecording | b) Recording (weighing type)       |
| 1) 8-inch gage  | 1) Belfort (Fischer & Porter) gage |
| 2) 4-inch gage  | 2) Universal gage                  |

These are described below.

#### 2.2.1 EIGHT-INCH NONRECORDING GAGE

This gage (exhibits 2.3 and 2.4) consists of the large diameter outer can (in the left-center of exhibit 2.4), a smaller diameter measuring tube inside it (right-center), a funnel that connects the above two (right), a measuring stick (bottom), and a support (left in exhibit 2.4). The outer can and top of the funnel are 8 inches in diameter. The funnel directs precipitation into the measuring tube, which is 20 inches tall and holds exactly 2 inches of rainfall (additional rainfall will flow into the overflow can). This ten-to-one ratio makes it possible to read rainfall amounts to the nearest hundredth of an inch. The measuring stick is marked at .01 inch intervals.

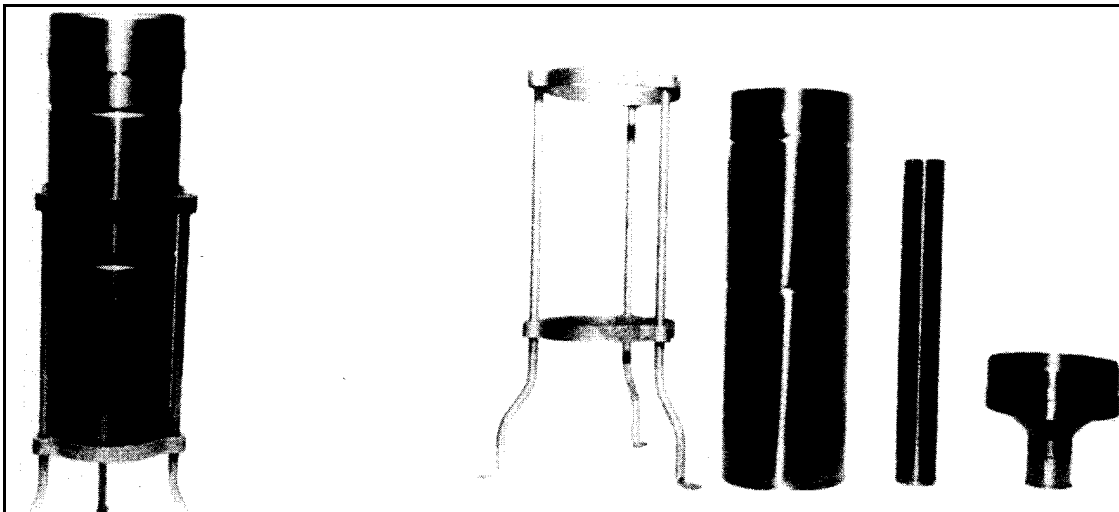

Exhibit 2.3: Eight-Inch  
Nonrecording Gage, Assembled

Exhibit 2.4: Eight-Inch  
Nonrecording Gage, Unassembled

## PRECIPITATION

### 2.2.1.1 INSTALLATION AND MAINTENANCE

The metal support (exhibit 2.4, left side) must be firmly mounted on a horizontal platform to prevent it from being blown or knocked over. The top of the gage must be horizontal. This should be checked by laying a carpenter I s level across the open top of the gage in two directions, one crossing the other at right angles. If the top is not level in both directions, report this to the NWS representative. If you level the gage, please add a note to the observation form giving the date the defeat was discovered and the date corrected.

Leaks in the tube or overflow can and should be reported promptly to the NWS representative.

### 2.2.2 FOUR-INCH NONRECORDING GAGE

The four-inch gage (exhibit 2.5) consists of the outer overflow can (lower left), measuring tube (center), a funnel (top) that catches the precipitation and directs it into the tube, and a mounting bracket with screws (lower right). The gage is made of clear plastic. No measuring stick is needed because the measuring tube is graduated to hundredths of an inch. This tube holds exactly one inch of precipitation. Any additional amount will fall into the overflow can and can be measured as with the eight-inch gage (section 2.2.1).

### 2.2.3 WEIGHING-RECORDING GAGE

The weighing-type recording gage is designed to record the rate and amount of precipitation. The precipitation rate is measured in hundredths or tenths of an inch per unit time. The amount is measured in hundredths or tenths of an inch. These gages consist of a receiver with an inside diameter of exactly 8 inches that funnels precipitation into a collector mounted on a weighing mechanism.

There are two types of weighing gages used by the NWS:

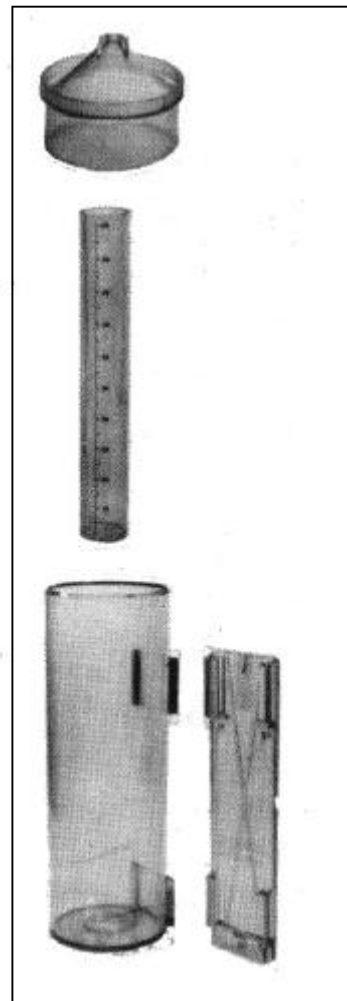

Exhibit 2.5:  
Four-Inch  
Nonrecording Gage

## PRECIPITATION

- a) The punched tape type, manufactured by Belfort Instruments or Fischer & Porter (exhibit 2.6), and:
- b) The universal type (exhibit 2.7).

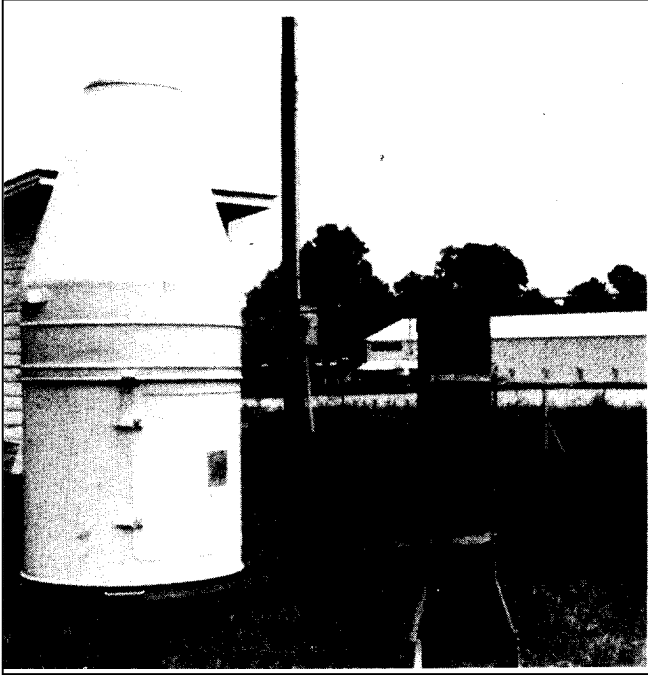

Exhibit 2.6: Belfort  
(Fischer & Porter) Recording Gage

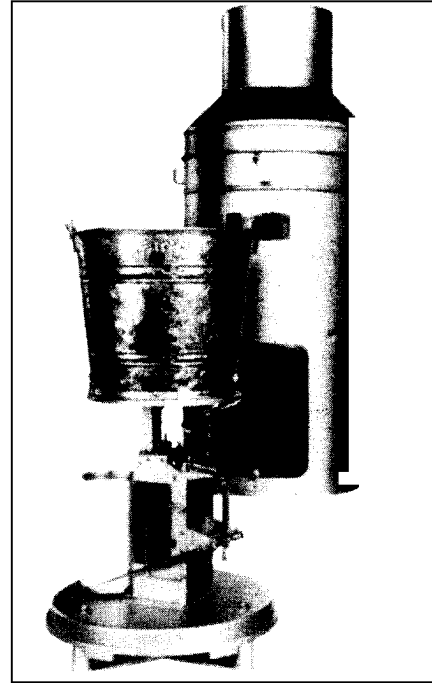

Exhibit 2.7: Universal  
Recording Gage

### 2.2.4 UNIVERSAL GAGE

Precipitation falls into the universal gage receiver, where it is funneled into a collector mounted on a weighing mechanism. The weight of the precipitation in the collector compresses a spring, which is connected to a pen (ink) arm. Ink from the pen leaves a trace on a paper chart, which is wrapped around a clock-driven cylinder. The cylinder rotates continuously, making one revolution every 24 hours. Ink tracings on the chart provide a "history" of precipitation rates and amounts.

Charts are graduated to the nearest .05 inch and may be read to the nearest .01 inch by interpolating between the graduations. The total capacity of the gage is 12 inches, although the chart is graduated to only 6 inches. When the 6-inch mark is reached, the pen of the chart reverses direction. The reverse in pen direction is commonly referred to as "dual traverse."

## PRECIPITATION

### 2.2.4.1 CALIBRATION AND EQUIPMENT PROBLEMS

The gage requires occasional calibration and other adjustments to maintain its accuracy. This will be done by inspectors with special equipment. clock failure, or any trouble that cannot be corrected as described below, should be reported immediately to the NWS representative.

### 2.2.4.2 GAINING ACCESS TO BUCKET AND CHART MECHANISM

You will need access to the chart and bucket in order to read or change the chart, wind the clock, or empty the bucket. Most universal gages have an inspection door large enough to provide access to the clock and chart. On gages with inspection doors too small for this, you can remove the receiver (top) and outer shield to gain access.

### 2.2.4.3 PREPARATION OF CHARTS

Enter the following information in the spaces provided on the chart before putting the chart on the cylinder:

- a) Station name as specified by the NWS representative.
- b) Date and local time, to the nearest minute, that the pen will be placed on the new chart.

Cross out P.M. when it is morning or A.M. when it is afternoon. When Daylight Saving Time is in use locally, enter 'D' following A.M. or P.M. For example, if the chart is changed in the morning, enter A.M.D.

### 2.2.4.4 INSTALLING AND REMOVING CHARTS

Charts should be changed on all of the following occasions.

- a) At least once a week.
- b) On the first day of each month.
- c) Within 24 hours after precipitation has ended.

Do not change the chart during rain that is heavy enough to wet the trace and cause the ink to spread. Rather than change the chart, empty the bucket during heavy rain when the bucket may overflow or the capacity of the chart may be exceeded.

When installing and removing charts, make a vertical mark about 1/4 inch long on the chart (trace) by gently touching the weighing mechanism which moves the pen. This mark will serve as a time check for the office receiving the chart. If the pen is not making a trace on the chart, place a small dot on the chart.

## PRECIPITATION

to mark the position of the pen. Draw a circle around the dot to identify it, and enter a note of explanation on the chart (e.g., "chart removed").

### 2.2.4.5 CHANGING CHARTS ON GAGES WITH LARGE INSPECTION DOORS

- a) Open the inspection door and make a time check on the chart.
- b) Remove the pen from the chart by shifting the pen bar forward.
- c) Remove the receiver.
- d) Empty and replace the bucket except when charged with antifreeze or when oil has been used to retard evaporation
- e) Raise the outer shield (if so equipped) and rest it on the vertical guides.
- f) Grasp the cylinder at the top with one hand and, with the other, gently lift it over the spindle.
- g) Release the clip holding the chart. Avoid touching or storing the chart in a way that will cause the trace to be smeared before it dries.
- h) Wind the clock. Caution: the clock may stop if wound too tightly.
- I) Wrap the new chart around the clock cylinder so the time reads left to right, and so the chart fits smoothly and snugly on the clock cylinder. The chart base must uniformly contact the flange or cylinder.
- j. Replace the clip. Check to be sure that corresponding ends of each "inch" line coincide where they meet. The exposed end of the chart must extend 1/4 inch to the right of the clip.
- k. Replace the cylinder. Lower it gently over the spindle until the gears mesh.
- l. Re-ink the pen. Return it almost to the surface of the chart. Make sure it reads within .025 inch of the last reading on the previous chart. It should read zero, however, if you have emptied the bucket, unless the NWS representative specified some other value.
- m. With the pen almost touching the chart, turn the cylinder until it reads three hours fast, then turn it back so it reads the correct time. Be sure the time is correctly written on the chart.
- n. Return the pen to the chart. Touch the weighing mechanism to make a vertical time check on the chart. Replace the shield and receiver.

## PRECIPITATION

### 2.2.4.6 CHANGING CHARM ON GAGES WITH SMALL INSPECTION DOORS

Use the following method on gages having small inspection doors.

- a) Remove the receiver and shield (exhibit 2.6).
- b) Make a time check or identify the pen position on the chart by touching the weighing mechanism.
- c) Shift the pen bar forward and lift the pen from the chart.
- d) Empty and replace the bucket, except when charged with antifreeze.
- e) Grasp the chart cylinder at the top with one hand, and with the other, gently lift it over the spindle. Release the clip holding the chart, taking care not to smear the ink.
- f) Wind the clock. Wrap the new chart around the clock cylinder so the time reads from left to right, and so the chart fits smoothly and snugly. The chart base must uniformly contact the flange of the cylinder.
- g) Replace the clip. Check to be sure that corresponding ends of each "inch" line on the charts coincide. The exposed end of the chart must extend 1/4 inch to the right of the clip.
- h) Replace the cylinder. Lower it gently over the spindle until the gears mesh.
- I) Re-ink the pen and return it almost to the surface of the chart. Note the amount the pen indicates on the chart. It should indicate the same value (within .025 inch) as before the chart was changed. It should read zero if the bucket was emptied unless the NWS representative has specified that it read some other value at the time of the last calibration.
- j) Return the pen to the chart. Touch the weighing mechanism to make a vertical time check on the chart.
- k) Replace the shield and receiver.

### 2.2.4.7 COMPLETING THE CHARTS

After removing the chart from the gage, enter the following.

- a) The local time and date of removal, as, in section 2.2.4.3.b.
- b) An arrow (↖) with the word "on" at the place the timecheck was made when the chart was installed.



## PRECIPITATION

- c) An arrow (↔) with the word "off" at the place the timecheck was made when the chart was removed.
- d) Notes that will explain unusual or missing parts of the trace. Inspect the weighing gage daily to be sure the clock is running and the pen is raking a trace. If the clock has stopped and cannot be restarted, turn the cylinder forward ½ inch each day until the clock is replaced. The chart need not be replaced until the time or precipitation range has been used or the clock is replaced. Contact the NWS representative promptly for a replacement clock.

### 2.2.5 BELFORT (FISCHER & PORTER) PUNCH TAPE GAGE

Belfort Instrument Co. took over manufacturing of this gage in the early 1980's. It is gradually replacing the universal weighing gage. Precipitation amounts are recorded at 0.10 inch increments. The maximum capacity is 19.5 inches. A machine punches holes in a paper tape on a moving scroll every 15 minutes. Although the punch tape is designed for automatic machine processing, it may be read visually by summing the values of the holes punched. Punches are made for the following values: 0.1, 0.2, 0.4, 0.8, 1.0, 2.0, 4.0, 8.0 and 10.0 inches. For a precipitation amount of 3.7 inches, the following punches would be made: 2.0, 1.0, 0.4, 0.2 and 0.1 inches, the sum of which equals 3.7 inches.

An illustrated instruction bulletin is provided with each instrument. It should be consulted for details on any specified model. The following sections refer to the Model #35B155911XX1 with an electronic timer—the most recent model produced.

The Belfort gage shown in exhibit 2.7 is powered by a 6.75 volt DC battery. The measuring device consists of:

- a) a collection bucket for receiving and storing precipitation,
- b) a weighing device for measurement, and
- c) an indicator dial showing the amount of precipitation collected to the nearest whole inch.

#### 2.2.5.1 OPERATION AND MAINTENANCE

The NWS representative will place the gage in operation and explain its operation to the observer. The observer should do the following.

- a) Inspect the gage weekly to assure that the tape is at the proper time. Red figures on the left side of the tape indicate the days. Make a dial reading and enter it on the observer form. If the time indicated on the tape is in error by more than an hour (4 spaces), reset it to the correct time. Make a notation of this on the tape. Refer to section 2.2.5.2 for Instructions on setting the tape to the correct time. Do not make manual punches before adjusting or removing the tape.

## PRECIPITATION

- b) If the reading on the indicator dial is near or exceeds 10 inches, either remove and empty the collector or unhook the plastic drain tub from the rim and lower to the drainage position, diverting the stream away from the instrument. CAUTION: do not spill or empty where oil and antifreeze will damage the grass or other vegetation. Replace the collector on the force post. Fasten the drain tube hook firmly over the edge of the collector. Rotate the zero adjustment knob until the code disk pointer is at the exact "zero" position. Add one pint of oil (supplied by the NWS representative) to the collector. During the time of year when snow or freezing weather may be expected, you must remove the funnel and you must add antifreeze to the collector. Replace the hood.
- c) As soon as possible after the beginning of each month (or as requested), remove the recorded portion of the tape. Advance the tape so about 20 inches of blank tape are included following the punched portion. Remove the tape by slipping it off the end of the take-up spool. Mark the date, time of removal (indicating standard or daylight time), and station name and number on the recording tape. Include any other information that may be helpful -in processing the tape.
- d) Check the amount of tape remaining on the spool. If there is enough for the next entire month, rethread the loose end of the tape from the supply roll onto the take-up spool. Install a new roll of tape when necessary. Make sure that the printed side of the tape is right-side-up when facing the front of the instrument and that the tape is threaded through the punch arm assembly and paper guide.
- e) Set the tape to the correct time (section 2.2.5.2) and mark the day and month on it.
- f) Remove and empty the chad tray.
- g) Put the punched tape for the past month in one of the mailers supplied by the NWS representative and mail. Be certain that a mailing address has been stamped on the mailer. If not, obtain the address from the NWS representative and request new mailers that are properly addressed.
- h) Close and fasten the door with both latches to keep out dust and moisture. Insert the latch cover in its retainer on the base of the gage. The slot near the top should be over the padlock eye on the hood. The latch cover need not be installed if it is not necessary to lock the gage.

## PRECIPITATION

### 2.2.5.2 SETTING THE TAPE TO THE CORRECT TIME

The electronic timer will trigger the gage to punch every 15 minutes. The power switch must be "ON." When the leads from the timer are connected to the battery, the recorder will punch 33 seconds after pushing the manual punch button. The best time to change the tape is immediately after a routine punch-out. This will allow 15 minutes to change the tape without missing any readings.

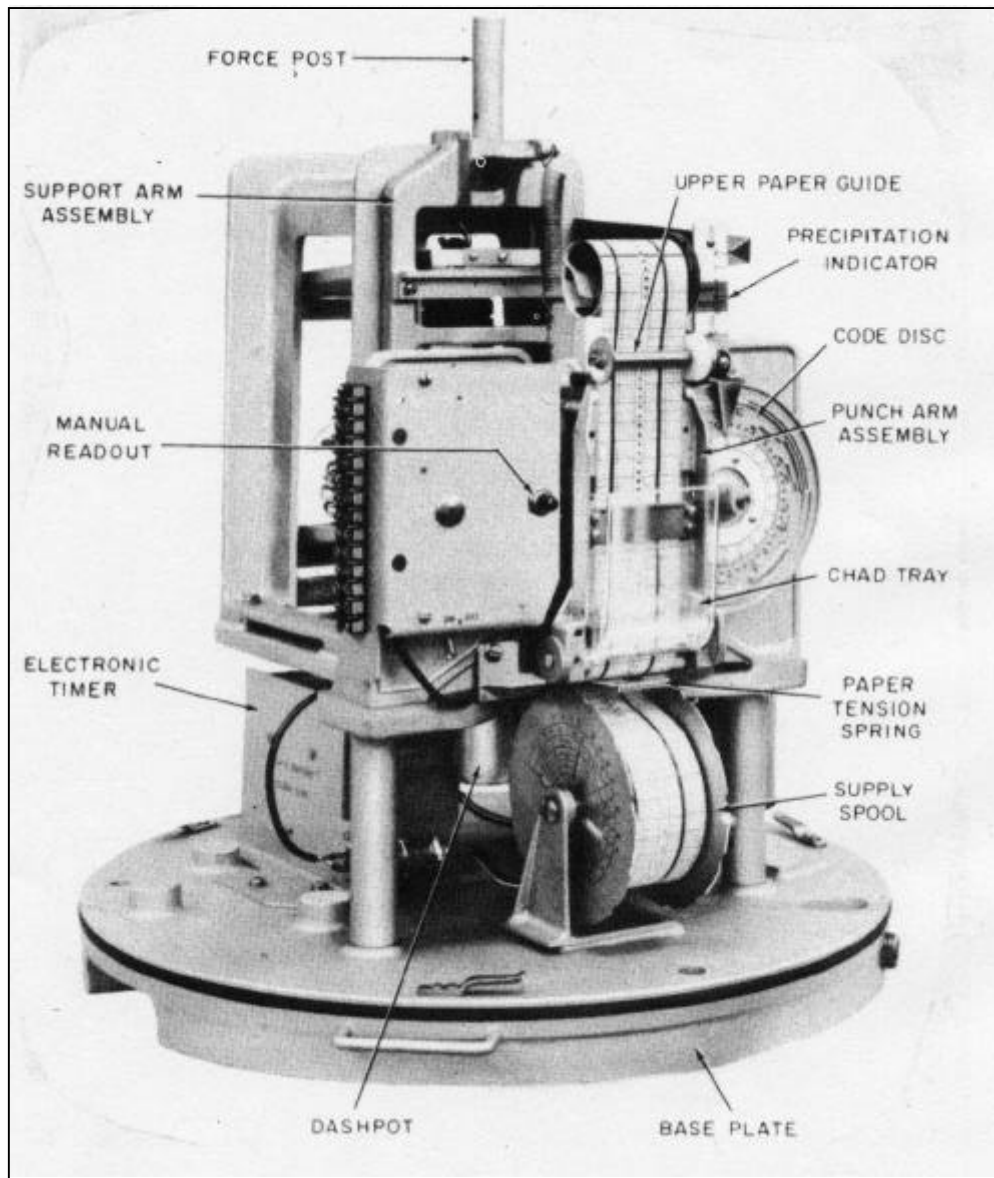

Exhibit 2.8: Belfort Recorder—Front View with Cover Removed

## PRECIPITATION

Set the tape to the correct time, as follows.

- a) With the power switch "OFF," feed the tape through the die block onto the take-up spool. Continue feeding the tape until the first time line to appear above the die block reads two hours before the current time. See exhibit 2.8.
- b) Turn the power switch to the "ON" position and push the button to advance the tape at least 8 lead punches or until the time line on the tape corresponding to the next 15-minute time interval is lined up with the holes in the punch block. Next, draw a line across the tape just above the punching block, using a felt tip pen. Write the date and time on the tape. This reference will determine the actual start of the record. The **next punch** should occur at the next 15-minute clock interval and it should agree with the time shown by the tape within 15 minutes. Hold the button down 5 seconds for each punch.

### 2.2.6 WINTER OPERATION

During the season when frozen precipitation (except hail) or freezing temperatures are likely to occur, both of the above types of gages need to be winterized, as described below.

- a) At the start of winter, remove the funnel from the collector. Snow rings (on some universal gages) should be installed in place of the funnel.
- b) Empty the bucket or collector and replace it in the gage. Remove and replace the collector very slowly on Belfort gages to avoid breaking a cable in the mechanism.
- c) On the universal gage, turn the adjusting knob so the pen reads zero on the chart. On the Belfort gage, rotate the zero adjusting knob until the code disk pointer is at the exact position.
- d) On the universal gage, pour one quart of antifreeze (supplied by the NWS representative) into the bucket. Do not use commercial antifreeze or add water.

On the Belfort gage, pour two quarts of the above antifreeze into the collector. Do not add water.

- e) Make no adjustments to the gage after antifreeze has been added. The pen should rest between the 1 and 2 inch lines after antifreeze has been added to the universal recorder. The dial on the Belfort gage should read between 2 and 3 inches.
- f) Enter a note on the chart or tape identifying the time and date the gage was charged with antifreeze.

## PRECIPITATION

### 2.2.7 ROUTINE MAINTENANCE

Take the following actions during the year.

- a) Stir the antifreeze solution occasionally during the winter, especially after rain or snow, to help maintain a uniform mixture.
- b) Empty the universal recorder bucket when the pen reaches approximately the 5-inch level. Empty or drain the Belfort gage when the 10-inch level is reached. Do not adjust the pen in either case.
- c) Change charts on universal gages, as follows:
  - 1) On the first day of each month.
  - 2) After each measurable rain or snow.
  - 3) Once each week.

Change tapes on the Belfort gage on the first of each month.

- d) Notify your NWS representative when additional antifreeze materials are needed.
- e) Mail recorded data as instructed by the NWS representative.

### 2.3 HOW TO MEASURE RAINFALL

#### 2.3.1 BELFORT GAGE

See section 2.2.5 for instructions on reading the Belfort gage.

#### 2.3.2 UNIVERSAL GAGE

The universal gage may be read directly from the trace on the drum. If the gage did not read zero at the last observation time, subtract the previous reading from the current reading.

#### 2.3.3 FOUR-INCH NONRECORDING GAGE

The four-inch clear plastic gage may be read directly by observing the marks etched in the measuring tube. This tube holds up to one inch of water. If more than an inch of rain has fallen, empty the water in the measuring tube, pour the water in the overflow cylinder into the tube, measure it, and add this to the amount originally in the measuring tube. Repeat this if more than two inches have fallen. When finished, put the emptied measuring tube back inside the empty outer cylinder and replace the funnel on top.

## PRECIPITATION

### 2.3.4 EIGHT-INCH NONRECORDING GAGE

Remove the funnel and insert the measuring stick into the bottom of the measuring tube, leaving it there for two or three seconds. The water will darken the stick. Remove the stick and read the rainfall amount from the top of the darkened part of the stick. Example: if the stick is darkened to three marks above the 0.80 inch mark (the longer horizontal white line beneath the 0.80), the rainfall is .83 inch.

If the measuring tube is full (indicating at least two inches of rain), empty the tube carefully to avoid spilling any water back into the overflow can. Allow a few seconds for all the water to drain from the tube. Then pour the water from the overflow can into the measuring tube. Measure this amount and add it to the two inches already emptied from the tube. If more than four inches of rain has fallen, the measuring tube will be filled at least twice.

When finished, put the emptied measuring tube back inside the empty outer can and replace the funnel on top.

### 2.4 MEASURING THE WATER EQUIVALENT OF SNOWFALL

The Belfort and universal gages measure precipitation by weighing it. Thus, snow falling into these gages is automatically measured, and no melting is required. This value is the water equivalent. If snow or ice is stuck to the inside of the funnel, it should be scraped loose and allowed to fall into the antifreeze solution before taking a reading.

For nonrecording gages, remove the funnel and measuring tube from the outer can during winter or whenever snow is likely to fall. The water equivalent of frozen precipitation that has fallen into the gage can be determined by following these steps.

- a) Bring the overflow container that contains the snow into a warm building.
- b) Wait for the snow to melt.
- c) Pour the melted snow into the measuring tube.
- d) Measure this as you would measure rain.

Melting the snow can be accelerated by carefully measuring an amount of warm water in the measuring tube, pouring this in the overflow can with the snow, letting the snow melt, measuring the total amount of melted precipitation, then subtracting the amount of water added.

Take care not to leave water standing in the gage if the temperature is expected to drop below freezing, as this can bend and crack it, causing leaks.

## PRECIPITATION

### 2.4.1 OBTAINING CORE SAMPLES OF SNOW

In cases where strong winds or drifting snow prevent the gage from receiving the correct amount of snow, or when snow overflows the gage or clings to the top to block snow from falling inside, direct measurements can be very inaccurate. Often the best solution in these cases is to take a core sample. Do this as follows.

- a) Find an area where drifting is minimal. This will usually be a flat area away from obstructions such as trees and buildings, although obstructions at some distance can help minimize drifting.
- b) Invert the overflow can and force it down through the snow. The rim will cut a cylindrical vertical sample. If the snow is very deep, it may be necessary to push the can part way to the ground. Then, remove and empty the snow into a container, and insert the can in the same hole to obtain the rest of the snow.

Caution! Do not push the can through snow that was measured at the previous observation, or its water equivalent will be counted in both measurements.

- c) Slip a piece of sheet metal or thin wood beneath the mouth of the can to prevent the snow from falling out.
- d) Take the snow indoors, melt it, and obtain the water equivalent as described in section 2.4.
- e) If there is a question about the accuracy of the water equivalent of snow measured directly in the can, compare it with the amount determined by a core sample and use the larger of the two readings.

### 2.5 MEASURING THE DEPTH OF FROZEN PRECIPITATION

#### 2.5.1 DEFINITION

Although frozen precipitation includes snow, ice pellets, glaze, hail, and sheet ice formed directly or indirectly from precipitation, the following text will use the word "snow" for all of the above.

Two types of snow depth are reported:

- a) The depth of newly fallen snow (snow having fallen since the previous scheduled time of observation), reported in inches and tenths.
- b) The total depth of snow on the ground (new and old), reported to the nearest whole inch.

## PRECIPITATION

### 2.5.2 MEASURING WITH A MEASURING STICK

Find a location where the snow appears to be near its average depth. This may be difficult if the snow has drifted. Look for a flat, somewhat open area away from buildings and trees. Some trees in the distance may be helpful in breaking the wind, preventing drifting, and thus providing for a more even distribution of the snow.

Measure the depth with a sturdy measuring stick, such as that used with the 8-inch nonrecording gage, a ruler, or a yardstick. Convert readings to the nearest tenth inch. If using the 8-inch gage stick, multiply the scale reading by 10; i.e., if it reads 1.15 inches, the snow depth is 11.5 inches. Measure the depth at several locations and use an average depth if drifting has occurred.

When snow has fallen between observation times and has been melting, measure its greatest depth on the ground while it is snowing, or estimate the greatest depth. If all snow melted as it fell, enter a trace for the snowfall.

### 2.5.3 MEASURING NEW SNOW FALLING ON TOP OF OLD SNOW

When fresh snow has fallen on old snow, it is necessary to measure the depth of the new snow (tenths of inches) and the total depth of all snow (whole inches). Snow boards (section 2.5.4) provide the best method of taking measurements in this case. If you do not have a snow board, and if the old snow has settled or partially melted enough to develop a crust or to be noticeably denser than the new snow, it may be possible to insert the snow stick until it meets the greater resistance of the crust of old snow, and to use this depth as the amount of new snow having fallen. Sometimes pollution or partial melting will give the old snow a darker color than the new. If so, cut a vertical core through the snow down to the ground. Measure the new (whitest) snow depth to the nearest tenth inch, and the total snow depth to the nearest inch.

### 2.5.4 SNOW BOARDS

Snow boards (exhibit 2.9) are laid on top of the old snow when there is any possibility of new snow falling. They may be made of thin lumber or other light material (Styrofoam) that will not sink into the snow, yet be heavy enough not to blow away. They should be painted white. Push them into the snow just far enough that the top of the board is level with the top of the snow. A 16" X 16" snow board will allow cutting more than one snow sample.

After each observation, boards should be cleaned and placed in a new location. Because of evaporation or drifting, they may need adjusting daily to assure that the top of the board remains flush with the old snow.



## PRECIPITATION

### 2.5.5 SNOW STAKES

Snow stakes are used in geographical areas frequently having deep snowfalls, as in the western mountains and to the lee of the Great lakes. Stakes should be graduated in whole inches, with numerals inscribed at 10-inch intervals; i.e., "20" for 20 inches. Stakes should be sturdy, water-resistant, and painted white to minimize snow melt around them. If possible, they should be located on level ground where the snow depth is typical of the area. In hilly areas, select a northerly exposure (Northern hemisphere). The area around the stake should be free from trees, buildings and other obstructions that could seriously affect the wind flow around the stake. Low, leafless bushes, however, can be beneficial in reducing drifting. The stakes may be mounted on a securely anchored vertical post or other support.

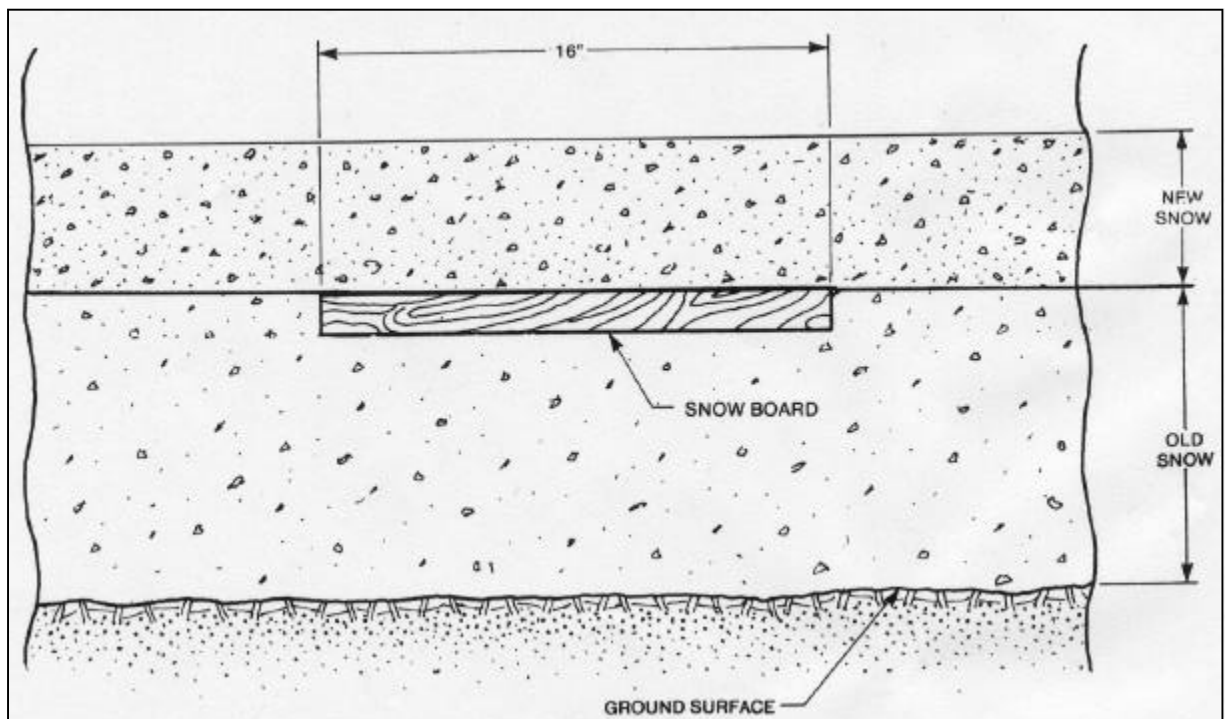

Exhibit 2.9: Snow Board

## 2.6 KEEPING AND MAILING RECORDS

### 2.6.1 PURPOSE

One of the most important tasks of the cooperative observer is to record precipitation and other data on forms that are mailed, either directly by the observer or through the NWS representative, to the National Climatic Data Center (NCDC). NCDC archives and publishes these records, which comprise the major



# PRECIPITATION

Forms should be mailed as soon as possible, but no later than the fifth day of the following month. Complete instructions for filling out the B-91 are contained on the cover pages of the form.

Exhibit 2.11: WS Form B-91 (Formerly WS Form E-15)  
Record of River and Climatological observations

## 2.7 REAL-TIME REPORTING OF PRECIPITATION, TEMPERATURES AND HAZARDOUS WEATHER EVENTS

You may be among the many observers requested to report precipitation (and in some cases, temperature) values to an NWS office every day or whenever a certain minimum amount of precipitation has fallen. If you agree to do this, your information will be vital to the NWS river and flood forecast and warning

## PRECIPITATION

program. During the winter, you may be requested to measure and report the water content (water equivalent) of snow on the ground twice a week. This information helps the NWS forecast the amount of runoff and potential flooding from snow melt during warm spells or the spring thaw. Some observers maintain precipitation gages from which the data are automatically interrogated by telephone or satellite.

The NWS may also ask you to report immediately by telephone any severe weather event that may endanger life and property. This information will aid in determining the need for warnings of severe weather. If you participate in this program, you will be asked to report one or more of the following types of events.

- a) Flash flooding (give the time of your observation and state if the water level is rising or falling).
- b) Severe thunderstorms with damaging winds (50 mph or stronger) or 3/4 inch or larger hail.
- c) Excessive rain; i.e., 0.50 or 1.00 inch or more per hour.
- d) Unusual snow accumulation (4 inches or more, or as instructed).

This special reporting is entirely voluntary and is not intended to interfere with the regular weather duties you agreed to do for the NWS. However, these extra reports can be valuable means of saving lives and minimizing the destruction of property.

## SECTION 3: AIR TEMPERATURE

### 3.1 DEFINITIONS

The word temperature as used in Section 3 refers only to the air temperature. Temperature readings are taken from maximum and minimum thermometers, or from the digital displays of maximum-minimum Temperature systems (MMTS).

The minimum temperature is the lowest temperature to have occurred since the minimum thermometer or MMTS was last read and reset.

The maximum temperature is the highest temperature since the maximum thermometer or MMTS was last read and reset.

The current temperature is the temperature at the time the thermometer or MMTS is read. This is read from the maximum thermometer while in a vertical position after it has been whirled.

### 3.2 TYPES OF THERMOMETERS

There are two types of temperature sensors in common use at cooperative stations: the liquid-in-glass maximum and minimum thermometers (exhibit 3.1) and the MMTS (exhibit 3.2). Exhibit 3.1 shows the liquid-in-glass maximum and minimum thermometers in their correct "set" positions.

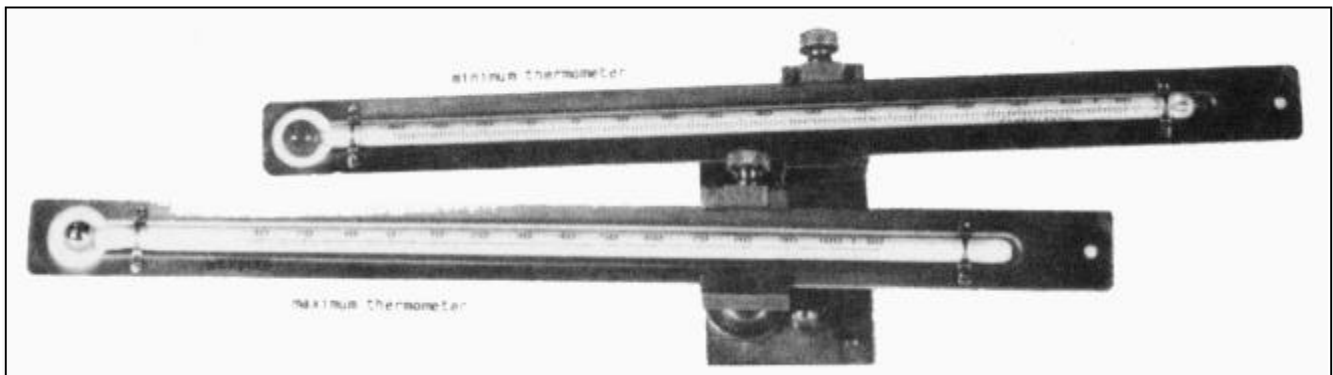

Exhibit 3.1: Liquid-in-Glass Maximum and Minimum Thermometers

### 3.3 INSTRUMENT SHELTERS

Thermometers must be enclosed in shelters, which act as shields from the sun, rain, snow, and other sources of light, heat, or cold which can cause erroneous readings. Shelters are designed to allow the maximum possible free flow of air while providing protection from heat and light. This is accomplished with louvers which slope downward from the inside to the outside of the shelter and with a double top. The VMS shelter is shown in exhibit

Exhibit 3.3 shows the medium-sized shelter used most often for liquid-in-glass maximum and minimum thermometers.

## AIR TEMPERATURE

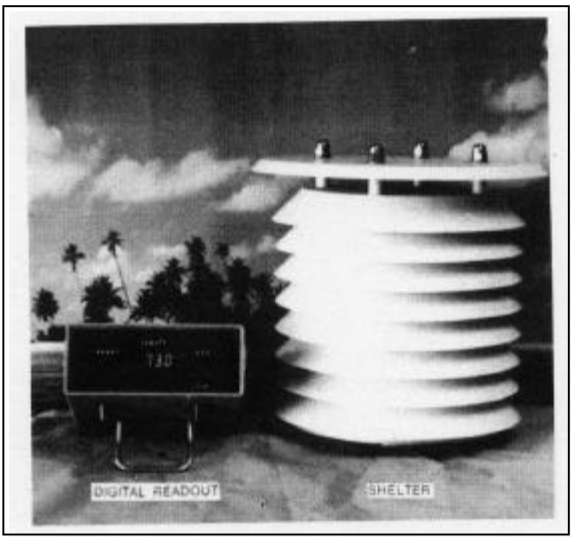

Exhibit 3.2:  
MMTS Outdoor Shelter  
with Indoor Digital Readout

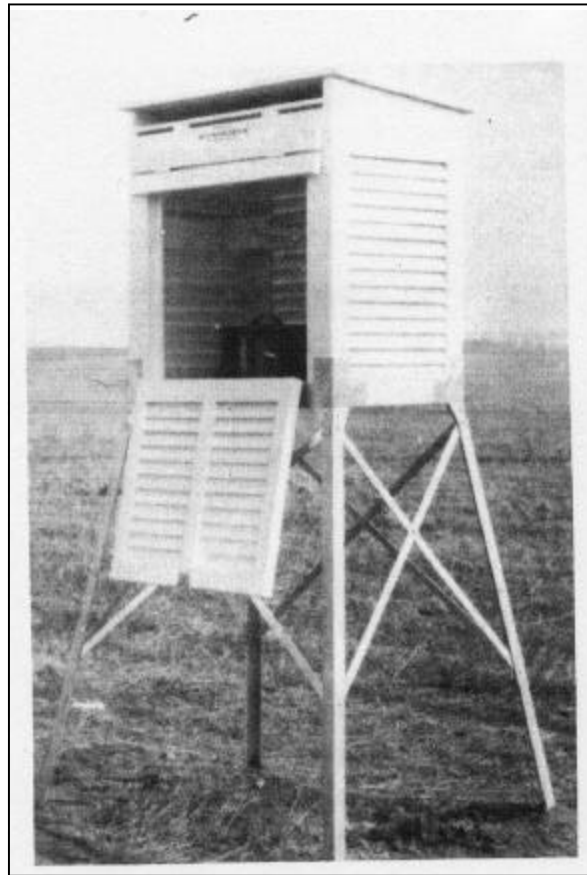

Exhibit 3.3.:  
Medium-Sized Instrument Shelter

Liquid-in-glass thermometers are mounted on a horizontal board located in the upper middle part of the shelter.

### 3.3.1 SHELTER PLACEMENT

The ground over which the shelter is located should be typical of the surrounding area. A level, open clearing is desirable so the thermometers are freely ventilated by the flow of air. Do not install on a steep slope or in a sheltered hollow unless it is typical of the area, or unless data from that type of site are desired. When possible, the shelter should be no closer than four times the height of any obstruction (tree, fence, building, etc.). It should be at least 100 feet from any paved or concrete surface.

## AIR TEMPERATURE

All shelters should be mounted securely enough into the earth or a concrete slab to eliminate vibrations. Strong winds can cause vibrations that will displace the indices on maximum and minimum thermometers, causing erroneous readings. The wooden shelter door must face north to prevent the sun from shining on the thermometers when the door is open.

### 3.3.2 SHELTER MAINTENANCE

Dust the inside of wood shelters occasionally with a dry cloth. Inspect supports for secure mounting. Report any defects or changes to the NWS representative. The NWS representative will paint the shelter when needed.

Remove insect nests and other matter restricting air flow through the MMTS shelter now and then. If this is not possible, report the condition to the NWS representative.

### 3.4 LIQUID-IN-GLASS MAXIMUM AND MINIMUM THERMOMETERS

#### 3.4.1 MAXIMUM THERMOMETER—HOW IT WORKS

The maximum thermometer has a mercury-filled bulb (sensing element). It is exposed in a nearly horizontal position (exhibit 3.1). Graduations at 10 intervals are etched on the stem. The bore is constricted between the graduated portion of the stem and the bulb, as shown in exhibit 3.4. As the temperature rises, some of the expanding mercury in the bulb is forced to pass through the constricted portion into the graduated portion. When the thermometer is lowered for reading, the top of the mercury column indicates the highest temperature reached.

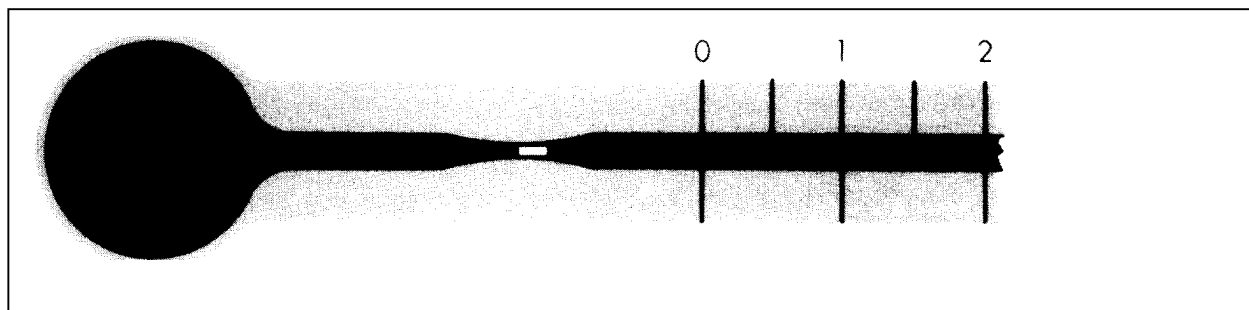

Exhibit 3.4: Liquid-in-Glass Maximum Thermometer

#### 3.4.2 MINIMUM THERMOMETER—HOW IT WORKS

The minimum thermometer has an alcohol-filled bulb, graduated at 10 intervals, and exposed as shown in exhibit 3.1. The alcohol is often colored to make it easier to read. The bore contains a dark

## AIR TEMPERATURE

dumbbell-shaped object called an index 3.5). As the temperature rises, the alcohol expands and flows around the index without displacing it. Part A of exhibit 3.5 shows the top of the alcohol column some distance to the right of the index. In Part B, the alcohol column has retreated with falling temperature until the top just touches the index. Further cooling moves the index nearer the bulb (to the left). As the temperature rises again, the alcohol column moves toward the right without moving the index. Part C shows an incorrect reading with the index trapped in the broken alcohol column. Correcting this problem is described in Section 3.4.6.2.

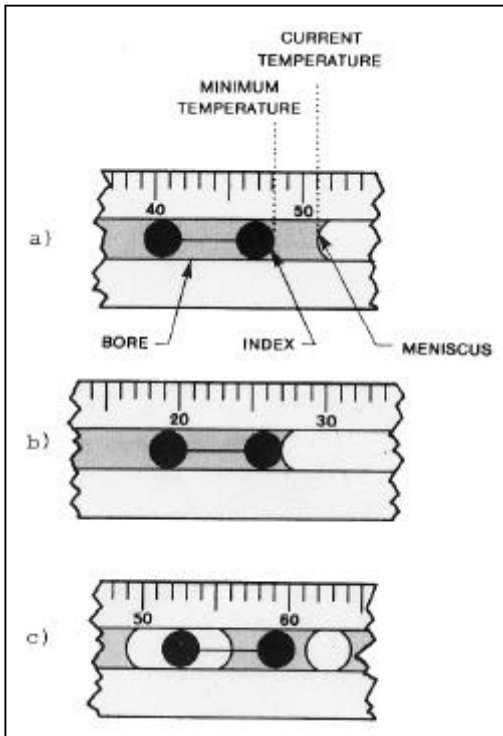

Exhibit 3.5: Index on Minimum Thermometer

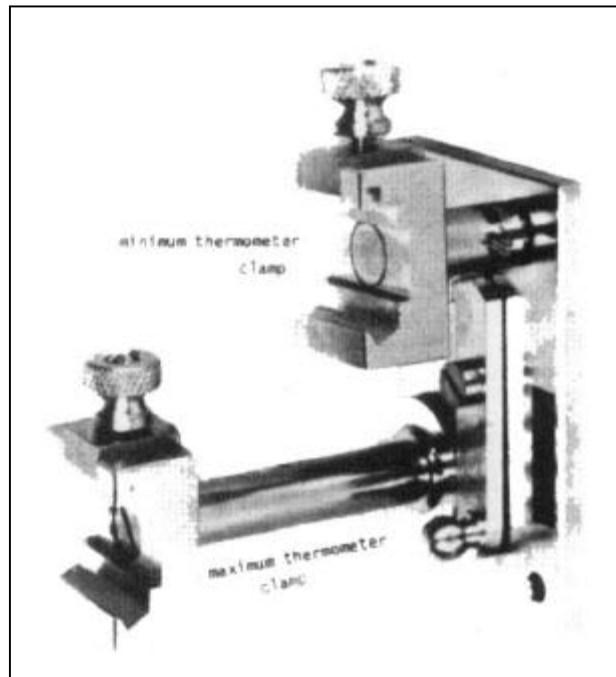

Exhibit 3.6: Supports for Maximum and Minimum Thermometers

### 3.4.3 MOUNTING AND MAINTAINING THE THERMOMETER SUPPORT

Thermometers are mounted in instrument shelters on supports such as the one shown in exhibit 3.6. The support makes it easy to read and reset the thermometers to the current temperature at the time of observation.

The support consists of two metal shafts fastened to a metal base plate. Clamps, which hold the thermometers, are attached to the end of the shafts. The longer shaft holds the maximum thermometer, while the shorter holds the minimum. The maximum thermometer may be spun (rotated) by hand to reset the



## AIR TEMPERATURE

mercury column to the current temperature. A pin in the minimum thermometer shaft prevents it from rotating more than a quarter turn (about 90°). It is reset by rotating it to the vertical position.

The thermometer support should be mounted with screws near the center of the shelter, where the bulbs will be exposed to the freest possible flow of air through the shelter. The longer shaft should be at the bottom, and the longer sides of the base plate should be vertical.

Oil the longer shaft of the support occasionally with a thin motor oil (exhibit 3.6). Wipe any visible oil from the surface of the support.

### 3.4.4 MOUNTING THE THERMOMETERS

Clamp the metal back of the maximum thermometer to the lower (longer) shaft of the support at a point 3.5 inches from the high-temperature end of the back. The bulb end will be to the left when the thermometer is set.

Clamp the metal back of the minimum thermometer to the upper (shorter) shaft. The back should be clamped at a point slightly closer to the high temperature end than the bulb end. The bulb end should be to the left when the thermometer is set.

Be certain that the bulbs will not touch any object when rotated or tilted vertically. If properly installed and set, the bulb end of the minimum thermometer will be slightly (about 5°) above the horizontal (exhibit 3.1).

### 3.4.5 HOW TO READ AND RECORD TEMPERATURES

Thermometers are read and recorded to the nearest whole degree. Readings should usually be recorded on WS Form B-82 (optional) and B-91 (see sections 2.3.2 and 2.3.3). Below zero temperatures are recorded with a minus (-) sign to the left of the digits; i.e., -15 for 15° below zero. The thermometers should be reset after they are read, as described in sections 3.4.5.1 and 3.4.5.2. and exhibit 3.7.

**CAUTION!** Stand as far from the thermometers as possible to prevent body heat from changing the readings. This is particularly important in cold weather. Do not touch the bulbs of the thermometers.

Be sure that the line of sight from your eye to the top of the mercury or alcohol column is level. If not, your reading will be too high or too low, as illustrated in exhibit 3.8.

## AIR TEMPERATURE

- a) Read right end of index in minimum thermometer.
- b) Unlock and slowly lower maximum thermometer; read top of mercury column.
- b) Whirl maximum thermometer until its reading agrees (within  $1^\circ$ ) with reading at top of alcohol column on minimum thermometer. When the two thermometers differ by more than  $1^\circ$  report to supervising office.
- c) Read this temperature from maximum after it has been whirled, except at evaporation stations (Section 5, para 4.1).
- d) Lock maximum thermometer in its set position.
- f) Invert minimum until index drops to end of alcohol column.
- g) Return minimum to its nearly horizontal position.

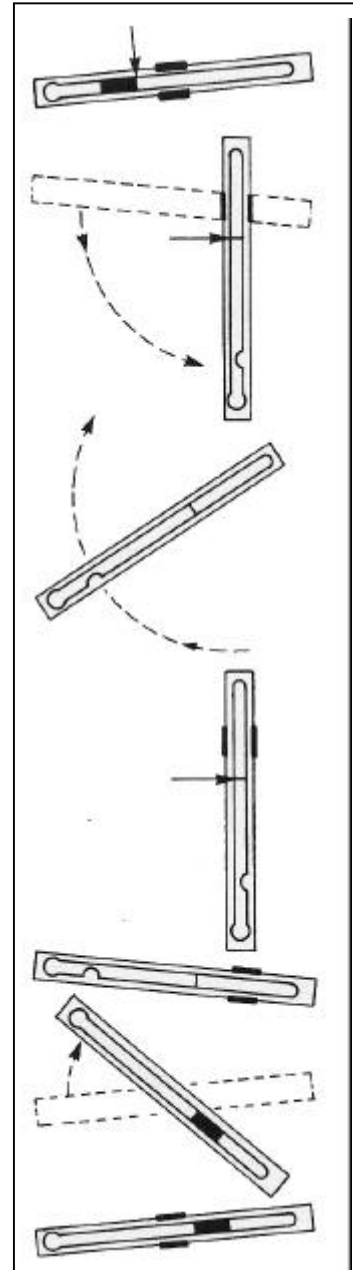

Exhibit 3.8: Reading and Setting Thermometers

### 3.4.5.1 READING AND SETTING THE MAXIMUM THERMOMETER

The highest temperature occurring since the maximum temperature was previously set is the reading at the top of the mercury column, taken with the bulb end

## AIR TEMPERATURE

lowered. Carefully release the support catch back of the clamp to lower the bulb end of the thermometer. See exhibit 3.9.

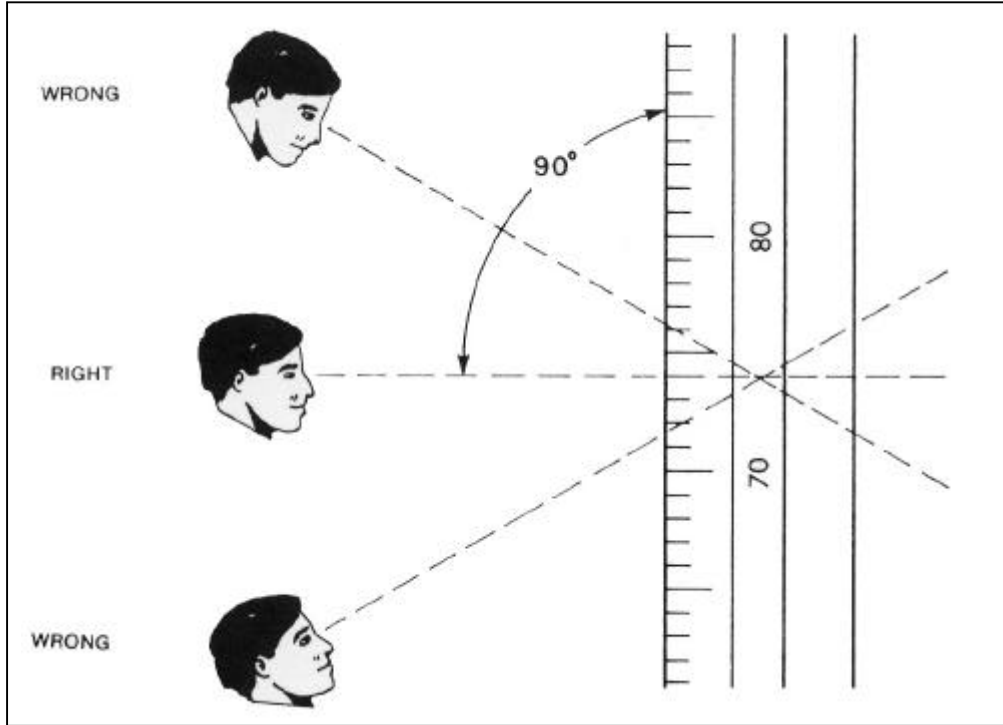

Exhibit 3.8: Reading Thermometers

To set (reset) the maximum thermometer, start with the bulb end lowered (as above) and whirl it rapidly, allowing it to spin freely until it comes to rest. Repeat the whirling if necessary until the mercury will not retreat farther into the bulb; that is, until the column is no longer separated at or below the constriction. See exhibit 3.10.

Now move the catch on the support until it touches the longer shaft. Carefully elevate the bulb end of the thermometer until the catch locks the shaft in place on the support. The thermometer is now "set." It is ready to indicate the maximum temperature that occurs before it is set again in the same manner.

#### 3.4.5.2 READING AND SETTING THE MINIMUM THERMOMETER.

The minimum temperature is the reading at the end of the index farthest from the bulb (not the reading on the alcohol column). Read the thermometer before moving it from the almost horizontal position in which it was set at the time of the last observation.

## AIR TEMPERATURE

To set the minimum thermometer, point the bulb end upward (exhibit 3.11). Allow the index to fall to the end of the alcohol column. Then turn the thermometer counterclockwise until it stops. The bulb end will now be slightly lower than horizontal.

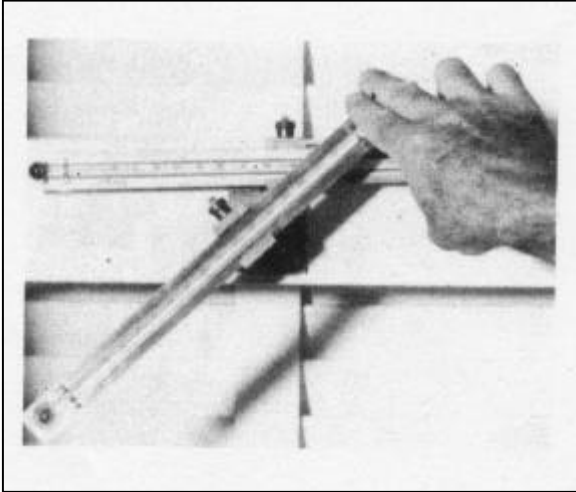

Exhibit 3.9: Maximum Thermometer  
in Reading and Whirling Position

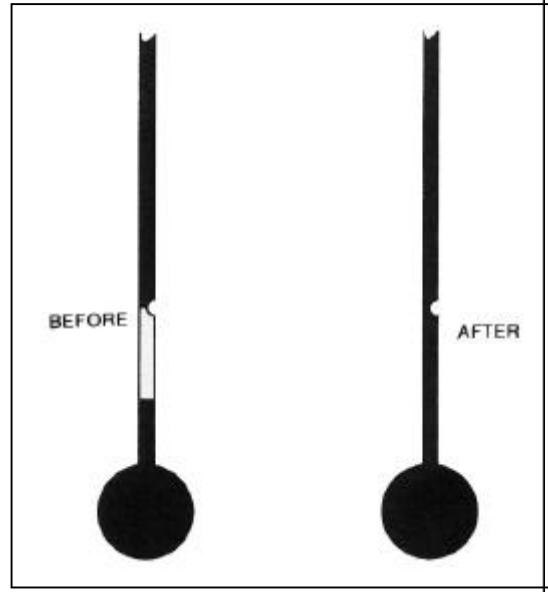

Exhibit 3.10: Maximum Thermometer  
Before and After Whirling

### 3.4.5.3 READING THE CURRENT TEMPERATURE

Read the current temperature from the maximum thermometer while it is in a vertical position after spinning. Read the temperature at the end of the mercury column farthest from the bulb. Read it immediately after setting it.

### 3.4.6 CORRECTING THERMOMETER ERRORS

Sometimes there may be breaks in the mercury or alcohol columns, the thermometer may be too difficult to reset, or it will reset itself between readings. The following instructions tell how to correct some of these problems. If correction is impossible, request a replacement from your NWS representative immediately.

#### 3.4.6.1 CORRECTING MAXIMUM THERMOMETERS

The constriction shown in exhibit 3.4 may not be small enough in some thermometers to prevent the mercury from withdrawing into the bulb when the temperature falls after reaching its maximum value. Sometimes rough handling will cause this problem. To test for this defect, place the thermometer in

## AIR TEMPERATURE

a vertical position. If the mercury withdraws into the bulb without spinning the thermometer, it must be replaced. Please report this to the NWS representative promptly.

If the constriction is too small, it may require many spins of the thermometer to get the mercury to return to the bulb, especially at low temperatures. If so, report this to the NWS representative.

Sometimes a small amount of mercury will lodge in the upper end of the bore. If so, hold the thermometer vertically with the bulb upward. Tap the metal back of the thermometer gently with a finger until the column joins the mercury at the bottom. Lower the bulb, allowing the column to slide slowly down the bore to the constriction.

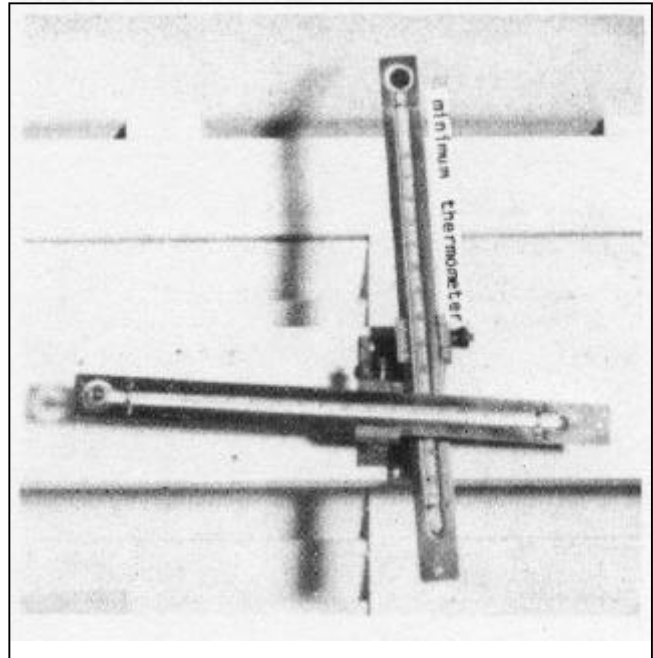

Exhibit 3.10: Minimum Thermometer in Vertical Position During Resetting of Index

When the mercury cannot be united as above, remove the thermometer from its support and whirl as in Method II of section 3.4.6.2.

### 3.4.6.2 CORRECTING MINIMUM THERMOMETERS

Sometimes the alcohol column of a minimum thermometer separates into small parts, causing incorrect readings. Separations may appear as small bubbles, making the column too long and readings too high, and trapping the index. Some alcohol may separate completely and remain in the upper portion of the bore, resulting in readings too low. The thermometer should be inspected regularly for these problems. The methods described below may have to be repeated several times, taking 15 to 20 minutes, before the column can be joined. The thermometer should be kept in a vertical position for several hours after parts of the column have been joined, in order that alcohol clinging to the sides of the bore will drain down. When repeated attempts fail to join the alcohol column, request a new thermometer from the NWS representative.

#### METHOD I: TAPPING

Grasp the thermometer slightly below the middle with the bulb end down. Strike the edge of the metal back sharply against the palm of your hand as shown in exhibit 3.12. Repeat this procedure several times. The thermometer must not be held so that your fingers or any part of your hand presses against the stem.

## AIR TEMPERATURE

The bulb end may also be tapped on an open book.

### METHOD II: CENTRIFUGAL FORCE

A short, quick swing of your arm is often effective in forcing the index toward the bulb and reuniting segments of the alcohol column. Grasp the thermometer firmly by the edges of the metal back a little above the midpoint. Avoid pressure on the back. With your arm extended upward, quickly swing the thermometer downward through an arc of 3 or 4 feet, stopping the motion suddenly when the thermometer is vertical. Sometimes it will be necessary to repeat this operation several times. See exhibit 3.13.

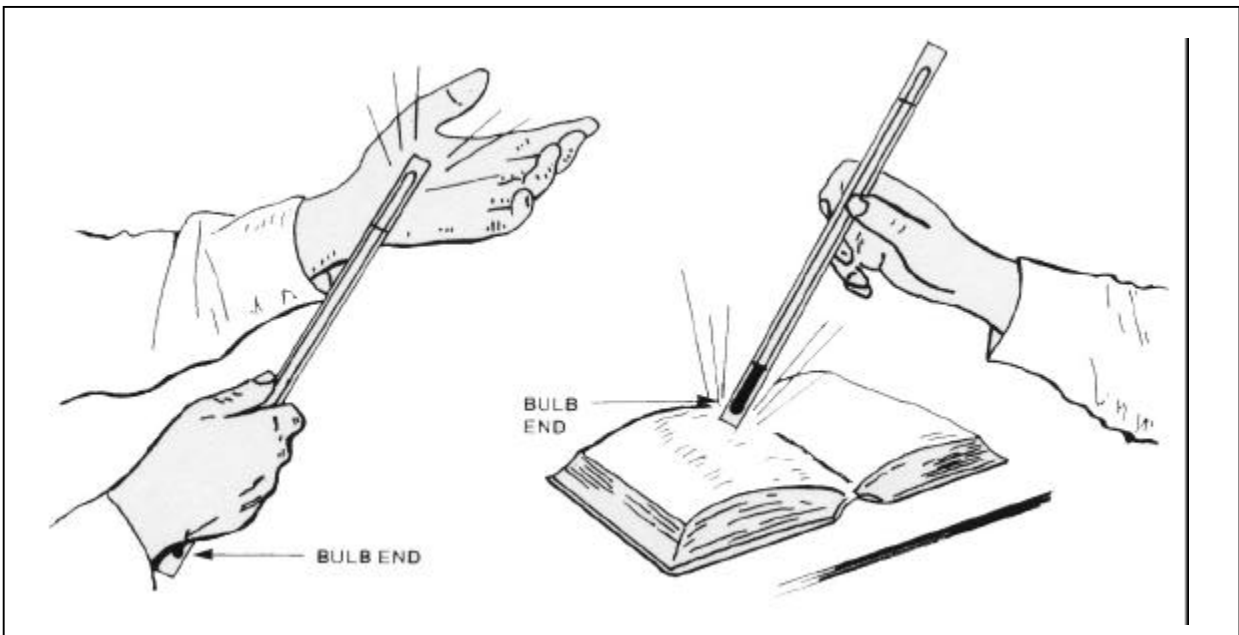

Exhibit 3.12: Joining the Alcohol Column Tapping Method

The thermometer can also be whirled on a short cord. Pass a strong cord through the hole in the top of the metal back of the thermometer. Firmly grasp the cord 6 to 8 inches from the thermometer and whirl it rapidly. Stand clear of all objects the thermometer might strike while whirling. It may take considerable practice to spin the thermometer rapidly and stop it safely. This method will often bring down an entrapped index and unite detached segments of the column. Make sure the cord is not cut by the thermometer back as it is whirled.

### 3.5 MAXIMUM/MINIMUM TEMPERATURE SYSTEM (MMTS)

The MMTS measures the current temperature average range from -55o to +1250F and compares it to the highest and lowest values stored in the memory of a microcomputer. If the current temperature exceeds the previous highest or lowest reading, then it becomes the newest maximum or minimum temperature.

## AIR TEMPERATURE

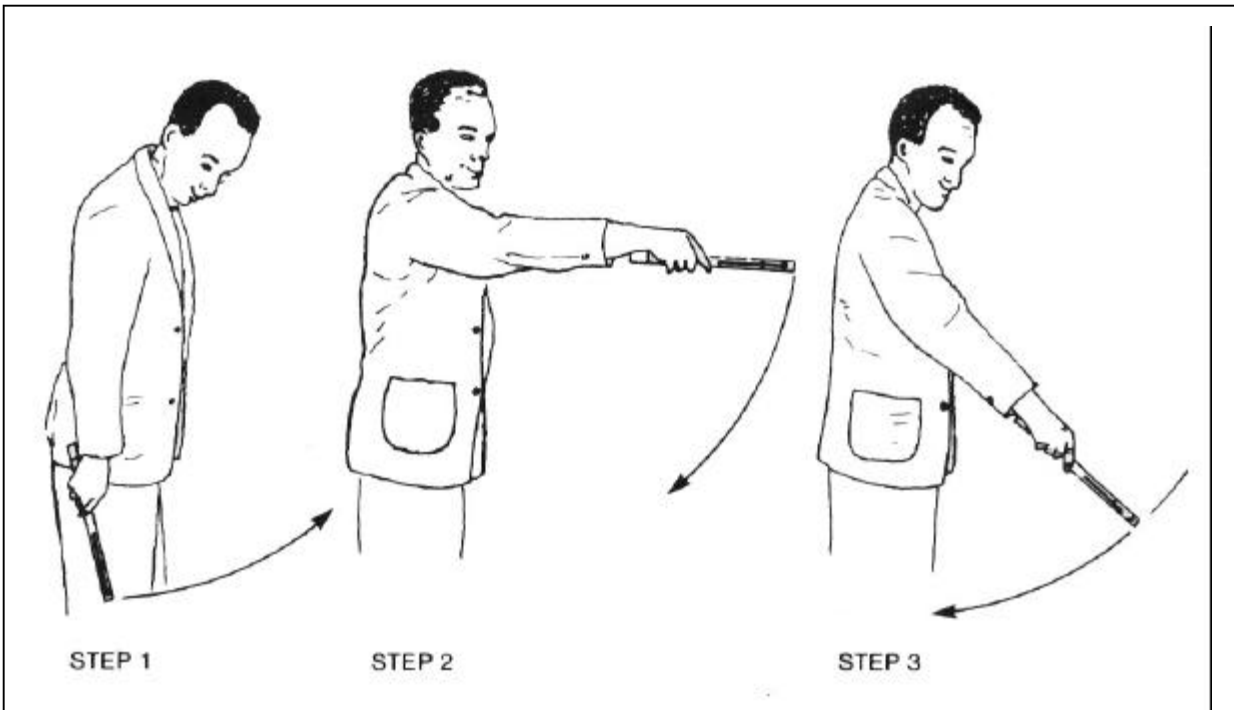

Exhibit 3.13: Joining Alcohol Column—Centrifugal Force Method

### 3.5.1 INITIAL CHECKOUT OF INSTRUMENT

Important: always turn the electronic display unit power switch off when not in use. With the power switch on and the unit unplugged, the battery supplying the emergency backup power will severely discharge, permanently damaging the system.

- a) Connect the instrument shelter to the display unit with the fabricated cable.
- b) Plug the AC power cord of the display unit into an AC outlet.
- c) Turn on the power switch located on the rear panel of the display unit.
- d) Allow one hour for the backup nickel cadmium battery to charge and then turn the display unit off and back on to reset it.
- e) Observe that the display shows the message "HELP." This indicates the microcomputer is functioning properly. Exhibit 3.14 shows the display reading .

## AIR TEMPERATURE

- f) Depress the button labeled "RESET."  
The message "HELP" will be replaced by the current temperature; e.g., 66.3.
- g) Press and hold the "MAX" and "MIN" buttons simultaneously to test the fluorescent display for missing segments. All segments that are not already illuminated will flash intermittently.

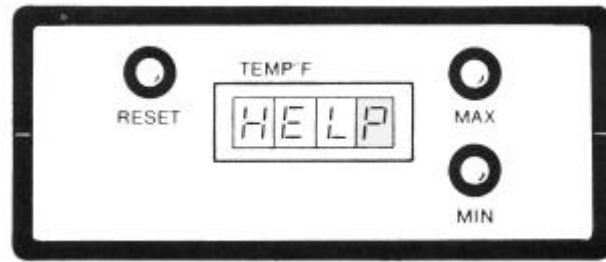

Exhibit 3.14: MMTS Display Panel Showing "HELP"

- h) The message "LO" or "HI" may appear indicating an open or shorted sensor, or less likely, a temperature colder than  $-55^{\circ}$  or hotter than  $+125^{\circ}$  F.

### 3.5.2 CALIBRATION

Often, no calibration is necessary due to the design of the MMTS. Due to possible errors caused by power surges, some observers may be given calibration equipment by the NWS representative, who will provide instructions on its use. Temperature sensors are accurate within  $0.4^{\circ}$  F between  $-40^{\circ}$  and  $+104^{\circ}$ , and within  $0.7^{\circ}$  for temperatures between  $-40^{\circ}$  and  $-55^{\circ}$  and between  $+104^{\circ}$  and  $125^{\circ}$ .

### 3.5.3 OPERATION

The current temperature is displayed if no -buttons are pressed. Depress the "MAX" button to display the maximum temperature that occurred since the MMTS was last reset. Depress the "MIN" button to do the same for the minimum temperature.

Simultaneously press the "RESET" and "MAX" buttons to reset the stored maximum temperature. Do the same with the "RESET" and "MIN" buttons to reset the minimum temperature.

Do not reset the maximum or minimum temperatures between the scheduled times of observation. Resetting at unscheduled times is the most frequent cause of errors.

Record the maximum, minimum, and current temperatures on WS Form E-15. Record to the nearest whole degree, even though the readings are displayed to the nearest tenth degree. If the last digit is a 5 (e.g., 43.5), round the temperature upward to the next higher whole degree (i.e., 44).

### 3.5.4 IDENTIFYING AND CORRECTING ERRONEOUS MAXIMUM AND MINIMUM TEMPERATURES

Today's maximum temperature must be at least as high as the higher of today's or yesterday's temperatures at the time of their respective observations temperatures were  $64^{\circ}$  and  $52^{\circ}$ , and today's



## AIR TEMPERATURE

maximum temperature is displayed as 62° , you must raise today's MAXIMUM to 64° . See section 3.5.7 for a description of the most frequently occurring errors.

Similarly, today's minimum temperature must be at least as low as the lowest of today's or yesterday's current temperatures. If not, lower it to the lowest of the two readings. Unauthorized resetting between observation times creates more errors than all other causes combined. Persistent errors from other causes (i.e., vibrations) should be reported to the NWS representative.

### 3.5.5 "HELP" AND BLINKING DISPLAYS

If the "HELP" message appears on the display, press the "RESET" button to clear it and to show the current temperature. "HELP" indicates an interruption to the A.C. line voltage has occurred. The microcomputer enters a "power down" condition in which the internal backup battery is used to preserve the maximum and minimal values stored in memory. These values are stored up to two hours without power. However, no updating of new maximum and minimum temperatures occurs during or after the power interruption until the "RESET" button has been pressed.

Blinking of the tenths (right-most) digit on the display indicates that the internal backup battery is charging. If the blinking persists and is not caused by power outages, the battery is probably defective, and the NWS representative should be informed.

### 3.5.6 ENTRY OF TEMPERATURE READINGS ON WS FORM B-91

Maximum, minimum and current temperatures are recorded to the nearest whole degree on WS Form B-91. See exhibit 2.10. WS Form B-82 (exhibit 2.9) is designed to record readings taken outdoors, so as not to forget values between the time the instruments are read and the readings are recorded on WS Form B-91. Since the MMTS is read indoors, Form B-82 may be needed only for recording precipitation.

### 3.5.7 COMMON ERRORS TO AVOID

Maximum and minimum temperature data are keyed into computers at NCDC. Data which are inconsistent must either be rejected or corrected (estimated) . observations are flagged most commonly for the following types of errors.

- a) Maximum temperature lower than the time-of-observation temperature at the previous observation (24 hours earlier). This error is most frequently committed by people taking observations in the afternoon or evening.
- b) Minimum temperature higher than the time-of-observation temperature at the previous observation (24 hours earlier). This error is most frequent among morning observers.



## SECTION 4: RIVER STAGES AND RELATED PRECIPITATION OBSERVATIONS

### 4.1 INTRODUCTION

The stage of a river or lake is the height of the water surface above some established datum or reference elevation. The term "gage height" is used for readings from a gage, but river stage and gage height are often used interchangeably. The datum may be a recognized elevation such as mean sea level or an arbitrary datum chosen for convenience. In either case, the gage is adjusted so that only positive gage heights are possible and these are relatively low numbers. This is done by setting the lowest possible gage height (the case of no stream flow) to a value of zero. The elevation of the zero gage height is referenced to the datum by running levels to a reference mark which has a known elevation relative to the datum. It is important that an elevation reference mark for the datum be located (or established) that is permanent even if the gage is destroyed.

The depth of inundation of a flood can be determined by plotting the indicated elevation contour on a topographic map. Determining the elevation above sea level of high water is especially significant during a flood of record.

River stages are affected by many factors. Precipitation and temperature are the most commonly known causes of rises and falls in river stages. However, there are other factors, such as snow melt and glacial runoff into stream, and the release of water from any upstream reservoirs.

Precipitation readings at river cooperative stations are taken with the four-or eight-inch nonrecording gage (section 2.2). River stages are read using a staff, wire weight, or profile gage, as described below.

### 4.2 STAFF RIVER GAGE

The staff river gage (exhibit 4.1) is a fixed scale that can be in the form of porcelain-enameled iron sections, a wooden plank, or may be printed on available structures such as a bridge, pier, or wall. The gage may be mounted vertically or inclined with graduations for vertical depth. The inclined gage is used where ice or debris will not permit a permanent vertical staff to be installed. It usually consists of a heavy timber installed on the incline of the bank. The scale of the staff gage must be set so that a reading can be taken at zero flow in the low-water channel. Readings are made to the nearest tenth of a foot. The staff gage will usually have a gage datum that will be the elevation of its zero reading above mean sea level. The gage sections should be set so the readings are heights above the datum.

If vertical movement of the supporting structure occurs, such as settling, erroneous observations from the staff gage will result unless levels are run from a reference of known elevation and the staff scale is reset.

## RIVER STAGES AND RELATED OBSERVATIONS

If the gage has been set with a scale that has graduations above and below zero (exhibit 4.2), the below zero readings must be recorded on the report form with a minus sign; e.g., -0.3. If possible, the gage should be set so as to avoid negative values.

### 4.3 WIRE WEIGHT GAGE

The wire weight gage (exhibit 4.3) is permanently mounted inside a case that is attached to a bridge or similar structure. The gage consists of a drum wound with cable, a bronze or brass weight attached to the end of the cable, a check bar, a graduated disc, and a counter.

Take readings as follows.

- a) Unlock the case at (1) and gently open the cover (2). If the cover jams and will not swing freely, do not force it open. Close, relock, and submit a repair order. Inspect the wire (7) on the drum (8) for even windings that touch each other.

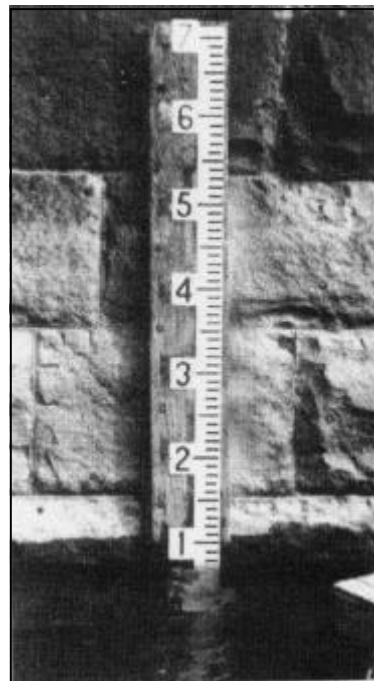

Exhibit 4.1: Staff River Gage

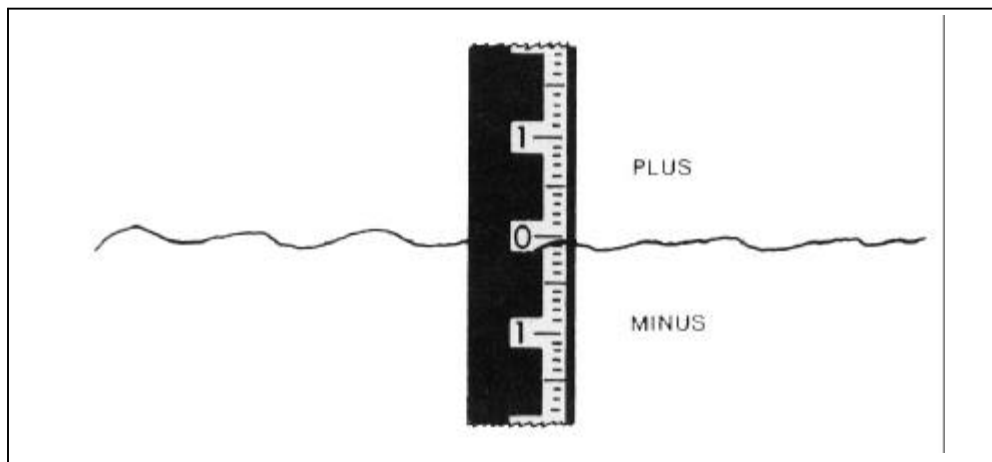

Exhibit 4.2: Staff River Gage Installation

- b) Grasp the crank handle (3) and release the pawl (4). Lower the weight (5) to just touch the check bar (6), which is read while in the forward position.

## RIVER STAGES AND RELATED PRECIPITATION OBSERVATIONS

Read the check bar elevation and record it. Enter this reading at the beginning, middle, and end of each month in the lower left corner of WS Form E-15. The feeder counter (9) displays units of feet. The index wheel (10) displays units of tenths and hundredths of a foot and is read at the pointer (11) .

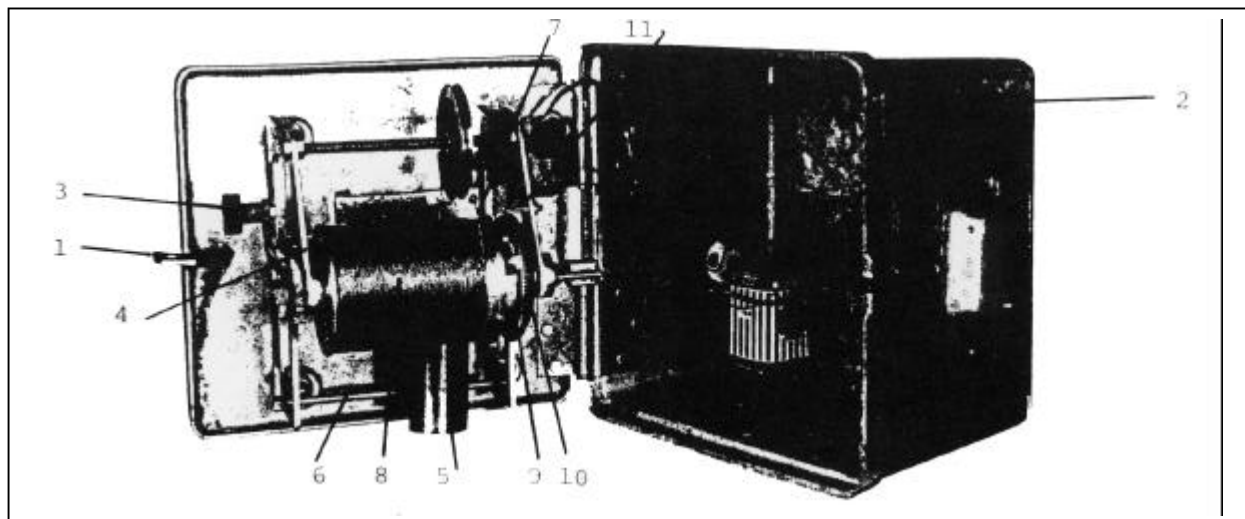

Exhibit 4.3: Wire Weight Gage

- c) Raise the weight and slide the check bar to the rear position. Lower the weight to the water surface and read this elevation just as the weight touches the water while descending. Average the peaks and troughs of elevation if the water surface is rough. You should repeat this process at least once. If the point of contact with the water surface is difficult to determine, it may be necessary to strum the cable or to swing the weight in a pendulum motion up and downstream to obtain an accurate reading.
- d) Every day, record the reading obtained in step © in the "GAGE READING AT" column on WS Form E-15.
- e) Engage the pawl and crank the weight to its original position within the gage. Slide the check bar to the for-ward notch. The crank handle should now be located in the rear position. This will allow the cover to close without touching the cutter tip of the crank handle.
- f) Close the cover and lock the case as you originally found it.

### 4.4 PROFILE GAGE

On some rivers, especially where man-made structures such as bridges are rare and where vertical or staff gages can be damaged by ice jams and breakup, profile gages are used. These consist of a marker, usually a brass cap benchmark, anchored in the bank above the levels of ice movement. The profile of the bank is surveyed to determine elevations to the nearest tenth of a foot and plotted on a graph. The cooperative observer, using a long surveyor's

## RIVER STAGES AND RELATED PRECIPITATION OBSERVATIONS

tape measure, determines the distance from the reference marker to the water's edge. From the graph, the slope distance is converted to a vertical stage. The observer always reports the slope distance to the NWS office.

### 4.5 RIVER GAGE LOCATION

Consider the following factors when selecting a site for the river gage.

- a) The gage should be located so that stages will best reflect flooding in the area of maximum damage potential.
- b) There should be access to the gage during high water, if at all possible.
- c) The gage should not be located in the backwater of a reservoir or of a main stem river, if possible.
- d) The river banks at the gage site should be stable.

### 4.6 RELOCATING RIVER GAGES

A river gage should be moved only after all other options have been exhausted. A different river gage location is likely to change such forecast components as the relationship of the gage reading to the discharge rate, flood wave travel time, and the attenuation, as well as changing the flood stage. Moving the gage may add or exclude a significant tributary from the drainage area. All users of the stage data would need to be informed of the change.

A new or moved river gage location will mean establishing a new gage datum if an arbitrary datum is used. If mean sea level is the datum, a bench mark or a new reference mark with known mean sea level will have to be located. It will then be necessary to run levels from the known elevation to the new gage site.

A wire weight gage will require that a new check bar elevation be determined, while a staff gage will require that the individual gage sections be set to given elevations above the datum.

If moving the gage is ultimately indicated, observers should contact their NWS representative.

### 4.7 TIMES OF RIVER STAGE AND PRECIPITATION OBSERVATIONS

Observations of river stage and precipitation should be taken at 7 a.m. each day unless otherwise specified by or agreed upon with the NWS. Special observations are taken at 1 p.m., 7 p.m., and 1 a.m. only when a report is required (section 4.8) or when the observer believes an emergency situation has occurred.

## RIVER STAGES AND RELATED PRECIPITATION ON OBSERVATIONS

### 4.8 WHEN TO REPORT

There are two types of reporting stations, daily and criteria. Criteria stations are sometimes called Occasional stations. In many areas of the country, criteria stations are being converted to daily stations.

At a daily reporting station, reports are to be sent immediately after the 7 a.m. observation. Send extra reports at 1 p.m., 7 p.m., and 1 a.m. when the river stage reaches a level designated by the NWS representative (the criteria level) .

The reporting station should send its first report when the river stage reaches the criteria level specified by the NWS. Reports should continue daily until the stages fall below this level. If the river stage goes above a second criteria level, extra reports are to be made at 1 p.m. , 7 p.m., and 1 a.m., until the stage falls below this level.

Observations of both precipitation and river stage should be recorded on the reporting form at 7 a.m. every day at criteria reporting stations, even if stages are below criteria and are not sent. Always report river stage and precipitation together.

If no precipitation has occurred, the daily record from both types of stations should indicate 0 or 0.00.

When the rain gage measurement reaches a criteria value (usually 0.50 inch), an initial report must be made at 7 a.m., 1 p.m., 7 p.m., or 1 a.m. Reports should continue at all of these times until precipitation has not been reported for 24 hours. For example, if 1.05", 0.22", 0, and 0 precipitation fell during the six-hour periods ending at 1 p.m., 7 p.m., 1 a.m., and 7 a.m., report 1.05" at 1 p.m. and 1.27" at the other three times. See section 4.9b below.

### 4.9 WHAT TO REPORT

The report should contain the following information.

- a) Location (station name or number), date, and time of observation.
- b) The amount of precipitation having fallen since the previous 7 a.m. observation (inches and hundredths).
- c) Character of the precipitation (rain, snow, ice pellets, etc.).
- d) The weather at the observation time (clear, cloudy, rain, snow, etc.).
- e) The depth of snow or ice on the ground (nearest whole inch).

## RIVER STAGES AND RELATED PRECIPITATION OBSERVATIONS

- f) The water equivalent of the above snow and ice (nearest tenth inch), if agreed to with the NWS.
- g) The river stage at the observation time (feet and tenths).
- h) The tendency of the river stage (rising, falling or stationary).
- I) The river stage at the previous 7 a.m. observation, if not previously reported
- j) In the remarks section, enter special comments such as snow melting slowly or rapidly, unusually heavy rainfall in a short period of time (e.g., 1.54" in 30 minutes), ice breaking up or an ice jam forming on the river, etc.

Make a special effort to obtain a stage Measurement at the river crest, recording the approximate time of occurrence. It is also very helpful to take observations, both as the river begins a significant rise and as it recedes from a crest. These reports, even when not transmitted, will be valuable input to computer models that relate precipitation to river stage, and which determine the relationships of river stages at different points on the river.

When the water surface is disturbed due to turbulence or waves, record the stage as the average of the peaks and troughs.

### 4.10 REPORT FORMS

All necessary forms are furnished by the NWS. Each pad of forms contains detailed instructions. A sample of WS Form B-91 is shown in exhibit 2.11.



## SECTION 5: EVAPORATION STATION OBSERVATIONS

### 5.1 INTRODUCTION

Observations are made of the amount of evaporation to the nearest hundredth inch from an open pan. Other elements recorded include wind movement, water and air temperatures, and precipitation. At some sites, additional parameters will be required, such as dry and wet bulb temperatures, humidity, and the temperature and moisture content of the soil. Section 6 contains instructions on soil temperature measurements.

### 5.2 SETTING UP THE OBSERVING SITE

#### 5.2.1 EXPOSURE OF EQUIPMENT

The equipment site should be fairly level, sodded, and free from obstructions (exhibit 5.1). It should be typical of the principal natural agricultural soils and conditions of the area.

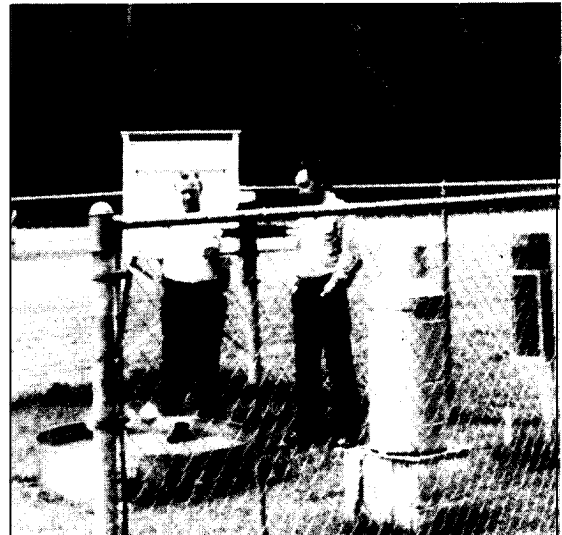

Exhibit 5.1: Evaporation Station Sites

Neither the pan nor instrument shelter should be placed over heat-absorbing surfaces such as asphalt, crushed rock, concrete slabs or pedestals. The equipment should be in full sunlight during as much of the daylight hours as possible, and be generally free of obstructions to wind flow. Obstructions that cannot be moved, such as trees, buildings, and nearby shrubs, should not be closer to the instruments than four times their heights. Shadows are permissible only near sunrise and sunset. Avoid areas subject to flooding or lawn sprinkling.

## EVAPORATION STATION OBSERVATIONS

At reservoirs (flood control, water supply, and irrigation projects) the pan should be placed on the upwind side of the water. This is based on the prevailing direction of the strongest winds. The pan site should be far enough from the water to avoid the chance that water or spray carried from a spillway, or picked up from the reservoir by a strong wind, will be deposited in the pan.

The layout of equipment on the plot is shown in exhibit 5.2. The orientation N of the layout should be as indicated by the North arrow. If necessary, the layout can be rotated as much as 45°.

### 5.2.2 PLOT LAYOUT

Note that the layout is designed to eliminate shadows from instruments at stations in the northern hemisphere. Shadows from small diameter fence posts will occur only briefly in the late afternoon. The minimum distances between instruments are shown in exhibit 5.2.

The 10- by 16-foot plot shown is the minimum size. If other equipment is installed, the plot should be enlarged accordingly.

### 5.2.3 ENCLOSURE

The plot must be enclosed by a fence that will keep out animals. A steel chain link fence (9 or 11 gauge), at least four feet high, with steel posts set in concrete is recommended. Fences of wood or other solid material shall not be used. It may be necessary to bury a barrier under the fence for protection from burrowing animals, or add 18 to 24 inches of one inch galvanized chicken mesh fence along the bottom of the chain link fence to keep out small animals.

## 5.3 EVAPORATION EQUIPMENT

This section describes the installation, maintenance, and method of taking observations from each instrument. Evaporation measurements are made with an evaporation pan and a fixed-point gage with a measuring tube. Evaporation stations have the following additional instruments:

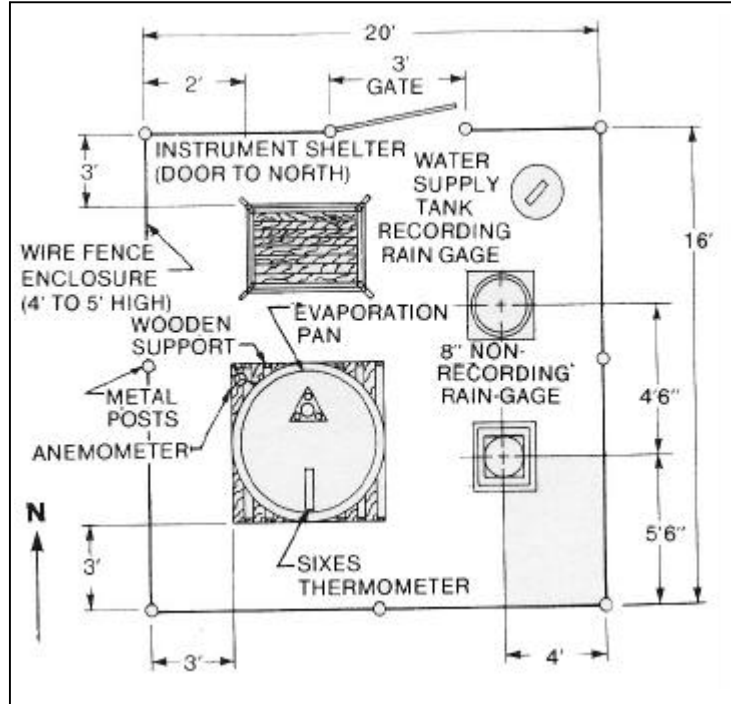

Exhibit 5.2: Evaporation Plot Layout

## EVAPORATION STATION OBSERVATIONS

- a) An anemometer to determine the daily wind movement over the pan and a display stand pintle (subsection 5.3.4).
- b) An Clinch nonrecording precipitation gage with appropriate measuring stick or in some cases, a weighing-type recording precipitation gage.
- c) A water temperature thermometer or thermograph to provide maximum, minimum, and current temperatures of the water in the evaporation pan (subsection 5.3.6).
- d) Maximum and minimum thermometers or a thermograph for measuring the air temperature. Some stations have a hygrothermograph in place of these for measuring air temperature and humidity (subsection 5.3.5).
- e) An instrument shelter for housing the temperature and humidity measuring instruments.
- f) A water storage tank (if necessary) to provide a reserve water supply for the pan (subsection 5.3.3).

### 5.3.1 EVAPORATION PAN

The pan is circular, 10 inches deep, and 47.5 inches in diameter (inside diameter). It is constructed of monel metal. See exhibit 5.3. Also shown in exhibit 5.3 are the pan support and an anemometer.

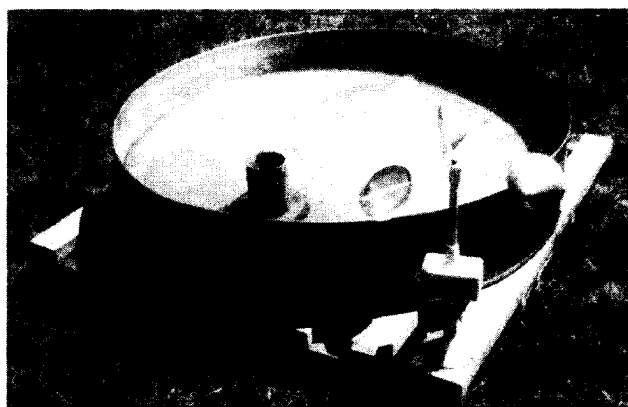

Exhibit 5.3: Evaporation Pan

#### 5.3.1.1 INSTALLATION

The pan must be centered on supports resting on leveled ground. Take care to locate the pan in an area that is free from flooding even in heavy rains, or where runoff could wash away the support. If fill dirt is required to level the ground, it should be tamped firmly. The top of the support should be .5 inch above

## EVAPORATION STATION OBSERVATIONS

the dirt. This will leave an air space between the bottom of the pan and the fill dirt to simplify inspecting the pan for leaks.

### 5.3.1.2 MAINTENANCE

Carefully inspect the pan for leaks at least once a month (leaks make measurements useless). Report any leaks immediately to the NWS representative. Record the date the leak was discovered and the date the pan was repaired or replaced.

Clean the pan as often as necessary to keep it free from any substance that will alter the evaporation rate, such as sediment, SCUM algae, and oil films. Oil films greatly reduce evaporation.

The pan should never be painted. This would alter the evaporation characteristics. In order to compare measurements between sites, all pans must have identical characteristics.

Under no circumstances should the pan be lifted and emptied with a significant amount of liquid in it, as such action can split or bend the pan. Most of the water should be syphoned or dipped out first.

During months when freezing conditions are likely, empty, clean, and store the pan, preferably indoors. If left in the fenced enclosure, it should be turned upside down and secured to the support with a strong rope.

### 5.3.1.3 CONTROL OF ALGAE

A small amount of copper sulphate may be added to the water to discourage algae growth. The NWS representative will supply the copper sulphate. If algae are already present, they must be removed by thoroughly cleaning the pan

### 5.3.2 FIXED POINT GAGE

The fixed point gage consists of a pointed rod mounted in a tube called the stilling well. It is placed inside the evaporation pan, one foot from the north edge. The stilling well makes readings more precise by eliminating wind-caused surges in the water level and ripples.

The stilling well is 2.5 to 3.5 inches in diameter and 10 inches tall, and is attached to a base. All parts are made of non-corrosive metal. The base must be heavy enough to resist being moved by the wind. The stilling well has two small openings, 1/8 inch in diameter, located opposite each other near the base. They permit the flow of water in and out of the stilling well.

The pointed rod is 1/8 inch in diameter. It is attached to the center of the base inside the well. The point is 7.5 inches above the bottom of the evaporation pan when in position.

## EVAPORATION STATION OBSERVATIONS

Evaporated water must be replaced. This is done by using the transparent measuring tube, shown beside the stilling well in exhibit 5.4. It is 15 inches deep with an inside diameter of 4-3/4 inches, which is one-hundredth of the surface area of the evaporation pan. The tube is graduated at one-inch intervals, with the zero mark at the top. One inch of water in the measuring tube is equivalent to .01 inch in the evaporation pan.

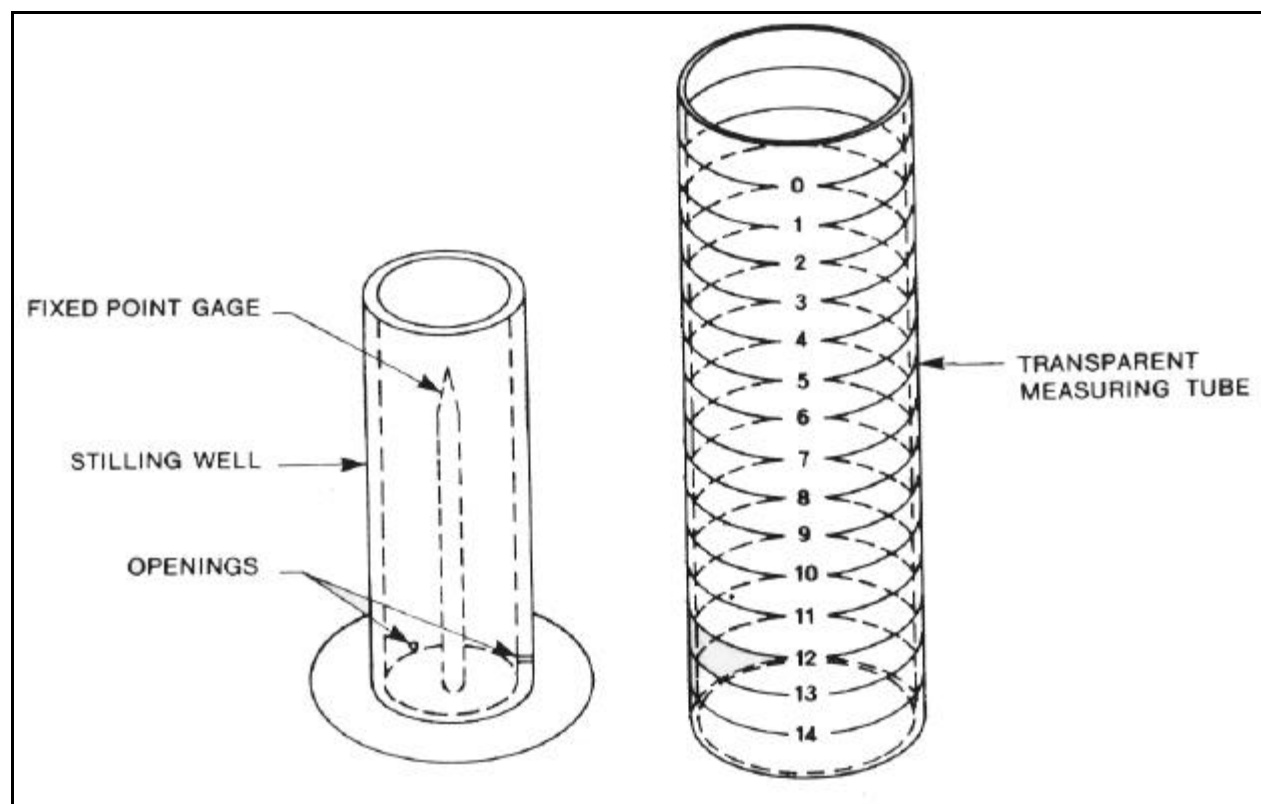

Exhibit 5.4: Stilling Well, Fixed Point Gage, and Measuring Tube

### 5.3.2.1 MEASURING THE AMOUNT OF EVAPORATION

Evaporation is measured by determining the amount of water required to bring the water level in the stilling well exactly to the tip of the pointed rod. Use the transparent measuring tube to add or remove water from the evaporation pan. When water must be added, fill the measuring tube to the zero mark (the top mark on the tube), then pour (slowly) exactly enough water into the evaporation pan (not in the stilling well) to bring the water level to the tip of the fixed point. Next, read the level of water remaining in the measuring tube. If this reading is closest to the 12 mark, for example, 0.12 inches of water has evaporated (or else evaporation has exceeded precipitation by 0.12 inches). See exhibit 5.5.

If precipitation has occurred since the previous observation, the water level may be above the tip of the fixed point. In this case, remove water by filling the measuring tube up to the zero level with water from

## EVAPORATION STATION OBSERVATIONS

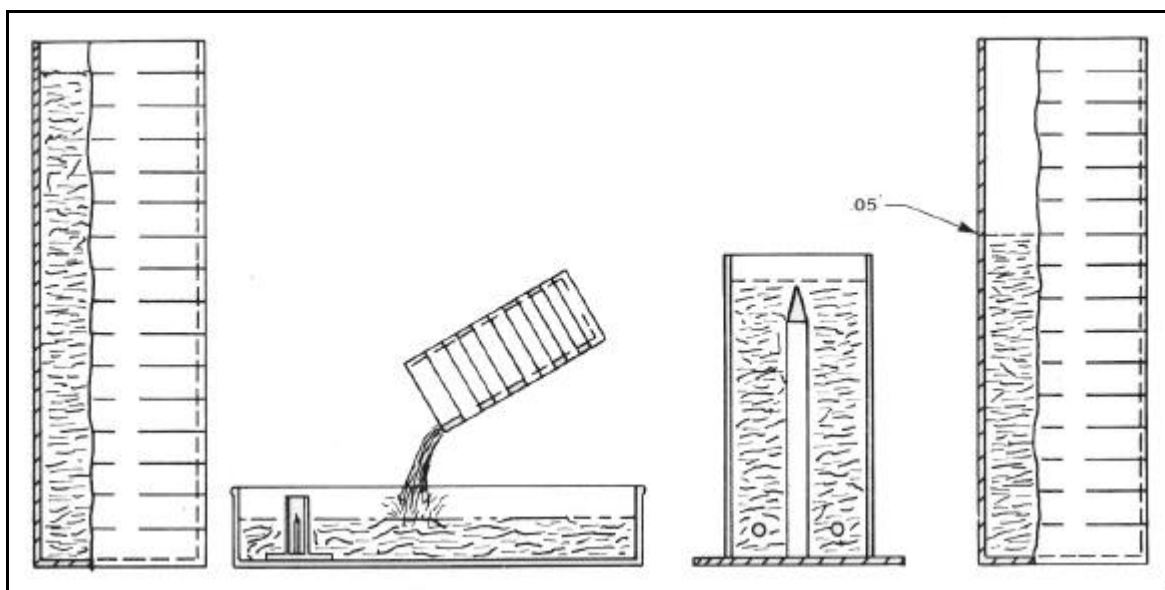

Exhibit 5.5: Evaporation Measurements

the evaporation pan as many times as necessary to bring the water level to the fixed point. Be sure to keep track of the number of times the tube is filled. Each filling represents 0.15 inches of water. When enough water has been removed to bring the water level below the fixed point, fill the measuring tube with water from the storage tank (subsection 5.3.3) to the zero level, and pour enough water back into the pan to bring the level to the tip of the fixed point. Deduct this amount from the total removed.

An alternative to bringing the water level below the fixed point is to remove enough water from the pan into the measuring tube to bring the water exactly to the fixed point, measuring the amount in the tube, and subtracting this from 0.15 inch. For example, if the tube is filled to the "5" level (0.05 inch), subtract 0.05 from 0.15. The amount removed by dipping is thus 0.10 inch. This is added to the amount removed (if any) by filling the tube from the pan as described in the previous paragraph.

For recording purposes, water added is positive and water removed is negative. For example, if 0.24 inches of water must be added, record this as +0.24. On the other hand, if rain has fallen and the measuring tube must be filled three times to bring the level below the fixed point, 0.45 inch is deducted. If 0.06 inch of water is then added to bring the level back to the fixed point, enter the sum of -0.45 and +0.06, or -0.39, on the recording form (WS Form B-92).

## EVAPORATION STATION OBSERVATIONS

### 5.3.3 WATER STORAGE TANK

If clean water is not available at the site, a storage tank should be located there. The tank should be placed where it will not shade or reduce wind flow over the pan. It should be thoroughly cleansed at the beginning of the evaporation measuring season. The water must be completely free of oil.



Exhibit 5.6: 5-Digit, 3-Cup Anemometer

When the season ends, empty and secure the tank to prevent freeze and wind damage.

### 5.3.4 ANEMOMETER

A standard 3-cup, 5 digit counter anemometer (exhibit 5.6) is mounted on a wooden pan support.

#### 5.3.4.1 INSTALLATION

The anemometer is mounted on a specially designed display stand pintle on the northwest projecting corner of the pan support. The center of the cups should be 6 to 8 inches above the rim of the pan. In this position, the shadow of the cup falls on the pan only during the late afternoon. The anemometer retaining screw (the knurled head set screw located in the adaptor at the bottom end of the anemometer housing) is used to attach the anemometer to its support base. This screw should be turned only hand-tight.

#### 5.3.4.2 MAINTENANCE

The NWS representative will service and clean the anemometer on his routine inspection trips, normally twice a year. Bearings of an anemometer that lacks oil will squeak and wear badly within a few hours. A squeaking anemometer should be removed immediately from its support and examined carefully. If it is not seriously damaged, clean and oil it. Otherwise, report the problem to the NWS representative immediately. If service is required between NWS representative visits, use the following procedure.

- a) Loosen the set screw near the bottom end of the housing.
- b) Remove the anemometer from its support base with a slight twisting motion.

## EVAPORATION STATION OBSERVATIONS

- c) Remove the nut on top of the spindle above the cups.
- d) loosen the screw on the hub side of the cups and remove the cups from the spindle.
- e) Remove the spindle bearing. To do this, loosen the retaining screw on the back near the enlarged portion of the housing. The spindle and ball bearings can then be removed. Take care not to lose any ball bearings.
- f) Remove all dirt and used lubricant from the spindle with a clean cloth. If necessary, wash the spindle and upper bearings in kerosene or a similar petroleum-based solvent. Noticeable amounts of dirt in the anemometer should be reported to the NWS representative.
  - 1) Where a sleeve-type bearing is used, roll a piece of cloth into a small rope and run it through the spindle bearing until it is bright and clean.
  - 2) For a ball-type spindle bearing, clean the bearing with petroleum based solvent. Use a cloth to clean the outer race of the bearing (in the top end of the housing).
  - 3) If an oil-reservoir type retaining nut is used, loosen the knurled cap at the top and refill it with oil. Make sure the wick enters the small hole in the end of the spindle when replacing the nut.
- g) Apply a drop of oil to the worm threads and two or three drops to the bearing before reassembling the anemometer. Remove excess oil so it will not become a trap for dust and abrasive particles.
- h) Under "Remarks" in WS Form E-22, enter "anemometer cleaned" with date.

### 5.3.4.3 WIND MOVEMENT READINGS

Read the anemometer counter daily at the scheduled time of observation, to the nearest whole mile. For example, if the counter shows a total wind movement of 9291.3 miles, enter 9291.

### 5.3.4.4 DATA FROM 5-DIGIT-COUNTER TYPE ANEMOMETERS

The five digits appearing in the window of the meter indicate the total wind movement in tenths of a mile for any total from zero to 10,000 miles. The right hand digit indicates tenths of a mile.

Generally, you will not have to compute the number of miles of wind movement since the previous reading. When asked to compute the miles of wind travel, subtract the previous day's reading from the number currently on the counter. When 10,000 miles have accumulated, the reading starts over at zero. Thus, when the current day's reading is less than the preceding reading, compute the 24-hour wind



## EVAPORATION STATION OBSERVATIONS

movement by adding 10,000 to the current reading. Subtract the preceding reading from this total. For example, if today's reading is 10,109 and the previous reading 9,986, subtract 9,986 from 10,109. The movement will thus be 123 miles.

### 5.3.5 DRY- AND WET-BULB TEMPERATURES

Dry- and wet-bulb temperatures are read in order to compute a measure of humidity. The NWS representative may request that the wet and dry bulb temperature data be used to compute the dew point or relative humidity. The dry-bulb thermometer of the psychrometer gives the current air temperature. The wet-bulb temperature is the lowest temperature obtained from the moistened wick-covered temperature-sensing element of the psychrometer that has been cooled by evaporating water.

#### 5.3.5.1 TYPES OF PSYCHROMETERS

The psychrometer in general use consists of two identical mercury-in-glass thermometers, shown hanging from a hook to the left of the ventilating fan in exhibit 5.7. The lower one of the two (the wet-bulb thermometer) has a close fitting, loosely woven muslin wick covering the bulb. The fan is operated with a hand crank to provide forced ventilation of the thermometers.

Another type of psychrometer, called the sling psychrometer, is shown in exhibit 5.8. On this instrument, evaporation from the wet-bulb, wick is enhanced by whirling the thermometer through the air around the sling handle.

#### 5.3.5.2 MAINTENANCE

The only additional maintenance which the wet-bulb thermometer requires over other liquid-in-glass thermometers (subsection 3.4) concerns the muslin wick. This wick must be close-fitting and tubular, so it holds tightly to the thermometer bulb. Slip about 3 inches of wicking over the bulb until it extends beyond the narrow part of the stem. Change the wicking frequently to keep it clean. A dirty wick, or one filled with mineral salts (often invisible) from evaporated water, will not allow water to evaporate as readily as a clean wick and will result in readings being too warm.

#### 5.3.5.3 MOISTENING THE WET BULB

The wet-bulb should be moistened just prior to ventilating it, with the following two exceptions.

##### a) HIGH TEMPERATURE AND LOW HUMIDITY

In hot, dry weather, moisten the wet-bulb wick thoroughly several minutes before reading it, leaving a drop of water on the end. Natural ventilation will cause partial evaporative cooling before it is ventilated. The drop of water is necessary to prevent the wick from drying before the lowest wet-bulb reading

## EVAPORATION STATION OBSERVATIONS

can be obtained. Nevertheless, under very low humidity conditions the wet-bulb must be pre-cooled by one of the following methods to prevent premature drying.

- 1) Store the moistening water in a porous jug in the shelter.
- 2) Equip the wet-bulb with a longer wick, and insert the end of the wick in a water container placed a few inches below the bulb. Move the container away before ventilating the wet-bulb.

### b) DRY-BULB TEMPERATURE BELOW 37°

Moisten the wick thoroughly 10-15 minutes before reading. This time interval will allow the latent heat released by the freezing of the wet bulb wick to escape before ventilation is started, use waster at room temperature to melt any accumulation of ice. A thin coating of ice will form during the above 10 to 15 minute wait or during ventilation. The

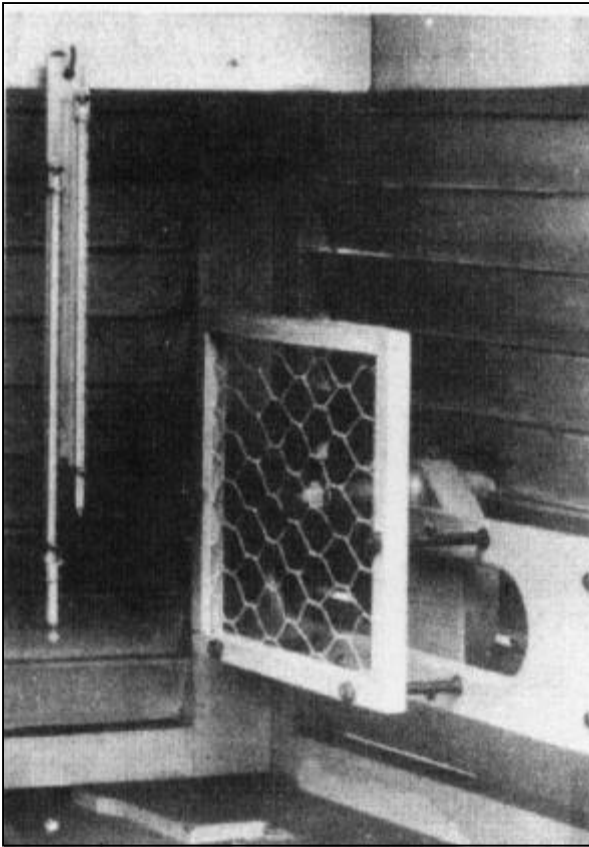

Exhibit 5.7:  
Psychrometer with Fan

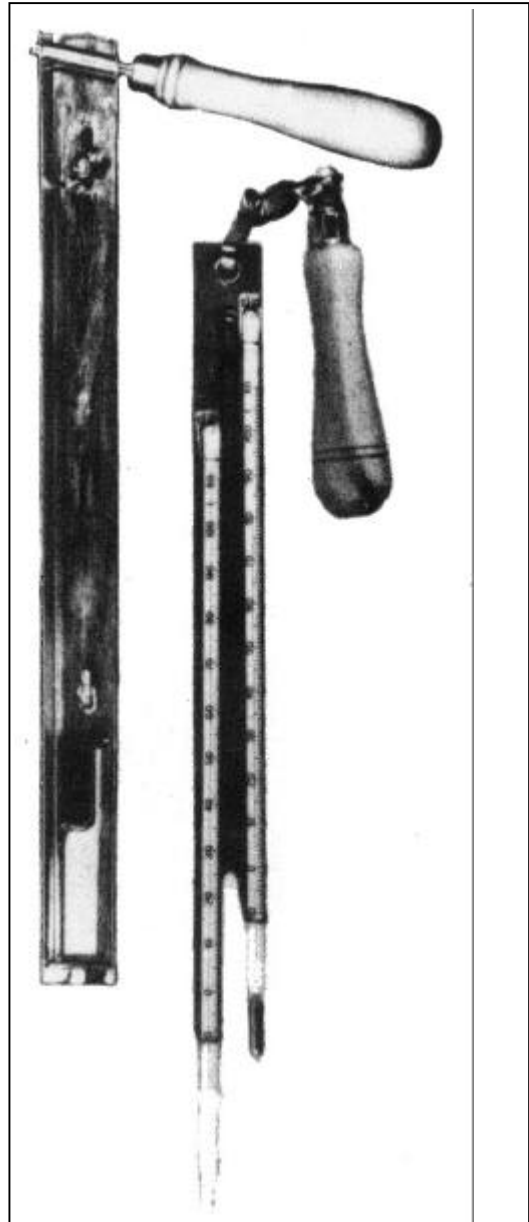

Exhibit 5.8:  
Sling Psychrometer

## EVAPORATION STATION OBSERVATIONS

ice coating must be thin in order to get accurate readings at these wet-bulb temperatures. If water remains unfrozen at wet-bulb temperatures below 32° in spite of ventilation, freezing may be induced by touching the wick with snow or ice.

### 5.3.5.4 TAKING PSYCHROMETER OBSERVATIONS

Moisten the wick as above. For psychrometers with hand-cranked fans, turn the crank at least 3.5 revolutions per second to ventilate properly.

For sling psychrometers (exhibit 5.8), select a shady spot that has plenty of room for whirling the psychrometer. Face into the wind. Whirl the psychrometer at least two revolutions per second, as far in front of the body as possible, for at least 10 to 15 seconds between each reading. Ventilate longer if the temperature is near or below freezing.

For both of the above types of psychrometers, read both thermometers to the nearest tenth degree two or more times immediately following each period of ventilation. Repeat the ventilation operation until two successive readings of the wet-bulb are the same. Record the lowest wet-and dry-bulb readings. Follow the procedures given in subsection 5.3.5.3 if the air is very dry or the temperature is below 37°.

### 5.3.6 WATER TEMPERATURES

Other factors being equal, the rate of evaporation increases rapidly with increasing water and air temperature, approximately doubling with each rise in temperature.

Maximum and minimum water temperatures are determined from. Sensing elements placed beneath the surface of the water in the evaporation pan. Evaporation occurs from the immediate surface of the water. Since warmer water is lighter than colder (if above 39°F), it will rise to the top and tend to stratify there during the day, especially with the sun shining. Therefore, the thermometer should measure the water temperature as close to the surface as possible without being exposed to the air (Section 5. 3. 6.1.1 below).

Water temperatures are measured with the recording or (more frequently) the maximum-minimum (Six's) thermometer, 20°F as shown in exhibit 5.9.

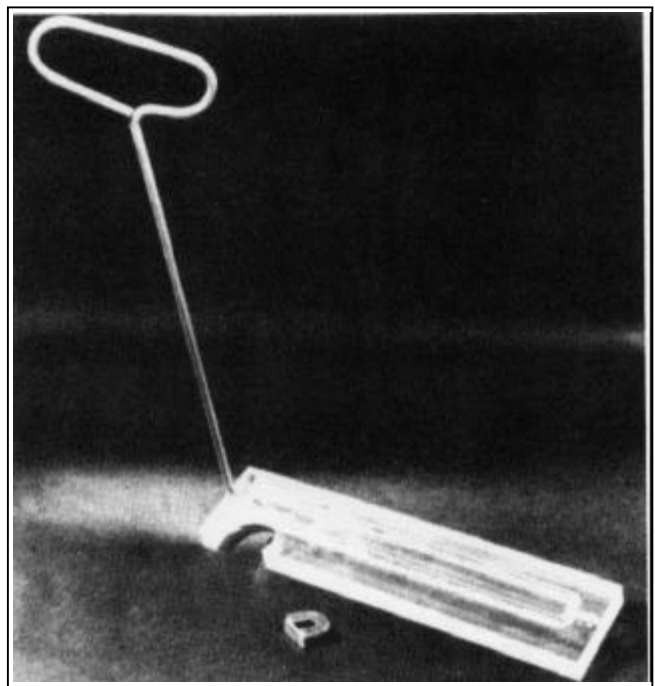

Exhibit 5.9: Six's Water Thermometer, Submerged-Mount

## EVAPORATION STATION OBSERVATIONS

Some Six's thermometers are provided with a float-mounted frame. This is being replaced with the submerged mount.

### 5.3.6.1 INSTALLATION

#### 5.3.6.1.1 FLOAT-MOUNTED INER43KETM

The float-mounted thermometer is provided with a shield to prevent sunlight from striking the bulb. It is mounted horizontally on a float-supported nonmagnetic frame. The frame supports the thermometer which can be set to ride approximately 1/4 inch below the water surface. This is done by adjusting the screws holding the bulb end. Attach the float to an anchor using flexible lines at least 10 inches long, but short enough to keep the unit one foot from the edge of the pan and gage. Two lines may be used, one attached to each end of the frame.

#### 5.3.6.1.2 SUBMERGED

The submerged-mount thermometer is mounted horizontally on a plastic holder which rests on the bottom of the pan. A non-magnetic metal handle is fastened to the bulb end of the holder and hooks over the edge of the pan, as shown in exhibit 5.10. The holder should be located on the inside bottom (south side) of the pan. The thermometer bulb should be shaded as much as possible from direct sun rays. Submerge the thermometer gently to prevent the small indices inside the tube from jarring away from the mercury column.

#### 5.3.6.1.3 RECORDING THERMOMETERS

Any recording thermometer with an immersible sensing element may be used. Examples are electrical resistance, mercury-in-steel, and gas-filled steel elements.

The line connecting the thermometer to the recorder should be long enough to permit installation of the recorder where it will not cast a shadow on the pan, and more than four feet from any instrument. It should be in a low housing along a fence in the northern half of the enclosure (northern hemisphere). The thermometer should be mounted on an adjustable float mechanism in a horizontal position. It must be shielded from direct solar and sky radiation and from possible physical damage. The float mechanism should be adjusted to support the thermometer about 1/4 inch beneath the surface of the water near the center of the pan.

### 5.3.6.2 MAINTENANCE

Follow the manufacturer's instructions for maintaining the recording thermometer and for changing its charts.

Keep the Six's thermometer assembly (floats, shield, and plastic holder) free from dust and sediment. Use a soft wet cloth for cleaning the unit. A very fine grade steel wool or SOS-type pad can be used to clean salt deposits from the thermometer bulb and tube.

## EVAPORATION STATION OBSERVATIONS

### 5.3.6.3 ACCURACY CHECKS

Check the accuracy of the water temperature readings once a month when the pan is cleaned by removing the Six's thermometer from the pan and placing it in the instrument shelter. Allow enough time for the thermometer to dry and reach the air temperature. Read the current air temperature from the minimum thermometer without re-setting. Then read the temperature from the Six's thermometer. Enter the readings in the "Remarks" column. If readings differ by 20 or more, notify the NWS representative.

#### 5.3.6.3.1 REJOINING SEPARATED MERCURY COLUMNS

The mercury columns in Six's thermometers are subject to separation, causing inaccurate readings. The columns should be joined as soon as possible. Remove the thermometer and holder from the pan. Do not remove the thermometer from either its plastic holder or float frame. Hold the thermometer near its bulb end and swing rapidly in an arc until the mercury column is rejoined. Take care to avoid striking any objects and breaking the thermometer.

### 5.3.6.4 READING AND RESETTING THE SIX'S THERMOMETER

Read temperatures to the nearest whole degree, as indicated by the end of the metal indices nearest the mercury columns in each tube. If possible, read while submerged. Then, remove the thermometer from the pan to reset the indices.

To reset the thermometer, place a horseshoe magnet (open end down and parallel to the thermometer tube) directly above one metal index. Move the magnet slowly toward the mercury column until the index touches the mercury. Gently lift the magnet away from the tube so the index will not spring away from its contact with the mercury. Repeat this procedure for the other index.

The submerged-mount thermometer comes with a small metal strip for storing the magnet when not in use. If the strip is lost, a nail or small metal piece may be used.

Readings from recording thermometers need not be recorded on a form unless instructed to do so by the NWS representative. Enter the date, time, and station name on the chart when changing it.

## 5.4 READING OBSERVATIONS FROM EVAPORATION STATIONS

Record observations on WS Form B-92 (formerly WS Form E-22), "Record of Evaporation and Climatological observations," unless instructed otherwise by the NWS representative. The cover of Form B-92 contains instructions for recording observations.

## EVAPORATION STATION OBSERVATIONS

Exhibit 5.10 shows sample entries on this form for a station equipped with a fixed-point gage. Note that you do not have to fill in the columns for the dew point, 24-hour wind movement, and the amount of evaporation. These values are computed by the office processing your data.

Station		County		State		Date (Month & yr.)		Time of Complete Observation (Local time)		Standard Time in Use		RECORD OF EVAPORATION AND CLIMATOLOGICAL OBSERVATIONS										
DATE	AIR TEMPERATURE °F					PRECIPITATION				WIND		EVAPORATION (Inches & hundredths)		WATER TEMP. °F		ADDITIONAL DATA REMARKS						
	24 Hours Ending at Observation		At Observation			Supplemental Readings at			Time of beginning	Time of ending	Time of beginning	Time of ending	24 Hour Amount		At Obs. (W. by)		At Obs. (W. by)	24 Hour	Gage Reading at	Reading When Filled or Amount Evaporated	24 Hours Ending at Observation	24 Hours Ending at Observation
	Max.	Min.	Dry bulb	Wet bulb	Dew Point	Dry bulb	Wet bulb	Dew Point	beginning	ending	beginning	ending	Rain, Wet snow, etc. (in. & hundredths)	Snow, Ice pellets, Hail (in. & tenths)	(W. by)		(W. by)	Amount	of	Evaporated	Max.	Min.
1																						
2																						
3																						
4																						
5																						
6																						
7																						
8																						
9																						
10																						
11																						
12																						
13																						
14																						
15																						
16																						
17																						
18																						
19																						
20																						
21																						
22																						
23																						
24																						
25																						
26																						
27																						
28																						
29																						
30																						
31																						
Sum																						
Avg																						

U.S. DEPARTMENT OF COMMERCE  
NATIONAL WEATHER SERVICE

UNDERSEVEN

STATION NUMBER

Exhibit 5.10: WS Form B-92 (formerly WS Form E-22)  
Record of Evaporation Climatological Observations

## SECTION 6: SOIL TEMPERATURE STATIONS

### 6.1 INTRODUCTION

Knowledge of the soil temperature is very important to the agricultural industry. All species of plants have a specific range of temperatures in which they will grow. Most seeds require a certain amount of warmth in order to germinate. Some vegetation will suffer if the soil temperature is too warm. Information collected from soil temperature stations is used for general weather purposes as well as for agriculture.

Many stations measuring soil temperature transmit their readings over nationwide communications circuits, especially during the beginning and middle portions of the growing season. Nationwide weekly average soil temperatures are published during the growing season in the *Weekly Weather and Crop Bulletin*, and daily readings for one or more levels are published in *Climatological Data* by the National Climatic Data Center.

Soil temperature station may have the following additional instrumentation: precipitation gage, air temperature thermometer with shelter, evaporation pan, and anemometer.

### 6.2 EXPOSURE AND PROTECTION OF EQUIPMENT

Soil thermometers should have an exposure typical of the principal natural agricultural soils and conditions of the area. The site should not be subject to irrigation, overflow, or unusual ground-water conditions. The site should be open to full sunshine, with the exception of certain designated sites or where partial shade is considered typical of the area.

The observing plot should be fenced or have other protection from humans and animals.

#### 6.2.1 SIZE OF PLOT

The plot should be 10 by 1-foot or larger, with the thermometers centrally located. Where both sod and bare plots are maintained, the bare plot should also be at least 10 by 10 feet. If the location is not typical of the surroundings, the plot should be larger—at least 30 by 30 feet.

### 6.3 MAINTENANCE OF PLOTS

#### 6.3.1 SOD-COVERED PLOTS

Sod-covered plots should be under bluegrass, alta fescue, perennial rye, or other grasses used for lawns or pastures in the areas. The area should be trimmed and otherwise maintained at a uniform 2 or 3 inch height. No irrigation should be applied, except to start cover before beginning observations. If, during extreme drought, it is necessary to irrigate, the soil temperature should be noted as not being typical and should be excluded from published data.

## SOIL TEMPERATURE STATIONS

### 6.3.2 NATURAL COVER

At some locations, normal climate and soil do not permit maintenance of a sod cover. Then, maintain the cover like the natural cover common to the area.

### 6.3.3 BARE SOIL

Bare soil plots should be kept free of weeds and other vegetation all times. This can be done by scraping with a hoe or by chemical treatment. Chemicals are often easier to use, longer lasting, and will cause less change in the soil structure. Shallow raking to avoid heavy crusting after precipitation is recommended. Avoid deep cultivation.

If chemical treatment is used, be aware that the effects of some sterilants on the physical properties of soil are not completely understood. Over dosages have been reported to increase crusting, with a loss of structure. Follow carefully the manufacturer's recommendations on the method, quantity, and time of application.

Some chemicals can wash away during heavy rain, seriously injuring desirable vegetation in adjoining plots, while the more soluble products tend to move down into the soil. The following products have been suggested.

- a) Sodium chlorate (this comes in several forms, including pellets).
- b) Boron (brand name Barascu).
- c) Meth-lurea compounds (Monuron and Diuron, under the brand names of Telva and Karmex)
- d) Erbon and Simazine.

Many factors, including soil type and climate, influence the effectiveness of these chemicals on vegetation and the soil. Boron has been found more favorable in arid regions, and chlorates better in humid areas. Get recommendations from local soil and weed experts for the best sterilant to use.

### 6.3.4 SNOW COVER

Snow cover should remain natural and undisturbed. The observation site should be located so that snowfall is normal and free of obstructions that can cause artificial drifting or wind scouring.

## 6.4 TYPES OF THERMOMETERS AND READINGS

Dial-type or digital thermometers may be used. Maximum, minimum, and current temperatures are generally recorded at lesser depths. At greater depths where temperature changes are slower (generally, below the 8-inch level), only the current temperature is usually recorded. At most observing sites,



## SOIL TEMPERATURE STATIONS

maximum and minimum air temperatures are read and recorded at the same time and location as the soil temperatures. See Subsection 6.9 for a description of the Palmer soil and other types of thermometers in use.

### 6.4.1 INSTALLATION OF THERMOMETERS

Sensing elements should be located in and under undisturbed soil. They should be in close contact with the ambient soil, with no insulating air spaces or pockets, and without artificial channels for the entry of water. They should be in or very near the center of the observation plot. Readouts should be mounted high enough above ground to make it easy and convenient to read and reset the thermometers.

Dig a small trench just to the north of the spot where the sensors will be imbedded in the earth. This should be as small as possible without hindering the necessary work. Remove the sod carefully and set it aside on boards or a tarpaulin (you will replace this later). This should be removed in layers, as it can be replaced as close to its original condition as possible.

The trench should be slightly deeper than the lowest depth for the sensor. This allows enough working space and permits a slight looping of the flexible cables to be installed. Make a hole for the sensing elements with a rod 18 inches long and 5/16 inch in diameter for installing the 13-inch long mercury-in-steel sensors used with the Palmer soil thermometer (subsection 6.9). The rod should be pressed into the face of the south end of the pit at the proper depth and be driven into the soil nearly its full length. It should remain parallel to the surface above it so that it is the same depth throughout its full length. If smaller sensors (such as thermistors or thermocouples) are used, a rod with a diameter equal to or only slightly larger than the sensor should be used. See exhibit 6.1, which shows the instrument trench (unshaded area) as it would appear before replacing the soil.

Press the sensing element into the hole with the least force possible. If too much resistance is met, withdraw the element and clear the hole with the rod.

### 6.5 SHELTERS

#### 6.5.1 THERMOMETERS HEAD SHELTERS

Soil temperature thermometer heads or recorders must be protected from the weather by a shelter, such as that shown in exhibit 6.2., in which the access door opens from the side or top., The length of the shelter depends on the number of thermometers installed.

Soil temperatures measured with an MMTS will have the display mounted in or near a shelter housing the air temperature sensor. A multiple positions switch on the display is used to read and reset temperatures from all sensors.

## SOIL TEMPERATURE STATIONS

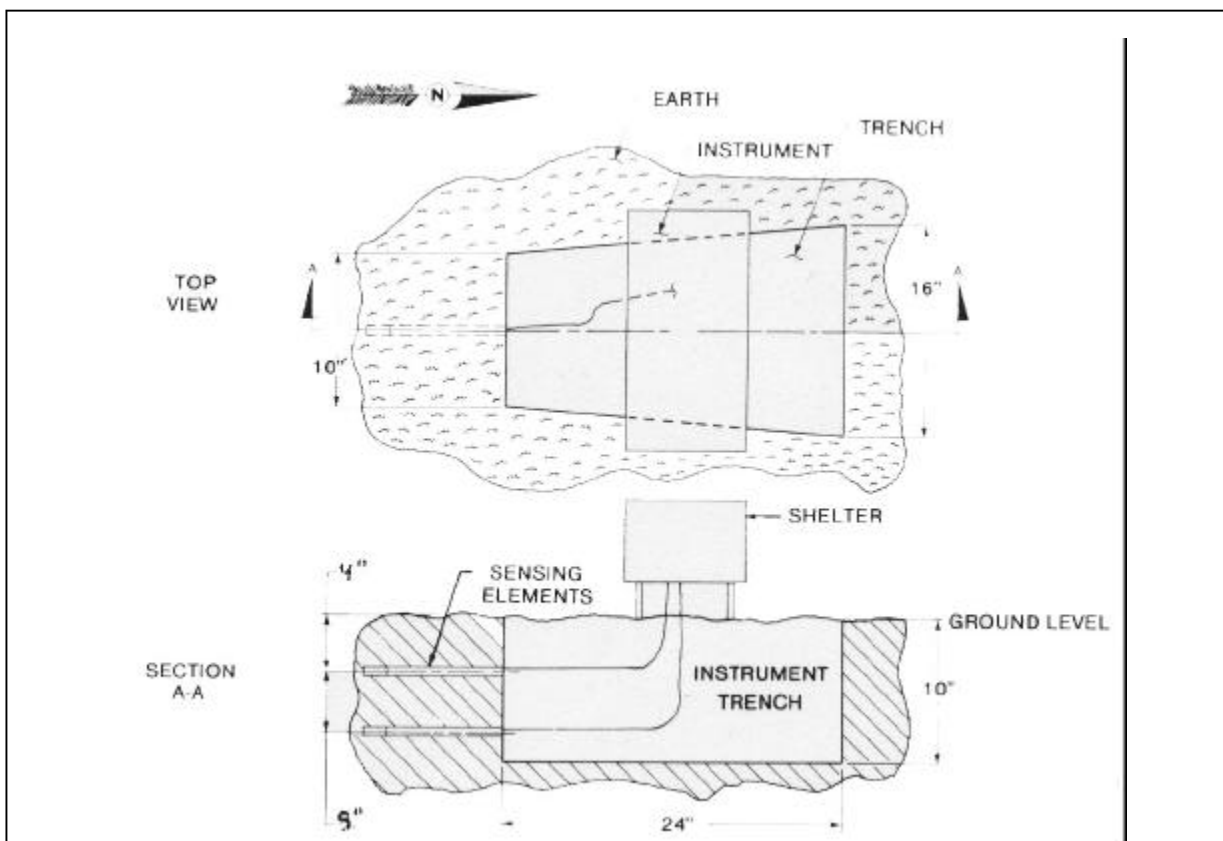

Exhibit 6.1: Installation of Soil Thermometers

### 6.5.2 LOCATION OF SHELTER

The shelter should be located about one foot north of the south edge of the trench. Set the supports for the shelter in the trench before replacing the soil. The 5-foot cable will permit the shelter to be about three feet above ground. This will allow for a slight loop of the cable in the trench floor for sensors as deep as eight inches.

If electric wires connect the sensors to the recorders (as with the MMTS), the shelter may be located outside and to the north of the trench, where no shadows will affect the soil above the sensors.

### 6.5.3 REPLACING SOIL IN TRENCH

The soil should be replaced as nearly as possible in its original condition. This will usually require firm packing as each layer is replaced. Soak soil as it is returned to the trench, then replace the sod. Excess moisture will assist in renewing sod growth.

### 6.6 DEPTH OF SOIL TEMPERATURE MEASUREMENTS

The following depths (in inches) have been recommended by the Commission for Climatology (CC1) and the Commission for Agricultural Meteorology (CagM) of the World Meteorological Organization (WMO) for observing soil temperature: 2, 4, 8, 20, 40, 60, and 120.

## SOIL, TEMPERATURES STATIONS

The two-inch depth was suggested only by the CAgM, for agricultural purposes. This depth is extremely sensitive to microscale differences in soil type and color, moisture, and vegetative cover. It has been found difficult to maintain an accurate two-inch depth, especially with a bare soil cover. The 60- and 120-inch depths were recommended only by the CC1, for climatological purposes-

Where a choice of depths must be made due to sensor limitations, the following order of priority is recommended:

Priority	1	2	3	4	5	6	7
Depth (inches)	4	8	20	40	2	60	120

Many soil temperature measuring stations record temperatures only at the four-inch depth.

### 6.7 OBSERVATIONS

#### 6.7.1 TYPE AND FREQUENCY

Readings are usually taken daily. At stations closed over weekends that do not have recording thermometers, the Monday maximum and minimum temperature readings cover the preceding 72 hours.

Daily ranges in the soil temperature can exceed air temperature ranges in the shallow layers. This amplitude diminishes rapidly to about 1° at depths of 18 to 24 inches. Therefore, maximum and minimum temperatures are normally recorded at depths through 20 inches, while only the current or daily average temperature is recorded at greater depths.

#### 6.7.2 TIME OF OBSERVATION

Because nearly all soil temperature stations also record daily maximum and minimum air temperatures, all readings should be taken at the same time of day. Generally, this will be between 7 and 8 a.m. or between 5 and 8 p.m. Pick a time that is convenient and adhere to this as closely as possible.

If recording instruments are used, they should be checked daily to be sure they are operating properly.

### 6.8 ENTRY OF READINGS ON PERMANENT RECORD FORMS

WS Form B-83a (formerly WS Form F-10a), "Supplementary Record of Climatological observations," is designed for recording soil temperatures at up to 6 depths. Temperatures should be recorded to the nearest whole degree. For levels at which you are recording both maximum and minimum temperatures, enter these in the appropriate depth columns under soil temperatures and label ,max., and "Min" under inches as shown on the inside of the WS Form B-83a cover. At levels where you record only the current temperature, enter only the one value.

## SOIL TEMPERATURE STATIONS

### 6.9 PALMER SOIL THERMOMETER

This subsection describes the operation, maintenance, and calibration procedures for the Palmer soil thermometer. This thermometer has been in general use for many years. See exhibit 6.2. Subsections 6.4 and 6.5 describe installation procedures.

#### 6.9.1 RESETTING MAXIMUM AND MINIMUM POINTERS

After recording the maximum and minimum temperatures, carefully reset the red(maximum) and green (minimum) pointers reset the red pointer first by bringing it into contact with the black (current temperature) pointer- Next, gently rotate the green pointer to the opposite side of the black pointer. Do *not* press down on the green pointer knob, as this will result in tension loss in the pressure washer and cause loose pointers.

During the above resetting, check the flex of the black pointer. It should flex or move less than 10 in response to pressure from the red and green Thermometer pointers. Movement in excess of this indicates either a loss of tension in the sensor system or too much drag tension in the maximum and/or, minimum pointers. If lubrication does not correct the situation, the instrument must be replaced.

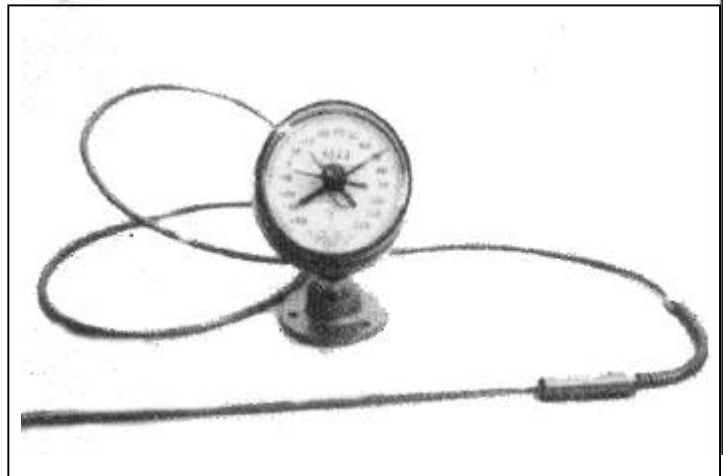

Exhibit 6.2: Palmer Soil Thermometer

#### 6.9.2 MAINTENANCE

The most common maintenance needs of the Palmer soil thermometer are as follows: loose or frozen pointers, moisture in the head, broken covers, and calibration errors.

##### 6.9.2.1 LOOSE POINTERS

This usually results from improper resetting procedures. To correct this, remove the bezel ring and glass cover (the red and green pointers are mounted in the glass cover). Remove the allen set-screw embedded in the green knob. The tightness of this knob controls the tension on both pointers. With your thumb on the bottom of the connecting shaft (inside the glass cover), carefully reset the green knob to the desired tension. Clockwise rotation increases the tension. Replace the allen set-screw in the green knob and reassemble. You may find it necessary to replace the tension washer under the green knob.

## SOIL TEMPERATURE STATIONS

### 6.9.2.2. FROZEN PRINTERS

Frozen pointers can often be corrected by cleaning and lubricating. Use a good silicone lubricant, preferably in a pressure spray applicator. In some case you may have to remove the bezel ring and glass cover to perform adequate cleaning and lubrication

### 6.9.2.3 MOISTURE IN THE HEAD

This indicates the need for a new gasket. Remove the bezel ring and glass cover. Replace the sealing gasket on a day with as low humidity as possible.

### 6.9.2.4 BROKEN COVER

A file or hacksaw may be required to remove the bezel ring. Make a cut across the outside edge of the ring and use a screwdriver to press downward and outward to snap it off. Request a new cover and ring from the NWS representative. This will be sent complete with a connecting screw to fasten it in place.

## 6.9.3 CALIBRATION ERRORS

Calibrate the thermometers at least twice a year. Without this, the thermometers are likely to drift upward or downward. This subsection describes calibration procedures.

### 6.9.3.1. IN-PLACE CALIBRATION CHECKS

Incorrect date resulting from long-term calibration drifts can be eliminated with careful routine periodic calibration checks. The following three procedures may be used to accomplish this.

- a) A bi-metal or similar type of thermometer of known accuracy can be used for comparison. It is imperative that the sensor of the bi-metal be pushed to the same depth as the Palmer soil thermometer sensor bulb and left there long enough to stabilize at the soil temperature (4 to 5 minutes).
- b) A more desirable technique for the shallow depths is to remove soil to the level of the base of the Palmer 13-inch sensor bulb. The comparison thermometer sensor should then be inserted along the 13-inch sensor bulb, 2 to 3 inches from the base, and the soil replaced above it. The thermometer must remain imbedded long enough for the removed and replaced soil to regain the temperature of adjacent undisturbed soil at the same depth. When the soil has been removed, check to be certain the soil thermometer is still at the prescribed depth.
- c) If the soil at the depth of a soil thermometer is in the process of freezing, the temperature will often remain at the 32 °F ice-water equilibrium point for several days. Check the temperature during this period to determine the accuracy of the thermometer.

## SOIL TEMPERATURE STATIONS

### 6.9.3.2 CALIBRATION OF PALMER MODEL 35B

A calibration check of Palmer model 35B should be performed at least twice a year.

Methods (a) and (b) above should not be used on model 35B soil thermometers between about 9 a.m. and 6 p.m. on bright, sunny days, as sensitivity to heat penetration under these conditions can make it read higher.

Make the following two allowances for discrepancies between the Palmer model 35B and the check thermometer.

- a) The tolerance of the Palmer (about 2 °F) and the check thermometer (generally 1 percent of the scale) may be additive.
- b) A seemingly slight difference in exposure between the two may contribute to a variation in readings. A spread of up to 4 °F between the two readings should be considered satisfactory. For method © above, a reading between 29 °F and 35 °F should be considered sufficiently accurate at the icepoint.

Note: Never apply any allowable difference as a correction to future observations.

### 6.9.3.3 THE CALIBRATION

If the above checks indicate a calibration offset, calibrate the thermometer as follows.

- a) Place both the probe and the reference thermometer in the shelter housing the dial indicator and close the door.
- b) After 10 minutes, open the door and record both readings.
- c) Immerse both the reference thermometer and the entire probe of the Palmer thermometer in a slushy ice bath.
- d) After 10 minutes, record the temperatures. Leave the sensors in the ice bath, in case step (f) below must be used.
- e) If the difference in the readings of the two thermometers is approximately the same in steps (b) and (d), an offset is indicated. See step (f) below. If the differences are not approximately the same, the Palmer must be considered inoperative and replaced.

## SOIL TEMPERATURE STATIONS

- f) If an offset is indicated, turn the "reset" screw on the back of the dial head until the thermometer reads 32° while the probe is still in the ice bath.
  
- g) On some older instruments, an access screw in back of the dial head must be removed first. The adjustment on these models is limited to about two degrees. If a greater adjustment is needed, remove the bezel ring and glass cover. Place a screwdriver in the center screw of the black pointer hand and loosen it. Rotate the pointer hand gently to the desired setting. Re-tighten the center screw. If the instrument is equipped with a non-reusable bezel ring, the ring may be removed with a file. Obtain a replacement from the NWS representative.

## SECTION 7: ATMOSPHERIC PHENOMENA

### 7.1 INTRODUCTION

The following atmospheric phenomena should be observed and recorded on your WS Form E-165 or other form designated by your NWS representative: Tornadoes, waterspouts, thunderstorms, damaging winds (including squalls), fog, haze, smoke, dust, frost, and any form of precipitation. Recording haze, smoke, dust and frost is optional, except when dangerous, i.e., to travelers or crops. Damaging and life-threatening phenomena, especially tornadoes, would be reported immediately to the state police, the designated NWS office or forecast office or as directed by your NWS representative.

Observations of the above phenomena are an important part of the record from climatological stations, and they are often the only written account of these occurrences from the observer's are that will be sent to NCDC. Except for precipitation, no instruments are required to record these phenomena.

### 7.2 TORNADOES, WATERSPOUTS AND FUNNEL CLOUDS

Tornadoes and funnel clouds are nearly always associated with intense thunderstorm activity, While some waterspouts may develop in the absence of thunderstorms and often be much less destructive, others are tornadoes that have formed or moved over water, as they are just as dangerous over water as land.

#### 7.2.1 TORNADO

Tornadoes are local storms usually of short duration, consisting of violently rotating winds, nearly always turning counterclockwise in the northern hemisphere. A tornado will usually appear hanging from the bottom of the storm cloud, generally close to but outside the area in which rain is falling. Part or all of the funnel may be invisible if the air is dry, but the tornado can still often be identified by the rotating particulate matter, especially near the ground, and in Intense tornadoes, by a loud roaring sound. Rotating debris not associated with clouds are whirlwinds (dust devils) rather than tornadoes.

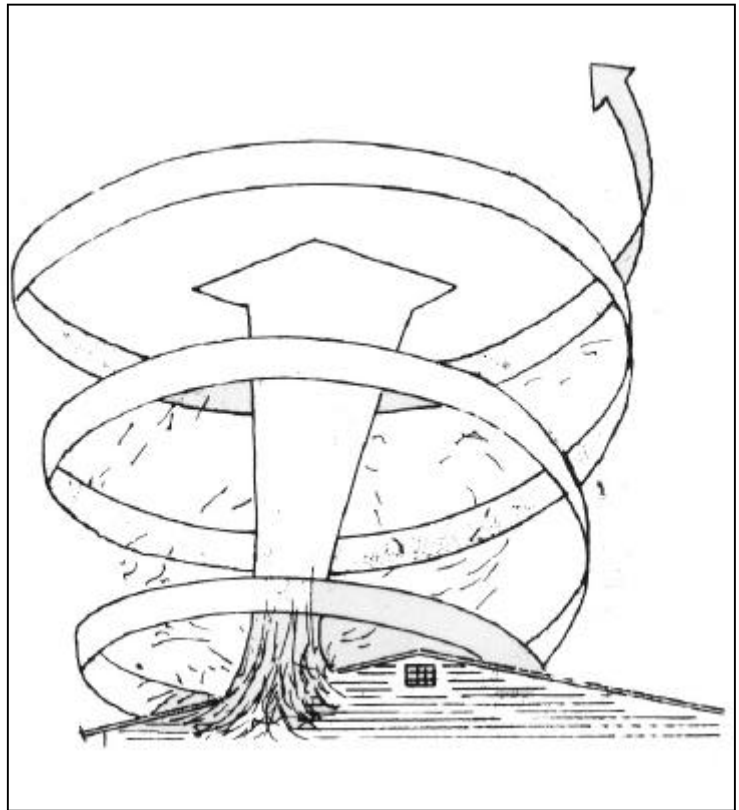

Exhibit 7.1: Winds Associated with a Tornado



## ATMOSPHERIC PHENOMENA

Tornadoes do their destructive work through the combined action of their strong rotary winds and the partial vacuum in the center of the vortex. As a tornado passes over a building, the winds twist and rip from the outside at the same time the abrupt pressure reduction in the tornado's "eye" causes explosive over-pressure inside the building (exhibit 7.1) (this exhibit will be re-drawn to show winds rotating counter-clockwise). Walls collapse or topple outward, windows explode, and the debris of this destruction is driven through the air with dangerous force. Heavy, objects like machinery and railroad cars can be lifted and carried by the wind for considerable distances.

### 7.2.2 FUNNEL CLOUD

A funnel cloud is a tornado that does not reach the ground. Nearly all tornadoes start as funnel clouds, forming at the base of dark, heavy cumulonimbus clouds and developing downward. Some never reach the ground. Others reach the ground (becoming tornadoes), then rise again or dissipate.

### 7.2.3 WATERSPOUT

Over a large body of water, a tornado is called a waterspout. It rises from the water into the cloud in an upward spiral. With some exceptions, they do not develop into dangerous storms, and diminish rapidly when moving over land.

### 7.3 THUNDERSTORM

For record purposes, a thunderstorm is considered in progress when thunder is heard, whether or not rain is falling or lightning is seen. The intensity may vary from occasional distant thunder to very frequent, sharp thunder with heavy rain, sometimes associated with strong winds and hail.

### 7.4 HYDROMETEORS

Winds are considered "damaging" when vegetation, buildings, or other property has been injured, damaged, or destroyed.

A squall is a sudden, violent wind, often accompanied by rain or snow. Gusty winds are characterized by sudden, periodic increases in speed. There are noticeable differences in speed between the peaks and lulls. All of these often occur with thunderstorms, or they can occur alone.

### 7.5 HYDROMETEORS

A hydrometeor is any form of atmospheric water (liquid or frozen) or water vapor that (a) falls through the atmosphere, such as rain or snow; (b) is suspended in the atmosphere, such as fog; (c) is blown from surfaces by the wind, such as blowing snow or blowing spray; or (d) is deposited on objects, such as freezing rain (glaze).

## ATMOSPHERIC PHENOMENA

### 7.5.1 FORMS OF PRECIPITATION

Hydrometers include precipitation in all its forms. It may be continuous, intermittent, or showery. The intensity is classified as light, moderate, heavy or excessive. Precipitation is observed in the following forms.

- a) Rain: Drops of water in liquid form falling from the sky, larger than .02 inch in diameter.
- b) Drizzle: Fairly uniform precipitation composed exclusively of fine droplets (less than .02 inch in diameter), uniformly dispersed, that may appear to float with the air currents.
- h) Ice pellets: Round or irregularly-shaped pellets of ice with a diameter of 1/5 inch or less, either transparent or translucent. Pellets usually rebound when striking hard surfaces, making a sound on impact. The following two types of ice pellets are observed.
  - (1) Hard grains of ice consisting of frozen raindrops or melted and refrozen snowflakes (often called sleet).
  - (2) Pellets of snow encased in a thin layer of ice. These are softer than sleet and rarely bounce on impact.

The first type falls as continuous precipitation, while the second is associated with showers.

- d) Glaze: Rain or drizzle that falls in liquid form but freezes to objects and/or on the ground. It forms a smooth coating of transparent ice layers, as seen in exhibit 7.2. Ice storms result from heavy coatings of glaze and may do great damage to trees, shrubs, and telephone and power lines, creating unsafe conditions such as those shown in exhibit 7.3.
- e) Hail: Pieces of ice, often round or in irregularly shaped lumps, falling individually or several pieces frozen together. They range from 1/5 inch to two or more inches in diameter. Exhibits 7.4. and 7.5 show examples of hail.

Hail usually consists of alternate opaque and clear layers of ice. It is normally associated with thunderstorms and temperatures above freezing.

Hail can cause serious damage to anything it strikes. Crops may be destroyed (exhibit 7.5) and livestock injured.

- f) Snow: White or translucent ice crystal, mostly in six pointed star form often mixed with simple crystals. Snow occurs under conditions similar to those of rain, but the air temperature aloft must be freezing or lower.

## ATMOSPHERIC PHENOMENA



Exhibit 7.2: Glaze

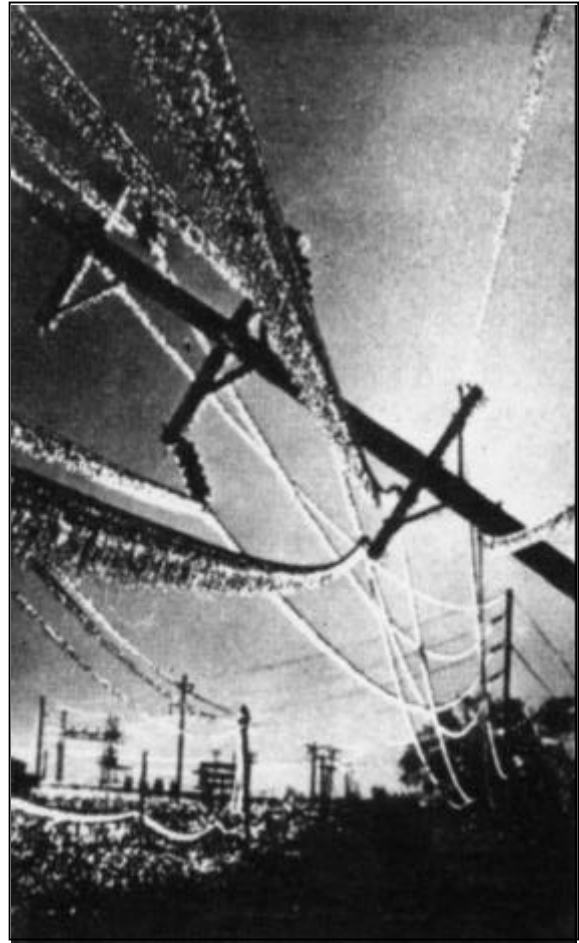

Exhibit 7.3: Road Hazard  
Caused by Glaze

- g) Snow pellets: White, opaque grains of ice, round or conical, 1/16 to 1/4 inch in diameter. They are crisp and easily compressed and may bounce or burst when striking hard surfaces.
- h) Snow grains (granular snow): Minute opaque, branched, starlike snowflakes or very fine simple crystals. They are smaller than snow pellets and usually fall in small quantities from low stratified clouds. They do not bounce or shatter on impact.

Both snow pellets and snow grains should be recorded as snow.

## ATMOSPHERIC PHENOMENON

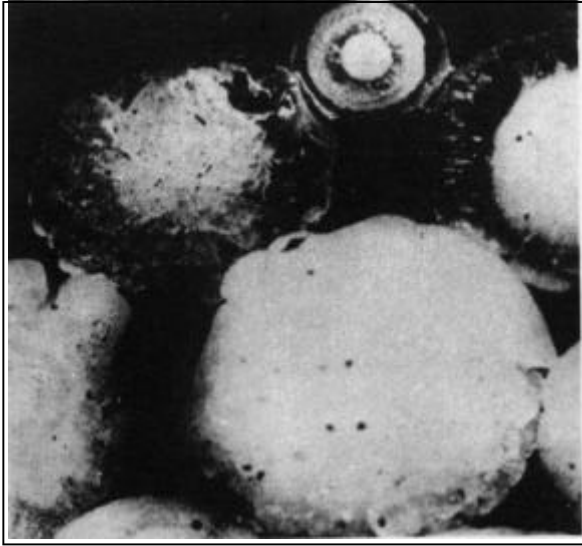

Exhibit 7.4: Closeup View of Hail Exhibit



Exhibit 7.5: Hail Accumulated on the Ground, having Damaged Crops

### 7.5.2 HYDROMETEORS OTHER THAN PRECIPITATION

- a) Fog: Minute water droplets suspended in the atmosphere to form a cloud at the earth's surface. There is no visible downward motion. The horizontal visibility is usually less than 3 miles. It is called ground fog if the depth is less than 20 feet. Fog differs from haze by its dampness, and gray color.
- b) Ice fog: Minute suspended particles in the form of ice crystals and/or needles. It occurs at very low temperatures ( $-20^{\circ}\text{F}$  or colder), usually in clear, calm weather at high latitudes. It does not produce rime or glaze on objects.
- c) Dew: Liquid water that has condensed on objects on or near the surface of the earth with above freezing temperatures. Dew occurs on calm, clear nights.
- d) Frost: Thin ice crystals shaped like scales, needles, feathers or fans, that form on objects with a temperature of  $32^{\circ}$  or lower. Frost can occur on the ground when the air temperature at the instrument shelter level is several degrees above freezing. It is the same as hoarfrost.
- e) Freeze: The condition of the lower atmosphere when the temperature of surface objects is  $32^{\circ}$  or lower. A freeze may or may not be accompanied by a deposit of frost. When vegetation is injured by a relatively low temperature (with or without a frost), the condition is termed a freeze.

## ATMOSPHERIC PHENOMENON

During a freeze, the air at the instrument shelter level may be above 32 °, although the ground is 32 ° or colder. This occurs most frequently during calm, clear nights, with the greatest temperature difference near sunrise.

Freezes are classified as follows.

- 1) Light freeze: little destructive effect on vegetation, except to tender plants and vines. Shelter level temperatures are often above freezing but drop below freezing for a short period at the surface.
- 2) Killing freeze: widely destructive to vegetation. It is often defined as a sufficiently severe freeze to cut short the growing season. Temperatures at thermometer level are generally below freezing. This is sometimes called a "killing frost."
- 3) Hard freeze: staple vegetation is destroyed. The ground surface is frozen solid under foot, and heavy ice forms on puddles and other exposed water surfaces. It is colder and more prolonged than a killing freeze.
- f) Rime: a white or milky and opaque granular deposit of ice formed by the rapid freezing of supercooled water droplets of fog, as they impinge on exposed objects. It is denser and harder than hoar frost, but lighter and softer than glaze.
- g) Blowing snow: snow particles raised from the surface by strong turbulent winds to eye level (six feet) or above. It is blown about in sufficient quantities to restrict the horizontal visibility. It is called "drifting snow" if raised to a height below eye level.

Blowing and drifting snow should be recorded when causing damage, such as blocking -roads or exposing seeded fields.

### 7.6 LITHOMETEORS

Lithometeors are visible phenomena suspended in the air that are not associated primarily with water vapor. Examples are dry haze and smoke.

#### 7.6.1 DRY HAZE

Dry haze consists of fine dust or salt particles suspended in the air in sufficient quantity to reduce the visibility. It resembles a uniform veil that subdues all colors. Dark objects have a bluish tinge. Bright objects (the sun or distant lights) appear a dirty yellow or have a reddish hue.

Dry haze may be caused by a variety of substances, including dust, salt, residue from distant fires or volcanoes, or pollen.

## ATMOSPHERIC PHENOMENA

### 7.6.2 SMOKE

This is suspended particulate matter resulting from combustion. Smoke will cause the disk of the sun at sunrise and sunset to appear very red or to have a reddish tinge at other times of day. Smoke coming from a great distance, such as from forest fires or volcanoes, usually has a light grayish or bluish color.

As this smoke continues traveling from its source, the larger particles drop out, leaving haze.

### 7.6.3 DUST

Fine particles of dust or sand suspended in the air, often as the result of a dust storm or sand storm that may have occurred at or far away from the observing site. It imparts a tan or gray hue to distant objects. The sun's disk is pale, colorless, or tinged yellow. Dust manifests itself in the following additional forms.

- a) Blowing dust: dust picked up locally from the surface and blown about in clouds or sheets, reducing the horizontal visibility to 6 miles or less.
- b) Dust storm: blowing dust reducing the visibility to less than  $\frac{5}{8}$  of a mile. A dust storm usually arrives suddenly in the form of an advancing dust wall which may be miles long and several thousand feet high. Ahead of the dust wall the air is very hot and the wind usually light.
- c) Dust devil: a small vigorous whirlwind, usually of short duration, made visible by dust and debris picked up from the surface. Dust devils usually occur on hot, calm afternoons with clear skies. They are seldom intense enough to cause appreciable damage.

### 7.6.4 BLOWING SAND

This is sand that is picked up from the surface of the earth by the wind and blown about in clouds or sheets, reducing the visibility to 6 miles or less. It is called a sandstorm when the wind is very strong and the visibility is reduced to  $\frac{5}{8}$  of a mile or less.

IMPORTANT road hazards created by dust storms and sand storms should be reported immediately to the Weather Service Office.

## 7.7 ELECTROMETEORS

An electrometeor is a visible or audible display of atmospheric electricity.

### 7.7.1 AURORA

The aurora, sometimes known as the "northern lights" in the northern hemisphere, is a luminous phenomenon of arcs, bands, or curtains of light in the high (and occasionally middle) latitudes and at very

## ATMOSPHERIC PHENOMENA

high altitudes. These are usually white, but they may have other colors. The lower edges of the arcs or curtains are usually well defined, while the upper edges are not. The aurora is caused by electrically charged particles ejected by the sun, acting on the rarified gases of the higher atmosphere. The particles are channeled by the earth's magnetic field, so the bases of the curtains are pointed toward the earth's magnetic poles.

### 7.7.2 THUNDER

This is a sharp or rumbling sound which accompanies and follows lightning discharges. It is caused by rapidly expanding gases along the channel of a lightning discharge.

### 7.7.3 LIGHTNING

Lightning is the flash of light from a sudden visible electrical discharge produced by thunderstorms. It takes the following forms:

- a) Cloud to ground - bolts occurring between cloud and ground.
- b) In-Cloud - lightning within the cloud only. The streaks are not visible from the ground.
- c) Cloud to Cloud - streaks of lightning from one cloud to another, or from one part of a cloud through cloudless air to another. The streaks are visible from the ground.
- d) Air discharges - lightning from a cloud into the air, but not striking the ground.

## 7.8 LUMINOUS METEORS

A luminous meteor is an atmospheric phenomenon appearing as a luminous pattern in the sky. It is produced by the reflection, refraction, diffraction, or interference of light from the sun or moon. The following types are observed.

### 7.8.1 HALO PHENOMENA

This is a group of phenomena in the form of rings, arcs, pillars, or bright spots produced by the reflection or refraction of sunlight or moonlight by ice crystals suspended in the atmosphere. Cirrus and cirrostratus clouds often produce halos. The rings are about 22° away from the sun or moon.

### 7.8.2 CORONA

One or more sequences of small colored rings centered on the sun or moon. A corona is usually smaller than a halo, and all colors may not be visible. Colors may be repeated irregularly, causing iridescence. They are produced by sunlight or moonlight shining through thin clouds consisting of water vapor.

## ATMOSPHERIC PHENOMENA

### 7.8.3 RAINBOW

A group of concentric arcs produced on a "screen" of falling precipitation by the light from the sun or moon. In some cases a double rainbow may be seen, with the weaker bow being outside the stronger and having the sequence of colors reversed.

### 7.8.4 FOG BOW

A primary rainbow consisting of a white band which appears on a screen of fog. It is usually fringed with red on the outside and blue on the inside.

## 7.9 REPORTING AND RECORDING ATMOSPHERIC PHENOMENA

While all of the above phenomena should be recorded on the forms used by the observer to record other parameters, only a few of the phenomena need to be reported in real-time.

### 7.9.1 REAL-TIME REPORTING

Phenomena posing threats to lives and property should be reported to the NWS Forecast Office and, in many cases, to the police or other emergency preparedness office, as soon as possible. This will greatly assist the Office in the issuance of accurate warnings for areas in the path of the storm. The NWS representative or other NWS official will inform you where to report.

#### 7.9.1.1 REPORTING TORNADOES AND FUNNEL CLOUDS

Whenever a tornado is observed in progress, call the designated NWS office immediately by telephone collect or other designated means, giving the following information:

- a) Distance and direction from your station.
- b) Direction toward which it is traveling.
- c) Time it was observed.

Report funnel clouds also, when it appears they are intensifying, as tornadoes develop from funnel clouds. As noted above, what may appear as a funnel cloud may actually be a tornado, if the lower part has no cloud associated with it.

#### 7.9.1.2 REPORTING OTHER PHENOMENA

Record information in the "Remarks" column of WS Form B-91 or other designated form, or on a separate sheet of paper. See subsection 2.7 for real-time reporting of other phenomena.



## ATMOSPHERIC PHENOMENA

### 7.9.2 RECORDING ATMOSPHERIC PHENOMENA

#### 7.9.2.1 TORNADOES, WATERSPOUTS, AND FUNNEL CLOUDS

Record as many of the following as you can: time of occurrence, direction and length of path, width of the path, destruction from wind and hail, injuries, deaths, and any other relevant circumstances.

#### 7.9.2.2 THUNDERSTORMS

Record the time of occurrence, the direction and distance from the station, and the direction toward which the storm moved.

#### 7.9.2.3 OTHER PHENOMENA

Record other phenomena in the "Remarks" column. Include information on damage, deaths, or injuries, if any.

## SECTION 8: FLASH FLOODS

### 8.1 INTRODUCTION

Flash floods are caused mostly by sudden heavy rains filling natural and manmade drainage systems beyond their capacities. At other times, flash floods can result from dam breaks, the buildup of water behind ice jams, and by the breakup of ice jams. Water cannot be carried away fast enough. This results in the overflowing of the drainage systems, with raging water and its deadly cargo of uprooted trees, smashed structures of boulders, mud, and other debris. Rain-caused excessive runoff begins when the soil and vegetation cannot absorb rain or the combination of rain and melting snow.

### 8.2 AREAS MOST SUBJECT TO FLASH FLOODING

Flash flooding can occur quickly in urban areas where land development has made the earth's surface impervious to water, sweeping away vehicles and damaging residential and industrial property. It can occur in and near mountainous areas where steep slopes can accelerate runoff rates, quickly changing dry or trickling brooks into dangerous raging torrents. Flash flooding can also occur within a few hours of heavy or excessive rainfall which caused a dam failure. Sudden flash flooding is possible in areas having no rain, due to thunderstorms many miles away, out of sight and hearing range.

Even moderate rain, falling on impervious frozen, snow- or ice-covered ground, can produce flash flooding, especially if temperatures are high enough to add melted snow to the runoff.

Flash flooding is especially likely near the headwaters of river basins, where water levels may rise quickly in heavy storms. It can begin well before the rain stops falling. While water levels in major rivers usually change gradually, there is relatively little time between the onset of heavy rain and flood conditions in smaller basins.

Flash flooding occurring on streams and rivers behind ice jam and following the breakup of jam can cause severe devastation from chunk ice scouring and literally destroying anything along the banks of rivers.

### 8.3 FLASH FLOOD WARNINGS

The NWS assigns flash flood warning responsibilities to Weather Service Forecast Offices and Weather Service Offices. These offices rely on satellite, radar, observations from weather stations operating 24 hours per day, and particularly on reports from private individuals, the police, and local preparedness agencies.

Because flash floods, and particularly the thunderstorms that may cause them, can occur very suddenly and in very limited areas, the density of weather observations from 24-hour stations is inadequate to detect conditions leading to flooding. This, in turn, makes it very difficult for NWS offices to issue warnings with enough lead time to protect lives and property adequately.

## **FLASH FLOODING**

You do not have to wait for a team to arrive. You can call unofficial observers to get their rainfall amounts during or promptly after the storm, lest they forget their readings later. Then, call the weather office (voice telephone) to report this information. This may be the only way the weather office learns of these extreme rainfall amounts or flood levels.

## **FLASH FLOODING**

Therefore, individuals in these areas must be aware of the potential flood hazards and develop local preparedness plans to protect themselves from loss.

### **8.3.1 ROLE OF COOPERATIVE OBSERVERS**

Cooperative observers can play a vital role in protecting lives and property by being alert to report excessive rains and rapidly rising or flooding streams to the Weather Service Office and to the police or other preparedness agencies in their communities. They should thus be encouraged to become involved in any preparedness plans developed by their community. Observers should be certain any special telephone numbers they have been given for reporting these events, are current.

### **8.4 SUPPLEMENTAL SURVEYS**

Frequently in the aftermath of flash floods or other exceptionally heavy rainfall events, NWS or other authorities may decide to conduct supplemental precipitation surveys - popularly known as "bucket surveys." Within two or three days of the event, officials will go to the area of flooding or heavy rainfall to obtain data from citizens who do not routinely report rainfall amounts. They will contact people who had trash cans, jars, other containers, or any type of personal raingage that can be used as unofficial gages. They will also look for high water marks on buildings, trees, etc., to determine the maximum stream levels attained during flooding. Surveys must be done before subsequent rains wash away these water marks and before memories dim and records are lost.

The time rain began and ended (i.e., the duration of heavy rainfall) is also very important.

#### **8.4.1 PURPOSE OF SURVEYS**

Data obtained from bucket surveys are used to correlate heavy rainfall amounts with flood and flash flood crests. This information is vital in developing models that relate heavy rainfall to peak water levels. These relationships are used to increase the accuracy of future flash flood forecasts. They are also needed to justify the building of dams, the widening of drainage channels, the control of upstream urbanization (which can greatly increase future flooding risks), and to decide legal questions.

#### **8.4.2 HOW THE COOPERATIVE OBSERVER CAN HELP**

Since many cooperative observers routinely compare rainfall amounts with others, they can be of great help to the bucket survey teams by providing the locations and rainfall amounts recorded by others, or by informing the team how best to contact the other observers for further information. They can often help the team identify the area(s) having received the most precipitation.

## SECTION 9: MISCELLANEOUS FORMS

### 9.1 INTRODUCTION

This section describes and displays forms used in the cooperative Program to record or mail weather information, to request information or supplies, and to record information on cooperative stations in a master data base.

### 9.2 WS FORM B-18A: PUNCHED TAPE MAILING LABEL

This is the gummed label shown in exhibit 9.1. It is used for mailing Belfort (Fischer & Porter) precipitation tapes to NCDC or to other offices.

The form is a rectangular label with a grid for station information and a postage stamp area. The grid is divided into four main sections: 'STATION NAME, STATE', 'STATION NO.', 'TAPE BEGINS', and 'TAPE ENDS'. The 'TAPE BEGINS' and 'TAPE ENDS' sections are further divided into 'DATE' and a blank space. The label includes the following text: 'U.S. Department of Commerce', 'NOAA - National Weather Service', 'Southern Region Tapes Program, Mpt', '315 Taylor Street, Room 311-10', 'Fort Worth, Texas 76102', 'FIRST CLASS', 'POSTAGE AND FEES PAID', 'U.S. DEPARTMENT OF COMMERCE', 'FORM 710', and 'U.S. MAIL'. The bottom left corner of the label contains the text 'WS FORM B-18A (7-86)'.

F R O M	STATION NAME, STATE	
	STATION NO.	
DATE	TAPE BEGINS	TAPE ENDS

Exhibit 9.1: WS Form B-18A - Punched Tape Mailing Label

### 9.3 WS FORM B-44: COOPERATIVE STATION REPORT

This form (not shown) contains a complete file on the location, instrumentation, observer name, etc., of each station. It is not used by cooperative observers. After the NWS representative visits an observer, he will mark any changes in the observing site on the form (change of equipment, instrument exposure, time of observation, new observer, etc.) and send it to his regional headquarters. There, the changes will be keyed into a regional and national computer data base.

### 9.4 WS FORM F-54: METROPOLITAN NETWORK MONTHLY REPORT

Form F-54 is used mainly in volunteer temperature and precipitation-observing networks in metropolitan areas. The forms are mailed to local NWS offices, some of which use them in studies of the effects of urbanization and terrain on local weather patterns and to promote public interest in weather. Data from these networks are also used by lawyers, insurance companies, etc., much as the E-15's are used.

The metropolitan networks usually have many more observing sites per unit area than the cooperative network. The accuracy of data, however, can vary greatly from one network to another, as there may be no station inspection program.

## MISCELLANEOUS FORMS

These data are classified as unofficial, and are not generally archived or published by NCDC.

WS FORM F-54  
(7-86)

**U.S. DEPARTMENT OF COMMERCE**  
**NATIONAL OCEANIC AND ATMOSPHERIC ADMIN**  
**NATIONAL WEATHER SERVICE**

### METROPOLITAN NETWORK MONTHLY REPORT

*Please mail by fifth day of month*

STATION NUMBER	MONTH	YEAR
NAME		
TIME OF OBSERVATION		
TEMPERATURE	PRECIPITATION	OR <input type="checkbox"/> AFTER PRECIP ENDS

DAY	TEMPERATURE			PCPN HNDTHS	SNOW TENTHS	REMARKS
	PAST 24 HR MAX.	MIN.	AT OB TIME			
1						
2						
3						
30						
31						
TOTAL						
AVER- AGE						<input type="checkbox"/> Check if more cards are needed

WS FORM F-54