



U.S. Department
of Transportation

**Federal Highway
Administration**

Publication No. FHWA-TS-89-035
July 1989

Work Zone Traffic Management Synthesis:

Work Zone Pedestrian Protection

Research, Development, and Technology
Turner-Fairbank Highway Research Center
6300 Georgetown Pike
McLean, Virginia 22101-2296

NOTICE

This document is disseminated under the sponsorship of the Department of Transportation in the interest of information exchange. The United States Government assumes no liability for its contents or use thereof.

The contents of this report reflect the views of the contractors who are responsible for the facts and the accuracy of the data presented herein. The contents do not necessarily reflect the official views or policy of the Department of Transportation.

This report does not constitute a standard specification, or regulation.

The United States Government does not endorse products or manufacturers. Trademarks or manufacturers' names appear herein only because they are considered essential to the object of this document.

| | | | | | |
|---|--|--|--|--|-----------|
| 1. Report No. FHWA-TS-89-035 | | 2. Government Accession No. | | 3. Recipient's Catalog No. | |
| 4. Title and Subtitle Work Zone Traffic Management Synthesis: Work Zone Pedestrian Protection | | | | 5. Report Date July 1989 | |
| | | | | 6. Performing Organization Code | |
| 7. Author(s) Errol C. Noel, Ziad A. Sabra, Conrad L. Dudek | | | | 8. Performing Organization Report No. | |
| 9. Performing Organization Name and Address Contractor: Daniel Consultants, Inc. Columbia, Maryland Subcontractor: Dudek & Assoc., Bryan, Texas | | | | 10. Work Unit No. (TRIS) NCP 3A9a 0073 | |
| | | | | 11. Contract or Grant No. DTFH61-88-X-00007 | |
| 12. Sponsoring Agency Name and Address Federal Highway Administration Turner-Fairbank Highway Research Center 6300 Georgetwon Pike McLean, Virginia 22101-2296 | | | | 13. Type of Report and Period Covered Final Report May 1988 - May 1989 | |
| | | | | 14. Sponsoring Agency Code | |
| 15. Supplementary Notes FHWA Contract Manager: Guenther Lerch, HRT-20 | | | | | |
| 16. Abstract This report is a synthesis of research findings and current practices in controlling and protecting pedestrian traffic in work zones. The information presented here is based on a review of research reports and work zone manuals of a selection of state and city highway agencies, discussions with highway officials, and field observation of projects involving road work and building construction and maintenance. The report presents an assessment of the state-of-the-practice and makes recommendations for future revisions of the <u>Manual on Uniform Traffic Control Devices</u> . | | | | | |
| 17. Key Words pedestrian safety, work zones pedestrian protection, worker protection | | | 18. Distribution Statement No restrictions. This document is available to the public through the National Technical Information Service, Springfield, VA 22161 | | |
| 19. Security Classif. (of this report) Unclassified | | 20. Security Classif. (of this page) Unclassified | | 21. No. of Pages 57 | 22. Price |

SI* (MODERN METRIC) CONVERSION FACTORS

APPROXIMATE CONVERSIONS TO SI UNITS

| Symbol | When You Know | Multiply By | To Find | Symbol |
|----------------------------|------------------------|-------------|---------------------|-----------------|
| LENGTH | | | | |
| in | inches | 25.4 | millimetres | mm |
| ft | feet | 0.305 | metres | m |
| yd | yards | 0.914 | metres | m |
| mi | miles | 1.61 | kilometres | km |
| AREA | | | | |
| in ² | square inches | 645.2 | millimetres squared | mm ² |
| ft ² | square feet | 0.093 | metres squared | m ² |
| yd ² | square yards | 0.836 | metres squared | m ² |
| ac | acres | 0.405 | hectares | ha |
| mi ² | square miles | 2.59 | kilometres squared | km ² |
| VOLUME | | | | |
| fl oz | fluid ounces | 29.57 | millilitres | mL |
| gal | gallons | 3.785 | litres | L |
| ft ³ | cubic feet | 0.028 | metres cubed | m ³ |
| yd ³ | cubic yards | 0.765 | metres cubed | m ³ |
| MASS | | | | |
| oz | ounces | 28.35 | grams | g |
| lb | pounds | 0.454 | kilograms | kg |
| T | short tons (2000 lb) | 0.907 | megagrams | Mg |
| TEMPERATURE (exact) | | | | |
| °F | Fahrenheit temperature | $5(F-32)/9$ | Celcius temperature | °C |

NOTE: Volumes greater than 1000 L shall be shown in m³.

APPROXIMATE CONVERSIONS FROM SI UNITS

| Symbol | When You Know | Multiply By | To Find | Symbol |
|----------------------------|---------------------|-------------|------------------------|-----------------|
| LENGTH | | | | |
| mm | millimetres | 0.039 | inches | in |
| m | metres | 3.28 | feet | ft |
| m | metres | 1.09 | yards | yd |
| km | kilometres | 0.621 | miles | mi |
| AREA | | | | |
| mm ² | millimetres squared | 0.0016 | square inches | in ² |
| m ² | metres squared | 10.764 | square feet | ft ² |
| ha | hectares | 2.47 | acres | ac |
| km ² | kilometres squared | 0.386 | square miles | mi ² |
| VOLUME | | | | |
| mL | millilitres | 0.034 | fluid ounces | fl oz |
| L | litres | 0.264 | gallons | gal |
| m ³ | metres cubed | 35.315 | cubic feet | ft ³ |
| m ³ | metres cubed | 1.308 | cubic yards | yd ³ |
| MASS | | | | |
| g | grams | 0.035 | ounces | oz |
| kg | kilograms | 2.205 | pounds | lb |
| Mg | megagrams | 1.102 | short tons (2000 lb) | T |
| TEMPERATURE (exact) | | | | |
| °C | Celcius temperature | $1.8C + 32$ | Fahrenheit temperature | °F |

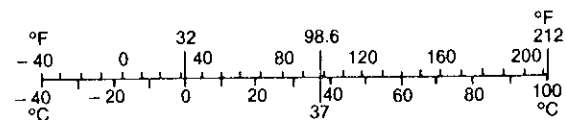

* SI is the symbol for the International System of Measurement

(Revised April 1989)

TABLE OF CONTENTS

| | Page |
|---|------|
| LIST OF FIGURES | iv |
| LIST OF TABLES | v |
| I. INTRODUCTION | 1 |
| A. Pedestrian Right to Safe Pathways | 1 |
| B. Pedestrian Protection Standards | 1 |
| II. LITERATURE REVIEW | 15 |
| A. Pedestrian Information Needs in Work Zones ... | 15 |
| B. Protection of Workers | 17 |
| C. Pedestrian Traffic Control Devices for Work Zones | 18 |
| III. PEDESTRIAN PROTECTION PRACTICES | 21 |
| A. Pedestrian Information Signs | 23 |
| B. Pedestrian Barriers, Canopies, and Fences | 23 |
| C. Delineation Devices | 36 |
| IV. ASSESSMENT | 46 |
| V. CONCLUSIONS | 48 |
| VI. RECOMMENDATIONS | 49 |
| LIST OF REFERENCES | 51 |

LIST OF FIGURES

| | | Page |
|------------|---|------|
| Figure 1. | Pedestrian pathway discontinuity | 2 |
| Figure 2. | Pedestrian pathway discontinuity | 3 |
| Figure 3. | Opaque fence restricting driver's view | 4 |
| Figure 4. | Diagonal crossing by pedestrians | 4 |
| Figure 5. | Pathway discontinuity unsuitable for handicapped pedestrians | 5 |
| Figure 6. | Pedestrian control for mid-block sidewalk closure | 7 |
| Figure 7. | Pedestrian control for crosswalk and mid- block closures | 9 |
| Figure 8. | Pedestrian control for corner closure | 10 |
| Figure 9. | Pedestrian control for mid-block sidewalk closure | 12 |
| Figure 10. | Use of fences and canopies | 13 |
| Figure 11. | Sidewalk closure and temporary walkway | 14 |
| Figure 12. | Pedestrian control for closure of sidewalk | 16 |
| Figure 13. | Pedestrian information signs | 20 |
| Figure 14. | Pedestrian signs at pathway entrances | 25 |
| Figure 15. | Signs for guidance and transit information | 26 |
| Figure 16. | Low mounting height of sidewalk closure signs | 27 |
| Figure 17. | Spray-painted and hidden pedestrian signs .. | 28 |
| Figure 18. | Detour sign and sign with permit number provision | 29 |
| Figure 19. | Signs with different background on the same site | 30 |
| Figure 20. | Sign with lengthy message and sign with contractor's name | 31 |
| Figure 21. | Sign at detour entrance and closure sign without directional information | 32 |
| Figure 22. | Protecting workers with concrete barriers .. | 33 |
| Figure 23. | Protecting pedestrians with concrete barriers | 34 |
| Figure 24. | Building demolition without pedestrian protection | 35 |
| Figure 25. | Barrier used to protect pedestrians | 35 |
| Figure 26. | Mobile and stationary canopies for overhead protection | 37 |
| Figure 27. | Wooden canopy used in underpass | 38 |
| Figure 28. | Chain link fences in work zones | 39 |
| Figure 29. | Wooden fences in work zones | 40 |
| Figure 30. | Pedestrian channelizing rails used in San Francisco | 41 |
| Figure 31. | Pedestrian channelizing rails used in New York City | 42 |
| Figure 32. | Use of orange plastic mesh for delineating pedestrian pathway | 44 |
| Figure 33. | Drums and barricades draped with orange plastic mesh | 45 |

LIST OF TABLES

| | Page |
|--|------|
| Table 1. Pedestrian information signs and color codes used in some cities | 24 |

I. INTRODUCTION

A. Pedestrian Right to Safe Pathways. Work zones located in areas with moderate to high pedestrian traffic can jeopardize the safety of workers and pedestrians. Although much progress has been accomplished to date regarding work zone safety, the safe accommodation of pedestrians in work areas is often neglected by the traffic safety community. The right of pedestrians to safe passage is an important issue that must be considered in planning, design, and implementation of traffic control for work areas. Since 1981, the continuing neglect of pedestrian safety in work zones has been the subject of research papers (1, 2, 3, 4) based on the efforts of the Federal Highway Administration (5) to better understand the issue. These papers (1, 2, 3) present photographic evidence of the neglectful treatment of pedestrians in urban work zones. Recent field observations in the downtown areas of several major cities -- New York, Philadelphia, Washington, D.C., and Chicago -- clearly indicate a continuing disregard for pedestrian safety in urban work zones. The abuse of pedestrian pathways during roadway rehabilitation and maintenance, building demolition and construction, and diverse utility operations in downtown areas reflects a continuing unawareness of pedestrian rights. Figures 1 and 2 illustrate common urban work zones where pedestrians are deprived of pathway continuity. Figures 3 and 4 illustrate how a driver's view of a crossing pedestrian can be restricted by opaque fences at intersections and how pedestrians are forced to make diagonal crossings when no safe path is indicated. Although there is evidence of some effort to aid pedestrians in identifying work areas, no guidance and improper guidance are common occurrences. Figure 5 illustrates a contractor's effort to protect his work from pedestrians; no alternative path is provided. Figure 5 also illustrates blatant disregard for physically handicapped pedestrians by directing them through pavement excavation below the level of the streetcar rails. The rights of pedestrians to access properties abutting work areas and to enjoy safe passage through and around construction projects is of no less importance than the right of safe passage accorded to motorists.

B. Pedestrian Protection Standards. At present, there is no comprehensive national standard on pedestrian accommodation in work areas. Part VI of the Manual On Uniform Traffic Control Devices (MUTCD) (6) is held in high regard for its coverage of traffic control principles and devices for vehicular traffic in work areas but it is grossly deficient in pedestrian protection. States and localities rely on the fundamental principles presented in the Traffic Control Devices Handbook (TCDH) (7). However, the TCDH is not regarded as a standard nor as having any legal significance, and thus, its principles have not been widely adopted into state manuals. The TCDH

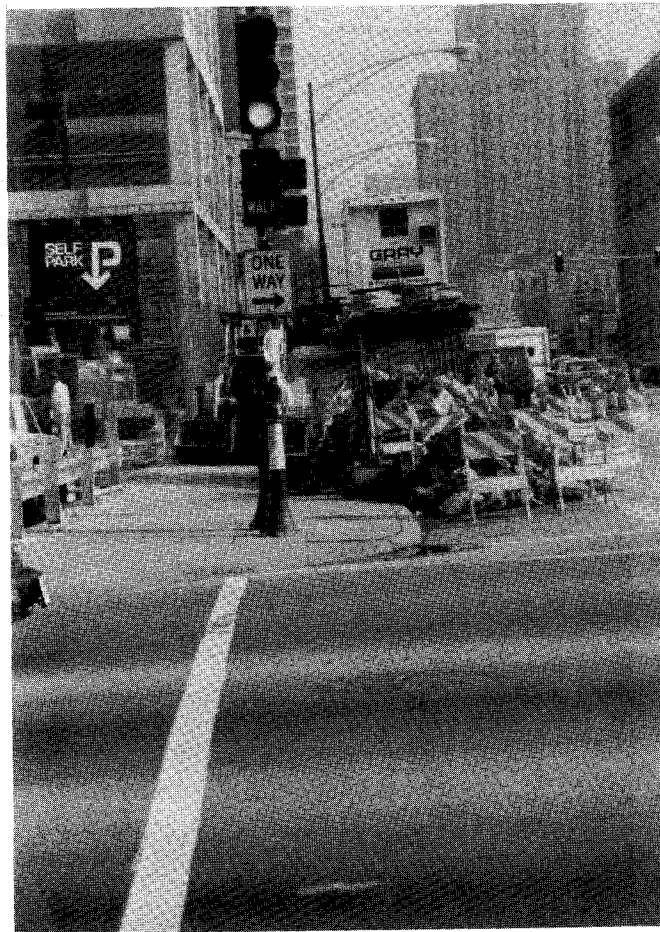

Figure 1. Pedestrian pathway discontinuity

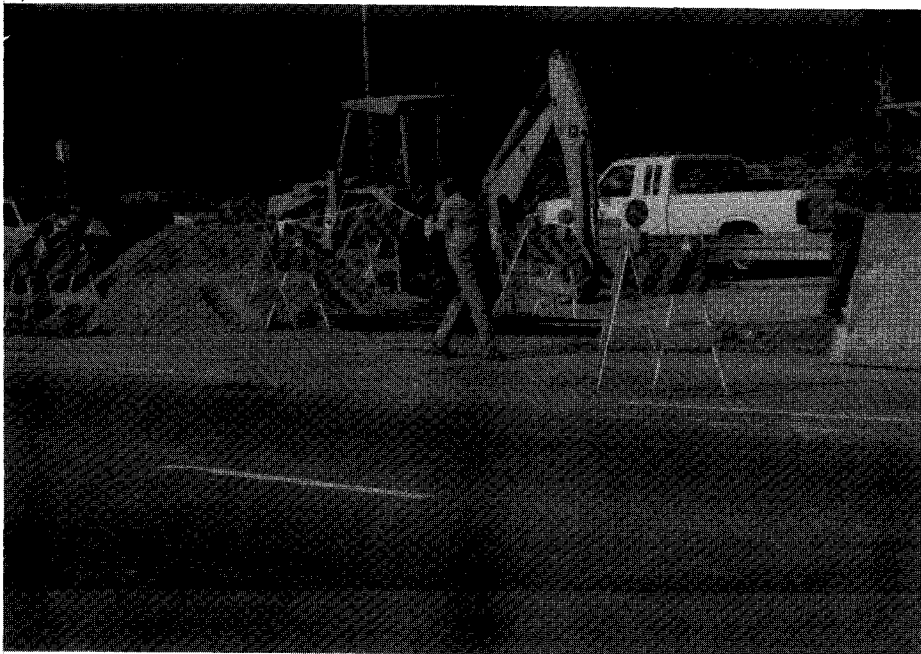

Figure 2. Pedestrian pathway discontinuity

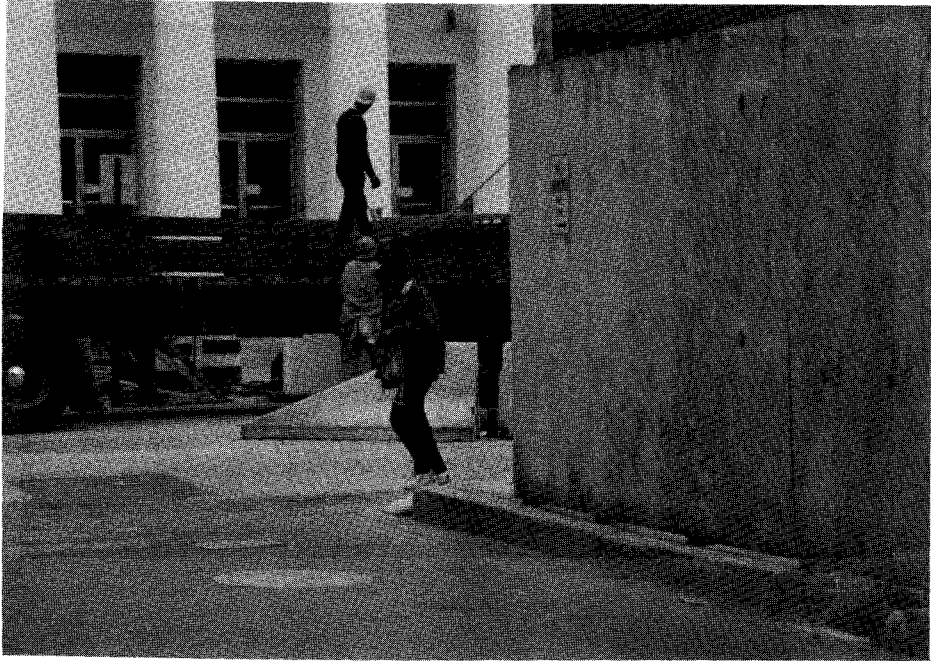

Figure 3. Opaque fence restricting driver's view

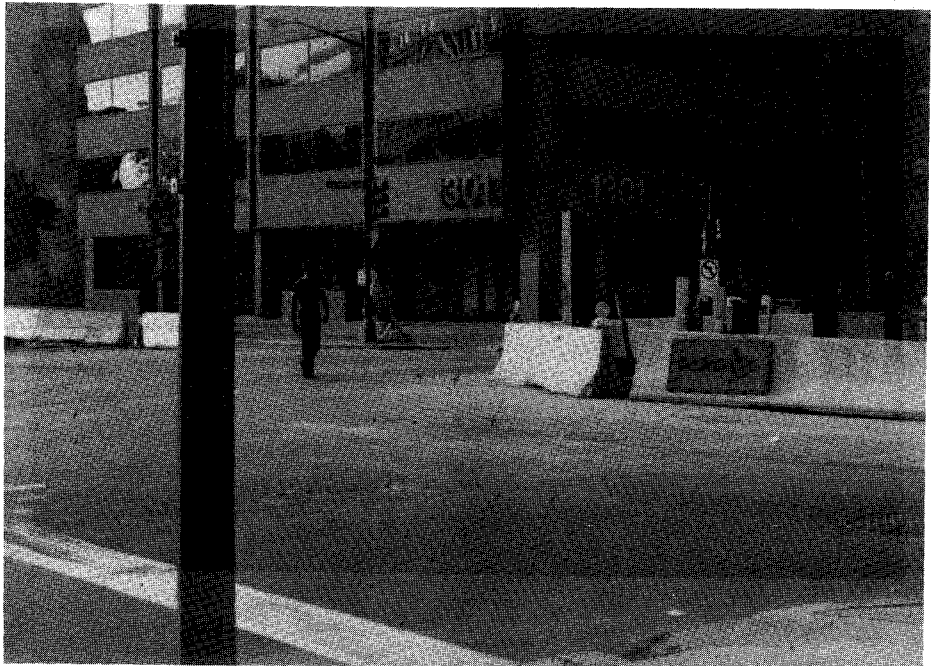

Figure 4. Diagonal crossing by pedestrians

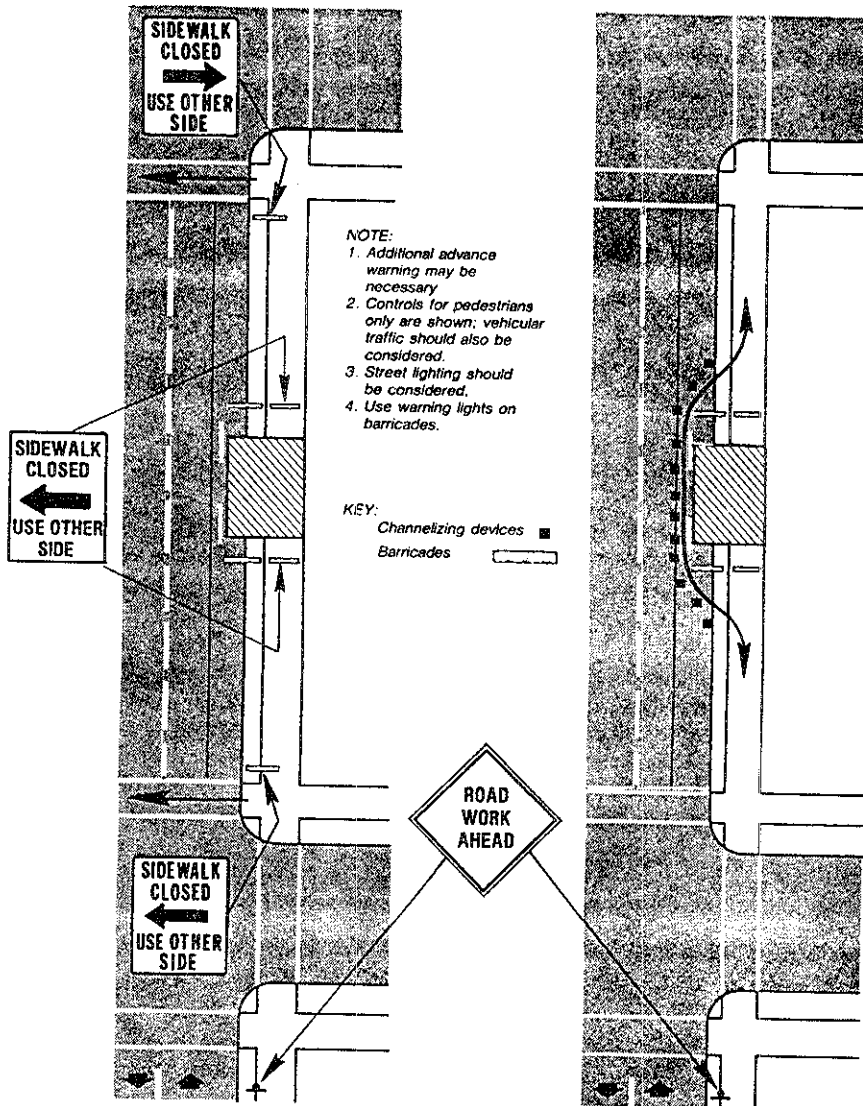

**Figure 5. Pathway discontinuity unsuitable for
handicapped pedestrians**

provides the following guidelines on pedestrian control in highway work zones:

1. Pedestrians and vehicles should be physically separated (i.e., by barriers, barricades, or similar items).
2. Pedestrian walkways should be maintained free of any obstructions and hazards such as holes, debris, mud, construction equipment, stored materials, etc.
3. Temporary lighting should be considered for all walkways that are used at night, particularly if adjacent walkways are lighted.
4. Walkways should be at least 4 or 5 feet wide, and should be wider in areas of high pedestrian activity.
5. All hazards (ditches, trenches, excavations, etc.) near or adjacent to walkways should be clearly delineated.
6. Walkways under or adjacent to elevated work activities such as bridges or retaining walls may require a protective roof.
7. Where safe pedestrian passage can not be provided, pedestrians should be directed to the other side of the street by appropriate traffic control devices.
8. Signs and traffic control devices should not be a hazard to pedestrians.
9. Signs located near or adjacent to a sidewalk should have a 7-foot clearance.
10. Where construction activities involve sidewalks on both sides of the street efforts should be made to stage the work so that both sidewalks are not out of service at the same time.
11. In the event that sidewalks on both sides of the street are closed, pedestrians should be guided around the construction site.
12. Reflectorized traffic control devices are of little value to pedestrians. Warning lights should be used to delineate the pedestrians pathway and to mark hazards as appropriate.

Figure 6 presents the two methods included in the TCDH for controlling pedestrians during mid-block sidewalk closure. It should be noted that no typical pedestrian information signs are presented in the bypass illustration.



Source: Traffic Control Devices Handbook

Figure 6. Pedestrian control for mid-block sidewalk closure

Large cities and counties traditionally rely on the limited provisions of state and local building codes for pedestrian traffic control in downtown work zones. For example, a permit is required for any excavation in the street or sidewalk in the City and County of San Francisco. The street excavation provisions of San Francisco (13) stipulate that contractors must provide and maintain safe and adequate passage of pedestrians and vehicles over and adjacent to excavations. However, these provisions seldom include procedural guidelines for the selection and placement of pedestrian protection devices in work zones that are not related to utility and building construction. In spite of this deficiency, the building permit review process is regarded by City officials as the primary opportunity to determine the adequacy of proposed pedestrian management systems for urban construction projects. The building permit review process was never intended to prescribe pedestrian safety needs for most urban work zones. Current use of pedestrian canopies and fencing are due to progressive building codes and, to some extent, to the special efforts of contractors and developers as they attempt to minimize their liability.

Illinois is one of the few states which has included typical treatments for corner, crosswalk, and mid-block closures (see Figures 7 and 8) in its Manual on Uniform Traffic Control Devices (8). The work zone traffic control manuals and the construction standards and specifications of Michigan, Ohio, Delaware, California, Virginia and Pennsylvania provide standard traffic control schemes for vehicular traffic but not for pedestrians. However, there is no evidence that pedestrian safety is disregarded in state highway work zones. State officials feel that project traffic control plans present ample opportunities to ensure that the safety of pedestrians is considered and implemented. Maryland officials are in the process of developing design drawings for pedestrian control during typical mid-block sidewalk closures. The design in Figure 6, for example, could be improved by including signing for a pedestrian bypass, showing the conversion of a parking lane to a pedestrian pathway, and providing notes on appropriate channelization devices. In general, the information on pedestrian control in work zones as presented in state manuals is as limited as the Federal MUTCD.

The conflict between work areas and pedestrian traffic is more pronounced in large cities. As a result, city officials tend to be more knowledgeable about pedestrian issues and practical solutions to pedestrian traffic problems in work zones. However, cities which have developed substantive guidelines on pedestrian protection in work zones are more the exception than the rule. Surprisingly, major cities such as New York, Chicago, and Washington, D.C. do not have such guidelines while smaller cities such as Seattle, Washington, Minneapolis, Minnesota, and Greensboro, North Carolina do. For example, the

CROSSWALK CLOSURE

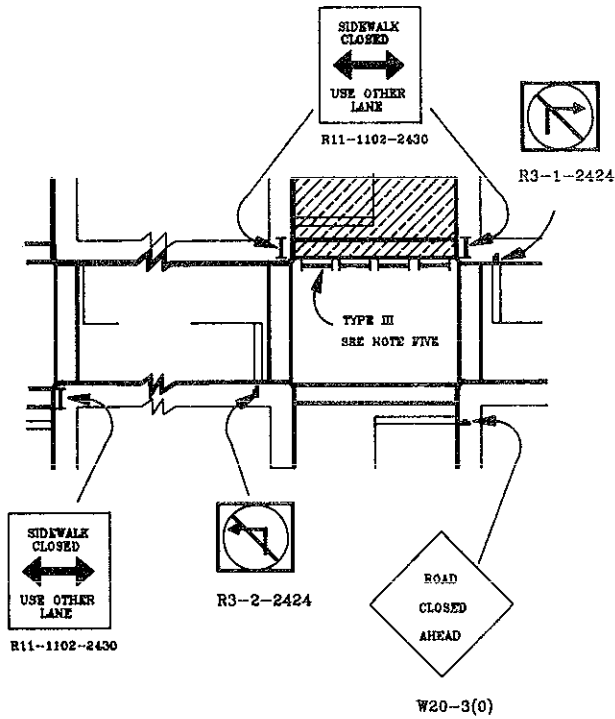

MID-BLOCK CLOSURE

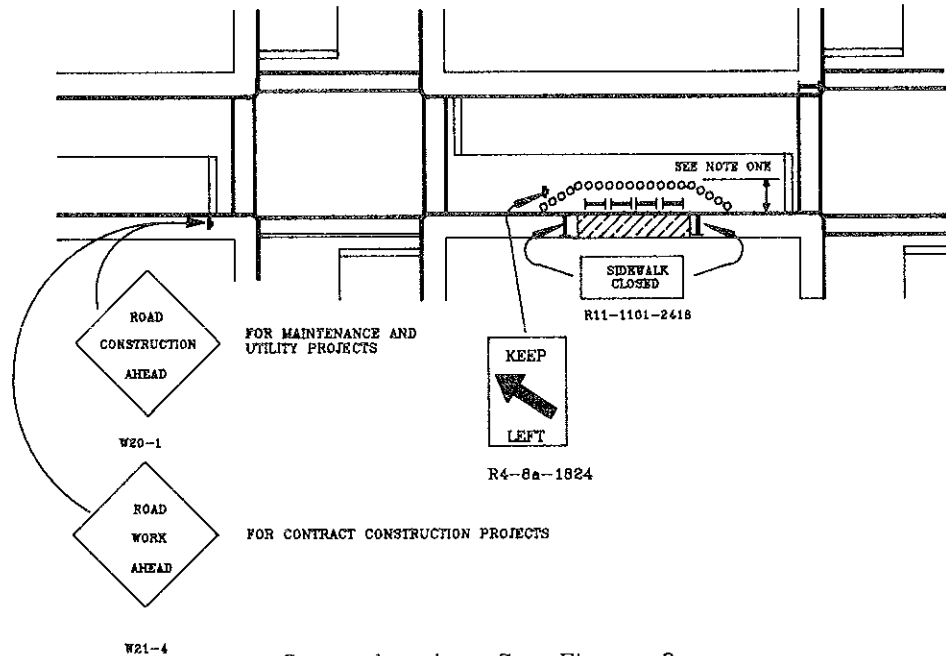

General notes: See Figure 8.
 Source: Reprint part VI of the Illinois, 1987.

| SYMBOLS | |
|---------|---------------------------------------|
| | WORK AREA |
| | BARRICADE OR DRUM |
| | CONE, DRUM OR BARRICADE |
| | SIGN ON PORTABLE OR PERMANENT SUPPORT |

Figure 7. Pedestrian control for crosswalk and mid-block closures

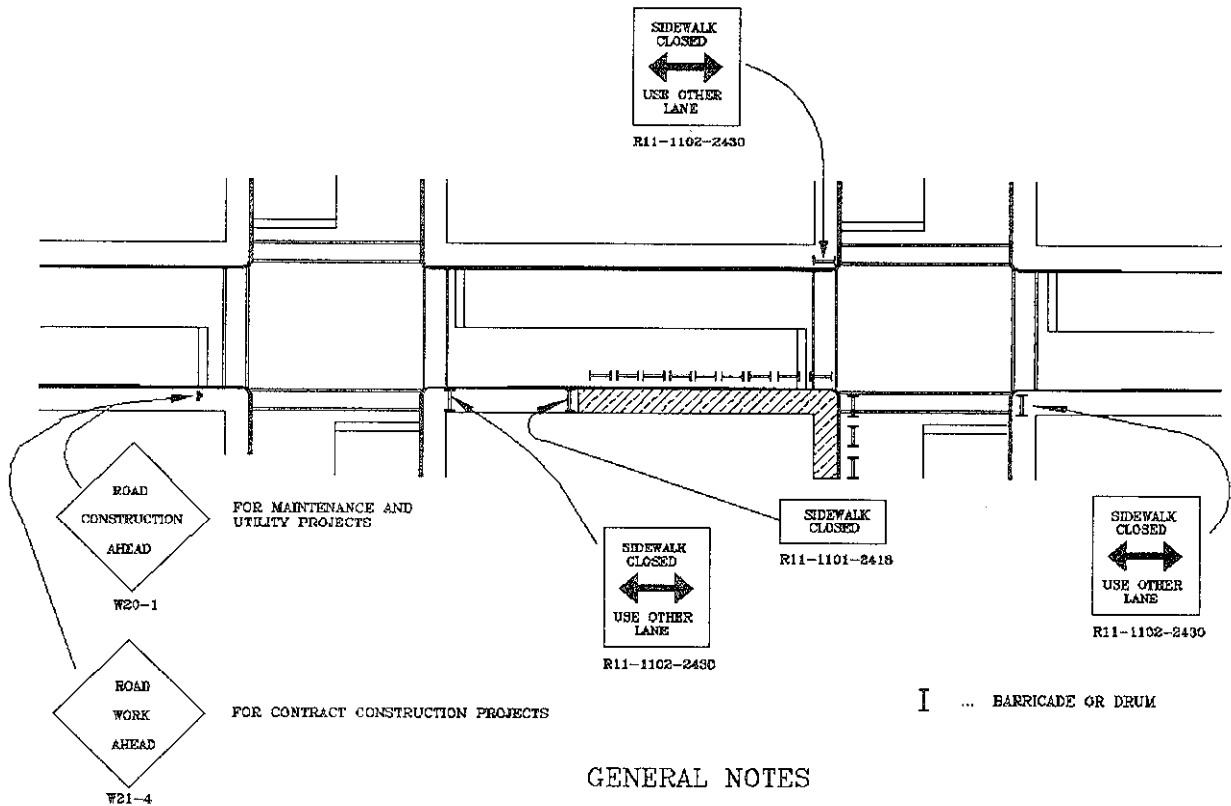

1. A temporary walkway may encroach on an existing parking lane. If the temporary walkway encroaches on a traveled lane, the lane shall be closed in accordance with Case U-1, U-2, or U-3.
2. The SIDEWALK CLOSED/ USE OTHER SIDEWALK sign shall be placed at the nearest crosswalk or intersection to each end of the closure. Where the closure occurs at the corner, the signs shall be erected on the corners across the street from the closure. The SIDEWALK CLOSED signs shall be used at the ends of the actual closures.
3. All walkways shall be clearly identified, protected from motor vehicle traffic and free of any obstructions and hazards such as holes, debris, mud, construction equipment, stored materials, etc.
4. All hazards (ditches, trenches, excavations, etc.) near or adjacent to walkway shall be clearly delineated.
5. Type III Barricades and R11-2-4830 signs shall be positioned as shown in "Road Closed To All Traffic" detail on Highway Standard 2298.
6. When the posted speed limit is 35 M.P.H. or more, all warning signs shall have a minimum dimension of 48 inches by 48 inches or, with the approval of the engineer, 36 inches by 36 inches. If the posted speed limit is 30 M.P.H. or less, all warning signs shall have a minimum dimension of 36 inches by 36 inches.

Source: Reprint Part VI of the Illinois MUTCD, 1987

Figure 8. Pedestrian control for corner closure

work zone traffic control manual (9) of Greensboro, North Carolina includes several paragraphs on pedestrian traffic control principles and references sections of the North Carolina State Building Codes which deal with pedestrian protection and facilities. Protective barricades, fences, handrails for physically handicapped pedestrians, illumination, and vertical clearances are among the subjects discussed. However, the Greensboro manual (9) does not provide typical illustrations of signing and layout for work zones where pedestrians are anticipated.

San Francisco, Sacramento, and Los Angeles rely on the Work Area Traffic Control Handbook (WATCH) (10) which was developed especially for California's cities. The WATCH includes several paragraphs on the type and use of pedestrian control devices and mandatory requirements such as 1) minimum walkway width of four feet, 2) prohibiting abrupt changes in grade and 3) prohibiting diversion of pedestrians into any portion of the street used for vehicular traffic. The typical drawing for work zone pedestrian control presented in the WATCH (see Figure 9) is similar to that of the TCDH (7); the WATCH has minor variations in the wording of pedestrian signs, a different type of work area delineation, and more clearly defined parking lanes.

Seattle's Traffic Control Manual for In-Street Work (11) uses many of the fundamental principles of the TCDH. An eight-foot minimum walkway width is required for areas with heavy pedestrian traffic. The manual also emphasizes the need to accommodate visually impaired people by preventing them from inadvertently entering the work area through the use of physical barricades. Its guidelines for foot bridges state that such bridges must be strong, free of bounce and sway, and free of cracks, holes, and irregular ties that could cause tripping. Standard pedestrian signs, in black and white, carry such messages as "Street Closed," "Sidewalk Closed," "Sidewalk Closed Ahead," "Crosswalk Closed." Two important considerations in the Seattle manual are constructing temporary bypass walkways through abutting property and the use of fences and canopies in building construction. The design of fences and canopies is illustrated in Figure 10. Figure 11 presents Seattle's typical traffic control for sidewalk closure and the use of a temporary walkway through adjacent property.

The Minneapolis manual (12) requires the use of signs, barricades, fencing, handrails and bridges, together with warning and guidance devices to ensure the safe passage of pedestrians through and around work areas. The minimum width of a pedestrian passageway is four feet, and its vertical alignment must be free of abrupt changes in grades. The manual (12) also includes a standard illustration of a mid-block sidewalk closure which is similar to the one in the TCDH.

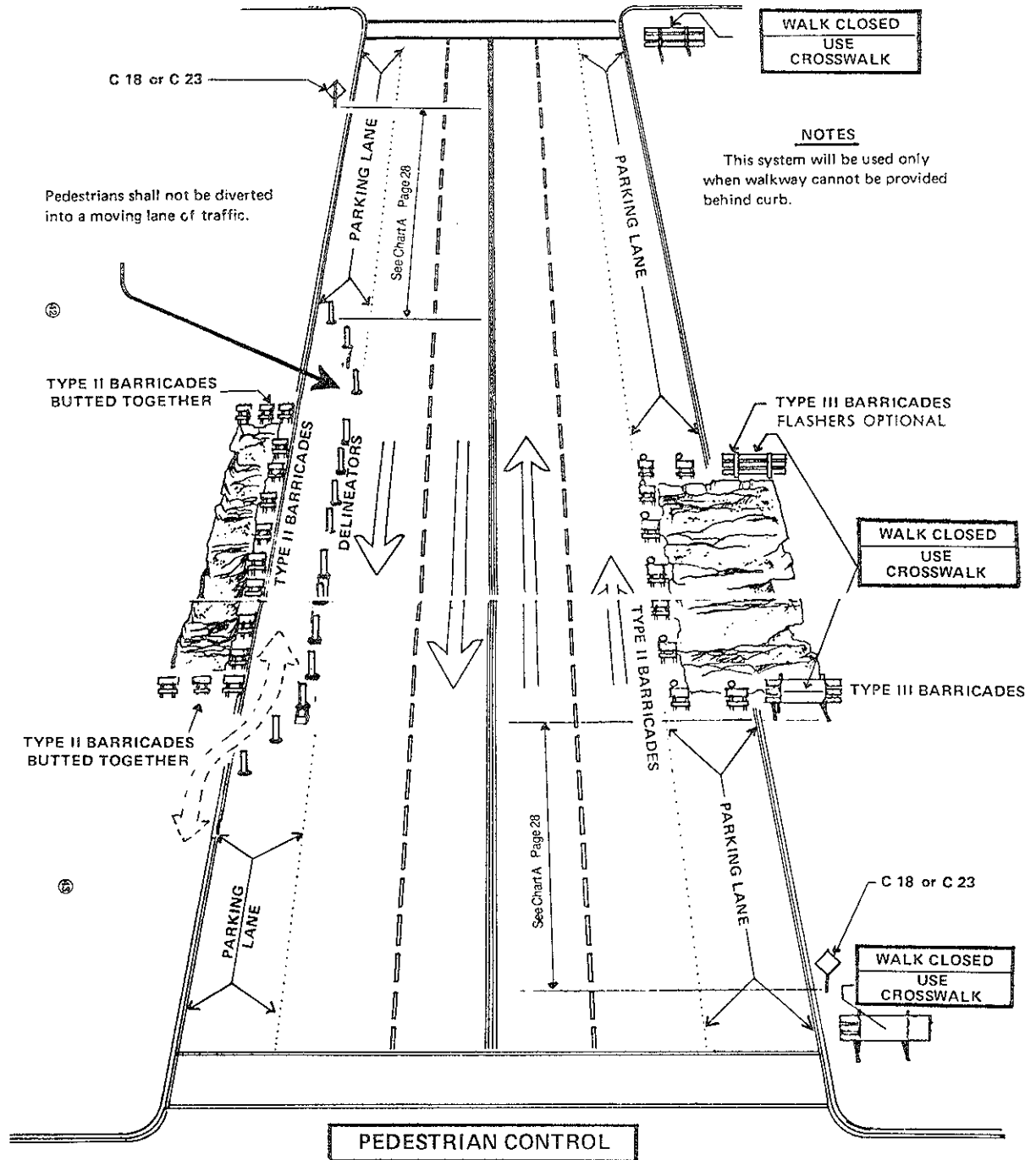

Source: Work Area Traffic Control Handbook

Figure 9. Pedestrian control for mid-block sidewalk closure

NOTE: INTERIOR ILLUMINATION FOR PEDESTRIANS SHALL BE PROVIDED

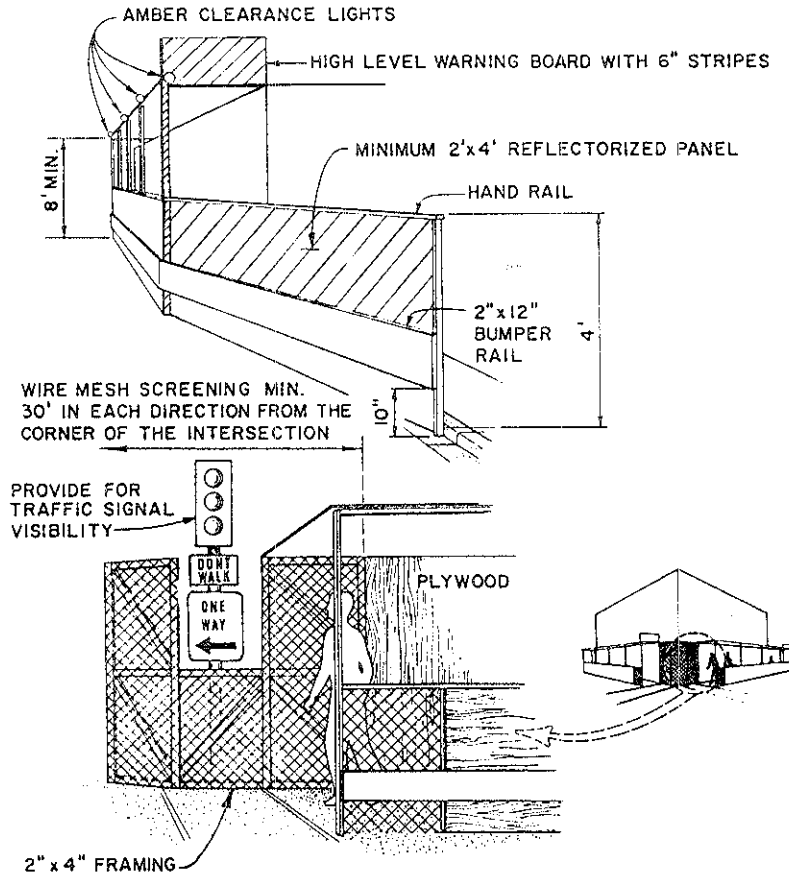

PEDESTRIAN PROTECTION

Source: City of Seattle Traffic Control Manual for In-Street Work

Figure 10. Use of fences and canopies

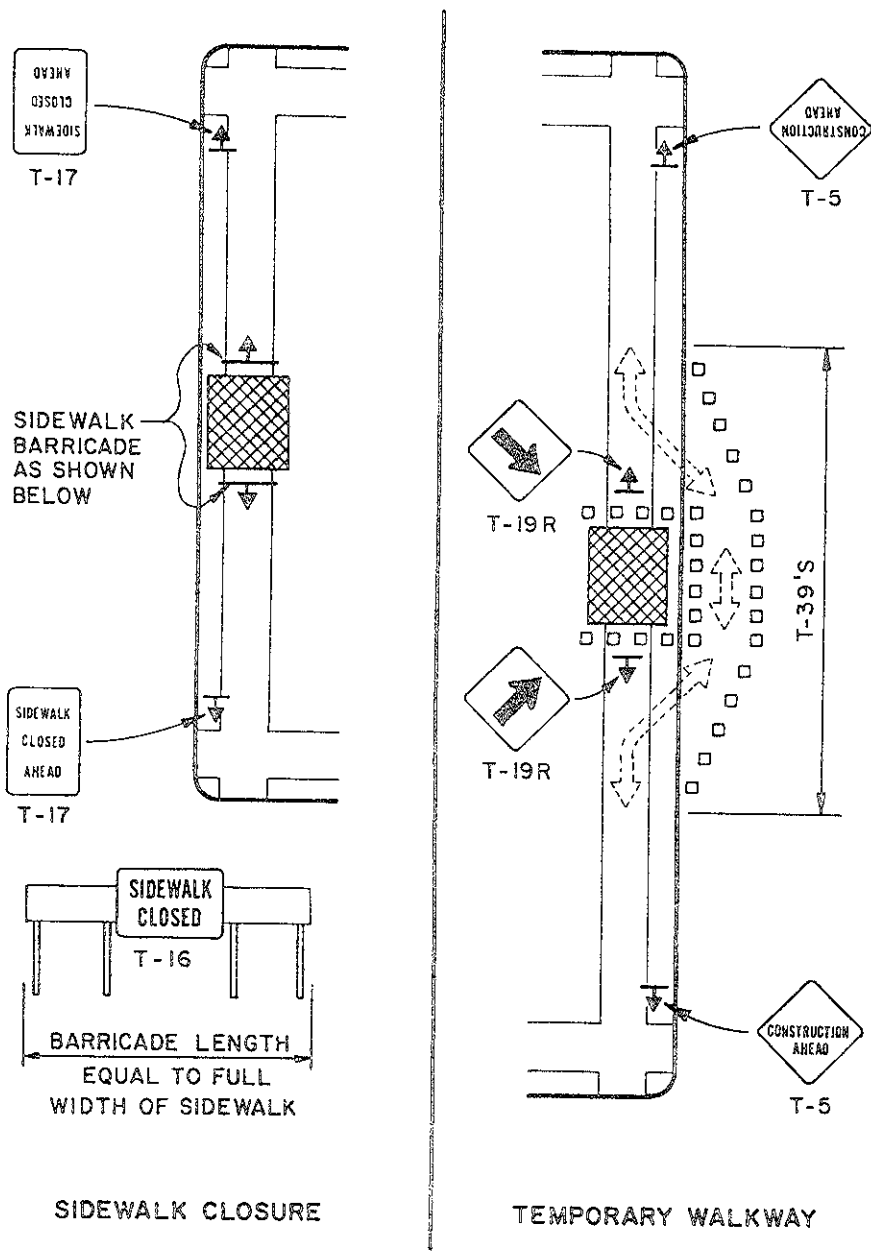

PEDESTRIAN CONTROL

Source: City of Seattle Traffic Control Manual for In-Street Work

Figure 11. Sidewalk closure and temporary walkway

II. LITERATURE REVIEW

A. Pedestrian Information Needs in Work Zones. Pedestrians need information to enable them to recognize work areas and potential hazards and to guide them safely through and around work zones. Sometimes the mere use of work area delineation devices is sufficient to alert pedestrians to the potential danger. In complex situations where pedestrians are required to use bypasses and detours, a special effort must be made to provide positive guidance.

Research publications on methods for accommodating pedestrians in work zones are scarce. Except for a FHWA study (5) which formed the basis for several publications by Chadda and McGee (1, 2, 3, 4), the subject of pedestrian safety in work zones has been virtually ignored. Chadda and McGee (1, 2) stated that positive guidance for pedestrians must be comprised of four elements: advance information, transition information, work area information, and exit information.

Chadda and McGee (2) described advance information as information placed at appropriate distances from the work zone which allows pedestrians to make timely decisions regarding alternative paths. The authors (1, 2) noted that situations requiring pedestrian pathway blockage or detours are ideal for advance information and presented the following guidelines on the subject:

1. Advance information is needed if the pedestrian pathway is blocked or detoured.
2. Signs are most appropriate for this information.
3. Signs may be tailored to particular circumstances.
4. Signs should be strategically placed at points of decision.
5. Pedestrian signals which no longer apply must be covered.

The authors (1, 2) indicated that "Sidewalk Closed Ahead," "Sidewalk Closed - Use Other Side," and "Pedestrian Detour - Follow Arrow" are typical signed messages. The authors' (1, 2) illustration of a typical treatment for a corner sidewalk closure is presented in Figure 12. The color code for pedestrian signs was not indicated. In another paper, Chadda and Brisbin (3) noted that there is no uniformity in the design of pedestrian information. There was wide variation among the states on the colors, size, message and placement.

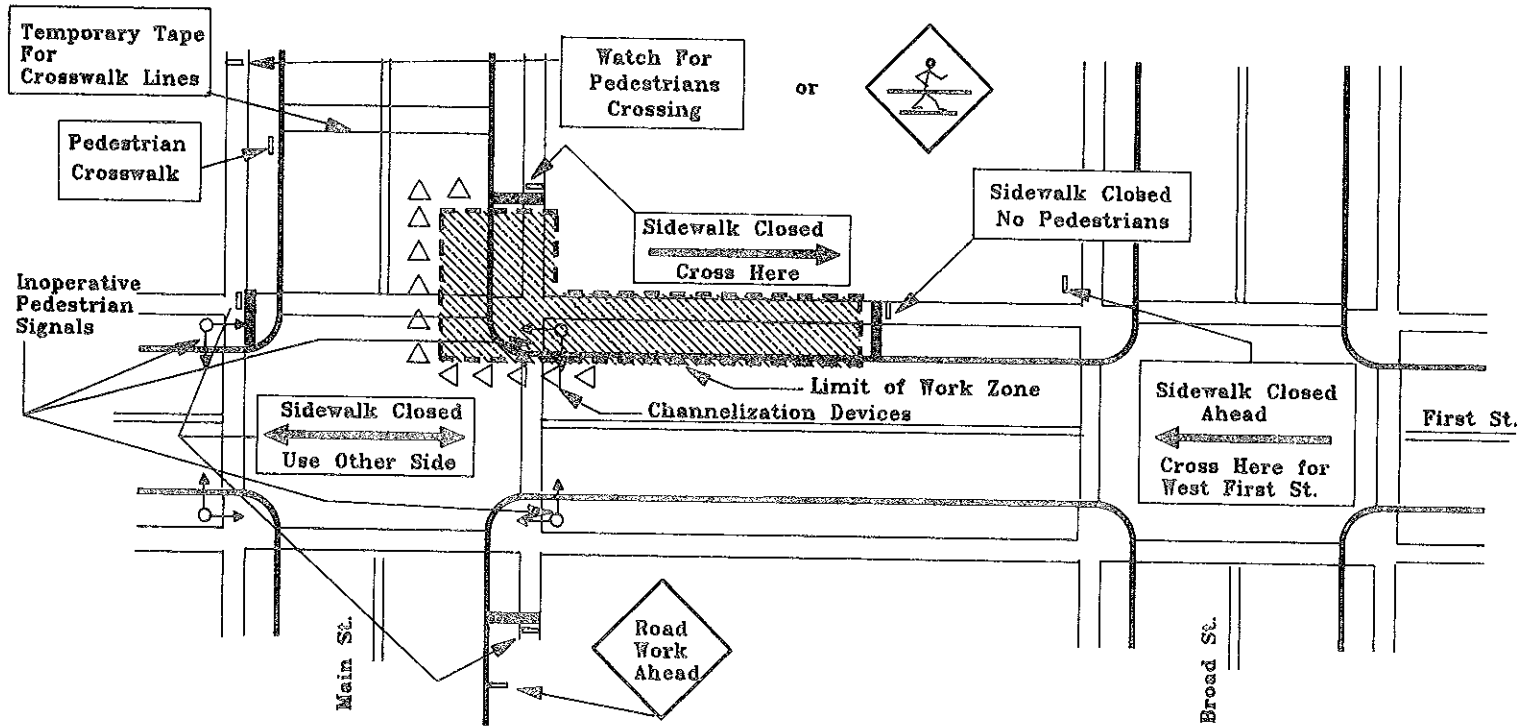

Source: (2)

Figure 12. Pedestrian control for closure of sidewalk

Transition information allows pedestrians to find a safe path through and around work zones. This type of information is particularly important when the work activity restricts the width of pathways or requires a pedestrian bypass or detour. Chadda and McGee (1, 2) recommended the following guidelines on transition areas:

1. Transition to redefined or relocated pathways should be clearly delineated by either markings, tapes, tubes, cones, signs, wooden railing, barricades, portable concrete barriers, or other devices to provide positive guidance.
2. Physical barriers may be necessary to restrain pedestrians from using unsafe pathways and wandering into construction areas.
3. If the pathway is used at night, illumination or delineation with steady burn lights should be used.
4. All temporary crosswalks should be clearly delineated by signs and markings.

Work area information aids the pedestrian's passage through the work zone. This information is needed on all pathways except detours. Chadda and McGee (2) recommend the use of devices that separate and protect pedestrians from the work activity and adjacent vehicular traffic and with clear delineation of pedestrian pathways. Markings, portable fences, barricades, flagging tape, cones, railings, barrels, drums, portable concrete barriers, and other devices were recommended for these purposes. The authors (2) noted that the selection of devices should be appropriate to the type of project and the nature of the hazards, and that pedestrians should be informed of pathway geometric and surface conditions on the pathway that pose special hazards.

According to Chadda and McGee (1, 2) exit information becomes necessary only on new pathways involving bypasses and detours. Exit information can be communicated by signs and channelizations that direct pedestrians back to the original pathway.

B. Protection of Workers. A 1977 report (16) prepared by the American Public Works Association drew attention to the need for protecting workers in fixed and mobile work zones. The report noted that setting up fixed protection and working within the defined area expose employees to traffic hazards, and that consideration should be given to precast concrete safety-shaped barriers for positive guidance and protection of workers and motorists. For mobile operations, the report recommended the use of shadow vehicles equipped with

energy absorbing devices as a buffer between workers on foot and the traffic approaching from the rear. Arrow panels were also recognized as being effective in providing advance warning to motorists.

An increasing number of fatalities involving maintenance personnel prompted Brackett et al. (14) to investigate the effectiveness of the flaggers uniform in Texas. Two designs of an orange fluorescent mesh vest were developed and distributed in Texas for field use and evaluation: one involved the "11" striped pattern and the other a "W" striped pattern made with fluorescent reflective material. The study concluded that the "W" pattern was more recognizable and that stripes of brilliant yellow-green fluorescent reflective material should be used on traffic control vests. It was also recommended that the main body of the vest be made with red-orange fluorescent mesh material.

Gordon (15) also experimented on new designs for improving the effectiveness of the work-zone-flagger's vest at nighttime. He advised that there is a need to be selective about the type of material for vest designs. Cotton, nylon mesh, and retro-reflective bandoleer were identified as suitable materials for use during hot or cold weather and for providing good visibility during day or night. Vests made with white or silver-colored encapsulated or cube-corner reflective trimming were determined to be more effective at night. Gordon (15) discouraged the use of vertical or horizontal stripes for retro-reflective patterns on vests. He advised that patterns which outline the flagger's figure are more recognizable than other designs at night. The author also recommended the two-foot x two-foot flag used to signal motorists be outlined with a one-inch margin of retro-reflective tape.









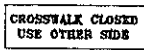
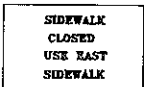
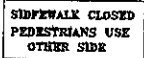
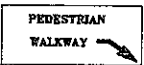
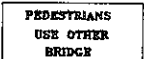
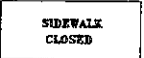

C. Pedestrian Traffic Control Devices for Work Zones. The following is a list of devices mentioned in the literature (2, 4, 15) for accommodating pedestrians:

1. **Channelization Devices:** Cones, tubes, barricades (Type I and II), markings, flagging tapes, ropes, construction delineators, foot bridges.
2. **Advance Warning Devices:** Signs, barricades, cones, arrow panels (in slow moving operations).
3. **Pedestrian-Vehicle Separators:** Traffic cones, barricades, portable concrete barriers, timber barriers, shadow vehicles (in slow moving operations).
4. **Pedestrian-Work Area Separators:** Wooden handrails, opaque fences, chain link fences, orange plastic mesh fences, portable concrete barriers, canopies

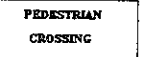
(overhead work areas).

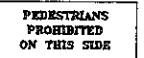
5. **Pathway Surface Material:** Concrete, wood, plywood with friction surface, steel plates, asphalt, stabilized aggregate.

Information signs observed in the field by Chadda and Brisbin (3) are presented in Figure 13.

| <u>SIGN MESSAGE</u> | <u>COLOR BACKGROUND</u> | <u>COLOR LETTERING</u> | <u>MATERIAL</u> | <u>SIGN MESSAGE</u> | <u>COLOR BACKGROUND</u> | <u>COLOR LETTERING</u> | <u>MATERIAL</u> |
|---|-------------------------|------------------------|-----------------|--|------------------------------|------------------------|-----------------|
|  | WHITE | BLACK | WOOD |  | WHITE | BLACK | METAL |
|  | WHITE | BLACK | WOOD |  | WHITE | BLACK | CARD-BOARD |
|  | WHITE | BLACK | METAL |  | WHITE | BLACK | WOOD/METAL |
|  | RED | BLACK | METAL |  | WHITE CONSTRUCTION ORANGE | BLACK | METAL |
|  | WHITE | BLACK/ RED | WOOD |  | WHITE | BLACK | METAL |
|  | WHITE | BLACK | METAL |  | WHITE | BLACK | METAL |
|  | CONSTRUCTION ORANGE | BLACK | METAL |  | YELLOW | BLACK | METAL |
|  | CONSTRUCTION ORANGE | BLACK | METAL | | | | |
|  | CONSTRUCTION ORANGE | BLACK | METAL | | | | |

NOTE: SIZES OF SIGNS VARY AND ARE IRREGULAR

Source: Reference No. 3

Figure 13. Pedestrian information signs

III. PEDESTRIAN PROTECTION PRACTICES

Despite deficiencies in pedestrian control information in work zone manuals, good pedestrian protection practices were observed in the states and cities visited -- Chicago, Illinois; San Francisco, California; Richmond, Virginia; Albany and New York City, New York; Baltimore, Maryland; Lansing and Detroit, Michigan; Philadelphia and Harrisburg, Pennsylvania; and Washington, D.C. Efforts to insure pedestrian safety in work zones are manifested in other ways as indicated below:

- (1) **Building Codes:** Contractors are expected to follow pedestrian safety requirements for work in public rights-of-way as stipulated by state and/or local building codes. These codes, generally, do not specify pedestrian safety treatments for diverse work situations. Contractors use their judgment in implementing pedestrian control measures. Local officials may review field sites to assess safety and recommend additional safety measures, if needed.
- (2) **Building Permits:** Local governments often require the review of building projects to ensure that adequate traffic control measures are taken during construction. The contractors rely on the limited information in work area traffic control manuals of cities, the Federal MUTCD or the State MUTCD. This is a routine practice in the large cities visited. Traffic engineering officials of New York, Chicago and Philadelphia speak highly of this process, since it forces the contractors to submit traffic control plans --in scaled detail or schematic, depending on type of building -- for approval before a building permit is issued. In large cities visited, all projects that use the public right-of-way -- buildings, utility, and road work -- are channeled through this review process. Specific devices, their message, size, location, placement and their period for application are approved by local traffic engineers.
- (3) **Coordinated Management of Traffic:** For major projects in San Francisco, a coordinated effort involving state and local traffic engineers, local police, and contractors is used when the disturbance due to construction in urban centers -- subways, freeways, skyscrapers, rehabilitation of streetcar rails -- is estimated to be major and long lasting. The coordination involves the participation of the police, and traffic engineers in working with contractors in developing a mutually agreeable traffic control plan for all stages of construction.

Subsequently, the police play a major role in enforcement.

- (4) **Traffic Control Plans:** Most states require traffic control plans for highway construction work. Pedestrian safety measures are detailed on traffic control plans where pedestrian traffic is anticipated. The California, Maryland and Virginia Departments of Transportation use this procedure, although their work zone manuals do not detail pedestrian protection measures.
- (5) **General Specifications:** Some states -- Maryland and Virginia, for example -- include a general statement about construction specifications or traffic control plans for highway projects indicating the need for contractors to provide for the safety of pedestrians. However, no details on pedestrian control devices are provided. Contractors are expected to use principles which are acceptable to state officials.
- (6) **Coordinated Policy on Construction Safety:** A coordinated safety policy which brings together several divisions of local government -- maintenance, traffic engineering, building permits, police, and street cleaning -- is used to ensure that individual public works subdivisions do not work against the interest of pedestrian safety in work zones. This ensures that all construction projects that are likely to disturb public space are subject to traffic safety review before work is initiated. San Francisco routinely follows this strategy.

In spite of the measures described above, the actual practice suffers from a general lack of policies to ensure continuing enforcement. Hence, the research team was able to observe many field practices which do not reflect the review and enforcement policies of local governments. A chronic problem which exists at the local levels of government is the lack of training of those individuals who must approve traffic control plans and inspect the field setup for compliance: the lower the cost of the project, the less stringent are the measures to protect pedestrians. This explains why contractors doing curb, gutter, and sidewalk work often display little sensitivity for pedestrian needs in downtown areas. This problem appears to be worse in cities where there are no formal guidelines for protecting pedestrians in work areas, and where approval of traffic control plans is not required for certain types of short-term roadway maintenance projects. A lack of state and local specifications on traffic control devices for pedestrians has allowed room for contractors to be creative about the message, color code, and placement of pedestrian information signs. The following sections provide a sample of field practices.

A. Pedestrian Information Signs. Pedestrian information signs vary widely in message, size, color code, and placement. An assortment of observed signs and their respective message and code are indicated in Table 1. The color of the worded messages are black, blue, green, red, red and black, and white. In addition, signs with lower formality were spray painted on portable concrete safety-shaped barriers. A flat non-reflective white background is most frequently used. Other observed background colors for pedestrian information signs were orange, yellow and red. Combinations of black and red were being used to emphasize caution. Figures 14 through 21 illustrate field applications of a sample of pedestrian information signs. It is clear that mounting height is also subject to wide variation.

B. Pedestrian Barriers, Canopies, and Fences. Barriers are used to protect pedestrians from work activities and to protect workers and pedestrians from vehicular traffic. The barriers are more prevalent in urban work zones when the construction activity is of long duration. The construction, demolition, and rehabilitation of buildings in downtown areas often require special efforts to ensure that work activities do not endanger pedestrians. To protect pedestrians from this type of danger, fences, canopies, and portable concrete safety-shaped barriers are being used.

While several designs of fences and overhead protection structures were observed in all the cities visited, portable concrete barriers were less popular for that purpose. The naturally hilly topography of San Francisco has discouraged the use of portable concrete barriers for protecting workers and pedestrians in urban work zones. However, concrete barriers are often utilized in some cities -- Harrisburg, Philadelphia, and New York, for example -- as worker and pedestrian protection devices.

Figures 22 and 23 illustrate the application of devices to protect pedestrians and workers. The bridge construction project in Figure 22 is a typical case where devices which can restrain and/or redirect errant vehicles are used. The second photograph in Figure 22 illustrates the use of short segments of portable concrete safety-shaped barriers to protect workers from vehicular traffic in a downtown work zone. Figure 23 illustrates the use of portable concrete barriers to protect pedestrians along temporary pathways created in parking lanes. It was observed that without proper signage pedestrians will enter gaps in the barrier which were specifically created for the access of construction vehicles. Use of such gaps should be discouraged, since they expose blunt ends of concrete barriers which could be hazardous to vehicular traffic. Figure 24 shows a building demolition work area where pedestrian needs are blatantly violated. Figure 25 illustrates the protection of

Table 1. Pedestrian information signs and color codes used in some cities

| Worded Message | Message Color | Background Color |
|---|----------------|-----------------------------------|
| 1. "No Ped Crossing Use Crosswalk," with black arrow | Black | Reflective White |
| 2. "This Stop Temporarily Discontinued Use Stop in Next Block," with black arrow | Black | Construction Reflective Orange |
| 3. "No Bicycle Traffic Beyond This Point" | Black | Flat White |
| 4. "Ped. Walk," with black arrow | Black | Flat White |
| 5. "Sidewalk Closed Use Other Side," with or without black arrow | Black | Reflective Orange |
| 6. "Sidewalk Closed Pedestrians Use Opposite Side of Street" | Red | Flat White |
| 7. "We Apologize for the Inconvenience Please Follow Walkway to 49th Street," with blue arrow | Blue | Flat White |
| 8. "West 49th Street Sidewalk Closed Please Use Other Side of Street," with blue arrow | Blue | Flat White |
| 9. "Sidewalk Closed, Use Opposite Side of Street" | Red | Flat White |
| 10. "Walkway," with red arrow | Red | Flat White |
| 11. "Sidewalk Closed, Permit No. ----" | Red | Flat White |
| 12. "Pedestrian Crossing," on diamond with black arrow | Black | Reflective Orange |
| 13. " <u>Caution Sidewalk Repair in Progress Please Pass with Care</u> " | Red | Flat White |
| 14. "Sidewalk Closed Please Use Other Side" | Black | Flat White |
| 15. "Notice Sidewalk Closed Please Use Other Side" | Blue | Flat White |
| 16. "Notice Sidewalk Closed Please Use Other Side" | Green | Flat White |
| 17. "Sidewalk Closed Please Use Other Side" | Red | Flat White |
| 18. "Sidewalk Closed" on diamond | Black | Flat White |
| 19. "Pedestrian Walkway to 16th Street," with black arrow | Red | Flat Yellow |
| 20. "Pedestrian Walkway to 16th Street," with black arrow | Black | Reflective Orange |
| 21. "Sidewalk," with black arrow | Black | Reflective White |
| 22. Impromptu "Walkway" signs spray-painted on concrete barriers | Any | Concrete |
| 23. "Sidewalk Closed" | Red | Flat White |
| 24. "Sidewalk Closed" | White | Flat Red, |
| 25. "Sidewalk Closed Caution" | Black & Red | Flat White |
| 26. "Sidewalk Closed Pedestrians Please Use Other Side of Street," with blue arrow | Blue | Flat White |
| 27. "Sidewalk Closed Please Use Pedestrian Walkway" | Red & Black | Flat White |

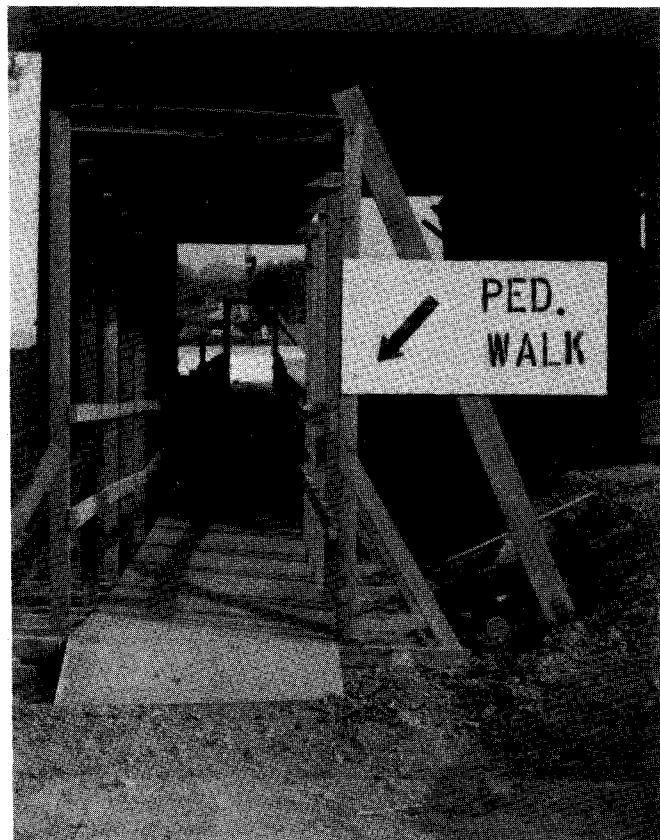

Figure 14. Pedestrian signs at pathway entrances

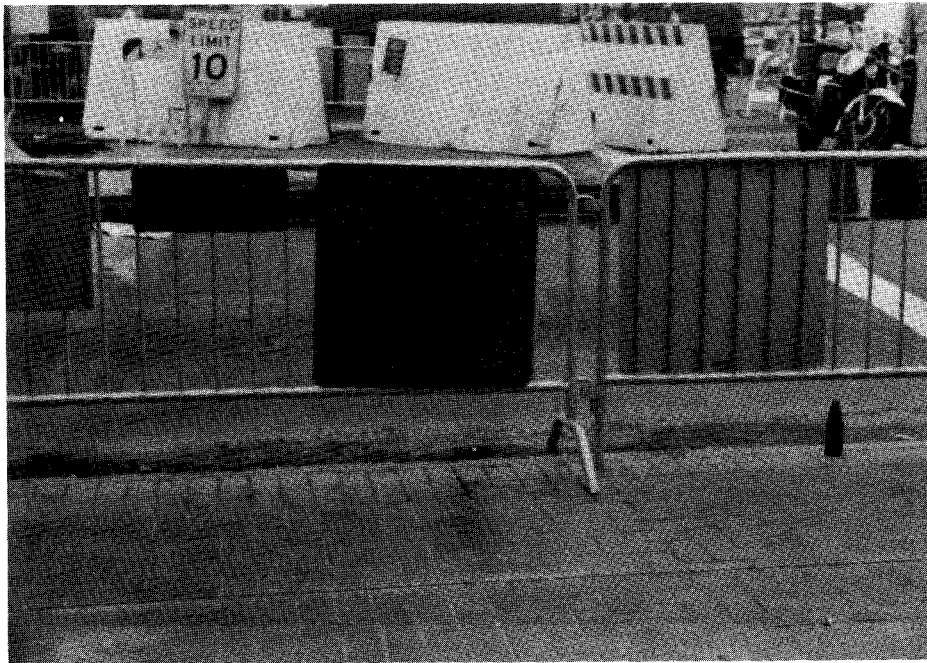

Figure 15. Signs for guidance and transit information



Figure 16. Low mounting height of sidewalk closure signs



Figure 17. Spray-painted and hidden pedestrian signs



Figure 18. Detour sign and sign with permit number provision

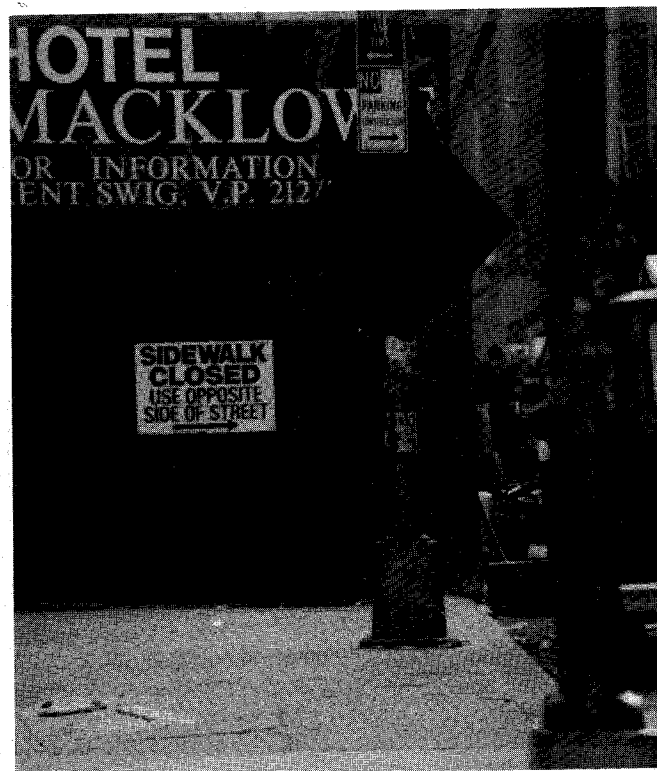

Figure 19. Signs with different background on the same site



Figure 20. Sign with lengthy message and sign with contractor's name

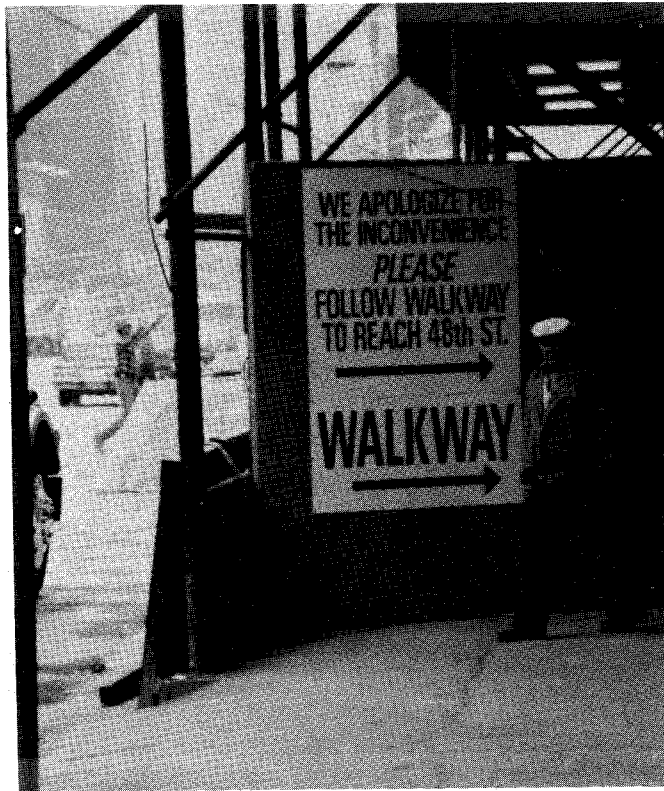

Figure 21. Sign at detour entrance and closure sign without directional information

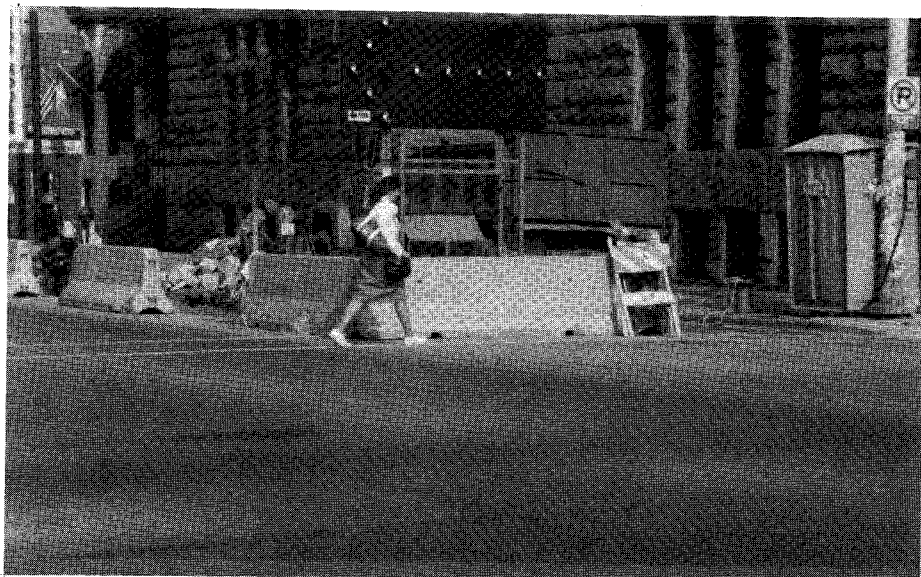
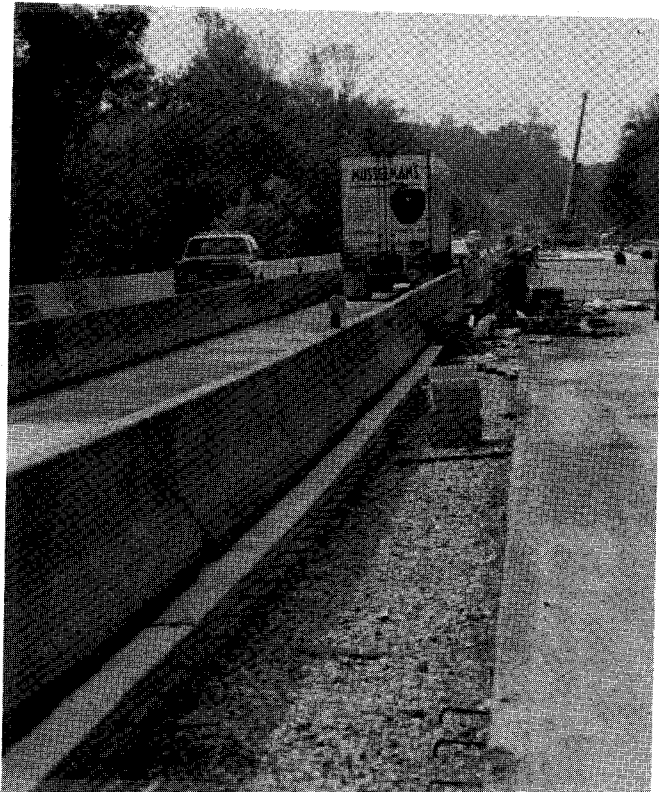

Figure 22. Protecting workers with concrete barriers



Figure 23. Protecting pedestrians with concrete barriers



Figure 24. Building demolition without pedestrian protection



Figure 25. Barrier used to protect pedestrians
(Note: Stripes on the barricades are incorrectly oriented in relationship to vehicular traffic).

pedestrians from work activity with portable concrete barriers. Both work sites in Figures 24 and 25 were in the same city, within walking distance from each other.

As indicated earlier, building codes are often the primary basis for the wide use of fences and canopied structures in urban building projects. The building construction industry generally follows the provisions of local codes. Traffic engineers are becoming increasingly aware that problems in the design of these devices can affect the capacity of walkways and limit sight distances at intersections. The City of Seattle, Washington, for example, requires fence corners at intersections to be made of chain-link material in order to facilitate good visibility. Richmond, Virginia has not yet documented its practice, but its officials no longer allow opaque construction fences or walls at intersections and driveways. Philadelphia, Pennsylvania requires the use of protective canopies in building construction as well as in maintenance activities above public thoroughfare; for example, window washing. Figure 26 presents typical mobile and stationary canopies used in Philadelphia. A typical wooden canopied walkway used to protect pedestrians during overhead bridge rehabilitation is shown in Figure 27. Although the wooden handrails are quite pronounced, they were not specially prepared to prevent injury from wood splinters. Figures 28 and 29 illustrate fences to prevent pedestrians from wandering into work areas. The bottom photograph in Figure 29 illustrates the need for see-through material at the corners of walls and fences at intersection and driveways to prevent collisions between pedestrians and between pedestrians and vehicles as they approach the intersection.

C. Delineation Devices. Methods for delineating pedestrian pathways include traditional devices such as cones, barricades, concrete barriers, orange construction tapes, and flashing warning lights for nighttime. Extensive use of pedestrian channelizing rails was observed in San Francisco and New York. Officials of both cities expressed satisfaction with the flexibility and performance of pedestrian channelizing rails such as those presented in Figure 30. These rails are used for pedestrian control in work areas, as well as for crowd and vehicular traffic control during emergencies and social events. Their design allows interconnection into a chain of any desired length, and they are sturdy enough to discourage movement by pedestrians and vandalism by motorists. The design used by San Francisco is presented in Figure 30. New York City uses the pedestrian rail presented in Figure 31. San Francisco does not paint its rails but chooses to accent them with traffic cones as needed. New York City paints its rails bright yellow.

Recently, construction safety fences made of orange plastic have been appearing on roadway work in urban areas. They are available in 4-foot x 160-foot and 5-foot x 160-foot rolls and

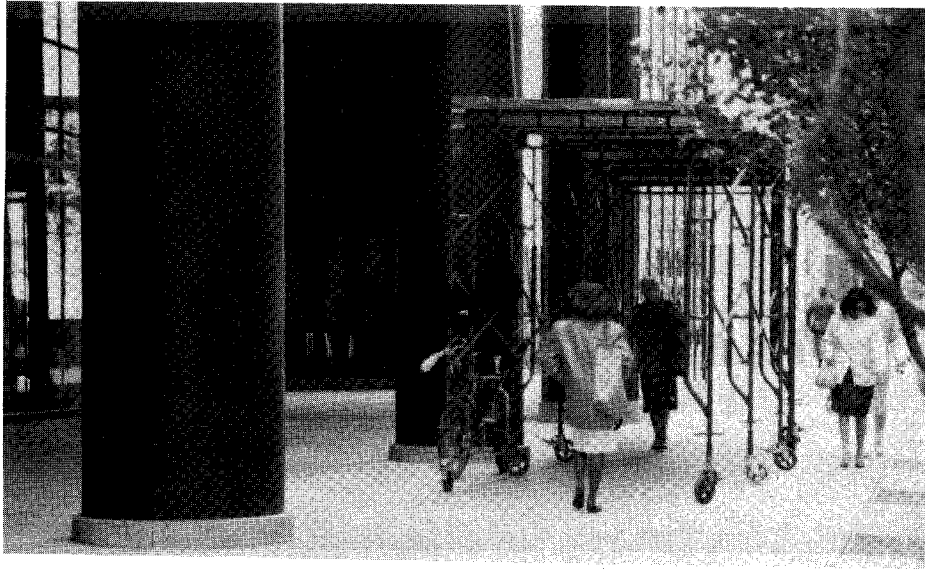

Figure 26. Mobile and stationary canopies for overhead protection

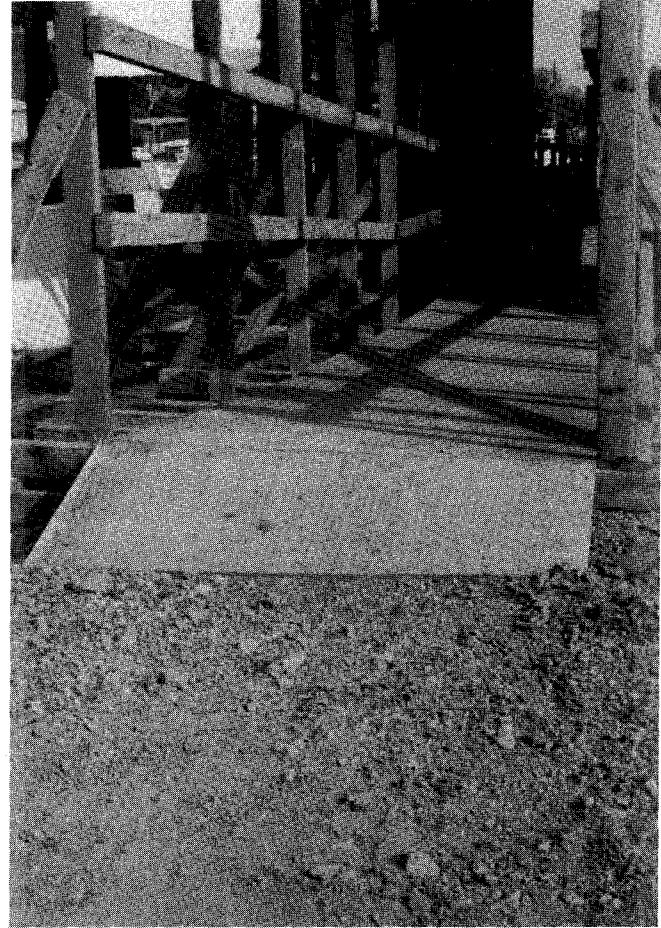
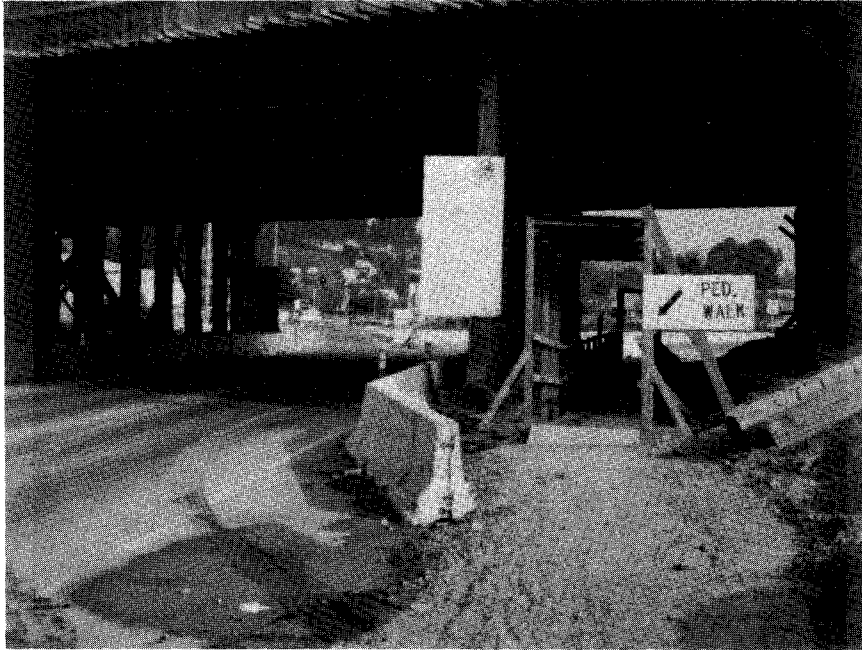

Figure 27. Wooden canopy used in underpass

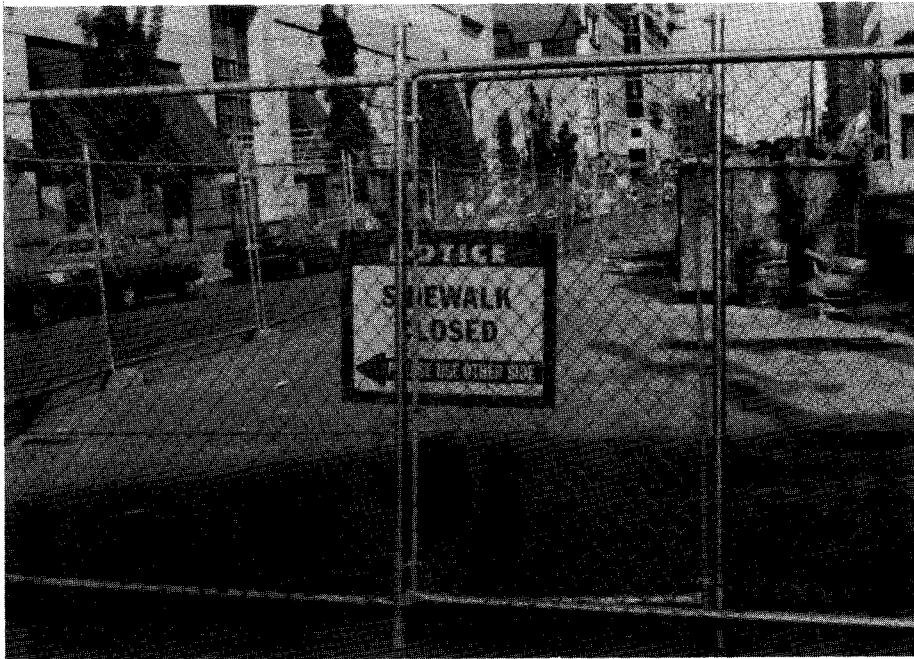
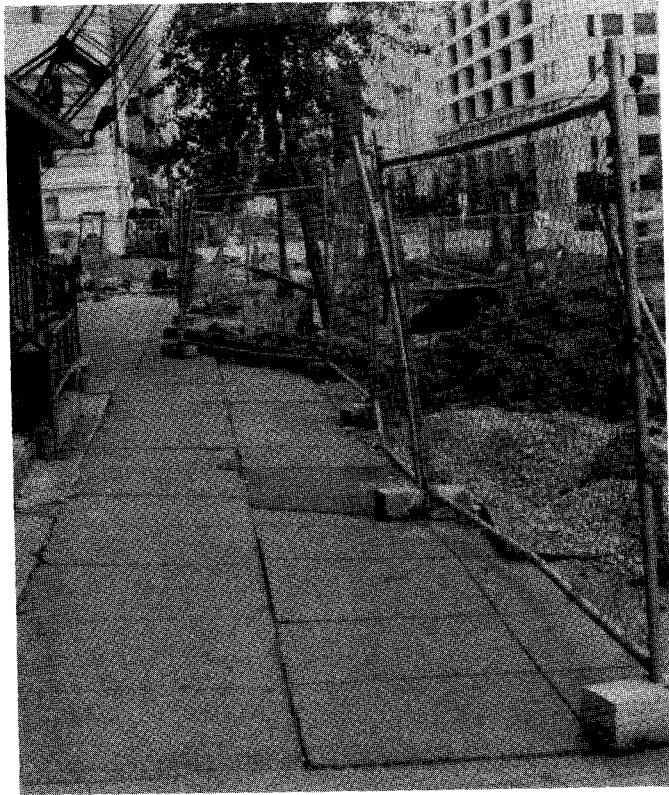

Figure 28. Chain link fences in work zones

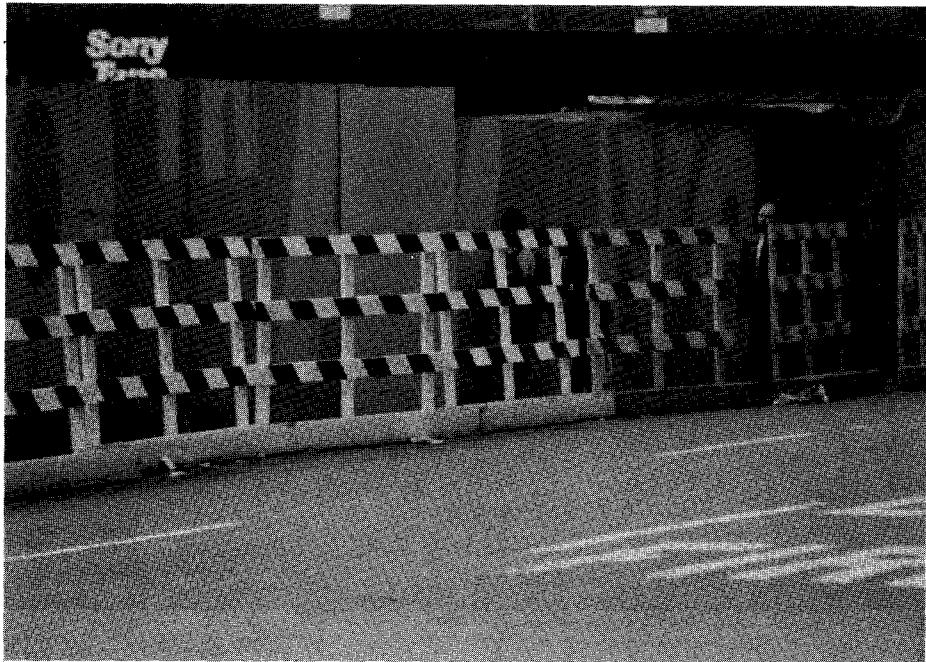
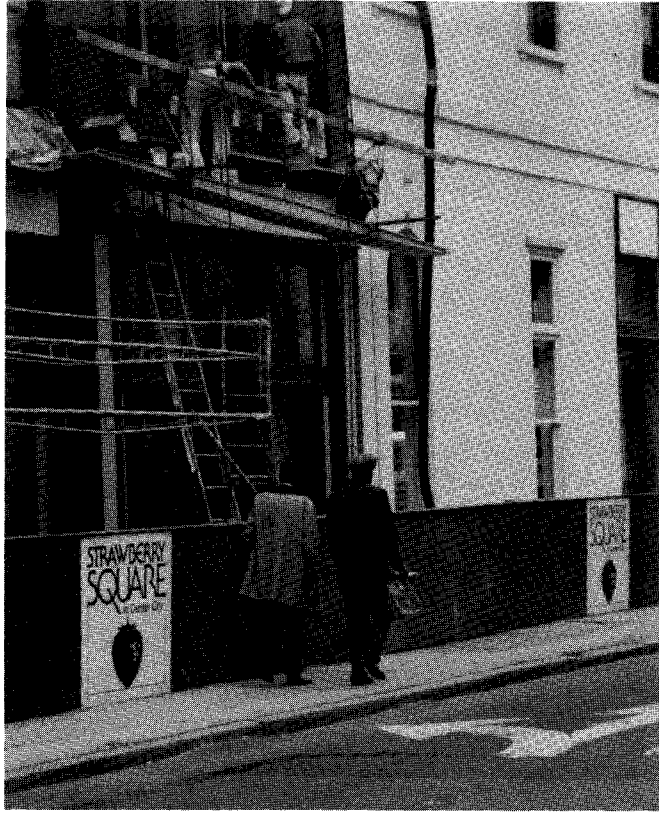

Figure 29. Wooden fences in work zones



Figure 30. Pedestrian channelizing rails used in San Francisco

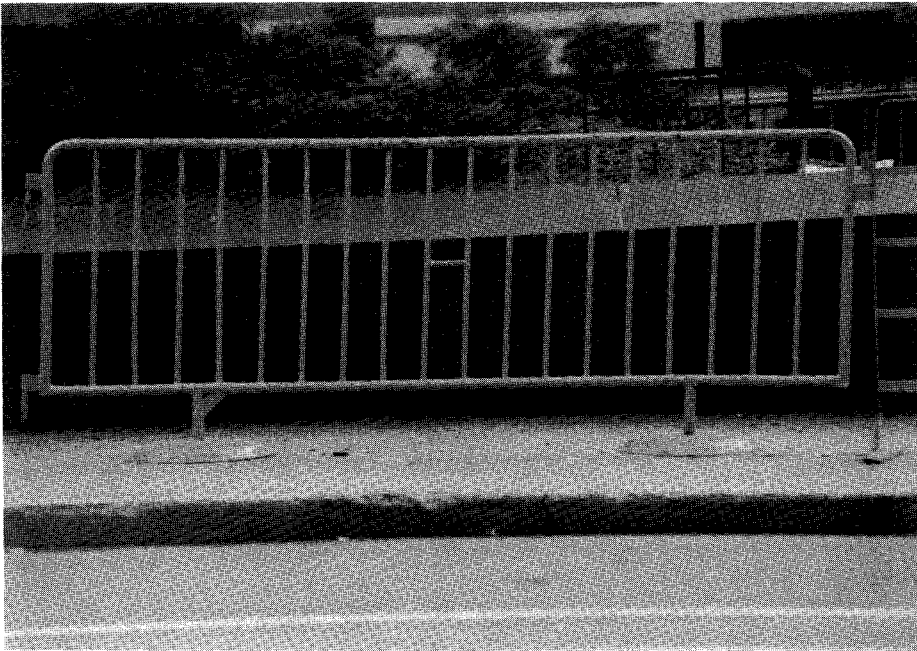

Figure 31. Pedestrian channelizing rails used in New York City

require a number of posts for installation. Typical installations are indicated in Figure 32 where a fairly sturdy fence was created with the material. However, in many field installations, as indicated in Figure 33, drums, barricades, and cones are draped by the orange plastic mesh. It is not known whether the mesh, used as drapery over standard devices, is contributing to further negligence in delineating pedestrian pathways. But with its bright orange color, the mesh is easily visible and has the advantage of closing gaps normally associated with standard barricades.

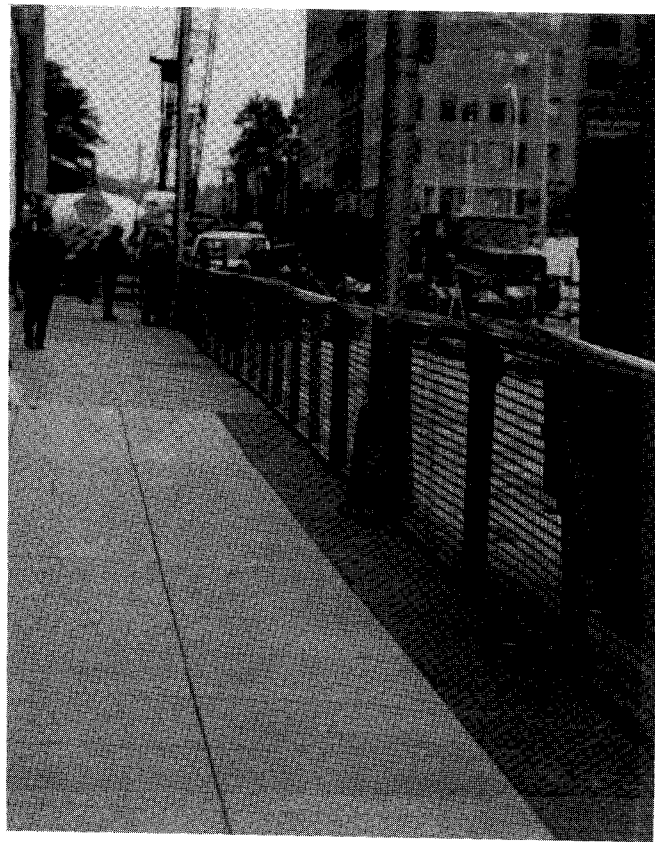
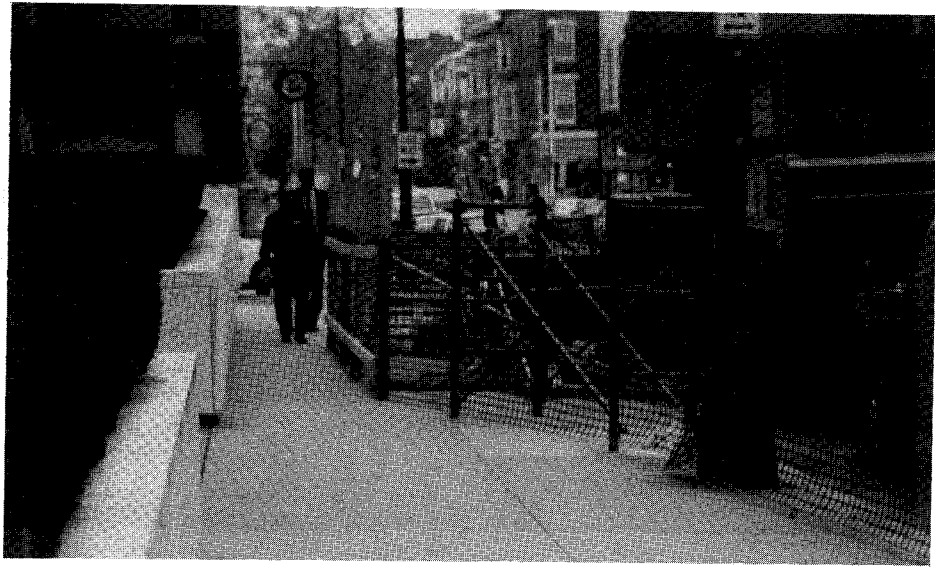

Figure 32. Use of orange plastic mesh for delineating pedestrian pathway

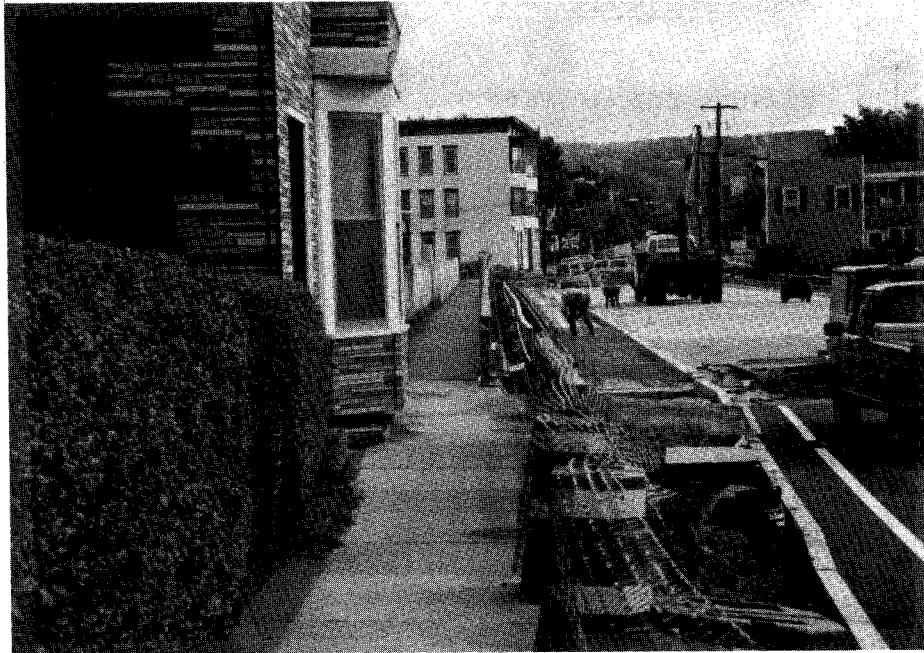
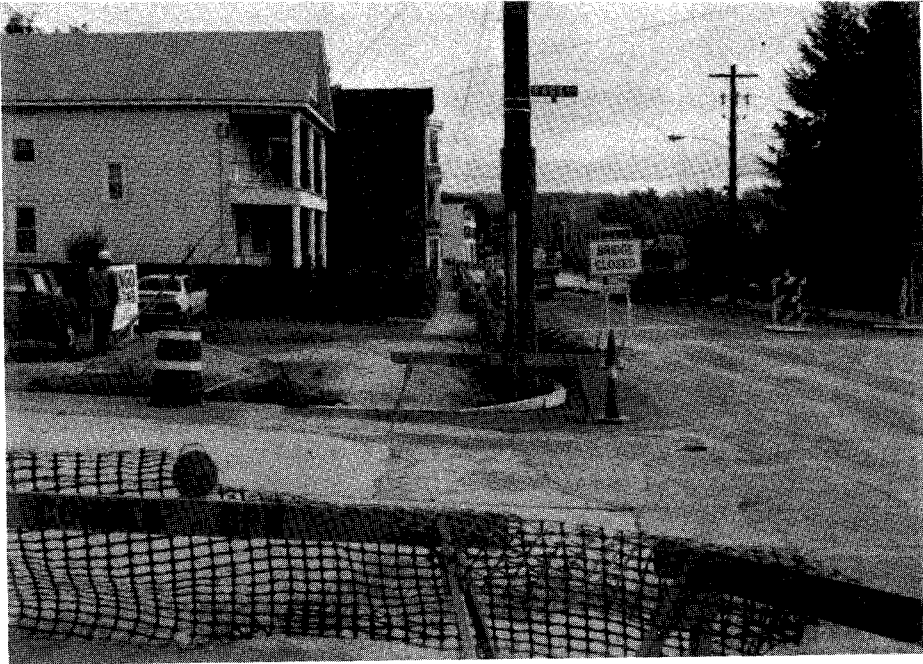

Figure 33. Drums and barricades draped with orange plastic mesh

IV. ASSESSMENT

The assessment summarized below and the conclusions and recommendations discussed later are based on a review of work zone traffic control manuals of a selection of cities and states, a literature review and field observation in a sample of cities.

1. The safe accommodation of pedestrians and cyclists in work zones is often neglected by state and local governments. This neglect is more severe at the local government levels -- counties, cities, and townships -- than at the state level. However, the majority of work zones which affect pedestrians are located in urban areas where local safety standards are more prevalent.
2. Although the Traffic Control Devices Handbook (TCDH) presents some principles for accommodating pedestrians in work zones, many local traffic safety personnel are not aware of its existence. In addition, since the TCDH is not a national standard, there has been no movement to adopt its guidelines on pedestrian safety into local practices.
3. City officials have recognized the need for guidelines for accommodating pedestrians in work areas, but few localities have included written guidelines in their work zone traffic control manuals. Many cities, including high population centers, have no reference material on their pedestrian accommodation practices, and consequently, no standards for contractors to follow.
4. There is evidence that state highway officials routinely review projects planned for areas with pedestrian traffic to ensure the adequacy of safety measures. However, the project team observed a lack of concern about the quality and maintenance of pedestrian control devices on state highway projects. The unavailability of published state standards on the design and application of devices for controlling and protecting pedestrians in work areas may explain the non-uniformity in the design of signs used in some state-administered roadway construction projects in large cities.
5. The state MUTCD's are generally a reflection of the Federal MUTCD and have a similar deficiency in their methods for managing pedestrian traffic in work zones. State officials appear to be cautious about adopting formal guidelines on matters which have not

been detailed in the Federal MUTCD.

6. The actual practices of the state officials do not reflect the lack of information on pedestrian safety in their work zone manuals. The traffic control plan review process presents ample opportunity to determine whether pedestrian needs will be adequately accommodated.
7. There is very little uniformity in the design and application of pedestrian control devices. The impact of using different colors for the same signed message on different backgrounds is not an apparent concern among state and local officials.
8. Inadequate attention is given to the geometry and surface quality of temporary pathways. The needs of pedestrians with ambulatory handicaps are often neglected.

V. CONCLUSIONS

1. The traffic engineering community, contractors, and utility companies involved in building construction and/or road work need safety standards for accommodating pedestrians and protecting workers in work zones.
2. Improvement of Part VI of the MUTCD, to include information on pedestrian accommodation and worker protection in work zones, has the greatest potential for promoting sound practices at state and local government levels.
3. There is adequate information on effective practices for managing pedestrians in work zones that could be considered for the MUTCD. The TCDH is a good start.
4. The abuse of pedestrian rights in work zones can be blamed, in part, on the fact that many types of roadway and building maintenance work escape inspection by city officials or are reviewed and approved by inadequately trained inspectors.
5. Work zones involving building construction and maintenance are very common in urban areas. They frequently expose pedestrians to hazardous situations. Future improvement in Part VI of the MUTCD should cover pedestrian protection in such work zones.

VI. RECOMMENDATIONS

1. Part VI of the MUTCD should be updated to include material on the principles for accommodating pedestrians in work zones, a standard set of traffic control devices and any caution regarding their use, a set of standard signs and guidelines for customized signs, delineation, illumination, and typical illustrations covering: (a) mid-block sidewalk closure with detour and bypass through pathways along the curb parking lane or through adjacent property, (b) corner closure of sidewalk, (c) crosswalk closure, (d) fencing near intersections, and (e) canopies for protecting pedestrians from the danger associated with overhead work.
2. Current practice leans toward the use of black and white signs for pedestrian information. There is a need to determine whether this practice should be officially encouraged, since these colors have a regulatory significance. There is no evidence that regulations were considered in their selection.
3. Figure 6-24 of the TCDH presents a typical application for controlling pedestrians in work zones. This figure details only a mid-block closure, provides no guidelines on the size and color of signs, and may be inappropriate for the MUTCD without improvements. Figures 7, 8, 9 and 10 should be considered in selecting illustrations for the pedestrian information of Part VI.
4. Sections 6B-5 through 6B-39 of the MUTCD deal with regulatory and warning signs for work zones. Standard designs for a selection of pedestrian signs could be included in these sections. This type of information would aid in standardizing the color codes for pedestrian signs. In practice, the majority of the pedestrian signs used in work zones are for warning. In upgrading Sections 6B-5 through 6B-39, there is need to determine whether there are standard regulatory signs that could be included. The text in these sections should be edited, where necessary, to reflect the added pedestrian information.
5. Section C of the MUTCD covers barricades and channelization devices from a motorist perspective. That text should be modified to include pedestrians. Devices which are also applicable to pedestrian safety should be identified in the appropriate subsections. For example, barricades, drums, cones and barriers should be identified as being suitable

for channelizing pedestrian traffic. This section may also be the place to introduce and discuss other pedestrian channelization devices such as fences and pedestrian rails.

6. There is need to determine whether Section 6A-5, which discusses fundamental principles, should be expanded to include principles which relate to pedestrian safety, or whether a separate section should be created for addressing pedestrian safety principles. It should be noted that some of the principles articulated in Section 6A-5 also apply to pedestrians and should not be duplicated. However, since there is a need to sensitize the traffic safety community to pedestrian needs, a separate section following Section 6A-6 should be considered. Its caption must include the word "pedestrian," and its contents should be oriented toward a number of briefly-stated principles that apply only to pedestrians and are excluded from Section 6A-5. The text should cross-reference appropriate illustrations and other relevant material in the entire manual.
7. Workers are as vulnerable as pedestrians to work zone dangers. Practitioners who are far removed from the work site need to be made aware that workers are exposed to two dangers: that of the work activity and that of errant vehicles. Although much of the protection devices for pedestrians may apply to workers, a special section following the treatment of pedestrian protection principles in the MUTCD should address principles which apply to workers. Reference should be made to sections of the MUTCD which deal with flagger protection and the names and application of special worker protection devices. Typical situations which may warrant special worker protection measures should be noted. Concrete barriers, their connectors and anchorage should receive special mention. There should be a brief discussion on worker dress, measures to insure good visibility, and the need for organizations involved in highway work to maintain a continuing effort to promote work zone safety practices.
8. Section E of the MUTCD deals with lighting devices. The use of illumination and warning lights for pedestrian safety should be recognized. The illumination needs of detoured and/or canopied temporary walkways should be discussed.
9. Although retro-reflectivity is not often a characteristic of pedestrian signs, the use of fluorescent material should be encouraged to improve visibility under all lighting conditions.

LIST OF REFERENCES

1. Chadda, Himmat S. and McGee, Hugh W., "Pedestrian Consideration in Highway Work Zones," ITE Journal Vol. 54 No. 9, Institute of Transportation Engineers, Washington, D.C., September, 1984.
2. Chadda, Himmat S. and McGee, Hugh W., "Pedestrian Safety Through Work Zones: Guidelines," ASCE Journal of Transportation Engineering Vol. 109 No. 6, American Society of Civil Engineers, New York, November, 1984.
3. Chadda, Himmat S. and Brisbin G. H., "The Obstacle Course: Pedestrians in Highway Work Zones," Transportation Research Record No. 904, Transportation Research Board, Washington, D.C., 1983.
4. Chadda, Himmat S., McGee, Hugh W. and Ligon, Claude M., "Pedestrian Accommodation in Highway Work Zones," Traffic Quarterly Vol. 36, No. 3, Eno Foundation for Transportation, Connecticut, July, 1982.
5. Chadda, Himmat S., Ligon Claude M. and McGee Hugh W., Improved Pedestrian Control in Highway Work Zones, Report No. FHWA/RD/009, Federal Highway Administration, Washington, D.C., November, 1981.
6. U. S. Department of Transportation, Manual on Uniform Traffic Control Devices for Streets and Highways, Federal Highway Administration, Washington, D.C., 1984.
7. U. S. Department of Transportation, Traffic Control Device Handbook, Federal Highway Administration, Washington, D.C., 1983.
8. Illinois Department of Transportation, Reprint-Part VI of the Illinois MUTCD, Bureau of Traffic, Springfield, Illinois, 1987.
9. City of Greensboro, Work Area Traffic Control Handbook, Traffic and Transportation Division, Greensboro, North Carolina, 1977.
10. Building News Inc., Work Area Traffic Control Handbook, Los Angeles, California, 1985.
11. City of Seattle, Traffic Control Manual for In-Street Work, Transportation Division, Washington, 1987.
12. City of Minneapolis, Minneapolis Work Area Traffic Control, Department of Public Works, Minnesota, 1983.

13. City and County of San Francisco, Street Excavation Regulations and Requirements, Bureau of Engineering, Department of Public Works, 1987.
14. Brackett, R. Q., Protection of Personnel in Maintenance and Construction Zones, Texas Transportation Institute, College Station, Texas, 1984.
15. Gordon, D. A., Design of Work Zone Flagger's Vest, Report No. FHWA-RD-83-003, Federal Highway Administration, Washington, D.C., June, 1983.
16. Franklin, Jerome D. et al., Traffic Controls In Construction and Maintenance Work Zones, Report No. FHWA-TS-77-204, Federal Highway Administration, Washington, D.C., 1977.