

Evaluation of a Prototype Advanced Taxiway Guidance System (ATGS)

Eric S. Katz

February 2000

DOT/FAA/AR-TN00/9

This document is available to the public through the National Technical Information Service (NTIS), Springfield, Virginia 22161.



U.S. Department of Transportation
Federal Aviation Administration

NOTICE

This document is disseminated under the sponsorship of the U.S. Department of Transportation in the interest of information exchange. The United States Government assumes no liability for the contents or use thereof. The United States Government does not endorse products or manufacturers. Trade or manufacturer's names appear herein solely because they are considered essential to the objective of this report. This document does not constitute FAA certification policy. Consult your local FAA aircraft certification office as to its use.

This report is available at the Federal Aviation Administration William J. Hughes Technical Center's Full-Text Technical Reports page: www.actlibrary.act.faa.gov in Adobe Acrobat portable document format (PDF).

1. Report No. DOT/FAA/AR-TN00/9		2. Government Accession No.		3. Recipient's Catalog No.	
4. Title and Subtitle EVALUATION OF A PROTOTYPE ADVANCED TAXIWAY GUIDANCE SYSTEM (ATGS)				5. Report Date February 2000	
				6. Performing Organization Code	
7. Author(s) Eric S. Katz				8. Performing Organization Report No.	
9. Performing Organization Name and Address Federal Aviation Administration William J. Hughes Technical Center Atlantic City International Airport, NJ 08405				10. Work Unit No. (TRAIS)	
				11. Contract or Grant No.	
12. Sponsoring Agency Name and Address U.S. Department of Transportation Federal Aviation Administration Office of Aviation Research Washington, DC 20591				13. Type of Report and Period Covered Technical Note	
				14. Sponsoring Agency Code AAS-200	
15. Supplementary Notes					
16. Abstract <p>The Federal Aviation Administration (FAA) Office of Aviation Research, Airport Technology Research and Development Branch, AAR-410 has designed, installed, and evaluated a prototype Advanced Taxiway Guidance System (ATGS) at the Atlantic City International Airport (ACY). The principal feature of this prototype is automatically controllable taxiway lighting, which is used to provide improved surface route guidance to taxiing aircraft. The system automatically illuminates a specific taxiway route for each arrival and departure thus reducing the chances of an aircraft making a wrong turn. The system is also designed to detect and provide Air Traffic Control (ATC) alarms for potential runway incursions, pilot route deviations, and route conflicts between aircraft.</p> <p>The prototype ATGS incorporates subsystems that are used to locate/identify aircraft and to automatically control and monitor all of the taxiway lighting located within the test bed. A key objective in the evaluation of the ATGS was to determine whether these subsystems could be successfully integrated. Another objective was to determine the effectiveness of the system in improving safety in terms of reducing incorrect taxiing turns and runway incursions.</p> <p>After evaluating the prototype ATGS during numerous test sessions, it was determined that these various subsystems could be integrated into a single automated visual guidance system. Data collected from the evaluation indicate that implementation of an ATGS would help improve airport safety by reducing incorrect taxiing turns and runway incursions, particularly in night and/or low-visibility operations.</p>					
17. Key Words Advanced Taxiway Guidance System, Automatically controllable taxiway lighting, Pilot route deviations, Runway incursions			18. Distribution Statement This document is available to the public through the National Technical Information Service (NTIS), Springfield, Virginia 22161.		
19. Security Classif. (of this report) Unclassified		20. Security Classif. (of this page) Unclassified		21. No. of Pages 19	22. Price N/A

TABLE OF CONTENTS

	Page
EXECUTIVE SUMMARY	v
INTRODUCTION	1
Background	1
Objective	1
SYSTEM COMPONENTS	1
SYSTEM EVALUATION	4
SUMMARY AND ANALYSIS OF PILOT QUESTIONNAIRE RESPONSES	11
CONCLUSIONS	12
APPENDIX A—SUMMARY OF PILOT COMMENTS	

LIST OF FIGURES

Figure		Page
1	Advanced Taxiway Guidance System Block Diagram	2
2	Taxiway Test Bed Components	3
3	Aircraft Arrival Scenario	5
4	Potential Conflict Scenario	7
5	Potential Conflict Scenario Resolution	8
6	Wrong Turn Scenario	9
7	Potential Runway Incursion Detection	10
8	Subject Pilot Briefing/Questionnaire	11

EXECUTIVE SUMMARY

The Federal Aviation Administration (FAA) Office of Aviation Research, Airport Technology Research and Development Branch, AAR-410 has developed an Advanced Taxiway Guidance System (ATGS). A prototype was designed, installed, and evaluated at the Atlantic City International Airport (ACY). The principal feature of this prototype is automatically controllable taxiway lighting that is used to provide improved surface visual guidance to pilots operating within the system. In addition to receiving taxiing instructions from air traffic control, the automatic lighting feature provides the pilot with a visual confirmation of the assigned route by illuminating only that particular path. The basic theory is that the task of taxiing an aircraft on complicated taxiway configurations during nighttime and/or low-visibility conditions can be made safer and easier. By illuminating only the taxiway segments that are needed to comply with the air traffic clearance, the possibility of pilot route deviations and inadvertent runway incursions will be reduced.

The prototype ATGS incorporates relatively inexpensive nonradar-based sensors to provide aircraft identification and location on the taxiways. This was done to demonstrate that automatically controlled lighting can work at many airports that do not have ground radar systems such as airport surface detection equipment (ASDE) and airport movement area safety systems (AMASS). Additional research on a technologically upgraded ATGS could include the feasibility of integrating automatically controllable taxiway lighting with existing ASDE and AMASS systems. This research would help to determine if automatically controllable lighting could successfully be added at airports that already have these systems.

The prototype system was also evaluated to determine its effectiveness in improving airport safety. Data collected from subject pilots indicate that implementation of an ATGS would help to improve airport safety by reducing the chances of incorrect taxiing turns and runway incursions, particularly in night and/or low-visibility operations.

INTRODUCTION

BACKGROUND.

This project was undertaken in response to a request from the Federal Aviation Administration (FAA) Office of Airport Safety and Standards, Engineering and Specifications Division, AAS-200. The request specifically asks for the development and evaluation of a prototype Advanced Taxiway Guidance System (ATGS) that is designed to provide improved airport surface guidance to pilots through automatically controlled taxiway lighting.

Advanced Surface Movement Guidance and Control Systems (A-SMGCS) are presently being researched and implemented at various airports throughout the world to provide improved surveillance, routing, guidance, and control of aircraft and vehicles. The purpose of this AAR-410 research project is to investigate the feasibility of automatically controlled taxiway lighting systems to meet certain A-SMGCS operational requirements.

OBJECTIVE.

This evaluation was directed specifically towards determining:

1. If the various subsystems contained within the ATGS could be integrated into a single automated taxiway visual guidance system.
2. If implementation of an ATGS would improve airport/aircraft safety by reducing incorrect taxiing turns and runway incursions, particularly in night and/or low-visibility operations.

SYSTEM COMPONENTS

The various components of the prototype ATGS were installed in three distinct locations at ACY, as shown in figure 1. The host computer was installed in the FAA hangar's flight observation area, which is located adjacent to the ATGS test bed. The host computer is the master controller of the entire system. It includes a processor that receives aircraft location, identification, and direction of travel information from sensors located within the taxiway test bed. Based on the input from the sensors, the host computer determines which groups of taxiway lights need to be illuminated to provide the necessary visual guidance to the aircraft's destination. The host computer also detects potential taxiway routing conflicts between aircraft, incorrect aircraft turns, and any abnormal system operation.

The host computer's color monitor serves as a mimic panel for the ATGS. The mimic panel displays an illustration of the taxiway segments that are part of the test bed. When an aircraft enters the test bed, the mimic panel will show the aircraft's identification and location at the point of entry and will continue to track the aircraft as it taxis through the system. The taxiway lights, as portrayed on the mimic panel, will illuminate to show the route that the aircraft will follow. The mimic panel also shows other valuable information such as the number of aircraft in the system and the location of potential traffic conflicts between aircraft. In addition, the panel will provide warnings to the air traffic controllers if an aircraft deviates from the assigned

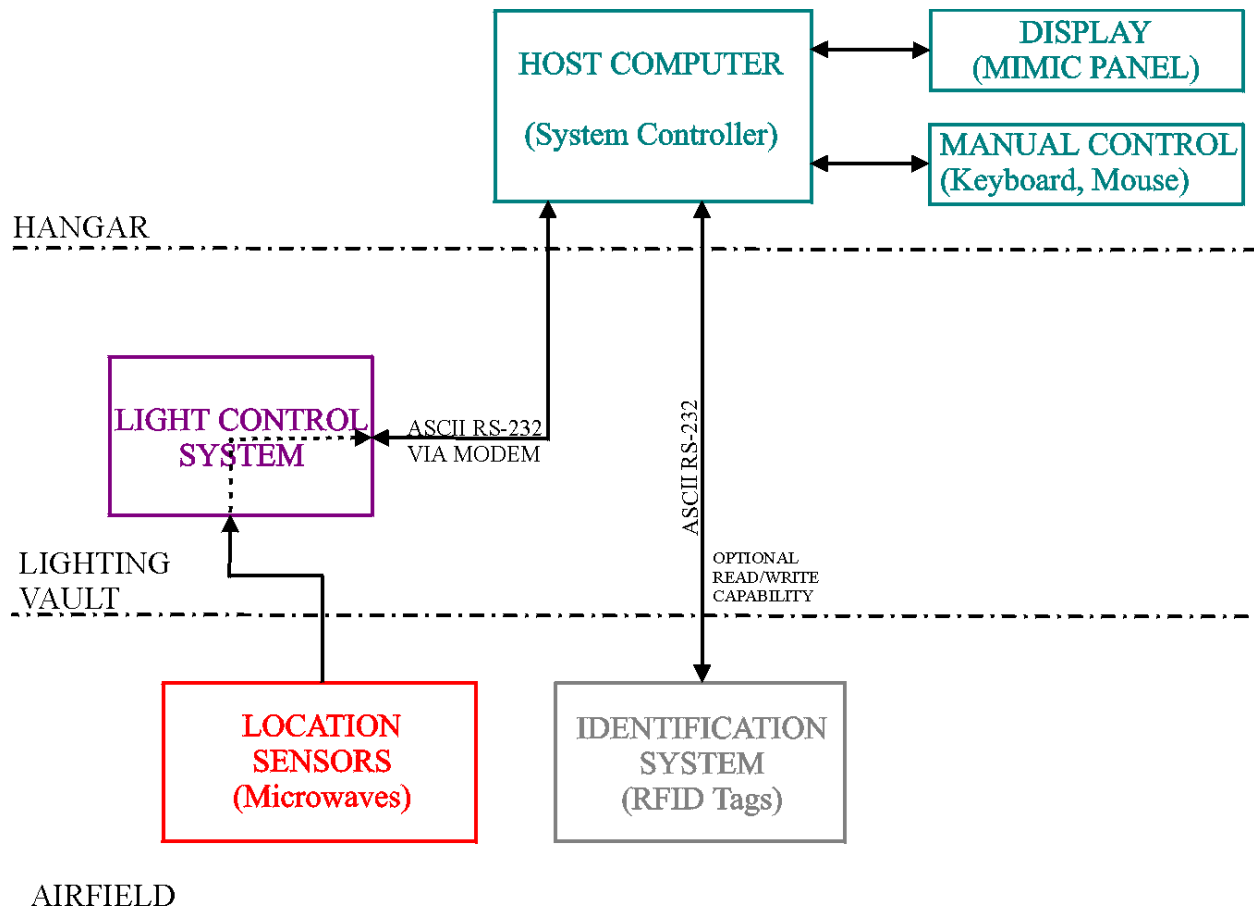

FIGURE 1. ADVANCED TAXIWAY GUIDANCE SYSTEM BLOCK DIAGRAM

taxiway route or if any taxiway lights, sensors, or computer systems malfunction. If one of the computers completely fails, all taxiway lighting within the test bed will automatically illuminate, allowing operations to continue on any taxiway as needed.

Another major subsystem of the ATGS is the lighting control computer equipment that is located in the airfield lighting vault. This computer acts on command from the host computer. After the host computer analyzes which groups of taxiway lights need to be illuminated for a particular aircraft, it then issues an electronic command to the lighting computer. The lighting computer is equipped with an interface to enable it to control the taxiway lights within the ATGS test bed. Based on the input from the host computer, the lighting computer equipment will send signals over the appropriate taxiway power cables to illuminate the correct light groups. The lighting computer equipment also monitors all of the lights and aircraft location sensors within the test bed and informs the host computer of any malfunctions with these components.

The other major components of the ATGS are all located within the taxiway test bed. There are twelve microwave barrier detectors located throughout the test bed. The location of the twelve detectors (numbered 1 through 12) is shown in figure 2. When an aircraft passes through a detector, a signal is sent to the lighting computer indicating that the aircraft has passed that

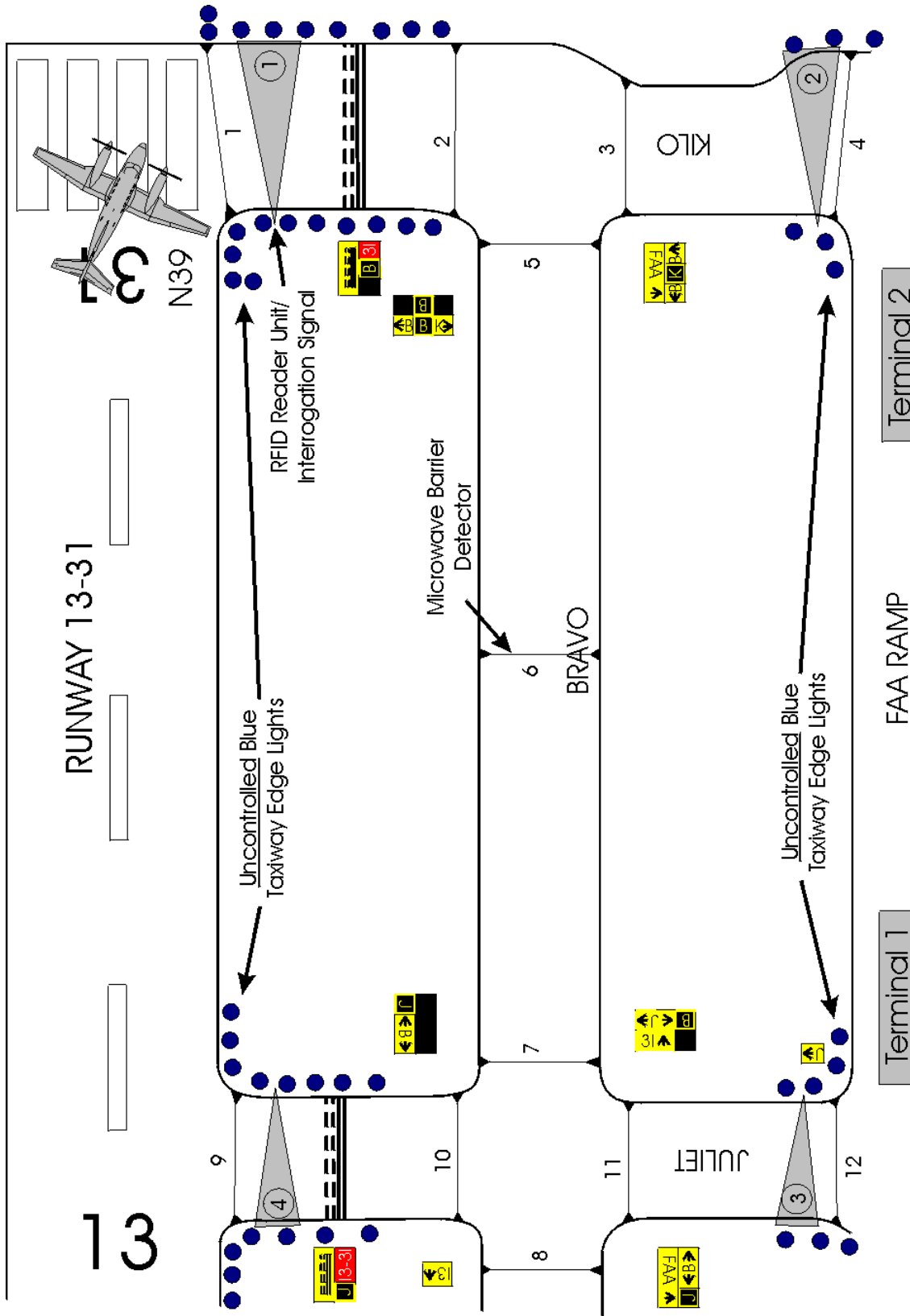

FIGURE 2. TAXIWAY TEST BED COMPONENTS

particular location. This information is then sent to the host computer and is shown as that aircraft's location on the mimic panel. As an aircraft taxis past each microwave detector along the intended route, the groups of taxiway lights behind the aircraft will be automatically turned off assuming that there are no other aircraft in trail that would need these lights for guidance. The microwave detectors are also used to immediately trigger an air traffic control alarm if an aircraft makes an incorrect turn or if there is a routing conflict between aircraft.

Another major subsystem of the ATGS is the radio frequency identification system (RFID). This subsystem is installed within the test bed area and is used to uniquely identify aircraft without the use of radar. The RFID system consists of four reader units, four antennas, and the identification tags that were installed on the FAA test aircraft. The location of the four reader units and antennas are shown in figure 2. Each test aircraft was equipped with one identification tag on each side. As the tagged aircraft approaches a reader antenna, it interrupts the stream of radio frequency signals that the antenna is broadcasting. When the tag is interrogated by the reader, it modifies a portion of the signal and reflects it back to the antenna. This reflected signal carries the identification code of the aircraft. The antenna transmits the reflected signal to the reader unit that interprets the identification information. This information along with the code number of that particular reader is then sent to the host computer and is shown as that aircraft's identification and location on the mimic panel. It is important to note that the RFID tags do not radiate signals unless they are interrogated by a reader.

SYSTEM EVALUATION

Figure 2 shows the configuration of the ATGS taxiway test bed at ACY. The test bed consists of taxiways Bravo (B), Juliet (J), and Kilo (K) and is located adjacent to the FAA ramp. The test bed is approximately two thousand feet long and is designed to simulate a basic airport configuration consisting of a runway, a parallel taxiway, and a ramp area. This proof-of-concept evaluation incorporated basic traffic flow scenarios and was designed for use in nighttime and/or low-visibility operations. During the test scenarios, all arrivals and departures were in the runway 13 direction.

In figure 2, FAA aircraft N39, a Convair-580, is about to exit runway 13 and receive an air traffic clearance to taxi to terminal 1 using taxiways B and J. Since the aircraft has not yet taxied past any microwave detector, it is not within the confines of the ATGS test bed. The only taxiway lights that are illuminated at this point are the uncontrolled blue taxiway edge lights. These lights remain on at all times so that visual guidance is provided during the time frame when an aircraft exits the runway or ramp area but has not passed by the first microwave detector. For the prototype installation, a decision was made to use the blue edge lights that are presently installed at ACY. In future installations, however, it would be preferable to use green taxiway centerline lights in lieu of the blue edge lights.

In figure 3, N39 is passing through microwave detector number 1 and into the RFID interrogation signal. From this sequence, the host computer interprets the direction of the aircraft's travel and realizes that the aircraft is an arrival and is exiting the runway. In addition, the identification and location information of the aircraft is sent to the host computer. The host computer then issues a command to the lighting computer in the vault to illuminate the appropriate groups of taxiway lights that will provide visual guidance to terminal 1. The route

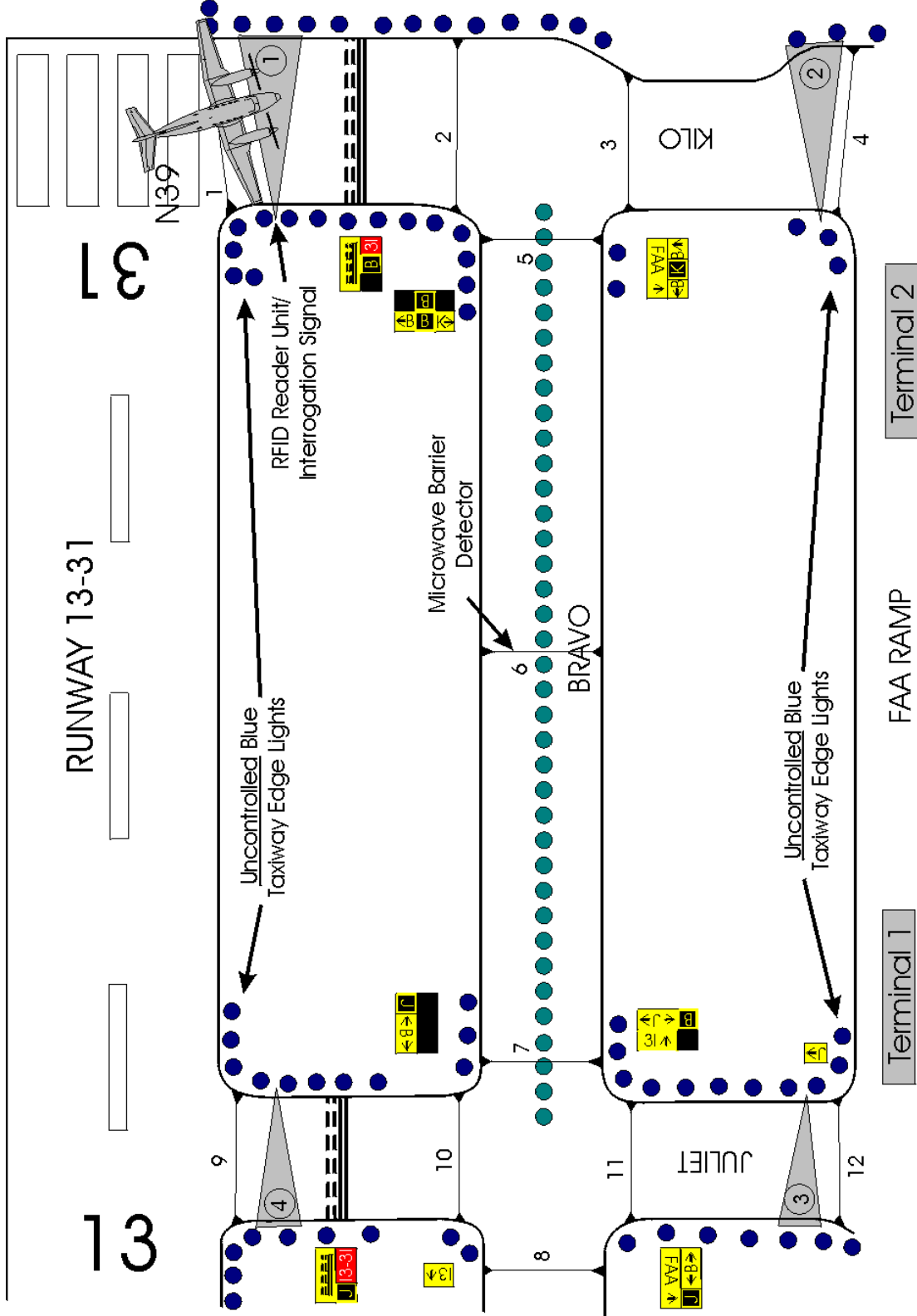

FIGURE 3. AIRCRAFT ARRIVAL SCENARIO

specified by air traffic control has now been automatically illuminated, providing a visual confirmation of the taxi clearance. The route will also be illuminated on the mimic panel. During the test sessions, the route began to automatically illuminate between 3 and 4 seconds after the aircraft tripped the initial microwave detector.

As shown in figure 4, FAA aircraft N35, a King Air-200, has received an air traffic clearance to taxi to runway 13 from terminal 1. N39, now located on taxiway B and approaching the intersection of taxiway J, has been told by air traffic control to hold short of taxiway J for N35. When N35 entered the ATGS test bed by passing the initial microwave detector (number 12) and RFID signal reader, the host computer detected a potential conflict between the N39 and N35 as they both approached the intersection of taxiways B and J. In response to this, the mimic panel displayed a message stating “potential conflict at taxiways B/J”. In addition, the host computer issued commands to the lighting computer. The lighting computer then illuminated the previously extinguished blue edge lights on taxiway J between taxiway B and runway 13 to provide the necessary guidance to N35. In addition, the green taxiway centerline lights located near microwave detector number 7 on taxiway B were extinguished. This provided an additional visual cue to the pilots of N39 that they are to hold short of taxiway J. It also extinguished lighting that was not needed by N35 as it taxied straight ahead toward the runway. Finally, it should be noted that as N39 passed through microwave 6 the automatically controllable green taxiway centerline lights were extinguished behind the aircraft because there were no other aircraft in trail.

As shown in figure 5, N35 has passed through microwave detector 10 resulting in the green centerline lights in front of N39 on taxiway B being automatically re-illuminated to provide the necessary visual guidance to guide N39 to terminal 1. In addition, the mimic panel message stating “potential conflict at taxiways B/J” disappears. In future installations, the exact location of microwave detector 10 would have to be determined so that the tail of the most critical aircraft is clear of the intersection.

As the two aircraft continue to taxi correctly toward their respective destinations on the airport surface, the taxiway lights behind them will automatically extinguish. When the aircraft have exited the ATGS test bed, the lights will again be in their original configuration as shown in figure 2.

Another important operational scenario that was tested is shown in figures 6-7. In figure 6, N35 has entered the test bed from terminal 2 and has started to taxi to runway 13 for departure. As N35 passes through microwave barrier detector number 4 and RFID number 2, the taxiway lighting on taxiways Kilo, Bravo, and Juliet automatically illuminate to provide the required visual guidance to runway 13. As shown in figure 7, N35 has deviated from the intended route and is proceeding towards runway 31. In our test scenarios, the FAA test pilots were instructed to taxi straight ahead toward runway 31 and ignore the green centerline light guidance that would correctly lead them on the intended path. The purpose of this was to test and demonstrate the ability of the microwave barrier to immediately detect the pilot route deviation. As soon as N35 taxied into microwave barrier detector number 2, a warning message stating “potential runway incursion N35-King Air” was displayed on the ATGS mimic panel to alert air traffic control of a potentially serious safety condition.

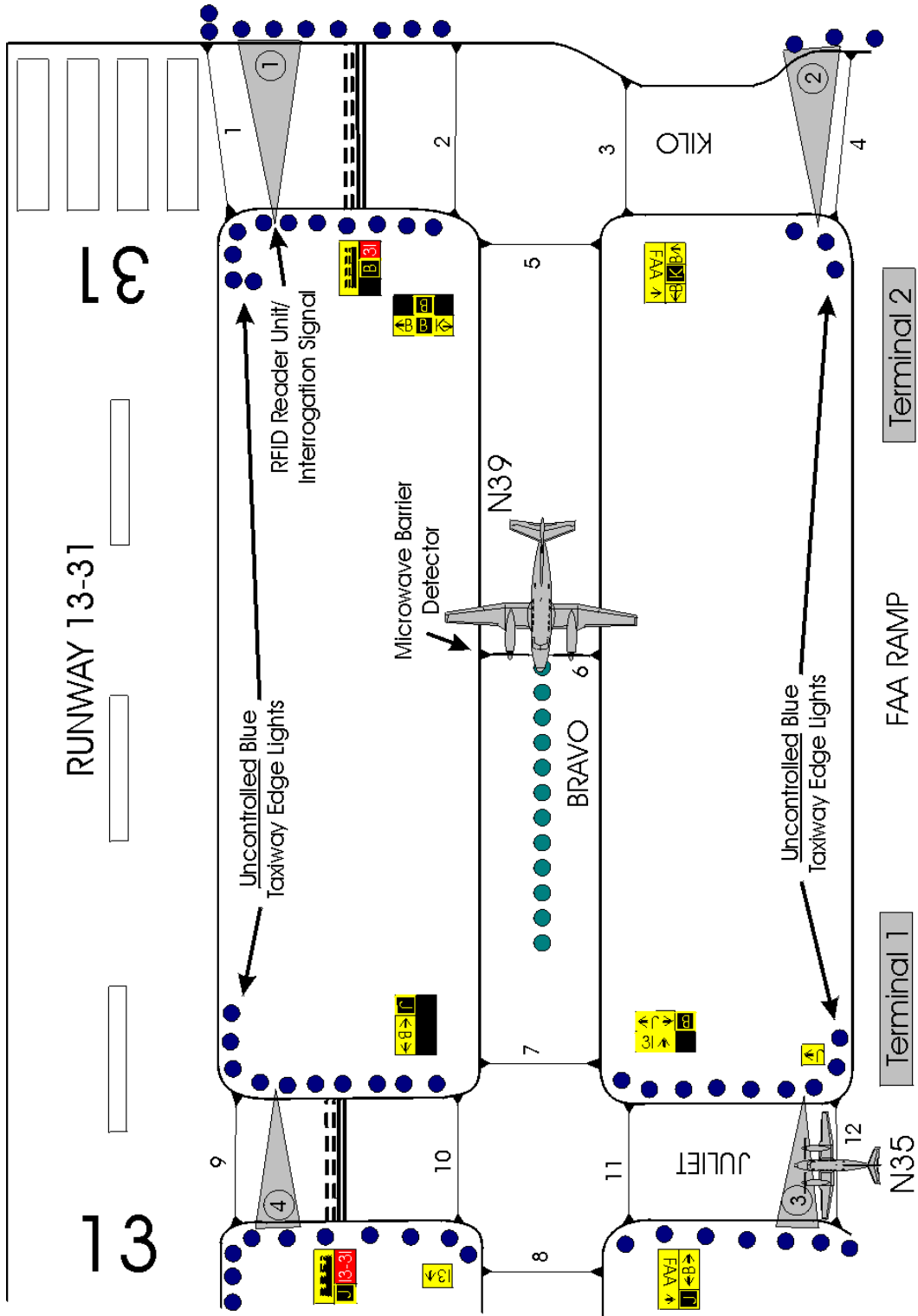

FIGURE 4. POTENTIAL CONFLICT SCENARIO

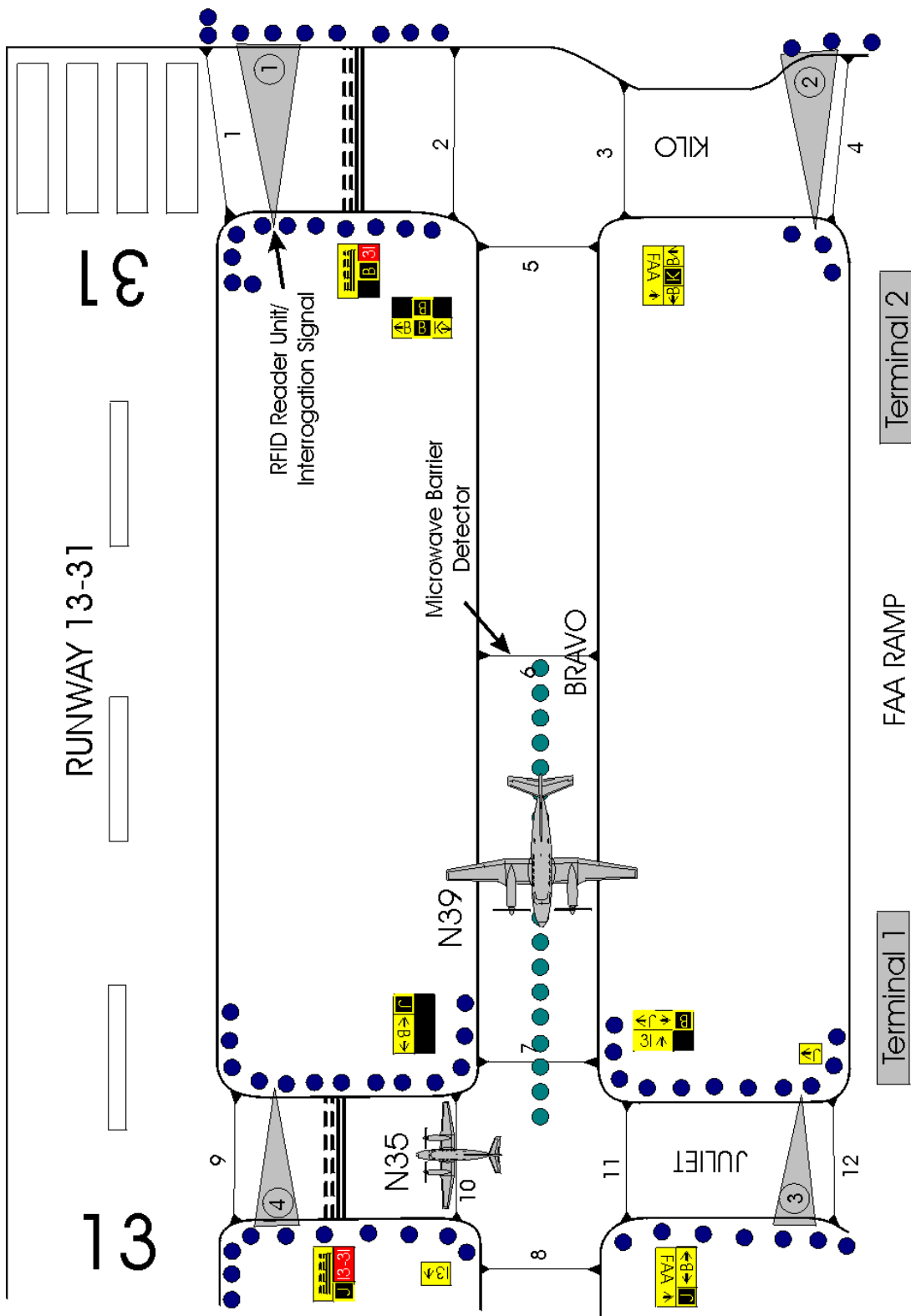

FIGURE 5. POTENTIAL CONFLICT SCENARIO RESOLUTION

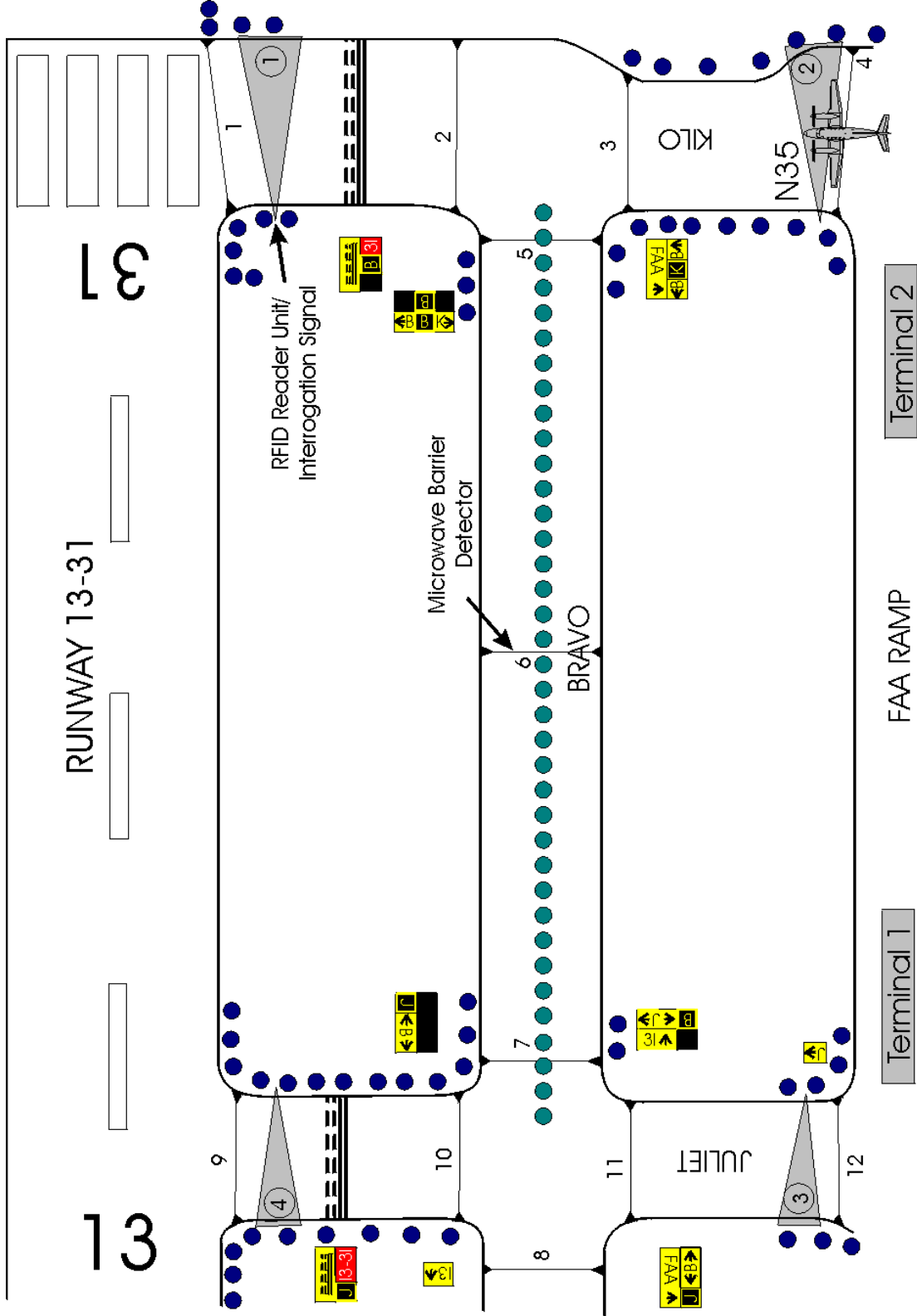

FIGURE 6. WRONG TURN SCENARIO

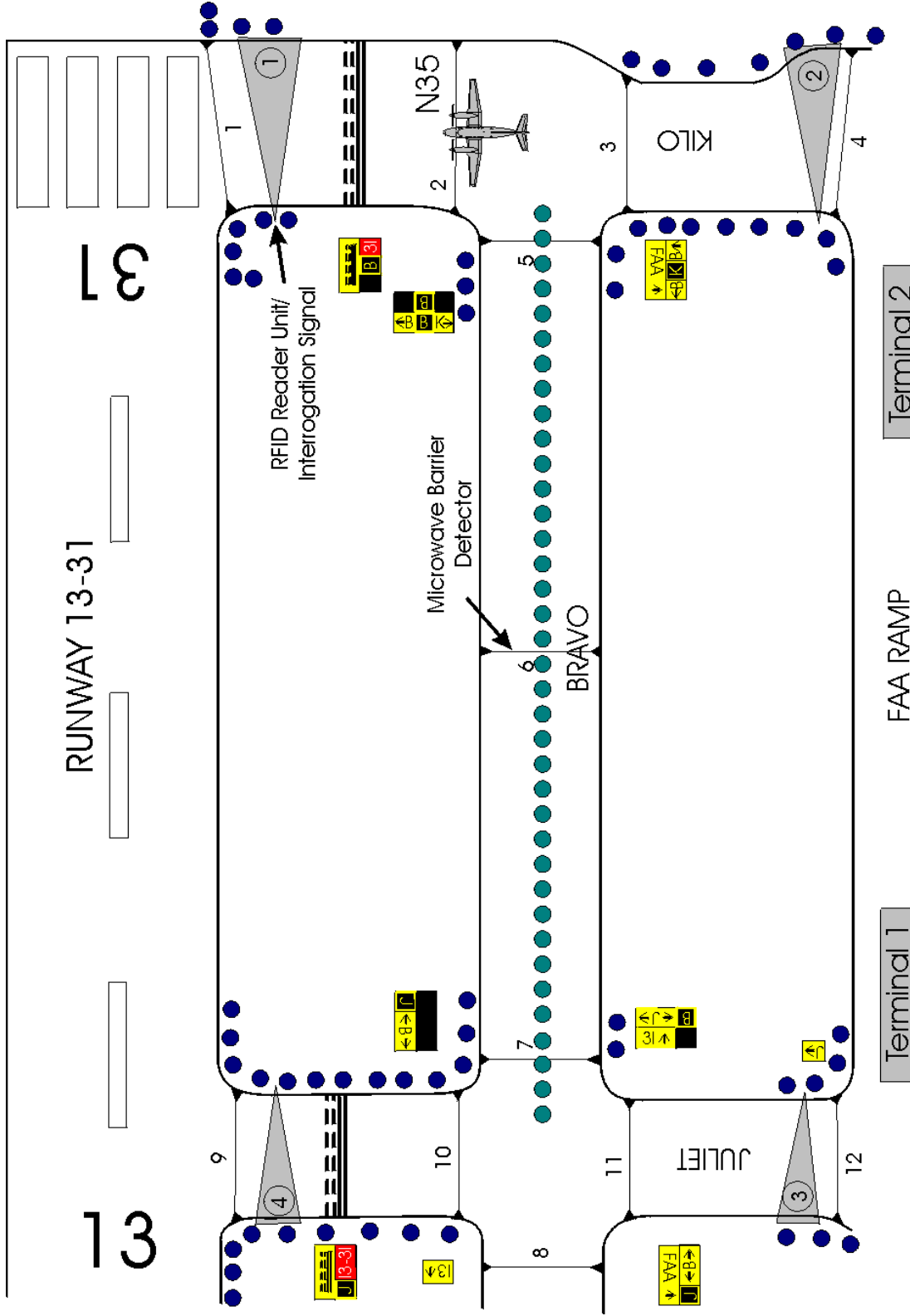

FIGURE 7. POTENTIAL RUNWAY INCURSION DETECTION

During the numerous evaluation sessions, it was not uncommon for untagged airport operations vehicles to enter or exit the ATGS test bed at arbitrary points. At the present time, the system has no automated way to handle these vehicles. If the vehicle enters the system at a nonpoint of entry, no lights illuminate until a microwave sensor is tripped. At that time, the ATGS determines that the system contains an unexpected vehicle and turns on all the taxiway lights within the test bed. The ATGS correctly tracks the vehicle from segment to segment, shows its position on the mimic panel, and removes the vehicle when it leaves the system at a point of entry. If the vehicle enters the system through one of the microwave sensors, but departs the taxiway at a nonpoint of entry, the ATGS is unable to automatically remove the vehicle from the system. Software was included, however, that allows for manual input of vehicle identification and desired route.

SUMMARY AND ANALYSIS OF PILOT QUESTIONNAIRE RESPONSES

A summary of subject pilot responses to specific questions is shown in figure 8. Pilot comments are summarized in appendix A.

<p style="text-align: center;"><u>PROTOTYPE ADVANCED TAXIWAY GUIDANCE SYSTEM (ATGS)</u> <u>SUBJECT PILOT BRIEFING/QUESTIONNAIRE</u></p> <p>NAME: <u>8 TOTAL</u> DATE: <u> </u> AIRCRAFT TYPE: <u>CONVAIR-580, KING AIR- 200</u> WX: <u>VFR NIGHT</u></p> <p>The principal feature of this prototype ATGS is automatically controllable taxiway lighting, which is used to provide surface route guidance to pilots operating within the system. The system will automatically illuminate a specific taxiway route for each arrival and departure thus reducing the chances of an aircraft making a wrong turn. The system is also designed to detect and provide ATC alarms for potential runway incursions, route deviations, and route conflicts between aircraft.</p> <p>1. In your opinion, would implementation of an ATGS help to improve airport/aircraft safety by reducing the chances of incorrect turns and/or runway incursions, particularly in night and/or low-visibility operations? Yes: <u>8 (100%)</u> No: <u>0 (0%)</u></p> <p>Comments: <u>See appendix A</u></p> <p>2. In the context of following a specific and unambiguous illuminated taxiway route, do you have a preference for the visual guidance that is provided by the automatically controllable elevated blue taxiway edge lights or the inset green taxiway centerline lights?</p> <p> Blue edge lights: <u>0 (0%)</u> Green centerline lights: <u>6 (75%)</u> No preference: <u>2(25%)</u></p> <p>Comments: <u>See appendix A</u></p> <p>3. Having participated as a subject pilot, do you have any suggestions as to how the system could be improved? Comments: <u>See appendix A</u></p>
--

FIGURE 8. SUBJECT PILOT BRIEFING/QUESTIONNAIRE

CONCLUSIONS

1. The various subsystems of the prototype ATGS that were used to locate/identify aircraft and to automatically control and monitor taxiway lighting were successfully integrated into a single automated visual guidance system.
2. Data collected from the subject pilots indicate that implementation of an ATGS would help to improve airport/aircraft safety by eliminating incorrect taxiing turns and runway incursions, particularly in night and/or low-visibility operations.
3. Although the prototype ATGS was successfully evaluated, further in-service testing at a major airport is needed to validate the concept. Specifically, additional research on a technologically upgraded ATGS should include the feasibility of integrating automatically controllable taxiway lighting with existing ASDE/AMASS systems.

APPENDIX A—SUMMARY OF PILOT COMMENTS

Subject pilot comments, as recorded by the pilots on their postflight questionnaire forms, are shown below. The excerpts, while not necessarily direct quotes of individual pilots, reflect the general nature of their comments.

Comments: Question 1

- The ATGS is an excellent concept and is a significant improvement compared to having all taxiway routes illuminated.
- The ATGS is an excellent system for low visibility/nighttime operations. It would also be very useful for flight crews who are taxiing at unfamiliar airports.
- Taxiing into a “black hole” will certainly get your attention and should increase safety by keeping you from continuing on a wrong path.

Comments: Question 2

- When approaching an intersection, blue taxiway edge lights may be confusing. Green taxiway centerline lights leave no doubt as to where to go.
- I prefer the centerline lights because I need to only look straight ahead, instead of side to side, to get steering and stop/go visual cues.
- Centerline lighting is a more positive appearing form of visual guidance.
- Both taxiway centerline and edge lighting should be used.
- My preference is the green centerline lights; however, the blue edge lights work just fine.

Comments: Question 3

- The ATGS is a good idea, but a larger test bed is needed to validate the concept. The ATGS concept needs to be tested using more of the taxiway lights.
- I would really like to see a larger test scenario implemented. I would suggest using green centerline lighting with an in-ground stop bar across the taxi route.
- I would suggest using taxiway lighting that sequentially flashes along the desired route.
- The automatic taxiway lights should illuminate sooner. Because of the nature of airport lighting, small areas of lights going on and off are not noticeable enough to be good, positive guidance.

- You need to determine the minimum segment of lighting needed to be unambiguous to the pilot.
- I would hope that the reaction time of the lights to aircraft movement would be quicker. Also, I believe that more ground sensors would be required to better identify aircraft position.
- More of the taxiway lights need to be under the system's control. Keep working towards a larger scale system because this is an excellent concept.
- I like the system's simplicity. It should be very easy for most pilots to use.