

United States
Environmental Protection
Agency

Office of Research and
Development
Washington DC 20460

EPA/625/R-96/007
September 1996

Seminar Publication

National Conference on Sanitary Sewer Overflows (SSOs)

April 24-26, 1995

Washington DC

4



EPA/625/R-96/007
September 1996

Seminar Publication
National Conference on Sanitary Sewer Overflows (SSOs)

April 24-26, 1995
Washington DC

U.S. Environmental Protection Agency
Office of Research and Development
National Risk Management Research Laboratory
Center for Environmental Research Information
Cincinnati, Ohio

Notice

This document has been subjected to the U.S. Environmental Protection Agency's (EPA's) peer and administrative review and has been approved for publication as an EPA document. The views expressed are those of the authors and do not necessarily reflect those of the Agency. Mention of trade names or commercial products does not constitute endorsement or recommendation for use.

When an NTIS number is cited in a reference, that document is available from:

National Technical Information Service
5285 Port Royal Road
Springfield, VA 22161
703-487-4650

Contents

	<i>Page</i>
ACKNOWLEDGMENTS	xi
INTRODUCTION	xv
SESSION 1 -A: AN OVERVIEW OF SSOs-1	
An Introduction to Sanitary Sewer Overflows <i>Jonathan B. Golden</i>	1
An Analysis of the Root Cause of Sanitary Sewer Overflows <i>Ralph G. Petroff</i>	8
SESSION 1-B: MODELING AND ASSESSMENT OF SSOs-1	
Modeling Inflow and Infiltration in Separated Sewer Systems <i>Robert Swarner and Michael Thompson</i>	16
Computer Modeling of Sanitary Sewer Overflows Resulting From Peak Flow Conditions <i>Marc P. Walch, Thomas J. Christ, Kathleen S. Leo, Stephanie L. Ross, and William M. Brant</i>	26
New Collection System Modeling Techniques Used in Houston <i>Kathlie Jeng, Michael J. Bagstad, and James Chang</i>	33
SESSION 2-A: AN OVERVIEW OF SSOs—2	
Controlling Sanitary Sewer Overflows in Small Communities <i>Mark G. Wade</i>	42
Separate Sanitary Sewer Overflows in Illinois <i>Allan L. Rae</i>	54
SESSION 2-B: MODELING AND ASSESSMENT OF SSOs-2	
Is It a Ford or Jaguar? Appropriate Data Management and Modeling Tools for Sanitary Sewer Overflow Reduction Management and Analysis <i>David Crawford and Virgil Adderley</i>	58
Sanitary Sewer Overflows Leave Telltale Signs in Depth-Velocity Scattergraphs <i>Patrick L. Stevens and Heather M. Sands</i>	69
Evaluation of Methodologies To Estimate Peak Inflow in Sanitary Sewers <i>Aaron A. Witt and Richard E. Nelson</i>	78
Real World Hydraulic Modeling for Long-Term Sanitary Sewer Overflow Management <i>Thomas C. Davies</i>	88

	<i>Page</i>
SESSION 3-A: SEWER SYSTEM MAINTENANCE	
Stopping Sanitary Sewer Overflows: Beneficial Maintenance Practices <i>Albert E. Gallaher III and Scott L. Brown</i>	96
The Influence of Crisis Sewer Maintenance on Sanitary Sewer Overflows <i>James D. McGregor</i>	105
City of Portland Sewer Collection System Maintenance Management Plan <i>Graham Knott and Dave Singleterry</i>	112
SESSION 3-B: SYSTEM INVESTIGATION AND REHABILITATION	
Line Blockage Assessment Documents Sewer Conditions That Contribute to Overflow <i>Philip M. Hannan, Julie Delaney, and John McLeod</i>	126
Corrosion Inspection of a 78 -Inch Interceptor-While Live <i>Kent Von Aspern</i>	132
Sewer Rehabilitation: The Techniques of Success <i>David E. Jurgens and Hugh M. Kelso</i>	138
SESSION 3-C: INSTITUTIONAL ISSUES-I	
Prioritizing Sanitary Sewer Overflows Based on System Impacts and Water Quality <i>Timothy W. Kraus and Gordon R. Garner</i>	149
Ohio and Sanitary Sewer Overflows: Enforcement, Data Needs, and Implementation <i>Rob Frutchey, David Crouch, Gary Stuhlfauth, Reynold Gerson, and Chris Hauser</i>	154
Addressing Community Concerns While Managing Sanitary Sewer Overflows in the Wayne County Downriver Collection and Treatment System <i>Mark J. TenBroek, Joe Goetz, and Larry A. Roesner</i>	157
SESSION 4-A: DEALING WITH PRIVATE SERVICE LATERALS	
Infiltration Contribution From Private House Laterals and Services <i>Art Hamid</i>	167
The Private Sector and Sanitary Sewer Overflows <i>Donna Evanoff Renner, Ken Matthews, and Gary Morgan</i>	174
Data Handling Procedures Expedite Sewer Evaluation and Repair of Service Laterals <i>Reggie Rowe and Danny Holmberg</i>	184

SESSION 4-B: DATA COLLECTION AND ANALYSIS-I

Flow Monitoring and Rainfall Gauging for the City and County of Honolulu's
Long-Term Sewer Rehabilitation and Infiltration/Inflow Minimization Program
Gary N. Skipper and Felix Limtiaco 196

The Use of Sewer Monitoring Information for Operation and Maintenance
Thomas J. Day 204

SESSION 4-C: INSTITUTIONAL ISSUES-2

Sanitary Sewer Overflow Institutional Issues: How Did We Get Here,
and Where Are We Going?
Roger C. Hartung 212

Sanitary Sewer Overflow Draft Strategy
Bruno Rumbelow and Steve Parke 217

Strategy for Wet Weather Sanitary Sewer Overflows
James L. Graham, Jr. 223

SESSION 5-A: SEWER SYSTEM REHABILITATION

Recent Advances in Technologies for Collection System
Evaluation and Rehabilitation
Jey K. Jeyapalan and John Jurgens 232

Dade County's Mandated Improvement Program To Reduce Sanitary
Sewer Overflows
Anthony J. Clemente and Rosanne W. Cardozo 242

Lessons Learned From the City of Houston's Structural Rehabilitation Program
Henry/V. Gregory Jr. and Christine A. Kahr 250

SESSION 5-B: DATA COLLECTION AND ANALYSIS-2

Separate Sewer Overflows: Determining the Appropriate Storm Protection Level
Alan J. Hollenbeck 261

Visualizing Your Sanitary Sewer Overflow Status Using Desktop Mapping
Darin H. Thomas and Thomas W. Trybus 268

Accuracy Limitations in Open Channel Flow Monitoring
Jeffrey L. Den Herder 274

SESSION 5-C: INFILTRATION/INFLOW ANALYSIS

Infiltration and Inflow, Infiltration or Inflow-Which Is the Problem?
Steve Merrill, Andy Lukas, Bob Swarner, and Steve Klusman 285

New Approach to Sanitary Sewer Overflow Evaluation Yields
Surprising Results
Peter Keefe 292

SESSION 6-A: DEALING WITH ROOF DRAINS AND SUMP PUMPS

The Roof Drain and Sump Pump Removal Program:
An Innovative Approach to Inflow Reduction
Jay Reynolds..... 303

Rainfall-Derived Infiltration and Inflow: An Innovative Approach to Removal
Joseph P. Niehaus 310

Mismanagement of Sump Pump Connections to Sanitary Sewers
Russell E. Nerlick 315

SESSION 6-B: FLOW MONITORING ISSUES

Hydraulic and Technical Realities of Flow Monitoring for
Sanitary Sewer Overflows
Michael D. Kyser..... 321

An Assessment of State-of-the-Art Flow Measurement Techniques for
Sanitary Sewers and Overflows
Thomas J. Day 331

SESSION 6-C: COST ISSUES

The Costs of Eliminating Sanitary Sewer Overflows Using Defect Flow Analysis
S. M. "Noah" Walker..... 338

Cost/Benefit Drives Houston's Billion-Dollar Sanitary Sewer
Overflow Control Program
Teresa Battenfield and Christine Kahr 345

Determining the Cost-Effectiveness of Sanitary Sewer Rehabilitation in
Norfolk, Virginia
Lamont W. Curtis and Gregory K. Anderson 354

SESSION 7-A: CASE STUDIES-1

Case Study: Sanitary Sewer Overflow Abatement in a Multiagency Sewer System, Village of Wilmette, Illinois <i>Thomas Rowlett and Paul M. Shadrake</i>	362
Master Planning for the Removal of Sanitary Sewer Overflows in the Sanitary Sewer System in Lima, Ohio <i>Shane F. Clark and Alice H. Godsey</i>	372
Combating Sanitary Sewer Overflows in Western Carolina <i>Lauren R. Hildebrand, David T. Zimmer, and Aaron M. Frazier</i>	380

SESSION 7-B: CASE STUDIES-2

Program Management of the Dade County Infiltration/Exfiltration/Inflow Flow Reduction Program <i>Luis Aguiar, James T. Cowgill, and Thomas G. Scheller</i>	387
Infiltration/Inflow Flow and Sanitary Sewer Overflow Reduction Project in Lynn, Massachusetts <i>Richard K. Smith, William A. Di Tullio, Leo R. Potter, and Daniel F. O'Neill</i>	392
Sanitary Sewage Discharges in the City of Edmonton, Alberta <i>John E. Hodgson, Christopher J. W. Ward, and Nancy U. Schultz</i>	403

SESSION 7-C: STORAGE SOLUTIONS FOR SSOs

Continuous Simulation for Sanitary Sewer Overflow Control Planning <i>Edward H. Burgess and Charles I. Moore</i>	414
Storage Solution for Handling Excessive Wet Weather Sanitary Flows <i>Terry L. Krause, Lloyd E. Witte, and Lee J. Glueckstein</i>	425
Design and Operation of a Wet Weather Storage Facility To Eliminate Sanitary Sewer Overflows in the Vicinity of a Publicly Owned Treatment Works Using an Extended-Period Simulation Model <i>Larry A. Roesner and Richard A. Carrier</i>	432

SESSION 8-A: CASE STUDIES-3

Eliminating Sanitary Sewer Overflows in Three New England Communities <i>Sean M. Mullins and Jonathan B. Golden</i>	443
Sanitary Sewer Overflows in Cobb County, Georgia <i>Gene Ramer, Steve McCullers, and Timmy Vaughn</i>	451
Sewer System Operation and Maintenance: A Practical Program To Minimize and Mitigate Sanitary Sewer Overflows <i>John Larson and Kent Von Aspern</i>	453

SESSION 8-B: CASE STUDIES-4

A Case Study in Inflow and Infiltration Management
David Crouch 462

Correcting Sanitary Sewer Overflows Through Infiltration and Inflow Control, City of McMinnville, Oregon
John Kennedy and Carrie Pak 472

Sanitary Sewer System Rehabilitation at Lawrence Livermore National Laboratory
Robert J. Velling, Randy Burton, and Bruce Fritschy 482

SESSION 8-C: TREATMENT SOLUTIONS FOR SSOs

U.S. Environmental Protection Agency Urban Wet Weather Flow Research Program Overview on Sanitary Sewer Overflow Control
Richard Field and Thomas P. O'Connor 492

Automated Treatment Plant Reduces Sanitary Sewer Overflows
Stephen R. Maney 503

Innovative and Economical Sanitary Sewer Overflow Treatment Using Fine Screens and Chlorination
Darrel R. Gavle and David G. Mitchell 511

SESSION 9-A: CASE STUDIES-5

Total Catchment Management for Sanitary Sewer Overflows in Sydney, Australia
Patrick A. Hayes 520

System Understanding Delivers Solutions at Affordable Cost
Robert Serpente, Gerry Moss, and Phil Wildbore 529

SESSION 9-B: CASE STUDIES-6

Sanitary Sewer Overflow Removal: The Approach Used by the Metropolitan Sewer District of Greater Cincinnati
Steve Donovan 538

The Facility Plan To Mitigate Sanitary Sewer Overflows in Charlotte, North Carolina
Jacqueline A. Townsend and S. Wayne Miles 546

Correcting Sanitary Sewer Overflows: An Evaluation of the East Bay Infiltration/Inflow Correction Program
Thomas E. Harvey, Judith D. Parker, and Paul R. Giguere 554

SESSION 9-C: WATERSHED AND REGIONAL APPROACHES

Mill Creek Watershed Management: An Evaluation of Study Methods,
Benefits, and Costs
Lester Stumpe and Art Hamid 563

Using a Watershed Management Approach To Evaluate the
Effects of Sanitary Sewer Overflows on Creek Water Quality
T.R. "Buddy" Morgan and William Kreutzberger 574

Regional Flow Monitoring for Sewer Rehabilitation Performance Evaluation,
Oakland County, Michigan
Michael D. Waring and Keith D. McCormack 580

Acknowledgments

The success of the conference and this document is due largely to the talents and efforts of many individuals. Gratitude goes to each person who was involved.

Authors

A special thanks goes to the many authors of the papers presented in this document. Their efforts in preparing papers made this document possible and led to the overall success of the conference.

Peer Reviewers

The following individuals peer reviewed the papers presented in this document:

- Michael **Bagstad**, Greater Houston Wastewater Program, Houston, Texas
- Michael Borst, U.S. Environmental Protection Agency (EPA), Office of Research and Development (ORD), National Risk Management Research Laboratory (NRMRL), Edison, New Jersey
- Rosanne Cardozo, Montgomery Watson, Coral Gables, Florida
- Chien Chen, EPA, ORD, NRMRL, Edison, New Jersey
- Thomas Day, City of Philadelphia Water Department, Philadelphia, Pennsylvania
- William **DiTullio**, Camp Dresser and McKee, Inc., Cambridge, Massachusetts
- Steve Donovan, Hamilton County Metropolitan Sewer District, Cincinnati, Ohio
- Martin Dot-ward, Greater Houston Wastewater Program, Houston, Texas
- Carolyn Esposito, EPA, ORD, NRMRL, Edison, New Jersey
- Jack **Farlow**, EPA, ORD, ORD, NRMRL, Edison, New Jersey
- Ray Frederick, EPA, ORD, NRMRL, Edison, New Jersey
- Uwe Frank, EPA, ORD, NRMRL, Edison, New Jersey
- Albert Gallaher, III, Charlotte-Mecklenburg Utility Department, Charlotte, North Carolina
- Philip **Hannan**, Washington Suburban Sanitary Commission, Laurel, Maryland
- John **Harkins**, EPA, Region 4, Water Management Division, Atlanta, Georgia
- Thomas Harvey, East Bay Municipal Utility District, Oakland, California
- Patrick Hayes, MGD Technologies, Inc., San Diego, California
- King Hsu, EPA, ORD, NRMRL, Edison, New Jersey

- Gisa Ju, Greater Houston Wastewater Program, Houston, Texas
- Herbert Kaufman, Clinton **Bogert** Associates, Englewood Cliffs, New Jersey
- Peter Keefe, ADS Environmental Services, Inc., Mentor, Ohio
- Timothy Kraus, Louisville and Jefferson County Metropolitan Sewer District, Louisville, Kentucky
- Michael Kyser, Badger Meter, Inc., Tulsa, Oklahoma
- Steve Merrill, Brown and **Caldwell** Consultants, Seattle, Washington
- Richard Nelson, Black and Veatch, Kansas City, Missouri
- Russell Nerlick, Western Monmouth Utilities Authority, Englishtown, New Jersey
- Thomas O'Connor, EPA, ORD, NRMRL, Edison, New Jersey
- Joyce Perdek, EPA, ORD, NRMRL, Edison, New Jersey
- **Allan** Rae, Consultant, Aurora, Illinois
- Donna Renner, RJN Group, Inc., Dallas, Texas
- Michael Royer, EPA, ORD, NRMRL, Edison, New Jersey
- Richard Smith, Camp Dresser and McKee, Inc., Cambridge, Massachusetts
- Mary Stinson, EPA, ORD, NRMRL, Edison, New Jersey
- Lester Stumpe, Northeast Ohio Regional Sewer District, Cleveland, Ohio
- Daniel Sullivan, EPA, ORD, NRMRL, Edison, New Jersey
- Anthony Tafuri, EPA, ORD, NRMRL, Edison, New Jersey
- Jacqueline Townsend, Charlotte-Mecklenburg Utilities Department, Charlotte, North Carolina
- Robert Vellinger, Lawrence Livermore National Laboratory, Livermore, California
- Kent Von Aspern, Central Contra Costa Sanitary District, Martinez, California
- James Yezzi, EPA, ORD, NRMRL, Edison, New Jersey

Editorial Review and Document Production

Eastern Research Group, Inc., of Lexington, Massachusetts, handled conference logistics and guided the compilation, peer review, and editing of this publication. In particular, the efforts of Elaine Brenner, Helen Genz, Sandy Cummings, Jan Power, Karen Altschuller, and Heidi Schultz are sincerely appreciated.

Technical Direction and Coordination

Daniel Murray, EPA, ORD, NRMRL, Center for Environmental Research Information, Cincinnati, Ohio, coordinated the preparation of this document and provided technical direction throughout its development.

Special Thanks

The contributions of the following individuals in the development of the conference and this document are especially appreciated:

- Mike Cook, EPA, Office of Wastewater Management, Washington DC.
- Bob Lee, EPA, Office of Wastewater Management, Washington DC.
- Lam Lim, EPA, Office of Wastewater Management, Washington DC.
- Tim **Oppelt**, EPA, ORD, National Risk Management Research Laboratory, Cincinnati, Ohio.
- Bob Perciasepe, EPA, Office of Water, Washington DC.
- Dan Sullivan, EPA, ORD, NRMRL, Urban Watershed Management Branch, Edison, New Jersey.
- Kent Von Aspern, Central Contra Costa Sanitary District, Martinez, California.
- Kevin Weiss, EPA, Office of Wastewater Management, Washington DC.
- Jim Wheeler, EPA, Office of Wastewater Management, Washington DC.

Introduction

The National Conference on Sanitary Sewer Overflows was held in Washington DC on April 24-26, 1995. The conference was a forum for nearly 500 environmental professionals to exchange technical information and experiences relating to the complex issues of sanitary sewer overflows (SSOs).

Thousands of municipalities across the nation are serviced by separate sanitary sewer systems. A chronic problem that faces many of these systems is the occurrence of SSOs. Caused mainly by the infiltration and inflow of wet weather flows and blockages and flow restrictions in the sewer system, these SSOs pose a risk to public health and the quality of our nation's waters.

The conference was held to bring together individuals from across the country to discuss the technical and institutional issues surrounding SSOs. As such, the conference examined a variety of topics relating to the regulation, analysis, evaluation, management, and control of SSOs. Presentations at the conference and papers in this publication address the following:

- Background and problem definition
- Modeling and assessment
- Institutional issues
- Dealing with private service laterals
- Data collection and analysis
- Case studies
- Storage solutions
- Watershed and regional approaches

This seminar publication presents selected, peer-reviewed papers from the conference. The purpose of the publication is to share the information presented at the conference with individuals who were unable to attend. The publication will be useful to individuals who are currently facing the complex issues of SSO management and control, including environmental regulatory personnel at the federal and state level; decision-makers and technical personnel from regional and municipal wastewater management authorities; private-sector personnel, including environmental consultants and equipment manufacturers; university professors, researchers, and students; and other interested persons.

The goal of sharing this information with a broader audience is to help environmental professionals and others to better understand the complex institutional and technical issues surrounding SSOs and to assist environmental decision-makers in making cost-effective decisions.

An Introduction to Sanitary Sewer Overflows

Jonathan B. Golden
Metcalf & Eddy, Inc., Wakefield, Massachusetts

Definition of the Problem

This paper provides an overview of sanitary sewer overflows (SSOs), including the impacts, causes, and methods of SSO control.

An SSO is the discharge of untreated or partially treated sewage from a sanitary sewer system. An SSO occurs when flow in the system exceeds the capacity of the conveyance system. An SSO can occur during dry weather, but it is more commonly associated with wet weather events due to rainfall-induced infiltration and inflow (RDII) entering the sewer system.

From a legal perspective, Section 301 (a) of the Clean Water Act prohibits unpermitted discharge of pollutants (1). The National Pollutant Discharge Elimination System (NPDES) permit program allows discharges under specific conditions, which usually include technology-based effluent limits. The conditions may also include stricter limits to meet water-quality standards for particular bodies of water. NPDES permits also require permittees to properly operate and maintain all facilities and impose self-monitoring and self-reporting requirements.

The U.S. Environmental Protection Agency (EPA) has sought to correct SSOs through enforcement actions for discharges without a permit. In some situations, addressing SSOs through an enforcement action for an unpermitted discharge may not be appropriate, as in the case of a sewerage authority that operates a publicly owned treatment works (POTW) and therefore is issued an NPDES permit. Because EPA has no formal policy or guidance regarding SSOs, the Agency is currently conducting a series of dialogues between stakeholders representing municipalities, environmental groups, and regulatory officials in an attempt to evaluate the need for a national policy.

The national scope of the SSO problem is not well documented. Two-thirds of respondents to a recent survey by the Association of Metropolitan Sewerage Agencies (AMSA) indicated that SSOs occurred during wet weather events. The survey also indicated that the volume of SSOs represented a small percentage when compared with total treated wastewater volume. Respondents also felt that sewer system rehabilitation efforts were expensive and met with limited success (2).

The Impacts of Sanitary Sewer Overflows

SSOs are a concern due to a number of potential adverse impacts. The discharge of untreated or partially treated sewage represents a health risk. Raw sewage contains pathogenic organisms. SSOs often occur in locations where public access potential is high and contact with raw sewage may occur. For example, an SSO may result in basement flooding. Other high-exposure areas include streets and small drainage streams in residential areas. For example, in San Diego SSOs have threatened public drinking water supplies, creating the potential for serious adverse public health impacts.¹

SSOs can also cause adverse impacts to receiving waters. In addition to pathogens, raw sewage contains pollutants that exert oxygen demand and may contain toxics. The addition of these pollutants can affect the aquatic environment. In Alabama sewage discharges have had an impact on the number

¹ Stephany, G. 1995. Personal communication from Gary R. Stephany, Director, Department of Environmental Health, County of San Diego, CA. March 18, 1995

and range of species found in the Cahaba River (3). They also reported low levels of dissolved oxygen and algal blooms. Water-quality studies of Alabama's Catoma basin, however, determined that SSOs contributed insignificant amounts of pollutants compared with urban and rural runoff sources (4). Similarly, study of the effects of SSOs on water quality in Houston, Texas, concluded that, because SSOs were small in volume relative to stormwater runoff, water-quality considerations should not be the primary justification for investment in correcting overflows (5).

The potential effects on receiving waters include use impairment, such as beach closings in coastal areas and swimming prohibitions in inland areas. Shellfish bed closings can also result from SSOs. Nutrient loading may accelerate eutrophication. Because raw sewage contains other pollutants such as oil and grease and materials classified as floatables, SSOs can cause aesthetic degradation.

A third area of impact is property damage and loss of economic activity. Surcharged collection systems may back up into basements through fixtures or open cleanouts, causing damage. Also, pump stations may flood when flows exceed pumping capacity, damaging mechanical and electrical equipment. Beach closings and aesthetic degradation of water bodies may result in loss of economic activity, including tourism and convention business. Enforcement action by regulatory authorities can lead to sewer connection moratoriums, which may limit economic growth. Finally, significant legal and financial resources may be required to deal with legal enforcement actions or citizen lawsuits.

Causes of Sanitary Sewer Overflows

A sanitary sewage collection and conveyance system surcharges when flow exceeds the theoretical capacity of the pipe flowing full (Figure 1a). Surcharging results in an SSO when the hydraulic grade line rises to a level where the system is open to the environment (Figure 1 b). A surcharged sewer will overflow at fixtures or open cleanouts in basements, manhole covers in streets or easements, or constructed overflows to a receiving water or storm sewer. Constructed overflows exist in separate sanitary sewer systems mainly as a way to mitigate the property damage and health risks associated with other overflows such as basement flooding. A surcharged sewer can also exfiltrate raw sewage through open joints to ground water and other areas of the environment.

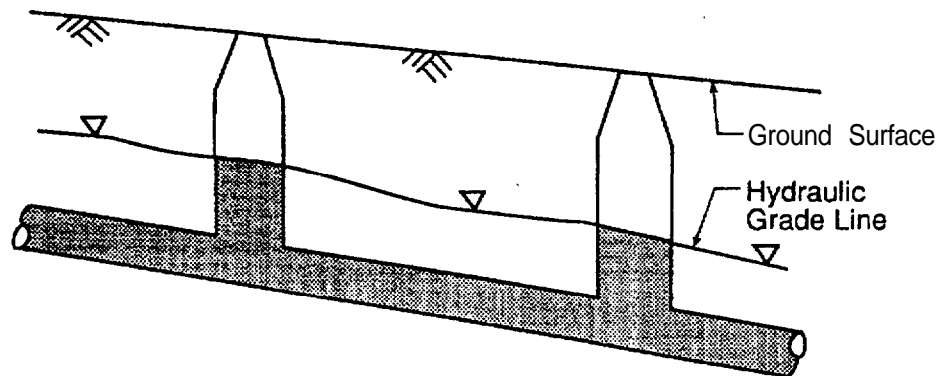

Figure 1a. Sewer surcharging without flooding.

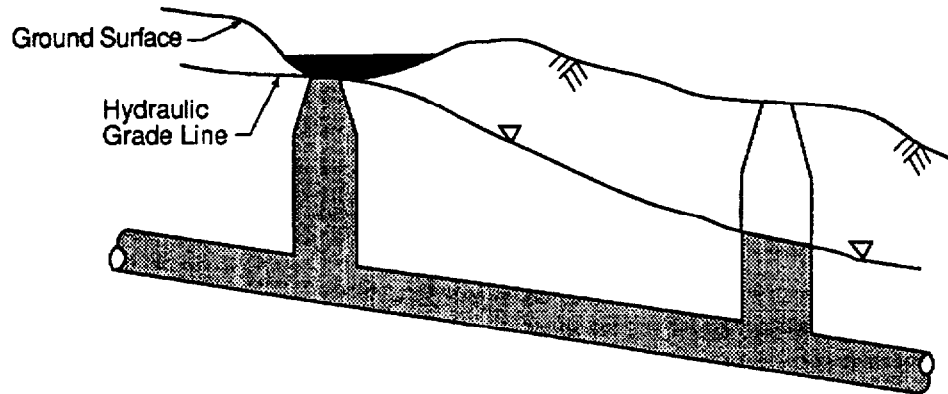

Figure 1 b. Sewer surcharging with flooding.

A conveyance system can also overflow at a pump station or treatment facility if flows exceed the pumping capacity of the station or hydraulic capacity of the headworks. Constructed overflows may also be located at pump stations and at treatment plant headworks to mitigate damage to the facility.

A constriction in the conveyance system can be due to an undersized pipe but may also occur when the capacity of the pipe has been reduced. Reductions in pipe capacity occur because of obstructions (e.g., roots, grease, debris), broken pipe, or joint failure. Debris can enter the sewer from construction activities, vandalism, and even from sewer maintenance work. Obstructions can exacerbate surcharging and backups by causing a buildup of solidified grease, detergents, sticks, rags, plastic bags, brick, rocks, sand, eggshells, and silt. In Chattanooga, Tennessee, overflows in one major interceptor were caused by blockages due to accumulated debris on the exposed reinforcing bars of deteriorated concrete pipe. Pipe lining appears to have eliminated the problem in this location (6). Constrictions can also occur due to deposition of materials (such as grit) due to low velocities during minimum flows and in areas with very flat slopes (7).

Infiltration and inflow (I/I) are extraneous flow that enters the sewer system. Inflow is generally defined as stormwater that enters the collection system through direct connections, and infiltration is defined as water that enters from the ground. In the late 1980s, the term "rainfall-induced infiltration" was first used to describe infiltration with flow characteristics resembling inflow (i.e., a rapid increase in flow mirrors the rainfall event). RDII results when stormwater runoff causes a rapid ground-water recharge around sewers, including manholes and building connections, which then enters the system through defective pipes, pipe joints, or manhole walls. Therefore, SSOs occur when inflow and RDII cause a peak flow in the sewer that exceeds the capacity.

A review of 10 case studies by EPA found that peak wet weather flow ranged from 3.5 to 20 times the average dry weather flow (8). The ratio of peak wet weather flow to average dry weather flow can be used as a parameter to determine whether a particular area of sewer system will overflow. Typically, as the ratio approaches 4 to 5, the likelihood of surcharge and overflow increases. The peak flow ratio at which overflows occur varies depending on the specific characteristics of the system. For example, the peak wet weather flows in Sydney, Australia, are eight times the average dry weather flow, causing thousands of overflows (9). Figure 2 shows a graphic representation of the impact of I/I on flow rate.

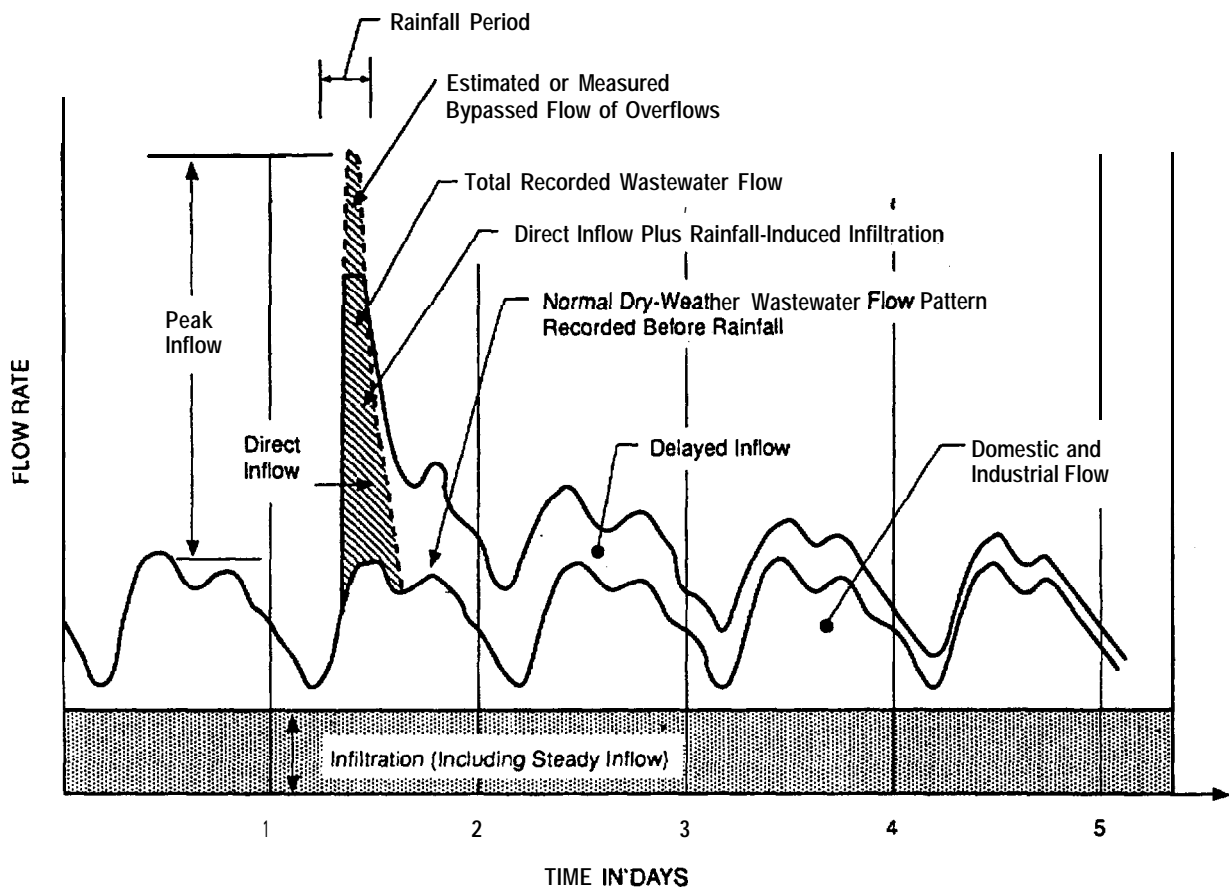

Figure 2. Graphic identification of infiltration and inflow.

In the design of separate sewers, a conservative design allowance component is typically provided in the peak design flow for unavoidable I/I expected within the sewers at the end of their service life or design period. Usually, design allowances for infiltration were calculated on a "sewered area" basis and would take into account sewer pipe and jointing materials as well as prevalent ground-water conditions. For example, vitrified clay sewers designed during and prior to the 1950s, when jointing materials were cement-mortar, jute, and bituminous compounds, would have had a high design allowance for infiltration somewhere between 2,000 and 4,000 gallons per acre per day. More recently, with the introduction of high quality pipe materials, rubber gasket joints, and improved manhole construction products (including resilient pipe connections at manholes), a design allowance as low as 1,000 gallons per acre per day would be used.

Reducing Sanitary Sewer Overflows

SSOs can be reduced through:

- Sewer system maintenance
- Reduced peak flows (by removing I/I)
- Increased conveyance and treatment capacity

- Wet weather storage and treatment facilities

Sewer System Maintenance

Many sewer systems receive little or no preventive maintenance and need enormous rehabilitation programs. Most municipalities only provide maintenance when an emergency, such as clearing a blockage or repairing a collapse, necessitates action.

Some of the factors that contribute to the high level of needed rehabilitation include (7):

- Poorly planned systems with no provision for long-term growth.
- Poor installation causing unnecessary maintenance problems.
- Materials that do not withstand settling of structures, earth movement, or traffic.
- Joints that were not designed to prevent root intrusion.

Some of the factors that contribute to low level of preventive maintenance include (7):

- The “out-of-sight, out-of-mind” attitude.
- Budget limitations, with no maintenance provision except for emergencies.
- The other responsibilities of the agencies charged with sewer maintenance.
- Poor record-keeping procedures combined with poor documentation of the collection system.

A preventative maintenance program to reduce **SSOs** would address areas that become plugged using regular hydraulic, mechanical, or chemical cleaning and root removal, and replacing line to eliminate hydraulic restrictions. Often during an emergency repair, the crew discovers a damaged pipe nearby that they can fix as part of the preventative maintenance program. A collection system preventative maintenance program should also include pump stations. Procedures would be based on the recommendations of equipment manufacturers and knowledge gained from experience.

Reducing Peak Flow by Reducing I/I

Over the past 25 years, significant effort and resources have been allocated to reducing **I/I**, not only to eliminate backups and overflows but to reduce capital costs of treatment facilities and make operations more efficient. Many **I/I** reduction programs have had only limited success, for a variety of reasons (10):

- **I/I** from building laterals on private property has often been excluded from rehabilitation programs. It is estimated that 50 to 70 percent of **I/I** may originate from sources on private property. Municipalities are often unable or reluctant to address **I/I** from these sources. A building lateral can serve as a connection point for area drains, roof leaders, and foundation drains. If these connections, which are usually illegal, are removed, alternative outlets are often not readily available. In addition, the building connection is often installed with lower inspection standards and controls.
- **I/I** analysis methodologies were often based on inaccurate metering data, poor diagnostic methods for identifying **I/I** sources, and overly optimistic assumptions on rehabilitation effectiveness. Metering programs may not have accounted for peak flows

that were bypassed or overflowed. After rehabilitation, these flows could enter the system due to capacity increase downstream. The effectiveness of I/I removal programs did not account for migration to a new source that had not been repaired.

Although some ambitious I/I programs aim for a **50-percent** reduction, a maximum **30-percent** reduction may be a more realistic goal. For older systems, such as a recent project in Canberra, Australia, it was suggested that systemwide reduction goals should be (9):

- 0 to 10 percent infiltration reduction
- 10 to 30 percent inflow reduction
- 10 to 20 percent overall I/I reduction

I/I reduction programs require a comprehensive study to identify areas where further efforts should be concentrated, followed by diagnostic techniques to locate specific sources. A cost-effectiveness analysis will provide a basis for rehabilitation efforts. It is often prudent to monitor the program's effectiveness through a phased approach. Postrehabilitation monitoring is used to measure effectiveness.

In addition to removing inflow sources by disconnection from the sanitary sewer, I/I reduction includes rehabilitation of pipelines. Pipeline rehabilitation methods include excavation and replacement, chemical grouting, insertion, cured-in-place pipe lining, fold and formed, specialty concrete, liners, and coatings.

Increasing Conveyance and Treatment Capacity

To increase conveyance capacity, an evaluation of the collection system must be made to identify and eliminate restrictions. This can be accomplished by inspection, monitoring, and modeling of the system to characterize its features and behavior. To eliminate restrictions, a relief sewer can be constructed, or undersized pipe sections can be enlarged. Another method is to transfer flow from one drainage basin to another. If an SSO occurs due to capacity limitations at a pump station, pumping capacity can be increased. It is sometimes possible to increase pumping capacity by adjusting controls.

A number of "in-system" technologies or strategies can be used for in-line storage. These are generally most effective with large-diameter pipelines and require careful analysis to ensure that flooding will not occur. Disadvantages include the possibility of sediment deposition and increased maintenance costs.

Flow equalization basins have been used to reduce overflows. They can be located in the collection system or at the POTW. Another strategy is to increase flow to the primary treatment portion of the POTW, which may have a "wet weather" capacity significantly greater than the secondary treatment process. If permitted, the flow can be discharged after bypassing the secondary phase.

Wet Weather Treatment Facilities

A wet weather storage and treatment facility can provide hydraulic relief to the collection system. The objective of such a facility is to provide storage of flow for smaller wet weather events, and treatment with a controlled discharge during larger wet weather events. The sizing of the facility could be based on providing a minimum treatment level to meet water quality standards or to reduce the number of overflow events. Typically, wet weather facilities are designed to provide for primary clarification, disinfection, and removal of floatables.

References

1. Federal Water Pollution Control Act, 33 U.S.C. 1251 et seq.
2. AMSA. 1994. Draft SSO survey data. Association of Metropolitan Sewerage Agencies, 1000 Connecticut Avenue, NW., Suite 410, Washington DC 20036.
3. Cahaba River Society. 1993. CRS special report: Sewage and the Cahaba River. Birmingham, AL (July).
4. **CH2M HILL**. 1993. Catoma basin water quality study. Montgomery, AL (September).
5. Espey, Houston and Associates, Inc. 1994. Analyses of sanitary sewer overflow effects on surface water quality, Vol. III. Houston, TX (February).
6. Consolidated Technologies, Inc. 1992. Engineering evaluation, sanitary sewage overflow elimination program, City of Chattanooga. Chattanooga, TN (July).
7. California State University at Sacramento. 1991. Operations and maintenance of wastewater collections systems: A field study training program, 3rd ed. Hornet Foundation, Inc., California State University, Sacramento, CA.
8. U.S. EPA. 1990. Rainfall induced infiltration into sewer systems, Report to Congress. **EPA/430/09-90/005** (August).
9. **Kinhill**, Metcalf & Eddy. 1993. Report to Canberra, Australia: Discussion paper on infiltration/inflow reduction. Canberra, Australia (December).
10. Metcalf & Eddy, Inc. 1981. Wastewater engineering: Collection and pumping of wastewater. New York, NY: McGraw-Hill.

An Analysis of the Root Cause of Sanitary Sewer Overflows

Ralph G. Petroff
ADS Environmental Services, Inc., Huntsville, Alabama

Nationwide, sanitary sewer overflows (SSOs) have been recognized **as a** major problem (see Figure 1). Much discussion has focused on determining the extent of the problem and the best approaches for dealing with it.

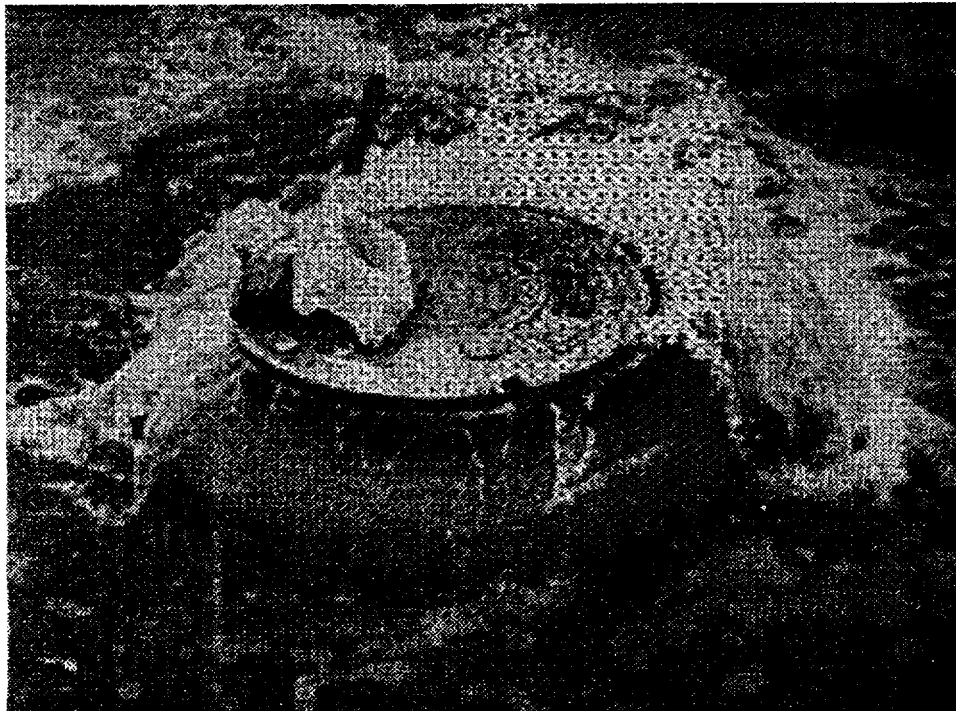

Figure 1. A sanitary sewer overflow.

Several different types of solutions have been proposed for controlling the SSO problem. Many of these solutions involve great expense in the form of construction of relief and storage. With the increasing financial pressures on municipalities, such solutions are becoming less affordable.

Albert Einstein offers some useful advice for those attempting to determine the optimal solution for sanitary sewer overflows: "The problems we face cannot be solved with the same type of thinking that created those problems in the first place."

Total Quality Management Applied to SSOs

A new type of thinking can be found in the principles of total quality management (TQM), developed by the famous quality expert Dr. Edward Deming. Deming's problem-solving approach assumes that solutions to most problems can be found by carefully diagnosing the nature and extent of the problem before rushing ahead with solutions. A key to this is what he terms "fact-based management" and "the search for the root cause problem."

TQM emphasizes determining the root cause of a problem, rather than addressing the symptoms of a problem. The key to this, Dr. Deming noted, is to “ask ‘why’ five times.” Applying this criteria to the subject of **SSOs** reveals a much different perspective on the nature of the problem, and therefore a different set of solutions.

Why Do Sanitary Sewer Overflows Occur?

SSOs occur for two reasons: The first and most obvious reason is extraneous flow in the form of infiltration and inflow (I/I). The second reason is because sewer pipes surcharge excessively. We will address the issue of extraneous flow later. First we will concentrate on the question of why pipes surcharge excessively.

Why Do Sewer Pipes Surcharge?

Sewer pipes surcharge either because of an hydraulic overload or because of the lack of downstream capacity. As part of “fact-based management,” Dr. Deming was fond of saying, “In God we trust, all others bring facts.” To determine which cause is more common entails examining available data. From our database we reviewed 8,000 surcharging manholes from across the country, querying the database to determine whether surcharge was caused by overload or lack of hydraulic capacity. The surprising result: over 96 percent of pipe surcharges are caused by lack of downstream capacity. In other words, 96 percent of pipes that surcharge do not achieve their theoretical capacity (see Figure 2).

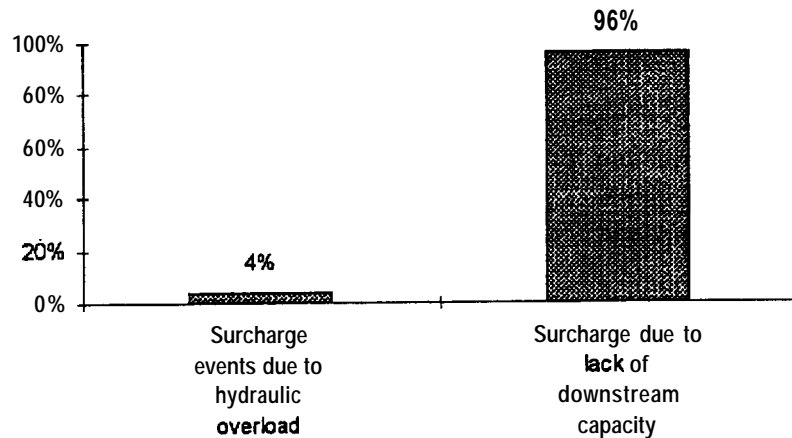

Figure 2. Most sewers discharge well short of their theoretical design capacity.

Why Do Such Downstream Capacity Restrictions Occur?

Downstream capacity restrictions occur because depth increases but velocity decreases. In Figure 3, the depth in this sewer increases significantly while the velocity decreases. When these depth and velocity data are plotted for quantity of flow using both Manning's flow equation and the continuity equation ($Q=AV$), an unusual pattern forms (see Figure 4). Both flow equations match up perfectly during normal flows, but during backwater Manning's equation overstates flow by 250 percent. In other words, this pipe surcharges but the flow rate does not change.

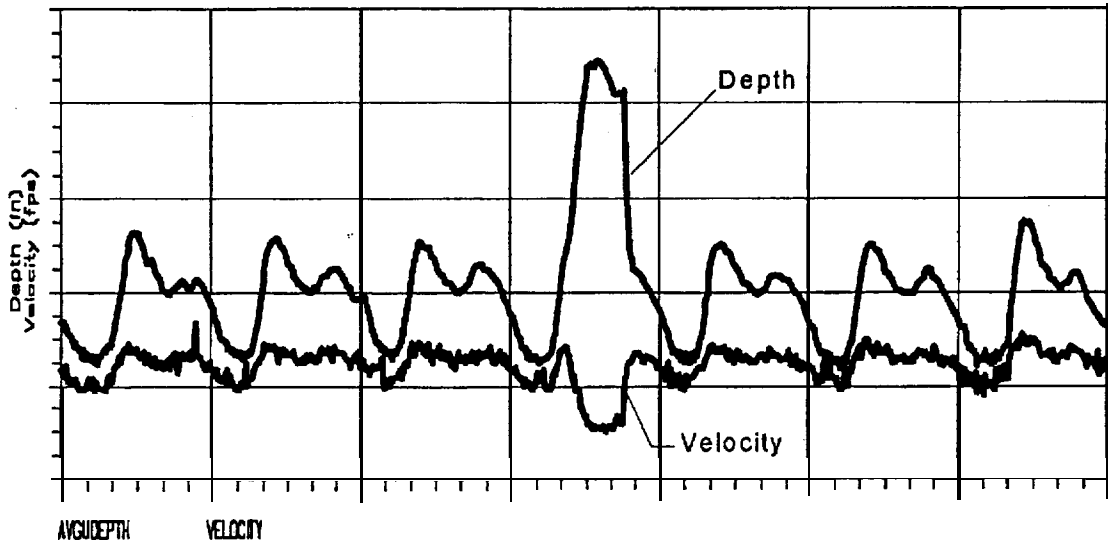

Figure 3. Depth increases but velocity decreases.

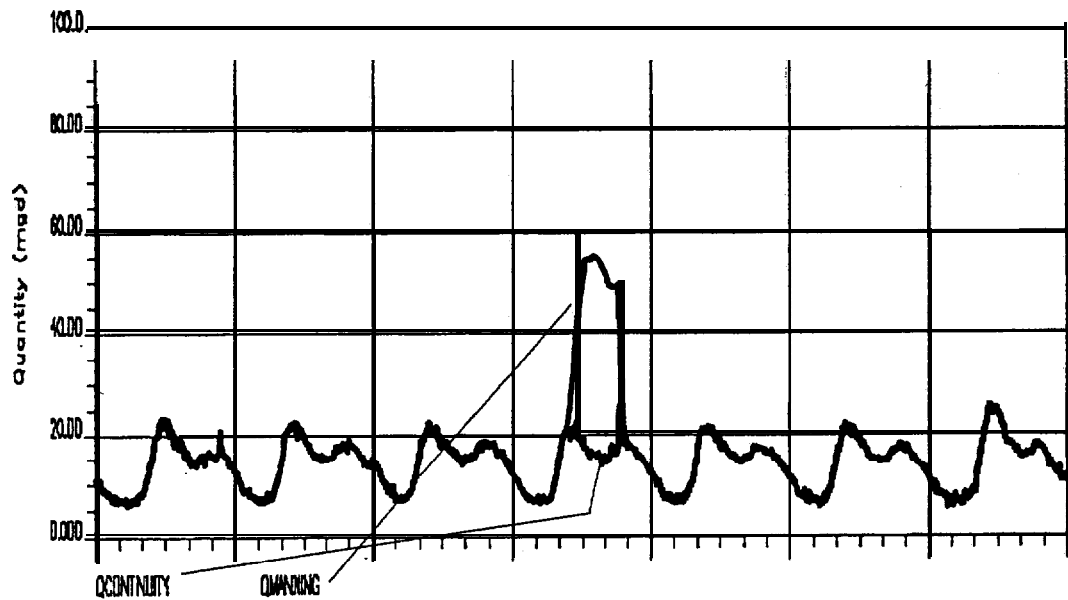
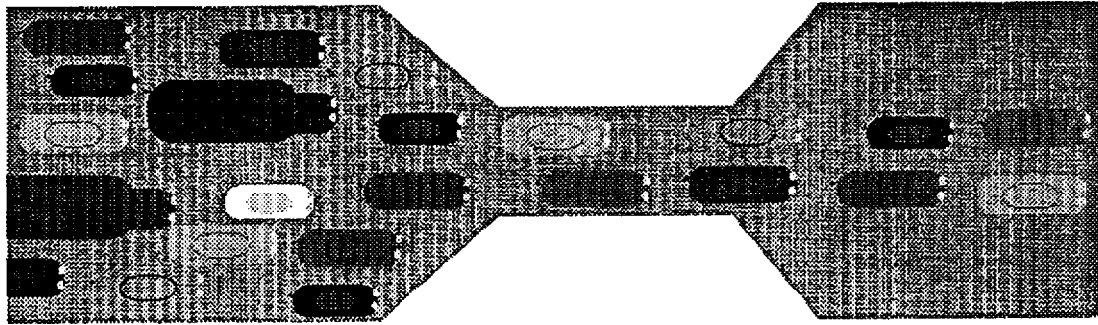

Figure 4. Flow unchanged but Manning's overstates.

Why Does Depth Increase but Velocity Decrease?

The answer is because of downstream hydraulic constrictions that cause a point-specific bottleneck. A bottleneck has the same throttling effect on sewer flow as a two-lane bridge has on six lanes of traffic (see Figure 5). The optimum solution is to remove the bottleneck rather than build expensive additional capacity.



A two lane bridge creates the same throttling effect on traffic as a bottleneck does in sewers.

Figure 5. How many more lanes should be built?

Bottlenecks in a sewer system can create a backwater condition similar to the effect of the two-lane bridge. The sewer system may have adequate theoretical capacity, but its actual capacity is much less. In this sense, each pipe has seven different pipe capacities.

- The theoretical design capacity.
- The capacity as the pipe was actually constructed.
- The present capacity of the pipe.
- The capacity of the pipe as influenced by downstream bottlenecks.
- The capacity that could be obtained if such downstream bottlenecks were removed.
- The capacity that could be obtained if upstream I/I was removed.
- The capacity that could be obtained if downstream I/I was removed.

Figure 6 shows an example of this capacity limitation. During the rain event, depth increases but velocity significantly decreases. Depth increases to the point where the depth exceeds the manhole rim elevation, and an overflow occurs.

Figure 7 shows the depth and velocity data expressed as flow rate instead. Both the Manning's and continuity flow rates are graphed. When viewing these data as flow rates (using the two different flow equations), we see that the pipe surcharges, even though the flow in the pipe increases by only 20 percent. The pipe surcharges (and even overflows) at 2.2 million gallons, although it has almost a 6 million gallon theoretical capacity. The pipe in this case is carrying only about 30 percent of its capacity.

Why Do Such Bottlenecks Occur?

There are four basic types of bottlenecks:

- **Design bottlenecks**, such as a 12-inch pipe being throttled down into an 8-inch pipe or a greater than 90 degree turn. These are rare.

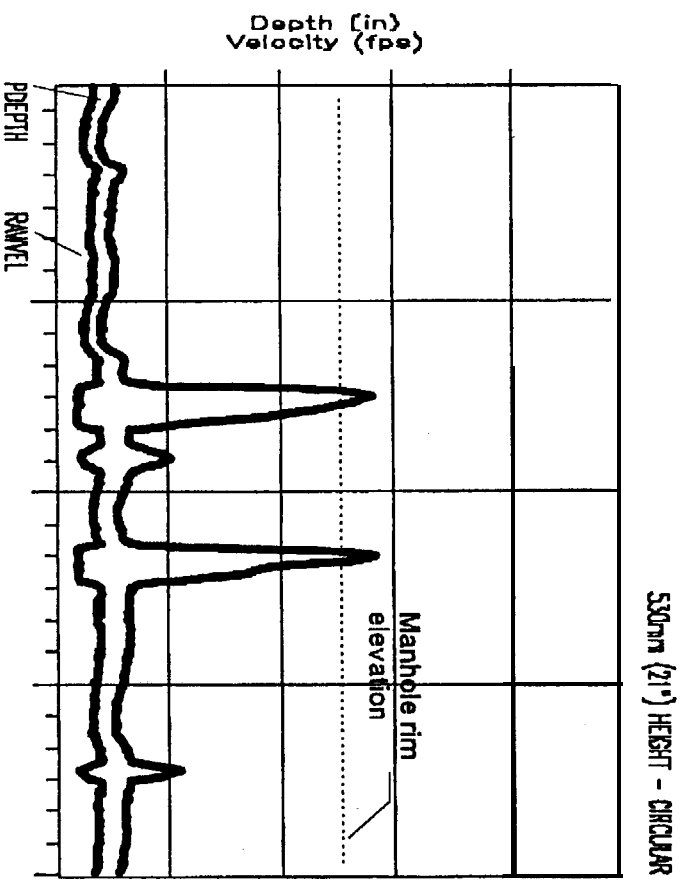

Figure 6. Pipe surcharges, velocity decreases.

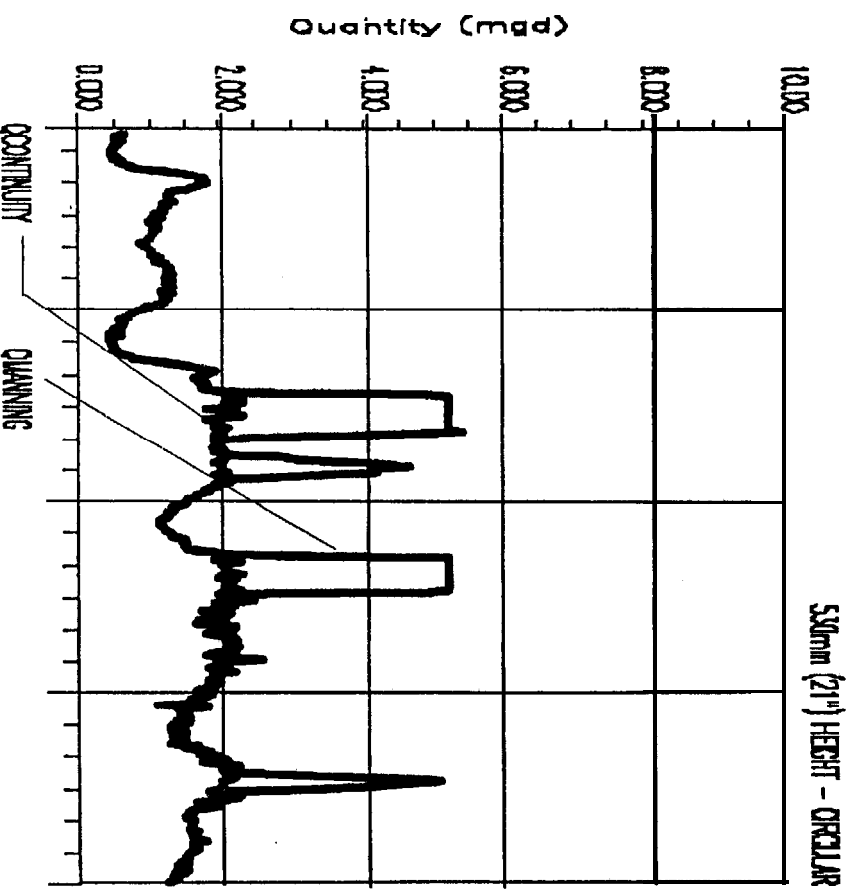

Figure 7. Depth and velocity expressed as flow rate.

- **Construction bottlenecks**, such as sags in the line and offset pipe joints. These are more common.
- **Maintenance bottlenecks**, such as roots and grease. These are more common still.
- **Accidental bottlenecks**, such as those due to vandalism in the form of debris thrown down sewers. These may be the most common type of bottleneck. Their impact on sewer flow is similar to that of a jackknifed tractor-trailer on a freeway (Figure 8).

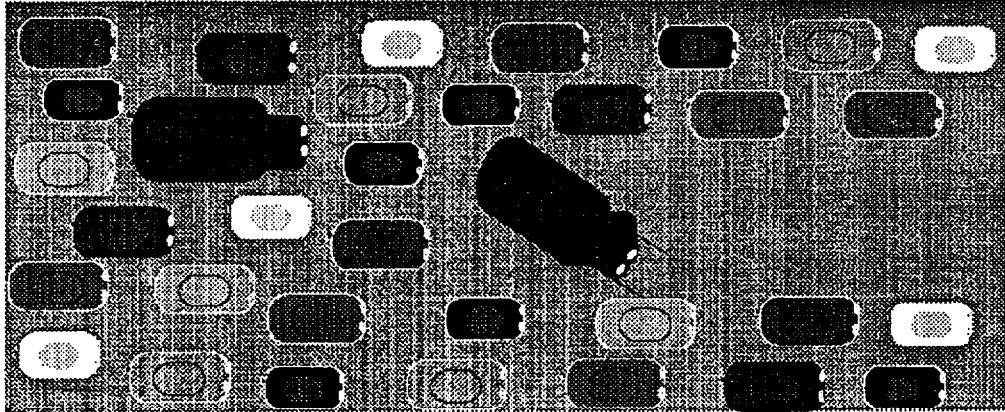

Figure 8. Accidental bottleneck.

Again, the capacity of a sewer system is only as strong as its weakest link. By removing specific bottlenecks, significant reserve capacity can be obtained and extensive construction avoided. As a side note, the only type of bottleneck that can be detected by hydraulic modeling is also the least common: design bottlenecks. Therefore, hydraulic modeling greatly understates the quantity of bottlenecks, unless accurate and intensive minisystem flow monitoring is performed.

The Other Root Cause of SSOs

The other root cause of **SSOs** is extraneous flow due to **I/I**. The extent of this problem is difficult to overstate. Nationwide, **I/I** is almost half of all flow at treatment plants. In addition, a 1-year storm typically generates a four- to tenfold peaking factor in minisystems. Few sewer systems can handle these flows.

I/I is a huge problem, and, significantly, it only worsens over time if it is not removed. Without **I/I** reduction, additional storage will always be required, even without population growth. Fundamentally, in the long run you can never build enough storage. The storage dilemma is well illustrated in Figure 9, from the Sydney Water Board.

Implications of the Root Cause Analysis

Many of the **SSO** control projects assume that **SSOs** are caused primarily by hydraulic overload. Therefore, relief and storage are frequently recommended. Storage is usually inappropriate, however, because a major root cause is downstream constrictions. Eliminating these downstream constrictions is a more appropriate (and far less expensive) solution than storage. Therefore, large scale storage construction projects should be considered the last, not the first, resort.

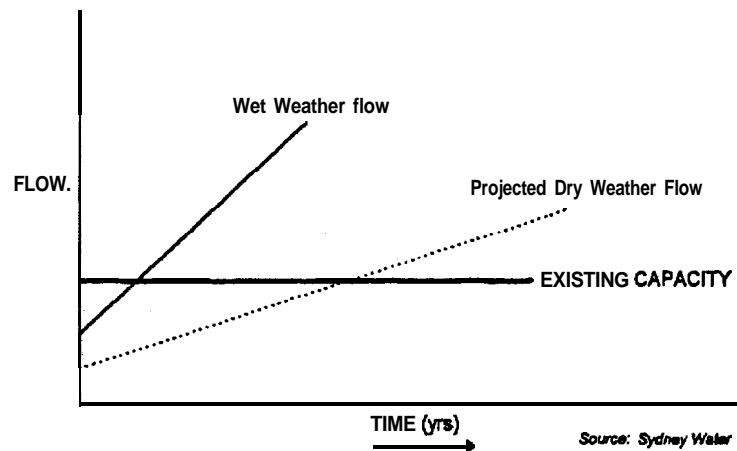

Figure 9. The storage dilemma.

The implications of this root cause analysis should shift some of our paradigms of how to deal with **SSOs**. Six new paradigms have been developed:

- Surcharging is usually caused by downstream bottlenecks and not by hydraulic overload.
- Most surcharging pipes surcharge without reaching their design capacity.
- Most surcharging pipes have significant reserve capacity.
- Storage-only solutions are usually cost ineffective.
- In the long run, you can never build enough storage.
- Attacking the root causes of I/I and bottlenecks greatly reduces projected SSO control costs.

Conclusion

Vigorous application of TQM theory to the SSO problem significantly reduces **SSOs** for, in most cases, a fraction of the projected cost. The TQM root cause analysis process can provide solutions that address the root cause of the problem, rather than the symptoms of the problem.

Additional Reading

1. Petroff, A.M. 1995. Digital doppler velocity technology improves performance and accuracy of sewer flow measurement. Presented at the WEF Specialty Conference, Minneapolis, MN (June).
2. Stevens, P.L. 1994. Characterizing combined sewer systems. Presented at the annual IPWCA conference (November).
3. Petroff, R.G. 1994. Infrestretching: Meeting mandates with less money. Presented at the WEF conference, Richmond, VA.

4. **Cadden, R.E., and P. West.** 1985. The design and implementation of strategies to manage dry and wet weather wastewater flows in the Sydney region. Presented at the Australia Water and Wastewater Association conference (April). Sydney Water, Level 1, 285 Crown St., Surry Hills, New South Wales 2010, Australia, 612-339-9375.

Modeling Inflow and Infiltration in Separated Sewer Systems

Robert Swarner and Michael Thompson
King County Department of Metropolitan Services, Seattle, Washington

Introduction

Flows in a separated sewer system, by definition, are not intended to be influenced by rainfall-induced infiltration and inflow (I/I). Many separated sewer systems, however, do experience significantly increased flow during and after storm events. Peak flows in these leaky systems can be five to ten times the average dry weather flow. This increase in peak flows causes several problems for local public agencies and regional governments.

The adequate design of conveyance and treatment facilities requires the estimation of peak flows. Conveyance facilities are designed to handle peak flows and to avoid sanitary sewer overflows (SSOs). Outfall pipes from treatment facilities are also sized to pass the peak flow. All extraneous I/I contributes to the additional costs of conveyance and treatment facilities.

Efforts have been somewhat successful in developing empirical relationships between antecedent rainfall and I/I (1). Empirical relationships between rainfall and I/I are limited in that the distinction between infiltration and inflow can be quite fuzzy. A computer model is needed that can distinguish between infiltration and inflow and provide increased knowledge of I/I sources. The information gained from this type of model can be used effectively to estimate the cost-effectiveness of I/I reduction efforts.

This paper presents an innovative method of modeling I/I in a separated sewer system. The model was developed by and for the King County Department of Metropolitan Services (Metro), which serves the area around Seattle, Washington.

Sources of Inflow

Inflow to sewer systems can enter from a number of sources, such as:

- Street drains connected to the sewer system
- Rooftop leaders connected to the system
- Manhole covers that are not sealed
- Sump pumps
- Streams or springs connected to the sewer system
- Overflow from storm drains

One Metro employee stated that it was standard practice for a park department in which he had worked to connect problem springs to the sanitary sewer system. Overflow from stormwater pipes may also contribute flow into the sewer system, as has been found to occur in Seattle. Figure 1 displays potential sources of inflow and infiltration in a cutaway view of a sewer lateral connection.

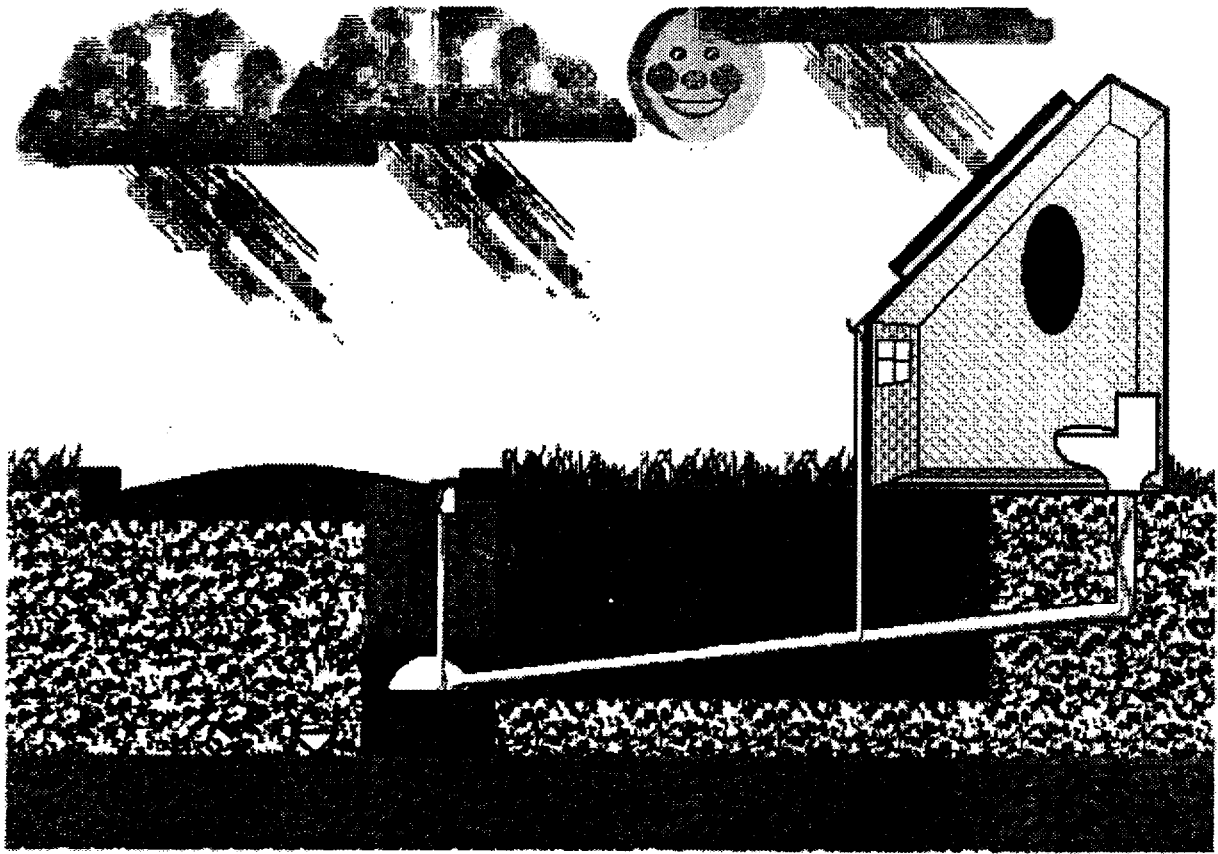

Figure 1. Sources of inflow and infiltration.

Sources of Infiltration

In a combined system, the contribution from direct runoff dwarfs the flow from infiltration during large rainfall events. In a separated sewer system, however, the flow from infiltration can be the dominant contributor to peak flow.

Two fundamental mechanisms are assumed to be contributing to this infiltration into the sewer pipes. The first mechanism is rainwater percolating into the ground and concentrating in the filled-in trenches that were dug for the sewer pipes (see Figure 1). Connections of house laterals to street sewers are the prime suspect of predominant leakage. Loose joints in the sewer pipe and deteriorated pipes are other means of water entering the sewer system.

Generally, the pipe trenches are dug, and a structural material is placed in the bottom. This structural base for the pipe is placed to inhibit settling and consists largely of sand and gravel, which are very porous. As rainwater seeps into these trenches, and in particular, into the sand and gravel surrounding the sewer pipe, it can easily be conveyed along the trench until a crack or loose joint is encountered, whereupon it enters the pipe as infiltration.

The second mechanism for infiltration is the ground-water table. Infiltration into pipes lying below the ground-water table occurs in dry weather. This infiltration increases as the ground-water table rises but decreases as the water table falls. Ground water recedes at a slower rate than water in the sewer pipe trenches recedes.

Infiltration/Inflow Model Development

Metro has done extensive flow monitoring and computer model development and calibration to quantify the I/I experienced in large portions of its separated collection system. An innovative and informative approach has been developed to estimate the I/I that will enter the separated sewer system during rainfall events.

The new methodology incorporates the runoff computer model that is used for the combined portion of Metro's collection system (2). The runoff model simulates the runoff of stormwater using a kinematic wave approximation for overland and minor sewer flow. Detention depth is used to remove the initial rainfall before excess rainfall begins to contribute to sewer flow. Flow from both impervious and pervious areas can contribute to the sewer flow.

Components of Flow Modeling

Metro's computer model simulates the following components of flow:

- **Base** flow (does not include dry weather infiltration)
- Rainfall-dependent inflow
- Dry weather infiltration
- Rainfall-dependent infiltration
- Long-term ground-water leakage

These five components of flow in the sewer system provide an increased understanding of the collection system and give an indication of the major problem sources. Knowing the probable source of I/I beforehand can increase the effectiveness of a project attempting to correct the problem.

Modeling Base Flow

Metro has recently completed a study estimating the population in 105 basins in the service area. The population estimates were based on 1990 Census data. **Sewered** population was obtained from overlaying both **sewered** area maps and septic system area maps on the map of Metro's service area. The fraction of population **sewered** was then estimated. Population projections were then made for the next 40+ years for use in alternatives analysis of future facilities.

Per capita base flow factors were used with the 1990 population estimates to provide an estimate of base flow (which, in Metro's nomenclature, does not include dry weather infiltration). The base flow factors used were:

- Residential: 60 gallons per capita per day
- Commercial: 35 gallons per employee per day
- Industrial: 75 gallons per employee per day

The residential flow factor of 60 gallons per capita per day has been used for planning purposes within Metro for over 10 years and is generally accepted within the agency. The industrial factor of 75 gallons per employee per day was derived from adding the permitted industrial process flow (40 gallons per employee per day) to the commercial employee factor.

The commercial flow factor was derived using a hydraulic routing model to simulate flow through a major portion of the Metro conveyance system. A reasonable diurnal variation of flow from each subbasin was used as input to the model. The attenuated model result at the flow monitoring site was compared with actual flow data collected at the site. The commercial factor of 35 gallons per employee per day was derived by adjusting the commercial factor (along with the industrial factor) and dry weather infiltration until a good match of the modeled and actual flows was achieved at the flow monitoring site. The commercial contribution varies throughout the day and the dry weather infiltration is expected to be constant throughout the day, so a different downstream response was achieved by increasing one as opposed to the other. The resulting factors fit the flow data at the treatment plant quite well when dry weather infiltration is taken into account.

Modeling Direct Inflow

Inflow models from **sewered** collection systems have been available for many years. Available models range in complexity from the rational method to sophisticated mathematical models. The Runoff Block of Storm Water Management Model (SWMM) is an example of a mathematical model that makes use of the kinematic wave simplification of the full St. Venant equations of flow to simulate overland flow. The Transport Block of SWMM uses the same simplification of the flow equations to simulate the flow through the minor sewers.

Metro uses a similar runoff/transport model to simulate base flow and runoff from impervious and pervious areas into the sewer system. The Green-Ampt equation of rainfall infiltration into the soil is used in Metro's model. Direct inflow from both pervious and impervious areas is simulated in the model. Direct inflow is the easiest to model because it is apparent first with any storm. Because even the small storms contribute direct inflow, there are generally several storms from which good data can be used for calibration of surface runoff factors.

Modeling Infiltration

Problems in Modeling Infiltration

There are several obstacles to modeling infiltration. The first obstacle is obtaining good rainfall and flow data. Rainfall data must be available to give a reasonable estimate of the rain that fell over the entire basin during a period of significant rainfall for which flow monitoring data are available. Metro/King County has about 35 rain gauges in the 240-square-mile service area. The gauges are generally in the combined sewer area or on the perimeter of the separated sewer area.

Good quality flow monitoring data from key locations in the system are a necessity. Most of Metro's transportable flowmeters gather depth and velocity readings. The point-velocity flow from the meter is compared with the flow calculated from Manning's equation. If significant differences exist, a judgment is made as to which is more indicative of the actual flow in the sewer. The meter may also need to be checked to determine whether the level sensor is calibrated correctly.

Metro has 63 Marsh-McBirney Flo-totes in the collection system. Roughly half of these are short-term, the other half long-term. Flow calculations are performed for several pumping stations. Magnetic flowmeters are also installed on force mains in pumping stations. The data evaluated to be the best at each location were used in developing and calibrating the I/I model.

Infiltration comes from unknown sources, through unknown ground conditions, into pipes whose condition is somewhat or altogether unknown. These factors complicate the development and calibration of an infiltration model.

Modeling Dry Weather Infiltration

Dry weather infiltration is determined by subtracting the base flow (derived from population estimates) from the flow measured at a particular site after several weeks of dry weather. Some pipes are always below the ground-water table, because they lie below the water surface level in nearby lakes, rivers, or bays. Therefore, some dry weather infiltration is expected in these subbasins.

Modeling Rainfall-Dependent Infiltration

The model simulates flow into the trenches in which the sewer pipes lie, and then the flow into the pipes from the trenches. The flow out of the trenches to the ground water is also simulated. Calibration of the rainfall-dependent infiltration is the most complicated part of the model calibration process. The following factors must be estimated:

- Soil parameters
 - Hydraulic conductivity
 - Suction head
- Trench capacity
- Threshold storage at which time flow to pipes begins
- Relationship of storage versus flow into pipes
- Peak rate into pipes
- Rate of flow going to ground water

The Green-Ampt equation is used to compute the maximum infiltration rate into the soil. This maximum rate changes during the storm depending on antecedent moisture conditions. When rainfall exceeds maximum infiltration rate, excess water runs off. When the rainfall rate is less than the maximum infiltration rate, then all of the rainfall on the pervious area infiltrates into the soil and contributes to soil moisture and trench storage.

Additional factors that are used to vary the long-term ground-water contribution are:

- Decay rate of soil moisture, which varies with moisture content
- Relationship between infiltrated volume and ground-water contribution

Model Calibration

Four storms with return intervals from 1 to 20 years occurred in the Seattle area between December 1989 and April 1991. This was fortunate for Metro in that these storms could be used to calibrate the newly developed computer model using the population estimates based on the 1990 Census data.

Metro staff used the hydraulic routing model "UNSTDY" to simulate the routing of flows from the runoff model basins through the major conveyance pipes (3). The match between recorded flow and simulated flow using this model is shown in Figures 2 through 6 for various locations in the system.

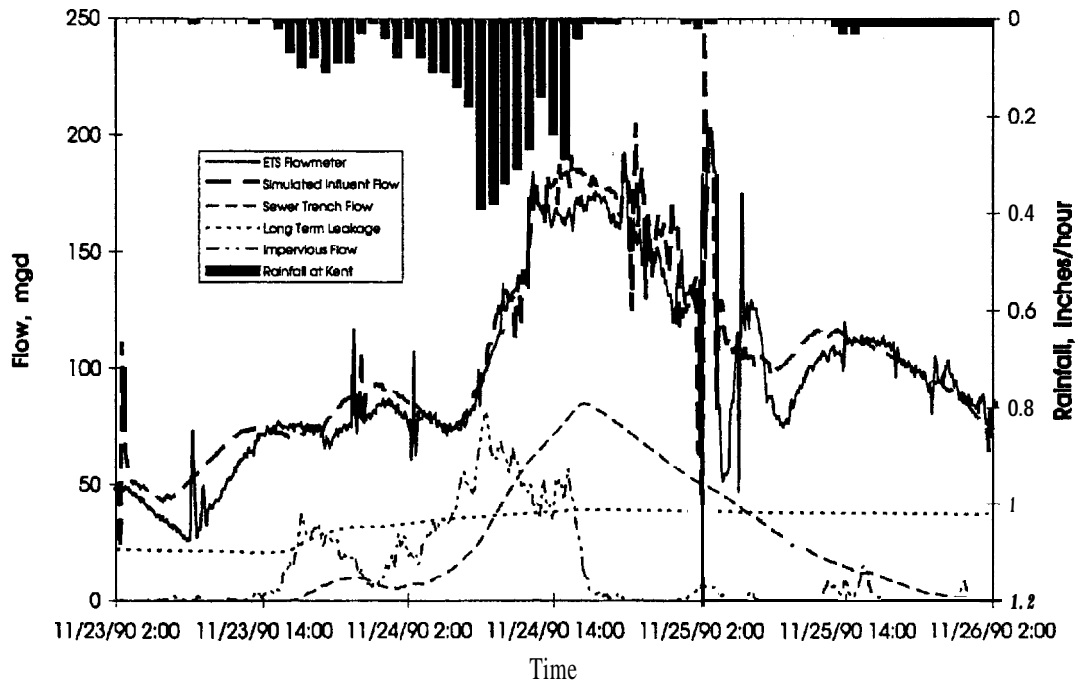

Figure 2. November 1990 EDRP model results.

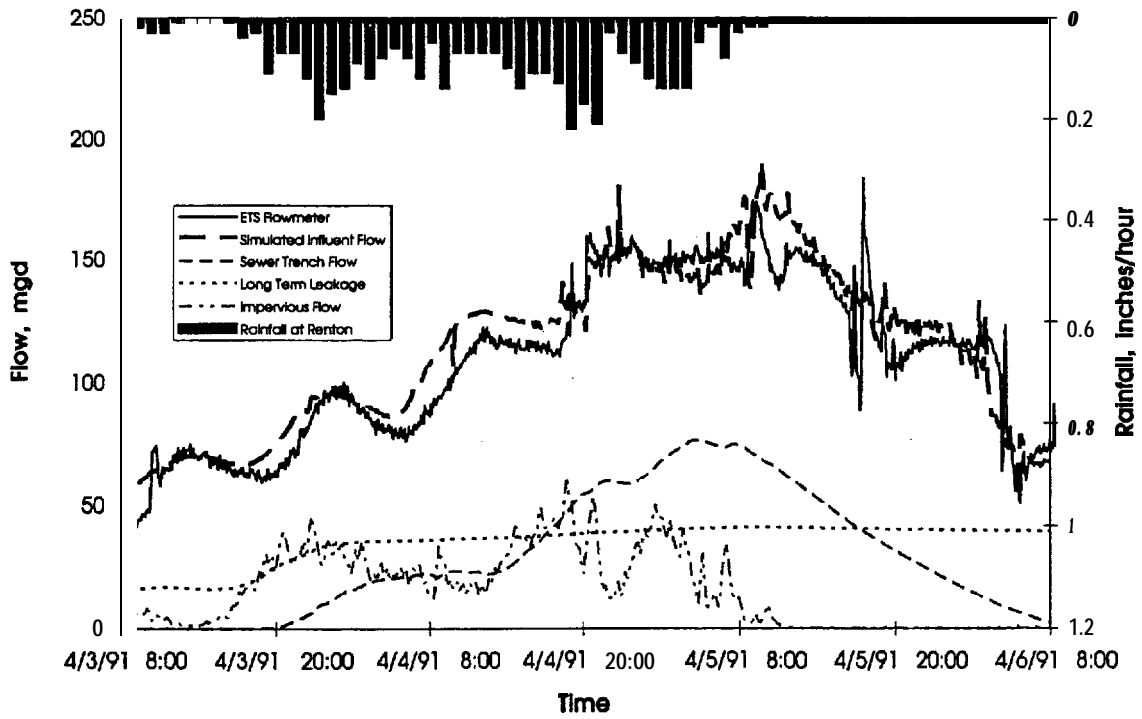

Figure 3. April 1991 EDRP model results.

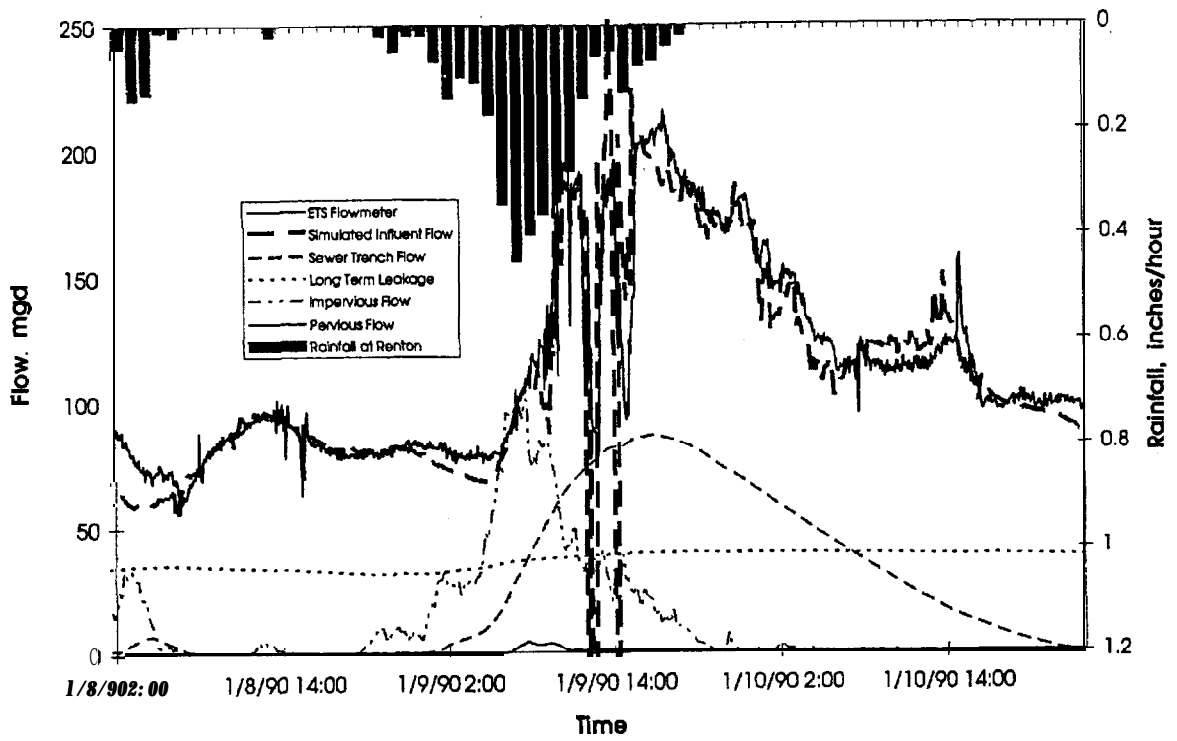

Figure 4. January 1990 EDRP model results.

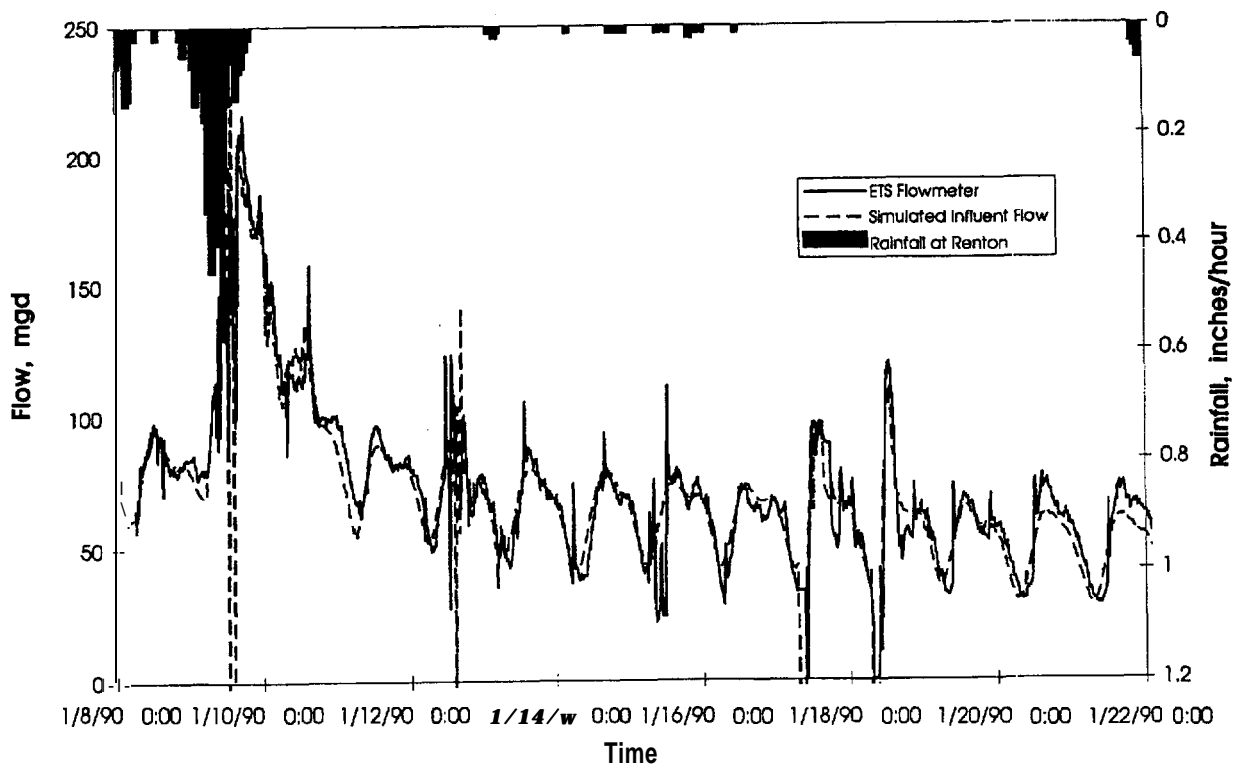

Figure 5a. January/February 1990 EDRP model results.

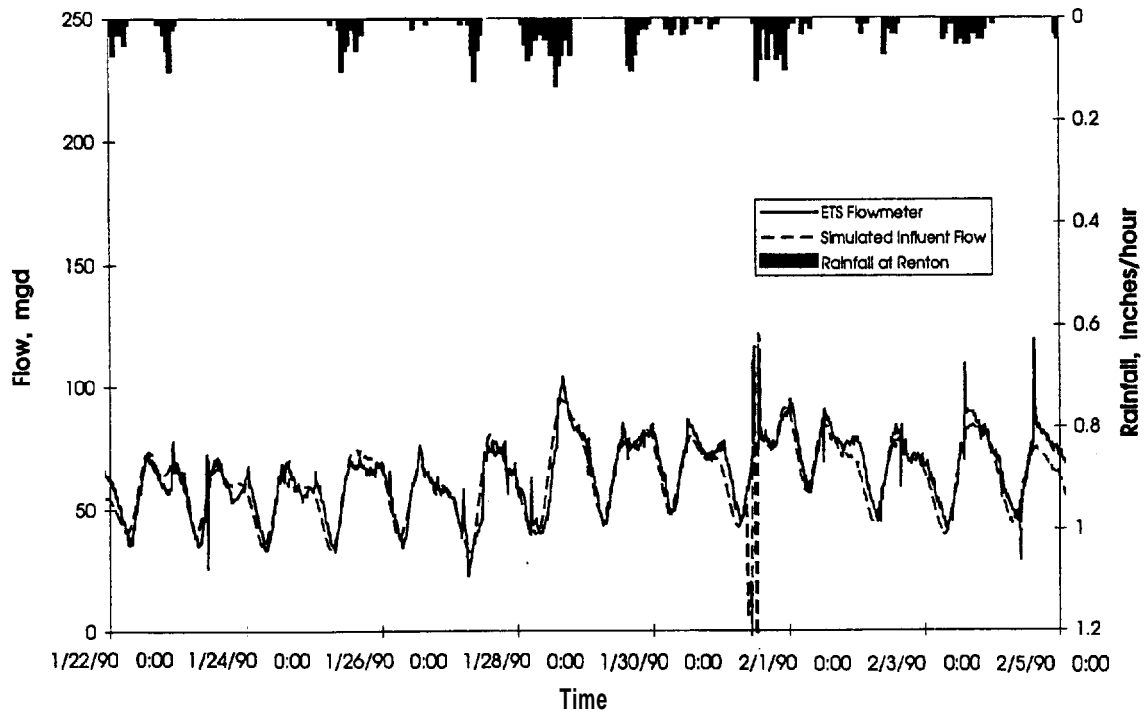

Figure 5b. January/February 1990 EDRP model results.

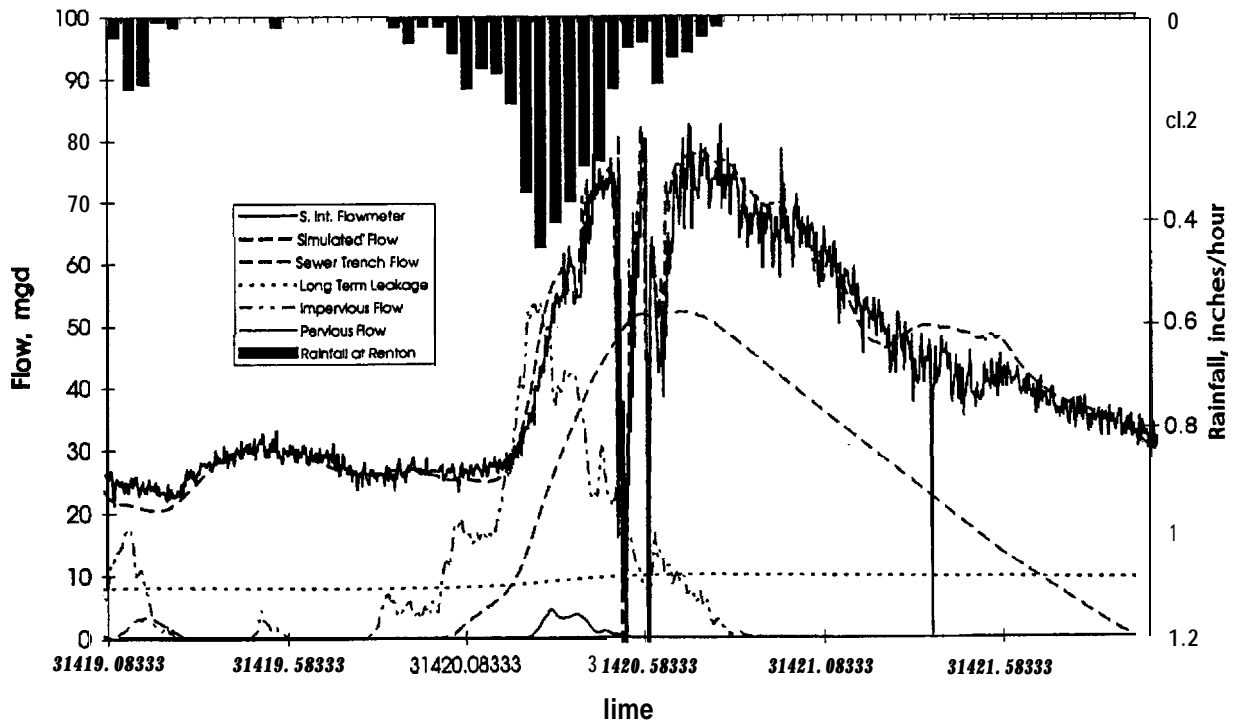

Figure 6. January 1990 South Interceptor model results.

Model Results

Each of the I/I components are displayed on the graphs in Figures 2 through 4 and 6. There is very good agreement between model output and flow data. The model was verified by simulating storms for which the model was not calibrated. Good results were obtained on these storms as well.

Figures 2 through 5 show the results for the Renton Service Acres (136 square miles). Figures 5A and 5B show the simulated and measured data during a 6-week period during and after a large storm at the East Division Reclamation Plant (EDRP) at Renton. The decay of infiltration is evident during this period. These graphs reveal the results of the model on smaller storms. The flow stoppages displayed on the graphs were the result of the influent gates closing because of problems with the effluent pumps or within the plant. Stoppages in the simulated flow were a result of events in the simulation that would cause the influent gates to close.

Model results for the South Interceptor are shown in Figure 6. The results of the calibration of several storms produced a calibrated model in which Metro staff can place confidence. The resulting hydrographs represent the response of each basin as a whole.

In the case of the South Interceptor (a 56-square-mile basin divided into 30 subbasins), individual subbasins may be leakier or tighter than the average of the whole basin. It was later found that a 5.8-square-mile subbasin responded very similarly to the whole basin, but in two basins of only 9 to 24 acres the inflow was much less and the infiltration much higher than average. This variation in specific response is to be expected for very small basins.

Basins with very small sizes (9 to 24 acres) were modeled to evaluate the effectiveness of sewer rehabilitation efforts. The information from this type of modeling is important to indicate whether these particular subbasins are representative of the entire basin. Because there is a large difference between the basin as a whole and the small subbasin, one should not assume that the same rehabilitation results could be expected everywhere in the large basin.

In the large South Interceptor service area, it was found that 2.5 percent of the impervious area is connected to the sewer system; in other words, the stormwater from 2.5 percent of the impervious area enters the sewer system directly. The largest portion of a 20-year peak flow is contributed by infiltration of the water that collects in the filled-in sewer trenches. Figures 2 through 6 reveal that base infiltration is the largest contributor to I/I in the systems at the beginning of the storms. Later, direct inflow becomes the largest contributor in several basins. Finally, after a large volume of rainfall, the rainfall-dependent infiltration is the dominant influence.

Peak Flow Analysis

Once the basin parameters were calibrated to measured data, a long-term rainfall record was used to generate statistics on flows that would be expected at the particular sites. Forty-three years of rainfall data from the SeaTac Airport were used to simulate a long-term record through the runoff/transport model. The flows were then routed through the hydraulic routing model, and a flow frequency curve was generated for each point of interest. The peak flow with a 20-year return interval is of particular interest to Metro staff for use in the design of conveyance facilities.

Benefits of the Inflow/Infiltration Model

A model of this type has several uses. It provides a much clearer picture of what is happening in the basin than a simpler model does. Metro staff used this model and the information gained from it to:

- Determine peak flows of various return intervals by simulating 43 years of rainfall record.
- Plan and design conveyance and treatment facilities based on the peak flow estimates.
- Quantify the I/I problem in the service basins.
- Quantify the differences in I/I between basins.
- Determine whether the bulk of the I/I is from infiltration or from direct inflow.
- Compare the I/I contribution from various basins in the service area.
- Evaluate effectiveness of sewer rehabilitation projects.
- Estimate the impact of various I/I control options (e.g., how much would peak flow be reduced if direct inflow were eliminated?).
- Determine where additional flow monitoring would be most effective.
- Compare measured data with simulated data for a couple of storms, and determine whether the basin upstream of the meter is a prime candidate for rehabilitation or whether it is fairly tight.

The improved runoff/infiltration model is useful in simulating the response of the combined system, especially when doing continuous long-term modeling of the collection system. Infiltration into the pipes between storms can have a significant effect on the available capacity in the collection system when storm flow arrives.

Summary

The King County Department of Metropolitan Services has developed a model for simulating the I/I into its separated sewer system. The model has been calibrated for basins ranging widely in size and has been found to give a credible simulation of both inflow and infiltration in both dry and wet weather. The model is being used to plan conveyance and treatment facility needs in the future. The model also provides the highly useful information of how much of the peak flows is the result of inflow and how much is from infiltration. This information has been used to evaluate control options for reducing I/I in the separated sewer system. The model also is being applied to the combined collection system and incorporated into the CSO planning effort that is under way at Metro.

References

1. Merrill, M.S. and R. Butler. 1993. New dimensions in infiltration/inflow analysis. Proceedings of the WEF 1994 CSO Specialty Conference, Louisville, KY. pp. 6-1-6-10.
2. Vitasovic, Z., R. Swarner, and E. Speer. 1990. Real time control systems for CSO reduction. *Water, Environment, and Technology* 2(3):58-65.
3. Swarner, R. and Z. Vitasovic. 1989. Simulation of large urban wastewater conveyance system. Proceedings of 16th Annual Conference of Water Resources Planning and Management, Sacramento, CA. pp. 222-225.

Computer Modeling of Sanitary Sewer Overflows Resulting From Peak Flow Conditions

Marc P. Walch, Thomas J. Christ, Kathleen S. Leo, and Stephanie L. Ross
Post, Buckley, Schuh & Jernigan, Inc., Winter Park, Florida

William M. Brant
Miami-Dade Water and Sewer Department, Coral Gables, Florida

The impetus for accelerating improvements to the Miami-Dade Water and Sewer Department (MDWASD) sewer transmission and collection system is a negotiated settlement contained within a Consent Decree with the U.S. Environmental Protection Agency (EPA). MDWASD has undertaken an improvement program to ensure the long-term adequate capacity of the transmission system, including a study to determine rainfall-dependent infiltration and inflow (RDII), and procedures for the management of peak flows. Dade County is currently restricted in its ability to issue new building permits for new sewer connections for which additional flow would result in any pumping station violating its operating criteria related to peak flows. Through the use of metered data at representative pump stations, realistic and unique unit influent hydrographs will be developed for each of MDWASD's approximately 900 pump station service areas (PSAs). Combining the unique hydrographs into hydraulic models of MDWASD's sewer system with specialized modeling software will result in the ability to predict sanitary sewer overflows (SSOs).

The sanitary sewer collection system of the MDWASD has experienced surcharging and overflows during wet weather. Flow monitoring and Sewer System Evaluation Surveys (SSES) performed within the system have determined that the cause of these overflows is excessive infiltration and inflow (I/I) entering the system during wet weather in conjunction with insufficient conveyance and/or system storage capacity. The primary purposes of the rainfall-dependent peak flow management study are 1) to develop unit influent hydrographs for the collection and transmission system model, and 2) to perform an evaluation of the adequacy and additional needs of the pump station systems to store and/or convey peak wet weather flows without system overflows.

MDWASD's sewer system is expansive. MDWASD provides sewer service to all of Dade County with the exception of septic systems. This includes 13 municipalities and more than 239,000 retail customers. The system covers approximately 400 square miles and includes approximately 900 pump stations and 1,500 miles of force main. The flow from the system goes to one of three wastewater treatment plants: one located in the northern, one in the central, and one in the southern portion of the county. The total 1995 plant wastewater treatment plant capacity is 355.5 million gallons per day. Flow can also be shifted between the three plants by several booster stations. The ability to transfer flow to different areas in the system is critical in preventing SSOs.

Prediction of overflows requires careful definition of wastewater flows. Wastewater flow components can typically be broken into three main components: base wastewater flow (BWWF), ground-water infiltration (GWI), and RDII. BWWF is domestic (or sanitary) wastewater generated from residential, commercial, and institutional sources, plus industrial wastewater. GWI is defined as ground water entering the collection system through cracked or defective pipes, pipe joints, and manhole walls. The magnitude of GWI depends on the depth of the ground-water table above the pipelines, the percentage of the system that is submerged, and the physical condition of the system. The variation in ground-water levels in the study area, and hence the amount of GWI, is seasonal in nature. RDII is stormwater that enters the collection and trunk sewer system. For Dade County, RDII is a direct response to the intensity and duration of individual rainfall events. These three components make up a total flow hydrograph that shows the quantities of flow over a given period. Figure 1 illustrates a typical flow hydrograph. From the data collected, actual I/I will be extracted. In 1994, BWWF (excluding RDII) for the MDWASD system was approximately 126 million gallons per day. System infiltration from retail customers was estimated at

approximately 81 million gallons per day; however, this number did not distinguish between GWI and RDII.

To develop representative unit hydrographs for each pump station, the **PSAs** were grouped into representatively similar categories. The parameters considered in the grouping process include type of construction material and system rehabilitation data; density of service connections; average age of the gravity sewer system; soil type and permeability; maximum, minimum, and average yearly ground-water elevations; proximity to surface water bodies; tidal influence; ratio of pervious to nonpervious surface area; land use; historic *I/I* data; seasonal population patterns; and collection system construction materials. To complete this task, continuous flow monitoring data are being collected and revised from as many as 125 gravity flow measuring devices. Through analysis of the flow monitoring and rainfall data, relationships will be developed to correlate **RDII** flow into the system with rainfall within the **PSA** groupings for which field data were collected. Evaluation criteria for the **PSAs** will be developed to include the following:

- A planning storm event for which the system shall control wet weather flows without overflows.
- Appropriate storage volumes within each **PSA** based on estimated ground-water elevations, volume of gravity system, and extent of surcharging that can be used without violating the state, local, or EPA criteria established.
- Appropriate pump station peaking factors necessary to accommodate **RDII** flows.
- Recommendation as to means of storage and location of wet weather storage/treatment facilities if flows exceed the design conditions.

Currently, flow meters have been installed in all representative **PSAs**. Unit hydrograph parameters will be calibrated for those areas where flow monitoring data have been collected. Calibrated parameters will be extrapolated to other pump station service areas within the same group and used to predict **RDII** hydrographs from unmonitored areas in the system. The result of this study will be to correlate peak flows to rainfall and **RDII** characteristics, rather than use arbitrary or standard peaking factors when modeling. Through metered data and unit hydrograph analysis, realistic unique **influent** hydrographs will be determined for each pump station. The hydrographs will be input into the model to create a simulated dynamic event. (See Figure 2 for sample of data obtained for Pump Station 524 in February after a rainfall event.)

The 900 pump stations were divided into 17 groups. The groups comprised at least three to nine representative pump stations to be monitored. The Consent Decree required field testing of at least 10 percent of the total pump stations within a group, but never fewer than three pump stations. Within each group, pump stations were selected at random to demonstrate that the pump stations in one group do in fact have similar peak flow characteristics. Selections were made to avoid tributary pump stations (or flows from the tributary pump stations were small relative to the flow within the monitored service area). Service areas selected for flow monitoring were to represent a range of typical service area sizes for a given group. First and second choices were made for desired installation of each meter. First choices were primarily pump station wetwells. Second choices were manholes, typically those closest to the pump station. The selection of manholes was based on estimated representative flow characteristics and accessibility. The flow meters in use are Marsh-McBirney, Inc. (Flow-Tote), meters.

MDWASD is also simultaneously undergoing a sewer rehabilitation program. MDWASD staff members were alerted that during the monitoring period they should avoid areas scheduled to have rehabilitation performed. Rehabilitation during the flow monitoring study could invalidate the flow results as representative of that group. Plans were made to calibrate all flow monitoring sites to ensure the highest degree of accuracy possible. Accuracy is crucial because hydrographs generated from the flow data will be used to calibrate the computer model.

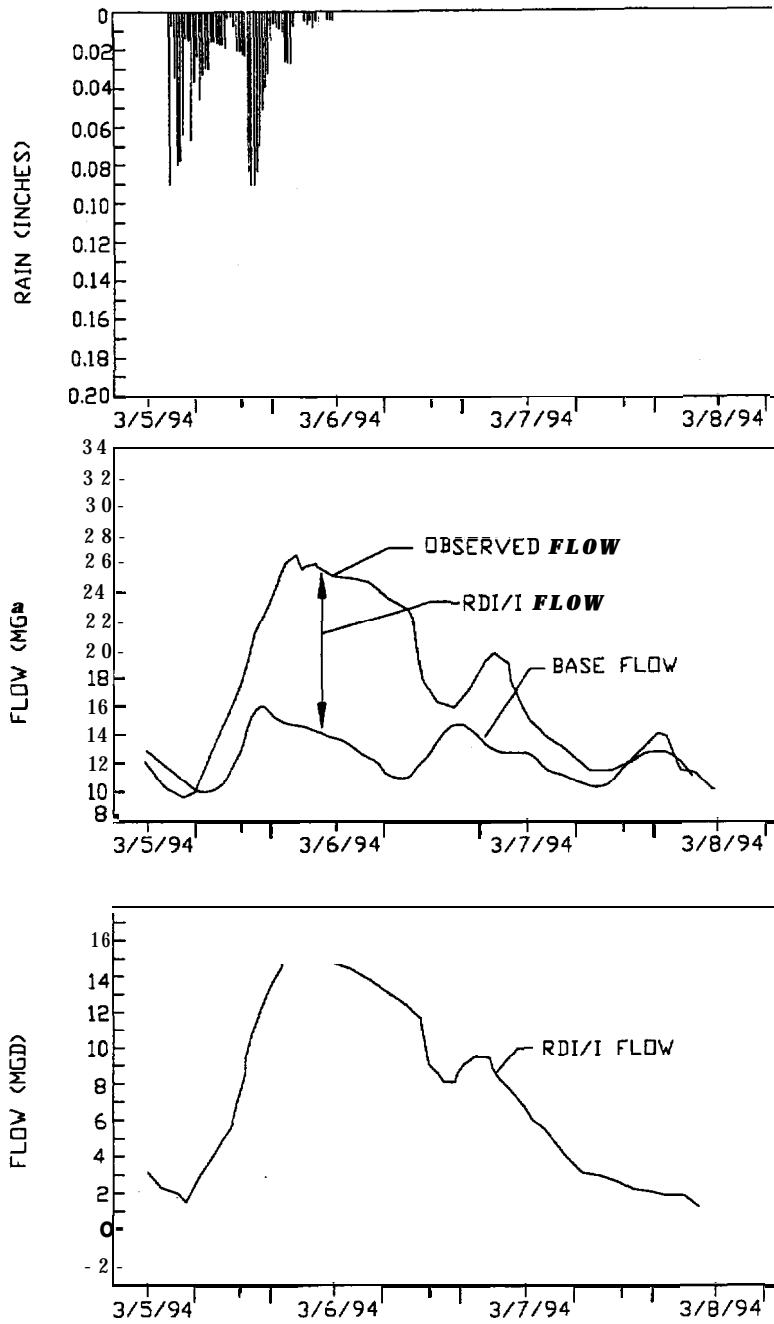

Figure 1. MDWASD peak flow management study: hydrograph decomposition.

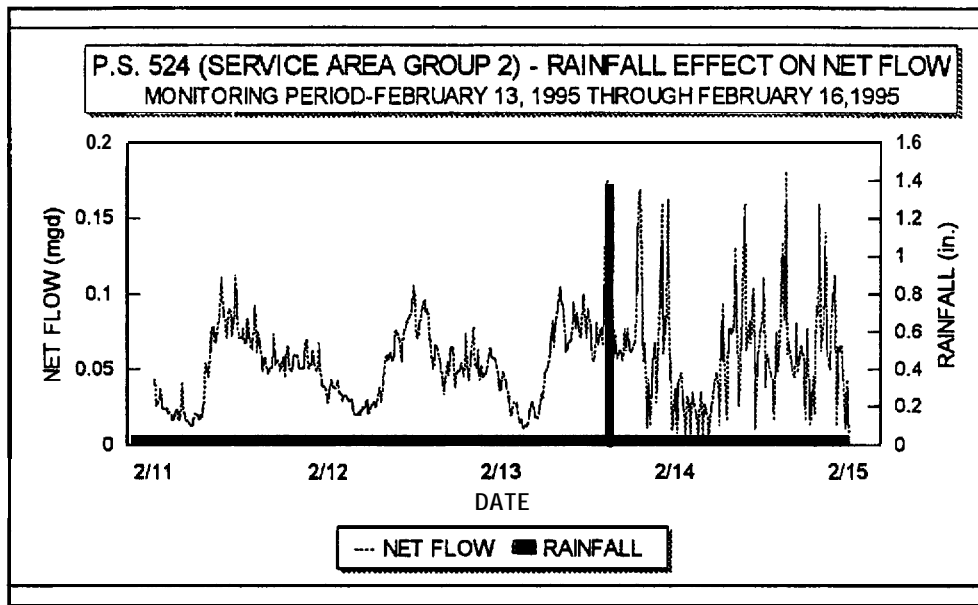

Figure 2. Pump Station 524: rainfall effect on net flow.

The model being used to predict potential SSOs is XP-SWMM by XP-Software. Influent hydrographs will be incorporated into the model, which, when completed, will have great predictive power, allowing for the accurate determination of flows and pressures throughout the collection and transmission systems. With the incorporation of the peak flow management study, the model will be capable of determining the location and quantity of potential system overflows and flow impacts on wastewater treatment plants during simulated rainfall events, based on the storm event, location, and rainfall amount. Once incorporated into the XP-SWMM model for hydraulic analysis, recommendations for MDWASD's sewer collection and transmission system will be made.

The XP-SWMM model uses EPA's SWMM solution module. XP-SWMM is capable of modeling gravity and force main systems dynamically over time. XP-SWMM also allows for input of influent hydrographs to the system. Samples of XP-SWMM's input screens are shown in Figures 3 and 4. Figure 3 illustrates a simplified model segment. The sample segment contains a manhole and a gravity pipe, which leads to a pump station (represented by a pipe) with a wetwell (shown as a node). Discharging from the wetwell is a force main (fm 1). Figure 4 illustrates a sample inflow hydrograph, which controls flow input to the manhole. The accuracy of the hydrograph and other inputs to the model are crucial. With wet weather inflow hydrographs, potential system overflows will be simulated.

In XP-SWMM, potential overflows can be seen both visually and dynamically (over time). Figure 5 shows a cross section of the sample model segment shown previously. The results can be played out in a movie format. When an overflow occurs, water levels at a wetwell will rise above the manhole invert elevation. The elevations shown in Figure 5 are for demonstration purposes only. As the figure illustrates, the pump is currently pumping at a head of approximately 107 feet. As the wetwell fills, an overflow will occur at 95 feet. The driving force for predicting this SSO is the inflow hydrograph illustrated in Figure 4.

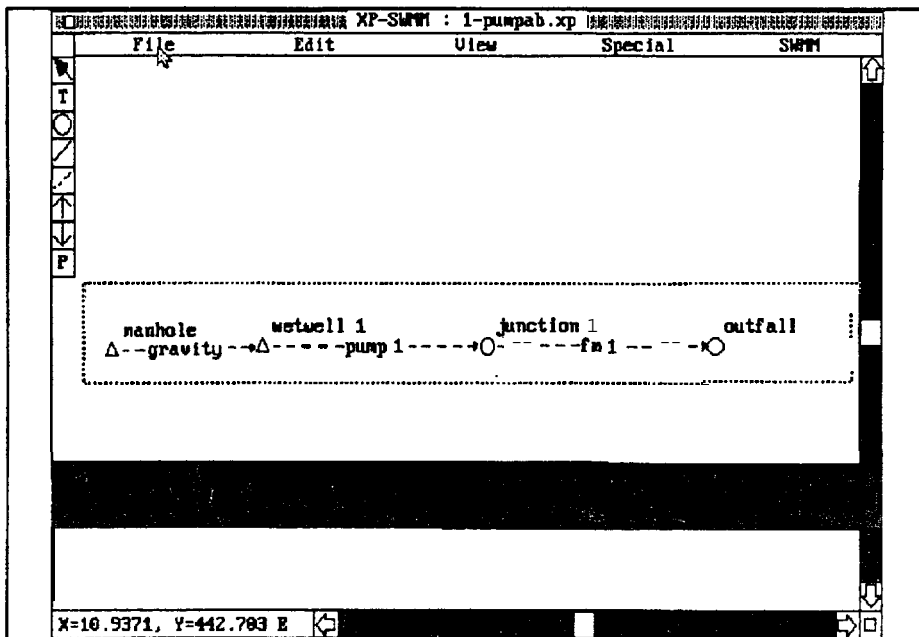

Figure 3. Simplified model segment from XP-SWMM.

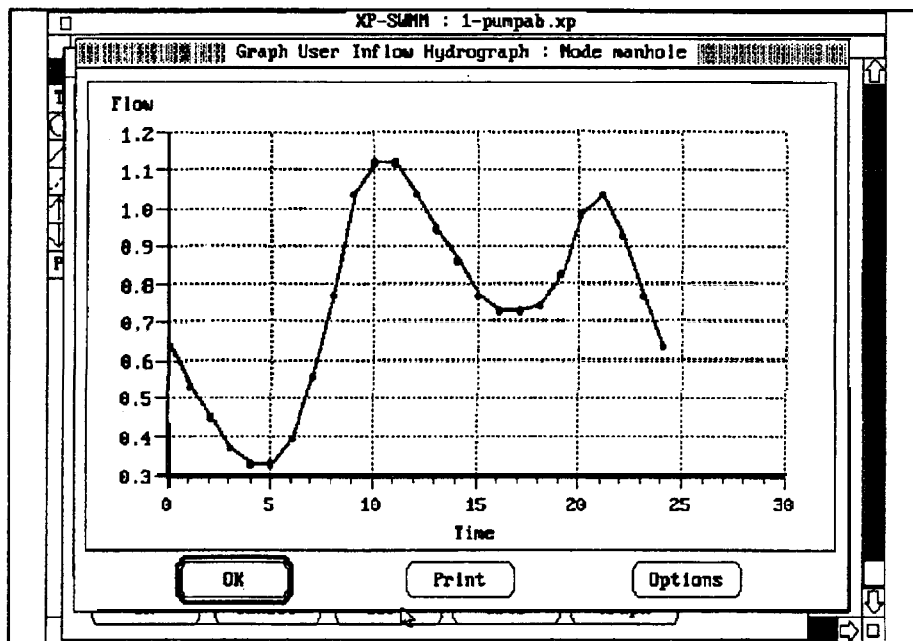

Figure 4. Sample inflow hydrograph from XP-SWMM.

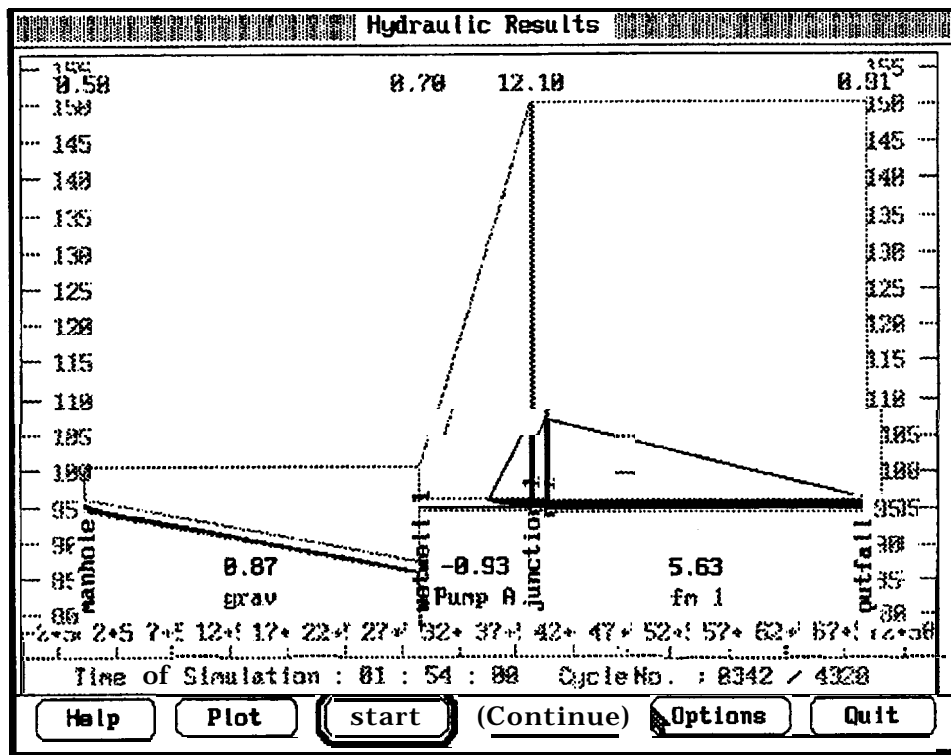

Figure 5. Cross section of sample model segment.

Previously, rainfall data would have been obtained using conventional rain gauges scattered throughout the system. Rain gauges measure the rainfall in a very small localized area. There is an implied assumption that scattered rain gauge data are representative of what is happening over a much larger scale. MDWASD's system covers approximately 400 square miles. Typical Florida summer storms vary dramatically in intensity and duration throughout the system at any given time. Quite often, rainfall is highly localized and variable. The use of rain gauges for these types of storm are, therefore, unreliable.

To properly utilize the predictive capabilities of the model, more accurate rainfall data are necessary. Weather information is being obtained using software from WSI Corporation called Weather for Windows. WSI offers an on-line service that presents satellite imagery and national weather service information. Integration of the model with the WSI Virtual Rain Gauge (updated at 15-minute intervals) will provide additional accuracy. This technology will be used to model the impact and relationship of rainfall events to actual wastewater flows. It will also allow for operational flow transfers between the three wastewater treatment plants, preventing potential sewer system overflows. Wet weather hydrographs will be developed using the state-of-the-art rainfall data developed through the use of radar imaging technology provided by WSI. WSI is used by such professionals in the weather field as the National Weather Service, the National Severe Storms Forecast Center, and The Weather Channel. Radar is proving to be an effective and accurate means of determining average rainfall, because it senses average areal conditions as opposed to point data.

WSI uses satellite imagery to obtain weather information and computes precipitation totals based on NOWrad mosaic radar intensity and environmental conditions. WSI provides data resolution of 2 kilometer by 2 kilometer area and 16 levels of reflectivity. With multiple-scan angles and increased areal coverage, WSI provides high sensitivity for better coverage and definition of precipitation, updated every 15 minutes. Also, all radar imagery is quality assured and approved by meteorologists before it is released.

A sample radar image obtained from WSI is shown in Figure 6. As a storm event moves across a service area, intensities and durations of rainfall can be obtained using WSI. When data from the flow monitoring program are complete, estimates of time travel of rainfall within the sewer system will be determined. With time of travel known, unit hydrographs can be multiplied by the intensities shown by WSI NOWrad radar or estimated by WSI. Areas in the system can be targeted where potential SSO would occur. These potential problems can be avoided by transferring flow to portions of the system with excess capacity.



Figure 6. Sample radar image from WSI.

With complete flow monitoring data, unit hydrographs will be developed for each representative pump station grouping. The unit hydrographs will be scaled according to the amount of flow they receive. The unique influent hydrograph for each pump station will be used as inputs to the model. In addition to rainfall information, ground-water levels-both wet and dry season-and soils information have been obtained. Ground-water and soils information will be combined with the unique inflow hydrographs to estimate the lag time of potential rainfall entering the sewer system. Using XP-SWMM, potential SSOs can be identified. Once an area is identified as a potential overflow area, flows can be transferred throughout the system to avoid overflows. The result of this effort will be a comprehensive, dynamic, hydrograph-based computer model capable of predicting SSOs, and preventing overflows through the development of system flow transferring abilities.

New Collection System Modeling Techniques Used in Houston

Kathlie Jeng
City of Houston, Houston, Texas

Michael J. Bagstad and James Chang
Greater Houston Wastewater Program, Houston, Texas

The City of Houston has over 26 million feet of sanitary sewer mains and an approximately equal length of service laterals. Deterioration and subsequent infiltration and inflow (I/I) in a significant portion of the system have become a major problem. By 1987, the overflows due to rainfall-dependent I/I had increased to an unacceptable level. The Texas Natural Resource Conservation Committee (TNRCC), formerly the Texas Water Commission, and the U.S. Environmental Protection Agency (EPA), Region 6, placed the city under Administrative Orders in 1987 and 1989 to correct the wet weather overflow situation.

In 1992, the city reevaluated its progress toward meeting the mandated goals of the Administrative Order. Deadlines were drawing dangerously near, the reduction in I/I actually achieved by the city's structural rehabilitation program was uncertain, and the city's proposed relief program was exceeding the capacity of the available budget. The Greater Houston Wastewater Program (GHWP) was created to ensure that design, budgetary, and schedule goals would be met. The GHWP team consists of both city staff and consultants.

Understanding the Problem

Developing a solution to Houston's sanitary sewer overflow (SSO) problem begins with understanding the nature of I/I in Houston. I/I is stormwater and ground water that enter the sanitary sewer system by infiltrating the soil to cracks and holes in the system and by entering through directly connected storm drain inlets, roof leaders, and yard drains. The I/I problem in Houston is exacerbated by the city's unusually heavy year-round rainfall. Houston experiences an average annual rainfall of 41 inches, with a low monthly average of 2.3 inches falling in March and a high monthly average of 4.4 inches falling in June.

If the first necessary ingredient for I/I is rainfall, the second is an avenue for the rainfall to get into the system. Houston's sanitary sewers have all of the typical defects that allow rainfall to enter. Two conditions that magnify the I/I problem in Houston are roadside ditches and backyard mains. Roadside ditches are typically unlined, and service laterals cross under them to connect to the main lines. Backyard mains are frequently aligned under drainage swales.

Flow monitoring data reveal the nature of the I/I problem in Houston. During storm periods, peak flows in the sewers are often many times larger than the normal dry weather flow. The ratio of the peak of the storm flow to the average dry weather flow is called the wet weather peaking factor. A review of Houston's flow monitoring data shows that wet weather peaking factors of 30 to 1 are typically recorded, and factors reaching 50 have been recorded in individual basins. Another characteristic of Houston's I/I hydrograph (a record of flow over time) is its steep rise and fall. The entrance of I/I into the system is almost immediate. Field inspections and corrections have eliminated inflow as the major source, leaving infiltration as the main contributor. Infiltration that looks like inflow has been called "rapid infiltration."

Schedule constraints are a big concern to both the regulatory agencies and the program. Construction of GHWP facilities is scheduled to be complete by the end of December 1997. That gave the program little more than 5 years between program its inception in July 1992 and program completion. In that 5-year period, time was allotted for the modeling effort, facility design, review, right-of-way acquisition, bidding,

and construction. Because the schedule had **to** be divided among so many activities, the amount of time allotted to the initial planning and modeling effort was cut extremely short.

Houston operates 48 wastewater treatment plants (**WWTPs**). The contributing collection system defines the service area for each WWTP. Twenty-three of the city's service areas, divided into three groups or "rounds," are included in the **EPA/TNRCC** Administrative Order. The first round was called the rapid mobilization phase (RMP) and was intended to set the pace for the rest of the GWHP. The goal of the RMP was to complete modeling and draft reports on four large service areas, representing 25 percent of the city's system, within 90 days.

Modeling Process

One of the major components in the early stages of the GHWP was the modeling effort. The modeling group was responsible for the following activities:

- Analyzing the flow monitoring data
- Developing rainfall to I/I characteristics
- Projecting those characteristics to design storm conditions
- Analyzing deficiencies in the existing sewer network
- Developing alternatives to alleviate the simulated problems

The modeling effort had to be sensitive to all of the program constraints, schedule, budget, and uncertainty about I/I flows. The modeling process had to be completed early so that design and construction could begin in time to meet the deadline. The modeling process had to be thorough enough **to** eliminate any unnecessary conservatism from the design so that costs could be contained. And, the modeling process had to answer questions about the nature of the rainfall and I/I relationship.

Houston's Three-Dimensional Planes

Because Houston sewers surcharge during very small events, it was necessary to characterize the rainfall-to-I/I relationship in a way that would allow projection to larger storm events. The method initially chosen was a two-dimensional (2D) plot of I/I volume versus rainfall. I/I volume is plotted on the vertical axis, and rainfall is plotted on the horizontal axis. An upper envelope line is drawn in such a manner that most of the plotted points fall below the line. The design I/I volume is then estimated from the design rainfall amount using the envelope line to define the relationship between the two axes (Figure 1).

Often the upper envelope line is curvilinear, indicating a relationship in which the percentage of rainfall that enters the system as I/I decreases with increasing rainfall. This is indicative of collection systems with capacity constraints and soil permeability limits. Collector sewers reach their capacity to deliver flow to the downstream trunk lines at some magnitude of rainfall. Increased rainfall beyond that point will not necessarily make the collector line deliver more water. Soil permeability works in the same manner. The pores in the soil act like the collector lines. They reach their capacity at a certain magnitude of rainfall and will not deliver additional flow to the sewer pipe with increased rainfall.

The curvilinear rainfall-to-I/I relationship could not be detected, however, in the Houston flow monitoring data. This is because Houston sewers surcharge before collector line and soil permeability limits are reached. Only small events can be observed without surcharging. Larger events that cause surcharging cannot be used because there is an uncertainty about whether the observed reduction in I/I is a result of system limits or loss of flow out of manholes above the monitoring points. The small observable events

are plotted in the lower portion of the rainfall-versus-I/I plot, where the upper envelope boundary tends to be linear.

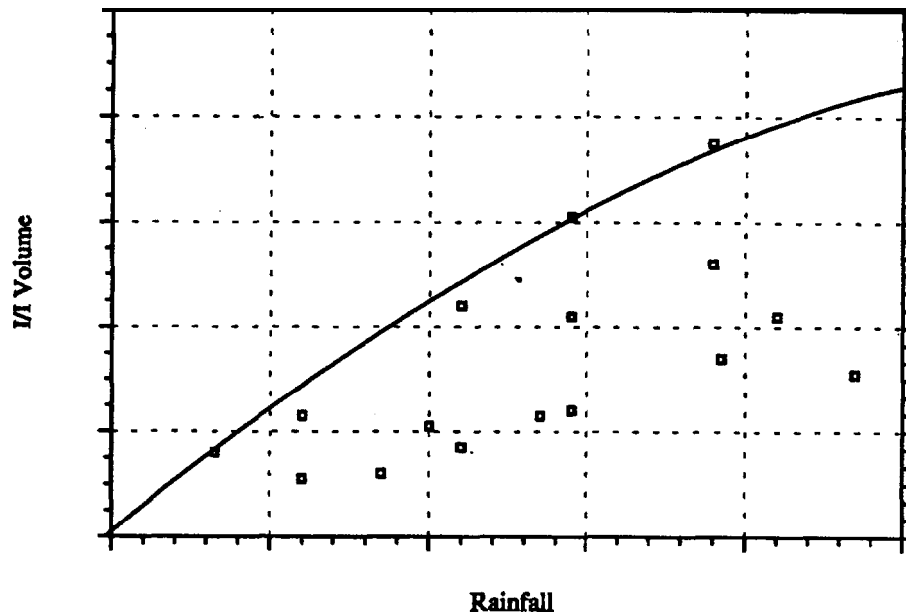

Figure 1. 2D plot.

When linear upper envelope lines were used to project to design storm conditions (a 2-year, 6-hour rainfall amount), the resulting design flows were far in excess of existing capacities, requiring upgrades costing much more than the program budget. This precipitated an intensive effort to gain a better understanding of the rainfall-to-I/I relationship. A significant spread of plotted points were noted beneath the envelope line. Research centered around the conditions that might explain the variation. A third significant variable, storm duration, explained the variation and gave the additional insight needed.

The original 2D plots were reanalyzed in three dimensions: I/I volume on the vertical (z) axis, and rainfall volume and storm duration on the horizontal (x and y) axes. When analyzed in three dimensions, a plane could be plotted through the points with a high degree of correlation. The resulting plane showed that I/I volumes increased in the positive directions along both the rainfall and duration axes. The flat 2D plots of I/I versus rainfall with an unexplainable scatter of plotted points beneath the upper envelope line was replaced with a well-behaved three-dimensional (3D) plane that now sloped gently up along the storm-duration axis through that same scatter of points (Figure 2).

The 3D planes fit the following equation:

$$I/I \text{ vol} = A + Bx + Cy + Dxy$$

where

x = rainfall amount

y = storm duration

A, B, C, and D = constants

The new 3D planes were logical. For any given rainfall amount, the percentage entering the system as I/I increases directly with the duration of the storm. This is because short, intense rainfalls tend to produce more surface runoff, but longer duration, less intense storms have more of a chance to soak into the ground and permeate down into the sewer network.

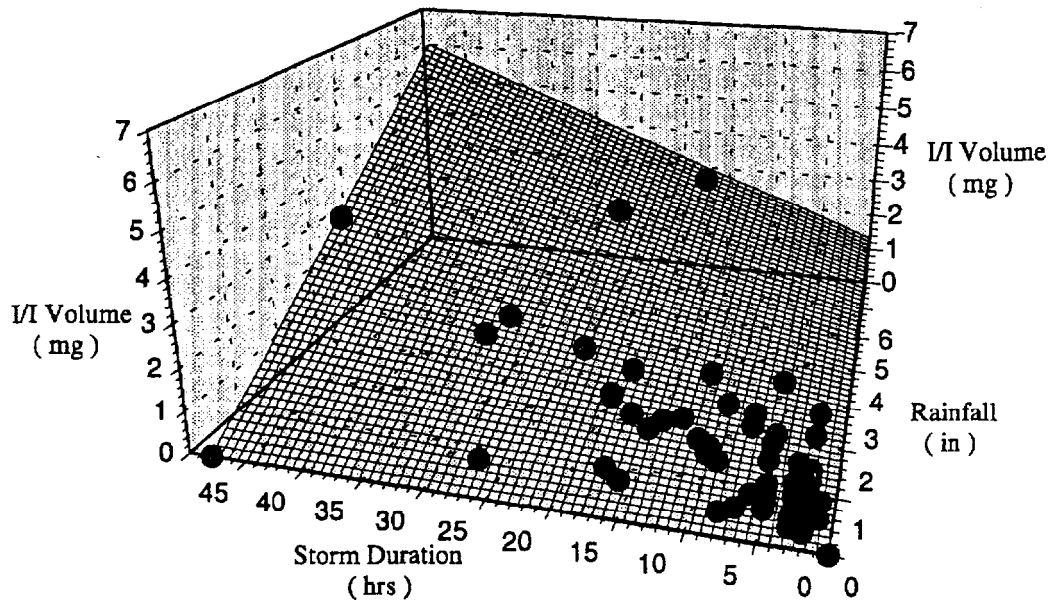

Figure 2. 3-D plane.

For several permanent meters with long-term data, the results (predicted design I/I volumes) of the new 3D plane analyses were compared with the 2D plot upper envelope predicted volumes as shown in Table 1. All I/I values in the table were projected for 4.45 inches of rainfall. As can be seen, the 6-hour I/I volumes projected by the new 3D planes were significantly less than the corresponding I/I volumes projected by the traditional 2D plots for all but one meter. The traditional 2D plots overestimated the I/I volume. The new 3D planes allowed a reduction in both the I/I volume and the resulting design flows.

Table 1. Comparison of I/I Volumes (mg)

Flow Meter	3D Plane, 6-Hr Duration	3D Plane, 48-Hr Duration	2D Plot
FB01	3.5	20.6	10.0
IV01	0.6	0.6	0.6
NE09	1.1	3.2	2.0
NW09	1.5	4.2	2.5
NW12	2.3	13.6	4.0
SB19	0.2	0.7	0.2
SW15	1.8	3.8	2.5

Another interesting point to note is that the 3D plane projections for 48-hour duration rainfall are significantly greater than the traditional 2D projections. This means that while the 2D plots overestimate I/I volumes for short duration events, they underestimate I/I volumes for long duration events because most plotted points are for relatively short events. Longer events typically have more rainfall, causing the system to surcharge; therefore, they are not used in the analysis. The 3D planes use no more events than the 2D plots; because they have a slope on the duration axis, however, it is possible to project to durations that cannot be directly measured.

Design Storm

An analysis of south Texas rain storm climatology revealed that flood-producing storms were dominated by short-duration thunderstorms. The 6-hour duration storm was selected to match typical travel times in service-area sewer system networks. The 2-year recurrence frequency was based on the water quality study, which showed that the discharge of peak rainfall-dependent I/I did not have a significant impact on the receiving water.

The 2-year, 6-hour duration design storm was constructed in a conservative manner. The peak hour of rainfall was set equal to a 2-year, 1-hour rainfall. The combined rainfall for the two peak hours was set equal to the 2-year, 2-hour rainfall. In this manner, the storm hyetograph could be constructed to any duration, and there would never be a shorter duration storm that was more intense, and therefore a worse condition than the longer storm would not occur.

While the method of constructing the design storm hyetograph is conservative, other techniques were employed that tended to have the opposite effect. It is well known in stormwater hydrology that rainfall varies in intensity across the storm. Rainfall is most intense in the center of the storm, while intensity at the fringes of the storm are very low. If a drainage area feeding a collection system is very small, it can be covered by the intense central core of the storm. If an area is very large, it will have portions under the intense central core and portions under the fringe intensity. For modeling purposes, the differing intensities across an area are averaged. The resulting fraction of the intensity of the central core is called a depth-area-reduction factor (DARF). DARFs were used in the Houston modeling effort to ensure that the design flows for major proposed facilities were not unduly conservative (Figure 3).

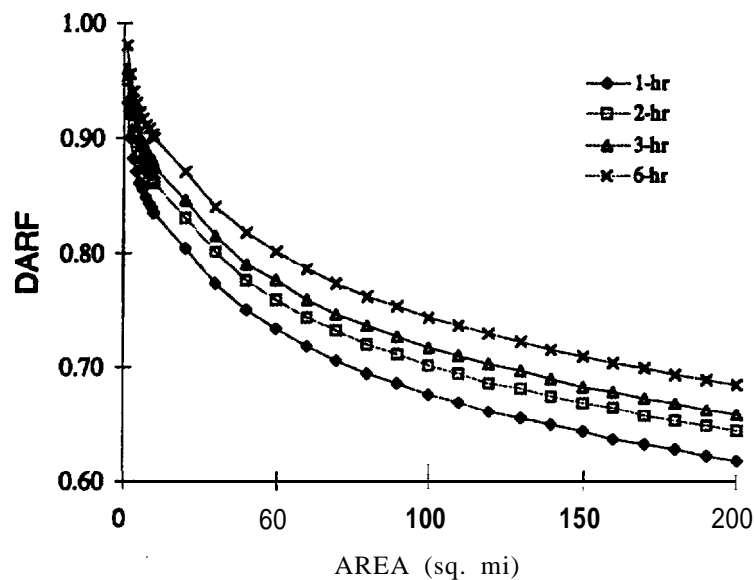

Figure 3. Depth-area-reduction factors.

Design Hydrograph Development

Design rainfall and I/I volume are two parameters of the design I/I hydrograph. The characteristic shape for each I/I hydrograph must be determined by observing real events at a meter. Base flow (flow during dry periods without rainfall) is subtracted from the total flow for a recorded storm event to leave only the I/I hydrograph. This I/I hydrograph is related to the rainfall that caused it in a manner that allows analysis of other rainfall events, such as the design storm, to determine the design storm I/I hydrographs.

This process uses an approach called unit hydrograph theory. The analysis determines what effect a unit of rainfall will have based on the flow response for an observed event. The result is a unit hydrograph defined by the I/I volume, the time to peak, and the time for the hydrograph to recede back to base flow condition (the recession time). The methodology adopted for use in Houston, first developed for the East Bay Municipal Utility District (EBMUD) in California, uses a combination of three triangular-shaped unit hydrographs and applies a percentage of each unit of rainfall to each of the three unit hydrographs. In this manner, any observed hydrograph can be approximated by a combination of unit hydrographs simply by varying the unit hydrograph parameters (time to peak, the recession time, and the volume percentage assigned to each of the three unit hydrographs). These parameters are determined by an iterative process until the simulated (synthetic) hydrograph approximates the observed hydrograph.

Once the parameters representing the characteristics of the rainfall-to-I/I relationship for a meter have been determined, they are combined with the design rainfall to produce the design hydrograph for the basin. In theory, this is the hydrograph that would be expected under design rainfall conditions. In this way, a design hydrograph can be developed for a meter based on flow data from storm events that are much smaller than the selected design storm.

Model Development

The other necessary components in the modeling process are the hydraulic model and the pipe network database. In selecting a hydraulic model for Houston, the initial constraints-schedule and budget-again played major roles. Schedule dictated the quickest solution, which would have been to use the city's existing steady-state hydraulic model. Budget dictated the use of a new model, a dynamic model that would take advantage of travel times and storage (routing effects) in the pipe network. A dynamic model, however, would require a significant investment of time for development. Schedule and budget were competing goals; neither could be completely satisfied. The answer was a compromise between the two.

A dynamic model would be constructed for the larger pipes (30 inches and larger), less than 10 percent of the system. The existing steady-state model would be used for the smaller diameter sewers (10 to 27 inches). It was reasoned that flow attenuation and pipe storage were minimal in the smaller lines; therefore, use of a dynamic model would not substantially affect the results. The dynamic model would be used for the larger lines where the major costs for relief facilities would be found and where attenuation and storage could be significant factors. The flows and the hydraulic gradelines (HGLs) were matched at the interface of the two models. Use of the two models in this manner met both objectives. Models were built in the least amount of time, and costs for proposed facilities were kept within budget.

Model Calibration

3D planes, design hydrographs, and dynamic models are only as good as the data upon which they are based. Most cities lack the sufficient long-term data from flow monitors on a tight enough grid to allow the detailed distribution of flows needed to develop 3D planes for design. Houston is no exception. Houston is fortunate, however, to have permanent meters with long-term data at key locations in the system, plus a massive amount of short-term data from a temporary flow monitoring effort that covered the city in a detailed fashion. The challenge was to use each type of data to maximum advantage.

The short-term data provided the variation in flows across the system, and the long-term data provided the needed accuracy. The short-term data were used for developing model hydrographs for the upstream basins. The long-term permanent meter data were used for model calibration. 3D plane design hydrographs were developed for permanent meters in the system. The upstream hydrographs were routed in the dynamic model to the points in the system where the permanent meters were located. The routed hydrographs were then compared with the permanent meter hydrographs and adjusted until the routed hydrographs matched the permanent meter hydrographs to within 10 percent in both peak and volume (Figure 4).

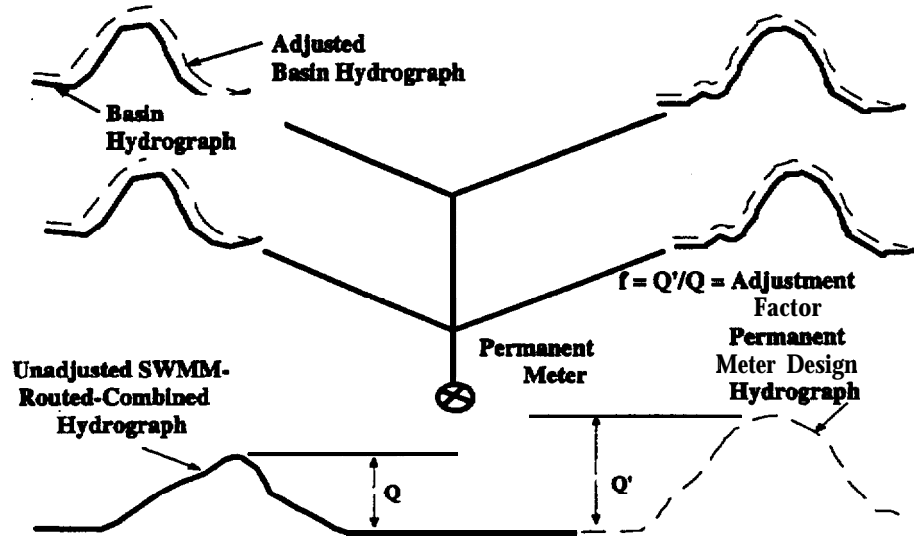

Figure 4. Model calibration.

Cost-Effective Solution

The dynamic models, loaded with calibrated 2-year design hydrographs, were run to identify deficiencies in the existing system. Once deficiencies had been identified, solutions could be proposed. Proposed solutions were tested by replacing existing system components in the model by alternative facilities. Alternative facilities studied included combinations of relief conveyance facilities, treatment plant expansions, wet-weather retention facilities, stormwater clarifiers, and system rehabilitation to reduce I/I.

The analysis of alternative facilities, called the cost-effectiveness analysis (CEA), identified the least-cost combination of facilities for each service area. The cost-effective solution that has emerged in Houston is the construction of relief facilities with stormwater clarifiers at critical locations in the system. Rehabilitation for the purpose of I/I reduction was not found to be cost effective in Houston. Structural rehabilitation, however, is part of the city's long-range program. Its purpose is to maintain the hydraulic capacity and physical integrity of the existing sewers, and to prevent deterioration that may lead to future increases in I/I.

Long-Term Simulation Model

While the cost-effective solution in Houston uses stormwater clarifiers, these facilities have not previously been permitted in Houston. Stormwater clarifiers are facilities upstream of the existing WWTP that discharge to the bayou on the average of four times per year and provide less-than-secondary treatment.

Many questions about these facilities needed to be answered to address regulatory concerns. These questions included:

- How often will the stormwater clarifiers receive flow?
- How often will they discharge to the receiving bayou?
- What is the anticipated volume of discharge?

To answer frequency-of-flow questions, a long-term simulation model (LTSM) was employed. The LTSM is a variation of the dynamic model modified to run theoretically an infinite number of consecutive storms. For Houston, a period of 50 years of rainfall record was analyzed using the LTSM. While the **single-event** model (the dynamic model) could accomplish the same thing, it would require the constant attention of an operator to save results and restart the model after each storm. The LTSM could be set to run overnight when analyzing the larger storms of record or over the course of several days when analyzing the more than 1,600 storms in the **50-year** period.

With use of the LTSM, Houston's 50 years of rainfall data were analyzed to see what might be expected at each clarifier facility. The results of the LTSM were used to estimate the average number of times each year a facility could expect to receive flow, as well as the average number of times each year a facility could expect to discharge flow to the bayou. The LTSM was also used to adjust the clarifier volumes to ensure that discharge frequencies remained within regulatory limits.

Summary and Conclusion

The GHWP modeling effort accomplished both of its goals, keeping capital costs to a minimum and ensuring regulatory buy-in. It accomplished the first goal using the following techniques:

- Applying **DARFs** to average rainfall intensities.
- Developing new **3D** planes for flow projections.
- Using a dynamic model to benefit from flow routing and system storage.
- Analyzing a variety of alternatives to identify the most cost-effective solution.

The modeling effort worked in conjunction with the water quality study and regulatory negotiations to reduce the design storm from a **5-year** to a **2-year** recurrence interval. For the Round 2 service areas, the estimated savings to the city was nearly \$400 million dollars. Further, the modeling effort continues to support the alternative analysis, preliminary design, and final design efforts to find better solutions to I/I problems in Houston and to reduce program costs even more.

The second goal of the modeling effort was to obtain regulatory "buy-in." Regulatory buy-in was ensured by:

- Using a conservative approach to the construction of the design-storm hyetograph.
- Showing the magnitude of the flows to receiving waters.
- Using a long-term simulation model of 50 years of rainfall record to demonstrate the expected long-term performance of the system.
- Meeting the tight, mandated schedule constraints.

The modeling effort has played a significant role in keeping Houston on track to comply with TNRCC and EPA Region 6 Administrative Orders. It has completed 23 CEA reports covering more than 90 percent of the city's system in less than 2 years. In addition, the modeling effort provided information and facility data that were instrumental in obtaining the city's first wet-weather facility (stormwater clarifier) discharge permit from the TNRCC on February 1, 1995. The modeling effort continues to provide assurance to the regulators that every effort is being made to anticipate and design for every contingency by running the long-term simulation model.

Controlling Sanitary Sewer Overflows in Small Communities

Mark G. Wade
Wade & Associates, Inc., Lawrence, Kansas

Today, small communities across America are facing unprecedented challenges to restoring their infrastructure systems. Maintenance of roads, bridges, and utilities demands ever-increasing operation budgets and capital investment. Nationwide, many municipalities experience chronic overflows and bypasses in their separate sanitary sewer systems during intense or extended periods of rain. Most are unaware of their obligations regarding sanitary sewer overflows (SSOs), which are violations of Section 301 of the Clean Water Act. Most are unaware of the provisions of their National Pollutant Discharge Elimination System (NPDES) permits. For small communities, the problem with the sanitary sewer is three-fold: 1) inflow and infiltration (I/I), 2) structural deterioration, and 3) chronic maintenance demands. Regrettably, all three conditions are almost always present in small-community sewers systems, causing chronic overflows and bypasses that must be addressed.

Once these conditions exist, the question then becomes one of prioritization. Sometimes the decision is a political one, often made by someone not directly affected by the problems and their solutions, such as the U.S. Environmental Protection Agency (EPA). Important here is that a sewer system assessment program must be formulated from specific goals and objectives established by cities themselves. For example, if overflows and bypasses are of greatest concern, then a plan must be developed to incorporate those field tests and inspections that will accurately diagnose the problem and make way for an effective solution for reducing I/I flows and eliminating overflows. If I/I is a minor issue compared with structural problems such as system backups from line failures and cave-ins, then a different set of diagnostic tools are needed.

Miami, Oklahoma, and Fort Scott, Kansas, are small communities in the Midwest. Both have a history of chronic SSO-related problems. They also exhibit similarities in population, local government, economic development, collection system age, budgets, and staffing.

Both cities were experiencing:

- Uncontrolled bypasses and overflows.
- Structural deterioration of pipelines and manholes.
- Hydraulic limitations to accommodate wet weather flows.
- Increased frequency of unscheduled maintenance.
- Backups into basements and low-lying areas.

The similarities fade, however, when we examine the approaches each community has taken to reduce system wet weather overflows and bypasses. One community is located in EPA Region 6 and the other in EPA Region 7, even though these two cities are only 70 miles apart (see Figure 1).

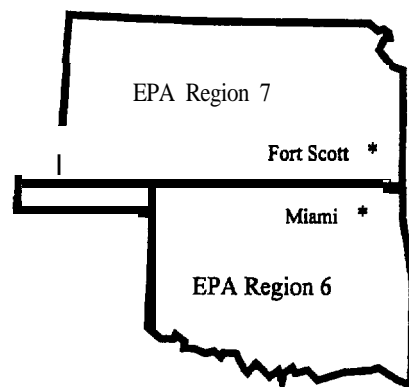

Figure 1. Locations of Fort Scott, Kansas, and Miami, Oklahoma.

This paper looks at the cities separately and examines how each coped with its respective situation. Although this paper will be of particular interest to small communities, it focuses on practical issues all cities should consider when reviewing their bypass abatement programs.

The paper discusses the following relevant issues:

- Establishing a relationship with regulatory agencies
- Characterizing I/I in the system
- Selecting the appropriate field procedures
- **Prioritizing a Sewer System Evaluation Survey (SSES)**
- Assessing financial capability
- Evaluating funding alternatives
- Budgeting for an I/I reduction program
- Negotiating a schedule with EPA

Miami, Oklahoma

The City of Miami is located in northeast Oklahoma, 25 miles south of the Kansas border. With a population of 13,300, the city operates and maintains approximately 430,000 linear feet of separate sanitary sewers, several pumping stations, and two treatment facilities. The oldest sections of the system were constructed before 1950. As in other rural, midwestern cities, the post-war years of 1947 to 1950 resulted in dramatic residential growth. The collection system was expanded dramatically in the absence of adequate construction specifications and practices. As a result, much of the collection system infrastructure is in very poor condition, including private service laterals.

In 1986, Miami made several equipment purchases totaling \$117,000 and began a comprehensive program to clean, televise, grout, and repair the collection system. The program was designed to accomplish two goals. First, a system inventory would be developed of the system, including an update of the sewer atlas maps and a permanent record of each line segment. Secondly, leaking pipe joints and broken pipe would be rehabilitated. Each goal was also two-fold: 1) to reduce I/I, and 2) to improve the system's structural integrity. Ultimately, this plan would reduce wet weather overflows and bypasses. As the program evolved, the city became painfully aware that a more comprehensive effort was needed because the problems encountered in the work were greater than earlier believed. Also, flow monitoring at the two treatment facilities showed negligible reduction in I/I.

In 1986, the city's largest employer, BF Goodrich, began to close its facility in Miami. At the time, employees numbered 2,000. Within 6 months, the plant closed completely. Consequently, there was a significant decrease in the city's population and resulting revenue to support the operation and maintenance of city-owned facilities. The following shows this impact on Miami's population, from the 1950 to 1990 Census.

<u>Year</u>	<u>Population</u>
1950	11,800
1960	12,900
1970	13,900
1980	14,200
1990	13,100

One year later, in September 1987, Miami was issued Administrative Order No. VI-87-1270 by EPA Region 6. Under the conditions of the order, the city was required to implement a program that would "eliminate. . . bypasses." The order came at a time when the city was losing an annual revenue base of

\$40 million, which partially financed the operations and maintenance of the wastewater collection and treatment facilities.

In 1988, the city retained a consulting firm to develop a long-term I/I reduction and sewer system management program. This program was more comprehensive than the first, beginning with a complete diagnosis of the system. The program had three phases:

- Phase I-Study
- Phase II-Construction (system rehabilitation)
- Phase III-Construction (system expansion)

Phase I—Study

The first phase of the project had four parts. In Part A, I/I in the collection system was quantified and identified. At completion of Part A, the city had identified eight of the 17 basins (60 percent of the system) with excessive I/I. In Part B of the study, a series of field inspections and tests were conducted to locate, quantify, and characterize all I/I and non-I/I-related defects. A careful evaluation of the hydraulic impact of wet weather induced I/I was accomplished in Part C by developing a computer-based hydraulic model from flow monitoring data collected in Part A and SSES data collected in Part B. The model ultimately allowed the city to identify the least-cost solution to its SSO problems in Part D. The 1 -hour, 25-year storm event became the basis for the program. A further breakdown of the tasks involved is shown in Figure 2.

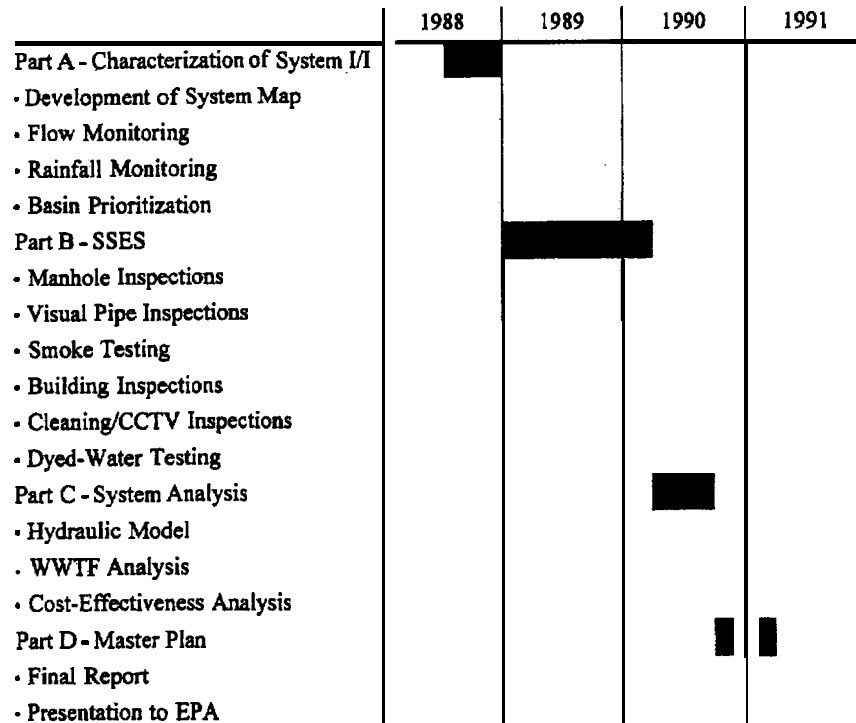

Figure 2. Components of Phase I--Study.

The results of the study phase, submitted to the city in February 1991, revealed what everyone had suspected. The total cost to implement a successful SSO abatement program would be a staggering \$13.3 million. The final program costs were further segregated into the categories shown in Table 1. Costs for manhole and pipeline rehabilitation included improvements needed to reduce I/I and correct structural deficiencies.

Table 1. Program Costs for SSO Reduction Miami, OK

Activity	Cost Estimate
Study	\$248,000
Rehabilitation (Force Account 1987-90)	345,000
Rehabilitation (Force Account 1991-93)	289,000
Rehabilitation (Force Account 1994-96)	150,000
Manhole rehabilitation	1,630,000
Pipeline rehabilitation	1,183,000
Private I/I abatement	59,000
Program management	27,000
Postrehabilitation evaluation	68,000
Flow equalization and WWTF improvements	1,750,000^a
Relief sewers	7,516,000^a
Total program cost	\$13,265,000

^aEstimated.

The costs required to make these improvements far exceeded the city's available cash reserves, which were also needed to pay for other public utilities such as streets, parks, storm sewers, water treatment and distribution, landfills, and public buildings. It would have been ludicrous to believe that a rural community, with a shrinking economy and declining revenue base, could afford a \$13.3 million sewer improvement program.

At the completion of Phase I, the city realized that financing would become a significant issue. Previous meetings with EPA, however, indicated that financial capability could be a consideration in the final schedule approved by Region 6. Therefore, the city retained an expert in the area of municipal financing to develop a multiyear strategy for funding sewer improvements. The report submitted to the city, "Wastewater System Improvement Financing Plan," presented a funding plan that would enable the city to comply, in part, with EPA's Administrative Order in an affordable and timely fashion.

Miami city officials then met with representatives from EPA Region 6 and the Oklahoma Department of Environmental Quality (ODEQ) to present the findings of the Phase I report, the financing plan, and their proposed schedule for all subsequent phases. This proved a very important step in the city's SSO abatement program. The city and EPA agreed to focus on the following basic elements of the SSO program:

- Eliminate excessive I/I

- Reduce I/I in the private sector
- Increase systemwide operation and maintenance (O&M) activities
- Reduce the frequency of wet weather SSOs

As a result of this agreement, EPA issued an amended Administrative Order that allowed for reasonable deadlines to complete all manhole and pipeline rehabilitation and implement a private-sector I/I reduction program. In addition, the city also approved a modest sewer rate increase and established an Emergency Fund and Repair and Replacement Fund. Both funds were established while Phase I work was under way.

Phase II-Construction (System Rehabilitation)

In 1992, design began for rehabilitation of selected manholes and pipelines. Separate contracts were prepared for each and awarded at the end of that year. Basic improvements to the wastewater collection system included rehabilitation and replacement of leaking and deteriorated manhole structures, removal of all direct and indirect storm sewer connections to the sanitary sewer system, pipeline rehabilitation, and point repairs.

Construction began in early 1993, with multiple contracts being awarded to keep the program on schedule. The city also allowed competitive bids from contractors who specialized in certain aspects of the program, such as manhole rehabilitation. The final cost of system rehabilitation-including actual construction, engineering, and program administration-was \$2.81 million. This includes both manhole and pipeline rehabilitation costs shown in Table 1.

As part of the interim schedule approved by EPA, the city redeployed flow monitors. Results were used to recalibrate the hydraulic model and determine the program's effectiveness in reducing wet weather SSOs. The program goal of 20 percent I/I reduction (representing rehabilitation in 60 percent of the system) was achieved and even exceeded in some of the basins. An example postrehabilitation analysis is shown in Figure 3.

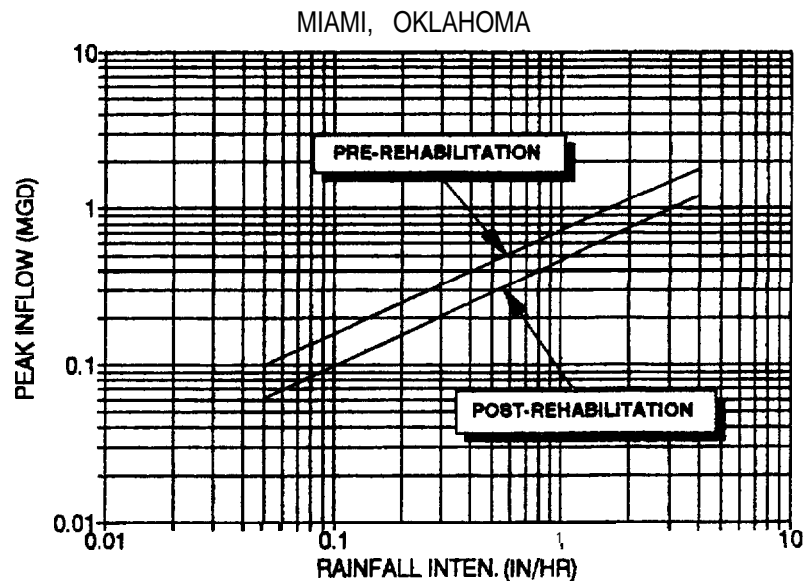

Figure 3. Example Postrehabilitation analysis, Miami, Oklahoma.

At the same time, Miami also embarked on an aggressive program to educate the public and eliminate sources of I/I in the private sector. These included directly connected downspouts, sump pumps, area or yard drains, and uncapped cleanouts. The passage of a comprehensive ordinance provided the city with adequate legal authority to enforce the removal of these sources when necessary. Homeowner compliance was almost 100 percent.

Phase III—Construction (System Expansion)

The greatest cost component, or \$7.3 million, is earmarked for this third phase. Within this phase, the city has prioritized a series of relief sewer projects based on their effectiveness in reducing overflows and wet weather bypasses. Again, the model developed under Phase I and recalibrated under Phase II became a superb tool for not only targeting the location and size of these relief lines, but also predicting the impact of each on the level of I/I and overflow reduction. Currently, the city is negotiating this third and final phase with EPA Region 6 and ODEQ. A 10-year program is being considered.

Fort Scott, Kansas

Just up Highway 69 from Miami is the city of Fort Scott, Kansas: another state, another EPA region, and another world when it comes to SSOs. Fort Scott is another rural community that has seen its share of ups and downs. During the years of strip mining, the city enjoyed prosperity and growth. During the past few decades, however, southeast Kansas like northeast Oklahoma has struggled to survive. Fortunately for Fort Scott, hard work in the area to attract industrial development has stabilized the local economy in recent years. These efforts have been bolstered by a series of community improvement projects, many financed by loans and grants from Farmers Home Administration (FmHA) and Community Development Block Grant (CDBG) programs.

The city currently operates and maintains approximately 260,000 feet of sanitary sewers. With a population of 9,000 and one central wastewater treatment facility, the city has been able to finance, through its current user charge system, a modest O&M program and small-scale capital improvement projects. The current annual operating budget for the wastewater system is \$450,000. The last major project was the construction of the new treatment facility in 1963. In 1967, a devastating flood (500-year return), caused serious damage to the plant and various pumping stations. This curtailed the city's plan to fund certain projects related to SSO control.

Regulatory History

The last major I/I study and SSES program was conducted in 1976 and 1979 as part of the Step I work required under EPA's Construction Grants Program. Some minor improvements were made to the collection system. The majority of EPA grant money, however, went into upgrades of the main pumping stations and the treatment facility. Since completion of plant improvements, the city has seen little activity on behalf of the EPA Region 7 office or the Kansas Department of Health and Environment (KDHE). As in Miami, Fort Scott experiences infrequent bypasses and overflows associated with extended or high intensity rain events. The city also receives two or three calls each month reporting basement backups.

As part of the O&M program, sewer maintenance personnel attempt to clean all accessible sewer lines once each year. Also, flow monitoring information from the 1978-1979 study indicated that although average daily flows ranged from 1.5 to 2.5 million gallons per day, peak flows exceeding 25 million gallons per day could be expected from a 1-year rainfall event (1.8 inches per hour). Peak response time in the collection system was less than 2 hours. It was clear from the data that the city had a serious inflow problem.

In 1993, the city and KDHE met to discuss proposed conditions in Fort Scott's next NPDES permit. Some of these conditions included an I/I evaluation of the collection system and followup rehabilitation. The requirements were relatively modest and included:

- A report of prioritized basins
- Investigation of I/I (via an SSES)
- An ordinance to remove private-sector I/I
- Elimination of excessive private-sector I/I
- Development of plans and specification for public-sector I/I reduction
- Completion of construction related to public-sector I/I reduction

The City's Program

In the absence of Administrative Orders, Consent Decrees, and penalties, the city has been able to take a less comprehensive approach than that taken by the city of Miami. Also, more time has been available to develop the initial phases of the project, particularly the field activities used to pinpoint I/I. The focus of the program has been on reducing I/I in the private sector and eliminating inflow in the public sector. Because most of the data collected under the 1978-1979 study were unreliable, the city decided to begin its SSO reduction program in 1994 with the following goals:

- Use trained city personnel to conduct all field investigations.
- Eliminate all identified private-sector I/I.
- Develop a computer-automated tracking system for I/I control.
- Implement a "bricks-and-mortar" approach to SSO reduction, targeting repair where obvious sources of I/I enter the sanitary sewer system (e.g., directly connected storm sewer inlets, vented manhole covers subject to ponding, active and significant infiltration leaks).
- Train sewer maintenance personnel to perform basic rehabilitation work.

Therefore, more sophisticated and analytical work such as hydraulic modeling and engineering evaluations have been deferred. The city has not been required by EPA or KDHE to follow a prescribed procedure, whereas Miami was required to follow, more or less, the EPA Region 6 policy. The mission of the program in Fort Scott is a simple one-find and fix. Direct and indirect inflow sources are the city's top priority for removal. Table 2 lists some of them.

The Private Sector

Beginning in early 1994, the city embarked on a program to locate these inflow sources. The program included a door-to-door inspection of all properties in the city connected to the sanitary sewer system. A followup dye test program was used to confirm each suspected connection. The city also purchased high-capacity blowers to smoke test the entire system. Defects on the private side were recorded, photographed, and field measured. At the same time, major revisions to the existing ordinances were made that tightened prohibitions on I/I connections to the city's sewer system. Key elements of the revised ordinance are included in Table 3.

Table 2. Top Priority Inflow Repairs

Public Sector Inflow Sources	<ul style="list-style-type: none">• Direct storm sewer connection• Indirect storm sewer connection• Drainage crossing• Curb inlet connection• Cross connection• Vented manhole cover• Deteriorated manhole frame seal• Leaking manhole frame adjustment
Private Sector Inflow Sources	<ul style="list-style-type: none">• Downspout• Area/Yard drain• Uncapped cleanout (sump)• Driewav drain

Table 3. Ordinance No. 3107

Article I	Definitions
Article II	Prohibited I/I connections
Article III	I/I disconnect order (procedures)
Article IV	Termination of service
Article V	Reconnection of service
Article VI	Abatement of nuisance (public health)
Article VI I	Right of access and entry
Article VI I I	Financial assistance (reimbursement)
Article XI	Penalties
Article X	Severability
Article XI	Disclaimer of liability
Article XI I	Effective date

The ordinance itself was a key instrument in making the city's SSO abatement program a success. For example, the field inspections and tests conducted to date have located more than 550 sources of I/I in the private sector. A further breakdown is shown in Figure 4. Beginning in March 1995, the city started the actual abatement program by sending out notification letters. Administration of the program is being managed with the aid of a customized computer program that keeps track of the type of source, address, and disconnect status. It is expected that the program will be completed by July 1995.

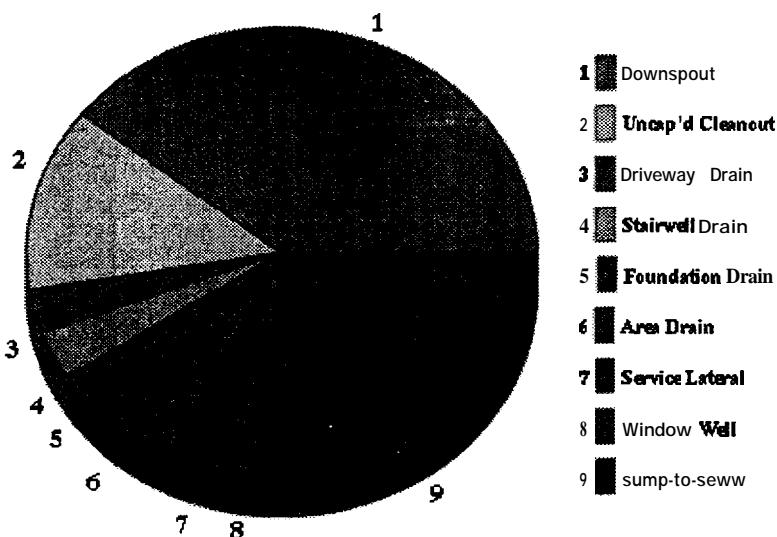

Figure 4. Proportion of I/I from various private-sector sources.

The Public Sector

As part of the revised NPDES permit, the city was required to examine public-sector I/I connections (Table 2). Smoke testing results (described in the previous paragraph) and manhole inspections were combined to develop a rehabilitation program that would eliminate inflow from the collection system. Results of the field work showed that the majority of inflow originates from manholes, although significant inflow also enters the system from connections between the city's storm and sanitary sewer systems. Specifically, a total of 636 I/I sources were located within 309 manholes. This represents almost 40 percent of the manholes that contribute excess I/I to the city's collection system. A brief summary of the program is shown in Table 4.

Table 4. Inflow Reduction Program

Type of Connection	Number
Direct storm sewer connections	3
Indirect storm sewer connections	8
Raise manholes to grade	280
Replace manholes covers/frames	105
Top-side manhole repairs (top 18 inches)	363
Manhole replacement	75

The city will televise all storm sewer-related defects to characterize each connection and determine the cost-effective repair method. The city will conduct most of the work by force account. For example, because the majority of repairs were within the top 18 inches, city crews will purchase all materials and perform the necessary construction work to make the structure watertight. A typical detail of this type of repair is shown in Figure 5. A modest rate increase last year is expected to produce additional revenues

of \$80,000 annually. This, combined with the current operation budget, is expected to finance force account work for 3 years.

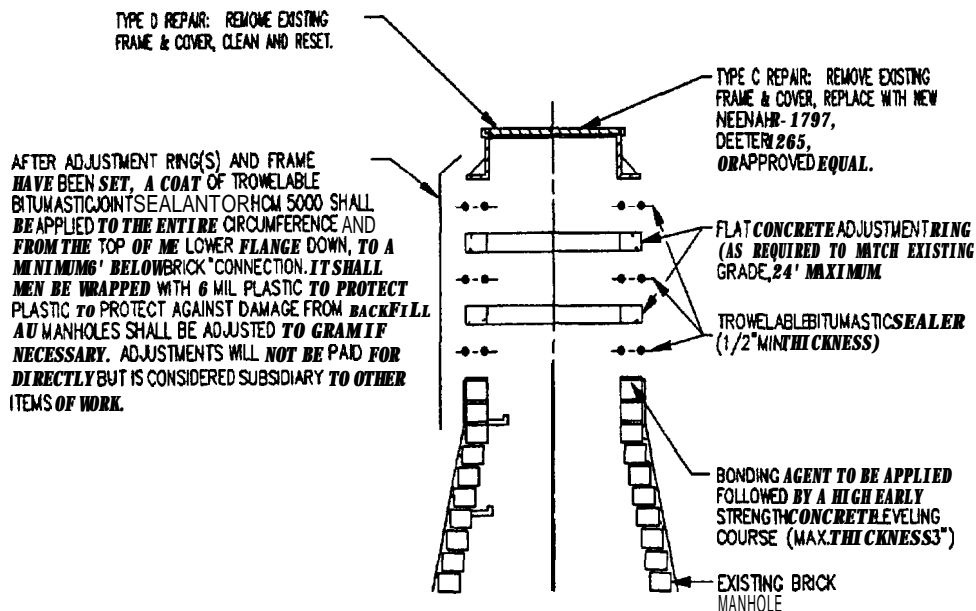

Figure 5. Repair detail.

Program Costs to Date

To date, the costs have been modest and represent only a fraction of the total costs to be incurred by the city. Table 5 shows a cost breakdown.

Future Program

City officials know that the current rehabilitation program will not eliminate all SSOs. The need for major improvements-including relief sewers, pumping station upgrades, and modifications to the existing treatment facilities-is anticipated. The city has budgeted monies in 1995 to purchase six flow monitors. Also, plans are under way to survey the collection system so that a hydraulic model can be developed. Results of each will be used to identify relief sewer requirements and necessary improvements to the treatment facility and pump stations. Currently, the city is pursuing grants and other funding alternatives, including the state's revolving loan fund. Final improvements to the treatment facility will ultimately depend on the state's water quality standards, which are still in draft form.

Lessons Learned

The saying "hindsight is 20-20" remains as true as ever. It was certainly the case in the two programs cited in this paper. EPA enforcement can be an intimidating experience for smaller NPDES permittees. Because the city of Miami entered into its SSO abatement program by way of an Administrative Order and without specific policies, it was extremely difficult to separate expectations from reality. For example, many parameters-such as acceptable wet-weather overflow frequencies, distinctions between downstream and upstream overflows, and water quality impacts-were never resolved. The final program continues to be a moving target.

Table 5. Program Costs for SSO Reduction—Fort Scott, Kansas

Activity	cost
Program consultant	\$45,000
Building inspections	26,000
Dyed-water testing	6,000
Smoke testing	37,000
Manhole inspections	16,000
Computer hardware/software	3,000
Administration	25,000
Manhole rehabilitation (force account)	230,000
Storm sewer disconnections (sanitary sewer only)	90,000^a
Pipeline rehabilitation	140,000^a
Relief sewers	N/A^b
Pump station upgrades	N/A^b
WWTP improvements	N/A^b
Total program cost	\$616,000

*Estimated.

^bTo be determined.

Clearly, SSO program costs range widely. The EPA region in which the city is permitted is one of the many variables that impact program costs. SSO policies (when available) and enforcement activities are inconsistent from region to region, and even state to state. Elements in each program, however, could be helpful to other small communities that find themselves at the beginning or even in the middle of their SSO control programs. A few, obvious but worth repeating, are described below:

- Continue to report wet weather overflows.
- Begin a relationship with regional EPA and state representatives.
- Maintain a frequent reporting system to state and EPA regional offices.
- Do not be intimidated by these regulations.
- Make inflow reduction first priority.
- Develop in-house training for SSES activities.
- Purchase equipment and materials to perform most of the rehabilitation work.
- Review and update sewer use ordinances to control private-sector I/I.
- Develop a financial capability and financing plan.

- Consider financing alternatives such as CDBG and FmHA grants and loans.
- Form partnerships with larger, regional cities.
- Stay informed through professional associations such as the Association of Metropolitan Sewer Agencies (AMSA).
- Pursue I/I reduction in the **private** sector.
- Negotiate reasonable and affordable implementation schedules with EPA.
- Organize and maintain a systematic database that will help monitor the program.
- Implement modest but consistent rate increases.

Small communities need to be proactive in their efforts to reduce I/I and improve their sewer system infrastructures. The wastewater collection system is one of the biggest investments a community makes. It must be properly maintained through careful capital improvement planning. Specific national policies are needed, however, to give small communities information regarding EPA's program goals and objectives. This is essential if small communities are to be successful running local SSO control programs. The need for equitable, commonsense national policies is critical. Inequities, particularly in smaller rural communities, must be avoided if SSO reduction programs are to be effective.

Separate Sanitary Sewer Overflows in Illinois

Allan L. Rae
Consultant, Aurora, Illinois

The Illinois Association of Wastewater Agencies (IAWA) received one of five awarded grants to gather data on separate sanitary sewer overflows (SSOs). IAWA chose to send a survey form to all of its 61 members requesting information about their agencies and their SSOs. One criterion of the survey was that responding agencies would not be asked to incriminate themselves or otherwise make themselves liable for enforcement action from the U.S. Environmental Protection Agency (EPA) or the Illinois Environmental Protection Agency. For that reason, no agency names are mentioned in the report.

Questions on the survey form fell into seven areas:

- General
- Weather
- Design
- Operations
- Maintenance
- Legal
- Policy

The questions in the general category were:

- Do you have **SSOs**?
- Do you have a combined sewer overflow (CSO) National Pollutant Discharge Elimination System (NPDES) permit?
- Does a customer have a CSO permit?
- Do you discharge to an agency with a CSO NPDES permit?
- What kind of sewers do you have?
- Do you record wet weather **SSOs**?

The questions in the weather category were:

- What is your average annual rainfall?
- What is the weather's effect on an SSO?

- Does it overflow during rainfall?
- Does it overflow after the rainfall stops?
- What amount of rainfall causes an overflow?

The questions in the design category were:

- How frequently does your collection system overflow?
- Do overflows occur in developed areas?
- Are overflows due to design standards at the time of installation?
- When did you last revise your design standards?
- Are there storm sewers in the SSO area?
- Do you have a planned rehabilitation or replacement program?

The questions in the operations category were:

- Does the age of the system affect **SSOs**?
- How do you manage your collection system?
- Do you have permanent flow monitoring installations in your system?

The questions in the maintenance area were:

- Do you have a preventive maintenance program?
- Is it adequate?
- If not, what needs to be done?
- What do you spend annually on maintenance?

The legal area had one question:

- Do you have the legal means to control wet weather **SSOs**?

The policy area had one question:

- How would you like to eliminate wet weather **SSOs**?
 - By flow reduction or control upstream?
 - By increased transport capacity?
 - By in-system treatment?

Of the 61 members who received this survey, 27 (44 percent) responded. The number was reduced to 24 for analysis because three agencies did not have control of the collection system upstream of their treatment plants.

Results of this survey indicate that 83 percent had separate sanitary overflows; 35 percent had a system for recording overflow events.

Rainfall in these Illinois **POTWs** averaged between 35 and 40 inches annually. Eighty-seven percent reported overflows during rainfall events. The smallest rainfall event causing an overflow was 0.5 inch.

Twenty-six percent prefer designing for a **25-year** design storm, with another 30 percent preferring a 1 **0**-year design storm. Most overflows (83 percent) occur in developed areas.

Design standards for collections systems are between 1 month and 16 years old. Overflows are caused by structural problems in 65 percent of the systems, with 74 percent of respondents reporting infiltration and inflow (**I/I**) problems.

Seventy-eight percent report that the age of the collection system is a factor in overflow events. Thirty percent of the respondents report having an ongoing flow monitoring program.

Eighty-seven percent report having a preventive maintenance program, with 70 percent of the respondents saying that their preventive maintenance program is adequate. Maintenance spending varies from \$1 .00 to \$30.00 per capita.

At a meeting in early November, **IAWA's** ad hoc subcommittee on **SSOs** decided to ask the 24 agencies to respond to a second survey in a narrative format, as opposed to short-listing five to eight agencies for **onsite** visits. This second survey covered:

- Pump stations
- Overflow locations
- Record-keeping
- Wet weather overflow events
- **I/I** and Sewer System Evaluation Surveys (**SSESs**) done previously
- Water quality
- Maintenance
- Prioritizing

Most pump stations were modern or very modern and did little to cause **SSOs**, but were subject to vandalism.

Most of the overflow locations were in basements beyond agency control: other agencies did the initial collection.

In the record-keeping area:

- Flat slopes in sewers allowed hydrogen sulfide to form, which leads the sewer to fail structurally and the street above to collapse.
- Agencies depend on mobile equipment to examine and clean sewers, with the larger agencies owning the equipment and the smaller ones renting the equipment.

- Confined-space entry regulations were increasing the cost of examining the sewers.
- Two agencies have wet weather **SSOs** in their NPDES permit.

For wet weather overflow events:

- Rain gauges were located within the boundaries of the agency, but not always at the publicly owned treatment works (**POTWs**).
- All overflows were very site specific.
- Overflow causes varied widely-from a **5-year** to a **25-year** storm.
- The water table and the most recent storm are factors.
- Various multiples of dry weather flow cause **SSOs**.
- Intensity, duration, and total amount of rainfall are factors.
- The same recorded rainfall yielded two different results.

I/I and SSES efforts did not help to reduce flow to the POTW. No agency reported finding a “big leak.” Most of the I/I came from private property.

The final three categories of the questionnaire revealed that all **POTWs** have wet weather **SSOs**. Each agency should control its overflows the way its customers wish.

Is It a Ford or Jaguar?

Appropriate Data Management and Modeling Tools for Sanitary Sewer Overflow Reduction Management and Analysis

David Crawford and Virgil Adderley
CH2M HILL, Portland, Oregon

Introduction: “Deciding To Buy”

Similar to buying a car, the driving force behind the implementation of data management and modeling systems can be as simple as wishing to go between points A and B. Many decisions are involved, including the style and degree of comfort required and the power of the engine and drive train. Travel is necessary for many reasons, such as a sanitary sewer overflow (SSO) policy, and the passengers and co-drivers picked up along the way affect a host of decisions. The financing or purchase cost is a key consideration, as are the annual maintenance bills. Annual maintenance includes the cost of gas, akin to adding new or updating old data, and the need for dedicated drivers for more elaborate or specialized vehicles.

This paper provides an overview of the steps usually followed in selecting data management systems and hydraulic models. General features and selection criteria are discussed. Several “showroom examples” are also presented.

In general, municipalities **have** limited resources to implement comprehensive management systems. This, combined with the need for greater management and coordination of efforts within various municipality departments, requires the careful consideration of the overall goals and objectives of the community. Even during a recession, the justification for comprehensive systems can be made. The goal is to define the many overlapping areas that bridge the gaps between diverse departments with diverse agendas. As for automobiles, a need clearly exists for system integration; this need is particularly acute for the use and sharing of data. This need must be met through user friendliness (driveability), data management, and analysis systems. (The car doesn't break down and gets you there in one piece.)

The driving forces behind the trend for greater integration of data management, mapping, and analysis are the following:

- Facility management:
 - Inventory
 - Maintenance
 - Replacement/perpetual life programs
 - Capital improvement projects (CIP)
- System capacity issues:
 - Capacity increases due to population growth/redistribution
 - Capacity loss due to system deterioration

- Control of SSOs:
 - State policy and actions
 - Federal SSO policy
 - Court orders, memorandums of agreement, stipulations, and final orders

The general pattern for developing an information management system is illustrated in Figure 1. The overall goal for any type of linked data management hydraulic model integration interface system is to provide the service of intelligently integrating the business activities, tools, and data to help accomplish the desired tasks. The triangles in Figure 1 show the three basic activity groupings in a typical municipality/sewerage agency; at the center is the integration package. The business activities are essentially what the municipal departments must accomplish and include the processes by which data are collected and analyzed, as well as the production of reports or new data. The platform resources are the hardware and software (including operating systems) available to accomplish the tasks. The data resources are all the data and information the user has available to accomplish the tasks. The information system may be a simple or a very complex program or set of programs that integrate these components in an intelligent and helpful manner. The complexity of the program will often be dictated by the level of funding available. Adequate and appropriate financing is required to support the information framework.

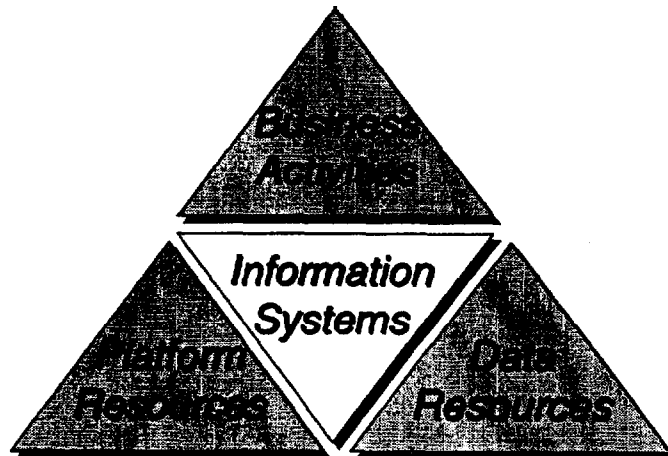

Figure 1. Integrated information framework.

Fundamental Components and Issues

Whether the sewer system to be examined is small and simple or large and complex, certain fundamental components should be included in most SSO analyses, including:

- Data collection and inventory
- Hydrologic and hydraulic models
- Support for the required business functions

These basic components can be as simple as paper maps, handwritten tables, and calculated estimates of the system performance. The components must meet the required business functions. In most cases, these components will be more complicated and require that some thought is given to how they will be implemented.

Data Collection and Inventory

The first fundamental component required in performing an SSO analysis is to define the system in sufficient detail. Data collection and inventory of the sewer system can be accomplished using existing data tables, sewer maps, field surveys, as-built drawings, aerial photos, and whatever else is available that is useful. Additional information can then be collected by field investigations. The required data encompass several types of information:

- Geographic features of study area, including land use and land cover, sewerage subcatchment boundary and aerial size, soil characteristics, topography, and location of streams.
- Manhole data, including location, invert and rim elevation, size, and any special structural configurations.
- Conduit data, including location, size, shape, connectivity, upstream and downstream invert elevation, and roughness.
- Rainfall monitoring data if available for the local area.
- Sewer depth and flow rate monitoring data at key points.
- Pump station and treatment plant flow records.

These data, which are extremely valuable for many functions throughout the organization, should be kept in a structured database management system. In a structured database, similar types of information (e.g., all conduit information) are stored in the same table, and different types of information are stored in separate tables (e.g., separate conduit, manhole, and sewer monitoring tables). A key element in the database is the assignment of unique identifiers for each facility, conduit, and manhole. These identifiers allow the monitoring data to be assigned to the proper structure or location. The database should also include a unique basin or subcatchment identified for the hydrologic data, such as subcatchment area, land use, soil, or rainfall. These identifiers (also called common fields or foreign keys) provide the link that allows the tables to be tied together in a relational database management system (RDBMS) such as Access, FoxPro, or Paradox.

Some of the most important data are graphical and reside in maps and drawings developed to provide a visual understanding of how the system is laid out and connected. An important step in the data collection and inventory is to tie graphical information to tabular data. This can be done in several ways:

- For paper maps, the unique identifiers can be printed from the database onto the map near the appropriate structure or subcatchment.
- For computer-aided design (CAD) drawings, the unique identifiers can be entered into the data block attached to each graphical representation of the hydraulic structures and subcatchments. This assumes that each structure or subcatchment has been represented as a unique graphical element such as a point (manhole), line (conduit), or polygon (subcatchment). CAD drawings that are digitized in this manner and contain the unique identifiers in the attached data blocks are said to be “intelligent” or “smart” maps and are very useful for geographic information system (GIS) type functions.
- GIS maps or “coverages” consist of graphical elements that are tied to the complete data record. The graphical element displays the visual and topographical features of the structure, while the data table(s) provide a list of the structure’s attributes. The GIS software maintains the graphic-data link and allows the user to perform queries and analyses on both the graphical and tabular information.

Hydrologic and Hydraulic Model Components

The goals of most hydraulic models are to perform a routing of flow through the system under normal and design storm conditions, to assess existing system capacity, and to analyze and design new sewer systems. Existing databases and visualization of hydraulic results are often necessary components.

Flow monitoring at critical points within the system is a subprogram of the wastewater management program. Any models constructed from the data must be simulated, calibrated, and verified to real storm events.

Rational approaches must be adopted in defining a flow monitoring program, however. It is often not necessary to monitor every basin, as some basins can act as proxies for other similarly developed basins. Also, preliminary hydrologic/hydraulic model simulations can point to the critical basins that would benefit from flow monitoring.

The model selection process must consider the specific needs of the community for sewer system modeling analyses. A workshop attended by interested parties is often the best way to determine the results and analysis required of the model. These features or results often include the ability to:

- Estimate and model the main components of flows in the sewer system for a variety of land uses and rainfall and soil moisture conditions.
- Link sewerage system data management to a comprehensive database.
- Model flow conditions through a variety of sewer shapes and flow controls.
- Determine the significance of surcharge and backwater conditions.
- Determine the significance of control structures, such as diversion weirs, orifices, and pump stations.
- Add areas and new sewer systems.
- Be used easily by city personnel with limited training and support.
- Link to future GIS system for data and result visualization, and to address the need to or advantages of tying the model engines to data and “intelligent” maps.

When selecting an appropriate engine for system modeling, consider the quality and extent of basic input data and the complexities of model operation and interpretation. In general, the costs and benefits of applying more complex modeling schemes follow the trends given in Figure 2. Typically, as model complexity increases, the cost to run and maintain the model increases exponentially without a commensurate increase in benefits. The simplest model for the desired objectives is often the best selection; the optimal selection is that which provides the greatest net gain, as illustrated in Figure 2.

BENEFIT-COST ANALYSIS
FOR MODEL SELECTION

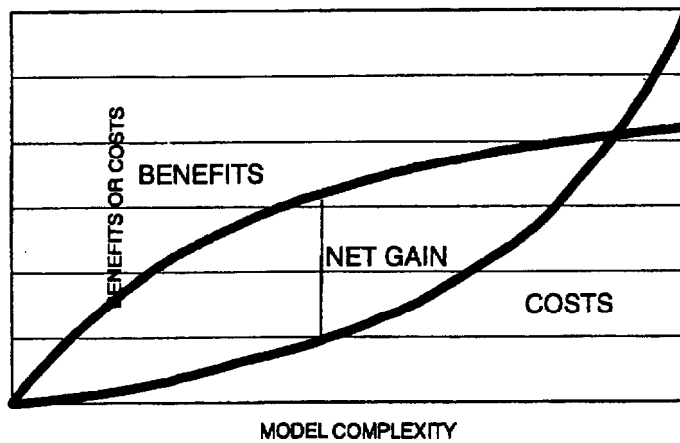

Figure 2. Model selection guide.

A typical model selected through analysis of required features and ability to meet the objectives of the community is illustrated in Table 1. The table shows a features list developed for the McMinnville, Oregon, project. The features include those that are considered essential, necessary, or an enhancement. This allows the features to be weighted, such as by applying a value of 3 for essential, 2 for necessary, and 1 for enhancement. The evaluation of a variety of hydraulic models is usually best performed by the various stakeholders in the project, with a consultant providing expert advice on the technical aspects of the programs evaluated. The familiarity of programs to the potential users, similar to brand-name loyalty in cars, is an important feature in all selection processes.

Table 1. Model Features for McMinnville, Oregon, VI Reduction Program

Feature	Weight	Priority	Comment
Runs on microcomputer	3	Essential	Preferably 466, with memory
Uses common, high-level language	1	Enhancement	Code changes unlikely
Makes source code available	1	Enhancement	
Interfaces with LYNX	1	Enhancement	
Allows dynamic hydraulic routing	1	Enhancement	Flows vary temporally
Models surcharging	1	Enhancement	System surcharges
Allows weir/diversion input	1	Enhancement	System has diversions
Is expandable for growing system	3	Essential	
Models all or part of system	2	Necessary	Local flooding problems
Has vendor support	3	Essential	
Has documentation	3	Essential	
Models variable speed pump station	1	Enhancement	

Feature	Weight	Priority	Comment
Models constant speed pump station	1	Enhancement	
Models weir/diversion hydraulics	2	Necessary	Relief points
Models off-line storage	1	Enhancement	Alternative analysis
Models in-line storage	2	Necessary	Alternative analysis
Models wetwell surcharge	2	Necessary	
Is compatible with city database	3	Essential	Database provides model input
Has a reasonable cost	3	Essential	
Generates sewage flows	3	Essential	Daily and weekly pattern
Generates infiltration and inflow flows	2	Necessary	Seasonal variations
Generates rainfall-derived infiltration inflow flows	2	Necessary	Response to rainfall events
Generates basin runoff	1	Enhancement	Probably not appropriate to city
Determines " n " from materials and age	1	Enhancement	From database
Reports full pipe capacity	3	Essential	
High quality output	2	Necessary	
Provides tabular data	2	Necessary	
Provides hydrographs	2	Necessary	
Provides hydraulic grade lines	2	Necessary	
Controls quantity or extent of output	2	Necessary	
Allows controlled diversions	1	Enhancement	Operational considerations
Is computer efficient	1	Enhancement	Answers timely not overnight
Has water-quality capability	1	Enhancement	

Addressing the Primary Business Functions

The tools discussed above (database management, CAD, GIS, and modeling programs) are critical for an effective and efficient SSO analysis. An equally important issue is how these tools support the primary business functions that the organization must perform. An organization can leverage both the tools and the raw data required for SSOs to help in other important areas.

Data collection and inventory are fundamental to a good operation and maintenance system, and are especially needed for a customer service program. Facilities plans and long-term system planning rely heavily on the ability to model the current system and simulate future development scenarios. CAD maps and GIS coverages play an important role in operation and maintenance as well as surveying, documenting, and reporting actual system performance. Finally, a user-friendly database management system is necessary for updating and maintaining the data tables and their relationships.

Selecting Available Levels of Power, Integration, and Intelligence

Part of any vehicle selection is the comparison of features and performance. How powerful and fancy a system do you need, and how much will it cost? This depends on how much information you need, how accurate an analysis you need, and what kind of results you require to support engineering and management decisions.

Database management systems have a fundamental set of capabilities such as data table development, data editing, importing, indexing, user-specified querying, and chart and report generation. Higher database systems can provide more user-friendly tools such as “query-by-example,” graphical query tools, relational joins between data tables, and enforced referential integrity. Some of the more advanced database management systems support extensive import/export formats; powerful programming and macro capabilities; automatic recording; “wizards,” “experts,” or “smart” tools that walk users through different processes; and extremely fast data query engines. Programming capabilities are critical for establishing links to other programs, especially for writing model input files and reading model output results. Many of today’s users will quickly agree that in this category of software, the more powerful and complex database programs such as Access and Approach are often as easy to use and inexpensive as the less powerful, simpler programs.

Drawing and graphic programs (**Corel Draw**, **MacDraw**, **Visio**, **Intelli-Draw**) allow the user to draw points, lines, and polygons that remain as independent objects like CAD programs. Drawing programs, however, do not usually allow the characteristics of those objects to be accessed as data, nor do they allow the user to “attach” data to the graphic objects. This characteristic, as well as the capabilities for detail drawing quality, registration to a real-world coordinate system, and extensive built-in drafting functions make CAD programs necessary for developing intelligent maps of the sewer system. Higher-end CAD programs (or their add-ons) provide additional database management functionality within the CAD environment, including data queries, graphical display of data characteristics and query results, and low-level GIS-type graphical analyses. Three examples of this type of combined software are **MicroStation** with **Lynx** add-on, **FMS/AC**, and **AutoCAD** with **ADE** add-on.

In addition to database management add-ons to CAD programs, users also have GIS add-ons that bring full GIS capabilities to CAD. These programs, such as **FMS-AC** and **ArcCAD**, use the CAD program as the primary user interface and provide high-level GIS functionality, including polygon overlays, topological queries, raster-vector image conversion, programming tools, and built-in operations that apply “artificial intelligence” to process the graphical data information. These features can be used to process data and graphics to generate sewerage and subcatchment input data for external modeling programs, display model results as hydrographs or thematic maps, and generate reports with new maps to document the SSO analysis.

GIS programs integrate database and graphical tools to provide a level of analysis that is not otherwise possible or easily performed. As the level of integration between data and graphics increases, the software is able to provide capabilities and features to support a wider range of tasks and analyses. The operations that are difficult outside of a GIS program are made easier, but the overall GIS program itself is more complex and requires special personnel and hardware to support it.

In addition to the integration of data and graphics, the SSO system could also examine the use of integrated models and facilities management software. Hydrologic and hydraulic models can be

integrated in two distinct ways. The first method is “linking” the data to the external hydrologic/hydraulic model by directly writing the input files to the models, automatically executing the models externally, and then importing the model results back into the data or GIS system. The second method is “embedding,” by which the mathematical functions required for the model simulation are embedded or contained within the **data/GIS** master program. With embedding, the simulation is performed completely within the environment of the master program. This method was once rare and available only in special purpose, nonstandard software. It is becoming more readily available, however, in powerful GIS packages such as ArcInfo, for which universities, consultants, and the Environmental Systems Research Institute, Inc. (ESRI), continue their efforts to integrate and embed standard modeling functions.

Facilities management software is *one* of the most important components to examine when “shopping” for an SSO analysis system. Facility management programs seek to integrate the sewer system data (with maps and graphics) with special purpose queries and reporting tools aimed at meeting the business functions of a system maintenance organization. These programs provide sophisticated data tracking tools (including real-coordinate maps and GPS data) for both sewer systems and facilities. They support a variety of business functions, including field inventory and inspection, maintenance and testing, customer service tracking and response records, external or embedded modeling, permit applications, integration with CAD and GIS packages, and integration with other related civil engineering information such as streets and utilities. The two leaders in this industry appear to be Hansen Information Technologies and the RJN Group.

Body Style and Comfort: User Interface Issues

Having a well-integrated, high-power vehicle is great, but what if you can't reach the pedals? What if the steering wheel is so large that you can't get your arms around it? What if the panel is so complex that every time you want to turn on the radio, you turn on the back wiper instead? Similar issues about sewer system information applications are continually debated as developers strive to improve the interface and level of service provided by their products. The best, ideal interface is the one **that** takes care of the mundane work of manipulating data and graphics (with checks and approvals from the user) and lets the user quickly get to the “real information” to perform the most interesting and challenging tasks.

Additionally, the interface must be flexible in moving data in and out via standard file formats (ASCII, dBase, Lotus 1-2-3, Excel). It should also be flexible enough that the user or select individuals within the user organization can customize it. This will prevent the steady stream of upgrade or customization costs paid to the developer for minor ongoing updating.

Example “Test Drives”

The following are examples of systems used by CH2M HILL in projects around the country. These three examples show that various platforms are available to integrate data inventories, mapping, and hydraulic modeling of sewer systems to plan and design the alternatives to reduce SSOs. The examples show a custom development program to integrate a system, an Autocad system, and a Microstation system. Other examples, such as the integration of systems in Los Angeles with ArcInfo as the platform, can be provided.

Modeling System, Portland, Oregon

The Portland modeling system was developed for the city's combined sewer overflow (CSO) facilities plan and CSO program, but many of the elements are the same as for an SSO study. This system also demonstrates the different types of integration that can be implemented with many of today's common tools.

The Portland modeling system is controlled by the SWMenu interface. SWMenu is a Visual Basic application developed to automate the generation and execution of Portland's CSO models. It is also used to edit the system data, display the modeling results, and link to the AutoCAD basin maps via MapInfo. As shown in Figure 3, SWMenu is able to access the various databases of the Portland CSO system. It can update the modeling databases and generate new SWMM input files as needed to reflect changes in the system data or possible changes in the settings of Portland's 200 diversion structures. During model simulations, SWMenu launches the Portland-modified version of SWMM 4.2 in a background DOS shell while keeping track of the success of each run. Postprocessors and macros are used to import the results into Excel and generate tables, summary statistics, and time-series graphs of depth and flow. The model results can be stored in the database and displayed on the model maps in MapInfo. An ultimate objective of the modeling system is to tie directly into the city's facilities maintenance database (currently in Hansen's water quality management system) and use the maintenance data to update the model database.

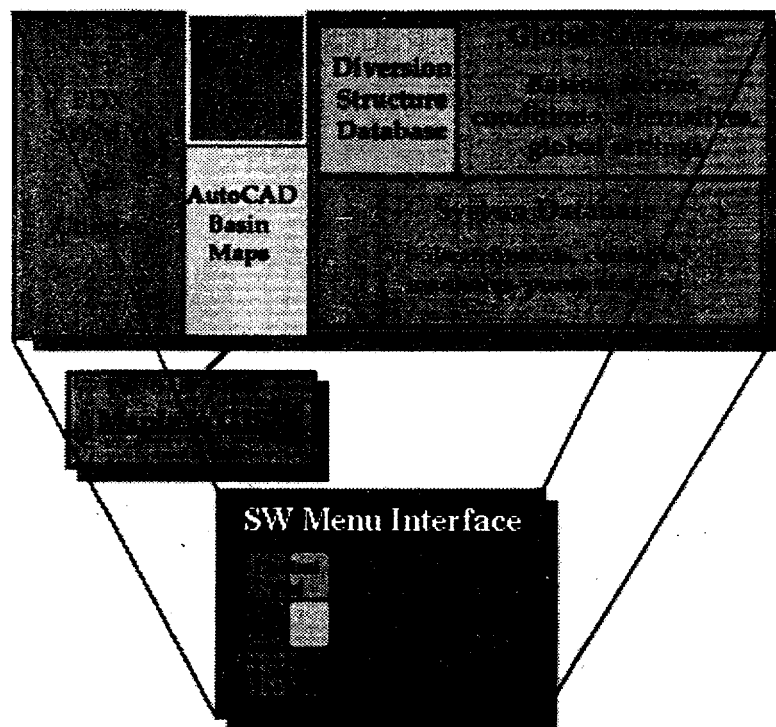

Figure 3. Portland, Oregon, modeling system.

Major Interceptor Study, Dallas, Texas

The Dallas project involved detailed analysis of more than 200 miles of sewers for determination of wet weather overflows and development of strategies to reduce these overflows. The study concluded that major capital improvements would require more than \$800 million. The study integrated existing databases and sewer modeling through use of facility management systems and Autocad. Model data input creation and result interpretation used a common Autocad-based platform with database queries and reporting linkages to SWMM. The Autocad system also provided links to evaluation of alternatives, including interceptor replacement and storage tunnels. Figure 4 shows a typical results screen from the project.

Sewer System Evaluation Survey and Master Plan, Salem, Oregon

In partnership with City of Salem personnel, CH2M HILL is defining and implementing a sewer system evaluation and master planning effort that will provide a framework for wastewater services well into the next century. The project has incorporated and linked the city's Hansen, GLADS, and LYNX systems. This has maximized the integration of the city's databases in the development of the sewer master plan.

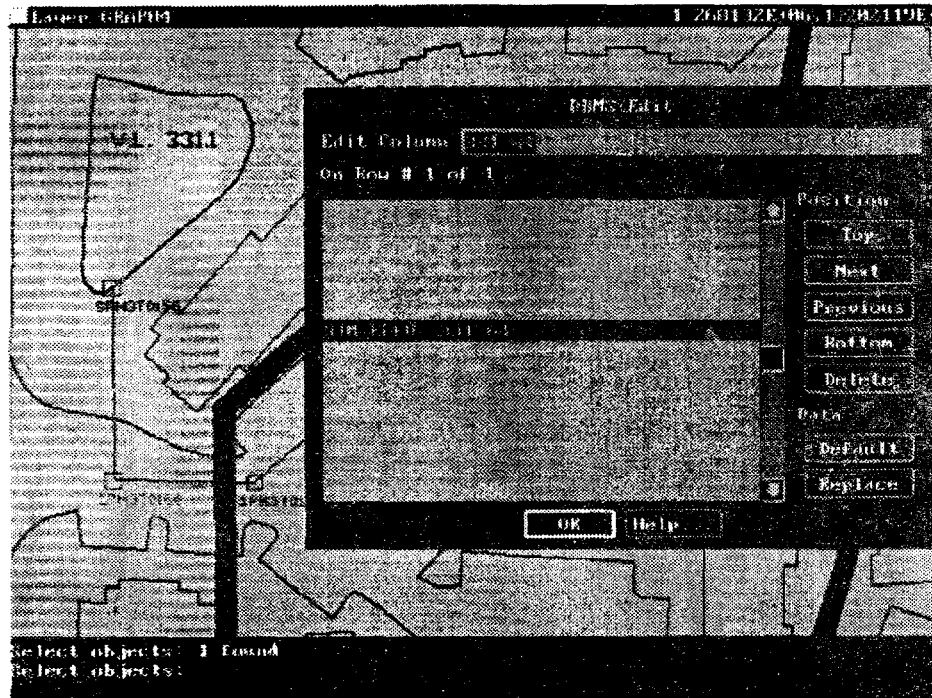

Figure 4. Dallas, Texas, interceptor study.

The project involves the characterization and quantification of wet weather flows that exceed the city's goals for the 5-year/24-hour and 25-year/4-hour storm events. Flow monitoring is being conducted to determine whether excessive wet weather flows (those that exceed the city's objectives) pervade the city's system or whether they are more prevalent in some drainage basins than in others. This geographic distribution of the peak wet weather flow problem is a critical flow characterization effort that will identify whether corrective elimination measures or storage/conveyance is more cost effective. Figure 5 shows a typical database query of modeling results with visualization of critical capacity constraint areas.

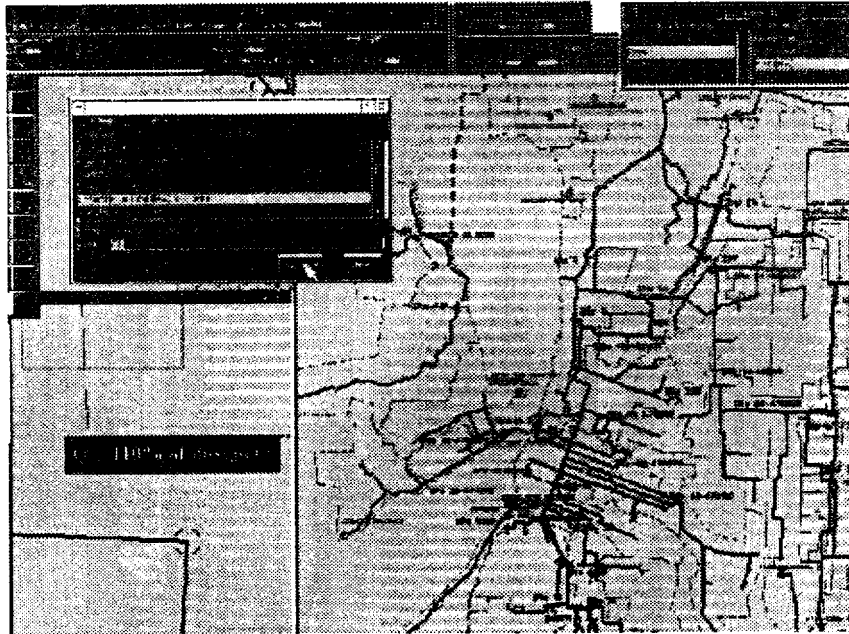

Figure 5. Salem, Oregon, sewer system evaluation survey.

Conclusion

The variety of systems available to the community is relatively limited. The linkages between the most popular data management systems and common hydraulic models are under development and are expected to be widely available in the next few years. **As** in selecting a suitable vehicle to drive and enjoy, it is necessary to consciously determine the features required of the various systems and the level of comfort required in maintaining and operating the vehicle. The decision between a low-cost Ford or a luxury Jaguar can usually be rationally supported; a decision to buy a **DeLorean**— from a nonstandard, single vendor, with poor support, and “heading toward bankruptcy”—should be avoided.

Sanitary Sewer Overflows Leave Telltale Signs in Depth-Velocity Scattergraphs

Patrick L. Stevens and Heather M. Sands
ADS Environmental Services, Inc., Indianapolis, Indiana

Sanitary sewer overflows (SSOs) are elusive. They are difficult to witness or document because they usually occur during rain events, when people are indoors. Frequently they are located out of sight at the lowest manholes or structures along creeks and ravines. Toilet paper in the branches along the creek might be the only evidence that some SSOs leave behind. Casual observers and some collection system managers first assume that they need a greater capacity pipe. More often, most SSOs have a downstream bottleneck as a contributing cause, and in many cases greater capacity is not needed. SSOs and bottlenecks each leave telltale evidence in the data of nearby flowmeters. This paper discusses how SSOs and bottlenecks reveal themselves when the flowmeter data are displayed as a depth-velocity scattergraph.

The Hydraulic Grade Line

The hydraulic grade line (HGL) connects the surface of a liquid at various points. In open channel flow, HGL corresponds to the water surface, as shown in Figure 1. If flow exceeds the capacity of the pipe, the water level will rise and the pipe will operate in a surcharged mode. Under ideal conditions, the HGL is parallel to the slope of the pipe, as shown in Figure 2.

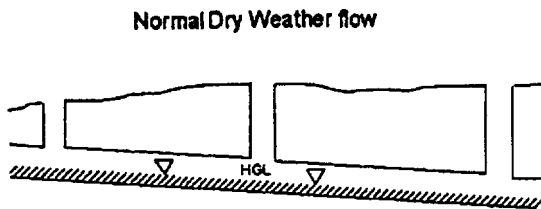

Figure 1. HGL corresponds to water surface.

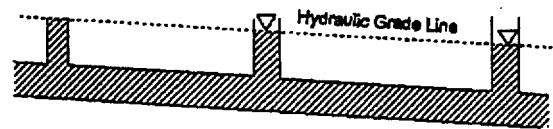
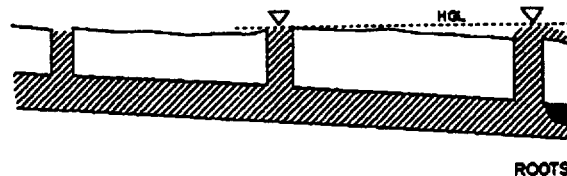

Figure 2. HGL is parallel to pipe.

If a downstream restriction prevents the pipe from carrying its full capacity, the pipe will fill during rain events and become surcharged while carrying only a fraction of its design capacity. If the bottleneck is major, such as from a collapsed pipe or excessive amounts of roots, the flow slows significantly and HGL becomes almost horizontal. Figure 3 shows roots reducing the pipe's capacity by approximately 50 percent and causing an SSO. Here HGL is measured from the elevation of the SSO and can become nearly horizontal.



SSO caused by a Bottleneck -
Severe Bottlenecks Flatten the HGL

Figure 3. HGL flattens during an SSO.

Scattergraphs

Manning's theory states that velocity in an open channel pipe increases as the depth of flow increases and that, for a given pipe, a certain depth should always correspond to a certain velocity. This relationship between depth and velocity is often displayed as the hydraulic elements curve shown in Figure 4. Open channel flowmeters on the market today calculate flow by the continuity method (cross-sectional area times velocity) and use depth and velocity sensors as their primary input. Plotting a flowmeter's data in a depth-velocity scattergraph offers a quick and easy way to check on the quality of the raw sensor readings. If the shape of the depth-velocity scattergraph resembles that in Figure 4, then the sensor readings are repeatable and valid. Scattergraphs are easily created using spreadsheet software. (All scattergraphs in this paper were created in Lotus 1-2-3, Version 4.0.)

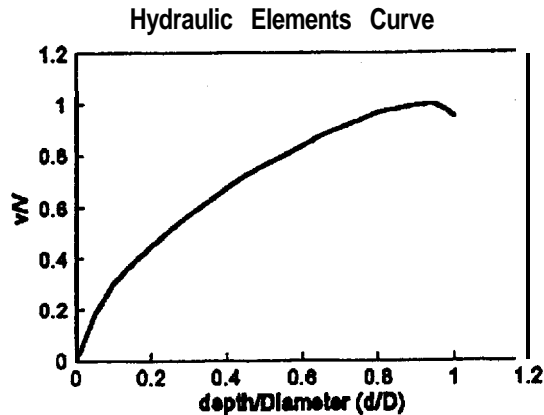

Figure 4. Manning's theory.

Figure 5 is a scattergraph that exhibits a classic cigar-shaped pattern, which indicates that the depth and velocity readings are valid. This scattergraph and most of the other scattergraphs in this paper are from data collected during infiltration and inflow (I/I) studies around the United States. All data were either collected by ADS Environmental Services or provided by municipalities, and most of the scattergraphs are from data collected over 60 days. No attempt was made to verify the accuracy of the data.

Depth and Velocity Sensors

Most of the depth data displayed in this paper are readings captured by ultrasonic and pressure transducer technologies. Most of the velocity data were captured by a digital Doppler velocity sensor. In routine situations, all three sensors are installed together. Figure 6 shows the basic configuration of the ultrasonic depth sensor used to measure flow depths during routine conditions. The measurements are accurate and drift free, and are used for depths less than full pipe. Figure 7 shows the basic configuration for pressure transducer measurement, which records depth of surcharging. In this paper, all depth readings below full pipe are ultrasonic readings, and those above full pipe are from the pressure sensor.

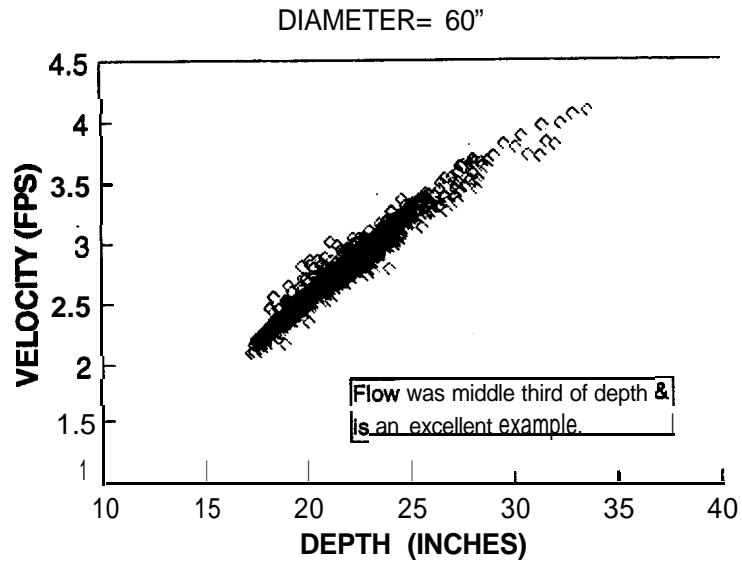

Figure 5. A classic cigar-shaped pattern.

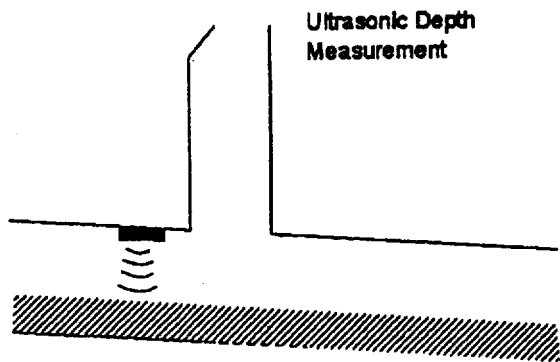

Figure 6. Ultrasonics used for normal flow.

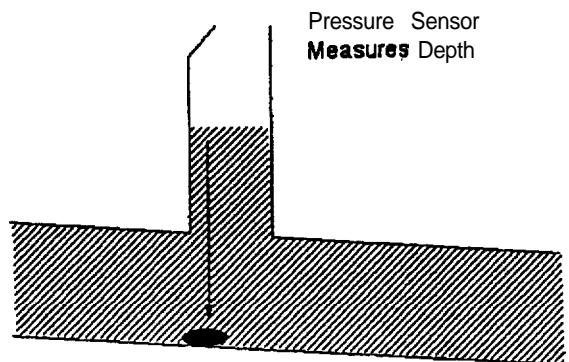

Figure 7. Transducer measures HGL.

The pressure sensor measures pressure in the adjoining manhole. Think of the pressure sensor as recording HGL above the flowmeter.

Velocity is measured by a digital Doppler sensor mounted on or near the bottom of the sewer. Its signal is transmitted upstream, as shown in Figure 8.

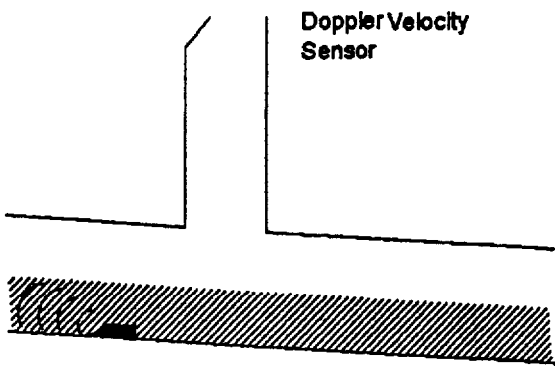

Figure 8. Digital Doppler looks upstream.

Classic Signature of a Bottleneck

Figure 9 is the classic scattergraph signature of a bottleneck downstream of the flowmeter. This scattergraph shows that during the minimum flow at this site, depth is around 4 inches while velocity is around 2 feet per second (fps). As the depth increases to around 10 inches, the velocity increases as expected to greater than 4 fps. As depth increases from 10 inches to full pipe (24 inches), velocities drop to around 2 fps. As depths increase above 24 inches, the sewer begins to surcharge, and additional pressure forces greater flow through the bottleneck. As depth increases to 60 inches, velocity increases to around 3 fps, the same as at 6 inches of depth.

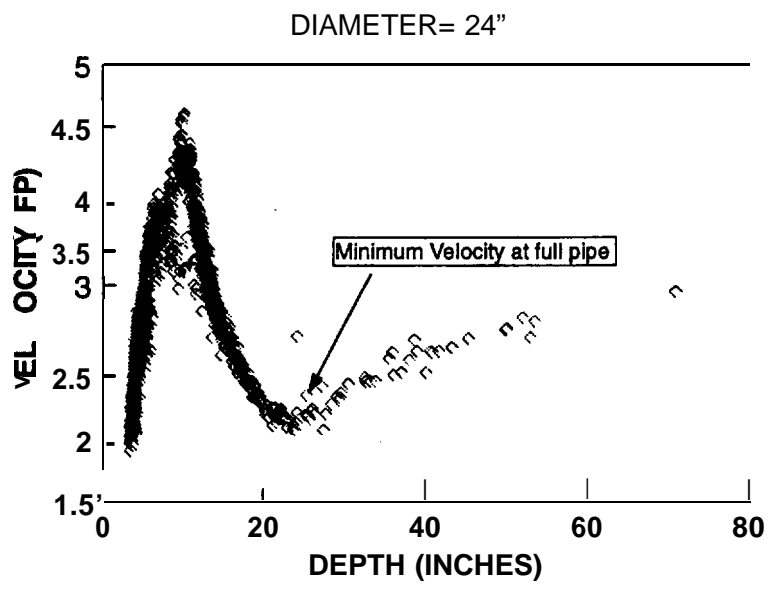

Figure 9. A classic bottleneck signature.

Signature of an SSO

An SSO occurs whenever the HGL rises to the lowest outlet in the sewer system, or when the SSO limits the height of the HGL. Therefore, if there is a pressure (or HGL) that is never exceeded, regardless of the number of surcharge events or the amount of rain, one must assume that an SSO is occurring. The classic scattergraph signature of an SSO can be seen in Figure 10. This 33-inch sewer experienced several wet weather events during the study, and there is a very distinct limit to the pressure depth or HGL. The low velocities reveal a flat sewer. Even during the SSO event, the velocities seldom exceeded 1.5 fps.

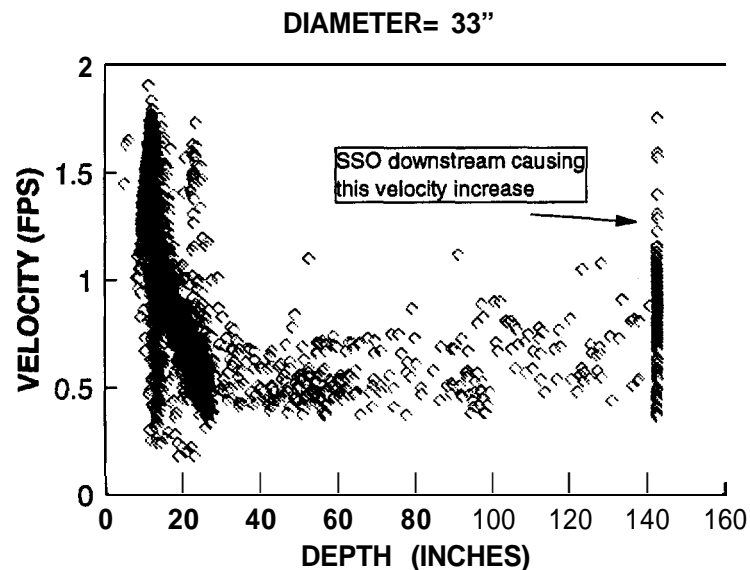

Figure 10. Vertical line at right is from an SSO.

Is the SSO Upstream or Downstream of the Flowmeter?

The shape of the scattergraph during the SSO event helps determine whether the SSO is upstream or downstream of the flowmeter. If the overflow occurs below the meter, as shown in Figure 11, activation of the overflow increases the volume of water passing by the meter, and an increase in velocity will be detected. Figure 12 is the scattergraph of a site with the SSO downstream. The telltale characteristic is that the velocity increases once the SSO is activated. Activation of the SSO allows more flow to leave the system. Because the pipe is already full, greater flow rate means greater velocity. The overflow at this site was within two or three manholes downstream.

SSO and Bottleneck Downstream of Flowmeter

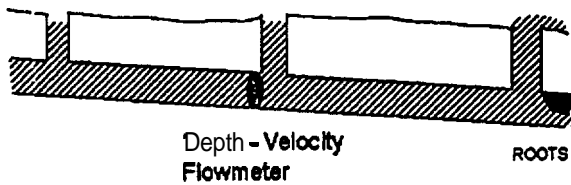

Figure 11. An SSO increases velocity at the meter.

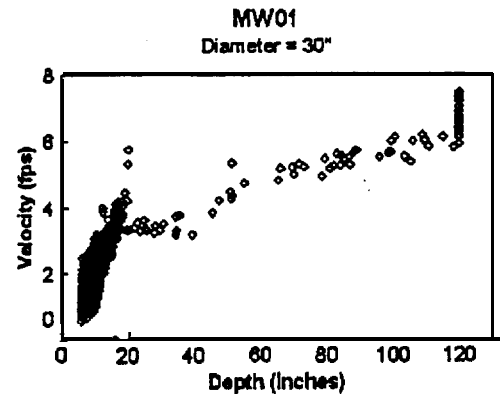

Figure 12. SSO activation downstream increases velocity at the flowmeter.

A word of caution is in order here. It is possible that the apparent limit to pressure (HGL) is actually the upper limit of the sensor. Even if the upper limit of the sensor is exceeded, a significant velocity increase would indicate that an SSO is active. It is also possible for a flooded basement to dampen depth increases sufficiently to create an apparent SSO signature in a scattergraph. Although EV08 (shown in Figure 10) appears to have reached the upper sensor limit, the SSO is documented by the velocity increase and **was** verified by field **crews**.

What should we expect if the SSO is upstream of the flow monitor, as shown in Figure 13? The volume of water passing through the flowmeter should remain steady during the activation of the SSO. Figures 14 and 15 are both sites that appear to have an SSO activated upstream of the flowmeter. The telltale characteristic here is that the velocity remains low during the SSO activation. Here again caution is in order. If the pressure sensor limit is exceeded and velocity remains low, it is invalid to assume that an SSO has occurred.

SSO Upstream of Flowmeter

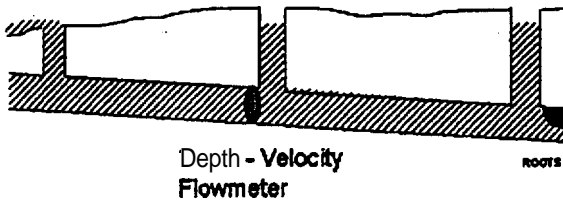

Figure 13. SSO volume escapes undetected.

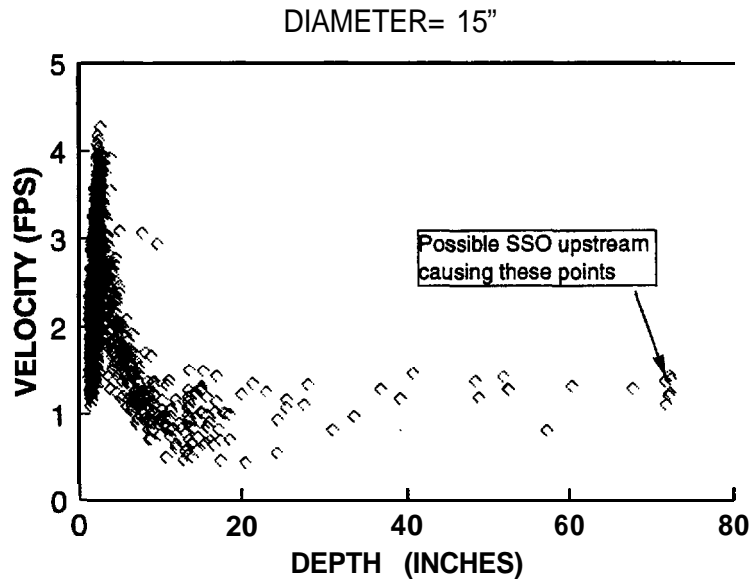

Figure 14. A likely SSO upstream.

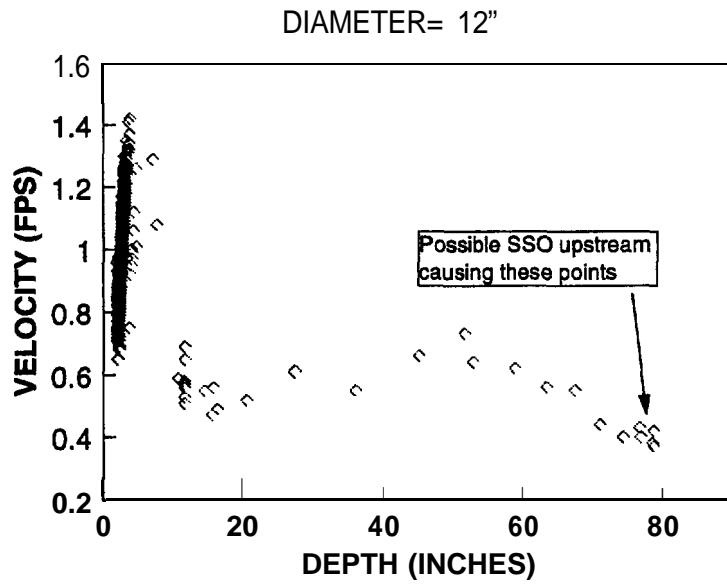

Figure 15. A likely SSO upstream.

These two sites are from the same study, and only one system-stressing rain event occurred during the study. Both sites exhibit the bottlenecked scattergraph patterns, and both sites maintain the same low velocity even after the SSOs activate at around 72 and 79 inches of depth. Even though each

scattergraph shows multiple readings at the upper depth, these sites should be monitored for a longer period to be certain that SSOs are present.

How Close Must the Flowmeter Be to the SSO?

In theory, any maximum pressure depth repeated over multiple storms indicates that the flow monitor is within the HGL influenced by the SSO. The flatter the HGL, the greater the influence. Consider a housing subdivision served by a 12-inch pipe that is almost completely blocked by roots or debris. Such a bottleneck would likely cause a surcharge with very little additional I/I, and the HGL would be nearly flat over the entire subdivision. A flow monitor anywhere within the subdivision would detect an SSO.

Do All Flow-Measuring Technologies Work the Same?

Technologies used to measure depth in open channel sewers today include ultrasonic and pressure transducers. Velocity technologies include electromagnetic, analog Doppler, and digital Doppler. Each exhibit characteristic signatures in scattergraphs.

The three scattergraphs in Figure 16 are from three flowmeters installed in adjacent manholes on a 30-inch line that experiences rapid fluctuation in flow rate. These data were provided by the municipality that conducted the 60-day test. The scattergraphs display depth and flow and are similar in shape to depth-velocity scattergraphs.

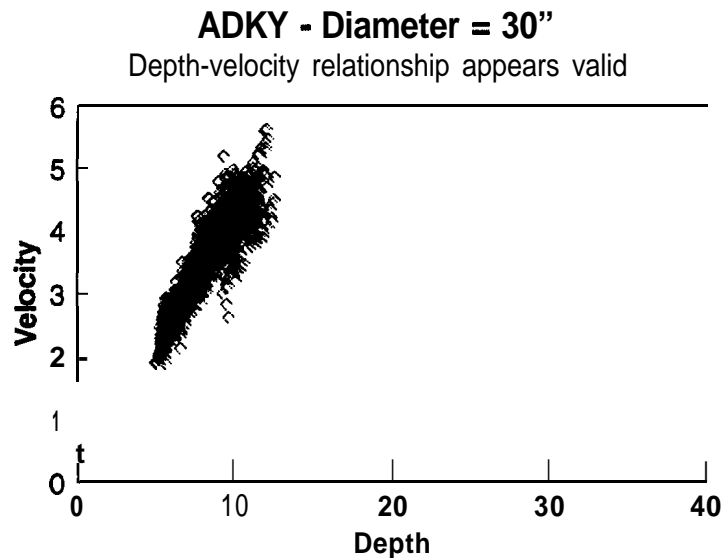
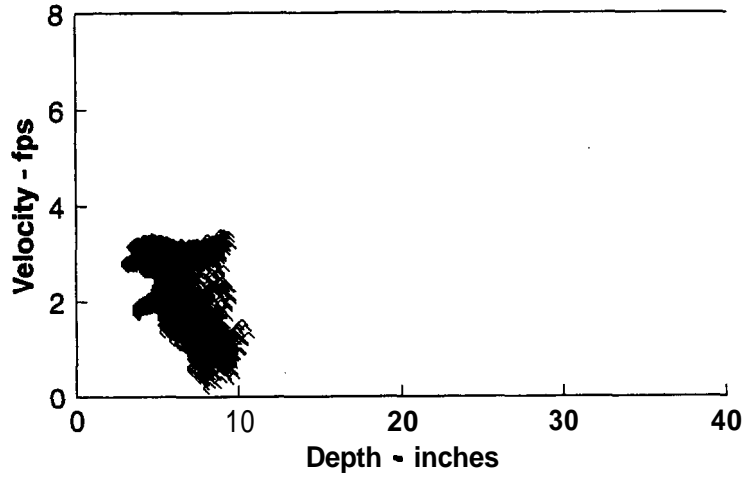

Figure 16. Scattergraphs from flowmeters installed in adjacent manholes at site AEBV.

MMKY - Diameter = 30"

Electromagnetic Velocity sensor gradually fouled.



ISKY - Diameter = 30"

Velocity Sensor has fouled or failed some of the time.
Depth-Velocity relationship not well formed.

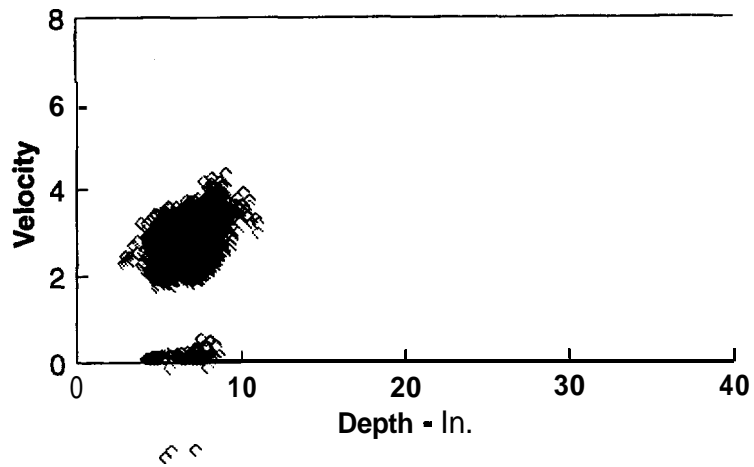

Figure 16. Scattergraphs from flowmeters installed in adjacent manholes at site AEBV (continued).

Evaluation of Methodologies To Estimate Peak Inflow in Sanitary Sewers

Aaron A. Witt and Richard E. Nelson
Black & Veatch, Kansas City, Missouri

The need for standard methods of flow analysis in sanitary sewer systems is apparent by the lack of accepted or approved methodologies detailed in civil engineering reference manuals and other reference materials. With increasing emphasis on sanitary sewer overflows (SSOs), municipalities and agencies need standards for evaluating the current state of their collection systems and gauging the effectiveness of implemented improvements.

The purpose of this paper is to provide statistical evaluation of several flow analysis methodologies used to evaluate short- and long-term flow monitoring data. Analyses of flow parameters used in estimating peak flow rates were performed, including determination of confidence limits and the sensitivity of estimators developed for peak flow determination. The analyses performed suggest that some methodologies may be more appropriate with limited flow monitoring programs. In addition, a wide range of projected peak inflows can be obtained depending on the method applied.

Background

One objective of flow monitoring programs in separate sanitary sewer systems is to collect sufficient data to estimate peak system flow rates during selected design storm events. The estimated peak flow rates are used for:

- Evaluating sewer capacity and peak flow rates (level of protection)
- Prioritizing subsystems for future study
- Relief sewer sizing
- Quantifying infiltration and inflow (I/I) source data
- Evaluating the system before and after rehabilitation

In many systems, a correlation exists between peak flow rates and rainfall. Except for systems in arid regions, high flow rates in separate sanitary sewer systems are generally due to precipitation and the resulting inflow through system defects and other clearwater connections.

One technique for estimating inflow uses an exponential variation of the rational method of determining peak discharge (1):

$$Q = a i^b \quad (\text{Eq. 1})$$

where

Q = peak inflow rate (acre-inch per hour, taken as cubic feet per second)

a = flow coefficient (acres)

i = average **30-minute** rainfall intensity (inches per hour)

b = flow coefficient

A relationship between the type of inflow sources and the flow coefficients is suggested. The work suggests that a high linear correlation exists between rainfall and peak inflow using the peak **30-minute** rainfall intensity of monitored system events. For the five municipalities studied, the average correlation coefficient reported was 0.909. Linear regression is required to estimate the "a" and "b" flow coefficients.

A second technique for estimating inflow uses a modification of the rational formula as follows (2):

$$Q = KiA \quad \text{(Eq. 2)}$$

where

Q = peak inflow rate (area-inch per hour, taken as cubic feet per second)

I = average rainfall intensity for a measured time of concentration (inches per hour)

A = gross **sewered** area (acres)

K = average measured inflow coefficient (dimensionless)

Several advantages are discussed:

- Direct comparison of cumulative inflow coefficients at each monitoring point can be made.
- System dynamics is considered because peak rainfall intensity is based on measured time of concentration.
- The technique is easy to use and can be directly applied to computer models.
- The technique allows determination of inflow generation for interior subsystems with at least one tributary subsystem. The inflow generated within an interior subsystem cannot be directly measured because measured flow is the cumulative total of all tributary subsystems.

Study Areas

Data from four study areas were used for analysis: the West Branch Shunganunga service area in Topeka, Kansas; the City of Garland, Texas; the Trinity River Authority's Central Regional Wastewater System (CRWS), in Texas; and a service area of the City of Houston, Texas. These study areas range from a watershed system to a large regional wastewater system:

- The West Branch Shunganunga service area in Topeka includes about 2,500 acres of residential, commercial, and industrial land use. The study area includes 66 miles of sanitary sewer, excluding building service laterals. The line sizes range from 8 to 27 inches in diameter.
- Garland includes a total developed area of about 110 square miles. The study area is divided into two major service areas and includes about 930 miles of sanitary sewer, excluding building service laterals. The line sizes range from 8 to 48 inches in diameter.

- The Trinity River Authority's CRWS includes a total tributary area of about 190 square miles. The study area is divided into five interceptor systems and includes about 3,300 miles of tributary sanitary sewer, excluding building service laterals. The tributary service area includes line sizes ranging from 8 to 90 inches in diameter.
- The study area in Houston is designated as the Sims Bayou Service Area and includes about 42 square miles of **sewered** area. The study area includes 727 miles of sanitary sewer, excluding building service laterals. The line sizes range from 8 to 84 inches in diameter.

All of the study areas are subject to significantly higher sanitary sewer flow rates during wet weather conditions due to *I/I*.

Data Collection

For all four projects, flow and rainfall monitoring and data analysis were performed specifically to correlate flow rate and rainfall intensities.

Continuously recording tipping-bucket rainfall gauges were utilized. Accuracy of recordings was to 0.01 inches. Multiple rain gauges were installed to provide spatial rainfall distribution information for each rainfall event.

Depth and velocity flow monitors were used to measure open channel flow. All flow monitors were calibrated to ensure accurate flow readings. The importance of meter calibration has been documented (3).

Data Summaries

Rainfall Summary

For each rainfall event and each rain gauge, the maximum rainfall depth was summarized for various storm durations. A rainfall event was defined as an event with at least 0.15 inches of rain depth and separated by 6 hours or more from previous rainfall. These data were used to determine the maximum rainfall intensity in inches per hour for the various storm durations, as well as to determine the flow coefficients in Equation 1 and Equation 2. For Equation 1, analyses were performed for both the peak 30-minute rainfall intensity and the critical rainfall for the subsystem time of concentration. The equations used in these analyses will henceforth be referred to as Equation 1₃₀ and Equation 1_{tc} respectively. For Equation 2, the rainfall intensity corresponding to the measured time of concentration was used for analysis. The time of concentration was estimated based on the initiation of peak rainfall to the time of peak inflow and from the tributary area.

Inflow Determination

Inflow for a specific storm event includes all rainfall-induced flow, including direct inflow and what is sometimes known as rapid infiltration. The total peak instantaneous flow measured during inflow periods includes wastewater production (base flow) and infiltration flow (ground-water related flow) and inflow (rainwater-related flow). Inflow for each rainfall event was determined by subtracting the wastewater production and infiltration flow from the measured peak flow. Normally, the wastewater production and infiltration flow was estimated from flow data 24 hours before the peak flow during the inflow period.

Data Analysis

To make effective use of sanitary sewer flow and rainfall data, the monitored data must be used to provide reliable projections of peak flow for selected design storm conditions. Equation 2 was actually implemented in all study areas to make peak flow projections. These projections were used to prioritize areas for detailed physical inspections and to size relief facilities. To evaluate peak flow projections using alternative methodologies, flow projections were compared using Equation 1₃₀, Equation 1_{tc} and Equation 2; the confidence limits of these projections were evaluated; and additional insight into the reliability and usefulness of each equation was provided.

Statistics

Although Equation 1₃₀, Equation 1_{tc}, and Equation 2 are quite similar in many respects, the derivation of the coefficients has a pronounced impact on the reliability of the flow estimates, especially with the limited data that are normally available in short-term flow monitoring programs. In many cases, three or four data points are used to predict peak flows for a selected design storm event. Selection of the flow analysis model, therefore, greatly influences the reliability of the flow projections.

Use of Equation 1₃₀ and Equation 1_{tc} requires determination of the a and b coefficients using simple linear regression analysis. The nonlinear equation can be written in linear form in the logarithm of Q and I as follows:

$$\log Q = \log a + b \log i \quad (\text{Eq. 3})$$

The parameter a controls the vertical elevation of the regression line; in other words, it gives the value of I at which the regression line intersects the ordinate. The b value is the slope of the regression line. Estimates of a and b are obtained using the least squares technique. The least squares method is discussed in most books on statistics (4).

Remember that, for a given sample, the statistics a and b are estimates of the population parameters and are derived on the basis of certain assumptions, including the following key assumptions:

- The regression analysis assumes that the independent variable is not subject to error and may even be controlled. For sewer flow monitoring, the independent variable is rainfall. The variable certainly cannot be controlled and, with respect to the spatial distribution of rainfall, can be subject to measurement error.
- The deviations of a and b are assumed to be independent and normally distributed. Again, in sewer analysis involving flow and rainfall, this assumption is not always satisfied. There is a narrow range of rainfall intensities within which quality flow data can normally be obtained.

The regression model is appropriate for situations in which a functional relationship is postulated. By contrast, correlation analysis implies no dependence and considers only the covariation of the variables. Correlation analysis is also discussed in most books on statistics (4). The coefficient of determination (4), which is the square of the correlation coefficient (r), provides a level of explained variation. Whether there is any causal mechanism linking the two variables or whether one is conditional upon the other is never resolved by statistical analysis alone.

The use of log-log plots for Equation 1₃₀, Equation 1_{tc}, and Equation 2 is convenient, but the quality of data should be carefully reviewed as log-log plots tend to make a straight line out of most sets of data. It should be noted that Equation 1₃₀ and Equation 1_{tc} can be readily transformed into Equation 2 assuming linearity (b = 1) and substituting the value KA for a.

Use of Equation 2 requires additional analysis to determine total **sewered** tributary area, to determine system time of concentration, and to summarize each rainfall for the various times of concentration measured. Once these values are determined, however, the methodology using Equation 2 does not rely on simple regression analysis for determination of the K coefficient (defined as the inflow coefficient) but rather measures K directly by substituting measured flow, rainfall, and acres into Equation 2 and solving for K. The measured K represents the reaction rate or leakage rate of the system in question. The average of measured Ks from selected storm events is used in Equation 2 to estimate peak inflow for various design storm events.

Evaluation of Equations 1 and 2

The evaluation of Equation 1₃₀, Equation 1_{tc}, and Equation 2 includes the following analyses. It should be noted that the same data were used for all analyses.

- The average inflow coefficient (K) was determined for each monitoring point to be used in Equation 2.
- The coefficients a and b were determined for each monitoring point to be used in Equation 1, and Equation 1_{tc}, using simple linear regression.
- The correlation coefficient of Equation 1 data points was determined using the linear model ($\log Q = \log a + b \log i$), the peak **30-minute** rainfall intensity, and the variable time of concentration.
- The correlation coefficient of Equation 2 data points was determined assuming the linear model ($Q = KiA$) and variable time of concentration.
- The **90-percent** confidence intervals for the 1-year storm inflow projections for Equation 1₃₀, Equation 1_{tc}, and Equation 2 were determined.
- The **90-percent** confidence intervals of the b coefficient in Equation 1₃₀ and Equation 1_{tc} were determined and evaluated.
- The **90-percent** confidence interval range of the 1 -year flow projection for Equation 1₃₀, Equation 1_{tc}, and Equation 2 to the estimated 1 -year inflow value was evaluated.

Results

Flow Coefficient Data

Flow monitor information, number of storm events (data points) analyzed, and flow coefficients are summarized in Table 1.

Table 1
Subsystem Monitored Flow Coefficients

Study Area	Flow Monitor	Cumulative Area	Number Of Data Points	Equation [1] 30		Equation [1] tc		Equation [2] "K"
				a	b	a	b	
Houston	SB11	779	3	2.49206	-0.20798	1.32571	-0.43268	0.024690
Houston I	SB16	686	6	0.95535	0.44842	2.39152	0.78869	0.005880
Houston	SB22	1831	3	5.29440	-0.05672	5.37544	0.03058	0.006140
Houston	SB27	236	5	1.11857	0.94285	2.04352	1.16373	0.011950
Houston	TSB-006	56	3	0.11603	1.32995	0.27849	1.65049	0.002720
Houston	TSB-014	151	3	0.17468	0.28825	0.23253	0.34808	0.004590
Houston	TSB-024	134	4	0.53692	0.55475	0.65647	0.52237	0.006630
Houston	TSB-030	931	5	2.97778	1.10096	7.53295	1.02609	0.007970
Houston	TSB-038	198	7	0.27936	0.39380	0.39550	0.49319	0.003640
Houston	TSB-044	107	6	0.94185	0.22128	0.94230	0.09776	0.026790
Houston	TSB-050	79	3	0.26533	0.53139	0.38154	0.67911	0.007880
Houston	TSB-058	140	4	0.10811	-0.28336	0.13436	0.37555	0.002080
Houston	TSB-072	77	5	0.46725	0.08755	0.69345	0.67405	0.011130
Houston	TSB-078	149	7	1.40215	0.20716	1.70237	0.29551	0.023950
Houston	TSB-084	107	8	0.59774	0.42981	0.50873	0.56173	0.008580
Houston	TSB-091	263	6	1.32135	1.25144	2.83055	1.30959	0.007860
Houston	TSB-100	2355	8	4.71244	0.83403	8.43940	0.70769	0.005530
Houston	TSB-106	95	9	0.09652	0.45047	0.11150	0.44786	0.002180
Houston	TSB-113	118	3	0.31117	0.59964	0.38071	0.25522	0.007100
Houston	TSB-118	121	5	0.57522	-0.00800	0.57278	-0.00513	0.013890
Houston	TSB-129	298	4	0.21627	0.38170	0.34083	0.48151	0.002120
Houston	TSB-135	98	8	0.32423	1.07211	0.60926	0.86183	0.008300
Houston	TSB-140	203	9	0.83250	0.57564	1.24998	0.60512	0.011710
Houston	TSB-149	577	4	0.48028	1.92501	2.95335	2.93394	0.009550
Houston	TSB-161	94	7	0.21734	0.45709	0.27287	0.49578	0.004200
Houston	TSB-167	140	4	0.94308	0.35564	1.06646	0.39419	0.011190
Houston	TSB-173	448	5	15.37020	-0.00274	16.93706	0.14608	0.070710
Houston	TSB-179	760	4	2.98229	-0.10701	2.63724	-0.17083	0.012610
Houston	TSB-186	866	4	1.07022	0.24766	1.21658	0.24030	0.002330
Houston	TSB-192	105	7	0.36930	0.88450	0.51027	0.90768	0.005110
Houston	TSB-203	1285	7	3.91957	0.58579	7.88305	0.73497	0.010200
Garland	MB09	1340	10	3.43975	0.64844	11.15414	0.91174	0.009845
Garland	MB10	459	8	1.67731	1.02185	10.51440	1.59227	0.014604
Garland	MB11	3026	9	3.63906	0.27066	5.69055	0.31063	0.009441
Garland	RH12	707	11	1.09873	0.73806	3.48643	0.94026	0.005735
Garland	RW03	264	10	0.08794	0.62449	0.34350	0.83294	0.001974
Garland	RW04	447	9	0.59946	0.81376	2.95786	1.16605	0.005379
Garland	RW05	392	8	0.75095	0.90207	3.62486	1.23100	0.006745
Garland	RW06	5651	10	4.60670	0.91022	63.34902	1.23132	0.007173
Garland	RW07	803	10	0.59506	0.53136	1.63172	0.78430	0.003140
Garland	RW08	6172	8	5.52484	0.77945	42.70666	0.95042	0.008660
Garland	SPO1	913	8	0.95510	0.22222	3.58074	0.88422	0.005247
Garland	SPO2	3118	7	2.35222	0.07643	12.31485	0.93493	0.004816
Garland	STP1	17552	5	18.85630	0.93958	118.51082	0.98852	0.007291
Garland	DC03	11559	9	14.23699	1205	67.27566	1.03624	0.005806
TRA	16.5E	10994	8	10.33809	0.59078	63.91876	0.92767	0.004806
TRA	T004	33882	7	17.69702	0.14818	142.82304	0.87189	0.006400
TRA	10W	1481	6	2.10200	0.32317	5.21960	0.78069	0.004961
TRA	EF1&EF2	4366064	7	54503906	0.80101	1094.78156	1.38103	0.009160
TRA	WF5	2633	8	3.72748	1.25601	24.98804	1.58224	0.005340
TRA	2.0M	794	6	0.26273	0.10432	0.56067	0.49447	0.001753
TRA	9.0M	2554	7	1.88268	-0.15907	4.30182	0.34528	0.006304
TRA	BC1	22226	9	20.95599	0.11910	37.88715	0.26913	0.012020
TRA	BC2	18902	9	18.73946	0.08065	23.27911	0.13183	0.008572
TRA	JAX	2470	7	6.61794	-0.00829	10.24296	0.24217	0.016805
TRA	JA2	1580	7	0.90702	-0.41005	0.01581	-2.52020	0.004390
TRA	WF6	9223	8	5.18582	-0.26141	3.80847	-0.27796	0.004698
Topeka	8.1	1174	4	2.84551	1.11372	22.19.165	1.66642	0.004625
Topeka	09	174	5	0.18980	-0.01740	0.29668	0.33591	0.004376
Topeka	08	1303	4	0.59033	-0.44634	0.10702	-0.88609	0.005465
Topeka	01	2531	6	1.66929	-0.20852	0.78353	-1.46815	0.008240
Topeka	5.1	237	5	0.11663	-0.24801	0.08485	-0.32249	0.004082
Topeka	06	1562	3	0.88372	-0.11428	0.69963	-0.17040	0.006267
Topeka	07	415	7	0.55796	0.33314	0.78315	0.40444	0.007239
Topeka	05	534	9	0.45123	-0.00268	0.81811	0.30570	0.007578
Count 65		Average	6.5		0.43378		0.56167	0.008608

A total of 65 monitoring sites were analyzed. Cumulative tributary acres to the monitoring sites analyzed ranged from **130** to 43,960 acres. The number of data points per meter ranged from 3 to 11, with an average of 6.5 data points per monitoring site.

Because the a coefficient includes a leakage factor and an area factor, the absolute value of this coefficient by itself does not have much meaning. The slope (b) of Equation 1₃₀ ranged from -0.446 to 1.925, with an average of 0.434. A negative b value results in decreasing flow estimates with increasing rain, an unrealistic estimate and one difficulty of the linear regression analysis with a small amount of data. The slope (b) of Equation 1_{tc} ranged from -1.468 to 2.934, with an average of 0.562.

The inflow coefficient (K) ranged from 0.0018 to 0.02679 (dimensionless), with an average of 0.00861.

Confidence Limits of 1-Year Inflow Estimates and Correlation Coefficients

The **90-percent** confidence limits for mean 1 -year inflow estimates were made for Equation 1₃₀ and Equation 1, using a t distribution with n-2 degrees of freedom, in accordance with standard statistical procedures (4). The **90-percent** confidence limits for l-year inflow estimates were made for Equation 2 assuming normally distributed errors in the measurement of the inflow coefficient (K) using at distribution with n-2 degrees of freedom (4).

- The correlation coefficients for the linear form of Equation 1₃₀ and Equation 1_{tc} ranged from -0.999 to 0.998, with an average of 0.484. In general, the linear association between log Q and 30-minute log shows a positive correlation. The correlation coefficient of the data points used for analysis in Equation 2 ranged from -0.800 to 0.998, with an average of 0.512.

The confidence limits for Equation 1₃₀ and Equation 1_{tc} reflect a large uncertainty in the mean response. The confidence limits for Equation 2 are smaller than those for Equation 1₃₀ and Equation 1_{tc} even though the correlation for both equations is about the same. This is shown on Figure 1, where the confidence limits, expressed as a percentage of estimated inflow value, are plotted against the correlation coefficient.

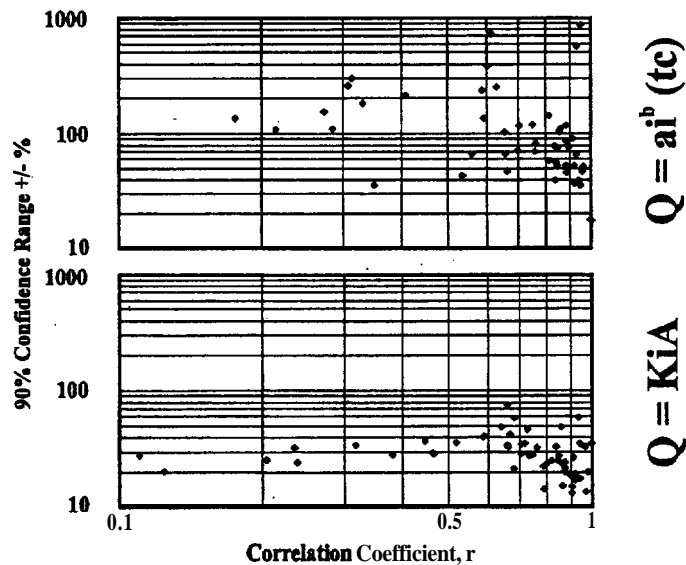

Figure 1. Confidence limits and correlation coefficients.

Analysis of b, Slope for $Q = at^b$, Equation 1

The 90-percent confidence interval of b, the slope of the logarithmic form of Equation 1₃₀ and Equation 1_{tc}, was determined using the t distribution with n-2 degrees of freedom, in accordance with standard statistic procedures (4). The confidence intervals were generally large, ranging from negative to positive values. It is interesting to note that 34 of the 65 confidence intervals in Equation 1₃₀ and 46 of the 65 confidence intervals in Equation 1_{tc} include the value 1.000. A plot of the correlation coefficient for Equation 1₃₀ and Equation 1_{tc} and the estimated slope, b (shown in Figure 2), shows a tendency for b to approach 1.0 as the correlation coefficient approaches 1.0. This suggests that variations in b are due to the quality of the data and not to the specific characteristics of the area being monitored.

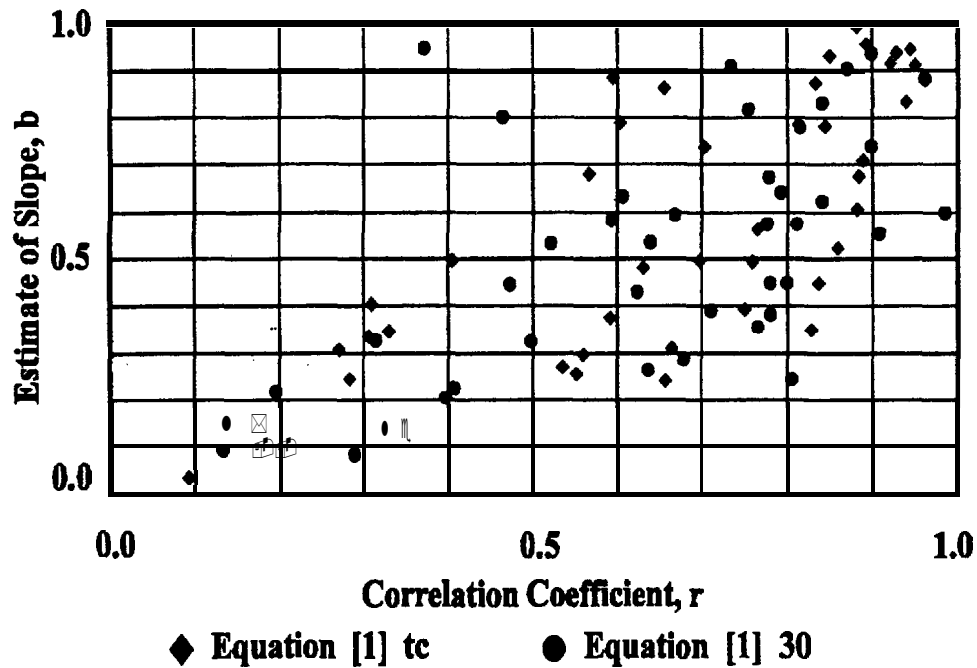

Figure 2. Correlation coefficient and slope.

Evaluation of Confidence Interval to Estimated 1-Year Inflow Value

The 90-percent confidence intervals for 1-year inflow estimates using Equation 1₃₀, Equation 1_{tc}, and Equation 2 were determined. The confidence intervals for Equation 1₃₀ and Equation 1_{tc} are generally larger than the confidence intervals for Equation 2. This is demonstrated by comparing the bar charts in Figure 3, where the confidence intervals are expressed as a percentage variation from the estimated inflow value. For example, 60 percent of the data points for Equation 2 have a confidence interval of ±30 percent of the estimated inflow value, whereas using Equation 1₃₀ and Equation 1_{tc} less than 10 percent of the data points are within ±30 percent of the estimated inflow value.

Comments

The results of this work indicate that linear regression analysis may not be appropriate for inflow projections using short-term flow data. The number and quality of storms normally available do not lend themselves to this type of rigorous calculation. One apparent problem is that the good quality data points tend to be grouped in a narrow band of mid-range rainfall while the slope determining data points are at the extreme high and low rainfall events-the worst quality flow data that can be collected in a sewer study.

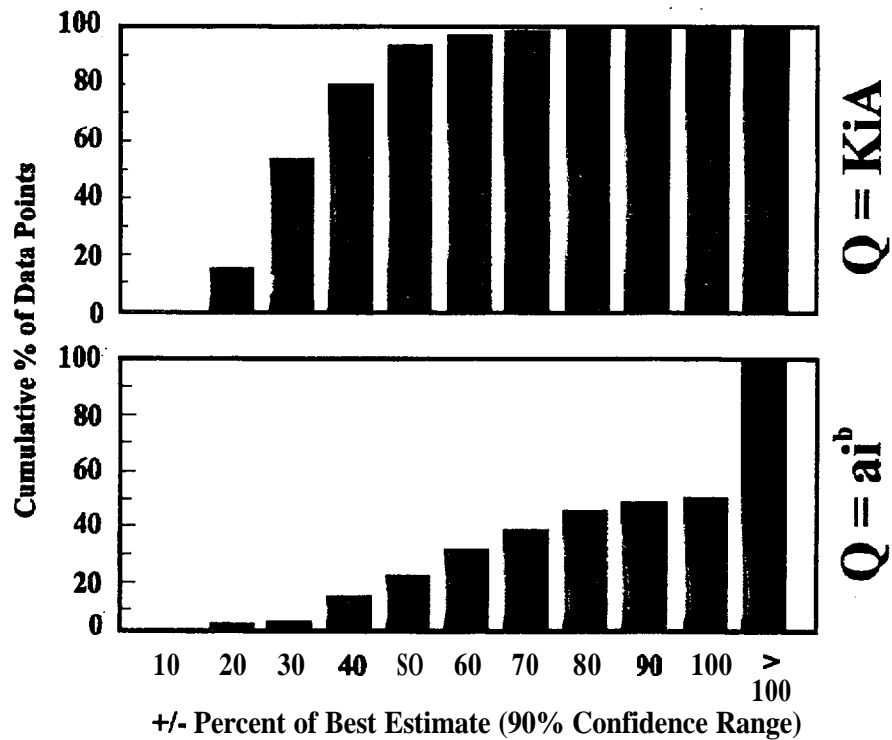

Figure 3. Confidence intervals expressed as a percentage variation from the estimated inflow value.

Conclusions

Although much additional research is needed, the following conclusions are made based on the results of this work:

- It appears that the estimate of b in Equation 1₃₀ and Equation 1_{tc}, $Q = ai^b$ is highly unreliable using short-term flow monitoring data and is not a good indicator of system characteristics. The value of b may be more a function of the quality of data and not the system characteristics.
- The confidence limits of Equation 1₃₀ and Equation 1_{tc} ($Q = ai^b$) are large and highly variable using short-term data.
- The confidence limits of Equation 2 ($Q = KiA$) are moderate and fairly consistent.
- A straight linear correlation of inflow to rainfall appears at least as statistically valid as an exponential relationship.
- Additional research is needed to define the quality and quantity of data needed for optimal flow monitoring programs.

Acknowledgments

Data used in this paper were obtained during a sewer study conducted for the City of Topeka, Kansas; the City of Garland, Texas; the City of Houston, Texas, ADS Environmental; and the Trinity River Authority of the Texas Central Regional Wastewater System.

References

1. Nogaj, R.S., and A.J. Hollenleck. **1981**. One technique for estimating inflow with surcharge conditions. JWPCF April: 491-496.
2. Nelson, R.E. 1987. Sanitary sewer modeling. Presented at the 37th Kansas University Environmental Engineering Conference (February).
3. U.S. EPA. 1983. The value of flow calibration for decision making in infiltration/inflow studies. **EPA-600/S2-83087** (November).
4. Wolpole, R.E., and R.H. Myers. 1972. Probability and statistics for engineers and scientists. New York, NY: MacMillan.

Real-World Hydraulic Modeling for Long-Term Sanitary Sewer Overflow Management

Thomas C. Davies
Applied Geographic Technologies, Inc., Fort Worth, Texas

Introduction

This paper describes the integration of sanitary sewer collection system hydraulic analysis with analysis of the increasingly important issues surrounding sanitary sewer overflow (SSOs), including 1) quantity of overflow water, 2) quality of overflow water and its impact on receiving waters, and 3) the parallel issue of analysis and design of structural controls to regulate these overflows. The power of continuous hydraulic simulation modeling is combined with two other computational modules to adequately address issues of water quality, surface conveyance, and storage. The water quality module allows for the simulation of in-pipe and subsequent SSO water quality, which can then be combined with background water quality information recorded for receiving waters. The structural controls module simulates the placement of structural controls in the system for overall sanitary sewer collection system evaluation and overflow location management. Structural controls, for the purposes of this paper, refer to regulated overflow structures, upstream off-line storage tanks, and other mechanical systems for flow balancing and control in wet weather conditions.

Current engineering standard of care dictates that SSOs should be 1) minimized in number and severity or eliminated, 2) located at optimal locations in the community (Le., away from people, parks, and thoroughfares), and 3) designed so that they decrease the required capital outlay needed to mitigate the overflows. This requires a multidimensional investigation and analysis of sewer system hydraulics, drainage basin hydrology for infiltration and inflow (I/I) analysis, and sewer flow and receiving stream water quality, as well as an associated cost comparison analysis of the various capital construction schemes needed to mitigate the overflows.

This paper expands on the relationships between the above-noted sewer system characteristics, sewer constituent properties, and ground surface characteristics through practical approaches to the analysis of SSOs that use advanced computer simulations to model collection systems. Advanced computer modeling enables the requirements of existing and future U.S. Environmental Protection Agency (EPA) SSO policy to be met through the analytical realms of hydraulics, hydrology, and water quality sciences. Examples are presented to explain the procedures, methodologies, and results of an integrated overall collection system analysis. The paper also compares the cost impacts of pipe replacement or parallel mains versus allowing regulated overflows to occur through properly designed structural controls. The cost effectiveness of traditional I/I abatement is compared with that of the approaches outlined in this paper. Finally, the paper presents what the author believes to be a unique approach to SSO analysis and subsequent overall system management. This integrated modeling approach is a realistic and attainable solution to properly operating a sewage collection system at the lowest overall cost, balancing the need for additional downstream pipe capacity with regulated upstream control structures designed to convey expected wet weather overflows.

Why Model Your Sewer System?

To Minimize the Number of SSOs and Their Severity

Reduction or outright elimination of SSOs should obviously be a primary emphasis of any SSO-related modeling effort. Various schemes and alternatives can be simulated in a model, facilitating the choice

between remedial actions required to reduce or possibly eliminate **SSOs**. Depending on the type and quantity of data available for a modeling effort, different scenarios can be studied. If rainfall intensity versus I/I is known from flow monitoring, then a return period analysis is often possible. A return period analysis shows which segments of the system overload during storm events of a particular intensity and duration.

To Optimize the Location of SSOs

Of equal importance to the number and severity of **SSOs** is the location of **SSOs**. **SSOs** near concentrations of people, such as near parks, schools, or thoroughfares, are particularly problematic. An SSO in a park or a schoolyard is naturally more sensitive, requiring more monitoring and subsequent attention than an SSO in an industrial district located on the bank of a major river occurring during high storm flows. A model should allow the engineer to locate the **SSOs** under design events and develop plans for remediation of those **SSOs** located in sensitive areas.

Water quality issues related to **SSOs** are highly dependent on the location of the **SSOs**. The public health concerns associated with raw sewage overflowing in public places-especially where children often play-are serious and require intensive attention in a modeling effort. Relocation of an SSO to mitigate water quality issues should be studied in conjunction with the hydraulic analysis of the SSO. In addition to public health concerns, the issue of overall receiving stream-water quality must be addressed. Studying the impacts of receiving stream-water quality combined with an analysis of SSO relocation ensures that the full impact of the SSO-both before and after the relocation-is understood.

To Minimize Capital Outlay

Modeling of alternatives for SSO abatement should culminate in a series of recommendations that provide for the lowest cost plan to minimize or eliminate **SSOs** combined with an analysis of water quality effects on public health and on the waters of the United States. The rightsizing of sewer system line improvements providing for the relocation or elimination of **SSOs** should be thoroughly analyzed in the hydraulic modeling effort.

Rightsizing is critical in an SSO abatement project. Oversizing of sewer lines to eliminate **SSOs** causes two problems. First, excessive costs divert funds from badly needed maintenance. Second, and often overlooked, is that oversizing allows for free outfall of flows previously attenuated upstream in the system. Oversizing the sewer passes the problem downstream or at the very least increases flows to sewer lines downstream that have previously benefitted from upstream attenuation and overflows. In the overall scheme, if lines are properly sized, then all flow for a particular design event may be conveyed to the treatment plant with attenuation occurring within the system, something that does not presently happen in many cities.

Real-World Modeling

In general, real-world hydraulic modeling refers to a departure from the current state of modeling and SSO analysis into a mode of analysis that focuses on the elimination of **SSOs**, through a systemwide review of the hydraulic characteristics of the system. This hydraulic analysis features a study of flow quantity under various design events, a study of flow quality in-pipe and subsequently from overflows, and a study of the physical characteristics of the system for analysis of existing flow constraints and for future control facilities for flow control and SSO abatement. There are three major categories of this type of modeling: quantitative, qualitative, and physical.

Quantitative

Dry and Wet Weather Flow Generation

A quantitative analysis of a sewer system for **SSOs** involves an assessment of flow quantity for several aspects of the system. First is the generation of flow from flow monitoring data or other historical data such as population distribution. The generation of this type of flow is primarily concerned with the base dry weather flow, the normal diurnal flow in the system. Second is the development of flows for wet weather analysis. Although this can be done in numerous ways, the author of this paper is an advocate of a combination of short- and long-term flow monitoring combined with rainfall intensity analysis. Once flow data are determined, the task of routing the flows through the system is next.

Flow Routing and Backwater (Surcharge) Analysis

Routing of flows through the system is critical. Many simplistic out-of-date models are still widely used (and continue to be marketed) that involve commensurably old hydraulic calculations for flow routing. These models tend to fall into two categories: 1) poor hydraulics, creating an overprediction of downstream flows, and 2) fair-to-good hydraulics, which suffer from frequent calculation instabilities and have poor user interfaces.

Modeling done with these archaic models creates another “black box” of SSO analysis. Many models do not calculate backwater or surcharge analysis, an absolute necessity for an accurate assessment of the collection system for any SSO project. Overprediction of flows routed downstream may indicate millions of dollars in unwarranted pipe improvements; a more accurate hydraulic solution would not recommend these larger pipes because of the more advanced routing that can be simulated. Careful attention to the hydraulic mathematics used by a model will ensure that you understand what you are getting from your analysis and how much faith you can place in it when developing recommendations that may cost millions of dollars.

For an SSO project in which overflows are the overwhelming issue, a model capable of performing accurate flow calculations is imperative. With respect to sewer system capacity, all sewer systems subject to **SSOs** benefit from flow attenuation, not just in the general area of the SSO but every point downstream of the SSO. **SSOs** are caused by backwater conditions created by any one of potentially numerous physical constraints. The key to addressing **SSOs** is to try to eliminate them totally at the lowest possible cost. Attenuating flows “up” in the system saves money throughout the system by minimizing the peak flow seen by downstream pipes. Attenuation and surcharging are not bad as long as they do not cause an SSO at the design event chosen.

Quantification of **SSOs** by Location

A hydraulic model should be able to identify the locations of **SSOs**; of equal importance, however, is the quantity of flow exiting the system from an SSO. A quantitative analysis should provide both of these crucial pieces of data, not simply a peak flow rate.

Using a model capable of performing backwater analysis, the user can simulate design events, showing the location and quantity of **SSOs** throughout the study area. From this design event analysis, the modeler can begin to determine the required improvements necessary for action to eliminate or mitigate **SSOs**.

Targeting of Critical **SSOs**

Cities experiencing **SSOs** do not have unlimited funds to attack all **SSOs** with equal attention. Prioritization is the key to phasing most SSO projects. A real-world hydraulic model should provide a city with information as to which **SSOs** are the worst from a hydraulic viewpoint. Targeting or prioritizing these **SSOs** can be valuable in developing a long-range plan for SSO abatement.

Qualitative

A qualitative analysis of a sewer system refers to the use of a hydraulic model to route constituent pollutants and characteristics through the system. This type of analysis parallels the effort to quantitatively analyze the system.

The purpose of a qualitative analysis is to determine the quality of sewer flow at any point in the system. From this analysis, we can determine the water quality at any overflow in the system. Design event analysis gives us the ability to test scenarios of varying water quality dependent on the event size and for each SSO location. This qualitative analysis also provides a tool to test the impacts of industrial flows on the system and publicly owned treatment works (POTW).

An analysis of sewer flow quality in conjunction with an analysis of receiving stream water quality allows the user to test assumptions about the impact of particular **SSOs** on U.S. waters and the previously discussed issue of SSO relocation or elimination.

Physical (Structural Constraints and Controls)

Existing System Analysis

An existing system analysis is an important step in a hydraulic modeling effort for SSO abatement. Modeling to determine the response of the system under everyday dry flows and wet weather events less severe than the design event chosen will provide the engineer with an understanding of the system. These less-than-design-event models are early indicators of backwater, surcharge, and ultimately **SSOs**. System response to a particular design event usually provides the preliminary results for determining the **SSOs** that require remediation.

Remediation Analysis

Remediation analysis is the task of determining actual recommendations for abatement of **SSOs**. A remediation analysis consists of two major tasks: the determination of SSO locations by backwater hydraulic calculations and the development of real-time control analyses for structural SSO controls.

Analysis of Backwater Attenuation. Backwater attenuation is the study of sewer hydraulics combined with the transport of sewer flows through the system. As noted above, all sewer systems experiencing surcharging and **SSOs** benefit from the resultant attenuation of these flows. Building bigger lines to relieve bottlenecks and prevent **SSOs** often merely passes the problem to another location downstream.

This analysis helps determine the remedial actions required to accomplish the stated goals of the project. A reduction in the number of **SSOs** (or outright elimination) and the potential relocation of **SSOs** to less public places are typical goals of a project. For this analysis, it is necessary to seek the hydraulic conditions conducive to elimination of **SSOs** without excess capital expenditure, for both the immediate study area and the affected downstream sewer lines. The next step is to determine the actual physical facilities required to mitigate the overflows.

Real-Time Controls Analysis. Real-time controls analysis is the study of the facilities that an engineer uses to develop a plan for SSO abatement. For the purposes of this paper, the term “controls” refers to any facility within the sewer system that can be used passively or proactively to regulate sewer flows so that **SSOs** can be abated. The real-time aspect of the phrase “real-time controls” refers to the fact that in a sewer system, the discrete nature of sewer hydraulics requires that the control facilities be analyzed and designed with respect to real-time hydraulics, rather than analysis based on a simple peak flow rate.

- Upstream Structural **Flow** Controls: Attenuation of wet weather flows should not be overlooked. As discussed above, properly placed flow controls for attenuation can not only eliminate downstream **SSOs** but can also reduce the cost of planned capacity improvements downstream. The use of supervisory control and data acquisition (SCADA) systems for sewers is a vastly untapped and mature technology available for sewer system flow control. With upstream flow controls, the system can be managed to mitigate the effects of flow surges from adversely affected downstream collector sewers. A model should be capable of analyzing the placement and operation of such flow controls.
- **SSO Reduction and Relocation Analysis:** Additionally, as discussed above, the reduction and relocation of **SSOs** are major tasks in a modeling effort. These tasks are done in conjunction with the upstream **flow regulators**, as discussed.
- **Structural Controls for Regulated SSOs:** For a city under administrative action to go from hundreds of **SSOs** to zero in 5 to 10 years is virtually impossible. EPA engineers understand this and have acknowledged that cities will experience **SSOs** above a certain storm event. The key components of these overflows is their severity, location, and frequency of overflow. The modeling of structural controls for overflow regulation should be the focus of all SSO analysis. In line with EPA desires to mitigate the impact of **SSOs** on the community and receiving streams, the development, analysis, and design of regulated SSO facilities is a major task that can be accomplished only through an intensive modeling effort.

Relief Sewers. Only after the above modeling analyses are fully explored should the addition of relief sewers be considered. Use of a modern hydraulic model can ensure the recommendation of only relief sewers that are absolutely required as a part of an overall SSO abatement program. These lines would be developed with upstream attenuation fully addressed, and the location of SSO control facilities would be considered to minimize **SSOs** and relocate them to areas away from people, parks, and thoroughfares.

Black Boxes of SSO Analysis

An important aspect of developing real-world modeling for long-term SSO management is the application of some key areas of SSO projects that often fall short of technically advanced methods or solutions. These areas of technical deficiency are virtual “black boxes” of analysis that can be applied vastly differently, and can therefore greatly affect the results of the analysis. The result is that these black boxes can be deceptive or used to make the answers be whatever the modeler wants them to be, especially when misapplied or developed by inexperienced engineers. The following are several areas that need addressing.

Model Calibration for Design Event Analysis

Typically, models for design event analysis require the application of a storm event simulated to occur over the entire basin. This assumption is inherently conservative, but might not reflect the actual hydrological condition of what will actually happen in the study area during an event. The bigger the

study area, the bigger this error becomes. A solution to this is the development of storms that pass through the area and generate rainfall-dependent infiltration/inflow (RDII) hydrographs for input into the system. The distribution of storms and, subsequently, design event RDII is critical to modeling an actual scenario. The use of next-generation radar technology (NEXRAD) is a step in the right direction, but without a thorough analysis of the related areas of storm hydrology and resulting runoff hydrograph generation, the use of storm events with sewer studies will remain overly conservative.

Rainfall Intensity Versus RDII

This black box needs serious discussion. Plotting random rainfall intensity versus inflow events without regard to soil conditions, hydrology, or other factors that can affect the quantity of inflow regardless of the rainfall intensity is a misapplication of data. This, however, is standard practice on many sewer studies. As noted above, through the development of NEXRAD and other technologies, combined with the study of rainfall generation by return period and an analysis of runoff entering the sewer, we can come closer to simulating the actual reaction of a sewer system to wet weather events.

Source Defect RDII Flow and Cost Assignments

Assigning RDII to individual defects located in a collection system is another black box of SSO analysis. This can be considered only a rough approximation that leads the user of the data to make many unrealistic assumptions. Attributing flows and cost of repair to each defect leads to the assumption that at a given level of expenditure a certain level of RDII can be removed from the system. This is highly questionable and often bears no reflection on the RDII entering the system under other storm events. The defects not repaired as a result of this analysis may be many times worse than those repaired.

Cost-Effectiveness Analysis

This is perhaps the biggest black box of all in SSO analysis. Because of the numerous assumptions of the analysis that must precede a cost-effectiveness analysis in the life cycle of an SSO abatement project. Almost statutory as a requirement of an SSO project, this cost-benefit analysis has proven itself to be inaccurate and severely misleading in the opinion of this writer. Comparing certain levels of RDII removal with specific levels of needed pipeline capacity improvements is dangerous. The assumption is that the remaining defects, those not repaired or rehabilitated, will remain in the system as static contributors of RDII. This is obviously not the case. All RDII and so-called structural or maintenance (non-RDII) defects should be addressed in the plan for the system, and taken into consideration in a long-term plan for SSO abatement.

A truly cost-effective plan is based on finding out what it takes to mitigate the SSO problem for that project, striking the right balance between controlled flow and SSOs, and using whatever is the **lowest-cost** alternative needed to achieve this goal.

Conclusions

Modeling Your SSO Project

Modeling can be the most important aspect of an SSO abatement project. The data used in the model are critical to precision modeling. The most important aspect of a modeling project, however, is the actual modeling software used for the project. The following sections will attempt to explain the conclusions reached through experience with various models.

Flow Monitoring and Rainfall Intensity Analysis

Flow monitoring for determination of dry and wet weather flows provides the basis of calibration for any modeling study. Comparison of rainfall intensity to **RDII** rates and volumes can also be derived from flow monitoring. As noted above, this analysis should be done carefully to ensure stability and normalization of results. Soil conditions from previous wet weather events can greatly affect the quantity of surface runoff reaching the sewer system.

For wet weather analysis, data comparison and understanding the relationships between rainfall intensity, soil conditions, and the corresponding flow observed for the event provide the user with more realistic data than normal rainfall intensity versus **RDII**, without a soil condition analysis. Additionally, the shape or pattern of rainfall intensities during an observed event can greatly affect the **RDII** response in the system.

For real-world modeling, these actual in-field conditions must be taken into consideration. The cost associated with this additional analysis or approach is insignificant when considering the minor adjustment required to explore this alternative area of analysis.

Long-term flow monitoring at strategic locations throughout the system, combined with rainfall intensity gauges, provides the best data for accurate modeling and long-term control of **SSOs**. Long-term flow monitoring and rainfall intensity data can be used to test scenarios, build systemwide operational schemes, and truly manage the system through real-time data supplied by the wet weather monitoring system.

Accurate Modeling Engines

Models that analyze only a peak flow rate condition will tend to give grossly conservative results. Two models generally meet the criteria for accuracy as required for the type of analysis outlined in this paper. EPA's Storm Water Management Model (SWMM) and Extran block in general terms performs the type of analysis required to study backwater conditions. Many do not consider SWMM to be user friendly, however. In addition, SWMM also can suffer from hydraulic instabilities. Inexperienced users of SWMM often do not know when such instabilities occur or when adjustments to the model are required to correct these instabilities. These hydraulic instabilities can cause problems with the final results-or might not-but they do exist and should be addressed in any modeling effort. SWMM requires the user to trick it into performing several functions important to an SSO-type analysis. With this in mind, SWMM is not recommended for modern SSO analysis.

The other model known to this author that meets the criteria required for this level of analysis is the HydroWorks model by Wallingford Software Ltd. of the United Kingdom. Wallingford is part of the HR Wallingford Group, which was formerly a British government research station for hydraulics. Privatized in the 1980s, Wallingford Software is the industry standard for hydraulics research and software for sewers, rivers, and other drainage-related issues in the United Kingdom. The HydroWorks software addresses all components discussed in this paper, including backwater/surcharge, time varying routing of flows, water-quality routing, and real-time controls, and is a Windows-based program providing an easy-to-use graphical user interface.

Backwater calculations are imperative for analysis of **SSOs**. A model with this capability can accurately determine the hydraulic and/or energy grade line (HGL). The HGL is required to determine the locations of **SSOs** and the quantity of flow leaving the system through **SSOs**. Some models available on the market calculate a HGL, but this is often very inaccurate because the calculation of HGL depends on the time-varying level of flow at any point in the system. Static HGL calculations provide no useable information for an SSO project.

Calculation of overflow volume at any given SSO in the system also is important. This calculation allows the engineer to distinguish the true magnitude of a particular SSO at a particular location within the system. All SSOs are not equal, and this capability proves the difference.

Finally, the ability to model water quality characteristics through a system and out of the system through SSOs is an interesting capability. As stated above, all SSOs are not equal, because they have both volume considerations and water quality considerations. Modeling of water quality is not easy to do, but if law requires millions of dollars of improvements, then careful consideration should be given to the cost effectiveness of water-quality modeling in addition to hydraulic modeling.

Investigating Alternatives to Traditional (Outdated) Methods

The rational application of modern water industry technology can result in considerable cost savings. Our current approaches to systemwide SSO abatement projects need to be carefully reviewed. We need to approach SSO abatement as a hydraulics problem first and foremost. In most cities plagued by SSOs, the hydraulic conveyance (sewer collection system pipes) has proven to be insufficient. RDII abatement should continue to be performed as it has been, with the notable exception that repair of defects often does not have a direct correlation to the lack of capacity in a sewer system.

Repair or schedule for repair should be accomplished for all the defects located through the Sewer System Evaluation Survey. Repairing only alleged RDII contributors is a mistake, because many of the non-RDII defects are structural failures that very soon become large contributors of RDII or at best block conveyance, creating even more SSOs.

Summary

The following are the key steps in developing a strategy for an SSO abatement program:

- Look carefully at your system hydraulics, and determine why an SSO is occurring here.
- Be creative with the remediation of your SSOs and the subsequent changes in system hydraulics.
- Avoid or understand your project assumptions. "Black boxes" many times hide the "garbage in, garbage out" syndrome that often accompanies computer modeling.
- Consider water-quality modeling as a means of determining answers to the questions regulators ask, and use it to your advantage in determining your remedial actions.
- Use permanent flow monitoring along with a model to manage your system controls.
- Look at upstream flow controls for attenuating flow in a controllable real-time fashion instead of the uncontrolled fashion you now use with SSOs.

Stopping Sanitary Sewer Overflows: Beneficial Maintenance Practices

Albert E. Gallaher III and Scott L. Brown
Charlotte-Mecklenburg Utility Department, Charlotte, North Carolina

Introduction

Proper separate sanitary sewer preventive maintenance can delay the need for costly sewer rehabilitation. Aged, recently rehabilitated, or new sanitary sewer systems require continuing intelligent preventive maintenance to ensure structural integrity and to prevent infiltration and inflow (I/I) and exfiltration. The oldest subsystems should be the top priority for systematic monitoring and rehabilitation. Neglect of proper sewer preventive maintenance will result in sanitary sewer overflows (SSOs), costly sewer rehabilitation, and adverse public health effects.

This paper is based on a case study conducted by the Charlotte-Mecklenburg Utility Department (CMUD) for the U.S. Environmental Protection Agency (EPA). The case study investigated the effects of SSOs on water quality. The effects of ground water and rainfall were investigated. Analysis of data from January 1983 through December 1993 identified the primary causes of the SSOs. To prevent the introduction of predetermined bias in the study, the Office of Statistics and Applied Mathematics (OSAM) of the University of North Carolina at Charlotte was independently contracted to statistically analyze the data.

Stream Water Quality

OSAM performed an analysis of stream water quality. Water quality is a complex issue. The objective of this investigation was not to develop efficient models for stream water quality but to determine whether SSOs are a distinguishable factor affecting the quality of stream water.

Basic Data Consideration

The pertinent data sets were linked by T.W. Trybus and Associates. SSO activities that occurred within 30 days upstream of a stream monitoring site were investigated by OSAM. If no SSOs were reported, that sample was represented as $SSO = 0$. If SSOs were reported, that sample was represented as $SSO = 1$. All relevant reported SSOs were linked to the water sample along with the distance in time and space to the water sample.

OSAM attempted to assess the relative impact of SSOs on water quality by defining scores that took into account the distance, elapsed time, and number of reported SSOs for a given time period. Because the SSO reports are qualitative in nature (the quantity of overflow is unknown), however, such scores later proved to be no more informative than the variable $SSO = 1$.

Data that appeared as recording errors were deleted. For example, an observation with a temperature reading of 118°C or a fecal coliform count of 51,000 fecal coliform per 100 milliliters was deleted.

Fecal Coliform in Stream Water

Fecal coliform is considered the indicator of choice for wastewater effluent in the United States. The database that was used for this investigation had a lower detection limit of 100 coliforms per 100 milliliters and the right or upper detection limit of 6,000 coliforms per 100 milliliters. Any observations outside these limits were included as censored data. OSAM reported that 30 percent (21.2 percent left censored and 8.8 percent right censored) of observations for this study were censored.

The question OSAM asked was, "Does SSO activity tend to increase the likelihood of higher fecal coliform count in stream water?" To answer this question, OSAM visually inspected two relative frequency histograms. It was visually clear that SSO = 0 had a heavier left side and a lighter right side compared with SSO = 1. The distribution of fecal coliform counts in the group SSO = 1 is more skewed to the right. This observation was supported statistically by considering a simple binomial model. This model suggests that the fecal coliform level is higher in the stream water if any SSOs occurred in the previous 30 days.

The Statistical Analysis System (SAS) LIFEREG procedure, from the SAS in Cary, North Carolina, was applied to the whole data set with assumed lognormality. The outcome of the analysis confirmed that SSO activity was a statistically significant factor in increasing the concentration of fecal coliform in stream water.

Ammonia in Stream Water

Ammonia is another important indicator of stream water quality. Particularly in this study, ammonia is thought to be associated with SSO activity. OSAM examined the ammonia data and detected 2,706 observations. The detectable limit was 0.01 parts per million. Fifty-four percent or 1,459 of the observations were below this limit.

Visual inspections similar to that of the fecal coliform examination were performed. The group with SSO = 1 tended to have a heavier right side and a lighter left side in comparison to the group with SSO = 0. OSAM supported this observation by a large two-sample proportion. The generalized Wilcoxon test through SAS LIFETEST procedure was applied. With the appropriate transformation, the left censored problem became a right censored problem. The generalized Wilcoxon test showed a p value of 0.0001. The log-rank test gave a p value of 0.0001, supporting the hypothesis of SSO impact on the ammonia level in the stream water. This confirmed the visual observation that SSO activity tends to increase the level of ammonia in stream water.

The SAS LIFEREG procedure was also applied. The outcome of the analysis confirmed that SSO activity was a statistically significant factor in increasing the concentration of ammonia in stream water.

Biochemical Oxygen Demand, Dissolved Oxygen, and Nitrate in Stream Water

The variables of biochemical oxygen demand (BOD), dissolved oxygen, parts per million (DOPPM), and nitrate (NO₃) were of interest in evaluating water quality associated with SSO activity. OSAM noted that these variables seemed to be correlated, and the censoring involved (if any) was very light.

OSAM noted that 2,698 observations in the data set had values. Of the 2,698 observations, 53 (2 percent) had BOD values of zero (censored) and 68 (2.5 percent) of the observations had NO₃ values of zero. These 1-2-1 observations (4.5 percent) were deleted from consideration.

OSAM considered the following variables:

- Log(BOD) (LBOD)
- DOPPM
- Log(NO₃) (LNO₃)

Visual inspection revealed that all three variables had similar distributions across the groups SSO = 0 and SSO = 1. The slightly elevated levels of LBOD and DOPPM with SSO = 1 was checked by OSAM for statistical significance. The SAS UNIVARIATE procedure did not support the normality assumption for

any of the variables. Nonparametric tests were used to detect the differences between the groups. As with the visual test, all the nonparametric tests led consistently to the same conclusion. LBOD levels are slightly higher in the SSO = 1 group. DOPPM levels seemed to be the same across both groups. LNO₃ levels were almost identical across both groups.

OSAM considered a secondary tool: a multivariate regression model. The measures LBOD, DOPPM, and LNO₃ are taken from the same sample, so there are correlations among the variables. In the multivariate regression model, the dependent variables are vectors; the covariance matrix allows correlations. The multivariate regression model is based on the mean effects of rainfall in the past 48 hours (R48), temperature (TEMP), turbidity (TURB), total solids (TS), and SSO. The results confirmed that SSO activities seemed to affect the level of BOD, but not DOPPM nor NO₃.

Causes of Sanitary Sewer Overflows

OSAM reported the frequency of SSO occurrences by most frequently reported condition code. Poisson regression models for the occurrences of SSOs were applied. The models were not intended to predict when and where the next SSO will occur but to determine the factors related to the frequency of SSOs.

SSOs by Cause

The Charlotte-Mecklenburg Utility Department's (CMUD's) computerized Complaint History and Maintenance Processing System (CHAMPS) has a list of 99 condition codes that are used to describe the characteristics of a reported SSOs. These condition codes are not mutually exclusive; one SSO could fall into several categories. For the purpose of this study, these condition codes were aggregated into four categories:

- Maintenance (MNTNN)
- Structural (STRCTL)
- Private (PRVT)
- Other (OTHER)

Of the 3,005 SSOs reported in the 1983-1993 period, 100 percent were attributed to a maintenance problem (MNTNN), 6.5 percent included a structural problem (STRCTL), and 6.3 percent included a private property problem (PRVT). The other category was an empty set.

Due to the high percentage of SSOs falling into the MNTNN category, OSAM investigated the most frequent condition codes occurring within this category. Table 1 tabulates the overall percentages of SSOs that were related to the following conditions: roots, grease, sand/silt, and rags/paper/plastic.

Table 1. Percentage of SSOs Condition Code

Cause	Condition Code	Percentage
Roots	10	49
Grease	11	70
Sand/Silt	12	40
Rags/Paper/Plastics	13	15

For additional insight into the main causes of SSOs, OSAM investigated the condition codes on a monthly basis. Table 2 tabulates the percentage by month and the overall percentage for each of these condition codes. Figure 1 uses a bargraph to illustrate the data in Table 2.

Table 2. Percentage of SSOs per Month by Condition Code

Cause	Jan.	Feb.	Mar.	Apr.	May	June	July	Aug.	Sept.	Oct.	Nov.	Dec.	Yearly
Roots	55	51	46	55	44	43	41	57	50	51	47	49	49
Grease	76	75	64	73	65	74	69	69	68	66	71	71	70
Sand	14	15	13	17	12	18	12	15	19	13	15	13	15
Rags	38	42	36	47	42	43	45	40	37	43	35	42	40

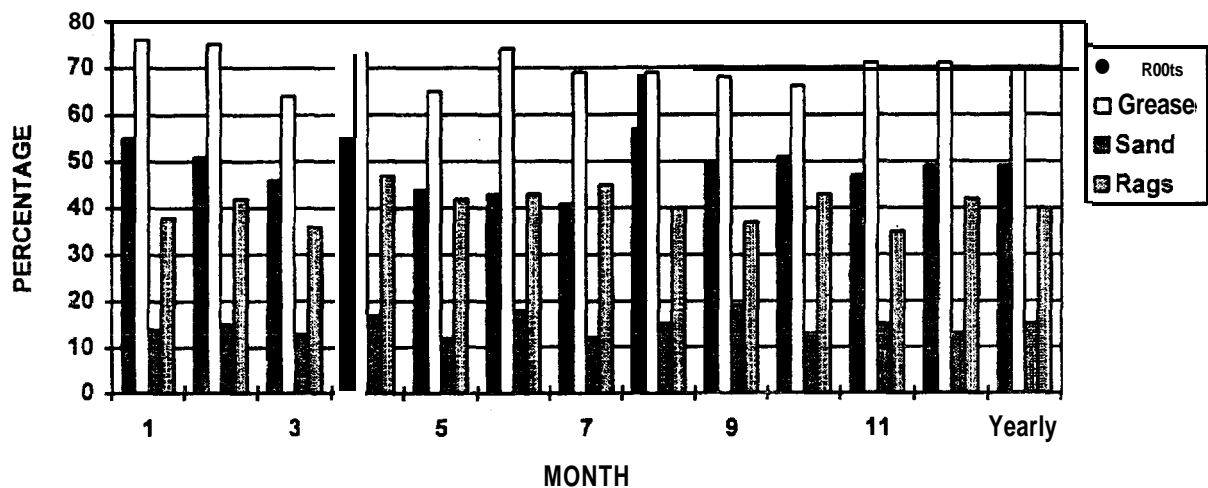

Figure 1. Percentage of SSOs per month by condition code.

Several observations can be made with respect to these data. The yearly SSO percentage due to roots is 49 percent. The largest deviations from the yearly percentage are January (55 percent), April (55 percent), May (44 percent), July (41 percent), and August (57 percent). The yearly SSO percentage due to grease is 70 percent. Monthly percentages to be noted are January (76 percent), February (75 percent), and March (64 percent). The higher percentages in January and February may be attributed to the lower temperatures in these months, thus allowing the grease to solidify. The warmer temperatures of March and significant flow may allow a system to transport the grease deposits. The percentages of SSOs related to sand/silt and rags/paper/plastic remain relatively stable from month to month.

Frequency of All Reported SSOs

Table 3 shows the frequency of all reported SSOs for the 1983-1993 period. Figure 2 represents the same data with a bargraph. On most days, no SSOs are reported. It is not unusual, however, to have multiple SSOs reported on a single day.

Description of Rainfall, Ground- Water Level, and Flow by Month

OSAM reported several observations. There is little variation in average monthly rainfall in the Mecklenburg County area. The intensity of rainfall exhibits seasonal variation. Of the following variables-rainfall in the 24 hours preceding the SSO (R24), ground water level (GW) (mean number of

feet below surface), and monthly averaged daily average flow of effluent from the wastewater treatment plants (FLOW)-rainfall and flow demonstrate the highest variable correlation.

Table 3. Frequency of Reported SSO Occurrences

SSOs/Day	'83	'84	'85	'86	'87	'88	'89	'90	'91	'92	'93	Totals
0	211	240	242	231	232	176	125	149	160	149	154	2,069
1	124	95	96	107	90	118	135	111	116	121	117	1,230
2	23	23	27	20	33	42	62	73	47	66	64	480
3	5	8	0	7	9	24	25	19	31	19	23	170
4	1	0	0	0	1	5	13	9	8	8	5	50
5	1	0	0	0	0	0	2	3	3	1	2	12
6	0	0	0	0	0	0	3	1	0	1	0	5
	0	0										

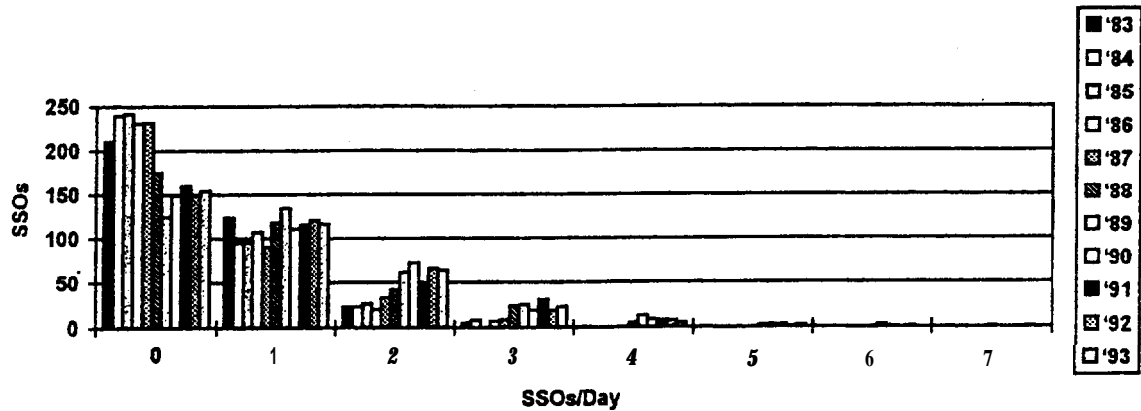

Figure 2. Frequency of reported SSO occurrences.

Poisson Regression Model for SSO Occurrences

OSAM performed a statistical analysis using the **SAS** GENMOD procedure for the data from January 1983 through December 1993. The SAS GENMOD procedure is a generalized linear model procedure that is applicable to the type of data being analyzed, namely a Poisson-type dependent variable.

After extensive exploratory data analysis, several variables were analyzed as to their relationship to the occurrence of an SSO. Two primary models were considered and compared to generate elicited explanations of the possible causes of an SSO occurrence. A third model was explored for additional contribution to understanding the phenomenon addressed in the first two models. These models are not attempting to predict an SSO occurrence but rather to understand the factors related to the frequency of an SSO for this period in the CMUD system. The two primary models use the variables year (YY) and month (MM), while the second model incorporates flow (FLOW). Year was included because it captures the increase in the size of a system. Simply stated, increased population of the area and length of a system are captured by the variable year (YY). Due to the cyclical behavior of SSOs, month (MM) was used as a variable. It was felt that the month incorporated various factors: temperature, rainfall intensity, and the soil's antecedent moisture condition. Due to the massive amount of data involved, it was not practical to include these variables individually.

To summarize the two models, both explained 78 percent of the variability of SSO occurrences. Model 1 uses the variables YY and MM, while Model 2 uses the variables YY, MM, and FLOW. When FLOW is used as an explanatory variable, it picks up some of both the MM and YY effects in Model 1 (Table 4); however, significant MM and YY effects still remained.

Table 4. Percentage of Variability Explained

Model	MM	YY	Flow	Overall
1	57%	21%	—	78%
2	11%	23%	44%	78%

Using the two models in combination, OSAM suggests that FLOW is a good indicator of the antecedent moisture conditions of the soil. FLOW incorporates a seasonal (or monthly) effect as well as changes in the population and size of a system. The flow, although cyclical, shows an upward trend over the lo-year period, just as SSOs show an upward trend during that period. It was noted that, after FLOW was entered into the model, the overall proportion of explained variability retained MM and YY effects. Each variable's contribution to the overall percentage of explained variation is as follows: 44 percent of variation is explained by FLOW, 11 percent of variation is explained by MM, and 23 percent of variation is explained by YY. FLOW addresses both inflow and infiltration. The MM effects could be attributed to temperature and rainfall intensity. The YY effects could be attributed to the condition of a system (infrastructure and maintenance situations), growth in population, and an overall decrease in the GW for the period.

To enhance understanding of the contribution of FLOW to the occurrence of SSOs, OSAM considered a third model. Model 3 includes GW and rainfall, attempting to analyze factors of FLOW. This analysis covered the period from January 1985 through December 1993. OSAM observed that the SSO occurrences were most frequent when GW indicated the lowest antecedent moisture conditions. SSO occurrences were least frequent when GW indicated the highest antecedent moisture conditions. The effect of rainfall in the two circumstances might be different. Model 3 incorporated the interrelationship between GW and R24. Model 3 explains 82 percent of the variability of SSO occurrences.

OSAM's Model 3 suggests that during periods of high antecedent moisture conditions the flow is adequate to move sewage through a system. During periods of low antecedent moisture conditions, a settling out of solids could occur. This would adversely affect a system's ability to handle sudden increases in flow from heavy rain storm induced I/I. During periods when the antecedent moisture increases, a system's ability to transport additional flow could be limited by increased infiltration. OSAM suspected that during unusually low moisture conditions, exfiltration could be occurring, causing inadequate flow conditions to properly transport the solids in the **sewage**.

OSAM compared the number of SSOs 3 days before and 3 days after the 30 largest storm events (rainfall in a 24-hour period) for January 1983 through December 1993. These events were equal to or greater than 1.75 inches of rainfall. During the months of October and November, when the soil was becoming more moist, these storms increased the chances of an SSO, an anomaly indicating lag time in their relationship (see Figure 3). During the other months, positive and negative effects were equal in number.

Maintenance Practices

Proper preventive maintenance practices can greatly reduce SSOs, the need for costly sewer rehabilitation, and adverse effects on public health. The approach to preventive maintenance should be concise. The entire length of a sanitary sewer system does not require the same maintenance approach

and regularity, due to the different land uses and natural conditions above a system. For example, an area covered by impervious surface may not need root control to the same degree as a naturally covered area. Priorities must be established through proper flow monitoring, flow modeling, and complaint history analysis.

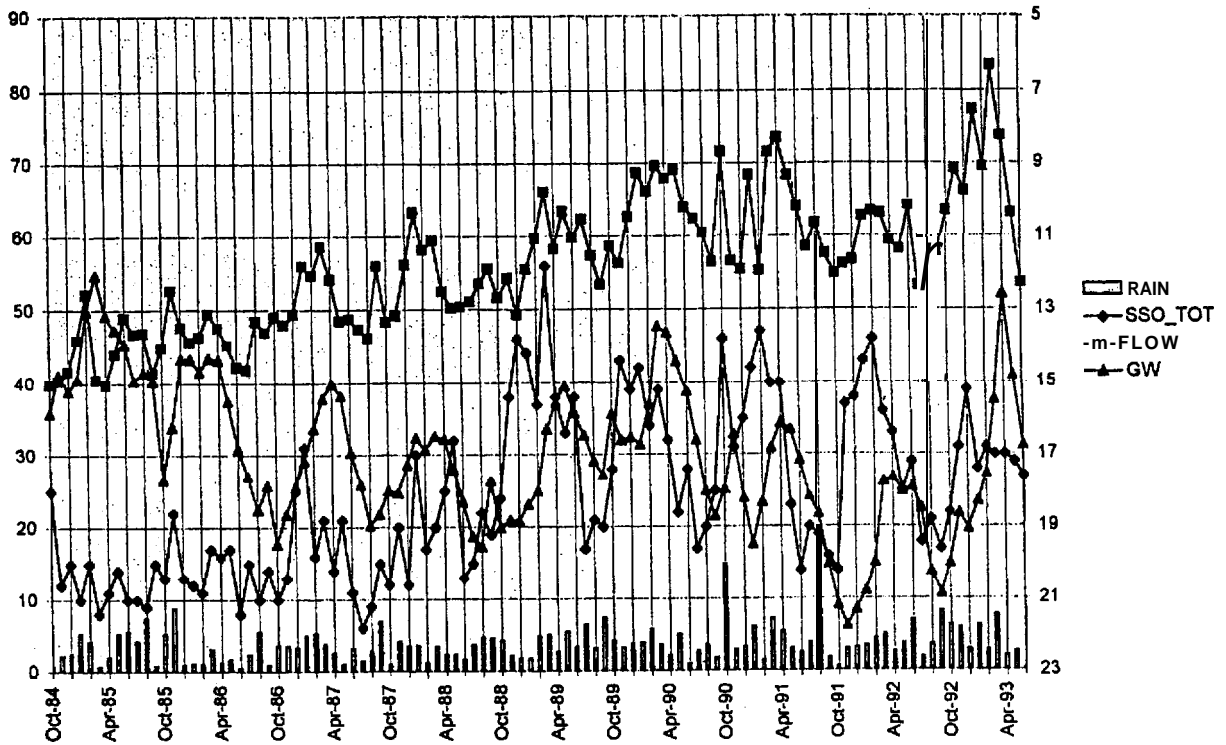

Figure 3. Sanitary sewer overflow, flow, ground water, and rain.

Flow monitoring provides insight into current real-time flows and water surface elevations. This information can be used to troubleshoot upstream of the monitor sites. If significant deviations from normal flow patterns are observed, a system operator can direct personnel to that location and possibly prevent an SSO from occurring. Event notification systems are the current technology of choice.

A flow model allows a sanitary sewer system to be analyzed for both current and future needs. A model can provide understanding of system capacities, bottlenecks, and infrastructure capital improvement options and planning.

A comprehensive complaint history database that includes SSO location and cause allows identification of recurring problem geographical areas and contributing factors. This information is invaluable in directing situation-specific preventive maintenance techniques to problem areas. This process of preventive maintenance ensures that the highest priority areas are addressed first. By monitoring these high priority areas over an extended period, a site-specific schedule can be established. A sanitary sewer system should dictate preventive maintenance schedules and techniques, not a system operator. A comprehensive preventive maintenance approach is not the most cost-effective way to maintain a sanitary sewer system.

Maintenance Scheduling

OSAM observed that fewer **SSOs** occurred from May to October. During this period, it is speculated that blockages are forming due to decreased flows. These result in increased SSO occurrences during the months of November through April.

This information would suggest that, because **SSOs** occur less frequently from May through October, preventive maintenance and rehabilitation should be the highest priorities. The weather during these months is preferable for performing this type of work. From November through April, the ambient conditions subject a system to a worst-case I/I scenario. Sewer System Evaluation Surveys (SSES) and emergency maintenance should become the workforce's highest priority. All sanitary sewer system process adjustments should be incremental, thus allowing a system to react to modifications.

Hydraulic and Mechanical Cleaners Versus Combination Cleaners

Following identification of redundant maintenance areas involving grease, sand/silt, rags/paper/plastic, and other debris, situation-specific maintenance techniques can be applied to prevent **SSOs** from occurring. The primary techniques to address these situations are hydraulic cleaners, mechanical cleaners, and combination cleaners.

Hydraulic cleaners use a high pressure (graduated up to 4,000 pounds per square inch) jet of water to dislodge blockages. Both hydraulic and mechanical cleaners are effective in breaking up solids and offer an immediate solution to a blockage under emergency situations. The benefits of using hydraulic and mechanical cleaners for standard preventive maintenance should be evaluated. Although hydraulic and mechanical cleaners are effective in cleaning a line segment, they simply provide temporary relief by moving the debris from one point to another point within the collection system. The problem is not remedied, simply deferred.

Combination cleaners are similar to hydraulic cleaners except that combination cleaners actually remove debris from the sewers. Upgrading to higher pounds-per-square-inch combination cleaners does not appear to be as beneficial as sufficient water volume (gallons per minute) combination cleaners. The induction of larger volumes of water during periods of low antecedent moisture conditions could be very beneficial. Two-person crews are more productive. Compared with hydraulic and mechanical cleaners, combination cleaners are expensive, and the long-term benefits should be evaluated when considering the initial cost.

Mechanical Cleaners Versus Herbicide Treatment

Because they collect grease, sand/silt, rags/paper/plastic, and other debris, roots should be of primary concern. Once an area has been identified as having a maintenance problem caused by roots, a proper maintenance technique can be identified. The primary tools to address these situations are hydraulic, mechanical, and combination cleaners.

Commercial mechanical rodders are generally divided into two categories: sectional rodders and continuous rodders. The major difference between the two is that the sectional rodder has approximately 3-foot sections that may be uncoupled and replaced if broken. The rodders have various end attachments used to cut or tear the roots within a sanitary sewer system.

The effectiveness of mechanical cleaners is limited to the roots within a system. Due to the nature of the mechanical rodders, root removal is only minimally effective. This allows the roots to grow back in a rapid manner because they are not isolated from their food source.

Herbicide may be applied to roots in a sanitary sewer system in various ways: complete foaming, spot foaming, or soaking. The herbicide treatment penetrates into cracks, joints, and lateral openings. The herbicide penetrates the root tissue up to 3 inches beyond the sewer walls, isolating the roots from their food source and thereby extending the grow-back period up to 3 years. The herbicide treatments available on the market today are not terminal to trees and plant life, and do not damage pipes when used in accordance with manufacturer's instructions.

Interviews with North Carolina utility officials revealed that, generally, mechanical rodders are obsolete. There is serious concern that the rodders may actually be causing serious infrastructure damage because of minimal technology improvements, the excessively abrasive nature of the couplings and endpieces, and poorly trained operators. Herbicide use for root control is the preferred preventive maintenance methodology.

Conclusion

Targeted preventive maintenance processes can greatly reduce the frequency of **SSOs** over time. As with all changes concerning a sanitary sewer system, implementation should be incremental, thus allowing a system to react to the adjustment of processes. The most effective tool in preventive maintenance is a computerized complaint and maintenance history database. This **tool allows** problem areas to be identified and schedules to be monitored.

The goal of eliminating **SSOs** should not be thought of as a dream. It must be a reality to protect human populations from the effects of adverse environmental factors and to improve the human health quality and well-being of present and future generations.

The Influence of Crisis Sewer Maintenance on Sanitary Sewer Overflows

James D. McGregor
Killam Associates, Millburn, New Jersey

Introduction

Sanitary sewer overflows (SSOs) are an unfortunate occurrence in many sewer systems. The most dramatic SSO is the surcharged sewer, which creates a column of water in a manhole forceful enough to dislodge a manhole cover. This type of SSO receives public attention because the manhole geyser shows are unique occurrences. Motorists must drive carefully to avoid dislodging a cover and damaging their vehicles. While the overflowing manhole is the most apparent SSO, the general public is not aware of other underground connections that permit wastewater to flow from sanitary sewers to storm sewers. Some SSOs may be unintentional, such as those from structurally damaged pipes or in older sewer systems through sanitary sewer underdrain piping systems. Many SSOs were intentionally constructed, however, to relieve sanitary sewer hydraulic loads. The intentional SSOs are direct piping connections from sanitary sewers to storm sewers or receiving waters. These SSOs are intended to prevent sewer surcharging and the accompanying sewage backups into those strategically located buildings that experience recurrent problems.

Many municipalities and utility authorities that operate and maintain sanitary sewer systems blame the SSOs on extraneous flows. In recent years, the very high extraneous flow rates caused by inflow and rainfall induced infiltration (RII) are targeted as the culprits that activate SSOs. After all, most SSOs coincide with significant rainfalls, when extraneous flows reach their highest rates. Although extraneous flows and undersized pipes do activate SSOs, poorly maintained sanitary sewers are also responsible for many SSO incidents.

Sanitary sewer evaluation surveys, which include television inspections, frequently detect sewer pipes partially obstructed by root masses, grease buildup, and sediment. Older sewers through right-of-ways are notorious for partial blockages, because of both vandalism and their inaccessibility for cleaning. In many instances, partial pipe obstructions of 70 to 90 percent are not enough to activate dry weather SSOs because many sanitary sewers have excess conveyance capacity. Available capacity in many sanitary sewers should allow them to convey even peak extraneous flow rates without activating SSOs. The cumulative adverse influence of crisis sewer maintenance over years, however, has appreciably reduced the design capacity of many sewers. Consequently, while the rainfall-related SSOs may indicate extraneous flow problems, the same SSOs may be providing clues about partial sewer blockages.

The findings presented herein are primarily based on sanitary sewer investigations performed in New Jersey; however, similar findings have been reported throughout the country.

Influence of Crisis Sewer Maintenance on SSOs

A gravity sanitary sewer system, a part of the subsurface network of infrastructure pipes and conduits underneath urbanized and suburban communities, is designed to protect the public health and welfare. Unfortunately, because a sanitary sewer system is out of sight underground, little thought is given to operating and maintaining it. Few problems should occur in new sanitary sewer systems; however, operation and maintenance (O&M) needs increase as a sanitary sewer system ages, design and construction flaws become evident, and construction on nearby utilities reduces available sewer capacity.

Sanitary sewer O&M programs can vary from proactive to crisis level. A proactive O&M program aims at preventing sanitary sewer maintenance problems and maximizing the longevity of the existing sanitary

sewer system. The program is overseen by an agency or municipality that recognizes the importance of the sanitary sewer system and allocates sufficient funding and other resources to ensure a properly functioning sewer system.

Crisis O&M, on the other hand, involves doing the least amount of work for the least possible cost, with unfortunate results: the perpetuation of sewer problems, accelerated sewer deterioration, and more **sewage** backups. Crisis sewer O&M is characterized by the following:

- Response only to complaints and emergency situations
- Poorly trained and equipped staff
- Insufficient sewer cleaning procedures
- Minimal television inspection
- Emergency excavations and spot repairs
- Inadequate mapping
- Minimal record-keeping and difficult data retrieval

Response Only to Complaints and Emergency Situations

The primary objective of crisis O&M is to respond to complaints and emergencies as they arise, usually investigating odors, manhole cover problems, insect or rodent problems, sewage backups and overflows, and sewer collapses. The number of these incidents per sanitary sewer system corresponds to the sewer system size, age, and previous O&M program. Smaller sewer systems might have only a few emergencies each year, whereas older, deteriorated sewer systems may have full-time emergency crews that respond to problems on a daily basis.

Poorly Trained and Equipped Staff

Crisis O&M programs usually do not have enough staff members, and the personnel they do have are poorly trained and equipped. Budgetary limitations restrict all but the essential training required by Occupational Safety and Health Administration regulations.

Sewer cleaning equipment is sometimes not adequate to satisfactorily clean all sizes of pipe within the sewer system. In many instances, hydraulic sewer jets may have only two or three basic nozzles, which are not adequate to clean even 8-inch diameter sewer pipes with severe problems. Special nozzles to penetrate blockages, cut through grease, or remove accumulations of sediment and stones may not be available.

Equipment manufacturers usually limit on-the-job training to the **day** the equipment was delivered (perhaps 10 or more years ago), often **by** an operator who may never have been properly trained him- or herself. Moreover, equipment O&M manuals may be nonexistent. These conditions lead to unsatisfactory sewer cleaning.

Insufficient Sewer Cleaning Procedures

In crisis O&M cleaning, usually just enough cleaning is done to eliminate a sewer surcharge or backup problem; a standard radial sewer jet nozzle pokes a hole in the obstruction to relieve the blockage so that the surcharged wastewater can flow through the sewer. The emergency response crew departs after the emergency cleaning. In many instances, no effort is made to trap and remove sediment, stones, pieces of broken pipe, or grease in the downstream manhole. Material dislodged from the sewer is simply flushed downstream, where it ultimately contributes to other problems. Surprisingly, some sewer departments with sewer jet vacuum trucks even fail to vacuum materials out of sewers because no designated disposal site exists for these materials.

Intruding root masses are a common sewer blockage problem in crisis O&M sewer systems. Roots at some locations may persist for years because ineffective corrective steps are taken. Municipalities' reluctance to use root cutters, apply chemical herbicide treatment, or excavate and replace damaged pipe allows major root problems to obstruct sewer pipes.

Partial blockages from accumulated grease also cause sewer backups and **SSOs**. In a crisis O&M program, sewer workers poke holes in the blockages. Ordinance provisions requiring restaurants to use grease traps are rarely enforced, sewers are rarely cleaned properly, and grease blockages persist. Before long, sewer blockages recur at problem spots throughout the sewer system. These sites might be designated as "hot" spots, which are then scheduled for and receive periodic cleaning.

Minimal Television Inspection

Budgetary limitations under crisis O&M restrict the use of television inspection as a means to inspect problem sewers internally and identify the problems that cause surcharges and backups. Television inspection is conducted once in a while, but its effectiveness may be limited.

Some managers of crisis O&M programs are not well-versed in television inspection procedures and camera capabilities. To reduce contractor costs, the manager may arrange to have the maintenance staff perform preliminary sewer cleaning. More often than not, the proposed television inspections are impeded by debris in the pipe or surcharging from downstream sewers, which are partially plugged from sewer flushing debris. Television inspection time is lost while sewers are recleaned. Sometimes the proposed inspections cannot be completed because of debris or root obstructions in the sewer pipes.

After television inspections, the videotapes might be reviewed by someone unfamiliar with sewer pipe analyses and rehabilitation procedures. Consequently, appropriate sewer rehabilitation or maintenance may not be recommended or undertaken.

Emergency Excavations and Spot Repairs

Emergency excavations and spot repairs are the prevalent sewer repair technique in a crisis O&M program. Repair excavations may be required to fix collapsed pavements, dislodge cleaning equipment from a sewer, or eliminate sewer obstructions.

The sewer replacement may be limited to the minimal amount of pipe needed to secure the collapse site. Television inspection is usually not performed to assess pipe replacement needs. Sometimes improper repair techniques result in future problems at the repair site. Improper repairs include:

- Small diameter pipes shoved into larger diameter pipes
- Large diameter pipes spanning the gap where smaller diameter pipe was damaged

- Severely offset joints
- Nonwatertight repairs
- Different diameter pipes aligned crown to crown

These repairs can cause partial sewer blockages, permit surface subsidence when soil enters the sewer at the repair site, and allow ground-water infiltration. When correcting these repairs in the future, determining where emergency repairs were made can be difficult because crisis O&M programs have few records to track sewer activities.

Inadequate Mapping

Accurate sewer maps depicting the entire sanitary sewer system are essential records for an O&M program. The maps identify elements of the sewer system and document the location of problem sites. Ideally, the mapping should be part of a geographic information system (GIS) so that the relationship of sanitary sewers to other utilities can be determined and the advantages of computer technology can be used to improve O&M.

The cost of implementing a GIS for smaller communities may **be** prohibitive, making it easier to continue with crisis O&M mapping. Often the sewer mapping is missing information or may contain incorrect information, such as:

- New sewer developments may be missing.
- The limits of drainage basins may not be defined.
- Manholes may not be shown.
- No manhole numbering system is used.
- Pipe sizes may be incorrect or missing.

Minimal Record-Keeping and Difficult Data Retrieval

A proactive O&M program requires a comprehensive database from which cost-effective planning decisions evolve and problems are solved. Major elements of this database are:

- An updated **sewer map**.
- As-built record plans.
- A municipal piping inventory.
- A building service connection piping inventory.
- Service connection installation records.
- A major commercial/industrial user list.
- Field reports (e.g., complaints, routine inspections).

- A report library (e.g., design reports, capacity analyses, infiltration and inflow studies, sewer repairs, sewer extensions).
- A videotape library (smaller systems).
- Digital images attached to television logs or field inspection reports (larger systems).

Computer technology is the best method of storing, retrieving, and evaluating information. Crisis sewer O&M programs rarely use computers and generally have minimal written records and plans. Existing sewer records are scattered in various files and offices, making data retrieval difficult and time consuming. Elements of the sewer database are sometimes misplaced or lost.

Current record-keeping is unorganized or nonexistent. Emergency response field crews may record cursory comments in a field book, but the problems and corrective actions are not explained in detail. When a department of public works (DPW) responds to sewer emergencies, site records may be included with other DPW records, complicating the task of determining sewer site conditions and corrective actions.

After emergency responses, few office records are compiled to evaluate the response and determine whether future investigations or corrective actions are required. If emergency sewer cleaning has resolved the problem, no further actions may be planned.

The database inadequacies of crisis O&M programs impede the resolution of sewer problems. Sewer managers cannot develop appropriate solutions without a database from which to formulate a solution. Consequently, intermittent problems tend to be overlooked or periodically reevaluated without corrective actions.

Reasons for Crisis Maintenance

Crisis O&M programs exist in many sanitary sewer systems because of funding limitations, an absence of public pressure to properly maintain sewers, and limited enforcement pressure by regulatory agencies. Many communities operate and maintain their own sanitary sewer systems, meaning that the communities are responsible for operating and maintaining underground piping networks and for performing specialized investigations to assess sewer system conditions. A licensed collection system operator and staff are supposedly accountable for an adequate O&M program. These system specialists are relied upon by the general public, which usually understands very little about the O&M needs of sanitary sewers. Community officials decide how to allocate limited community resources, and sanitary sewer O&M must compete for funding with many other projects and budgetary needs.

Unfortunately, few who attend municipal meetings request funding for sewer O&M, usually only the few residents who experience sewage backups or **SSOs** near their homes. Because these problems are only intermittent, the public shows limited interest in sewer **O&M**.

Communities may become complacent about sanitary sewer O&M if they have conducted crisis O&M for years with minimal funding, personnel, and equipment. The slow, steady deterioration of their sanitary sewer systems is not envisioned. More often than not, when an intermittent sewer problem reappears, different decision-makers may be in office. Because these officials have to learn the sewer maintenance system, very few sewer problems are quickly resolved. For sewer users who experience backups, municipal accountability for problems tends to be low.

Many small to medium-sized communities do not have the funding for O&M on their sanitary sewer systems, unlike a utility, which would expect to achieve an annual profit. Revenue collected or allocated for sanitary sewer O&M is usually limited to funding the existing O&M program, which is usually a crisis program. Communities find it hard to comprehend the need for sewer investigations, contractor services

to clean and television-inspect sewers, sewer rehabilitation, and sewer replacement. Financial assistance for these communities might be limited, especially for sewer investigations and cleaning. The Clean Water Act does not provide enough low cost funding to satisfy the funding requirements for projected sanitary sewer collection system needs. Therefore, many sanitary sewer O&M needs go unfunded.

Finally, crisis sewer maintenance survives because no strong regulatory agency requires proactive maintenance programs. Regulatory agencies direct their focus more on wastewater treatment plants than on sanitary sewer collection systems. Regulatory agencies become involved with sanitary sewer collection systems usually when the sewer systems have severely deteriorated and are detrimental to the environment. More regulatory **agency involvement** with sanitary sewer O&M is needed to prevent collection systems from severely deteriorating.

New Sanitary Sewer Strategies

New strategies are needed to improve sanitary sewer O&M, which in turn will reduce **SSOs**. The strategies must develop guidelines to convert crisis O&M programs into proactive, preventive O&M programs. The transition must change the attitude many communities have toward sanitary sewers and must publicize the benefits of preventive maintenance. Problems in the private sector of the collection system, such as illegal connections and sewer piping defects, must be eliminated. The greatest obstacle to overcome may be the dramatic change in attitude that must accompany O&M changes to sustain proactive O&M programs.

Substantial investments will be necessary for training, investigating, cleaning, and rehabilitating existing sanitary sewer systems. O&M expenditures are justified in helping to reduce the extensive deterioration evident in many of the older sanitary sewer systems. Improved O&M programs will also help protect the enormous capital investment in new sewers by limiting deterioration in these systems.

The most difficult O&M transition may be in small to medium-sized communities, whose resources are limited and where the incentive for improved O&M programs may be low, especially if the communities are not affected by **SSOs**. Their wastewater discharges may contribute to **SSOs** in regional interceptor sewers and at wastewater treatment plants, however. Only improved **O&M** programs in the tributary communities can eliminate these **SSO** problems.

The perspective and involvement of the regulatory community will also require a transition. Regulatory staff with an understanding of sanitary sewer system O&M must oversee the program to assess the capabilities of municipal O&M programs and to recommend realistic improvements.

Recommended O&M strategies include the following:

- Require sewer collection system reports to regulatory agencies similar to wastewater treatment plant discharge monitoring reports.
- Develop proactive O&M guidelines.
- Require sewer mapping using GIS technology.
- Require computer use for sewer records.
- Designate disposal sites for debris and materials removed from each sewer system.
- Provide funding.
- Develop enforcement provisions for noncompliance.

- Improve training programs for collection system operators.
- Require television inspection of all problem sewers.

Summary

The challenge to improve **O&M** programs and reduce **SSOs** is nearly insurmountable given the reluctance of many municipalities to improve sanitary sewer O&M and resolve illegal connection problems. In 1980, the U.S. Environmental Protection Agency's Conklin Report (1) stated the need for improved O&M programs. The Agency's 1985 construction grants manual (2) repeated the need for comprehensive and effective sewer maintenance programs.

Today, we are still facing the same O&M problems and now realize that some structurally damaged sewers are exfiltrating wastewater into storm sewers and receiving waters. How long can we afford to continue with crisis O&M programs?

References

1. U.S. Environmental Protection Agency. 1980. Evaluation of infiltration/inflow program. Final draft report. **EPA/68/01/4913**. Washington, DC: Office of Water Program Operations.
2. U.S. Environmental Protection Agency. 1984. Construction grants 1985 (CG-85). **EPA/430/9-84/004**. Washington, DC: Office of Water Program Operations (July):

City of Portland Sewer Collection System Maintenance Management Plan

Graham Knott
Brown and Caldwell Consultants, Seattle, Washington

Dave Singleterry
City of Portland Bureau of Environmental Services, Portland, Oregon

Aside from insufficient hydraulic capacity and the structural failure of the collection system, operation and maintenance (O&M) probably has the greatest impact on the frequency and severity of sanitary sewer overflows (SSOs). Grease and sediment buildup, roots, rodents, and infiltration and inflow can all severely affect the ability of the system to perform. Insufficient maintenance of pumping facilities and inadequate cleaning of storage facilities can also have a negative impact on the performance of the system.

Annual operating expenses directly affect the required revenue rates through user fees. Unlike capital projects that can be amortized over many years, annual O&M costs are generally borne in the year in which they are incurred. Maintenance therefore competes with other short-term activities and, without sufficient justification, is often the loser against other higher profile, more visible programs. The challenge is to convince elected officials of the importance of collection system maintenance, especially challenging in an election year, when money spent on sewers is not typically a big vote winner.

It is therefore necessary to justify the money spent on maintaining the sewer system, and to maximize the benefit of maintenance activities for the dollars spent. A well-organized maintenance program with measurable goals is more likely to be successful and more readily approved. If ratepayers can see specific benefits from the dollars spent, politicians can more readily support the program. In a recent benchmark study for a major client in the Pacific Northwest, Brown and Caldwell found there was a wide variation in the cost and frequency of maintenance activities.

To clearly justify its future operations budgets, the City of Portland, Oregon, prepared maintenance management plans for wastewater collection and stormwater collection facilities to manage the above concerns. The collection system plans are divided into two volumes: Maintenance Management (Volume 1) and Maintenance Manual (Volume 2).

The purpose of Volume 1 is to provide the management requirements of the program and includes:

- An **introduction** that defines the overall goals/objectives for the maintenance manual and gives an overview of the sewer collection system, explaining how the physical characteristics relate to the maintenance program.
- The **maintenance management program**, which defines the mission statement, management goals, and authority by which the maintenance program can be implemented, as well as specific responsibilities.
- **Program administration**, including organization structure, communication, relationship between engineering and maintenance bureaus, interaction with other programs, and intergovernmental agreements.
- An overview of **maintenance activities**, including system operation and performance criteria, the inspection program, condition assessments, and critical facilities evaluation.

- **Development of the maintenance plan**, including a maintenance activity evaluation spreadsheet, annual maintenance plans, labor requirements, and equipment and material requirements.

Volume 2 includes:

- **Details** of maintenance procedures
- **Abnormal operation**, including catastrophic events, personal injury, and traffic accident
- **Safety information**

Definitions, maintenance frequency tables, a spreadsheet user manual, a manual of condition defect classification, policies and procedures, critical sewer identification procedures, and a seismic evaluation are contained in appendixes.

This paper discusses variations in the maintenance activities of several Pacific Northwest cities. The elements contained in the City of Portland's *Sewer Collection System Facilities Maintenance Manual* are then outlined, and the maintenance activities are described. The method of assessing the impact of the various maintenance activities on the performance of the collection system is presented, and the spreadsheet model used for estimating the costs is outlined. The need for an integrated maintenance management software will also be demonstrated.

Objective of Maintenance Programs

Sewer collection systems are constructed to provide for the health and safety of the public by safely transporting sanitary and industrial wastes to wastewater treatment facilities and away from public contact. During wet weather, some discharges are diverted to receiving streams as a result of infiltration and inflow to the system. During dry weather, similar discharges can occur as a result of poor system O&M. Maintenance programs are developed to protect the public's investment in the infrastructure and to ensure the collection system operates at maximum efficiency. The maintenance program contributes directly to the health and safety of the public and the environment.

Historically the maintenance objectives for sanitary collection systems have focused on reducing public exposure to polluted water, often at the expense of the environment. Recent changes in philosophy, however, have expanded the scope to also improve, protect, or preserve the environment. It is therefore important to define the goals and scope of the maintenance program.

The goals of the City of Portland maintenance management program are shown in Table 1.

Table 1. Maintenance Management Goals, City of Portland, Oregon

Goal	Reason for Goal
Protect the community's investment in the sewer collection system	A scheduled maintenance management program will maximize the useful life and capacity of the sewer collection system.
Provide for public health and safety	A scheduled maintenance program will help reduce health hazards from flooding or SSOs.
Protect fish and wildlife habitat	Maintenance procedures implemented with an environmental awareness will help reduce negative impacts on fish, wildlife and the environment.

Goal	Reason for Goal
Increase operational reliability, and protect against flooding and system backups	Facilities maintained to convey design flows will minimize the potential for system backups, including localized flooding and basement flooding problems.
Provide cost-effective O&M	Routine preventive maintenance will help avoid costly emergency repair tasks and the damage that may result from system failures.
Provide effective customer service	Customer service activities performed in a timely manner will help reduce hazards to the public and minimize claims against the city.
Reduce the potential for catastrophic failure	The implementation of a maintenance program will help reduce potential hazards to the public and loss of system operation.
Prevent or reduce wet weather and dry weather SSOs	The number of SSO events and the quality of overflow during each event will be reduced through a routine maintenance program that maintains the hydraulic and structural integrity of the system.
Provide for a planned response to natural and other disasters	Health and safety hazards resulting from natural and other disasters are alleviated through planned response procedures.

Types of Maintenance Programs

Two types of maintenance program exist: reactive, in which the maintenance organization responds to an incident; and proactive, in which a portion of the maintenance activities are performed in advance of an incident to prevent the occurrence. Proactive programs should concentrate on areas where they are needed. For example, cleaning should be focused on sewers that require cleaning and not on sewers that are operating effectively. In this case, some sewers will be cleaned annually, while others will never be cleaned.

Given these provisos, reactive programs are typically more expensive to implement and are less effective overall than proactive programs. While it is desirable to transition to a proactive approach, incidents will always occur that require reactive maintenance. In addition, the initial cost of setting up a proactive maintenance program will initially be more expensive, because tools for performing the program are put in place at the same time reactive activities are still required. A typical startup cost curve is shown in Figure 1.

Variation of Maintenance Activities

In a recent benchmark study for a major client in the Pacific Northwest, Brown and Caldwell found a wide variation in the cost and frequency of maintenance activities. Some typical comparisons are shown in Tables 2, 3, and 4.

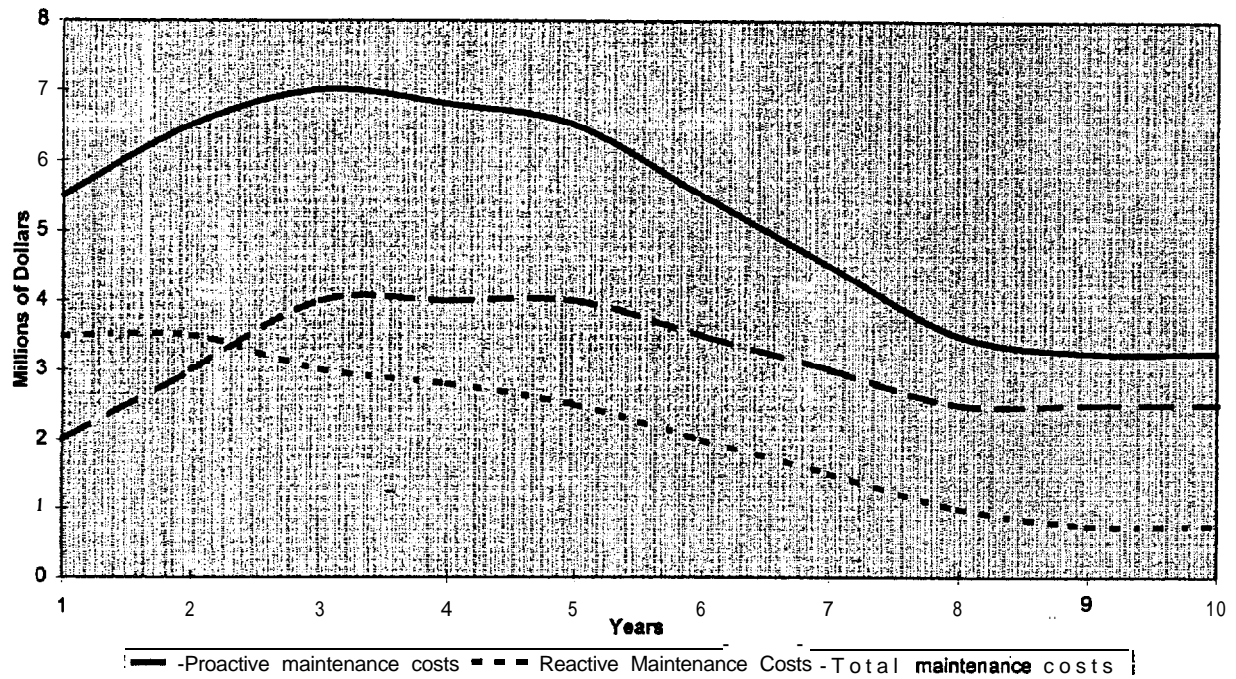

Figure 1. Proactive versus reactive maintenance.

Table 2. Annual O&M Benchmark Comparison

City	1993 Annual Cost (\$ millions)	Sewer System (miles)	Unit Cost (\$ per mile)
City 5	1.9	250	7,502
City 2	0.7	377	1,934
City 4	6.5	672	3,734
City 1	2.4	805	2,950
City 3	7.6	1,506	5,106

Table 3. Sanitary Sewer Maintenance Staffing Comparisons

City	Number of Staff	Miles of Sewer	Miles per Worker
City 1	29	805	27.8
City 2	50	377	7.5
City 3	76	1,506	19.8
City 4	63	672	10.6
City 5	30	250	8.3

Table 4. O&M Activity Frequency Comparison

City	Closed-Circuit Television Inspections	Flushing/Cleaning
City 1	89 years	9 months
City 3	22.5 years (frequency varies from annually to never)	21 years (frequency varies from annually to never)
City 4	20 years (5 years for critical sewers, 15 for noncritical sewers)	7 years
City 6	10 years	2.5 years (target; frequency varies from 3 months to 2.5 years)
City7	10 years	6 years (frequency varies)

The unit O&M cost varies considerably from around \$2,000 to \$7,500 per mile of sewer. Variation depends somewhat on the age and type of system to be maintained. Unfortunately, the records were unable to provide any measurement of system performance, in comparison to the amount of money spent.

The above data show that cities vary widely in frequency of their performance efforts. In particular, the frequency of inspection varied considerably from very little proactive inspection to a more focused inspection program in which sewers were prioritized, with some pipes receiving frequent inspection and others infrequent inspection. Similarly, the flushing/cleaning program varied from widespread annual flushing to prioritized, focused programs. In many cases, flushing/cleaning was in response to complaints. As part of the recent program of spill prevention, another city has begun to implement a general inspection/flushing program with a return frequency of 6 years. This program was associated with a mandated inspection/flushing frequency, although there was no stipulation about the split between inspection and flushing, or what inspection and flushing comprised.

In general, comparing the various programs was difficult because of the wide disparities in system inventory records and the financial tracking and reporting systems. In addition, the communication link between engineering and maintenance was often not effective in passing information on maintenance problems between city departments.

Maintenance Activities

Maintenance of the sewer collection system involves a number of people who perform a variety of different activities. Maintenance program managers and others who are either directly or indirectly involved in the maintenance program must have a basic understanding of the purpose of each of these activities. Such an understanding should include knowing the answers to the following questions:

- Why is the activity performed?
- How is the performance of the collection system related to maintenance activities?
- How is the maintenance activity performed and implemented?
- Who performs the activity?
- What equipment or material is required to perform the task?

Knowing the answers to these questions will enable managers to make informed decisions regarding the development and implementation of the maintenance program.

System Operation and Performance Evaluation Criteria

The gravity sewer system operates simply, requiring minimal mechanical or operator effort. It does, however, still require an active maintenance program.

Since the primary function of the system is conveyance, maintenance activities focus on maintaining the hydraulic capacity of the system. Typically, two different classes of problems reduce hydraulic capacity:

- **Structural defects** that degrade the sewer pipe. Serious defects can lead to pipe failure and produce backups, flooding, SSO events, and ground-water contamination if exfiltration is a problem. Sewer repair and rehabilitation activities focus on restoring the structural integrity of the pipe.
- **Operational defects** that directly affect the hydraulic capacity of the pipe. These include roots, sediment, and fats, oils and grease (FOG). Sewer cleaning and source control activities focus on preventing or reducing the impact of operational defects on the collection system.

Inspection activities can be used to assess both structural and operational defects. Depending on who is performing the inspections, however, efforts may concentrate only on one measure of performance, resulting in inadequate data and/or the need for repeat inspections.

Understanding the impact of the maintenance activities on sewer collection system performance will help a city or district develop and implement efficient maintenance programs. Such programs utilize limited funds, labor, and equipment in a way that provides the greatest benefit to the community.

It is well known that maintenance activities can directly affect the performance of the collection system. What is not as well known or documented is how to quantify the relationship between maintenance and collection system performance. The City of Portland has therefore selected performance evaluation criteria to help define this relationship. Table 5 summarizes the maintenance program goals, the recommended evaluation parameters, and the way in which maintenance activities help achieve the program goals.

Table 5. Maintenance Goals and Maintenance Activity Relationships

Maintenance Program Goals	Evaluation Parameter	Maintenance Role
Protect the community's investment in the sewer collection system	Structural and operational condition grade of the sewer collection system	Inspections help detect maintenance requirements. Early defect detection can lead to lower-cost repairs. Repair and rehabilitation activities maintain structural integrity.
Provide for public health and safety	Number of claims filed for health and safety issues	Inspections, repairs, and cleaning can improve the hydraulic and structural performance of the system. Flooding, backups, and catastrophic failures can be reduced.

Maintenance Program Goals	Evaluation Parameter	Maintenance Role
Protect fish and wildlife habitat	Number of dry and wet weather SSOs and/or the amount of sediment removed	Cleaning activities can improve hydraulic capacity, thus reducing the likelihood or duration of SSO events.
Increase operational reliability and protect against flooding and system backups	Number of flooding and backup claims	Cleaning activities can improve hydraulic capacity, thus reducing the likelihood of flooding and backups.
Provide cost-effective O&M	Most efficient plan identified with a maintenance optimization model	Limited funds, labor, and equipment should be used where they provide the greatest benefit to the community.
Provide effective customer service	Time required to respond to a complaint	Expanding the customer service team can reduce response times.
Reduce the potential for catastrophic failure	Percent of Condition Grade 5 sewers	Inspections, repairs, and rehabilitation activities will reduce the risk of catastrophic failure.
Prevent or reduce wet weather and dry weather ssos	Number of SSO events	Cleaning activities can improve hydraulic capacity, thus reducing the likelihood or duration of SSO events.
Provide for a planned response to natural and other disasters	Identification of major components of an emergency response plan	Labor, equipment, material, and standby contractors are available to respond to disasters, and staff are trained to handle them.

Inspections

The inspections identify and quantify structural and operational defects affecting sewer system performance. A manual of defect descriptions that describes the types and severity of defects identified has been prepared for the City of Portland. This manual improves the probability of having reproducible inspection results from several inspectors and contractors. It is very important inspection records are kept current, since all cleaning, repair, and rehabilitation activities are based on this information. Typical structural and operational defects for pipe sewers are shown in Table 6.

Table 6. Typical Structural and Operational Defects for Pipe Sewers

Structural Defects	Operational Defects
Joint separation	Silt
Joint deflection	Grease
Longitudinal cracks	Manufactured debris
Radial cracks	Pea gravel/rocks
Multiple cracks	Vermin
Radial fractures	Encrustation
Multiple fractures	Infiltration
Broken pipes	Roots
Collapsed pipes	Protruding service connections
Corrosion	
Worn inverts	
Sags	
Deformation	

Inspection Frequencies

Inspection frequencies for sewers vary depending on the consequence of a particular failure and the risk of the failure occurring. To help achieve the goal of reducing the failures in the most “critical pipes,” a critical facility rating and risk assessment procedure have been developed (see Figure 2). The intent is to pursue all potential failures in the system. It is acknowledged, however, that some failures would have greater impact than others, and that these failures should be pursued more aggressively. The ultimate objective is to eliminate failures from the system. Since it is unlikely this goal will be achieved due to budgetary and resource limitation, however, the goals are to:

- Eliminate failures from the highest category facilities
- Reduce or, if possible, eliminate failures from the intermediate category facilities
- Reduce failures in the lowest category facilities

Priority Ranking Module

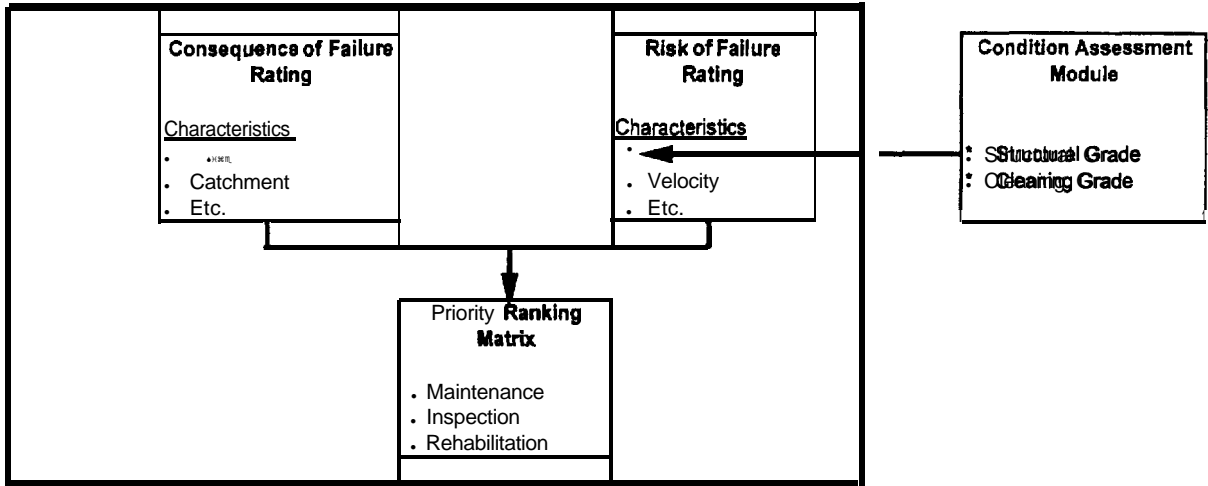

Figure 2. Priority ranking process.

The risk of failure is also an important factor in determining the frequency of maintenance, especially inspection and cleaning. Typical factors affecting the likelihood or risk of failure include:

- Structural and operational condition
- Velocity of flow
- Pipes with a history of problems
- Infiltration
- Frequency of surcharge
- Soil conditions
- Pipe material
- Seismic vulnerability (both location and material)

Inspections can be prioritized as shown on Figure 3 by combining the results of the criticality and risk assessments.

Consequence	Risk				
	5	4	3	2	1
A1					
A2					
A3					
B					
C					

Inspection Frequency	
	Annual
	2 years
	5 years
	10 years
	20 years

Figure 3. Typical inspection program.

The actual frequency of inspection or cleaning depends on whether a minimum, intermediate, or maximum level of maintenance is to be performed. A typical level of inspection frequency for each level of maintenance is shown in Table 7.

Table 7. Frequency of Inspection Activities

Condition	Category A Sewers (interval between activity in years)			Category B Sewers (interval between activity in years)			Category C Sewers (interval between activity in years)		
	Grade	Level of Maintenance		Level of Maintenance		Level of Maintenance			
(5=worst; 1=best)	Min.	Inter.	Max.	Min.	Inter.	Max.	Min.	Inter.	Max.
Condition 5	1	1	1	2	1	1	1	1	1
Condition 4	2	1	1	5	2	1	5	2	1
Condition 3	5	2	1	10	5	2	10	5	2
Condition 2	10	5	2	15	10	5	15	10	5
Condition 1	15	10	5	25	15	10	40	25	10

Required Maintenance and Expected Performance

Pipelines are inspected, cleaned, repaired, and rehabilitated to maintain the design conveyance capacity. Inspections help identify sections of sewer requiring cleaning and repair. Cleaning activities help improve hydraulic capacity, which results in fewer backups, flooding, and SSOs. Repair and renovation activities help maintain structural integrity, which in turn helps prevent catastrophic failures that could negatively impact the health and safety of the public and the environment and typically are very expensive to repair. The inspection, cleaning, and repair activities used for maintenance of pipes and sewers in Portland are summarized in Table 8.

Table 6. Typical Pipeline Maintenance Activities

Maintenance Activity	When Required	Facility Performance
Inspect sewers-surface	As part of the normal work routine	Surface depressions and unusual conditions that might be indicative of a collapsed pipe and/or subsurface cavity are discovered.
Inspect sewers-closed-circuit television (CCTV)	Periodic inspection to determine condition; frequency based on criticality and risk of failure assessments	Cleaning and/or repair needs are identified by assessing structural and operational conditions.
Conduct detailed sewer investigations	When litigation may result from problems or when investigation requires special skills	Problems are located and documented; repairs are made if the city is responsible.
Inspect sewers-walk-through	Similar to CCTV inspection but using more costly walk-through techniques	Cleaning and/or repair needs are identified by assessing structural and operational conditions.

Maintenance Activity	When Required	Facility Performance
Vactor clean sewers	When inspection indicates excessive sediments, grease, and root accumulations. Frequency may be based on recommendations or history	Material is removed from the sewer so that sewer service and capacity are restored.
Jet clean sewers	As above, but when sediment can be flushed downstream	Material is removed from the sewer so that sewer service and capacity are restored.
Machine rod sewers	In smaller pipes when inspection identifies heavy accumulations of grease and roots	Sewer capacity and service are improved or restored.
Conduct root clearing—chemical	Chemical foam root killer is applied when excessive amounts of roots are noted or in sewers with a history of problems	Sewer capacity and service are improved or restored.
Repair/Replace shallow sewers-shaft method	Less than 12 feet deep, and when a backhoe cannot be used	Structurally defective lines are replaced to ensure proper operation.
Repair laterals—machine method	Removal and replacement of defective service laterals	Structurally defective service laterals are replaced to ensure proper operation.
Repair sewers-deep shaft method	Greater than 12 feet deep	Structurally defective lines are replaced to ensure proper operation.
Repair/Replace shallow sewers--trench method	Greater than 12 feet deep, and backhoe can be used	Structurally defective lines are replaced to ensure proper operation.
Repair/Replace shallow sewers-hand method	Where equipment access is limited	Structurally defective lines are replaced to ensure proper operation.
Repair laterals-hand method	Used in parking strips, landscaped areas, and other areas inaccessible to equipment	Structurally defective lines are replaced to ensure proper operation.

Developing Maintenance Plans

Maintenance managers are constantly challenged to meet program objectives with limited maintenance resources. A section of the City of Portland's Maintenance Management *Manual* provides guidelines and tools that can be used to help managers develop maintenance plans to meet that challenge.

A **maintenance optimization model** has been developed to evaluate collection system performance relative to inspection and cleaning activities. Performance is evaluated by assessing the impact on structural deterioration, hydraulic capacity, water quality and odor, as well as impacts on the combined sewer overflow (CSO) program in the combined sewer areas. The optimization model develops the cost of performing the maintenance activities by using labor and equipment costs and maintenance frequency. Consequently, the impact of changing the maintenance frequencies can be assessed in terms of both cost and environmental impact.

A **rehabilitation module** is being developed to identify and prioritize repair and rehabilitation projects that will be included in the capital improvement plan budget. The module is external to the current wastewater collection management system facility inventory and maintenance history database. Potential rehabilitation projects will be ranked according to their rehabilitation requirements and the effects the sewer's failure would have on overall sewer collection system performance. The module assigns a rehabilitation priority and determines associated capital costs.

Developing the Annual Maintenance Plan

The annual maintenance plan is a major element of the budgeting and planning process. The plan is divided into two phases: planning and implementation. The whole procedure is illustrated on Figure 4. The planning phase is divided into five steps:

1. Summarize maintenance **goals**
2. Evaluate the maintenance plan from the previous year
3. Identify plan modifications
4. Determine maintenance budget requirements
5. Determine labor and equipment requirements

The implementation ("do the work") phase can be considered in three broad areas: unscheduled items that can be budgeted from history data (e.g., responding to local emergencies and customer service), unscheduled and unbudgeted activities (e.g., widespread emergencies such as volcanic eruptions and earthquakes), and scheduled maintenance including inspections and cleaning.

Figure 4 shows a data management system that includes a facility inventory and maintenance history database, computer-aided design and other maps and drawings, and a geographic information system (GIS)-an integral part of the maintenance management activities. The final piece of the puzzle is a plan for dealing with abnormal operation of the system. This requirement has been emphasized in recent years throughout the country in reference to several major disasters. In planning for emergencies, the following general guidelines should be remembered:

- Follow *all* safety procedures.
- Evaluate the severity of the situation and the threat to public health.
- Don't do anything that could make the damage or cleanup more extensive unless absolutely necessary to protect human health or life.
- Assign only trained employees who are properly equipped with the necessary protective equipment to respond to the emergency.
- Remember the primary concern in an emergency situation is the safety of the public and the workers responding to the problem.

Typical abnormal operation conditions include widespread power failure, fire, spill response, severe weather, seismic disturbances, volcanic eruption, sewer collapses, personal injury, and traffic accidents.

Figure 4. Maintenance program activities.

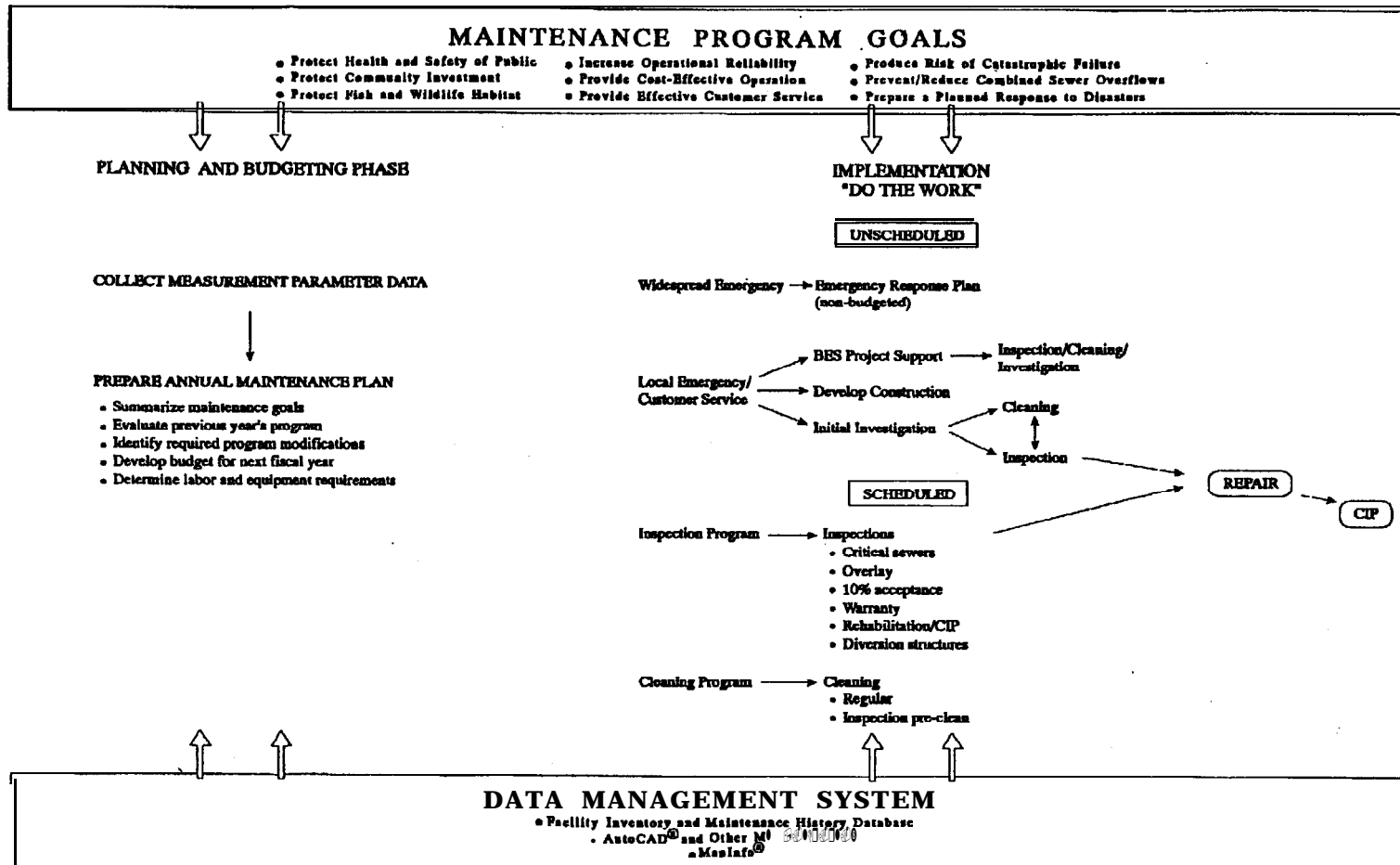

Conclusion

Maintenance and operational problems are beginning to receive a higher profile. Planning procedures and documents are needed to help organize the operation, reduce costs, and maximize system performance. In completing work for the City of Portland, the authors realized that very little research and experience relating maintenance to system performance have been reported in the key areas of structural deterioration, hydraulic capacity, water quality, CSO and SSO impacts, and odor control.

Further, the maintenance management systems will need to be supported by integrated software systems that link the traditional facility inventory and condition history maintenance history databases with mapping and GIS systems. In larger cities, information system departments can help the engineering and maintenance departments make these connections. In smaller cities, package systems could be a more attractive option in a world of ever changing and increasingly complex computing requirements.

Line Blockage Assessment Documents Sewer Conditions That Contribute to Overflow

Philip M. Hannan, Julie Delaney, and John McLeod
Washington Suburban Sanitary Commission, Laurel, Maryland

The Washington Suburban Sanitary Commission (WSSC) provides water and sewer services to the nearly 1.5 million residents of Prince George's and Montgomery Counties, Maryland. Within the 1,000-square-mile service area, approximately 350,000 connections and more than 100,000 manholes are associated with the 4,600 miles of separate sanitary sewers. The service connections and manholes collectively represent nearly a half million opportunities to affect a customer or the environment when a sewer surcharges or overflows.

Many common characteristics affecting collection system performance exist in both large and small systems. Insufficient capacity, hydraulic restrictions, extraneous infiltration and inflow (I/I), roots, grease, debris, sand, silt, and other material settling out due to low velocity are all capable of converting the desired open-channel flow to surcharge. Depending on the lowest elevation available, the rising wastewater finds an outlet in a basement or the environment.

A review of WSSC records for the past 5 years reveals insights into the nature and frequency of backups and overflows. This review was funded by a grant from the U.S. Environmental Protection Agency's (EPA's) Office of Wastewater Management; the results of the review will concentrate on backups and be briefly discussed in the context of a well-designed and maintained collection system with an active I/I abatement program. In general, this collection system is predisposed to fewer capacity restrictions and I/I impacts than perhaps comparable large systems. **As** a result, the focus of this presentation will be the relative role of sewer pipe conditions in contributing to backups during non-wet-weather flows.

For purposes of this review, wet and non-wet-weather problems were identified. A network of 18 tipping-bucket-style rain gauges is maintained throughout the sanitary district. A "significant" rain event for this service area was selected as greater than 1.5 inches per calendar day, a less than 1-year return interval storm. This rainfall was selected independent of the season, intensity, antecedent ground water, or carryover into the next calendar day, but with WSSC experience of a threshold storm necessary to record measurable impacts in the collection system. Sixty-four events over the 5 years met these criteria. All "wet weather" characterizations for backups are in this context.

Backups

A customer experiencing a backup is advised to call WSSC. Because of the split responsibility for the sewer lateral dictated by the property line, WSSC inspectors first check the sewer main for stoppages or surcharge. If the sewer is clear, the customer is told that the problem is on the property and is advised to get a plumber. If the plumber snakes and finds the problem outside the property line in the lateral, the plumber makes a "commitment" for that service, meaning subsequent problems are the WSSC's responsibility. If the sewer main was surcharged, sewer relief and cleanup are the responsibility of the WSSC.

Once the backup is confirmed to be WSSC's responsibility, a crew is dispatched to clean the premises. The majority of the backups result from mainline stoppages, although individual lateral problems may be mixed in. Over the past 5 fiscal years, **2,960** basements were cleaned as a result of all causes, mainline or lateral. Of these only 5 percent coincided with significant rainfall days as previously defined and can be described as specifically wet weather related. Even if the wet weather definition was expanded, a review of the data indicated that this percentage would not increase appreciably.

Overflows

A similar analysis was performed to evaluate the 1,064 manholes that overflowed during the **5-year** period, but with some important differences. The comparison is identical to the basement backup evaluation where "significant" rainfall days are researched against the reports of overflowing manholes. This is not as accurate, however, because many of the manholes reported are in right-of-way areas and the date of the report may not coincide with the overflow's commencement, only its initial observation. The wet weather factor was found to influence only 13 (or 1 percent) of the overflows. The remoteness of many of the overflowing manholes may influence that number because the reporting party would usually not be able to observe the overflow during the rainstorm. This figure does not include facility overflows such as pumping stations, which may also serve **as** a relief location.

Because a customer is not affected, results of sewer investigations from overflowing manholes are recorded separately. The Commission nevertheless understands that the causes of sewer stoppages resulting in backups and overflowing manholes are similar; only the relief point differs. The lowest elevation available at the point of surcharge will determine where the wastewater will exit. Evidence indicates that the distribution of causes is similar in examining the provocation for both backups and overflows.

Line Blockage Assessment

Line blockage assessment (LBA) is a coordinated process of investigation and response to a customer backup. An effort initiated by the Maintenance Bureau in April 1993 to expand and improve service to customers, LBA complements existing preventive maintenance (PM) and sewer reconstruction programs. LBA includes emergency relief, customer contact, **followup** cleaning, internal investigation of the problem sewer section, rehabilitation and PM recommendations, and final customer correspondence and response. The objective is to document the causes of sewer backups and overflows and remedy the identified problems.

In nearly 2 years, the LBA program completed more than 1,100 investigations. Procedures and practices have been revised several times to enhance the service response and to achieve greater consistency in the application of PM and rehabilitation recommendations. The current program requirements are reviewed in the following discussion.

Emergency Relief

After an inspector confirms the backup or overflow, a Systems Maintenance crew is dispatched to provide emergency relief. This crew might use one of several pieces of cleaning apparatus to relieve the stoppage-high-pressure water jet, power rodder, or cable drag equipment-depending on access (street, right of way), type of sewer segment (terminal or through), equipment availability (day shift or off hours), and type of pipe (e.g., polyvinyl chloride, concrete).

The objective is to thoroughly remove the source of the stoppage to both relieve the problem and prepare the line for subsequent internal inspection. The cleaning job is not complete until a bucket or brush can be pulled through the entire sewer segment. If a jet machine was the first responding apparatus, a **followup** drag is automatically scheduled within 7 days. Once work is complete, a door hanger advises the customer of the emergency actions taken. Any basement cleaning is coordinated at the customer's convenience either with the Systems Maintenance crew or an outside services contractor.

Customer Contact

To respond more aggressively to customers, the LBA process requires written correspondence from Systems Maintenance to the affected customers. This letter identifies the anticipated time frame for the investigation and final response to the customer with recommended actions by the commission. A contact name and phone number are provided for any questions in the interim.

Internal Inspection

At the time of the initial service call and emergency response, Maintenance Services writes a work order to direct the internal inspection of the sewer component. Customer addresses are associated with sewer segments in the maintenance management information system (MMIS) to ease identification of the proper component.

The work order directs Systems Analysis to perform a TV evaluation to identify the cause of the stoppage. Although the cleaning of the segment may remove the primary evidence of the stoppage, it is a necessary step both to relieve the immediate problem and to permit a complete internal evaluation of the pipe. Experience has shown that sufficient evidence of a chronic problem will still be visible 30 to 60 days later when the TV is performed.

The internal inspection is performed in accordance with existing commission standards. At a minimum this involves plugging the upstream flow to isolate the segment, using radial view or pan and tilt camera for maximum viewing of defects and service connections and using color cameras to distinguish mineral deposits and other stains for proper identification. Corresponding logs document service connection addresses while confirmation flushes identify activity from abandoned taps. Estimates of any leakage are also provided so I/I recommendations can be made simultaneously. Any remedial cleaning needed is ordered and completed within 7 days of the TV effort.

Evaluation

Once the inspection is complete, Systems Analysis reviews the videotape of the segment. The sewer pipe is observed for structural and nonstructural sources of problems that could have contributed to the backup or overflow. Roots, grease, debris, line, grade, and structural problems are all noted for their relative impacts. A matrix aids in the determination of appropriate PM to eliminate or control the problem. Written procedures for the rehabilitation evaluation guide the reviewer through the available repair options. The objective here is to ensure consistency and effectiveness with both PM and renovation recommendations.

PM options include several types of cleaning at selected frequencies for grease and chemical root control when roots are in evidence. Drag or jet cleaning is effective for debris and sand, with a scheduled **followup** TV 1 year later to determine whether the accumulation is chronic or isolated. The rehabilitation menu takes into account the nature of the structural defect and matches it with a rehabilitation technique after reviewing access, diameter, location, and capacity issues.

Response

Once the recommendations have been made, the customer is again contacted in writing and advised of the results. The appropriate unit is then charged with implementing the PM or rehabilitation action.

Causes of Overflow

The evaluation process in the LBA is analogous to the problem definition. By properly defining the cause of the backup or overflow, the most cost-effective resolution can be implemented. As discussed earlier, 95 percent of the backups and 99 percent of the overflows are non-wet-weather occurrences. The factors responsible for these include structural problems, roots, grease, alignment, and sewer lateral defects.

An analysis of these conditions reveals the largest single result (38 percent) was a finding of no further problem beyond the immediate stoppage material removed through the emergency cleaning. One of the risks associated with aggressive cleaning following the backup or overflow would be elimination of the evidence of the problem. Certainly that is one reason contributing to this high percentage. But this also speaks to the randomness of a portion of the stoppages, a fusion of independent factors generating an occurrence, ultimately eliminated by the emergency cleaning.

Poor alignment (33 percent) is the second ranked category, characterized by depressions, standing water, offset joints, and lack of significant finding of roots or grease. The chief defects described here are the depressions (and resulting low velocities) that allow material to accumulate and settle out of the flow stream. Offset joints and misaligned pipes are also factors snagging debris and initiating stoppages,

Roots (14 percent) have an easily identifiable, direct relationship to a backup or overflow. Only the most aggressive cleaning will remove them entirely prior to the TV inspection. Roots at joints and taps are the most frequent observations, although there is the occasional crushed pipe caused by roots searching for water. Not surprisingly, these problems are more numerous in older neighborhoods with more mature trees. Although weeping willows may have the most notorious reputation, almost any type of tree root will infiltrate sewers and inflict damage if the water need is sufficient.

Structural problems (4 percent) are significant breaks, cracks, or collapses that can be directly linked to the backup. The defect is severe enough that more than a casual relationship can be inferred. Backfill, gravel, and other material migrating into the sewer through the break tend to compound the hydraulic restriction leading to overflow.

Grease (3 percent) is the last of the definable factors playing a direct role in the overflows. This category describes isolated grease problems. This is primarily domestic grease dumping from individual homes as opposed to commercial contributors. This relatively low percentage excludes instances where grease acts in combination with other factors.

There is another group (8 percent) of indeterminate problems associated with the lateral. These will only be identified through followup lateral inspections in the public sector (property line to the main).

None of the factors should be taken as discretely as the percentage would imply. Clearly, there is interaction among them (roots with grease, debris and depressions, grease and depressions) that aggravate the stoppage potential. Combinations of these factors are probably more the rule than the exception.

Preventing Overflows

Once the causes of the backups and overflows have been identified in individual sewer segments, recommendations are made for treating the problems. Options available include preventive maintenance (cleaning, chemical root control) and rehabilitation (sewer lining, pipe bursting, point repairs, joint sealing).

To further the consistency of the LBA options, the Maintenance Bureau collaborated on a PM matrix. This matrix assembled the cleaning and root control options and prescribed the appropriate PM and

frequency for a given set of conditions, providing a complement to the existing guidelines for rehabilitation selections.

Leading the list of recommended actions was cleaning only (39 percent). Either the emergency cleaning resolved the problem with only a one-time **followup** required, or the problem is associated with sags, depressions, or grease. Cleaning is generally a cost-effective alternative to rehabilitation. Even the least expensive excavation repair to reestablish grade can be many times the cost of a cleaning, although the present worth of a frequently scheduled PM could change the cost-effectiveness balance.

Rehabilitation (35 percent) is the next ranked category, although in reality it is not as prominent as it may appear. When recommendations are made, a subjective priority is assigned. Only priority "1" recommendations move forward to active contract backlogs. Lesser-priority defects were judged not responsible for overflows but will be addressed if time and funding permit. This category comprises the following types of work:

- Joint sealing, 42 percent
- Structural lining, 26 percent
- Pipe bursting (replacement), 11 percent
- Point repair, 10 percent
- Connections, 11 percent

The "do nothing" option (16 percent) is also significant, as this supports the assessment that emergency relief resolved most of the perceived problem.

Chemical root control (10 percent) is used extensively throughout the WSSC area, and these line segments are routinely added to existing contracts. The disparity between root identification (14 percent) and root control (10 percent) lies in internal debate over the effectiveness of the chemical applications versus scheduled cleaning to handle roots. Evaluation of the chemical control program is continuing.

Costs

Backups and overflows have a financial impact on both the customer (property damage, lost time) and the WSSC. In fiscal year 1994, the Claims Section paid out claims of \$853,000, the majority of which were associated with property damage (depreciated cost) as a result of backups. This averaged approximately \$700 per claim.

Several levels of cost are borne by the commission. One impact is intangible: the frustration and aggravation suffered by customers because of backups. A swift and comprehensive response to relieve the problem is the first step to restoring customer confidence. Eliminating a repeat occurrence is the final objective. This degree of line maintenance comes at a price.

Three different divisions within the Maintenance Bureau share custody of the LBA program. The direct costs for staffs administrative handling, field relief, and problem analysis total nearly \$3 million in support of the LBA effort. PM cleaning, chemical root control, and rehabilitation to preclude future backups are approximately another \$4 million annually. None of these costs are additional budget expenses as a result of LBA, rather a packaging of previously budgeted efforts into a more coordinated, comprehensive approach to better serve the customer.

Summary

Overflows and backups result from a variety of influences in the collection system. Advanced capacity planning, active I/I abatement, and aggressive line maintenance are factors that sustain and preserve open-channel flow in the collection system. The commission's customers benefit from all of these programs, each of which is a necessary facet to minimizing the inconvenience of a backup.

This presentation focused on the LBA program, one component of an integrated approach to addressing the occurrence of backup or overflow. Customers are provided individual attention, with the focus of the program being proper definition of the problem with a solution tailored to that sewer segment. With constant fine-tuning and tracking of the problem from backup event through rehabilitation, this is a program that is here to **stay**.

Corrosion Inspection of a 78-Inch Interceptor-While Live

Kent Von Aspern
Central Contra Costa Sanitary District, Martinez, California

Central Contra Costa Sanitary District (CCCSD) provides wastewater collection, treatment, and disposal for the communities of Martinez, Pleasant Hill, Clyde, Walnut Creek, Lafayette, Moraga, Orinda, Alamo, Danville, and portions of San Ramon, as well as the unincorporated areas of central Contra Costa County in northern California. In addition, CCCSD treats and disposes of the wastewater generated in the cities of Concord and Clayton on a contract basis.

A key facility in the collection system is the A-Line interceptor. About 90 percent of the total flow is transported to the treatment plant through this pipeline. This paper discusses corrosion inspection work conducted on a 1,000-lineal-foot section of the interceptor. Specifically, the planning and performance of a walk-through inspection is described in detail, with an emphasis on safety requirements.

Description of Study Area

The pipeline to be evaluated consists of 1,064 lineal feet of 78-inch reinforced-concrete pipe (RCP), located 11 to 13 feet underground in an easement adjacent to a major freeway. The upstream manhole is near the end of Galaxy Way. The downstream manhole is situated within the parking lot of a new car dealership (see Figure 1).

Flows from the City of Concord enter the A-Line at the upstream manhole. As early as 1978, high hydrogen sulfide levels had been documented at the Concord pumping station. To control sulfides, chlorine was injected into the flow stream at the pumping station. The City of Concord terminated its sulfide control program in 1991, however, due to escalating costs.

As part of a freeway improvement project, CalTrans planned to construct a new off-ramp over the interceptor at Burnett Avenue. Since this would restrict maintenance access to the interceptor, CalTrans planned to add two new manholes to the interceptor and place a concrete cap over the reach beneath the new off-ramp.

Furthermore, CCCSD elected to inspect this reach of interceptor to assess the condition of the pipeline prior to construction of the off-ramp. As is typical in these applications, the pipeline was television inspected.

Television Inspection

Television inspection of large interceptors is especially difficult and frequently yields unsatisfactory results. Common problems associated with television inspection of large pipelines include high flows, inadequate lighting, and excessive distance between the camera and the crown of the pipe. These conditions make interpretation of television inspection videotape more of an art than a science.

The videotape of the A-Line inspection showed a strong line near the crown of the pipe, which appeared to be a series of longitudinal cracks with vertical displacement. In addition, color changes from the 10:00 to the 2:00 position seemed to indicate severe sulfide-related corrosion and spalling.

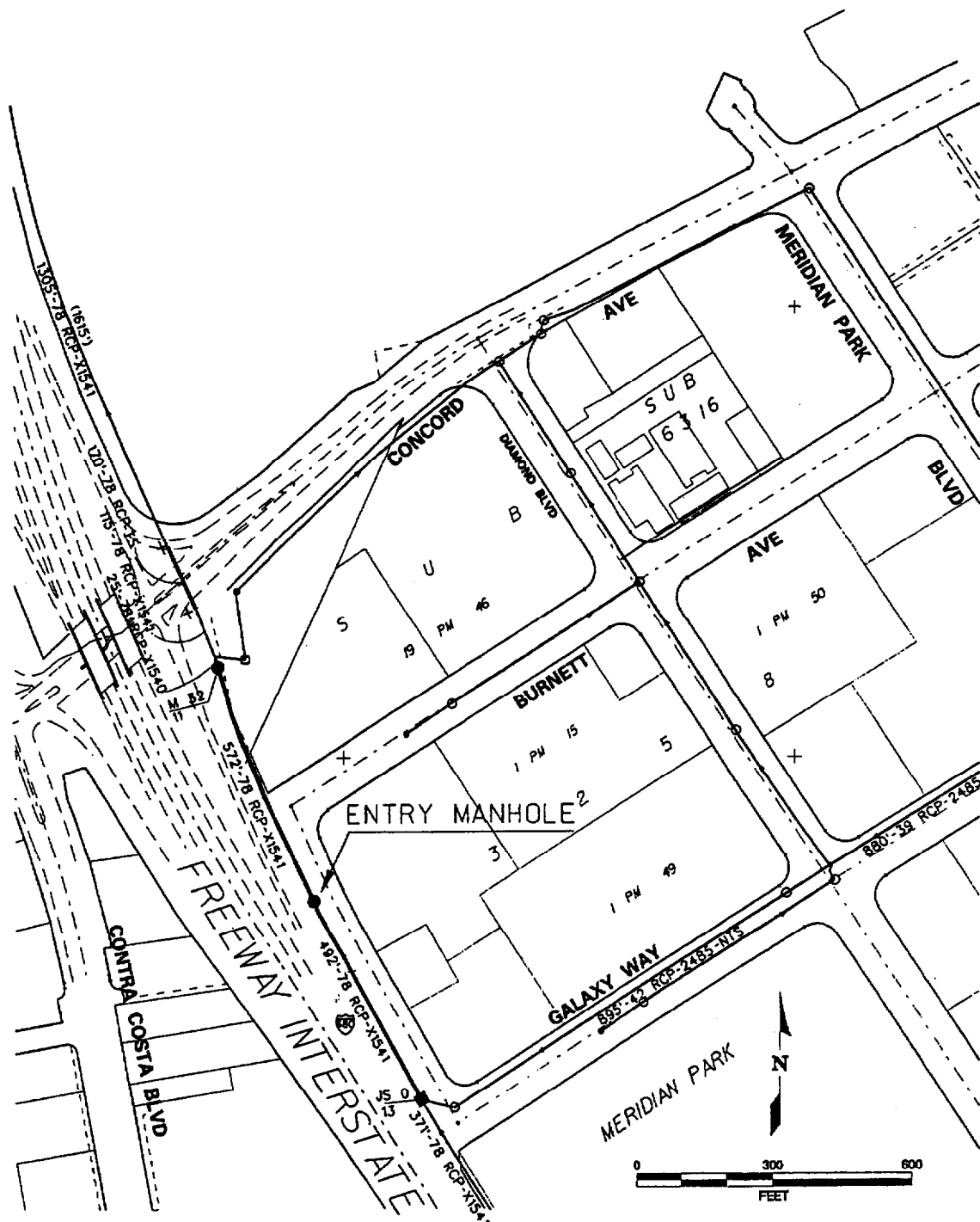

Figure 1. Internal corrosion inspection study area.

Because of the problems associated with television inspection of large interceptors, however, it was not possible to determine whether rehabilitation of the interceptor was necessary. On one hand, the A-Line interceptor is a critical link in the collection system. A catastrophic failure of this pipeline would have dire environmental consequences. On the other hand, the videotape did not provide incontrovertible evidence that rehabilitation of the interceptor was required.

It was determined that the suspected results of the television inspection would have to be verified by conducting a walk-through investigation of the interceptor.

Inspection Planning

Coordinating an internal inspection of the A-Line interceptor was a major undertaking and was not to be taken lightly. The first hurdle would be overcoming the initial reaction that it could not be done.

Several planning meetings were held including members of CCCSD's Safety Group, the Engineering Department, and the Collection System Operations Department (CSOD). Safety was the primary consideration; if the risks could not be reduced to a manageable level, then the walk-through would not be allowed. From these meetings, we determined the following:

- The walk-through would have to occur during minimum flows (between 2 a.m. and 6 a.m., during dry weather).
- A new intermediate manhole would have to be installed to use as an entry point.
- The entire entry would be a confined-space entry; CCCSD confined-space entry procedures, including self-contained breathing apparatus (SCBA), adequate standby personnel, continuous atmospheric monitoring, and radio communications, would have to be followed strictly.
- The Concord pumpingstation would have to be shut down during the walk-through (to further reduce flows in the interceptor).
- A specialty firm experienced in this type of work would have to be hired.

Manhole Installation

The interceptor modifications planned by CalTrans included the addition of two manholes located on either side of the new off-ramp. Coincidentally, one of the planned manholes was located approximately midway between the two existing manholes. We elected to construct this manhole for use as our entry point.

Through telephone conversations and faxing of structural details back and forth, we were able to coordinate construction of this interceptor manhole. CalTrans was able to modify their plans to delete construction of this manhole and to show it as existing.

CCCSD hired a local contractor to install the interceptor manhole. From initial contact to completion of construction took only 5 days and was completed at a cost of \$5,390.

The RCP crown of the pipe was removed intact to evaluate the extent of corrosion. A significant amount of concrete was missing from the pipe; the aggregate was exposed and the rebar showing in several places. From the videotape, the middle of the reach appeared to be the most severely damaged portion of the line, so these findings were not surprising.

Once the manhole was installed, the walk-through was scheduled.

Walk-Through Inspection

With complete confidence (or total foolishness), we scheduled the walk-through for a Monday morning. All parties met at the **jobsite** at midnight.

A professional diving company, Underwater Resources (UR), was contracted to provide the entry person (who was a certified diver experienced in the evaluation of concrete pipe), an in-line standby worker, a topside tender, and an electronic specialist. In addition, UR provided the following equipment:

- Two sets of **600-foot** hose and communication cable attached to positive-pressure face masks, adapted for two-way communication.
- Harness and emergency-escape air bottle.
- Appropriate personnel entry clothing (e.g., waders, gloves), and sampling and testing **tools**.
- An underwater color video camera with transmission cable, lighting, ground-fault interrupter, generator, monitor, videocassette recorder, and audio recorder.
- Primary and secondary breathing compressors and air sources.
- One set of diver's radios for local communications between the entry worker and topside staff.

CSOD provided staff to stand by at each manhole, an SCBA-equipped rescue worker to stand by at the entry manhole, and attendants certified in cardiopulmonary resuscitation at each manhole. CSOD also provides site lighting, manhole opening tools, forced-air ventilation equipment (at the upstream and downstream manholes), personnel-lowering equipment, gas detectors, and radios for communicating between the various manholes, the safety base, and the Concord pumping station.

Engineering Department staff was responsible for coordinating the shutdown of the Concord pump station, obtaining keys to allow access to the downstream manhole (located in a fenced-in parking lot), obtaining the **confined** space entry permit, monitoring and recording atmospheric gas levels, maintaining radio communication with the safety base, and supervising the operation. Engineering also provided the necessary sample bottles and litmus test paper.

Field Briefing

Following introduction of all field personnel, a complete checkout of all equipment was performed. Then a dry run of the inspection was conducted.

During the dry run, specific instructions were given to identify the actions and responsibilities of each person. Emergency situations were imagined and discussed, and appropriate plans made. Rescue operations and contingency plans were discussed in depth. All questions were answered before the inspection began.

Every member of the inspection crew was included in the dry run. Each person gave full attention to the instructions and discussion. The professional manner employed by the field personnel was instrumental to the safe and successful completion of the inspection program.

Walk-Through

The Concord pump station was shut down at approximately 2:15 a.m. By 2:45 a.m. the flow depth had dropped to less than 12 inches and the flow velocity was estimated to be about 4 feet per second. The first manhole entry **was** made at that time.

The entry worker initially proceeded upstream. The diver looked for signs of corrosion, paying particular attention to the crown of the pipe and the joints. At each joint, the diver used a hammer to test the structural integrity of the concrete and measured the depth of deteriorated concrete. Wherever sulfide powder was encountered, the diver collected a sample for subsequent analysis. At various locations, the pH at the crown of the pipe **was** measured using litmus paper.

After completing the inspection 240 feet in the upstream direction, the entry worker returned to the center manhole. The Concord pump station was restarted while the diver rested. When the pumps at the pump station kicked off, the pump station was again shut down. After the flow in the interceptor dropped to acceptable levels, the inspection proceeded 240 feet in the downstream location. The downstream inspection was completed at about 6 a.m.

Although the safety of the entry workers was never in jeopardy, "surprises" occur in all field work, no matter how well planned. Our surprise for this project occurred just after the first manhole entry was made, when it became apparent that the sprinklers along the easement were set to come on at 3 a.m. After a brief delay while most of the standby observers ran around turning off the sprinkler heads, we were able to proceed with the inspection.

Procedural adjustments are also a part of field work. We found that carrying the video camera, flashlight, and backpack full of tools and sample bottles, and dragging the lifeline, air hoses, video transmission cable, and communications cables behind him made it impossible for the diver to measure the pH at the crown of the pipe. Also, since sulfide powder was not encountered, no samples were collected.

Findings and Recommendations

Generally, it was found that the pipe was in good condition and no rehabilitation was required. Debris and damage at the pipe invert were minimal. The aggregate at the crown of the pipe was exposed, but not protruding. Soft concrete and protruding aggregate from the 2:00 to 4:00 and from the 8:00 to 10:00 positions was observed, with depths ranging from 1/4 to 1 inch. Similar corrosion patterns were observed at the joints.

No exposed steel was observed at any point. At two joints, minor spalling of the concrete was observed; this damage appeared to be construction related, however.

What had appeared to be significant crown corrosion on the videotape turned out to be high water marks and the transition from very light corrosion at the crown to light corrosion at the sides of the pipe. The possible longitudinal cracks with displacement that we thought we saw on the videotape turned out to be a small ridge of thickened concrete from the fabrication process, which just happened to occur at the crown of the pipe.

It was also interesting to note that the piece of pipe we removed during the manhole installation, which showed significant signs of corrosion, was not representative of the rest of the line. This was attributed to either one of two causes:

- We managed to install the manhole at the exact spot of the only significant corrosion in the line.

- The sawcutting process employed during construction caused the concrete on the inside of the pipe to separate and fall off.

It was enlightening to see our interpretations of the videotape translated to “real-world” information. The inspection program was completed at a cost of \$16,323, including the manhole design and construction, planning efforts, field work, and report preparation. The cost of rehabilitation, which could be in the millions, was avoided.

Conclusion

In addition to providing valuable information regarding the interpretation of video inspection, the **walk-through** also gives us a baseline for monitoring the condition of the A-Line interceptor. CCCSD has instituted a corrosion monitoring program for this interceptor that includes monthly atmospheric measurements, quarterly wastewater sampling for dissolved oxygen and total sulfide levels, and internal inspection to be repeated every 5 years.

Moreover, this program proves that a large interceptor can be inspected safely, even if flow cannot be bypassed. CCCSD now has an established procedure for walk-through inspections and is less intimidated by the prospect of placing a person inside a pipeline. Many millions of dollars of unnecessary rehabilitation may be avoided by verifying corrosion conditions; and more importantly, that money can be used to rehabilitate the pipes that really need replacement.

Sewer Rehabilitation: The Techniques of Success

David E. Jurgens
City of Fayetteville, Fayetteville, Arkansas

Hugh M. Kelso
RJN Group, Inc., Dallas, Texas

Introduction

Since 1989, the City of Fayetteville has expended over \$10 million to curb its sanitary sewer overflow (SSO) problem. A number of projects have been successful, while several have been less successful. From these experiences, we have identified specific techniques from throughout the SSO elimination process that have proven successful and we have felt the effects of unsuccessful corrective actions. This paper will identify techniques we have tried, both successful and not, so that others may learn our lessons without expending the great deal of time and money that we have invested.

Background

In 1989, when more than 545 SSOs were reported, Fayetteville's SSO problem came to the attention of Region 6 of the U.S. Environmental Protection Agency (EPA). Fines resulted, and EPA placed the city under a negotiated Administrative Order (AO) with the mission of eliminating all SSOs. The AO specified tasks and projects aimed at achieving this objective. The deadline for completion was December 31, 1993.

The objective would not be easy to reach. The oldest portion of the city's sewer system was designed in 1889 and constructed immediately thereafter. With customer cities and growth areas included, Fayetteville now encompasses 71 square miles and a population exceeding 55,000. The city straddles two major watersheds. Half the natural drainage flows into the Illinois River, and thence into Oklahoma; the other half flows via the White River into Beaver Lake, the source of the entire area's drinking water (including Fayetteville's). With large hills on the ridge line, the city provides sewer services to areas that differ in elevation by 560 feet. As a result, over 400 miles of pipe, 6,000 manholes, and 22 pump stations (2 more are under construction) transport the city's 11.4 million gallons per day (mgd) average daily flow of wastewater to its single treatment plant.

Like many cities, Fayetteville participated in EPA's Construction Grants Program in the late 1970s. Using methodologies espoused in that program, the city contracted with a consulting engineering firm to perform a thorough Sewer System Evaluation Study (SSES). Based on this study, several construction projects were completed, but with negligible improvement in overflows or infiltration/inflow (I/I). In 1985, another sewer study was completed in conjunction with a master facilities plan. A great deal of work was performed, including construction of a new treatment plant and over 15 miles of interceptor sewers. The projects produced no measurable or observable reduction in overflow or the amount of I/I entering the system. The plant was almost immediately overwhelmed during small to medium rain events.

The SSO problem was enormous. Many more than the 545 SSOs identified in 1989 occurred, but were not discovered and reported to city personnel. They were, quite simply, a part of life for the residents.

Upon receiving the AO, the city immediately embarked on the plan negotiated therein, hiring engineering consultants to perform a systemwide SSES, installing a permanent flow monitor system, establishing a Supervisory Control and Data Acquisition (SCADA) system for the pump stations, upgrading the in-house sewer maintenance staff, and performing rehabilitation and construction projects required to accomplish the mission. To complete the system SSES, separate consultants (each using their own methodology)

were retained to work in the two watersheds. In addition, city forces have performed SSES functions separately and with the consultants in various parts of the city.

One consultant's SSES used the comprehensive I/I reduction methodology, which consists of determining inflow potential during a design storm event, performing intensive survey activities to identify specific sources of I/I, hydraulic modeling to evaluate the system's capacity to transport expected peak wet weather flow, flow balancing, and analyzing data to arrive at the most cost-effective solution for eliminating overflows through I/I reduction and minimal capacity improvements. The hydraulic modeling, flow balancing, and cost-effectiveness analysis were performed with the aid of a comprehensive source model. Initially, the other SSES, which was based on the Construction Grants Program methodology, was based mainly on a physical evaluation of the sewer system and did not include projections of design storm inflow, capacity analysis, or flow balancing. A hydraulic model was developed and design storm flows were projected after the SSES was complete.

Rehabilitation Projects

The city has been successful in greatly reducing the overall number of overflows experienced per year. The number of SSOs dropped from 545 in 1989 to 123 in 1994 (Figure 1). These overflow figures include *all* identified overflows, from 10 to 1,000,000 gallons. Of the 123 SSOs in 1994, 36 percent and 39 percent were from I/I in 1993 and 1994, respectively (Figure 2). Moreover, several recurring rainfall-induced overflow points undiscovered in 1989 have been identified, and many have been eliminated. City forces now hunt additional recurring overflow sites, as this is the first step in their elimination.

Fayetteville's remarkable success in reducing the number of SSOs is the result of many contract projects and significant in-house efforts. The project most easily quantified and isolated is that in the Wilson Park area of town (Area 1), and this paper will examine it first. The paper will then compare SSES work performed in Area 2, and will briefly discuss some less successful rehabilitation projects performed in Areas 3 and 4.

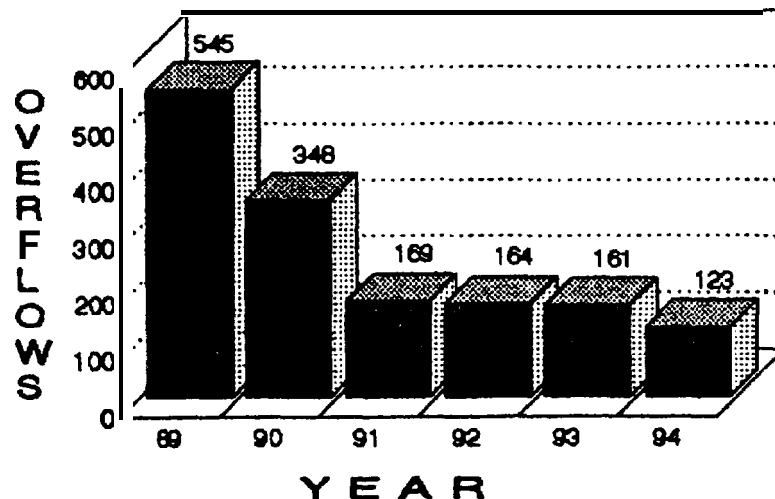

Figure 1. Number of SSOs per year in Fayetteville.

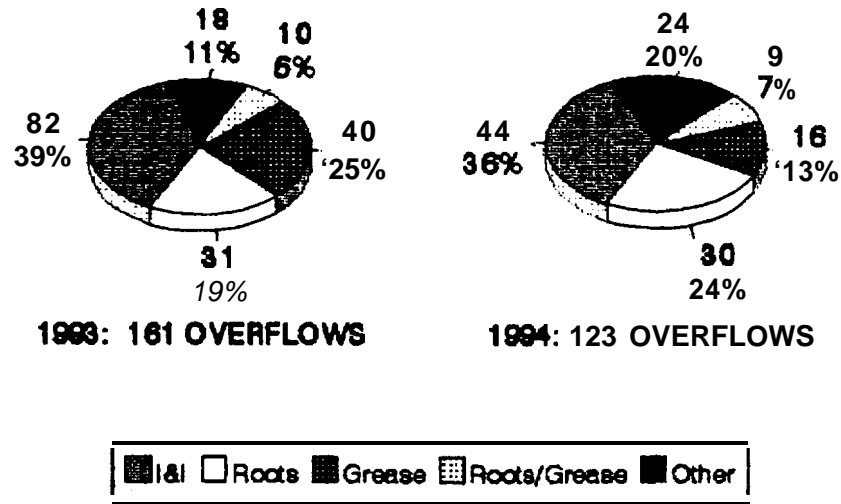

Figure 2. Causes of SSOs in Fayetteville.

Project Area 1: Wilson Park

Centered in the historic district of the city, seven sites in the Wilson Park area experienced SSOs during virtually every rainfall. Using the techniques discussed in this paper and spending approximately \$1.7 million on public and private line replacement, cured-in-place piping, point repairs, manhole rehabilitation, manhole replacement, and relief sewer construction, all these overflows were eliminated for rain events up to and including the 5-year design storm. This success was validated through pre- and postrehabilitation flow monitoring.

Before rehabilitation, the area experienced a total flow rate of 4.145 million gallons per day (mgd) during a 5-year storm. Rehabilitation reduced this rate to 1.592 mgd (Figure 3). Identified I/I-induced overflows dropped from 38 in 1992 to 0 in 1994 (Figure 4).

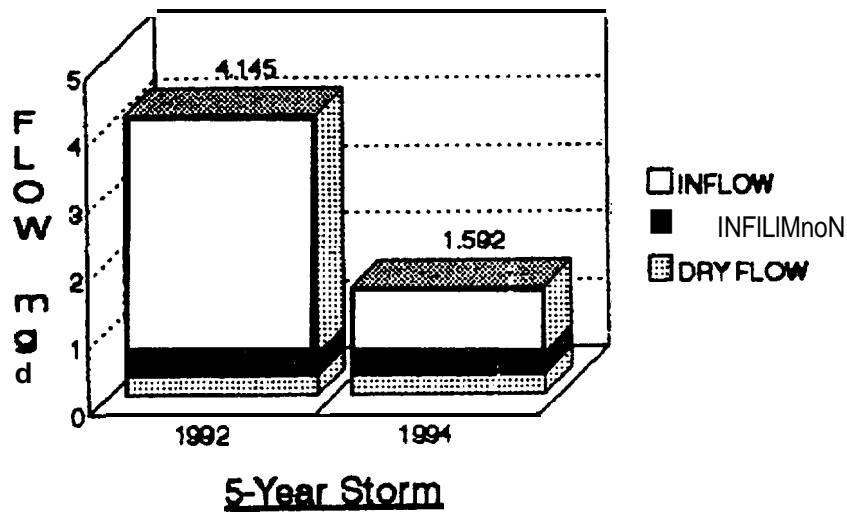

Figure 3. Quantities of water, Wilson Park area.

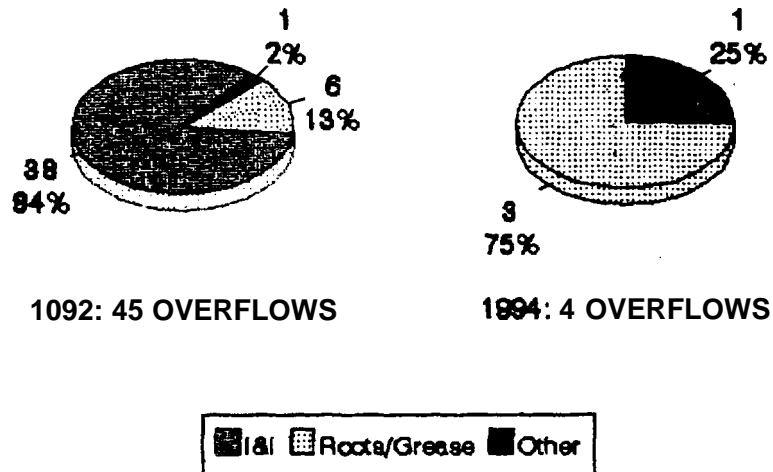

Figure 4. Overflows by cause, Wilson Park area.

The construction repairs producing these results were made based on the recommendations of the comprehensive I/I reduction study of the Illinois River Watershed completed in 1993. Through manhole inspection and smoke testing activities, this study identified 1,062 inflow defects. Physical inspection and smoke testing of this system was also performed by others conducting SSES activities in 1989. They identified 54 defects using smoke testing methodologies similar to those employed under the Construction Grants Program, excluding manholes. A summary of defects identified from smoke testing is shown in Table 1.

Table 1. Defects in the Wilson Park Area Identified Via SSES Smoke Testing

I/I Source	Construction Grants Method SSES ^a	Comprehensive Method SSES ^b
Main sewer defects	16	49
Storm sewer cross connections	6	10
Building lateral defects	18	60
Building lateral cleanouts	14	17
Downspouts	0	1
Area drains	0	12
Total defects	54	149

^aSmoke testing of 80 percent of area. Defects identified via television inspection not included.

^bSmoke testing of 70 percent of area. Defects identified via television inspection not included.

The Construction Grants Method SSES was performed using single blower smoke testing; it relied most heavily on television inspection to identify pipe defects. This SSES was halted in the Wilson Park area before televising was initiated. The Comprehensive Method SSES used dual blower smoke testing; it used television inspection only to confirm and quantify inflow defects and to identify major pipe defects.

Manholes were also a significant problem, with 913 defects contributing an estimated 1.435 mgd of inflow during a 5-year storm.

Project Area 2

A comprehensive I/I reduction study was completed in 1994 in another portion of the city, designated Area 2. Like the Wilson Park area, this basin contains some of the oldest pipes in the city. The 1994 study identified a total of 783 inflow sources (not including those identified via television investigation). The area was also studied in the 1989 SSES which used the Construction Grants Method. Table 2 summarizes the smoke test data from both studies.

Table 2. Defects in Area 2 Identified Via SSES Smoke Testing

I/I Source	1989 Construction Method Study^a	1994 Comprehensive Method Study^b
Main sewer defects	8	26
Indirect storm sewer cross connections	6	16
Building lateral defects	29	100
Building lateral cleanouts	22	80
Area drains/downspouts	2	12
Total defects	67	234

^aInformation derived from field investigation forms.

^bDefects identified via television inspection not included.

The results of the two studies highlight the impact that methods can have on results. In both Area 2 and the Wilson Park area, dual blower smoke testing (1994 Comprehensive Method study) and single blower testing (1989 Construction Method study) yielded very different results: 234 versus 67 main and building defects, respectively, for Area 2. Similarly, the results point to the importance of the manhole investigation. The 1989 study relied on data from the late 1970s SSES rather than a comprehensive manhole study. Because the study did not identify manholes as a major source of I/I, manholes did not appear in construction recommendations, This severely limited the effectiveness of rehabilitation performed in Area 2. By contrast, the 1994 study identified 549 manhole defects, accounting for an estimated 1.92 mgd of inflow during a 5-year storm. The manhole defects included pickholes, frame seals, corbel and wall leaks, and pipe seal leaks.

The two studies also differed in the amount of television investigation performed. In the 1989 study, nearly 58 percent of the system was televised, identifying 8,657 pipe defects, This televising was performed under normal flow conditions, did not include pipes larger than 12 inches in diameter, and was not performed in conjunction with dyed water flooding. The televising produced an excellent pipe condition database and resulted in a long-term maintenance plan, but it did not identify and quantify I/I sources. Thus, it was not helpful for developing an I/I reduction construction project. In the 1994 study, on the other hand, just 8 percent of the pipe was televised, but the televising strongly targeted suspected inflow defects, was performed with simultaneous dyed water flooding, and confirmed the location and allowed quantification of inflow defects. Television tapes from the 1989 study were used to identify major pipe defects, eliminating the need for retelevising approximately 7 percent of the system. The comprehensive approach significantly reduced the cost of the study by reducing the amount of

televising, yet identified 1,219 I/I defects and greatly increased the I/I reduction potential of the resulting construction project.

Project Areas 3 and 4

Rehabilitation was performed in two other areas studied in the 1989 Construction Grants Method SSES. Each area contained one or more recurring, I/I induced overflow sites, Construction consisted primarily of pipe replacement. Some manholes were spray-sealed, but no other manhole work was performed. The overflows continued to occur, and inflow declined by less than 10 percent after the construction.

Rehabilitation Methodology

In our experience, the comprehensive approach to overflow elimination and I/I removal has proven very successful. The fundamentals of the approach are listed in Figure 5. The Comprehensive Method differs significantly yet subtly from the Construction Grants method. It targets system characteristics that directly contribute to overflows rather than inventorying the system condition. As a result, it may yield a recommendation to replace 20 percent of the pipe and to conduct specific repairs as necessary on the remainder while a Construction Grants Method study of the same area might yield a recommendation to replace 70 percent of the pipe. The comprehensive approach produces the most realistic, cost-effective, and expedient repair plan to eliminate overflows. The approach is discussed in more detail below.

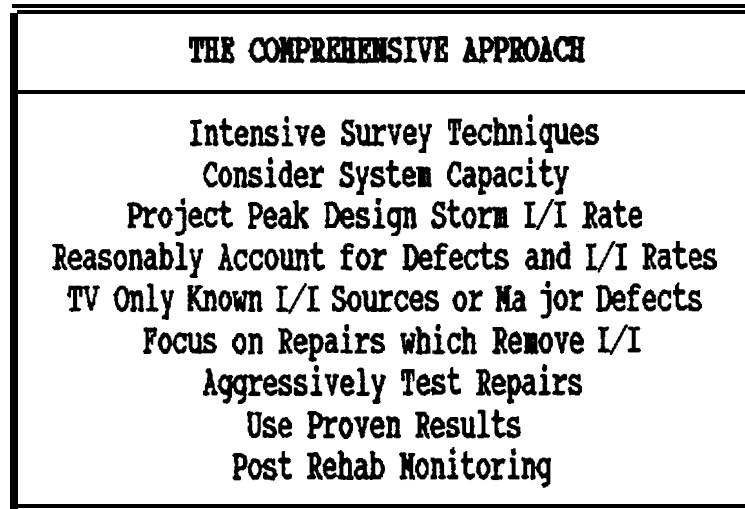

Figure 5. The comprehensive approach to overflow elimination and I/I removal.

SSES Techniques

In our experience, relatively subtle differences in techniques can affect the success of an SSES. Differences in techniques arise from different perspectives on the mission and focus of the SSES. For example, a Construction Grants Method SSES focuses on inventorying and identifying all defects in the sewer collection system rather than on determining peak inflow potential, comparing the sewer system's transport capacity with the peak expected wet weather flow rate, and balancing source flow rates with monitored flows. The successful SSO elimination study addresses all these issues.

The field investigation phase of an SSES provides the foundation for a successful rehabilitation program. We have found the following techniques to be useful.

Smoke Testing

When smoke testing, every effort must be made to force the smoke into all available channels in the pipe segment being tested. As smoke testing is relatively inexpensive, it should be used to find all possible leaks and to identify all buildings connected to a line segment. To do this, the segment being tested must be temporarily pressurized. This is achieved in two ways. First, use plugs or sandbags to isolate the segment from the upstream and downstream segments (i.e., so that smoke does not enter these segments). Second, using high-volume blowers, blow smoke into both ends of the line segment.

Many potential pitfalls can reduce smoke testing's effectiveness. A common pitfall is to try smoke testing several line segments at the same time. Although this appears to produce acceptable results, potential inflow sources can remain unnoticed as the smoke follows the path of least resistance in the pipe itself rather than being forced through leaks into the ground. Similarly, using only one blower and/or low-volume blowers produces results that seem to be good but are nevertheless incomplete. If the ground is damp or wet, ground water can block the path of the smoke. Occasionally, pipes exhibit active infiltration during a smoke test, neutralizing the test's effectiveness. Less frequently considered, high surface winds (greater than 15 miles per hour) can blow the smoke away so fast that the field crews cannot see it or cannot identify where the smoke surfaced. This is especially true inside storm drains, where smoke tends to dissipate before being seen.

Dyed Water Flooding

Dyed water flooding is essential to confirm the exact location of drainage cross connections to the sewer line and to quantify leak entry sites. When used with television inspection, it allows the investigator to firmly establish exact repair locations in the pipe. Dyed water flooding is also used to test suspected defects such as area drains, window sill drains, and downspouts piped underground that did not smoke during smoke testing because they were clogged or equipped with a trap. Dyed water flooding helps to determine if the suspected sources are connected to the sanitary sewer.

Television Investigation

Televising, the most expensive field technique, should be used least and with maximum efficiency. Pipes should be televised in conjunction with dyed water flooding to pinpoint storm sewer cross connections and other major inflow sources. These sources might have been identified during smoke testing, but smoke and water often travel quite a distance laterally between the pipe and the ground. Simultaneous dye flooding and televising will pinpoint the leak entry point in the pipe and yield a good estimate of the magnitude of the leak.

As with all other field investigation techniques, pitfalls can significantly reduce the effectiveness of televising. For example, televising without dyed water flooding can facilitate characterization of the pipe's conditions, but not identification of specific leak entry points or quantification of the leaks. Televising when a pipe is partially or almost completely full is also ineffective because potential leak points are concealed from the camera.

Manhole Inspection

Manhole inspection, one of the largest weaknesses of the Construction Grants Methods of the 1970s, is among the most important efforts in an SSES because manholes generally account for 30 to 50 percent of the inflow entering a sanitary sewer system. Manhole investigations must be thorough, must examine every portion of the manhole, and must be conducted from inside the manhole. Leaks around pipe seals, in the trough, and along the floor can easily contribute up to 30 gpm, yet they usually remain unnoticed if the investigation is conducted from the surface. Leaks in the corbel are virtually impossible to find, but are frequent sources of inflow as water passes down the outside wall of the manhole. Obvious ring and lid defects must also be identified. All these leaks must be quantified and prioritized.

Performing the investigation from the surface and failing to thoroughly check the manhole are the two most common pitfalls resulting in inadequate manhole investigations. I/I leaks around taps into manholes are often confused with flow from the tap itself. If not closely inspected, leaks on the floor, in the trough, or around pipe seals are often misidentified as eddies in the normal pipe flow.

Physical Pipe Inspection

Performed from inside the manhole, physical pipe inspection is the only opportunity to actually see the inside of the sewer pipe during an SSES. When properly conducted, a visual pipe inspection can identify pipe problems that might otherwise be undetectable. It is also important in verifying the size and type of pipe.

Getting close to the pipe to look down its length (rather than simply looking at the pipe from the surface) is important. Even to an experienced field investigator, pipe diameters can be deceiving. Not infrequently, a different diameter pipe was stubbed out from a manhole and the true diameter cannot be seen from the surface. Different pipe materials may have been used to stub out of manholes. Concrete and mortar can also conceal pipe size and type. Other than televising, the only way to identify the type of pipe in the segment is to physically inspect it. At times, physical inspections yield unexpected results, such as when a creek or storm sewer cross connection has ground water flowing that can be heard when **lamping** the line. If the creek or storm drain always contains some flow, it might not be identified through smoke testing because the water blocks the path of the smoke.

Flow Isolation

Most I/I-related SSO problems are caused by inflow during and immediately after a rain event. Flow isolation, on the other hand, generally identifies infiltration. Because infiltration does not generally contribute a great deal to the SSO problem, both in terms of volume and timing, we seldom perform flow isolation tests except in areas where infiltration is a major problem. This practice is usually in the city's best interests, because infiltration leaks are much more costly to repair per volume of water removed from the system. They are also the leaks most prone to migration.

When performed, flow isolation should be conducted during a period of minimal diurnal flow. Plugs in the upstream section of the pipe must be checked frequently to ensure that water is not migrating in the area around the manhole and causing inaccurate results.

Analysis and Design Techniques

System Analysis and Flow Balancing

Flow balancing is a cornerstone of the comprehensive approach. Through good flow balancing, the designer can estimate a percentage of I/I removal and achieve the ultimate objectives: elimination of

overflows and a realistic reduction of I/I. Based on flow monitor data, flow balancing involves developing a balance sheet of flows entering the system, identified I/I from sources in the system, and flows leaving the system downstream. If the flow balance sheet does not balance, some water sources have not been identified and rehabilitation probably will fail. Inaccurate data can also cause the rehabilitation project to fail. The flow balancing process depends on realistic estimates of the I/I rate associated with each defect, detailed water usage data, and accurate identification and measurement of the flow in all pipes entering the system.

The impact of inaccurate or inadequate flow balancing is easily demonstrated. For example, if only 50 percent of the monitored I/I is identified, and it is cost-effective to remove only 50 percent of the identified I/I, the net reduction will be just 25 percent of the total I/I. While this is progress, it is generally insufficient to eliminate overflows, and the project will not accomplish the mission. If, after the SSES is performed, all the I/I cannot be attributed to identified sources, more field investigation must take place to find the sources.

To analyze overflow problems in a collection system, it is insufficient to use total volume from a specific storm event or annual I/I volume calculations to determine flow. Rainfall-induced SSOs are a rate-based problem, not a volumetric problem. Intensity is the key. Thus, the flow balancing and I/I data should be extrapolated from medium intensity storms that do not overload the system. If overflows occur, the flow balance equation will be inaccurate.

Hydraulic Modeling

A hydraulic model is an integral tool for detailed flow balancing. The model allows subportions of a basin to be examined, and it readily identifies specific line segments that have inadequate capacity. A good model can make allowances for real world diversity, must contain all the information from the SSES, and must be updated to prevent future problems. The model should be incorporated into the city's development process, analyzing flows from new construction. Only through such systemwide analysis will we prevent an overflow problem from becoming cyclic (overflows → containment → growth → overflows).

Permanent flow monitoring is integral to maintaining an up-to-date model to accurately account for new flows, both I/I- and growth-related. The hydraulic model should also have the flexibility to model flows for a variety of design storms, with the models being validated as these storms occur.

Rehabilitation Construction Method Selection

Once SSES field work is complete, the flows balance, and a cost-effectiveness analysis is performed for repairs, it is time to address the actual rehabilitation construction. The system is analyzed on a manhole-by-manhole and segment-by-segment basis. While this sounds very time consuming, the model and SSES database make it relatively straightforward. Because the cost-effectiveness analysis identifies all leaks that are cost-effective to repair, the analysis becomes a matter of placing the identified leaks on the line segment and determining what method of repair is most appropriate based on ground conditions. After identifying the most cost-effective repair for one segment, it is useful to look at the adjacent segments-if these are also being repaired, the sum of the repairs might make a different technique more cost-effective. Addressing the repairs first one at a time and then slowly expanding the view will reveal the most cost-effective repair strategy.

Designing To Control Migration

Ground-water or inflow migration is one of the most controversial issues facing sewer rehabilitation designers. Many feel rehabilitation is ineffective because when one leak is fixed, the water simply migrates to the next hole in the system. Fayetteville's experience shows that this is not always the

case-that it is possible to design to control migration. To control migration, we use three strategies: we fix leaks close to major I/I sources and structural defects, we ensure that services are repaired along with the main, and we install clay dams.

Sealing leaks close to I/I sources and structural defects slows water flow, minimizing migration. When slip-lining or using a trenchless technique such as cured-in-place piping, sealing leaks involves ensuring that the laterals are watertight and any annular spaces are sealed with grout. Although trenchless contractors prefer not to, this often means digging up and externally reinstating lateral taps, as well as replacing as much of the lateral as necessary to keep the water that follows the trench from entering the main. In Fayetteville, we usually replace to the property line.

Installing underground clay dams is also effective in controlling migration-so much so that some residents have reported water leaks where a clay dam was installed. At four sites, we had to install supplemental ground-water drainage systems to carry the water that had previously entered the sewer through pipe defects. Clay dams have successfully controlled migration around point repairs, near creek and ditch crossings, on slopes, at the junction of new pipes and existing systems, and in many other applications. They have worked so well that we now incorporate clay dams into new construction performed by city crews, and we are considering making it mandatory at specific sites for *all* new sewer construction.

Construction

Techniques

When considering construction options, a major lesson we learned is to match the repair with the problem. Some espouse rehabilitating the entire system with cured-in-place pipe or other trenchless technologies, others claim that all manholes should be replaced, and still others advocate replacing all pipes. Even more question whether rehabilitation works at all; they recommend transporting and treating *all* water, including I/I. Unfortunately, few cities can afford these efforts. Often, less than 5 percent of a city's system could be rehabilitated, if these approaches were used with existing budgets. Moreover, most of these approaches (except the transport and treat method), might fail to eliminate important overflows, resulting in the removal of very little of the I/I.

Reliance on short-term repairs is a pitfall to avoid. Although short-term repairs produce quick results, they are not cost-effective in the long run, and they reduce confidence in the overall I/I removal process. Other pitfalls include using one repair technique for the entire system and replacing entire pipe segments. In many cases, a small point repair combined with some type of migration mitigation measure is all that is required to eliminate or significantly reduce the I/I at the point. In some cases, only one part of a manhole is defective, while the rest of it is sound. The Wilson Park project, which was very successful in removing I/I, involved:

- Installing approximately 4,000 linear feet of **upsized** replacement sewer.
- Replacing 10,265 linear feet of same-size sewer.
- Lining 2,500 linear feet of pipe.
- Replacing 205 manhole frames and covers.
- Replacing 200 vertical feet of manhole frame and grade adjustments,
- Sealing 210 manhole frame and grade adjustments.
- Sealing 180 manhole walls.
- Performing 25 point repairs.

This took place in an area containing 69,000 linear feet of pipe.

Testing and Inspection

Construction testing and inspection have been vital components of our rehabilitation program. Full-time inspection is essential to ensure that the rehabilitation will meet its I/I removal objective. Inspection must be coupled with rigorous testing of *all* aspects of the construction. Table 3 summarizes the testing techniques we employ. Using tests appropriate for the repairs, so that test conditions match natural conditions as much as possible, is important. Testing must occur during the construction process, and it must be validated by a neutral observer (e.g., a resident engineer or construction observer).

Table 3. Testing Techniques by Type of Defect

System Defect	Rehabilitation Method	Testing Technique
Manhole cover holes	Replace cover	SF
Defective manhole frame and seal	Reseat frame to corbel	SF
Defective manhole structure	Replace, grout, or seal	SF, DI, VT
Defective sewer pipe	Replace or line	TV-DWF, AT, WT, M
Leaking joints	Replace or grout	TV-DWF, AT, WT, M
Leaking laterals	Replace or grout	TV-DWF, AT, WT, M
Direct stormwater connection	Remove and reroute	TV-DWF

Key:

SF	=	Surface flooding of manhole
DI	=	Dye injection
TV-DWF	=	Television inspection with dyed water flooding
AT	=	Air testing
WT	=	Weir testing
VT	=	Vacuum testing
M	=	Mandrel

Postconstruction

In the postconstruction period, several efforts are very important to maximize the benefit and validate the results of the work performed. Postrehabilitation flow monitoring validates the work and provides guidance and justification for future work. It also permits updating of the model and improved projections of downstream flows. **Followup** testing at 1-, 2-, and even 5-year intervals permits further validation of the construction methods used and facilitates identification of techniques that are effective in the long-term.

Conclusion

Using the comprehensive approach to overflow elimination and I/I reduction can produce excellent, cost-effective results. Significant attention to detail is necessary throughout entire process to avoid pitfalls that will render the entire process unsuccessful. Focusing on I/I sources and overflows and analyzing the system's flow balance sheet allows the designer to develop a cost-effective, predictable rehabilitation strategy. The bottom line is that inflow and infiltration can be significantly reduced, and overflows *can* be eliminated under normal conditions.

Prioritizing Sanitary Sewer Overflows Based on System Impacts and Water Quality

Timothy W. Kraus and Gordon R. Garner
Louisville & Jefferson County Metropolitan Sewer District, Louisville, Kentucky

Introduction

Like most agencies, the Louisville and Jefferson County Metropolitan Sewer District (MSD) in Kentucky is currently dealing with the overwhelming problem of controlling sanitary sewer overflows (SSOs) due to excessive wet weather flow. MSD created a priority listing of those separate sanitary sewer areas that experience excessive wet weather flows and/or SSOs. (Combined sewer overflow [CSO] issues are being addressed by MSD using a different basis.) This paper discusses the issues surrounding SSOs, as well as the steps taken by MSD to develop an SSO priority list.

Background

MSD is a quasi-governmental agency responsible for both storm and sanitary sewer service in most of Jefferson County, Kentucky. The MSD sanitary sewer service area covers approximately 250 square miles and is expanding. Service is provided to more than 400,000 people. Most of the collected wastewater goes to one of four major treatment plants. In addition to these four major plants, approximately 52 other plants exist with individual capacity greater than 2,000 gallons per day.

As part of an aggressive program, MSD has been acquiring small, privately owned treatment plants with the goal of closing them and integrating them into a regional system. At this writing MSD has acquired over 106 small plants and has closed 40 of them. With each small package plant and tributary sewer system, MSD also acquires additional wet weather problems.

History of Wet Weather Issues

Many of the acquired sewage collection, transportation, and treatment facilities were poorly constructed, operated, and maintained prior to MSD ownership. Approximately 82 sanitary sewer collection systems in the MSD service area, most of which were acquired, exhibit problems during rainfall events. Unlike CSOs, hydraulic capacity in the separate sanitary sewers can be restricted quickly for a number of reasons, and the resulting SSO can occur in hundreds of locations throughout the system.

MSD established a stream monitoring program with the cooperation of the U.S. Geological Survey (USGS) in 1988. Although this level of stream monitoring is not directly correlated with specific SSO events, it does provide substantial evidence of water quality impacts from wastewater discharges (e.g., septic tanks, waste water treatment plants, SSOs, and CSOs). Stream monitoring has revealed high levels of fecal coliform, but many sources are known to contribute to stream pollution in an urban environment. SSO abatement programs should be implemented concurrently with urban watershed assessments and prioritized with other water quality problems, such as CSO discharges, septic tank effluents, and stormwater runoff.

MSD is addressing the CSO issue through the requirements of the National Pollutant Discharge Elimination System (NPDES) permit program administered by the Kentucky Division of Water (KDOW). The Kentucky Pollutant Discharge Elimination System (KPDES) permit for MSD's largest treatment facility lists and identifies the location of CSOs. In addition, procedural guidance for wastewater release reporting has been developed in accordance with an Agreed Order between MSD and the state. MSD also has a demonstration grant from the U.S. Environmental Protection Agency (EPA) to address the

causes and effects of separate **SSOs**. MSD intends to get ahead of permit compliance requirements. An SSO abatement program has been initiated not only to assist with national policy but also establish a precedent for the state.

Why Create a Priority List?

In 1993, KDOW issued MSD an Agreed Order to create a priority list of those areas of the separate sewer system to be addressed with regard to infiltration and inflow (I/I). This request was part of a larger Agreed Order that also dealt with SSO reporting issues. The priority list allows MSD to address wet weather issues proactively by creating a planning tool instead of using an informal trial and error approach, such as was used in the past. Moreover, the priority list allows remedial actions to be implemented as part of a watershed management approach. Finally, it allows all of MSD to be involved in the process, which produced across-the-board ownership of the problem and enabled the compilation of the quality data existing within the district; up to 80 percent of the necessary information existed within MSD.

Preparation of Prioritization Matrix

The first step in preparing the priority list was to identify MSD staff who were most knowledgeable about the sanitary sewer system. Everyone was asked to participate, but a leader was assigned for each group to expedite the process.

The MSD groups included in the I/I priority list development process were:

- Maintenance Division
- Operations Division
- Engineering Division
- Customer Service
- Community Relations
- Mapping (GIS)
- Legal Division

The next step was to hold a kickoff meeting with the group leaders to review the priority list's intent and development process. The meeting also encouraged suggestions before the next step began.

The kickoff meeting yielded a list of 25 questions used to obtain information from the groups, information that laid the groundwork for the data collection. Some of these questions were:

- What are specific issues that concern your department during periods of wet weather?
- How does your department respond to wet weather problems?
- What equipment does your department have for monitoring wet weather problems?
- Does anyone in your department collect, compile, or maintain flow, rain, or stream monitoring data?

- What is the most frequent problem that you have to deal with during a major rainfall event?
- What policies exist (or are needed) for dealing with wet weather issues?

Interviews were then held conducted with each group. At least four people from each MSD department were encouraged to participate in the interview, which was held on a group's "home turf" for access to data and for comfort. To create an accurate priority list, each participant was asked share as much information as possible. Answers were compiled, then redistributed to interview participants. Sharing this information provided better understanding within the groups and identified issues that each group needed to resolve to help address wet weather issues.

The next step in developing the I/I priority list was to identify specific wet weather problems within each area sewer system and create a facilities matrix. The matrix was set up in table format, with the name of the facility in the first column and associated data in the adjacent columns. Among the 20 categories of data gathered were:

- Location.
- Any known I/I sources.
- Available data (e.g., Sewer System Evaluation Surveys, television inspection, flow monitoring).
- Any improvements planned within the system.

Filling in the data was an iterative process and required many exchanges with the groups. Of all the steps, this one was the most challenging.

To prioritize the areas listed, a set of weighting factors was created. These factors included:

- Areas with basement flooding.
- Areas with known SSOs.
- Areas requiring bypass pumping to avoid basement flooding.
- Pump stations with recurring high-level alarms.
- Excessive wastewater treatment plant (WWTP) odors occurring during startup after excessive wet weather flows.

As the final step in creating the matrix, group leaders participated in a workshop designed to reach an agreement on prioritizing the weighting factors. A nominal group technique was used for this workshop to enable an open format, with each participant having an equal vote. Priorities were set in the following order:

1. Basement backups
2. Wastewater releases to the environment
3. Odor problems at treatment facilities
4. High-level alarms at pump stations

5. Reduced development capacity
6. Additional operations and maintenance (O&M) costs

Table 1 shows a sample of the listing.

Weighting the factors to create a priority list was not simple. If used for a general purpose, the priority list is valid, but not for specific planning or budgeting. Issues that were not accounted for but need to be considered when determining the quickness of control efforts are volume of overflow released to the environment, severity of basement flooding within the service area, the condition of the receiving stream, and potential solutions to an area.

As well as continually quantifying and evaluating values of weighting factors, the list must always remain dynamic. Information uncovered each day might affect the list. Regulatory and political pressures change, shifting priorities, and budget constraints change, affecting control efforts.

Implementation

The MSD priority list has been finalized and will be used for several wet weather remediation actions, the first of which was submittal of the list to the MSD board for acceptance. The priority list was also submitted to the state as part of the Agreed Order with KDOW. Finally, the list will be used as a tool for budgeting and managing a proactive program addressing wet weather issues.

Summary

SSOs are usually not specifically listed or located and are very difficult to monitor or report, making it difficult for MSD and regulatory agencies to assess their significance or environmental impact. Procedural guidance for wastewater release reporting has now been developed in accordance with an Agreed Order between MSD and KDOW. MSD has also implemented a systematic approach to monitor and report **SSOs** and specific characteristics of the wastewater release event.

Even without a substantial amount of field data, in most **SSO** events the water quality impact from the wastewater releases is apparently less significant than the impact of other types of stream pollutant sources. Results of the MSD and USGS stream sampling program indicate water quality impairment from **CSOs**, **SSOs**, septic tank effluent, stormwater runoff, and other sources.

From a watershed approach, the overall impact of **SSOs** may not be readily discernible. Dry weather **SSOs**, however, can have an immediate impact on water quality or public health and should be reported and corrected immediately. Some wet weather **SSOs**, usually those with a high occurrence frequency or large discharge volume, can also have significant impacts and should be abated. In each situation, operators of publicly owned treatment works should assess impacts of wastewater releases from **SSOs** while considering other stream pollutant loadings in the watershed. All wet weather problem categories should be identified and prioritized for remediation programs.

Table 1. Sample Priority Listing, Wet Weather Reduction Program For Sanitary Sewers, Louisville and Jefferson County Metropolitan Sewer District

Priority Area	Separate/Sanitary Area and/or Facility	Symptoms										Sewer Improv. Status					Acquired System
		Base-ment Backup	Potential for Environ. Release	PS High-Level Alarms	Surface Flooding	WWTP Odor	Reduced Develop. Capacity	Add'l O&M/Treat. Cost	Pumping	Known MI	Service Area Growth	Planned Improv. Within 5 Years	Sewer Improv. Status	TVI Data	MI Study	STP/PS Flow-meter	
1	Jeffersontown STP	N	Y	Y	Y	Y	N	Y	N	Y	Y	D	YP	Y	Y	N	Y
2	Newmarket PS/Northfield	N	Y	Y	N	N	Y	Y	Y	Y	Y		N		N	N	N
3	Santa Paula	Y	Y	N	Y	N	N	Y	N	Y	Y		Y		N	Y	Y
4	The Pines STP	N	Y	Y	Y	Y	Y	Y	Y	Y	Y	D	Y		Y	N	Y
5	Beechwood Villages	Y	Y	N	Y	N	Y	Y	Y	Y	Y		Y	Y	N	Y	Y
6	Woodland Hills PS	N	Y	Y	N	N	Y	Y	Y	Y	Y	P	Y	Y	N	Y	Y
7	Old Maple Grove STP	N	Y	N	N	Y	N	Y	N	Y	Y	D	Y		Y	N	Y
8	Bon Air Area	Y	Y	N	N	N	Y	Y	Y	Y	Y		YP		N	N	N
9	Spring Lake Farms PS	N	Y	Y	N	N	Y	Y	Y	Y	Y		Y		N	N	Y
10	Camp Taylor	Y	Y	N	Y	N	Y	Y	Y	Y	Y		YP		N	N	N
11	Treasure Island W. Area	Y	Y	Y	N	Y	Y	Y	Y	Y	Y	C	Y		Y	Y	Y
12	Apple Valley STP	N	Y	Y	N	Y	Y	Y	Y	Y	Y	D			Y		Y
13	Silver Heights STP	N	Y	Y	N	Y	Y	Y	Y	Y	Y				Y		Y
14	Sungold Service Area	Y	N	Y	N	Y	Y	Y	Y	Y	Y	C	Y		Y	N	Y
15	York Town STP	N	Y	Y	N	Y	Y	Y	Y	Y	Y		Y		Y	Y	Y
16	Fern Hill STP	N	Y	Y	Y	Y	Y	Y	Y	Y	Y		YP		Y	N	Y
17	Hite Creek STP	N	N	N	N	N	N	N	N	N	N		YP		Y	N	N
18	Cross Creek STP	N	Y	Y	N	Y	Y	Y	Y	Y	Y	P	YP		Y	N	Y
19	Cedar Lake Park STP	N	Y	Y	Y	Y	Y	Y	Y	Y	Y	C	YP		Y	N	Y
20	Fordhaven STP	Y	N	Y	Y	Y	N	Y	Y	Y	Y	D	YP		Y	N	Y

Key:
C = construction.
D = design.
P = planning.
PS = pump station.
STP = sewage treatment plant.
TVI = television inspection.
YP = a portion of the system.

Ohio and Sanitary Sewer Overflows: Enforcement, Data Needs, and Implementation

Rob Frutchey
Montgomery Watson, Cincinnati, Ohio

David Crouch
City of Fairfield, Fairfield, Ohio

Gary Stuhlfauth
Ohio Environmental Protection Agency, Columbus, Ohio

Reynold Gerson
City of Toledo, Toledo, Ohio

Chris Hauser
FPS, Toledo, Ohio

This paper is presented on behalf of the Ohio Water Environment Association Sanitary Sewer Overflow (SSO) Subcommittee. The paper focuses on a policy's enforcement, data needs, and implementation.

Enforcement

During Ohio's National Municipal Policy Initiative, elimination of **SSOs** was enforced in over 200 municipalities, which invested heavily in capital improvements to comply with this enforcement. The Ohio Environmental Protection Agency is now taking action in some 20 other municipalities with **SSOs**. To do so, the Ohio Environmental Protection Agency must find the appropriate enforcement action. The SSO Subcommittee has discussed a certain level of amnesty for municipalities to encourage achieving SSO goals, as well as both flexible and formal schedule methodologies. The Ohio Environmental Protection Agency has a firm philosophy to eliminate **SSOs** completely, however, stating that enforcement provides the motivation for collection system improvements. Too often, municipalities perform infiltration and inflow (I/I) studies and Sewer System Evaluation Surveys (**SSEs**), identify problems, and propose remedies, but then improvements are not performed. This may be due in part to a lack of enforcement. In essence, the subcommittee believes that the enforcement issue is of significant importance. Discussion aimed at developing an SSO policy should consider the historical enforcement actions, as well as the approach for enforcing such an envisioned policy.

Information Collection

Data on **SSOs** is sparse. Databases containing SSO information are not maintained in Ohio. Moreover, varying opinions exist regarding the severity of **SSOs** in the state of Ohio. In essence, there is no factual understanding of the number and effect of SSO discharges.

Most recently, SSO panel discussions were held at Ohio Water Environment Association section meetings. Panel members included representatives of both municipalities with **SSOs** and the Ohio Environmental Protection Agency. Audiences at the section meetings were interested in the SSO topic; however, the audiences generally did not participate in the discussion, which was attributed to a general reluctance to discuss the SSO issue.

Gathering data on **SSOs** is paramount and should include an efficient way to report information and ascertain the effect of **SSOs** on the receiving streams. Procedures and protocols for inspecting, monitoring, and reporting SSO impacts should be considered.

A step-by-step procedure for data gathering should, for example:

- Establish methods to identify the location and type of SSO.
- Establish methods to determine the activity of the SSO (without continuous monitoring).
- Establish methods for reporting on SSO activity.
- Provide a long-term and a short-term plan to eliminate SSO discharges.
- Include periodic monitoring of SSO flows and receiving stream impacts subsequent to approval of the plans.

The National Pollutant Discharge Elimination System (NPDES) permit may be an important vehicle to develop the reporting requirements for **SSOs**. Clear and obvious permit language should be considered so that entities are completely aware of their responsibilities. Regulatory language should not be hidden in fine print within the permit. Also, entities may be more inclined to contribute information if they understand how it will be used.

Situations in which communities own sewers but send their wastewater to a treatment facility owned by another entity should also be considered. The communities without permits are not directly subject to any requirements.

How we become aware of SSO problems is also important. At this time, citizen complaints and Ohio Environmental Protection Agency inspections are primary avenues of detection. The policy dialogue should include ways to detect **SSOs**. Some of the existing mechanisms do not encourage the acknowledgment of SSO locations. While evidence exists regarding the potential environmental and public health detriments of **SSOs**, the extent of water quality problems associated with **SSOs** is not adequately documented.

Further, a comprehensive watershed approach should be considered. In other words, the impacts of such contributors as surface runoff, leachates, combined sewer overflows (**CSOs**), and stream modifications should also be assessed, and the relative impact of each contributing source determined. Also, the analysis should include a framework for cost-effective reduction (or elimination) of the sources. Although the watershed approach is a currently hot topic, the existing regulatory process does not allow easy implementation of watershed plans. Overlapping entities and agencies are often one of the most difficult barriers to proceeding with the watershed approach. The policy dialogue should include discussions on effective ways to foster coordination and cooperation among such entities.

Biological measurements should be considered in addition to water quality measurements. Biological monitoring can be a tool to determine both the effect of **SSOs** and compliance with quality goals.

Implementation

Part of the policy dialogue should identify design criteria for SSO elimination or reduction. Ohio often towards elimination of **SSOs**; however, total elimination is often technically and economically infeasible. Therefore, criteria such as design storms should be considered. For example, **SSOs** can be eliminated up to a certain recurrence interval, beyond which conditions will occur that cannot control overflows. Also, criteria such as **SSOs** that meet water-quality based effluent limits should be considered.

A phased approach, which entails both short- and long-term implementation, should also be discussed. Historical data should be closely reviewed as they relate to **SSOs**, I/I reduction, and collection system operation and maintenance. A great deal of data have been gathered over the last 20 years in these areas as a result of the construction grants program; these data could be used in the short-term implementation plan. For example, considerable information exists regarding effective SSES techniques, the type of sewer rehabilitation that is most conducive to I/I reduction, house lateral impacts, and effective ways to analyze sewer systems and I/I. We also have more effective ways to measure, analyze, and represent sewer systems and receiving streams through modeling analyses. Much of this information can be used to establish goals for short-term implementation. These same tools can then be used to measure the effectiveness of long- term programs or long-term goals.

Another important aspect of implementation is affordability and financing. In addition to understanding the cost/benefit of the proposed improvements, the overall program should be evaluated financially for a given entity. This evaluation should use the proper user rate structure to finance the required improvements. Also, the municipal users' ability to pay for the necessary improvements should be related to appropriate baseline measurements, such as median household incomes.

Addressing Community Concerns While Managing Sanitary Sewer Overflows in the Wayne County Downriver Collection and Treatment System

Mark J. TenBroek
Camp Dresser & McKee, Detroit, Michigan

Joe Goetz
Wayne County Department of the Environment, Detroit, Michigan

Larry A. Roesner
Camp Dresser & McKee, Maitland, Florida

Abstract

The downriver collection and treatment system, located in Wayne County, Michigan, serves 13 communities in the southern suburbs of Detroit, Michigan. The Wayne County Department of Public Services operates this system, while each tributary community system is responsible for its individual collection system. Most of the Wayne County collection system was constructed in the 1960s. About half of the collection systems predate this, with the remaining half constructed since that time.

For many years, the different community collection systems were known to contribute different amounts of wet weather inflow. To deal with wet weather flows that exceeded wastewater treatment plant (WWTP) capacity, separate sanitary flows were discharged through a combined system retention treatment facility located next to the WWTP. This facility provided minimal treatment prior to discharge to the Detroit River.

In the early 1990s, the Michigan Department of Natural Resources and the federal courts became involved in the National Pollutant Discharge Elimination System (NPDES) permit negotiation. To address the sanitary sewer overflow (SSO) problem, Wayne County prepared a comprehensive review of the system operation and investigated each community's contribution to wet weather inflow. A system project plan was prepared to eliminate the problems. Technical and political representatives of each of the 13 tributary communities met monthly to review project status, present interim work products, and address community comments. A second forum included the system policy committee, which included political representatives. This committee met periodically to learn about recent project progress.

This paper discusses the process of including the key stakeholders, reviews the technical and political benefits from this type of approach, and addresses the pitfalls that might occur in this process. This paper also describes the final system solutions selected to resolve SSOs resulting from wet weather inflow and infiltration (I/I) problems.

Introduction

The downriver collection and treatment system is located south of Detroit, Michigan, in Wayne County. The downriver area comprises 13 communities with over 300,000 residents served by a combination of separate sanitary and combined sewer systems. Prior to 1940, three of these communities—River Rouge, Ecorse, and Wyandotte—were significantly developed. These communities, shown in Figure 1, are adjacent to the Detroit River and were developed with combined sewers that discharged directly to the Detroit River without treatment.

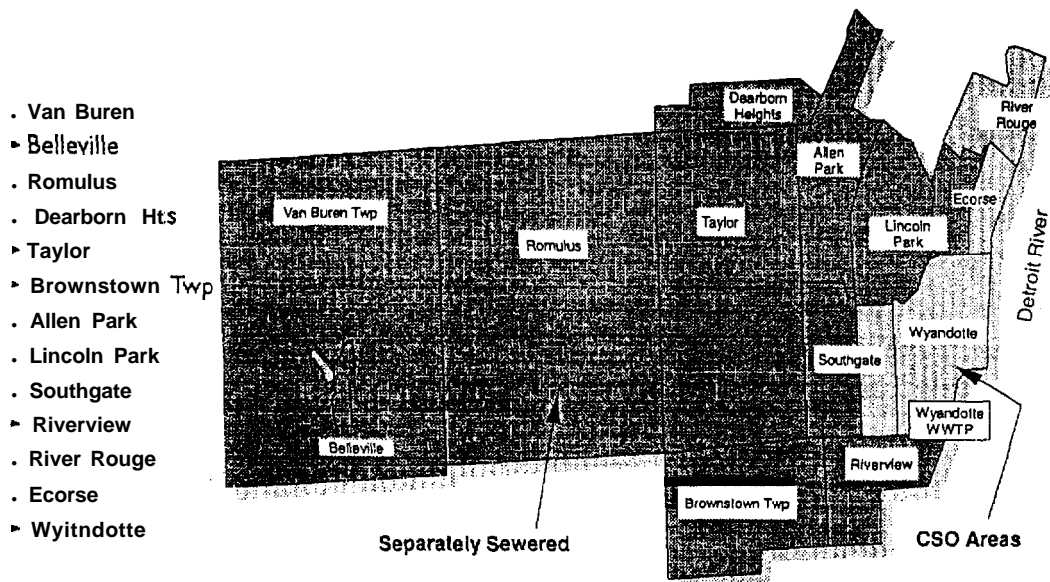

Figure 1. Wayne County downriver collection system.

In the late 1940s and 1950s, the tributary area expanded to the west and south as large portions of Lincoln Park, Allen Park, Dearborn Heights, Riverview, and Southgate were developed. While portions of the dry weather flows from these areas received primary treatment at community treatment works, the major improvements involved building pumping stations and large combined sewers to convey the storm flows to the receiving waters.

Major construction occurred in the 1960s, when the collection system was extended to the west to convey and treat flows from a number of western suburbs, as shown in Figure 1. Up to that time, these smaller, mostly rural communities were served by a combination of small combined systems, separated systems with small treatment plants, and septic fields. Expansion of the conveyance and treatment system allowed development of industry and housing throughout this area. Much development did take place during the 1960s and 1970s, although not to the density that was originally anticipated. All of this new development was built using “modern” sanitary sewers.

The Problem

In the late 1970s, the Community of Wyandotte and the combined portion of Southgate designed and built a combined sewer retention treatment basin near the Wyandotte WWTP and sent only dry weather flows and flows from dewatering their basin to the WWTP. The combined communities of Allen Park and Lincoln Park separated their combined sewers and installed sanitary equalization basins to manage their wet weather flows to the WWTP to peak rates allowed in the treatment contract.

After the collection system expanded in the 1960s and after development took place in the 1960s and 1970s, the collection and treatment system had more than adequate capacity to handle flows during dry weather conditions, just as designed. During wet weather, however, flows at the WWTP were much higher than anticipated. These capacity problems resulted in basement backups in some areas. Pumping stations and other structures were designed and built to deal with these problems.

During this time, the capacity of the WWTP was routinely exceeded several times each year. To manage these excess flows and to ensure that the WWTP pumping station was not inundated and flooded, the

excess flows were discharged to the receiving waters through a number of discharge locations, including the combined sewer overflow (CSO) retention treatment basin located in Wyandotte.

Because of this practice, the U.S. Environmental Protection Agency (EPA) and the Michigan Department of Natural Resources (MDNR) brought an enforcement action against Wayne County, the owner and operator of the Wyandotte WWTP, and the associated collection system in 1987. The other defendants in the case included the 13 units of government served by the Wyandotte WWTP, as well as the Southgate-Wyandotte CSO district.

This enforcement action alleged that the Wyandotte WWTP violated the provisions of its NPDES permit in the discharge of pollutants from the facility. Discharging sanitary sewage other than through the WWTP was illegal, because no treatment was being provided during these episodes. Wayne County, as the operator of the WWTP, was responsible for the overall NPDES permit to operate the treatment works and was therefore responsible for formulating an overall solution to the problem.

Because this case was brought before the federal courts, the judge in the matter decided to seek a technical solution promptly before any legal remedy was pursued. The federal judge therefore appointed a court monitor to review the problems and monitor the progress of the defendants in solving the problems surrounding these SSOs. The court monitor took several steps to quickly establish the cause of the problems, determine alternative solutions, and develop a design to eliminate the SSO problems.

Wayne County hired Camp Dresser & McKee to evaluate the systemwide problems and work with the court monitor and the technical committee to recommend solutions.

The Committee Approach

The 13 communities served by the downriver system, as well as Wayne County, became involved in two committees. The technical committee, consisting of the engineering representatives of each of the 13 communities, met monthly to review project work direction and products as presented by Wayne County and the consulting engineering staff, to coordinate individual community work with the project activities, and to keep each community's officials apprised of project status. A policy committee formed from interested downriver political and technical personnel, who met quarterly to present the project deliverables.

The court monitor and representatives of the MDNR also attended these committee meetings as active members to expedite the review of work products and to gain a better understanding of the project goals and objectives. This involvement allowed the regulatory agency to understand the complexity of the problems and the steps taken to understand and resolve the issues. The technical committee oversaw the technical conduct of the project, ensured that adequate progress was being made, and reported to their community political bodies. The court monitor and the parties involved in the lawsuit met periodically to review project status and to ensure an appropriate schedule.

Flow Monitoring

The interceptor collection system was constructed to convey flows from the 13 tributary communities to the Wyandotte WWTP. The interceptors were constructed to convey the expected average dry weather sanitary flows with a peaking factor of about 2.0, as was the practice at the time of construction. Several of these interceptor sewers passed through a number of communities as they conveyed flows to the WWTP. Many of the communities through which these interceptors passed had multiple connections-up to 90 in one community.

The objective of systemwide flow monitoring was to determine the amount of I/I that was generated within each community as a result of wet weather. The relative impact on the wet weather problem was

important because each community had a specific peak flow contractual rate that it could contribute to the collection system. Because many of these communities exceeded these rates, each community was to pay for the solution to the problem based on its relative contribution to the problem. Therefore, the flow monitoring would have a major impact on the cost apportionment.

To obtain the relative contribution from each community, the incremental flow increases from each community were needed. Flow monitors were installed at the boundary of each community to estimate these flow differences. The meter locations are shown in Figure 2. The flow metering program reviewed the effect of high ground water that occurred during the fall rainy season in 1990.

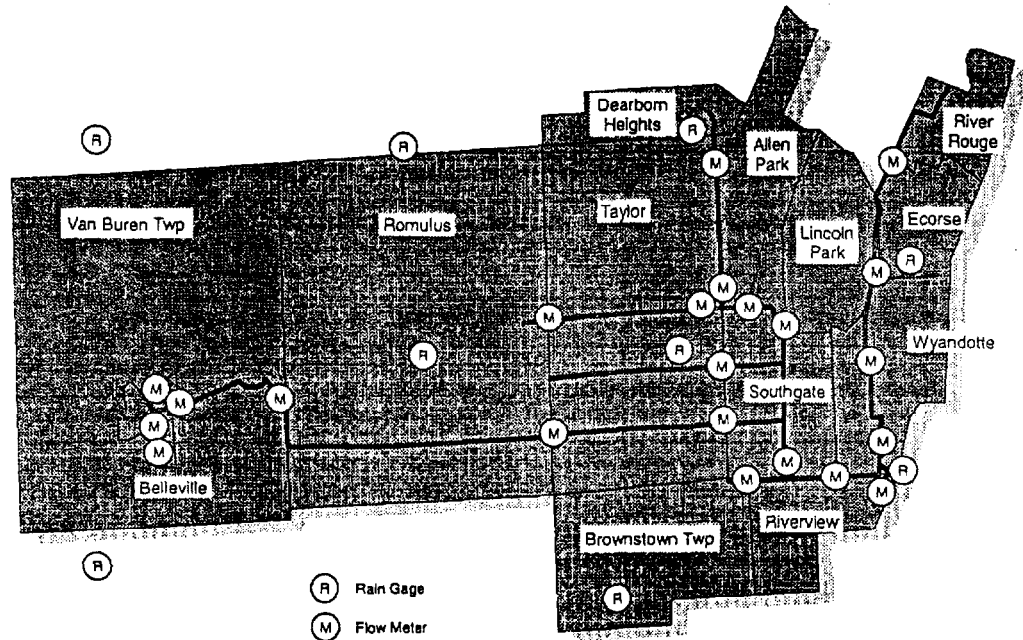

Figure 2. Flow metering program.

Most of the tributary communities also undertook a concurrent flow monitoring program to determine the areas that were sources of the greatest wet weather impacts. These overall flow monitoring programs were also used to correlate local estimates with systemwide average wet weather impacts. In general, the correlation between these two sets of flow monitors was good.

The hydrographs generated at each of the meter locations were carefully reviewed. Both peak flows and total wet weather volumes were estimated for each segment of interceptor, and the estimates were compiled for eight different storm events. The rainfall fraction—the amount of rainfall that entered the collection system—was estimated for each interceptor segment and for each of these rainfall events. Figure 3 is an example of one of these hydrographs.

Estimates of peak flow and the rainfall fraction were plotted for each of the storm events. These curves allowed estimation of the wet weather response of the system at each of the locations throughout the collection system. The curves generally had an envelope shape that reached a peak value used for predicting the behavior of the collection system under large design storm events.

In general, communities that had been developed as combined systems and had then been separated had rainfall fractions ranging from 11 to 18 percent. These high rates were largely due to relatively large, older sewers and to the remaining stormwater connections that had not been eliminated during the separation process. Areas developed in the 1950s and 1960s as sanitary systems also had rainfall

fractions as high as 18 percent but were generally in the range of 10 to 15 percent. Most of the wet weather I/I problems in these areas resulted from deteriorating sewer pipes and leaks in manholes, as well as footing drain problems.

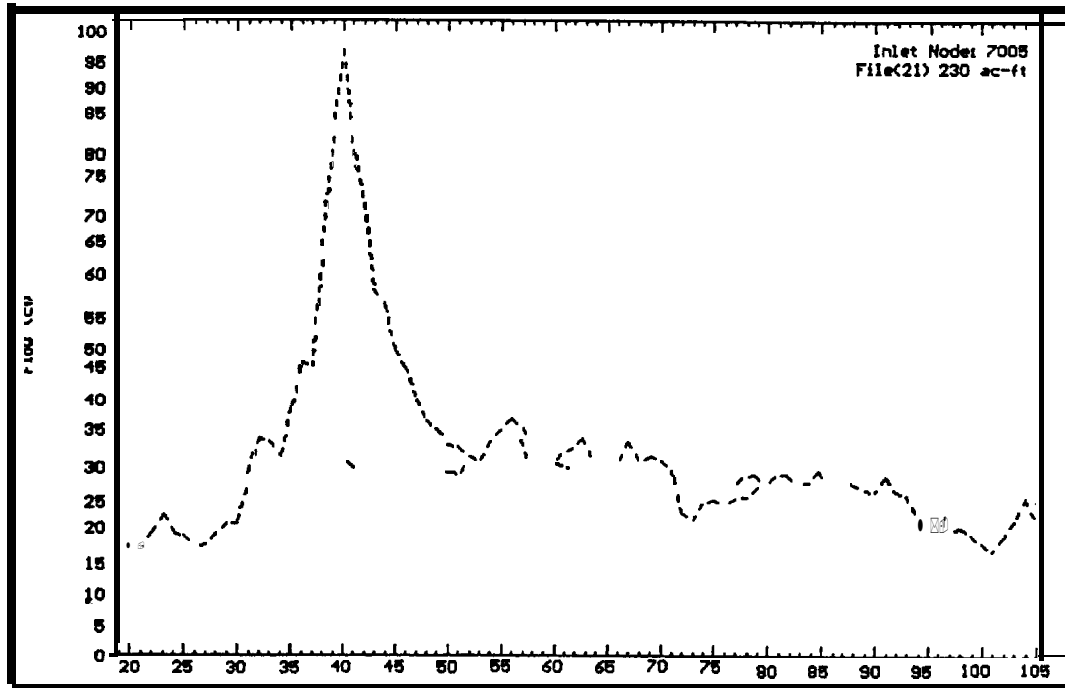

Figure 3. Characteristic inflow hydrograph.

In many of the newer areas, constructed since the 1970s when footing drains were no longer connected to the sanitary collection system, rainfall fractions were generally below 5 percent. These lower rates were also the result of the better materials and construction methods used during that period.

The Predictive Model

Flow monitor analysis placed estimates of inflows throughout the collection system. To estimate the impacts of these inflow sources on the collection system and on the WWTP, a predictive hydraulic model was prepared. This model was based on the EXTRAN stormwater management model. The model layout is shown in Figure 4.

The inflow hydrographs were generated using the “characteristic shape” method. To determine a characteristic shape, response hydrographs from each incremental area were plotted on a unit basis (flow per acre) for a number of events. The general inflow shape was determined throughout the collection system. This analysis showed that, in the upstream areas, the shape of the inflow hydrographs was usually well behaved and consistently shaped. As the hydrographs were examined downstream, they tended to be flatter in shape, which was attributed to the attenuation in the system because of pipe storage and as a result of increasing backwater present in the system in those locations.

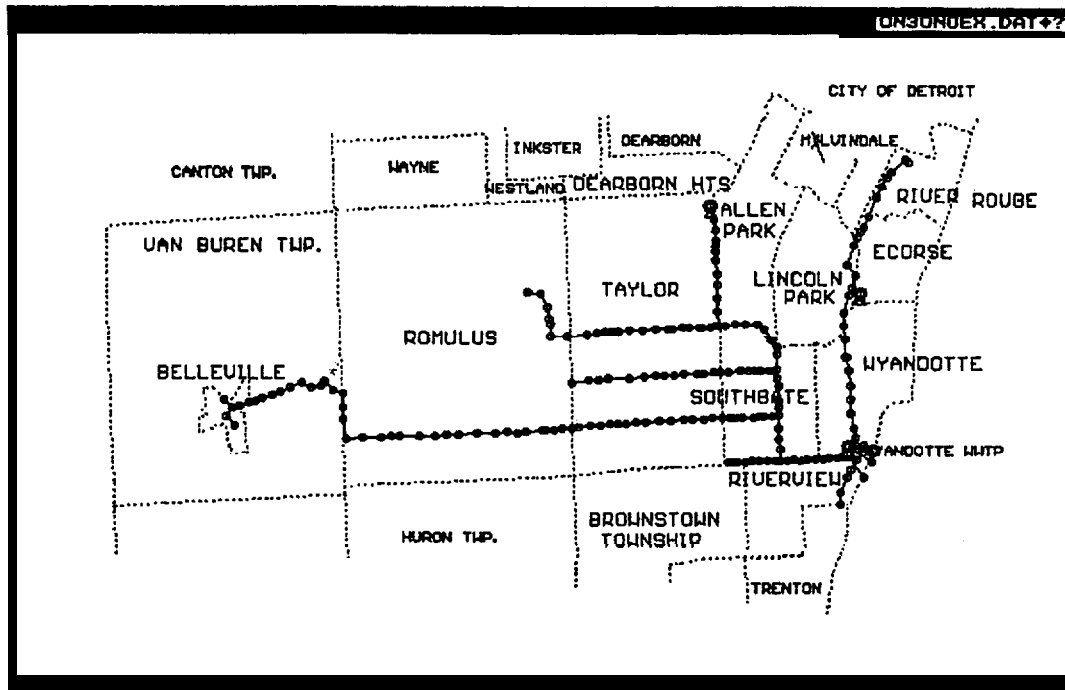

Figure 4. Sewer system model layout.

The “characteristic shape” from the upstream areas was used throughout the collection system, first to prepare hydrographs throughout the collection system and to allow calibration under a number of events. Figure 5 is an example of an inflow hydrograph used for calibration. Most of the flow monitors showed similarly good correlation between modeled and measured data. The model was used later in the project to evaluate the different alternative solutions.

The Sewer System Evaluation Survey

A first step in correcting the wet weather problem was to estimate how I/I could be eliminated cost effectively. A Sewer System Evaluation Survey (SSES) did so by identifying any defects in the manholes and covers, and in and along the pipe joints. Because of high ground-water levels throughout most of the collection system tributary area, defects in the manholes could be a major source of the I/I problems that could be rehabilitated.

SSES inspections were performed on each and every manhole in the Wayne County interceptor collection system. In addition, most of the communities prepared SSES inspections in those parts of their systems identified as being significant sources of I/I and therefore as locations where the most cost-effective I/I removal work could be performed.

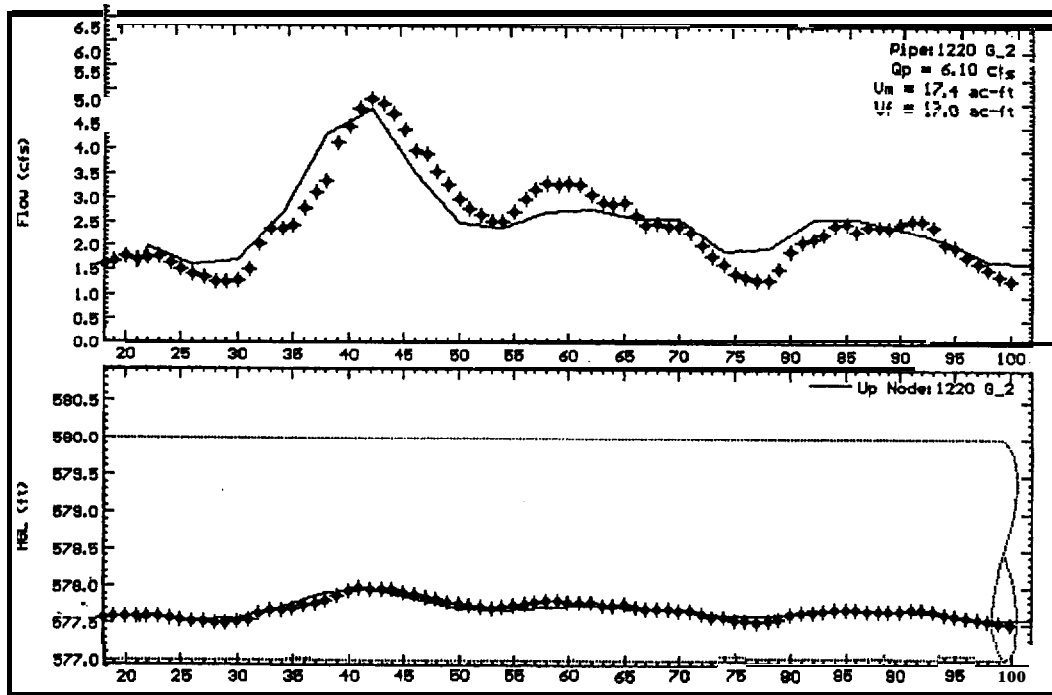

Figure 5. Model calibration.

In many of these communities, foundation footing drains have long been recognized as a major source of wet weather inflows. Flow monitoring in several locations throughout the area have shown that footing drains contribute between 30 percent and 50 percent of the wet weather inflows. Because these drains are such an important source of I/I, one downriver community developed a pilot program to evaluate the cost effectiveness of removing these sources completely. Their pilot area selected about 40 homes where the footing drains and sanitary sewer connections were connected in a T near the front foundation wall. In this area, a new sanitary sewer was installed and a secondary sanitary lead connected at the basement wall to convey only the sanitary sewage, as shown in Figure 6. The existing foundation footing drains were conveyed the existing sanitary sewer system, which had been converted to use as storm drainage only so that it could be discharged without treatment.

Unfortunately, this program met with a great deal of local resistance because of the disruption that construction caused. Although the pilot program demonstrated that these footing drain connections could be removed and a large amount of the wet weather flows eliminated, the prospect of continuing public relations problems and the potential for cross connections resulted in this alternative being eliminated from further consideration.

This community SSES work resulted in cost estimates for expected removal throughout the collection system. In general, it was expected that removal rates would be cost-effectively reduced by up to 15 percent, while most communities found that reductions of 5 to 10 percent were cost effective. One community prepared an aggressive I/I reduction program that included replacement or lining of all sewers in its collection system. Although the planned improvements would not remove the footing drain inflows, the designer anticipated that this set of improvements would reduce the I/I sources by 36 percent. Verification of these consult estimates will be prepared in a later project.

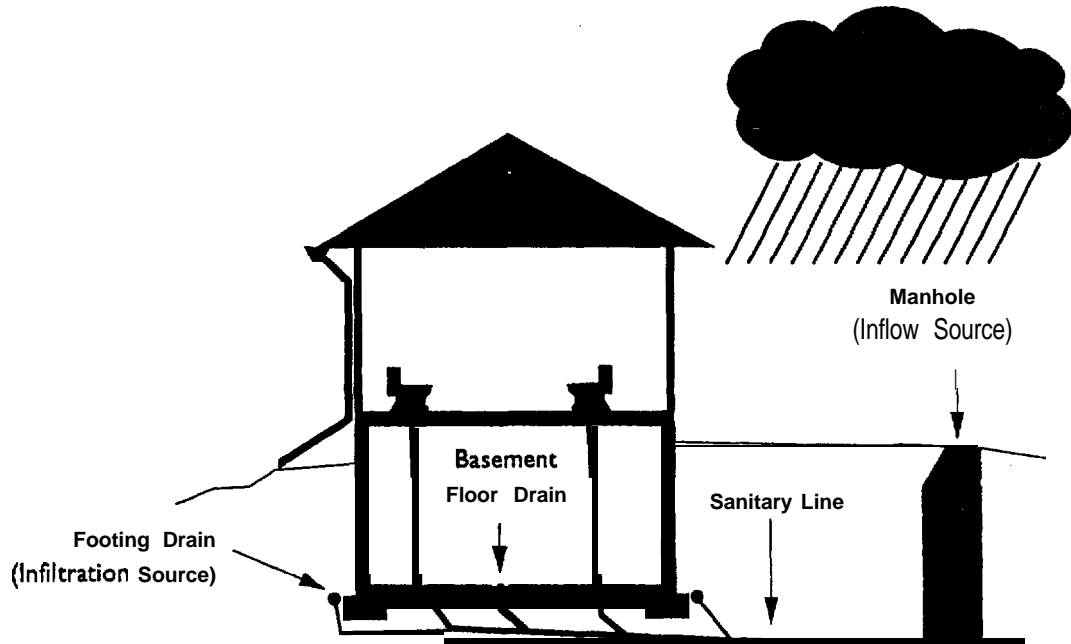

Figure 6. Footing drain and other I/I sources.

The Project Plan

Four basic alternative solutions were developed to manage wet weather flows:

- Relief sewers and increased WWTP capacity
- Community surface equalization storage
- Regional surface equalization storage
- Storage and transport in a single-tunnel facility

These alternatives were evaluated based on managing design storms, which were developed based on discussions with the MDNR. For the relief sewer and local storage alternatives, a 25-year point volume of 3.7 inches was used to calculate pipe capacity and volume requirements because each of these facilities must locally handle the storm to be successful in reducing SSOs.

For the regional surface storage, an area-reduced 25-year volume of 3.48 inches was used to calculate volume requirements because regional storage can be used for management of storms that cover much larger areas. The storage and transport alternative was required to store flows from a 3.0-inch design storm. This relaxed volume requirement was allowed because this facility was also required to convey all flows from a 100-year storm to the WWTP, where these flows would be provided with at least minimal treatment at the WWTP before discharge.

The cost-effectiveness of these systemwide alternatives was based on the initial capital and the present value of the lifecycle costs of the alternatives. These costs, which include a number of capacity improvements at the Wyandotte WWTP, are shown in Table 1.

Table 1. Cost Comparison of Alternative Solutions

Option	Capital Cost (\$ million)	Lifecycle Present Value (\$ million)
Relief sewer option	266	189
Community storage	209	197
Regional storage	144	126
Tunnel storage	172	105

The final plan also included the costs of the local improvements to remove I/I from these systems. The final sizing of the systemwide facility included these estimated reductions in I/I volume. The selected alternative called for a tunnel storage facility that would include approximately 10.5 miles of tunnel, ranging from 6.5 to 18.5 feet in diameter. The capital cost of these facilities would be almost \$172 million, with a lifecycle present worth of about \$105 million.

The rehabilitation of the individual community collection systems nears completion. The system is to be remonitored in 1995 to evaluate the effectiveness of the community rehabilitation programs. This work is critical, because the sharing of these systemwide costs is based on the wet weather contribution from each community.

Expansion of the WWTP is based on the contractual peak flow that each community currently "owns" at the WWTP, while the allocation of cost for the collection system would be based on the actual contribution of wet weather flows that exceed their contractual flows. The actual removal rates from the 1995 flow monitoring would be used in preparing the final cost allocations to each of the communities. The estimate of these removals and the allocation of these values are critical to final sizing and cost-sharing between each of these communities.

The Advantages of Information Sharing

This work has aimed to be fair and equitable to each community. The political and technical representatives naturally are skeptical of removal rates and cost estimates presented by the different consultants. A key function of the technical committee has been to break down these barriers of district. This forum also provided the opportunity to ensure that common methodologies have been used in the measurement of the I/I contributions and in the estimates of cost and cost effectiveness. The monthly technical meetings have fostered a common goal and purpose between these representatives.

The political committee has provided the opportunity to present the preliminary and final findings to the political entities so that there have been fewer surprises than during a normal project. These representatives have also been able to discuss strategies for payment and public participation. Together, these two committees have consumed a great deal of time and effort but have provided numerous benefits.

While political differences have continued to appear, as was expected, the technical differences have in large part been reduced to manageable levels as a result of the sharing of information and partnering on developing the approach to the problems. The federal courts and the MDNR, by participating in these meetings, have allowed the approval process to **move** quickly.

The Pitfalls of information Sharing

In conclusion, the involvement of the local technical and political entities almost always has a positive outcome. This project has benefitted in many significant ways as a result of the increased involvement

between Wayne County, the regulatory agencies, and the technical and political representatives of the tributary communities. Certain elements of this process, however, must be handled carefully:

- *Too much information:* In general, the technical committee dealt with a wide range of complex and often confusing technical issues. Although these issues were appropriate for discussions between engineers, this information needed to be clarified for the political entities.
- **Changing information:** Technical problems are necessarily evolving processes. As a result, the project issues were changed, revised, and updated a number of times during the course of the project, creating a source of confusion and consternation to the political entities. The information needed to be reduced into a final (or near final) format.
- **Bad news:** Bad news is always difficult to break, especially when large costs are involved. The political entities were willing to address the issues once they understood them, but changes, especially increasing costs, were particularly exasperating. Limiting the frequency of bad news is important.

Sharing technical information throughout the project proved valuable in arriving at a fairer and better solution to the problem.

Infiltration Contribution From Private House Laterals and Services

Art Hamid

Montgomery Watson Americas, Inc., Cleveland, Ohio

Introduction and Background

A sewage collection system has three basic components: mainlines, manholes, and building laterals. Additionally, pump stations and forcemains are used in a sewer system when topography prevents gravity flow.

Cities and agencies have expended considerable effort in evaluating infiltration and inflow (I/I) contribution from mainlines and manholes, but few data are available to estimate I/I from private laterals. Laterals generally account for one-half of the length of the collection systems in residential neighborhoods, yet laterals have generally been neglected in previous I/I control studies.

I/I reduction results have been disappointing when laterals were neglected in the rehabilitation effort. The U.S. Environmental Protection Agency (EPA) established two primary reasons for the poor I/I control:

- A piecemeal approach to sewer rehabilitation is generally ineffective.
- Laterals may constitute a major source of I/I in any sewer system.

To answer some of the questions on laterals, the East Bay Municipal Utility District in California, as part of an I/I study, developed a lateral testing and rehabilitation program with the following components:

- Lateral classification
- Lateral testing
- Rehabilitation
- Postrehabilitation evaluation
- Cost-effectiveness evaluation

This paper presents the lateral selection and testing results using the rainfall simulation method. The City of Berkeley, California, conducted the work in the selected areas shown in Figure 1. The study team initially selected 600 laterals, 50 of which were tested by the rainfall simulation method. Approximately 100 laterals were rehabilitated using different methods for postrehabilitation testing after 5 years.

Rainfall Simulation Methodology for Lateral Testing

Lateral testing methods include the following:

- The exfiltration test, which is used to determine sewer conditions based on water leakage from the pipe.
- The air test, which is similar to the exfiltration test but monitors the leakage rate of air rather than water.

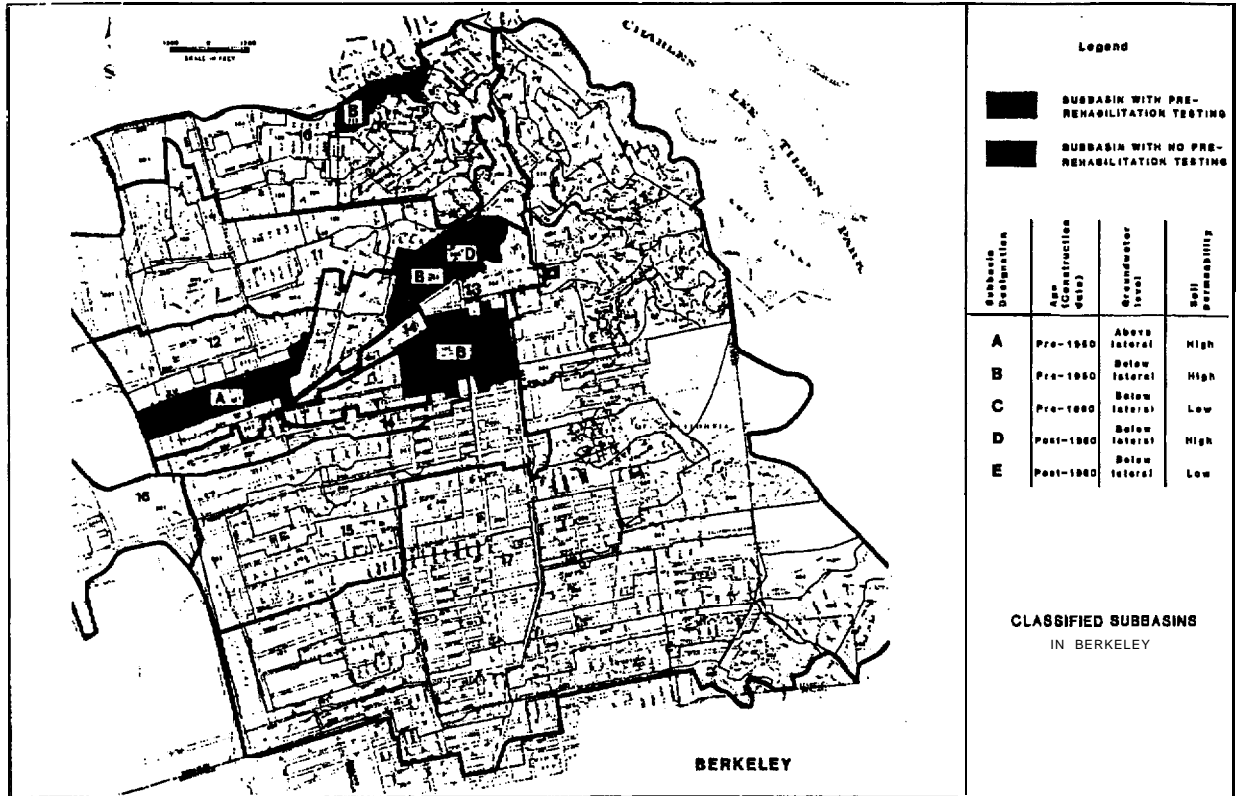

Figure 1. Classified subbasins in Berkeley.

- The television inspection test, which visually inspects and accurately indicates the condition of the laterals and shows structural and other defects that could contribute I/I.
- The smoke test, which is the most inexpensive method and indicates lateral condition by the amount and location of smoke exiting the lateral defects during the testing period.
- The rainfall simulation test, which is the only test that quantifies the amount of I/I contributed by the laterals.

Lateral Classification

The prerenhabilitation test procedures had four objectives:

- Establish the actual condition of the laterals.
- Determine the most suitable testing method.
- Determine whether laterals can be classified by age, soil permeability, and ground-water levels.
- Estimate the amount of I/I entering the sewer system.

The study team selected 50 house laterals for rainfall simulation testing and divided them into five categories:

1. Pre-1960 construction, high permeability, lateral below ground water
2. Pre-1960, high permeability, lateral above ground water
3. Pre-1960, low permeability, lateral above ground water
4. Post-1960 construction, high permeability, lateral above ground water
5. Post-1960, low permeability, lateral above ground water

Rainfall Simulation Methodology

Figures 2 and 3 show the rainfall simulation testing methodology. To simulate rainfall conditions, soaker hoses connected to garden faucets with water meters were placed over the laterals. Water was sprayed over the laterals all night to simulate design rainstorm conditions. The study team measured the infiltration flow rates in laterals with a packer device, a calibrated V-notch weir, and a television camera strategically placed in the mainline to measure rainfall-related and ground-water infiltration.

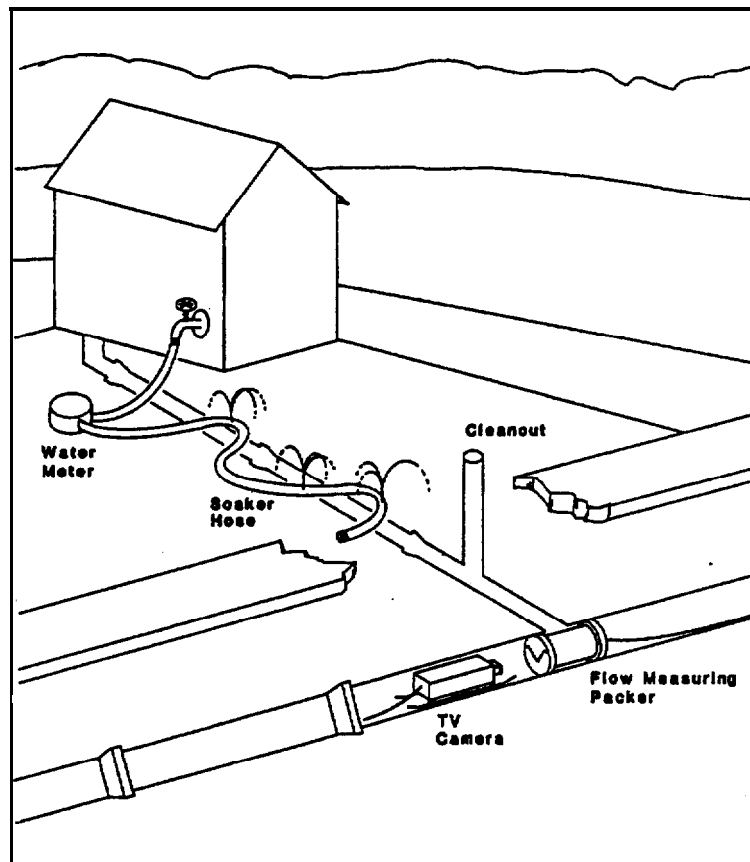

Figure 2. Rainfall simulation testing equipment schematic.

The modified packer used to measure the flows was the key piece of equipment in this testing program. The packer was modified by blocking its upstream end and installing a calibrated V-notch weir at the downstream end. Sewage from the lateral entered the packer and exited over the weir. The modification allowed measurement of the sewage from the lateral without any upstream sewage contribution. The study team observed depth of flow from the calibrated weir with a television camera that was also used to position the packer.

Rainfall Simulation Results

Soaker hoses sprayed water over the laterals to simulate different design storm conditions ranging from 1- to 20-year rainfall return periods, as indicated in Table 1. Flows from the laterals were measured during the rainfall simulation period, and equations to fit the data were developed for each of the selected categories. Coefficients of correlation and standard error of estimates were developed. The correlation coefficient ranged from 0.2 to 0.6.

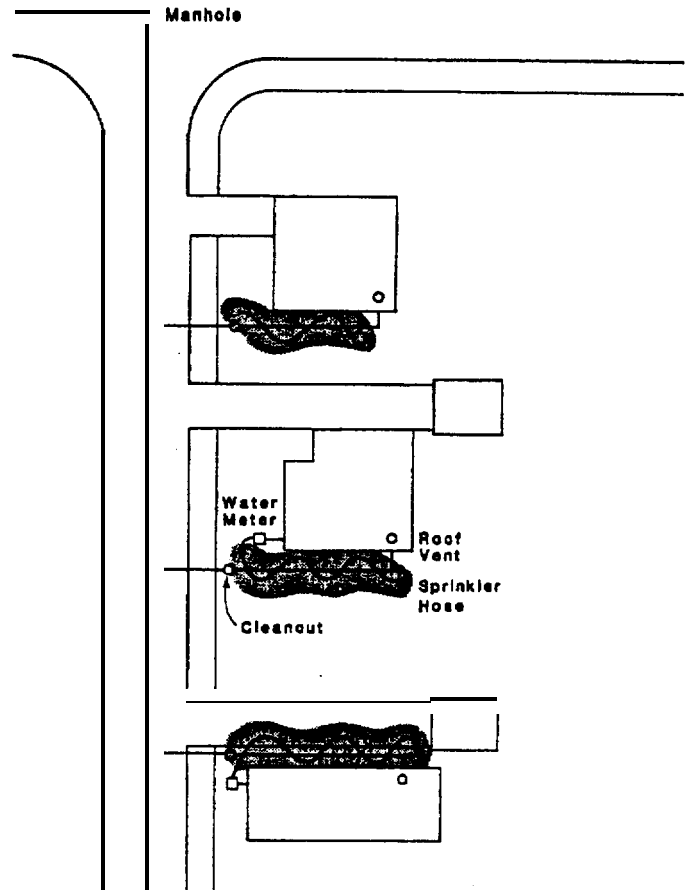

Figure 3. Sprinkler hoses over house laterals, rainfall simulation test.

Table 1. Hourly Precipitation Rate of Various Durations and Return Intervals

Duration (hours)	Storm Return Period (years)	Average Precipitation Rate (inches/hour)
4	1	0.19
4	2	0.23
6	2	0.21
4	5	0.35
6	5	0.32
8	5	0.26
1	20	0.85

Figures 4 and 5 show typical results of the simulation testing program. Figure 4 shows a hydrograph with ground-water flow of 1/8 gallon per minute (gpm) present before and after the test. A steady-state peak flow of 1/2 gpm was reached within 90 minutes of the rainfall simulation and continued for about 3 hours. During the simulated rainfall, a plug was inserted at the cleanout located at the sidewalk. The flow dropped immediately, indicating that the upper lateral contribution was significant.

The testing results are shown in Table 2 and summarized below.

- Laterals constructed before 1960 showed considerably more infiltration than post-1960 laterals.
- Ground-water impacts were relatively difficult to assess because of water tap leakage in the houses.
- The infiltration from laterals was rapid, with response time similar to inflow.
- The percentage of simulated rainfall (R factor) entering the laterals was similar to or higher than the R factor for the subbasin.
- Both the pre- and post-1960 laterals were major contributors of rain-related infiltration in the sewer system.

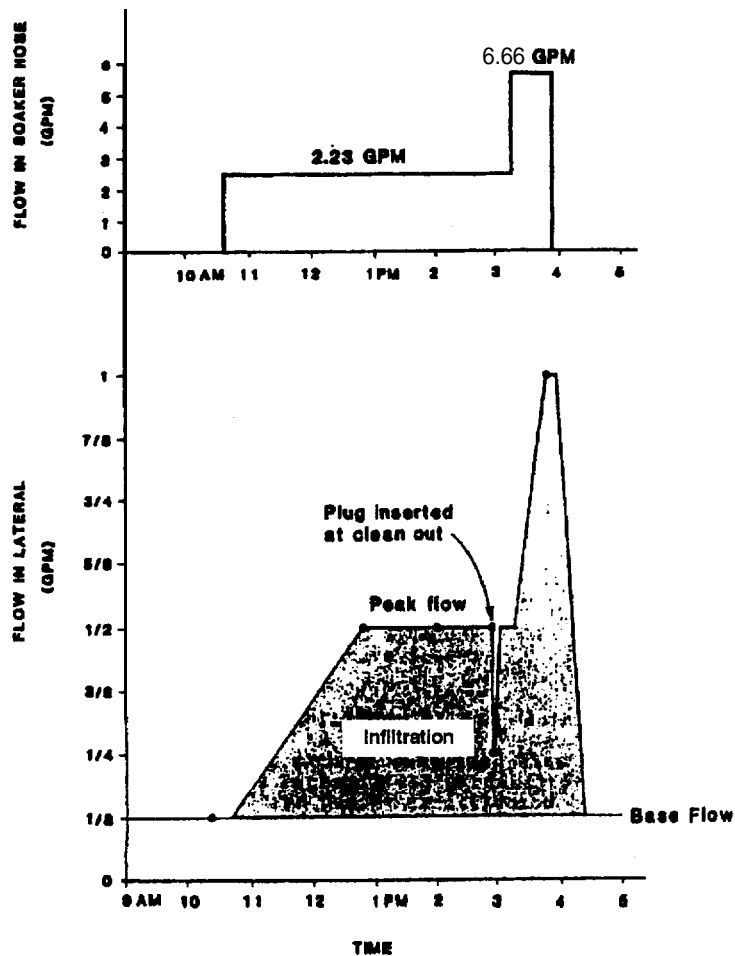

Figure 4. Typical house lateral hydrograph, Example 1.

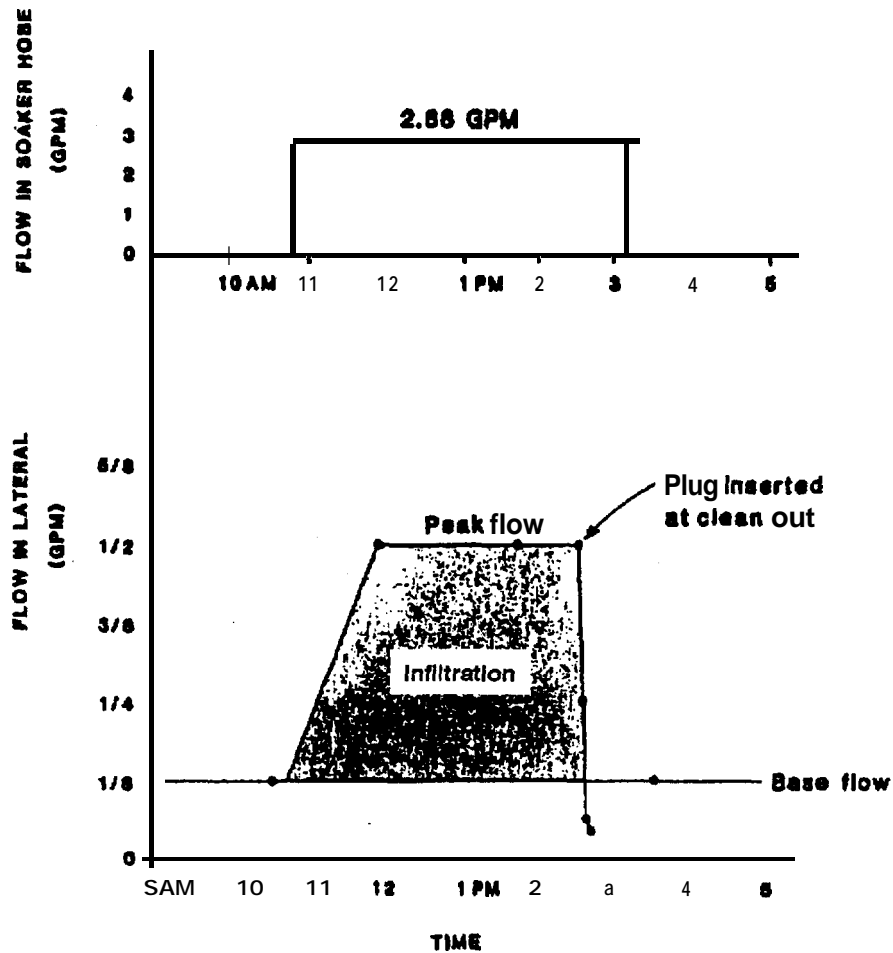

Figure 5. Typical house lateral hydrograph, Example 2.

Table 2. Rainfall Simulation Test: Projected Average Flow for Design Storm'

Designation	Characteristics	Average Flow (gpm)
A	Pre-1960, below ground water, permeable soil	0.32
B	Pre-1960, above ground water, permeable soil	NC
C	Pre-1960, above ground water, impermeable soil	0.48
D	Post-1960, above ground water, permeable soil	0.1
E	Post-1960, above ground water, impermeable soil	0.25

*Design storm is 1.56 inches in 8 hours.

NC = Not computed because of negative flow.

The findings of this testing program confirmed that house laterals contribute as much or more infiltration into sewer systems than main sewers contribute and must be considered in any rehabilitation program geared toward I/I reduction.

As a **followup** to this testing program, the City of Berkeley rehabilitated the same house laterals using different rehabilitation techniques to determine the cost-effectiveness of the lateral rehabilitation program for I/I control.

The Private Sector and Sanitary Sewer Overflows

Donna Evanoff Renner
RJN Group, Inc., Dallas, Texas

Ken Matthews
City of Tulsa, Oklahoma

Gary Morgan
Dallas Water Utilities, Dallas, Texas

Most sanitary sewer overflows (**SSOs**) occur during rainfall when infiltration and inflow (**I/I**) enter a sanitary sewer system. A Sewer System Evaluation Survey (**SSES**) can be conducted to identify where **I/I** enters the system. During the **SSES**, field investigation techniques such as smoke testing, dyed-water flooding, television inspection, and building inspection are used not only to identify public sector sources but also to identify private sector sources. Public sector sources are those identified at manholes and along main lines. Some cities maintain the sewer system within city rights of way, where the sewer tap and several feet of each service lateral adjacent to the main are considered public sector. Only that portion of the lateral located on private property is the responsibility of the private property owner. Other cities consider the tap and entire lateral, whether in the right of way or not, to be privately owned and, therefore, privately maintained.

SSESs performed in various cities in the south central United States in the past few years indicate that private sector defects, which are cost effective to eliminate, produce an average of approximately 20 percent of the total cost-effective inflow. Cost-effective sources are those sources that are cheaper to repair than it would be to transport the inflow through the system and treat it at the plant for a selected planning period. Table 1 indicates the total inflow into a system during a rainfall event with a 1-year/60-minute intensity, the total cost-effective inflow, and the total cost-effective private sector inflow for selected cities. Cost effectiveness is based on the estimated cost for a contractor to repair private sector sources.

Table 1. Total Inflow Versus Private Sector Inflow

Study	Total Inflow (mgd)	Cost- Effective Inflow (mgd)	Cost-Effective Private Sector Inflow (mgd)	Cost-Effective Private Sector Inflow (percent)
Ft. Worth, TX, M-272D2	4.928	2.394	0.362	15.1
Ft. Worth, TX, M-219	3.555	2.062	0.265	12.9
Arlington, TX, Basins 24, 25, and 26	1.971	0.534	0.212	39.7
Irving, TX, Basin 8	1.639	1.154	0.079	6.9
Highland Village, TX	0.220	0.200	0.023	11.5
Tulsa, OK, Coal Creek Basin	21.292	13.134	3.555	27.1
League City, TX	11.298	6.806	1.347	19.8

Study	Total Inflow (mgd)	Cost- Effective Inflow (mgd)	Cost-Effective Private Sector inflow (mgd)	Cost-Effective Private Sector Inflow (percent)
Ft. Worth, TX, M-272D2	4.928	2.394	0.362	15.1
Dallas, TX, Woody Branch	6.734	3.462	0.818	23.6
Irving, TX, Basin 1 and Basin 2	2.464	1.041	0.072	6.9
Johnson Co., KS, Phase I	13.591	5.793	2.026	35.0
Siloam Springs, AR	5.815	3.866	0.281	7.3
Arlington, TX, Basins 28, 30, and 32	4.391	2.415	0.576	23.9
Lancaster, TX, Basin 8	0.630	0.436	0.025	5.7
Fayetteville, AR, Illinois River Watershed, Phase I	6.745	4.630	0.229	4.9
Ft. Worth, TX, M-31 1	4.516	2.456	0.256	10.4
Dallas, TX, Kidd Springs	2.839	1.408	0.193	13.7
Ft. Worth, TX, M-269	2.471	1.139	0.142	12.5
Ft. Worth, TX, M-216	3.496	1.140	0.369	32.4
Total	98.595	54.070	10.830	20.0

Identification of Private Sector Defects

Private sector defects are identified during field activities performed during an SSES. When smoke testing is performed, smoke coming from defects in the private sector may indicate an inflow source. Smoke from downspouts, area drains, yard drains, and sump pumps indicates direct inflow connections. Smoke at defects such as cleanouts and building laterals indicates indirect inflow connections. Other private sector sources include window, stairwell, patio, and crawl space drains. A dyed-water test, with television inspection, can be used to determine whether defects found near the main line during smoke testing are private sector or public sector defects. Dyed-water testing can also be used to verify suspect sources found during building inspections. Suspect sources are those sources such as area drains, patio drains, stairwell drains, downspouts, and sump pumps that did not smoke during smoke testing but that indicated possible connection to the sanitary sewer system.

Impacts of Private Sector Defects

Many cities have ignored private sector defects. Rising treatment cost, capacity limitations, and regulatory actions under the Clean Water Act, however, have caused cities to take an interest in eliminating these defects and their negative impacts on the sanitary sewer system. Figure 1 compares

the amount of inflow from cost-effective private sector sources with the amount from cost-effective public sector sources for the cities identified in Table 1.

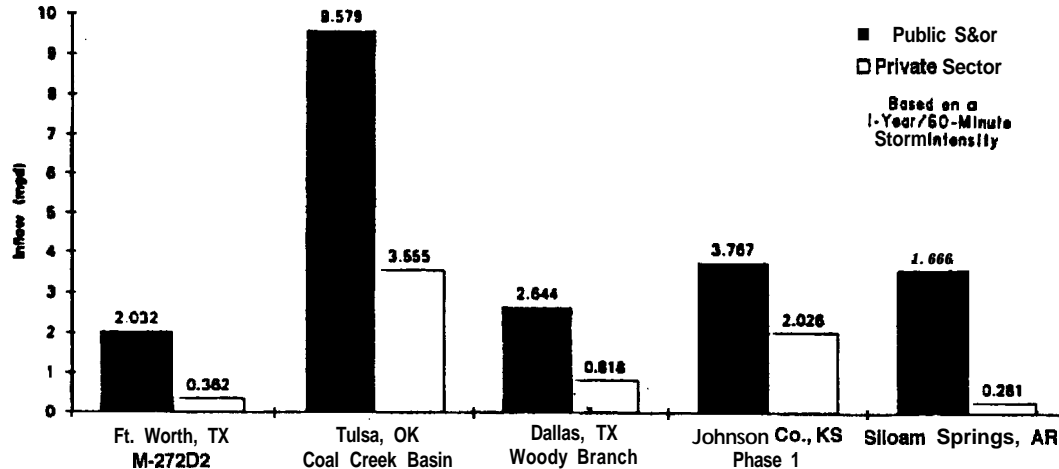

Figure 1. Public sector versus private sector cost-effective inflow sources.

According to an SSES performed for the Coal Creek Sanitary Sewer Collection System in Tulsa, Oklahoma, 3.555 million gallons per day (mgd) (1-year/60-minute) of inflow is from cost-effective private sector inflow sources versus 9.579 mgd (1-year/60-minute) from cost-effective public sector inflow sources. A total of 27 percent of the cost-effective inflow is from private sector defects. The Coal Creek system was constructed between 1930 and 1950. Most of the system is clay pipe with brick manholes. The area studied consisted of approximately 700,000 linear feet of mains and 3,400 manholes. The area is mostly residential, with some commercial and a small amount of industrial development.

Figure 2 indicates the costs to repair the cost-effective public and private sector inflow source for the cities identified in Figure 1. The average cost-to-inflow ratio of cost-effective public sector sources in Tulsa's Coal Creek collection system is \$0.252 per gallon per day (gpd). For cost-effective private sector inflow sources, the average cost-to-inflow ratio is \$0.200 gpd. This cost is based on construction costs for a contractor to repair the defects. Tulsa has developed a program in which the property owner is responsible for the cost to repair the defect. The private sector repair program for Tulsa costs the city approximately \$9,000 per month to administer. At an average rate of 150 repairs performed in the private sector per month, the cost-to-inflow ratio of the city's portion of the program averages \$0.020 gpd. Table 2 indicates individual private sector defect sources, the amount of estimated inflow generated by these sources, and the cost to repair these sources.

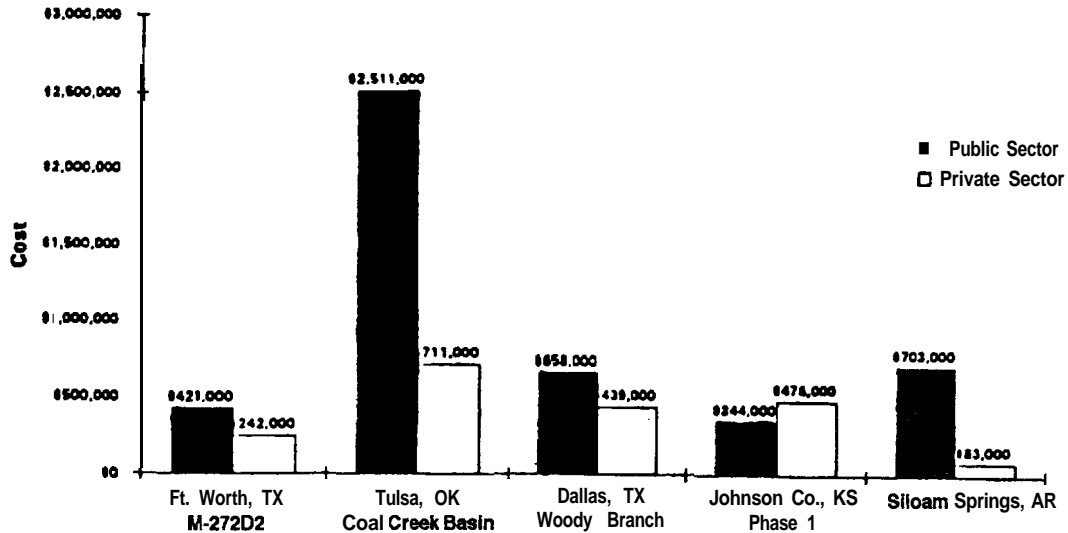

Figure 2. Public sector versus private sector repair costs.

Table 2. City of Tulsa Cost to Repair Private Sector Defects¹

Defect Description	No. of Inflow Sources	Total ^b Inflow (mgd)	Cost for Contractor Repair (\$)	City Program cost (\$)
Cleanouts	664	1.377	117,100	39,840
Building laterals	437	1.326	524,700	26,220
Area drains ^c	48	0.627	57,600	2,880
Sump pumps	11	0.036	8,500	660
Downspouts	9	0.188	2,700	540
Total	1,169	3.554	710,600	70,140

*Data are from a study performed by RJN Group, Inc., for the City of Tulsa in the Coal Creek drainage area.

^bBased on a 1 -year/60-minute storm intensity.

^cIncludes patio drains, driveway drains, etc.

Repair Methods

Cleanouts considered defective are those with missing caps, broken caps, and broken pipe. Many defective cleanouts are flush with the ground or broken below the ground and act as an area drain during rainfall. Repairs of defective cleanouts can be very effective as they often allow a substantial amount of inflow into the sewer system and are very inexpensive to repair. Repairs include replacing caps and/or

broken pipes, and raising cleanouts. Disconnection of area drains, yard drains, downspouts, sump pumps, window well drains, and stairwell drains is also very effective in reducing the amount of inflow entering the system. Defective building laterals are replaced from the location of the defect to the next portion of structurally sound pipe.

Benefits of Private Sector Defect Repairs

Several benefits can be gained from the repair of private sector defects. As defects are repaired, inflow is eliminated, as is the cost to transport the inflow through the system and treat it at the plant. Repair of these defects also reduces the amount of inflow into the system, reducing the number of SSOs that occur during wet weather. Repair made in the private sector also can reduce the amount of inflow enough to eliminate the need for some sewer system capacity improvements. Many enforcement agencies have made direct connections, such as area drains and downspout connections, a violation. Elimination of these defects can ensure that the sanitary sewer system is in compliance with applicable regulations.

The Coal Creek study in Tulsa identified 1,169 cost-effective private sector defects. Elimination of these sources would save the city approximately \$22,400 per year in transport and treatment costs. A capacity analysis in the Coal Creek system was performed with and without private sector defects eliminated. All cost-effective public sector defects were eliminated in both analyses. The analysis with the private sector defects eliminated reduced the cost of capacity improvement from approximately \$8.5 million to approximately \$5.6 million, saving the city \$2.9 million. The potential cost to the city versus the potential savings if private sector defects are eliminated is shown in Table 3.

Table 3. Private Sector Defects, Cost Versus Savings

	cost	Savings
Defect elimination	\$70,140.00	
Capacity improvement*		\$2,900,000.00
Treatment and operation and maintenance costs		\$22,000.00^b

^aBased on a **5-year/60-minute** storm intensity.

^b**Annual** savings.

These savings represent private sector defect repair in a small portion of the city. As other areas of the city are studied and private sector defects are eliminated, the savings will multiply.

Tulsa, Oklahoma: Private Sector Inflow Defect Elimination Program

The City of Tulsa (population 370,000), began construction of its sanitary sewer system in the early 1900s. In 1990, the city was issued an Administrative Order from the U.S. Environmental Protection Agency (EPA) and a Consent Order from the Oklahoma Department of Environmental Quality (ODEQ) for wet weather SSOs in several areas of the city.

The city had been working to eliminate its I/I problem for many years, but with the new, stricter requirements in the Administrative and Consent Orders and the rising cost of required relief interceptors and treatment plant construction, a decision was made in October 1990 to become more aggressive about elimination of I/I. SSESs were begun in several areas of the city in the spring of 1993. As the SSESs progressed, the city realized the significant impacts to the system of inflow from private sector defects. In August 1994, the city began retooling its private sector defect enforcement program to better

meet the needs of the aggressive I/I reduction program. The program is a joint effort of the Public Works Engineering Services and Building Inspections departments. Public Works Engineering administers the SSESSs, collects defect information, manages the information with a computer-assisted defect inventory, and routes defect information to Building Inspection. When the defect is repaired, it is removed from the inventory.

The city has assigned one full-time building inspector and one part-time building inspector, each with a plumbing license, to the program. (Building inspectors are used in Tulsa because they are authorized to write citations.) One city vehicle is used for the program. Other miscellaneous expenses such as printing, postage, and supplies are incurred.

Engineering Services provides building inspectors with forms, completed during the SSES projects, that show the approximate locations of private sector inflow defects. Photographs of the defects are taken during the SSES and are given to the city for use as verification and location.

The inspector visits each site where a defect is located. If the owner/occupant is available at a defect location, the inspector leaves an official notice indicating the location of the defect, a business card, and a letter describing the I/I elimination program. If the defect would be difficult for the owner/occupant to locate, the inspector spraypaints the defect location. The notice gives the owner/occupant 7 days to take action to repair the defect. An example of an official notice used by city inspectors is shown in Figure 3.

CITY OF TULSA, OKLAHOMA		<ul style="list-style-type: none"> • I BUILDING 596-9666 <input type="checkbox"/> COMB. RES. 596-9696 <input type="checkbox"/> PLUMBING 596-9686 <input type="checkbox"/> ELECTRICAL 596-9656 <input type="checkbox"/> SIGN 596-9664 <input type="checkbox"/> MECHANICAL 596-9676 <input type="checkbox"/> ELEVATOR 596-1847
TO THE OWNER OR OCCUPANT	OFFICIAL NOTICE	
(NAME IF KNOWN)	(DATE)	
(STREET ADDRESS)		
<p>You are hereby ordered to immediately <input type="checkbox"/> STOP <input type="checkbox"/> CORRECT <input type="checkbox"/> REMOVE THE FOLLOWING: <input type="checkbox"/> OCCUPANCY <input type="checkbox"/> HAZARD <input type="checkbox"/> CONSTRUCTION on your property or from the public street at the above address, and directed to the following action:</p> <p><u>Inflow/Infiltration of surface water into sanitary sewer. Please install metal or plastic screwed cleanout dun into exposed, existing cleanout. NO plumbing permit required. Please or cdl me when complete at _____ between 8 9 am M-Fri.</u></p> <p>Compliance with the above is required within _____, CODE OFFICIAL _____</p> <p>Failure to heed this notice is a violation of City Ordinance and uch offence is subject to penalties as prescribed by law.</p>		
TUL-547-D		

Figure 3. City of Tulsa, Oklahoma, official inspection notice.

The letter describing the city's I/I elimination program is written on official City of Tulsa stationery and generally includes the following paragraphs:

The City of Tulsa is under an order from the U.S. Environmental Protection Agency (EPA) to correct inflow and infiltration problems in the sanitary sewage system. In order to accomplish this, a program of smoke testing our sewer mains has been initiated, locating any problem areas in our main lines which our crews then repair. Additionally, this same smoke test may indicate a problem with an individual private property. When

this is the problem, City Inspectors will notify the property owner of the problem, and what is required to correct it. In most cases the problem can easily be corrected by installing a screwed plug into the existing clean out. In others, unfortunately, repair or even replacement of the property service line may be required which can place an unexpected financial burden on the property owner.

The objective of the program is to identify and eliminate any areas where rain water or ground water is entering our sanitary sewer system. By accomplishing this the Citizens of Tulsa will receive the best service while keeping the sewage fees at a minimum.

If you have any questions, please feel free to ask the Inspector while he is at your location, or call 596-9687 to talk to an Inspector.

For each site visited, the inspector completes an index card that includes the following information:

- Address of defect
- Date
- Action taken (e.g., taped notice to door)
- Name of occupant (from water meter records)

The inspector uses this card for followup. If a permit is obtained for repair of the service, the inspector notes the date. If a **cleanout** cap was required, the inspector revisits the site after 7 days. If the repair of a defect requires a permit and no permit has been sought for that repair, the inspector revisits the defect location. If, on the second visit, the defect has not been repaired, the inspector leaves another notice giving the owner/occupant 24 hours to respond. Because many of the defects require **cleanout** caps only, the city has begun to provide those caps in an effort to avoid a second visit to each site. Providing the caps is not only cost effective but results in a good public image for the city.

If no action has been taken to correct the defect 48 hours after the second visit, the city sends a registered letter stating that the water meter will be pulled if action is not taken immediately. One meter has been pulled in Tulsa since the program began.

The city inspector spends approximately 5 to 10 minutes at each defect location and averages about 200 visits per month. The city estimates that approximately 85 percent of the defects are corrected after the first notice. Of the sites visited, approximately 10 percent have an occupant at the site. At the sites where notices are left, approximately 90 percent of the owners/occupants call the inspector, and 10 percent of those want the inspector to meet them.

The city has several ordinances that can be used to enforce these actions, if required. The following is from Title 11 -C (Waterworks and Sewerage), Chapter 5, Section 512 (Private Sewers):

It shall be the duty of all persons owning any property upon which there is a house sewer line connecting with the public sanitary sewer system, to keep such house sewer line in a sufficiently good state of repair that it does not constitute a health nuisance nor interfere with the operation and maintenance of the public sanitary sewer system. It shall be the duty of such owner to have the proper repairs made by a licensed contractor or licensed plumber to such house sewer line within five (5) days after written notice to make such repairs is given by the Director.

Chapter 11, Section 1100, states the following about penalties for those failing to make repairs as described above:

- A. Unless otherwise specifically provided in this title, any person violating any of the provisions of this title shall be guilty of an offense and, upon conviction thereof, shall be punished by imprisonment in the City Jail for a period of not more than ninety (90) days and/or by a fine of not more than FIVE HUNDRED DOLLARS (\$500.00), excluding costs; provided, however, that anyone found guilty of violating any of the provisions of Chapter 12 of this title shall be punished by imprisonment in the City Jail for a period of not more than ninety (90) days and/or by a fine of not more than ONE THOUSAND DOLLARS (\$1,000.00), excluding costs. Each day of such violation shall constitute a separate offense. (Ord. No. 17420)
- B. Any person who shall violate any of the provisions of this title with respect to obtaining water or sewer service through connection to any water or sewer line under the jurisdiction of the City of Tulsa for its operation, repair and maintenance, upon substantiation of the facts, shall be denied water or sewer service until such violation is abated.

The city also has an ordinance entitled "Prohibited Discharge," which states:

No person shall discharge, or cause to be discharged, any storm water, ground water, roof run-off, subsurface drainage or any water from downspouts, yard drains, yard fountains, ponds, septic tanks, or lawn sprays into any sanitary sewer unless prior approval of the Director is given.

The city has run into several obstacles since beginning its defect elimination program, but it has found solutions as well. For example, some of the defects are located at abandoned buildings, where notification of the owner is nearly impossible. If the water meters are pulled, the inflow problem will still exist; therefore, the city plugs these services at the main after a certain number of days with no response. Some defects are located so close to the main that it is difficult to determine whether the defect is the responsibility of the city or the property owner. In this case, assuming the city performs additional tests, the exact location of the defect was not verified in the study using dyed-water testing while performing internal television inspection. For some defects found at building laterals, it is difficult to determine which property owner is responsible for the repairs. In this case, the city makes judgment and notifies one owner to correct the defect. If it is determined that the lateral belongs to another property owner, the city then notifies the correct owner.

The city has also addressed the problem of slow information transfer between the consultant performing the SSES and Building Inspections. Initially, private sector defect information was not provided to Building Inspections until several studies were completed. This led to a backlog of paperwork and meant that, in some cases, inspectors did not receive information until 2 years after the defects were first found. If the flow of defect information had been more direct, the city could have initiated remedial action much sooner, saving money and reducing the backlog of paperwork.

The city has currently corrected approximately 550 private sector inflow defects with approximately 2.6 mgd of inflow (1-year/60-minute storm). Postrehabilitation flow monitoring to determine the amount of I/I reduction from private- and public-sector defect repair has not yet been performed.

Dallas, Texas: Private Sector Inflow Defect Elimination Program

The City of Dallas, Texas, began its program to eliminate private sector I/I defects in 1987. The program is administered by the Dallas Water Utilities. A two-person crew and one vehicle are used for the program, which is similar to Tulsa's program. The individuals employed in the program are selected for their neatness, courteousness, and professionalism. The city feels these traits are important to the success of the program.

Demographics play an important part in the Dallas program. For example, in Hispanic neighborhoods, a Hispanic crew member who speaks Spanish are more effective than an individual to whom residents cannot relate.

The city calls on every occupant/owner having a private sector defect. If no one is present on the first visit, the city leaves a notice requesting the occupant/owner to call and set up an appointment. The city uses completed smoke testing forms and pictures to show defects to the property owners.

Crews explain to residents the problems caused by the defects and the benefits in repairing them. Crews visit each site as many as three times to ensure that the defect has been corrected. The city has approximately a **95-percent** success rate. Pursuit of approximately 5 percent of the defects, which have been found to be minor and expensive to fix, is deferred. The city also provides **cleanout** caps and plugs sewer services to abandoned buildings at the main.

In areas where **SSOs** are apparent, property owners respond quickly and repair the defects. The city does not experience a differential in its success rate in low-income and high-income neighborhoods. In the 8 years since the program began, the city has used its ordinances twice, threatening to pull two meters. In these instances, the defects were repaired immediately, and the meters did not have to be pulled.

Several ordinances in Dallas are used to enforce the repair of private sector inflow defects. The following are excerpts from the Dallas City Code, Chapter 49, "Water and Wastewater":

Authority to discontinue service. The Director may refuse application for service, discontinue service, or refuse to restore service to a customer at any premises if the director determines that a substantial waste of water, or a health hazard, is occurring as a result of leaking, damaged, open or disconnected private laterals, pipes, or drains on the premises.

The director's authority to discontinue service includes the right to cut and plug water or wastewater connections to private property. The costs of cutting and plugging connections will be charged to the customer in addition to the delinquent charges due.

Penalties. A person who violates any provision of this article or any term or condition of an industrial waste discharge permit granted pursuant to this article is guilty of a separate offense for each day or portion of a day during which the violation is continued. Each offense is punishable by a fine not to exceed \$2,000.

Certain discharges prohibited. No person shall discharge, or cause or permit to be discharged, into the wastewater system: inflows or infiltration, as illustrated by, but not limited to, storm water, ground water, roof run-off, subsurface drainage, a downspout, a yard drain, a yard fountain or pond, or lawn spray.

Enforcement actions. If a person discharges a substance into the wastewater system in violation of this section, the director may terminate water and wastewater service to the premises from which the substance was discharged and bring a criminal or civil enforcement action as authorized in Section 49-41.

Dallas's program is capable of eliminating approximately 1,800 private sector defects per year, which would eliminate approximately 2.8 mgd of inflow (**1-year/60-minute** storm). Postrehabilitation flow monitoring has not been performed to determine the actual amount of I/I reduction from repairs performed in the public and private sectors.

Conclusion

SSOs, system capacity, and treatment are affected by inflow from private sector defects. As shown in Table 1, an average of 20 percent of cost-effective inflow is generated from private sector sources. Developing a program to have private property owners repair the private sector defects can be done effectively and with minimal cost to city government. Property owners are very responsive to these programs when they are informed of the impacts of defects on the sanitary sewer system, as well as the benefits resulting from defect repair. Both the City of Dallas and the City of Tulsa have very successfully worked with the public to eliminate private sector inflow defects. These cities feel that this success is due to their use of personal, courteous enforcement techniques, in conjunction with thorough recordkeeping and tough laws and ordinances.

Data Handling Procedures Expedite Sewer Evaluation and Repair of Service Laterals

Reggie Rowe
CH2M HILL, Montgomery, Alabama

Danny Holmberg
Montgomery Water Works and Sanitary Sewer Board, Montgomery, Alabama

Introduction

Communities across the nation are reexamining the issue of service laterals as a significant source of extraneous infiltration and inflow (I/I). This renewed interest has been prompted by the current industrywide emphasis on correcting sanitary sewer overflows (SSOs), the increasing concerns of the public about water quality, and the need for maximum water system efficiency mandated by tight operating budgets and limited capital improvement funds.

Traditionally, lateral problems have been avoided or ignored, primarily because of the reluctance of public officials to tackle the administrative and legal issues associated with a public or semipublic government body doing work on private property. The potential liabilities of regulatory noncompliance, the possibility of related civil actions, and an increased public awareness and concern over water quality and public health issues, however, have provided a strong impetus for addressing the lateral rehabilitation issue.

This paper reviews the efforts of the Water Works and Sanitary Sewer Board of the City of Montgomery to encourage and expedite the process of service lateral rehabilitation by private property owners. It describes how the board has introduced new technology and field procedures to significantly improve the overall efficiency of lateral problem detection, reporting, and rehabilitation activities.

What Are Service Laterals?

Service laterals are the component of the sewer collection system that connects a house or commercial building with the collector sewer. Depending on the region of the country, they can be called service laterals, house sewers, service mains, house services, or building sewers—all describing the same house-to-sewer system connection.

The service lateral pipe forms the connection between the collector sewer and the house or building drain. This pipe (with appurtenances) is further divided into two segments: the upper lateral, consisting of the pipe between the house and the public/private easement boundary, and the lower lateral, which completes the connection from the easement boundary to the collector sewer. Figure 1 shows the service lateral, the upper and lower lateral boundaries, and the typical lateral components such as cleanout and service wye or tee. Some communities also require two cleanout points: one at the house or building and the other at the easement.

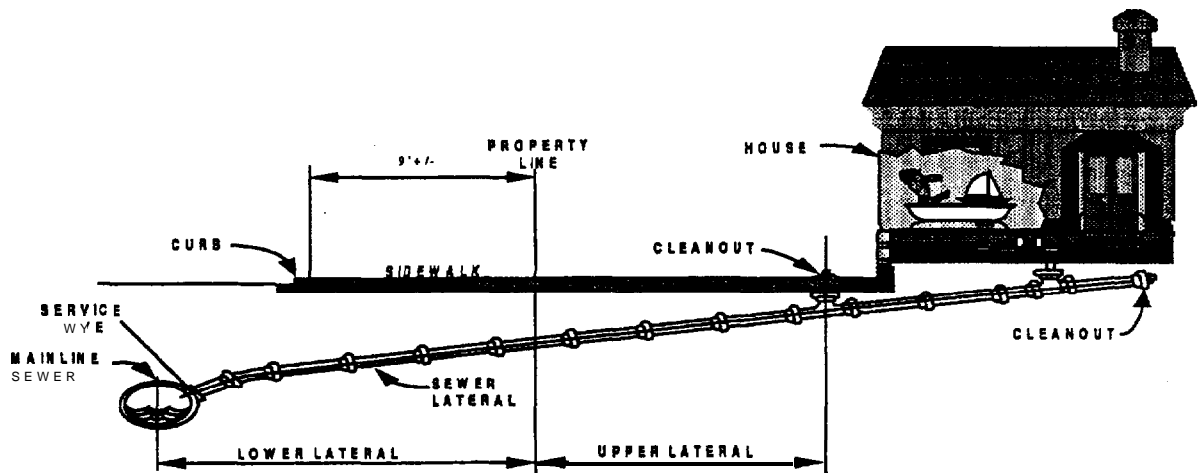

Figure 1. Service lateral, upper and lower lateral boundaries, and typical lateral components.

Service Laterals' Contribution to SSOs

The extraneous flow contribution of service laterals has not been widely documented. Despite the considerable network of installed sewer and service lateral pipe, very little specific data are available distinguishing between the wet weather flow contributions of a service lateral and the flow contributions of other collection system components. Typically, before an area system rehabilitation project begins, the combined lateral and collection system flow for that area is monitored and documented. Then, either the collector sewers or laterals are repaired, and a deduction is made for the flow contribution of the nonrehabilitated systems by comparing pre- and postrehabilitation flow rates.

Perhaps the primary reason that service laterals have seldom been monitored is the sheer quantity of connections. Also, it is difficult to physically isolate service laterals from a collector sewer for installation of flow monitors, and placing a flow rate meter in an existing lateral typically requires significant and often expensive lateral modifications.

Measuring the Specific Extraneous Flow Contributions of Service Laterals

Kurz et al. (1) report on a study by Bible (2) in the Nashville subdivision area of Oak Valley, in which the infiltration reduction value increased from 50 to 75 percent simply by renewing the lower lateral and collector sewer connection. Similarly, Wallis (3) reports that in California's East Bay Municipal Utility District, I/I reductions ranged from 52 to 86 percent in three community subbasins where the sewer collectors and lower and upper laterals were completely rehabilitated. In two subbasins where only the sewer collectors and lower laterals received rehabilitation, the I/I reductions were 45 and 87 percent. In subdivisions where only portions of the laterals and sewers were repaired, the I/I reductions results ranged from a gain of 100 percent to a reduction of 89 percent.

Variations in I/I reductions can be caused by a number of factors, and determining the cost-effectiveness of lateral rehabilitation will vary from community to community. Based on an analysis of over 3 million linear feet of sewer pipe serving Montgomery, Alabama, however, it was determined that for fully 86 percent of the collection system, it was cost-effective to rehabilitate inflow type sources. Some rehabilitation decisions were obvious. For example, replacing a missing 4-inch cleanout cap, identified through physical observation or smoke testing, was clearly very cost-effective. A significant I/I problem was detected and remedied with little expense. Of course, other methods like flow isolation or

closed-circuit television inspection are more costly and require more preliminary rehabilitation value analysis.

Findings of Montgomery's Lateral Service Testing Program

In Montgomery, the board has produced engineering reports and documentation on smoke testing conducted over the past 3 years for approximately 865,000 linear feet of pipe. These areas represent only portions of the board's overall collection system improvements program. The smoke-tested areas include 14 subbasins covering approximately 6,155 sewer acres. This work showed, as indicated in Tables 1 through 3, that of the 1,338 collection system defects observed, 1,239 (93 percent) were service lateral problems. Of the 1,239 service lateral problems, approximately 591 (48 percent) were upper lateral and 648 (52 percent) were lower lateral related. Almost a quarter of these service lateral problems (24 percent) were simply a matter of restoring or replacing missing **cleanout** caps. On average, the board found a service lateral problem for every 700 linear feet of sewer.

Table 1. Catoma Basin, Genetta Ditch, Area Smoke Testing Results

	Subbasin					Total
	11	13	15	16	17	
Acres of sewered area	588	248	860	656	317	2,669
Linear feet of sewer	88,704	47,890	130,258	111,619	54,648	433,119
Number of smoke defects (all types)	106	97	263	143	119	728
Number of lower lateral defects	24	71	195	89	61	440
Number of upper lateral defects	71	23	53	48	48	243
Number of cleanout defects	31	10	33	18	10	102
Percentage of lateral defects	90	97	94	96	92	94
Percentage of cleanout defects	29	10	13	13	8	14
Feet of sewer per lateral defect						634

Table 2. Towassa Basin Smoke Testing Results

	Subbasin						Total
	2	3	4	5	10	11	
Acres of sewered area	97	93	239	32	929	588	1,890
Linear feet of sewer	21,042	12,778	51,533	8,336	134,690	88,704	317,033
Number of smoke defects (all types)	52	24	49	105	69	2	299
Number of lower lateral defects	4	4	27	66	47	1	148
Number of upper lateral defects	48	20	22	38	19	1	147
Number of cleanout defects	45	12	13	29	12	1	111
Percentage of lateral defects	100	100	100	99	96	100	99
Percentage of cleanout defects	87	50	27	28	17	50	37
Feet of sewer per lateral defect							1,075

Table 3. Econchate Basin, Ann Street Area, Smoke Testing Results

	Subbasin			Total
	5	6	7	
Acres of sewered area	32	569	5159	2,815
Linear feet of sewer	8,336	87,226	69,115	362,000
Number of smoke defects (all types)	91	170	50	311
Number of lower lateral defects	10	28	22	60
Number of upper lateral defects	65	115	21	201
Number of cleanout defects	52	26	4	82
Percentage of lateral defects	82	84	86	84
Percentage of cleanout defects	57	15	8	26
Feet of sewer per lateral defect				1,387

Development of New Policy and Procedures

In early 1994, after reviewing the field reports of recent source detection work in **Subbasin 6** (the Caney Creek area of the Catoma Basin) it was noted that of the 258 smoke defects, 247 (96 percent) were a matter of missing or broken **cleanout** caps on service laterals (see Table 4). Also, no storm drains were located in the area, and the cleanouts were serving as stormwater drains. A review of the flow monitor hydrographs indicated that the area responded rapidly to storm events.

Table 4. Catoma Basin, Caney Creek Area, Smoke Testing Results (Subbasin 6)

	Subbasin Total
Acres of sewered area	569
Linear feet of sewer	87,226
Number of smoke defects (all types)	258
Number of lower lateral defects	11
Number of upper lateral defects	247
Number of cleanout defects	247
Percentage of lateral defects	100
Percentage cleanout defects	96
Feet of sewer per lateral defect	338

Shortly after reviewing the Caney Creek data, discussions were held with the board's staff regarding the significant impact that the lateral defects appeared to have on this area and on other sectors of the collection system. This initiated a reexamination of the board's lateral rehabilitation policy.

Historically, the policy placed sole responsibility for lateral maintenance from the collector to the house with the private property owner. When lateral service problems were discovered, the property owner was **notified** and directed to make the correction. The board had made provision for repairs to the lower lateral if the lateral repair was associated with a capital improvements rehabilitation project; however, initial capital improvement projects failed to address the upper portion of lateral service defects.

After board staff understood the urgent need to address the upper lateral problems if the goal of significant I/I reduction was to be realized, they agreed to revise board policy, recommending and approving a more aggressive policy. Private property owners would make I/I repairs detected on their laterals or risk having their water service terminated.

First, the property owner receives a **60-day** notice of lateral repair requirements. When a property owner fails to respond to the initial notice, a second 10-day notice is generated advising of possible interruption of service. If the property owner has not responded within the specified time frame, water service is terminated.

The board gave the property owner the option of permitting the board's staff to make the repair to the lower lateral as long as the repair cost was reimbursed by the property owner. If the owner elected to use board restoration services, any other lower lateral defects discovered in the course of the work would also be repaired.

A maximum cost ceiling to the property owner for lower lateral repairs was established at \$1,200, with the board assuming any cost over that amount. The board also offered property owners interest-free financing for owner-incurred lower lateral repair costs up to the maximum amount, with repayment to be made over a 4-year period. As further incentive to property owners to resolve lateral problems, the board would replace missing or broken cleanout caps for a cost of \$13.52—far below local plumber fees for the same procedure.

Under the present policy, property owners retain the option of repairing any private defect themselves. If they choose that option, the board will conduct a visual inspection of the work performed. If the repair is complete and of acceptable quality, a thank-you letter is sent to the property owner. If the repair is not acceptable or another defect is located, a second notice is generated stating what needs to be done to bring the owner up to board standards. This process is depicted in Figure 2.

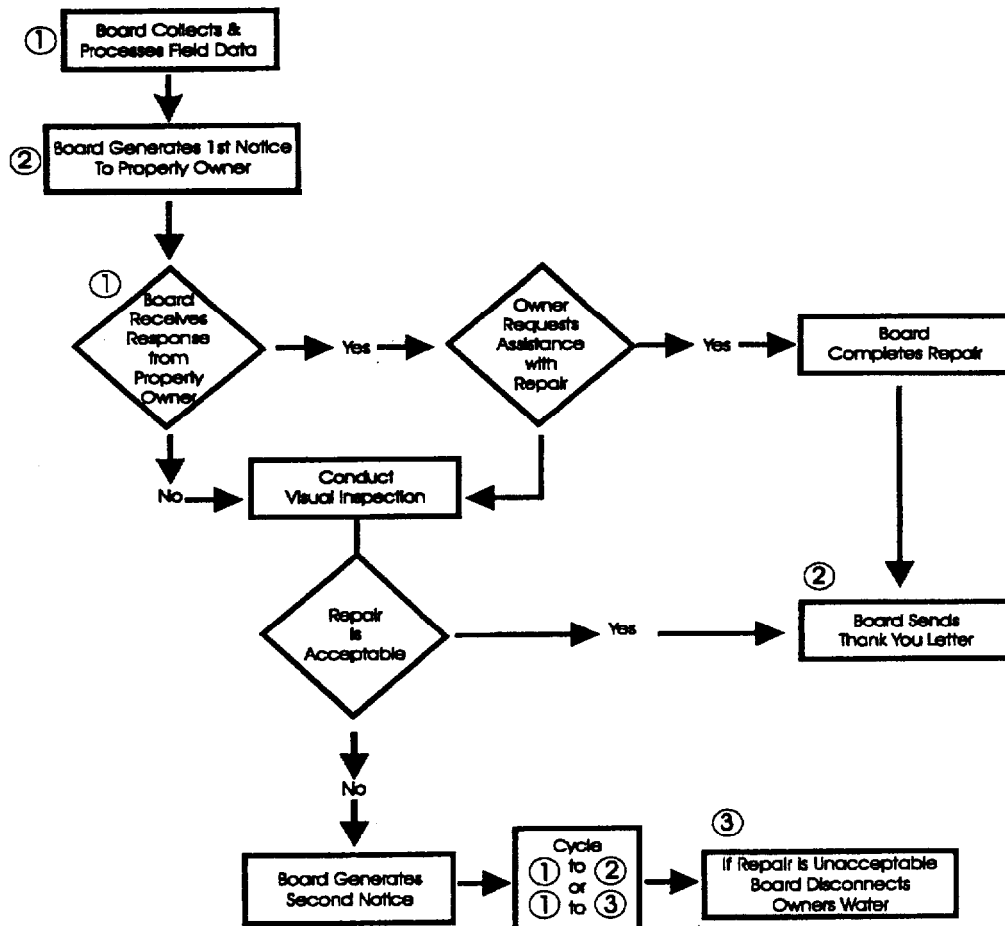

Figure 2. Revised lateral property owner notification decision tree.

Improved Documentation Through Computerization

While making these policy revisions, the board developed an improved approach to lateral defect identification and documentation so that this important data could be gathered and processed and the appropriate repairs performed quickly and cost-effectively.

The existing method of recording the noted defects in an engineering report needed improvement. Engineering reports were not being prepared until the field activities for multiple subbasins were complete—a long and costly time lapse. The board realized that it was missing major opportunities to make significant I/I reductions through actions as simple and inexpensive as replacing missing cleanout caps.

Subsequent discussions on improving data collection, reporting, and property owner notification procedures focused on options for computerization and automation of the process. The board was already midway through a major modernization of its customer information system and was incorporating a departmentwide geographical information system: the board had experienced the benefits of computerization and wanted to extend this concept into the field.

At that time, the data handling process involved field crews writing field information on forms, then bringing the information back to the office for entering into a software database. Multiple Polaroid photographs of each observed field defect were taken, and Polaroid film duplicates were attached to copies of the form in the office for later distribution to the board's staff. Because the database summaries and the field data information were included as a part of the engineering report, this information was taking from 6 to 8 weeks to reach the board.

For the new system, the field crews were provided with laptop computers to directly enter inspection observations into the database while still at the site. Polaroid cameras were replaced with digital versions. Now, photographs of a defect could be inserted into the appropriate electronic inspection form and all of these data processing functions accomplished in the field.

Each day, the field crews download their data into the master database. Then, about once each week, the database sorts the work for service lateral defects. Information and photos of these defects are electronically transmitted to the board from CH2M HILL's office.

Figures 3 and 4 show two of the computer interfaces that the crews use for smoke setups and smoke defects. The interface was designed so that it can be used much like a paper form. Built-in scroll bar menus are provided for as many of the entry cells as possible. This allows more information to be accessed from a smaller screen, and tends to reduce error and expedite data entry. For example, on Figure 3, all of Montgomery street addresses have been loaded into the database. A crew member need only type the first few letters in the street address and the scroll bar advances to the general area of the street on the street list. On the next setup, the same street address remains in the cell; therefore, the crew member need only change the address number for the next task when working on the same street. When the crew member is ready to record the observed smoke defects, he simply activates the "Defect" button.

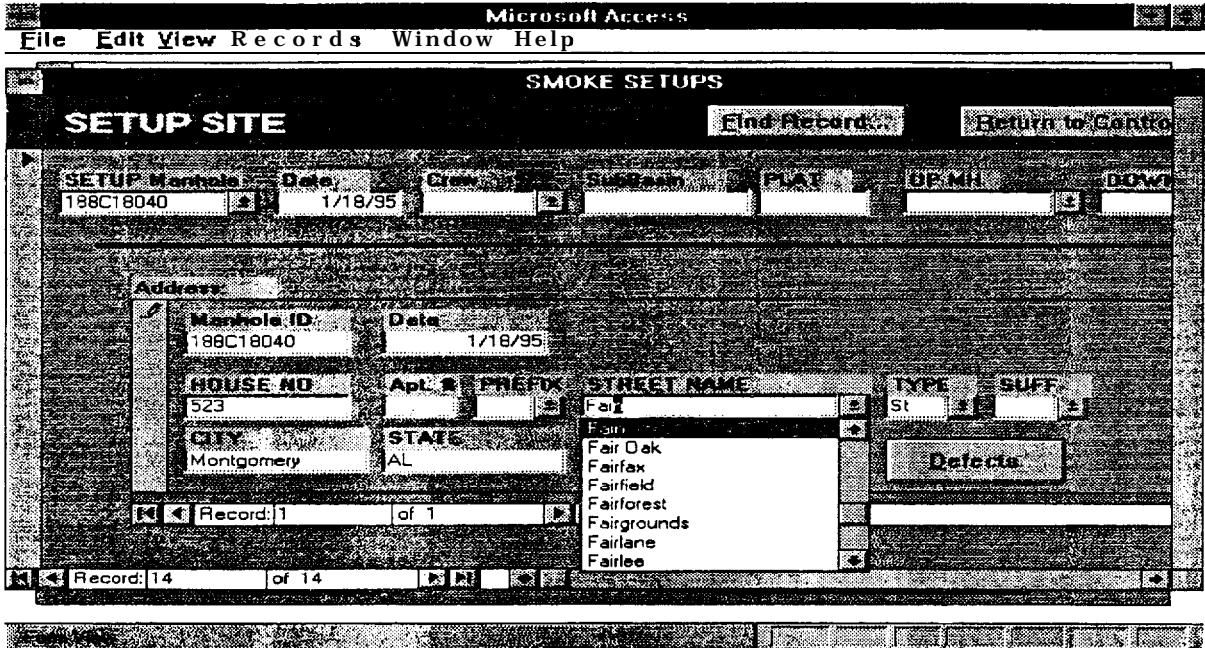

Figure 3. Smoke test setup screen.

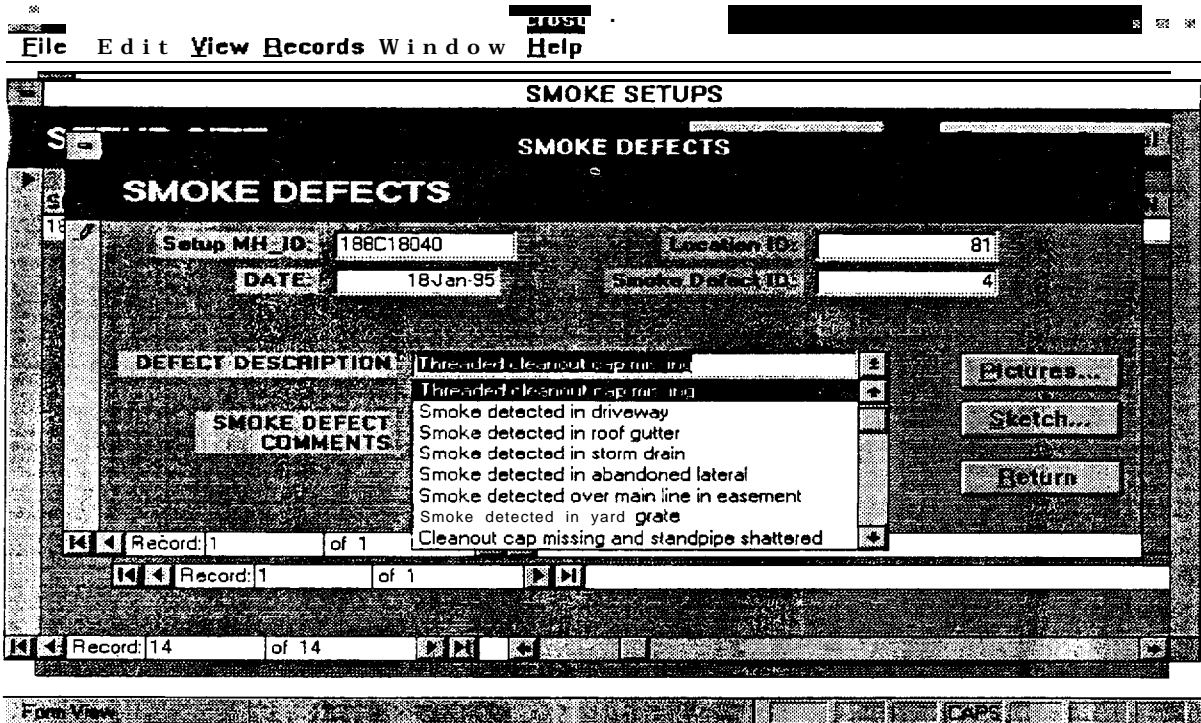

Figure 4. Smoke test defect screen.

In Figure 4, information on the observed smoke defect is recorded. A scroll-down menu lists the standard defects options. Highlighting and pressing "Enter" automatically records the selection into the database. Also, this screen has a button for pictures and sketches. These buttons activate subprograms that allow a digital photo or scanned image to be inserted in this screen. Multiple photos can be attached. Currently, field sketches showing dimensions and other information to locate the problem are being drawn on paper forms and later scanned and attached to the record when the crews are in the office. Standardized sketches with minor field drawing using computer software packages are being evaluated.

A first notice to a property owner is generated by bringing up a Microsoft Access screen called Generate Customer Correspondence (Figure 5). This screen provides the user with overall control of a variety of actions, depending on where the property owner is in the repair process. For instance, pushing the "Generate First Notice" button opens up the screen shown in Figure 6. This screen displays data buttons and menus that allow the board to access information on all the locations that were sent a first notice. Another button allows the board to find out the status and history of a specific location. This screen is shown in Figure 7. This record is where detailed information about the defect is located. For instance, the administrative issues and repair costs taken from field work orders are retrievable from this screen. If a property owner contacted the board regarding the status of work, the data could be quickly accessed from this screen.

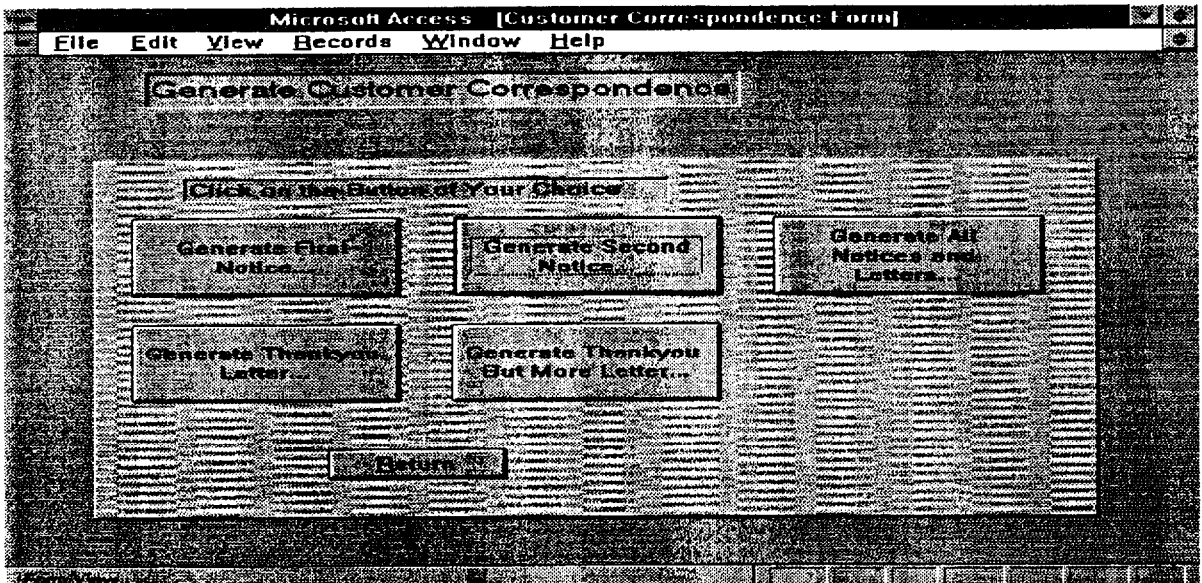

Figure 5. Customer correspondence screen.

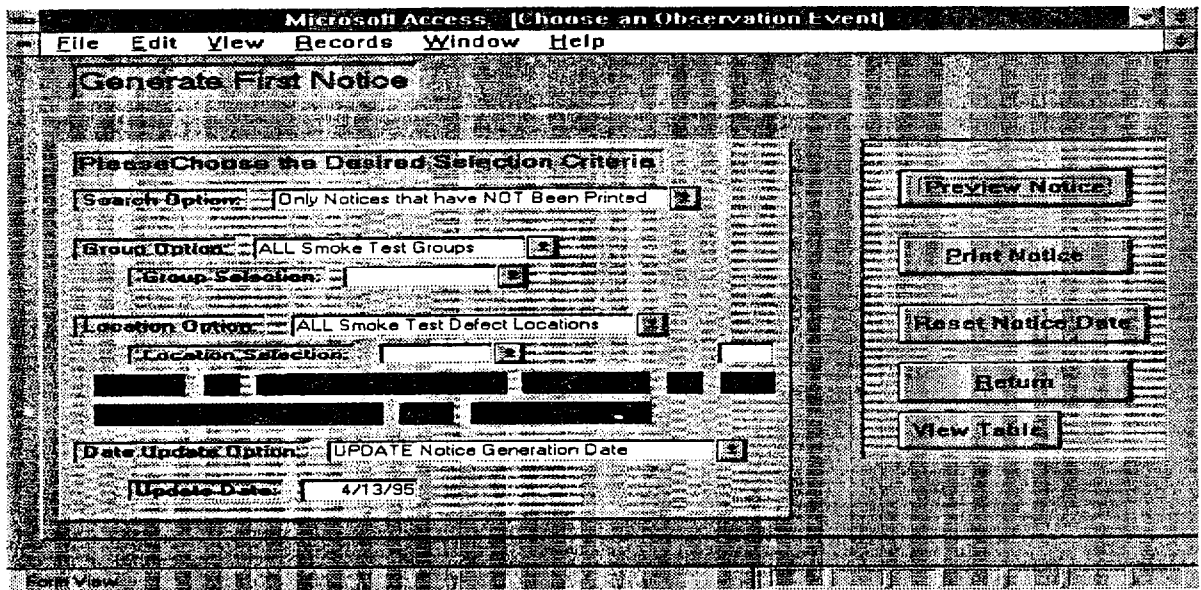

Figure 6. First notice screen.

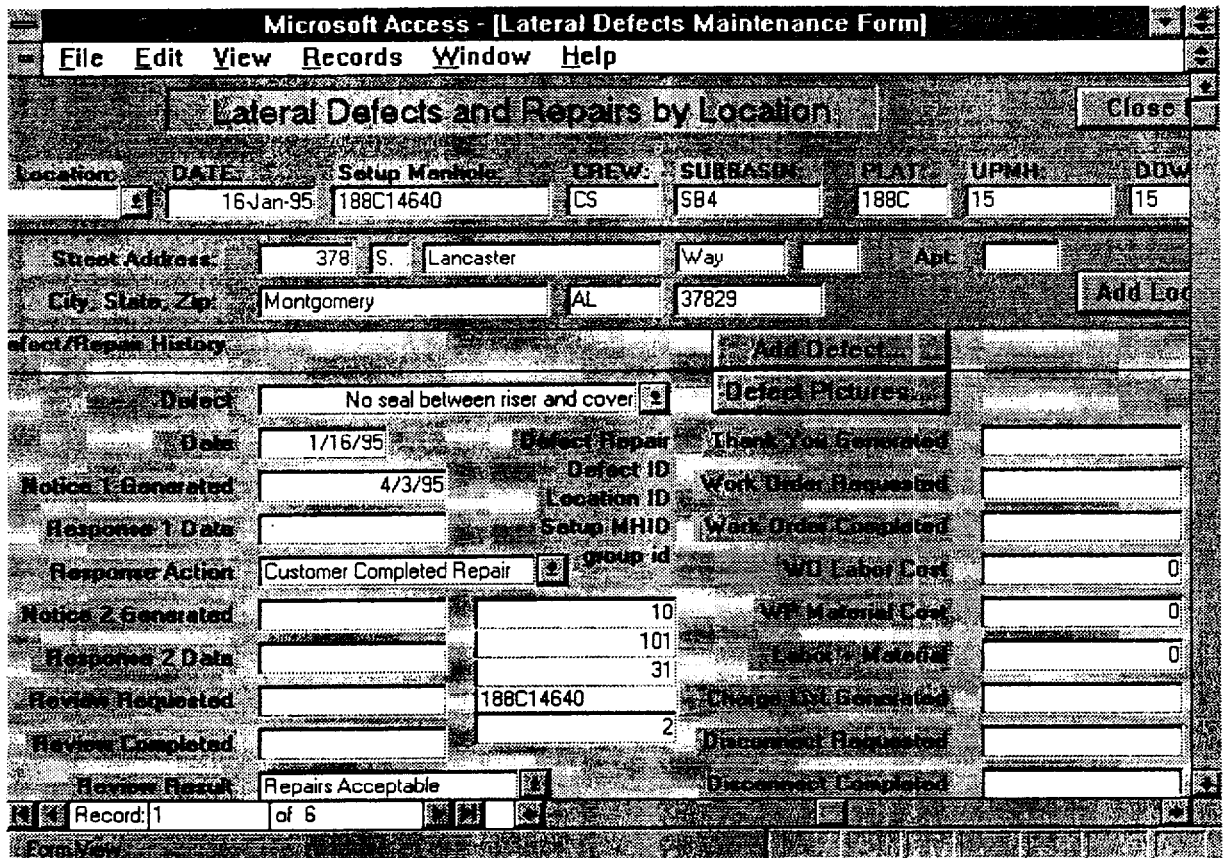

Figure 7. Lateral defects and repairs by location screen.

Positive Response of the Montgomery Area Public

The board has been using this process since the fall of 1994 with a surprisingly favorable level of participation from the public and very minimal customer resistance. Table 5 shows the areas that have been smoke tested but not yet documented in an engineering report similar to the data included in the previous tables. The data indicate that after just the first notice to property owners, 475 (69 percent) out of a total of 664 defects were repaired through the process described above. Approximately 93 percent of the individual laterals evaluated revealed only one defect. The remaining 7 percent of owners with multiple defects is possibly due to the absence of adequate lateral air pressure from the missing or broken **cleanout** cap. Defects discovered during the initial repair must also be repaired.

The 209 property owners (31 percent) who did not respond to the first notice received a second notice. Under the threat of having their water service discontinued, however, each of these customers corrected their defects. In addition, it should be noted that the **cleanout** cap problem for these areas is considerably higher than the 24-percent frequency average reported in Tables 1 through 3. The average shown in Table 5 is 97 percent.

Table 5. Private Property Lateral Response/Repair Status as of April 1995

Subdivision Area	Total Smoke Defects	Cleanout Cap Defects	First Notices	Second Notices	Board Repairs	Owner Repairs	Total Repairs
Woodcrest"	7	6	7	4	3	4	7
Hopehull ^a	36	36	36	9	21	15	36
Southlawn"	215	205	215	61	111	104	215
Carriage Hills	61	61	61	27	18	43	61
Brighton Estates	151	145	151	42	63	88	151
Halcyon	24	24	24	2	7	17	24
Regency Park	190	188	190	64	103	87	190
Totals	684	665	684	209	328	358	684

^aCatoma Basin, Subbasin 6.

Postrehabilitation flow monitoring is currently under way in the board's system; therefore, I/I reduction values are not yet available. There are strong expectations and indications that noticeable reductions will be measured, particularly downstream of subdivision areas like Southlawn and Brighton Estates.

Conclusion

Despite the strong evidence that service laterals should be included in the SSO rehabilitation plan, many communities are still reluctant to open up the proverbial public/private "can of worms." The board's experience in Montgomery to date, however, has been revealing and encouraging-particularly regarding service area systems that are less than 30 years old, in which a high percentage of lateral defects are in the upper segment, with many of those consisting of easy to repair items like missing or broken cleanout caps.

Communities that have been unwilling to pursue service lateral rehabilitation would be well **served** to review the data on Montgomery's experience and note the significant **I/I** reduction benefits that potentially can be achieved through relatively inexpensive and cost-effective innovations in policy and procedure, as well **as** the application of new technology.

References

1. Kurz, G.E., P.A. Stonecipher, C.W. **Dillard**, G.A. Ballard, L.B. Scott, and **C.Q.** Toosi. 1995. Successful sewer system rehabilitation. Alabama Water Environment Association, Orange Beach, AL.
2. Bible, D. 1991. Results from sewer rehabilitation test areas. Presented at the Water Pollution Control Federation 84th Conference, Orange Beach, AL.
3. **Wallis**, M. 1989. East Bay Municipal Utility District Infiltration/Inflow Program. Presented at the Water Pollution Control Federation Conference, San Francisco, CA (October).

Flow Monitoring and Rainfall Gauging for the City and County of Honolulu's Long-Term Sewer Rehabilitation and Infiltration/Inflow Minimization Program

Gary N. Skipper
ADS Environmental Services, Inc., San Diego, California

Felix B. Limtiaco
Department of Wastewater Management, City and County of Honolulu, Hawaii

Introduction

The City and County of Honolulu has recently negotiated a Consent Decree with the US. Environmental Protection Agency (EPA), the U.S. Department of Justice, and the Hawaii State Department of Health. According to EPA, the City and County of Honolulu has failed to operate and maintain Honolulu's wastewater collection system in an acceptable manner. At least 60 releases of untreated wastewater exceeding 1,000 gallons occurred between 1987 and 1992. The City and County of Honolulu will pay \$1.2 million in fines for violations. The Consent Decree comprises many components, including a Collection System Program consisting of a spill prevention program, infiltration/inflow (I/I) minimization program, and wastewater information management program.

Like other programs arising from Consent Decrees between EPA and municipalities, the City and County of Honolulu's Collection System Program is aimed primarily at preventing and/or reducing the occurrence, frequency, and volume of:

- Dry and wet weather spills from the wastewater collection system
- Wet weather bypasses at wastewater pump stations
- Wet weather bypasses at wastewater treatment plants

To accomplish this objective, the City and County of Honolulu has initiated a long-range plan to evaluate and rehabilitate its entire wastewater collection system. The City and County of Honolulu is committed to improving its wastewater system operations and meet the compliance requirements of the Consent Decree agreement.

Background

The City and County of Honolulu encompasses Oahu and the sparsely populated Northwestern Hawaiian Islands. Oahu is the most populated of the Hawaiian islands. It is home to 74.6 percent of the State of Hawaii's residents (nearly 900,000 people), but represents just 10.2 percent of the land. Moreover, according to the Hawaii Visitors Bureau, 4.5 million people visit the island every year, translating to an average of about 79,000 visitors each day.

The City and County of Honolulu is the sole public provider of wastewater collection and treatment services on Oahu. The collection system consists of approximately 1,900 miles of gravity and pressure pipelines; scattered throughout the system are 64 wastewater pump stations. The collection system is generally divided into 16 distinct major collection basins. Flow from 15 of these basins discharges into 12 wastewater treatment plants owned and operated by the City and County of Honolulu. The 16th major basin serves the east Honolulu community of Kuliouou and connects to the privately owned wastewater collection and treatment plant at Hawaii Kai. Several other private and military wastewater collection and treatment systems also exist on the island.

I/I Minimization Program Scope

Entry of infiltration/inflow into a wastewater collection system has many negative impacts, including the potential to create sanitary sewer overflows (SSOs), spills, and bypasses and the potential to limit sewer system capacity. A significant portion of the Collection System Program instituted under Honolulu's Consent Decree is aimed at minimizing entry of I/I into the City and County of Honolulu's collection system. The City and County of Honolulu has established a Long-Term Sewer Rehabilitation and I/I Minimization Plan with two goals: to institute cost-effective, corrective measures where necessary to minimize I/I, and to provide adequate hydraulic capacity to transport wastewater generated by Oahu residents, businesses, and visitors.

In 1992, the City and County of Honolulu contracted with Fukunaga and Associates, Inc., a local consulting engineering firm, to develop and implement the Long-Term Sewer Rehabilitation and I/I Minimization Plan. The Fukunaga and Associates project team consists of Brown and Caldwell Consultants, Belt Collins Hawaii, Inc., and ADS Environmental Services, Inc. The City and County of Honolulu is now beginning the third year of its multiyear Collection System Program investigation and evaluation effort to establish a Long-Term Sewer Rehabilitation and I/I Minimization Plan with these firms. All work is being conducted in accordance with the guidelines and performance standards described in EPA's handbook *Sewer System Infrastructure Analysis and Rehabilitation* (1).

The Long-Term Sewer Rehabilitation and I/I Minimization plan has been developed and is being implemented in three phases. The first phase is an I/I assessment phase consisting of three stages:

- Stage 1-Interim I/I assessment
- Stage 2-Preliminary cost-effectiveness assessment
- Stage 3-Final long-term sewer rehabilitation and I/I minimization plan

The assessment is being performed to determine the extent and severity of I/I entry into the collection system. The assessment includes an analysis of the hydraulic capacity of the collection system and an assessment of corrosion in and the structural integrity of the entire wastewater collection system. Importantly, portions of the collection system exhibiting negative impacts from I/I, corrosion, and/or structural integrity deficiencies will receive highest priority for rehabilitation.

In the second phase of the Long-Term Sewer Rehabilitation and I/I Minimization Plan, the pilot study phase, basins in the collection system exhibiting negative I/I impacts and/or structural integrity deficiencies will be targeted for I/I minimization, to be accomplished by rehabilitating the sewers. The cost-effectiveness and success of available sewer system rehabilitation methods and techniques will be evaluated.

The third phase of the Long-Term Sewer Rehabilitation and I/I Minimization Plan is rehabilitation. Based on the results of the first two phases of work, the City and County of Honolulu will undertake a **20-year** island wide rehabilitation program to improve its wastewater system operations and meet the compliance requirements of the Consent Decree.

Significant deadlines for work under Long-Term Sewer Rehabilitation and I/I Minimization Plan (as established in the Consent Decree) are shown in Table 1.

Table 1. Sewer Rehabilitation and I/I Minimization Deadlines

Plan Component	Completion Deadline
Phase 1 - I/I assessment	
Stage 1 - Interim I/I assessment	October 31, 1994
Stage 2 - Preliminary cost-effectiveness assessment	December 31, 1995
Stage 3 - Final plan	December 31, 1999
Phase 2 - Pilot study	December 31, 1998
Phase 3 - Rehabilitation program	December 31, 2019

EPA Guidelines for I/I Assessment

According to EPA's *Sewer System Infrastructure Analysis and Rehabilitation* handbook, the first step in I/I assessment is to identify "problem" areas by reviewing and analyzing existing wastewater treatment plant and pump station flow monitoring records. EPA has established a peak flow limit of 275 gallons per capita per day. Areas of the collection system with higher peak flows are considered to have excessive I/I and are targeted for a cost-effectiveness analysis. Problem areas also include areas with known peak flow bypasses. Cost-effectiveness analysis of problem areas determines whether flows generated in the areas should be minimized or transported for treatment.

Existing Flow Monitoring Records and Pre-Consent Decree Studies

The City and County of Honolulu has a Supervisory Control And Data Acquisition (SCADA) system that collects data from 103 sites around the island. Flow monitoring data is collected at 47 wastewater pump stations and at all 12 wastewater treatment plants. Relevant flow monitoring information from the SCADA and other sources was reviewed and analyzed. This information consisted mainly of:

- Wastewater treatment plant SCADA flow records.
- Wastewater pump station SCADA flow records.
- Previous reports, including the 1986 Islandwide Sewer Adequacy Project (ISAP).
- Other pertinent information, including precipitation data and ground-water levels.

A common misperception is that the 1986 IAP study was intended to be the City and County of Honolulu's initial I/I analysis effort. In fact, I/I analysis was the secondary objective of the IAP study. The primary purpose of the study was to inventory and determine the hydraulic adequacy of the sewer system as it existed in 1986. Lack of significant rainfall during most of the study period prevented I/I analysis of the flow data collected.

First-Year Flow Monitoring and Rainfall Gauging Program

Based on the review and analysis of existing flow monitoring information, a first-year flow monitoring and rainfall gauging program was developed. The program plan noted the need to use several different types of flow monitors (gross flow monitors, intensive flow monitors, special purpose flow monitors, and rainfall

gauges) to obtain a better understanding of collection system hydraulics and system responses to wet weather events.

Gross Flow Monitors

Gross flow monitors are monitors that are permanently installed over a relatively large area to give a broad picture of the range of I/I problems over the area. Gross flow monitoring sites were located at strategic positions in the City and County of Honolulu's collection system to facilitate verification of computer hydraulic models of the collection system. Sites included 22 existing SCADA sites at wastewater treatment and pumping stations, 52 new gross flow monitoring sites in the collection system, and 8 sites converted from intensive to gross flow monitors (total of 60 gross flow monitors). Data from the sites were used to identify relatively large areas of the collection system without significant I/I (that can be eliminated from further study) and to identify and prioritize areas with significant I/I (requiring more intensive investigation/ study). Tributary wastewater drainage basin areas to gross flow monitoring sites are approximately 100,000 lineal feet of sewer main, excluding building laterals and other service connections.

Intensive Flow Monitors

Intensive flow monitors cover small, high I/I areas within gross flow monitoring areas. They are generally left in place for short periods (less than 12 months). Based on existing flow monitoring records and pre-Consent Decree studies, six parts of Oahu had previously shown evidence of significant I/I and were recommended for intensive flow monitoring:

- Ahuimanu
- Kaneohe
- Kailua
- Wahiawa
- **Whitmore** Village
- **Kahala/Kuliouou**

Under Honolulu's first-year flow monitoring and rainfall gauging program, a total of 48 intensive flow monitors were placed in these areas. The 48 sites were selected to facilitate identification of relatively small subareas without significant I/I (that can be eliminated from further study) and to identify and prioritize subareas with significant I/I (for later Sewer System Evaluation Surveys [SSES]). The sites were also selected to facilitate detailed verification of computer hydraulic models of the collection system and the cost-effectiveness analysis. Tributary wastewater drainage basin subareas to intensive flow monitoring sites are approximately 25,000 lineal feet of sewer main, excluding building laterals and other service connections.

Special Purpose Flow Monitors

Special purpose flow monitors were installed at some wastewater treatment plants because existing flow monitoring equipment was insufficient to measure and record the upper end of the range of peak flows known to have occurred at the plants. Special purpose flow monitors were installed at other wastewater pumping stations because the stations did not have flow meters. The State of Hawaii's Department of Health required flow data at these sites to determine the acceptability of construction of bypass facilities.

Rainfall Gauges

Precipitation on the island of Oahu varies greatly by location, in part because of the island's diverse topography. Average annual precipitation is as low as 19 inches per year on the leeward side of the mountain and as high as 78 inches per year on the windward side of the island. In general, higher elevations receive more rain than do lower elevations. A total of 12 rainfall gauges were installed to monitor precipitation in the first-year study area..

Flow Monitoring and Rainfall Gauging Equipment

The City and County of Honolulu's 1986 IAP study flow monitoring efforts had revealed a wide range of hydraulic flow conditions, including backwater and surcharge conditions. Because the velocity-based continuity equation must be used under nonfree flow conditions (such as backwater and surcharge), use of flow monitoring equipment with velocity and depth sensors was mandatory for the current project. Equipment manufactured by ADS Environmental Services, Inc., was provided for the project.

The gross flow monitoring units are equipped with modems to permit access, interrogation, and downloading of collected data via telemetry from a remote location. Knowing that flow monitoring would be a multiyear effort, the City and County of Honolulu decided at the onset of the flow monitoring program to purchase the gross flow monitoring equipment.

The intensive flow monitoring units are not all equipped with modems, thus, they are accessed, interrogated, and downloaded on site using a laptop computer.

Results

Nearly 300 proposed flow monitoring sites were field investigated to locate suitable conditions for the approximately 100 gross and intensive first-year flow monitoring sites. Gross flow monitors were in place from late December 1992 through the end of December 1993. Intensive flow monitors were in place from late December 1992 through the end of March 1993. The Interim Sewer Rehabilitation and Infiltration and Inflow Minimization Plan (2) noted that:

A major setback encountered during the first year program was an overall lack of rainfall during the monitoring period. As a result, only sparse wet weather data was available for analysis and therefore a firm statistical base for the interim results was not provided. The storm event[s] used for analyses were typically less than a 1-year recurrence interval. The resulting flow data from these low intensity storm events were used to synthetically project design flows for a 5-year rainfall. Since in most cases only a single storm was available for analysis, the design flows were linearly extrapolated. It is anticipated that additional data collected in subsequent years of the flow monitoring program will provide a stronger statistical basis for the I/I Assessment Study.

Flow monitor basins and results of the flow data analyses (including projected I/I rates) are shown in Figure 1. Projected wet weather I/I rates for the 82 gross flow monitoring basins are:

- Low (less than 2,750 gallons per acre per day) in 14 basins
- Moderate (2,750 to 10,000 gallons per acre per day) in 38 basins
- High (greater than 10,000 gallons per acre per day) in 24 basins

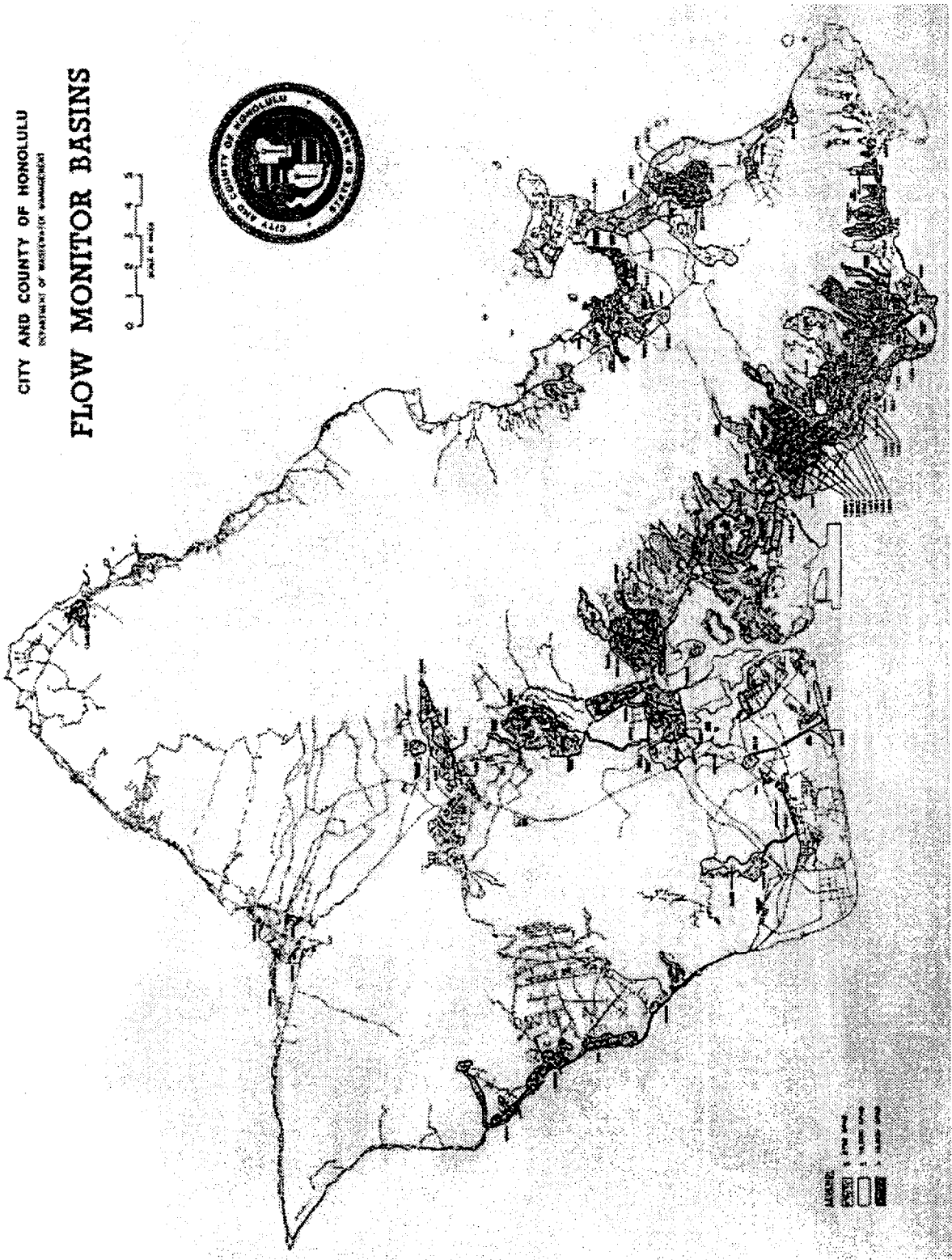

Figure 1. Projected I/I rates in the flow monitor basins.

Second-Year Flow Monitoring and Rainfall Gauging Program

Due to the lack of significant rainfall during the first-year program, several changes were made to the second-year flow monitoring and rainfall gauging program. The City and County of Honolulu elected to purchase the intensive flow monitor units to make cost-effective the option of leaving the units in place until a significant number of rain events occurred. The units were equipped with modems and were identical to the first-year gross flow monitoring equipment previously purchased by the City and County of Honolulu. Having modems would allow conversion of the intensive flow monitors to gross flow telemetered monitors, if needed.

The second-year flow monitoring and rainfall gauging program began in late November 1993 with the installation of:

- 51 intensive flow monitors
- 4 new gross flow monitoring sites (for a total of 64)
- 13 new rainfall gauges (for a total of 25)
- 15 new staff gauges for surcharge indication

In addition, the 22 SCADA sites used for I/I analysis were retained for the second-year program. Several first-year gross flow monitors were relocated based on a better understanding of system configuration and flow routing, and several stations were relocated to different sites with better hydraulic conditions. The staff gauges were placed in selected manhole locations to provide a qualitative indication of suspected surcharge conditions at nonflow monitored sites.

By mid-November 1994, at least three significant rain events had occurred at most of the intensive flow monitoring locations. Based on this knowledge:

- 22 intensive flow monitors were relocated
- 2 new intensive flow monitors were added
- 2 gross flow monitors were relocated
- 4 intensive flow monitors were converted to gross monitors

This brought the total number of gross flow monitors to 68 and the total number of intensive flow monitors to 49 (117 sites total).

Although the results of the second-year flow monitoring program are currently being reviewed and analyzed, the City and County of Honolulu's decision to purchase the intensive flow monitoring equipment appears to have been wise. Rain events were sporadic and widespread during the second-year program, and most occurred outside the typical rainy season. Because the City and County of Honolulu had the intensive flow monitors in place for an extended period, most locations have received a minimum of three significant rain events, permitting I/I analysis. The second-year flow monitoring program concluded at the end of February 1995.

Third-Year Flow Monitoring and Rainfall Gauging Program

The third-year program started at the beginning of March 1995. A significant rain event occurred islandwide at about that time. The results of that rain event will be analyzed as a part of the second-year I/I analysis. The third-year program will continue through March 1996. Currently, 68 gross flow

monitoring locations, 49 intensive flow monitoring locations, 15 SCADA sites, and 25 rainfall gauge units are operating.

Conclusions

Flow monitoring and rainfall gauging are being 'conducted on a gross and intensive basis under the City and County of Honolulu's Long-Term Sewer Rehabilitation and I/I Minimization Program. The gross flow monitors are being used to provide baseline data to identify and isolate large basins without significant I/I, so that those basins can be eliminated from further study. The intensive flow monitors are being used to provide subarea flow data within gross flow monitor basins that have significant I/I. A lack of rain events during the first-year data collection period prompted the City and County of Honolulu to change the number and location of monitoring and gauging sites to increase the likelihood of capturing rain event flow data; these changes resulted in success. The City and County of Honolulu's Flow Monitoring and Rainfall Gauging Program is expected to facilitate hydraulic computer model calibration, evaluation of future increases in sewer flow and I/I, correlation of flows from different rain events and years, identification of high I/I portions of the sewer system, and evaluation of I/I reduction efforts.

References

1. U.S. EPA. 1991. Handbook sewer system infrastructure analysis and rehabilitation. **EPA/625/6-91/030**. Cincinnati, OH.
2. Fukunaga and Associates, Inc. 1994. Interim sewer rehabilitation and infiltration and inflow minimization plan. Executive summary. Honolulu, HI.

Additional Reading

Fukunaga and Associates, Inc. 1993. Long-term sewer rehabilitation and infiltration/inflow plan gross and intensive flow monitoring plan (first year flow monitoring). Draft final report. Honolulu, HI.

Fukunaga and Associates, Inc. 1993. Technical memorandum. Second year flow monitoring program. Honolulu, HI.

Pacific Business News. 1994. All about business in Hawaii. Honolulu, HI.

The Use of Sewer Monitoring Information for Operation and Maintenance

Thomas J. Day
Water Department for the City of Philadelphia, Philadelphia, Pennsylvania

Overview

Many companies that provide sewer monitoring equipment sell or provide software to retrieve their data and review it in a static fashion. This discussion focuses on the dynamic use of sewer data for maximized operation and maintenance, and discusses additional benefits that can be derived from the obtained information. The discussion also covers the system, dynamic evaluation of the data, and retrieval and use of the information.

Introduction

Some form of a permanent sewer monitoring system will assist municipalities in determining sanitary flows and thereby assist in preventing sanitary overflows. The effective placement of the devices making up the sewer monitoring system and the evaluation of the data collected can provide the operator with an intimate knowledge of system's characteristics. This will allow the operator to enhance operation and maintenance activities.

There is a trend for operators of sanitary, combined, or pressure systems to build computer models at great expense to simulate flows within the system. Although this is an alternative, the results from these computer models tend to be marginal at best without extensive investment of resources. Also, computer models require actual data to calibrate them properly. This requires some type of active monitoring of the sewer system. Therefore, a commitment to monitoring the sewer system becomes necessary whether a computer model is used or not. The purpose of this paper is to provide insight concerning the alternate use of sewer system monitoring on a dynamic basis to provide operators with useful and dynamic operations and maintenance information as well as engineering data.

Determining the Cost of a Monitoring System

The age of inexpensive electronics has caused a technology revolution within the instrumentation industry that has gone fairly unobserved. The effect of these changes has been felt, however, through the entire industrial environment. It has produced a variety of low-cost alternatives and enhancements that were not available 5 years ago. This radical change in the face of instrumentation has allowed for more utilization of existing equipment and the use of low cost PC-based systems for analysis and process. Therefore, the aggregate cost of monitoring is (or should be) substantially less than it was just a few years ago and may decrease in future years. This allows the placement of a more extensive monitoring system than could have been installed several years ago with the same budget. In this way, a municipality can prepare a capital program for several years ahead, knowing that the amounts budgeted should be sufficient to purchase more hardware for the same cost in future years. This is also supported by the relative stability of labor costs over the same time frame.

In the budget planning process, a municipality must be aware of the relative cost of monitoring instruments, computer hardware and software, and required support services. The municipality can start this process by addressing several questions:

- How extensive will the monitoring system be?
- What is the current budget for operation and maintenance of the sewer system?
- Can the municipality's work forces install the monitoring system and collect the data, or will outside help be required?
- If outside help will be required, how much help will be needed?
- What is the current regulatory climate for fines and court orders?
- What are the current budgetary constraints? Will the current sewer rates fund the budget necessary for the monitoring system?
- Can additional connections be made to the sanitary sewer system to finance this endeavor?

The answers to these questions will help determine the budget needed for the monitoring system.

An estimate of relative costs needs to be developed for purchase and installation of the monitoring system. Soliciting vendor input is critical in obtaining fair and reasonable pricing for budgetary purposes. First, develop a wish list of network instrumentation needs. When you are sure of the needs, request cost proposals from vendors who have good track records in this area. This will aid in keeping your costs in line with necessary target budgets. Also, listen to input from the vendors, because they are experienced in this area and can give you valuable advice about designing and implementing the target system, as well as share real experiences from other contracts. Vendors can provide tremendous insight into the particulars of installation, performance, and operation and maintenance of their equipment. Some of these unique aspects may not have been considered by the specification writer and should be integrated for a more complete package. Be certain to check references for verification of the successes the vendors are relaying. Vendors provide the cutting edge of technology to the market; their input dramatically increases the monitoring system's potential for success.

Always remember that the utility is expecting a cost savings by installing a monitoring system, even if solely to detect sanitary overflows. This is how the utility operator justifies these programs to the ratepayers and administrative boards. The extra benefit is the use of this information for operations and maintenance purposes. Multiple benefits for a single project usually sell better than straight compliance activities alone.

Choosing Instrumentation

The choice of instrumentation is generally based on the budget allocation. This author recommends that monitoring systems include the ability to measure velocity, even if it is not used for flow calculations. The ability to determine whether there is forward motion in the system gives operators very specific and imperative information about conditions within the sanitary sewers. The affordability of velocity equipment, however, along with the extra maintenance required to keep it functional, may make such systems cost-prohibitive. Therefore, two versions of monitoring systems will be discussed: the level-only monitoring system and the level and velocity (flow) monitoring system. These discussions will enable readers to determine the best monitoring system for their circumstances based on the type of system and budget.

In the level-only monitoring system, a reasonable representation of the sewer system can be afforded by the critical placement of level sensors at strategic points in the sewer systems: where high levels may indicate blockages during dry weather flow, where sanitary discharges are suspected, or in areas of

special interest to the operators. The general condition of the sewer system, its relative age, and current maintenance procedures should be evaluated first:

- Are there accumulations of silt, grit, or debris within the system?
- How old are the sewers?
- Do other extraordinary conditions need to be evaluated?

These questions will help the operator decide whether ultrasonic or bubbler devices should be used. If flow levels are high and the critical areas are fairly inaccessible, then ultrasonic devices may provide the best results. Generally, the pressure transducer is the least expensive device and easiest to maintain. Stilling wells serve not only to protect the devices, their cables, and mounting hardware from flowing debris, but also can be used to establish a basepoint for determining references within the system. Stilling wells also reduce or eliminate turbulence in the flow surrounding the monitoring device. This is critical to the performance of any ultrasonic device and provides relative stability for the remaining technologies. Stilling wells also help personnel locate the devices for modification, replacement, or maintenance.

Level devices usually have standard **4- to 20-milliampere** or **1- to 5-volt** linear output signals. Most standard remote terminal units, dataloggers, or programmable logic controllers accept these signals. As a result, several different level sensors are available, and many can be purchased with limited funding. Where budget constraints effect the extent of the monitoring system, the level-only system provides the operator with the most useful information at the lowest cost. Additionally, where overflows are suspected or are known to occur, these devices can be placed within the overflow structure to gather information and provide alarms for high levels. Operators are cautioned, but encouraged, to standardize the instrumentation on a systemwide basis to maintain uniformity in stock for replacement parts.

This author prefers a flow quantification monitoring system where actual velocity measurements are used to verify movement of the wastewater. Although more expensive than the level-only monitoring system, this alternative provides a clearer representation of the conditions within the sewer system. For example, a blockage usually produces a high level of wastewater in a sewer but little or no velocity. Consequently, a level-only monitor will give a false indication of the actual condition in a blocked sewer. This is critical for troubleshooting the system to determine whether a sanitary overflow has occurred or may occur. Therefore, flow quantification equipment should be placed in areas where actual flow rates are unknown or flow quantification is desirable. Budget conditions may permit a mixed and matched system with some flow measurement. Critical flow points can then be monitored with most other points reserved for level-only.

Flow quantification equipment can be quite expensive; therefore, care should be taken when developing a level and velocity monitoring system. The information derived from the flow quantification approach usually justifies the extra expense encountered in equipment and installation.

Committing Resources

The operating agency of the sewer system must make a commitment of resources to maintain the equipment. This commitment can be realized through either contract operations or use of in-house personnel with the necessary expertise. Contract operations are generally preferred to using in-house personnel, not because of the skill level of the technicians but because municipal procurement policies regarding the purchase of necessary parts and supplies to maintain the workforce are usually cumbersome and inflate the costs. In addition to procurement policies, third-party verification of equipment becomes advantageous if it becomes necessary for the local governing authority to take legal action for an overflow condition caused by a private operator or property owner. Depending on the commitment made by the municipality, an in-house operation may be very successful. Some

municipalities have been able to develop in-house expertise to a point where the municipal workers are superior to the contract workers.

Contract operations, however, are a way to downsize governments and reduce costs. For example, the City of Philadelphia has received bids to completely maintain the wastewater monitoring system instrumentation for both sanitary and combined sewers. The successful vendor has proposed to perform the work for the cost of approximately five technicians at current municipal wages only (not including overhead or benefits). As a result, the city will not have to store spare parts or supplies; maintain vehicles, tools, shop facilities, or other items necessary for these activities; or pay overtime to city workers.

The commitment of resources is critical for the continuation of any monitoring system. Analyze your current fiscal and political status. The decision to maintain the new monitoring system in-house or provide contract operations is best made at system installation.

Quantifying the Sewer System

A monitoring system will not be useful unless specific knowledge of the sanitary sewer system is obtained first. The key is to look at the sanitary system as a whole, not just its individual branches:

- Where are the known trouble spots?
- Where are the overflow points?
- Do they cause problems?
- Are there hydraulic constraints within the sanitary system?
- Do any junction points cause hydraulic problems?

Many questions such as these can be answered by reviewing drainage plats if they are available.

The best source for obtaining information about the sanitary system and its intricacies, however, is the workers responsible for the operation and maintenance of the system. These workers know the system. They know where the trouble spots are, and which are critical. A successful monitoring system will include the operation and maintenance workers in the information collection phase because a **complete** and accurate understanding of the sewer system is needed to develop a meaningful monitoring system.

Deploying the Network

The single most difficult task in developing a base monitoring network is to choose the monitoring **location** points. Installation of monitoring equipment is usually easier than trying to select the location within the structure that will be the most useful. Level sensors are usually better located in the manholes prone to overflows, while flow measurement devices are best located in main intercepting sewers or branches feeding main sewer systems. Again, intimate knowledge of the sanitary sewer system is the best basis for selecting monitoring locations.

Some form of communication with the monitoring equipment is essential if early warning systems are to be set up to predict overflows. The least expensive telecommunications technology available today appears to be standard telephone **dialup** lines. These have significant cost and logistical advantages over radio transmitters or other similar devices to communicate information.

The monitoring system should include one or more rain gauges (the number being dependent on the size of the sanitary sewer system), level detection equipment at critical overflow manholes and at points of interest, and velocity (flow) gauges if the budget allows such usage. The data collected by the instrumentation must be transmitted to a central computer with software able to interrogate the instrument, store the data transmitted, and alert the operator if a problem exists.

The interval in which the data is collected is important. Data collected infrequently may not be a good representation of the conditions within the sewer, and data collected too frequently may bog down the computer with unnecessary and possibly redundant information. The current standard used by the City of Philadelphia is a 5-minute average of samples taken every 5 seconds. This standard is presently being reevaluated and will likely be reduced to a 2.5-minute average of samples taken every second. Averaging small increments of data is acceptable because there is still a qualitative contribution of the data point. A data format of 15-minute to 30-minute point intervals has the inherent potential for missing pump cycles or other hydraulic effects, which may not properly represent conditions within the sewer system. Watch the data interval closely to be sure that all possible conditions are reflected in the format.

Data collection and analysis are easy and more flexible today with standard PC-type software. The data can be stored in individual files using, for example, a 24-hour time frame (midnight to midnight), as is currently used by Philadelphia, or in one large data file per location with time and date stamps for a month at a time. Philadelphia is presently considering a change to the single file per location procedure. This discussion uses the midnight to midnight, 24-hour data format because it is a good way to begin implementation of monitoring-based maintenance,

Identifying Sanitary Sewer System Characteristics

The first use of a monitoring system should be to learn about the general behavior of the sanitary sewer system. To accomplish this, monitoring data should be collected for at least 1 month. Data might have to be collected for a longer period because the data should include some significant storm events. The significant storm events should range from minor events (a 1-year storm) to major events (intense 5- or 10-year storms or greater). The data should be viewed graphically over the entire period, which will allow the operator to see the general characteristics of the sanitary system during periods of normal (or dry weather) flow and storm-related flow.

The first variable in a sanitary sewer system study is the effect of the treatment plant on system response. Unexplained rises and falls in the level of the sewer system sometimes can be attributed to gate or pump action at the treatment plant. A review of the treatment plant's operations logs or discussions with plant operators will usually reveal when and by how much gate positioning has changed and the status of pumps. This information will give the system operator valuable insight into the general characteristics of the sanitary system during dry weather conditions. The system operator may also want to try coordinating a temporary closing or dipping of the gates at the treatment plant to study the effects this action has on the sewer system response. Activities such as these give the system operator general information on how the sewer system behaves under known and controlled conditions and will help the system operator predict the response to uncontrolled conditions.

A sanitary system that includes pumping stations may experience "treatment plant" effects in several areas of the sewers. If the pump station has a wet well that is operated by a level switch, the cycling of the pump or pumps can affect the sanitary system upstream of the pumping station, especially if the flow is entering the pumping station faster than the pump or pumps can handle. Knowledge of this effect, which can be observed from strategically located monitoring points, will also help the system operator become familiar with the general characteristics of the sanitary system.

Monitoring will also help the system operator understand the response of the sanitary system to the effect of regulators and tide gates in combined systems for which the sanitary may be tributary. The actions of regulators and tide gates tend to affect the upstream sanitary portion of the combined

collection/ conveyance system. This is a condition found in many older urban areas, where flow in the older combined sewers (generally located closest to the treatment plants) starts to back up the newer sanitary lines. The actions in these combined systems tend to be very complex but can be predicted based on intuitive knowledge of the entire system using monitoring information. Knowledge of the actions within a combined collection system is extremely important, given the fact that the actions can lead to combined sewer overflows (CSOs) or sanitary sewer overflows (SSOs), depending on the critical hydraulic points.

Tides and tidal patterns are unique characteristics generally affecting CSOs but have specific effects on SSOs as well if tributary to combined sewers, a condition particular to expanding older cities. Monitoring can be used to determine whether tidal changes are affecting either sewer system. An examination of tidal patterns can be correlated with monitoring data to evaluate conditions within the combined system:

- Do dry weather flows change during high tides?
- Do CSOs or sanitary sewer overflows occur during dry weather?

Many questions such as these can be answered by analyzing the monitoring data, the answers to which allow the system operator to provide proper maintenance for the entire sewer system.

Municipalities providing wastewater collection and treatment services for tributary municipalities on a contract basis will benefit from the data collected by a monitoring system. The point at which a tributary sanitary system connects to the host system can be the source of problems upstream in the tributary system as well as downstream in the host system. Monitoring can provide information as to the hydraulic conditions above and below the point of connection:

- Does the tributary flow surcharge the host system and cause a backup below the connection point?
- Does the tributary flow cause a backup above the connection point?
- Do backups occur only during wet weather flows?
- If tributary to a combined system; does the tributary flow cause an SSO either at the metering chamber or somewhere downstream?

Monitoring will provide the keys to answering these questions, allowing the system operator to isolate and resolve problems. Monitoring provides a fair and more accurate bill for the customer as well.

Watching the general patterns is also very critical. The City of Philadelphia assisted the Township of Lower Moreland in locating and prosecuting an illegal dumper of wastewater based on changes in the normal flow pattern. Here is an example of not only good system maintenance but extending aid to suburban customers in finding problems within their systems.

Evaluating data collected through monitoring in conjunction with other known data will provide system operators with information to verify or dispel assumed conditions or characteristics of the sanitary system. Monitoring will also provide knowledge about conditions that warrant further investigation. Sanitary system monitoring will demonstrate that every sewer system is unique and has identifying characteristics. Generalizations cannot be made about the conditions or characteristics of sanitary sewer systems without first evaluating monitoring data gathered dynamically.

Implementing Maintenance Programs

A sewer system monitoring network will assist municipalities in implementing maintenance programs. Maintenance for a sanitary system can be reactive, predictive, or preventive. Once sanitary system characteristics are known and baseline conditions established, the monitoring data can be used to direct the type and method of maintenance required. Reactive maintenance uses these monitoring data to pinpoint problems as they are occurring or shortly thereafter:

- Do the data indicate that an area of the sewer system is experiencing dry weather flow significantly higher than normal?
- Does a velocity meter indicate that the velocity in another area has significantly decreased?
- Has the level in a monitoring manhole increased?
- Are there apparent dry weather discharges or bypasses?

If the data indicate a positive response to these or similar questions, then a problem probably exists, and maintenance workers can be dispatched to make the necessary repairs, on an emergency basis if needed.

Sometimes the data will indicate certain trends, such as periodic high dry weather flows in a specific area. Maybe a reactive maintenance crew has cleared a debris buildup from the same area repeatedly. Data such as this can be used to predict problems before they develop, allowing repairs to be made before reactive maintenance becomes necessary. This is known as predictive maintenance. Monitoring data can also be used as an indicator for determining whether preventive maintenance procedures, which should be ongoing, are being followed. The preventive maintenance program should grow out of the reactive maintenance program.

Providing System Benefits

In today's climate of tight fiscal responsibility, return on investment becomes a strategic point. Sanitary sewer monitoring systems and overflow alarms do not appear to yield any direct return on investment except for those meters recording flow at tributary municipality connection points. These flow meters provide the system operating agency with accurate flow data for billing purposes. Sanitary sewer monitoring systems and overflow alarms do have the potential for significant indirect returns on investment. The indirect returns on investment can be attributed to the savings that can be realized by using the data gathered by the monitoring system to implement both emergency and nonemergency repairs or to quickly react to overflow alarms. When data are evaluated and reacted to properly, small problems can be resolved before they become large, costly problems.

Another benefit of a monitoring system is that it can provide documentation for regulatory agency compliance. With system monitoring, a system operator has readily available documentation about the following:

- Overflow events (times, durations, actions taken)
- Maintenance activities (discovery, actions taken)
- Comments about individual events, if necessary

Documentation gives the system operator and the regulatory agencies information about the system operator's good-faith efforts to identify and correct problems within the system, as well as provides records of maintenance for planning purposes.

The issue of documentation is also reinforced here as the ability to verify maintenance crew activities by observing the daily flow or level patterns. This method can provide productivity information without strictly relying on field personnel reports. If the event logs are used for recording field activities, they can be verified through daily flow or level pattern recognition.

System monitoring will also allow the system operator to see what impact infiltration and inflow (I/I) are having on the sanitary system. Dry weather flow levels in the sewer system can be compared with wet weather increases. Increased wet weather flow levels in a separate sanitary system, or in the sanitary portion tributary to a combined system, will generally indicate the presence of I/I. Monitoring gives the system operator the ability to dispatch maintenance crews to those areas indicating I/I for investigation and possible repair. These patterns require observation for significant time frames to determine ground-water recharge and discharge, and should be used in conjunction with accurate rain information. Increased flows or levels in specific areas of the sewer system during dry weather periods may indicate unreported broken or leaking water mains or hydrant abuse. Again, maintenance crews can be dispatched to rectify the situation.

System monitoring will allow sewer system operators and treatment plant personnel to see what impact the treatment plant is having on the sanitary sewer system and vice versa. Some sanitary system backups and overflows can be attributed to actions by the plant operators at critical hydraulic points within the treatment plant during both dry and wet weather conditions. Sewer system operators and treatment plant personnel can and should work together with the monitoring data to develop strategies for determining and maintaining critical hydraulic heads, system responses, and ultimate actions before, during, and after storm events.

Summary

The dynamic use of sanitary sewer monitoring information can provide system operators and treatment plant personnel with many benefits other than regulatory compliance. The Philadelphia Water Department implemented such a program in 1989 which continues today with tremendous success. The enhanced knowledge of system responses, the ability to dispatch maintenance crews based on alarm conditions, the ability to predict problems, the ability to determine I/I, and the ability to see specific hydraulic responses based on in-system action all are tools the sewer system operator can use to develop the best and most efficient methods for operating the entire system. Long-term evaluation of the data will also provide sewer system operators with the maintenance information necessary to develop ongoing maintenance programs. Dynamic information utilization also provides documentation for regulatory agency use with respect to the operation and maintenance of the system. Information concerning tributary systems can also be obtained and, at times, aid another community in its own system maintenance. By utilizing computer technology and obtaining the data dynamically every day, additional benefits can be realized for the investment in a sanitary system monitoring network.

Sanitary Sewer Overflow Institutional Issues: How Did We Get Here, and Where Are We Going?

Roger C. Hartung
Roy F. Weston, Inc., Fort Worth, Texas

The objective of this paper is to review the past events and practices that led to the current dialogue concerning a national U.S. Environmental Protection Agency (EPA) policy on sanitary sewer overflows (SSOs), as well as the issues that face those involved in solving SSO problems today.

In many areas of the country, the sanitary sewer infrastructure has greatly deteriorated. As a result, rainfall-induced infiltration and inflow (I/I) is rampant, and SSOs pop up throughout the sewer collection system all too frequently. In many cities, understaffed and under equipped operation and maintenance (O&M) crews are forced to “fight fires” during stormy weather by installing temporary check valves to keep private lateral lines from allowing sewage backups into homes. Other cities experience hundreds of citizen complaints and send out cleanup crews to “sanitize” sewer overflow areas after the SSOs have subsided. Children run through wastewater from SSOs that continue from manholes hours, even days after storm events have passed. Untreated wastewater from overflowing manholes discharges into streams and rivers at numerous uncontrolled locations when it rains. In past years, and even today, public utilities fail to report a vast number of these wet weather SSOs to regulatory agencies for fear of mandatory directives from those agencies to alleviate the overflows.

How did we get to this condition? With admittedly 20/20 hindsight, this paper attempts to explain the events and institutional policies that contributed to the current condition of our many sanitary sewer systems.

It has been said that if we are ignorant of the past, we are doomed to repeat it. While this may not always be true, we should certainly try to learn from past mistakes. How were SSOs viewed and addressed by cities and utilities in the 1970s, 1980s, and 1990s? What role did EPA, state environmental agencies, and consultants play in how cities coped with their SSOs? Why were certain technical approaches so popular? EPA and state policies are still a major factor in the way cities do business in the wastewater treatment arena. SSOs are no exception.

The 1970s

in the 1970s, the Clean Water Act (CWA), as it pertained to publicly owned treatment works (POTWs), was viewed by Congress, EPA, state governments, and public utilities as a public works statute. Cities and consulting firms now fondly refer to those years as the “good old days” because the flow of EPA and state grant monies seemed endless. Congress appropriated billions of dollars year after year to fund POTW improvements. Not only was grant money plentiful, EPA and the states were eager to provide it to POTWs without requiring a significant local monetary contribution. In the late 1970s and into the 1980s, Sewer System Evaluation Study (SSES) grants were funded at a minimum of 75 percent by EPA monies. Under Public Law 92400 (CWA), no EPA construction grant could be awarded unless it was “documented” that sewer systems discharging into treatment works were not subject to “excessive infiltration and inflow.” Between 1978 and 1989, the amount of grant funds that were spent on the I/I analysis and SSES portions of wastewater construction alone totaled \$1.997 billion. (Interestingly enough, the EPA grant funds spent on actual sewer replacement or major rehabilitation totaled only \$1.835 billion.)

EPA requirements in the 1970s required grantees to compare the cost of rehabilitation with the cost of transportation and treatment for each source of I/I. Rehabilitation programs were funded to eliminate “all defined excessive I/I.” EPA provided criteria to define excessive versus non-excessive I/I.

After passage of the CWA in 1972, the establishment of water quality stream standards and National Pollutant Discharge Elimination System (NPDES) permit limits, and the national definition of secondary treatment, the size of wastewater treatment plants (WWTPs) began to grow. The influx of 75- to 85-percent construction grant funds was evidenced by the addition of treatment units at almost every POTW. Because the federal government was footing the lion's share of the costs, it was fairly easy for cities to add the needed technology to bring them up to secondary treatment/water quality standards.

Toward the end of the decade, however, **WWTPs** began to grow for another reason: to accommodate massive amounts of **I/I** being brought to them for treatment through bigger interceptor sewers. This was the result of EPA's grant requirements, which favored transport and treat (T&T) over rehabilitation for "nonexcessive **I/I**." Three things occurred: 1) treatment plants got bigger, 2) sewer lines got bigger, and 3) unpredictably, **I/I** problems got bigger. For the most part, only **I/I** defined by EPA grant regulations as "excessive" was addressed, and "non-excessive **I/I**" was left unattended to become excessive over time.

If that wasn't bad enough, cities and consulting firms were shocked and disappointed to learn years later that the expected **I/I** reductions did not materialize after rehabilitation of the sewer lines. In the early days of **I/I** reduction and **SSESs**, EPA predicted reduction rates in the range of 75 to 90 percent. What generally occurred if sewer rehab work was actually undertaken, however, was **I/I** reduction more in the range of 5 to 25 percent. The concept of only rehabilitating the "excessive" **I/I** appeared to be a little suspect.

Enormous amounts of money were spent in those early days, but it was a case of "too far, too fast" in too many situations. The lack of a comprehensive approach to analyzing sanitary sewer collection systems, the basic engineering assumptions made at the time, the lack of modern technology, and the availability of "easy money" to fund projects all combined to make reality fall far short of expectations. Many utilities applied for **SSES** grant funds and carried out the studies, but never attempted to rehab their systems because there was really no followthrough by EPA or the states to make them actually fix their identified **SSO** problems. Many in the wastewater treatment business considered **I/I** reduction in the early 1980s a failed experiment. Public utility complaints usually sounded something like this, "We spent the money on the **SSES**, we rehabilitated the excessive **I/I**, but we got almost no positive results." And the **I/I** and **SSOs** continued to get worse.

The 1980s

SSES grant-funded work continued in the 1980s because of the lag time between Public Law 92-500 grant application, grant award, and actual study and rehab. In general, **I/I** and **SSOs** continued to grow. In the **1980s**, EPA focus shifted from providing POTW grant funding to POTW compliance. Instead of the previously helpful EPA, which offered advice and monies, EPA now showed a regulatory face to those same cities.

Permit effluent violations were common for **POTWs** in the 1970s and **1980s**, but in 1984 EPA issued a "get tough" policy which announced that EPA was now in the municipal permit enforcement business. In early 1984, William Ruckelshaus signed the National Municipal Policy (NMP), which restated the statutory deadline of July 1, 1988, for municipal National Pollutant Discharge Elimination System (NPDES) permit compliance. What was unusual about the NMP is that it required this deadline be met "with or without federal funds." **POTWs** were to fund their own treatment plant and sewer line improvements, if necessary.

In the 1970s and early **1980s**, the NPDES municipal permitting process was in its infancy. Therefore, few if any construction grants were linked to POTW permit effluent limit compliance, let alone other permit provisions. During that period, the primary mission of the NPDES authorities was to obtain compliance with first-round industrial permits and issue second-round industrial permits.

Quite understandably, POTW permit compliance took a back seat to putting POTW permits in place. This was a country that still had many, many POTWs with only primary treatment processes in place. If a utility received a compliance order from a state or EPA, it typically required them to "submit a grant application" to the agency.

SSOs were continuing to occur with regularity during all these years, but the NMP transfixed everyone's attention on treatment plant permit effluent limit compliance. With grant monies drying up and the July 1, 1988, deadline staring them in the face, cities began to cope in a different way with persistent I/I problems. During wet weather periods, ever increasing amounts of I/I coming to the **WWTPs** through the large interceptors built during the T&T days contributed to permit effluent violations. Cities now could ill afford any type of effluent violation. Peak flows were becoming much bigger than anyone would have ever predicted, and they were wiping out the biological treatment processes. To cope with these conditions, many POTWs began to routinely bypass most of the **influent** around the process train and directly to the receiving stream during wet weather events. Others built huge equalization basins upstream of the plant headworks to attempt to dampen the effects of the caused peak flows by I/I. Hydraulic overloading of **WWTPs** during wet weather had become commonplace in many parts of the country by the mid-1 980s.

Still, the main focus of EPA and the states was on POTW permit compliance by the 1988 deadline for dry weather conditions. Money was becoming hard to obtain, and the deadline concentrated efforts on doing what it took to meet effluent limitations when rain was not falling.

Roughly 95 percent of all major POTWs either met the July 1, 1988, deadline or were under a compliance schedule to meet their effluent limits by that date. The NMP was declared a federal government success story, and everyone relaxed for a while. And the I/I and SSO problems continued to grow.

The 1990s

In the **1990s**, the affected institutions began to recognize that **SSOs** are a problem that is not going to go away. Much of the country's collection system infrastructure has continued to deteriorate in the last 20 years.

In 1994, EPA published a policy on combined sewer overflows (**CSOs**), and the agency now appears to be concerned with **SSOs**. Instead of dwelling only on reducing I/I, the emphasis has shifted to controlling **SSOs**. Although the existence of large amounts of I/I is generally not treated as a compliance problem, **SSOs** are clearly prohibited by the CWA as unpermitted discharges. Recent SSO cases brought by EPA through the Department of Justice (DOJ) against Miami/Dade, Florida, and Honolulu, Hawaii, have gained national attention. Many cities across the country are dealing with **SSOs** at the insistence of DOJ, EPA, and the states.

Past institutional policies are still contributing to I/I problems. The flatter slopes of the aforementioned large (T&T) interceptors have caused corrosive acids to form during dry periods when these sewers are only partially full, and I/I problems have been exacerbated as a result. Many cities have ineffective grease trap ordinances and/or ordinance enforcement. Grease buildups in collection systems are a chief contributor to **SSOs** during both dry and wet weather.

In 1993, the EPA formed a National SSO Policy Workgroup which was charged with exploring the need for a national SSO policy. The Workgroup included several EPA regions, and EPA Headquarters, as well as state environmental agencies. In the fall of 1994, the debate over what to do about **SSOs** was formalized by the formation of a National SSO Committee under the Federal Advisory Committee Act (FACA), which is examining the pros and cons of issues involved in developing a national policy. The FACA group is comprised of POTWs, environmentalists, national and state public utility organizations, and EPA and state environmental agency personnel.

The FACA group and all involved institutions are going to have to deal with the realities of the 1990s. The following are some of the most important issues to address when decisions are made about how to deal with **SSOs**:

- The extent of **SSOs** nationwide
- Criteria for "significant" **SSOs**
- Regional treatment authorities and customer cities
- Economic tests
- Phased construction
- Private sewer lateral contributions to **I/I** problems
- Design storms versus costs
- Use of wet weather storage and discharge facilities in the sewer system
- Long-term maintenance **O&M**
- Dry weather **SSOs**
- Funding sources

These issues cannot be properly addressed in this paper, but a few are analyzed briefly below.

Extent of SSOs

The FACA group has uncovered a wide variation in the reporting of **SSOs** to regulatory agencies across the country. This is not surprising, given the negative incentive for doing so. The group is attempting to come up with an amnesty approach to obtain better information on how pervasive **SSOs** are nationwide.

Significant SSOs

Although the CWA prohibits **SSOs**, **SSOs** can never be completely eliminated under all possible storm events. The question then becomes what is considered a significant number of **SSOs** per year, or under what set of conditions can **SSOs** be allowed?

Multi-Jurisdictional Sewer Authorities

How should regional treatment authorities deal with customer cities that own and operate their own collection systems but discharge into regional **WWTPs**? **SSOs** occur in these "customer" collection systems, and they have **I/I** problems that contribute to the wet weather peak flows of the downstream regional authorities that are in the spotlight. Currently, these regional **POTWs** have varying degrees of control over the amounts of wastewater flow they accept from the customer city collection systems.

Private Sewer Laterals

Far too little attention has been paid to this source of I/I. While public utilities generally work very hard at eliminating as many sources of inflow as possible in their public sewer lines, there has been a natural reluctance to tackle inflow sources on private property. Actual case histories have shown that contributions to overall collection system I/I volume from sewer lines on private property can range anywhere from 5 to as much as 70 percent, depending on the circumstances. When smoke testing is done on public lines to determine cracks in joints and pipes, the smoke invariably billows up from citizens' yards and storm gutter downspouts.

This is a problem that cannot be ignored, even though it is a tough issue for public institutions to handle. Many POTWs have existing programs to address I/I contributions from private laterals, but they must be more effective if the I/I problems are to be brought under control. In past years, agencies have often fixed problems on public lands and ignored the private I/I problems.

Wet Weather Storage/Discharge Facilities

In the 1990s, it is now recognized that not all I/I can be detected, not all detected I/I can be fixed, and SSOs will inevitably occur at some storm event. The issue has now become what amount of SSOs is acceptable, and how often? A background issue is what can public utilities afford that will still satisfy the need for protecting water quality and public health and safety and for providing customer service?

Storage or equalization basins have been tried in many cities, mostly near the treatment plant to dampen I/I-caused peak flows at the headworks and protect the integrity of the treatment process. Some POTWs are now seriously considering (and implementing) storage and/or treat and discharge facilities at critical locations in the WWTP service area to minimize SSOs during high frequency storm events.

The basic approach is to conduct a comprehensive SSES; address the identified problems, rehabilitating the system to some design acceptable to the environmental agencies; and provide wet weather facilities, where practical, at critical locations so SSOs do not occur at uncontrolled locations in the system when a storm occurs that is higher than the sewer system design frequency.

If these wet weather facilities are built to discharge, they have to treat the incoming wastewater and they must be permitted to discharge. Effluent monitoring and reporting, as well as receiving stream water quality sampling, are necessary to protect water quality standards. The City of Houston has just been permitted by EPA and the State of Texas to utilize such a wet weather facility. Houston averages over 65 inches of rainfall per year and is breaking new ground in its attempts to cope with widespread SSO problems.

Long-Term O&M

For those POTWs that are currently suffering from I/I and SSO problems, it is sometimes difficult to imagine a maintenance program that does routine, preventive maintenance. A lot of city tax money is currently being spent on collection system maintenance programs in these cities that are, by circumstance, almost totally reactive in nature. Once a comprehensive SSO abatement program is put in place in these cities, the dollars that are now spent on SSO and cave-in cleanup can be funneled into long-term continuous maintenance-long-term because it must remain continuously in place if SSOs are to be held in check.

Most of this paper is based on the author's experience with construction grants and NPDES enforcement programs at EPA Region 6 between 1971 and 1994 and as a municipal project manager with Roy F. Weston, Inc., in 1994 and 1995. While with EPA, the author dealt with hundreds of POTWs and their wastewater collection and treatment problems.

Sanitary Sewer Overflow Draft Strategy

Bruno Rumbelow and Steve Parke
City of Fort Smith, Fort Smith, Arkansas

Background

In October 1993, the US. Environmental Protection Agency (EPA) Region 6, in Dallas, Texas, issued a draft policy on sanitary sewer overflows (SSO). The policy, intended to be a guidance document for local governments, received a great deal of analysis and criticism from cities in Region 6. According to the February 16, 1994, *Water Policy Report*, 85 cities in Region 6 were under Administrative Orders for SSOs. Many in Region 6 cities believed that EPA's draft SSO policy had the potential to be the largest waste of money ever by spending billions of dollars with no measurable gain in water quality. In our judgment, a new SSO policy should rely on a regulation based on water quality and be cost effective and flexible. It should provide for a sufficient level of customer service (i.e., reduced overflows and system backups onto private property). In addition, its development should be negotiated with all affected parties. The Region 6 draft policy lacked these important elements.

In addition to the perceived faults of the new Region 6 SSO policy, the matter was further complicated by the recent passage of (and media attention surrounding) the National Combined Sewer Overflow (CSO) Control Policy. The CSO policy was considered by EPA and the affected cities, states, environmental groups, and industry as a policy that reflected broad-based consensus and was a "win" for all participants. Because of the CSO policy, cities in Region 6 asked a logical, straightforward question: if EPA is willing to allow interested party participation and consensus building for a CSO policy, why not follow a similar process in the development of an SSO policy? Fortunately for the cities in Region 6, EPA listened to the cities' concerns.

Region 6 agreed to host a meeting for cities that desired to come to Dallas and jointly express concerns about the policy. The list of those invited by the cities was expanded to include affected state agencies. In all, 11 cities and three state agencies from within Region 6 participated in developing the draft strategy. There was a cross section of population sizes in the group, with the largest participating city being Houston, Texas (1.6 million population) and the smallest being Greenville, Texas (23,000 population).

The process to develop a consensus for the policy was difficult at times, but participants agreed on the key issues used to develop the policy from the start, namely, that a reasonable SSO policy should be water-quality based, protect the public health, and be flexible and fair to cities that would bear the cost of implementing system improvements. In Fort Smith's case (74,000 population), the cost to implement proposed wet weather improvements ranged from \$80 million to \$109 million, or a maximum of \$1,472 per capita. Houston is slated to spend \$1 .1 billion over the next 5 years to address its wet weather overflow problems, or \$687 per capita. Obviously, the cost to correct wet weather overflows and bypasses is staggering.

The development of the draft strategy took about 12 months to complete and consisted of the participants hammering out acceptable language in a series of four meetings. EPA received draft copies of the strategy as the process moved forward, and was asked to participate and critique our efforts. EPA provided valuable insight and direction during our meetings. It would be presumptuous to say that the final draft strategy presented from the Region 6 cities to the Regional Enforcement Director conclusively reflected EPA staff's official direction on the SSO issue. There is, however, little question that Region 6 cities will use the draft strategy as guidance to negotiate their wet weather plan elements and compliance schedules with EPA and state agencies.

SSO and CSO Issues

As mentioned earlier, EPA's acceptance of the CSO policy and the perceived relevance of key principles contained in that policy were a motivating factor for the Region 6 cities to pursue a new SSO draft strategy. In fact, the starting point for the strategy was a copy of the CSO policy. Sections of the CSO policy that did not apply were deleted and replaced with language arrived at by the consensus of the group. The effect is an SSO strategy that contains many of the same principles as the CSO policy but is by no means a replica of that document.

An understanding must be developed that while a separated sanitary sewer system is distinct from a combined sewer system by definition, the performance and characterization of both types during wet weather conditions are strikingly similar. In fact, many current separated sanitary sewer systems were originally constructed as combined sewer systems that later underwent storm and sanitary separation projects with the requirement for construction of publicly owned treatment works (POTWs). Early piping systems and installation techniques in both systems did not anticipate the need for watertight construction. Only a regulatory distinction creates the expectation that a separated sanitary sewer system must be able to convey all waters entering its collection system to the POTW without a release, overflow, or bypass due to hydraulic overload, whether caused by older system construction allowances for infiltration and inflow (I/I), improper stormwater connections on public or private property, or system deficiency. An SSO is the discharge from a separated sanitary sewer system at a point before the POTW, similar to a CSO. An SSO may contain domestic sewage, industrial and commercial wastewaters, and stormwater which enter the system, similar to a CSO. An SSO may contain high levels of suspended solids, pathogenic microorganisms, potentially toxic pollutants, floatables, nutrients, oxygen-demanding organic compounds, oil and grease, and other pollutants, similar to a CSO. An awareness of this "second-cousin" relationship will become clearer as an SSO policy evolves.

Region 6 Cities' Draft Strategy

Because each separated sanitary sewer system is unique, each system owner is responsible for creating and implementing a long-term SSO control plan that effectively protects water quality and public health. The site-specific plan must evaluate a range of control options and strategies as well as consider the plan's cost effectiveness. The selected option for SSO control must also allow for expansion or retrofitting if additional controls are later needed to meet water-quality standards for existing and designated uses.

Owners of separated sanitary sewer systems should expect to review and assess the major elements identified in the long-term SSO control plan. These include the design storm selection for the collection system conveyance, wet weather events, and potential wet weather facilities. The collection system design storm sets the capacity of the piping system to convey, transport, or store wet weather flows. This design storm would be developed from standard hydrological techniques and historical rainfall patterns or a historical storm event. No wet weather overflows should occur in the collection system from storms up to the intensity and antecedent conditions of the selected design storm. Representative design storms may be the 1-, 2-, or 5-year storms of appropriate duration. A single storm having intensities greater than the design storm, or consecutive storms having lesser intensities, may cause system overflows to occur.

A wet weather overflow event is a weather-induced occurrence that causes at least one SSO at one or more locations in a system and may last longer than 24 hours. Wet weather events must be characterized to establish the system's response to precipitation events and the water-quality impacts that may result from SSOs. This should be done through monitoring and modeling for a range of storm events to determine the number, location, and frequency of SSOs that might occur within the system. The volume, concentration, and mass of pollutants potentially discharged must also be quantified.

Wet weather facilities can be either treatment or storage facilities located upstream of the POTW. These improvements would be designed to handle only wet weather flow events and sized according to the selected design storm. A wet weather facility can be used to shave the peak flows within the collection system by storing them for eventual return to the downstream sewer system for treatment and discharge. It is also conceivable that these facilities can provide treatment and direct discharge for wet weather flows. The level of treatment required for that discharge would be determined by the water quality and public health requirements during the appropriate high-flow conditions in the receiving water. Treatment might include screening, solids removal, chlorination, dechlorination, or other processes.

The objectives of the proposed SSO strategy document and their anticipated effects must be considered in a coordinated fashion. Doing so allows the effective evaluation of options for the SSO system's long-term planning, selection of alternatives, design, and implementation schedule. The objectives, when properly implemented, will provide a manageable and cost-effective way to develop SSO controls that ultimately meet appropriate health and environmental objectives and public expectations. It is also important to recognize the system-specific nature of **SSOs**, their impacts, and needed flexibility for controls to address local conditions. The objectives of this SSO strategy document are to:

- Ensure that if **SSOs** occur, they are only a result of inadequate capacity due to wet weather flows, vandalism, improper discharges, or unavoidable system failures.
- Bring all wet weather SSO discharge points into compliance with technology-based and water-quality-based requirements.
- Minimize impacts to water quality, aquatic biota, and human health from **SSOs**.
- Mitigate SSO discharges from separated sanitary sewer systems.

The entire process-including SSO controls, community planning, water-quality standards and permit development, enforcement/compliance measures, and public participation-must be properly coordinated to address **SSOs** effectively. Additionally, SSO controls must meet the objectives of the Clean Water Act.

Minimum Controls

A separated sanitary sewer system known to have **SSOs** resulting in water quality or public health problems must start a process to accurately characterize the system. System characterization involves an evaluation of the condition and performance of the collection, conveyance, and treatment systems to determine the number, location, and frequency of overflows and their causes. The SSO strategy document then requires separated sanitary sewer systems to demonstrate the implementation of minimum controls and to develop a long-term SSO control plan. The recommended minimum controls are:

- Proper operation and maintenance programs for the sewer system.
- Review and modification of pretreatment requirements to assure SSO impacts are minimized.
- Maximization of flow to the POTW for treatment.
- Immediate abatement of **SSOs** during dry weather.
- Monitoring to effectively characterize SSO impacts and the efficacy of SSO controls.

Documentation of the minimum controls may include operation and maintenance plans, revised sewer use ordinances for industrial users, sewer system inspection reports, I/I studies, public notification plans, facility plans for maximizing the capacities of the existing collection, storage and treatment systems, and contracts and schedules for minor construction programs for improving the existing system's operation. Any information or data on the degree to which the minimum controls achieve compliance with water-quality standards must also be developed. These data and information should include results made available through monitoring and modeling activities done in conjunction with the development of the long-term SSO control plan.

Presumption Versus Demonstration Approach

The SSO strategy document states that a long-term SSO control plan should adopt either a "presumption" or "demonstration" approach in determining the appropriate SSO control alternative. The regulatory authority must be shown that the SSO control alternative selected will protect water quality and public health. The presumption approach might be selected by owners of systems who believe that the results of their system characterization efforts (number, location, frequency, volume, concentration, and mass) adequately defined the extent of their needed improvements to control SSOs. This approach establishes the requirement that the collection system convey, store, or treat all flows produced by a 2-year design storm. Storm events greater than a 2-year design frequency could overflow, or discharge from, the constructed wet weather facilities. Based on this presumption approach, a wet weather facility would be allowed to discharge flows greater than a 2-year design storm without further treatment if the discharge represented a volume less than 15 percent of the total volume collected in the separated sanitary sewer system during the precipitation events on a systemwide average basis. The discharge strength must not exceed the mass loading shown to cause water quality impairment for the volume captured for treatment. A wet weather facility meeting the 2-year design storm criterion would be allowed an average of four overflows per year that would not meet minimum treatment requirements and could be documented as not causing water quality impairment.

The demonstration approach takes a watershed approach for attaining WQS and is most likely suited to larger systems for the control of SSOs. Within a separated sanitary sewer system, the quantity of wet weather flows may be so large that wet weather facility discharges continue even with the best efforts applied to system rehabilitation, conveyance, storage, and treatment. The demonstration approach requires a separated sanitary sewer system to evaluate a series of collection system design storms up to and including a 5-year storm frequency. The SSO control plan should then evaluate a series of overflow event alternatives from a long-term average of one overflow event every 5 years to 12 events per year to evaluate the effect of their frequency and volume on water quality and public health. Rather than using overflow events, a control plan could evaluate controls that achieve flow capture of wet weather flows for treatment ranging from 75 to 100 percent of the total sewage collected in the separated sanitary sewer system during the precipitation event.

The demonstration approach also requires review of the POTW primary and secondary process capacities to maximize its performance in the SSO alternative analysis. The review of the various alternatives should be suitable to make a reasonable determination of cost and performance. Under the demonstration approach, a separated sanitary sewer system might be able to show that the selected control program provides protection of water quality and public health even though the water-quality standards or uses cannot be met as a result of natural background conditions or pollution sources other than SSOs. The separated sanitary sewer system should then assess the controls needed within that watershed that would have the greater impact on attaining water-quality standards. This planned control program must also show that the plan will not prevent the attainment of these standards and the receiving waters' designated uses, or contribute to their impairment. The control program must also demonstrate that it will provide the maximum pollution reduction benefits reasonably attainable and allow for cost-effective expansion or retrofitting if additional controls are deemed to be needed to meet water-quality standards at a later date. Additionally, long-term monitoring and modeling of SSO discharge

impacts are required after implementation of the control program to confirm that WQS and designated uses are attained.

Wet Weather facility

Not all systems will be able to size separate sanitary sewer collection systems and FOTWs that will convey, store, and treat wet weather flows because of the magnitude of peak wet weather flows and the construction costs associated with the needed facilities. Therefore, owners of some systems may propose to use upstream wet weather facilities that discharge.

Those separated sanitary sewer systems should develop cost/performance curves to show the relationship of the proposed control strategy to a comprehensive set of reasonable control alternatives analyzed to develop the selected long-term control plan. This may include an analysis to determine where the increment of pollution reduction achieved in the receiving water diminishes and to assess the increased costs. One effective strategy for those systems to reduce discharges from wet weather facilities would be to maximize the delivery of wet weather flows to the POTW. This would ensure that these flows receive at least primary treatment before discharge and that the use of the POTW is maximized. Additionally, increased flows to the POTW might eliminate or minimize overflows to sensitive areas.

Under EPA regulations, the intentional diversion of waste streams from any portion of a POTW, including secondary treatment, is a bypass. These bypasses, as regulated by 40 CFR Section 122.41 (m), are allowed only if the system can show that the bypass was unavoidable to prevent loss of life, personal injury, or severe property damage, that there was no feasible alternative to the bypass, and that the system submitted the required notices. It is the responsibility of the system to document, on a case-by-case basis, compliance with the regulation to bypass flows legally. For the purposes of applying this regulation to a SSO system, "severe property damage" could include situations in which flows above a certain level cause loss of the secondary treatment process of the POTW. Therefore, the study of feasible alternatives in the SSO control plan may provide sufficient support for the POTW permit to define the specific parameters under which a bypass could legally occur. These systems' long-term SSO control plans should provide justification for the cutoff point at which the flow will be diverted from the secondary treatment **capability** in the POTW. The plan must also provide a cost-benefit analysis showing that conveyance of wet weather flow to the POTW for primary treatment is more beneficial than other SSO alternatives, such as storage and return for secondary treatment, collection system rehabilitation, or satellite treatment. This provision would apply to only those situations in which the POTW would normally meet the requirements of 40 CFR 122.41 (m) as evaluated on a case-by-case basis.

Financial Considerations

Finally, a separated sanitary sewer system's ability to perform any of the work now required to correct SSOs by EPA's current regulations, or as anticipated by this proposed SSO strategy document, relates to its financial capability. In other words, its ability to pay will affect its success. This factor should be used to set the level of improvements and schedules for implementation of the SSO controls. The SSO strategy document addresses this by using EPA's current affordability index as a model. The SSO affordability index was developed based on the prior experience of using EPA's current index on earlier construction projects. The proposed index considerations are:

- Elimination of overflows that discharge to sensitive areas as the highest priority.
- Use impairment.
- The system's financial capability, including considerations of such factors as:

- 20th-percentile household income.
- Total annual wastewater and SSO control costs per household as a percentage of median household income.
- Overall net debt as a percentage of full market property value.
- Property tax revenues as a percentage of full market property value.
- Property tax collection rate.
- Unemployment.
- Bond rating.
- Grant and loan availability.
- Previous and current residential, commercial, and industrial sewer user fees and rate structures.
- Other viable funding mechanisms and sources of financing.

Conclusion

It is not the intent of this SSO strategy document to set aside the responsibility of separated sanitary sewer system owners to address the correction of **SSOs** caused by wet weather flow conditions within their systems. Under this strategy document, separated sanitary sewer systems are responsible for documenting implementation and developing and implementing a long-term control plan. EPA and state authorities are encouraged to undertake action to ensure that all separated sanitary sewer systems are subject to a consistent review in the permit development process, have requirements that protect water quality and public health, and are subject to enforceable schedules that require the earliest practicable compliance date considering physical and financial feasibility.

Strategy for Wet Weather Sanitary Sewer Overflows

James L. Graham, Jr.
Texas/New Mexico Compliance Section,
U.S. Environmental Protection Agency Region 6,
Dallas, Texas

Introduction

Many municipalities in U.S. Environmental Protection Agency (EPA) Region 6 are experiencing overflows in their wastewater collection systems, compounding the major urban pollution problems they are experiencing from nonpoint sources of runoff entering streams and rivers. The region's approach to addressing sanitary sewer overflows (SSOs) is to require permittees to develop and implement an SSO corrective action program that will result in locating and eliminating overflows in the shortest possible time. Each permittee is responsible for aggressively pursuing solutions for the technical and fiscal problems that may arise during the implementation of a corrective action program, and EPA expects permittees to utilize state-of-the-art methods and expertise in evaluating their systems. The intent of this strategy is to provide guidance and establish a standard for regulated communities, EPA Region 6, and state regulatory agencies in addressing wet weather SSOs. This strategy recognizes the site-specific nature of SSOs, and provides flexibility for local situations and consistency for enforcing the existing requirements of the law.

The majority of overflows in collection systems occur because of wet weather inflow and infiltration (I/I), combined with hydraulic restrictions such as insufficient line capacity and line blockages from poor maintenance. Those permittees experiencing only dry weather overflows must develop and implement a preventive maintenance program for these overflows. Permittees with wet weather overflow problems within the collection system, however, must develop and implement a program to address all existing and potential sources of overflows.

A permittee may demonstrate that a selected control program is adequate to locate and eliminate SSOs, thereby achieving compliance with its National Pollutant Discharge Elimination System (NPDES) permit and the Clean Water Act (CWA). Alternatively, permittees have the option to show, through a systemwide evaluation, that rehabilitation of the collection system alone will not achieve compliance with the CWA and the NPDES permit. A permittee may then consider the use of wet weather alternatives in addition to the rehabilitation program. These approaches incorporate the options and principles contained in the National Combined Sewer Overflow (CSO) Control Policy (40 CFR 122), which are applicable to SSOs. If wet weather discharges are allowed, then the permittee must consider environmental justice and water-quality impacts in the location of such discharges. Any SSO control program must provide long-term adherence to the technology-based and water-quality based requirements of the CWA.

The Problem

Many municipalities in the region have separate sanitary sewerage systems that experience overflows of untreated wastewater from the sanitary sewers during and after periods of rainfall. Over the years, many of these systems have experienced major infrastructure deterioration because of inadequate preventive maintenance programs and insufficient planned system rehabilitation and replacement programs.

Extraneous flow enters sanitary sewers through holes or cracks in pipes and manhole walls, holes in manhole lids, cross connections to storm sewers, residential and commercial roof drains connected to sanitary sewers, and other illegal connections on both private and public properties. In addition, the hydraulic capacity of many lines in the municipal system has decreased due to bottlenecks in the system caused by root intrusion into the lines, dropped pipe joints, and foreign materials and debris deposited in

the lines. In many instances, these bottlenecks reduce hydraulic capacity to the extent that although the lines may have the capacity to transport the dry weather flows, during and following rainfall events the system cannot retain the increased wet weather flow.

The combined problem of increased hydraulic load from the wet weather I/I and decreased hydraulic capacity resulting from system bottlenecks has resulted in wet weather overflows of raw wastewater from the sanitary sewer systems. In many cases, these overflows are occurring throughout residential neighborhoods, flowing across lawns, in the streets, along the curbs, and in drainage ditches, and depositing unsightly debris along the way. In other instances, the overloaded lines cause sewer backups onto private property or render the lines unusable until flows recede. SSOs often contain high levels of suspended solids, pathogenic microorganisms, toxic pollutants, floatables, nutrients, oxygen-demanding organic compounds, oil and grease, and other pollutants. Uncontrolled SSOs can result in discharges of pathogens into residential areas, cause exceedances of water-quality standards, pose risks to human health, threaten aquatic life and its habitat, and impair the use and enjoyment of the nation's waterways.

Sanitary Sewer Overflows Versus Combined Sewer Overflows

On April 19, 1994, EPA published the National CSO Control Policy in the Federal Register. The policy contains the Agency's objectives, control plans, and alternative approaches for addressing overflows from combined sewer systems but does not address EPA policies for dealing with SSOs. Because of similarities between SSOs and CSOs, many of the objectives and control requirements contained in the national CSO policy are applicable to SSOs. Because major differences also exist between SSOs and CSOs, however, the CSO policy does not address all issues that must be resolved for satisfactorily addressing SSOs and achieving compliance with the CWA. The following is a summary of some differences between SSOs and CSOs (see Table 1).

Table 1. Summary of Major Differences

Sanitary Sewers	Combined Sewers
Designed to convey only sanitary wastes.	Designed to convey sanitary wastes and stormwater.
Not designed with diversion and outlet structures except to protect some pump stations from flooding.	Designed with diversion and overflow outlet structures.
Designed to discharge wastewater to a treatment plant during wet weather.	Designed to discharge a significant portion of combined flow to a waterway during wet weather.
During wet weather, systems may contain overflows at uncontrolled locations.	During wet weather, overflows occur at controlled points.
SSOs occur through manholes and broken lines, at pump stations, and inside buildings, discharge throughout the system.	CSOs occur through overflow outlet structures discharging directly to a receiving stream.

The key differences are that 1) sanitary sewers have no diversion and discharge structures designed into the system to release the excessive flows into receiving streams at controlled discharge locations and 2) overflows in sanitary systems occur through manholes and lines which release the flows indiscriminately throughout the system into residential areas, streets, and drainage ditches, onto private property, and at any other low point in the system. Because the sanitary systems were designed with no diversion and

controlled discharge locations and the resulting overflows occur indiscriminately throughout the system, no centralized discharge points are designed into the system that would allow the application of technology-based and water-quality based requirements of the CWA to the SSO discharges. For this reason it is not possible to apply the national CSO policy per se to SSOs.

Many similarities exist between SSOs and CSOs, however, and any of the objectives and principles of the CSO policy are applicable to SSOs. If the indiscriminate SSO locations can be controlled so that the excessive flow causing overflows can be either eliminated or reduced to a level that flow is contained and diverted to select locations, then the SSOs become very similar to the CSOs; a modified CSO-type approach becomes a feasible option for dealing with SSOs. The intent of this strategy document is to develop this option so that all applicable CSO policy objectives and principles can be utilized in an SSO strategy.

The SSO Control Plan

In Region 6, each permittee with SSOs is responsible for developing and implementing an SSO program that ultimately achieves compliance with the requirements of its NPDES permit and the CWA. This program includes accurately characterizing the sewer system, demonstrating implementation of nine minimum controls analogous to those in EPA's CSO policy, and developing a control plan to eliminate SSOs. Permittees should prepare appropriate documentation demonstrating implementation of the nine minimum controls, including proposed schedules for completing any construction activities.

The program should consider the site-specific nature of SSOs and evaluate the cost effectiveness of a range of options. The development of the SSO program and its subsequent implementation should also be coordinated with EPA Region 6 as well as state regulatory agencies. Permittees should develop and submit their SSO programs as soon as possible. Once the dates for completion of a program are agreed upon, these dates will be included in an appropriate enforcement mechanism. The plan should include fixed-date project implementation schedules. The individual elements of the SSO program plan are described below.

Characterization, Monitoring, and Modeling of the Sanitary System

To determine the extent of SSOs within the collection system, a permittee must have a thorough understanding of the sanitary sewer system's features, such as its capacity, the response of the system to various rain events, the characteristics of the overflow events, and the extent of inadequate capacity in the system for handling wet weather flows. The permittee must develop adequate flow monitoring data through installation of continuous flow monitoring stations throughout the system. Without adequate flow monitoring of various storm events, it is almost impossible to determine the peak inflow rates. Also, the existing system capacity must be compared with projected peak flows from various storm events to evaluate the need for relief sewers and other modifications to ensure that the system will not overflow.

Computer modeling can be an effective tool in evaluating the capacity and the response of a sewer system to storm events of varying frequency and duration. The modeling of the sewer system may include hydrologic/hydraulic models using both steady-state and dynamic computer simulations of flow through the sewer network and computing hydraulic grade lines for storm events of varying frequency and duration.

Control Options

After characterizing its sanitary sewer system, the permittee may take either a demonstration approach or a presumption approach to address SSOs and achieve compliance with its NPDES permit and the CWA.

The demonstration approach is applicable for a permittee with minor and very infrequent overflows, that can demonstrate that data from the monitoring and modeling of its sanitary sewerage system together with its long-term maintenance records have enabled the permittee to 1) locate all of the system overflows and 2) design and construct system improvements that will eliminate the SSO and transport all flows to the Publicly Owned Treatment Works (POTW) for treatment. Construction activities must eliminate all SSOs and transport all flows to the POTW for treatment. Wet weather interim storage facilities for storage of peak wet weather flows and pump back for treatment might be constructed as part of the POTW.

Permittees should implement the presumption approach where:

- The flow monitoring and modeling of the system provide inadequate data to locate all SSOs and to design and construct appropriate improvements to eliminate all SSOs.
- Rehabilitation of the existing system to eliminate I/I and construction of adequate relief lines to transport all flows to the POTW for treatment might not be technically or financially achievable.
- System rehabilitation plus construction of wet weather discharge facilities might be necessary to eliminate SSOs in the collection system.

Municipalities with these wet weather SSO problems are expected to initiate a comprehensive program to evaluate the condition of the sanitary sewer system, locate the SSOs and sources of I/I, determine the method of system rehabilitation and improvement, and develop a design and construction program that will achieve compliance with the CWA and the permittee's NPDES permit.

In developing an SSO program, the permittee should complete all of the following steps:

- Implement a thorough Sewer System Evaluation Survey, with special emphasis on locating all inflow sources.
- Rehabilitate the system, eliminating all inflow sources located during the study that are on public lines (including public and private roof drains, yard drains, and other stormwater connections).
- Rehabilitate additional areas as necessary to restore the system's structural integrity.
- Provide system capacity to maximize delivery of remaining wet weather flows to the POTW for treatment.
- Give priority to elimination of all overflows from high public use and public access areas.
- Design a wet weather facility, when needed, to discharge at a specific location under controlled conditions and directly into a receiving stream.
- Provide water-quality sampling and receiving stream modeling in accordance with the region's guidance to demonstrate that water quality is not adversely affected by the proposed wet weather facility discharges.
- Provide long-term wet weather monitoring or receiving stream and wet weather facility discharges in accordance with the region's guidance.

Elimination of **SSOs** is typically addressed by a three-phase corrective action program:

- Phase I is diagnostic evaluation of the collection system to assess the nature and extent of the overflows, including the integrity and capacity of the system. This phase includes the planning and implementation of all fieldwork and other activities necessary to evaluate the system fully and develop a proposed rehabilitation or replacement program, or both.
- Phase II consists of implementation of the remedial action program via design and construction of the facilities necessary to contain the wet weather flows within the system.
- Phase III incorporates the concepts of pollution prevention, preventive maintenance, and planned rehabilitation and replacement to prevent infrastructure deterioration and maintain the quality of the system achieved through the Phase I and II programs.

Historically, many municipalities with **SSOs** implemented Phase II without undertaking the diagnostic study of Phase I. The constructed improvements usually addressed obvious **SSOs** and created new **SSOs** downstream or compounded existing unknown SSO problems. The results were capital investments in improvements that caused continued **SSOs** and unsatisfactory program results.

Specific details of the three phases appear below.

Phase I

Recommended field activities in the first phase of the program include, but are not limited to, the following items:

- *Characterization, monitoring, and modeling of the sanitary system:* This field activity would not be necessary if it was completed before the decision to implement the presumption approach. Otherwise, it would be completed as described previously.
- *Physical inspection:* A physical inspection of the wastewater collection system will isolate obvious problem areas, establish a complete inventory of the collection system, update existing maps and record systems defects. Because manholes are often a significant source of inflow contributing to surcharge lines and **SSOs**, an inspection of manholes can often reduce subsequent, expensive field tasks. Thus, field crews should perform visual pipeline and manhole inspections, correcting and updating maps as they move through the collection system.
- *Smoke testing:* Smoke testing of the sanitary sewer system, when properly done, is a relatively inexpensive way to locate sources of wet weather inflow to the system. Smoke machines with sufficient capacity to pressurize the system will locate roof drains cross connected to the sanitary sewers and identify storm sewer connections and other sources of inflow through broken, misaligned and defective pipes and manholes. Given the relative ease and low cost of the procedure, permittees should consider smoke testing the entire collection system.
- *Flow isolation:* Flow isolation is the instantaneous measurement of flows at key manholes between the hours of midnight and 6:00 a.m. to determine infiltration rates. Evaluation of data from the continuous flow monitoring phase of the study will identify areas subject to infiltration of the magnitude that would warrant flow isolation fieldwork. Correlation of flow isolation data with continuous flow monitoring data will enable the permittee to pinpoint the line segments (manhole to manhole) subject to excessive

ground-water infiltration. These line segments should then be evaluated for cleaning and televising to determine the sources of infiltration and establish the method of repair.

- Dyed wafer *testing*. Dyed water testing is used primarily to locate and quantify inflow sources identified during smoke testing. It is typically performed on suspected cross connections between storm sewers and sanitary sewers, and on sections of storm ditches that either cross or are parallel to the sanitary sewer. Suspected inflow sources such as area drains can also be dye tested to verify cross connections to the sanitary sewers.
- Cleaning and televising. Cleaning and televising of the sanitary sewers is used to determine the structural condition of line segments, determine the method of rehabilitation of line segments, verify exact locations of cross connections to storm sewers or other illegal connections to the sanitary sewers, verify the condition of joints and other structures, and determine exact locations of inflow sources. During smoke testing, smoke may surface at a point laterally removed from the actual defect in the sewer line. By flooding the surface smoke point while televising the sewer line, the exact location of the inflow source can be determined. Cleaning and televising the sanitary sewers are usually the most expensive survey field tasks per linear foot, but also two of the most valuable tasks performed during the analysis of the system.

Upon completion of field activities, the permittee needs to complete engineering and financial evaluations, as well as a Phase I final report. Financial evaluation of the overall program should include implementing the appropriate wastewater user rate structure to finance all required improvements. The financial ability of the permittee to pay for necessary improvements will vary with the economic condition of each municipality.

In addition, the permittee shall prepare a schedule for the rehabilitation of the system and submit it to EPA. In large systems where the permittees have divided the system into two to three areas for performing field activities, the permittee will perform different field activities concurrently in each of these areas or on a system priority basis. As the final report and engineering evaluations are completed for an area, the design and construction schedule for the area must be provided to EPA.

Phase II

The permittee must initiate and complete the necessary design and construction. All work must be completed in a timely manner and in accordance with the schedule submitted.

The final construction project may include activities or items such as repair, replacement, or relining of existing sewer lines; construction of relief lines; upgrading or construction of lift stations; increased treatment plant capacity; and construction of surge/flow equalization facilities to eliminate wet weather overflows.

Phase III

The permittee must develop a comprehensive monitoring program for the operation and maintenance (O&M) of the collection system after construction is completed.

Wet Weather Facilities

In many areas subject to intense rainfall, the flooding of streets and other areas may present a stormwater handling situation, which in turn creates complex technical and economical problems that must be considered when developing a program to eliminate **SSOs**. The cost of implementing a construction program to eliminate all *I/I* sources and **SSOs** located in the Phase I study and transporting all remaining flows under all conditions to the treatment facility may be beyond some permittees' economic abilities. Thus, efforts are prioritized as follows:

- Eliminate or minimize uncontrolled **SSOs** in residential and other high-use public access areas.
- Maximize *I/I* reduction and delivery of flows to the POTW.
- Prevent overflows to environmentally sensitive areas.
- Prevent any water-quality standards violations.
- Design sanitary sewer diversion structures and overflow outlet structures so that any discharges occur at designated controlled overflow points.

The Region 6 SSO strategy incorporates the following major concepts from EPA's national CSO policy:

- Allowable wet weather facility discharges under specified conditions
- Controlled discharges at selected points
- No overflows to environmentally sensitive areas
- Protection from water-quality standard violations

The use of allowable overflows at controlled outlet structures under specified conditions and at controlled overflow locations would be considered only when the permittee's diagnostic system evaluation and economic feasibility analysis determines that rehabilitation and elimination of all located inflow sources and expansion of the collection system alone would not achieve the goal of eliminating **SSOs**. In such cases, the region would consider the use of wet weather facilities under specified conditions in addition to the system rehabilitation and expansion program.

Options

Each **permittee** considering wet weather facilities must provide a financial analysis demonstrating that:

- Conveyance of all wet weather flows to the POTW after system rehabilitation is not economically achievable by the permittee.
- Alternatives such as storage and pump back for secondary treatment have been considered.
- Satellite **POTWs** are beyond the permittee's economic ability to pay.
- Economic justification exists (including the factors listed below) for the cutoff point at which the flow will be diverted from the collection system to the wet weather discharge facility.

Permittees must also evaluate a reasonable range of alternatives, including achieving zero discharge events per year. For purposes of this criterion, a discharge from a wet weather facility is one or more discharges as the result of a single precipitation event. Municipalities with SSOs are encouraged to work with the region to develop a proposed overflow control program and schedule for implementing the program. The region welcomes site-specific programs tailored to the permittee's situation to include more cost-effective means of solving the municipality's SSO problems.

Economic Considerations

The economic analysis of alternatives must be sufficient to make a reasonable assessment of cost. The permittee's financial capability to construct the improvements should consider such factors as:

- Median household income.
- Total annual wastewater and SSO control costs per household and as a percentage of median household income.
- Overall net debt as a percentage of full market property value.
- Property tax revenues as a percentage of full market property value.
- Property tax collection rate.
- Direct net debt per capita.
- Overall net debt per capita.
- Sewer fund operating ratio.
- Sewer fund coverage ratio.
- Unemployment.
- Bond rating.
- Grant and loan availability.
- Previous and current residential, commercial, and industrial sewer user fees and rate structures.
- Other viable funding mechanisms and sources of financing.

NPDES Permit Specifications

Any permittee proposing to construct wet weather discharge facilities must demonstrate through a **water-quality** study that discharges from proposed wet weather facilities will meet water-quality standard requirements.

If approval is granted, the NPDES permit will specify what monitoring and effluent limitations and requirements apply to the discharge. At a minimum, permittees must provide in the initial construction phase facilities that meet water-quality standards requirements, including removal of floatables and solids. The initial construction must also provide a phased approach capable of expansion to provide a higher level of treatment, if necessary to meet more stringent effluent requirements in the future. The

permit will also specify that approval for the discharge will be reviewed and may be modified or terminated if there is a substantial increase in the volume or character of pollutants being discharged, new information, or additional studies that indicate water quality standards violations.

The permit-tee must also continue to evaluate the impact of discharges from any wet weather facilities and document that it will not cause a violation of in-stream water-quality standards. The permit may be reopened to require additional treatment if water quality impacts are shown.

Recent Advances in Technologies for Collection System Evaluation and Rehabilitation

Jey K. Jeyapalan
American Ventures, Inc., Bellevue, Washington

John Jurgens
Gelco Services, Inc., Kent, Washington

Abstract

This paper reviews the technologies used for assessment of physical, chemical, and hydraulic conditions of sewage collection pipelines and manholes. Detailed descriptions of various well-established and new technologies for rehabilitation of sewer collection systems are given. In addition, the paper presents some guidance on proper design philosophy for choosing and implementing most suitable materials and methods for rehabilitation of collection system pipes and manholes. The paper concludes with projections of future technological needs to better assess the current conditions of collection systems and rehabilitation.

Introduction

Rehabilitation of sanitary sewers using "trenchless" methods has grown in popularity in recent years due to the congestion occurring as utilities elect to go underground. Water, sanitary sewers, storm sewers, and steam lines were the only inhabitants below grade until about 30 years ago. Recently, telephone lines, television cables, gas lines, and electrical systems have come to clutter up this segment of our unseen infrastructure.

When many pipeline infrastructure components were constructed, future expansion was not always considered. To compound the problem, many new state, federal, and local regulations have made open excavation virtually impossible in busy streets, close to waterways, and in environmentally sensitive areas. For example, worker safety regulations have become much stricter over the years. Federal and state governments have been more vigilant than ever before in protecting wetlands. Cities face pressures to minimize inconveniences to the public from blocked traffic and detours due to open-cut excavation for pipe installation. Perhaps most importantly, cities and counties have limited budgets and must seek the most cost-effective methods available. These limits, and the fact that trenchless technology often costs less than the alternatives, have forced most cities, counties, state, and private entities to turn to trenchless techniques for pipeline repairs and renovation.

The condition assessment of aging collection systems, materials, and methods used for pipeline and manhole rehabilitation has seen numerous advances in the past 10 years. Many well-known technologies for investigation have been either supplemented or replaced with newer methods. Closed-circuit televising, smoke testing, dye-water testing, infrared thermography, radar and sonic devices, ground-water monitoring, ground surface observations, flow monitoring, and corrosion evaluation are all technologies in use to some degree in collection system assessment, most of which have seen significant improvement over the years. Many new pipe materials and installation methods for collection system rehabilitation have entered the marketplace, while several old ones are becoming obsolete. In a broad sense, slip-lining, cured in-place lining, deformed lining, fold and form lining, segmented lining, grouting, fill and drain repairing, and multifunction robotic repairing are all methods using many new materials year after year.

Closed-circuit television (CCTV) inspection is an excellent example. Ten years ago the industry standard was black-and-white equipment. The camera was pulled through the pipeline manhole to manhole.

Today the standard is color pictures, with the ability to look directly into any lateral to determine whether the pipe is actively serving a building or whether it is a source of infiltration. Pulling the camera through the system is still the most common inspection method, but the trend is for cameras to be mounted on a tractor unit, which allows inspection up to a specific location in the collection system and retracking back to the original manhole through which access was made.

Collection System evaluation Methods

Preliminary System Evaluation

The main objectives in performing the preliminary system evaluation are to identify the local areas with the most problems and to determine the need for subsequent detailed investigation. The major sources of information include:

- As-built collection system maps
- Operation and maintenance records
- Geological, geotechnical, and climatological records
- Topographical maps
- City and municipal planning records
- Treatment plant records
- Collection system monitoring records
- Historical sewage flow records
- Water usage records
- Population trends and user surveys
- Industrial surveys
- Corrosion records

Rehabilitation of collection systems using trenchless methods has grown in popularity in recent years. With the advancement of television cameras, communities can determine whether a segment of pipe needs to be repaired or replaced or whether the total collection system needs to be addressed. A condition assessment should be performed before making any such repairs, unless the work is of an emergency nature. In recent years, infiltration and inflow (I/I) in collection systems have caused major problems nationwide. Sanitary sewer overflow (SSO) problems also have gained national attention. If I/I problems are not addressed properly, the collection system will reach its capacity well before its intended design life, and the cost of treating sewage will become quite high. Thus, an accurate assessment of the I/I problem needs to be performed very early when evaluating the collection system.

Assessing the I/I Problem

Sanitary sewer systems have three components of flow: base flow, infiltration, and inflow. Flow metering provides as accurate an assessment as feasible for separating total flow into these three subcomponents. Water consumption data adjusted for seasonal variations, irrigation usage, unmetered

connection<, and water meter discrepancies provide some means of estimating the base flow. Infiltration rates are estimated using minimum flow rates and flow rates from periods several days after significant rain events, with some adjustments for dry weather variations. Inflow rates are based on historical data and peak flows during and immediately after some rainfall events. Data on annual precipitation and ground-water levels are also used to verify some of the flow estimates.

Smoke testing provides easy location of I/I sources and is used for testing inflow from storm sewer cross connections and point source inflow leaks. It is important to recognize that a negative finding during smoke testing is not an indication that no I/I problems exist in the collection system. Significant advances have taken place in the types and effectiveness of smoke testing methods available to public agencies for I/I detection. Dyed-water testing is also commonly used to detect I/I problems in a sewer collection system. CCTV inspection is always part of assessing I/I problems.

Assessing the Structural Condition

Evaluation of the structural condition involves:

- Visual inspection and recording
- Delamination sounding
- Estimate of wall thickness loss
- Causes of wall thickness loss
- Estimate of changes in pipe material properties
- Inspection of soil conditions
- Record of structural loadings and anticipated changes
- Ground-water level and seasonal variations
- Changes in pipe wall geometry
- Design calculations to determine the remaining structural capacity
- Maintenance history
- Rehabilitation history

Evaluation of structural capacity is the most difficult task of all evaluation phases, and it is prudent that the investigation team allocate adequate resources and time for this phase. The geotechnical characteristics of sewer system sites could be documented with more modern tools such as infrared thermography, seismic measurements, ground-penetrating radars, continuous soil sampling, strength evaluation with electric and piezo-cone soundings, and pressuremeter testing. Use of seismic wave propagation techniques across the pipe wall thickness at selected stations and smart pigs that can travel down the collection system to determine the wall thickness left in an aging system are becoming more reliable for routine use in structural condition evaluations.

Assessing the Hydraulic Condition

An aging collection system needs to be tested in a controlled manner to establish the drop in flow characteristics and to estimate the available hydraulic capacity. It is most common for the Manning's coefficient used for flow roughness calculations to increase with age in a collection system; this would normally be the worst for concrete pipes due to significant uneven loss of wall thickness from sulfide corrosion. The increase in roughness coefficient is caused by laterals protruding into the main waterway of the pipes, walls deflecting excessively into the pipes, structural members such as brickwork moving into the pipes, and joints becoming badly fitted with time. All contribute to a substantial reduction in the flow capacity of the collection system.

Pipeline Rehabilitation Methods

The factors to consider in selecting the most suitable technology for pipeline rehabilitation are:

- Design life
- Size of pipe
- Length of the reaches
- **Access**
- Size of manholes
- Type of fluid carried
- Soil and ground-water conditions
- Past track record of the technology
- Availability of qualified contractors
- Structural condition of the aging system
- Hydraulic capacity needs
- Size and number of laterals
- Depth of the sewer collection system
- Traffic patterns
- Environmental concerns

Some descriptions of various technologies and their potential, strengths, and weaknesses are given below.

Cleaning

In many collection systems and their components, proper cleaning alone could return most of the lost capacity back to the line. Lack of sufficient flow capacity in old pipelines has generated many new pipeline construction projects. In this regard, jet cleaning is most commonly used to renovate sewer

collection systems. A CCTV video is prepared before any cleaning begins as a baseline measurement of the current condition of the system. After jet cleaning, a second video is prepared to determine the collection system's level of rejuvenation. If a lining method using a paint mixed into an epoxy hardener would enhance collection system capacity, this is always undertaken following the jet cleaning operations. It is important to recognize that the skill level and past experience of the operators employed by the city determine the degree of success of cleaning operations. Although chemical cleaning is being tried with some good results for water distribution systems, use of such technology for sewer collection system cleaning would have to ensure that the chemicals used do not interfere with the treatment functions of the sewage treatment plants. The best tool for verifying the effectiveness of cleaning efforts is CCTV.

Root Control and Removal

Chemical root control is commonly used to kill root growth into the sewer system and to inhibit regrowth without causing significant damage to trees and plants, the ambient environment, and the wastewater treatment process. Tools used in root control could also cause damage to the walls of collection pipes if proper care is not taken. The usual ingredient for killing roots is a special herbicide that works at low concentrations. Common materials include sodium methyldithiocarbonate and diclobenil. Root prun is one such fumigant gel, and others use foam for delivery of materials provided by **Avanti**, Tobys, and Airrigation. Although some attempts were made to include formation of copper sulfate solution in situ by providing copper wires to react with other chemicals around pipes with root intrusion problems, due to the contamination caused this approach is no longer accepted by the U.S. Environmental Protection Agency (EPA).

Trenchless and Less-Trench Methods

Numerous technologies have been in use for some time for rehabilitation of sanitary sewers and manholes. These methods could be broadly classified into two types: trenchless and less-trench. It is most common not to have any open-cut excavation at all in or around the job site. Examples of trenchless methods are cured-in-place pipes, fold and formed pipes, pipes by directional drilling, robotic repairs, and fill and drain technologies. In the less-trench methods, some excavation is always required. These are used to introduce the new pipe into the system and to reactivate the laterals. Some processes require pits and auger holes, while others need sloping trenches leading into the old pipe. A few examples are slip-linings, **swaged** and rolled down pipes, spiral wound pipes, segmented linings, pipe bursting, microtunneling, pipe ramming, and manhole rehabilitation technologies.

Coatings

Reinforced shotcrete and cast-in-place concrete are possible coatings only when corrosion is not a problem. Other engineering materials and resins also could be used with or without fibrous reinforcements for coatings.

Point Repairs

Most of the spot repair systems available involve the application of chemical grout to fill cracks, a **cured-in-place** sleeve or mat, or an epoxy-based resin. Differences lie in the method of application, with some processes using robotic devices, a winched-into-place sleeve, or a combination of methods. The latest advances in point repair include performance liner, link-pipe, amkrete, econoliner, fibers in gunite or shotcrete, and chemical grouts. In these methods, a preformed segment of a new pipe is inserted where the existing sewer system needs renovation; the new pipe is then expanded or cured to form a new

structural and/or hydraulic liner. The most effective point repair technique uses either a cementitious or chemical grout and an inflatable packer guided by a CCTV.

Chemical Grouting

Although the earliest form of sewer collection rehabilitation technology involved some form of chemical grouting, this method is still seeing many new developments. Use of many new chemical and cementitious grouts with varying properties, set times, and functions are emerging in the marketplace. The most common types include epoxy, gels, acrylamide grout, acrylic grout, acrylate grout, urethane grout, and urethane foam. Cementitious grouts continue to see several enhancements, such as the use of centrifugally acting spraying machines (which travel along the pipeline and provide new coatings and linings without a human operator), and admixtures and fibrous reinforcements (to increase the tensile and corrosion characteristics of such grouts). The internal grouting is usually applied using a remotely inflated packer guided by CCTV. The external grouting process involves a detailed study of soil conditions to determine which grout would flow effectively into the subsurface around the pipe.

Chemical grouting has been used successfully for more than 30 years. The success rates of grouting are based on the level of competence of the contractor and the ability of the engineer to design the project in a manner that guarantees good results. People who are inexperienced at working with varying soil and pipe conditions and different grouts are quick to claim that "grouting doesn't work." Grouting was looked on as a cure for all pipe problems, however, and if grouting didn't work on a given project, the causes of its failure often were not researched.

In summary, two primary methods/procedures exist for this type of work. One method is chemical grout, which uses a packer to first air test a joint for water tightness. If the joint fails the air test, then the joint is grouted using a grout with a viscosity of less than 10 centipois. This process allows for a pipeline system installed in the 1940s to be brought up to 1990 standards. Chemical grouting as a form of maintenance for pipelines is increasing in popularity. Many managers of aging systems are using this technology to ensure the additional longevity of their pipes. This philosophy is similar to a homeowner painting his or her dwelling; the work is viewed as a preventive effort to maintain the integrity of the house. The process must be repeated periodically. The second method, epoxy placement, is performed with robotic tools, again with the aid of CCTV. Some processes use routing bits to allow the epoxy to bond to a clean surface.

Cured in Place Pipes

Cured-in-place pipe (CIPP) systems enable sewer pipelines to be repaired from within by inserting a lining material through existing manholes. The liner is made of a fabric reconstruction tube, which is impregnated with a thermosetting resin that hardens into a structurally sound jointless pipe when exposed to hot, circulating water or steam. Once cured, the pipe is allowed to gradually cool to prevent thermoshock. The laterals are then reconnected. The rehabilitation liner not only serves to repair the deteriorated structure of the existing pipe but also reduces infiltration of unwanted ground water.

The CIPP process was introduced in the United States in 1977, and millions of feet of CIPP have been installed since then. Until recently, competition was almost nonexistent from other trenchless rehabilitation products, and CIPP's primary competitors were open-cut construction and slip-lining. In the mid-1980s several new CIPP products were introduced. The fact that multiple options exist for owners to consider for pipe renovation has its strengths and weaknesses. On one hand competition is greater among many technologies, while on the other many new products in the marketplace do not have the same amount of research results that the original technology has.

CIPP systems are either winched into place or inverted in place using air or water pressure. The curing process uses steam or hot water. All thermoset resins commonly used for reinforced plastic mortar

(RPM) and fiberglass-reinforced plastic (FRP) pipes are used for cured-in-place pipes. Among these, polyester is the most common resin used. In situ cutters guided by CCTV open the laterals. The liner pipe is designed either to perform just the hydraulic function or both hydraulic and structural functions, depending on whether the structural capacity of the existing pipe is intact. The most significant advantage of CIPP systems is that they can be used for old pipes of any size and shape. New innovations include using reinforced felt to handle internal pressures of substantially high values. The design of CIPP systems is similar to slip-liner pipes except that it lacks any pulling or pushing forces and annular grouting.

Fold and Formed Pipes

Folded and formed pipe (FFP) allows for pipelines to be repaired through existing manholes, similar to the CIPP process. The FFP system uses a thermoplastic material that has been deformed from a circular shape (i.e., folded) to result in a smaller cross section that can be easily fed into an existing sewer. These products use either extruded polyvinyl chloride (PVC) or high-density polyethylene (HDPE) pipe that is flattened and folded longitudinally. The plastic pipe is fed from a spool into an existing pipe, where hot water or steam is applied until the liner reaches its temperature for rounding. After rounding, the materials are allowed to cool, and then the laterals are reactivated. As with the CIPP process, additional testing is needed to determine the longevity of these products.

Softer PVC cell class resins and HDPE folded pipe require minimal heating to reform the pipe into its original shape. For folded pipes, it is common to use a rounding device and apply the technology effectively when the old pipe is not surrounded by excess amounts of ground water. In the presence of ground water, the heat input from the source would not be sufficient to keep up with the loss of heat into the ambient ground unless a heat containment tube is used.

FFP using HDPE resins cannot compare to pipes using PVC resins in the pipe stiffness property, particularly in meeting long-term buckling capacity requirements. The HDPE FFP has a mere 10 percent of the long-term buckling strength of equally thick PVC fold formed pipe. In all applications of pipeline rehabilitation, the long-term buckling strength would govern the choice of the pipe material. Therefore, HDPE would never be the material of choice compared with pipes made of PVC resins.

FFPs must be designed to withstand external ground-water pressures and for soil and traffic loads if the old pipe has deteriorated enough to be incapable of providing appreciable support to the new pipe. Testing of FFPs for strength and stiffness should be done preferably on pipe that has been folded and formed and not *on* pipe at the plant before it is folded.

Directional Drilling

With directional drilling methods, a pilot bore is made and the product pipe is pulled behind the backreaming operation on the return trip from the exit point to the starting point. This method cannot be used for minimum-grade gravity sewer collection systems. The drift control is within inches using electromagnetic tracking systems. Cobbles and boulders cause serious problems and may prevent finishing of the line. Usually, fluid additions reduce friction on the outer wall of the pipe, assist in cutting of the borehole, and prevent the borehole from collapsing. Most projects use either steel or HDPE pipe materials for renovation or new line installation. The capability is subdivided into mini, midi, and maxi, which can handle pipe sizes up to 900 millimeters for a distance of up to 1,500 meters to a depth of 30 meters with pull forces up to 250 tons.

Robotic Repairs

Intelligent robots are becoming increasingly popular. The robots can brush away the dirt in the collection systems, jet clean the pipe walls, cut down the root growth back to the pipe wall, fill holes with proper grouts, mill away damaged and badly fitted pipes and laterals, perform point structural or hydraulic repairs, and provide a continuous video record of the internal condition of the collection systems.

Fill and Drain Methods

With this method, two chemical solutions that react when they are brought into contact with one another are filled and pumped out, one after the other, into the collection system, forming a third material that provides structural repair to all components of the system in a monolithic fashion. Although the same method and materials could be used for any existing pipe material and for all components of the collection system, there are some drawbacks in this method of repair, such as clogging of the main waterway in smaller collection systems and difficulties when these products come in contact with roots.

Slip-Linings

In the most recent form of this process, a new pipe is inserted either by pulling or pushing in continuous length or in short discrete lengths. It is very common to have the annulus grouted with proper care once the slip-liner is inserted if no compression fit is present. Without the grout the slip-liner will not be able to withstand most of the external water pressure and other buckling loads. The preferred material for slip-lining is HDPE due to its superior characteristics in corrosion resistance, abrasion, impact strength, and strain tolerance. The design checks should lead to the selection of proper wall thickness for the liner pipe. The hydraulic capacity must not diminish excessively, and the structural strength and stiffness and the liner pipe and its composite action with the existing old pipe must be evaluated. The liner pipe should be able to withstand grouting pressures during construction in addition to the pull or push force in the axial direction. Also, the capacity of the liner/existing pipe composite to withstand soil, live, and groundwater loads needs to be checked. In many situations, use of simple American Society of Testing and Materials or American Water Works Association equations for structural checks could lead to either underdesign or overdesign of the liner pipe. Detailed structural analysis calculations, using tools such as the finite element method, are always more cost effective and reliable when evaluating composite structures.

Continuous and Discrete Pipes

A nose cone is attached to a butt-fusion-welded HDPE for continuous pulling or pushing into a sewer requiring rehabilitation. It is common to clean the line before slip-lining operations start.

Short pipes using either gasketed or mechanical joints are inserted in situ using hydraulic jacks. For discrete pipes, smooth-wall HDPE, profiled-wall HDPE, profiled-walled PVC, FRP, RPM, ductile iron, steel, and clayware are all used quite effectively in discrete pipe form to slip-line collection systems. The design checks for discrete pipes should include evaluation of the joints for adequate structural strength and stiffness.

Swaged Pipes

Because HDPE is a soft resin, this permits swaging or rolling down of this pipe to be able to insert it into smaller internal diameter old pipe. Swaging die or, gradually sized-down rollers can be used to insert HDPE pipes into old pipes. The design of swaged pipe is similar to that of slip-liner pipe.

Spiral Wound Pipes

Even with proper grouting behind them, spiral wound pipes are so weak structurally that this technology could never be a match for CIPP systems for structural pipe repair. In the spiral wound process, the seam is made using the ribs located at the edges of the extruded strip, and the pipe is wound into an insertable form at the bottom of the manhole in small sizes. In larger sizes, either segmented spiral pipe or continuous spiral pipe is unwound inside the broken pipe while grouting the annulus for strength and stiffness. In essence, the spiral pipe acts only as a framework to make the grout liner; whatever grouting one does is the main structural help this process can give to the old pipe. Some in situ testing of the effectiveness of the grouting is essential.

Segmented Linings

Segmented linings are suitable for large pipes of various shapes. These are installed through either manholes or special access shafts built during the repair contract. The sewer has to be dry, and bypassing is commonly employed. Common materials are FRP, RPM, PVC, HDPE, and steel.

Pipe Bursting

Pipe bursting is generally not used if congestion underground is a question or if the existing pipeline is not of a brittle nature. In smaller pipes, pipe bursting becomes a viable tool. A hydraulically activated cutting head breaks the old pipe and pushes into the native ground, making way for the new pipe, which can be up to twice its size. This method, however, causes major noise and vibration problems, and is somewhat uneconomical if too many laterals have to be reconnected.

Microtunneling

Unmanned tunneling systems in pipes smaller than 900 millimeters are normally referred to as microtunneling. This method has been used, however, for pipes as large as 3,600 millimeters and drive lengths of more than 1,000 meters, in most soil conditions. Either auger or slurry soil removal systems are employed. The precision is within 25 millimeters on line and grade and essentially installs a new pipe in place of the old pipe at the same time tunneling is done. The advantages of this method are that cost does not increase in direct proportion to the depth of the sewer; it can handle a wide variety of soil conditions; it has greater precision than traditional dig and replace methods; it is completely remote controlled, and is safer, causing the least disruption to surface structures and traffic; and it can be used for contaminated soils. The primary disadvantages are that this method is uneconomical; the length of installation is limited; mixed soils cause problems; and access to the installed pipe is poor.

Pipe Ramming

Pipe ramming is the cheapest and quickest form of pipe renovation but suffers from no steering capability. Only certain pipe materials can be handled by this method, and the drift is usually about 2 percent of the drive length or more. Hard inclusions cause major difficulties with this method.

Manhole Rehabilitation

Chemical grouting, epoxy linings, waterproofings, sealings, coatings, structural linings, and cementitious grouting are the primary methods available for manholes.

Future of the Industry

The technologies used for the assessment of the conditions of various components of a sewer system need further improvements. Taking videos of the inside of the pipe, manholes, and laterals and performing situation analyses of the structural condition of the pipes and chemical and hydraulic condition studies all could be done in a single pass of the inspection equipment, from one end of the line to the end of the site in question. The industry will continue to use chemical grouting as a versatile and effective method for repairing sewer collection systems and for better control of I/I problems. More monolithic repair technologies such as the fill and drain methods will prove to be very convenient for public agencies to use for all components of the collection system, particularly when pipes are made of many different materials. Robots that “think” for themselves and select the most appropriate repair methods from an array of technologies would make collection system evaluation and renovation highly automated. In this regard, the human bias causing the public agency to use any technology other than the most effective one could be eliminated.

Acknowledgments

The following companies and groups provided useful data to make this paper possible: **Gelco** Services, Insituform Technologies, Insituform of Mid America, Pipe Rehab International, **Avanti**, **DeNeef** Chemicals, Nupipe, Uliner, **AMliner**, Airrigation, Tobys, Performance Liner, Chevron Plexco-Spirolite, APM Permaform, Permalok, **Lamson Sessions**, **LinkPipe**, Amkrete, Sika, Iseki, Herrenknecht, Soltau, Akkerman, Flowmole, Vermeer, Straightline, Clearline, TT Technologies, British Gas, Paltem, Hobas, Sarplast, Powermole, Sanipor, Strong Seal, Owens Corning Fiberglass, NASTT, and the U.S. Environmental Protection Agency.

Dade County's Mandated Improvement Program To Reduce Sanitary Sewer Overflows

Anthony J. Clemente
Miami-Dade Water and Sewer Department, Coral Gables, Florida

Rosanne W. Cardozo
Montgomery Watson, Coral Gables, Florida

This paper focuses on the preliminary results of the mandated improvements that the Miami-Dade Water and Sewer Department is implementing to reduce sanitary sewer overflows (SSOs). An overview of the mandated improvements is provided, along with lessons learned during negotiations of the enforcement actions and during implementation of the mandated program. Also included is a discussion of the characteristics of SSOs that have occurred in Dade County, Florida.

Introduction

The Miami-Dade Water and Sewer Department serves a population of 1.5 million located within a 400-square-mile service area. The department is the largest water and wastewater utility in the southeastern United States, maintaining over 2,400 miles of gravity sewers (up to 72 inches in diameter), 640 miles of forcemains (up to 102-inch diameter), and nearly 900 pump stations. In addition, the department operates three regional wastewater treatment plants (WWTPs)—the North, South, and Central District WWTPs—which have recently been upgraded from a total annual average daily flow of 298 million gallons per day (mgd) to the current treatment capacity of 355.5 mgd.

In the late 1980s and early 1990s, the department experienced a series of sewage overflows in its wastewater collection and transmission system, which led to enforcement action from the U.S. Environmental Protection Agency (EPA) and the Florida Department of Environmental Protection (FDEP). Over a 2-year period, the department negotiated two separate Consent Decrees with EPA and two separate Settlement Agreements with FDEP that mandate over \$1 billion in improvements to Dade County's wastewater facilities.

Overview of Mandated Program

The mandated improvements are aimed at ensuring that the department's system will have both adequate transmission and treatment capacity to minimize SSOs and to provide for future growth in Dade County. The program improvements, scheduled to be completed by the year 2003, include:

- Construct major pump stations and forcemains.
- Expand and upgrade WWTPs.
- Improve over 400 pump stations.
- Design and implement a comprehensive *infiltration/exfiltration/inflow (I/E/I)* and sewer rehabilitation program.
- Design and implement a pump station inspection and repair program.
- Install supervisory control and data acquisition (SCADA) systems in more than 870 pump stations.

- Enact an infiltration and inflow (I/I) ordinance.
- Develop various contingency plans.
- Enact a grease trap ordinance.
- Eliminate illegal stormwater connections.
- Develop a collection and transmission system model.
- Develop collection system operation plans.
- Conduct a peak flow management study.
- Develop a maintenance tracking and spare parts program.
- Develop a treatment plant optimization plan.
- Enact an ordinance to require volume sewer customers to implement a similar improvements program.
- Design and implement supplemental environmental programs to provide for effluent reuse and water conservation.

Specific requirements of the corrective actions are detailed in Table 1.

Table 1. Summary of Corrective Actions

Agency	Enforcement Action	Approximate Compliance Dates	Description of Activities
FDEP	Settlement Agreement-Bay Crossing	February 1993 to December 1996	<ul style="list-style-type: none"> • Construct new Cross Bay Line • Develop contingency plan for failure of existing Cross Bay Line (ECBL) • Construct O₂ injection system • Final disposition of ECBL
FDEP	Settlement Agreement-Systemwide	July 1993 to December 2000	<ul style="list-style-type: none"> • Make odor control improvements at Central District WWTP • Expand and upgrade WWTPs • Construct major new forcemains and pump stations • Conduct comprehensive I/E/I and Sewer System Evaluation Survey • Develop pump station inspection/ evaluation program • Evaluate transmission system capacity • Enact I/I ordinance

Agency	Enforcement Action	Approximate Compliance Dates	Description of Activities
EPA	First partial Consent Decree	September 1993 to December 1998	<ul style="list-style-type: none"> • Construct new Cross Bay Line • Final disposition of ECBL • Develop various contingency plans • Construct 4th Street to 9th Street forcemain • Construct sulfide/corrosion control system • Upgrade over 400 pump stations and construct 60 miles of forcemains to improve transmission capacity • Enact grease trap ordinance
EPA	Second and final partial Consent Decree	January 1994 to January 2003	<ul style="list-style-type: none"> • Perform comprehensive I/I and sewer rehabilitation • Eliminate illegal stormwater connections • Inspect/Repair pump station • Conduct pump station remote monitoring (SCADA) • Develop and implement collection system operation plans • Develop collection/transmission system model • Conduct peak flow management study • Develop and implement maintenance/spare parts programs • Conduct treatment plant optimization • Enact volume sewer ordinance • Develop Supplemental Environmental Projects (water reuse and conservation)

Evaluation of Wastewater Facilities

An evaluation of the department's wastewater facilities and operations yielded some interesting discoveries:

- Knowledge of the collection system and how it operates was limited. The existing documentation was incomplete for such items as an inventory of the collection system, flow data for dry and wet weather conditions, SSO data, flow routing capabilities, inspection and maintenance records, and illegal stormwater connections.
- As with most utilities, the department has historically focused on plant expansions rather than on maintaining and rehabilitating the collection system because federal funds were available for plant expansion work.

- I/I presents a significant problem. I/I during wet weather accounts for an estimated 40 percent of the total flow to the plants. The effect of infiltration on wastewater flows can be seen in Figure 1, which shows a correlation of the total monthly average daily flows received at the three regional wastewater treatment plants and an average of ground-water levels measured throughout Dade County, as reported by the U.S. Geological Survey (USGS). Figure 2 shows a correlation of the same wastewater flows and rainfall measured at the Miami Airport. The I/I is attributable to the unique characteristics of south Florida, such as:
 - The service area is largely flat, with a high ground-water table that is often only 2 to 3 feet below ground surface.
 - The average annual rainfall is an astounding 60 inches, and frequent tropical storms can inundate a service area in a matter of minutes.
 - Many areas of Dade County do not have adequate drainage facilities but rely on percolation as a means to dissipate stormwater. Illegal stormwater connections have also been identified.

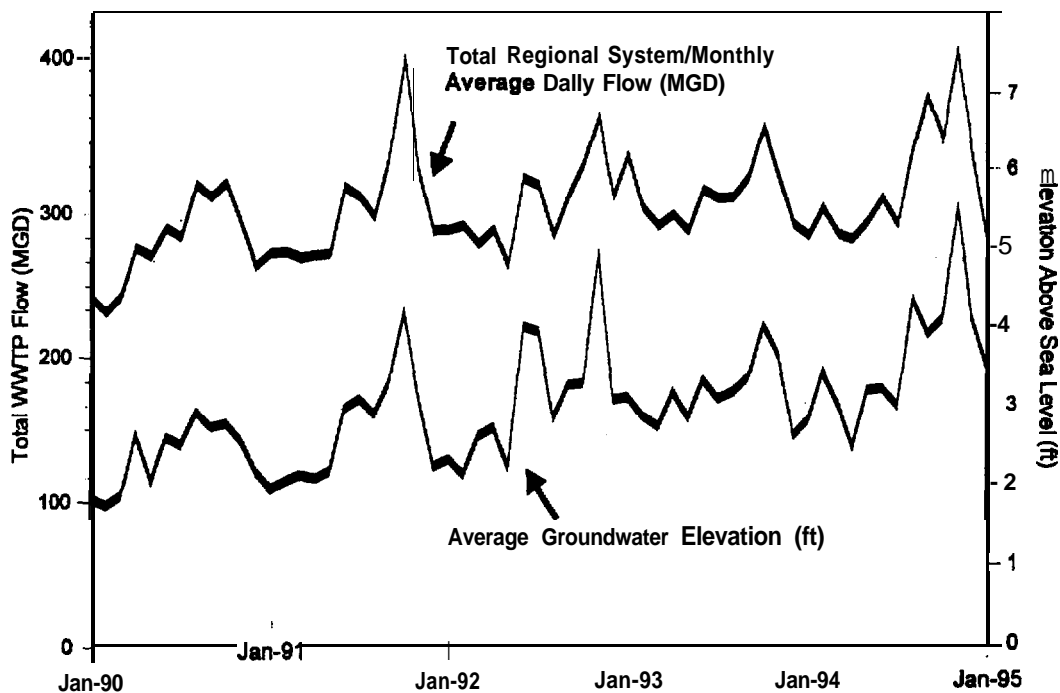

Figure 1. Correlation of wastewater flow and ground-water elevation.

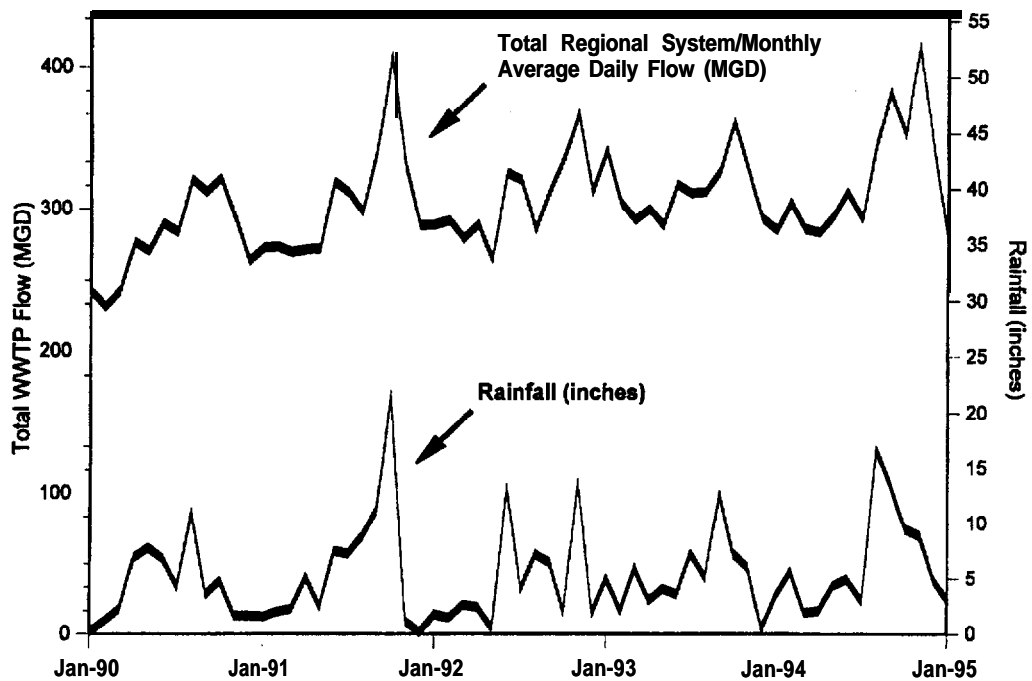

Figure 2. Correlation of wastewater flow and rainfall at Miami International Airport.

Characterization of Overflows

Until the department became involved in enforcement actions, little attention was given to documenting the occurrence of SSOs and the corresponding corrective measures. During negotiations with EPA, the department went through a very labor-intensive exercise of trying to research and reconstruct over 20 years of unscheduled maintenance records. Once the extent of the documentation problem was discovered, the department revised its reporting practices and implemented a comprehensive SSO-event tracking database. This database contains information on all known SSO events that have occurred in Dade County from January 1, 1993, through the present. Records include information on the date of the overflow event, the location, cause, corrective action proposed or taken and schedule, unusual conditions, associated rainfall event, overflow volume, and destination (i.e., directly or indirectly to surface water, not to surface water). A summary of the 471 overflow events that occurred over a 2-year period from January 1, 1993, through December 31, 1994, is shown in Table 2.

Approximately 26 percent of the 471 overflow events were recurrent, most of which were caused by insufficient capacity during wet weather and by pump station system failures. Nearly one-half of the overflows occurred during dry weather as a result of non-capacity-related problems.

The department continues to identify the cause of the overflows and implements corrective measures accordingly. To minimize the frequency of overflows associated with pump station system failures and to eliminate dry weather overflows, the department has added more staff, equipment, and other resources to its pump station inspection program and the routine and preventive maintenance programs.

Table 2. Summary of Overflow Events (January 1, 1993, through December 31, 1994)

Cause of Overflow	Percentage of Total Overflows
Pipe breaks (pipe deterioration and accidental breakage)	36
Pump station system failures	30
Insufficient capacity due to wet weather	19
Pipe blockages	15
Total	100

Most pipe blockages occurred due to an abundance of **builtup** grease. Dade County has since implemented an ordinance to control the discharge of grease and oil from industrial and commercial users of the county's wastewater treatment and collection system. The department has also implemented a comprehensive sewer inspection and cleaning program.

Approximately two-thirds of the pipe breaks were due to corrosion and to an overall deterioration of the county's aging infrastructure. The department has instituted an aggressive corrosion control program and pipe rehabilitation and replacement program to upgrade the collection system. The remaining pipe breaks were mainly attributable to accidents during construction and were promptly repaired. The frequency of accidental breaks might be reduced once sewer information is more accessible. The department is currently entering sewer information into its new geographical information system (GIS).

The pump stations that have contributed to overflows as a result of insufficient capacity are being carefully evaluated by the department. Only 3 percent of these pump stations exceed the operating provisions outlined in EPA's first Consent Decree and will be upgraded. The operating provisions of the first Consent Decree require the department to upgrade the capacity of all pump stations with a total nominal average pump operating time (NAPOT), for all pumps in a station (less one for standby), that exceeds 10 hours per day. This requirement allows for a peaking factor of 2.4.

Those pump stations that have contributed to an overflow only as a result of a severe storm event (greater than 5 years) but are otherwise operating below EPA's NAPOT limit will not be upgraded until a peak flow management study has been completed. Once a design storm has been established, the department will address the upgrading of these stations. If a storm event exceeds the design storm, however, overflows will occur. Torrential storms, such as Tropical Storm Gordon, will inundate a service area in a matter of minutes. The department uses a formal contingency plan to minimize the number and volume of SSOs discharging to surface waters. The department continually monitors weather conditions, and when notified of an impending severe storm event department personnel are quickly mobilized to aid in the emergency transfer of flows away from highly sensitive areas in the collection system.

Preliminary Results

At this writing, the department has successfully completed approximately 30 percent of the mandated improvements included in the program and remains in compliance with the terms of the Settlement Agreements and Consent Decrees. Several positive results are apparent: an overall decrease in pump station operating times, the cumulative 29 mgd I/I flow reduction in the collection system (1 mgd per month), and the increased ability of the wastewater treatment plants to handle greater flows. Moreover, approximately 80 pump stations originally proposed for upgrade were eliminated from the program as a result of I/I reduction, the construction of regional forcemains, and maintenance repairs. At this stage, however, the program's true effect on reducing overflows is hard to gauge by comparing the number of

overflow events this year with past years because of incomplete historical records. The new reporting procedures will allow a more accurate comparison in the future.

Lessons Learned

The department learned some valuable lessons, not only in the negotiations with EPA and FDEP but also in implementing an improvements program of this magnitude. Some of the key lessons are:

- Prevent enforcement actions. Adequately plan and invest in a comprehensive maintenance, rehabilitation, and upgrade program. Continually monitor the wastewater facilities and system operations to identify potential problem areas.
- Avoid enforcement actions. It is easier to negotiate with EPA engineers than with the attorneys from the Department of Justice. The focus of discussion quickly turns from finding the best solutions to imposing costly programs, stipulated penalties, and inflexible compliance dates. The attorneys never acknowledged the cost-effectiveness and affordability of improvements. The Department of Justice also appears eager to obtain cash penalties rather than to allow Supplemental Environmental Projects.
- If enforcement actions are inevitable, assign a resource of people to prepare for litigation in the event that a reasonable settlement cannot be negotiated. Involve all volume sewer users in negotiations.
- If at all possible, one enforcement action should be negotiated that satisfies the demands of all regulators. Having separate enforcement actions with FDEP and EPA for, in many cases, the exact same improvements has been and continues to be a major problem because enforcement agency personnel use different and sometimes conflicting methodologies. At this time, the department is trying to resolve these conflicts by renegotiating of the state Settlement Agreement, because the Department of Justice does not acknowledge the requirements of the state's agreement.
- If at all possible, the enforcement action should allow the agency to complete improvements in a logical fashion that results in the best long-term solution to the deficiency that is being corrected. A logical approach would be to complete a peak flow management study that would detail the most cost-effective means to handle peak flows in order to minimize SSOs. This type of a study would determine whether I/I corrections, upstream or downstream storage for flow equalization, or increased transmission system capacity (i.e., larger pump stations and forcemains) would be the best way to minimize SSOs. In addition, sufficient time should be allowed to conduct a comprehensive Sewer System Evaluation Survey (SSES) before any I/I corrections are required to be implemented.

For a number of reasons, such as the regulatory climate at the time, the department was required to negotiate an agreement with FDEP and EPA that did not allow adequate time for this logical process to occur before improvements had to be made. Therefore, improvements are currently being made that may not be the optimal, most cost-effective solution.

- Do not commit to eliminating *all* overflows, because this goal is not feasible. A better approach would be to focus on maximizing flows to treatment facilities and minimizing flows to sensitive areas within the collection system.

- The department realized through this process that its internal record-keeping was not as good as it should have been, particularly for the records kept by the field maintenance crews, who were responsible for responding to customer complaints about sewer-related problems. Because the records were not well kept, the departments negotiating position was not as strong as it could have been against the enforcement agencies' accusations. In most instances, the enforcement agencies used the incomplete records against the department.

Conclusion

The department is implementing all of the mandated improvements in accordance with the terms of EPA's two Consent Decrees and FDEP's two Settlement Agreements in an effort to minimize SSOs; however, the improvements that the department is required to make may not be the most cost-effective, optimal solutions. Once the peak flow study has been completed and more is known about how the collection system operates during both dry and wet weather, a reevaluation of the mandated improvements will be required. The Consent Decrees and Settlement Agreements should then be modified to accommodate a change to a more logical approach, based on system-specific characteristics. The current policy of the Department of Justice does not allow for this transition.

Lessons Learned From the City of Houston's Structural Rehabilitation Program

Henry N. Gregory Jr.
City of Houston Public Works and Engineering Department, Houston, Texas

Christine Kahr
Greater Houston Wastewater Program, Houston, Texas

introduction

In 1987, the City of Houston was issued an order by the Texas Natural Resources Conservation Commission, formerly the Texas Water Commission, requiring the improvement of its wastewater system. Similarly, in 1989, a series of U.S. Environmental Protection Agency (EPA) orders were issued dictating the correction of wet weather overflows. This prompted Houston to initiate an ambitious program to evaluate and rehabilitate its sanitary sewer system. The experiences offered here should benefit municipalities in the formulation or modification of their structural rehabilitation programs.

The Challenge

In the 1980s, Houston experienced a substantial amount of sewer breaks. Deteriorating sewers contributed to eroding quality of service and customer confidence, inconveniencing citizens and visitors, threatening water quality, and damaging public and private property. According to the Guide to Benchmarks of Urban *Capital* Condition, prepared by The Urban Institute and based on late 1970s data associated with 62 cities, Houston was experiencing the second highest rate of reported sewer breaks per 1,000 miles of sanitary sewer. Furthermore, the guide indicated that Houston reported the sixth highest need in EPA Categories IIIA and IIIB for correction of infiltration/inflow (I/I) and sewer rehabilitation.

The Solution

Only an intensive structural rehabilitation program of proportions currently under pursuit by the city could turn the situation around. In its fourth year of implementation, the program is realizing dividends; corrective maintenance work orders show significant decline, while customer satisfaction improves.

The Commitment

Houston has committed, to both EPA and the Texas Natural Resources Conservation Commission, to spend \$300 million over a 5-year period on its structural rehabilitation program. This program is expected to continue well beyond this period, with an average annual expenditure of \$50 million or more. The city has staffed accordingly to prepare an estimated 100 bidding documents, and has supplemented required construction engineering and inspection services with consultant staff as part of the Greater Houston Wastewater Program.

Houston's \$300 Million Sewer Rehabilitation Program

The undertaking of a program of this magnitude would tax the financial and human resources of even the most highly organized and well-funded municipality. To wisely use its limited resources, Houston was compelled to take a new approach to carrying out its program. This approach was designed by a

progressive-thinking Council drawing on existing skilled staff, hiring strategically, and utilizing the able resources of the local consulting engineering and construction contracting communities.

Recognizing that past data gathering efforts did not truly represent the reaction of the sewage collector system and wastewater treatment plants during wet weather conditions, it was necessary to initiate a new Sewer System Evaluation Survey (SSES) and accomplish the following:

- Establish existing system conditions
- Rehabilitate the existing system
- Model the collection system
- Construct relief facilities
- Provide for future system management

Overview of Sanitary Sewer System

Houston provides service to a **594-square-mile** area with approximately 348,000 customers and a total population of 1.63 million. Rainfall averages 45 inches per year. Much of the growth in the system in the past 20 years has occurred with the city's annexation of municipal utility districts in unincorporated county areas. Forty-four wastewater treatment plants (**WWTPs**) of a wide range of capacities provide secondary treatment or higher, with the treated effluent discharged to various bayous tributary to the Houston Ship Channel and Galveston Bay.

The collection system has 5,000 miles of gravity sanitary sewers, with pipe diameter sizes varying from 6 to 144 inches. Seventy percent of the system is **6- and 8-inch** diameter pipe with unreinforced concrete the dominant pipe material. Expansive soils are widely present, and surface faults provide further geotechnical challenges to pipe design. Although the general condition of the system is improving with increased preventive maintenance and the rehabilitation investment made to date, much work remains, including initial televising of more than 40 percent of the system before the condition can be assessed. For purposes of collection system maintenance, the service area is geographically divided into quadrants, Cleaning and televising by city crews is performed through a centralized group in Utility Maintenance.

System Evaluation

in 1987, Houston commenced its evaluation with intensive flow monitoring, followed by an SSES and hydraulic modeling.

Intensive Sanitary Sewer Flow Monitoring

Each of the city's WWTP service areas was subdivided into common flow tributary areas or subsystems averaging 20,000 lineal feet of mainline. Flow data were collected for a minimum of 8 weeks or the number of weeks necessary to demonstrate a minimum of four rainfall events that prompted an adequate system response. Data were analyzed to identify typical flow components, and peak inflow rates were determined for each subsystem for **1-, 3-, and 5-year** storm events. The subsystems were ranked based on inflow rates in gallons per day per 1,000 feet. Those subsystems with inflow rates greater than 20,000 were recommended for physical inspection. A total of 1,334 subsystems were established citywide, with physical inspection recommended for 1,119.

Sewer System Evaluation Survey

To identify sources of excessive wet weather inflow and dry weather infiltration due to pipe defects, Houston formulated a program to conduct field inspections of the problematic subsystems, established televising and inspection standards to facilitate the use of private contractors, and adopted data reporting and management procedures.

The city's \$65 million SSES began in November 1989, and by late 1992 the physical inspection work had been completed. A summary of the accomplished work is provided in Table 1.

Table 1. Summary of Completed Physical Inspection

Activity	Unit	Total
Smoke testing	Miles	3,180
Manhole inspection	Each	72,900
Manhole dye flooding	Each	6,300
Nighttime flow isolation	Each	4,300
Cleaning	Miles	2,270
Closed-circuit television	Miles	2,320

Today, cleaning and televising continues, focusing on closing the data gaps left under the original physical inspection work and initiating activities on parts of the system not previously targeted under the original SSES.

Hydraulic Flow Modeling

Houston followed its flow monitoring and physical inspection efforts with collection system flow modeling using a proprietary static model and a public domain dynamic model. Each line 10 inches in diameter or larger was modeled using:

- Calibrated population flow
- **2- and 5-year** inflow
- Estimated flow from commitments to serve
- Estimated flow from vacant acreage
- Other land use data

Those line segments requiring rehabilitation and wet weather relief were turned over to Greater Houston Wastewater Program (GHWP) design consultants to develop plan and profile drawings, bidding documents, and technical specifications using GHWP guide documents. The bidding documents for line segments requiring only rehabilitation were prepared by the city's rehabilitation group under the GHWP.

Supporting the Structural Rehabilitation Effort

The Department of Public Works and Engineering refined its organization to accommodate the rehabilitation program (see Figure 1). Major support is provided by the Greater Houston Wastewater Program. This is an integrated organization of city and consultant staff providing program management, planning, design, and construction services to Houston's \$1 billion sanitary sewer overflow relief and structural rehabilitation program. In addition, the Utility Maintenance Division is also involved with implementing structural rehabilitation projects through two approaches: bidding and administering annual service agreements with scopes that can provide sewer cleaning, televising, and all city-approved methods of rehabilitation; and supplying city maintenance crews to furnish cleaning, televising, point repairs, sliplining, paving, and **hardscape/landscape** restoration.

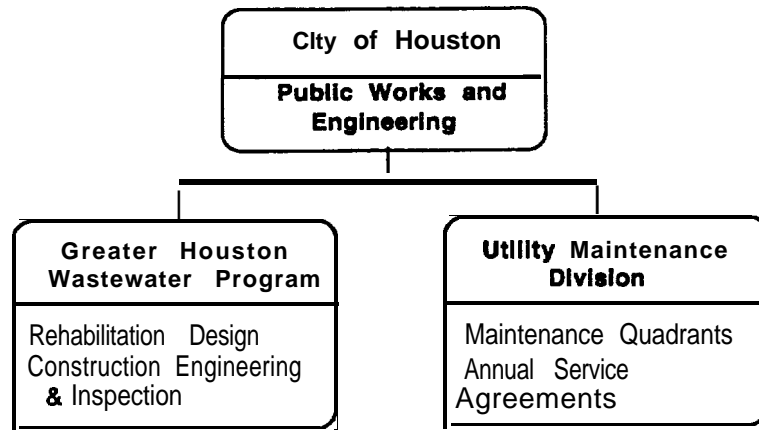

Figure 1. Organizational chart for the City of Houston Department of Public Works and Engineering, Greater Houston Wastewater Program, and Utility Maintenance Division.

“City Method” of Rehabilitation

Upon conclusion of system evaluation, it was apparent that the magnitude of collected physical inspection data and the extent of needed rehabilitation required a systematic approach to the selection of cost-effective rehabilitation technologies. The “City Method” of pipeline rehabilitation was devised dependent on a calculated mainline rating system incorporated into a proprietary sewer system database. The rating reflects structural condition, roots, and infiltration and inflow. City staff set the threshold of the mainline rating for which any line section having an equal or greater mainline rating would be rehabilitated. This threshold reflected a reasonable level of need for rehabilitation and fiscal limitations. Generally, the City Method is described as follows:

- Line segments that have a mainline rating of 12 or more and a line deterioration rating of moderate or worse are identified.
- Laterals (i.e., lines connecting private services to the mainline) that require point repairs are identified with smoke leaks.
- For each line segment to be rehabilitated, television tapes are reviewed and a “decision tree” is used to guide the selection of a rehabilitation method.

- Contract documents are prepared and competitively bid, and the needy line segments are rehabilitated.

Initially, the application of a mainline rating threshold of 8 was used, resulting in an estimated rehabilitation need of \$750 million. After contrasting the structural condition of a rating of 8 versus 12, the threshold was adjusted to 12 resulting in a need of \$478 million.

In a given area of a rehabilitation contract, the City Method results in 15 to greater than 50 percent of the mainlines and laterals being rehabilitated. The city's program does not include the rehabilitation of private services.

Annual Service Agreements

In addition to the rehabilitation effected under the GHWP and the maintenance quadrants, Houston takes a construction contracting approach, which allows the competitive bidding of a number of unit price contracts for sewer cleaning and televising and for various approved rehabilitation methods. A not-to-exceed fee of \$3 million is established for each contract. The city awards \$10 to \$20 million a year of such contracts. These are 1 -year contracts with a city option to extend them up to 2 years by 1 -year increments. Services are used citywide through work orders which specify the location, quantities, and types of services to be provided. Although the application of these services is highly flexible and could be used to support corrective maintenance driven by customer complaints, these services are generally reserved for scheduled activities.

State Revolving Fund

The compressed schedule of the city's wet weather overflow correction program and the extent of required rehabilitation have greatly affected the finances of the utility enterprise operation. Additionally, rising conventional financing costs will increase user fees that are already some of the highest in the nation. An average residential sewer bill is about \$21 per month.

Recently, Houston obtained a \$300 million loan commitment for its rehabilitation effort from the Texas Water Development Board (TWDB) under the State Revolving Fund (SRF) loan program. The city had previously received a \$122 million loan commitment for its overflow relief program and anticipates an additional commitment of \$350 million over the next 18 months. Under the loan program, upon state approval of the project report and environmental assessment, a loan commitment is made. Subsequently, loan proceeds are deposited to a restricted escrow fund from which disbursements are made to an active city construction account as construction contracts are awarded. Annual service agreements, program management and design engineering fees, and city force account costs are eligible for participation; however, real estate costs are not.

This is a highly flexible loan program with interest rates 70 basis points, or 0.7 percent, below market rates available to the city. This rate break has the potential to save the city tens of millions of dollars in debt service over the 20-year term of the loan. There are no federal "Title II" requirements, which simplifies the contracting process and reduces some of the increased costs of administration and increased bid prices associated with other federal and state grant and loan programs.

Methodology for Physical Inspection of the Sanitary Sewer System

Houston competitively procured seven contractors and consultants to carry out the physical inspection program during the period of 1989 through 1992. Standards were developed to guide the program, and training sessions for city staff and contractors were conducted. Using the intensive sanitary sewer flow

monitoring data, physical inspection was split into two phases for each of those basins exhibiting excessive inflow or excessive infiltration.

Excessive Inflow

For basins with excessive inflow, the first phase included the following tasks:

- Visual inspection of all manholes
- Smoke testing of all lines 24 inches in diameter or less
- Televising of all lines 15 inches in diameter or greater
- Cleaning of all lines 15 to 30 inches in diameter

A second phase followed, including:

- Dye-water flooding in conjunction with televising of suspected cross connections.
- Dye-water flooding of manholes where smoke leaks were detected.
- Cleaning of all lines designated for televising but not televised under the first phase.
- Televising of lines having major structural defects, lines having one or more smoke leaks within 100 feet, and lines that cannot be smoke tested.

Excessive Infiltration

For basins with excessive infiltration, the first phase included the following tasks:

- Night flow isolation of lines less than 15 inches in diameter
- Televising all lines 15 inches or greater in diameter
- Cleaning prior to televising any lines equal to or less than 30 inches in diameter

A second phase followed, including:

- Inspection of manholes of line sections with excessive infiltration
- Televising of all line sections less than 15 inches in diameter with excessive infiltration

Manhole Inspection

This inspection included the assessment of pipe connections and overall structural condition. Connecting lines were documented for condition, flow direction, diameter, and material type. Casings, risers, cones, walls, benches, inverts, and steps were assessed for structural integrity.

Reporting

The physical inspection program resulted in a number of reports which ultimately supported decisions on which lines to rehabilitate. These reports, available in hardcopy and electronic file (database) format, include:

- Manhole inspections
- Smoke testing
- Television inspections

Quality Assurance/Quality Control

Inconsistencies were identified in the contractor reports, which prompted the city to incorporate a quality assurance/quality control process. The city viewed all television tapes and inspection reports, and criteria assessment nomenclature used by the contractors was adjusted for purposes of standardization.

Determination of Need for Rehabilitation

Upon normalization of data, the city determined what mainlines were to be rehabilitated based on the mainline rating and line deterioration. For a mainline rating greater than or equal to 12, rehabilitation was required either along specific points in the mainline (i.e., point repairs identified by television) or for the entire mainline section length (i.e., manhole to manhole).

Prioritizing Rehabilitation Work

To accomplish all work expediently would outstrip reasonably available human and financial resources. The sheer volume and associated cost of the required rehabilitation have challenged Houston to develop a prioritized work plan. Tools to set priorities more effectively are under consideration, while others are in place. Four basic areas are driving the setting of priorities:

- Commitment to regulatory agencies
- Customer complaints
- Critical rating
- Fiscal limitations

Commitment to Regulatory Agencies

Although a schedule for rehabilitation is not incorporated into the city's Administrative Orders, Houston has indicated to EPA and the Texas Natural Resources Conservation Commission that it would spend \$300 million on rehabilitation over 5 years. Competing priorities for capital funds have made this no easy task, but the city remains true to its schedule and commitment.

Customer Complaints

The city is very concerned about the quality of service it provides to its customers. Strict guidelines and goals for response to all complaints are followed. Efforts have been made to analyze the incidence of complaints for purposes of directing rehabilitation projects and preventive maintenance. In 1994, over 20,000 dry weather complaints received in 1993 were mapped, and the number of line sections and number of complaints per line section involved in the complaints were analyzed.

Critical Rating

Although the mainline and line deterioration ratings are the cornerstone of the rehabilitation evaluation process, they only support a “yes” or “no” decision on the need for rehabilitation of a particular line section. The ratings offer little or no assistance in establishing priorities or resolving conflicting priorities. Although not implemented at this time, a method of applying a factor to the mainline rating to reflect the “critical nature” of each line section is under consideration. The degree to which a line section is critical is a function of the consequences should it structurally fail. These consequences could include impacts on public health, public safety, and water quality; other socioeconomic factors: the degree of traffic and business disruption; and the extent of loss to public and private property. This should be an effective tool in prioritizing work.

Fiscal Limitations

Ideally, leveling the annual expenditure for rehabilitation would be helpful to planning and optimizing a work plan. In any given fiscal year, however, conflicting capital spending priorities make this nearly impossible. Capital funds made available at levels incongruous to need will always dictate the “adjustment” of the best-intended and well-conceived priorities. An approach to setting priorities that reflects customer complaints and the critical nature of specific line sections should assist with managing a long-term rehabilitation program.

Methodology for Selection of Rehabilitation Technology

In 1992, the GHWP developed design guidelines for the rehabilitation of concrete pipelines. The guidelines include design procedures and criteria with the objective of assisting city design teams in developing complete and consistent bidding and contract documents and in selecting appropriate rehabilitation methods. Currently Houston specifies sliplining, cured in place, point repair, pipe bursting, and remove and replace. Below is a summary of the key decision points in the selection process.

Point Repair Assessment

The point repair criteria are based on assessing when the cost of point repairs plus rehabilitation, if needed, reaches or exceeds the cost of removal and replacement of the pipeline section. If the number of point repairs exceeds the threshold, then remove and replace is selected.

Deterioration Assessment

The condition of the line section is assessed to determine the relative degree of deterioration (e.g., protruding aggregate, holes in pipe top or side) due to structural defects and corrosion. The degree of deterioration greatly influences the selection of a rehabilitation method.

Buildout Analysis

The tributary area to a pipe section to be rehabilitated must be analyzed to determine the potential for future development. If **buildout** has occurred, then a hydraulic analysis is performed to select the appropriate rehabilitation method. If **not**, remove and replace is selected to avoid the capacity reduction of liner methods.

Hydraulic Analysis

For line sections with moderate or heavy deterioration whose tributary area is built out, a hydraulic analysis is performed to estimate required capacity. This will determine how much reduction in the inner diameter of the line can be tolerated, resulting in the selection of sliplining, cured in place, or remove and replace methods.

Field Survey

Finally, line sections selected for point repairs, remove and replace, or rerouting are visually surveyed for physical conditions affecting the construction feasibility of any of these methods.

Reduction of Customer Complaints by Structural Rehabilitation

To date, Houston has appropriated more than \$200 million to rehabilitation projects. When completed, these contracts will have rehabilitated or replaced over 3 million feet of sewers. Although difficult to attribute directly to the investment in rehabilitation, results are perceivable. Maintenance personnel indicate that wet weather complaints are substantially less, and the number of service calls to clear stoppages is showing a decline. While rehabilitation is ambitiously pursued, so are line cleaning and grease control. The combination of the two can be credited with the recent turnaround in the quality of service. The city will consider methods for measuring the success of its program for subsequent implementation.

Contracting Approaches To Enhance Bid Pricing

The city has bid 77 rehabilitation projects and completed 34 to date. This level of bidding activity has provided much insight into the market. The GHWP Rehabilitation Design and Construction Management groups are gathering additional information that will be incorporated in future bidding. The following are some suggestions to enhance bid pricing:

- Minimize rehabilitation work performed under Annual Service Agreements, which tend to be a more costly approach on a unit cost basis.
- Use clean, well-conceived bid documents and specifications to obtain “tight” bids.
- Limit the number of rehabilitation methods per contract to minimize subcontractor markups.
- Accept as many products and installation methods as feasible to enhance competition.
- Avoid conflicts by sequentially putting general contractors through areas to be rehabilitated.

- Handle proposed product alternates during pre-bid to maintain competitive pricing.
- Maintain a standard products list, and eliminate nonperforming products.

Standard Wastewater Products Committee and the Evaluation of New Technologies

The mission of the Standard Wastewater Products Committee (SWPC) is to maintain a list of approved standard products, materials, and construction methods associated with the installation, maintenance and rehabilitation of sanitary sewers. Literature reviews, case studies, manufacturers' printed materials, demonstration projects, and field investigations are used in the evaluation of products. The list is continuously updated to add and remove items accordingly. Currently, 17 products are approved. This resource provides the city with improved control of the quality of its projects. Furthermore, it facilitates the bidding of its jobs by minimizing contractor proposals of untried and unproven materials.

New Product Approval

The SWPC uses a four-step approach to evaluating and approving new technologies and products:

- **Step 1:** The application completed by the product representative is reviewed, and preliminary research is initiated.
- **Step 2:** References, past performance history, applicable American Society for Testing and Materials tests, and need for a demonstration project are evaluated.
- **Step 3:** A demonstration project, if required, is designed and implemented, and a report is prepared.
- **Step 4:** The SWPC decides on whether or not to include the product on the city list.

Field Investigations

In the near future, the SWPC expects to evaluate through field investigation 14 products that have been in the ground 4 years or longer, including polyvinyl chloride (PVC) Truss pipe, Hobas Fiberglass pipe, and T-Loc PVC liner. Results from these investigations will determine whether these products remain on the city list.

Sanitary Sewer Rehabilitation Demonstration Project

In an effort to further refine and improve its program, Houston is pursuing a special rehabilitation demonstration project with the following goals:

- Assess the reduction in peak I/I flow resulting from the City Method of rehabilitation and the "Comprehensive Method" of rehabilitation (i.e., 100 percent rehabilitation of mainlines, laterals, and private services).
- Obtain construction cost data on implementing the Comprehensive Method.
- Assess the feasibility of accurately estimating I/I flow from specific types of defects by rainfall simulation analysis methods.
- Identify benefits and problems associated with rehabilitating private services.

Overview of Approach

The work plan for the demonstration project includes the following steps:

- Develop criteria for test basin and control basin selection
- Select basins
- Conduct a physical inspection of test basins
- Conduct prerehabilitation flow and rainfall monitoring
- Perform rehabilitation
- Conduct postrehabilitation flow and rainfall monitoring
- Prepare report

Early Observations and issues

Significant problems have arisen during the **2-year** course of the project, and some still persist today. Some of the issues have included:

- Difficulty in finding basins that meet selection criteria.
- Construction schedule conflicts with other city and transit projects.
- Difficulty in obtaining prerehabilitation flow data due to sewer surcharging and inadequate storm activity.
- Institutional issues threatening the ability to accomplish private services rehabilitation.

Project Status and Schedule

The project design is complete, and bids will be open in June 1995. Construction should be completed in early 1996, followed by a 3- to 6-month postrehabilitation flow monitoring period. A final report should be available in August 1996.

Conclusion

A municipality can learn invaluable lessons from examining Houston's experience. There is little sense to "reinventing the wheel" when it comes to making a reinvestment of tens or hundreds of millions of dollars in one's infrastructure. Of course, the benefits of a structural rehabilitation program are multifaceted, but they all add up to the same objective: improved customer service. The successes of such a program-including a reduced frequency of corrective maintenance, less incidence of damage to public and private property, the extension of infrastructure service life, and the decrease of overflows and stoppages-are a winning combination for customers, elected officials, and municipal personnel.

Separate Sewer Overflows: Determining the Appropriate Storm Protection Level

Alan J. Hollenbeck
RJN Group, Inc., Wheaton, Illinois

Emerging national policy on separate sanitary sewer overflows (**SSOs**) must ultimately address the following fundamental question: “How frequently, if ever, will separate sewer overflows be allowed?” The first step to developing equitable, cost-effective regulations for **SSOs** hinges not on answers, but rather on asking the right questions. By framing the proper questions, emerging policy is most likely to be equitable, cost-effective, and ultimately enforceable.

Following the first fundamental question, the following more detailed questions, either directly or indirectly related to design storm protection level, must be answered:

- What is an SSO?
- How can an SSO be predicted?
- Does it make any difference when a storm event occurs?
- How is a 1-year storm event defined?
- What approach or approaches to cost/benefit analysis are appropriate?

This paper focuses on wet weather **SSOs** that are caused by intense storm events. There are, however, other events or conditions that can cause **SSOs**, including power outages at pump stations and treatment plants, system blockages due to maintenance and vandalism, and rapid snowmelt coupled with low-intensity, long-duration storm events. In some collection systems, these events may occur as often or even more frequently as **SSOs** from intense storm events. SSO program guidance must provide answers to the same fundamental question for SSO events other than those caused by intense storm events.

What Is an SSO?

Section 301 of the Clean Water Act and National Pollutant Discharge Elimination System (NDPES) permits have in the past emphasized discharges to “waters of the United States.” Recent SSO policy dialog has expanded this to include “diversions to public or private property and the environment (including ground water) that do not reach waters of the United States, such as basement floodings.”

This approach properly puts more emphasis on primary human contact with **SSOs** and ultimately less emphasis on the receiving water quality impacts of **SSOs**. In a climate of limited financial resources, this new emphasis seems appropriate. Some communities have **SSOs** that discharge in the vicinity of public beaches or other primary-contact areas. In addition, **SSOs** in some communities discharge to waters used for fishing and shellfishing. In many cases, however, the likelihood of primary human contact with SSO discharges to waters of the United States is *lower* than the likelihood of human contact with basement backups and localized overflows in residential neighborhoods. The impact of **SSOs** in urban areas on water quality violations has not been widely reported. The limited number of published studies seem to rank **SSOs** well below urban stormwater runoff and combined sewer overflows (**CSOs**) as contributors to water quality violations.

This approach will also most likely result in a policy that focuses on the following question: “How many times per year will there be an SSO that could result in primary human contact?” This is a fundamentally

different question than “How many times a year will there be a water quality violation?” In addition, any emphasis on primary human contact tends to focus on the human health and aesthetics of SSO discharges over the impact of SSOs on traditional water quality parameters such as dissolved oxygen and ammonia-nitrogen. The key parameter normally used for water quality modeling of human health impacts is fecal coliform count. The use of this indicator for waterborne pathogens has not been as widely researched (including model calibration) in the water quality modeling field as dissolved oxygen and other water quality indicators. The water quality modeling of viruses and protozoans and their survival period in receiving waters is also not well researched.

Floatables are probably one of the most visible components of SSOs and, therefore, are a relatively significant factor in the aesthetic impact of SSOs. Unfortunately, floatables also fall in the same category as viruses regarding the lack of published research or computer modeling and calibration data of SSO volume/duration relationships. “First-flush” studies of separate sanitary sewer systems have typically analyzed total suspended solids and biochemical oxygen demand (BOD) as indicators of wet weather SSO pollutant content, not floatables. Total suspended solids and BOD are more closely related to water quality violations for solids and dissolved oxygen than to aesthetics.

How Can an SSO Occurrence Be Predicted?

Almost every separate sanitary sewer system experiences some level of surcharging after intense storm events, such as a 1 -year storm. This condition requires that some methodology exists for predicting how a wastewater collection system will operate under extreme storm event conditions that cannot be monitored due to system surcharge and possible overflow. The author published a paper almost 15 years ago on one technique for predicting sewer system peak flow response to extreme storm events. An example of this technique is shown in Figure 1. Other techniques have also been presented at this conference. Ultimately, any technique depends on empirical data analysis and has a built-in uncertainty due to the need to project up-to-design storm conditions.

This built-in uncertainty in projecting peak flow rates in a sewer system in response to intense storm events requires more research and discussion in relation to SSO regulations. The need to narrow the range of uncertainty in these projections seems to have been overshadowed by the debate on the relative accuracy of flowmeter technology. The ability of current meter technology to measure “average” flow profile velocity is only one step in the process of predicting sewer system behavior under intense storm events.

The other component of SSO events is the volume/duration of the overflow, The relationship between storm recurrence interval/duration and peak wet weather flow volume/duration is also reliant on empirical data. In the author’s experience, this relationship is more difficult to quantify than the rainfall/peak flow relationship, and fewer data have been presented on this subject. The sizing and ultimately the cost of deep tunnel storage solutions in large urban systems are very reliant on accurate predictions of wet weather flow volume resulting from the design storm event.

Separate sanitary sewer systems have historically been designed not to surcharge under peak flow conditions. The combination of unanticipated future growth and unaccounted for infiltration/inflow (VI), however, often results in surcharging after intense storm events. In communities subject to basement backups, detailed modeling of hydraulic grade lines may be required if some level of “acceptable surcharge” is going to be allowed under the design storm peak wet weather flow. This analysis requires elevation data for manhole rim and pipe inverts, as well as basement elevations for homes without overhead sewers.

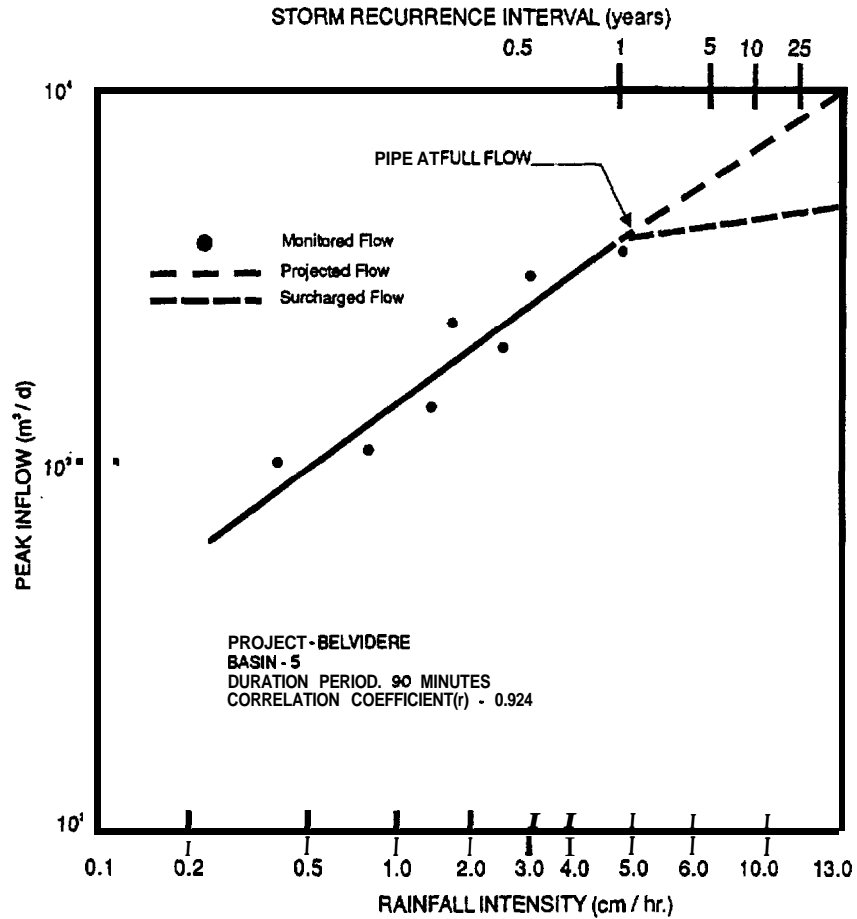

Figure 1. Typical relationship of peak inflow to rainfall intensity.

Does It Make Any Difference When a Storm Event Occurs?

The impact of a given extreme storm event on the occurrence of **SSOs** cannot be isolated entirely from other conditions. It is a well known fact that antecedent soil moisture conditions have a tremendous impact on the occurrence of **SSOs** following extreme storm events. As shown in Figure 2, the 1 inch per hour storm event in April or May, when soil moisture content is very high, will not have the same impact on SSO occurrences as the identical storm event in September or October, when soil moisture is lower. The determination of how many SSO events per year will occur and the duration of each event need to incorporate the impact of antecedent moisture conditions. SSO system solutions designed around design storm events during low soil moisture conditions will typically result in system surcharge and continued SSO events for the design storm after construction.

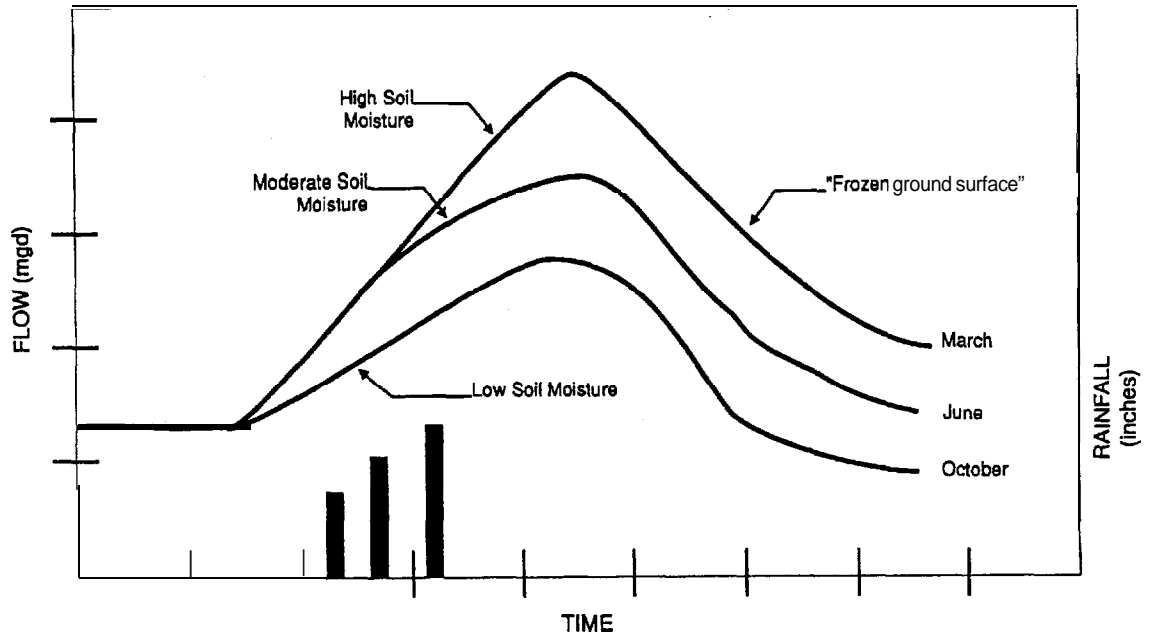

Figure 2. Seasonal impacts on peak flow/volume.

This same phenomenon can be observed when a second intense storm event occurs shortly after an initial isolated event. As shown on Figure 3, the response to the second storm is proportionally higher and more likely to cause an SSO than the first storm event. Statistical data are not always available on the time interval between intense storm events in a given region.

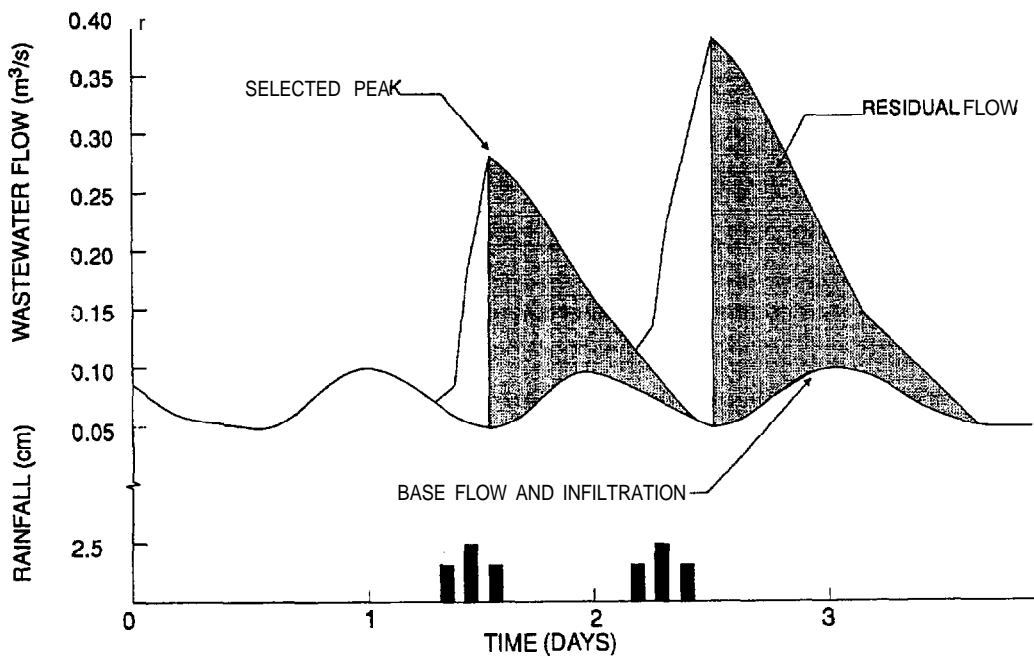

Figure 3. Typical effect of rainfall on wastewater flow.

How Is a 1-Year Storm Event Defined?

Storm recurrence interval (e.g., 1-year, **5-year**) must always be coupled with storm duration (e.g., 1-hour, 6-hour) in relation to SSO occurrences. The storm duration most likely to cause SSOs in a sanitary sewer system is a duration approximately equal to the time of concentration of the system tributary to the SSO. On a very localized level, this is often a **30-minute** duration storm created by a relatively small storm cell over a relatively small geographic area. On a larger scale, this may be a **6-hour** duration storm caused by a large storm cell over an entire watershed. The characteristics of the individual system dictate the “critical” storm duration most likely to cause an SSO occurrence.

Storm recurrence intervals are ultimately a function of statistical data gathered over time. If overall climatic patterns did not shift, then the definition (inches per hour) of a 1-year or **5-year** storm event would not change over time. Statistical data for intense storm events in the Midwest, however, indicate that the period from 1900 to 1940 was statistically “milder” than the period from 1940 to 1990; the frequency of extreme storm events was significantly greater from 1940 to 1990. As shown in Figure 4, design storm rainfall in many urban areas of Illinois has increased as much as 20 percent.

Current research is also exploring the relationship between urban development (in particular, the increasing percentage of urban areas with paved or impervious surfaces) and the increasing incidence of intense storm events and resulting flooding. If this relationship does exist, the general trend would also continue towards a higher incidence of intense storm events in urban environments. Nationwide, local statistical data must be updated with recent rainfall data to account for any long-term shifts in climate related to intense storm events. Yesterday’s **5-year** storm may be today’s 1-year storm!

Intense rainfall occurrences vary dramatically from one region of the country to another. For example, the **5-year, 60-minute** duration storm for New Orleans is approximately 3.5 inches per hour, while the same storm in northeastern Illinois is only 1.9 inches per hour, a difference of 84 percent. If it can be assumed that the occurrence of SSOs is related in some fashion to rainfall intensity and duration, then it could be far more costly to limit overflows in New Orleans to, for example, one SSO event per year than in Chicago. National regulations must ultimately deal with these regional variations.

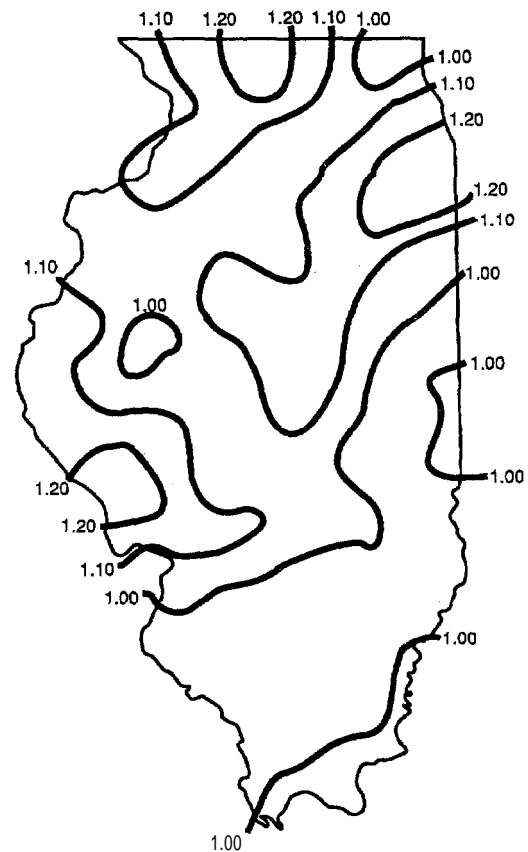

Figure 4. Ratios of 1941-1980 to 1901-1940 P-year storm rainfall.

What Approaches to Cost/Benefit Analysis Are Appropriate?

Establishing the cost to provide a given level of protection in a sanitary sewer system involves quantification of the following components:

- System rehabilitation to reduce wet weather flows.
- Relief sewer/pump station construction to transport remaining peak wet weather flow after rehabilitation to prevent an SSO occurrence.

- Treatment or storage of remaining wet weather flows.

System rehabilitation has proven to be effective in reducing peak wet weather flow rates and total wet weather flow volume resulting from intense storm events. Cost-effective system rehabilitation, however, is normally not sufficient by itself without some combination of relief sewer/pump station expansion and treatment plant/storage facilities. All three of the cost components involve some level of ongoing maintenance, which should be factored into the cost/benefit analysis by converting annual maintenance costs to total present worth. The success rate of many rehabilitation programs completed in the 1970s and 1980s has declined due to the lack of an ongoing annual maintenance and rehabilitation program.

It is often difficult to accurately quantify these costs under intense rainstorm conditions (greater than 1-year storm). It is normally far more difficult to quantify the benefits associated with providing a given level of storm protection. These benefits can include, but are not necessarily limited to:

- Reduction in water quality violations in receiving streams and waters.
- Reduction in damages to private property from basement backups.
- Reduction in the number of opportunities for primary human contact with **SSOs**.
- Reduction in the number of **SSOs** that result in closure of public recreation areas and fishing waters.

Quantification of the impact on water quality violations often depends on computer modeling of receiving streams and waters. Computer modeling of water quality impacts of extreme event rainstorms is only as accurate as the model's ability to predict water quality conditions during and after events that happen very infrequently. This calibration of actual water quality sampling data with model results cannot rely on dry weather or even moderate stormwater quality sampling data. Computer modeling of water quality conditions under extreme storm events must be calibrated with water quality sampling data gathered during extreme storm events. Even some of the most sophisticated water quality models (including those developed under the old Section 208 **Areawide** Water Quality Management Plan programs) are lacking this type of extreme event calibration data.

Many communities do not have access to fully developed, calibrated water quality models developed in the past and maintained over time. In addition, the time and expense to develop and calibrate such models for extreme event conditions may not be justified given the uncertainty built in to the modeling results under extreme event conditions.

Damage to private property from basement backups is also extremely difficult to project due to the number of variables involved, including the number of homes affected per SSO occurrence, the nature of the contents of each basement subject to backups, and the reduction in resale value of a home subject to basement backups. Quantifying damages for primary human contact with **SSOs** are also an inexact science, along with quantifying the damages associated with closure of public recreation facilities and fishing waters.

An approach that RJN Group has used over the last 15 years is based on traditional knee of the curve cost/benefit analysis. Instead of attempting to quantify the previously listed benefits, this approach simply evaluates where the break occurs in the cost to prevent an SSO occurrence. An example of this analysis is shown in Figure 5. This analysis could be performed on a systemwide basis for small or medium-sized communities or on a separate basin or watershed scale for larger communities.

Every case in which we have applied this methodology, some type of clear break point emerged where the marginal cost to prevent an SSO increased dramatically. The knee of the curve typically fell between a 1-year and a 10-year storm event. This would suggest a “level of protection” for an event that would occur on the average of between once per year and once every 10 years. As expected, this is a “higher” level of protection than is normally provided for CSO discharges.

Recommendations

Emerging national policy on **SSOs** must incorporate the determination of design storm protection level. This determination will most likely be based on site-specific conditions related to storm intensity statistics, occurrences of **SSOs** in residential neighborhoods and /or basement backups, and the cost to reduce the incidence of **SSOs** for the design storm. The answer to the fundamental question “How frequently, if ever, will **SSOs** be allowed?” should consider these site-specific conditions. The following recommendations, which are directly or indirectly related to design storm protection level, should be incorporated into the national SSO policy:

- The definition of SSO should be modified to emphasize primary human contact/aesthetics of **SSOs** over water quality violations.
- Local/regional rainfall data should be updated to ensure that design storm definition (inches per hour) is based on recent historical rainfall patterns.
- Additional research should be conducted on the empirical relationship between design storm intensity and wet weather flow volume.
- SSO events not caused by intense storm events must also be factored into site-specific marginal cost analyses.
- Marginal cost analyses based on marginal cost to prevent an additional SSO event should be used where sophisticated water quality models are not available or practical to develop.

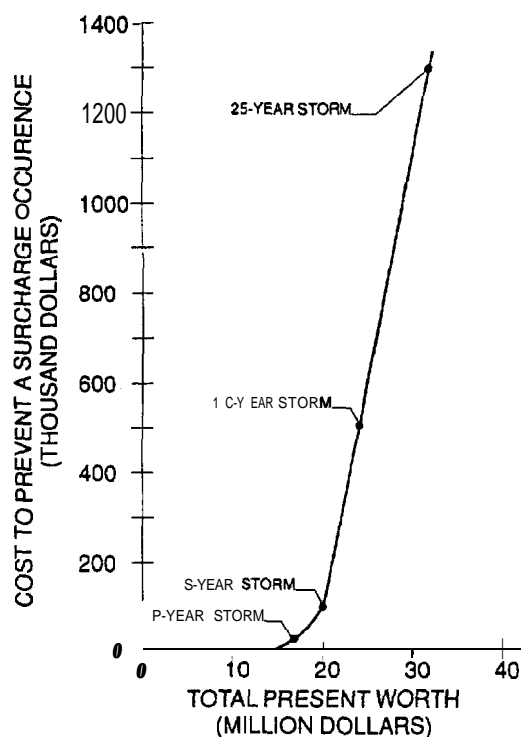

Figure 5. Relationship of cost for protection and design storm.

Visualizing Your Sanitary Sewer Overflow Status Using Desktop Mapping

Darin H. Thomas
Byrd/Forbes Associates Inc., Greensboro, North Carolina

Thomas W. Trybus
T.W. Trybus & Associates, Naperville, Illinois

Objective

This paper is designed to demonstrate a method that collection system managers can use to quickly gain an understanding of complex data on sanitary sewer overflows (SSOs). It also provides an overview of a low-cost personal computer technology known as desktop mapping (DTM), which can be best understood as a subset of the more expensive geographic information systems (GIS) technology.

Background

Underground sewer infrastructure is difficult to evaluate with tabular data. Most collection systems are quite expansive and comprise hundreds of miles of interconnected pipes with differing characteristics, such as location, material, size, age, and physical condition. Evaluating the sewer pipe network for maintenance and high-priority repair has historically been difficult on a systemwide basis. Most often, small areas of a system are targeted for attention. Closed circuit television is often used for detailed inspection of these small areas, and repairs or maintenance is performed based on the results of such inspections. While this approach yields some results, it prevents managers from evaluating the entire network as a cohesive system.

Many communities have either implemented or are considering implementing GIS. Unfortunately, not all sewer authorities can afford GIS hardware and software systems. In most cases the full power of a GIS system is simply not required; the collection system manager needs simply to keep track of the sewer pipe network. For years most of the information about this underground infrastructure was stored in the memory of senior employees. Through the use of inexpensive DTM technology, collection system professionals can use information gathered over many years to gain a visual perspective of their systems, thereby ensuring that limited resources are directed where they are most needed. DTM offers all the GIS functionality that collection system managers require and provides a powerful alternative to past methods of data visualization.

A DTM solution integrates field data with mapping software programs, all running on inexpensive desktop computers. It allows the user to visualize data having some geographic characteristic, such as SSO locations. Often, the best way to visualize these data is simply to "put it on the map." The major distinction between GIS and DTM is that GIS offers more tools for basemap drawing and manipulation. DTM relies on the use of basemaps, drawn with computer-aided drafting (CAD) software or purchased from map vendors, and concentrates its power on viewing overlying data in many different ways.

GIS has been a buzzword in the industry for some time. Many agencies investigating this technology, however, have been frustrated by high prices and long, costly startup times. DTM, however, provides a way to learn, understand, and use GIS technology within a reasonable budget. Indeed, DTM often can provide functionality that is difficult to implement with costlier GIS systems.

Methodology

Over the last 20 years an enormous amount of information has been collected on sewer infrastructure, which has spawned a huge “sewer evaluation” industry. Specialists in such areas as hydraulic behavior, structural assessment, corrosion rate analysis, and innovative rehabilitation processes are now common. The sewer infrastructure in many communities has been pushed to its limit, resulting in recurring problems that are forcing collection system managers to rethink or reengineer how they manage their collection systems.

The causes of and solutions for SSOs are not identical in all situations. The variables that control an SSO may include infiltration and inflow (VI) problems, deterioration of the physical condition of pipe, debris or roots, or lack of capacity. All SSO problems in this country are difficult to address through permanent solutions. A way to quickly visualize the interaction of myriad variables governing system performance is required. While DTM is not the total solution to addressing SSO problems, it is a tool that greatly enhances the collection system manager’s understanding of the sewer system.

An understanding of key variables that contribute to SSO problems can be gained quickly through “data visualization” of much of the data collected during a sewer system evaluation survey (SSES). The basic steps are:

1. Establish basemaps.
2. Gather sewer condition and performance data.
3. Update map and link data.
4. Analyze data by calculation and visualization.

Step 1. Establish Basemaps’

Those who try to understand the relationship among all the variables governing the performance of a sewer system often overlook the identification of map resources. Evaluating a complex sewer network without some form of maps almost always leads to confusion. Accuracy of **basemaps** is a common issue among GIS professionals; however, this should not be an issue for collection system managers.

If funds are insufficient to allow generation of a survey-accurate CAD drawing or aerial photography and digitizing, there are less expensive options. The U.S. Census Bureau has compiled Topologically Integrated Geographic Encoding and Referencing (TIGER) maps of the entire United States for use in analyzing census data. These map files are in the public domain (i.e., not copyrighted) and are available for a reasonable distribution fee from the Census Bureau. TIGER maps are not designed for engineering accuracy but are inexpensive and visually correct. Because the “raw” map files require significant “massaging” before they can be easily used with specific mapping software, various vendors have acquired the data, done some error checking, and translated the files into specific mapping formats. TIGER **basemaps** can be purchased from various vendors for less than \$300 per county, and all counties in the United States are available on CD-ROM from some vendors for as little as \$1,500.

TIGER maps sold by most vendors (and in their native format) are single-line street maps (like gas station street maps) that also contain layers of municipal boundaries, water features, and railroads. In addition, they are “intelligent” maps that contain hot-linked data files specifying the street name and address range for each street segment in the database. Address ranges for street segments are

‘The DTM software discussed herein is MapInfo for Windows. All references to DTM capabilities are specific to this product and do not necessarily reflect the capabilities of similar products.

currently available for about 80 percent of the streets in the United States. Large urban areas generally have very complete databases; those for rural areas frequently are incomplete. The address ranging provides another capability in MapInfo: a street address can be automatically located through built-in functionality, an excellent aid to dispatch services when locating trouble in the collection system.

TIGER maps are a bargain for collection system management, providing a high degree of functionality for a low price. Consider the following inexpensive procedure for obtaining an initial map of the system: First, purchase the TIGER map(s) for your locale. Second, acquire an inexpensive hand-held global positioning system (GPS) receiver (about \$800). Use a field technician to acquire latitude and longitude readings for each manhole. If your area has public or private data sources for differential correction of the GPS data, make your field readings more accurate by applying the correction software. Enter the manhole number, latitude, and longitude into a database created directly in MapInfo. (No other database is needed.) Last, use the MapInfo built-in functions to create the manhole objects overlaying the TIGER map. To create the pipe layer, draw connecting lines between the manholes with snap mode on.

Although MapInfo has drawing tools for creating maps, it does not have the powerful coordinate geometry drawing tools available in CAD software that are required for engineering construction drawings. Consequently, users frequently create **basemaps** in CAD packages for import into DTM. The usual method of drawing transfer is via a drawing exchange file format commonly referred to as "DXF." This format was pioneered by **AutoCAD** and is the standard for exchanging CAD drawings between different CAD software. MapInfo supports import and export of DXF files, making it compatible with the full range of CAD software.

Step 2. Gather Sewer Condition and Performance Data

Once a **basemap** has been chosen, a sewer condition assessment program should be used to inventory and verify the location and length of the sewer system and to determine its physical condition. Because **SSOs** typically occur at manholes, evidence of prior SSO activity should be noted. Inaccurate sewer maps must be corrected or updated to ensure that all future field data are attached to accurate geographic locations.

Attributes of specific manholes should include:

- Manhole identification number.
- Indication of whether the manhole is buried or unlocated.
- Pipe length to the next downstream manhole.
- Manhole size and opening.
- Number and size of cover holes.
- Evidence of ponding.
- Evidence of SSO.
- Construction materials and conditions of cover, ring, walls, steps, aprons and troughs.
- Quantification of visible sources of extraneous flow.
- Evidence of leaks and their location.
- Type and depth of debris.

- Condition of incoming and outgoing sewer lines connected to the manhole, noting length, size, type, and depth, as well as evidence of root growth and visible I/I sources.

Step 3. Update Map and Link Data

Added to the **basemap** completed earlier is the sewer layer, with manholes and pipes drawn. At this point the field data are ready to be “linked” by first establishing a manhole numbering system and noting flow direction. (This linking is also possible with existing SSES data, perhaps from old facilities projects.) New “intelligent” map layers for the manholes and pipes and linked SSES field data emerge. The new **map-linked** database includes all inventory and condition assessments that allow for clearer understanding of the sewer system’s needs.

The sequence of this data linking is helped by **MapBasic**, a programming language provided by MapInfo for customizing the use of and extending the basic functionality of MapInfo. First, open a window for the **basemap** and a second window for the tabular data. Via the **MapBasic** tool, select a particular tabular manhole record, then set its geographic location on the map in the accompanying window (i.e., draw the manhole to which the tabular record corresponds).

A completed map consists of two map layers: a manhole layer and a pipe layer, each linked to tabular information in a corresponding database.

Step 4. Analyze Data by Calculation and Visualization

Much of the functionality of the completed DTM system lies within the standard capabilities of MapInfo. Because the purpose of a DTM package is to help visualize the geographic content of tabular data, it contains strong query functionality, appearing in two forms in MapInfo: a simple select and a more powerful Standard Query Language (SQL) select. SQL is a quasi-standard syntax for specifying queries to most database packages being sold today. Although each database type may have a unique and incompatible file format, each allows querying of its data within a standard syntax. For DTM, MapInfo has extended this query syntax to include geographic operators, such as “Contained Within” and “Entirely Within” (for geographic queries such as “contained within the city limits”). SQL queries allow the user to join multiple databases based on a common field, select or group records meeting specified criteria, perform aggregating functions, and sort the output—all in a single statement. By contrast, simple selects let the user select and sort records from a single database, although the selection specification may be complex.

Either of these query methods can be used to specify a subset of the original data for viewing or other action. For example, one query might highlight on the map all the manholes showing evidence of surcharge (possible SSO sites). The field SSES database contains a field that records surcharge evidence. For this example, if surcharge code “T” (true) meant that the manhole showed evidence of surcharge, then select all those records that have a surcharge code = T. Because a hot link between the manhole SSES database and the map objects has been established, when the selection “engine” determines which records meet the specified criteria it can highlight their location on the map and in the database. The location of these surcharge sites appears very quickly. Sometimes these visuals lead to a new understanding of the data. For example, if all the pipe sections downstream from these surcharge sites had heavy root codes = T, and heavy debris codes = T, then those pipe sections could be cleaned and the surcharge problems upstream could be resolved.

The geographic extensions to SQL allow maintenance supervisors to draw a polygon around a specific area targeted for repair, called a “region” in MapInfo. SQL, or simple selects, can then be executed that pick certain defects and add the criteria within the newly drawn region. After all the tabular criteria are met, the selection engine then determines whether the geographic location of that defect falls within the

specified region. Once all the appropriate manholes or pipes are selected, the supervisor can view the selections, then make manual additions or subtractions to the selection list if desired. Small maps of the work areas in question can be printed from MapInfo. Larger maps can also be produced on standard printers by using the built-in MapInfo functionality to produce tiled output (although the tiles must be manually cut and pasted together). Use of standard office printers keeps the total application cost low. Completed work orders are returned from the field, and the office database is updated by changing the value in the "repaired" database field to "Yes." Defects marked as repaired are then excluded from future work order queries.

Discussion

Collection system managers do not always require maps with engineering accuracy. Manholes and pipes can frequently be placed in a "visually correct" location. Engineering accuracy usually means location to the nearest centimeter or even millimeter in the horizontal plane. "Visually correct" means that the manhole is located approximately in the proper location on the map and is correct relative to other features in the vicinity. Approximate location does not have any specific meaning except to the map user, but if a manhole is located at the intersection of two streets, it should look that way on the map. Zooming in closely might reveal a particular manhole 3 meters off the intersection on the map, whereas in the field the manhole could easily be found and uniquely identified. Similarly, if two manholes were in an intersection and Manhole A was to the north and east of Manhole B, then the visually correct map should show Manhole A located northeast of Manhole B. In most paper collection system maps today, the manhole "dots" are commonly not drawn to scale and may be as large as the street is wide. Duplicating these maps by manual, visual methods delivers an "electronic" map of similar accuracy.

Other functionality that can be integrated with sewer DTM systems includes digital photo display, the viewing of AutoCAD drawings without import to MapInfo format, digital photo display of fiber-optic cable junction boxes, viewing AutoCAD drawings of building floor plans for facilities management, graphics viewing for airport signage management and complex traffic sign management using MapInfo on a pen-based computer with custom software for inventory of traffic safety signs and "activity report" generation.

The ability to see sewer system attributes without investing in full-scale GIS would allow collection system managers to concentrate on rehabilitating and maintaining their sanitary sewer collection systems. In recent projects, DTM efforts revealed areas of collection systems that had been thought to be in good shape but in fact required repair. Areas requiring preventive maintenance were also quickly identified. The powerful SQL capabilities of the systems assembled allow for rapid decision-making. DTM system users could quickly get answers to questions such as "Where is all the pipe of a particular diameter located?" or "How many manholes does the system contain?" DTM also allows quick visualization of sewer lines that have offset joints or line segments that have evidence of root intrusion.

Although most DTM solutions offer GIS functionality, they do not require staff who have received extensive, expensive training in GIS to operate them. Because few workers are experienced in the emerging GIS technology, hiring people "ready to work" can be difficult. In contrast, the DTM systems are user friendly; many of them will run on field- or pen-based computers, which allows for direct entry of field data. This capability can be useful for quickly gathering and assimilating field data.

Conclusion

Many databases in existence today have a geographic component, whether the data pertain to sanitary sewers or other physical structures, making nearly all current databases in both the public and private sector "enhanceable" with DTM. The data we gather and store has position, and position is difficult to visualize without a map. DTM allows its users the ability to visualize data and to discover and display trends that can only be visualized geographically.

In the 1970s and 1980s, CAD and the personal computer made map creation and modification easier. In the 1980s, the advent of inexpensive PCs and database software allowed users to collect and store endless amounts of data regarding these systems, DTM provides the missing link between the maps and the data. DTM not only maintains the graphic map but also attaches data to the elements of the map. The days of color-coding map elements with felt-tipped markers or making manual changes to CAD drawings are over.

Collection system managers realize that they have tons of data but ounces of information. DTM provides them a method for dealing with the complex task of maintaining one of their city's most valuable assets: the underground sanitary sewer infrastructure.

Additional Reading

Water Environment Federation. 1994. Existing sewer evaluation and rehabilitation. In: Manual of Practice FD-6. Alexandria, VA.

American Society of Civil Engineers. 1994. ASCE manual and report on engineering practice, number 62. New York, NY.

Accuracy Limitations in Open Channel Flow Monitoring

Jeffrey L. Den Herder
ADS Environmental Services, Inc., San Diego, California

Wastewater collection system managers are often faced with the need to obtain information about the wastewater flow rates and patterns in various locations within the collection system. This information can be a crucial decision-making aid in determining how much capacity remains in the collection system, if and when capacity limitations may lead to potential sanitary sewer overflows (SSOs), and what impacts inflow and infiltration (I/I) may be creating in the system.

A variety of flow monitoring equipment can be used to obtain flow data relevant to the decision-making process, but generally the accuracy of the collected flow data is not known. Assessing the accuracy of the flow monitoring system allows the collection system manager to better analyze the collected flow data and evaluate collection system operation and performance. This paper presents a framework for understanding the types and sources of accuracy limitations (errors) inherent in the open channel flow monitoring process and a methodology for assessing their impacts on the collected flow data.

Types of Flow

Flow of liquids can be divided into two basic types. The first type, closed conduit flow, consists of flows with no free water surface; in other words, the flow completely fills the conduit, typically under pressure. The second type, open channel flow, includes all liquid flows with a free water surface. These flows may occur in natural or improved channels or in totally enclosed conduits. Channels and conduits for open channel flow are typically not designed to accommodate pressurized flow, although that may occur under certain abnormal conditions.

Flow monitoring in closed conduits offers one great advantage over that conducted in open channel flows. In closed conduits, the area of flow remains constant and only the velocity of the liquid must be determined to generate flow quantities. Devices such as propeller meters, magnetic flowmeters, and ultrasonic (Doppler and transit time) flowmeters are readily available for flow monitoring in closed conduits, and typically can be factory calibrated to an error of plus or minus 5 percent of rate or better when applied in a hydraulically suitable location.

Conversely, flow monitoring in open channels requires determining both the cross-sectional area and velocity of the flowing liquid. This fundamental difference is the source of the challenge in open channel flow monitoring. It has many profound implications in the design and application of flow monitoring equipment, since many of the assumptions inherent in the design of equipment for flow monitoring in closed conduits are not met in open channel flow. In addition, it adds new sources of errors and imprecision to the flow quantification process.

Methods of Monitoring Open Channel Flows

Three general methods are commonly used to quantify open channel flows. Open channel flow monitoring equipment typically is designed to use one or more of these three methods. Each of these methods uses a primary element and rating equation, and one or more secondary elements to develop the flow quantification. Several specialized methods can also be used for flow monitoring depending on the particular situation. In most cases these specialized methods are not suitable for continuous flow monitoring purposes.

The first general method of quantifying open channel flows is the slope-hydraulic radius method. In this method, an empirical flow equation is used in conjunction with depth-of-flow measurements and the

conduit geometry to determine flow quantities. The empirical equation most commonly used in the United States is the Manning equation. Additional parameters (e.g., slope and roughness factor for the Manning equation) are required for a complete solution of the empirical equation. Values for these parameters must be estimated or developed from record information, observation, and/or measurement. In this method, the conduit itself is the primary element while the depth measurement system, supporting instrumentation, and recording system are secondary elements.

The second general method used to quantify open channel flows is the area-velocity method. In this method, both depth-of-flow and velocity measurements are taken. The continuity equation, $Q(\text{quantity}) = A(\text{rea}) * V(\text{elocity})$, is used in conjunction with the conduit geometry to calculate flow quantities from the depth and velocity measurements. If average velocity is measured, no additional parameters are required. If, however, a local or peak velocity is measured the relationship between that velocity and the true average velocity must be developed. In this method, the conduit again is the primary element. The depth and velocity measurement systems, supporting instrumentation, and recording system are secondary elements.

The third general method of open channel flow quantification entails the use of hydraulic structures to produce a known relationship between the depth-of-flow and the discharge at a specific point relative to the structure. Hydraulic structures are typically classified as weirs or flumes depending on their configuration and construction. The relationship between depth of flow and discharge for the hydraulic structure is known as its rating curve. The rating curve is used in conjunction with depth-of-flow measurements to determine flow quantities. Typically, no additional parameters are required. In this method, the hydraulic structure is the primary element while the depth measurement system, supporting instrumentation, and recording system are secondary elements.

Several other specialized methods can be used to quantify open channel flows. Some of these methods can be applied in any hydraulically suitable location in the collection system, while others can be used only in locations with specific features or configurations. Salt dilution and dye dilution are two techniques that can be applied to any suitable location in the collection system. In these techniques, a known concentration of salt brine or fluorescent dye is injected into the flow stream at a constant rate. The flow stream is sampled at a downstream location, and the discharge is calculated using the sample concentration, the background concentration, and the injected concentration and rate. These techniques are generally not suitable for continuous flow monitoring due to the personnel and material requirements inherent in their use.

Two other specialized flow monitoring techniques, which can be applied only if suitable collection system features and configurations are available, are gravimetric and volumetric analysis of flow rates. The gravimetric method requires facilities for capturing and weighing the flow at the monitoring location. The volumetric method requires facilities for capturing and determining the volume of flow at the monitoring location. Practical application of either technique requires very low flow rates or the presence of the appropriate facilities.

One situation in which volumetric analysis of flow rates is commonly possible is at pump stations. The pump station **wetwell** can be used to measure the **influent** flow rate in the period between pump run cycles. Continuous flow monitoring is possible in this situation by recording the time and duration of each pump run and **wetwell** fill cycle. Prerequisites for use of this technique are fixed-speed pumping units, pump cycles of reasonable duration, a pump control system that provides consistent **wetwell** volume changes during each pump cycle, and a **wetwell** fill interval within the pumping cycle, during which all pumps are off.

Types of Errors

Errors in the flow monitoring process may be either random or systematic in nature. Random errors are characterized by variations (randomness) in both magnitude and direction. As such, the effect of a

random error cannot be predicted for any particular measurement. If the probability distribution of errors in a particular measurement is known or can reasonably be assumed, inferences about the maximum probable random error in that measurement can be developed in the form of a confidence interval for the measurement. The variations between multiple measurements under nonvarying conditions is an example of random error. Random errors are often assumed to follow a normal probability distribution.

The effect of random errors in a measurement is generally reduced when a sufficiently large number of measurements are considered, since errors in opposite directions would tend to cancel out. For example, the effect of random errors on a single flow measurement would likely be much greater than the effect of random errors on an estimate of average daily flow computed by averaging the individual flow measurements taken at regular intervals during a 24-hour period.

Systematic errors are those that result in the same magnitude and direction of error each time a measurement is repeated for a certain set of conditions. Generally, systematic errors will also vary in a predictable pattern under varying conditions. If the source and pattern of a systematic error can be identified, corrections can be applied to provide more accurate results. The effect of systematic errors in a measurement is generally not reduced when a series of such measurements is considered, because they typically act in a consistent direction, and often are a function of the magnitude of the measured value.

The relative significance of random and systematic errors in a flow monitoring system cannot be assessed without some knowledge of the respective magnitudes of such errors and knowledge of how the collected flow monitoring data will be used. Consider the consequences of each type of error in a flow monitoring system used for interagency wastewater billing purposes. In this scenario, relatively large random errors in individual measurements would be partially or completely canceled out by other measurements with errors similar in magnitude but opposite in direction, yielding daily, weekly, or monthly flow totals with a high degree of accuracy. In the same scenario, lesser systematic errors would be directly reflected in the flow totals and thus could have greater impact on the billing accuracy.

Consider a second flow monitoring system used for the purpose of assessing I/I at a monitoring location due to a rainfall event. To conduct this assessment, flow rates at a given time of day during a nonrainfall period are compared to flow rates at the same time of day during the rainfall event. The absolute accuracy of daily flow totals is thus of lesser importance than the difference in flow rates during the periods of comparison. In this scenario, systematic errors would affect both sets of measurements in a similar fashion, whereas the random errors could easily combine to either mask or exaggerate the difference in flow rates between the two periods. Random errors in individual flow measurements thus would have a much greater effect on the analysis than systematic errors of the same magnitude.

Accuracy of Data Collection Sensors

The data collection sensor(s) are the heart of every open channel flow monitoring system. Depth measurements are required for all three of the general quantification methods previously discussed. Velocity measurements are also required for flow quantification using the area-velocity method. Common depth measurement sensors include pressure transducers, single-transducer ultrasonics, multiple-transducer ultrasonics, and bubbler systems. Common velocity measurement sensors include point electromagnetic, weighted average Doppler, peak Doppler, and transit-time ultrasonic. Each of these sensor types has its own unique performance and accuracy characteristics.

Accuracy of depth measurement sensors will vary depending on the type of sensor used. A multiple transducer ultrasonic sensor has an accuracy of ± 0.125 inches throughout its range, with even more precise resolution and repeatability, and provides stable long-term performance. Presently, ADS Environmental Services, Inc., is the only manufacturer of multiple transducer ultrasonic sensors. In comparison, a typical pressure transducer may be rated for an accuracy of 0.5 percent of full scale, where full scale is zero to 10 feet of depth, for an accuracy of ± 0.6 inch. Pressure transducers have also

demonstrated poor long-term stability characteristics, and errors in excess of 1 inch are not uncommon due to reasons such as sensor drift, hysteresis, air vent fouling, temperature variation, and Bernoulli effects. Ultrasonic sensors can be adversely affected by temperature, and some have large dead bands; however, these effects can be minimized by proper sensor design.

The effect of depth errors on flow quantification is dependent on the depth of flow, size and geometry of the channel, and the quantification method used. Errors in flow quantification using slope-hydraulic radius and area-velocity methods are directly proportional to errors in the area of flow (see Tables 1 and 2 and Figure 1). To illustrate the relationship between errors in depth and errors in area, the error in area at various depths for circular channels 12 and 48 inches in diameter was calculated using depth measurement errors of 0.125, 0.6, and 1 .0 inch.

Table 1. Depth Errors in Circular Channels: 12-Inch Pipe Diameter

Depth (Inches)	Error in Depth (inches)		
	0.125	0.6	1
1	18.9%	99.1%	175.2%
2	9.1%	45.7%	78.5%
4	4.3%	20.9%	35.2%
6	2.7%	12.7%	21.1%
8	1.8%	8.3%	13.6%
10	1.1%	5.0%	7.8%

Table 2. Depth Errors in Circular Channels: 48-Inch Pipe Diameter

Depth	Error in Depth (Inches)		
	0.125	0.6	1.0
1	20.4%	109.9%	198.5%
3	6.7%	33.3%	57.4%
6	3.3%	16.2%	27.5%
9	2.2%	10.7%	16.1%
12	1.6%	8.0%	13.5%
15	1.3%	6.4%	10.7%
18	1.1%	5.3%	8.9%
21	0.9%	4.5%	7.6%
24	0.8%	4.0%	6.7%

Errors in Circular Channels

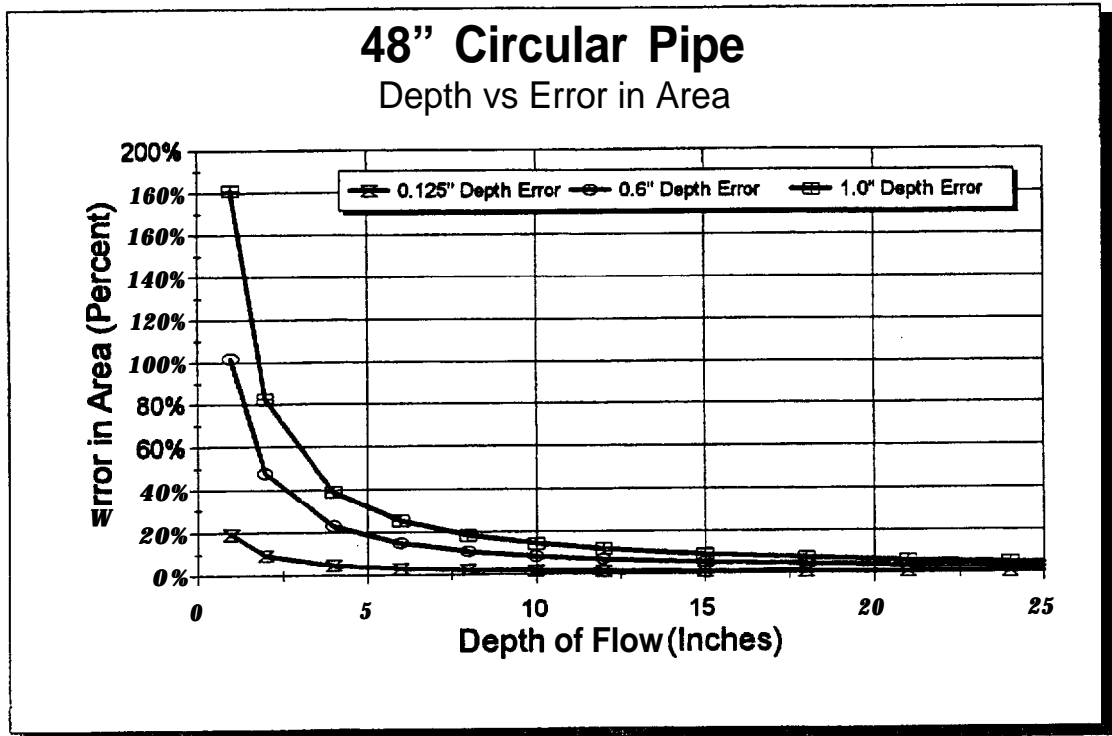
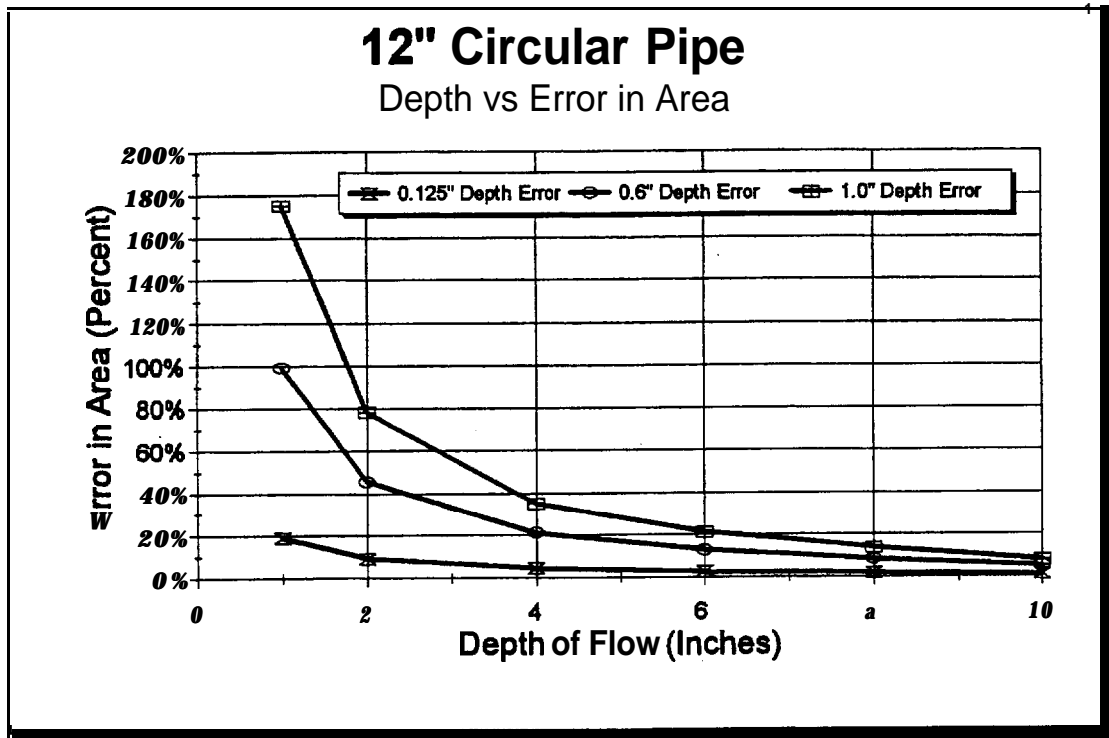

Figure 1. Errors in circular channels.

The error in area resulting from a depth measurement error of 0.125 inch was less than 5 percent for both 12- and 48-inch diameter lines when the depth of flow was approximately 4 inches or greater. When the error in depth measurement increased to 0.60 inch, the error in area was approximately 22 percent for the 12-inch channel and 23 percent for the 48-inch channel at a 4-inch depth of flow. With a 0.60-inch error in depth measurement, depths of flow greater than 10 inches in the 12-inch channel and 15 inches in the 48-inch channel were required to obtain an error in area of less than 5 percent. When the depth measurement error was increased to 1.0 inch, the errors in area were 35 percent and 38 percent, respectively, for the 12-inch and 48-inch channels at a 4-inch depth of flow.

Errors in discharge at various depths for Parshall flumes with throat widths of 1 foot and 4 feet were also calculated using the same depth measurement errors (see Tables 3 and 4 and Figure 2). For a depth measurement error of 0.125 inch, the error in discharge was less than 5 percent when the depth of flow was approximately 4.5 inches or greater. For depth measurement errors of 0.6 inch, depths of flow in excess of 18 inches were required before the error in discharge was less than 5 percent.

Table 3. Depth Errors in Parshall Flumes: 12-Inch Flume Throat Width

Depth (Inches)	Error in Depth (Inches)		
	0.125	0.6	1.0
1	19.2%	101.6%	1
2	9.4%	47.6%	82.5%
4	4.6%	22.8%	38.8%
6	3.1%	14.9%	25.2%
8	2.3%	11.0%	18.6%
10	1.8%	8.7%	14.5%
12	1.5%	7.1%	11.9%
18	0.9%	4.5%	7.5%
24	0.7%	3.2%	5.3%
30	0.5%	2.3%	3.9%

Table 4. Depth Errors in Parshall Flumes: 48-Inch Flume Throat Width

Depth (Inches)	Error in Depth (Inches)		
	0.125	0.6	1.0
1	20.4%	109.9%	198.5%
3	6.7%	33.3%	57.4%
6	3.3%	16.2%	27.5%
9	2.2%	10.7%	18.1%
12	1.6%	8.0%	13.5%

Depth (Inches)	Error in Depth (Inches)		
	0.125	0.6	1.0
15	1.3%	6.4%	10.7%
18	1.1%	5.3%	8.9%
21	0.9%	4.5%	7.6%
24	0.8%	4.0%	6.7%

This analysis demonstrates the high sensitivity of flow monitoring accuracy to errors in depth measurements. Adverse hydraulic conditions that create surface turbulence of similar magnitudes will cause errors of the same magnitude. Depth measurement errors are typically a combination of random and systematic errors. Zero-adjustment errors and pressure transducer drift are systematic errors that can be positive or negative in direction. The remaining errors are random errors.

Accuracy of velocity measurement sensors likewise varies considerably between types of sensors. The weighted average Doppler velocity sensor purports to directly measure the average flow velocity, but the author has not yet seen data that demonstrate successful long-term (i.e., 3 or more years) performance in actual applications. The transit time ultrasonic velocity sensor also measures the average flow velocity and has a proven history, but to date is suitable only for a limited range of applications. The point electromagnetic velocity sensor measures point velocity adjacent to the channel wall. The relationship between point and average velocity is highly dependent on the depth of flow in the channel, resulting in a significant potential for gross inaccuracies for this sensor type. This sensor is also prone to fouling, which reduces the achievable accuracy. Estimated errors for this type of velocity sensor are ± 10 to 15 percent or greater.

In the authors experience, peak Doppler velocity sensors exhibit the most consistent performance in practice. The relationship between peak and average velocity is generally constant for a given site and does not vary with depth of flow. Estimated accuracies for the peak Doppler velocity sensor are ± 5 to 10 percent in hydraulically suitable locations. Adverse hydraulic conditions such as vortexing and severe turbulence will of course reduce the achievable accuracy. Velocity measurement errors are typically a combination of systematic and random errors. Incorrect relationships between point velocity or peak velocity and the average velocity are systematic in nature and can be either positive or negative in direction. Other errors are random in nature.

Sources of Errors in Flow Monitoring Systems

None of the open channel flow monitoring systems in common use today directly measure flow rate. Each of the three general flow monitoring methods described previously requires the use of secondary elements to measure the depth of flow, or depth and velocity of flow, through a primary element. Flow rates are calculated from the measured values using the rating equation and associated parameters for the primary element. Continuous flow monitoring also requires that a record of periodic measurements be kept. This record may consist of the measured values (depth or depth and velocity), the resulting calculated flow rates, the results of intermediate calculations, or any combination of these values that will establish a permanent record. All of the components in a flow monitoring system, from primary element to recording device, influence the overall accuracy of the flow monitoring system.

Errors in Parshall Flumes

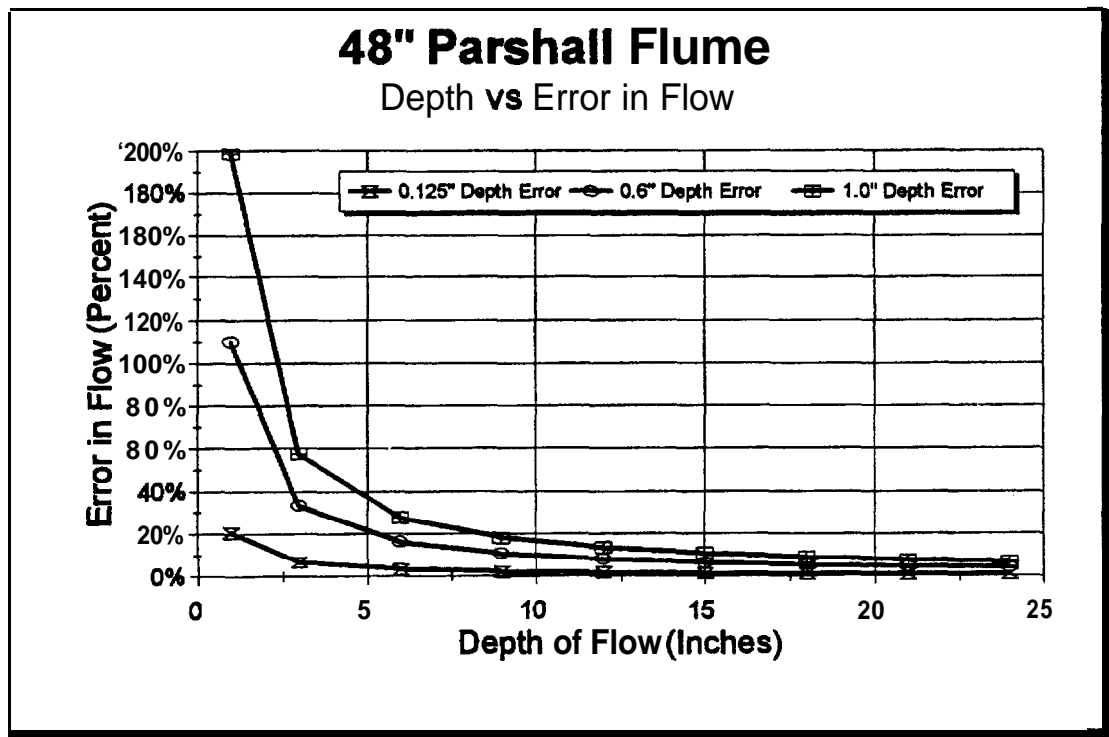
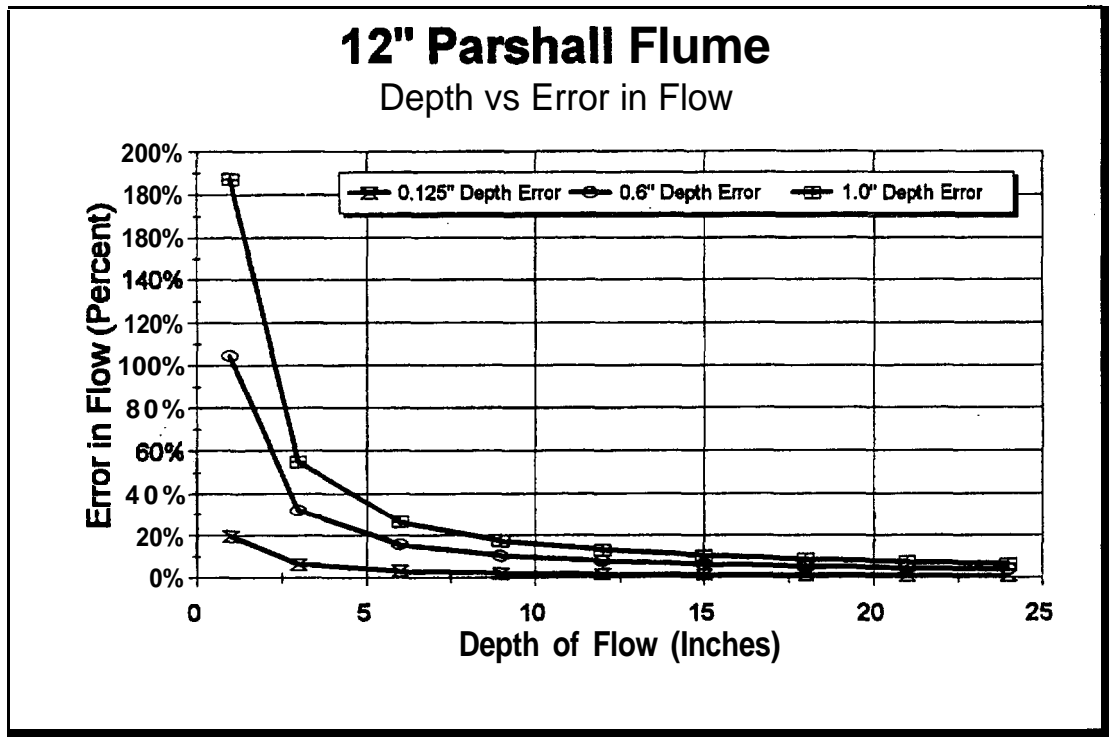

Figure 2. Errors in Parshall flumes.

In addition, the hydraulic conditions present at the flow monitoring location will affect the accuracy of the flow monitoring process. In some locations, the errors introduced by adverse hydraulic conditions can be much greater than any errors present in the flow monitoring system itself. Adverse hydraulic conditions can include surface turbulence and waves, skewed or distorted three-dimensional velocity distributions, nonprismatic channel segments resulting in axially varied flow profiles, and rapidly varying flow conditions. Adverse hydraulic conditions can affect the rating equation of the primary element as well as impair the performance of data collection sensors.

To properly assess the accuracy of a flow monitoring system, the potential errors in each component in the system must first be assessed. The composite system must then be analyzed to determine the combined effects of errors in the individual components. Finally, the accuracy limitations imposed by hydraulic conditions at the monitoring location must be compared to the capabilities of the flow monitoring system to determine the best achievable flow monitoring accuracy for that installation. Only in this manner can a realistic assessment of the accuracy of flow monitoring results be obtained.

The specific potential sources for error in a flow monitoring system will depend partially on the general quantification method used by the flow monitoring system. Two potential sources for error common to all three of the general quantification methods are the calculation of dependent quantities such as area, hydraulic radius, and discharge from the measured data and input parameters, and errors in recording the results of the flow monitoring process. Flow monitoring systems that store measured data in digital format for subsequent data collection and processing using computer software programs are considered to have negligible potential for errors in these categories. Systems that use mechanical or electrical devices for converting the measured data into discharge may have errors of 2 to 3 percent or more.

Data recording devices that do not store collected data in digital format will introduce errors corresponding to the resolution and zero-adjustment error of the device. Data stored by a chart recorder, for example, typically cannot be read more accurately than ± 3 to 5 percent. A discussion of the most likely sources of error for each general method is provided in the following paragraphs.

Slope-Hydraulic Radius Methods

Flow monitoring systems using this method are subject to the largest number of potential error sources, since the rating equation includes site-specific input parameters. Primary sources of errors, in addition to errors in measuring the depth of flow, are listed below.

- Uncertainties in the empirical equation used to relate depth to velocity and flow rate. The Manning equation is the empirical open channel flow equation most commonly used in the United States. No definitive study is available to establish the accuracy of the depth-discharge relationship provided by this equation, in part because of the difficulties inherent in estimating the proper parameters (slope S and friction factor n) appropriate for a given location. For this analysis, a random error of ± 5 percent will be assumed. Adverse or inconsistent hydraulic conditions such as the formation of a backwater curve-due to a downstream obstruction or capacity limitation-will greatly decrease the accuracy of the Manning equation. Errors resulting from such events will be systematic in nature and generally positive in direction.
- Selecting proper values for S and n in the Manning equation. Numerous field studies have shown that the in-situ slope of the conduit at the flow monitor location can and does vary dramatically from the design slope, the as-built slope, and the slope calculated from survey data of the monitoring location and upstream and downstream manholes. Estimating the proper value of " n " can also be problematic. Much of the difficulty in selecting proper values for these two parameters can be overcome by conducting field calibration measurements to determine the effective value for $(s^{1/2}/n)$ in the Manning equation. With field calibration, an error of 5 percent or less will be assumed. Without

field calibration, the error can easily be 10 to 15 percent or greater. This error will be systematic in nature, and can be positive or negative in direction.

- Variation of n with depth. Experiments have shown that the friction factor n is not constant for all depths of flow, but rather varies with the depth of flow. The ratio of n/n_{full} was found by Camp to be as high as 1.28 at a depth equal to 25 percent of the pipe diameter. If the variation of n with depth is incorporated into the flow calculations, the accuracy of the Manning equation is assumed unaffected. If this consideration is not included and field calibrations for $(s^{1/2}/n)$ are not conducted, a systematic error of up to 28 percent in the positive direction will be introduced. If field calibrations are conducted, the magnitude and direction of the error will depend on the relative depths of flows for field calibrations and actual flow monitoring measurements.

Area-Velocity Methods

Primary sources of errors in flow monitoring systems using this method are errors in the measurement of depth and velocity. Additional errors are possible in converting depth to area if the channel geometry is not well defined or if the channel is deformed. Adverse hydraulic conditions will affect systems of this type to the extent that they reduce the accuracy of the depth and velocity sensors.

Hydraulic Structure Methods

The primary source of error in flow monitoring systems using hydraulic structures, other than those previously discussed, is deviations in performance from the theoretical rating curve for the structure. Many hydraulic structures are sensitive to deviations from the published dimensions and installation conditions, which were used in developing their rating curves. Theoretical rating curves for flumes and weirs are generally believed to be accurate to within 3 to 5 percent for structures that are properly constructed and located in hydraulically suitable areas. Improper construction or adverse hydraulic conditions can increase the error in the rating curve to ± 15 to 20 percent or more.

Combined Accuracy of Flow Monitoring Systems

In assessing the combined effects of several source of errors on a flow monitoring system, consideration must be given to the type of error (e.g., random or systematic) and its magnitude and direction (if known). Random errors are typically combined by taking the square root of the sum of the squares of the individual errors. Systematic errors, however, always act in the same direction. For this analysis, systematic errors will be combined by addition.

A definitive answer to the question, "How accurate will this flow monitoring system be?" is not possible without first defining the hydraulic characteristics of the flow monitoring location. The following examples will demonstrate the process of estimating what the best achievable accuracy may be for a given set of circumstances.

In Example 1, flow monitoring for I/I analysis is desired in a **12-inch** circular conduit. Hydraulic conditions are good. The depth of flow is approximately 4 inches. What accuracy would be expected when using a flow monitor with a pressure transducer depth sensor and a point electromagnetic velocity sensor?

The nominal depth error expected for a pressure transducer is approximately 0.6 inch (0.5 percent of 10 feet). For a **12-inch** circular conduit with 4 inches of flow, a depth error of 0.6 inch corresponds to an error in area of 21 percent. The error in velocity for a point electromagnetic sensor is estimated to be 10 percent. Assume that both errors are completely random and that no other source of error will affect flow monitoring at this site. The combined effect of the two

sources of errors is $[(0.21)^2+(0.10)^2]^{(1/2)}=0.23$, or 23 percent. This represents the best achievable accuracy expected for a flow monitoring system in this location using the specified sensors.

What accuracy would be expected if a multiple transducer ultrasonic depth sensor and peak Doppler velocity sensor were used instead?

The nominal error in depth expected for a multiple transducer ultrasonic sensor is approximately 0.125 inch. This corresponds to an error in area of 4.3 percent. Assume that the systematic component of this error is 2 percent and the remainder is random. The error in velocity for a peak Doppler velocity sensor is estimated to be 5 percent. Assume it is all random. The combined effect of the two sources of errors is $0.02 + [(0.023)^2+(0.05)^2]^{(1/2)} = 0.075$, or 7.5 percent. This represents the estimated best achievable accuracy expected for a flow monitoring system in this location using these sensors.

In Example 2, you suspect capacity limitations in a 48-inch interceptor may be contributing to overflows at an upstream location. The only location available to you for flow monitoring has 30 inches of flow with 1 -inch surface waves. What accuracy would be expected using an area-velocity flow monitoring system with a multiple transducer ultrasonic depth sensor and peak Doppler velocity sensor?

The nominal error in depth expected for the ultrasonic depth sensor is approximately 0.125 inch. In this application, however, the surface turbulence of 1 .0 inch controls rather than the sensor accuracy itself. A 1 .0-inch error in depth for a 48-inch circular channel with 30 inches of flow corresponds to a 3.9-percent error in area. Assume that this error is entirely random. The error in velocity for the peak Doppler sensor is estimated to be 7.5 percent due to the amount of turbulence in the line. Assume that this error is also completely random. The combined effect of these two error sources is $[(0.039)^2+(0.075)^2]^{(1/2)} = 0.0845$, or 8.5 percent. This represents the estimated best achievable accuracy for this flow monitoring system.

These two examples demonstrate how to reach an estimate of the best achievable accuracy for a particular flow monitoring location. These estimates assume peak equipment performance and suitable hydraulic conditions. Actual system performance may not match the projected performance due to hydraulic conditions, reduced sensor performance, or other factors.

Some flow monitoring systems will support the simultaneous use of the slope-hydraulic radius and area-velocity methods. Comparison of flow quantities generated using both methods can be used to provide increased confidence in the flow monitoring system and determine whether free-flow conditions exist at the monitoring location.

Conclusion

Continuous flow monitoring can provide information essential to the management and operation of a wastewater collection system. Assessing the accuracy of a flow monitoring system provides the collection system manager with a better basis for analyzing the collected flow data and evaluating system operation and performance.

Infiltration *and* Inflow, Infiltration *or* Inflow—Which Is the Problem?

Steve Merrill and Andy Lukas
Brown and Caldwell Engineers, Seattle, Washington

Bob Swarner and Steve Klusman
King County Department of Metropolitan Services, King County, Washington

Introduction

The evaluation of infiltration and inflow (I/I) in separated sewer systems is becoming increasingly important. Collection and treatment systems are exceeding design capacities well ahead of their original design life, resulting in surcharges, backups, bypasses, and reduced treatment efficiency. Discharge regulations are becoming more stringent, requiring reductions in sewer overflow events and more extensive treatment (e.g., larger facilities). Operation and maintenance costs continue to increase as greater-than-designed flows result in excessive wear, higher power demands, and operation outside of the optimum range of efficiency. At the same time, agencies are expected to reduce budgets.

A strong need exists to reduce excessive I/I to conserve system capacity and avoid or reduce expenditures for capacity upgrade and system operation. This will involve the collection and analysis of a large amount of information. The traditional method of I/I analysis, collecting large amounts of rainfall and flow data in numerous locations, may not provide the answers necessary to optimize reduction efforts because these methods are not reliable outside the range of measured rainfall that occurred. Without many years of data, for example, it is almost impossible to extrapolate measured flows to infrequent events (like the once-in-5-year storm or greater) unless a computer simulation model is available to organize the available data and simulate the causative factors; this allows extrapolation with confidence. This approach is critical, for example, when the results of I/I reduction programs must be determined by comparison with the uncorrected state. Because rainfall patterns will invariably be different before and after, the use of a computer model that can be calibrated to both states is necessary for a direct comparison. This paper presents an overview of the development of such models in Seattle, Washington. ,

Beyond the tools to analyze flow data, deciding whether I/I removal is cost effective requires a knowledge of the principal sources of I/I, the effectiveness of alternative approaches to its removal, and the cost of these approaches. This paper also presents the results of pilot programs conducted by King County Department of Metropolitan Services (Metro) to control I/I involving the complete replacement of sewers, both agency mains and private side sewers. The model that Metro developed was used to determine the effectiveness of these programs.

Simulation Model Development

Work in Seattle, Washington led to the development of computer simulation models that can accurately reproduce the total flows in sewer systems resulting from long-term rainfall effects (1, 2). These models have been used in the design of facilities and in the determination of I/I rehabilitation effectiveness. The power of these models to predict I/I flows is illustrated in Figure 1. In this application, any simulation model must adequately account for antecedent precipitation. Prior rainfall raises ground-water levels and soaks the trenches in which sewers are laid. The flow at any given moment reflects about 6 months of prior rainfall. The flows during prolonged rainy spells thus will be higher than during isolated events. Peak flows during long, low-intensity events, therefore, can exceed flows from a much more intense but shorter duration storm.

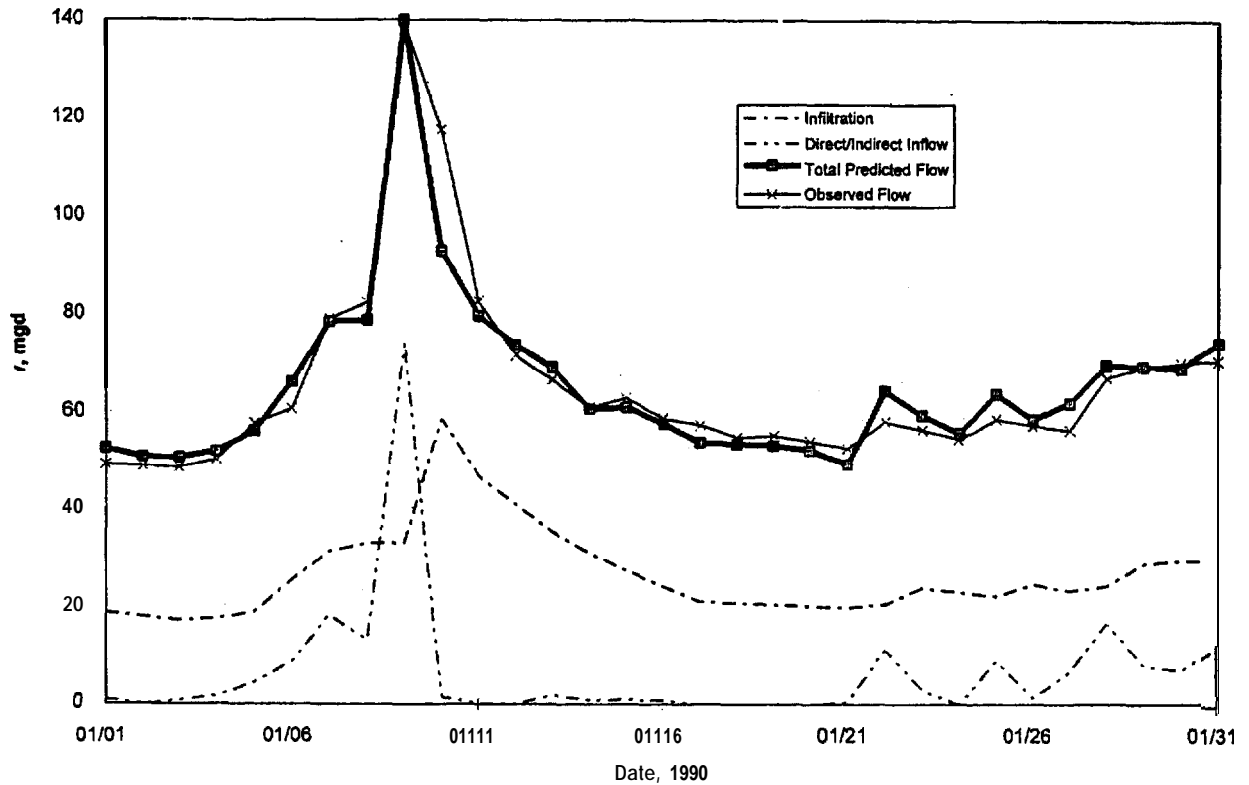

Figure 1. Comparison of I/I model results with observed flows at the Metro East Division Reclamation Plant.

One of these models makes use of Antecedent Precipitation Indexes (API) over various periods, from a few days to 6 months, to account for the impact of previous rainfall on current flows (1). The API is used as a surrogate for soil moisture. The other model (2) takes a deterministic approach, simulating overland flow to inflow points and estimating infiltration by simulating the flow of water into the sewer trenches and then into the pipes through defects or to ground water. Once the flows into the sewer are known, they are used in hydraulic routing models to determine the magnitude of downstream total flows. Both models depend on good flow and rainfall data for calibration.

Once calibrated on isolated flow and rainfall data, long-term rainfall records (40 years or more) can be run through the models to develop a database of flows for every hour of the record. This database is then used to develop peak flow occurrence frequency distributions to estimate peak flow with specified return intervals. Facility sizes may then be selected with confidence as to the risk of failure (overflow or backups). If this is done both before and after a rehabilitation program, the frequency distributions or the peaks at a specified return period can be used to measure I/I removal effectiveness.

Because the models can reveal the source of extraneous flow, their use can also focus I/I rehabilitation efforts in the most cost-effective manner. For example, if the models predict very little inflow, then pipe rehabilitation is in order rather than smoke testing for inflow sources. Use of the models in the Northwest generally has indicated that peak sewer flows are dominated by short-term infiltration-water that enters the sewer trenches of the upper side sewers and appears in the sewers within a few hours of rainfall. In large events, the peak flows associated with this source have been found to be as large or larger than the peaks associated with direct inflow sources. It has become apparent that significant reduction in peak I/I flows will require rehabilitation of the private upper side sewers in addition to main line agency sewers.

This is consistent with findings elsewhere (3). Rehabilitation pilot programs of this scope are the subject of the remainder of the paper.

Metro Pilot I/I Removal Program

Metro wholesales sewage collection and treatment to 33 entities in and adjacent to King County, Washington. Local agencies own and operate small collection systems that deliver flow to Metro's interceptors. Metro is facing the need to construct new conveyance and treatment facilities to accommodate future sanitary and I/I flows. With service area growth and existing I/I flows, Metro needs to parallel major portions of large conveyance systems leading to their East Division Reclamation Plant (EDRP) unless the I/I peaks flows can be reduced. Because of the size of the service area with separate sanitary sewers (over 85,000 acres) an aggressive I/I reduction program would be costly. The generally unsuccessful history of I/I removal programs raised concern as to whether such a program would be successful.

To better determine the elements of a successful program, Metro began an I/I reduction pilot program in 1987 with the following goals:

- Identify the extent of I/I in the Metro service area
- Identify local agencies with the greatest opportunity for I/I reduction
- Determine the effectiveness and cost of eliminating I/I in local systems

The first phase of the pilot program identified the Cities of Kent and Issaquah, Washington, as the best opportunities for the pilot I/I removal project. Within these cities, four basins were chosen for further study. In each basin, flow monitoring and I/I identification were conducted. One basin from each city was chosen for the I/I removal program (termed "the rehab basins"), with the other two used as control basins against which to measure removal effectiveness.

Further analyses were conducted to define the most cost-effective I/I removal approach in the rehab basins. In both cases, rehabilitation of the entire piping system (replacement, slip-lining, or cured-in-place lining) was determined to be the most cost-effective approach to reducing the impact of excessive flows in Metro's system.

After finalizing documentation, Metro entered into negotiations with both cities to perform the sewer rehabilitation work. The formal agreement indicated the schedule for completion of the work, cost reimbursement percentages available to the city by Metro, a description of which costs could be reimbursed, the limit of the reimbursement, and contract document and construction review rights by Metro. Costs available for reimbursement included:

- Construction costs and sales tax
- Permit fees
- Legal costs
- Property restoration costs
- Engineering design costs
- Construction inspection

The amount of Metro reimbursement was to be based on the percentage of I/I removal that would benefit Metro. Initial estimates of these percentage reimbursements were 54 percent in Kent and 67 percent in Issaquah.

After finalization of the agreement, the cities prepared plans and specifications including sewer, manhole, and private side sewer replacement. Public involvement programs were conducted early in the design phase of the projects. The cities prepared mailings describing the projects and their benefits, met with individual homeowners, and held public meetings. In general, homeowners near the projects were receptive-no resistance was encountered. The early public involvement efforts contributed to acceptance, as did the fact that landscaping was not significantly affected.

Study Area Characteristics

Characteristics of the basins are given in Table 1. The two rehab basins are similar in most respects. The Issaquah basin does not have a local drainage system installed, whereas the Kent basin does. The sanitary sewers in both basins are clay pipe, constructed in the 1930s with oakum joint seals. Topography is generally flat in both basins. The Issaquah basin soils consist of glacial **outwash** and alluvial loam with high permeability. The soils in Kent consist of poorly drained alluvial loam and are subject to a high ground-water table. These characteristics contribute to storm-related ponding and flooding.

Table 1. Study Basin Characteristics

Basin	Area (acres)	Population	Side Sewers	Inch-diameter-miles	Previous Rehab
Issaquah					
Rehab	9.87	157	31	2.57	None
Control	17.55	214	68	8.37	None
Kent					
Rehab	9.93	113	41	4.45	Grout
Control	25.32	252	89	10.52	Grout

Project Execution

The recommended pilot project was to completely rehabilitate all city sewers by slip-lining or replacement, replacement of manholes, replacement of private side sewers from the city sewer to the house, and disconnection of any direct stormwater connections found during construction. The actual construction in both areas entailed replacing the city sewer with polyvinyl chloride (PVC) pipe, replacing manholes with new precast concrete manholes, and replacing side sewers with PVC pipe. No sliplining was performed.

Most side sewers were replaced from the city sewer to the house connection. In instances where yard improvements (e.g., concrete patios) were "significant," the side sewers were only replaced to the property line; this occurred at two of the Kent side sewers. Otherwise, the system was replaced in its entirety.

Roof-top drainage from a few of the units was detected and eliminated in the Kent basin. (Contractor and inspection logs do not specify the number.) Roof tops were purposely not disconnected in Issaquah due to the lack of a formal stormwater drainage system. In both systems, costs for inflow removal in contractor billings are limited to replacement of leaking manholes. In one instance in Kent, a backyard drain had been installed up to the manhole but did not penetrate it.

Project Costs

Actual construction costs for the Kent rehabilitation projects are shown in Table 2. Costs for the Issaquah project were similar. These are representative of an Engineering News Record Cost Index of 5491. Analysis of the payment schedules indicates the following characteristics:

- **Equipment** costs are included in labor costs.
- Shoring, cribbing, and extra excavation are counted as labor.
- Pipe removal and disposal are counted as labor.
- Manholes are included in the cost per foot of the **8-inch** main sewer.
- Costs include contractor overhead and profit.

Table 2. Kent Rehab Basin Construction Costs

Cost Item	Unit	Quantity	Unit Price	cost
Mobilization/Demobilization	LS	1		\$17,000
Clear/Replace landscaping	SY	1,299.6	\$4.82	\$6,264
Remove/Replace asphalt paving	SF	691	\$2.13	\$1,474
Remove/Replace crushed rock surface	SF	13,970	\$0.35	\$4,905
New 8-inch ductal iron pipe	LF	55	\$61.82	\$3,400
New 8-inch PVC	LF	1,258	\$41.27	\$51,924
Replace side sewers	LF	2,924	\$11.44	\$33,447
Subtotal				\$118,409
Sales tax @ 8.2%				\$9,710
Total construction cost				\$128,119

LF = linear feet.
 LS = lump sum.
 SF = square feet.
 SY = square yards.

Several advantages characteristic of the sites chosen for these pilot projects resulted in reduced costs compared with initial estimates. These factors are:

- *Clearing and replacement of landscaping:* The pilot projects were located in areas with smaller homes that did not have special landscaping. Landscaping replacement was essentially limited to lawn restoration; the cost of landscaping replacement is therefore probably below average
- *Location of sewers in alleys:* The sewers in these projects were located under crushed gravel alleyways. The cost for removal and restoration of the surface was low due to the lack of pavement. In addition, traffic control was minimal.
- *Removal and replacement of utilities:* These projects replaced the pipe in the same trench as the original pipe. No utility relocation was required.
- *Backfill material:* The excavated material met the requirements for backfill, saving the project the cost of imported material and excavation disposal.

In addition to construction costs, the projects incurred costs for administration, analysis, and preparation of plans and specifications; these costs are presented in Table 3. These allied costs were 38 percent of the total project cost. The cost of analyses in this case may have been higher than average because the lack of rainfall the winter following project completion forced postmonitoring activities to continue for an additional year.

Table 3. Allied Cost Summary

Cost Category	Average Cost	Percent of Construction
Administration	\$15,181	5.5
Analysis	\$103,876	37.4
Plans and specifications	\$44,554	16.0

Rehabilitation Program Results

Metro's I/I model was calibrated to postrehabilitation flow and rainfall monitoring data for both the control and rehab basins. The long-term rainfall record was then run through the calibrated models to determine the peak total I/I flows with a 20-year return frequency. The reduction of I/I in the rehabilitation projects was estimated by comparing the results for the rehab and control basins. Figure 2 shows the results.

Inflow was estimated to be reduced by 50 to 70 percent in the Kent and Issaquah basins, respectively. Inflow reduction was higher in Issaquah even though roof leaders were not eliminated because only two roof leaders were connected and because the original inflow was small. Correcting manhole leakage eliminated most of the Issaquah inflow. Infiltration reduction was higher in Kent, with estimates ranging from 50 to 80 percent. The higher infiltration removal in Kent occurred because the original infiltration was very high. The total I/I reduction rate was about 60 percent in each basin.

The estimated removals are lower than expected for a complete replacement project, possibly because of some incompleteness in execution. For example, two side sewers were not completely replaced in Kent. Also, the manhole lids in Kent are not sealed and are below grade. Because this area is subject to surface ponding, this may contribute to estimated inflow.

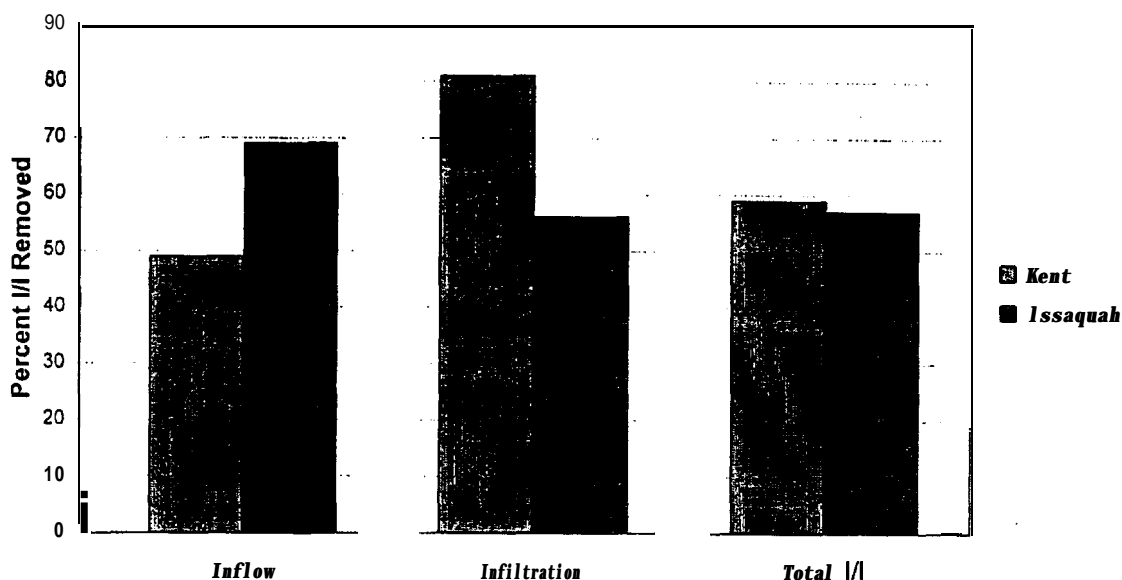

Figure 2. I/I reduction.

On the basis of total I/I, the unit costs for the removal programs are shown in Table 4. The project costs (including both construction and allied costs) ranged from \$2.17 in Kent to \$4.16 in Issaquah for each gallon per day of peak 20-year I/I removed. Both basins are of approximately equal size, and the construction costs were similar. The difference in unit costs is a function of the Kent basin exhibiting nearly twice as much peak 20-year I/I as Issaquah. These costs are roughly half of the preliminary estimate.

Table 4. Unit I/I Removal Costs (dollars per gallon per day reduction in 20-year I/I peak flow rate)

Basin	Actual Construction Cost	Actual Project Cost'
Kent	\$1.26	\$2.17
Issaquah	\$2.83	\$4.16

'Project cost includes construction and allied costs.

References

1. Merrill, M.S., and R. Butler. 1994. New dimensions in infiltration/inflow analysis. Presented at the Water Environment Federation Specialty Conference, Louisville, KY (July 10-13).
2. Swarner, R., and M. Thompson. 1994. Modeling inflow and infiltration in separated sewer systems. Presented at the U.S. Environmental Protection Agency Sanitary Sewer Overflow Conference, Washington DC, and the Annual Water Environment Federation Conference poster session, Chicago, IL.
3. Bible, D.W. 1991. Results from sewer rehabilitation test areas. Presented at the 64th Annual Water Pollution Control Federation Conference, Toronto, Ontario (October).

New Approach to Sanitary Sewer Overflow Evaluation Yields Surprising Results

Peter Keefe
ADS Environmental Services, Inc., Mentor, Ohio

Rainfall is the engine that drives virtually every sanitary sewer performance problem, from infiltration and inflow (I/I) to sanitary sewer overflows (SSOs) to basement flooding, yet we have largely ignored rainfall in sanitary sewer evaluations for the past 20 years. We have concentrated instead on the symptoms (basement flooding and SSOs) by trying to quantify the disease (I/I) without properly quantifying the root cause (rainfall). This paper presents a different system—a root cause system—for evaluating SSOs and I/I. It proposes that we measure the performance of sanitary sewers like we measure the performance of storm sewers. From this process come two powerful diagnostic and design tools,

The thinking in the past has been that sanitary sewers should not and do not respond to rain like storm sewers do, so they should be evaluated differently. Even the U.S. Environmental Protection Agency (EPA) has jumped on the bandwagon by issuing sanitary sewer performance criteria measured in gallons per day per inch-mile (gpd/in-mi) (1, 2) and in gallons per capita per day (gpcd) (3). Gallons per day per inch-mile is measured the day after the storm (see Figure 1), and gallons per capita per day is the annual average flow at the waste water treatment plant (WWTP) divided by the population. Interestingly, neither of these two criteria deal with either peak flows or with rainfall. We know that rainfall is the force that stresses our sanitary sewer systems, yet our primary tests have nothing to do with either the stress or its cause.

Concentrating on both peak flow and rainfall, we have devised a pair of extremely simple performance tests for sanitary sewers which require answers to two elementary questions:

- How much rain fell on each basin?
- How much of this rainfall reached the sewers?

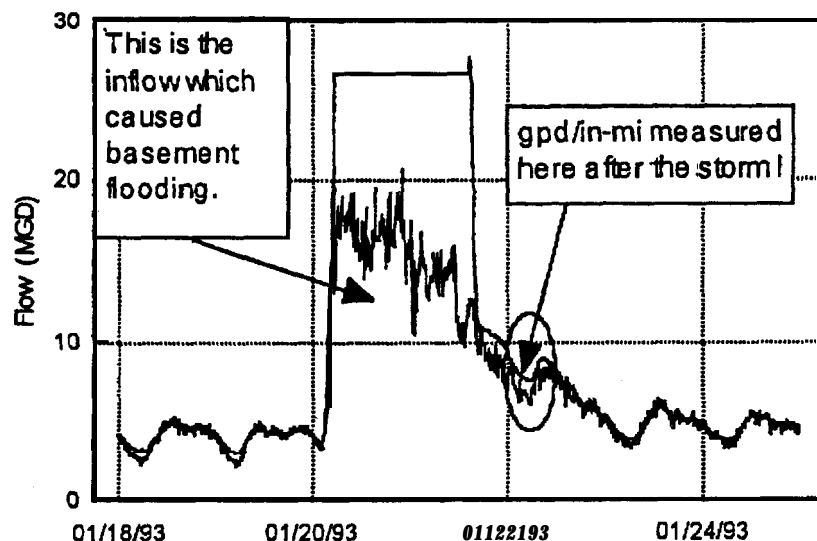

Figure 1. Gallons per day per inch-mile measured the day after a storm.

The Point Place map was prepared as part of an SSO elimination program. It shows the relationship between rainfall and I/I. The lightest shade shows basins where less than 5 percent of the rain that fell on the ground got into the sanitary sewers; the next darker shade indicates basins where 6 percent to 10 percent of the rain got in; the medium shade, 11 percent to 20 percent; and the darkest shade, over 21 percent. Considering that none of the rain is supposed to get into the sanitary sewer, these results are quite surprising. Further, considering that only 35 percent of the rain that falls on the ground in an urban neighborhood like Point Place is expected to get into storm sewers, I/I rates into the sanitary sewers of over 21 percent are astonishing. Finally, the southernmost dark shaded basin, called PP03, had an I/I runoff coefficient of over 600 percent. In other words, for every gallon of rain that fell on this basin, more than 6 gallons of I/I got into the sewers. Because this is physically impossible, we had to search for answers to the paradox.

What happened in **PP03**? First we checked the flow data to see if we had made a mistake. Not only did the data check out and balance with the downstream site, but the same phenomenon occurred during each of the six monitored rain events. Checking the Point Place map, we found that the Detwiler Ditch crosses over the sanitary sewer just upstream of PP03. Mystery solved. Storm water from the Detwiler Ditch is running directly into the sanitary sewer. So the new performance tool, "I/I coefficient," allows us to see something that we have never been able to see before: direct stream connections to sanitary sewers. The tool also allows us to compare basin performance on the bases of peak flows and rainfall, the two most important factors in activating SSOs.

Was Point Place a case of beginner's luck? Not necessarily. In seven projects where we have tried this type of analysis, we have discovered four direct stream connections. The seven projects were located in Indianapolis, Evansville, and New Albany, Indiana, and Cincinnati, Toledo and Lodi, Ohio. The four stream connections were in Cincinnati, Toledo, and Indianapolis (2).

Linking Rainfall and I/I

The link between rainfall and I/I is straightforward as long as you have enough rain gauges and flow monitors for proper resolution. For SSO and I/I purposes, rain gauge density should be approximately one gauge for every 1 to 3 square miles of drainage area, subject to a minimum of three rain gauges (4). As recently as 3 years ago, we were recommending rain gauges at 5- to 10-square-mile intervals; however, the more we have learned about uneven spatial rainfall distribution, the more rain gauges we have installed. For flow monitors, the average basin size should be approximately 8,000 linear feet of sewer main, not including building laterals (5). Actual basin sizes depend largely on the geometry of the system, with branch isolation being more important than adhering strictly to 8,000-foot basin sizes (5, 6). Basins, then, may range in size from 5,000 to 12,000 linear feet of sewer main. Another advantage of 8,000-foot basins is that 8,000 linear feet is approximately the size of a subdivision, so by following this guideline, the engineer tends to put monitors on individual subdivisions where all the sewers were built at the same time, out of the same materials, by the same contractor, and using the same construction practices. This gives each basin its own character and helps define both problems and solutions. Basins over 12,000 linear feet in length tend to lose their individual character, and large local I/I problems begin to blend in with other areas that are not so bad. The effect is to lose definition or resolution of local problems.

Good flow measurements can be assured by concentrating on an 8,000-foot average basin size and by concentrating on repeatable, nondrifting, calibrated flow monitoring data. Good flow monitoring data are very difficult to obtain. Because most sensors deliver unrepeatably, diffuse, and drifting or deteriorating data, the user should demand proof that the data are at least stable and repeatable. The best proof today seems to come in the form of scattergraphs. Good scattergraphs combined with good calibrations virtually ensure that the monitoring data will be accurate (7). Figures 3, 4, and 5 show the differences between good scattergraphs and bad scattergraphs for three sites in Wichita, all installed in a free-flowing sewer. That is to say, none of the three sites were subject to hydraulic backup.

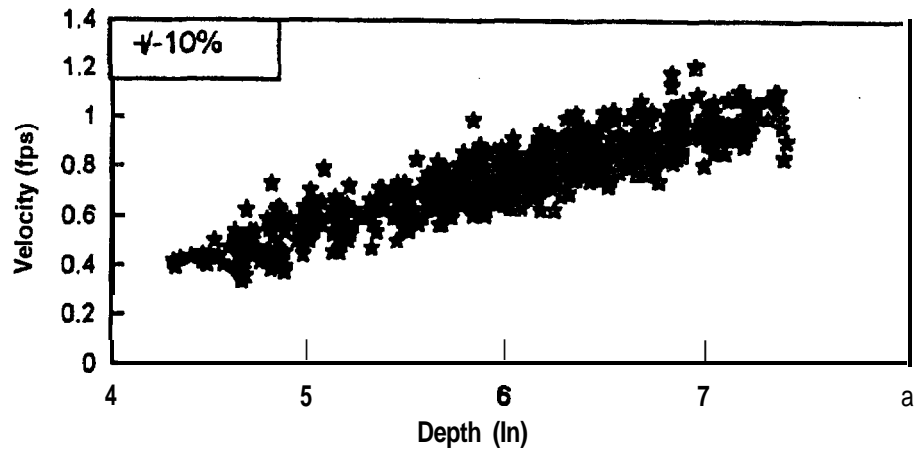

Figure 3. Depth-to-velocity scattergraph.

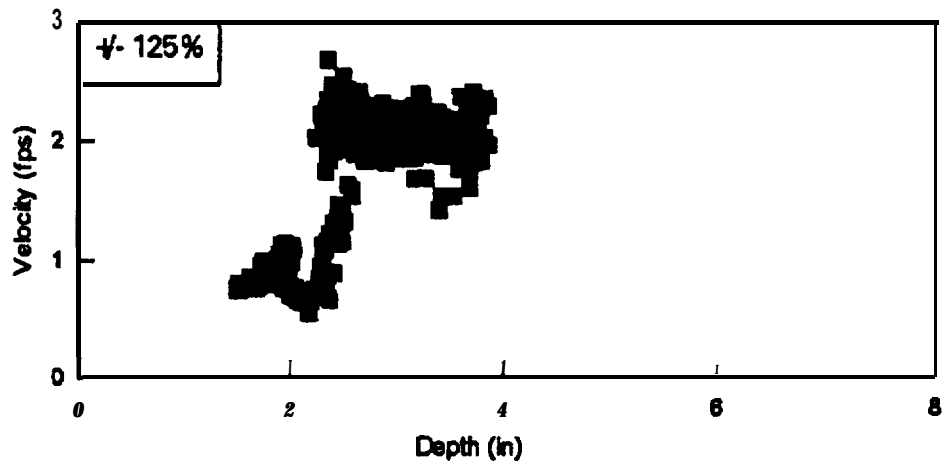

Figure 4. Depth-to-velocity scattergraph, pressure and "average Doppler,"

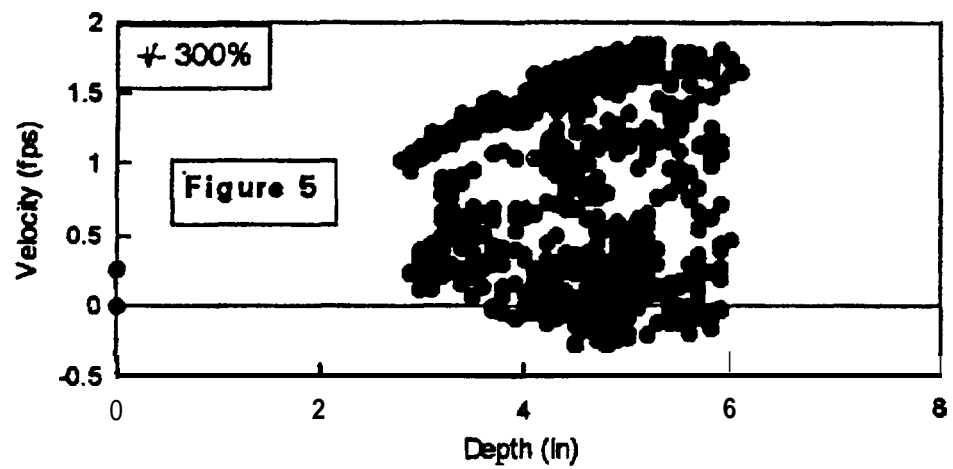

Figure 5. Depth-to-velocity scattergraph, pressure and electromagnetic.

Figure 3 shows a good depth-to-velocity scattergraph. Velocity increases gradually as depth increases. The data agree with hydraulic principles and are repeatable to within ± 10 percent. Figure 4 shows a monitor installed in the same line as Figure 3; however, the depth-to-velocity relationship is quite different. In this case, there is a discontinuity below 2 inches, flat velocity data above 2 inches, and drifting depth data. Figure 4 **does** not agree with Figure 3, nor does it agree with established hydraulic theory for depth versus velocity in a free-flowing round pipe. Figure 5, from a monitor installed in the same pipe as those in Figures 3 and 4, shows classic sensor drift and signal deterioration. The data from Figures 4 and 5 should not be used for hydrological calculations. Be sure that free-flowing scattergraphs look like the one in Figure 3 before trying to correlate flow versus rainfall data. There is no sense in analyzing bad data.

Correlating Rainfall and Flow

I/I volume from flow monitors is often measured in gallons. Rainfall depth in rain gauges is usually measured in inches. The average rainfall depth of a basin, also measured in inches, can be estimated from one or more of the closest rain gauges. Knowing the area of each basin, we can convert rainfall depths from inches into gallons and compare rainfall and flow directly. To convert rainfall into gallons, we multiply the area of each basin by the estimated average rainfall depth across the basin. Because of local changes in rainfall intensity and distribution, it is often necessary to interpolate between rain gauges to estimate the amount of rain that fell on each basin. There are at least four interpolation methods:

- Nearest rain gauge
- Thiessen polygons
- Rainfall contours
- Calibrated weather radar

Examples showing all four types of rainfall estimates by both depth and volume are shown in Figures 6 through 9, which show rainfall depth estimates for two conterminous **100-acre** basins, labeled A and B in each of the four figures. Five rain gauges surround the two basins, with the total rainfall, in inches, shown beneath each rain gauge. Using the nearest rain gauge as an estimate, Figure 6 shows how much rain was calculated for each of the two basins. Figure 7 shows rainfall estimates for the same basins using Thiessen polygons; Figure 8 shows rainfall results using rainfall contours; and Figure 9 shows rainfall results using calibrated radar, which is called CALAMAR. For this document, Figure 9 is shown in black and white, with darker squares connoting heavier rainfall; however, radar images of rainfall intensity like the ones seen on television are always displayed in color.

One interesting observation is the great artificial differences in rainfall estimates created simply by choosing one or another of these methods of calculation. There is a **40-percent** difference between the highest (CALAMAR) and the lowest rainfall estimates (rainfall contours) in Basin A, and there is a **280-percent** difference in Basin B (nearest rain gauge versus rainfall contours). These differences have profound implications for urban hydrologists and profound implications for SSO spill threshold determination. So which rainfall estimate is most accurate? Experiments reported in the literature (8, 9) show CALAMAR to have an accuracy of ± 10 percent or better, with a 1 -square-kilometer geographic resolution. None of the other methods can claim geographic accuracy any finer than the physical distribution of rain gauges; however, the differences between the four methods diminish to zero as rainfall approaches homogeneity. Unfortunately, rainfall distribution is rarely homogeneous (10, 11), which is why we now recommend either CALAMAR or a host of rain gauges placed close together. So, to successfully correlate rainfall with peak flow, we must be sure to get good primary measurements of rainfall and flow. Good rainfall measurements can be assured using CALAMAR or a dense rain gauge network.

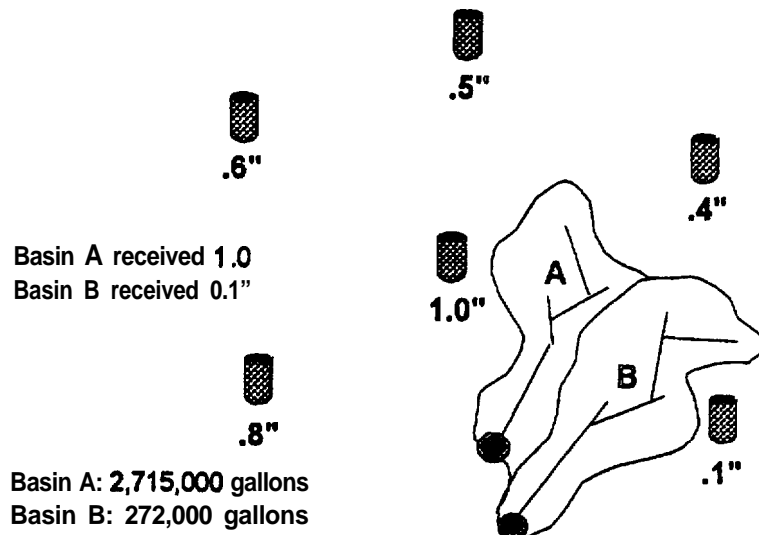

Figure 6. Nearest rain gauge.

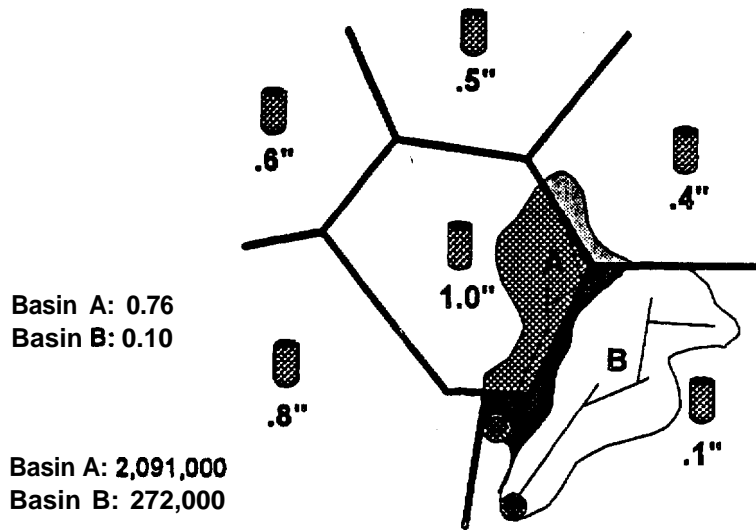

Figure 7. Thiessen polygons.

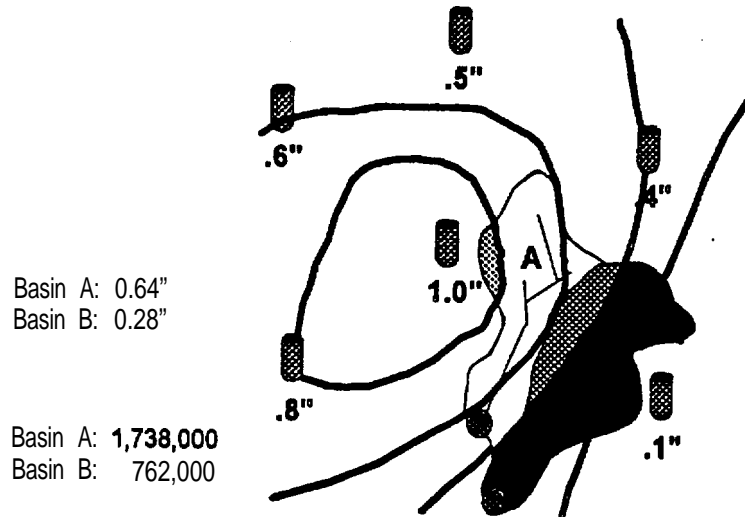

Figure 8. Rainfall contours.

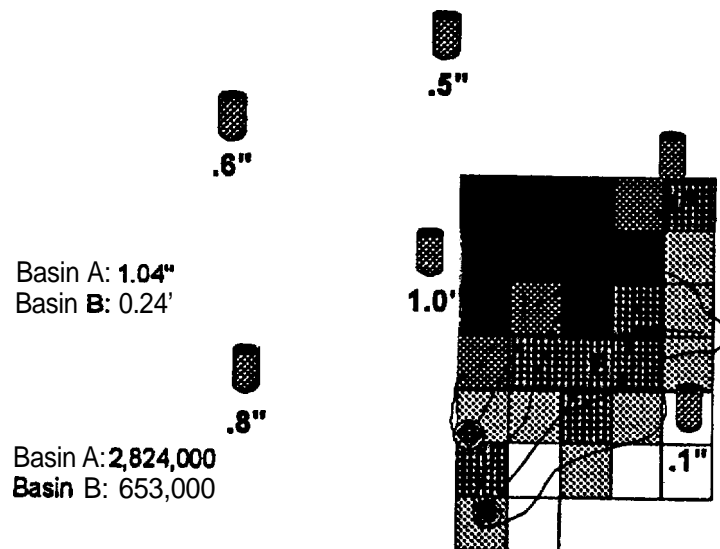

Figure 9. Calibrated weather radar.

Flow Versus Rainfall

The rational formula **relates** rainfall to flow as follows:

$$Q = c \times I \times A \tag{Eq. 1}$$

where

Q = flow

c = runoff coefficient (0 to 1)

I = rainfall intensity

A = area

When both rainfall and flow are measured in gallons, the rational formula becomes $Q = c \times I$. A simple, incisive way to evaluate the performance of a basin for a given storm is converting rainfall to gallons and plotting rainfall versus I/I. In this form, the formula can be used to compare rainfall with I/I either by volume or by rate. Rearranging terms, we have $c = Q/I$, and for sanitary sewers we define c as the "I/I coefficient." I/I coefficients should be near zero (i.e., very little actual rainfall should enter a sanitary sewer). When I/I coefficients are higher than 5 or 10 percent, then there is a serious performance problem in the basin. When over 100 percent, there is a direct connection to an outside source of water, such as a stream somewhere in the basin.

I/I coefficients vary from storm to storm and even within a storm due to antecedent rainfall and evapotranspiration from trees and plants. Therefore, Q to I data should be collected for at least six rainstorms of differing intensities and durations before an I/I coefficient is statistically established. Figure 10 shows what level of rainfall causes SSOs to activate, how much capacity is needed to transport a 5-year storm, and how much capacity is needed to transport a 10-year storm away from the SSO without activating. In short, it links cause and effect. Not only does this method of analysis provide a strong diagnostic tool capable of finding stream cross connections, it also provides a strong design tool for SSO remediation. Figure 10 shows that the SSO activates at 3.4 million gallons per day, while flow response to a 5-year storm is 4.6 million gallons per day and flow response to a 10-year storm is just over 6 million gallons per day. One way of eliminating SSO occurrence at this site up to the level of a 10-year storm would be to provide 6 million gallons per day of pipe capacity away from the SSO. Another way to eliminate the SSO would be to lower the storm response by eliminating the I/I from the upstream sewers.

Display

The two best ways to display I/I coefficients are as bar charts and maps. Bar charts such as the one shown in Figure 11 provide a ready-made priority list for the owner. Maps like the one shown in Figure 2 lose a little on the priority side but gain a great deal geographically and really bring the results home to those who maintain the sewer system.

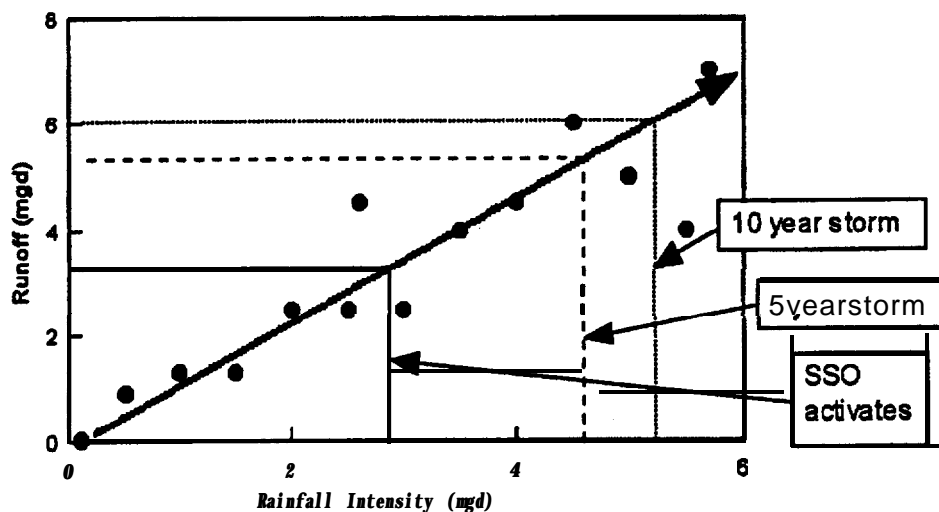

Figure 10. Q to I for a sample basin.

I/I Coefficient

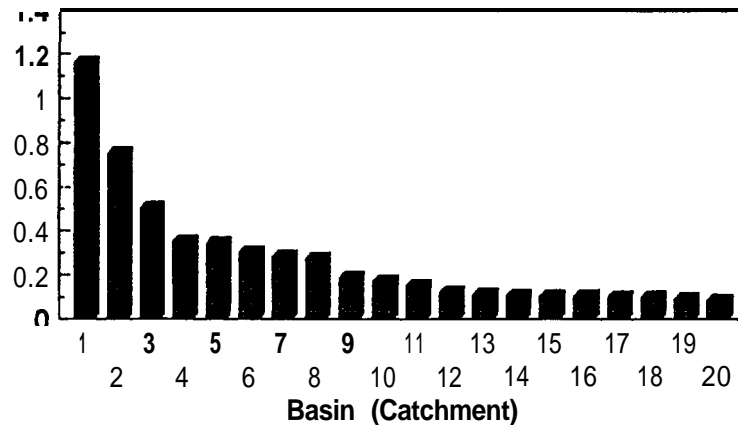

Figure 11. Cincinnati Basin 155 Q to I.

Conventions and Rules of Thumb

Having worked with I/I coefficients on seven projects and having been involved with the development of radar-rainfall technology, ADS suggests starting a color convention for I/I coefficient maps that matches the convention used by the NEXRAD radars and CALAMAR to show rainfall intensities:

- 0 to 2 percent = light blue
- 2 to 5 percent = green
- 5 to 10 percent = light green
- 10 to 15 percent = yellow
- 15 to 20 percent = orange
- 20 to 40 percent = red
- Over 40 percent = magenta

In addition, ADS suggests that streams, lakes, rivers, and oceans be shown in blue, while roads and other geographical features could be shown in a light background color, such as gray.

Sanitary sewer basins with I/I coefficients over 40 percent almost certainly have direct connections to a stream or other outside source of water; I/I coefficients over 100 percent definitely have connections to outside sources of water. I/I coefficients of about 5 percent have shown a rough correlation with EPA's 5,000 gpd/in-mi rule of thumb for infiltration (12, 13); however, the correlation may not be relevant to decision-making.

Finally, while I/I reduction has been quite fruitless in the past, recent advances in sewer diagnostic techniques such as those shown herein and advances in rehabilitation techniques have allowed several cities to remove as much as 90 percent of their I/I (see Figure 12) (14, 15). In addition to the projects shown in Figure 12, the City of Nashville reported in 1994 that I/I reduction in five pilot basins ranged

from 49 to 86 percent (16). So, 23 years after the formation of the EPA, it looks as if we may finally be able to deal effectively with SSOs and I/I in sanitary sewer systems.

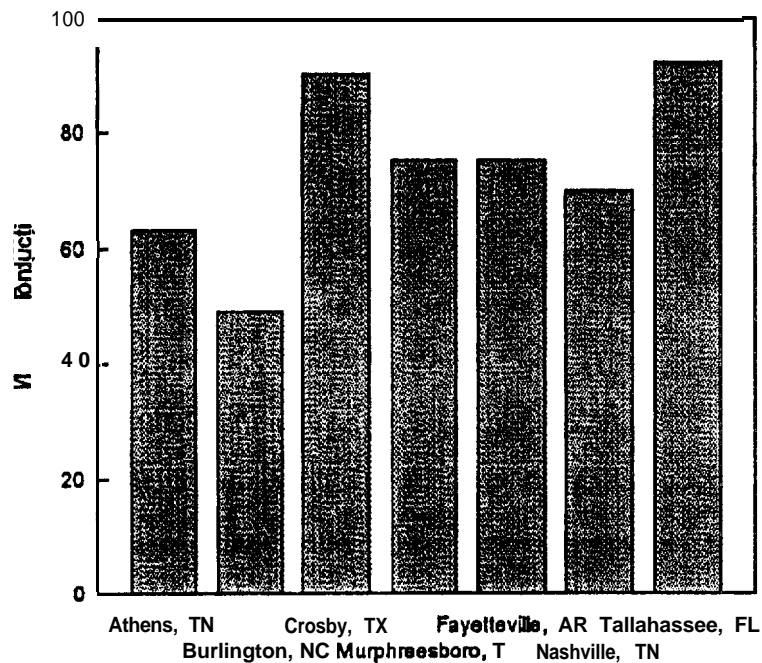

Figure 12. Recent I/I reductions using new sewer diagnostic techniques.

References

1. U.S. EPA. 1978. Program Requirements Memorandum 78-10.
2. U.S. EPA. 1985. Infiltration/Inflow: I/I analysis and project certification. May. NTIS PB85231165.
3. U.S. EPA. 1991. Handbook of sewer system infrastructure analysis and rehabilitation. EPA/625/6-91/030.
4. Water Research Centre. 1984. Sewerage rehabilitation manual, Vol. 2. Wiltsnire, Swindon, England.
5. Stevens, P.L. 1994. Improve your infiltration and inflow studies. Water Environ. Technol. 6(7).
6. U.S. EPA. 1985. Selected topics related to infiltration and inflow in sewer systems. EPA/600/2-85/020.
7. U.S. EPA. Stevens, P.L., and H.M. Sands. 1996. Sanitary overflows leave telltale signs in depth-velocity scattergraphs. In: US. EPA. 1996. Seminar Publication: National Conference on Sanitary Sewer Overflows (SSOs). EPA/625/R-96/007. Cincinnati, OH.
8. Faure, D. 1993. Application à l'hydrologie du radar météorologique - Comparaison d'estimations radar et pluviographiques pour des lames d'eau horaires sur des petits bassins versants cévenols. These de Doctorat de l'Université Joseph Fourier de Grenoble, Spécialité mécanique des milieux géophysiques en environnement.

9. Blanchet, F., A. Guillon, P. Briat, and P. Bourgoigne. 1992. A reference measurement of **areal** rainfall allowing for control of radar, raingauge estimates. Rhea, Nanterre, France.
10. Keefe, P.N. 1992. Rainfall distribution plays a major role in sewer system analyses. Presented at the Water Environment Federation Conference, Toronto, Canada. (October).
11. Blanchet, F., D. **Brunelle**, and A. Guillon. 1993. Influence of the spatial heterogeneity of precipitation upon the hydrologic response of an urban watershed. Rhea, Nanterre, France.
12. ADS Environmental Services, Inc. 1991. Basin #155 infiltration and inflow report. Prepared for the Cincinnati Metropolitan Sewer District, Cincinnati, OH.
13. ADS Environmental Services, Inc. 1992. New Albany infiltration and inflow analysis. Prepared for the City of New Albany, IN.
14. ADS Environmental Services, Inc. 1993. Inflow/Infiltration analysis for Newport Development, Crosby, Texas. March.
15. City of Tallahassee. 1993. Data provided by the City of Tallahassee, FL.
16. Kurz, G.E., C.W. Dillard, P.A. Stonecipher, G.A. Ballard, L. Scott, and C.Q. Toosi. 1994. Successful sewer system rehabilitation. Water Environment Federation.

The Roof Drain and Sump Pump Removal Program: An Innovative Approach to Inflow Reduction

Jay Reynolds
Engineering Department, City of South Portland, Maine

Introduction

South Portland is a city of approximately 23,000 residents located on the shores of Maine's scenic Casco Bay. Besides being a residential area within greater Portland, South Portland contains the largest retail complex in the state of Maine.

In January 1992, the City of South Portland was mandated under a Consent Decree from the U.S. Environmental Protection Agency (EPA) to reduce or eliminate combined sewer overflows (CSOs) entering the receiving waters of Casco Bay.

The city's Engineering Department began its study to determine how it was going to meet EPA's mandate. The first step was to map out the city's sewer system. Drainage areas were mapped, as well as any overflows corresponding to the areas (Figure 1). Next, the city had to assess the frequency of each overflow. To do this, water level recorders were installed at overflow structures to monitor each site continuously. The recorders enabled the city to identify the specific time and volume of each overflow event (Figure 2). From the data, the city found that 40 percent of its collection system was combined, and that ground water, snow melt, and precipitation caused virtually all of the overflows.

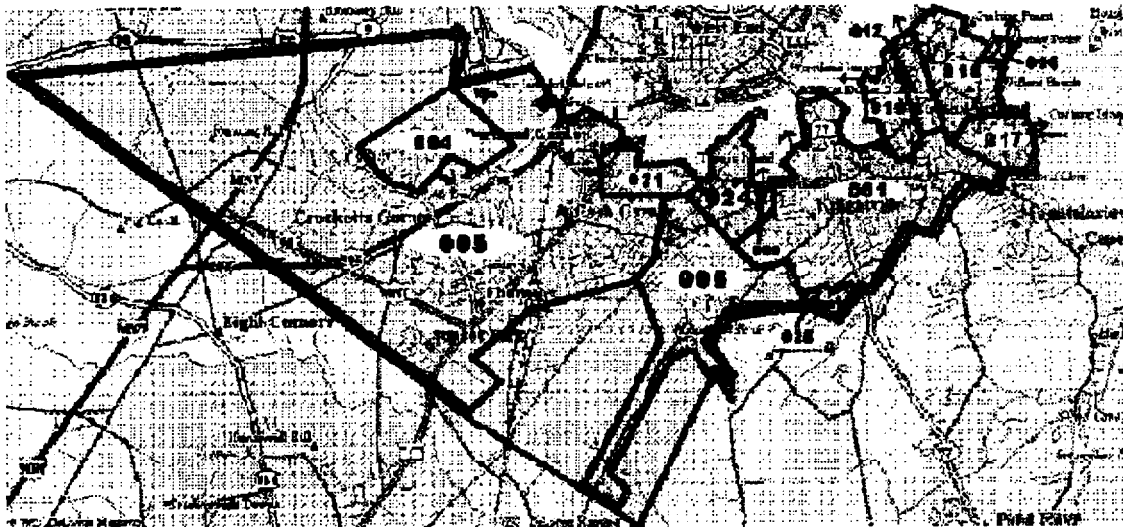

Figure 1. Drainage area map of South Portland, Maine.

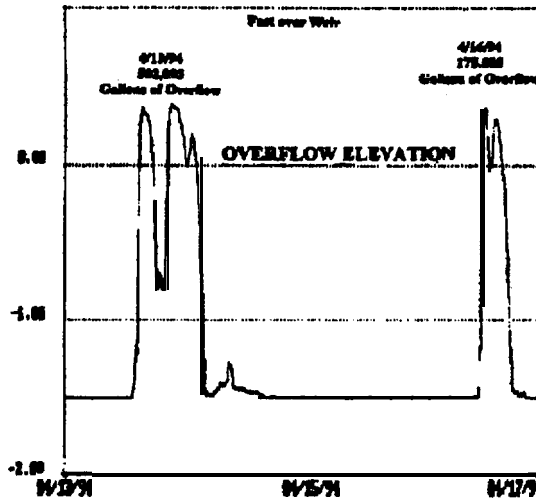

Figure 2. Overflow monitoring graph.

Identifying and Targeting Inflow Sources

To reduce flows, inflow sources needed to be removed from the sewer system. Two sources, roof drains and sump pumps, were suspected of contributing large amounts of storm water and/or ground water. South Portland's Engineering Department decided to investigate these sources by conducting a door-to-door survey. Eight students in the wastewater field at a local technical college were hired by the city to collect information from homeowners and businesses.

Survey of the Sewer System

The student surveyors were assigned areas of the city to canvass. Each surveyor received a picture identification badge, hard hat, flashlights and survey forms, all with city seals and identification. The surveyors also underwent a 4-hour training session that covered the following topics:

- Survey background
- Information required
- Records maintenance
- Approaching the homeowner
- Educating the homeowner
- Personal safety
- Computer entry of data

After receiving training, the surveyors executed the door-to-door survey. The survey involved a brief interview with homeowners or tenants to gather information about each property. Points of discussion were sewer history, stormwater drainage, and existing foundation drains, roof drains, and sump pumps entering the sewer system. Surveyors completed a form for each building (Figure 3). Information was transferred onto a computer database for easy recording and monitoring.

HOUSE/BUILDING # _____	STREET NAME _____
MAP _____ W T _____	SURVEYOR JD # _____
RESIDENTIAL _____ COMMERCIAL- _____ INDUSTRIAL _____	
CS DRAINAGE AREA _____	
SEWER DISCHARGES TO: POTW _____	SUB-SURFACE _____
ROOF DRAINS TO SANITARY SYSTEM (Y OR N) _____	
IF YES, SQ. FEET OF ROOF SERVED _____	
BASEMENT HAS A HISTORY OF BEING WET FROM:	
SEWAGE _____	RAINWATER _____
	BOTH _____
BASEMENT HAS A FLOOR DRAIN (Y OR N) _____	
BASEMENT HAS A SUMP PUMP (Y OR N) _____	
PUMP DISCHARGES TO: GROUND _____	SANITARY _____ UNKNOWN _____
ANY UNREPORTED SEWER PROBLEMS (Y OR N) _____	
DESCRIBE _____	

Figure 3. Building sewer survey form.

All of the 6,000 residential buildings surveyed were examined visually for roof gutters. Internal data were collected from approximately half the properties visited. Using the survey results, the engineers identified those areas that needed increased attention and those where the city could decrease their efforts. For instance, most sections of CSO Drainage Area 005 did not reveal any roof drains and contained only a handful of sump pumps entering the sewer system. The city, therefore, redirected its efforts to CSO Drainage Area 017, which contained more than 100 identified inflow sources after the first survey. Another reason for prioritizing Area 017 was that the overflow corresponding to this area is near Willard Beach, South Portland's only public swimming area.

The Engineering Department began an extensive survey of its priority areas, such as Drainage Area 017. The distribution of prestamped postcards to houses increased the percentage of houses from which sump pump information was obtained. Many areas, such as Area 001 (south), Area 006 (Bonnybanks), and Area 017, reached nearly 100-percent completion of the original survey (see Table 1). Not only did this percentage increase, but the number of known sump pumps entering the sewer system increased. Overall, the surveys found that approximately 300 sump pumps and 380 roof drains were discharging into the sewer system.

Table 1. Statistical Data for the Roof Drain and Sump Pump Removal Program

CSO Drainage Area	% Survey Completed		Inflow Sources Found Entering the Sewer System			% Remediation Completed (of Known Inflow Sources)			Rebate Cost	Gal./Year Removed
	Sumps	Drains	Sumps	Drains	Overall	Sumps	Drains	Overall		
001 (North)	82.8%	100%	24	21	45	66.7%	57.1%	62.2%	\$9,025	4,266,632
001 (South)	93.4%	100%	19	23	42	68.4%	56.5%	61.9%	\$8,725	968,883
001 (East)	63.3%	100%	6	28	34	83.3%	75.0%	76.5%	\$7,475	659,663
001 (Bridge + Ocean)	59.1%	100%	18	43	61	44.4%	44.2%	44.3%	\$6,425	815,627
001 (Knightville)	51.2%	100%	25	17	42	60.0%	52.9%	57.1%	\$7,650	5,097,923
004	3.9%	100%	4	0	4	NA				

CSO Drainage Area	% survey Completed		Inflow Sources Found Entering the Sewer System			% Remediation Completed (of Known Inflow Sources)			Rebate cost	Gal./Year Removed
	Sumps	Drains	Sumps	Drains	Overall	Sumps	Drains	Overall		
005 (North)	53.0%	100%	19	0	19	42.1%	NA	42.1%	\$3,200	2,330,650
005 (East)	55.4%	100%	6	0	6	63.3%	NA	63.3%	\$2,000	90,750
005 (West)	51.6%	100%	4	0	4	50.0%	NA	50.0%	\$600	132,000
005 (Cash)	64.5%	100%	14	0	4	50.0%	NA	50.0%	\$800	18,200
005 (Sunset Park)	60.6%	100%	16	4	20	66.8%	0.0%	55.0%	\$4,400	2,014,300
005 (Thornton)	62.4%	100%	1	11	12	100.0%	72.7%	75.0%	\$1,525	556,596
006 (North)	54.6%	100%	2	0	2	50.0%	NA	50.0%	\$400	150,000
006 (East)	50.8%	100%	3	6	9	33.3%	66.7%	55.6%	\$1,075	72,669
006 (Bonny banks)	98.7%	100%	46	1	47	69.6%	100.0%	70.2%	\$13,100	8,240,839
006 (Stanwood Park)	49.4%	10%	6	0	6	50.0%	NA	50.0%	\$1,200	172,500
006 (SW Stanwood Park)	44.4%	100%	3	0	3	100.0%	NA	100.0%	\$1,200	26,500
009	63.5%	100%	0	15	15	NA	73.3%	73.3%	\$2,025	224,840
012	77.5%	100%	20	26	46	70.0%	76.9%	73.9%	\$9,125	2,176,933
017	87.5%	100%	38	79	117	84.2%	74.7%	77.8%	\$25,025	22,309,184
018	54.8%	100%	18	35	53	55.6%	62.9%	60.4%	\$6,575	4,906,600
019	56.2%	100%	5	31	36	80.0%	71.0%	72.2%	\$5,500	741,293
021	44.1%	100%	4	4	8	50.0%	50.0%	50.0%	\$1,025	1,041,458
024	57.7%	100%	12	34	46	66.7%	58.8%	60.9%	\$7,325	697,960
028	68.5%	100%	1	1	2	100%	0.0%	50.0%	\$400	200,000
	Average	Average	Total	Total	Total	Average	Average	Average	Total	Total
	64.8%	100%	304	379	683	64.8%	64.3%	64.5%	\$128,000	58,112,022

Rebate Program

In autumn 1993, the survey work was completed. An engineering technician was hired to manage the rebate and inspection portion of the program. With the approval of the city council, letters were sent to homeowners with known roof drains and sump pumps connected to the sanitary sewer system. The letters included a rebate offer for those willing to redirect the flows from these inflow sources. After discussions with other communities, \$75 per roof drain and \$400 per sump pump were agreed on as financial incentives for homeowners' participation. All homeowners were given a list of suggested plumbers who could perform the work, or homeowners were encouraged to complete the work themselves. Once the work was completed, the homeowner notified the Engineering Department. After an inspection by the engineering technician, the homeowners were reimbursed.

Inspections

The city required that two conditions be met during the inspection:

- The sanitary pipe, where the inflow sources originally discharged, was permanently sealed and capped. This was to discourage any reconnecting to the sewer system and to prevent any potential sewer backups.
- The roof drain and sump pump discharges were redirected properly. This was to prevent any property damage, flooding, or any recirculation of water that may have occurred from these discharges.

Homeowners also signed an agreement stating that they would receive a rebate for their services. They agreed that if the sump pumps or roof drains were reconnected to the sewer system, they would have to return the rebate amount to the city. Homeowners also agreed that the city would not be liable for any property damage resulting from the redirection of these inflow sources.

The technician also gathered other valuable information during the inspection. Using the roof-top square footage of a house, the city calculated the number of gallons of stormwater being redirected from roof drains and, hence, from the sanitary system. For example: House 1 had two roof drains redirected. House 1's dimensions are 30 feet by 30 feet (900 square feet). Historically, the Greater Portland area receives an average of 44.3 inches of precipitation in 1 year. The conversion is as follows:

$$(900 \text{ square feet}) \times (44 \text{ inches/year}) \times (7.48 \text{ gallons/cubic feet}) \\ \times (1 \text{ foot/} 12 \text{ inches}) = 24,850 \text{ gallons/year}$$

Because all 44.3 inches of precipitation does not reach the sewer system, House 1 is listed as a redirection of 24,500 gallons of stormwater per year.

Removal rates were more difficult to quantify for sump pumps. Because of varying ground-water tables, soils, and foundation strength, the city found that there was no pattern to the frequency or duration of each sump pump's running time.

The majority of homeowners, however, were very familiar with the running time of their sump pumps. The owners of House 2 stated that their sump pump runs only in the spring. They asserted, "The pump will turn on twice every hour for about 1 minute (for the whole season), and then it won't run all summer, fall, or winter."

The sump pump at House 2 has a running time of approximately 72 continuous hours.

To supplement homeowners' reports, the inspector recorded the name of the sump pump, horsepower, pipe diameter, and distance pumped (head) for each inspection. The engineers cross referenced these dimensions to a catalog that gives pumping rates for each variable.

Given House 2's variables, its pump has an average pumping rate of 2,000 gallons an hour. The conversion is as follows:

$$2 \text{ minutes/hour} = 48 \text{ minutes/day} \times (90 \text{ days/year}) \\ = 4,320 \text{ minutes/year} \div (1/60 \text{ minutes/hour}) = 72 \text{ hours/year} \\ (2,000 \text{ gallons/hour}) \times (72 \text{ hours/year}) = 144,000 \text{ gallons/year}$$

Given the number of variables used to reach this estimate, the margin of error is higher for sump pump calculations than for roof drains.

Removal Rates/Results

Using the aforementioned calculations, removal rates for every area of the city were calculated and documented. These estimates were entered into a computer spreadsheet according to location. Table 2 represents the roof drain redirections from Area 024.

Table 2. Completed Removals (Roof Drains), CSO 024

Address	Rebate	Drains	Ft.2 Removed	Vol. Removed (gal/yr)	Total Volume (gal/yr)
49 Chapel St.	\$150	2	1,125	31,093	31,093
32 Stanwood St.	\$300	4	1,750	48,368	79,461
963 Broadway	\$300	4	1,650	45,604	125,064
8 Chapel St.	\$300	4	1,200	33,166	158,231
96 Chapel St.	\$150	2	625	17,274	175,505
39 Reynolds St.	\$150	2	1,200	33,166	208,671
54 Cole St.	\$150	2	750	20,729	229,400
35/37 Reynolds St.	\$225	3	1,125	31,093	260,493
31 Reynolds St.	\$300	4	1,650	45,604	306,097
166 Kelsey St.	\$150	2	600	16,583	322,680
15 Robinson St.	\$375	5	1,400	38,694	361,374
82 Kelsev St.	\$225	3	1,500	41,458	402,832
34 Cole St.	\$225	3	1,200	33,166	435,998
239 Elm St.	\$225	3	720	19,900	455,898
28 Reynolds St.	\$150	2	960	26,533	482,431
89 Kelsey St.	\$150	2	350	9,674	492,105
30 Reynolds St.	\$75	1	300	8,292	500,396
265 Elm St.	\$75	1	550	15,201	515,598
33 Latham St.	\$150	2	1,125	31,093	546,691
17 Chapel St.	\$300	4	1,000	27,639	574,330
Totals	\$4,125	55	20,780	574,330	574,330

The totals in cost, removal rates, and number of houses completed are then transferred to an even larger spreadsheet that fully summarizes the program (Table 1). Most numbers on this spreadsheet are automatically updated with the use of formulas within the cells of the spreadsheet. This allows the engineer to update a month's worth of redirections in a matter of hours. This spreadsheet was sent out quarterly to notify regulatory officials at EPA of South Portland's progress.

The totals and averages on this spreadsheet show the overall results as of March 1, 1995. An average of 64.5 percent of all known sources have been redirected. At a total rebate cost of \$128,000, an estimated 58 million gallons per year have been redirected.

Not all 58 million gallons were removed from the sewer system, however. Because 40 percent of the sewer system is combined, the Engineering Department theorized that a percentage of the 58 million gallons found its way back to the sanitary system, while a certain percentage remained separated.

To cross reference the 58 million gallons per year removal rate, the engineers obtained information from the city's pollution control plant. They found that the total in-system quantity (treated and overflowed) in 1993 was 2,096 million gallons and 2,060 million gallons in 1994. This amounts to a **1.7-percent** decrease in yearly flows. Total yearly precipitation was 43.85 inches in 1993 and 44.05 inches in 1994, only two-tenths of an inch difference. This difference between yearly precipitation levels eliminates rainfall as a variable contributing to the difference of 36 million in-system gallons.

Conclusion

Before a project of this magnitude can be initiated, it is imperative that the city council or other governing body endorse the program. The issue of entering private residential buildings should be addressed openly and, from South Portland's experience, voluntarily. Because of city staffs understanding of the collection system, they were able to approach the city council with confidence about the potential positive impacts of instituting such a program.

Theoretically, South Portland's 36-million-gallon reduction could be the direct result of sump pump and roof leader redirections. There are too many variables involved, however, to make that direct correlation. Though a majority of the redirections occurred in 1994, many are still being implemented in 1995. The impact of the most recent redirections will not be known until the total yearly flows for 1994 and 1995 are compared. At this time, the city concludes that the redirections were a major contributor to the reduction in flows.

Even though a percentage of flows eventually make it back into the sanitary system, there is still a benefit from these particular redirections. Overflows have been on the verge of becoming active during the peak of a rainstorm, yet have not gone active. Roof drain and sump pump redirections delay stormwater from entering the sewer system, creating extra time for the collection system to handle other incoming flows.

If the overflow becomes active, the benefit is still present. Reducing inflow during high intensities of a rainstorm results in a reduction of overflow volumes as well as duration. Reducing overflow volumes is the first step in striving to eliminate the overflow.

Cost effectiveness is the outstanding element of this program. The total cost of the original door-to-door survey was under \$15,000, and the total cost of in-house management was under \$20,000. These costs show what can be accomplished within a municipal department. The overall cost to date (\$160,000) in relation to the results (36 million gallons a year) equates to 225 gallons redirected for every dollar spent. No stormwater separation project comes close to matching this cost-to-benefit ratio.

South Portland, Maine, is one of only 10 known cities in the United States to consider or implement a program of such magnitude. This innovative approach to inflow reduction is highly recommended for communities similar to South Portland.

Rainfall-Derived Infiltration and Inflow: An Innovative Approach to Removal

Joseph P. Niehaus
Metropolitan Sewer District of Greater Cincinnati, Cincinnati, Ohio

Introduction

One of the most difficult factors involved in removing significant quantities of infiltration and inflow (I/I) from sewer systems is the large percentage of I/I sources that are located on private property,

Sewer agencies have struggled with ways to effectively reduce I/I from their sewer systems since the inception of mandated I/I analyses by the Water Pollution Control Act Amendments of 1972. I/I analyses and Sewer System Evaluation Surveys performed throughout the country revealed a common problem: a very large amount of I/I originates on private property, and removal of that I/I is a financial burden for property owners.

The Metropolitan Sewer District of Greater Cincinnati (MSD) has struggled for 23 years with the removal of rainfall-derived infiltration and inflow (RDII) discharges from private property. To reduce the effects of stormwater I/I on the wastewater collection system, the "Rainfall-Derived Infiltration/Inflow Removal Program" was established in 1992. The program is innovative because it reimburses property owners for the elimination of RDII on private property.

The RDII removal program is perhaps the most cost-effective program that MSD ever initiated. The program provides a process for property owners to remove improper stormwater connections, reducing basement flooding and sanitary sewer overflows (SSOs) and their associated health impacts and yielding immediate water quality benefits. The reduction in peak flows in the sewer system has led to the elimination of the need for expensive relief sewers and wastewater treatment capacity expansions, and has reduced pumping and treatment operation and maintenance costs. The estimated quantity of stormwater removed or identified to be removed from the sanitary sewer system is 76 million gallons per day. Savings to rate payers due to removal of stormwater is conservatively estimated at \$304 million.

This project exemplifies the "win-win approach" to problem resolution. The State of Ohio, Hamilton County, and the City of Cincinnati worked with local jurisdictional municipalities to enact the necessary legislation and pass a resolution to allow public funds to be used to reimburse private property owners and to implement the program.

Background

MSD provides centralized sewer service to the City of Cincinnati and surrounding municipalities and townships in Hamilton County, Ohio. Cincinnati's sewer system consists primarily of combined sewers; approximately 600,000 people located in surrounding communities and townships, however, are served by separate sanitary sewers. When MSD was formed in 1968, it assumed jurisdiction of sanitary sewer systems that were plagued by wet weather flow problems. Substantial quantities of RDII caused sewer surcharging, basement flooding, and SSOs, while contributing to the frequency and volume of combined sewer overflows in downstream interceptor sewers.

Beginning in the early 1970s, MSD conducted smoke testing, dyed water studies, and physical inspections in their separate sanitary sewer areas to identify RDII sources for elimination. Numerous sources were found, including a large percentage of unauthorized downspout, foundation drain, and area drain connections to the sanitary sewers from private property. Property owners were notified that they

were in violation of the district's rules and regulations and that they were required to remove the unauthorized connections at their own expense.

Typical responses to these notices were:

- "It's not our fault. The unauthorized connections were already here when we bought the property. Contact the former property owner."
- "It's too expensive. We're on a fixed income and can't afford to fix the problem."
- "We've owned this property for 20 years, and it's always been like this. Why is this suddenly a problem that we have to take care of? It isn't fair to apply new rules to us now that cost a lot of money."
- "It's too expensive. If you want it fixed, then sue me."

Some ignored the notices completely; very few property owners complied. MSD consists of nine townships, 18 cities, and 15 villages. Many property owners complained to their local elected officials that the requirements were too onerous. In many instances, MSD was either asked or told to ease up on enforcement of the notices. Then the next significant storm event would occur, triggering a new set of basement flooding complaints and stirring up the problem of unauthorized sewer connections all over again.

MSD, like most other sanitary sewer agencies, was faced with an important dilemma. Ignoring the sources of RDII on private property would mean that costly relief sewers would have to be installed, and pumping and treatment facility expansions would have to be constructed. This would require raising sewer rates and would result in unhappy rate payers. Enforcing the removal of RDII on private property would probably involve some litigation costs, would stretch out the time required to remove excess flow from the sewer system, and would make rate payers unhappy. Either choice represents a "lose-lose approach" to problem resolution. It was time for a change in thinking!

A "Win-Win" Strategy Surfaces

In 1990, MSD began an aggressive program of identifying and eliminating stormwater connections to the sanitary sewer system. RDII studies provided supporting documentation to the MSD master plan, completed in 1991, which identified unauthorized stormwater connections as the primary cause of basement flooding and SSOs in the collection system.

Recognizing that the costs for RDII removal from private property were less than the corresponding costs for constructing larger wastewater collection and treatment facilities, it was clearly of benefit to all MSD customers to find a way to fund RDII removal from private property. Under the Ohio Revised Code, however, cities, counties, and sewer districts were prohibited from using public revenues to make improvements on private property. At the request of the Hamilton County Board of Commissioners and the City of Cincinnati, the Ohio state legislature passed a bill in September 1991 that allowed for the reimbursement of property owners for rerouting storm flows and eliminating their discharge to the sanitary sewer system.

Wasting little time, local legislation was enacted. A resolution dated November 20, 1991, by the Board of County Commissioners of Hamilton County created the RDII removal program. This innovative program provides for the reimbursement of up to \$3,000 to each participating private property owner for rerouting storm flows and eliminating their discharge to the sanitary sewer.

How the Program Works

The RDII removal program begins with field studies to assist property owners in the identification of stormwater entry points into the sanitary sewer. Smoke testing, dyed water flooding and testing, manhole inspection, and sometimes television inspection of sewers in the vicinity of the study-area properties are conducted to document connections to the sanitary sewer. Then sketches of individual properties or a cluster of properties are prepared showing the locations of connections to be removed and other remedial measures required to effect removal of stormwater from the sanitary sewer. A sketch that is often included to show how to remove a downspout connection properly is shown in Figure 1; this would be furnished to the property owner along with a plan view of the property that shows locations of connections to be removed and the locations of nearby sanitary and storm sewers.

The maximum amount eligible for reimbursement is \$3,000 per property. Two options are permitted:

- Property owners may complete the work themselves and be reimbursed for materials plus \$50 for their labor.
- Property owners may obtain at least two cost proposals for the work and submit them to MSD for pre-approval. A list of pre-approved contractors is provided with the notice. **Once** the work is completed and inspected, a reimbursement check is issued jointly to the property owner and the contractor.

Administration of the program follows a set sequence of events beginning with the issuance of the First Violation Notice to the property owner. The First Violation Notice explains the purpose of the program, identifies the items to be corrected with supporting sketches, defines the two reimbursement options, and contains an Acknowledgment and Release Form to be filled out and submitted to MSD. The property owner submits his or her work proposal and estimated costs, or two or more competitive proposals for performing the work. MSD returns a Bid Approval/Notice to Proceed statement to the property owner, who then either performs the work or signs a contract with the low bidder to perform the work. When the work is completed to the owner's satisfaction, a Claim Voucher (invoice) is submitted to MSD for reimbursement. MSD conducts an inspection of the work and verifies that the RDII sources have been removed. A Compliance Letter and a reimbursement check are sent to the property owner (or jointly to the owner and the contractor) when the project has been completed to the satisfaction of MSD.

Monitoring Program Success

The initial target area for the RDII removal program was the Village of Mariemont, Ohio, where basement flooding during wet weather was a chronic event. Following completion of the field studies, 156 separate properties were notified of 304 unauthorized stormwater connections to the sanitary sewer. To date, 147 of the property owners have completed their RDII removal projects, with five more in progress, at an average cost of \$783 per property. Enough of the RDII removal projects had been completed by mid-1993 to nearly eliminate reports of sewer surcharging during several intense rain storms in June and July 1993, including a 50-year storm event. The success of the program in Mariemont has carried over to other communities as the program expands in coverage.

Through the end of calendar year 1994, over 10,700 unauthorized storm connections have been identified and 41 percent have been removed from the system, with the remainder being authorized for removal. The cost incurred for isolating and identifying the RDII sources is approximately \$9.2 million. The total cost to remove these connections, which includes the amount reimbursed to the property owners as well as the amount committed for approved contracts in various stages of completion, is \$6.3 million.

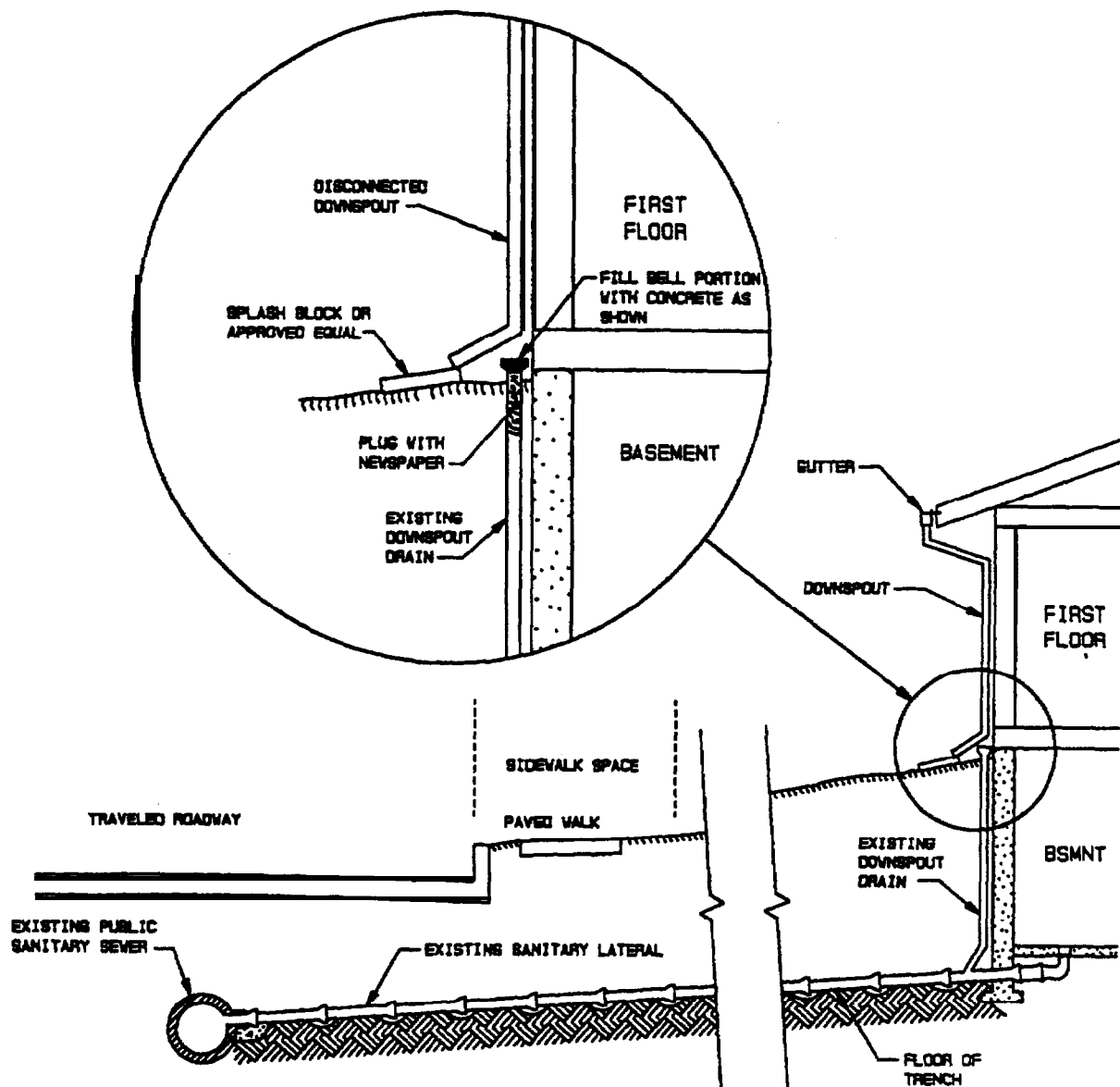

NOTES :

1. STORMWATER DISCHARGE FROM DOWNSPOUT MUST BE IN COMPLIANCE WITH LOCAL STORMWATER REGULATIONS.
2. TO BE ELIGIBLE FOR REIMBURSEMENT YOU MUST HAVE PRIOR APPROVAL FROM MSD BEFORE WORK CAN COMMENCE.
3. DISCONNECTED DOWNSPOUT SHOULD DIRECT WATER AWAY FROM FOUNDATION.

Figure 1. Acceptable method for sealing an existing downspout drain,

The reduction in peak flow to the sanitary sewer system resulting from the removal of the RDII sources is estimated using a 2-year storm event and the rational formula for runoff. Impervious area dimensions are measured or estimated during the field investigations and are noted on the plan sketches of each property. The cumulative quantity of peak RDII eliminated or under contract to be eliminated through the end of calendar year 1994 is 76 million gallons per day. In addition, by not paying for larger interceptor and trunk relief sewers or for expanding pumping and treatment facilities, MSD's customers have saved an estimated \$304 million. The cost effectiveness of the RDII removal program has been clearly demonstrated.

Results of the RDII removal program are updated quarterly and published in a quarterly report. The quarterly report summarizes RDII removal activity statistics for the past quarter and the cumulative statistics to date. Graphical summaries of the number and type of RDII sources that have been found and corrected are shown, along with their associated costs. The two most common types of RDII sources that have been removed under this program include downspout connections and driveway drains.

Another benefit of the program has been the identification of sanitary sewer system deficiencies or problem areas that require more frequent maintenance. The intensive field studies used to identify RDII sources on private property have increased MSD's and local sewer collection agencies' knowledge of their collection systems.

Conclusion

Faced with the difficulty of trying to remove RDII from private properties, MSD implemented an innovative solution that has been highly successful and has exceeded all expectations. Rather than resigning themselves to the fact that they were not empowered under the Ohio Revised Code to fund sewer improvements on private property, the leadership of MSD pursued a course to change the law to provide overall benefits to their constituents. The resulting program has expended or committed funds of less than \$16 million to produce an expected savings of over \$300 million thus far. With results like this, MSD hasn't received very many complaints from the people who live in a new subdivision at the top of the drainage area about paying for someone else's problem on private property. The overall benefits of this program to all rate payers are obvious.

MSD's RDII removal program has created a path in Ohio for other sewer agencies to follow for solving the problem of removing RDII from private property. Hopefully, this path can be followed in other states as well, as it clearly represents a "win-win" approach for dealing with a traditionally difficult problem.

Mismanagement of Sump Pump Connections to Sanitary Sewers

Russell E. Nerlick
Western Monmouth Utilities Authority, Englishtown, New Jersey

Sanitary sewer overflows from separate sewer systems are not tolerated in the State of New Jersey. The New Jersey Department of Environmental Protection (NJDEP) has required applicants for sewer extensions to certify that the downstream sewers have adequate capacity. The department has rules and regulations that specify what capacity of the sewer line may be utilized in wet and dry weather.

7:14A-1.9 - ADEQUATE CONVEYANCE CAPACITY MEANS:

That in the downstream sewers, the peak dry weather flow does not exceed 80 percent of the depth of the pipe and the peak wet weather flow does not result in overflows or discharges from any unpermitted location.

Regulations also provide for a Capacity Assurance Program:

7:14A-22.16 - CAPACITY ASSURANCE PROGRAM

- (a) Whenever the committed flow reaches or exceeds 90 percent of the permitted capacity of a treatment works, the participating municipalities and/or sewage Authorities shall submit to the Department a program to be implemented in order to prevent an overloading of their facility or a violation of their NJPDES Permit.

These regulations are aimed at ensuring that the capacity of the system is not exceeded and that authorities and municipalities act in a responsible manner to provide adequate collection and treatment capacity. The regulations provide the following framework to maintain adequate capacity:

- Implementation of water conservation measures.
- Reduction of infiltration and inflow (I/I) where appropriate. Measures shall be taken, to the satisfaction of the Department, which appropriately identify the causes and course of corrective action within a specified time frame.
- Implementation of measures to maximize treatment plant capacity at a minimum cost.
- Construction of improvements.
- Disconnection of roof leaders, sump pumps, and other sources of inflow from sanitary sewer lines and connect into storm sewer lines where storm sewers are available and to the extent feasible.

The sewer connection ban regulations require that a ban be imposed when the downstream capacity is insufficient, which results in an overflow:

7:14A-22.17 -

- (a) A Sewer Connection Ban shall be imposed in accordance with this subchapter, when the following occurs:
1. The downstream sewerage facilities do not have adequate conveyance capacity as defined in N.J.A.C. 7:14A-1.9.

While under a ban, only minor connections that serve a public or social purpose may be connected to a collection system. If the overflow is the result of a very unusual weather condition, however, such as flooding, it may be possible to avoid a sewer ban by requesting releases from the department:

1. If the cause of inadequate conveyance capacity is a one-time overflow occurrence which has been determined to be the result of extreme and unusual precipitation, or equipment malfunction which has been repaired, the owner/operator may notify the Department, Division of Water Quality in writing within 20 days of the occurrence and request relief from the imposition of the Sewer Ban.

The regulations enable the NJDEP to require that an applicant provide additional information and/or studies:

- ii. The Department may require any local agency requesting relief pursuant to this provision to provide additional detailed justification, including, but not limited to, a sewer system capacity analysis and evaluation.

The sewer connection ban regulations also require that a public resolution be adopted relative to the ban that the owner of a sewer system cease further approvals of connections:

7:14A-22.18 - PROCEDURES AND EFFECTIVE DATE FOR THE IMPOSITION OF A SEWER CONNECTION BAN

- (a) Within 20 days of the treatment works becoming subject to a Ban pursuant to N.J.A.C. 7: 14A-22.17, the owner/operator of the subject treatment works shall:
 1. Adopt a Resolution imposing the Sewer Connection Ban.
 2. Cease the further approval of sewer connections to the subject treatment works as of the effective date of the Ban.

They must notify affected municipalities also:

- (a) 3. Notify the affected municipalities that they shall cease the issuance of building permits and condition all other approvals which will require or modify a sewer connection, and which has not already obtained a valid Treatment Works approval issued by the Department before the effective date of the Ban as specified in (l) below.
 - l. For projects that do not require a Treatment Works approval and/or Sewer Ban exemption pursuant to N.J.A.C. 14:A-22-20, the (local) Authority (municipality) may issue building Permits or local approvals.

The regulations also require that a notice of the ban be published in a local newspaper:

- (a) 4. Give notice of the Sewer Connection Ban to the Department to residents of the area that contributes to the subject Treatment Works, landowners therein, local Planning Board, and other persons or legal entities affected by the Ban, within 10 days of adoption of the Ban imposition Resolution, and at intervals of no more than six months in a manner reasonably expected to be received by such persons.

In New Jersey, connection of sump pumps to sanitary sewer systems is a major problem in many collection systems and may result in sanitary sewer overflows during the spring, when wet weather and ground-water levels reach maximum levels. High land costs often result in the development of land that is

unsuitable for the construction of basements. Once the good high and dry land is used up, developers turn to land near wetlands for continued development.

When building a residential unit, developers commonly construct a sump in the cellar to receive ground water through drainage pipes placed under the concrete cellar slab. Unfortunately, most developers provide sumps but not outlet facilities. When a homeowner is faced with rising water levels in the sump, they either hire a plumber purchase a sump pump. Because the sump pump water has no outlet facility, the homeowner or plumber usually connects the pump to the sanitary sewer outlet, which is often conveniently adjacent to the sump. The 1980 Plumbing Code states that detrimental materials should not be discharged into sewer systems:

2.10 - EXCLUSION OF MATERIALS DETRIMENTAL TO THE SEWERAGE SYSTEM

No material shall be deposited into a building drainage system or sewer which would or could either obstruct, damage, or overload such system, which could interfere with the normal operation of sewage treatment processes, or which could be hazardous to people or property. This provision shall not prohibit the installation of special waste systems when approved by the administrative Authority.

It also prohibits stormwater from being drained into separate sewers:

13.1.2 - STORM WATER DRAINAGE TO SEWER PROHIBITED

Storm water shall not be drained into sewers intended for sewage only.

The 1993 Plumbing Code provides the same guidance:

2.10 - EXCLUSION OF MATERIALS DETRIMENTAL TO THE SEWAGE SYSTEM

2.10.1 -GENERAL

No material shall be deposited into a building drainage system or sewer which would or could either obstruct, damage, or overload such system; which could interfere with the normal operation of sewage treatment processes: or which could be hazardous to people or property. This provision shall not prohibit the installation of special waste systems when approved by the administrative authority.

Some municipalities in New Jersey have recognized this problem and require developers to provide for connection of sump pumps to a development's stormwater systems. Other municipalities have required that cellars be above the seasonal high water level. The following is an example from the Ewing Township Building Code, which discusses sump pumps control:

22.22 - SUMP PUMP DISCHARGE

- a. Sump pump discharge lines shall not be allowed to empty within ten feet of any property line or onto sidewalks within the street right-of-way.
- b. No Certificate of Occupancy shall be issued for any new residential or commercial construction with a full or partial basement, unless there shall have been installed a sump pump pit, sump pump electrical connection and a permanent connection to a storm sewer system or to some other permanent discharge point other than a sanitary sewer, approved by the Township Engineer.
- c. No sump pump installed in any new residential or commercial construction shall be permitted to discharge over land nor shall a sump pump be connected temporarily or

permanently to a sanitary sewer system or lines of the East Windsor Municipal Utilities Authority. Discharge over land where no storm sewers are available may be permitted on any property exceeding two acres in area, subject to the Township Engineer's approval.

- d. The agency granting approval may require a system of pipe drains paralleling the curb line to collect water from sump pump discharge lines where drainage conditions require. This collector system shall be connected to manholes or inlets as approved by the township Engineer.
- e. The Township Engineer shall periodically examine sump pump discharge lines to determine if any hazardous conditions such as potential ice hazards on sidewalks or creation of erosion or stagnant water in the public right-of-way exist.

While these actions may limit the number of new sump pumps connected to sanitary sewer systems, they do little to effect the removal of existing sump pumps, which may be seasonally overloading a sanitary sewer collection system.

The problem of sump pumps is a political problem that most municipalities do not want to face. An illegal sump pump connection in a private home is difficult to determine and to take enforcement action on, as the right of ownership protects the home from unwarranted inspection. At times, however, inspecting homes for the presence of illegal sump pumps is warranted, especially if those illegal sump pumps result in the overloading of sanitary sewer collection systems and the discharge of raw sewage into our environment.

Code enforcement officers in some municipalities have inspected every home within their areas for illegal sump pump connections, issuing orders to disconnect where they found improper sump pumps. Some of these programs were conducted not to prevent overflows but simply to reduce the cost of treatment at the regional treatment plants serving the municipalities.

The Borough of Belmar, a New Jersey coastal town, developed a program in which plumbing inspectors visited each basement within the municipality. When they found an improperly connected sump pump, they directed the owner of the home to have the discharge removed from the sanitary sewer system or face a fine. Flow records for the community before and after the program show that yearly flow was reduced by approximately 6.5 percent.

Wastewater regulations require that an adequate conveyance system be provided in downstream sewers:

7:14A-23.6 - GRAVITY SEWER DESIGN

- (a) Proposed sewerage systems shall connect into downstream sewer lines and pump stations that have adequate conveyance capacity.
- (b) Gravity sanitary sewers, including outfalls, shall be designed to carry at least twice the estimated average projected flow when flowing half full. In the case of large interceptor sewer systems, consideration may be given to modified designs. In addition, sanitary sewer conveyance systems shall meet the following requirements.
- (c) New sewerage systems or extensions shall be designed as separate systems, in which all water from roofs, cellars, streets and other areas is excluded, except that separate connections to an existing combined system may be approved when it is demonstrated to the satisfaction of the Department that no other alternative is feasible. In addition, the Department may permit, on a case-by-case basis, the introduction of contaminated stormwater from containment areas into sanitary sewers.

The regulations also require that when making an application to construct a sewer line, the applicant must certify that the downstream conveyance system will be adequate:

B. CERTIFICATION BY OWNER OF WASTEWATER CONVEYANCE SYSTEM

I (we) hereby certify that to the best of my (our) knowledge, the wastewater conveyance system, into which the project proposed under this application will connect, has adequate capacity in accordance with N.J.A.C. 7:14A-1.9 ("Adequate Conveyance Capacity"). Furthermore, I (we) am (are) not aware of inadequate conveyance capacity conditions in any portion of the downstream facilities necessary to convey the wastewater from this project to the treatment plant.

Name of Municipality or Authority: _____

Signed: _____ Date: _____

While working for the NJDEP in the mid-1970s, the author developed an equation to calculate how much new flow could be accepted into a system that was limited by the size of a downstream pumping station that would have overflows. The theory of the equation is that it would be acceptable for flow to increase as long as the overall discharge or bypass at the pump station did not increase the pounds of biochemical oxygen demand (BOD) discharge. Knowing the initial conditions of the overflow, it is possible to vary I/I, which will change the allowable sewage flow.

$$B_o = \frac{I(B_I) + S(B_S)}{I + S}$$

$$O_F = (I + S) - P_F$$

$$L_B = O_F \times B_o$$

$$S = \frac{-(IB_S - P_F B_S - L_B) \pm \sqrt{(IB_S - P_F B_S - L_B)^2 - 4B_S(-LB_I)}}{2B_S}$$

where

I = I/I

S = sewage flow

B_I = BOD, of I/I

B_S = BOD, of sewage

P_F = peak capacity of pump station or downstream sewer

O , = overflow or bypass

L_B = loading factor of overflow

B_O = strength of overflow in milligrams per liter of BOD,

The Western Monmouth Utilities Authority acknowledges that sump pumps are the major source of inflow at its collection system. The facilities of the Western Monmouth Utilities Authority, which were constructed during the 1960s through the **1990s**, are generally of asbestos, cement, concrete, or polyvinyl chloride (PVC) pipe and in good condition.

Studies conducted during the 1970s as part of I/I requirements for federal grants determined that the Authority was not subject to excessive I/I; however, these were done at a time when the Authority's facilities were in their infancy and many of the gravity sewers and pump stations were not near their capacity. As development continued, it became apparent that the flows experienced each spring were the result of sump pump water discharge. Unfortunately, the Authority does not have the right to enter into and inspect private homes, a right reserved for the municipalities. Elected officials, however, do not want to upset voters by inspecting their homes for illegal connections, then directing them to spend \$500 to \$2,000 to have those illegal connections removed and directed to a suitable location.

It is time to obtain the assistance of the federal and state government in enacting laws and regulations that will require the removal of sump pumps to sanitary sewer systems. A typical 1/3-horsepower sump pump has a capacity of 40 gallons per minute at a discharge head of 10 feet, the equivalent of 144 homes at 400 gallons per home run continuously during the seasonal high water-table period. It can easily be seen that it only takes a few sump pumps to overload a collection system and/or pump station.

Possible management alternatives to prevent the overflow of sewer systems during wet weather conditions include trucking the sewage in tank trucks from a location without capacity to a location with capacity. This alternative, which the Western Monmouth Utilities Authority has used, is costly, and the public has objected to the noise of heavy trucks in residential areas 24 hours a day. Increasing pump station and force main capacity is another alternative; this too is often costly, and public expenditures remove the effect of the problem but not the problem itself.

Inspections of homes upon resale and requirements to remove the sump pump discharge before property may be transferred may be long-term solutions that may be politically viable. Many municipalities have programs ensuring current codes are met when residential properties are transferred; this at times requires the upgrade of electrical and plumbing facilities. Removal of sump pumps could be incorporated into such programs.

State and federal governments have long overlooked the problem of sump pumps. Local governments may need their help to ensure that the problem is acknowledged and solutions are found.

Hydraulic and Technical Realities of Flow Monitoring for Sanitary Sewer Overflows

Michael D. Kyser
Badger Meter, Inc., Tulsa, Oklahoma

Introduction

Development of a practical sanitary sewer overflow abatement program requires dependable field information. One of the more critical steps in obtaining that information is flow monitoring. The amount of time and money required suggests that a comprehensive review of the current technologies and practices is timely.

Collection systems are **traditionally** designed to operate in free-flow gravity condition. Because structural degradation occurs, the integrity of the pipeline is often bridged as the line ages. Intrusion of surface and ground water, infiltration, and inflow are common problems. These conditions severely limit the hydraulic capacity of the sewer line, resulting in bypasses and/or overflow conditions. These symptoms not only indicate the limited capacity of the system but also that gravity flow conditions may not exist during a critical period in which flow information is needed.

Currently, collection system studies are using several techniques and different technologies to predict flow rates, all of which calculate flow by measuring variables such as level and velocity. No device on the market today directly measures flow rate in sewer lines; all must rely on certain hydraulic principles to compute flow.

Properties of Open Channel Flows

Wastewater may be conveyed in different channel geometries, each of which can and will create different velocity distribution for analysis. Two important flow properties are uniqueness and uniformity. Both properties refer to the local velocity profile. If z is the longitudinal or axial coordinate and x and y are the cross-sectional coordinates, the longitudinal velocity profile is defined as $v(z)$ and the cross-sectional velocity profile is defined as $dv(x,y)$. Interest is centered on the magnitude of the derivative

$$\frac{dv}{dz}(x,y) \quad (\text{Eq. 1})$$

Asymmetrical and unstabilized distributions of velocity profiles can result from changes in pipe configuration, alignments, inflow from side pipes, silt buildup, broken pipes, or insufficient straight piping runs after such obstacles as drop manholes. Distributions of the velocity profile will vary as the depth of flow increases or decreases, making it impossible for a velocity profile to be characterized without in situ measurements.

Unique Flows

Uniqueness is a property associated with either the physical structure of the flow channel or with the history of a flow. Flow is unique if a singular value of depth, y_n , is related to the average velocity under all flow conditions. Free-flow measurements, using friction flow energy equations such as Manning's,

require that flow conditions exhibit this uniqueness property. If the solution to Equation 1 is zero, the bottom water and energy slopes are exactly parallel, and the flow is unique (1).

An example of a flow that is not unique occurs with stagnation or backwatering of a channel, no matter how minor. Conditions such as backwatering eliminate uniqueness because there is no longer a unique value of y_n related to flow rate. For example, if the slope of the sewer is 0.001 and backwatering reduces the average area velocity to 90 percent of free-flow conditions, the measurement is in error because the relation between depth and volume flow rate will be incorrectly evaluated with the traditional Manning approach. The energy gradient of the flow is modified as the square of the area velocity ratio (0.81) and the effective energy slope is (0.81 x 0.001) which means the effect extends upstream, on a diminishing basis, for about 1,200 meters. Only then does uniqueness return to the flow condition.

If the average area velocity ratio is reduced to 50 percent of the unique condition, the length of the disturbance can be over 4,000 meters.' For example, an accurately calibrated free-flow measurement system is then subject to significant error should silting appear and disappear downstream of a metering site. The message is clear: suspect $\bar{v} = f(h)$ friction flow techniques unless backwater conditions are absolutely eliminated.

Commonly employed are practices whereby a single, or even several, traverse calibrations are used to "enable" Manning's equation specific to the site. This "modified Manning" technique may or may not be valid; its success depends on the presence or absence of backwatering, which is very difficult to observe except when exceptionally great. Further, the longer-term stability of that presence or absence is questionable. In addition, if hydraulic boundary conditions (such as wall roughness) are not stable, then uniqueness and any measurements using simply $\bar{v} = f(h)$ are invalid.

The great difficulty associated with ensuring unique flow conditions is the direct reason that flow devices such as flumes and weirs were developed. Each device concentrates the flow conditions into a short, recognizable distance that allows determination, interpretation, and ready correction. Again, suspect $\bar{v} = f(h)$ measurements unless backwater conditions are absolutely eliminated.

Uniform Flows

Uniformity is a second property of open channel flows. In this condition, the velocity profile is consistent and predictable under all conditions, even though the depth of flow, y , may not equal the unique depth of flow, y_n . A sufficient criterion for uniformity is that the change in the velocity distribution with axial position is small compared with the cross velocities. This can be described according to Equation 1, for which the solution is small compared with the cross flows $v(x,y)$. Cross flow rates, $v(x,y)$, in uniform flows are generally about 2 to 4 percent of the longitudinal flow rate, $v(z)$, so the axial derivative must be generally less than 0.5 percent of the longitudinal velocity, $v(z)$, to ensure uniformity.

If the derivative of Equation 1 is small but non-zero, the bottom, water, and energy surfaces are only approximately parallel and the depth of flow is not unique, but the flow remains approximately uniform and can be measured using techniques involving velocity profile relations. With uniformity present, measurements using $v(x,y)$ can be achieved using laboratory or in situ calibrations, or through mathematical modeling of the velocity distribution.

An example of uniformity without uniqueness is a channel that is backwatered to an artificial depth by downstream conditions and whose flow characteristics at a measurement site still meet the criterion

'This figure is based on a field study that compared a flowmeter to a flume. Both devices were approximately 4,000 meters apart; therefore, controlled real-time measurements were made determining the actual filling and emptying of the conveyance system. The results indicated that the line has its own hydraulic capacity and, in fact, can function as a surge tank to dampen out flow variations.

described in Equation 1, the solution for which is small compared with the cross flows. This nonunique example is uniform and may be readily measured using velocity distribution techniques, even if the gauging station is located within the backwatered region.

Nonunique and Nonuniform Flows

A third flow regime exists that is neither unique nor uniform and may be successfully measured. An example would be flow into an equalization basin. In this case the changing level in the retention basin will modify the upstream velocity profile. Use of either free-flow equations $\bar{v} = f(h)$, calibrated or not, or equations employing velocity profile relations $\bar{v} = f(h)$, calibrated or not, are absolutely invalid because no calibration relationships can be established.

Calibration Conditions

If calibration at the site is practical and permissible by the flow regime (the unique or uniform case), flow conditions during the entire calibration period must be constant. Even small depth variability during the period of the field calibration can produce significant errors. Further, the reproducibility of traverse positions in field calibrations is much more difficult than, for example, laboratory positioning. A velocity traverse used to define the distribution therefore usually requires a prolonged period of steady flow, and such an event is relatively uncommon in most sewers. Accurate field calibration requires correct positioning of the traversing device, which may not be a straightforward task given true field conditions of high fluid levels and velocities coupled with the safety requirements of the confined entry regulations.

Summary of the Flow Regimes

Regime 1

Flow is unique: a single value of “y” exists for each and every unique flow rate. Measurement using depth only relations, $\bar{v} = f(v)$, is practical. Calibration at the site must account for hydraulic boundaries. Backwatering errors can be severe. Depth stability during a site traverse calibration is paramount to accuracy.

Regime 2

Flow is uniform:

$$\frac{dv}{dz}(x,y) < v(x,y)$$

must be present under all conditions. Measurement using velocity distribution relations, $\bar{v} = f(v)$, is practical. Calibration on site or derived in the laboratory or by mathematical models is valid. Depth stability during a site traverse calibration is paramount to accuracy.

Regime 3

Flow is neither unique nor uniform. Neither $\bar{v} = f(h)$ nor $\bar{v} = f(v)$ utilization is valid. Measurement only by a sufficient real-time averaging method is practical. Calibration is impossible under any conditions.

Review of Flow Measuring Techniques

A brief review of flow measurement techniques provides insight into the practice of each.

Friction Flow Energy Equations

Commonly employed because of their ease of use are friction flow energy equations. The most commonly employed method in the United States is Manning's equation, a descendant of the uniform friction flow equations that were first developed around 1768 by the French engineer Antoine **Chézy**. Manning's equation, which was developed to replace the unwieldy Kutter's mathematical method for the derivation for the **Chézy** "C," was readily accepted due to its greater simplicity and the fact that the coefficient of roughness, n , was substantially equal to Kutter's values.

Chézy equation

(circa 1768)

$$V = C\sqrt{RS}$$

Kutter equation

(1869)

$$c = \frac{41.65 + \frac{0.00281}{S} + \frac{1.811}{n}}{1 + \left(41.65 + \frac{0.00281}{S}\right) \frac{n}{\sqrt{R}}}$$

Manning equation

(1889)

$$V = \frac{1.49}{n} R^{2/3} S^{2/3}$$

where

V = fluid velocity

n = coefficient of roughness

C = **Chézy** coefficient (flow resistance factor)

R = hydraulic radius

S = slope of the hydraulic gradient

The basic premise of all friction flow equations is to equate an energy loss to a specific length of conduit. This energy loss due to frictional resistance is primarily a function of the Reynolds number and the relative roughness of the conduit. The fact that the friction flow energy equations are empirical rather than theoretical indicates that observed results were "fitted" into a series of factors (or coefficients), thus deviation will occur among sites. These coefficients vary with size, shape, roughness, and flow characteristics.

To properly apply the friction flow equations requires knowledge of the slope of the hydraulic gradients or the water surface elevation. In uniform flow conditions, the slope of the hydraulic gradient should be identical to the slope of the conveyance structure. In this condition, the depth of flow will adjust itself accordingly to produce a velocity directly related to the friction losses in the channel. In nonuniform flow, the slope of the conveyance structure and the hydraulic gradients are not parallel, and specific frictional losses must be accounted for or substantial computation errors will result.

Variables such as surface roughness, vegetation growth or "sliming," silting, scouring, suspended solids concentration, and bed load require a different approach. These effects can be seasonal, such as vegetation growth, or even diurnal, as with sanitary wastes. Additional factors such as discharge, depth

of flow, suspended solids, load silting, and scouring add to the complexity because they vary essentially “on demand,” such as during a storm event.

Depth of flow and discharge are two variables requiring further explanation. The coefficient of roughness, n , at times considered constant, actually varies with depth of flow. Field and laboratory results (2) clearly indicate that the coefficient of roughness, n , varies, reaching a maximum of 1.28 at roughly 0.2 to 0.3 of the effective pipe diameter. Therefore, on a given circular conduit and assuming a continual free-flow hydraulic flow regime, n can vary up to 28 percent as the fluid level changes from no flow to full pipe conditions.

According to the *Sewerage Rehabilitation Manual* (3), “WRC have recently reviewed information on effective hydraulic roughness of existing sewers in various conditions....” As sewers deteriorate physically, their effective roughness increases, causing their hydraulic capacity to decrease. This increases the likelihood of surcharge and accelerates further structural deterioration.

Even with this method, the technique still neglects the variation of the roughness coefficient for long-term hydraulic or fluid variables with respect to depth of flow, pipe deterioration, and slime buildup.

In summary, the use of a friction flow equation such as Manning’s should be approached with a realistic understanding of the uncertainties and their effects. For short-term flow measurements where on-site calibrations can be made, the technique has merit. The dependence on these equations for long-term or permanent use must include a program of routine calibrations. Only in this manner can the variability in the flow regimes be accounted for.

Continuity Equation-Velocity X Depth Measurements

Methods used to compute flow using the continuity equation require the determination of flow velocity and the area occupied by flow. This fundamental hydraulic property is valid for steady, incompressible flows and is independent of the Reynolds number, but does require that the flow be continuous and uniform. While the continuity equation negates the effects of backwatering, stagnation, and surcharging (conditions that render friction flow equations unusable), it is not valid for discontinuous or spatially varied flow. Importantly, the effects of surface roughness, sliming, depth of flow, and discharge are eliminated. The equation is expressed as follows:

$$\frac{d}{dt} \int V dA = Q$$

where

- Q** = discharge
- A** = cross-sectional area occupied by the flow
- V** = mean velocity (\bar{v})

Computation of flow using the continuity equation requires the independent measurement of fluid velocity and area (or simple fluid depth, if the geometry is predictable). From these variables, flow can be computed. While simple in concept, the application of the equation requires understanding. The measurement of fluid depth is relatively simple with several techniques and, depending on the application and equipment choice, straightforward. Ultrasonic level transducers and pressure transducers are normally employed for depth. Knowing the conduit geometry, the area occupied by flow can be calculated

by programming in a level versus area relationship. For conduits having sufficient integrity to withstand scouring or excessive siltation, this method of computing area is valid.

The complexity of the measurement of fluid velocity is largely overlooked or simplified, but, in fact, may result in substantial errors if a true average velocity measurement is not made. The continuity equation is valid only if the mean velocity can be determined. Commonly used methods to estimate the mean velocity are single-point velocity, chordal velocity, and multichord velocity (see Figure 1).

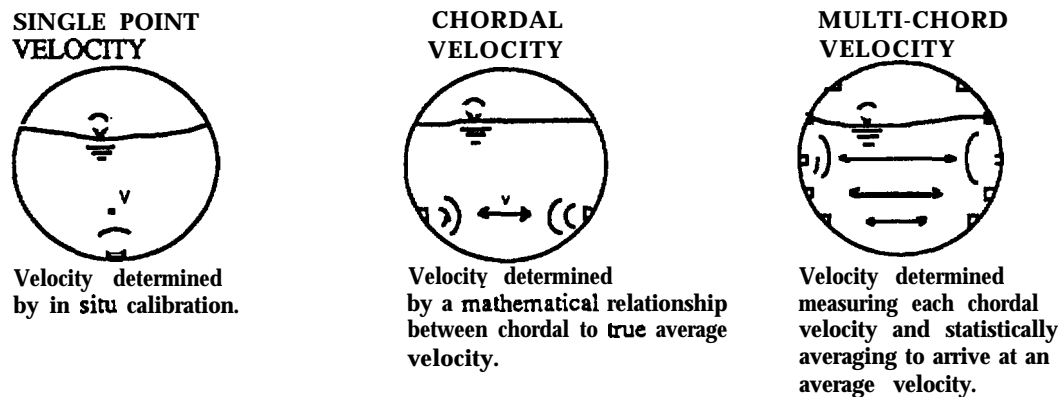

Figure 1. Single-point, chordal, and multichord velocities.

Single-Point Velocity

The term “single-point velocity” is meant to define technology that obtains velocity information at a very localized area within a specific flow regime. A magnetic flowmeter obtains its information on fluid velocity very near the sensor. Doppler meter technology normally looks at a specific regime in the flow profile or over the entire beam area to determine average velocity information, again, within a reasonably narrow beam of energy, all indicating single area or point velocity determination.

Both of these methods assume that average velocity is located roughly 40 percent below the surface level, assuming a well-developed profile distribution, and require either of the following quantification techniques:

- Determining the maximum velocity, measuring it continuously, and converting these readings to average velocity by multiplying by a scaling factor (normally 0.9).
- Obtaining a series of velocity readings from the installed device and comparing these to a portable velocity meter to determine a “calibrated” velocity relationship.

According to a paper by Debevoise and Fernandez entitled “Recent Observations and New Developments in the Calibration of Open Channel Waste Water Monitors” (4) on the ability for on-site calibration: “It is suggested that the technique (maximum velocity determination) has a larger degree of inherent human error....” This paper points out the difficulties in obtaining consistent, believable calibration values. From the velocity data points obtained during the field investigation of 36 meters, it was concluded that the maximum velocity values differed on the average by plus or minus 20 percent. The discussion implies that any technique employing an empirical method to estimate average velocity measurement and relying on Doppler methods to measure average velocity in an open channel is subject to uncertainty. Too many conditions exist to ensure reliable, long-term stability of the measurement without repeated in situ calibrations. Factors such as temperature and changes in fluid composition can

significantly affect Doppler readings, and, traditionally, they are not found in today's instrumentation. The article summarizes, "The single (point) velocity calibration techniques are unsatisfactory because the equation on which they are based provides a poor fit of the sewer profiles. Further, these techniques are error prone because they depend upon a single observation of a dynamic situation." The dynamics of a flowing sewer line greatly hamper the ability to perform a classic velocity traverse to ensure that a well-established and predictable velocity profile exists.

Continuous Wave Doppler

These methods are also a traceable technology. With continuous wave Doppler, an ultrasonic beam is projected into the fluid, and reflections of energy from the particles are received and measured. Assuming close to uniform distribution of particles that reflect ultrasonic energy in the sewer, good average velocity measurements (4 to 6 percent) are made over a range of about 450 to 600 millimeters in front of the sensor face. As this distance is exceeded, the acoustic energy received is significantly reduced due to scattering and absorption.

Reflection and refraction of acoustic energy off particles conveyed in sewage flow are a natural fact. These particles cannot be considered to travel in a simple, straight-line pattern from and to the transmitter; particles moving on both a horizontal and vertical plane scatter and absorb the energy. The information received by the Doppler must compensate for this, however, and many today rely on different techniques to determine velocity, but this is only a measurement of the velocity of the particles that may or may not travel parallel to the flow stream. Logically, as the distance increases from the transmitter to the Doppler-reflected source, those particles that are not conveyed parallel to the stream line of the flow will have a greater influence on the signal, resulting in erroneous information.

Magnetic Inductive Techniques

The bottom-mounted inverted magnetic sensor localizes the measured velocity in a small region close to the sensor itself; this is due to its limited power to reduce a magnetic field and the physical sensor shape. It can also be used in uniform flows with its own form of $\bar{v} = df(v)$ extrapolations.

This sensor must be directly calibrated. The extrapolation of the function is extended even further than in Doppler or transit-time devices and hence has an even further reduced degree of certainty in applications.

In summary, the shape of the sensor, solids deposition, and grease buildup all affect the velocity field, requiring in situ calibrations. For long-term use, periodic recalibration is strongly suggested to minimize the effects of these variables.

Chordal Velocity

Badger Meter is not the only company to employ chordal velocity techniques. To document performance, controlled testing was done under the auspices of the U.S. Environmental Protection Agency and the Milwaukee Sewage Commission in the early 1970s. This verified the theoretical and mathematical relationship that equated chordal to average velocity for an open channel. Not only was this report published, but since that time additional tests have been run in laboratories both domestically and worldwide to verify the principle.

The flow rate measured between sensors can account for both local wall effects and for distortions in the distribution of velocities located in the chordal beam. As long as transmission energy between the sensors is sufficient for operation, accurate measurement of chordal average velocity is assured. The relation between chordal average velocity and the area-average velocity is highly predictable, with

uniform flow profile conditions as discussed previously. This is due to a proven, predictable mathematical relationship of true average velocity, (\bar{V}), to a chordal velocity measurement at a defined level across the conduit (see Figure 2). Studies with various fluid levels and flow profiles in different channel geometries have shown that for the region from 25 to 100 percent of maximum channel depth, there is a predictable correlation between the chordal velocity (V_c) and average velocity (\bar{V}). This correlation permits prediction of true average velocity within plus or minus 1 to 3 percent using a single set of ultrasonic sensors (5).

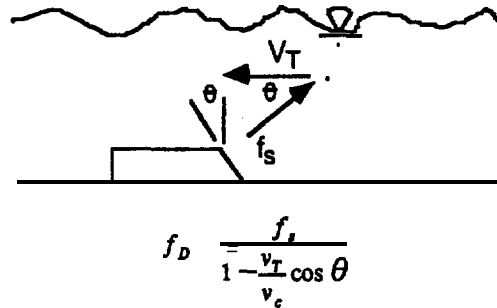

- where f_s = Transmitted frequency
- f_d = Received frequency
- V_T = Velocity of the target
- V_c = Sonic velocity
- θ = Angle of transmission

Figure 2. Theoretical basis for chordal velocity calculation.

Transit-time ultrasonic sensors are employed to determine the chordal velocity measurement. If poor hydraulic approach conditions exist, a sufficient number of parallel ultrasonic chords must be used that can be statistically averaged to ensure an average area velocity. The sufficient number of parallel ultrasonic chords, five averaged statistically, compensates for any in symmetrical velocity profile. Reduction in the number of chords to, say, three will require a sophisticated statistical approach to ensure the proper weighting of the chord components, compensated under varying fluid levels, for skewed profiling.

Whether single or multichordal, the requirement to transmit and receive ultrasonic energy over the entire path of the chord is absolute for performance. If solids loading is too heavy (some thickened sludges) or the signal is absorbed (aeration resonances), then performance is lost.

Transit-time methods provide very accurate measurements of chordal velocities and are very compatible with uniform flow concepts because the measurement basis for the relation $\bar{v} = f(v)$ is derived from relations over a long, horizontal path across the fluid. Further, transit time is capable of nonuniform flow measurement using multiple chordal measurements. Its inherent accuracy can often exceed the requirement for sewer flow measurement depending on the application, for example, custody transfer (where traceable accuracy is required) versus I/I survey work (where only trend analysis is required).

This method requires that the sensors be mounted off the channel floor, however, allowing a region of flow that cannot be computed by the continuity equation. Several techniques have been employed to overcome this limitation, including 1) relying on a flume or weir for the low flow, 2) reverting back to Manning's, or 3) installing a Doppler velocity sensor at the channel floor that can provide redundancy as well as low flow velocity estimates.

The employment of Manning's equation is unique in that the equipment has the ability to continuously compute a "fitted Manning electronically by comparing the flow rate computed by the continuity equation during its operation to the flow estimate predicted by Manning's equation and modifying accordingly:

$$K = Q_M/Q_{CE}$$

where

- Q_M = flow estimate predicted by Manning's equation.
- Q_{CE} = flow rate computed by the continuity equation during the "compound mode."
- K = correction factor applied by the instrument to the calculation of flow using Manning's equation.

Whichever method is selected, the single-path chordal systems virtually eliminate the effects of short or long-term variables that influence the uncertainty friction flow equation. In addition, because of the position of the velocity sensors, roughly 25 percent of full pipe diameter, the variable Manning n with depth is determined at its maximum value and by simple in situ calibrations at low and high flow conditions; this phenomenon can be compensated for accordingly.

"Multichord" flow metering has the potential to instantaneously measure multiple velocity chords in an attempt to statistically predict the true average velocity. This flow measurement method has the promise of eliminating dependence on the mathematical relationship of chordal to true average velocity and the requirement for well-established velocity profiles. To accurately predict the true average velocity, however, requires that a minimum of five independent chords be used for larger conduit sizes. Using multiple chords to determine the average fluid velocity is capable of giving the end user an accurate flow measurement during periods of nonuniformity because the average area velocity can be estimated. In a normal sewer system with greatly varied flows (hence, fluid levels), this system must operate on fewer than the optimum number of chords, requiring a complex "staging" or sequencing arrangement. Thus, a multichord system designed for traditional sewer flow must depend on in situ calibrations to ensure that operation during **nonideal** conditions can be predicted.

Practical Summary

Open channel flow measurement can trace its historical development from the **Chézy** friction flow energy relationships to Manning's equation and, finally, to the continuity equation. Friction flow and the continuity equation have sound hydraulic principles to support their use, but both require understanding to ensure proper application. For short-term flow monitoring studies where trend analysis is of primary concern and frequent access to the site allows for recalibration, friction flow energy equations or single-point velocity systems using the continuity equation have practicality. For long-term flow monitoring applications in which continual calibration is not practical, however, an alternate approach is suggested. Transit-time chordal velocity systems employing continuity principles provide a viable method of producing predictable flow measurements.

References

1. Kyser, M.D. 1993. Manning's equation revisited. Presentation at the Collection **Systems—** Operations/Maintenance Specialty Conference, Tucson, AZ. June 27-30.
2. Maynes, J.S. 1974. Flow data collection for infiltration-inflow analysis. *JWPCF* **28(8):2055-2061**.

3. Water Research Centre. 1990. Sewerage rehabilitation manual, 2nd ed. Wiltshire, Swindon, England.
4. Debevoise, T., and R.B. Fernandez. 1984. Recent observations and new development in the calibration of open channel waste water monitors. *JWPCF* 56(11).
5. U.S. EPA. 1976. Wastewater flow measurement in sewers using ultrasound. *EPA/600/2-76/243*. Cincinnati, OH.

An Assessment of State-of-the-Art Flow Measurement Techniques for Sanitary Sewers and Overflows

Thomas J. Day
City of Philadelphia Water Department, Pennsylvania

Introduction

There reaches a point when the activity within a sewer system needs to be known to its operators, whether they are a private contractor or a municipality. Assumptions and sporadic observations can no longer be used to determine operating conditions within the system, even for short-term events. Instrumentation that performs continuous monitoring of internal flow conditions is needed so sewer system operations personnel can make intelligent determinations about sewer system causes and responses. Having the ability to prevent sanitary sewer overflows (SSOs) is one of the many benefits of continuous monitoring. Without accurate information, the sewer system operators will not be able to make these informed determinations. Therefore, accurately and cost-effectively measuring flows and overflows becomes critical, not only for regulatory compliance but also for the protection of the general public. All of the laws and mandates are well meaning and intended to protect the health and property of the general public and to preserve resources for future generations.

The author has been employed for approximately 7 years by the City of Philadelphia Water Department performing temporary and permanent monitoring of the sewage flows within the 3,100 miles of sewers underlying the city. The city used various techniques to overcome the numerous and seemingly insurmountable obstacles in getting accurate data for the various water department units, consulting engineering firms, and suburban customers who feed into the system. When expanding programs and budgets within the department were approved, various manufacturers held demonstrations of electronic monitoring systems, proving their product line under the sewer system's unforgiving conditions and hazards for eventual purchase. These demonstrations were conducted during the 1993 to 1994 sewer system monitoring evaluation, the 1988 to 1995 independent equipment demonstrations, and the 1988 to 1995 equipment purchases through usual purchasing channels.

The discussion contained herein describes the equipment used in level, velocity, and flow measurement, data acquisition technology, and systems development. The equipment evaluation, based on many years of actual experiences, demonstrations, and practical applications, is intended to provide a baseline for sewer system operators to begin planning their own monitoring networks, including the provision for alarms and operations monitoring for SSOs.

It is important first to identify the various components of measurement. Level measurement equipment reads of the height of wastewater within the conveyance conduit. Level measurements are considered static, since it is not possible to determine the motion of the water. Flow measurement technology deals with the quantity of flow being calculated from the components of a cross-sectional area and provides some reference or average velocity. This technology can determine motions within the liquid. Data acquisition technology highlights the advances and applications of electronic devices to read, store, and, as required, provide power for sensing equipment. Systems development technology discusses meshing these other three areas into a cohesive, functioning unit so the necessary information concerning the conditions (level, velocity, and/or flow) within the sanitary system may be obtained.

Level Measurement Equipment

Many types of devices and technologies can determine a level in a conveyance conduit. The three discussed here are pressure transducers, ultrasonic, and bubbler devices. All have particular placement

and all have preferred applications over other devices. The three devices record only the water column and, in their pure form, will not detect motion of the liquid.

Of the three devices discussed, pressure transducers are the least expensive and easiest to install, integrate, and maintain, but probably the most susceptible to damage. They are intrusive in the sewage as they detect a pressure of liquid above them (using 2.768 in/psi as a conversion factor). Most of these devices use some electromagnetic coil or resistance device that is sensitive to pounds of pressure in the water column directly above it. A variety of devices in this category use a vibrating wire to determine pressure, and these devices appear to be stronger than their electromagnetic cousins. The vibrating-wire devices are also more costly and require special interfacing to data acquisition devices, which prices them above their counterparts. These devices are suited for either long- or short-term installations, depending on sensor quality and guarantee.

Pressure transducers are generally installed in “stilling wells” in or near an available manhole. A stilling well is a cavity that attempts to remove the force of motion of the conveyance liquid. The well also protects the measuring element from solids traveling with the flow. They are generally constructed from durable polyvinyl chloride (PVC) piping; however, any tube that can hold the sensor can qualify (e.g., black iron, galvanized steel). Temperature compensation is generally not a problem, but most devices allow for this in their construction. In addition, their relatively low cost can permit a reasonable stock of replacement devices to be used as required. With their relative ease of installation and maintenance, they can be moved throughout the system where necessary, especially if an SSO has been reported or suspected.

Ultrasonic level devices generate a pulse of sound toward the liquid surface, listen for its return, and calculate depth from the free air space above the liquid based on the time of signal flight. Therefore, actual depth of liquid (l) is determined from the free space (fs) in the conduit plus/minus the offset (of) of the sensor head minus the diameter (d) of the pipe ($l = d + fs \pm of$). This particular device is nonintrusive to the wastewater.

Ultrasonic sensors are adversely affected by temperature, which makes them unstable without proper compensation. Most devices have temperature-compensating crystals that will correct the ultrasonic travel time equation for variances in ambient temperature. Another method is a reference distance, which has been extremely successful in making this compensation. The reference distance refers to a known, fixed distance for which a generated sound pulse will be reflected. The device “knows” to “listen” for a particular pulse related to a specific fixed distance and makes necessary adjustments to the actual level measurement to determine a correct reading. The fixed distance approach has the major advantage of no crystal to wear out or corrode. The major advantage of the crystal compensator is that it requires only a very small offset distance in the sensor head, allowing for a greater reading span.

Each level device has its respective place in an installation. Ultrasonic devices are much more expensive than the pressure transducer and are susceptible to signal dispersion due to foam and acoustic particulars of the installation. They appear, however, to have a much longer life expectancy and require less maintenance than pressure devices. Also, being nonintrusive devices, they generally do not require stilling wells in the installation.

Bubbler systems are the oldest of the technologies and the most costly. Recent advances in electronics, however, have brought prices down remarkably in the last several years. They are “workhorses,” applicable in heavy silting and foaming areas within the sewer system where other technologies fail. Bubblers are based on pressure from water being measured against the differential of air. When an air bubble is blown down through a tube, the pressure it takes to push the bubble is directly proportional to the pressure in the water column above it. A differential pressure cell determines this pressure difference (usually in pounds), and a conversion is made to depth of water (using the value of 2.768 in/psi).

Bubbler technology has lost popularity due to the availability of less expensive technologies but is still the method of choice for difficult or irregular applications. Most modern bubbler devices today are self-

contained, provide standard signal outputs, and use plastic tubing, which easily installs within a conduit. They are not usually susceptible to temperature (other than the electronics package) and have a proven track record of reliability.

A stilling well is recommended for the installation of any level device that is intrusive to the flow. As described in the previous section, a stilling well protects the device from the force of fluid motion along with solids traveling in the liquid. The well is generally located in a manhole, generally at a point of sanitary discharges. Therefore, periodic maintenance is required to keep the stilling well free of solids, to verify calibration of the sensing element, and to ensure that no grit builds up at the base of the **measuring** point. The stilling well or measuring point of a level device should be in the most tranquil area available. Drilling holes in the well allows fluid to enter and drain from it so the level will equalize with true level faster. The holes should be situated away from the actual direction of the flow so that smaller solids will be restricted from entering.

Ultrasonic devices are not intrusive to the flow, and therefore usually do not require stilling wells. They do generally require a fairly uniform water surface, free of turbulence and foam, for optimal readings. If the ultrasonic head has integral temperature compensation and is of a low profile, it can be mounted within the highest point of the conveyance pipe or up in a manhole if surcharging or **SSOs** are suspected. Ultrasonic heads have a **deadband** (an area where depth readings are not reliable) from the crystal surface to a known fixed point in the measurement range. Each manufacturer is aware of its specific **deadband** and prints it in the product literature; therefore, keeping the face of the sensor well above the highest known point of the fluid flow is important to minimize the effect of the deadband.

Bubbler tubes can be mounted in stilling wells for protection or installed with traditional stainless steel tubing for protection. The pressure of the forced air plus the optional purging functions are fairly reliable in keeping the pressure end free of debris. Usually, the bubble tube is slightly offset from the floor in order to provide air-purging space.

Flow; Measurement Technology

Flow measurement involves determining a cross-sectional area (A) with a reference velocity (V) using the volumetric flow equation $Q = VA$. Four areas of flow measurement are discussed in this section. Three of the four are generally commercially available as off-the-shelf products. The fourth is an overview of innovative and experimental devices.

Point reference velocity measures velocity at a known point in a profile, works that known point into an assumed distribution of velocities within a cross section, determines a velocity average, and calculates a flow based on $Q = VA$. This technique works best on circular or rectangular pipes that are free of debris and have tranquil flows within them. The point velocity is generally determined through a small **electromagnetic** field generated just above the sensor head. Level is found by using a pressure transducer. Software setup includes pipe profiles so the position of the sensor and pipe shape become relative to each other. The flow calculating algorithm can then determine which point in the distribution is actual and derive the rest through algorithms developed by the manufacturer. These devices are highly susceptible to fouling and require a manufacturer's calibration. No accommodation is made for backflow or backwash due to a block unless the perturbing of the flow profile propagates down to the sensor head. For many years, these devices were the best on the market for portable flow measurement applications. Advances in other technologies have made point velocity devices less popular in recent years.

Area velocity devices have gained popularity with recent advances in electronics and stabilization of laws for portable flow measuring devices; the term "area velocity" comes from the continuity formula, $Q = VA$. These devices are based on Doppler-phase shifting of sound usually referred to as "peak Doppler," and they rely on fast fourier transformation (FFT) to determine the velocity value. Channel shape is programmed at setup, with the usual conduit shapes being either circular and rectangular. These Doppler devices rely on the velocity contribution of the entire sound pulse path, rather than one point.

Therefore, they appear to be more representative of the actual flow profile. The boundary condition for this application is the water surface. A frequency spectrum of the echo shifts is generated and resolved with the FFT. The resultant value is converted into velocity and calculated into the cross section. These devices appeared to be less susceptible to fouling than the point velocity technology. One manufacturer's device still produced reliable readings under an inch of grit. Doppler devices are incorporated into both temporary and permanent meters, with pressure, ultrasonic, and bubbler devices used for level readings. In most cases, their more affordable price makes area velocity devices more attractive than point velocity devices.

Transit-time or time-of-flight technology is one of the most exciting and reliable technologies. These devices were extensively tested in Philadelphia and were exclusively specified for flow measurement when the \$6.5 million instrumentation contract was released for bid. Two major U.S. manufacturers produce this technology for open-channel sewage flow measurement. In Doppler devices, the boundary condition is the surface of the water, which is variable due to changes in sewer level; this tends to inject an error based on the variable. The transit time devices use a fixed boundary, comprising the side walls of the sewer and another sensor head; this eliminates any error introduced to the changing head within the conduit.

In theory, a sound pulse of known frequency is angularly transversed through a flow of liquid, the time of travel recorded, and another pulse returned to the origin. The time it takes for the pulses to make the journey is called transit time, a direct reading of the velocity values for the entire travel path of the sound pulse as every incremental value affected throughout the duration of travel of the signal. Since the boundary condition is fixed, the error is at a minimum. The two manufacturers have distinct installation and flow calculation algorithms. One uses 30 percent of known depth for acoustic coupler placement (known as cordal velocity), while the other provides multiple signal paths based on pipe diameter (known as multipath).

In very small pipes (24 inches and below), little difference appears in the two philosophies under ideal conditions. Much above that, the multipath approach has definite and tangible advantages over the cordal approach. Multipath technology is the only approach that appears to accurately account for skewed, turbulent, or variable flow patterns and backwashes within larger conduits. It also appears to provide a better representation of the average velocity by representing a greater cross section of the flow than the cordal-designed device. Level is determined by any available level device. Conduit shape is programmed into the setup program. Based on the Philadelphia tests, the multipath device appears to have a greater ability to account for irregularly shaped, worn, or grit-laden channels than the cordal velocity equipment. Both devices will record reverse flow. Sensor fouling did not appear to be a problem, as both tested devices performed well under very heavy, dirty flows. If accuracy is a major concern, then transit time technology appears to be the preferred method of flow measurement.

Installation of these devices tends to be difficult, as the sensor elements must be level to each other in the conduit. Usually a laser alignment device performs this task. After their initial installation, no other significant maintenance or calibration appears to be required for proper operation. The sensor elements should be visually verified and the signal strength checked as part of an annual preventive maintenance program.

Specialized and experimental devices are noteworthy here as technology to watch. A differential pressure point velocity device was built and tested especially for the Philadelphia system demonstration by a local Philadelphia engineering firm. It involves reversing two pressure transducers and determining a point velocity from a reference differential pressure. Although removed from the qualification, it definitely worked as a velocity device. With a cost around \$1,500, it may prove to be a viable technology for specific applications if further developed. Open channel or partially filled magnetic flowmeters have become available in the United States after limited marketing in Europe. They are limited to installations as part of a pipe section and cannot be retrofitted after conduit installation. They are, however, extremely accurate. Variations in transit-time technology are reducing the aggregate cost of the technology, which will make it more applicable and affordable in the immediate future. Finally, laser Doppler is a very

accurate but very cost-prohibitive technology. As the electronics become less expensive, this technology may also become more readily available.

Data Acquisition Technology

Over the last 10 years, the electronics area has experienced great competition. This competition has generated advances in technologies that were not predicted to be developed for at least another 10 years. Data acquisition products for sewer monitoring systems are relatively inexpensive, easy to maintain, and very configurable and adaptable. Many of the devices tested in the Philadelphia evaluations reflected these advances.

Part of the reasoning for the Philadelphia test was massive advances in electronics. Product lines were changing faster than technical people could keep up with them, even if trend monitoring was a full-time endeavor. Just the advances in personal computer (PC) technology alone allow entire systems to be built with off-the-shelf components similar to those found in a standard desktop computer. This section describes these more current technologies and their applications.

Dataloggers are a low-end data storage device that have improved greatly with advances in electronics and dropped significantly in price as a result. Many, complete with batteries, cost as little as \$500. Some have competed by increasing their performance guarantees for as long as 5 years. The average datalogger runs about \$1,500 with battery pack. It provides basic data storage and instrument interfacing functions and has minimal configuration and control abilities. Programming the devices is usually limited to canned programming languages, which can provide certain advantages over standard compilers, however, such as the learning curve to understand the calls. A technician can readily understand the command set and can write structure to easily generate results.

Dataloggers have specific advantages. They have the lowest power consumption, which makes them ideal for temporary installations. Generally, they are compact and can be mounted readily in very small or compromised enclosures. Dataloggers usually offer little to no security functions for data retrieval or programming, however, making them very susceptible to accidents as well as sabotage. A datalogger is a very good low-end unit and applicable to temporary or selected permanent applications.

The remote terminal unit (RTU) or the programmable logic controller (PLC) should be considered first for any permanent or select temporary applications. There were at one time significant distinctions between the two device types, but the many advances in electronics makes these distinctions fairly small. The naming convention is best left to the manufacturer of the specific product. The best way to differentiate the two devices is to understand that an RTU is more of a data acquisition device whereas a PLC is more like a local control device, without any hard or fixed boundaries in terms. Their pricing has dropped significantly in the last 5 years, now being between one-fifth to one-tenth of their 1990 price. Currently, they approach the price of a standard datalogger while at the same time providing full functions and capabilities. Most are modular, which allows them to be readily adapted and configured. The attractive pricing makes them an even more suitable alternative to dataloggers for long-term or permanent applications.

The potential for control at the overflow point already exists in the architecture of most RTU/PLC families: it simply involves adding the control device to the RTU/PLC and writing the code. A variety of security options are available depending on the manufacturer and the particular specifications of the devices. Alarm conditions are easily handled with the flexible coding techniques, which allow for many "what if," "case," or "else" statements for filters, again depending on the particulars of the product. Data storage tends to be greater for the RTU family than for the PLC. Data storage specifications, however, are particular both to the customer and the specific field points being monitored. With both their competitive pricing and aggressive abilities, the RTU/PLC family of devices should always be considered first in long-term or large-scale installations.

Selecting the data storage device is difficult because there are many varieties of excellent products from which to choose. Before purchasing any of these devices, the interested party should examine the company (specifically the manufacturer if dealing through a local representative) and first determine whether smooth integration exists throughout their entire product line. Support levels from both the factory and representative should be assessed and literature reviewed for completeness and clarity. The purchaser should also determine what software is needed to interrogate the devices and their relative costs.

Systems Development Technology

The hardware and software mix at the user end of the system can either make or break any given system. With open-system architectures, most of the specific boundaries appear to be falling, but enough still exist today to make the selection of the products difficult. Many excellent products are on the market, and it would be difficult to examine all of them. The following are some guidelines for the selection process:

- Let the hardware match the software. Too often mainframe products are simply recompiled for the PC environment, a kind of transfer that generally does not work well. The hardware and software must optimally match. Avoid recompiled or modified mainframe-PC or PC-mainframe programs. Get the provider to guarantee a full compatibility among the products, from the **datalogger/RTU/PLC** to the end peripheral.
- Use PC-based devices *whenever possible*. They are the easiest to maintain and support, cost the least, and have the largest support base. The technology is currently more readily accepted than the mainframe and is in the area of the greatest computer research.
- *Avoid Apple/Macintosh computer products*. These devices were designed for home use or for students. They have a track record of performing poorly in industry, but not because of low quality; they are actually well-designed and well-constructed machines. Commercially applying an Apple/Mac is simply a misapplication of this technology. Also, very few (if any) software products and hardware additions support the Apple architecture. This limits your choices in a particularly wide field of product offerings. Although regrettable, it is simply a fact. Even their latest attempts to become compatible with the IBM-compatible PC world are either too new to judge or have not generated enough of a support base. It is therefore safer to avoid these products than to attempt their modification for system integration.
- *Avoid writing your own code*. The products on the market possess full function libraries. See what is available in the software library before writing your own code. Remember that "off-the-shelf" software is fairly well debugged, and custom coding requires expensive debugging.
- Observe some *successful* systems. If you see a successful system, hear about its problems, and check its results, you will better understand your own wants and needs. Check references and ask to see systems in operation.

Alarm Generation and Reporting

Alarm generation and reporting of overflows are critical elements in the ultimate success of the monitoring system. Alarms can be generated from either the site or the central computer system and are strictly a function of the size of the total network monitoring system. Two major conditions are recommended with two levels of alarms: "if rain" and "if no rain." The two-alarm conditions are "alert"

(when overflow is imminent) and “alarm” (when an overflow is occurring). Alert and alarm setpoints will vary per location and for the rain/no rain situation. Printed records of either time/duration of discharges, quantity of discharge, or all of these parameters must be obtained. If you are investing considerable funds in the system, these functions should be automatic and probably a function of the process software. Equally important are two other areas: first is the commitment of resources to correct problems as they are found, including long-term correction expenditures; emergency protocols should be established for response to and correction of emergency conditions. Second is a feedback mechanism where the results can be entered into the database for time of repairs and expenditures to correct the problems. The alarm reporting of a monitoring system will provide the user with the indirect return on investment necessary to justify the cost of the system itself.

Turn key Systems

There are not many sources from which turnkey sanitary sewer monitoring systems are commercially available. The Philadelphia Demonstration Project appears to show only one company that offers the entire package delivered to your facility, including installation and support. Therefore, most turnkey systems need to be built through some specification developed by the purchaser. The system integrators receive extra emphasis to make all parts of the project work. Most system integrators are process control people who are unfamiliar with sewer environments. These individuals operate best in factories and in limited spaces, not over square miles and in a variety of climates. Therefore, consulting engineers acting as system integrators appear to be the best choice for guiding the process control people in constructing the desired system.

As regulations for **SSOs** begin to be administered, the need for full monitoring and control of area sewer system becomes essential. Remember that the ability to respond to a sanitary sewer overflow is one of the best ways to show regulators that you are serious about preventing these undesirable occurrences. On the large scale, it is better to have the system provided at a cost than to attempt integration yourself, unless your staff is extremely knowledgeable and has a lot of time on their hands.

Summary

A sewer monitoring and overflow alarm system will provide operators with a tremendous indirect return on investment (see the author's additional paper, this volume). The system is only as strong as the specified products, the system integrator, and the commitment of long-term resources by the sewer system operators, however. This discussion presented an overview of the products commercially available and tips on installation and maintenance. Knowledge of these techniques will provide baseline information in the development of monitoring and reporting networks. The prevention of sanitary sewer overflows starts with locating them, determining their severity, and implementing actions to correct them.

The Costs of Eliminating Sanitary Sewer Overflows Using Defect Flow Analysis

S.M. "Noah" Walker
KG&A Environmental Consultants, Solana Beach, California

This paper conveys the methods and techniques used to prepare an improvements program to overcome existing system deficiencies and eliminate sanitary sewer overflows (**SSOs**). The tools used to prepare the plan included flow monitoring and dynamic modeling of the collection system. By analyzing the flow data for wet and dry days, it was possible to calculate the normal wastewater production, base inflow and infiltration, and wet weather flows created by system defects. A computer model was created to predict the performance of the system under various flow scenarios; this included current and predicted flows for wet and dry weather conditions. The model was used to investigate the impact of a comprehensive augmentation and rehabilitation program addressing system defect flows in addition to the traditional assessment of population based flows. Based on these analyses, recommendations were made to consider 10 major capital improvements, which would eliminate 47 known overflows. This paper will focus on the tools and techniques that were used which are applicable to assessing the costs associated with the removal of **SSOs**.

Background

Brisbane, Queensland, Australia, is a city of approximately 1 million people located in the northeastern corner of the Australian continent. The capital city of the state of Queensland, Brisbane has been growing at a faster rate than the remainder of the country. This long-term trend is similar to the US Sunbelt. Continued growth has created problems in the orderly expansion of the sanitary sewer collection system. At one time, Brisbane was known as the "Privy Capital" because it had the highest ratio of outhouses per capita. In the 1960s, only 38 percent of the city's population was connected to the sewer system. To address this problem an aggressive public works program was instituted to build sanitary sewer collection systems.

The Norman Creek Basin, subject of this paper, was the second major basin scheduled for installation of an interceptor system. While the original work began in 1917, the system was sporadically constructed until it was substantially complete in the 1970s. This area has suffered from overflow and capacity problems from the outset. An aggressive campaign was undertaken in the 1930s to identify roof leaders connected to the sanitary system. In the years that followed, a more expedient approach to dealing with backups in the sewer was undertaken. In 1951 and 1952, a public works program was launched to alleviate surcharging. That year several **SSOs** that discharged to the storm sewers were constructed. This practice has continued to the 1980s. These overflows were constructed in such a manner as to preclude the surcharging of the system and to prevent sewage from backing up into private residences. To address these problems, the city contracted for a master plan for the Norman Creek system.

The study area comprises approximately 2,000 hectares or roughly 5,000 acres and is serviced by approximately 74,000 meters or approximately 240,000 feet of collection system. The 1994 equivalent population was estimated at 65,536 capita with a predicted ultimate population of 83,439 capita.

This master plan was performed to recommend programs for both augmentation and rehabilitation of the system providing adequate capacity for the anticipated population growth and eliminating sanitary sewer overflows. Temporary flow monitoring and computer modeling of the system were performed to assess the capital requirements for augmentation and relief of **SSOs**. The following section discusses the approach used to assess the capital requirements.

Tools and Techniques

What is different in this approach to collection system master planning? In traditional master planning efforts, computer models are routinely used to analyze overall operation of the system and assess its hydraulic sensitivity to flow increases from population increases. Consideration of defect-generated flows (inflow and infiltration) is most often handled by some form of uniform distribution. This distribution may be based on drainage area or actual system measurements, such as inch-diameter-miles (IDMs) or total length of the system. Traditionally, flow monitoring for calibration of the model was based only on wastewater treatment plant records. As the use of flow monitors for calibration of collection system models increases, different techniques of defect-flow distribution are employed. By relying on the extensive use of flow monitor data and careful analysis of flow characteristics, defect flows can be quantified and considered on a more specific basis. The difference is, in addition to the traditional demographically generated flows, defect flows are considered on a metered-basin basis. This allows the consideration of not only pipe replacement for the removal of hydraulic limitations but also the sensitivity of the system to rehabilitation. Stated differently, the question becomes, "Can rehabilitation of the system delay or eliminate the need for extensive capital improvements?"

Another important difference is that the elimination of known **SSOs** was one of Brisbane's primary goals. This is especially important because no official mandate or enforcement agency prohibits the incorporation of **SSOs** into the system. In a large number of systems in the United States, **SSOs** are not officially acknowledged and are not considered in the modeling effort. Consequently, the Brisbane City Council is pursuing options to minimize public health risks without federal encouragement.

The following sections describe the overall techniques used in the system analysis. The primary tool used was the **HydraGraphics** sewer modeling program distributed by Pizer, Inc., of Seattle, Washington. A detailed discussion of this model is beyond the scope of this report.

Current System Flows

Dry Weather Components

The **HydraGraphics** model requires that each type of flow be defined by diurnal shape and daily volume. In the Norman Creek Basin, flows from predominately residential areas were diurnally "classical." The derived composite residential, nonresidential, and hospital curves are shown in Figure 1. By considering the diurnal variation of flows in the system, flow was divided into three major categories: wastewater production (WWP), base inflow and infiltration (**BII**), and rainfall-induced inflow and infiltration (RFIII). By evaluating the minimum flows that occur during the dry days of the monitoring period, a base inflow and infiltration quantity was determined for each basin. By subtracting this amount from the daily net average of each basin, the WWP for each basin was calculated.

Wet Weather Components or Defect-Generated Flows

The flow increases as a result of rain events are due to defects in the system that allow additional flows to enter the system. These are broadly termed defect-generated flows or defect flows. By subtracting the components of dry weather flows from rain-influenced flows, both the shape and volume of RFIII can be calculated. RFIII is the additional flow volume and shape that arises from rainfall-sensitive defects. Defect flows for a particular basin were calculated by assessing the volume and shape of the RFIII flows and the associated rainfall event.

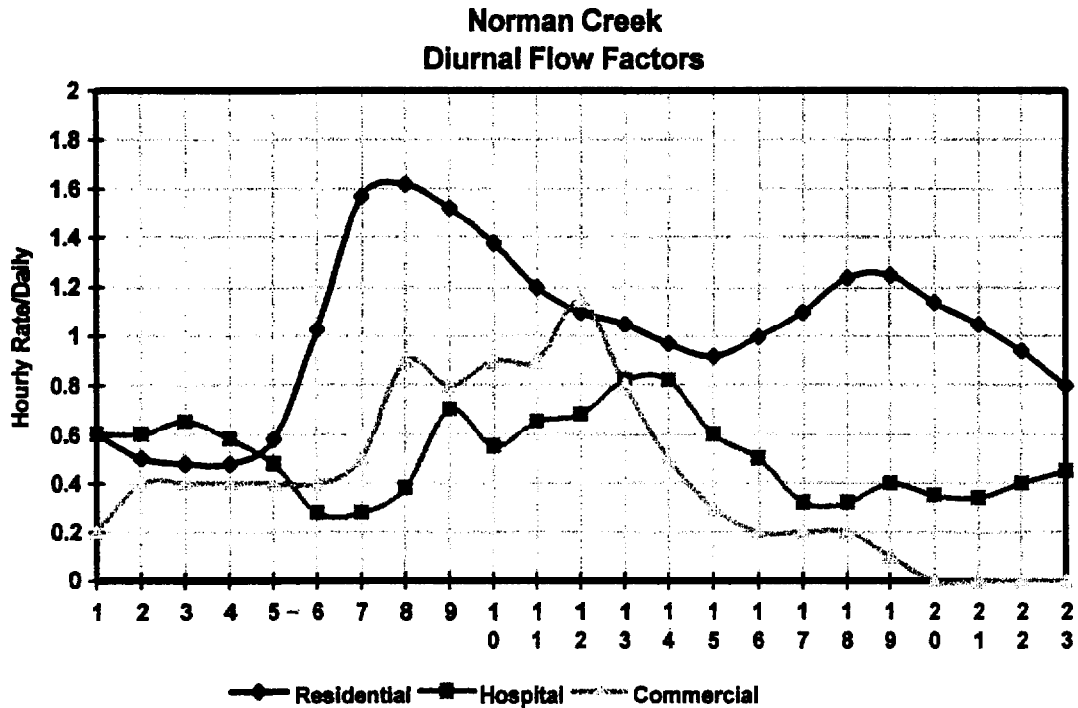

Figure 1. Diurnal curves derived from flow monitoring data.

Each basin's equivalent population (EP) was calculated by using each parcel's fire levy code and its area. For each parcel, a fire levy is assessed which is indicative of the type of structure and its current use. By considering the area of each parcel and the EP for the parcel's fire levy code, a theoretical population for all land use types could be calculated. By comparing the measured dry weather flows less BII with the population, it was found that on average the wastewater production rate was 285 liters per day per capita. Of general interest is that the city uses 300 liters per day per capita for planning purposes. The average dry day flow was calculated to be about 70 percent WWP and 30 percent BII (see Figure 2).

This allows a "first-cut" parameter for defect-generated flows that reflects current system operations better than defect flows that are uniformly distributed over the entire study area. More detailed physical inspection of the system, which would include smoke testing, dye flooding, and televised inspection of the system, allows even further definition of defects and the flows arising from those defects. To facilitate this, the HydraGraphics model provides for links to the defect inventory database. In this way, each defect is considered individually, which may have a greater impact on system hydraulics. The input screen for the Defects-Flow Generator is shown in Figure 3.

Predicted System Flows

Dry Weather Components

In the assessment of current flow conditions for the model, each parcel and its calculated equivalent population were considered using a technique called Point in Polygon, which is provided as a part of the HydraGraphics product. For the predicted increases in population, flows were derived from the city's GIS system called BIMAP. Node service areas were created for each manhole in the system. These service areas were then intersected with zoning areas, and an equivalent population and resulting flows were

Average Dry Weather Components

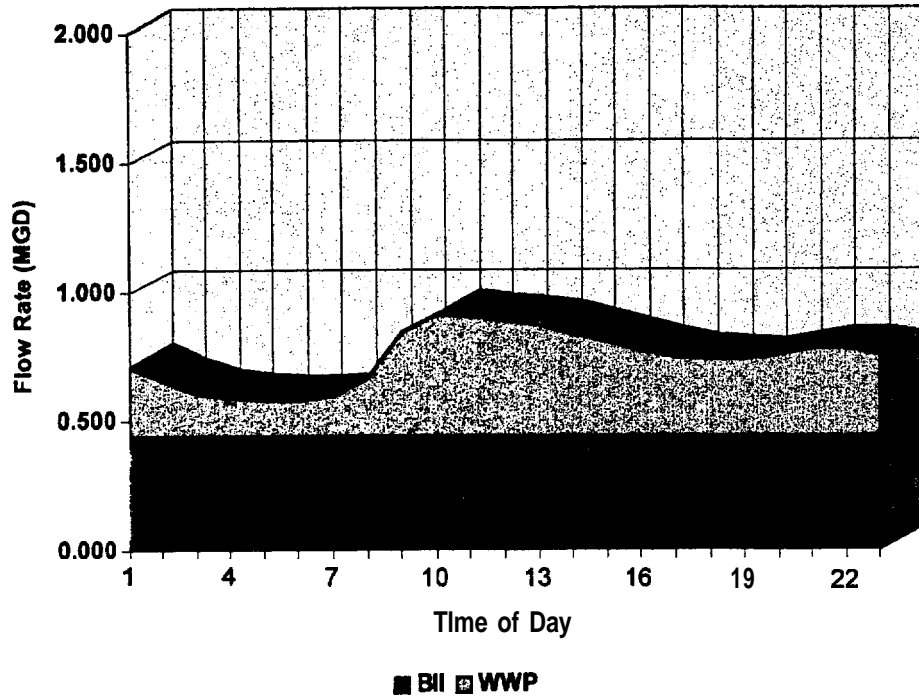

Figure 2. Average dry weather components.

ADS PIPE 2.0 - Defects FLO File Generator ver 1.2

NULL	True	0	0	0	0
01	False	352350	0	0	0
02	False	355050	0	0	0
03	False	612000	0	0	0
04	False	813600	0	0	0
05	False	600750	0	0	0
07	False	193050	0	0	0

Inflow

Step (min) Delay (min)

Hydrograph

```

0 10 32 103 138 140 140 146 150 145
137 135 137 132 122 113 96 87 81 70 69
70 72 72
                    
```

Interflow

Step (min) Delay (min)

Hydrograph

Repair

Priority 0 defects repaired
0 Gal Removed
\$0

Flow File Name

Figure 3. HydraGraphics defects-flow generator.

calculated and injected into the model. This technique is called a Polygon/Polygon intersect and is also available in the **HydraGraphics** model to facilitate flow generation. The WWP flows that were calculated were based on the use of 300 liters per capita per day. Due to the nature of the system and the difficulty inherent in the reduction of **BII** flows, no reduction was considered for the model. While it was estimated that as much as 18 to 20 percent of the base inflow and infiltration could be removed, this was unlikely. Further, a conservative approach would consider no removal of **BII** as an appropriate worst-case scenario.

Wet Weather Components or Defect-Generated Flows

For the consideration of a design storm event, it was assumed that the average percentage of total rain volume that entered the subbasins would remain constant. The design volume was the percentage of the design storm that entered a specific basin. The diurnal shape that was used for the design event was the one with the largest diurnal deviations created by the most intense rain during the monitoring period. This technique was used because of the lack of long-term flow monitoring records. If rainfall and flow monitoring records exist for a long enough period, predictions can be made that relate rainfall intensity and duration to the system response more accurately.

Considering the nature and location of defects contributing **RIII**, the predicted reduction would be more nearly 65 percent of the total volume of **RFIII**. To allow for the lines that were too deep or surcharged, which would preclude smoke testing and televised inspection, an overall reduction in **RFIII** of 50 percent was predicted. This would be the result of an aggressive, well-coordinated physical inspection and rehabilitation program.

Results

It was apparent from the beginning that large portions of the system were in poor condition. This was confirmed through the flow monitoring program. In wet weather conditions, many of the flow monitoring sites became surcharged and inaccessible for several days at a time. Even during dry weather, much of the lower reaches of the system were surcharged. Further analysis of the flow monitoring information showed that significant discharges were occurring at the **SSOs**. Field visits confirmed that **SSOs** were occurring even during relatively minor storm events. Regardless of the overall effectiveness of a physical inspection program, major capital improvements were required to address capacity limitations in the system. To address these needs, the **HydraGraphics** model was used to determine the approximate costs associated with elimination of **SSOs** and surcharging in the system.

The **HydraGraphics** model allows the system to be seen in plan and profile views. In the profile view, it became fairly obvious that many of the overflows were the direct result of designs that did not consider the use of the existing grade. As new pipes were laid, they were added at minimum grade, then tied into the existing structures through drop manholes. Lines that roughly paralleled the surface slope would have greatly increased the carrying capacity and eliminated the need for subsequent construction of **SSOs**.

A typical example of this is shown in Figure 4. The upper line is the ground elevation, while the vertical lines represent manholes. The darker lines represent the sewer pipe, while the gray line between the pipes is the hydraulic grade line (HGL).

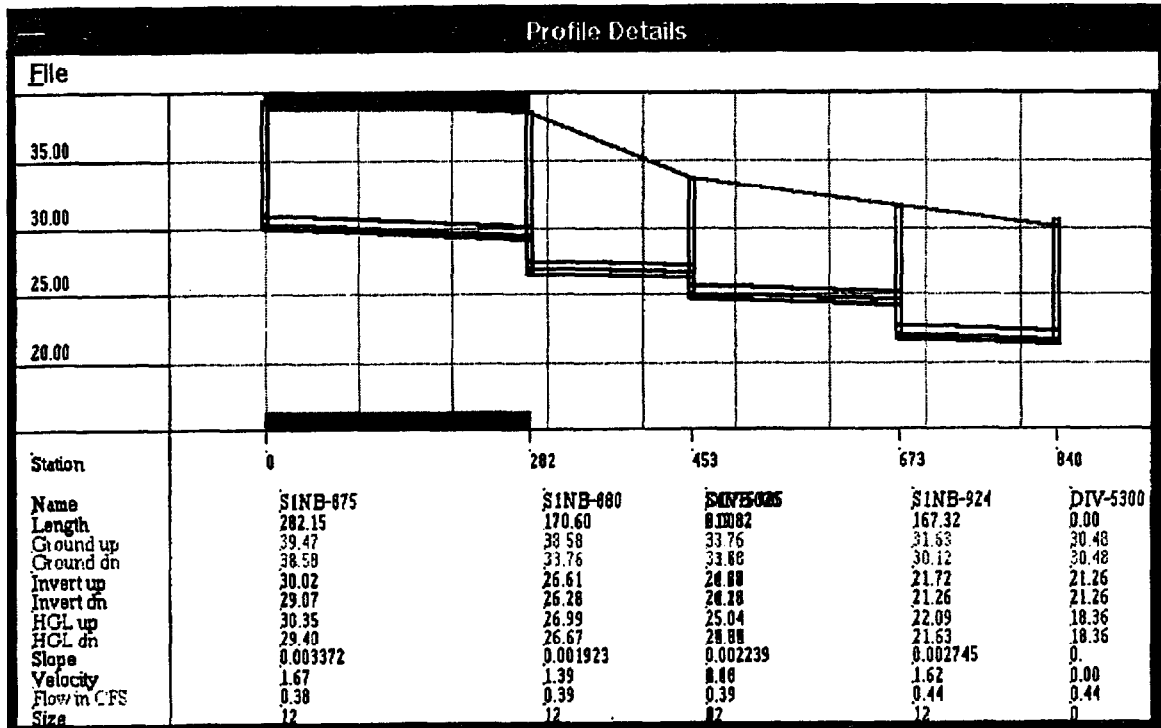

Please note that the elevations shown are in meters.

Figure 4. Typical examples of minimum slopes and drop manholes (elevations shown are in meters).

The results of the flow monitor calibrated model showed that under existing conditions, the system marginally handled dry weather flows without activation of the overflows. Given almost any rainfall event, some overflows within the system were activated. The system has inadequate capacity to meet the predicted requirements for future dry days. When considering the future population and a design storm event, the system is almost entirely surcharged. The cost to eliminate overflows for only the dry weather ultimate population would require an expenditure of \$29 million Australian. The cost to eliminate overflows for ultimate wet weather flows with aggressive rehabilitation would require approximately \$35 million Australian. The cost to eliminate overflows under ultimate wet weather conditions without rehabilitation **would require** an expenditure of approximately \$39 million Australian. Therefore, this system requires a significant investment to overcome existing deficiencies, as increased capacity is critical whether or not rehabilitation is performed. The distribution of costs among the various projects is shown in Figure 5.

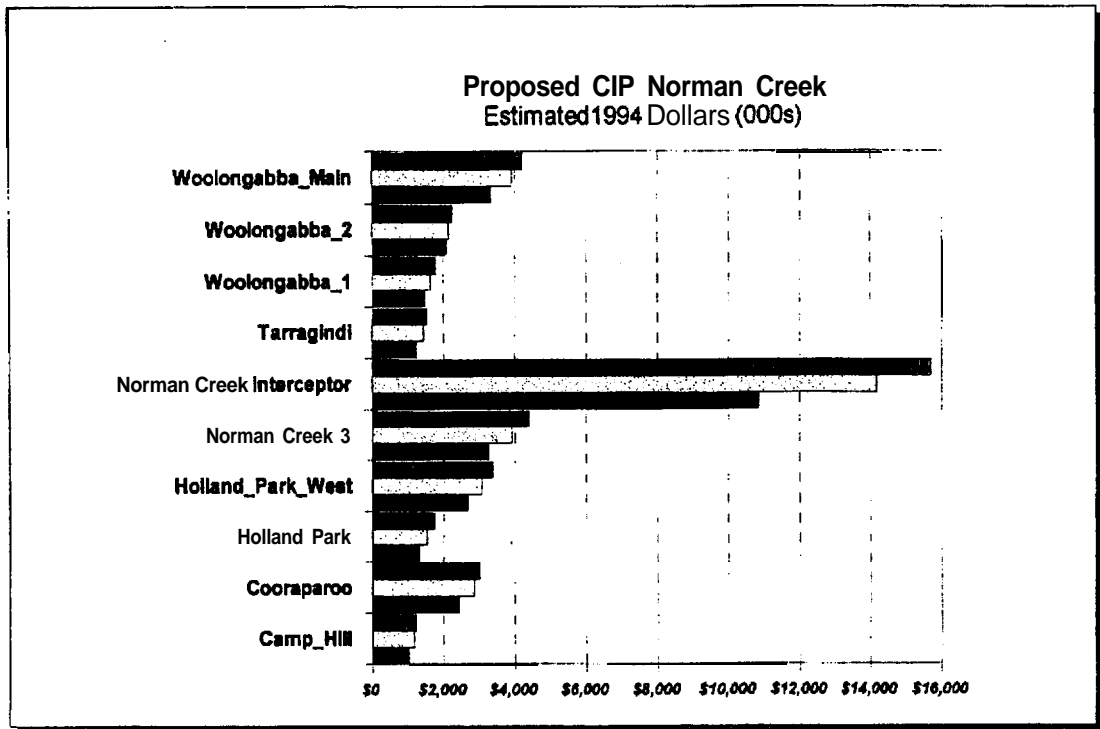

<i>All \$ in Thousands</i>	<i>Flow Scenario</i>		
	<i>Ultimate Population Dry Weather</i>	<i>Ultimate Population with 50% RFI3 Reduction</i>	<i>Ultimate Population No Reduction in RFI3</i>
Camp_Hill	\$1,020	\$1,170	\$1,220
Cooraparoo	\$2,410	\$2,840	\$2,970
Holland Park	\$1,310	\$1,530	\$1,720
Holland Park West	\$2,680	\$3,060	\$3,390
Norman Creek 3	\$3,270	\$3,930	\$4,380
Norman Creek Interceptor	\$10,850	\$14,190	\$15,680
Tarragindi	\$1,230	\$1,450	\$1,530
Woolongabba 1	\$1,470	\$1,660	\$1,790
Woolongabba 2	\$2,070	\$2,150	\$2,260
Woolongabba Main	\$3,310	\$3,900	\$4,190
Totals	\$29,620	\$35,870	\$38,130

Figure 5. Costs by proposed project.

Conclusion

Consideration of defect-generated flows in addition to population-based flows allows both rehabilitation plans and augmentation-only solutions to be considered. In this case, the system is currently operated so that SSOs occur even with minor rain events. Overcoming the SSOs as well as other capacity limitations would require significant capital investment.

In conclusion, tools and techniques now exist to make an optimal comparison of rehabilitation and replacement costs. In Brisbane, significant investment in the system will be required regardless of any aggressive rehabilitation programs. In our efforts to control SSOs in the United States, we must evaluate fully the most cost-effective way to minimize overflows.

Cost/Benefit Drives Houston's Billion-Dollar Sanitary Sewer Overflow Control Program

Teresa Battenfield
City of Houston, Houston, Texas

Christine Kahr
Greater Houston Wastewater Program, City of Houston, Houston, Texas

The City of Houston is under an order to control chronic overflows in its sanitary sewer collection system. Under a mandate imposed by the Texas National Resource Conservation Commission (TNRCC) and Region 6 of the U.S. Environmental Protection Agency (EPA), the city's system must be brought into compliance by late 1997.

Houston's Challenges

Like most major U.S. metropolitan areas with separated sanitary sewer systems, Houston's system is overloaded during storm events. Unlike most other systems, Houston has over 200 "constructed overflows," which act like combined sewer overflow (CSO) discharge points and relieve the sanitary sewers by discharging directly into bayous, drainage ways, or storm drains. In 1987, the TNRCC and EPA gave the city just 10 years to eliminate these overflow points and to upgrade Houston's massive wastewater collection system.

Houston is the fourth largest metropolitan area in the United States. The city's wastewater system is also one of the country's largest, with 48 wastewater treatment plants (**WWTPs**) that process a dry weather flow of over 250 million gallons per day (mgd). Wastewater flows to these plants through a collection system of over 5,000 miles that spans nearly 600 square miles. The system also includes over 80,000 manholes and more than 320 lift stations.

The Program

In 1992, Mayor Bob Lanier and Director of Public Works and Engineering Jimmie Schindewolf established the Greater Houston Wastewater Program (GHWP) to control the sanitary sewer overflow (SSO) problem before the mandated deadline. Under the GHWP, Houston has developed a \$1.2 billion plan to control wet weather overflows in its sanitary sewer system. The program includes implementation of comprehensive system improvements to control overflows up to the **2-year** storm event. Program success will be measured by:

- Improved customer service
- No uncontrolled overflows for up to the **2-year** storm
- Preservation of water quality
- Regulatory compliance

Meeting Customer Needs

The program's primary goal is to meet customer needs. The current wet weather capacity deficiency causes manholes to overflow into streets and surface waterways, as well as backups to occur on private

property (cleanouts and homes). There are over 200 known uncontrolled “constructed” bypass and overflow points in the Houston system that discharge 20 to 30 times per year. The basic cause of these overflows is wet weather infiltration/inflow (I/I) directly related to high-intensity rainfalls. Solving these SSOs is complicated by the stormwater handling problem associated with flooding of streets and other areas. Houston’s streets are generally designed to flow curb-to-curb for a 3-year storm.

The program’s goal is to reduce system overflows (and prevent backups into private property) to no more than an average of once every 2 years. This will be accomplished by reducing the amount of surcharge in the collection system through extensive rehabilitation and the construction of relief facilities.

The rehabilitation program, while not purposefully designed to remove I/I, is designed to restore structural integrity and carrying capacity to a deteriorated system. The collection system requires extensive rehabilitation to correct the effects of severe hydrogen sulfide corrosion, misaligned joints, cracked and broken pipe, and accumulated debris.

The relief strategy calls for construction of new sewer lines and pump stations, either to redirect wastewater flows from overloaded pipes to underused pipes, to bypass undersized pipes, to transfer peak capacity flows from one treatment plant to another, or to transfer peak capacity to stormwater clarifier facilities.

Affordability and Design Storm Selection

Local hydrologic conditions of significant peak hourly rainfall dictate the need for large conveyance capacity requirements. Table 1 compares peak hourly rainfall in three major metropolitan areas. Houston’s peak hourly intensity of 2.3 inches per hour exceeds the design standards of most other areas around the country.

Table 1. Local Hydrologic Conditions Dictate Large Conveyance Capacity

Agency	Sewer Design Criteria (Peak Hourly Rainfall)
Houston, TX	2.3 inches/hour
East Bay Municipal Utility District, CA	0.64 inches/hour
Los Angeles, CA	0.25 inches/hour

To meet the EPA Administrative Order deadlines for Round 1, which will include construction completion of some facilities by November 1995, a design event had to be selected for Round 1 prior to completion of the water quality study and modeling. Initially the city selected the 5-year design storm. After completion of the modeling effort, however, it was determined that the citywide cost to build relief facilities to control the 5-year storm exceeded the city’s ability to pay. Among the country’s top 20 major metropolitan areas, Houston’s sewer rates currently rank second and fifth highest, depending on customer type.

In Rounds 1, 2, and 3, the city then focused its modeling efforts on the 2-year design storm. After completion of the modeling effort, the city determined that the results of designing for the 2-year storm provided sufficient water quality protection and customer satisfaction at an affordable cost. Figure 1 illustrates the \$500 to \$600 million cost savings between the 2-year and 5-year design storms.

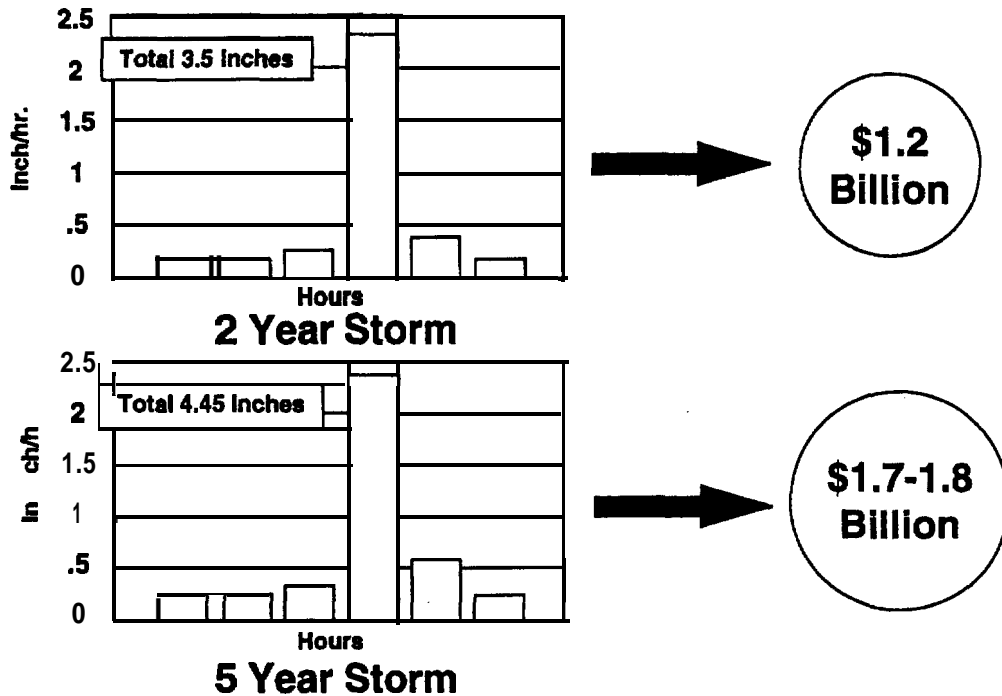

Figure 1. Affordability drives design storm selection.

Water Quality Impacts

Houston completed a water quality study in February 1994. Field sampling was performed to characterize the quality of SSOs and stormwater. The collection system flow monitoring and system hydraulic modeling performed determined that the unique nature of Gulf Coast meteorology produces a design storm characterized as a very high intensity, short duration convective shower (thunderstorm) for which peak I/I is also of short duration. This results in high flow, low volume wet weather events. These water quality studies determined that no significant impact on the receiving water streams results from the discharge of peak wet weather I/I, even under existing overflow conditions. Figure 2 illustrates one of the results of the water quality study and indicates that coliform levels in Houston's Buffalo Bayou are virtually the same in full containment (no overflows) and during overflows related to the 2-year design storm.

The direct impact on water quality notwithstanding, the city remains committed to the SSO control program to remove frequent overflows from houses, yards, and streets, and to improve customer service and system reliability.

Phased Approach

The relief and treatment capital construction effort is divided into three "rounds" of projects. Round 1 consists of four priority service areas with the most critical overflow problems. Planning and design of \$140 million in identified relief projects have virtually been completed, and most are into construction. The second round, involving more than \$300 million in construction, is currently in preliminary design, final design, or bid phase and will move into construction in mid-1995. The final round, estimated at about \$100 million in new work, is in the early design stages and will move into construction later in 1996.

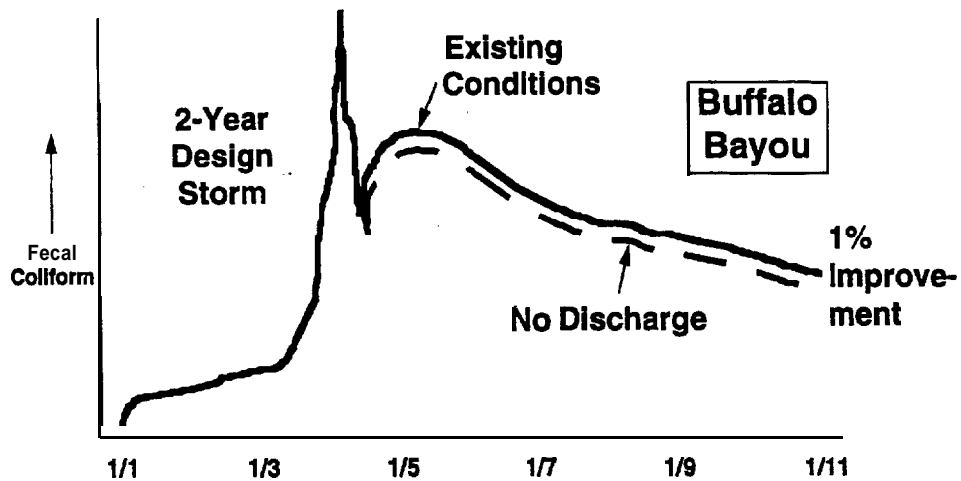

Figure 2. Based on waterquality studies, receiving streams are not affected by existing SSOs.

All projects are on schedule for completion by the December 1997 regulatory deadline. In the program's peak year of expenditure (fiscal year 1997), the city's wastewater capital improvement program will exceed \$275 million. It is believed that this program is among the largest ever completed over such a short period.

Cost-Effectiveness Methodology

With the problems that existed throughout a massive system involving 35 distinct service areas, it quickly became apparent that one overall "solution" to the problem would not be found; each area would require a unique combination of solutions; determined through a comprehensive planning strategy.

The GHWP developed a planning strategy (referred to hereafter as the cost-effectiveness analysis, or CEA) that involved several steps-cost-effectiveness analysis, alternative analysis, preliminary design, and final design. This process sought to funnel only the best and most cost-effective solutions to the final design stage. For each service area, the CEA's funnel approach identifies the system with the least life cycle cost.

The CEA strategy uses advanced engineering technology and practical economic analyses to formulate the most viable, low-cost combination of options to control overflows in each service area. The menu of options may include comprehensive sewer rehabilitation, construction of additional relief sewers and pump stations, flow equalization (storage), upstream wet weather treatment and discharge, and expansion of existing treatment facilities. Figure 3 shows the final elements from the CEA process in each of the four major drainage basins in Round 1. Round 1 represents approximately 25 percent of the linear feet of sewer in Houston's system.

The CEA process involves several steps. After a design flow is determined, a dynamic computer modeling program based on EPA's SWMM model is used to show the effects of flow routing in pipes larger than 30 inches in diameter. Static models are used for smaller pipes. The program also simulates changes in pipe diameter and the effects of adding new pipes or storing/treating excess flow. Costs are estimated for various alternative combinations. These models were used to size pipes for the 2-year, 6-hour design storm.

Round 1 Service Areas	Rehab.	Relief	Upstream WWTP WWF's Expans,	
Northwest	✓	✓		
Northeast	✓	✓		✓
FWSD 23	✓	✓	✓	✓
Sims Bayou	✓	✓	✓	

Figure 3. Cost-effective analysis results in different approaches.

To optimize sizing for treatment and storage facilities, the GHWP ran a **52-year** continuous rainfall simulation model using rainfall records from 1940 through 1992 as part of each SWMM model. This was done because two lesser events could occur relatively close in time and create a combined effect of greater consequence than the single design event. In addition, several service areas were studied simultaneously to determine whether facilities in one service area might be optimized to serve the needs of more than one area. Transferring flow among areas can achieve maximum efficiency and the **least-cost** solution. Experience has also shown that facilities sized using continuous rainfall simulation are somewhat smaller and less costly than facilities sized for the collection system design storm.

After the program management team completes the cost-effectiveness analysis phase, a design consultant performs a more detailed alternative analysis of potential options that emerge from the CEA. Typically during this stage (which includes value engineering), costs have been reduced by an average of 10 percent. Once the GHWP's technical review committee approves the design consultants' recommendations, each service area is divided into smaller project segments. Numerous local engineering companies are then selected to gather site-specific geotechnical information, develop engineering criteria, and submit a preliminary design report. The technical review committee reviews this information and then authorizes final design on a single solution. In most cases, the least-cost option becomes the recommended solution. In Rounds 1, 2, and 3, a total of 53 different lead design consultants will be completing over 240 construction bid packages.

The purpose of the CEA process is to save money. Every day at every stage, everyone involved focuses on how to provide a comparable functioning project while reducing cost and the subsequent impact on ratepayers. Early in the process, the funnel approach identifies multiple alternatives, which are successively refined at each stage, until a single cost-effective solution is developed. At each phase-cost-effectiveness analysis, alternative analysis, and preliminary design-alternatives identified as having similar costs are carried forward to the next phase. This prevents a viable alternative from being rejected too early in the process. Detailed final design is only performed on a single solution. Figure 4 provides the Program summary of the CEA process and the value of the final four overflow control components: relief, rehabilitation, WWTP expansion, and upstream stormwater clarifier facilities.

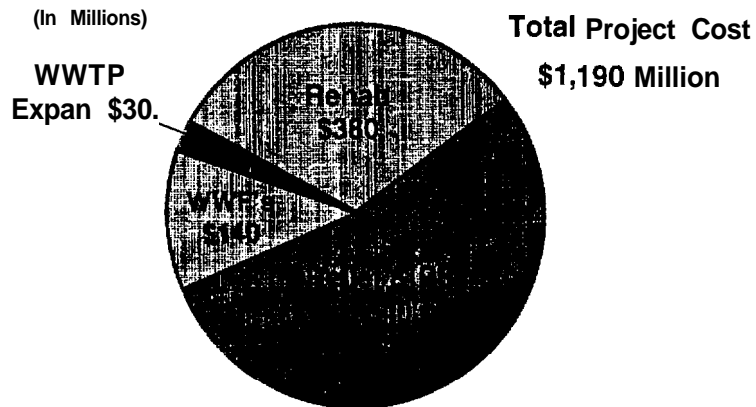

Figure 4. Program cost summary.

Upstream Stormwater Clarifier Facilities

In several service areas, upstream treatment and discharge were determined to be cost effective. Water quality studies showed that existing untreated discharges had no measurable impact on receiving waters. Therefore, secondary treatment was not required for wet weather flows. The concept of stormwater clarifiers was developed as a reasonable treatment technology. Wet weather flows in excess of the downstream hydraulic conveyance capacity in the existing gravity trunk sewers, up to the peak wet weather flow, are diverted and pumped to the stormwater clarifier facility (also referred to as a wet weather facility, or WWF).

During smaller storms, the flow is stored in the facility and held until flow in the downstream collection system subsides. The stored flow is then pumped back into the collection system for transport to the downstream WWTP. In Houston's proposed Scott Street stormwater clarifier facility, located in the Sims Bayou Service Area, flows are stored and pumped back to the collection system an average of 15 times per year.

During larger storms, the excess wet weather flow is treated and discharged to the nearby bayou. When flow in the collection system subsides, the wet weather flow and settled solids retained in the clarifier are returned to the collection system for subsequent downstream treatment at the existing WWTP. The basis for sizing of the stormwater clarifier limits the frequency of discharge events to an average of not more than four per year.

The Scott Street stormwater clarifier facility includes the following process components: influent diversion structure, chlorination, clarification, effluent coarse screening, automatic effluent sampling, effluent flow metering, effluent outfall to Brays Bayou, and return flow lift station. Also included are chemical storage and feed for odor control, washwater storage tank and booster pumping system (using city water), and a control building/personnel facility (e.g., control room, toilets, storage).

Influent enters the diversion structure via force mains from wet weather pumping stations. Weirs in the diversion structure allow three clarifiers to fill separately and sequentially. The feed to the clarifiers is specifically designed to limit turbulent conditions during the initial filling operation. (The clarifier is empty upon initiation of the wet weather diversion.)

The three stormwater clarifiers, each 130 feet in diameter, are used based on the following design criteria:

- Overflow rate of 2,400 gallons per day per square foot (**gpd/ft²**) at **5-year, 6-hour** design storm event (**2-hour** peak flow) and less than 1,800 **gpd/ft²** at 2-year, **6-hour** design storm event (2-hour peak flow).
- Side water depth of 18 feet for improved clarifier operation and to achieve volume sufficient to limit discharge to the bayou to a long term average of less than four events per year.

A return lift station with four pumps operating at 4,700 gallons per minute (gpm) returns detained flow, settled solids, and scum to the collection system for downstream treatment. Instrumentation in the downstream trunk lines will determine when the lift station can begin pumping.

Treated flows will be conveyed through an **onsite** effluent structure that will screen, sample, and monitor flow before discharge to the bayou. The collected debris will be manually removed from the screens after each use. After the clarifiers have been drained, they will be cleaned with strategically placed **high-pressure** water cannons to remove any sediment buildup or residual that might cause odors. Each cannon will deliver 750 gpm at 100 pounds per square inch (psi).

Odor control will be accomplished by controlling flow throughout the facility to minimize turbulence. The **influent** will also be dosed with sodium hypochlorite in the **influent** diversion chamber. The sodium hypochlorite will reduce odors and provide chlorination, which TNRCC requires.

The instrumentation/control system will be designed for local automatic operation, remote monitoring, and remote operation options. A control building/personnel facility will house all electrical switch gear and motor starters. The building will be equipped with a control/communications room, restroom, shower, off ice, and breakroom.

The construction of upstream stormwater clarifiers is a cost-effective solution to controlling overflows in at least two of the city's four largest service areas.

lack of National Policy Makes Going Difficult

The City of Houston is on track to complete all program projects by December 26, 1997. To date, over \$169 million in overflow control projects have been awarded, with an additional \$30 million planned in this fiscal year, which ends in June 1995. In addition, over \$281 million in sewer rehabilitation projects have been awarded. It has been difficult getting to this point in the absence of any national or state policies to guide the regulation of **SSOs**.

EPA is in the process of developing a national approach to **SSOs** and has formulated a policy advisory committee, consisting of environmental regulators, municipal dischargers, government and industry association members, and environmental interest group members, to collect data and to develop and recommend the scope or components of national guidance.

On February 1, 1995, the TNRCC issued a discharge permit for the city's first wet weather facility in the Sims Bayou Service Area. The permit, which allows an average of four discharges per year, was a big step in the implementation of the program's cost-effective approach. The use of this innovative technology minimizes the impact on ratepayers, improves customer service, and meets water quality and public health needs while minimizing the impact on ratepayers. Region 6 issued the final National Pollutant Discharge Elimination System permit for the wet weather facility on April 12, 1995, and continues to play a lead role in developing EPA's national SSO strategy.

Houston is not the only city moving ahead despite the lack of national policy. With over 80 Administrative Orders issued in Region 6 alone, many others have committed significant funds to the control of their SSOs and regulatory compliance. Region 6 cities with construction of rehabilitation or relief projects under way include Dallas and Ft. Worth. Houston and many other cities across the country are following the development of national policy closely. These cities are helping to shape future regulations through EPA's policy dialog process so that water quality and their investments are preserved.

Rehabilitation

The cost-effectiveness analyses referred to above included an analysis of alternatives to maximize I/I reduction as a means to control overflows. To date we have not yet found a service area in the city where the cost-effective SSO control alternative includes I/I reduction through systemwide rehabilitation. For example, in the Sims Bayou Service Area, the rehabilitation alternative-maximize I/I reduction-was found to be over two times as costly on a lifecycle basis when compared with the recommended stormwater clarifier alternative. While rehabilitation for I/I reduction is not cost effective, the city remains committed to this program of structural rehabilitation because it is necessary to prevent street collapses, improve customer service by eliminating bottlenecks in small pipes, and preserve the city's investment in its infrastructure. This program, when augmented by a sustained long-term maintenance program, will also limit future I/I levels from increasing beyond system design criteria.

Houston is committed to spending over \$300 million on its systemwide rehabilitation program through fiscal year 1998. The program uses a combination of state-of-the-art trenchless and open-cut methods of rehabilitation that are selected for compatibility with existing conditions. These methods include sliplining, fold-and-form liners, cured-in-place liners, pipebursting, and remove and replace. Figure 5 shows the breakdown of methods used by linear feet of sewer rehabilitated.

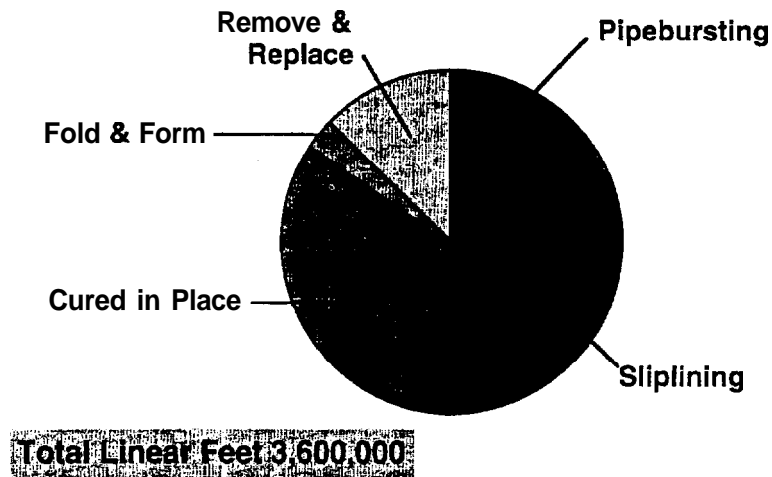

Figure 5. Rehabilitation program uses multiple methods to fit conditions.

Conclusion

The City of Houston is required by state and federal Administrative Orders to control its SSOs by December 1997. Despite the lack of a national regulatory policy on SSOs, the city has implemented an aggressive \$1.2 billion program through a CEA planning process. This process uses advanced engineering technology and practical economic analyses to formulate the most viable, low-cost

combination of options to control overflows. For each service area, the **CEA's** funnel approach identifies the combination of facilities with the least lifecycle cost. The resulting options include sewer rehabilitation, construction of additional relief sewers and pump stations, upstream wet weather treatment and discharge, and expansion of existing treatment facilities.

Although the deadline is less than 3 years away, the program is well on its way to achieving its basic goals of:

- Customer satisfaction
- Preservation of water quality
- Systemwide structural integrity
- Regulatory compliance

The mission statement of the GHWP says it best: "To provide our community with a safe, reliable, and affordable wastewater system, support economic vitality, and protect the water quality of our streams and estuaries."

Determining the Cost-Effectiveness of Sanitary Sewer Rehabilitation in Norfolk, Virginia

Lamont W. Curtis and Gregory K. Anderson
URS Consultants, Inc., Virginia Beach, Virginia

The primary goals of an infiltration and inflow (I/I) study and subsequent Sewer System Evaluation Survey (SSES) are to properly identify and quantify extraneous volumes of clean water, stormwater, and ground water entering a sanitary sewer gravity collection system, and to determine the cost-effectiveness of removing the extraneous clean-water quantity. This analysis requires locating deficiencies within the collection system piping, determining the severity of the deficiencies, recommending the proper form of work to rehabilitate or replace the piping, establishing construction costs for the work, and then analyzing the cost-effectiveness of performing the work. This paper compares the cost-effectiveness of rehabilitation methods to the other side of the equation: transport and treatment.

An SSES is a comprehensive approach to evaluating the sanitary sewer collection system infrastructure and generally includes extensive field work through a three-step investigation. As additional steps are taken to identify deficiencies, the cost associated with the evaluation process increases. Without the level of detail, however, recommending certain types of pipeline rehabilitation may be difficult. Rehabilitation recommendations, in part, depend on the age, condition, material, and hydraulic capacity of the collection system piping that can be restored through rehabilitation.

Determining the quantity of I/I that is cost-effective to remove is accomplished by comparing the lifecycle cost of transporting and treating the flow to the lifecycle cost of rehabilitating the sewer. In the preliminary engineering phase, it is helpful to develop a flow rate for the baseline value of I/I that is at the break-even point of being cost-effective or an acceptable amount below which rehabilitation is not cost-effective. This planning value, which varies from system to system and is sensitive to several variables, helps screen rehabilitation scenarios.

History

The problem associated with extraneous volumes of clean water entering sanitary sewers was emphasized by the 1972 Clean Water Act, when the law (PL92-500) and subsequent regulations required that measurements be taken to determine the quantity of I/I. At that time, the allowable rate of both infiltration and inflow was 275 gallons per capita per day (gpcd), which included 80 gpcd of domestic base flow, 40 gpcd of infiltration, and 155 gpcd of storm related inflow (1). In an urban area, this amounts to about 8,000 gallons per day per inch diameter mile of piping, which is consistent with the design allowances of sanitary sewer construction of that time. The problem of infiltration now is recognized, and design allowances have varied. In the period before World War II, typical allowances varied from 5,000 gallons per day per inch diameter mile to 25,000 gallons per day per inch diameter mile. Some cities used flat allowances in the range of 750 to 1,500 gallons per day per acre (2), which is comparable to approximately 22,000 to 40,000 gallons per day per inch diameter mile.

In the period between World War II and the introduction of premium pipe joint materials, allowances for existing piping varied from 4,000 to 50,000 gallons per day per inch diameter mile, and specifications were starting to evolve that limited infiltration of newly constructed sewers to 5,000 to 10,000 gallons per day per inch diameter mile as a performance criteria (3). These numbers were typically applied to sewers up through 15 inches and without premium *joints*. Inflow as defined by the Clean Water Act was not a matter of design considerations to this time (4).

After the passage of the Clean Water Act, measured flow data began to show the actual impact of infiltration. Cost-effectiveness analyses compared the cost of removing the I/I, typically by replacement,

with the cost of transporting and treating the clean water at the wastewater plant. Grouting, point repairs, and slip-lining were rehabilitation techniques that reduced infiltration, and disconnection of downspouts, yard drains, and foundation drains were rehabilitation techniques that reduced inflow. Predicted removal values were often very optimistic. The phenomenon of ground-water infiltration in low permeability soils was not generally considered, and the concept of rainfall-induced infiltration (RII) was often mistaken for direct inflow, which added to the optimism.

Many studies ignored the problems associated with house laterals or underestimated the flow quantities contributed by the private systems, which in many cases are equal to, or even greater than, the length of publicly owned collection systems.

To accurately predict the cost-effectiveness of a rehabilitation program, the flows that need definition include the annual infiltration of ground water, storm-related inflow, and RII. Both the publicly owned collections systems and the private laterals need to be accounted for with respect to the total annual contribution. Estimates of the costs of rehabilitation and removal effectiveness must be accurate. Obviously, some methods of rehabilitation are more cost-effective, but they may also have a different life. For example, grouting would typically have a shorter useful life than lining; however, each technique has its place and therefore requires evaluation.

Rehabilitation methods have advanced dramatically, and the costs compare favorably with replacement. Several variables are important when making the cost-effectiveness determination; these are discussed below. Improvements in pipe joints and materials in both the publicly owned collection systems and private laterals, as well as increased awareness of I/I problems, have reduced these extraneous waters in newer construction.

Basic Data for the Analysis

The benchmark for cost-effectiveness is the determination of the transport and treatment cost. In the case of the City of Norfolk, Virginia, this cost was easy to determine because the treatment cost was fixed by the local agency, the Hampton Roads Sanitation District, which provides a service of local sewer interceptors, treatment, effluent disposal, and biosolids management. The treatment rate, in 1994, was approximately \$1.40 per 1,000 gallons of metered water usage. In addition to that cost, the City of Norfolk identified the local sewer operation and maintenance (O&M) cost to be \$1.29 per 1,000 gallons; this includes the cost associated with the collection and conveyance of the wastewater and minor sewer repair, sewer maintenance, pumping station O&M, and miscellaneous administration. The cost to transport and treat wastewater then totals \$2.69 per 1,000 gallons. Conversely then, every 1,000 gallons of I/I removed saves \$2.69.

The other side of the equation is the cost to replace or rehabilitate the collection system piping and to determine the actual removal rates that rehabilitation would accomplish. Given the competitive nature of the rehabilitation business, for the Norfolk example the costs of the various methods to remedy infiltration (e.g., cured-in-place liners, fold-and-form liners, deformed liners, and nonproprietary slip-lining) were averaged and were all considered to provide the same degree of ground-water infiltration removal capability. For an 8-inch gravity sanitary sewer, this averaged \$55 per linear foot. A comparative cost of replacement was \$70 per foot. Note that this does not include house lateral replacement, so the effectiveness of infiltration removal must consider that fact. For the Norfolk example, Table 1 below was developed for a number of removal efficiencies that must be realized by replacement or rehabilitation. In other words, if the infiltration contributed a daily flow of some volume based on the traditional unit of gallons per day per inch diameter mile, what would the transport and treatment cost equal, and what is the present worth for comparing cost-effectiveness?

Table 1. Removal Efficiencies

Infiltration Volume	Annual Cost (A)”	Present Worth (P)
500 gal/in. dia/mile/day	\$4,000	\$56K
1,000 gal/in. dia/mile/day	\$8,000	\$113K
1,500 gal/in. dia/mile/day	\$12,000	\$169K
2,000 gal/in. dia/mile/day	\$16,000	\$226K
2,500 gal/in. dia/mile/day	\$20,000	\$282K
3,000 gal/in. dia/mile/day	\$24,000	\$338K
3,500 gal/in. dia/mile/day	\$28,000	\$395K
400 gal/in. dia/mile/day	\$32,000	\$451 K

“The annual cost was calculated by multiplying transport and treatment costs (see “Basic Data for the Analysis” in this paper) by the number of thousand gallons being evaluated by the number of days in a year and the pipe diameter.

To calculate the present worth (P) of sewer rehabilitation, certain assumptions were required, including the useful life of rehabilitation (n), the geometric gradient of inflation (g), and the interest rate (i) pertaining to the rehabilitation investment. For this analysis, a useful life (n) of 20 years, an inflation rate (g) of 5 percent, and an interest rate of 8 percent was used. The geometric series present worth factor expression identified in Equation 1 was used to develop the cost comparison:

$$P=A \left[\frac{1-(1+g)^n(1+i)^{-n}}{i-g} \right]$$

In the case where $i = g$, the expression is modified to the following (5):

$$P=An(1+i)^{-1}$$

Comparing the average cost to rehabilitate an **8-inch** line at \$55 per foot, or \$290,400 per mile, with the present worth of removal in Table 1 shows it might be cost effective to consider rehabilitation once infiltration exceeds 2,500 gallons per inch diameter per mile per day, or 20,000 gallons per mile per day.

A similar approach using pipe replacement would need to consider the average replacement cost and also evaluate the analysis period. In the rehabilitation analysis, a **20-year** useful life has been used.

To evaluate the cost-effectiveness of eliminating inflow, a similar approach on a straight volume of inflow computation can be made. In most cases, however, the cost of eliminating the inflow source is dramatically exceeded by the annual costs associated with conveyance and treatment of the extraneous volume of clean water. As an example, a home with 1,500 square feet of roof area with rain gutter downspouts connected directly to the sanitary sewer will contribute an additional average of approximately 100 gallons per day of inflow during a year when 40 inches of rainfall is recorded. Table 2 identifies the effective break-even point, in construction cost, to eliminate the source of inflow. The cost of removing the improper connections to the sanitary sewer would be considerably lower than \$1,400, and in this case would be the responsibility of the home owner. An analogy between the downspout

example with inflow through manhole cover pick holes or disconnection of basement sump pumps can also be made.

Table 2. Break-Even Cost To Eliminate inflow Sources

Inflow	Annual Cost (A) Transport and Treatment'	Present Worth (P)
100 gallons per day	\$190 per year	\$1,400
500 gallons per day	\$500 per year	\$7,000
1,000 gallons per day	\$1,000 per year	\$14,000
2,000 gallons per day	\$2,000 per year	\$28,000

^aThe annual cost was calculated by multiplying transport and treatment costs (see "Basic Data for the Analysis" in this paper) by the number of thousand gallons being evaluated by the number of days in a year and the pipe diameter.

Obviously, this method of determining the cost-effectiveness of I/I removal is illustrative, not site specific, and subject to many variables. Both Tables 1 and 2, however, are a viable means for determining theoretical acceptable I/I rates, which makes the information excellent for planning purposes. Before final recommendations for rehabilitation can be properly ascertained, an extensive evaluation of the piping systems should be undertaken.

Field Data

Methods for collecting the field data for determining I/I volumes are well documented in a wide variety of references. In the traditional approach, the first step is a preliminary survey, the second step is the classic I/I analysis of large subareas and drainage basins, and the third step is the SSES. During the SSES, comprehensive measurements are taken to define the annual volume of inflow, dry weather infiltration, and RII rates. Further data are collected for locating pipe deficiencies by smoke testing, dyed water testing, and internal pipeline inspections.

As the data collection effort increases, the associated costs also increase; however, the severity of the deficiencies must be properly identified in order to evaluate and prioritize any rehabilitation. Internal pipeline inspections provide the best data on actual structural condition, hydraulic capacity, and sources of ground-water infiltration. Because this is the most expensive task during the SSES, the work effort unfortunately is often recommended to be minimized. Figure 1 describes the typical tasks associated with the SSES and the order in which they are conducted.

I/I from private service laterals needs to be addressed as well, but typically the results of any SSES will identify system deficiencies and quantify I/I whether on public right of way or private property. Identifying required rehabilitation of private service laterals entails the same evaluation process as that used for the main line gravity sewers. In both cases, accurate data are required to identify deficiencies, and extensive field evaluations are needed to determine I/I sources, and the best method of eliminating defects.

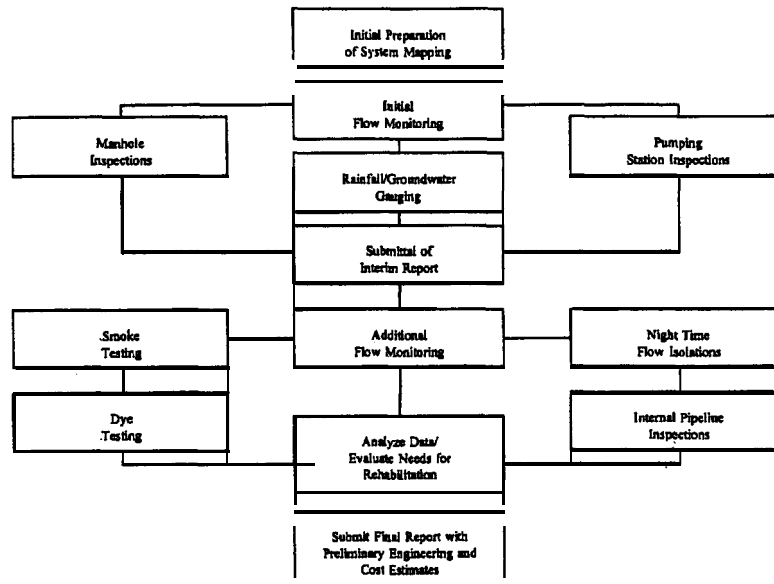

Figure 1. Typical tasks associated with an SSES.

Evaluation

The next questions are “What is the volume that can be removed?” and “What is the minimum field data needed to accurately quantify volumes and to identify the location and severity of system deficiencies?”

At a minimum, the following tasks must be undertaken to establish actual I/I rates:

- Flow monitoring
- Rainfall gauging
- Ground-water gauging

These tasks need to be performed concurrently and require accurate data compilation. Establishment of a base flow, wastewater generated by system users, is critical to the identification of ground-water infiltration rates and development of an average dry weather flow rate, which is used to establish and quantify wet weather inflow rates.

A subarea/minibasin approach minimizes much of the field work. For example, if flow monitoring does not identify a significant increase in flow during wet weather periods, or if there is little or no flow during late night/early morning hours, smoke testing, night flow isolations, and internal pipeline inspection efforts can be minimized. When preparing an interim report for additional field work, existing I/I rates should be established before making recommendations. If the measured infiltration or inflow volumes do not exceed the acceptable I/I rates, then additional field work might not be warranted. As mentioned previously, it is usually cost-effective to identify and remove direct inflow sources; therefore, smoke testing operations are typically recommended if any direct inflow is identified.

R/I must be accurately quantified to gauge the overall impact of wet weather on the collection system piping before a cost-effectiveness analysis can be completed. Entry points for R/I include pipe defects, manhole defects, foundation drains, pipe joints and service lateral defects. The volume and flow rates

attributable to RII generally are easy to identify but very costly to locate. Dye water testing/flooding and internal pipeline inspections can help identify the location and severity of defects at the entry points along the main line piping, but are ineffective in evaluating defects associated with service laterals. To accurately determine the volume of RII coming from the private sector, the volume attributable to the main line piping must be established. Past studies have determined that RII coming from private service laterals exceeds the volume generated from the main line piping. At this point, the evaluation becomes much more difficult because the actual sources contributing to the RII cannot be field verified without extensive closed-circuit television inspections. Certain assumptions are required before recommendations can be made concerning rehabilitation of the service laterals. The assumptions pertain to the age, length and density of the service laterals, soil characterization, topography, and the level of root intrusions within the service laterals.

Some cities have begun rehabilitating, or replacing, private service laterals as part of the sanitary sewer rehabilitation within the public right of way. The City of Norfolk began its program in 1991 and since that time has completed 11 projects in which the laterals have been replaced from the main line piping to the building being served. Table 3 below identifies each project, the cost of the entire project, and the cost of replacement of the service laterals.

Table 3. City of Norfolk Sewer and Laterals Improvements

Bid Date	Project Name	Private Laterals (Dollars)	Total Sewer Improvements (Dollars)	Private Laterals (% of Total)
May 1991	Norview Heights Phase IIA	82,140	389,058	22.9
July 1991	Norview Heights Phase IIB	87,270	477,925	18.3
February 1992	Norview Heights Phase III	127,365	630,419.9	20.2
September 1992	Brandon Place Sanitary Upgrade	130,866.25	835,735.25	15.7
October 1992	Norview/Norfolk Gardens	119,060	964,830	12.3
September 1993	East Fairmont Park/Norview	107,387.5	874,899.5	12.2
December 1993	Greenwood/Sherwood Forest	102,773.25	1,092,670.5	9
May 1994	Merrimac Avenue Sanitary	13,304.75	191,105.25	6.9
July 1994	Elmhurst Sanitary Upgrade	186,000	1,244,962.8	14.9
November 1994	Meadowbrook Terrace	151,462.5	1,097,238.5	13.8
December 1994	P.S. 23 Service Area	164,565	1,569,368	10.4
Totals and Average Percent/ Total		1,272,194.25	936,8212.7	13.6

As previously mentioned, determining the cost-effectiveness of service lateral rehabilitation/replacement requires an extensive analysis which in many cases is based on information gained through multiple assumptions. The City of Norfolk took the approach of including the lateral work with the main line rehabilitations in part because of the age of systems, high ground-water elevations in the service areas, and the opportunity to provide comprehensive system rehabilitation. The results of the postrehabilitation flow monitoring were not available, so the cost-effectiveness of the rehabilitation has yet to be determined.

Figure 2 was developed using the cost-effective strategy approach for making service lateral rehabilitation recommendations.

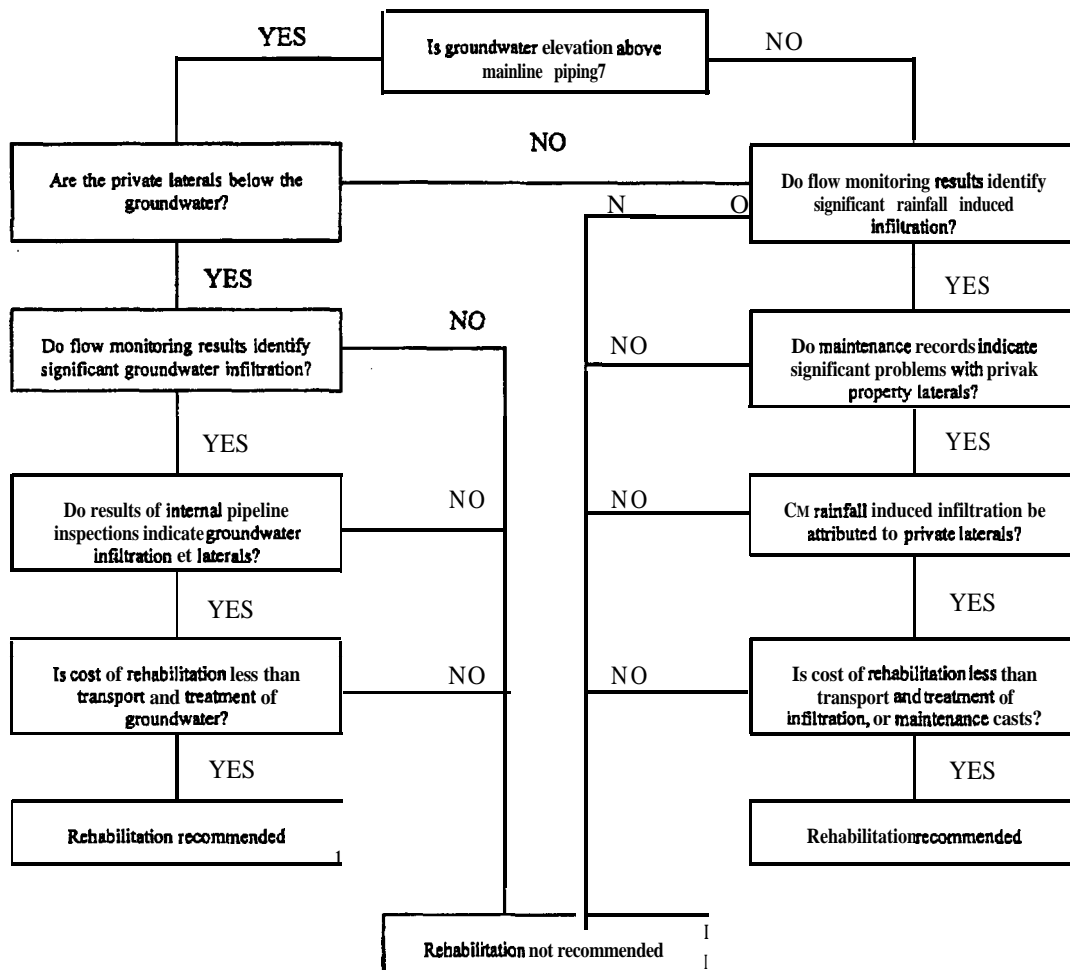

Figure 2. Decision flow chart for recommending lateral rehabilitation.

Figure 1 does not describe all tangible aspects of the evaluation process such as funding sources, public acceptance, landscape impacts, and service disruptions.

In conclusion, comparing the costs of transport and treatment of I/I versus removal is a viable and defensible approach for recommending when rehabilitation is warranted. If the cost of rehabilitation increases at a faster rate than the cost of transport and treatment of the extraneous flows of clean water, however, the acceptable rate of I/I also increases. Conversely, if the cost of rehabilitation decreases because of the development of new materials and processes and further advances in “no-dig” technologies, then it becomes more cost-effective to reduce I/I to lower levels.

References

1. ASCE. 1994. Existing Sewer evaluation and rehabilitation, 2nd ed. Manual of Practice No. 62, New York, NY: American Society of Civil Engineers.
2. Hardenbergh, W.A. 1936. Sewerage and sewage treatment. Scranton, PA: International Textbook Company. p. 123.
3. Steel, E.W. 1953. Water support and sewerage. New York, NY: McGraw Hill.
4. Fair, G.M., J.C. Geyer, and D.A. Okun. 1996. Water supply and wastewater removal. New York, NY: Wiley and **Sons**.
5. Newman, D.G. 1988. Engineering economic analysis, 3rd ed. San Jose, CA: Engineering Press. p. 79.

Case Study: Sanitary Sewer Overflow Abatement in a Multiagency Sewer System, Village of Wilmette, Illinois

Thomas Rowlett and Paul M. Shadrake
Harza Environmental Services, Inc., Chicago, Illinois

Statement of the Problem

Despite having completed an extensive program of sanitary sewer rehabilitation, the Village of Wilmette, Illinois, continues to experience extensive surcharging in the sanitary sewer system serving the western quarter of the Village. This surcharging causes recurring basement flooding throughout the sewer service area, which is a violation of state sanitary sewer regulations and creates potential health hazards for residents. Residents are experiencing considerable nuisance and suffer direct financial loss through damage to property. The residents also experience indirect loss due to diminished use of their property and reduced property values. The village sought the assistance of Harza Environmental Services, Inc., to determine the causes of the surcharging and to develop cost-effective solutions to this problem.

Setting

The Village of Wilmette is a predominantly residential community situated on the shore of Lake Michigan approximately 4 miles north of the northern corporate limit of the City of Chicago. Wilmette is fully developed and has a population of nearly 27,000. The village was incorporated in 1872, making it one of the oldest "suburbs" of the city. The eastern half of the village is served by a combined sewer system constructed in the late 1800s and early 1900s. The 1,750-acre western portion of the village is served by separate sanitary and storm sewer systems. Village records indicate that these systems date from the late 1920s, making Wilmette one of the first communities in Illinois to utilize separate sewers. The western outlet sewer of the Village of Wilmette sanitary sewer system also receives flow from a 60-acre separate sewer area of an adjacent community, the Village of Glenview.

A unique aspect of the sanitary and storm systems serving western Wilmette is that these systems were apparently intended to provide the same level of service as the combined system serving the east side of the village: direct sanitary and stormwater drainage from private property. Each building has both a sanitary sewer service line and a storm sewer service line. The storm service line routes storm runoff and other clear-water flows from downspouts, yard drains, stairwells, window wells, and building footing drains directly to the storm sewer system.

Wilmette's sanitary system discharges to the interceptor sewer system of the Metropolitan Water Reclamation District of Greater Chicago (MWRDGC) for routing to regional wastewater treatment facilities. Figure 1 shows the MWRDGC interceptor network serving Wilmette and surrounding communities. This interceptor also receives dry weather flows from Wilmette's combined sewer system. Combined discharges pass through conventional diversion structures, which limit wet weather flow to the interceptor to 1.5 times dry weather flow.

Figure 1. Map of the Metropolitan Water Reclamation District of Greater Chicago.

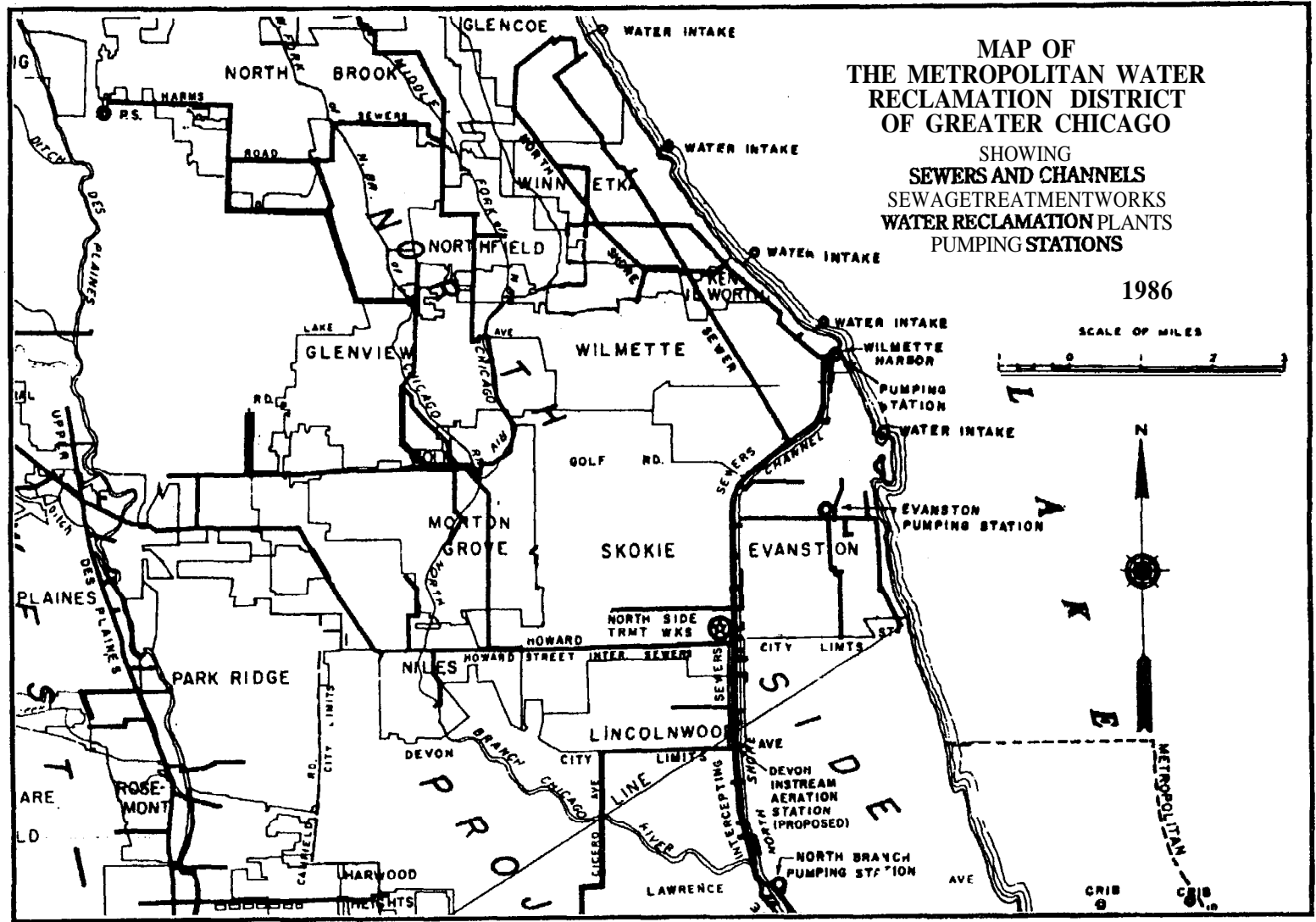

Previous Efforts To Reduce Sanitary Sewer Surcharging

The Village of Wilmette has already undertaken an extensive rehabilitation program to eliminate excessive infiltration and inflow (I/I) from its sanitary sewer system. This program was completed in the late 1980s and brought the village into compliance with MWRDGC's Inflow/Infiltration Corrective Action Program (ICAP) regulations. This compliance program generally follows the cost-effectiveness guidelines associated with the Sewer System Evaluation Survey (SSES) requirements of the Illinois Environmental Protection Agency and the U.S. Environmental Protection Agency (EPA), but also includes certain unique elements associated with assessing impacts on regional collection and treatment systems.

One of the more unique elements of the ICAP program is the standard selected for wet weather flow measurements. ICAP wet weather flow estimates are based on the maximum 4-hour flow generated by a 3-year recurrence interval, 2-hour duration event, which is 2.0 inches of rainfall in 2 hours. This measurement standard reflects the typical time of concentration in the MWRDGC interceptor system, soil conditions in northeastern Illinois, the flow standards used for interceptor design, and the political realities of achieving meaningful I/I reduction in the separate sewer systems of the more than 100 individual municipalities and other governmental agencies that MWRDGC serves.

To put this flow measurement standard in perspective, newer communities having sanitary sewers constructed primarily of plastic pipe are generally able to achieve 4-hour peak wet weather flow rates of 150 to 200 gallons per capita per day (gpcpd) following cost-effective sanitary sewer rehabilitation. Middle-aged communities having a blend of plastic and rubber-joint clay pipe in their systems are typically able to achieve 4-hour peak wet weather flow rates of 250 to 500 gpcpd. Older communities having primarily oakum-joint clay pipe in their systems, such as Wilmette, are able to achieve 4-hour peak wet weather flow rates of 600 to 1200 gpcpd following rehabilitation. Wilmette's systemwide postrehabilitation flow rate of approximately 750 gpcpd falls toward the lower end of the range for communities with sewers of comparable age.

The flow reduction achieved by rehabilitating Wilmette's sanitary sewers has not been sufficient to eliminate wet weather surcharging and resulting basement flooding, however. Therefore, Wilmette has also completed construction of an inline sanitary sewage storage system for a 1,100-acre area in the eastern half of the area served by separate sanitary sewers. This storage system was determined to be the most cost-effective solution for resolving sewer surcharging. It provides basement flooding protection for rainfalls of up to a 50-year recurrence interval. The storage system serving the eastern portion of the sanitary system was placed in operation in 1993 and has functioned satisfactorily for a number of major rainfalls, including a 4.99-inch event that occurred in 1994. Since the eastern and western portions of the Wilmette sanitary system are not interconnected, however, the storage system does not provide any benefit to the 650-acre area in the western part of the village that is served by separate sanitary sewers.

Study Approach

Harza elected to pursue the analysis of the Wilmette sanitary sewer system in three distinct steps. The first step involved the collection of rainfall and corresponding Wilmette sewer system and MWRDGC interceptor system flow data. The primary objectives of this first step were to:

- Determine current dry and wet weather flow rates and gradelines in the Wilmette system.
- Collect data regarding the influence of downstream sewer systems on the Wilmette system.
- Obtain flow data for calibrating a mathematical model of the Wilmette system.

The second step of Harza's analysis effort was development of a computerized hydraulic model to assess the effects of large storms on the operation of Wilmette's sanitary sewer system. This step also included development and evaluation of alternative solutions to resolve surcharging problems.

The third step involves coordination of the village's ongoing inspection and repair efforts to locate and eliminate wet weather flow sources from the sanitary system. Harza is also tracking the efforts of other agencies in addressing the causes of Wilmette sewer system surcharging.

Flow Monitoring Program

A coordinated flow monitoring program was conducted by MWRDGC, the Village of Glenview, and the Village of Wilmette. MWRDGC installed two flowmeters in its interceptor system—one upstream and one downstream of Wilmette's discharge to the interceptor. Glenview installed one flowmeter in Wilmette's Lake Avenue sewer, downstream of all Glenview discharges to this sewer. Harza installed six flowmeters in the Wilmette system: one in the Lake Avenue sewer immediately upstream from the Glenview discharges and five more throughout the Wilmette system, dividing it into individual subsystems. The flow monitoring locations within the Wilmette system are shown in Figure 2. In addition to flowmeters, two rain gauges were also placed in the study area for the flow monitoring period: one by MWRDGC and one by Harza for Wilmette.

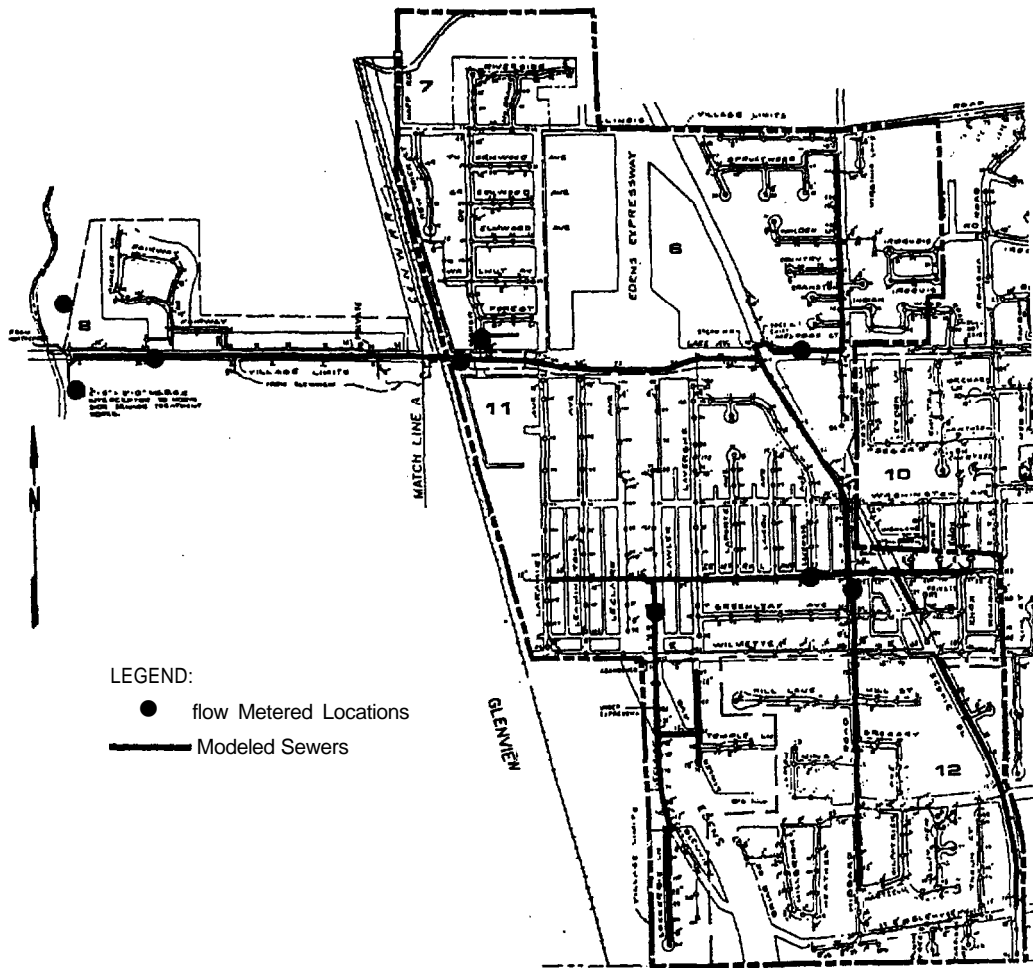

Figure 2. Lake Avenue interceptor.

Flow monitoring was conducted from May through July of 1994. This program was successful in monitoring flows during several "normal" rainfall events of 0.5 to 1.0 inches, as well as during the 4.99-inch major event on June 23 and 24, 1994. This latter rainfall was a 20- to 25-year recurrence interval event.

Selected flow monitoring and estimated flow data are presented in Tables 1 and 2. MWRDGC interceptor dry weather and wet weather flow rates were found to be extremely high. As indicated in Table 1, the midnight-to-5 a.m. dry weather flow measurements suggest that the interceptor is transporting a substantial amount of ground-water infiltration. Interceptor wet weather flow rates, as estimated following ICAP procedures, are also substantially higher than expected, especially considering that all communities upstream of Wilmette have also completed extensive sewer rehabilitation programs.

Table 1. Projected Wet Weather Peak 4-Hour Flows for MWRDGC-ICAP Storm Event (based on 6/20/94 rainfall)

Flow Meter Subsystem	Area (acres)	Population	Dry Weather Flow	Dry Weather Flow per Capita (gpcpd)	Wet Weather Peak 4-Hour Flow (mgd)	Wet Weather Peak 4-Hour Flow per Capita (gpcpd)
1	68.8	536	0.054	101	0.654	1,220
2	117.6	916	0.065	71	0.305	333
3	100.5	783	0.151	193	0.511	653
4	157.7	1,230	0.223	181	1.183	962
5	157.3	1,225	0.158	129	0.458	374
6	39.8	310	0.056	181	0.266	858
System	641.7	5,000	0.707	141	3.377	675
MWRDGC Harms Road 1 (dry weather flow midnight to 5 a.m.)	N/A	30,000	5.067 3.92	169 131	37.7	1,257
MWRDGC Harms Road 2 (dry weather flow midnight to 5 a.m.)	N/A	25,000	4.413 3.55	177 142	31.3	1,252

In particular, the flow monitoring program showed that the MWRDGC interceptor receiving flows from the Wilmette system operated at an extremely high hydraulic gradient during the June 23-24 storm event. Flows in the interceptor surcharged to within 3 feet of the ground surface (20 feet above its invert) and remained at that elevation for nearly 24 hours. This high gradient has proven to be the primary factor causing the sanitary sewer surcharging that occurs in Wilmette.

An additional concern is that there appears to have been a sanitary sewer overflow from the MWRDGC interceptor in the vicinity of the Wilmette connection during the June 23-24 rainfall event. As shown in Table 2, the volume of flow passing the upstream interceptor flowmeter location (MWRDGC HR-2) was approximately 20 million gallons more than the volume passing the downstream interceptor metering

location (MWRDGC HR-1) for the 3-day period June 23-25, 1994. At least part of this flow difference may be the result of flowmeter calibration irregularities. Comparisons between the upstream and downstream meter data during other rainfall periods, however, as indicated in Table 2, imply that interceptor metering was reasonably accurate overall.

Table 2. Wet Weather Flow Volumes

Rainfall Event	Duration	Volume Passing Flowmeter Location			
		MWRDGC (Harms Road 1)	MWRDGC (Harms Road 2)	Glenview Meter 1	Wilmette Meter 1
6/20/94	18 hours (6 a.m. to midnight)	8.64	6.33	1.1	0.82
6/23/94	12 hours (6 a.m. to 6 p.m.)	4.55	3.87	0.83	0.64
6/23-24/94	72 hours (midnight 6/23 to midnight 6/25)	53.1	73.8	N/A	N/A
Dry weather flow	Average of daily flows, 5/28 to 6/10	5.07	4.42	0.61	0.71

Flow metering also showed that certain subareas within the Wilmette system generate higher than expected peak wet weather flow rates, which also contribute to Wilmette sewer surcharging and the resulting basement flooding problem. As indicated in Table 1, the peak wet weather flow rate from the portion of the Wilmette sanitary sewer system that is tributary to the MWRDGC interceptor is lower than the village's systemwide ICAP flow rate of 750 gpcpd. Flow measurements for three of the subareas, #1, #4, and #6, however, show relatively high wet weather flows being generated in these portions of the Wilmette system. Further, the flow patterns recorded show that this flow is entering the system through direct or nearly direct connections.

Sewer System Modeling

To assess the impact of various "design" storm events, Harza developed a computerized hydrologic/hydraulic model of the Wilmette sanitary sewer system. The model selected was EPA's Storm Water Management Model (SWMM). Figure 2 identifies those Wilmette sewers included in a mathematical model of the Wilmette system.

While the Wilmette system has higher than desired wet weather flow, it is still remarkably successful at keeping out stormwater. Even at the estimated 675 gallon per capita, 4-hour maximum flow rate listed in Table 1, the western portion of the system is keeping out nearly 95 percent of the total precipitation amount. This low inflow rate presented a challenge in using SWMM to model the system. It was necessary to synthesize subcatchment physical characteristic data to yield reasonable approximations of runoff rates, volumes, and distributions over time for a variety of rainfall events. Fortunately, the flow metering data collected included a wide range of events representing "light" to "heavy" rainfalls. These data were invaluable in developing and calibrating the SWMM model.

The flow monitoring program showed that storm events as small as 10-year recurrence interval caused the MWRDGC interceptor system to surcharge at extremely high levels. The SWMM model was used to assess the impact of this interceptor surcharging on the Wilmette sanitary system. Selected SWMM model output data for a 10-year recurrence interval rainfall event are presented in Figure 3. The curves

for 3-foot, 6-foot, and 10-foot interceptor depth represent, respectively: maximum dry-weather flow depth in the interceptor, 1 foot above the crown elevation of the interceptor, and the estimated maximum surcharge depth in the interceptor during a 10-year event. These data show that as long as flow levels in the interceptor remain at or below its crown elevation, Wilmette's sanitary system will not be affected significantly. When the interceptor surcharges (flow rises above its crown elevation), however, Wilmette's sewers will also surcharge, generally regardless of the flow rate from Wilmette itself.

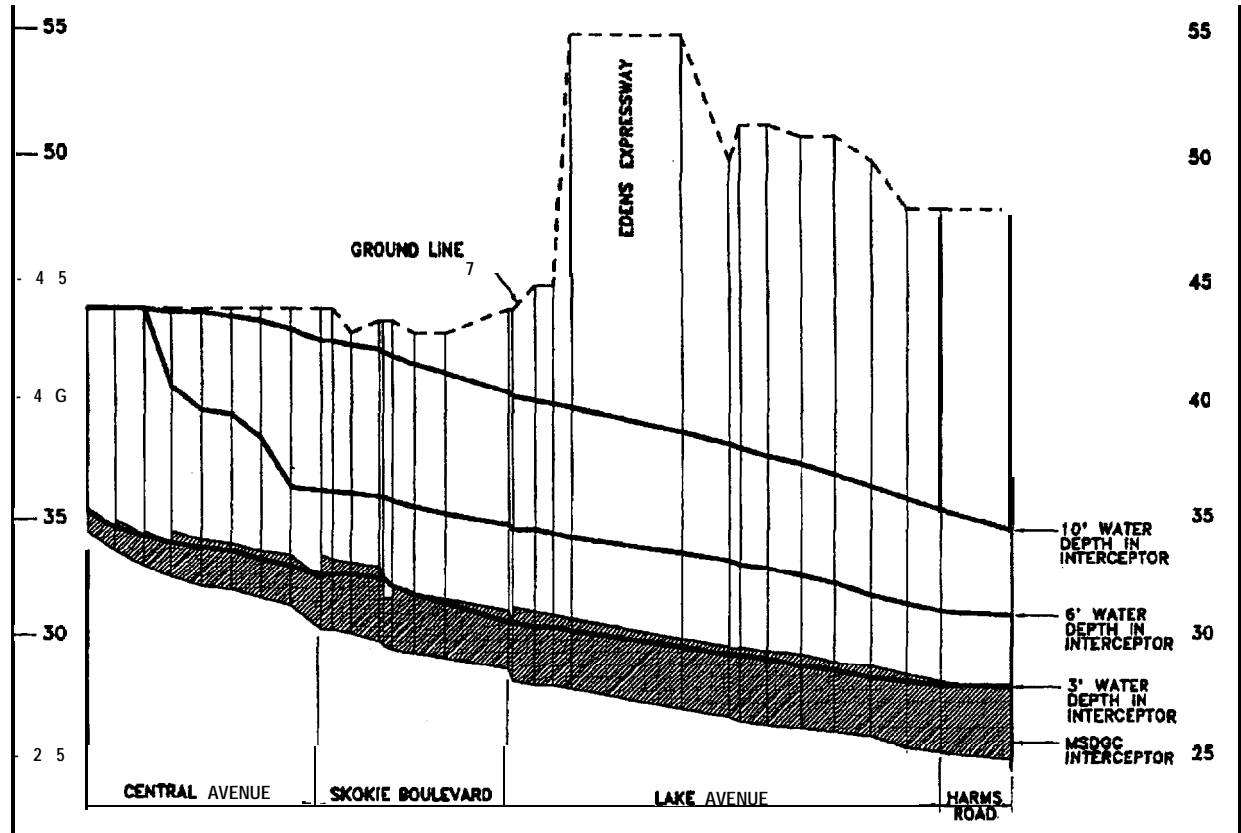

Figure 3. HGL profiles at various downstream water levels.

Surcharge Solutions

The "best" solution for reducing surcharging in the Wilmette sanitary system is to reduce surcharging in the MWRDGC interceptor system. Toward this goal, MWRDGC is conducting an extensive flow monitoring program in the upstream reaches of this interceptor to locate the sources of the high dry weather and wet weather flows. Should this flow monitoring program identify defects in the interceptor system itself, history has shown that MWRDGC will correct these defects as quickly as possible. This interceptor serves a local population of approximately 25,000 residing in five municipalities, however, all of whom have already expended substantial funds to reduce I/I in their sanitary systems. Additional flow reductions in these local systems may not be achievable from technical, economic, or political perspectives.

It would also be possible to construct additional interceptor and regional treatment capacity to resolve the interceptor surcharging problem at Wilmette; however, this would require a substantial expenditure on the part of MWRDGC. More importantly, a regional action to resolve a local wet weather flow problem

may set an undesirable precedent for MWRDGC with regard to the remainder of its interceptor system. MWRDGC generally follows a philosophy that wet weather flows in a separate sanitary system should not be appreciably different from dry weather flows. Therefore, unusually high wet weather flows are considered to be the sole responsibility of the local system owners. These local system owners are encouraged to implement whatever local sewer maintenance, including replacement, may be necessary to correct the wet weather flow problems. MWRDGC takes an aggressive position in enforcing these requirements; however, such actions may take many years to accomplish.

As such, the Village of Wilmette may well find that it must resolve its sanitary surcharge problem by itself, despite the fact that this problem is caused primarily by others. The most practicable solution for Wilmette is to isolate itself from high interceptor surcharge levels by constructing a pump station at its discharge to the MWRDGC interceptor system. Adding a pump station will ensure that a positive discharge from the Wilmette system is maintained at all interceptor levels.

MWRDGC is extremely cautious regarding construction of pump stations and other wet weather flow relief facilities out of concern that these improvement may worsen flooding in the other communities it serves. As such, the maximum discharge rate for pump stations or other wet weather relief facilities permitted by MWRDGC is 375 gpcpd, regardless of rainfall intensity. As indicated in Table 1, the peak 4-hour flow rate (generated by a 3-year rainfall) presently occurring in the western part of the Wilmette system is 675 gpcpd. Instantaneous peak rates from more severe rainfalls may reach 2,000 gpcpd. Therefore, in addition to a pump station, Wilmette will also need to construct storage facilities for capturing excess flows during peak flow periods. The size of such a facility depends on the level of protection desired. A storage capacity of 200,000 cubic feet is required for 50-year, 1-hour rainfall, whereas a capacity of 500,000 cubic feet is required for a 50-year, 24-hour rainfall based on current wet weather flows in the Wilmette system.

Since Wilmette would be solely responsible for the cost of any pumping and storage facilities needed, it is prudent for the village to reduce wet weather flows in its system as much as is practical. The village has already completed an extensive SSES program involving manhole cover replacements, general manhole repair, spot sewer replacement, disconnection of storm sewers, and other miscellaneous repairs. These repairs constitute the "easy" fixes in Wilmette's sanitary system. Intensive investigations will be required to locate additional I/I sources. The following additional investigations have been recommended to confirm the effectiveness of previous repairs and identify "new" I/I sources:

- Reinspect all sanitary manholes and, in particular, verify the condition of cover/frame seals.
- Dye-test parking lot drains and downspouts at commercial buildings to locate direct connections.
- Dye-test storm sewers that cross sanitary sewers to locate direct and indirect connections.
- Dye-test residential private storm drains to locate direct connections.

This inspection program is presently under way, but no significant I/I sources have been identified thus far. Manholes have been found to be in good condition, and no cross-connected private drains have been found at commercial buildings. The village has initiated the storm sewer dye-testing program but has not found any additional cross connections as yet.

There is also one additional potential source of inflow into the sanitary sewer system, but this source will be difficult, if not impossible, to correct. Each building has been provided with both a sanitary service line and storm service line. Figure 4 shows the typical configuration of these service lines. These services are generally 50 to 70 years old, are constructed of oakum-joint clay tile, and are laid in a common trench.

Native subsoils in the Wilmette area are dense clays having very low permeability. Therefore, the potential for indirect cross flows between the storm and sanitary services is extremely high.

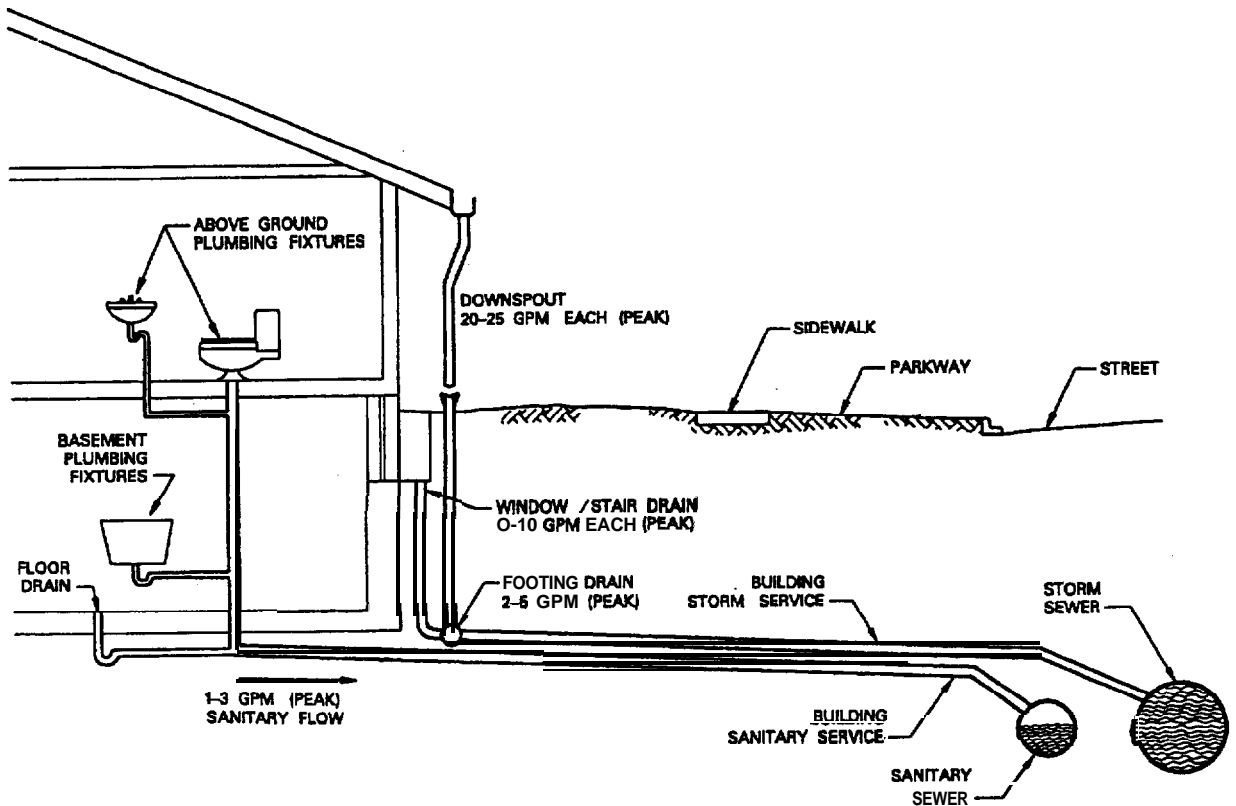

Figure 4. Typical configuration of storm and sanitary sewer.

This situation is further exacerbated by an undersized storm sewer system. The area's storm system only has sufficient capacity to transport up to 6-month recurrence interval rainfall events without surcharging. Larger rainfall events raise storm sewer flow levels nearly to ground elevation, thus "pressurizing" building storm service lines and increasing the potential for cross flows to the sanitary system. This cross-flow situation affects virtually all buildings in the study area. Therefore, the cost and disturbance associated with repairing these services make this problem largely unaddressable by direct means. The village is presently analyzing the storm sewer system to determine whether surcharging can be reduced, however, thereby reducing the potential for indirect storm cross flows to the sanitary system.

It is also suspected that the indirect cross-flow path between sanitary and storm services is a "two-way street" depending on which sewer system—storm or sanitary—is surcharged to a higher level. As previously discussed and as indicated in Table 2, it appears that 20 million gallons of wastewater overflowed from the MWRDGC interceptor system over the 3-day period during and following the June 23-24, 1994, rainfall. The Villages of Wilmette and Glenview did not observe any overflowing manholes or other visible discharges from their systems during this period, however. In addition, flow monitoring results showed that sanitary flow levels never reached ground elevations. The sanitary system also appeared to remain surcharged substantially longer than the storm system following this rainfall.

From these observations, it is hypothesized that the "missing" sanitary flow exfiltrated from individual sanitary services to adjacent storm services and was discharged to area waterways through the Wilmette storm sewer system. If this hypothesis is correct and Wilmette is successful in controlling sanitary sewer

surcharging, sanitary sewer overflows to area waterways will also be minimized by Wilmette's sanitary system improvement efforts. Wilmette will be testing this hypothesis as part of its continuing investigations of its sanitary and storm sewer systems. A pilot program involving the installation of storm inlet flow restrictors has been suggested for a selected portion of the village's storm sewer system to determine what effect reducing storm surcharging has on sanitary system flows. The village will consider this program after it completes the sanitary sewer system inspection and repair efforts previously described.

Acknowledgments

The authors express their appreciation for the assistance provided by many colleagues in the study of the Wilmette sanitary sewer system and in the preparation of this technical paper. In particular, we appreciate the assistance of Richard Hansen, Director of Public Works, and Donna Jakubowski, Zill Kahn, Ray Ames, and Brad Enright of the Village of Wilmette; William Porter, Director of Public Works, and Scott Huebner of the Village of Glenview; and Paul Griesbach, Jim Timmons, Harry Krajcer, and other staff of the MWRDGC. The authors also acknowledge the assistance of the Harza project team, including Richard Persaud, Heekyung Park, and Choo Teoh.

Master Planning for the Removal of Sanitary Sewer Overflows in the Sanitary Sewer System in Lima, Ohio

Shane F. Clark
URS Consultants, Inc., Columbus, Ohio

Alice H. Godsey
City of Lima, Lima, Ohio

Introduction

The City of Lima is located in northwest Ohio, approximately 90 miles northwest of Columbus. It is situated on the upper reaches of the Ottawa River, where the topography is flat and the land is drained by many small ditches throughout the city. Lima was founded more than a century ago and has grown to a current population of approximately 45,500. The city is supported by a strong industrial influence that expanded rapidly during and immediately following World War II but has since declined. Sewer systems have been constructed in Lima since the early days of the city. The type of sewers that now exist reflect the philosophies of when they were constructed. Some of the sewer systems constructed to meet the needs of industrial and residential development in years past are now considered inadequate because of direct overflows to streams and ditches. The discharge from these systems is now in violation of current water-quality standards. Lima must now find affordable ways to abate its pollution problems in the face of decreasing revenues from the industrial sector.

Background

Lima is **sewered** by both combined and separate sanitary sewers. The central core of the city is the oldest part, which was constructed using a combined sewer system. The combined sewers were designed to carry dry weather flows to the treatment plant, allowing wet weather flows to overflow to nearby streams. Beginning in the 1940s, the philosophy of sewer design began to change, and sanitary sewers were constructed separate from storm sewers. Although the systems were technically separate, inflow sources continued to be constructed for several decades. Most of the inflow sources are foundation drains and roof leaders. To provide relief to the sanitary sewers during storm events, sanitary sewer overflow (SSO) structures were installed as part of the system. Some overflow structures were constructed with the original sanitary sewer, while others were added later to relieve chronic flooding in specific areas. The combined sewer central core of Lima is now surrounded by seven distinct areas served by separate sanitary sewers as shown in Figure 1.

Each of the sanitary sewer systems discharge into the central core's combined sewers through a downstream pump station, except part of the Findlay Road system that flows into it by gravity. Lima's sanitary sewer system is somewhat unique; because of the pump stations, the hydraulic conditions that exist in the combined sewers do not influence the separate sanitary sewer system.

The seven separate sanitary sewer systems in Lima contain 37 overflow structures regulated by the Ohio Environmental Protection Agency. Currently, neither the Ohio Environmental Protection Agency nor the U.S. Environmental Protection Agency (EPA) has established an SSO policy. Legislation on the state level in Ohio, however, requires that no untreated wastewater be permitted to reach the waters of the state. This essentially makes overflow structures illegal. In Lima, overflow structures were permitted through the National Pollutant Discharge Elimination System (NPDES) permit system until 1990. Subsequent negotiations between Lima and the Ohio Environmental Protection Agency resulted in the issuance of findings and orders and removed the overflow structures from the NPDES permit. The new Administrative Orders require Lima to develop a comprehensive master plan that will lead to the elimination of all existing overflow structures.

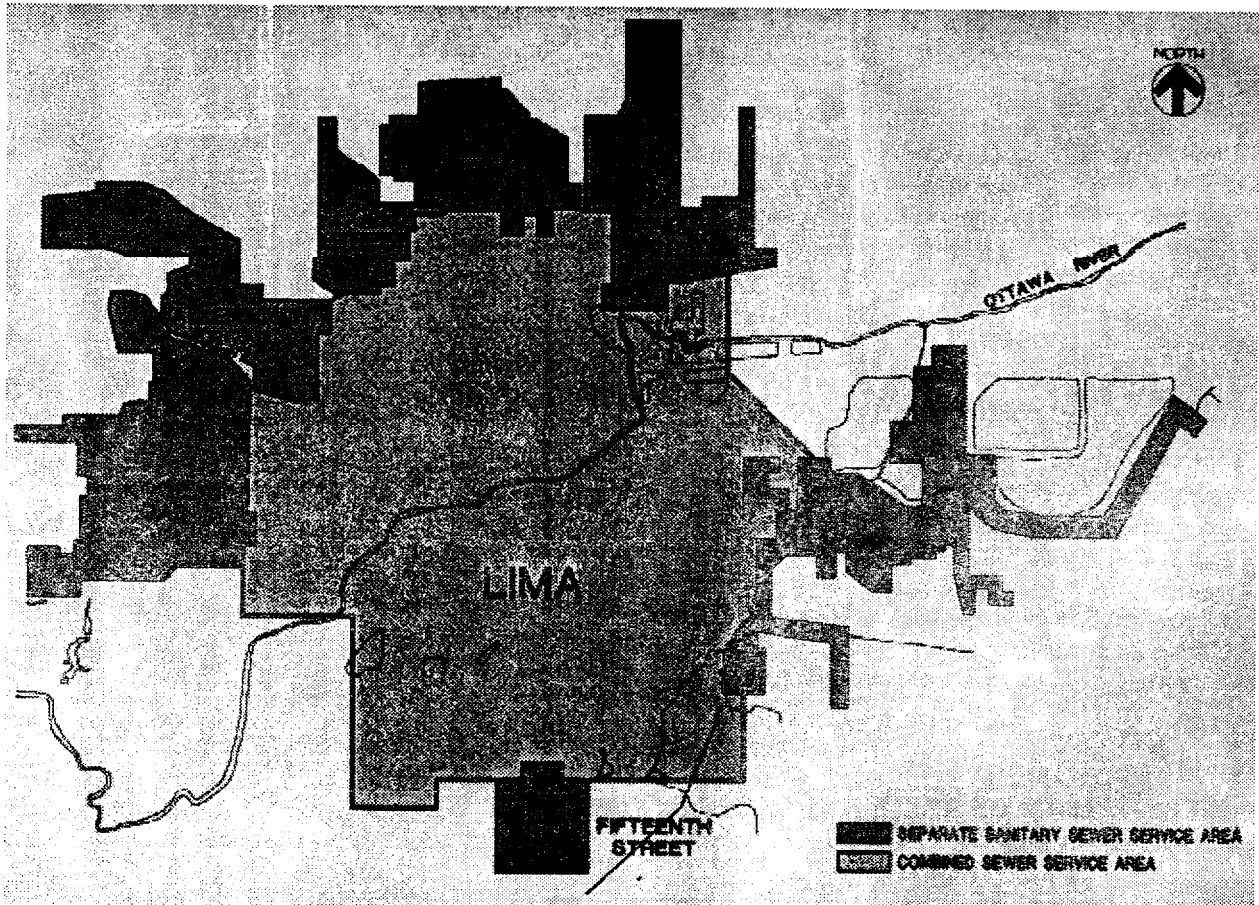

Figure 1. City of Lima, Ohio, Sewer Service areas.

The level of protection against basement and street flooding is often associated with the design storm frequency. The question many communities have is whether final SSO policies will include provisions for allowing overflow structures to remain active above a certain design storm. Overflow structures that are active only at these times may be considered to behave more like combined sewer overflow (CSO) structures and may be regulated in a similar way.

Methodology

Hydraulic Model Simulation

The common methods of computer simulation include the design storm approach, continuous simulation, or a combination of the two that uses past rainfall history. Each method has its own inherent advantages and disadvantages. The design storm approach is probably the most popular because of its simplicity and its similarity with the stormwater drainage criteria that many municipalities use. Continuous simulation is based on actual rainfall history and is believed to produce results that more truly represent the locale of the study. A combination approach uses past rainfall over several years to develop localized design storms and perhaps a better representation of the hydrographs for the specific area. The method ultimately selected is usually based on the goals and objectives, available data, the level of detail a system model must have, and the time and money available to perform the study.

In the design storm method, the watershed is characterized by comparing monitored field data with the hydrologic model. The hydrologic parameters of the model are modified as necessary until the results

match the monitored data within an acceptable tolerance, usually about 3 percent. The model must be calibrated using several storm events to gain confidence in its accuracy. A design storm is defined as the volume of precipitation falling uniformly over a catchment for a specific duration, which has a specific probability of return. When these three elements are combined, they produce intensity, duration, and frequency (IDF) curves. These data are commonly available in Technical Release No. 40 by the National Weather Service. The fundamental assumption in the design storm method is that the transformation of rainfall to produce runoff is linear. Because the model calibration is limited to the range of storms that occurred during field monitoring, the runoff produced by much larger design storms must be projected using the calibrated model. This produces more conservative results.

Because a much shorter time step is used in the computer analysis, the model developed from the design storm method will be more sensitive to peak flows from shorter storms of high intensity than can be economically modeled with continuous simulation. Therefore, the design storm method was deemed more suitable to the conditions of the watershed and goals and objectives of the master plan. This method is ideally suited for SSO studies in which continued monitoring and modeling of the system must be conducted to determine the effects of improvements, such as inflow source and overflow structure elimination. The results of design storm analyses are also more repeatable for use in quantifying inflow reduction efforts.

The model was developed using the XP-SWMM computer program. This program uses the EPA SWMM program as the main calculating engine, but adds a graphical interface. Field data necessary to calibrate the model included continuous rainfall and sewer flow measurements. Rainfall data were collected using a tipping bucket rain gauge, and flow data were obtained using the velocity-area type of flowmeters. Both rainfall and flowmeters recorded data at **15-minute intervals**.

Effective Watershed Area

The most definitive parameter in stormwater or CSO modeling is the catchment area. This parameter is usually known and can be readily verified. Less is known about catchment shape and soil characteristics, and therefore these parameters are often used as calibration parameters in modeling. In typical hydrologic analyses, rainfall leaves the system by losses or as excess runoff. In areas where significant sanitary sewer inflow is present, however, there is another means for excess runoff to leave the system. Studies of sanitary sewer systems must develop a means to separate the excess runoff entering the storm sewer from that entering the sanitary sewer. Because the sanitary sewer is the object of an SSO study, rainfall must be transformed to excess runoff entering the sanitary sewer system only.

Two approaches to separating runoff were considered in this project. One is to use an "effective hyetograph" in which rainfall volume is reduced to represent the runoff entering the sanitary system only, as illustrated in Figure 2. The remaining portion of the hyetograph represents runoff that leaves the watershed by other means (i.e., the storm system). In this method, the hyetograph becomes a calibration parameter and is modified by reducing the total rainfall volume until the model results corroborate the observed sanitary sewer flows. A concern of this approach is that altering the hyetograph will not produce a proportionate change in excess runoff. Attempting to apply the same volume reduction factor used in the actual storm hyetograph to a design storm hyetograph during calibration will introduce errors because rainfall available for loss to soil infiltration and ponding does not remain constant. In other words, infiltration and ponding will not affect the excess runoff produced by a small storm the same as they affect the runoff from a much larger storm.

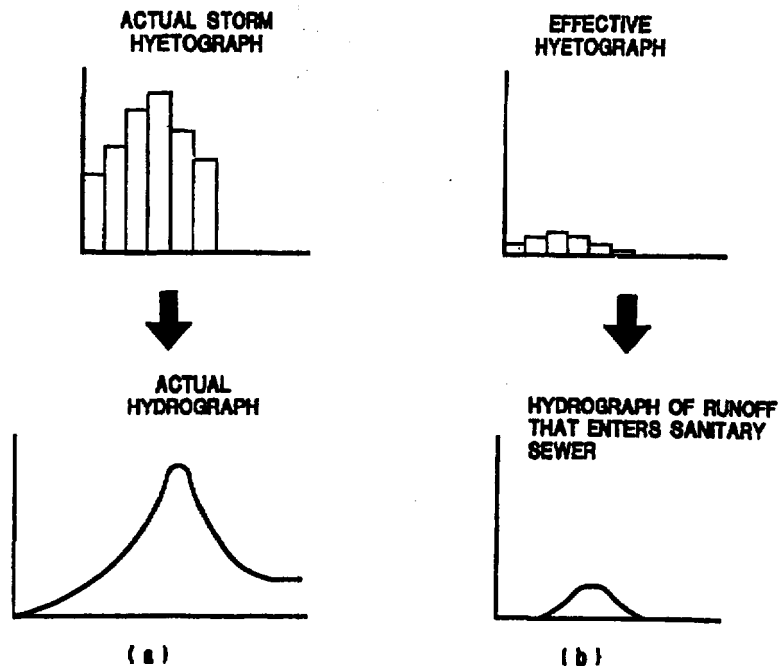

Figure 2. Effective hyetograph approach to watershed calibration: (a) actual hydrograph and (b) hydrograph from rainfall entering sanitary sewer.

The second approach considered is to determine the “effective area” of the catchment, that is, the actual area over which rain will fall and become excess runoff in the sanitary sewer system. Excess runoff produced by rainfall will be routed to either the storm sewer or the sanitary sewer. These areas are typically intermixed, which makes delineating their boundaries using maps and field work very difficult; therefore, the catchment area is used as a calibration parameter. The underlying assumption is that the degree of sanitary inflow is proportionate to the effective area of the catchment. In the Lima study, the effective area ranged from 2 to 25 percent of the total area served by the sanitary sewer system, depending on the severity of the inflow in each subbasin. Figure 3 is a graphical representation of the effective area method in a system such as Lima’s that contains sanitary, combined, and storm sewer systems. This figure also illustrates how the direction rainfall takes once it becomes excess runoff determines whether it falls under EPA’s SSO, CSO, or stormwater policies.

Master Plan Approach

Although Ohio is in EPA Region 5, the Lima SSO master plan is patterned after the three-phase approach outlined in the EPA Region 6 SSO draft policy. Phase 1 of the policy includes the following activities:

- Collection and review of available system maps and records.
- Field verification of record data.
- Monitoring of flows and rainfall.

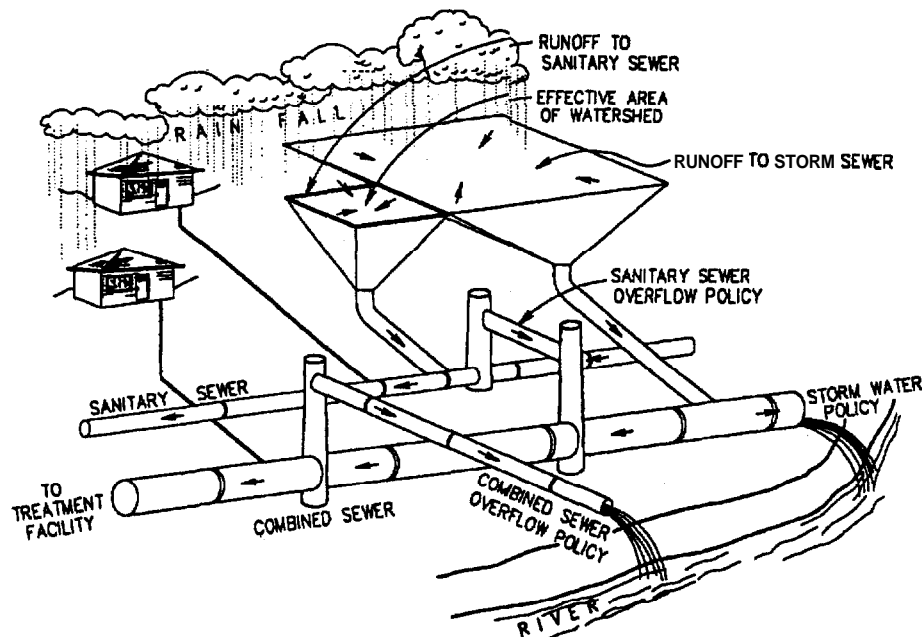

Figure 3. Effective area approach to watershed calibration.

- Identification of inflow sources.
- Physical inspection of overflow structures.
- Characterization of the sanitary system and development of the hydrologic and hydraulic models.
- Analysis of the sanitary system using the design storm.

Record drawings of the sanitary sewer system were compiled and entered in digital format, both to be used as the network for the model and to consolidate all the sanitary sewer information into an easily retrievable graphical format for use by the city. Sources of inflow were identified by smoke testing the entire sanitary system, which was supplemented with dye testing where necessary. Types of clean water sources discovered during this phase include roof leaders, yard drains, separated joints, cracked pipes, leaky manhole walls, and direct connections from catch basins. Inspection of the sewer system by peering down manholes and from televised sewer records revealed that some pipes were surcharged by **ponded** water. Areas of suspected cross connections could not always be confirmed because the **ponded** condition prevented smoke from passing through.

Findings

The field investigation phase of the project was successful in finding many inflow sources. Most of these consisted of obvious cross connections such as roof drains, catch basins, and direct connections between the sanitary and storm systems. Yet it also suggested that other sources may be present, including sources that are more difficult to pinpoint such as leaky joints, cracked pipes, trapped cross connections, and sump pumps.

Modeling results were based on the 5-, 10-, and 25-year design storms to determine what the overflow structure activity was and where constrictions exist in the system. The results of the model confirmed that some overflow structures were not active and could be eliminated immediately. Others were classified based on the volume of water leaving the system through the overflow structure for the duration of the storm. Generally, the most active overflow structures were found immediately upstream of pump stations. In the West Street area, it was determined that as much as 20 percent of the total storm volume entering the sanitary system exited through a single overflow structure located next to the most downstream pump station. The downstream pump stations that pump into the combined system were also under capacity. The model demonstrated how wastewater was backing up into the system until it found relief at overflow structures or by street flooding in very low areas. The upper reaches of the system were also not exempt from flooding due to insufficient pipeline capacity to handle the flows during larger storm events. The activity of the overflow structures and severity of the flooding depended upon the magnitude of the design storm. There was activity in all but only a few overflow structures during storms as small as the 5-year design storm.

Discussion

Very little information was available pertaining to sanitary flows or the activity of overflow structures before the study. The city is conducting an overflow structure monitoring program that uses a wood block set in the overflow pipe leading out of the sanitary manhole. The block is placed just inside the overflow pipe and secured by rope to a manhole step. The direction in which the block is observed to move after the rain event suggests whether inflow or outflow occurred at the sanitary manhole.

Records from the past 2 years show that the sanitary sewer overflowed into the storm sewer for 70 percent of the storm events; inflow into the sanitary sewer occurred during the other storm events. Although it cannot be confirmed without flow monitoring each overflow, it is suspected that some overflow structures experience both outflow and inflow during a single storm. The peak flow from the sanitary sewer may move the block one direction, only to have the peak flow from the watershed runoff move it back. This would most likely occur when the overflow is to a ditch or storm sewer where the storm catchment area extends beyond the sanitary sewer service area, resulting in a lagged peak flow. Rodents inhabiting the sewer are also suspected of dislodging the blocks between storm events, resulting in erratic data. Therefore, information provided by the wood block monitoring system was used with caution during the study.

Flow monitoring during dry periods was conducted to determine whether infiltration into the sanitary sewers was excessive. The excessiveness criterion used by the Ohio Environmental Protection Agency is 120 gallons per capita per day (GPCD) for primarily residential areas and 2,500 gallons per day per inch-mile (GPD/IM) of sewer for commercial or mixed land-use areas. Based on these criteria, only three of the 20 subbasins monitored were considered marginal for excessive infiltration.

The master plan recommends a three-phase approach for eliminating overflow structures:

- Phase 1: Begin an inflow reduction program designed to eliminate as many inflow sources and cross connections as possible, starting with those thought to be contributing the most inflow and those that are the most economical to remove.
- Phase 2: Eliminate 18 or 19 overflow structures identified within the study upon completion of the Phase 1 work, incorporate flow control devices in remaining overflow structures, and continue flow monitoring the sanitary sewer system to determine the effectiveness of the inflow reduction program. Monitoring will be conducted concurrently with Phases 1 and 3. The computer model will then be recalibrated, and improvements recommended.

- Phase 3: Perform the recommended facility upgrades to provide sufficient capacity to the sanitary system based on the accepted level of protection, and eliminate overflow structures determined to be inactive below the design storm.

An estimated 60 to 70 percent of the inflow could be eliminated by conducting an aggressive, comprehensive inflow reduction program. This percentage of removal is higher than normally expected in typical communities, but is believed possible in Lima because of the anticipated elimination of reverse flows from the storm sewers to the sanitary sewers. Based on these levels of inflow reduction, the 5-, 10-, and 25-year design storms were entered into the hydraulic model. A series of simulations were performed to optimize the wastewater facility improvements necessary to reduce the risk of basement flooding to an acceptable level, defined as a maximum manhole surcharge level of within 5 feet of the ground surface. The estimated project costs for the Phase 1, 2, and 3 programs for various design storms are presented in Table 1.

Table 1. Estimated Project Costs for Lima SSO Elimination Program

Phase		Lost Creek	West Street	Koop Road	Allentown Road	Total
B-Year Design Storm						
1, 2	Inflow reduction program	\$265,000	\$226,700	\$273,000	\$150,500	
3	Sewer system improvements	942,700	50,500	1,381,600	446,700	
3	Pump station improvements	701,000	523,000	528,500	599,800	
	Total 5-year design storm	\$1,908,700	\$800,200	\$2,183,100	\$1,197,000	\$6,089,000
10-Year Design Storm						
1, 2	Inflow reduction program	\$265,000	\$226,700	\$273,000	\$150,500	
3	Sewer system improvements	1,168,200	50,500	1,612,200	839,600	
3	Pump station improvements	742,000	575,000	711,000	905,600	
	Total 10-year design storm	\$2,175,200	\$652,200	\$2,596,200	\$1,895,700	\$7,519,300

Phase		Lost Creek	West Street	Koop Road	Allentown Road	Total
25-Year Design Storm						
1, 2	Inflow reduction program	\$265,000	\$226,700	\$273,000	\$150,500	
3	Sewer system improvements	1,185,800	176,800	1,767,800	1,065,700	
3	Pump station improvements	895,200	769,600	805,500	1,035,300	
	Total 25-year design storm	\$2,346,000	\$1,173,100	\$2,846,300	\$2,251,500	\$8,616,900

Note: Costs are based on January 1995 dollar value.

The key to a successful program is in balancing inflow source elimination with end-of-pipe solutions. The effectiveness of an inflow reduction program is very difficult to determine before it is completed; therefore, continued monitoring must accompany the inflow reduction program. The monitoring program will compare sanitary flows after inflow sources have been eliminated with pre-inflow removal flows. Modifications can be made to the Phase 3 recommendations based on the actual inflow reduction amount.

The downstream sanitary pump stations discharge into the combined sewer system that serves the central part of the city. The capacity of the combined sewer system is not known because this area was not included in the study. Flow from the sanitary sewer system affects the combined sewer system; therefore, both the SSO study and a CSO study must be coordinated. The sanitary pump stations are not permitted to cause an increase in flow at the CSO structures because this is in violation of Ohio Environmental Protection Agency policy. The city intends to initiate a master plan of the combined sewer system similar to that of the separate sanitary sewer system. This study will be coordinated with the inflow reduction program to optimize pump capacity and equalization storage requirements.

Summary

Costs associated with removing overflow structures in Lima are significant. Although SSOs are currently regulated by Ohio state law, the establishment of a national policy may offer relief to Ohio's current position of SSO elimination at any cost. Although the effect of SSOs on water quality was not within the scope of this project, the cost results in Table 1 suggest that it may need to be considered in future SSO policy-making if an affordable solution is to be realized. A fair solution should attempt to balance the costs of removal and subsequent system upgrades with a desired level of protection to the environment.

Combating Sanitary Sewer Overflows in Western Carolina

Lauren R. Hildebrand
Western Carolina Regional Sewer Authority, Greenville, South Carolina

David T. Zimmer and Aaron M. Frazier
Camp Dresser & McKee, Inc., Charlotte, North Carolina

Project Background

The Western Carolina Regional Sewer Authority has experienced wet weather overflows in the trunk sewer system serving the **Mauldin** Road wastewater treatment plant, which is the largest of the authority's treatment plants. Sewer system overflows occur when peak wet weather flows exceed the trunk sewer system's conveyance capacity. Previous studies and sewer system flow monitoring have confirmed that wet weather sewer surcharging and overflows in the authority's trunk sewer system are primarily the result of rainfall-dependent infiltration and inflow (**RDII**) entering the sewer collection system, much of which is owned and operated by seven separate sewer subdistricts within the **Mauldin** Road service area. **RDII** is water other than wastewater that enters the sewer system during a rainfall event through defects in the pipe system and laterals or through other unwanted sources such as stormwater drainage connections, foundation drains, or manhole covers. In addition to system capacity problems and overflows, **RDII** results in excess influent flows to the **Mauldin** Road wastewater treatment plant.

In an amended court order dated December 31, 1991, the South Carolina Department of Health and Environmental Control (DHEC) directed the authority to perform a wet weather engineering study of the **Mauldin** Road trunk sewer system. The wet weather engineering study was to include a comprehensive hydraulic model analysis of the **Mauldin** Road trunk sewer system and a recommended program of sewer system improvements to eliminate overflows. In January 1992, the authority selected Camp Dresser & McKee, Inc. (CDM), to perform the wet weather engineering study.

The service area of the **Mauldin** Road wastewater treatment plant consists of the Reedy River and the Brushy Creek drainage basins, with a total **sewered** area of approximately 41 square miles. Four primary trunk sewers convey flow into the **Mauldin** Road plant: two are parallel to Reedy River (36 and 48 inches in diameter), and two are parallel to Brushy Creek (24 and 30 inches in diameter). The **Mauldin** Road wastewater treatment plant has a permitted average discharge of 29 million gallons per day (mgd) and an average dry weather flow of approximately 20 mgd. Currently, the existing Reedy River and Brushy Creek trunk sewers can deliver up to 90 mgd during peak wet weather flows. The plant can treat approximately 40 mgd for a short duration (1 to 2 days) and has a **15-million-gallon** flow equalization storage basin where excess wet weather flow can be stored when flow to the plant is greater than the plant's treatment capacity.

The primary goal of this project was to develop and implement a phased plan of sewer system improvements to reduce **RDII**, eliminate overflows, and prevent overloading of the **Mauldin** Road wastewater treatment plant. Improvements considered included trunk sewer improvements, flow equalization facilities, and sewer rehabilitation. The study emphasized solutions that benefit the performance of the **Mauldin** Road wastewater treatment plant collection system as a whole and that do not increase overflow problems downstream.

This paper presents an overview of the wet weather engineering study approach, recommendations, and implementation of improvements.

Modeling Approach

The Extended Transport (EXTRAN) module of the U.S. Environmental Protection Agency's Stormwater Management Model (SWMM) was used to perform the hydraulic modeling. Although typically a stormwater model, EXTRAN was chosen for its ability to 1) handle surcharging, backwater, and overflow conditions, which were common in the trunk sewer system; and 2) route hydrographs dynamically and predict a time-varying series of flows and water surface elevations throughout the system during a wet weather event.

EXTRAN is a dynamic model that allows simulation of an entire storm event, in contrast to a steady-state or static model that models the system for only one point in time. The use of a dynamic model was important in the evaluation of the alternative sanitary sewer system improvements to assess the impacts of different sizes and locations of flow equalization storage. The dynamic model also assisted in the consideration of several other important factors, such as the timing of hydrograph peaks from the tributary sewers, the impacts of different line sizes on the shapes of flow hydrographs, and the benefits of sewer rehabilitation in reducing peak RDII flows and volumes. Because the model included the entire trunk sewer system, the analysis ensured that trunk sewer improvements would not lead to increased problems downstream.

The initial portion of the wet weather engineering study focused on development and calibration of the hydraulic model of the Mauldin Road trunk sewer system. As-built drawings and survey data were used to develop a computer model representation of the trunk sewer system. To calibrate the model, flow monitoring data and accounts of overflow events witnessed by authority staff members were used to verify that the hydraulic model was accurately representing flow conditions in the system. Historical rainfall records were also used to determine the relative frequency of the storm events for which flow monitoring data were available, and to develop planning storm events for use in evaluating the effectiveness of alternative sewer system improvements.

Sewer System Improvement Alternatives

Once the hydraulic model was developed and calibrated, it was used to analyze the trunk sewer system. Early analyses identified areas in the system that were prone to overflows, as well as the reasons for the overflows. Later analyses were aimed at developing a series of sewer system improvement alternatives that would eliminate overflows in the sewer system for planning storms with 1-, 2-, and 10-year return periods, as determined from historical rainfall records. Analysis of multiple planning storms was used to develop a phased improvements plan based on addressing the most critical problems on a short-term schedule while designing a long-term program to eliminate wet weather overflows for larger storm events.

As discussed previously, sewer system overflows within the Mauldin Road wastewater treatment plant service area occur when peak wet weather flows exceed the trunk sewer system's conveyance capacity. Three basic types of improvements can alleviate wet weather overflow problems: 1) increasing trunk sewer capacity to enable conveyance of peak wet weather flows, 2) reducing peak wet weather flows through flow equalization storage, and 3) reducing RDII through sewer rehabilitation.

Trunk sewer system improvements can be effective in relieving existing pipelines prone to surcharging and overflows by increasing sewer capacity. Trunk sewer improvement alternatives include replacement of sewers with larger diameter lines, construction of relief sewers, and pressurization of sewer lines. Because trunk sewer system improvements will result in increased downstream wet weather peak flows, downstream sewer system improvements (e.g., additional trunk sewer capacity, plant equalization and treatment) may be required in conjunction with upstream improvements.

Flow equalization storage facilities offer a means of reducing or eliminating wet weather overflows by storing peak flows in excess of the sewer capacity. During wet weather, flow may be temporarily stored

until the storm event has passed. Flow is returned to the trunk sewer once capacity is available to convey the flow to the treatment plant. This provides equalization of hydraulic surges and reduction in peak wet weather flows within the sewer system downstream of the equalization storage facility. Flow equalization facilities may also be located at the wastewater treatment plant. When flow conveyed to the plant by the trunk sewers exceeds the plant treatment capacity, flow may be diverted temporarily to the equalization storage facility. Flow equalization storage at the plant may be used in conjunction with increased trunk sewer conveyance capacity to eliminate overflows within the trunk sewer system.

Sewer rehabilitation reduces RDII and peak wet weather flows by eliminating the sources of the infiltration and inflow into the sewer system. A sewer rehabilitation program identifies and repairs defective sewer lines, laterals, and lateral connections. Major inflow sources, such as stormwater drainage connections, broken manholes, and foundation drains, are also identified and corrected. Because the separate subdistrict collection systems encompass a substantially greater length of sewer than the authority trunk sewer system, the majority of RDII conveyed through the trunk sewer system originates within the subdistricts. Therefore, sewer rehabilitation efforts aimed at overflow reduction should focus on the subdistrict collection systems.

Evaluation of Improvement Alternatives

Evaluation of the alternative improvements to the Mauldin Road sewer system was performed by first screening all initial alternative improvements and then performing a more detailed evaluation of those alternatives found to best eliminate overflows. The initial screening of the improvement alternatives was conducted by performing numerous hydraulic model simulations to determine the effectiveness of the improvements in eliminating overflows. Only those alternatives that eliminated overflows for a 2-year planning storm event were considered further. The detailed evaluation consisted of developing planning-level capital cost estimates for all trunk sewer system improvement alternatives. In addition, alternatives were compared using non-cost factors such as constructability, reliability, ease of operation and maintenance, permissibility, potential environmental impacts, and public acceptance/aesthetics (visual and odor concerns).

The initial trunk sewer system improvement alternatives focused on combinations of relief sewers, on-line and off-line flow equalization storage, and localized sewer improvements; they did not include sewer rehabilitation. Related improvements required at the Mauldin Road wastewater treatment plant were also evaluated, including upgrade and expansion of influent pumping, preliminary treatment (screening and grit removal), and flow equalization facilities.

Subdistrict sewer rehabilitation was evaluated by comparing the costs of performing sewer rehabilitation with the associated benefits in terms of the expected reduction in RDII. Reductions in RDII from sewer rehabilitation may allow other trunk sewer system improvements to be eliminated or downsized, thereby reducing the overall program cost.

Evaluation of the improvement alternatives supported the use of replacement and relief sewers in the short-term to increase the capacity of the system in delivering flow to the Mauldin Road wastewater treatment plant. Relief or replacement sewer improvements were shown to have the lowest cost of the sewer system improvement alternatives. While some of the other alternatives received higher ratings in the noncost factors, differences in the overall ratings of any of the alternatives were not significant. Relief and replacement sewer improvements also received the highest ratings in the areas of reliability and operation and maintenance.

In general, the evaluation showed that the total amount of flow equalization storage needed is approximately the same regardless of whether the storage is located within the sewer system, at the plant, or a combination of locations. The availability of existing lagoons at the Mauldin Road wastewater treatment plant makes the addition of equalization storage at the plant more cost effective than adding flow equalization storage within the trunk sewer system. The significant difference in the per-gallon cost

of providing equalization storage at the plant more than offsets the difference in cost of requiring larger replacement sewers to bring the increased flow rates to the plant. Therefore, the cost-effectiveness evaluation gave more favorable results for options with all flow equalization storage located at the plant.

A review of the preliminary costs of subdistrict sewer rehabilitation compared with the systemwide reductions in RDII that are estimated from the rehabilitation showed that rehabilitation would be a relatively expensive method of eliminating overflows from the Mauldin Road trunk sewer system. Therefore, the improvement plan did not rely solely on a widespread sewer rehabilitation program to eliminate overflows nor did it consider downsizing the trunk sewer system improvements based on expected reductions in RDII from rehabilitation. An ongoing sewer rehabilitation program, however, is an important part of the overall improvement plan to ensure that continued sewer deterioration does not cause trunk sewer system overflows after other components of the improvement plan are implemented. An effective rehabilitation program may defer or eliminate the need for later phases of trunk sewer improvements, and it will allow the sewer system to convey wet weather flows from larger rainfall events without overflows.

Recommended Improvement Plan and Implementation

Based on the modeling and analyses, it **was** recommended that the authority implement a phased improvement plan for the Mauldin Road line system. The plan included recommendations for 1) trunk sewer system improvements (\$35 million); 2) upgrade and expansion of the influent pumping, preliminary treatment, and flow equalization facilities at the Mauldin Road wastewater treatment plant (\$15 million); and 3) a subdistrict sewer rehabilitation program (\$200,000). Each of these elements is critical to meeting the overall goals of the plan, which are to eliminate overflows and to prevent overloading of the Mauldin Road wastewater treatment plant. Hydraulic model analyses have shown that the recommended improvements will eliminate overflows for a 2-year rainfall event.

The wet weather improvement plan is currently being implemented by the authority. The next three sections summarize the ongoing trunk sewer system improvement program, the Mauldin Road wastewater treatment plant wet weather facility improvements, and the subdistrict sewer rehabilitation program.

Trunk Sewer System Improvements

The recommended trunk sewer improvement plan consisted of phased construction of six primary projects to expand the capacity of the conveyance system. These improvements are listed below in the recommended order of priority. Improvements that have the greatest impact on overflow frequency and volumes and on overflows in areas most affecting the community were given the highest priority.

- Lower Reedy River Replacement Sewer (4 miles of 60- to 96-inch diameter sewer).
- Lower Brushy Creek Replacement Sewer (2 miles of 48-inch diameter sewer).
- **Richland** Creek Replacement Sewer (1 mile of 42-inch diameter sewer).
- Upper Reedy River Replacement Sewer (2 miles of 36-inch diameter sewer).
- Upper Brushy Creek Replacement Sewer (2 miles of 30- to 36-inch diameter sewer).
- Metromont Relief Sewer (3 miles of 24- to 42-inch diameter sewer).

Hydraulic modeling showed that construction of the first three replacement sewers would eliminate all system overflows for the 1 -year planning storm. These improvements were also shown to eliminate overflows in the lower Reedy River and lower Brushy Creek systems for the 2-year planning storm. Construction of all six of the listed improvements was shown to eliminate overflows throughout the **Mauldin Road** trunk sewer system for the 2-year planning storm. It was recommended that an evaluation of the need for the last three replacement sewers be conducted after completion of the first three projects and the initial phase of subdistrict rehabilitation. If subdistrict rehabilitation removes a substantial portion of **RDII** from the system, then the need for the remaining three projects may be eliminated.

The design of the first three replacement sewers has been completed. The design and construction of the Lower Brushy Creek Replacement Sewer was combined with a South Carolina Department of Transportation Interstate 85 Expansion Project due to the numerous construction coordination issues between the two projects, including road and bridge crossings. The construction contract for the Lower Brushy Creek Replacement Sewer was awarded in June 1994, with construction scheduled for completion by the end of 1995.

Design of the Lower Reedy River Replacement Sewer included routing the sewer through an exclusive golf course, a business park, a college campus, and a city park and zoo, as well as through numerous private properties. The design also included tunneling under several state and city roads. The construction contract for the first half (downstream portion) of the Lower Reedy River Replacement Sewer is expected to be awarded by the end of 1995. The second half of the Lower Reedy River Replacement Sewer is expected to be bid in 1998.

Design of the **Richland Creek** Replacement Sewer included routing the sewer through a city park and tunneling under an interstate highway and several state and city roads. This sewer project is expected to be bid in 2003.

Mauldin Road Wastewater Treatment Plant Improvement Plan

The existing trunk sewer system can deliver peak wet weather flows of up to 90 mgd to the plant. Hydraulic model analyses indicate that with the trunk sewer improvements in place, however, peak hour flows **influent** to the plant could range between 160 mgd (during a 2-year storm event) and 190 mgd (during a 1 0-year storm event) under surcharged conditions.

The recommended improvement plan includes upgrading and expanding the **Mauldin Road** wastewater treatment plant (WWTP) to handle the increased wet weather flows that the trunk sewer system improvements will deliver. Design of the **Mauldin Road** WWTP improvements is expected to be complete by the summer of 1995. The treatment plant improvements were divided into two implementation phases. The initial phase includes installation of a new **influent** pumping station, screening facilities, grit removal facilities, and flow equalization facilities. The construction contract for the initial phase is scheduled to be awarded by the end of 1995. The second phase includes upgrading the primary and secondary treatment processes. The second phase is expected to be bid in 1998.

Subdistrict Sewer Rehabilitation Program

The evaluation of flow monitoring data that was performed during the wet weather engineering study showed that the subdistrict collection systems contribute a large amount of **RDII** to the trunk sewer system and are in need of repair. Concurrent with the first phase of trunk sewer improvements, it was recommended that a subdistrict sewer rehabilitation program be initiated within each of the sewer subdistricts contributing flow to the **Mauldin Road** line system. The goals of the first phase of the sewer rehabilitation program are to eliminate major sources of **RDII** and to provide a better understanding of the costs, effectiveness, and optimal approach to sewer rehabilitation. The results of the first phase of sewer

rehabilitation will be used to further evaluate the cost effectiveness of sewer rehabilitation versus additional trunk sewer system improvements, if required.

To assist in implementing the subdistrict sewer rehabilitation program, a sewer rehabilitation committee was formed consisting of representatives from each of the seven sewer subdistricts, representatives of the authority, and technical support personnel. The committee has proceeded with implementation of the first phase of the subdistrict sewer rehabilitation program. Flow monitoring was performed at approximately 100 locations throughout the subdistricts from January 1995 to March 1995. The analysis of the flow monitoring data and recommendations for the first phase of SSES work are scheduled for completion by the end of April 1995. The Sewer System Evaluation Survey (SSES) work is expected to begin in May 1995, with the first phase of sewer rehabilitation design and construction scheduled to begin by the end of 1995.

Summary and Conclusions

To summarize:

- Wet weather surcharging and overflows in the **Mauldin** Road trunk sewer system are primarily the result of excessive **RDII** entering the subdistrict and authority sewer systems.
- The use of a dynamic, systemwide hydraulic model during this study was critical to the evaluation (and design) of a full range of improvement alternatives, including replacement sewers, equalization storage, and sewer rehabilitation. A dynamic model simulates system conditions during an entire storm event, in contrast to a steady-state model that only simulates one point in time. Therefore, the dynamic model allowed simulation of the impacts of alternative sizes and volumes of equalization storage and the benefits of reduced **RDII** peak flows and volumes from sewer rehabilitation in eliminating overflows from the trunk sewer system.
- The recommended improvement plan includes an integrated program of trunk sewer system improvements, **Mauldin** Road WWTP facility improvements, and a subdistrict sewer rehabilitation program to eliminate overflows within the trunk sewer system.
- Design of three of the recommended trunk sewer system improvements ranging from 42 to 96 inches in diameter is complete. Construction of a portion of the initial phase of improvements began in June 1994 and is scheduled for completion by the end of 1995. The construction contract for the second phase of the improvements will likely be awarded by the end of 1995.
- Design of the treatment plant upgrade and expansion is scheduled for completion by summer 1995. The phased implementation plan will handle the increased peak wet weather flows entering the WWTP as a result of the trunk sewer system improvements. The construction contract for initial phase of the treatment plant improvements is expected to be awarded by the end of 1995.
- A comprehensive flow monitoring program has been completed in both the trunk sewer system and the subdistrict sewer collection systems. Data collected from this program will be used to prioritize SSES and sewer rehabilitation efforts within the sewer subdistricts. The data will also be used to evaluate the effectiveness of the first components of the improvement plan in reducing **RDII** and eliminating overflows from the **Mauldin** Road trunk sewer system. An effective rehabilitation program may defer or eliminate the need for later phases of trunk sewer improvements, and it will allow the sewer system to convey wet weather flows from larger rainfall events without overflows.

The authority's wet weather improvement plan offers a balanced and integrated program to eliminate sewer system overflows and to comply with the DHEC Consent Order. The program's success depends on concurrent implementation of the trunk sewer system improvements, Mauldin Road WWTP facility improvements, and the subdistrict sewer rehabilitation program. The success of the project to date reflects the cooperative effort and commitment of the Western Carolina Regional Sewer Authority and the seven sewer subdistricts.

Program Management of the Dade County Infiltration/Exfiltration/Inflow Flow Reduction Program

Luis Aguiar
Miami-Dade Water and Sewer Department, Coral Gables, Florida

James T. Cowgill
Hazen and Sawyer, Coral Gables, Florida

Thomas G. Scheller
RUST Environment and Infrastructure, Inc., Coral Gables, Florida

Introduction

The Miami-Dade Water and Sewer Department (WASD) has entered into a Settlement Agreement with Florida's Department of Environmental Protection (DEP) and a Consent Decree with the U.S. Environmental Protection Agency (EPA) to reduce infiltration and inflow (I/I) flows into the WASD collection system. The 5-year infiltration, exfiltration, and inflow (I/E/I) flow reduction program will ultimately cost more than \$120 million. Within 5 years, after the entire system has been evaluated and necessary repairs have been performed, WASD will modify the I/I program to require survey of 10 percent of the system per year, rather than the current 20 percent.

This paper describes the program and gives a brief overview of how Dade County is addressing its I/I challenge.

Background

WASD is the regional wastewater utility for Metropolitan Dade County. It maintains and operates the three regional wastewater treatment plants, the North, Central, and South District Wastewater Treatment Plants, which serve 1.33 million people, or approximately 92 percent of the sewer population of Dade County.

Wastewater flows treated at the regional treatment plants are generated by both wholesale customers, who operate and maintain collection systems within their service areas, and by WASD, which operates and maintains the largest collection system in Florida. The WASD system comprises a total of 832 drainage basins served by individual sewage pump stations, with approximately 12,862,600 feet of gravity sewer and 56,600 manholes.

Metropolitan Dade County, located on the southeast coast of Florida, has unique characteristics that contribute to sewer system I/I. The county experiences an average yearly rainfall of 60 inches, and the land elevation varies only between 5 and 10 feet above sea level. Most of the wastewater collection system is below the ground-water table year long. The combination of extensive rainfall and high ground-water conditions result in substantial I/I contributions to wastewater flows.

I/I Analysis

I/I to the regional treatment facilities during the 1993 study period was calculated by mass balance analysis using the relative strength of the wastewater to the plant compared with that of typical raw sewage. Table 1 presents the results of the analysis.

Table 1. Dade County Wastewater Contributions

Wastewater Collection	Flow Rate (mgd)	Percent of Total Flow
Total wastewater flow	314.7	—
Average sewage flow (baseline flow)	187.9	—
Average yearly I/I flow	126.7	40
Wet weather I/I flow (maximum per month):	176.1	—
I/I from wholesale customers	59.1	34
I/I from WASD system	117.5	66

Table 1 indicates that an average of 40 percent of the total flow to the wastewater treatment plant is due to I/I. The wet weather I/I flow is estimated at 176 million gallons per day (mgd) and approximately one-third of that flow is from wholesale customer flows.

I/I Correction Program

Because of limited treatment plant capacity and excessive system I/I, WASD has entered into agreements with the Metropolitan Dade County Department of Environmental Resources Management (DERM), Florida's DEP, and EPA. To meet these regulatory requirements and realize the potential environmental and economic benefits, Metropolitan Dade County, through the WASD, has initiated one of the country's largest I/I reduction programs.

Faced with the challenge of reducing the estimated 127 mgd of yearly I/I out of a total wastewater flow of 315 mgd, and despite being 2 years into a comprehensive I/I reduction program in house, WASD decided to revise and augment its I/I program effort. In April 1994, the consulting engineering firms of RUST Environmental and Infrastructure and Hazen and Sawyer were selected as program managers for the WASD collection system I/I program. WASD's self-imposed goal is to reduce more than 60 mgd of I/I within the next 5 years, at an estimated cost of \$120 million.

The I/I correction program is designed to meet all DERM, DEP Settlement Agreement, and EPA Consent Decree requirements. The program takes step-by-step approach, and has the following elements:

- Basin prioritization
- Detailed basin evaluation
- System rehabilitation

Basin Prioritization

Individual basins are prioritized according to infiltration leakage rates, as indicated by night flow measurements. Because the stations are ranked by gallons per day (gpd) per mile of sewer and by gpd per inch diameter per mile of sewer, the following data must be gathered:

- The length and diameter of the sewers in the basin

- The amount of system I/I

The diameter and length of the sewers in each collection basin were compiled to calculate basin infiltration flow rates. Atlas information was used to define specific collection area boundaries and to develop sewer system inventories.

Night flow measurements were taken throughout the WASD collection system to identify relative I/I flows in each collection basin. Flow measurements were recorded at each drainage area pump station from midnight to 5:00 a.m. to minimize the affect of normal wastewater flows. The night flows are measured twice annually for the sewer system's entire 832 basins: once at low and once at high ground-water conditions during nonrainfall periods. The *wet/dry* season night flow measurements for each basin are averaged, and the infiltration rate in gpd per mile and gpd per inch mile is calculated. The Basin Priority List establishes the sequence in which the collection basin areas are assigned to the Sewer System Evaluation Survey (SSES) crews to ensure that the most critical I/I areas receive the most immediate attention.

Detailed Basin Evaluation

An extensive SSES program was developed for the WASD system. Manhole inspections, smoke testing, and television inspections are conducted over the entire system to identify system repairs. The manhole inspections methods used confirm the accuracy of the system atlas maps and identify sources of infiltration. Smoke testing identifies sources of inflow, and television inspection identifies infiltration sources and the overall integrity of the sewer lines. The filed data are then evaluated by office personnel, and specific repairs are identified and assigned to WASD forces or outside contractors for completion.

Several sewer repair technologies are available to reduce system I/I in manholes, service laterals, and sewer lines. Emphasis is placed on the use of trenchless technologies to reduce both repair costs and construction impacts in residential areas. The rehabilitation program includes an analysis of the various rehabilitation alternatives and the selection of the repair cost as defined by competitive bidding. The process includes a review of available repair techniques and establishes the criteria used to specify sewer repairs.

System Rehabilitation

The repair program includes the rehabilitation of manholes, sewer lines, and service laterals. Table 2 lists the various sewer repair tasks that WASD presently performs or contracts out for, and projects the yearly quantity and cost of the required repairs. The repair frequencies can be used for projecting future sewer program costs.

The program capital requirements are approximately \$20 million per year, and the overall five-year program budget is in excess of \$100 million. Service laterals are a source of infiltration. WASD staff are using pan and tilt camera technology; this new technology is more effective than the WASD's previous inspection program, thus increasing the amount of problems identified for repair by WASD.

Although I/I quantities are estimated in the initial field evaluation phase, overall program effectiveness is determined by actual flow measurements at each basin. The basin flows are metered for a 1-week period both before and after repairs are performed, and an analysis of the metering data is used to establish program credits. During the past 2 years, the program has eliminated approximately 30 mgd of system I/I.

Table 2. Sewer Repair Tasks-Yearly Quantities and Cost Projections

Repair Type	Repair Frequency %	System Criteria'	System Projection	Yearly Projection	Unit Cost	Yearly Cost
<i>Line Repair</i>						
Point repair ^b	4.50	56,600	2,547	509	\$3,755.00	\$1,911,269
Robotic repair	6.00	56,600	3,396	679	\$2,500.00	\$1,698,000
Sectional liner	1.00	56,600	566	113	\$2,500.00	\$283,000
Fold and form liner	3.50	12,862,600	450,191	90,038	\$38.00	\$3,42 1,452
Cured-in-place liner	3.25	12,862,600	418,035	83,607	\$44.00	\$3,678,704
Line replacement	1.00	12,862,600	128,626	25,725	\$82.00	\$2,109,466
Clean, test, seal	4.00	12,862,600	514,504	102,901	\$4.96	\$510,388
Clean, test, seal ^b	7.00	12,862,600	900,382	180,076	\$5.69	\$1,024,635
Large-diameter cleaning	1.30	166,848	168,848	35,000	\$31.50	\$1,012,500
<i>Manhole Repair</i>						
Realign manhole cover ^b	3.00	56,600	1,698	340	\$417.00	\$141,613
Manhole cover inserts ^b	100.00	56,600	56,600	11,320	\$60.00	\$679,200
Replace frame and cover ^b	2.00	56,600	1,132	226	\$540.00	\$122,256
Cementitious liner	10.00	56,600	5,660	1,132	\$1,069.00	\$1,210,108
Install fiberglass liner	0.30	56,600	170	34	\$3,000.00	\$101,880
<i>Lateral Repair</i>						
Cleanout cap replacement ^b	5.00	56,600	2,830	566	\$50.00	\$28,300
Cleanout repair	3.00	56,600	1,698	340	\$400.00	\$135,840
Line lateral	1.50	56,600	849	170	\$2,990.00	\$507,702
Replace lateral	4.00	56,600	2,264	453	\$4,500.00	\$2,037,600
Total cost						\$20,703,913
WASD Repair^b						\$3,907,273
<i>Contract Repairs</i>						\$16,796,640

^aTotal length of sewer: 12,862,600 feet; total manholes: 56,600.

^bThese repairs are completed by WASD staff.

Conclusion

WASD's goal is to reduce by one half the infiltration flow in Metropolitan Dade County within the next 5 years. WASD has elected to provide the resources to implement this important program, which will provide both environmental and economic benefits in the future.

Infiltration/Inflow Flow and Sanitary Sewer Overflow Reduction Project in Lynn, Massachusetts

Richard K. Smith and William A. Di Tullio
Camp Dresser & McKee Inc., Cambridge, Massachusetts

Leo R. Potter and Daniel F. O'Neill
Lynn Water and Sewer Commission, Lynn, Massachusetts

Background

For more than 25 years, the US. Environmental Protection Agency (EPA) has focused much of its regulatory attention on improving the water quality of our nation's surface receiving waters. For years, direct discharge of raw sewage and industrial wastes to surface waters was acceptable. With increases in the density of human populations and facilities and more intense usage of our waterways for recreational purposes, the water quality of many of the nation's surface waters experienced a degradation that had an impact on water environment and its uses.

Once the quality of water degraded to a level causing noticeable changes to the ecosystem, EPA took steps to correct the situation. Initially, the federal government enacted the Clean Water Act (CWA). Through the CWA and its amendments, EPA has been able to meet its objective to control or eliminate all untreated raw wastewater discharges and improve the water quality of the nation's receiving waters. With this mission under control, EPA focused its attention on improving the water quality of receiving waters during wet weather periods. Through the enactment of a federal combined sewer overflow policy, EPA intends to improve the water quality of surface waters receiving discharges from combined sewer overflows (CSOs). The 1994 National Combined Sewer Overflow Control Policy provides the national initiative to minimize water quality violations during extreme rainfall events.

This paper focuses on yet another important EPA initiative: control of sanitary sewer overflows (SSOs). As with CSOs, SSOs are the result of wet weather events and capacity deficiencies. SSOs occur as a result of insufficient sewer hydraulic capacity, which is caused by excessive sanitary and stormwater flow, inadequate maintenance, and/or the presence of excessive infiltration and inflow (I/I) flow in the sewer system. Therefore, an SSO is a wastewater overflow that occurs in a separate sanitary sewer system other than at a National Pollutant Discharge Elimination System (NPDES) facility. Overloaded or defective sewer systems cause street flooding, basement flooding, and other SSOs, all of which can affect public health. Excessive I/I flows also affect the cost of operating and maintaining a wastewater collection and treatment system. For these reasons, EPA has now focused its attention on the control of SSOs.

Properly designed I/I flow reduction programs will achieve realistic flow reduction and SSO control goals in sewer systems. This paper presents a brief summary of the efforts and events that led to the successful completion of an I/I flow reduction and SSO control project conducted in the City of Lynn, Massachusetts. This project resulted in the reduction of 2.7 million gallons per day (mgd) of peak I/I flow for the city's sewer system and either eliminated or significantly reduced many SSOs.

Why Do SSOs Occur?

Throughout our nation, sewer systems experience overflows during dry and wet weather. Overflows occur in both separated and combined sewer systems. Overflows during dry weather are almost always caused by lack of sufficient flow capacity or insufficient maintenance. Some of the most common causes of dry weather overflows are:

- Plugged pipelines (roots or debris) or leaky sewage force mains
- Buildup of sewer sediments in pipe and manhole inverts
- Defective infrastructure (structural defects)
- Poor sewer construction (adverse or flat slopes)
- Excessive infiltration
- Vandalism
- Undersized or flow-restricted sewers and pumping facilities
- Malfunctioning pumping and CSO facilities

Wet weather events and excessive infiltration similarly affect combined and separate sewer systems. Because of the nature of their design, we expect to see sewer flows increase substantially during high ground-water and wet weather events. When surcharging of combined sewer systems occurs, little concern is raised unless overflowing causes SSOs. Separate sewer systems having excessive I/I, however, react like combined sewer systems to high ground-water and wet weather flows. During wet weather and high ground-water events, wastewater flows within separate sanitary systems having inflow sources respond almost instantaneously to precipitation.

In recent years, surcharging and overflowing of separated sewer systems have become concerns, as they should. Some of the most common I/I sources that cause or contribute to wet weather overflows in sewer systems include:

- Leaky sewer pipes and structures.
- Direct connections of drainage and subdrainage systems to separate sanitary systems (e.g., roof, driveway, yard, floor, and cellar drains, catch basins, drainage sumps, surface waters).
- Sump pumps.
- Malfunctioning or undersized CSO and pumping facilities.

I/I sources occur on both public and private property. Those that occur in sewer services located on private property make the control of SSOs difficult. For SSOs to be reduced or eliminated, the cause of the SSO and the source of the wet weather flow must be identified. Inflow source-identification techniques include smoke testing, dye testing, and visual inspections (i.e., house-to-house inspections). During sewer surcharging conditions, flow backup sometimes cause some inflow sources to become SSOs.

SSOs can also be caused by sanitary flow exfiltrating or leaking from a sewer system and flowing to drain facilities or other improper discharge areas.

What Are the Consequences of SSOs?

The consequences of SSOs are far reaching. SSOs may result in street flooding, basement flooding, potential health hazards, insurance claims, temporary loss of receiving water recreational uses, and reduction of property values. Furthermore, subjecting sewer pipelines and structures to frequent

surcharging will eventually affect the structural integrity of the sewer system. All of these consequences can be avoided by implementing a comprehensive sewer flow reduction program.

Can the Causes of SSOs Be Categorized?

Wet weather overflows and pipeline capacity overloading are primarily the result of excessive infiltration, excessive inflow, and inadequate sewer system maintenance. Each of these causes alone and any combination of the three can have an impact on a system's capacity to convey wastewater flows during wet weather and peak flow conditions.

Infiltration of ground water into sewer systems occurs through sewer pipeline and structural defects. These defects result from poor construction techniques, aging or defective sewer pipe, open pipe joints, improperly installed service connections, defective sewer manholes, concrete corrosion, and root intrusion, among other reasons. In general, as pipelines age, infiltration increases. Left unaddressed, infiltration can progress to the point at which sewer flow capacity can be exceeded.

Sewer inflow is distinguishable from sewer infiltration. Inflow originates from surface water and precipitation events. Inflow sources also reduce the flow capacity of a system, especially a separate sewer system. Inflow enters a sewer system through sources such as basement, yard, area drains, and foundation drains, roof leaders, underdrain systems, cooling water discharges, drains from springs and swampy areas, manhole covers, cross connections from storm sewers, catch basins, stormwater, surface runoff, street washes, and drainage.

Experience has shown that most inflow sources are intentionally constructed. For example, due to a lack of drainage piping, catch basins may be connected to a sanitary sewer pipe to cost effectively eliminate surface runoff, street flooding, and ponding. Some private property owners are also responsible for inflow sources. For various reasons, they have intentionally connected inflow sources to the separate sewer system. They have constructed inflow sources, for example, to eliminate wet basements, wet or poor drainage areas, property flooding, and driveway ponding. Inflow represents the most significant cause of SSOs. High intensity storm events have the greatest impact on systems with direct inflow connections. Unaddressed, inflow sources alone can cause SSOs, sewer surcharging conditions, and permanent damage to the structural integrity of the sewer system.

With this understanding, sewer system operators should be able to design an effective flow/overflow reduction program.

The Four Key Elements of Successful Sewer Flow and Overflow Reduction Programs

To reduce or eliminate pipeline capacity overload problems, the sewer system operator must have a thorough understanding of the operating conditions of the sewer system. The operator must know which sewer facilities experience surcharging and/or overflows. Maintenance departments must be familiar with complaint records, pipelines that require frequent cleaning and maintenance, and pumping station operational records.

All successful flow and overflow reduction programs contain the following key elements:

- Realistic flow reduction goals.
- Thorough knowledge of the sewer system.
- Long-term sewer inspections, flow monitoring, and construction improvement programs.
- An informed and involved public.

Setting Realistic Flow Reduction Goals

The first step in designing a successful flow/overflow reduction program is to establish the goals of the program. Many programs fall short of expectations because flow reduction goals have not been established or unrealistic goals have been set.

The first and easiest step in setting flow reduction goals is to ask the following questions:

- Should only **SSOs** be eliminated?
- Should **SSOs** and surcharging **be** eliminated?
- Should pipeline flow capacity overload conditions be eliminated and pipeline defects eliminated to restore the integrity of the sewer system?

The answer to each of these questions has far-reaching impacts on the scope, budget, and duration of the flow reduction program.

The next step is to make a preliminary assessment of the quantity of I/I entering the sewer system. These data can be collected from existing records (treatment and pumping station records) or by conducting a limited sewer flow metering program. The intent here is to make a preliminary assessment of the I/I rates for the system. At a minimum, these data should cover at least 75 percent of the system within the flow reduction area. If adequate data are not available from existing sources, flow metering during a wet and dry period should be performed. The system's configuration and the desire to meter at least 75 percent of the system will determine the number of flowmeter installations. For most small systems with 100 to 150 miles of pipeline, three to five meters installed for a 6- to 9-month period is typically sufficient. Rain precipitation monitors and ground-water monitors should also be used.

Once the flow data are collected, I/I rates can be determined. This information can be very useful; it provides a first glimpse at the relationship between sanitary flow, infiltration, and inflow. With this information, operators can set I/I reduction goals more realistically.

Gaining a Thorough Knowledge of the Collection System

Understanding the collection system is probably the most important element of the flow reduction program. As a doctor performs preoperative questioning and diagnostic testing of a patient before operating, the collection system operator must have a comprehensive understanding of the key components of the wastewater or sewer collection system (e.g., service connections, sewers, interceptors, manholes, pumping facilities, and treatment systems). The operator must collect symptomatic information of the sewer system before designing and implementing the flow reduction program. Where and why does the system surcharge and overflow? Where and what are the major maintenance requirements? Why has pumping at a particular pumping station increased over last year? Why does a certain sewer reach require frequent cleaning?

Unlike a doctor, the system operator cannot ask the sewer system where it is having problems. The operator must observe and examine the sewer system closely-and more frequently as it ages. The system operator must collect and maintain records regarding the operation and maintenance requirements of the system to monitor changes in operation. These records should include at a minimum:

- Flow, ground-water, and rainfall data
- Sewer and drainage mapping

- Age, material, and methods of construction
- Reoccurring sewer system maintenance problems
- Complaint records
- Frequency, location, and magnitude of overflows and surcharging sewers

Historically, the system operators having the most up-to-date system mapping are the operators who have the most thorough knowledge of their systems. With a geographic information system, the operator has many tools to aid in developing, analyzing and maintaining up-to-date knowledge of how the system is operating, where and when maintenance should be performed, and where to concentrate flow reduction efforts. This knowledge is essential for developing a well-designed flow reduction program.

Establishing Long-Term Sewer Inspection and Construction Improvement Programs

The scope of the sewer improvement programs must be appropriately designed to address the long-term needs of the sewer system. This program consists of the following field activities:

- Physical survey
- I/I investigation
- Sewer System Evaluation Survey (SSES)
- Flow and SSO monitoring
- Construction

Physical Survey

The physical survey is conducted as the initial phase of the field program, when the wastewater sewer system is characterized. Existing data, maps, and reports are reviewed, and additional field data are collected to increase knowledge of the system. Activities that may be performed during the physical survey include review of complaint and maintenance records, interview of system operators, mapping, identification and location of SSOs, selection of manholes for flow metering, installation of permanent ground-water monitors and rain gauges, installation of long-term flow meters, and limited manhole inspections.

Long-term metering will provide flow data that initially will be used to quantify I/I quantities; later, flow data will help assess the effectiveness of flow reduction efforts. Manhole inspections performed during this phase of the project are conducted to make a preliminary assessment of the condition of the sewer system.

I/I Investigation

This phase of the project usually includes sewer flow metering, ground-water and rainfall monitoring, and flow data analysis. The density of metering is selected to meet the goals of the project. When metering entire collection systems, the optimal metering density is one flowmeter for every 20,000 linear feet of pipe. If infiltration reduction is desired, however, metering density could be increased to one flowmeter for every 5,000 linear feet of pipe. When inflow is the primary goal of the project, metering density could be reduced to one flowmeter for every 50,000 linear feet of pipe.

During the I/I investigation, I/I rates will be determined for each metering area. Each metering area can then be prioritized based on its I/I rates. A scope of work for the next phase of the field program, the SSES, can then be developed. In this fashion, the maximum cost benefit will be ensured.

Sewer System Evaluation Survey

The third phase of the sewer improvement program is the SSES, during which additional I/I investigations are conducted. To identify infiltration sources, flow isolation and television inspection are performed. Flow isolation consists of measuring infiltration quantities during dry weather, high ground-water, and low sewage flow conditions on a manhole reach by manhole reach basis. During flow isolation, flow calibrated weirs are used. Flow isolation is usually performed during dry weather between the hours of midnight and 6 a.m.; the flow measured in each reach during these hours is considered to be mostly infiltration. Pipelines having infiltration rates greater than 4,000 gallons per day per inch-mile are selected for television inspection. Television inspection is performed to identify pipeline defects and infiltration sources.

To identify inflow sources, rainfall simulation and house-to-house inspections are performed. Rainfall simulation consists of two types of investigations: smoke testing and dyed water studies. In smoke testing, the manhole reach to be tested is plugged and filled with smoke. Smoke escapes the collection system through pipeline defects and inflow sources. All sources of inflow are recorded on smoke testing log sheets. In dyed water testing, potential inflow sources are flooded with dyed water, and the downstream sewer is inspected for evidence of dye. If dye is observed, the flooded potential inflow source is recorded as confirmed.

House-to-house inspections are performed to identify inflow sources located on private property. During the inspection, building exteriors and interiors are examined. All confirmed and suspected inflow sources are recorded on a log sheet. Inflow sources that may be identified during the inspection include roof, yard, and driveway drains, sump pumps, and floor drains. The cooperation of private property owners is necessary to remove inflow sources identified by the house-to-house inspection.

The occurrence and location of all SSOs in the sewer system should be confirmed and identified during all of the above investigations and the survey.

Flow and SSO Monitoring

Long-term flow and SSO monitoring is a valuable tool used to observe I/I flow reductions and SSO control resulting from the flow reduction program. Additionally, long-term monitoring can be used to identify when future flow reduction or SSO control may be necessary. Often, the same manholes used during the physical survey for flow monitoring are used for installation of long-term flow monitors.

Construction

The final phase of the sewer improvement program is construction of sewer improvements. The selection and design of these sewer improvements are based on the recommendations and design criteria established in the SSES and on any other pertinent system needs.

Keeping the Public Informed and Involved

Public information programs improve the success of achieving I/I flow and SSO reduction goals. Many studies have shown that involving the public at the outset of the project increases the likelihood of getting people to participate when private inflow sources are identified. When I/I flow reduction goals are high,

more focused and persuasive public education programs are needed. An educated public will be more supportive of expending funds.

The Lynn Project Experience

In this section, we will summarize the efforts that led to the successful completion of a 2.7 mgd reduction of peak I/I flow in the City of Lynn, Massachusetts. This flow reduction program also resulted in the reduction of SSOs in the Lynn sewer system. The program, called "Sewer System Rehabilitation, Contract No. 1," was performed in accordance with the procedures outlined earlier. A locus plan is shown in Figure 1.

The Lynn Water & Sewer Commission (LWSC) owns and operates a wastewater collection system and treatment facilities in the City of Lynn. The City of Lynn, an old coastal community with a current population of about 80,000 people, is served by a sewer system of about 140 miles of separated and combined sewers. The collection system covers a city service area of about 6,000 acres. Approximately 47 percent of the system has combined sewers with four CSO facilities locations.

During the spring high ground-water season, which usually lasts from February through May, average daily flows increase, and wet weather events cause sewer system surcharging and backups, street flooding, and system operational problems in both separated and combined sewers. These are all classified as SSOs. Many of Lynn's sewers were constructed in the late 1800s and early 1900s. Sewers are predominantly constructed of brick, tile, vitrified clay, asbestos cement, and reinforced concrete pipe material. The system discharges to a 25.8 mgd regional wastewater treatment plant serving Lynn and the surrounding towns of Saugus, Nahant, and Swampscott. Presently, the treatment facility is operating at its design capacity.

LWSC hired Camp Dresser & McKee Inc. (CDM) of Cambridge, Massachusetts, to develop a flow reduction program to reduce flows to the treatment facility and improve wet weather/high ground-water operating conditions at the wastewater collection facilities. In 1991, LWSC established a 2.5 mgd I/I reduction goal for CDM in conjunction with a court-ordered Consent Decree. Because the city had never conducted any I/I investigations, extraneous flow and ground-water/wet weather I/I source locations were unknown. Accordingly, CDM was asked to conduct an I/I investigation and to provide design and engineering services during construction to attain the flow reduction goal. LWSC established an 8-month timetable to complete the required I/I field investigations, and the design and construction projects.

Through a carefully designed and managed program, CDM was able to accomplish the flow reduction goal within the difficult time constraint and certified that 2.7 mgd of peak I/I was removed from the sewer system.

Development of Flow Reduction Program

To develop the flow reduction program, CDM conducted an I/I investigation. CDM's I/I efforts focused on the Stacey Brook drainage basin and portions of the western interceptor tributary area. The study area included separated and combined sewers. Initially, a limited flow gauging program was conducted to identify and prioritize I/I flow sources for subsequent investigations. A total of nine continuous flow devices were installed in the study area, dividing it into nine gauged areas.

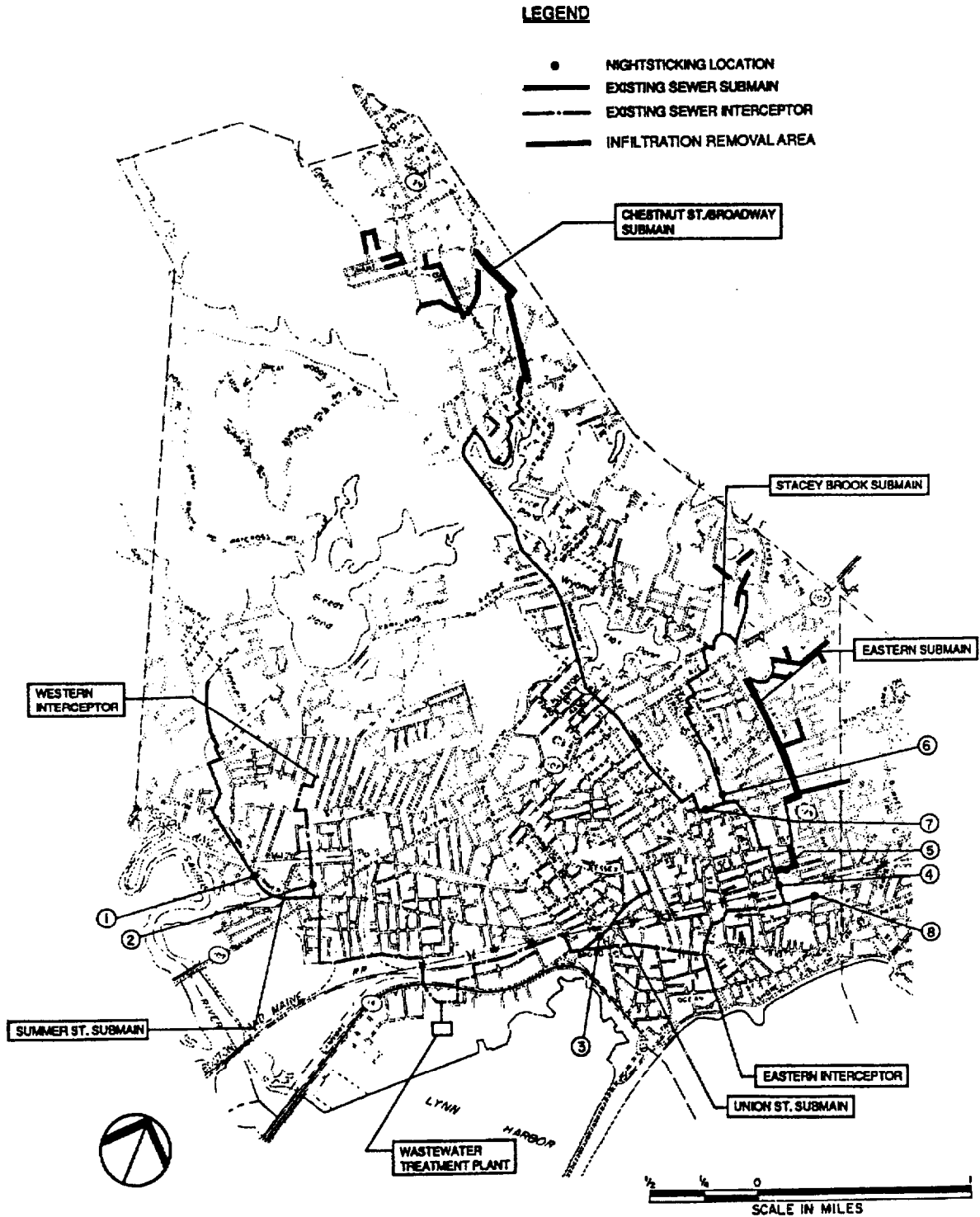

Figure 1. Lynn Water and Sewer Commission I/I reduction program: "Sewer System Rehabilitation, Contract No. 1."

I/I investigations were conducted during the spring of 1991. CDM retained a I/I specialist subcontractor to assist with the field investigations. Components of the field investigations included:

- Ground-water monitoring
- Continuous flow monitoring
- Flow isolation
- Television inspection
- Manhole inspection
- SSO and CSO inspection

For development of the flow reduction project components, CDM analyzed the field data; identified sewer pipeline and manhole rehabilitation alternatives and other flow reduction measures; conducted a cost-effective and value (benefit) effective analysis; assessed the impact of flow reduction on SSOs and CSOs; and developed a recommended plan of sewer improvements to achieve LWSC's flow reduction goals.

The recommended plan involved pipe replacement (included both spot repair and pipe section replacement), cured-in-place pipe lining, manhole spot repair, manhole lining and chemical sealing of leaking sewer pipe joints and sewer manholes, and SSO control measures. This plan was presented for approval to LWSC and the Massachusetts Department of Environmental Protection (DEP), which was funding portions of the overall flow reduction project. The authorization to begin design of the I/I flow reduction program was obtained within days of the plan's submittal.

Design Development

Design began in September 1991. At the same time, CDM provided chemical root removal treatment to all roots that would affect sewer rehabilitation improvements. The timing of the root treatment was critical to the success of this project, because root control typically takes 3 months to be effective. Design of the project proceeded with little trouble. A local Wetlands Conservation Commission Permit Application was filed, and the permit was received in October 1991.

Working closely with manufacturers, CDM designed and specified the sewer system rehabilitation work based on some of the latest available technology. Innovative design methods were used for both cured-in-place pipe lining systems and manhole lining systems. In addition, contract specifications required the manufacturers of these lining systems to provide 2- and 3-year guarantees, respectively. The general location of this sewer system rehabilitation work is shown in Figure 1.

The final plans and specifications for the construction of the sewer improvements were completed and approval was received from LWSC and DEP in November 1991. Bids for construction were received on January 31, 1992, and, following execution of the contract with the low bidder (Insituform of New England, Inc.), construction began on March 1, 1992, 75 days before the court-ordered completion date of May 15, 1992.

Construction

A detailed description of the project, including work quantities and costs, is shown in Table 1. The quantities and costs are based on the actual final payments to the contractor for the completed work. The

sewer rehabilitation methods for this project are based on the descriptions and classifications written in the EPA handbook entitled, Sewer System *Infrastructure Analysis and Rehabilitation* (October 1991).

Table 1. Breakdown Of Sewer System Rehabilitation Work

Rehabilitation Method	Total Quantity	Total Cost
<i>Trenchless Construction</i>		
Sewers: cured-in-place pipe lining (CIPPL)	11,201 linear feet	\$1,069,519.00
Sewers: chemical sealing or grouting	14,024 linear feet	173,773.00
Sewer manholes: cured-in-place manhole lining	24 manholes	72,000.00
Sewer manholes: chemical sealing or grouting	10 manholes	12,000.00
Sewer manholes: monolithic surfacing system	18 manholes	63,000.00
	Subtotal:	\$2,390,292.00
<i>Conventional Excavation Construction</i>		
Sewers:		
removal and replacement	620 linear feet	\$106,000.00
spot repairs	287 linear feet	94,500.00
	Subtotal:	\$200,500.00
	TOTAL COST:	\$2,590,792.00

This project rehabilitated approximately 5 miles of sewers or about 3.5 percent of the collection system. Almost 97 percent of the project was performed with trenchless pipeline rehabilitation or trenchless technology. Approximately 43 percent of the project sewers were rehabilitated with cured-in-place pipe lining, which is one of the most effective trenchless pipeline rehabilitation methods. Because of the time restraints, this project was very suitable for trenchless construction. Trenchless construction provided the following advantages:

- Fast installation times (hours) for maximum construction productivity.
- Minimal disturbance and inconvenience to existing environment, traffic, and congested living and working areas.
- Minimal disturbance to or interference with existing underground, surface, and overhead utilities.
- Minimal disturbance or damage to existing street and highway pavements and landscaping.
- Minimal disturbance or damage to existing structures and other adjacent facilities.
- Cost savings versus total replacement costs within the utility-filled and heavily traveled roadways.

Postconstruction Flow Verification

After substantial completion of project construction, certified flow verification was performed on the sewer system rehabilitation work to document I/I flow reduction. A unique specification was used for this postconstruction flow isolation and flow measurement work. Field acceptance inspections verified that five SSOs were eliminated and 10 SSOs were reduced.

Public Communications Program

Another notable feature of this project was its very successful and effective public communications program which included public education efforts. LWSC designed this program to address the very sensitive public attitudes and concerns prevailing before the start of construction. The City of Lynn had experienced some severe inconveniences and serious disruptions due to sewer system backups and overflows, as well as construction problems during several large water-main projects previously constructed and one still in progress. LWSC required that the sewer rehabilitation project provide minimal inconvenience and interference to the public, especially abutters. This goal was achieved and was a major project accomplishment.

Project Summary

To summarize, this project was an excellent example of an effective program to reduce I/I flows and SSOs and make timely improvements to an aging, urban wastewater collection system. The effective reduction of I/I flows to the treatment plant has provided additional flow capacity. This project was part of the first phase of the LWSC I/I flow reduction program, and its first objective was successfully met within the designated timetable.

Flow reduction programs that follow the ideas presented in this paper have a very good chance to meet the needs of the sewer system operator. LWSC has benefitted by the approach discussed herein, and other systems owners and operators can also.

Sanitary Sewage Discharges in the City of Edmonton, Alberta

John E. Hodgson and Christopher J.W. Ward
City of Edmonton Transportation Department, Drainage Branch, Edmonton, Alberta, Canada

Nancy U. Schultz
CH2M HILL, Milwaukee, Wisconsin

Abstract

The North Saskatchewan River is the potable water supply for the City of Edmonton. More than 300 locations in the city have interconnections between the sewerage system and the storm system. These interconnections, usually installed to prevent sewerage system surcharging, discharge wastewater to the river during certain rainfall conditions. Some of these are upstream of the city's raw water intake.

This paper reviews the many initiatives the city is taking to provide increased protection against wet weather discharges of sewage through the storm drainage system via system interconnections. These initiatives include the development of an interconnection control strategy, the evaluation of significant characteristics of infiltration and inflow (I/I) to sewerage systems, the study of flow contributions from foundation drains, and the development and implementation of modeling and monitoring programs. The city's environmental protection strategies are summarized initially to provide a proper perspective. Details of interconnection control issues (interconnection identification and assessment, I/I control assessment and economics, and I/I modeling) are provided to show the city's findings to date.

Introduction

The City of Edmonton is located in the north central part of the Province of Alberta, Canada, at approximately 54 degrees latitude. The city is serviced by 4,300 kilometers of sewerage and drainage facilities, of which 930 kilometers are combined sewers constructed between 1903 and 1960. The area serviced by combined sewers (about 5,000 hectares) represents about 16 percent of the currently developed lands in the city. The service area includes the downtown core plus residences for about 27 percent of the city's present population of 627,000.

To some extent during the 1950s, and exclusively since 1960, new development in the city has been serviced with separate sanitary sewerage and storm drainage systems. About 1,600 kilometers of sanitary sewerage piping and about 1,800 kilometers of storm drainage piping exist today. During the 1950s, flood control must have been emphasized because both the combined and sanitary sewer systems were frequently interconnected to adjacent storm drainage systems at common manholes or high-level overflows. The U.S. Environmental Protection Agency would likely have termed these illicit connections combined sewer overflows (CSOs) or sanitary sewer overflows (SSOs). In a recent count, about 337 of these system interconnections existed; subsequently, the number was reduced to 268 by expeditious remediation at sites providing no obvious flood control benefit.

The major drainage system through Edmonton is the North Saskatchewan River. Within the city, the river is the receiving water body for 6 small tributary creeks, 214 storm outfalls, 22 CSOs, and the secondary treated effluent from the city's Gold Bar Wastewater Treatment Plant (GBWWTP). The creeks, storm outfalls, and CSOs discharge to the river during spring snowmelt and rainfall events.

The Rosedale Water Treatment Plant, located in the center of the city, supplies potable water to about half of the population. Although the plant is not threatened by the GBWWTP or the 22 CSO discharges, 85 storm outfalls are upstream of the raw water intake. The Edmonton Board of Health recognized such contamination potential from development upstream of the intake as early as 1912 (1). In 1994, fecal

coliform levels in the raw water supply exceeded the guideline of 1,000 most probable number per 100 milliliters a total of 35 times.

A number of major studies have been conducted to assess a wide range of mitigative alternatives, including an \$85 million relocation of the intake to the newer E.L. Smith Water Treatment Plant site at the upstream end of the city. Because the Rossdale intake site is likely to remain unchanged for many years, however, the city is pursuing **ways** to maximize the protection for the Rossdale water intake.

Protecting the Aquatic Environment

The city is addressing water quality issues in the North Saskatchewan River by protecting the aquatic environment, which in turn requires controlling discharges that affect the river both near the **outfalls** and much farther downstream. As a result, discharges of ammonia and bacteria (near field) and nutrients (far field) are of specific concern to the city, which is addressing these discharges through a number of major initiatives.

Tertiary Treatment Program

A \$110 million upgrade of the GBWWTP is being implemented to provide nutrient (phosphorous, organic nitrogen, and ammonia) removal biologically and disinfection of the final effluent by ultraviolet light. Disinfection and the beginning stages of nutrient removal are being implemented from 1994 to 1997 at a cost of \$40 million. The remainder of the program will be implemented prior to the year 2005.

CSO Control Strategy

There are 22 CSOs in the City of Edmonton; all discharge to the receiving waters downstream of the potable water intakes. To control the impact of CSOs on the North Saskatchewan River, the city developed a four-phase strategy, the first of which was completed in 1994; the subsequent phases will be completed by 1998. Although the scope and cost of the CSO control program are not yet known, work is under way to mitigate CSO impacts. (See Hodgson et al. [2] for a description of a \$4 million storage tunnel.) The costs for CSO control are expected to be comparable with those of the tertiary treatment program. Most of the expenditures are expected after the year 2000 (following tertiary treatment) and will be completed **by** the year 2025.

Stormwater Quality Control

The quality of the city's stormwater discharges could also concern the aquatic environment. The city completed a stormwater management lakes water quality management study in 1993 and a contaminant reduction study on storm sewer mitigative measures (1). The contaminant reduction study focused on the storm sewers upstream of the Rossdale water treatment plant intake. The general conclusion of the work was that only first flush and spill containment were considered cost-effective means of control.

The city is also conducting a source control pilot project, involving a survey and inventory of contaminant sources, a public education program, and a monitoring program. Program costs are expected to be around \$10 million between 1995 and 1999.

Protecting Raw Water Supplies

The protection of raw water supplies involves much shorter time and spatial scales than does protection of the aquatic environment. Because the GBWWTP and CSO discharge points are located downstream of Rosedale, only the 85 upstream storm **outfalls** are of concern for spill containment, cross-connection removal, pump station storage, and interconnection control.

Spill Containment

An unacceptable spike of contamination could enter the water intake from a spill or illegal discharge to the upstream storm drainage systems. A spill containment pilot project aims to control these by evaluating potential sites, developing design criteria, constructing a pilot facility, monitoring, and assessing the project's effectiveness in preventing contaminant discharges to the North Saskatchewan River. The program is expected to cost about \$6 million between 1994 and 1999.

Cross-Connection Removal

Cross connections are sanitary services connected to the storm sewer on private property, most often in areas where properties have both storm and sanitary service connections. The city embarked on a \$400,000 program to identify and eliminate cross connections in priority areas. The program found 22 cross connections and 22 locations where inflow to the sanitary system occurs, particularly in apartments and condominium developments. The elimination cost is estimated to be \$137,000. The city is evaluating how to proceed most cost-effectively with this program (e.g., smoke test and dye test all existing multifamily sites plus provide better measures for development control on new multifamily sites).

Pump Station Storage

Many of the city's 66 sewage pumping stations overflow to nearby storm drainage systems. Off-line storage could be provided for each pump station as it is being upgraded for higher mechanical and electrical standards over the next 10 years. Presently, the provision of emergency storage for 4 hours of dry and wet weather flow (assuming coincident peaks) is recommended. The storage is provided to accommodate total station or forcemain failure without overflowing. This storage becomes larger and is utilized more frequently as the significance of wet weather flow increases.

Interconnection Control

This program commenced in 1994 with approximately \$4.4 million to be spent between then and 1999. The program targets the 270 known interconnections located in the city's sewerage and drainage systems. More details on this initiative are presented in the next section.

Interconnection Strategy

As part of the commitment to environmental protection, the city has prepared an interconnection identification and correction strategy, the primary objective of which is to identify and eliminate sanitary flows through storm outfalls. The strategy is proceeding in three phases: 1) identification and prioritization, 2) evaluation, and 3) design and construction. Each phase deals specifically with existing system features that contribute to the discharge of sanitary sewage to the river, creeks, ravines, and other natural *areas* (3).

Phase I, completed in 1994, gathered and analyzed all available information on the existing sewer system, including mapping and previously commissioned studies. The output from Phase I was a strategy to evaluate interconnections throughout the city.

Phase II involves additional studies necessary to gather data needed before any remedial action can be implemented. The output from Phase II is a recommended plan of action for all interconnections.

Phase III implements the work deemed necessary by the Phase II findings. The output from Phase III is designed works to eliminate or control interconnection discharges.

Prioritization

Interconnection correction was prioritized in three parts: identification and classification of all known interconnections, definition of geographic groupings (e.g., neighborhoods, service areas) to serve as the base units for which priorities would be developed, and development of prioritization rules.

Known Interconnections

Thirty-nine sewerage system related studies previously completed in the Edmonton area were reviewed for information relevant to the existence of interconnections. A sewer cross-connection testing program had focused on identifying and locating interconnections using the following indicators:

- Review of available mapping (all combined, sanitary, and storm sewers are digitally mapped and available on “cadastral” overlays) for probable interconnections or previously mapped interconnections.
- Review of the sewer network database (NETREC) to identify any pipe segments with upstream and downstream ends connected to different systems.
- Review of previous sewer studies for mention of cross connections.
- Microbiological testing to identify systems with a high likelihood of upstream cross connections.

Information reported on cross connections was supplemented with information provided from field personnel in the city’s Drainage Operations.

Other indicators of cross connections were considered but found to be less reliable than those listed above. A prevalence of sewer backups was considered as possible evidence that interconnections were contributing to hydraulic loading problems, but they could equally be the means by which historic backups were relieved. Similarly, frequent sewer maintenance needs in the area might indicate a need for the relief provided by interconnections but could easily be independent of interconnections. The investigation found evidence of 337 known interconnections, 69 of which have been corrected.

Geographic Basis

Because interconnections were clustered in some areas, interconnection corrections would be accomplished in geographic groupings rather than individually. Several groupings were considered, including areas defined in the sewer system database, maintenance districts, map grid areas, neighborhoods, land use categories, and drainage basin or sewerage areas. These geographic groupings were evaluated for reliability of the area definition, number of areas to be considered under such a grouping, compatibility of the grouping with existing data formats, ease of data compilation,

suitability of the area sizes for organizing actual correction activities, and flexibility of the geographic groupings for application in future projects. Against these criteria, grouping interconnections on a sewerage-area basis provided the best combination of compatibility with expected prioritization needs, existing data formats, and possible future translation into alternative geographic structures.

Prioritization Rules

Each sewerage area was evaluated and rated for prioritization of the correction of interconnections within the sewershed. Numerous rating criteria were considered. Those chosen for detailed evaluation included primary criteria most directly related to the concerns that prompted interconnection evaluation and secondary criteria that might lead to identification of additional interconnections or concerns. The rating criteria are listed in Table 1.

Table 1. Interconnection Rating Criteria

Primary	Secondary
Proximity to water treatment plant intake	Backwater sequencing (i.e., was the interconnection likely to relieve backwater from downstream restrictions)
Type of interconnections	
Fecal coliform count at the outfall	Historical basement flooding
Receiving water type at the outfall	Impact of roof leader disconnection programs
Sewage characteristics or strength	Future upgrading of sanitary/combined systems in the area
Past upgrading of sanitary or combined sewer system in the area	Other infrastructure upgrading plans
Combined, partially separated, or separate sanitary sewer categorization	
Accessibility of the outfall	
Age of the sewer infrastructure in the area	

A database was developed for entering objective measures of the criteria for each interconnection. The existing NETREC sewer system database was suitable for performing calculations with the values entered. Within the database, each criterion had an associated weighting factor adjustable to the community perceptions of interconnection needs. Initial weightings ranged from 200 for proximity to the water treatment plant intake to 10 for age of the interconnection itself.

Ratings for sewerage areas were calculated as the sum of the product of the rating factor and the associated weighting, for all interconnections in the area. Sewerage area ratings ranged from 3,910 to 472,480. The higher ratings largely coincide with larger numbers of interconnections and higher average ratings per interconnection within the area. Most significantly, the objective rating and prioritization were consistent with city operations staff understanding of where the problems were most severe.

Area Evaluation

Based on the findings from the Phase I prioritization work, Phase II area evaluation studies commenced in the top five prioritized areas. The studies have proceeded on the basis of a quick assessment of the capacity of the sanitary sewer in the vicinity of the interconnection and determination of the likelihood of an overflow occurring. This analysis identified those interconnections most frequently activated and those that rarely, if ever, overflow. The latter are to be closed immediately, and the flows routed through the sanitary sewers. A total of 99 interconnections are in the five areas. Of these only two can be easily closed without any adverse consequences. The remaining interconnections are being evaluated to determine those measures needed to reduce the sanitary I/I flows or to control the contaminants in the overflow.

Inflow and Infiltration

In 1992 and 1993, the city conducted a thorough review of I/I into its sewerage systems (4). Understanding and controlling I/I is crucial because it was a primary cause of sewer system backup and basement flooding in several neighborhoods in 1988 and 1991. As a result of this flooding, more than \$50 million has been committed and expended between 1988 and 1996 to rectify the problems in these areas affecting about 92,000 people.

A general review of I/I literature was conducted to identify significant I/I characteristics. A total of 52 site-specific studies in the Edmonton region and across North America were reviewed. I/I sources that are measurable and controllable to some degree were categorized as "on-lot" and "on-street" sources. The measurable on-lot characteristics include:

- Type of roof drain discharge, downspout (which discharges to the sewer) or roof leader (which discharges to the ground)
- Type of servicing, single or dual connections
- House backfill wedge material type and age (compaction or consolidation)
- Lot grading within 1 .5 meters of the foundation wall

The measurable on-street characteristics are:

- Leaks through holes in the manhole cover (in sags)
- Manhole defects
- Pipe defects
- Cross filtration
- Catch basin cross connections

Items such as catch basin cross connections and leaks through holes in the manhole cover (sag manholes) are corrected when found, as part of the city's ongoing operation and maintenance procedures.

Generally speaking, 70 percent of I/I flow is from on-lot sources, with the remaining 30 percent from on-street sources.

The evaluation of on-lot control measures indicated the difficulties of working on private property. The city has conducted programs involving various degrees of homeowner participation for lot regrading, roof leader disconnection, and sump pump and backwater valve installation. Review of these programs indicated that the maximum participation rate expected for an on-lot I/I control measure program is about 40 percent, assuming the city pays 100 percent of the costs, based on the finding that 85 percent of the lots in a typical development require improvements. The participation rate drops to 0 percent if homeowners are expected to pay 40 percent of the cost of any on-lot I/I control measure work.

On-lot I/I control should be considered only if the downstream conveyance system has the capacity to carry the expected flows after reduction of the on-lot I/I, allowing for effectiveness and poor participation rates. If the system capacity is not available, on-lot I/I elimination methods are not viable. Most system upgrading to accommodate I/I in Edmonton has had some measure of public participation but has more significantly relied on structural measures (storage and conveyance) for a significant portion of the protection. Prior to initiating any I/I control measure program, a systematic analysis must be undertaken to determine the percentage of I/I reduction necessary for the required level of protection. Then the most economic means of reducing or controlling the I/I can be determined.

The cost-benefit analysis considered the costs of controlling I/I, factoring in the participation rate of homeowners and the effective percentage of I/I control measures. The various control measures were ranked as shown in Table 2.

Table 2. Ranking of I/I Control Measures

I/I Control Measures	Unit Cost Per Lot for 1% I/I Control (\$)	Maximum % I/I Control Expected	Capital Cost Per Lot (\$)
Insensitive to Storm Frequencies			
Disconnect weeping tile (footer drains) with sump pumps	41	70	2,900
Roof leader connection to concrete swales	80	25	2,000
Roof leader connection to storm sewers	175	35	6,125
Lot regrading	197	17.5	3,445
Recompaction of backfill wedge around the house	264	17.5	4,625
Sensitive to Storm Frequencies			
Sewer main upgrading with storage for 5-year storm	38	100	3,800
Sewer main upgrading with storage for 25-year storm	49	100	4,865
Sewer main upgrading with storage for 50 year storm	56	100	5,550

*Canadian dollars.

The cost-benefit analysis (conducted for one of the project neighborhoods) determined that the savings derived from I/I control measures undertaken considering a 50-year life span (not including political, social, and legal costs) are as shown in Table 3.

Table 3. Basement Flooding Costs for a 50-Year Life Span

Level of Protection	50-Year Cost Per Lot of Basement Flooding'
No protection	\$2,118
2-year	\$1,599
5-year	\$818
10-year	\$57
25-year	\$145
50-year	\$0

"Canadian dollars; present-worth costs.

Based on a comparison with total costs from Table 2, without multiplying factors for intangible costs, the benefits are not sufficient to justify the I/I control measures. In reality, intangibles and level of service arguments prevail.

Foundation Drainage

Several years of I/I analysis, sewer system relief evaluations, and revisions to the design flow guidance for separate sewer systems have shown that much of the excess flow during wet weather originates from the city's past practice of connecting foundation drains directly to the sanitary sewer. Although foundation drains potentially contribute large wet weather flows, not all foundation drains contribute equal volumes of flow. To better assess (and model) foundation drain contributions to flow and to better set future design criteria, the city participated in a research project (5) to investigate and quantify the factors that most affect wet weather contributions from foundation drains.

The research facility consisted of a single-family home, typical of those currently being constructed in the area, on an isolated lot designed for application of artificial "controlled" rainfalls and measurement of foundation drainage rates. Foundation drainage rates were measured by routing the foundation drains to two sumps, then measuring the pumped discharge from the sumps.

Several variables potentially affecting foundation drainage were tested at the site under synthetic, applied rainfall conditions and under natural storms that occurred during the research period. Variables tested included:

- Storm event intensity (natural, 5-year, 25-year, 50-year).
- Storm event duration (natural, 4-hour, 24-hour).
- Ground cover type (bare and sod).
- Soil type used in backfill around the foundation (clay, silt, sand).

- Degree of compaction of the backfill (no compaction, frozen backfill, and mechanical compaction judged to emulate about 5 years of natural compaction, including freeze/thaw cycles).
- Grading of the backfill (sloped toward the foundation wall, sloped away from the foundation, and flat).
- Roof leader discharge (to storm sewers, to the lawn at the foundation, and to the lawn 1.5 meters from the foundation).

A total of 82 simulated rainfall test conditions, 3 simulated winter **snowmelt** conditions, 24 natural rainfall events, and 2 natural winter **snowmelt** and rainfall events were evaluated over the course of the study. The results were evaluated to determine the foundation drain sensitivity to each of the factors considered.

Soil type was found to be the most significant factor affecting foundation drain responses. Silty soils produce the lowest response to rainfall, followed by clay and then sand soils. The other variables in descending order of significance are degree of compaction, backfill zone grading, and roof leader location (6).

Sewerage Assessment

All sewerage investigations are based on accurate computer simulation and reliable monitoring information. Modeling and monitoring programs have been established to facilitate these needs.

Modeling

To assess wet weather I/I responses, the SEWHYMO hydrological model was developed (7). This model simulates dry weather base flow and wet weather I/I components of a sanitary sewage system.

Wet weather flow is any rainfall-induced infiltration or direct inflow that enters the sewerage system from a variety of sources classified into three different I/I processes: fast inflow, fast infiltration, and slow infiltration. Fast inflow are those wet weather flows generated from direct connections, such as roofs and catch basins. Fast infiltration is from wet weather generating sources that are somewhat slower in responding, such as weeping tile (footer drain) flows. Slow infiltration is from those wet weather sources that respond more slowly over a long period, typically ground-water infiltration through pipe and manhole defects.

To simulate wet weather flow, the effective rainfall for each of the I/I processes is computed, yielding the portion of the rainfall contributing to the wet weather response of the sewerage system. The effective rainfall is then convoluted by application of three variable unit hydrographs.

A quasi-linear standard instantaneous unit hydrograph is applied to simulate the fast inflow. The shape of this unit hydrograph is based on a storage coefficient that is a function of the basin parameters.

For the fast infiltration response, the same quasi-linear standard instantaneous unit hydrograph is applied. In this case, however, the storage coefficient is a function of the backfill material around the house and is representative of the response time of the weeping tile flows.

A NASH-type instantaneous unit hydrograph (7) is applied to simulate the slow infiltration processes. The response time of the hydrograph is defined by the infiltration time in the soil layers.

Dry weather flow is simulated by applying variable diurnal unit hydrographs (8) developed by review of flow data representative of different populations.

Monitoring

All sewerage assessments and evaluations are based on flow and water quality data. The city has developed and is implementing an environmental monitoring network (9) designed to collect data to identify volumetric and contaminant mass loadings to the North Saskatchewan River from storm outfalls and combined sewer overflows. Ultimately the network will have 30 permanent flow monitoring sites and up to 4 outfall water quality sampling stations. Additional monitoring and sampling are performed at the priority interconnections during area evaluation analysis and at critical locations throughout the collection systems as required.

To ensure data accuracy and control, a customized flow monitoring data management system has been implemented (10). This system provides the means to automatically retrieve, store, manage, report, interpret, and analyze flow monitoring data through a central file server. A similar system is being prepared for the water quality database.

The environmental monitoring network provides the basis for planning environmental protection strategies, including those outlined in this paper.

Conclusions

1. Although an important component of the city's environmental protection initiatives, SSO control is not the highest priority. Tertiary treatment and CSO control are believed to be more cost-effective measures.
2. A strategized approach toward the prioritization and evaluation of system interconnections has achieved an effective method of handling the scope of the problem and defining objectives.
3. The city has implemented and evaluated numerous methods of on-lot and on-street I/I control measures. On-lot measures have met with some success when implemented through rebates to motivated homeowners (e.g., sump pumps for flood-proofing programs).
4. On-street measures (most notable, storage and conveyance capacity increases) are the most cost-effective means for I/I control in most areas. Monitoring and field examination of the sewerage and drainage systems, however, are of paramount importance in developing the programs best suited for a given area.
5. The key factors affecting the flow contribution from foundation drainage systems are soil type and backfill zone compaction.
6. The basis of all sewerage system evaluations is an adequate understanding of the system's performance based on reliable monitoring data and an accurate modeling approach.

References

1. Buie, R.J., and C.W. Labatiuk. 1994. City of Edmonton contaminant reduction study. Report No. 46. Western Canada Water and Wastewater Association, Winnipeg, Manitoba, Canada.

2. Hodgson, J.E., D.Y.F. Yue, and K. Chua. 1994. Optimizing pump station storage for combined sewer overflow control. Proceedings of the Water Environment Federation Specialty Conference, Louisville, KY. pp. **6-11, 22**.
3. City of Edmonton. 1994. Cross connection and interconnection identification and correction strategy. Alberta, Canada.
4. Associated Engineering Ltd. 1993. Inflow/Infiltration assessment study: Significant I/I characteristics. Prepared for the City of Edmonton, Alberta, Canada.
5. **CH2M HILL** Engineering, Ltd. 1994. Lot drainage characteristics study. Alberta Municipal Affairs, County of Strathcona, Alberta New Home Warranty Program, and City of Edmonton, Alberta, Canada.
6. Bontus, G.J., K.L. Siu, and D.B. Prince. 1995. Quantification of foundation drain flow contribution to sewer systems. CSCE, Ottawa, Ontario, Canada.
7. Geoffrey, G.A., C.J.W. Ward, and J.F. Sabourin. 1994. Mathematical simulation of wet weather processes in a sewerage system. Water Environ. Fed. (Chicago, IL) **7:221**.
8. Bontus, G.J., J.F. Sabourin, and W. **Zwicker**. 1995. Developing and using a dry weather flow model for sewerage systems analysis. CSCE, Ottawa, Ontario, Canada.
9. Ward, C.J.W., J.E. Hodgson, C. W. Labatiuk, and M.G. Diebel. 1993. An environmental monitoring network for Edmonton's sewerage and drainage facilities. Water Environ. Fed. (Anaheim, CA) **6:213**.
10. Ward, C.J.W., K.L. Delaronde, and G. Thompson. 1994. An integrated systems approach to the management of flow monitoring data. Water Environ. Fed. (Chicago, IL) **6:47**.

Continuous Simulation for Sanitary Sewer Overflow Control Planning

Edward H. Burgess
Camp Dresser & McKee, Cincinnati, Ohio

Charles I. Moore
Camp Dresser & McKee, Annandale, Virginia

Introduction

For more than two decades, water quality planners have used hydrologic models that perform continuous simulation to evaluate the discharge of pollutants from urban watersheds and to quantify storage and treatment requirements for control of these pollutants. The wet weather response of sanitary sewer systems is often similar to that of urban drainage systems (especially combined sewer systems), and many of the same basic approaches to overflow control also apply to sanitary sewer systems. Recognition of this has enabled a new application for hydrologic models using continuous simulation: analysis and planning of inflow and infiltration (I/I) control facilities for sanitary sewer systems. This also represents a new approach to modeling sanitary sewer systems, which historically have been simulated using either dynamic single-event or steady-state models.

This paper presents the approaches and techniques developed for application of continuous hydrologic models to the analysis of wet weather sanitary sewer flows and I/I storage facilities and demonstrates the benefits of continuous simulation for hydrologic analysis of wastewater systems during wet weather, in contrast to the traditional application of steady-state techniques to sanitary sewer system analysis.

I/I into sanitary sewer systems has long been recognized as a source of operating problems in wastewater collection and treatment systems. I/I can cause sanitary sewer flows to increase during wet weather to rates that exceed the hydraulic capacity of the sewer system in one or more locations. When this occurs, the hydraulic grade line is elevated to a level that can cause problems such as surcharged flows entering basements, overflows to the street surface through manholes, or discharges to nearby streams through constructed overflow points. Some of the most critical problems currently facing wastewater management agencies are the control of I/I-induced sanitary sewer overflows (SSOs) and basement flooding. I/I has also been observed to contribute to serious operating problems at wastewater treatment facilities, including hydraulic overloading and disruptions of biological and other plant processes (1).

As wastewater management agencies examine alternative approaches to controlling I/I problems, storage facilities are increasingly being planned, designed, and constructed for the control of wet weather flows in sanitary sewer systems. While storage facilities have commonly been constructed at wastewater treatment facilities (where they are referred to as equalization basins) to maximize the processing of wastewater generated during wet weather while protecting the plant processes from hydraulic overloading or biological disruption, the use of storage at upstream locations within the collection system has only recently begun to gain acceptance. Collection system storage facilities are now being recognized as providing much of the benefit to treatment facilities realized with equalization basins, with the additional benefit of controlling SSOs and basement flooding while minimizing or eliminating the need to construct relief sewers.

As wastewater planners consider the use of storage, either at the publicly owned treatment works (POTW) or in the collection system, to enhance the wet weather performance of sanitary sewer systems, a continuous hydrologic model-such as the U.S. Army Corps of Engineers' Storage Treatment Overflow Runoff Model (STORM)-can be used in the planning and design of these facilities. This represents a new application of STORM, and while wet-weather conditions in an I/I-impacted sanitary sewer system

are similar to those of a combined sewer system, which enables the use of STORM for I/I analysis, there are important differences that must be understood.

Overview of STORM

STORM (2) is a hydrologic model developed for characterizing urban runoff pollution. STORM is a planning-level model that has been widely applied for quantity and quality analysis of urban watersheds and storage/treatment alternative screening for water quality planning. Since its early implementation on mainframe computers, STORM has gained wide recognition as a practical and effective computer model for planning-level simulation of urban watersheds, especially those with combined sewer systems. STORM has since migrated to the microcomputer environment, where it remains a popular and widely used hydrologic model.

A number of models are currently available that can provide continuous simulation of urban watersheds. Although not the first continuous hydrologic model, STORM (2) was the first significant application of continuous simulation to urban systems. STORM was developed primarily for application to combined sewer systems and has generally been applied to analysis of combined sewer overflows (CSOs). STORM is in many respects ideally suited to planning-level simulation of combined sewer systems because 1) dry-weather flows in the combined sewer system, in addition to runoff, can be simulated; 2) the input data requirements are appropriately matched to planning-level accuracy requirements; 3) continuous simulations can be performed to characterize CSO statistics; and 4) alternative storage and treatment tradeoffs can be examined as a key element of CSO abatement planning.

STORM uses the rational formula ($Q = CIA$), modified to handle depression storage explicitly, to compute rainfall runoff rates, as shown in Equation 1.

$$R = Q/A = C (P - f) \quad (\text{Eq. 1})$$

where

R = unit runoff (centimeters or inches)

Q = total runoff (cubic meters or cubic feet per second)

A = watershed area (hectares or acres)

P = rainfall depth (centimeters or inches)

f = available depression storage (centimeters or inches)

Since STORM uses a 1-hour time step, excess rainfall ($P - f$) and unit runoff can be thought of as intensities (centimeters or inches per hour). With English units, **C** in STORM is a dimensionless runoff coefficient that accounts for all hydrologic abstractions except depression storage losses. (The unit conversion factor of 1.008 for English units is normally neglected; with SI units, a conversion factor must be applied.) STORM uses monthly evaporation rates to compute the recovery of available depression storage during dry periods.

Although this is a simplified approach to runoff computation (especially for pervious areas), typically it is sufficiently accurate for CSO planning since most combined sewer watersheds are highly urbanized (i.e., highly impervious) and most storms that produce CSOs are small storms in which the runoff contribution from pervious areas is very small. In addition to computing runoff quantity throughout the simulation period, STORM can also compute runoff quality (for up to six parameters) using a buildup/washoff computational approach.

STORM computes runoff volumes, dry weather flow volumes, and pollutant loads, routing these flows and pollutants through storage and treatment at each time step throughout the simulation period. Figure 1 depicts the conceptualization of combined sewer systems in STORM. It should be clarified that virtually all combined sewer systems provide some storage (e.g., combined sewer volume upstream of regulators) and some treatment (e.g., wet-weather interceptor capacity). STORM computes the volume of overflow at each time step and provides both detailed output for individual rainfall events and summary output in the form of average overflow statistics (e.g., average annual CSO frequency, average annual CSO volume, average annual pollutant loads).

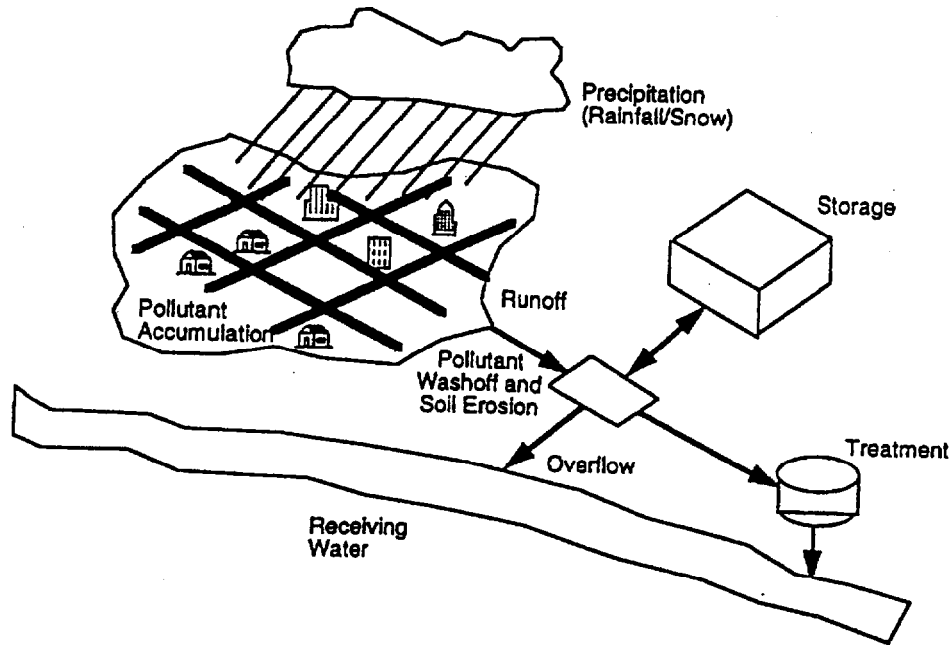

Figure 1. STORM conceptualization of combined sewer system.

Because STORM was developed for (and has most often been applied to) combined sewer systems, the foregoing overview of STORM referenced this application. Although sanitary sewer systems are designed to exclude the entry of stormwater while combined sewers are designed to collect stormwater, the response of a sanitary sewer system to I/I is conceptually very similar to the response of a combined sewer system (or more specifically, a combined sewer interceptor) to stormwater runoff; in other words, rainfall induces higher flows, which can in turn cause operational problems. In the case of combined sewer systems, the problem is typically frequent overflows to the receiving waters (CSOs). In the case of sanitary sewer systems, the problems are typically basement flooding, overloaded treatment processes, and sewer overflows (although SSOs generally occur less frequently than CSOs). The following section provides a brief overview of I/I in sanitary sewer systems.

I/I Occurrence and Control

The occurrence and control of I/I has been described in detail in the literature and is only summarized briefly here. I/I can be defined as relatively “clear” water that enters the sanitary sewer system “unintentionally,” through a variety of sources including pipe defects and improper stormwater connections. The reader interested in more detailed information is referred to U.S. EPA (1), American Public Works Association (3), and Water Pollution Control Federation (4).

inflow is the component of I/I that enters the sanitary sewer directly and causes an almost immediate response in downstream sewer flows. Typically inflow is a result of improper stormwater connections, but some pipe defects can cause inflow responses. Infiltration is the portion of I/I that is typically derived from subsurface water entering the sewer system through pipe defects. While infiltration typically produces a much more gradual increase in sewer flow rate than inflow does, with less impact on peak flow rates, the volume of infiltration can be significant. It is often useful to distinguish the portion of I/I that is derived directly from rainfall from the portion that is derived from ground water (which varies only seasonally, if at all). Figure 2 depicts conceptually the relative impacts of the various I/I components on sanitary sewer flow conditions.

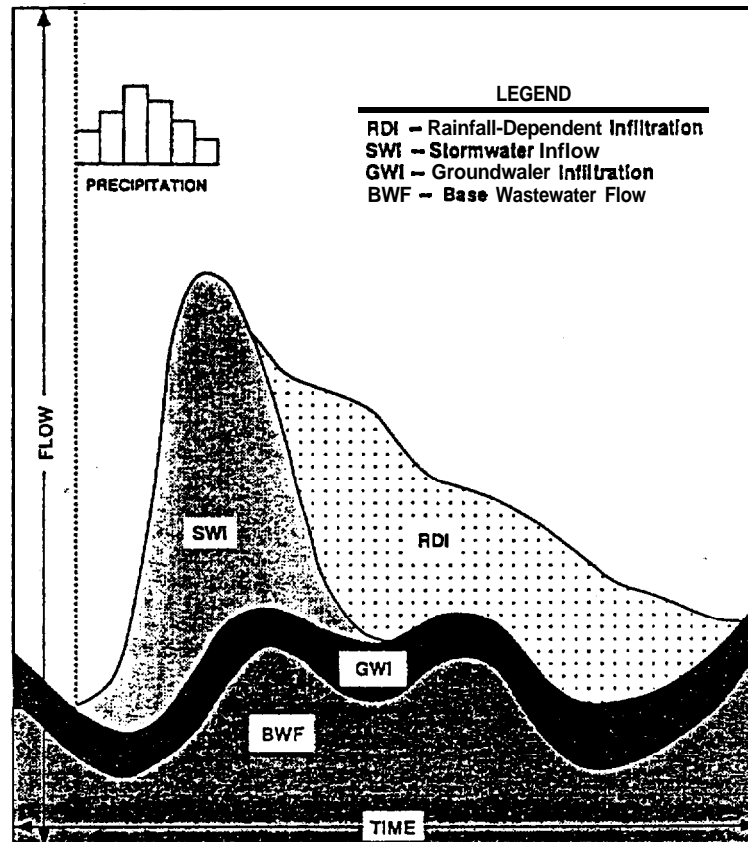

Figure 2. Flow components of the sanitary sewer hydrograph during wet weather.

The need to control I/I has long been recognized: to reduce property damage, water pollution, and public health risks associated with basement flooding and SSOs. The most common approach has been to construct relief sewers sized to accommodate design wet weather flow rates that are typically determined through hydraulic modeling and flow monitoring. This approach often results in upsizing the entire sewer network downstream of the first relief sewer, however, which can impose very high capital costs for sewer construction and may cause existing treatment facilities to become overloaded. For these reasons, other alternative control measures are often explored.

Alternative controls include I/I reduction programs and the use of storage. Attempts to reduce I/I levels with source controls (e.g., through downspout disconnection and sewer rehabilitation programs) have had only limited success in achieving sewer system performance objectives, and it is difficult to establish a priori the exact extent of the I/I reduction improvements required; therefore, a program may not achieve the required flow reductions. Storage in sanitary sewer systems has been widely implemented as

equalization facilities at POTWs, and collection system storage has been identified recently as the most cost-effective means to achieving the required level of performance in a number of locations. Collection system storage facilities have been planned, designed, or constructed for I/I control in California, Maryland, Michigan, Ohio, and other areas.

STORM Conceptualization of Sanitary Sewer Systems

Application of STORM to sanitary sewer systems is possible because the I/I response in sanitary sewer systems is very analogous to the urban runoff processes for which STORM was developed. The conceptualization of combined sewer systems described above can be adapted to simulate sanitary sewer systems in STORM, where the modeling objectives normally include characterizing SSO quantity (i.e., frequency and volume), sizing storage facilities, and evaluating storage-duration characteristics to support the design of I/I storage facilities.

STORM was developed specifically to simulate urban watersheds, which include a drainage network (e.g., a combined sewer system) that collects stormwater runoff in response to rainfall. Sanitary sewer systems, although designed much differently than combined sewers, typically function in a similar manner and capture stormwater in response to rainfall. The concept of a modeled watershed in STORM can therefore be applied to the sanitary sewer service area for I/I analysis.

STORM uses a modified form of the rational formula to compute the runoff response to rainfall of the modeled watershed, as described above. With this approach, two model parameters can define runoff rates: the rational C coefficient and the available depression storage. STORM computes the available depression storage at each time step using the hourly rainfall data and the monthly evaporation rates, based on the maximum depression storage determined for the modeled watershed.

The rational C coefficient for urban watershed applications represents the hydrologic abstractions other than depression storage (i.e., essentially infiltration losses). It is therefore a measure of the fraction of the rainfall that becomes runoff (less that portion lost to depression storage); typically values of 0.1 to 0.95 are determined for modeled watersheds. The physical interpretation of rational C for sanitary sewer applications is very similar. In this case the rational C coefficient represents the volume coefficient for I/I entering the sanitary sewer system, or the ratio of the volume of rainfall entering the sanitary sewer system to the total rainfall volume. Values of C are typically found to be roughly one order of magnitude lower for I/I than for surface runoff.

The rational C coefficient is assumed constant in STORM, which is a limitation for both I/I analysis and for urban runoff applications. C for urban watersheds has been observed to vary as a function of rainfall characteristics (intensity, duration, volume, and antecedent dry period). Some studies suggest C for sanitary sewer systems may decrease for larger storms and for events with extended antecedent dry periods. The assumption that C remains constant, however, is generally considered acceptable for the planning-level modeling objectives for which STORM is applied.

STORM handles surface depression storage explicitly, rather than including these losses with the other abstractions in the lumped rational C coefficient in simulating runoff from the modeled watershed. This formulation enables STORM to better simulate the frequent, smaller storms to which annual runoff and overflow volumes are relatively sensitive. When applying STORM to sanitary sewer system analysis, the depression storage parameter can be thought of as the rainfall volume threshold before I/I occurs. Although this analogous response to surface depression storage is commonly observed for sanitary sewer systems, it is difficult to provide a physical interpretation of this parameter in sanitary sewer system applications, since I/I mechanisms are still not completely understood. It may represent a lumped parameter that includes the average absorption capacity of the soil above the sewer system and other losses.

STORM is applied to both surface runoff and I/I analysis using a long-term precipitation record with hourly depth values. Data are typically available for a period of 40 years or more for a gauged site within reasonable proximity to the modeled system. This period of record enables overflow statistics (e.g., average annual frequency and volume) to be computed with acceptable statistical confidence. Spatial variation in rainfall between the gauged site and modeled watershed, while potentially significant for a specific event, can generally be considered insignificant over periods of this length.

Storage and treatment as defined in STORM are used in sanitary sewer system applications with essentially the same physical interpretation as for surface runoff applications. While combined sewer systems often provide relatively significant “in-system” storage volumes, however, by virtue of their physical characteristics (e.g., relatively large-diameter pipes, ponding areas form behind diversion dams) sanitary sewer systems are typically much smaller and provide very little in-system storage. In both surface runoff and I/I applications, “treatment” is defined as the capacity of the collection system to capture wet weather flows for conveyance to a treatment facility. Treatment capacity is typically determined externally to STORM, using a hydraulic model of the sewer system.

STORM application to sanitary sewer systems is limited to quantity analysis. Because no meaningful physical interpretation of the buildup-washoff process for surface pollutants used in STORM exists for sanitary sewer systems, the current public-domain version of STORM cannot support quality (pollutant load) computations for sanitary sewer applications. The modeling objectives for sanitary sewer system applications typically do not require that pollutant load estimates be computed (which is often an important component of STORM modeling for urban runoff applications), however, as SSOs generally must be “eliminated” under regulatory requirements for sanitary sewer system operation, irrespective of the characteristics of the pollutant loads that are discharged.

The above reference to the “elimination” of SSOs raises a most important point. I/I in sanitary sewer systems is a response to rainfall and therefore analogous in many respects to surface water hydrology. For example, I/I (like runoff) is a stochastic and highly variable process, which has been confirmed empirically in numerous I/I studies. The extreme variability of rainfall-and of the resultant I/I response-renders SSO elimination virtually impossible in many cases, or at least economically impractical and difficult to defend from a cost-benefit perspective. While it has long been recognized that elimination of surface flooding is impractical (e.g., the 100-year storm is often selected as a design event), however, it is not yet widely recognized that SSO elimination may be impractical. Much work remains to be done to establish methodologies for selecting appropriate design targets for control of I/I problems.

STORM Application for I/I Control

STORM can be used in I/I analysis to support sizing and design of storage facilities both within the sanitary sewer collection system and for equalization storage at wastewater treatment facilities. Techniques to apply STORM to I/I analysis in sanitary sewer systems are described here.

Overflow characteristics and storage facility sizing are sensitive to the rational C coefficient. While C coefficients can often be estimated from land use and topographic mapping of the modeled watershed for surface runoff applications, sewer flow hydrographs obtained from flow monitors installed in the modeled system and rain gauge records for the monitoring period must be analyzed to determine capture rates (C coefficients in STORM) for sanitary sewer applications. The volume of rainfall (V_{precip}) is found from the rain gauge record, and the volume of I/I (V_i) is found from the flow monitor record. C is simply computed as V_i/V_{precip} . Experience suggests that it is generally best to examine as many storms as possible and develop an average value for C, or a conservative design value or range of values, depending on the requirements of the specific application.

In addition to defining the existing I/I capture rates, it is often necessary to develop C values for future conditions, which could reflect projected conditions with proposed source controls in place (i.e., lower C

values) and/or with upstream relief sewers in place (i.e., higher C values), since storage can be effectively implemented in conjunction with these other approaches to I/I control. Reduction in C values to reflect source controls for I/I is reasonably straightforward (given that I/I reduction targets will be met); however, increasing C values to reflect upstream relief sewers is often difficult. If upstream SSOs are known to occur and are being eliminated, monitoring these SSOs can enable estimates of future C values to be developed that account for the I/I volumes currently lost as SSOs. A conservative design value for C can be obtained using the total pipe capacity for both the existing sewers and proposed relief sewers, but this requires 1) an estimate of the rainfall volume associated with an event that would cause the system to reach capacity (i.e., the design event for the relief sewer) and 2) the development of a synthetic hydrograph for the total sewer flow under the design event (since sewers are typically designed using only a design peak flow rate).

The value for the depression storage parameter in STORM applications to I/I analysis also requires the availability of flow monitoring data for the modeled system. By examining I/I hydrographs and rain gauge records for a number of smaller storms, determining the minimum precipitation depth required to induce an I/I response in the system is possible. This is analogous to determining the surface depression storage volume that must be occupied before surface runoff occurs from a modeled watershed.

STORM allows the modeler to account for routing effects in the modeled watershed with the use of an optional unit hydrograph computational approach. The modeler specifies the unit hydrograph parameters that define the shape of a triangular unit hydrograph for the modeled watershed, specifically two parameters: the time of concentration and the ratio of the time of recession to the time to peak (2). The use of the unit hydrograph option in STORM is often advantageous in sanitary sewer applications, especially where infiltration effects are significant and for larger systems. The modeler should examine the shape and time-to-peak of monitored flow hydrographs to develop the appropriate unit hydrograph parameters for the modeled sanitary sewer system.

STORM output includes both summary statistics (e.g., average annual volumes of rainfall, runoff, and overflow; average annual overflow frequency) and a detailed listing of a variety of parameters for each event in the simulation period. (The STORM users manual [2] provides a detailed description of STORM output.) STORM also produces graphic output of the storage-frequency characteristics of the simulated storage facility, referred to as the normalized storage utilization curve. An example of this graphic output, taken from an actual I/I storage simulation for a facility proposed in the Dayton, Ohio, area, is shown in Figure 3. Although this text-based graphic is quite crude by "modern" software standards, the curve is very useful for facility design, as the designer can determine the frequency and duration of exposure to wastewater for each chamber of a multi-chamber storage facility. This information is often useful for designing the cleaning and odor control components of the facility.

Example Application

In the recently completed Phase I Sanitary Sewer System Facility Plan performed for the Charlotte-Mecklenburg Utility Department in Charlotte, North Carolina (5), STORM was used to evaluate the effectiveness of converting existing, unused polishing lagoons at two wastewater treatment plants (WWTPs) to I/I storage. The Sugar Creek WWTP is located within the subject sanitary sewer system, and flows in excess of its 0.87 cubic meters per second (m^3/sec) or 20 million gallons per day (mgd) treatment capacity are bypassed to be treated at the downstream McAlpine Creek WWTP. The volume of the existing polishing lagoons at the Sugar Creek WWTP is 7.6 hectare-meters (ha-m), or 20 million gallons (MG), and the volume of the existing lagoons at the McAlpine Creek WWTP is 17 ha-m (44 MG). The McAlpine Creek WWTP has a permitted monthly average treatment rate of $1.7 \text{ m}^3/\text{sec}$ (40 mgd), of which $1.3 \text{ m}^3/\text{sec}$ (30 mgd) is dry weather wastewater flow, leaving $0.4 \text{ m}^3/\text{sec}$ (10 mgd) for the treatment of I/I flows. Analysis of plant treatment processes indicate that a rate of $3.1 \text{ m}^3/\text{sec}$ (70 mgd) can be maintained for several days without upsetting plant processes and/or violating permit criteria.

Flow monitoring data for the period October 1989 through May 1990 at monitors located near the points of interest were used to determine the I/I characteristics of the sanitary sewer system. Hydrograph decomposition methodologies were used to determine the I/I volume for each rainfall event that occurred in the monitoring period. Hydrograph decomposition enables the I/I component of the monitored hydrograph to be distinguished from the dry weather flow component (sanitary wastewater and ground-water infiltration).

The I/I volume coefficient C for each event was then determined by dividing the measured I/I volume by the total volume of rainfall over the service area tributary to the monitor. Several events were found to have very small C coefficients, likely due to antecedent conditions of very low soil moisture, and these events were neglected in determining C values for use in analysis. C values were found to range from 0.013 to 0.020 at the Sugar Creek WWTP and from 0.020 to 0.038 at the McAlpine Creek WWTP. These values, which indicate that between 1.3 and 3.8 percent of the rainfall over the sewer service area enters the sanitary sewer system, are typical of rates found elsewhere in the eastern United States in studies performed by Camp Dresser & McKee (6-9).

Review of the flow monitoring data indicated that events with rainfall depths of less than 0.5 centimeter (0.2 inch) do not produce an I/I response. The value for the depression storage parameter in the STORM model was therefore set at 0.5 centimeter (0.2 inch). Analysis of as-built data for the sanitary sewer system showed that approximately 0.8 ha-m (2 MG) of storage is available in the sewer upstream from the Sugar Creek WWTP and 4 ha-m (10 MG) is available in the sewer system upstream of the McAlpine Creek WWTP. This in-system storage was included in the STORM simulations of the existing system and of the system with the proposed I/I storage facility.

Forty-two years of rainfall data recorded at the Charlotte Airport were used in the continuous simulation with STORM to evaluate the efficacy of using storage to reduce the volume and frequency of excess I/I flow events. STORM model results show that using the existing 7.6 ha-m (20 MG) polishing lagoons to store excess I/I flows would reduce flow in the overloaded downstream sewers and also reduce total flows to the McAlpine Creek WWTP. The volume of flow bypassed to the McAlpine Creek WWTP would be reduced 80 to 90 percent over current levels.

The STORM analyses presented in Figure 4 show that by utilizing the existing 17 ha-m (44 MG) polishing lagoons at the McAlpine Creek WWTP, the quantity of excess flow would be reduced 70 to 90 percent. Furthermore, treatment provided within the storage facility will reduce settleable and floatable solids discharged during extreme events (those that exceed the available storage), resulting in estimated pollutant reductions of greater than 90 percent. In the preliminary design, the storage facility was segmented into three basins that would fill sequentially. The first basins would capture many of the smaller events and also be utilized for diurnal flow equalization to further optimize the effectiveness of treatment provided. Increases in headworks pumping capacity associated with the conversion of the existing lagoons eliminate the potential for overflows from upstream sewers resulting from backwater effects produced by the WWTP.

In some sanitary sewer system applications, there is significant uncertainty in C for future conditions (e.g., when storage is proposed in conjunction with other I/I controls). In these cases STORM is typically applied using multiple production runs over a range of C values to develop an envelope of values for model output (e.g., SSO frequency and volume, time series of storage characteristics) for various levels of I/I storage. The designer can then select the appropriate point on the envelope for design.

The STORM model results from this study showed that significant reductions in the frequency and volumes of overflows can be achieved quickly and with relatively small capital expenditures with the proposed implementation of I/I storage facilities. Other studies for I/I storage facilities both at POTWs and in the collection system have also found I/I storage to be cost effective.

TREATMENT RATE = 0.0021 IN/HR, 6.3 CFS, 4.047 MGD
 STORAGE CAPACITY = 0.0796 INCHES, 19.6 AC-FT, 6.392 MG
 NORMALIZED STORAGE UTILIZATION CURVE

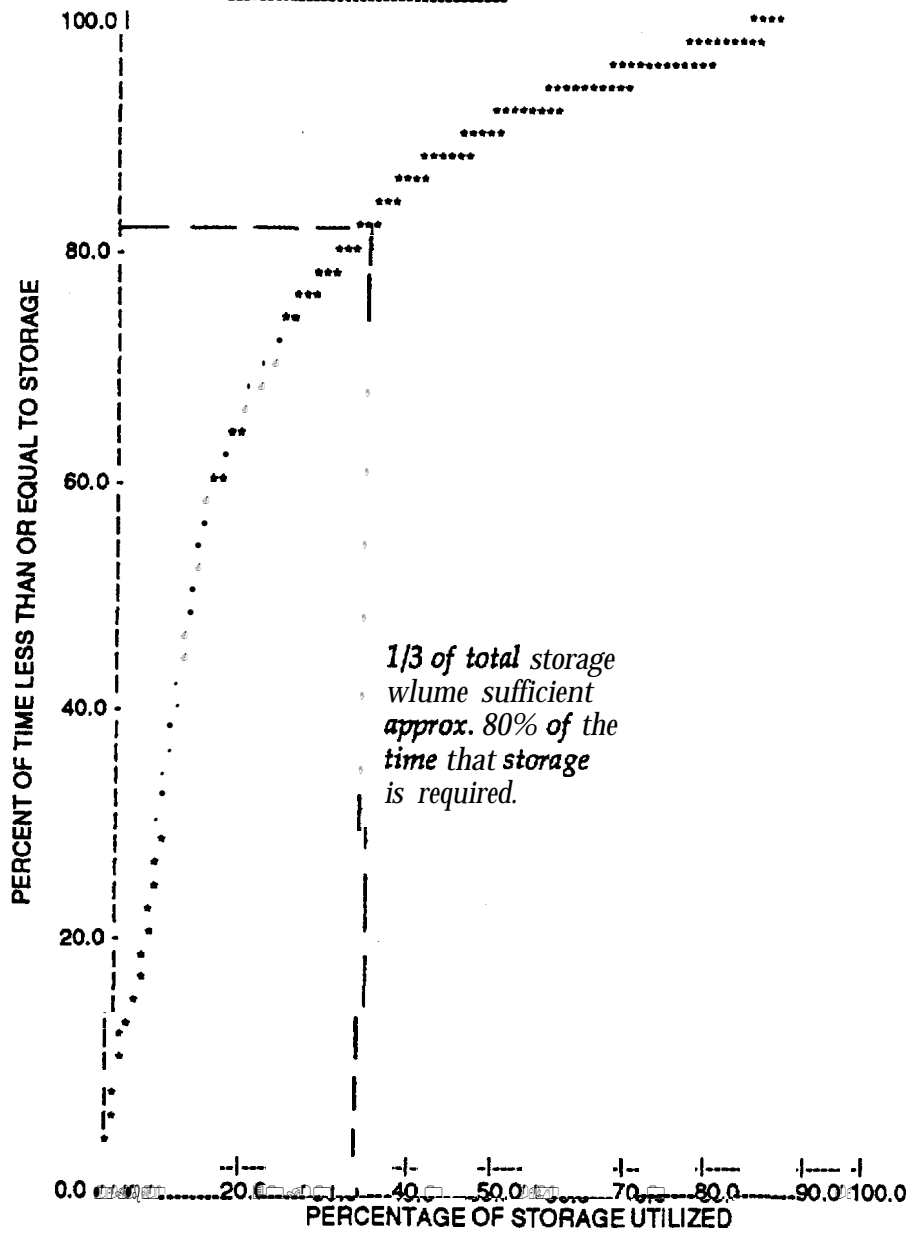

Figure 3. Normalized storage utilization curve from STORM.

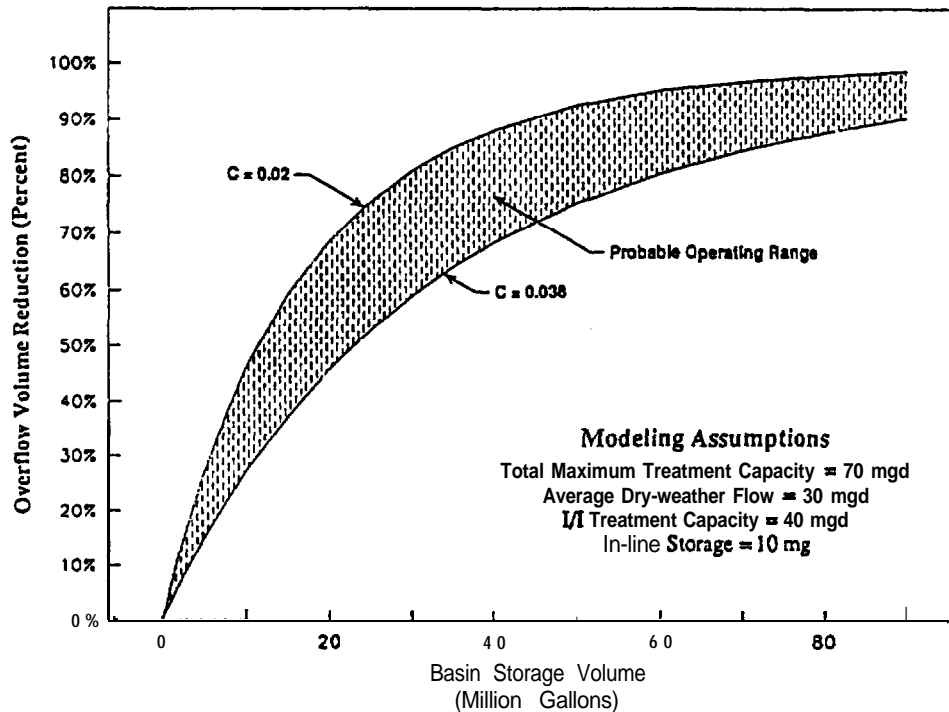

Figure 4. STORM simulation results for proposed storage at McAlpine Creek WWTP.

Conclusion

I/I problems are an important issue that many wastewater management agencies currently face, and the need to identify and eliminate I/I-induced sanitary sewer overflows is widely recognized. The use of storage facilities is increasingly being implemented to control the excessive flows often observed in sanitary sewer systems during wet weather due to I/I. STORM can be effectively applied to the analysis and planning of these facilities by employing a hydrologic modeling approach using continuous simulation. This represents a new approach to modeling sanitary sewer systems, which have historically been simulated using either steady-state or dynamic single-event models. This application of STORM also represents a new application for a widely recognized hydrologic planning model.

A hydrologic modeling approach for planning and designing I/I controls allows wastewater planners to simulate the random and highly variable I/I process and therefore better understand how storage facilities should be designed to achieve performance objectives while minimizing costs and operational problems. More specifically, continuous simulation is ideally suited to support planning and design of I/I storage facilities because storage design is by nature a volume "issue" and continuous simulation enables the volumes of I/I (not just the peak rates) to be accurately simulated to understand how the facility can be expected to actually perform once in service.

STORM has been shown to be a useful tool in planning and designing I/I storage facilities. Although the approach has some limitations, it offers a practical and cost-effective means to simulate I/I storage facilities and provides useful insights for planning, design, and operation. The planner can use STORM to establish the volume of the storage facility required to meet a specific design target. STORM also computes the frequency and duration of storage and produces storage utilization curves that can be used to establish the segmentation scheme for a multi-chamber storage facility, as well as to determine the requirements for cleaning and odor control.

References

1. U.S. EPA. 1975. Handbook for sewer system evaluation and rehabilitation. Washington, DC. **EPA/430/9-75/021.**
2. U.S. Army Corps of Engineers, Hydrologic Engineering Center. 1977. Storage Treatment Overflow Runoff Model (STORM) User's Manual. Davis, CA.
3. American Public Works Association. 1971. Prevention and correction of excessive infiltration and inflow into sewer systems. U.S. EPA Program No. **11022EFF.** Washington, DC.
4. Water Pollution Control Federation. 1983. Existing sewer evaluation and rehabilitation. MOP **FD-6.** Washington, DC.
5. Camp Dresser & McKee. 1992. Sanitary sewer facility plan, interim report number 1: **Charlotte-Mecklenburg** Utility Department, Charlotte, North Carolina.
6. Camp Dresser & McKee. 1990. Cabin John Basin Reevaluation Study, facility plan report. Washington Suburban Sanitary Commission.
7. Camp Dresser & McKee. 1991. Conceptual design report for wastewater treatment plant flow equalization facilities, Charlotte-Mecklenburg Utility Department, Charlotte, North Carolina.
8. Camp Dresser & McKee. 1991. Sanitary sewer system study, Arlington County, Virginia. Contract number 28-90.
9. Camp Dresser & McKee. 1993. Wet weather engineering study, Western Carolina Regional Sewer Authority, Greenville, South Carolina.

Storage Solution for Handling Excessive Wet Weather Sanitary Flows

Terry L. Krause
Metcalf & Eddy, Inc., Itasca, Illinois

Lloyd E. Witte
City of Des Moines, Des Moines, Iowa

Lee J. Glueckstein
Rust Environment & Infrastructure, Sheboygan, Wisconsin

Introduction

The Des Moines metropolitan area is a large insurance and agricultural center with a population approaching 300,000. Besides being the capital of Iowa, it is the home of several major food processing and meat packing industries. To keep pace with fast-growing development in the region, improved and expanded wastewater facilities were required.

In 1971, the City of Des Moines was issued a Consent Decree by the Iowa Water Pollution Control Commission to improve its wastewater conveyance and treatment facilities. With the advent of the Federal Water Pollution Control Act Amendments of 1972, the Des Moines metropolitan area was designated a Section 208 Areawide Planning Area. In 1973, the Central Iowa Regional Association of Local Governments initiated the Section 208 planning process. Fourteen units of local government formed an integrated community area (ICA), and the City of Des Moines became the operating agency for the ICA.

The Section 208 plan recommended several concepts for regional control of point and nonpoint sources of pollution. Major components of the plan included a new regional wastewater treatment facility, more than 50 miles of new interceptor sewers, six lift stations, and 13 flow equalization basins. The equalization basins, which ranged in size from 0.2 million to 9.2 million gallons, would be used for short-term, off-line storage of the peak flows.

Following the Section 208 areawide planning work, more detailed facilities planning was conducted in the early 1980s. As part of this process, the Section 208 plan recommendations were reevaluated in light of new information and proposed effluent standards. While the more detailed facilities planning confirmed the general concepts of the Section 208 plan, the actual recommended facilities changed. The facilities plan recommended the construction of eight new interceptor segments and five equalization basins and provided for the maintenance of six wastewater treatment plants, including the main new ICA Regional Wastewater Treatment Plant. The facilities plan was adopted in 1982 and became the blueprint for implementing new and improved wastewater facilities in the area.

Two of the major components of the recommended plan were the Southwest Outfall and Westside Equalization basins. The remainder of this paper focuses on the sizing, design, construction, and initial operation of these two major basins.

Equalization Basin Development

Basis of Selection

The ultimate goal during the planning phase of the project was for wastewater from the outlying areas to be conveyed to the treatment facilities in the most cost-effective manner while eliminating basement flooding and separate sanitary sewer overflows (SSOs) during wet weather. The flows to be conveyed were a combination of domestic and industrial wastewater base flow and infiltration and inflow (I/I), which

were not cost effective to remove. To determine how much I/I would remain in the system, I/I studies were conducted in the 1970s on all sewer subsystems. Those found to have significant I/I were subjected to more detailed Sewer System Evaluation Surveys (SSESs) to identify sources of the excessive I/I and to determine what portion could economically be removed. The remaining I/I would have to be accommodated in the upgraded and expanded wastewater conveyance and treatment system.

Once the I/I studies had been completed and future base wastewater flows projected, it was determined that six interceptor systems would be hydraulically overloaded. To correct this problem and reduce the potential for sewer overflows, various alternatives such as gravity relief sewers, pump stations with relief sewers, flow equalization basins, and combinations thereof were developed and evaluated. As a result of these evaluations, equalization basins were found to be cost-effective components of the overall wastewater management expansion plan.

Design Criteria

Conveyance system alternatives were developed to accommodate design flows for the year 2005 based on the results of the I/I studies and on projected domestic, commercial, and industrial wastewater flows. Interceptor sewers were sized to convey the peak hourly flows with a depth of 0.75 of the pipe diameter, which correlates to the Iowa design standards. The flow equalization basins were sized based on flow hydrographs representing a 5-year-recurrence-interval, 2-inch-per-hour rainfall event. Flows in excess of this level could be bypassed. This again met state design standards. Based on an analysis of rainfall frequency, the basins were to be designed to drain completely within 48 hours of the storm event.

Basin Sizing

As previously indicated, the purpose of the equalization basins was to attenuate the peak flow rates in the downstream conveyance systems and reduce the peak flow that had to be accommodated at the treatment facility. This is accomplished by temporarily storing a portion of the flow from the tributary upstream conveyance system off-line during periods of unusually high wastewater flows. The stored flow would then be returned to the downstream conveyance system once the wastewater flow rates in each system decreased below the full carrying capacity of the interceptor.

The primary input to the sizing of the equalization basins was the wet weather flows remaining after sewer system rehabilitation. Sizing was determined with the aid of a hydraulic computer model developed for each interceptor sewer system. Many possible hydraulic models could be applied; in this case, the SAM program was selected. This program consists of four separate modules or routines: land surface storm runoff, sanitary sewage contributions, I/I, and routed flow in a sewer (transport). In analyzing the Des Moines system, only the transport module was used.

The transport module accepts input hydrographs, developed from available wet weather sewer flow monitoring data, at key locations in the sewer system. It then routes the hydrographs downstream through the sewer system using modified kinematic wave equations. The effects of kinematic routing are to lower the hydrograph peak flows and delay the time of arrival. The storage in the conveyance system is accounted for under open-channel flow conditions. If flow exceeds the full conduit capacity, the model assumes full conduit flow and accounts for the volume of excess flows that need to be accommodated by off-line storage.

Using this model, various computer runs were made to optimize the conveyance/ storage sizing on those interceptor systems that were overloaded. From this series of analyses, the optimal size of equalization basins was determined for each system in which basins were considered to be a component of the cost-effective conveyance solution. In the case of the Common Trunk and Southwest Outfall systems, the proposed equalization basin would have a capacity of 9.2 million gallons. This would become the largest

basin in the planned Des Moines system. The second largest proposed basin in the Des Moines system would relieve the **Westside** Des Moines River interceptor. This basin had a proposed storage capacity of 4.8 million gallons.

Design Considerations

Upon completion and approval of the facilities plan, the Des Moines ICA proceeded with the design of the recommended improvements, including the flow equalization basins. Although a multitude of considerations went into the design of these basins, the most important considerations related to the two largest basins are discussed below. Each of these items was applicable to both basins.

Hydraulic Flow Pattern

Two alternative flow patterns into the basin were evaluated: gravity inflow/pumped dewatering and pumped inflow/gravity dewatering. Both these alternatives have monetary and nonmonetary tradeoffs that need to be considered. For the gravity inflow option, the basin would need to be below ground, which would add to the cost of construction. On the other hand, the associated pumping facilities for the pumped inflow option would be larger because the pump station would have to match the expected inflow rate diverted from the conveyance system. There was also a question of the reliability of the pumped inflow option. Because the gravity inflow option did not rely on pumps to fill the basin, this option was determined to be more reliable than a system that required power to operate the pumps, even if a second source of power was provided.

Given the costs, advantages, and disadvantages associated with the two options, the gravity inflow hydraulic pattern option was selected. Because both the Southwest Outfall and **Westside** basins were to be located in potential recreational areas, the underground tanks also fit in well with the future uses of the sites.

Recreational Site Uses

The Southwest basin was on property where the Des Moines Parks Department planned to construct a park. The **Westside** basin was on a site within the existing Prospect Park.

The major decision that had to be made during design was whether the basin facilities would be incorporated into park facilities or isolated from the recreational uses of the site. Early layouts of the Southwest basin included toilet facilities for park users accessible from the exterior of the building. These were removed from the design when the decision was ultimately made to keep park users away from the basin facilities at this site.

At the **Westside** basin location, the resulting hydraulic conditions left an interesting challenge. Either the basin would be constructed with substantial headroom above the high water level or the basin would be covered with approximately 15 feet of earth. Both options would have resulted in significant additional costs. Instead, an option was chosen to construct the basin with minimum open headspace above the high-water level and minimum cover over the top of the tank. The resulting site depression would be graded to allow seating on the slopes, and several basketball courts were to be constructed on top of the basin. In the winter, these courts could be covered with ice to serve as skating rinks. Basin facilities would be isolated from the recreational site uses by a chain-link fencing system.

Basin Configuration

Initial layouts of the basins called for conventional rectangular concrete tanks, divided into multiple chambers. This would permit only portions of the tank to fill depending on the size of storm event, reducing the associated cost of cleanup following the event. The flow would enter the first chamber; when this chamber was filled, overflow would enter the second chamber, and so on as required for that event. Once the basin was completely full, flows diverted to the basin would be diverted around the basin and bypassed to adjacent receiving streams as allowed by the state regulatory agency.

As the preliminary design proceeded, a value engineering review occurred, in accordance with EPA grant requirements. During this review, it was proposed to change the configuration to a deeper circular tank, which had lower associated construction costs. Again, this circular tank would be divided into four chambers, and the floor would slope to the center where the dewatering pumps would be located. This concept was adopted for both of the major basins. Table 1 summarizes some basic design data for each basin. Figure 1 shows a simplified plan and sectional view of the resulting basin configuration.

Table 1. Basic Design Data Summary

Parameter	Southwest Basin	Westside Basin
Inside diameter (feet)	208	228
Overall depth (feet)	61	25
Maximum side water depth (feet)	46.3	13.2
Open head space (feet)	14.7	4.6
Bottom slope (feet per foot)	0.058	0.044
Storage volume (million gallons)	9.2	4.8
Number of chambers	4	4
Design inflow rate (million gallons per day)	49.1	22.6
Construction cost (millions)	\$5.6	\$8.1 ^a

^aIncluding the Westside Sanitary Pump Station.

Basin Cleaning

The wastewater flow diverted to the off-line equalization basins was anticipated to be relatively dilute because it will occur during periods of high I/I intrusion into the sewer system, and because the initial flush of solids would be conveyed downstream prior to the diversion of flow. Regardless of the configuration, however, solids will still settle in the basin, with the greatest quantity expected in the first chamber. Therefore, facilities to clean the basins had to be incorporated into their design.

Many basin cleaning options exist. Most options have been applied in the United States to combined sewer overflow (CSO) basins. The two options evaluated in most depth for the Des Moines basins were permanently installed flushing water nozzles located along the tank walls and a similar system supplemented with high-pressure, manually operated spray water cannons. The combined flushing water nozzle/high-pressure water cannon approach was felt to be the most effective; however, it required personnel access into the basin during cleaning. A fixed flushing nozzle system alone may not be as

effective, but it could be fully automated and eliminate the need for frequent personnel access to the basin as well as the associated design provisions that would be required for this occurrence (Le., positive ventilation and its associated odor control facilities, permanent lighting, series of catwalks, and other provisions).

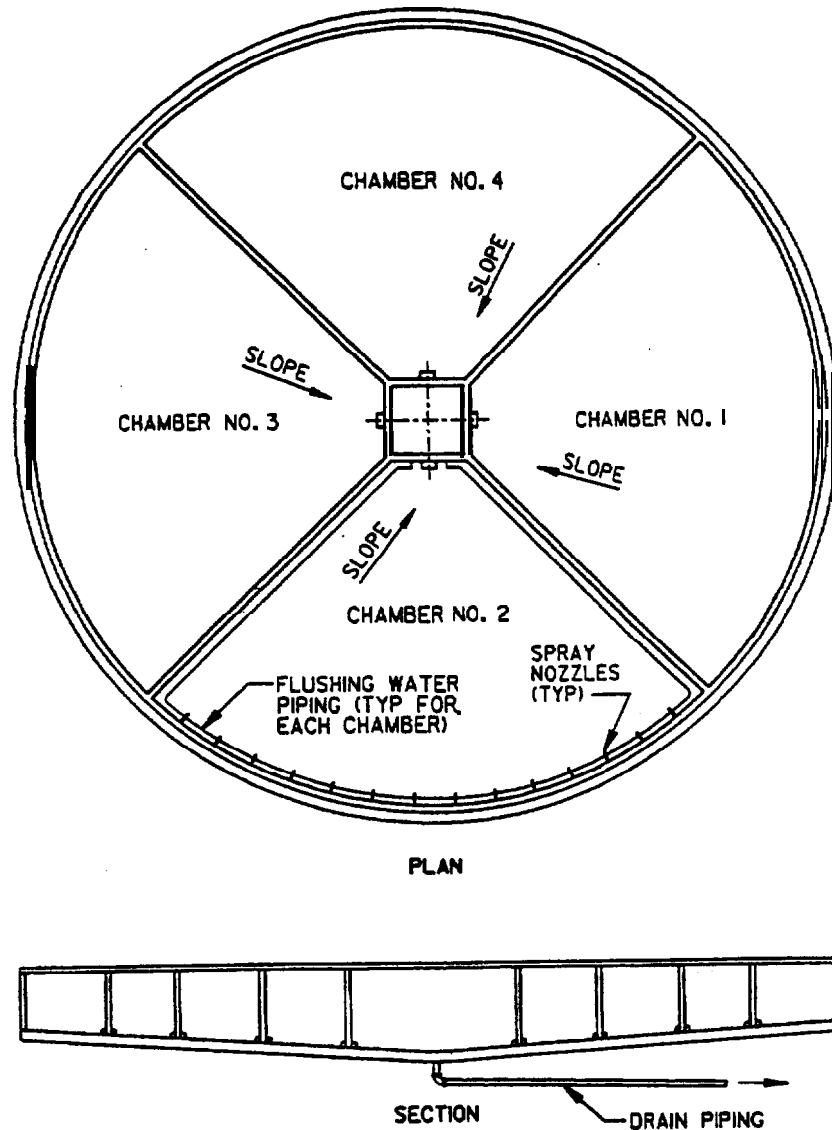

Figure 1. Simplified equalization basin plan and section.

Based on cost analyses and operator input, the automated flushing wash water nozzle system was selected. It was felt that this system would adequately clean the basin under normal conditions. Provisions were made to allow equipment and personnel to enter the basin using portable ventilation equipment to periodically remove any solids buildup not removed by the permanently installed flushing water system. To provide the necessary water for cleanup, an onsite flushing water storage tank was included in the design of both larger basins.

Construction Challenges

As with any major construction project, challenges arose during the construction of the two large basins. The challenges faced by the construction contractors for each of these basins is briefly described below.

Southwest Outfall Equalization Basin

Groundwater Intrusion Into Excavation

The construction contractor was fully responsible for the means and methods of construction. Excavation for the Southwest basin was deeper than 50 feet and protruded into the top of bedrock. As a result, the contractor had to contend with ground-water intrusion. For the construction method, he used an interlocking metal sheeting system driven into the bedrock and a minimal dewatering well point system to control ground water. During the driving of the sheeting, however, he encountered boulders, which spread the interlocking sheeting and allowed ground water to flow into the excavation. In addition, he did not obtain the sealing action at the bedrock interface that had been anticipated. As a result, the contractor had to install a much more elaborate well point dewatering system than planned to control seepage into his excavation. The revised dewatering program ultimately allowed the ground-water control he required to complete the below-grade construction.

Flooding

During construction of the Southwest basin, the portion of the city in which the basin was being constructed was hit with a large storm that caused extensive flooding. The contractor's deep excavation and worksite flooded as well. This flooding caused some damage to the completed work and delayed the contractor in project completion.

Westside Equalization Basin

Late in the final design stage of the **Westside** equalization basin, it was discovered that 100-year-old abandoned coal mines were potentially underneath the tank. Investigations were performed to confirm the existence of the mines. These investigations confirmed that the site was honeycombed with 3- to 4-foot tunnels that were full of water. To eliminate the potential for future settling of the new equalization basin, it was decided that the mine voids should be filled. Therefore, the construction contractor was directed to fill the voids through an extensive grouting program. After initial problems with the method of grouting, the program was completed successfully and the contractor resumed construction of the basin.

Initial Operational Experience

The Southwest outfall basin was placed into operation in the fall of 1988, and the **Westside** basin in October 1991. Since being placed into operation, the Southwest basin has been used 12 times. Of these events, only three have resulted in flow entering or filling all four chambers. The **Westside** basin has been used four times since its commissioning. Only two of those events resulted in water entering or filling all four chambers.

Mechanical bar screens installed in the **influent** to the basins have been effective at removing large material contained in the wastewater. Solids have settled out in all chambers that received water during an event and appeared to accumulate in equal amounts. **Floatables** have tended to move into all chambers that contained water.

Following each use, the basin is flushed out to remove solids that have settled out. The automatic flushing water system has proven very effective for removing settled materials remaining after the basins have been dewatered. Manual cleaning of the chambers has not been required, and no odor complaints have been received.

Acknowledgments

The authors wish to acknowledge the input and assistance provided by their coworkers during the development of this paper.

Design and Operation of a Wet Weather Storage Facility To Eliminate Sanitary Sewer Overflows in the Vicinity of a Publicly Owned Treatment Works Using an Extended-Period Simulation Model

Larry A. Roesner
Camp Dresser & McKee Inc., Orlando, Florida

Richard A. Carrier
Camp Dresser & McKee Inc., Charlotte, North Carolina

introduction

The Charlotte-Mecklenburg Utility Department (CMUD) operates five wastewater treatment plants (WWTPs). Three of these plants are located in the Sugar Creek drainage basin: the McAlpine Creek, Sugar Creek, and Irwin Creek WWTPs (see Figure 1). These plants operate as an integrated system in which flows from upstream plants (Irwin Creek and Sugar Creek) are bypassed to the downstream plant (McAlpine Creek) when flows exceed the upstream plant capacity. The locations of wastewater management facilities, pumping stations, and major trunk sewers in the study area, as well as drainage basin boundaries, are shown on Figure 1. Currently 13 major sewerage drainage basins are within the 240-square-mile study area.

Rainfall-induced overflows within the Sugar Creek drainage basin have been reported since the mid-1980s. Flow monitoring performed in 1987 confirmed that wet weather events can result in significant rainfall-dependent infiltration and inflow (RDII). In February 1990, a heavy rainfall event caused sanitary sewer overflows (SSOs) in the vicinity of the McAlpine Creek WWTP for several days. Subsequently, CMUD embarked on a program to mitigate SSOs in the Sugar Creek sewerage system.

In September 1990, CMUD selected Camp Dresser & McKee (CDM) to perform a sanitary sewer evaluation/rehabilitation/flow equalization project. The broad purpose of the project, as stated in the contract, was to "eliminate rainfall-induced overflows in the sewer system as quickly and effectively as possible." The project took a three-prong, systemwide approach to eliminate SSOs: 1) sewer system evaluation and rehabilitation, 2) flow equalization, and 3) trunk sewer capacity improvements.

One portion of the initial work focused on identifying "quick fixes" to reduce or eliminate sewer system overflows near the McAlpine Creek WWTP. The results of this work are summarized in this paper. Details can be found in the conceptual (1) and preliminary (2) design reports.

Wet Weather Overflow Analysis

A hydraulic model of the major trunk sewers in the CMUD system was developed using the EXTRAN block of the U.S. Environmental Protection Agency's Stormwater Management Model (SWMM). The EXTRAN model consisted of the major trunk sewers entering the McAlpine Creek WWTP (McAlpine Creek and Sugar Creek) and several tributary collector sewers (Four Mile Creek, McMullen Creek, Kings Branch, Lower Sugar Creek, Irwin Creek, and Coffey Creek), as shown in Figure 1. The trunk sewer model was extended upstream to the Sugar Creek and Irwin Creek WWTPs, which enabled analysis of flow bypassing to the McAlpine Creek WWTP.

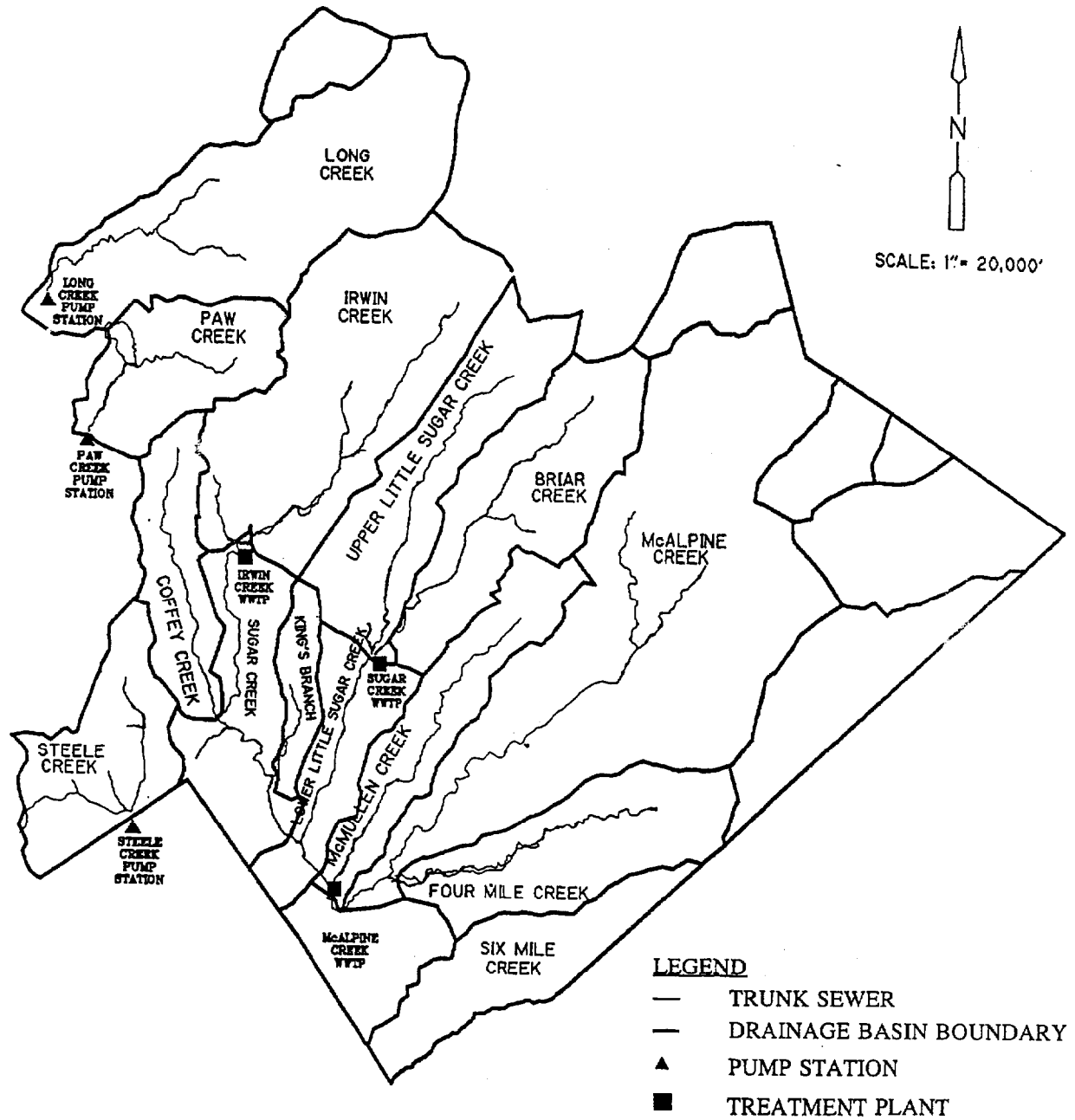

Figure 1. Location of major facilities and drainage basins.

The individual basins were subdivided into sewersheds ranging from 1 to 3 square miles. Wastewater flows were loaded into the hydraulic model for each sewershed based on its sewered area. The sewered area of each sewershed was estimated from the city's 1 inch = 1,000 feet scale sewer maps. Infiltration and inflow (I/I) flows for each sewershed were computed as cubic feet per second per acre (cfs/acre), multiplied by the sewershed area. Unit I/I flows were developed from flow monitoring of representative sewersheds.

System hydraulic performance under wet weather conditions was determined using a simulated system stress test (ramp function analysis). During this test, I/I flows into the system were steadily increased until its hydraulic capacity was exceeded, thereby resulting in overflows. With this analysis, wet weather system performance and potential weak points in the system were determined.

The first objective of the ramp function analysis was to determine the “maximum possible flows” that could occur in the major trunk sewer interceptors without resulting in an overflow. The maximum possible flow in each trunk sewer may be less than its maximum hydraulic capacity because upstream pipe restrictions may not allow the maximum hydraulic capacity to be reached. The results of this analysis, shown in Figure 2, were used to determine the maximum pumping capacity required at the McAlpine Creek WWTP during wet weather events to prevent backwater conditions and overflows in the interceptors directly upstream of the plant.

The ramp function analysis showed that the existing interceptors influent to the McAlpine Creek WWTP had a maximum possible flow capacity of 140 million gallons per day (MGD). Under existing operating conditions, however, the plant influent maximum pump capacity was only 84 MGD; firm capacity was 70 MGD. Consequently, wet weather flows exceeding the influent pumping capacity caused backwater to extend upstream into the Sugar Creek, McMullen Creek, and McAlpine Creek interceptors, with resulting overflows.

Determining the location of overflow points was the second objective of the ramp function analysis. Figure 2 shows the location of overflows due to backwater conditions in the area of the McAlpine WWTP. The model predicted that the first interceptor to overflow was the McMullen Creek interceptor. This prediction **was** verified by reports from McAlpine Creek WWTP operators.

Several factors caused the lower portion of the McMullen Creek interceptor to be extremely susceptible to overflow events. Modeling of this area showed that under surcharge conditions in the Sugar Creek interceptor (resulting from backwater from the McAlpine Creek WWTP), flow from the Sugar Creek interceptor would actually flow upstream into the McMullen Creek interceptor and overflow, both as a result of peak upstream flows and flows from the downstream Sugar Creek interceptor. Additional findings from the ramp function analysis included a number of manholes within the system that the model predicted would overflow under existing conditions (Figure 2). Investigations by collection system maintenance personnel confirmed that the model accurately predicted overflow locations.

Eliminating Overflows in the Vicinity of the McAlpine Creek WWTP

The McAlpine Creek WWTP was originally constructed in 1963 and has been expanded several times. The wet weather operating philosophy for the McAlpine Creek WWTP **was** to accept and treat as much flow as possible to help alleviate overflows in the collection system. This philosophy, however, sometimes resulted in operating difficulties such as in-plant overflows, solids carryover in the secondary clarifiers, and longer term impacts on solids handling systems from process overloads.

A desktop process and hydraulic evaluation of the McAlpine Creek WWTP was performed to define the reliable sustained treatment capacity of each unit process in the liquid train. Based on an overview of all processes, the limiting process at the McAlpine Creek treatment plant was found to be the aeration system. With the largest unit out of service and using conventional air flow rates and oxygen transfer efficiencies, the existing aeration system could provide enough air to treat approximately 61 MGD continuously.

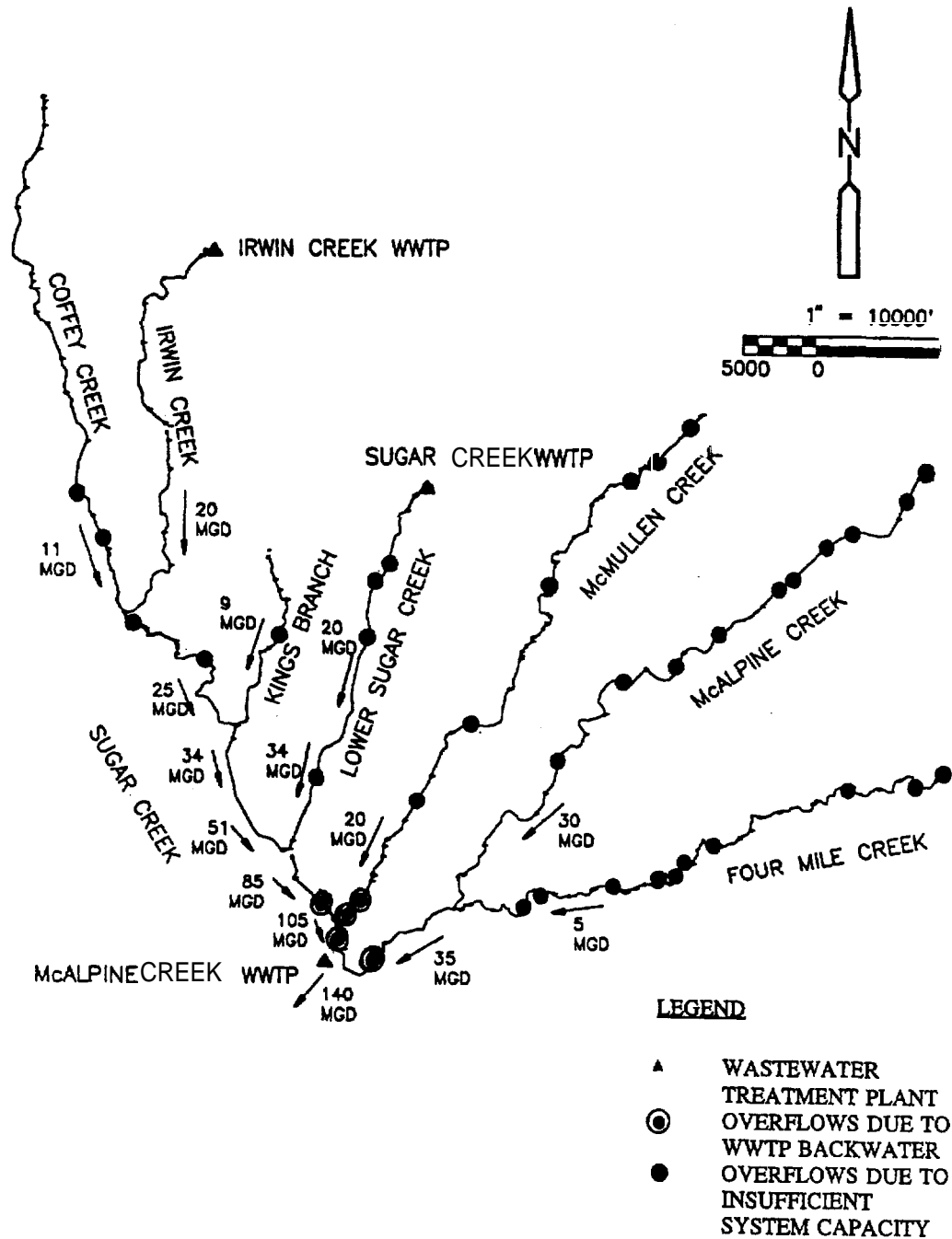

Figure 2. Maximum possible flows in major interceptors and overflow locations.

Plant operating experience had shown that the process system could accommodate flows over 70 MGD for short periods (24 to 48 hours) and still recover within a day without violating the permitted effluent ammonia requirements or having long-term adverse affects on the solids handling systems. The desktop process evaluation of the McAlpine Creek WWTP confirmed that the treatment rate of 70 MGD can be sustained for a 2-day period with all treatment units in service. This means that for storms producing more than 70 MGD of peak flow at the McAlpine WWTP, the excess flow up to an additional 70 MGD ($70 + 70 = 140 =$ system delivery capacity; see Figure 2) would have to be pumped to some additional

treatment facility or to a flow equalization basin for later treatment at the WWTP to avoid an overflow or violation of National Pollutant Discharge Elimination System (NPDES) permit limits.

Flow equalization could be added by converting the abandoned effluent polishing lagoon at the WWTP (see Figure 3) to a flow equalization basin. Flow equalization was found to be a significantly more attractive solution, because of both the lower relative cost (about \$0.19 per gallon) and the relative quickness with which equalization storage capacity could be added compared with additional treatment capacity.

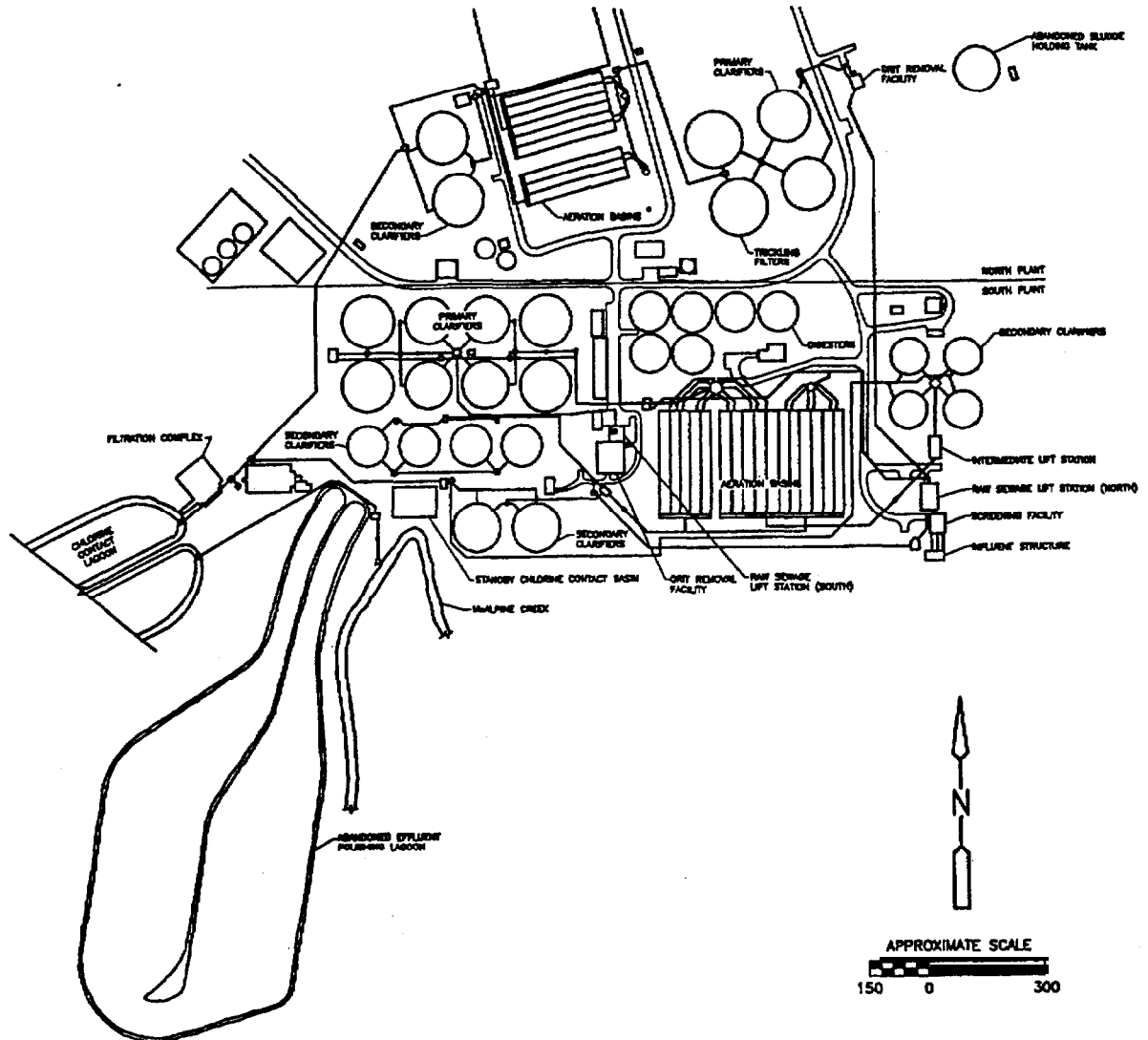

Figure 3. McAlpine Creek WWTP site plan.

The Storage, Treatment, Overflow, Runoff Model (STORM) (3) was used to estimate the average annual number and volume of overflows at the wastewater treatment facility created by RDI and to determine the effectiveness of wet weather flow equalization storage on reducing overflows in the vicinity of the McAlpine Creek.

Figure 4 shows a schematic of the STORM model representation of the storage and treatment system. STORM operates on an hourly time step, first determining the I/I flow rate ($Q_{I/I}$) produced by the rainfall. Wet weather flows in excess of available wet weather treatment capacity (Q_T) are routed to the flow equalization basin of the specified volume (V). If the storage capacity is exceeded, an overflow occurs (Q_O). When the total flow into the system declines at the end of the event, stored wastewater is routed into the treatment facility until the basin is empty. In this analysis, the available wet weather treatment capacity (Q_T) equals the available total treatment capacity minus the average normal dry weather baseflow to the treatment plant. The wet weather treatment rate represents the average treatment rate over the duration of the I/I event.

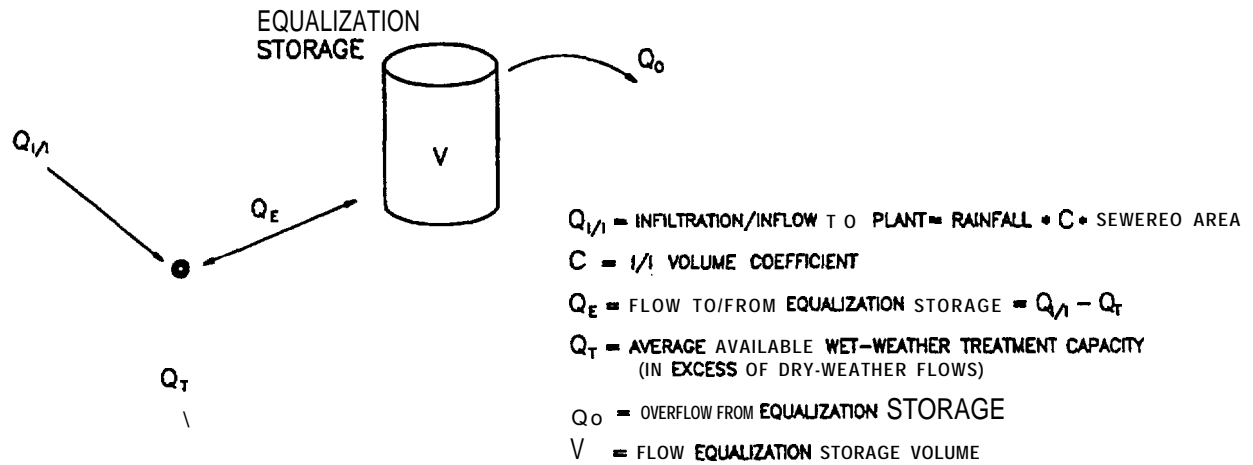

Figure 4. Storm model storage-treatment system schematic.

The STORM analysis used the 42-year record of hourly rainfall at the National Weather Service Charlotte-Douglas International Airport rainfall gauge. A modified rational formula was applied in which an I/I volume coefficient was used to estimate the volume of RDII that enters the collection system and reaches the treatment plant. The expected range in I/I volume coefficients was estimated from an analysis of flows observed at long-term flow monitors. The resulting I/I volume coefficient for McAlpine Creek WWTP ranged from 0.02 to 0.038. These coefficients represent the fraction of the rainfall falling on the sewered area that reaches the treatment plants via the sanitary sewer system and are based on the average RDII across the entire sewershed. Although the computed coefficients are not excessive compared with other systems, they reflect only flow measured at the monitors and may not account for I/I volume lost because of upstream overflows.

The analyses also accounted for other phenomena, including depression storage and storage within the collection system. Depression storage refers to the quantity of rainfall that must occur before RDII begins. A value of 0.2 inches was used in all analyses. The volume of storage in the major interceptors was also estimated and included in the STORM analysis.

STORM was used to evaluate the effect of providing a flow equalization basin at the McAlpine WWTP on 1) overflow reduction near the plant and 2) treatment plant operations. These analyses were performed for volumetric RDII coefficients of 0.02 and 0.038, as discussed above. Figure 5 shows the percent of RDII that could be captured for various sizes of flow equalization basins at the McAlpine Creek WWTP. The figure shows that if the abandoned South Plant polishing lagoon were used with 44 million gallons of available storage, 70 to 90 percent of the RDII would be captured.

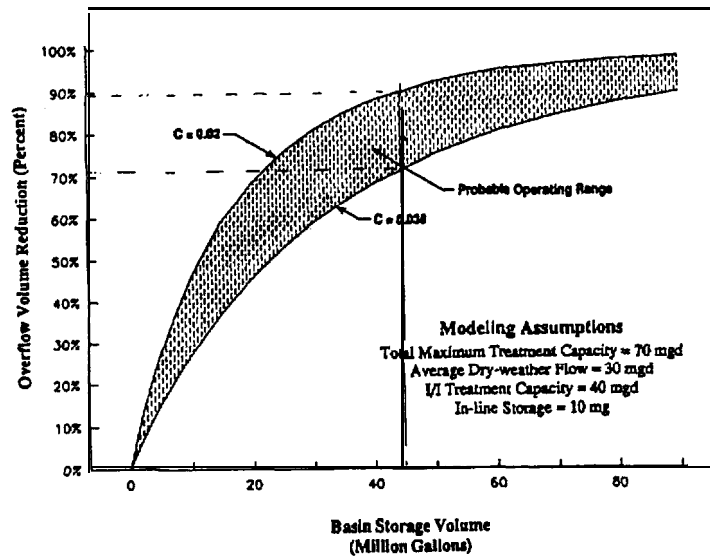

Figure 5. Modeled relationship between overflow reduction and storage volume at McAlpine Creek WWTP.

The effect of flow equalization on frequency of overflows is shown in Figure 6. The analysis showed that by utilizing the existing, abandoned 44-million-gallon polishing lagoon, overflow frequencies would be significantly reduced. The predicted number of SSOs without additional equalization storage (over 7 to 18 per year) was significantly greater than the actual reported number of SSOs because the STORM model tends to overestimate the number of overflows associated with smaller storage volumes; the STORM model assumes that the RDII appears at the plant within an hour after it falls on the ground (with no routing or time delay).

The predicted effect of using the polishing lagoon for flow equalization on operations at the McAlpine Creek WWTP is illustrated in Figure 7. The figure shows predicted basin cycle time frequencies (the total time to fill and empty the equalization basin for a given storm event). The basin cycle time also represents the duration that the WWTP would need to operate at an increased treatment rate in conjunction with basin filling and draining. If the plant can sustain the 70 MGD operating rate for only 48 hours, the figure shows that the plant treatment rate would have to be reduced only one to four times per year before the basin was completely drained.

Flow Equalization Facility Design

The abandoned South Plant effluent polishing lagoon was determined to be the best option for flow equalization storage. The lagoon is located in the southwestern corner of the plant site, as shown in Figure 3. Figure 8 presents a schematic of how the South Plant effluent polishing lagoon was used. Screened wastewater is pumped through a new 60-inch diameter pipe from the existing headworks via a new pump station to a vortex grit removal system to remove heavy solids before storage. The relative elevation of the lagoon is high; thus, stored wastewater can be drained back to the headworks by gravity through the same line.

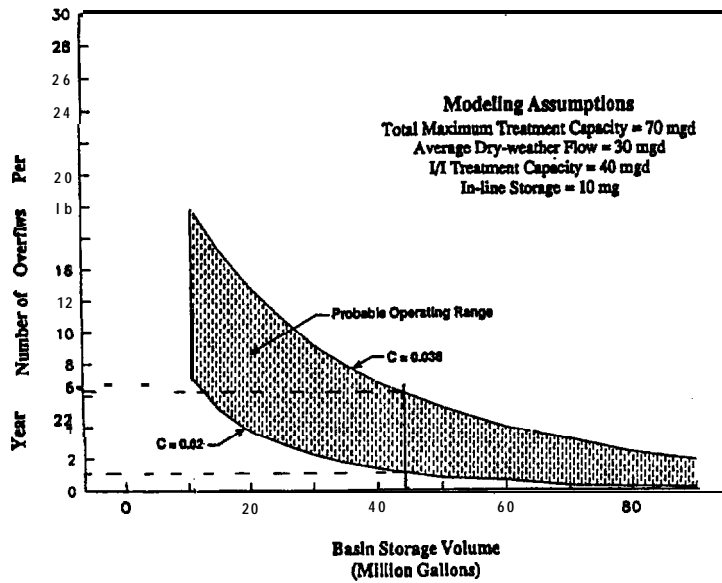

Figure 6. Modeled relationship between overflow frequency and storage volume at McAlpine Creek WWTP.

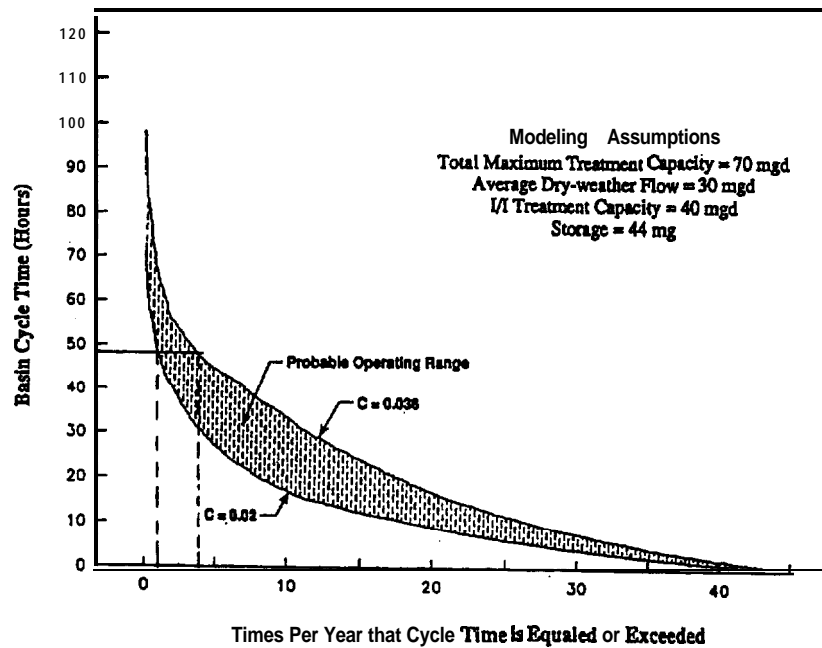

Figure 7. McAlpine Creek WWTP predicted equalization basin cycle time frequency.

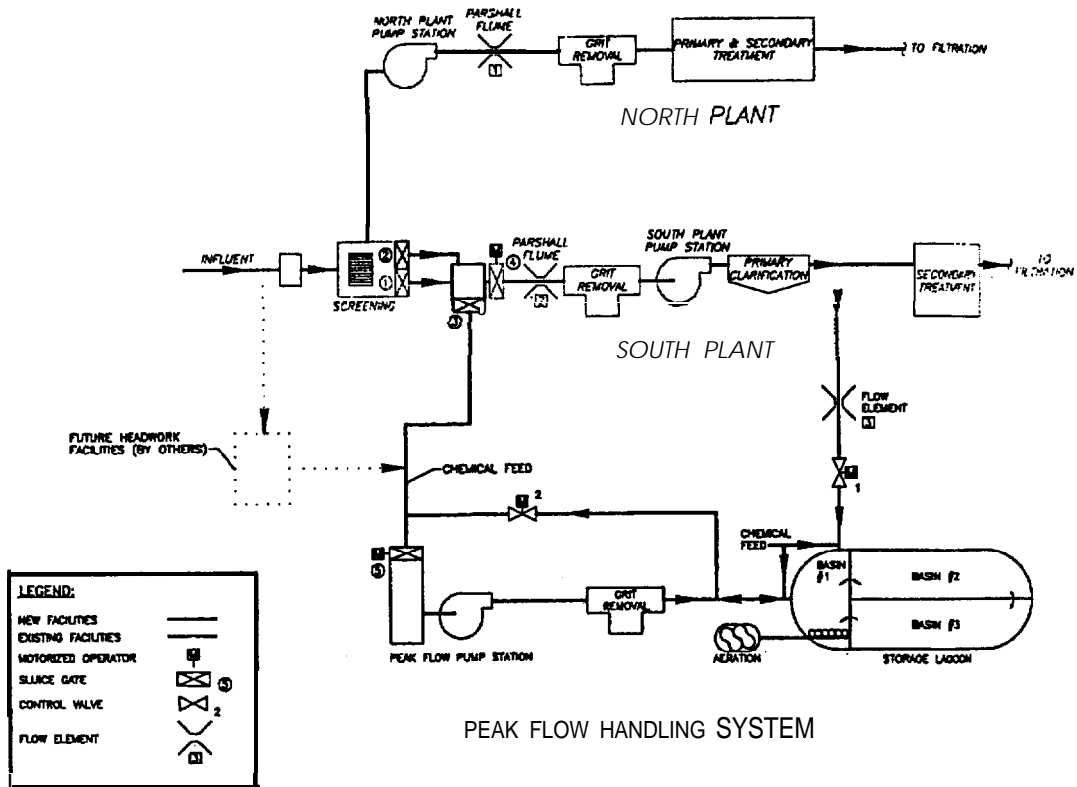

Figure 8. Facility schematic, McAlpine Creek WWTP flow equalization facilities.

The lagoon is depicted in Figure 9 with the improvements for equalization storage use. The basin was designed with two weir structures to compartmentalize it. Diurnal storage and small storms would be contained within the first compartment, which is 5 million gallons. STORM analyses predicted that on an average annual basis this compartment would overflow 10 to 20 times (42 storage events in an average year). The second weir was located to minimize the length of the span between the peninsula and the outer lagoon dike and to keep the third basin dry except for large I/I events. Figure 6 indicates that the second compartment (22 million gallons) would overflow 3 to 10 times per year. STORM predicts that the entire facility capacity would be exceeded only 1 to 5 times per year.

During a wet weather storage event, the first basin fills until wastewater spills over the first weir. The majority of the solids are deposited within the first basin. Then, wastewater begins filling the second basin until the level reaches the weir elevation of the second weir structure. If wet weather flows are large enough, wastewater likewise spills over the second weir until the third basin is full. In the case of an overflow, over 15 hours of quiescent settling will have occurred in the flow equalization facility. The overflow would be chlorinated and discharged through the plant's chlorine contact lagoon. Following a wet weather event, stored, excess wet weather flow is drained back through the fill line by gravity to the head of the plant for treatment. The weir structures are constructed with return pipe lines and check valves to allow flow back through the first compartment to the plant headworks through the 60-inch influent line.

References

1. Camp Dresser & McKee. 1991. Conceptual design report for wastewater treatment plant flow equalization facilities. Prepared for the Charlotte-Mecklenburg Utility Department, Charlotte, NC (March).
2. Camp Dresser & McKee. 1991. Preliminary design report for **McAlpine** Creek Wastewater Treatment Plant flow equalization facilities. Prepared for Charlotte-Mecklenburg Utility Department, Charlotte, NC (July).
3. HEC. 1977. Storage, Treatment, Overflow, Runoff Model ("STORM") user's manual. Hydrologic Engineering Center, Davis, **CA**.

Eliminating Sanitary Sewer Overflows in Three New England Communities

Sean M. Mullins and Jonathan B. Golden
Metcalf & Eddy, Inc., Wakefield, Massachusetts

Introduction

Many older communities in New England have separate sanitary sewer collection systems that were installed 75 to 100 years ago. Consequently, the older systems are subject to significant amounts of infiltration and inflow (I/I), which can cause sanitary sewer overflows (SSOs).

Three communities in New England that have experienced SSOs are Westfield and Plymouth, Massachusetts and New London, Connecticut. All three communities have had to address SSO control because of enforcement action by state regulatory officials. Westfield and Plymouth have completed their SSO control projects, while New London's is ongoing.

In all three cases, the solutions provide additional benefits beyond compliance with an order to eliminate SSOs. The intent of this paper is to describe the projects and to indicate what additional benefits were derived.

Westfield, Massachusetts

The City of Westfield is located approximately 9 miles west of Springfield in the western part of Massachusetts. The city's population growth has leveled off since 1980, at a stable population of approximately 37,000. The city's 50 square miles of land area consist of rugged hillsides, undisturbed forest, and semirural residential subdivisions surrounding a densely developed manufacturing and residential urban center (1).

The city developed a separate sewer system to serve the developed areas in the late 19th century. By 1915, over half of the present collection system was in operation. As the city grew the system was gradually extended. Wastewater flows are conveyed to the city's water pollution control plant for treatment and discharge to the Westfield River. About 90 percent of the sewers are vitrified clay pipe.

Two major deficiencies were experienced in the city's wastewater collection system in the early 1980s. Some of the major interceptor sewers were undersized for peak flow conditions. The system was also subject to very high rates of I/I. As a result, the sewers located in the Russell Road/Franklin Street area surcharged during high ground-water season and wet weather events (see Figure 1). Adjacent homes experienced sewage backups and basement flooding. As a temporary measure to alleviate this condition, the city was forced to bypass pump sewage into adjacent storm drain facilities. The duration of the bypass pumping varied from a single day to several weeks, depending on the severity of the weather. Although the wet weather period affected the city's collection system, no significant problems were experienced at the wastewater treatment facility.

Collection system problems in the Russell Road/Franklin Street area also had an impact on Westfield State College. Most of the existing state college facilities are served by the city's Western Avenue sewer, which flows into Russell Road. The capacity of this sewer was so limited that the college used a flow equalization tank to reduce its peak wastewater discharges (1). The severe lack of existing sewer capacity, combined with the lack of adequate land for additional on-lot disposal systems, had been an inhibiting factor in the college's plans to expand its educational facilities.

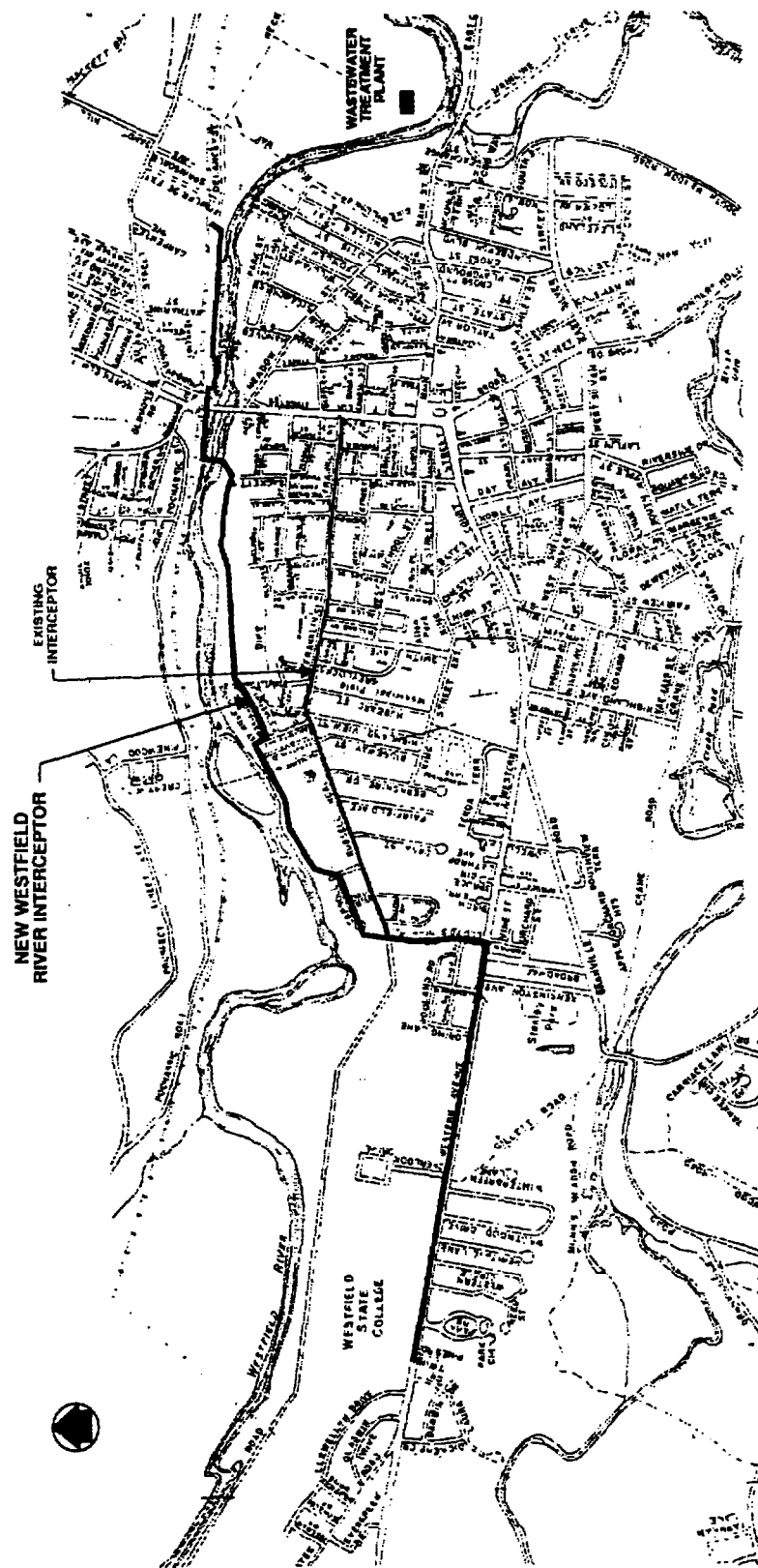

Figure 1. Westfield River interceptor, Westfield, Massachusetts.

In the early 1980s, the city was issued an order to eliminate the bypass pumping of raw sewage. A new relief interceptor was constructed in 1985 (see Figure 1). The new interceptor paralleled existing facilities and tied into an existing 30-inch interceptor, which runs directly to the treatment facility. The cost of new interceptor construction was approximately \$2.5 million.

Concurrent with the construction of the relief sewer, a sewer rehabilitation program helped reduce the amount of inflow entering the collection system. The new interceptor replaced portions of the sewer system that had exceeded their useful service life. As a result, the state college was able to expand its facilities, and neighboring housing developments could tie into the sewer system. The springtime overflow occurrences have been eliminated.

Plymouth, Massachusetts

The historic Town of Plymouth is located approximately 45 miles south of Boston on Massachusetts Bay. The town, which encompasses almost 100 square miles of land area, has experienced rapid population growth, currently estimated at 45,000. Only the older northeastern downtown is provided municipal sewer service, however, with approximately 11,000 residential users and some commercial and industrial users.

Plymouth's wastewater collection, treatment, and disposal system consists of approximately 215,000 feet of collection sewer, six pump stations, and a wastewater treatment facility. Approximately 75 percent of the sewers were constructed before 1918. The secondary wastewater treatment facility, which has a capacity of 1.75 gallons per day and was constructed in the late 1960s, serves 14 drainage areas that are spread out north and south along the shoreline. The interceptor system comprises large diameter sewers at minimum slopes built along the shoreline to convey flow from the drainage areas to the treatment facility.

In 1976, the plant began to experience daily flows in excess of the permitted capacity (see Figure 2). A number of factors contributed to the increase. The town experienced rapid population growth as a result of construction of the Pilgrim I nuclear power plant in the early 1970s. In addition, a study performed in 1980 determined that 56 percent of the annual wastewater flow was infiltration (2). Excessive flows during high ground-water periods caused the town to violate its National Pollutant Discharge Elimination System (NPDES) permit limits for flow, biochemical oxygen demand, and suspended solids. The Knapp Terrace Pump Station experienced flooding, which required the operation staff to throttle the influent gate so that flow could be stored in the collection system during high storm events. Both the Knapp Terrace Pump Station and Holmes Point Pump Station became potential overflow points if the operating staff could not respond to high-water alarm conditions. A manual wastewater bypass is located at the Holmes Point Pump Station, however; it is not clear whether and when the bypass was used.

As a result of the plant's continued violation of its NPDES permit, the town was administered a Consent Order from the Massachusetts Office of the Attorney General in April 1987. According to the order, the town could not authorize or allow any new connections to its sewer system. The town was required to implement an I/I reduction program and construct replacement sewers for the Cordage and Harbor interceptors. Both interceptors were in poor condition and were estimated to contribute 260,000 gallons per day of infiltration (3). Construction of these new interceptors was expected to substantially reduce both tidal and ground-water infiltration. The reduced flow would improve the treatment process at the plant as well as reduce the discharge of wastewater to within permit limits. The improvements were also planned to eliminate the potential for overflows or bypasses at the Knapp Terrace and Holmes Point pump stations.

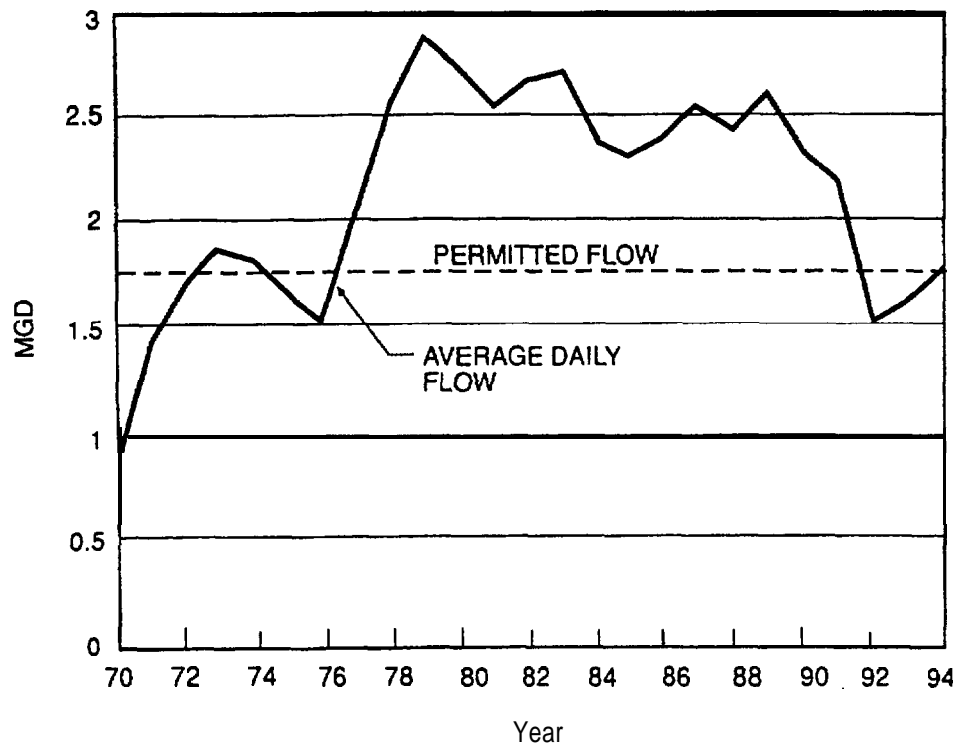

Figure 2. Wastewater flow at Plymouth, Massachusetts, wastewater treatment facility, 1970 to 1994.

The original interceptor was constructed in the late 1930s as a WPA project but was not placed in service until the completion of the town's treatment plant in 1969. The 18-inch reinforced concrete pipe interceptor with mortar joints collected sewage flow from the northern section of town, including Cordage Industrial Park. The pipeline conveyed flow along the Plymouth Harbor shoreline to the Knapp Terrace pump station (see Figure 3). The Cordage interceptor and Knapp Terrace pump station were replaced with a new interceptor located approximately 500 feet inland along a railroad right of way. The new Hedge Road pump station lifted flows from the Cordage Industrial Park to the new interceptor. The Harbor interceptor project included the replacement of 18-inch vitrified clay pipe (constructed in about 1918), which extended south near the harbor shoreline (see Figure 4). The town has also implemented a sewer rehabilitation program in an effort to eliminate many I/I sources throughout the sewer system. The sewer rehabilitation program augmented an ongoing program of sewer repair using Insituform pipe lining.

Upon the completion of the replacement interceptor project in 1991, significant wastewater flow reductions were recorded at the treatment facility (see Figure 2). Not only was the hydraulic load at the plant significantly reduced and the potential for overflows eliminated, but high chloride levels in the plant effluent were also eliminated as saltwater infiltration was removed. The reduction in chlorides required the use of new polymers for sludge dewatering.

The project cost was approximately \$3 million. As a result of the greatly reduced flow, a partial lifting of the sewer moratorium was allowed, and additional tie-ins were permitted for a local hospital and a new correctional center. Additional benefits included the removal of unsightly elevated manholes surrounded by riprap located on the shore, and reduced operation and maintenance costs at the plant. The town took advantage of the project to improve streets and sidewalks in one of its most popular tourist areas.

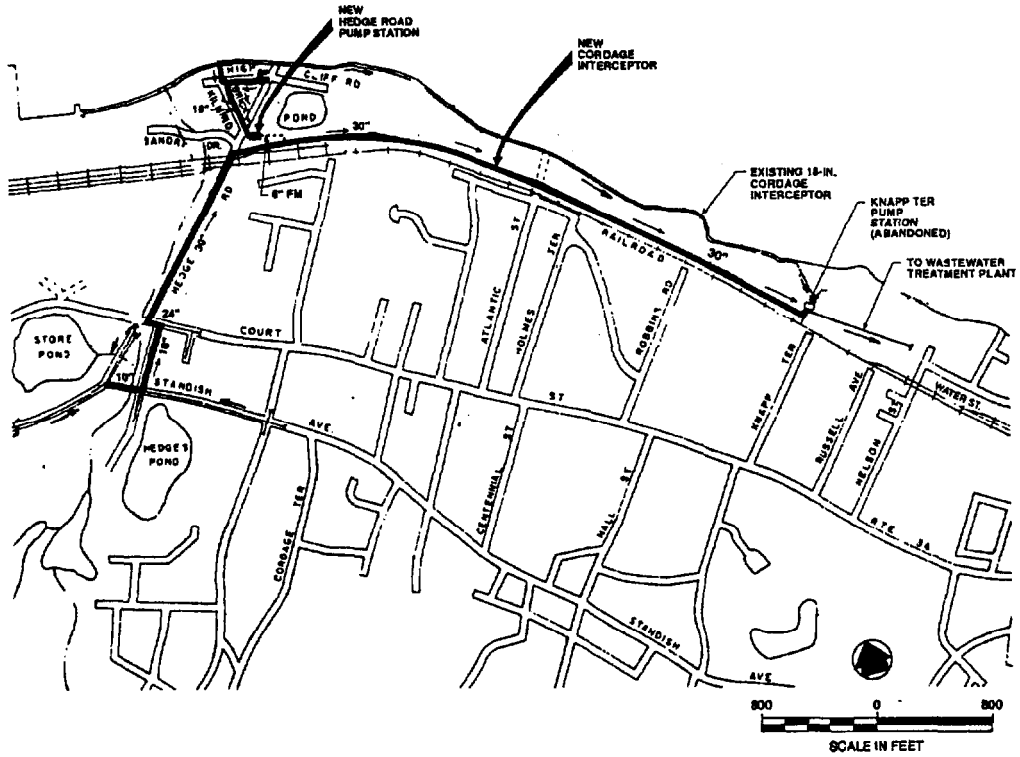

Figure 3. New Cordage interceptor, Plymouth, Massachusetts.

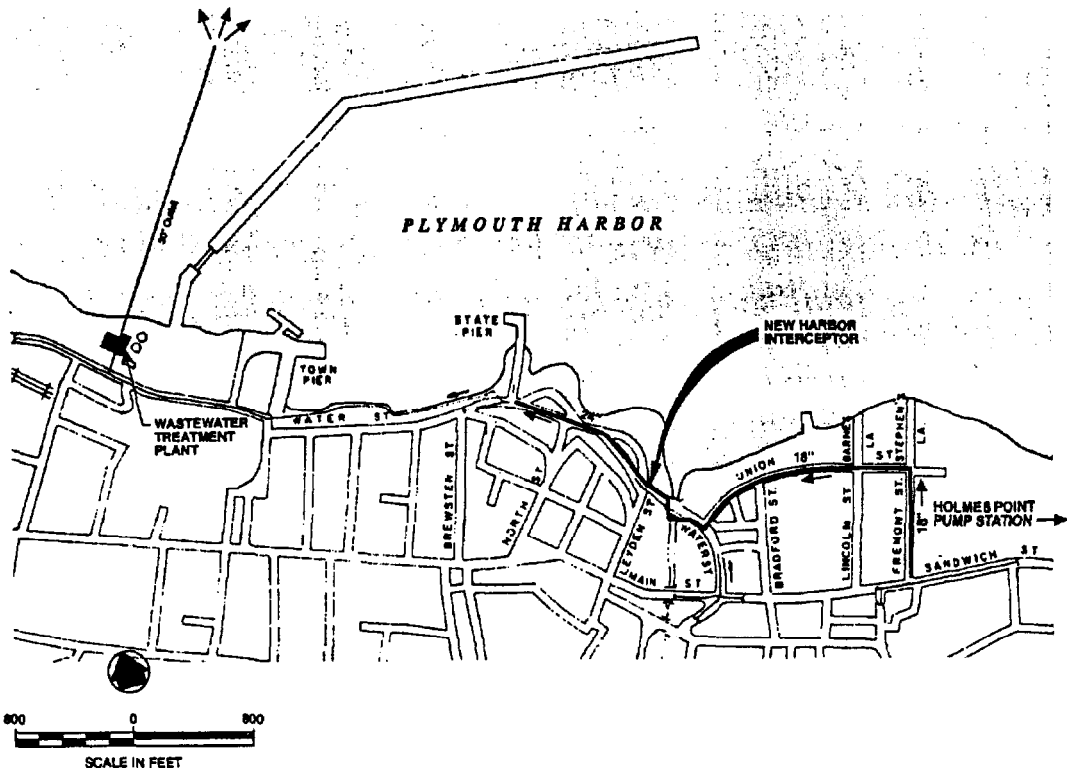

Figure 4. New Harbor interceptor, Plymouth, Massachusetts.

New London, Connecticut

The city of New London is a densely populated urban community located at the mouth of the Thames River on Long Island Sound in Connecticut. It is home to the U.S. Coast Guard Academy as well as a submarine manufacturing and naval center.

New London has been issued an order from the Connecticut Department of Environmental Protection that requires the elimination of all overflows from the city's sanitary sewer system. New London has four pump stations that are potential sources of raw sewage overflows. Pump Stations 1, 2, 3, and 6 receive gravity flow from their respective drainage areas and ultimately discharge into a common forcemain, which runs along the Thames River to the city's water pollution control facility (see Figure 5).

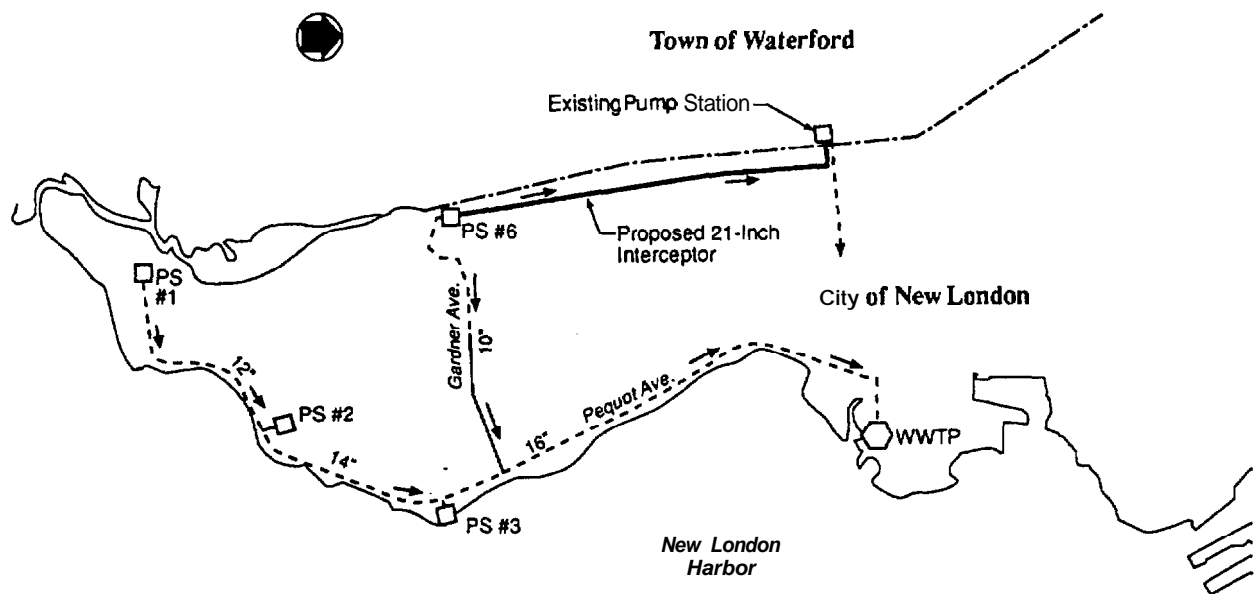

Figure 5. Sewer collection system, New London, Connecticut.

During periods of peak wet weather flow, the collection and conveyance system is overtaxed. When flows exceed the rated capacity of the stations, the city is forced to shut down one or more pump stations and bypass raw sewage into adjacent watercourses. If the pump stations were not bypassed, local residences would be flooded with raw sewage. The bypasses are infrequent.

Pump Station 3 is most often the station to bypass flow during a high-flow period. A valve located in the wetwell is opened manually to discharge flow into the Thames River. A 150-pound chlorine cylinder tank is located on site to provide disinfection of the overflow. On average, an SSO will occur at Pump Station 3 once or twice per year. In extremely high ground-water/wet weather conditions, Pump Stations 1 and 2 also experience SSOs. Raw sewage flows from Pump Stations 1 and 2 are discharged to Alewife Brook Cove and the Thames River, respectively. Pump Station 6 has a 10-inch bypass pipe running from the wetwell to Fenger Brook. It is unknown how often Pump Station 6 discharges to Fenger Brook.

The city is planning to eliminate raw **sewage** overflows by upgrading Pump Stations 1, 2, and 3 to handle future flows and by rehabilitating the sewer collection network to remove sources of I/I. Rehabilitation work for each pump station will include replacement of existing pumps, motors, and ancillary systems. Miscellaneous architectural, mechanical and site improvements will be required at each station. Table 1 provides a breakdown of each station's proposed capacity increases and the estimated capital costs.

Table 1. Proposed Capacity Increases and Estimated Capital Costs

Pump Station	Existing Capacity (gal/min)	Proposed Capacity (gal/min)	Capital Cost
1	625	650	\$430,000
2	500	1,000	\$435,000
3	700	1,125	\$475,000

In 1993, a Sewer System Evaluation Survey was completed. Historical records revealed that most collection systems tributary to the pump stations were installed between 1900 and 1920. The sewer system consisted of vitrified clay pipe with pipe segments 2 to 3 feet in length. The study identified both private and public sources of excessive I/I. Elimination of these sources would reduce the probability of SSOs during storm events and periods of high ground water. The city is in the process of developing a rehabilitation program to eliminate these I/I sources.

The city has elected to try a different approach to the elimination of SSOs at Pump Station 6. Instead of increasing the capacity of the station, a new gravity sewer was proposed which would eliminate the need for the existing station (4). The new gravity sewer would extend from the influent sewer at Pump Station 6 to an existing pump station in the town of Water-ford (see Figure 5). The existing Waterford pump station has significant excess capacity; therefore, it can accept present and future flows. Also, New London has an existing intermunicipal agreement with Water-ford, which made the plan more feasible. The following benefits are associated with this alternative:

- The need to upgrade the existing Pump Station 6 would be eliminated.
- The potential for SSOs at Fenger Brook would be eliminated.
- Savings in operation and maintenance costs would result in the elimination of Pump Station 6.
- Savings would result from eliminating the anticipated rehabilitation of 5,000 feet of vitrified clay sewer.
- Flow from Pump Station 6 is eliminated from the forcemain serving Pump Stations 1, 2, and 3.

The city is presently constructing the above alternative for Pump Station 6.

References

1. Metcalf & Eddy, Inc. 1982. Facilities plan for the City of Westfield, Massachusetts. Metcalf & Eddy, Inc., Wakefield, MA.
2. Metcalf & Eddy, Inc. 1984. Facilities plan for the Town of Plymouth, Massachusetts. Metcalf & Eddy, Inc., Wakefield, MA.

3. Metcalf & Eddy, Inc. 1986. Letter to Division of Water Pollution Control. Metcalf & Eddy, Inc., Wakefield, MA. April 4.
4. Metcalf & Eddy, Inc. 1993. Conceptual design memorandum for New London, CT, pump stations. Metcalf & Eddy, Inc., Wakefield, MA. May 6.

Sanitary Sewer Overflows in Cobb County, Georgia

Gene Ramer, Steve McCullers, and Timmy Vaughn
Cobb County Water System, Marietta, Georgia

Cobb County currently provides service to approximately 155,000 customers and maintains 1,794 miles of sewer line. The county has four wastewater reclamation facilities, ranging from 4 million gallons per day to 40 million gallons per day, with a combined average daily flow of 68 million gallons per day. The county also has 40 pumping stations and three major lift stations. The prevention of sewer overflows is an important part of system maintenance. The county has 50 percent of its land area tributary to the Chattahoochee River, with 40 percent above the City of Atlanta Raw Water Intake. The Cobb County Water System not only receives flow from its own system but also from five municipal systems within the county and two municipal systems outside the county. The Cobb County Water System only has responsibility for the sanitary sewer overflows (SSOs) in unincorporated Cobb County; however, the effects of overflows from the municipalities spread into the county because in most cases the municipal systems are upstream.

The major causes of SSOs in Cobb County are inflow and infiltration (I/I), root intrusion, and grease accumulation. In an effort to reduce SSOs from I/I, the county has conducted I/I source detection studies combining the use of flow monitoring, smoke testing, dye flooding, and video inspection. These methods helped determine I/I sources and corrective action plans. I/I is the largest contributor to SSOs and causes problems in the collection system, lift stations, and treatment plants. Inflow from flooding often leaves heavy sand deposits in sewers and wet wells. The sand reduces line capacity and increases the cost of maintenance (by causing impeller and pump wear) and additional treatment costs.

In areas where I/I has been widespread within a basin, the Cobb County Water System designed and constructed relief sewers to replace existing sewers. In areas where I/I is localized, the county used several different methods of pipe and manhole rehabilitation. Some of the methods are fold-and-form pipe liners, cured-in-place pipe liners, and pipe bursting. (No ground heave has been experienced during pipe bursting.) These methods provide one continuous section of pipe from manhole to manhole, eliminating joints that were sources of I/I. After the pipe liners are in place, manhole rehabilitation is performed to eliminate leakage between sections and around castings. A robotic saw is used to cut out openings where service laterals connect to the main sewer line.

SSO control can often be hampered by beavers damming up streams and flooding manholes. Only beaver dams that are built within the maintenance easement can be removed, and dam removal is further complicated by wetland issues and permitting processes. This often presents regulators with a dilemma about what takes priority: sewer overflows or beaver dams.

To reduce overflows related to root intrusion, the county has started a chemical root control preventive maintenance program. In this application, a foaming herbicide root control agent designed specifically to control root intrusion is applied to line segments. This method kills root growth present in the lines and inhibits regrowth without damaging the vegetation producing the roots. In root control contracts, the county requires the contractor to guarantee all treated line segments for 2 years. This allows treatment of line segments where root intrusion is evident every 2 years and maintains a constant guarantee against root-related blockages. Although this type of application is guaranteed not to interfere with the treatment process at the treatment plants, the county tries to equally distribute the chemical application to all four of treatment plants as much as possible. No blockages in lines treated occurred during the warranty period, so the contractor has not had to repeat any application.

To reduce overflows caused by grease accumulation, the county has implemented a grease trap ordinance, which is enforced by our industrial monitoring group. The monitoring group inspects grease traps on a regular basis to ensure that they are appropriately sized and cleaned. Because most heavy

grease accumulation in the collection system is a result of improperly maintained grease traps, this ordinance is a very important part of the preventive maintenance plan.

The county also uses methods that provide a continuous seed of selectively adapted bacterial cultures. These bacteria **liquify**, digest, and remove organic deposits from line segments and wet wells. For this simple and inexpensive delivery system, the product is suspended in the invert of a manhole. As the wastewater flows across the bag (or sock) it pulls bacteria into the wastewater flow, where they begin working in the downstream line segments. The bacteria are available in various blends to fight grease buildup or hydrogen sulfide odors and related corrosion. The bacteria are not only beneficial in the line segments but also aid in the treatment process at the treatment plants.

Through preventive maintenance and planning, the Cobb County Water System has been able to reduce the frequency of **SSOs** and the cost of treatment facilities. Due to increased growth, the amount of wastewater treated has also increased for the past 3 years. At the same time, through the preventive maintenance program the county has reduced spending for the past 3 years.

The county has also shown a significant reduction in the amount of **SSOs** for the past 2 years. In fiscal year 1994, Cobb County had a reduction of 16.2 percent as compared to fiscal year 1993. In fiscal year 1995, based on a 6-7 month average, the county projects a reduction of 30.4 percent as compared to fiscal year 1994.

The county has also placed generators at the pumping stations to prevent overflows caused by power failures. At the large lift stations where it was not feasible to place generators, the county worked with the power company to provide two separate power feeds. This allows power to reach the lift station in the event that power is lost from one substation.

Regulators will need to determine what actions municipalities can take to correct **I/I** caused by beaver dams. The impacts of house laterals on **I/I** and root intrusion, however, are very minimal as related to **SSOs** in county-maintained sewer lines.

Sewer System Operation and Maintenance: A Practical Program To Minimize and Mitigate Sanitary Sewer Overflows

John Larson and Kent Von Aspern
Central Contra Costa Sanitary District, Martinez, California

Introduction

The issue of sanitary sewer overflows (SSOs) is the subject of an important national discussion. The impact of these SSO events on public health, water quality, service, and cost is not well known at the local, regional, or national level. Very little data exist regarding the frequency and size of these events or their impact on receiving water quality. Sewer systems typically are not high on the local priority list for funding until the level of service is so poor that it becomes totally unacceptable.

This paper presents a success **story** in which planning, engineering, and operations are effectively integrated and adequate funding is provided. The objectives of the paper are to present: the elements of an integrated approach to operations and maintenance (O&M) to minimize the number of overflows; an approach to mitigating the impact of the overflows that occur; benchmark data for use by other operating utilities in conducting an assessment of their performance; and approaches for the practical application of portable computer technology.

Background

The Central Contra Costa Sanitary District (CCCSD) is a single-purpose special district responsible for the collection, treatment, and reuse or disposal of sewage. The center of CCCSD's 350-square-mile service area is located approximately 25 miles east of San Francisco. The service area is predominantly residential; the terrain in the service area varies from relatively flat to steep hillsides. The soils are predominantly clay over sandstone. The great majority of the sewer system is above the water table. Average annual rainfall is 18 inches; however, the rainfall during the past 12-month period ended February 1995 has been over twice the average. CCCSD serves a total population of 398,000, although only 277,000 are connected to the sewer system operated by CCCSD. The CCCSD sewer system consists of 1,500 miles of sanitary sewers (ranging in size from 4 to 108 inches in diameter) and 21 pump stations (ranging in capacity from 0.03 to 22 million gallons per day). The average age of the sewer system is just over 40 years; the oldest portions were installed before the turn of the century. Approximately 20 percent of the sewer system is located in a drinking water watershed serving the cities of Berkeley and Oakland.

CCCSD is staffed by 259 employees; 25 employees are involved in the planning as well as design and construction aspects of the sewer system, and 56 employees are involved in O&M for the sewer/pump station system. The 10-year capital improvement program for the sewer system is \$101 million, and the annual O&M budget is \$5.6 million (\$1.5 million for pump station operation and maintenance and \$4.1 million for sewer system operation and maintenance).

The CCCSD sewer maintenance operation won the California Water Pollution Control Association's Best Large Collection System Operation award in 1988 and 1992. It has also been recognized by the U.S. Environmental Protection Agency (EPA) Region IX with an Operations Excellence award in 1989.

CCCSD's sewer system experienced 205 SSOs during the 12-month period ended February 1995. An SSO, for the purpose of this paper, is defined as any overflow of any quantity (this has been referred to as the "wet spot" definition). SSOs that occurred over the past 12 months are summarized as follows:

- 7 were wet weather overflows caused by sewer system capacity problems.
- 3 were wet weather overflows caused by pump station problems (1 equipment failure, 2 power failures).
- 5 were dry weather overflows that exceeded 1,000 gallons in volume.
- 8 were dry weather overflows caused by pipe failures.
- 182 were small or very small dry weather overflows.

More than 90 percent of the dry weather overflows were caused by roots growing into 6-inch diameter clay sewers.

This level of performance compares favorably with the average of 827 SSOs and 153 pipe failures per 1,000 miles of collection system as reported by the American Association of Sanitation Agencies (AMSA) based on its survey of 79 operating agencies (1).

CCCSD Approach

The current level of SSO performance at CCCSD has been achieved through the integration of a number of sewer system management strategies. The key elements of CCCSD's integrated approach are 1) sewer system planning, 2) design and construction, and 3) O&M. Sewer system planning covers master planning, local area planning, development reviews, scheduling capital improvements, and supporting a fee structure to finance the capital program. Design and construction covers the process supporting the construction and acceptance of new facilities. Proper design and construction is essential to minimizing SSOs; poorly designed or built sewers are much more difficult-and expensive-to operate and maintain. O&M covers the process of operating and maintaining the facilities as well as the process of providing service to the customers. Various aspects of the three elements of the CCCSD's integrated approach are described below.

Sewer System Planning

Master Planning

The master planning process involves a thorough understanding of the existing facilities, the projection of future needs, and an assessment of the ability of the major facilities to meet those needs. Future regulatory requirements should be addressed. Because this level of planning projects needs out 20 to 30 years, the plan must be updated periodically.

In 1986, CCCSD completed a comprehensive Collection System Master Plan, which involved the following typical steps:

- Investigate the existing collection system
- Evaluate the existing and scheduled land uses throughout the district
- Project the population growth
- Calculate the flows at various increments
- Recommend the necessary collection improvements

The Master Plan was based on more than a desktop analysis of existing flows with typical ranges of wastewater contribution from each type of dwelling and an assumed level of infiltration and inflow (VI). Extensive flow monitoring also was conducted. Actual measured flows were used to establish existing wastewater flows and to quantify the I/I. Wet weather flows were measured during four significant rainfall events.

The district's service area was divided into 870 sub-areas. Measured flows and the detailed land use and population data were used to calibrate a computer model of the collection system. Good correlation was obtained by running the computer model for actual historical rainfall events and comparing the projected flows to the measured flows at the treatment plant. The computer model was then used to project future flows, evaluate hydraulic conditions, and identify deficiencies in the system.

Local Area Planning

One of the key products of the Master Plan was the calibrated computer model. The CCCSD staff regularly updates the model through the local area planning process. This level of planning involves assessing the ability of local facilities to handle changing capacity demands that result from changing land use patterns (wide area) and/or concentrated high capacity demands (e.g., industrial uses). It typically focuses on smaller sewers and pump stations.

This level of planning should be accomplished as the situation requires (e.g., change in land use plan/zoning) or when large projects are proposed. It ensures that **offsite** improvements needed to accommodate specific projects are identified and that the cost is borne by the new customer. Computer models are very useful for this type of activity. Sewers identified as deficient are added to the capital improvement program. Projected flows provide critical data for the subsequent design process.

Short- and Long-Range Capital Improvement Planning

The capital improvement program includes two initial components. The first, the Capital Improvement Budget (CIB), includes projects to be designed and constructed in the next year. The CIB is updated annually. The second component, the Capital Improvement Plan (CIP), lists the projects that are anticipated within the next 10 years.

Each planning tool has a distinct purpose. The CIB focuses on the work at hand. This document includes a description of each project, an estimate of project expenditures, and a listing of resource requirements. In general, once a project manager is assigned to a project, the project is added to the CIB. This individual is then responsible for shepherding the project through to completion. When the CIB is updated each year, completed projects are removed and new projects are added.

Prioritization of projects is part of the CIP. Planning level cost and resource estimates are made for each project for a full 10-year period. This approach provides CCCSD with the ability to forecast resource needs and to set the necessary rates and fees. In this manner, the needs determine the rates, as opposed to the available reserves setting the amount of work that can be done.

Design and Construction

Engineering Standards

CCCSD has developed a document establishing standards that all developers must adhere to. Not only does CCCSD hold the developers to a strict set of standards, but, to achieve conformity, the district holds its own design engineers and consultants to the same standards. The Standard Specifications outline

the design criteria to be employed, the materials to be used, and the construction techniques that are allowed for building collection systems within the service area.

The design criteria establish minimum pipe sizes (8 inches in diameter), minimum slopes (for each pipe size), minimum and maximum sewer velocities (3 to 10 feet per second), minimum pipe cover and clearance, and methods for projecting and calculating flows. The criteria are based on the district's experience in designing, constructing, operating, and maintaining collection systems.

The specifications cover allowable construction materials ranging from pipe to backfill. For example, types of acceptable joints and gaskets are described for each type of pipe. Materials that are not allowed (i.e., lead-caulked joints) also are listed. Standard details are liberally provided.

The document also describes requirements for inspection and testing (e.g., the use of laser control points). Furthermore, it informs developers that, for instance, jetting of backfill is not allowed and mandrel testing of all plastic pipes is required (tolerances are indicated).

Additionally, redundancy must be provided at each pump station. "Reliable capacity" is defined as the flow that can be pumped by each pump station with the largest pump out of service. Level systems are duplicated, often utilizing different technologies. Alarms are linked to the district's process computer room at the treatment plant to ensure rapid response to any emergency conditions.

An important part of the design process is appropriate review. All district projects are reviewed by the user groups at several stages throughout the design process. Thus, the valuable experience of the operating personnel is used completely. All developers' plans are reviewed by CCCSD staff before permits are issued.

Inspection To Ensure Quality

Along with applying strict design standards, CCCSD aggressively inspects the construction of each project, both district funded and developer based. The inspectors are well-trained, full-time district employees whose primary job responsibility is to inspect collection system construction.

This training is paramount in allowing the inspectors to make informed field decisions. Inspectors must be able to recognize problems, both construction and safety problems, and know when not to make a decision. Each inspector is provided with a radio to reach a supervisor at all times; also, all supervisors are provided with access to a radio and a beeper.

Testing and inspection are also critical for ensuring that CCCSD does not accept poor quality work. In addition to standard testing methods, such as hydraulic testing or pressure testing of pipelines, CCCSD requires either hydraulic, pressure, or vacuum testing of each manhole as well as mandrel testing of flexible pipes. CCCSD also requires that all smaller pipelines be "TV inspected" (i.e., using fiber-optic viewing technology) before the project is accepted. TV inspection is completed at the end of construction and again before the end of the one-year warranty period.

Operations and Maintenance

Preventive Maintenance To Minimize Dry Weather SSOs

The basis of an effective O&M program consists of identifying line segments and facilities that require periodic upkeep to maintain flow and developing a work scheduling system for providing information to the supervisor and the field crew. The preventive maintenance system should include accountability for the quality of the work being done to ensure that the maintenance was conducted (e.g., the lead worker's name should be recorded so that a pattern of premature overflows can be identified and corrected). This

system includes reporting on field conditions observed so that appropriate actions can be taken when underlying conditions deteriorate or new problems occur. This entire activity is appropriate for personal computer applications.

Corrective Maintenance To Eliminate Defects Before They Cause **SSOs**

The second step in building an effective O&M program involves identifying sewer system defects (broken pipes, dropped joints, corrosion, soil movement, and mechanical problems in pump stations) as part of preventive maintenance, investigation of service interruption (stoppage or overflow), and other activities. The corrective maintenance system should correct the defects in order of priority and within the limits of available resources. The quality of this work is important. The goal of the program should be to correct the problem immediately. Poor quality repairs or partial fixes have a way of falling apart at the worst possible time. A properly focused program will reduce the frequency of **SSOs** and reduce maintenance requirements (e.g., correcting a low spot, or sag, will eliminate stoppages due to the accumulation of grit or grease).

System Inspection To Identify Problem Areas Before They Cause **SSOs**

Preventive maintenance focuses on the portion of the sewer system that has known problems. It is the third building block in an effective O&M program. In many sewer systems the problem areas account for only a portion of the total system, typically 20 to 30 percent. Sewer system inspection could be termed "proactive maintenance." Its purpose is to identify problem areas before they become **SSOs**. This type of work is typically infrequent (every 5 to 15 years), and it can be as simple as inspecting every manhole for signs of trouble (debris on the shelf or barrel indicating surcharging), as straightforward as cleaning every line segment, or as rigorous as TV inspection. The challenge is to define a system that is effective for identifying problems.

CCCSD had a program to clean every line segment on a 7 to 10 year frequency; however, only one problem was identified for every 20 line segments cleaned. This approach is currently being changed to focus on the major source of its **SSOs (6-inch diameter clay pipe)**, with the hope that the frequency of problem identification will increase.

Pump station equipment should be routinely inspected using a checklist. Equipment used infrequently (e.g., in emergencies) should be exercised at both partial and full load to ensure it will work when needed (e.g., generators should be tested for a reasonable period at full load so that the adequacy of cooling system components can be evaluated).

Rehabilitation and Replacement Program To Keep Preventive Maintenance at Acceptable Levels

Sewer systems gradually deteriorate with time. For example, pipe and joint materials fail, concrete corrodes, root systems grow, and pipe and structure foundations settle. Thus, it is particularly important that maintenance activities be increased to compensate for an increase in sewer system performance (frequency of **SSOs**). Also, some of the current maintenance activities cause further deterioration.

A rehabilitation and replacement program, the fourth building block, will keep maintenance at acceptable levels. This program should focus on the sewers, with the highest frequency of required maintenance focused on the sewers associated with the most severe consequences of an overflow (property damage, a public health problem, environmental damage). This type of program is typically very expensive when compared to the cost of constructing new sewers (small-diameter lines in urban settings can cost \$300 or more per foot). Rehabilitation and replacement programs cannot be justified on the basis of reduced maintenance cost. They are, in most cases, justified when the costs of maintenance, service disruption,

and environmental cleanup are considered. Typical expenditures in this type of program would replace the entire sewer system on a 200- to 400-year cycle.

Effective Response to SSOs To Mitigate Their Impact

The impact of an SSO can be mitigated through the following steps:

1. Respond *quickly*. A quick response requires clear communication of performance expectations and accountability. At CCCSD the response time is 25 minutes during working hours and 45 minutes after working hours. Data are recorded for each call, and the dispatchers, the answering service (for after-hours calls), and the crew are held accountable for this performance. Rewards or consequences follow as appropriate. During wet weather when the sewer system must accommodate high flows, the response personnel must know when problems are likely. Dispatching field crews to known trouble areas is one approach. Using flow and/or level data can be more effective. When wet weather SSOs occur, the flow/level conditions associated with the event are noted (flow at the treatment plant may be used if other data are not available). Crews are dispatched to that location when flow/level data approach those readings. CCCSD pump station crews were able to respond to a pump station failure within 10 minutes using this system (normal response time would be 30 to 45 minutes).
2. Respond *effectively*. Although sending an inspector or a supervisor to check a problem may be cheaper, the overflow then continues until a properly equipped crew responds. CCCSD has chosen to screen calls and then to send a crew equipped to deal with the anticipated problem. The cost impact is mitigated during working hours by dispatching the nearest crew (the average labor cost of a crew responding to a call is \$70.20). A special van was developed by CCCSD crews for response to property damage overflows. The van contains mops, water vacuums, squeegees, and other materials and equipment to help the crew mitigate the extent of the property damage until professional teams respond.
3. Employ innovative approaches. CCCSD employs portable pumps for use around the stoppage. The use of portable pumps and portable piping/hoses allows the district to respond to an SSO event in less than 2 hours and pump up to 1,400 gallons per minute a distance of 1,000 feet. This method has also been effective in reducing the volume or eliminating overflows caused by hydraulic bottlenecks.
4. Contain the *overflow*. Small SSOs are amenable to containment and return to the sewer system for treatment, resulting in reduced potential for public health problems and environmental damage. Proper planning is needed to cover equipment and material needs. Plastic sheeting, hay bales, and shovels are useful materials for containment. A vacuum truck works efficiently to recover the sewage.
5. Restore the *affected* area. The elements of this step depend on the situation, from eliminating all signs of gross pollution to recolonizing a stream with crayfish. Toxic materials are not used.

Operational Benchmarking Data

Existing problems can be due to limitations on accountability, performance data, and resources (money, staff, equipment, facilities). This paper discusses a framework for developing operating data. Working to improve performance in the areas of safety, quality, quantity, and cost will free up resources that can then be used to improve facilities, equipment, and tools. These data are managed using a personal computer and a spreadsheet program. The total cost of this tool is less than \$3,000.

CCCSD's level of performance can be attributed to three factors: belief in the process of management by the data, belief in the process of continuous improvement, and belief in the ability of its field workers. The performance of the organization as a whole, its crews, and its individuals can be quantified and that data can be used to identify areas that need management or supervisory attention. That data, referred to as Key Operating Indicators, can also be used to assess the effectiveness of changes. The summarized data are presented in Table 1 for use as a basis for self-assessment.

The process is simple. Develop similar data for your operation. (You must ensure that the data you develop are comparable, and you must be painfully honest.) Compare your data and determine where you stand. If your performance is better, then take pride in your performance. If your performance falls short of these levels, then look for the underlying reasons (e.g., regional differences in labor rates and benefits). CCCSD may be working under different conditions or circumstances (although typically the standards in California are as rigorous as elsewhere). If there are no reasons, then look for improvements (as a last resort you may choose to call us to see what we are doing). Implement the improvements and monitor your performance. Your field workers must be involved throughout the process so that they understand the process and they can see the results of their work when the Key Operating Indicators improve. Be sure to post the results. Two thoughts that may help in understanding the process are: the open discussion of performance fosters improvement, and success breeds success.

Table 1. Key Operating Indicators for the CCCSD System

Safety	Injury rate	22.6 injuries per 100 employees per year
	Injury severity rate	0.0 lost days per 100 employees per year (450 days have been worked since the last lost-time accident)
	Average miles driven between vehicle accidents	62,574
Quality	Total overflows	205, or 137 per 1,000 miles (AMSA average = 827)
	Pipe failures	8, or 5.3 per 1,000 miles (AMSA average = 143)
	Service requests	750, or 500 per 1,000 miles
	Response time to service request	Less than 25 minutes during work day; less than 45 minutes after working hours
	Call-backs (sewer lines that plug/overflow before they are scheduled for next cleaning):	
	• Power rodder	7 per 100,000 feet of sewer cleaned
	• High-velocity cleaner	2.5 per 100,000 feet of sewer cleaned
Average overall service grade (based on an A = outstanding, F = unsatisfactory scale)	A-\B+ (source: mailed user feedback survey with 50-percent return rate)	

Quantity (Production and Productivity)	Power rodding crew (2 people)	2,720 feet per 8-hour day, or 170 feet per gross labor hour (one is expected to clean 113 miles per year)
	High-velocity cleaning crew (2 people)	2,920 feet per 8-hour day, or 182 feet per <i>gross</i> labor hour (one crew is expected to clean 121 miles per year)
	Television inspection crew (2 people)	1,460 feet per 8-hour day, or 91 feet per gross labor hour (one crew is expected to inspect and document 46 miles per year)
Cost	Sewer system O&M cost	\$0.51 per foot per year \$32.88 per connection per year
	Pump station O&M cost	\$23,800 per MGD of pump station rated capacity per year
	Labor cost to clean sewers (includes direct labor + benefits):	
	• Power rodder	\$0.28 per foot (2-person crew)
	• High-velocity cleaner	\$0.26 per foot (2-person crew)
	• Hand rodding	\$1.12 per foot (3-person crew)
	Labor cost to televise sewers (includes direct labor + benefits):	
	• New sewers	\$0.19 per foot (2-person crew)
	• Existing, small diameter, poor condition	\$0.74 per foot (2-person crew)
	Labor cost to complete a spot repair (includes direct labor + benefits):	
• Street	\$1,097 each (does not include labor to restore pavement)	
• Easement	\$3,010 each	
	Sick leave use	82 hours or \$2,623 per field employee per year

Conclusion

Proper planning, design, construction, operation, and maintenance will minimize the number of SSOs that a collection system experiences. When SSOs do occur, the impact that an overflow has on the surrounding environment must be mitigated. Responding with the proper crew and equipment the first time can keep the volume of an overflow to a minimum. Provide adequate training and encourage

innovative approaches to handling SSOs. Remember to restore the affected area; simply stopping the overflow is only the first part of the solution.

CCCSD has shown that operational benchmarks exist that can be used as management tools. You can use safety, system response, productivity, and cost to tell you where your collection system stands.

Reference

1. American Association of Sanitation Agencies. 1995. Separate sanitary sewer overflows: What do we currently know? January.

A Case Study in Inflow and Infiltration Management

David Crouch
Public Utilities Department, City of Fairfield, Fairfield, Ohio

It is becoming increasingly evident that excessive infiltration and inflow (I/I) levels in sanitary sewer systems pose major problems for many communities throughout the United States. In some cases, excessive I/I results only in additional flows, which must be handled at “end-of-the-line” collection points, such as wastewater treatment plants. In more extreme cases, particularly when coupled with hydraulic capacity limitations, I/I can cause localized sewer surcharging, service backups, and system bypasses. Whatever the net effect, the costs associated with this problem can represent substantial financial burdens and threaten continued economic and residential development.

This paper presents one approach taken by a community facing these issues. Specifically, the paper discusses the administrative approach taken to properly identify the problems and outlines the program instituted for corrective measures, a program combining aggressive efforts to reduce the level of extraneous flow as well as provide supplemental hydraulic capacity.

Contributing Factors: Growth and Hydrogeologic Conditions

I/I problems can stem from a variety of sources. While one of the most imposing tasks in dealing with I/I is correctly identifying these sources, the identification process can be expedited, in part, by careful analysis of factors that can contribute to the problem. For the City of Fairfield, two of the most important factors were the city's rapid growth rate and the hydrogeologic conditions of the area.

Population Growth

Incorporated in 1955, the City of Fairfield emerged from a sparsely populated, rural township in southwestern Butler County, Ohio. Its close proximity to Cincinnati and several other smaller communities made it particularly attractive for rapid development. Two state highway routes intersecting the city provide corridors to a major interstate highway system and form arteries through the city, interconnecting many secondary collector streets and providing a “marketplace” for various commercial businesses.

Proximity to major commercial and manufacturing areas contributed to tremendous residential, commercial, and light manufacturing growth during the 1970s and 1980s. Today, Fairfield's population is approximately 40,200 people and is expected to peak at 48,000, when remaining undeveloped parcels are “built out.”

To prepare for this impending growth, the city installed a public sewer system in 1968, including a treatment plant along the Great Miami River and primary and secondary interceptor sewers. The primary interceptor sewer extends nearly 3 miles to the center of the city, where it is met by three converging secondary interceptor systems radiating in predominately southern, southwestern, and eastern alignments. Consequently, the center of the city is a culmination point for virtually all wastewater flow generated throughout the city, a configuration that places heavy demands on the interceptor sewer system. This includes nearly 150 miles of primary and secondary collector sewers.

Hydrogeologic Conditions

Development continues to place increasing demands on the sewer system. Although the city appears to have adequate capacity to handle projected dry weather flows, the presence of several important hydrogeologic conditions render the system highly vulnerable to intrusion of clear water during periods of heavy and sustained rainfall. These conditions include the presence of a high water table and the location of the city in relation to the regional watershed.

Ground-Water Conditions

The city is located over one of the more productive ground-water sources in the Midwest: the Great Miami Buried Valley Aquifer. Significant recharge to the aquifer comes from the Great Miami River, which establishes the western border of the city. Seasonal weather conditions often raise the water table above the elevation of the sanitary sewer due to changing static ground-water levels, which results in excessive infiltration rates and high "background" flow conditions during sustained wet weather. This condition only compounds inflow conditions resulting from other sources.

Watershed Conditions

Fairfield must confront a number of drainage related issues as a result of its location in a regionwide watershed. One of the primary watercourses for this watershed is Pleasant Run Creek, which passes prominently through the center of the city. Much residential development lies contiguous to creeks, providing a native and rustic setting. The natural falling contour of the land was particularly conducive to the installation of sanitary sewers. As a result, many of the secondary collector sewers follow the general trend of the drainage pattern. On several occasions, the sewers "zigzag" underneath established creek beds, placing many sewers and manholes adjacent to flood-prone areas.

Growing Sewer Capacity Concerns

Evidence relative to sewer capacity concerns dates back to the mid-1970s, when it became apparent that excess levels of I/I readily exceeded the capacity of the primary and secondary interceptors, and some of the collector sewers. It was not uncommon for untreated **wastewater/stormwater** to discharge at several points; one prominent location is a manhole located on the eastern secondary interceptor, along one of the state highways.

Over the next several years, the city commissioned several studies to define the problem more clearly and propose corrective measures. Most reports were theoretical in nature, however, and provided only broad recommendations. One particularly damaging rain event in 1979 prompted the city to develop a backflow reimbursement program to install check valves and gate valves on the laterals for individual homeowners. Approximately 225 homeowners participated. In addition, three lift stations were installed to serve as elaborate "backflow prevention devices" to stop wastewater/stormwater from backing up through interceptors to the collector systems in residential neighborhoods. Approximately 150 homes were afforded protection through the pump stations.

Most corrective measures were considered to be remedial "fixes" and often pushed the problems to areas traditionally free of surcharging problems. Continuing problems prompted the city to commission an extensive engineering report in 1985. Like previous reports, the analysis was derived empirically and not based on quantitative data. The report suggested that I/I problems could be attributed to a number of causes, including defective sewers, leaking manholes, and perched sewer lines. The report also stated that an excessive number of unauthorized residential connections may be one of the single largest factors contributing to the I/I problem. The report predicted continuing hydraulic capacity problems

during periods of heavy and sustained rainfall, and provided a plan for construction of a parallel relief sewer system designed to capture and convey excessive flows to equalization facilities.

As a result of the 1985 study, the city invested in an arsenal of sewer maintenance equipment, including a sewer television truck, a truck-mounted sewer vacuum, smoke and dye testing equipment, and sewer grouting equipment. The total investment in sewer maintenance equipment was approximately \$677,000. In addition, the city created a maintenance division to focus on collection system maintenance activities. The annual operating budget of this division was \$200,000, with 30 percent of the division's workload targeted directly at I/I abatement efforts. This work focused specifically on areas suspected to be the largest contributors. Modest gains were made in abating I/I problems, only reinforcing the misconception that unauthorized connections lie at the root of the sanitary sewer problem. As a consequence, the lack of a concerted effort to address unauthorized connections became an even more divisive and politically sensitive issue.

Flow Monitoring Program

In February 1990, the city experienced a severe rain event resulting in widespread residential backups. Again, the city commissioned a study to investigate corrective alternatives. The 1990 study differed from previous ones, however, in its inclusion of a plan to install flow monitors throughout the city in an attempt to quantify and isolate target areas, as well as to help identify possible locations of relief facilities.

For the purpose of the study, the sanitary sewer system was divided into 27 drainage basins, thereby creating both identifiable and discrete collection areas. The configuration of the drainage basins defined for this study is depicted in Figure 1. Flow monitors were installed for a 45-day period, encompassing what is considered to be the wettest period in the city, May and June. The flowmeters are designed to measure flow even under extensive surcharge conditions. This was necessary due to the fact that they were installed in manholes recognized to become fully surcharged.

During the designated monitoring period, the city received an unusually high amount of rain, totaling 9.84 inches and resulting in numerous system backups. At one point in the study, the sewer system was surcharged a linear distance of 5.1 miles. Some areas actually experienced a net negative flow due to the extensive surcharging radiating from the primary and secondary interceptor systems. Table 1 contains the base dry weather flow and peak wet weather conditions. As indicated, it was conceivable that flow could rise readily, well above the average flow of 6 million gallons per day (mgd), to levels in excess of 20 mgd in routine rain events.

In hindsight, information from the flow study proved invaluable in gaining a fuller understanding of the nature and extent of I/I and sewer surcharging problems. Most significant was the recognition that excessive flows did not originate solely from previously suspected areas but, rather, were endemic throughout the city. In addition, the information revealed that the peak hydraulic rates were far greater than indicated by previous flow records, which measured only cumulative flows averaged over several days, consequently lessening the apparent intensity of the wet weather condition. These facts alone were in direct conflict with widely held beliefs that the I/I problem was largely a localized problem, as well as notions that "pockets" of private unauthorized connections were causing the problems.

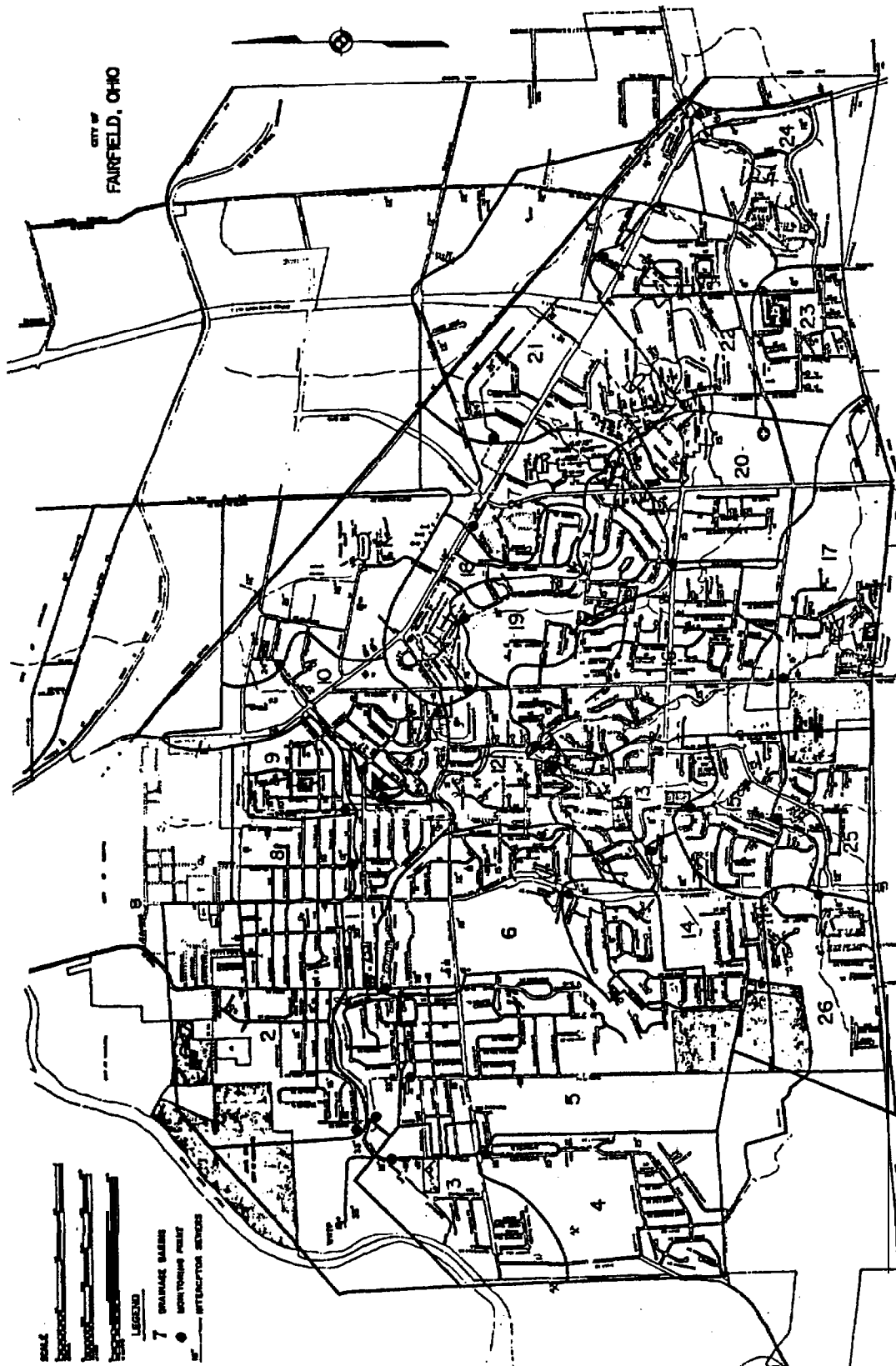

Figure 1. Fairfield, Ohio, wastewater collection system: existing interceptor sewers and drainage areas.

Table 1. Wastewater Collection System Interceptor Sewer Analysis, Fairfield, Ohio

Drainage Basin (MP)	Contributing Drainage Basin (MP)	Interceptor Diameter (In.)	Capacity Full (mgd)	Dry Weather Flow (mgd)	Percent Capacity	Ratio Dry Weather to Wet Weather	Design Flow' (mgd)	Reserve Capacity	
								Dry (mgd)	2-Year Rain (mgd)
1	2-4	33	0.45	5.350	63	1:3.8	20.090	3.10	-11.64
2		18	2.63	0.260	10	1:2.0	0.520	2.37	2.11
3	4	18	2.63	0.250	10	1:2.8	0.704	2.30	1.93
4		15	1.62	0.110	6	1:2.1	0.235	1.71	1.59
5		21	3.57	0.168	5	1:3.1	0.520	3.40	3.05
6	7	16	2.63	0.441	17	1:3.3	1.440	2.19	1.19
7		12	1.22	0.172	14	1:5.1	0.662	1.05	0.34
8		12	1.22	0.073	6	1:3.9	0.264	1.15	0.94
9		12	1.22	0.094	8	1:2.1	0.199	1.13	1.02
10	11	27	5.65	0.620	11	1:3.8	2.340	5.03	3.31
11		24	4.67	0.360	8	1:3.5	1.320	4.29	3.35
12	13-27	24	4.67	3.627	62	1:4.1	15.622	0.84	-11.15
13	14, 15, 26, 27	24	4.67	0.753	16	1:4.2	3.180	3.92	1.49
14		12	1.22	0.177	14	1:6.1	1.077	1.04	0.14
15	26, 27	12	1.22	0.443	36	1:3.5	1.556	0.76	-0.34
16	17	16	2.63	1.031	39	1:4.5	4.636	1.60	-2.01
17		15	1.62	0.341	19	1:4.9	1.460	1.46	0.16
18	19-24, 27	16	2.63	1.920	73	1:4.9	9.357	0.71	-6.73
19	20	16	2.63	0.541	21	1:4.1	2.212	2.09	0.42
20		15	1.62	0.267	15	1:2.9	0.762	1.55	1.04
21	22, 23, 27	24	4.67	1.041	22	1:4.9	5.069	3.63	-0.40
22	23	15	1.62	0.479	26	1:4.5	2.154	1.34	-0.33
23		8	0.54	0.141	26	1:6.2	0.880	0.40	-0.34
24		15	1.62	0.367	20	1:2.6	0.926	1.45	0.89
25	26	12	1.22	0.301	15	1:3.3	1.002	0.92	0.22
26		12	1.22	0.121	10	1:2.8	0.341	1.10	0.88
27	21-24	16	2.63	1.210	46	1:5.1	6.200	1.42	-3.57

*'Projected based on a 2-year rain event.
MP = monitoring point.*

Development of a Management Plan

Given this new information, the city began the difficult journey of redefining its approach to the I/I problem. Due to the history of the city's efforts and in light of this better source of information, it became apparent that any program must include measures for not only reducing the levels of excessive I/I but also for providing auxiliary capacity to handle wet weather flows. Consequently, a three-pronged program was designed.

First, the city would review existing sewer maintenance efforts, sewer hydraulic capacities, and operational protocol to ensure that progress measures were being employed to abate and better handle wet weather flows to minimize sewer system surcharging. Secondly, the city would develop a program to inspect and to coordinate the correction of privately originating unauthorized connections. Third, the city would commission a study to investigate the alternatives necessary to provide supplemental capacity during targeted rain events. A discussion of each phase follows.

Phase 1: Review of Existing Operational Practices

Phase 1 included several key measures designed to examine the ongoing efforts to abate excessive levels of I/I, as well as to provide a strategy for better handling peak flows to minimize hydraulic deficiencies. These measures would accomplish two primary objectives. First, Phase 1 would enable the city to better accommodate storm flows and maximize the capabilities of the existing system. Secondly, Phase 1 would reduce the level of supplemental capacity needed, possibly eliminating the need for supplemental capacity in marginally hydraulic-deficient areas.

As mentioned previously, the city had elected to equip itself with a formidable arsenal of equipment for performing sewer inspection and rehabilitation activities following the study completed in 1985. During the next few years, however, work was overly concentrated in areas suspected to be major sources of extraneous flow. While this resulted in several minor improvements, the effects of these efforts had been diminishing. The 1990 flow study provided better information than previously available, and these efforts were retargeted using the drainage basin information to establish priorities and quantitative goals for I/I reduction. A plan was formulated to inspect each area consecutively, enabling the city to perform remedial efforts to repair deficiencies in publicly owned sewers.

Funds were earmarked in the city's capital improvement program (CIP) for those repairs recognized as significant sources of I/I. A similar program was developed for the inspection of privately owned sewers in large apartment complexes. A list of these repairs was turned over to management firms or homeowner associations. Phase 1 also called for an in-depth review of the existing specifications for construction materials and installation requirements. Changes were made to allow use of only the latest technology, materials, and installation procedures. Construction inspection activities were bolstered, and a clear message was delivered to builders that the installation of sewers would be held to stricter material and construction standards.

Having outlined a program for aggressive sewer maintenance, the city directed its attention on operational procedures during wet weather events and improvements that would maximize existing hydraulic capabilities. As part of this effort, an algorithmic subroutine was installed on the computerized control system at the wastewater plant. The subroutine monitors wet well elevation, flow, and pump information to ensure that proper operational protocol is followed, and ensures that the necessary efforts are taking place to handle flows at the plant to alleviate upstream surcharging. The computer is also linked to five rain gauges installed at the plant and water booster stations as part of the system telemetry. The computer executes the subroutine automatically when the city experiences significant rainfall, or if wastewater flow rises above preset levels or exceeds predetermined trends. This enables the city to make ongoing correlations between rainfall, rainfall intensities, and wet weather flows.

Evaluation of the wastewater treatment plant identified several hydraulic "bottlenecks." In particular, the evaluation led to the removal of a decommissioned venturi constriction and a **flow-limiting** diversion gate to enhance hydraulic capacity in one of the **headwork** structures. Each enable the operators at the plant to perform more timely responses in extended storm weather conditions.

Phase 2: Elimination of Unauthorized Connections

As indicated previously, the issue of dealing with unauthorized use of the sewer for discharge of unpolluted water was highly controversial. Not only did the issue deal with basic privacy issues, but it had been identified unfairly as the primary source of extraneous wet weather flow. It became apparent early that no plan would be complete unless it attempted to deal squarely with the issue of unauthorized connections.

The city saw investigation of this matter as an opportunity to accomplish several objectives. First, removal of unauthorized connections would mitigate the I/I problem to some extent, particularly in localized problem areas. Secondly, the investigation indicated to residents that the city was pursuing the

sanitary sewer problem aggressively. After several months of considering various alternatives, the city proposed the following as the unauthorized connection program (UCP).

First, the city created a position of special projects coordinator to serve as liaison for the program. Promotional materials, such as informative brochures and a videotape, were prepared for a broad public awareness campaign. The information was made available for civic groups and real estate and homeowner organizations. Real estate organizations were targeted specifically to enlist their assistance and make them aware of disclosure requirements should remedial efforts be required after sale of a home. The videotape was aired on local cable access television in conjunction with televised sessions of city council meetings.

Using the promotional materials, the program coordinator embarked on an area-by-area campaign to perform homeowner inspections. Door hangers were distributed only at those homes to be inspected next to ensure that prompt and personal contact was initiated. A followup inspection was completed, and a report was issued outlining necessary corrective measures. Most unauthorized connections were made in an attempt to deal with private ground-water or drainage problems. The program helped to identify the source and suggested available options to properly handle these problems.

In addition to public outreach, the city initiated a review process to carefully evaluate plans for new construction and preliminary subdivision plats to ensure that drainage issues were addressed properly. The review process was incorporated in the activities of a technical review committee (TRC), composed of representatives of all major city departments. The TRC meets weekly to conduct a joint review of all new plans in a roundtable session. Among the issues discussed is the ability of the project developer to handle surface- and ground-water discharges. The city now enforces strict stormwater retention/detention requirements.

Since both Phases 1 and 2 were targeted toward abatement efforts, a plan was devised to conduct ongoing flow monitoring activities to provide an indication of the effectiveness of these efforts. The city purchased nine flow monitors to compare current information to that collected in the formal 1990 study. The city has established a goal of reducing the level of I/I by 40 percent through these efforts.

Phase 3: Commission of a Master Plan for Capital Improvements

The city recognized that these measures alone would not be enough to mitigate sewer backups or system bypasses. Clearly, additional hydraulic capacity was needed.

In 1992, the city commissioned a study to investigate alternatives, including improvements to divide the existing system into separate collection systems and/or installation of a network of parallel interceptors. In commissioning this study, the city required the consultant to incorporate the use of a computerized hydraulic model to better analyze system capacities and to serve as a tool for predicting the effect of different-intensity rain events under current and future flow conditions. Extensive flow monitoring information was applied to the model to see how the system responded, not only under present conditions but also under a number of "induced" circumstances. For the purposes of the 1992 study, all sewer lines 12 inches and larger were "reconstructed" using the hydraulic model. This included all of the interceptor sewers, as well as many of the primary and secondary collector sewers. The model was capable of analyzing surcharged conditions and provided a two-dimensional visual display.

The study of capital alternatives indicated that it was most feasible to install an overflow relief sewer system paralleling the secondary interceptor system. Excessive flow will exit the sanitary sewer through control structures and pass through the relief sewer system to a relief pump station, where it will be conveyed approximately 3 miles to off-line equalization facilities at the wastewater treatment plant. Wet weather will be metered into the plant as wet weather flow conditions subside. The plan also calls for minor improvements at the plant, primarily to ensure uniform hydraulic capacity throughout the plant to maximize treatment capabilities.

For design purposes, the city required that the relief sewer be designed to handle a projected flow rate rather than peak flow, ensuring that the relief system is able to eliminate surcharge conditions often resulting from wet weather. This was required due to the fact that I/I problems were primarily due to hydraulic problems in the collection system and not to excessive flow that must be accommodated at a treatment plant. Furthermore, I/I abatement efforts were estimated to eliminate approximately 40 percent of the peak I/I flow rate, an estimate that would later be attained through Phases 1 and 2. The plans for these improvements are currently under design, with construction anticipated beginning in 1996.

Subsequent Monitoring Activities

As part of a followup to Phases 1 and 2, the city conducted another flow study in 1993. Although not as comprehensive, the 1993 study paralleled the earlier study by focusing on 19 key locations in the collection system. The purpose was to determine the effects of I/I abatement efforts and provide a systems check for formulating corrective actions.

The results comparing a similar rain event are given Table 2. While it is unlikely that ground-water conditions were identical, the data clearly suggest that substantial progress has been attained through the city's efforts. In particular, dramatic improvement has been attained in Areas 10, 11, 13, 16, 19, 20, and 22, where wet weather flow had been reduced by as much as 90 percent.

Table 2. Comparison of Average and Peak Daily Flow for 1990 and 1993 Flow Monitoring Periods, Fairfield, Ohio

Drainage Area	Average Dry Day Flow (mgd)			Measured Peak Daily Average Flow (mgd)	
	1990	1993	% of 1990 Flow	1990	1993
WWTP	5.859	5.323	91	16.836	10.61
10	0.620	0.106	17	1.783	0.182
11	0.380	0.057	15	1.182	0.119
12	3.827	3.006	78	10.042	8.320
13	0.753	0.687	91	3.710	1.320
14	0.177	0.220	126	0.866	0.348
15	0.443	0.412	93	1.858	0.870
16	1.031	0.530	51	3.266	1.570
17	0.341	0.212	62	0.774	0.357
18	1.920	1.789	93	4.273	3.640
19	0.541	0.202	39	2.199	0.300
20	0.267	0.078	30	0.607	0.128
21	1.041	0.769	74	3.907	1.680
22	0.479	0.333	70	2.287	0.855

Drainage Area	Average Dry Day Flow (mgd)			Measured Peak Daily Average Flow (mgd)	
	1990	1993	% of 1990 Flow	1990	1993
23	0.141	0.210	149	0.670	0.538
24	0.367	a	a	0.713	a
25	0.301	0.163	54	0.602	0.260
26	0.121	a	a	0.211	a
27	1.212	0.769	62	3.463	0.920

"Incomplete data.

This information clearly parallels the amount of work that has been conducted in each of these respective areas. In summary, Phase 1 resulted in cleanup of nearly 140 miles of sewer line, televising of 123 miles of sewer line, two major sewer replacement projects, 35 inversion relining projects, 75 point repairs, 950 manhole repairs (ranging from simple sealing and grouting to major overhauls), and the removal of countless cubic yards of grit and large debris.

Phase 2 resulted in nearly 2,000 private contacts. The incidence of unauthorized connections ranged from less than 10 percent in some areas to nearly 25 percent in others. The compliance rate of this program has been exceptional, undoubtedly a result of the nonthreatening manner in which the program was conducted and the efforts made to help property owners find viable options for resolving ground-water problems. In most cases, the UCP resolved other surface- and ground-water handling problems. The greatest value in the UCP, however, lies in its educational benefits and demonstration of the city's commitment to address its history of sewer problems.

Summary

This paper discusses an approach taken by one community in an attempt to deal with severe problems related to excessive I/I levels in the sanitary sewer system. It was a problem that not only raised health concerns but also threatened the prospects for future growth and development.

While there are certainly no simple solutions, it is apparent, based on this experience, that severe I/I problems can be addressed effectively. This can only occur, however, when the problems are faced in a logical and informed manner. Consequently, the need for reliable and accurate information in formulating a concerted effort was essential. In this case, the value of information derived from comprehensive flow studies cannot be overstated, for this information was invaluable to gaining a full understanding of the nature and extent of problems, and guided officials in prudent decision-making.

In addition to reliable information, effective tools were also needed to assist in interpreting this information. Use of the hydraulic model provided greater analytical capabilities, enabling the city to project needs not only for present-day conditions but also for future demands.

After the information was obtained and the data analyzed, the next step was the formulation of a plan to focus proactive measures on specific problem areas. In this case study, corrective measures included both capital expenditures and careful evaluation of daily activities and operational procedures. The

experiences gained through this case study indicate that solutions were not the result of a singular cohesive measure but rather occurred through a series of smaller, well-targeted actions.

Finally, this case study emphasized the importance of good communication in building public support and of enlisting the public in decision-making and policy-setting processes. This, too, is an effort requiring effective planning and a well-devised approach.

There is no question that I/I management efforts in Fairfield will continue to be an ongoing process. The efforts the city has made to address this problem, however, have resulted in a concerted effort to better meet the needs of its residents.

Correcting Sanitary Sewer Overflows Through Infiltration and Inflow Control, City of McMinnville, Oregon

John Kennedy
City of McMinnville, Oregon

Carrie Pak
HDR Engineering, Inc., Lake Oswego, Oregon

Introduction

The City of McMinnville is located in northwest Oregon and has a population of 21,000. McMinnville has enjoyed considerable growth and development over the last 20 years. The city has become a focal point for a growing Oregon wine industry and is home to a private university and several high-technology industries.

A significant portion of McMinnville's sewer system was developed prior to 1920. The city's sewer system is subject to significant infiltration and inflow (I/I), and this has long been recognized as a problem. During larger storm events, the flow increases more than ten-fold over dry weather flow. Excess flows are bypassed directly into receiving streams without treatment.

On April 5, 1993, the State of Oregon issued a Stipulation and Final Order (SFO) requiring McMinnville to upgrade and repair its sewage collection system as necessary to eliminate untreated overflows from storms smaller than the 5-year, 24-hour storm by 1999. At the time the SFO was issued, the collection system had not been fully characterized and the I/I correction program had not been fully developed. Since agreeing to the terms of the SFO and subsequently submitting an I/I correction plan in July 1993, the city has continued to work to characterize the condition of its collection system, estimate the increase in sanitary sewer flow as a result of I/I, and develop an I/I correction program to control overflows.

This paper summarizes the activities undertaken to characterize McMinnville's I/I problem, the I/I control projects necessary to prevent sanitary sewer overflows (SSOs), and the program that the city will pursue to upgrade its collection system and reduce I/I.

Problem Identification

The McMinnville sanitary sewer system has been divided into seven distinct basins that form the city's current and future service area and cover approximately 10,430 acres. Approximately 511,000 linear feet of sewer pipes make up the collection system. Figure 1 shows the city's sewer basins. Currently, sanitary overflows occur at five points.

To identify the magnitude of the I/I problem, a comprehensive flow monitoring program was implemented. This section provides a brief description of the flow monitoring program, development of the design storm, and results of collection system modeling.

Flow Monitoring

McMinnville's collection system monitoring program was started in 1992. The monitoring program included in-system flow monitoring, bypass flow monitoring, rainfall monitoring, and ground-water monitoring. The monitoring program was used to assess major drainage basin flow contributions and bypass flows.

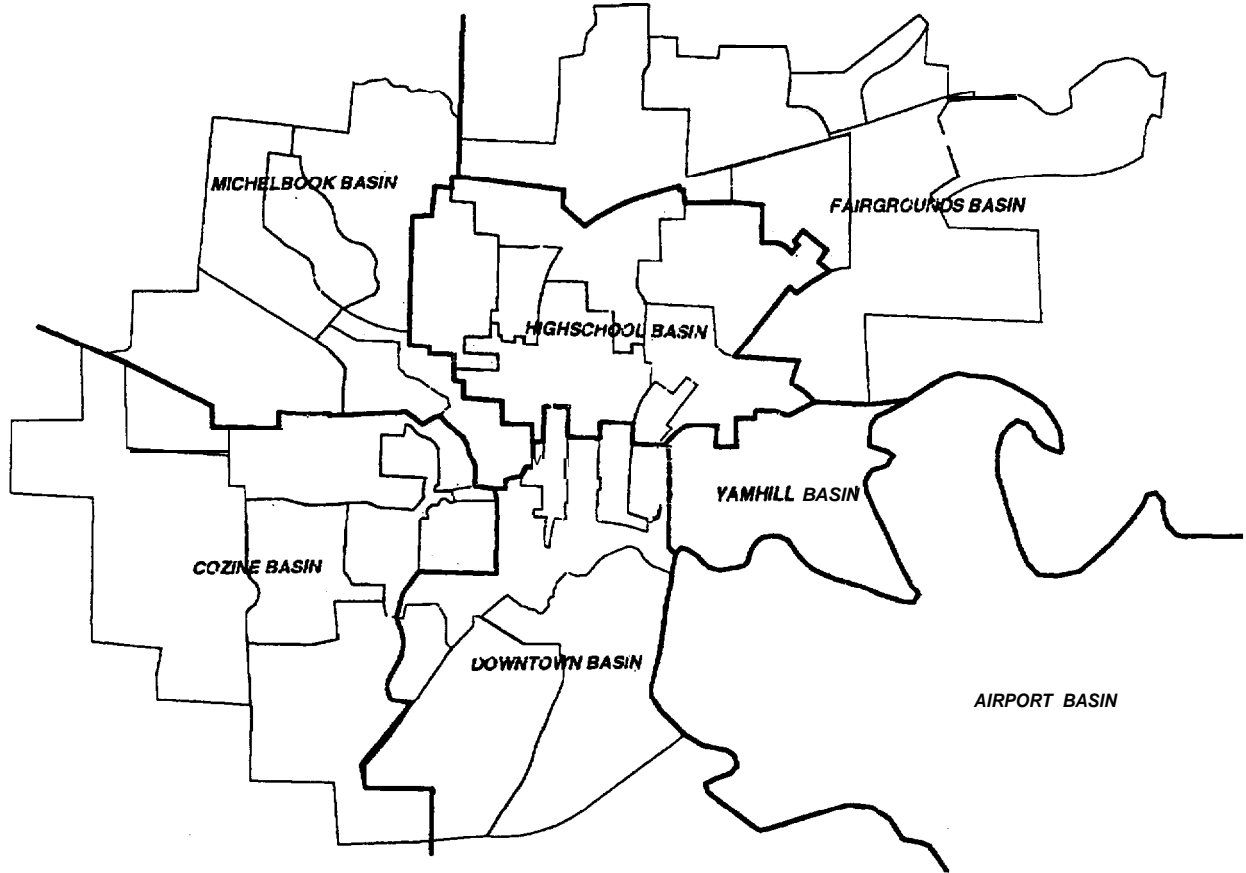

Figure 1. City of McMinnville sanitary sewer system.

In-system flow monitoring was conducted using portable electronic flowmeters. Data have been collected concurrently in each of the seven drainage basins and at the wastewater treatment plant. Data have also been collected for subbasins within most of the drainage basins. Table 1 summarizes the basin monitoring periods.

Permanent flow monitors were installed at each of the five system bypass locations in the Downtown and Yamhill basins as part of the flow monitoring program. The depth of bypass flow is recorded as it passes over a weir or through a flume. Bypass flow is read remotely using the telemetry system at the wastewater treatment plant. A continuous record of bypass flows since 1992 is available at the city offices.

The city's rainfall data are recorded using a tipping-bucket type of rainfall gauge at the wastewater treatment plant. Rainfall is recorded in **15-minute** increments. A continuous record of rainfall since 1992 is available at the wastewater treatment plant.

Ground-water levels are read and recorded at **2-week** intervals from a manhole in the Yamhill basin.

Data gathered as part of the collection system monitoring program have been used to guide other investigative activities, such as smoke testing. Using the systemwide flow data and the total length of pipe in each basin, an estimate for I/I per foot of pipe per day was calculated (see Table 2). This analysis showed that the High School, Downtown, and Yamhill basins were the largest contributors of I/I flows.

Table 1. Bash Monitoring Periods

Basin Name	Monitoring Period
Svstemwide	January 1 to August 15, 1992
High School	January 12 to March 19, 1993
Downtown	March 19 to April 20, 1993
Fairgrounds	April 20 to July 27, 1993
Cozine	October 26, 1993, to March 7, 1994
Michelbook	March 8 to May 4, 1994
Cozine and Yamhill	November 18 to December 12, 1994
High School and Downtown	December 15, 1994, to January 10, 1995
Michelbook, High School, Yamhill, and Fairgrounds	January 15 to March 24, 1995

Table 2. Estimated Flow Constituents

	Sanitary Flow (mgd)	Base Flow^a (mgd)	Ground-Water induced (mgd)	Rainfall Induced (mgd)	I/I per Foot of Pipe^b (gal/ft-day)	I/I for 5-Year Design Storm^c (gal/ft-day)
High School	0.43	0.43	2.38	2.03	110	180
Yamhill	0.15	0.21	0.36	0.35	79	134
Airport	0.09	0.09	0.21	0.1	30	51
Downtown	0.4	0.47	1.22	1.25	57	97
Cozine	0.21	0.27	0.42	0.31	33	55
Michelbook	0.06	0.06	0.17	0.1	27	43
Fairgrounds	0.22	0.52	0.72	0.29	26	46

^aBase flow = sanitary flow + nonstormwater infiltration base flow.

^bBased on observed peak I/I flow during a storm event with 1.95 inches of rainfall.

^cProjected flows using 3.1 inches of rainfall.

Flow, rainfall, and ground-water monitoring will continue as the collection system rehabilitation and replacement program progresses. Flow data are recorded at the treatment plant and at the major pump stations. Additional portable flow monitors will be used to meet specific needs as they are identified.

Design Storm

The design storm identified in the SFO is the 5-year, 24-hour storm. For McMinnville, this results in a 24-hour total rainfall of 3.1 inches. To predict the 5-year wet weather peak flow for the design event, monitoring data at the treatment plant, system bypass locations, and rain gauge data were analyzed.

Based on these measured flows, a statistical relationship was established between total flow and rainfall for five distinct storm events that occurred during the period from December 16, 1994, to February 17, 1995.

From the selected storm events, the period with the closest total of 3.1 inches during 24 hours was selected and increased proportionally to produce a total 24-hour rainfall value of 3.1 inches. After considering the data, a value of 48 million gallons per day (mgd) was derived as the total predicted flow to be distributed and input to the HYDRA collection system computer model.

Modeling Results

Several iterations of model runs were performed to reflect existing and future land-use conditions, the implementation of the Cozine project (replacement of a major interceptor in the Cozine basin), and I/I reduction in various basins within the system. A peak total system flow of 32 mgd was established for future land-use conditions at the new raw sewage pump station (RSPS) because of its pumping capacity, along with the need to eliminate system bypasses. Table 3 indicates that for existing land-use conditions, a total of 48 mgd is generated for the SFO design storm as was predicted from the design storm definition. The model also indicates that the expected total flow for future land-use conditions is approximately 58 mgd.

Table 3. Problem Characterization Summary

	Existing Land Use			Future Land Use ^a		
	Peak Base (mgd)	Rainfall-Derived I/I (mgd)	Total (mgd)	Peak Base (mgd)	Rainfall-Derived I/I (mgd)	Total (mgd)
High School	2.66	15.52	18.19	3.21	15.52	18.74
Yamhill	0.59	3.72	4.31	0.68	3.85	4.53
Airport	0.32	1.56	1.88	1.46	3.17	4.63
Downtown	1.72	9.79	11.51	2.33	10.38	12.71
Cozine	0.74	3.54	4.28	1.99	3.88	5.87
Michelbook	0.23	1.19	1.42	0.98	1.76	2.74
Fairgrounds	1.19	5.23	6.42	2.45	6.57	9.02
Total flow	7.45	40.55	48.00	13.10	45.14	58.24

^a5-year design storm, 2015 land use; includes Cozine basin I/I reduction based on the Cozine Trunk Project.

Given these flow characteristics, several I/I reduction scenarios were modeled to bring the total system flow to 32 mgd and also to eliminate SSOs in the system. The flow data collected clearly showed that some basins had higher I/I flows than others. As was mentioned earlier, the High School, Downtown, and Yamhill basins were identified as the largest contributors of I/I flows. As such, these basins were selected to be the focus of the I/I correction plan. An aggressive target reduction rate of 80 percent was assumed for each of these basins to maximize effectiveness and minimize disruptions (i.e., get the biggest bang for the buck). In addition, 10 to 25 percent reduction rates were assumed for the remaining four basins.

Table 4 shows the level of control needed to meet the 32-mgd constraint (i.e., to keep flows in the system and not exceed the RSPS capacity).

Table 4. Estimated Flows With Proposed I/I Reductions

	Percentage of I/I Reduction	Future Land Use			Required I/I Reduction (mgd)
		Peak Base (mgd)	Rainfall-Derived I/I (mgd)	Total (mgd)	
High School	80	3.21	3.10	6.31	12.42
Yamhill	80	0.68	0.77	1.45	3.08
Airport	10	1.46	2.85	4.31	0.32
Downtown	80	2.33	2.08	4.41	8.3
Cozine	25	1.99	3.51	5.50	0.37
Michelbook	10	0.98	1.58	2.56	0.18
Fairgrounds	10	2.45	5.91	8.36	0.66
Total flow		13.10	19.80	32.90	25.34

^aI/I reduction needed to accommodate the future land-use conditions.

Development of I/I Control Projects

Once the problem definition was identified through flow monitoring and system modeling activities, the city was ready to develop a program to meet the required I/I flow reduction. Field investigations, including smoke testing and television inspections, were used to identify I/I sources. This section describes efforts used to identify the I/I control projects.

Smoke Testing

While the city has smoke tested portions of their collection system since the 1970s, the most comprehensive smoke testing program did not start until 1992. Since 1992, approximately 30 percent of the system has been smoke tested for defects and sources of inflow. The majority of this effort concentrated around the most problematic basins, including the High School, Downtown, and Fairgrounds basins. Additional smoke testing is planned for other lower priority basins. The city plans to eventually smoke test all of their collection system. Table 5 shows the lengths of mainline pipe in each basin that were smoke tested.

These smoke test results were used to identify I/I sources. As the flow monitoring results indicated, the High School basin was of special concern again. Approximately 60 percent of its total pipeline was smoke tested, and approximately 600 individual defects were identified. Defects range from cracked manholes to catch basins directly connected to sanitary sewers. Table 6 shows the summary of collection system defects found in the High School basin during smoke testing conducted in 1993.

Table 5. Length of Pipe Smoke Tested

Basin	Total Length of Mainline Pipe in Basin (ft)	Length of Pipe in Basin Smoke Tested (ft)	Percentage of Pipe in Basin Smoke Tested
Airport	25,800	0	0
Cozine	118,650	1,110	1
Downtown	90,930	65,480	72
Fairgrounds	89,615	25,160	28
High School	102,090	63,070	62
Michelbook	58,935	0	0
Yamhill	25,130	3,110	12
Total	511,150	157,930	31

Table 6. High School Basin Defects

Collection System Defect	Number
Catch basin	136
Cleanout	24
Downspout	105
Side sewer	277
Man hole	18
Sewer main	23
Other	14
Total	597

Television Inspection

Prior to the I/I study, the city's television inspection program was limited to solving blockage problems. Because television inspection of the lines can be an economical way to identify significant structural defects, the city plans to use this resource more extensively in the future. Approximately 10 percent of the city's collection system was videotaped in the summer of 1994, and the city planned to conduct additional television inspection in 1995.

The initial goal of the television inspection was to correlate structural condition with age and materials of construction. This information was useful in helping McMinnville identify pipes needing repairs or replacement on a citywide basis. A general trend was that more defects were identified in pipes constructed before 1920.

Data Management

As the data from smoke testing and television inspection were being generated, it became obvious that some form of data management scheme was essential to use the data effectively. Although the city was in the process of developing a geographical information system (GIS), the planning team needed a system immediately. The Access relational database application and **MapINFO** were selected as working tools until a full GIS was available. (The city expects complete this within the next 2 years.)

A collection system database was created in Access with pertinent information such as the date of installation. This database was then linked to the MapINFO. The result was a simplified GIS with which data can be manipulated to assist with planning efforts. The planning team has found this tool to be very effective.

Conclusion

The results from the field investigation were used to identify the high priority areas within the city. The field investigation program will be used to evaluate the effectiveness of the proposed capital improvement program (CIP) projects as they are implemented. The results will be used to modify and improve the rehabilitation and replacement program. In reviewing the available data, the city concluded that the key to a successful maintenance program is to address problems as they are noted if possible. As such, the city has included an ongoing investigative program and companion rehabilitation programs in its budget for the CIP.

I/I Control Plan

Historically, the city of **McMinnville** has had a poor maintenance record. Years of neglect have resulted in a separated sewer system that behaves more like a combined sewer system. In recent years, the city has started to invest capital in its sewer collection and treatment system. The city is currently constructing a new wastewater reclamation plant. In addition, replacement of the Cozine trunk line, which will help address the I/I issues to a limited degree, is also under design. This project will be completed in fiscal year 1997.

While developing the city's CIP, it became painfully obvious that **McMinnville** did not have the necessary resources to meet the requirements of the SFO. Given this, the following strategies were considered:

- Develop a detailed **5-year** program and a long-term program.
- Focus on highest priority projects in early years.
- Focus on projects with the lowest cost per amount of I/I flow reduced.
- Initiate and maintain an ongoing maintenance program, including manhole rehabilitation and inflow removal projects.

Five-Year CIP Program

The city's proposed **5-year** program is divided into three broad groups: projects to address structural conditions, projects to reduce I/I from the High School basin, and ongoing maintenance projects. Figure 2 shows general areas of the proposed **5-year** program.

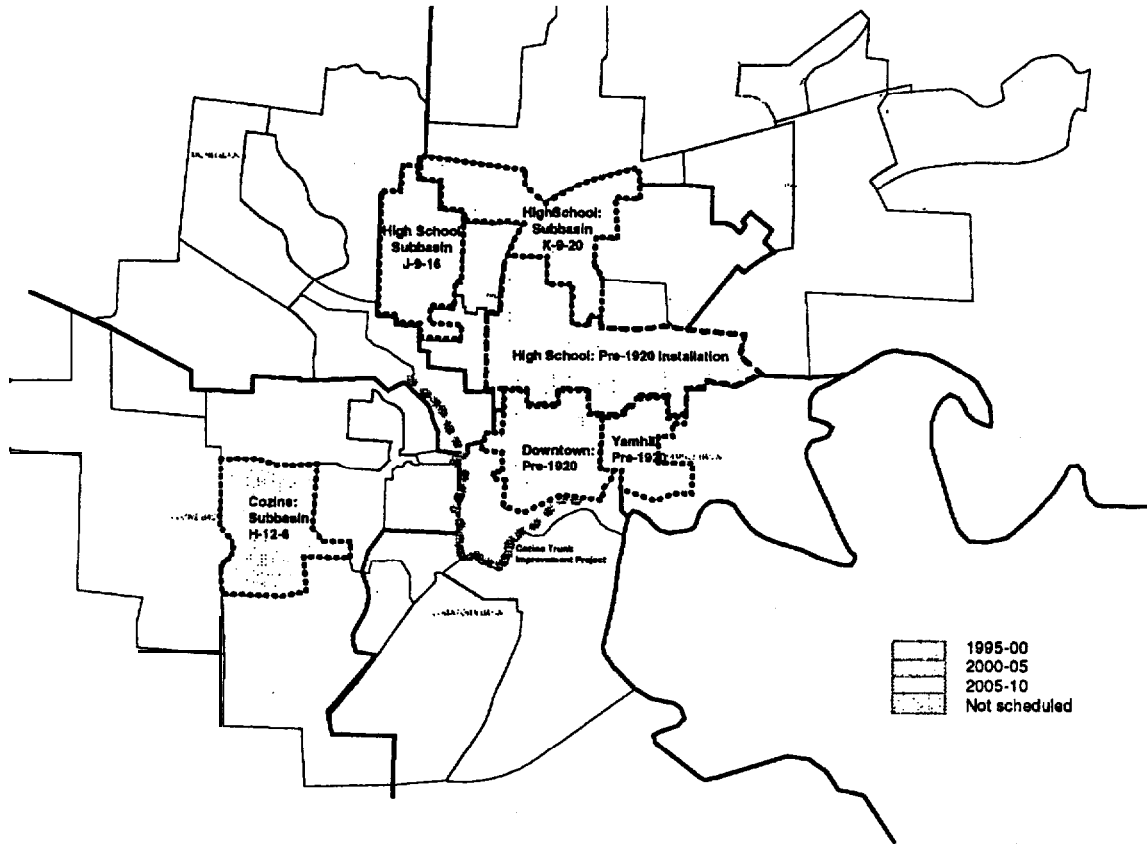

Figure 2. Proposed CIP area.

Cozine Trunk Rehabilitation Project

The Cozine Creek is surrounded by residential development as well as a private university. The Cozine Trunk, one of the major trunk sewers in the city, is located parallel to this creek. It also has experienced overflows into the Cozine Creek related to capacity problems. More urgent, however, is the structural condition of this trunk sewer. Because of these compounding conditions (and the ensuing public relations nightmare), this replacement/rehabilitation project was selected as an immediate action project and is currently under design. Construction is expected to end in fiscal year 1998.

Although those involved agreed that the Cozine Trunk Rehabilitation Project was the highest priority project, a feeling of helplessness remained after the budget was determined. The Cozine Trunk Rehabilitation Project was allocated approximately \$6.5 million, which did not leave very much money for the rest of the program.

High School Basin Projects

The High School basin includes the oldest part of McMinnville. As such, the sewer system is old and flawed. While smoke testing approximately 61,000 feet of sewer system in this area, inspectors noted approximately 600 defects ranging from minor cracks to crushed pipe segments, an average of one defect per 100 feet of sewer. Three distinctive areas within the High School basin were identified for rehabilitation of sewer pipes. These rehabilitation projects are expected to reduce I/I significantly.

As Table 2 indicates, the High School basin contributes approximately 180 gallons per foot-day of I/I. The proposed projects from the three areas in this basin are expected to achieve an estimated 9.78 mgd of I/I flow during a 5-year design storm. Additional reduction of approximately 2.64 mgd must be identified in the High School basin to meet the SFO requirements. Identification of these additional reductions is discussed below.

During the first 5 years of the program, the city will focus on replacement or rehabilitation of pipes constructed before 1920. In the High School basin, approximately 21,000 feet of sewer pipes will be replaced. All service laterals will be rehabilitated, and all roof drains will be disconnected and reconnected. The estimated capital cost is \$2.94 million. Completion of the replacements is expected by 1999. Because of budget constraints, other projects identified in the High School basin will be completed in the out years.

Ongoing Maintenance Projects

The importance of an ongoing maintenance program cannot be emphasized enough. In the past, McMinnville was operating in a reactive mode. With the proposed ongoing maintenance program, the city can be proactive in addressing not only I/I problems but also emergency structural failures. The city has budgeted funds to remove inflow sources as they are identified unless the identified sources are located in the area scheduled in the CIP program.

This program has yet to be developed. The basic idea, however, is to correct defects as they are identified. Currently, the city does not have sufficient operations resources and equipment to address many of these problems. As such, the proposal is to retain a list of contractors who will be preapproved and will be available on a short notice to provide necessary repair work-obviously not a new concept for many smaller communities. This ongoing maintenance program will be linked with the city's data management system so that necessary records can be maintained and will be available for quick retrieval for systemwide evaluation.

In addition, the city is aware of approximately 200 manholes that are either structurally unsound or leaking significantly. A priority list will be developed for these manholes. Approximately 40 manholes will be rehabilitated per year, as well as others as they are identified.

Long-Term Program

As mentioned before, the proposed 5-year CIP program will not be sufficient to address the requirements of the SFO. To meet these requirements, the city has developed a long-term planning program with an estimated cost of more than \$27 million. The city expects to complete the long-term program over a 20-year period.

The idea is to focus first on the project areas that have the highest probability of achieving anticipated reduction rates. As those projects are being completed, flow monitoring programs can be organized to evaluate the effectiveness of completed I/I control projects. If the completed projects are meeting the expected flow reductions, they should be continued. If, however, they are not meeting the expected reductions, the program can be modified to make appropriate adjustments. As such, the ongoing investigative projects become a crucial part of long-term program implementation.

In addition to the ongoing investigative program, projects in the Yamhill and the Downtown basins have also been identified. As the modeling results indicated, both of these basins require an 80-percent reduction in flows to meet the SFO requirements. To meet the estimated reduction level, pipes installed before 1920 will be replaced or rehabilitated. Rehabilitating these old pipes will address most of the I/I problems from these basins. Additional projects will be identified as the I/I control plan is implemented.

SFO Requirements Versus Long-Term Program

A significant gap obviously exists between the state's requirements as outlined in the **SFO** and the city's ability to finance this program. This has raised a question of whether alternate solutions could still protect water quality and whether the financial impacts can be reduced by extending the compliance schedules. The city is having ongoing discussions with the state to find workable solutions.

The situation with the regulatory agency is seldom simple, and this is no exception. The **SFO** requirements were developed based on available information. At that time, the collection system had not been fully characterized and the I/I control plan had not been fully developed. As the city continued to work to fully understand and characterize the system, the problems associated with I/I became more significant than was first estimated. Cost estimates have ballooned from approximately \$3 million to more than \$27 million. This new estimate was developed after the intensive flow monitoring activities. Additional, more accurate data showed that the City of **McMinnville's** collection system was in much worse condition than was originally assumed. The city has accepted the fact that this work needs to be accomplished and is hopeful that the state will be understanding and extend the **timeline** stipulated in the original **SFO** from the year 1999 to the year 2015 to lessen financial impacts to the rate payers.

Conclusion

The conditions of the **SFO** will need revision to reflect the ability of the city to fund this program. As plans are made as to how to accomplish this, implementation of the identified projects will begin. The city has already started designing the Cozine Trunk Rehabilitation Project. In addition, the inflow removal and manhole rehabilitation projects will be initiated this year. As these projects are completed, additional flow monitoring activities will evaluate the effectiveness of the projects.

Sanitary Sewer System Rehabilitation at Lawrence Livermore National Laboratory

Robert J. Vellinger, Randy Burton, and Bruce Fritschy
Lawrence Livermore National Laboratory, Livermore, California

introduction

Lawrence Livermore National Laboratory (LLNL) is operated by the University of California under contract with the U.S. Department of Energy (DOE). Founded as a nuclear weapons design laboratory in 1952, LLNL has diversified into other fields. LLNL is recognized nationally as a broad-based research center engaged in large-scale applied research programs. The mission of LLNL is to be a national scientific, technical, environmental, and engineering resource that focuses on national security.

The objectives of this paper are to:

- Present LLNL's collection system and innovative approach to sanitary sewer rehabilitation.
- Share issues identified and lessons learned from more than 4 years of rehabilitation work.
- Discuss proposed system standards for ongoing maintenance and repair activities.

Site Description/History of Collection System

LLNL is located on an 81 9-acre site at the eastern end of the Livermore Valley in southern Alameda County, California, approximately 50 miles southeast of San Francisco. The Livermore Valley has two distinct seasons: the rainy season and the dry season. Rainfall, which averages 14 inches per year, occurs primarily between October and May.

Pre-Laboratory

Pre-laboratory development began when the U.S. Navy purchased part of the Wagoner Ranch for a flight training base in the late 1940s. The Navy installed the original sanitary sewer system at LLNL in 1942. The system consisted of 4,800 linear feet of 10-inch gravity sewer in the southwest corner of the site.

Early Laboratory

Management of the Livermore Naval Air Station was transferred to the Atomic Energy Commission in January 1951. In 1952, Livermore was officially established as the Lawrence Radiation Laboratory, the nation's second laboratory dedicated to nuclear weapons research and development (R&D). The laboratory inherited not only barrack buildings and an airfield from the Navy but also a traditional grid street and utilities pattern. After 1952, the laboratory grew by filling in and extending the grid, with no overall site plan.

In the 1950s, an additional 12,350 linear feet of sanitary sewer were installed. The additional capacity was installed to conform with the grid street pattern, with flow traveling from east to west. Also at that time, Sandia National Laboratory (SNL) began discharging to the LLNL system at a single point.

Wastewater from LLNL and SNL was discharged to the City of Livermore at the southwest corner of the site.

Additional east-west gravity lines were installed in the late 1960s. Two lift stations were installed along the west side of the site to transport wastewater from the north part of LLNL downgradient to the southwest corner for discharge to the Livermore collection system.

Transitional Development

In 1968, the laboratory adopted the first long-range development plan, which dealt extensively with two topics: the sewer circulation pattern and the identification of areas for logical expansion. Under this plan, the grid utility system was modified and integrated into a loop system. This allowed for expansion and growth into the eastern portions of the site.

In 1969, the southwest connection to the city's sewer system was abandoned. All flow was redirected to the northwest corner for discharge to the city. At this time the lift stations were also abandoned. A flow monitoring station was installed at the new discharge point to record flow.

Following the guideline of the newly adopted development plan, the sewer system was extended into a looping pattern, serving the eastern portion of the site. During the 1970s nearly 15,000 linear feet of sewers were installed in the new looped pattern.

System Expansions

Since 1980, 15,860 linear feet of new sewers have been installed. In addition to completing the looping system in the southeast corner of the site, new sewers have been installed to replace some of the older sewers, primarily in the southwest corner of the site.

Present Sanitary Sewer System

Figure 1 shows basin boundaries of the sanitary sewer system.

Main Lines

The LLNL sanitary sewer system consists of 56,000 linear feet of primarily vitrified clay pipe that ranges from 4 to 15 inches in diameter. The system operates by gravity only. Two lift stations used previously are now abandoned and do not assist in transporting any wastewater flow.

Laterals

Building laterals are either 4 or 6 inches in diameter. The LLNL collection system contains 36,220 linear feet of laterals. A lateral is defined as the pipe from the main line to the first building cleanout.

Manholes

The collection system contains 271 manholes. In addition, approximately 500 cleanouts are located throughout the collection system, primarily in the building lateral lines.

Historical Flow

Monthly average water and wastewater flows have remained fairly constant for the past 5 years, with an average of 400,000 gallons per day (gpd), or 278 gallons per minute (gpm). Flow typically peaks at 600 gpm; daily low flows drop to 30 gpm. Peak flows of 1,000 gpm or greater occur monthly.

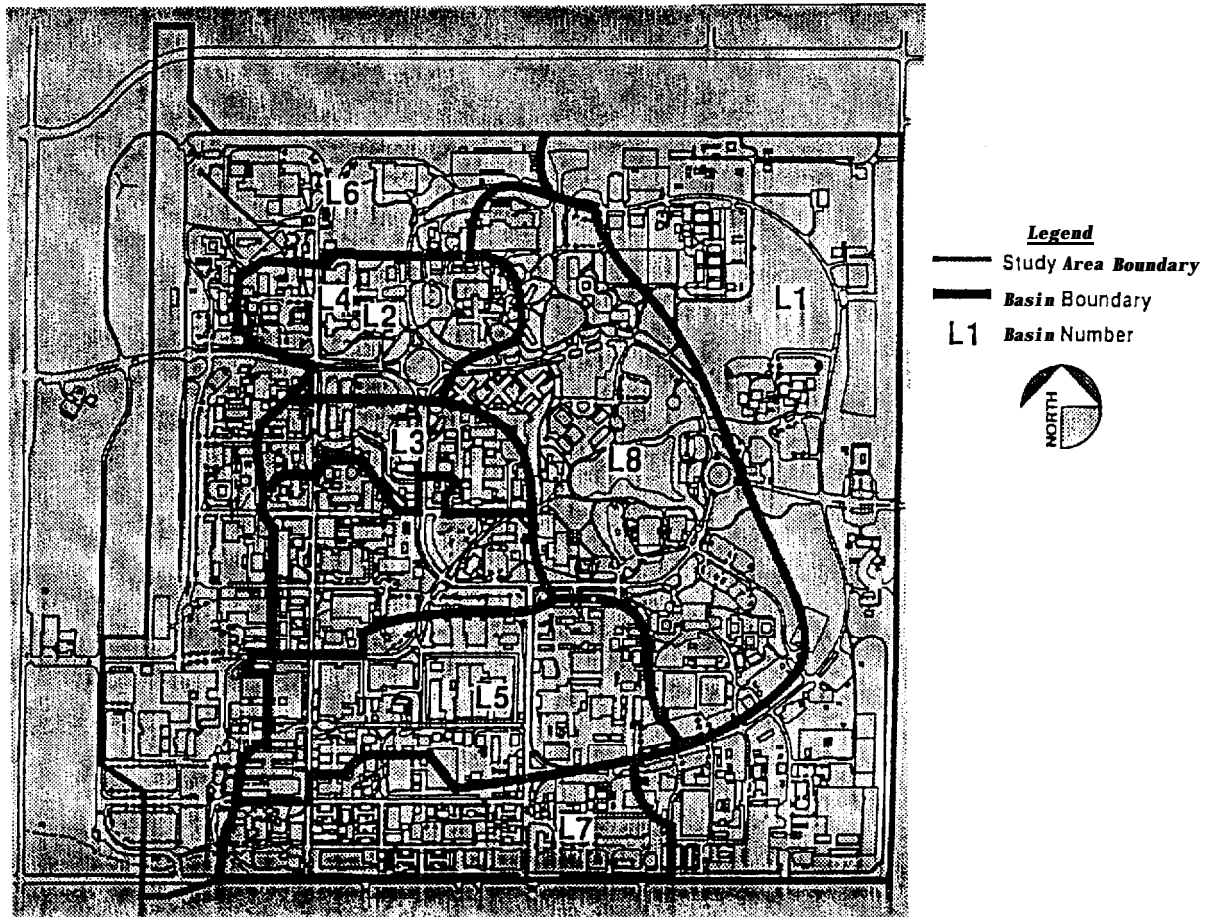

Figure 1. LLNL sanitary sewer system boundaries.

The Sanitary Sewer Rehabilitation Project

LLNL obtained the services of an outside architect and engineer to complete a conceptual design report. This was a rough-cut engineering assessment of the sanitary sewer system. A look at the water balance indicated major inflow problems. It was decided at that time to perform a more in-depth investigation, at which time LLNL obtained the services of another architect and engineer to develop a master plan. This was an in-depth assessment with a corrective action plan and requirements for long-range planning. The **new** master plan was completed in June 1990.

Based on all the information gathered from various architect and engineer reports, LLNL chose to initiate a rehabilitation effort. One of the primary drivers was the Porter-Cologne Water Quality Act, which regulates discharges to the ground (e.g., no exfiltration overflows).

Five million dollars in funding was obtained through a congressional line item. This facility supports 8,000 to 10,000 employees and is similar to a small municipality in many respects. LLNL then took the following 13 steps to success:

1. *Public Awareness*

Local newspapers, news stations, and fire and police departments were notified of upcoming smoke testing activities at LLNL. Memos were distributed site-wide, and regulatory agencies were notified.

2. *Smoke Testing*

Smoke testing is a commonly used method for detecting stormwater infiltration sources and providing data to select necessary corrective procedures. Typical sources detected by smoke testing include direct connections for stormwater infiltration, such as catch basins, roof drains, area drains, and low-lying manholes.

The smoke testing procedure begins with a portable, gasoline-engine blower located over the manhole, which forces smoke through the sewer. Smoke travels through the isolated sewer sections and escapes through sewer defects and cross connections. Anywhere that smoke escapes is a potential source of inflow and infiltration (I/I). The smoke sources must be recorded on data sheets and photographed for permanent documentation. Figure 2 shows a typical smoke testing setup.

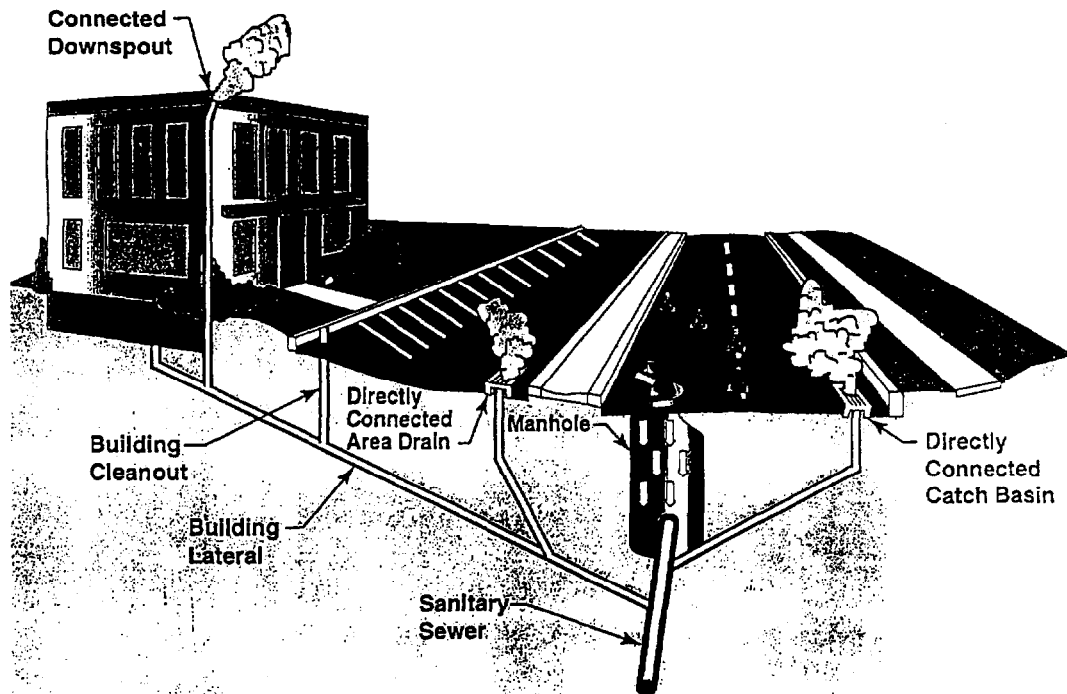

Figure 2. Typical smoke testing setup.

Smoke testing was performed on all mainline sewers (56,800 linear feet) at LLNL. Due to the nature of the work, smoke testing was scheduled on weekends with cooperation from the various programs using in-house maintenance personnel and an outside contractor.

3. *Site Survey*

Smoke testing revealed that site drawings were outdated. Based on this finding, it was decided that a complete **sitewide** visual inspection and documentation of the sewer system were required.

4. *Dyed-Water Testing*

Dyed-water testing was used to verify the smoke detection results or to identify other suspected or known cross connections. During this procedure, dyed water is poured through a suspected connection such as an area drain or catch basin. An observer positioned at the downstream sanitary sewer manhole watches for the appearance of dyed water. If dyed water is observed, there is a cross connection between the sanitary sewer system and the location where the dye entered the system. All sanitary sewer laterals were tested and documented as to their source and destination. In areas where the destination was in question, a nondestructive method of verifying was used: floating popped popcorn down lines.

5. *Manhole Inspection*

All 271 manholes at LLNL were inspected. Manhole inspection is best conducted during wet weather, when infiltration can be seen entering the manhole. Manhole inspection information is used to determine the appropriate rehabilitation technique for manhole repair and to make a qualitative assessment of the overall collection system condition.

6. *Cleanout Installation*

Cleanouts were installed to provide better access in evaluating and videotaping maintenance and lining activities. More than 150 cleanouts were installed and later found to be invaluable in ensuring uninterrupted service for LLNL researchers via bypass pumping of their sewer outflows during all phases of construction.

7. *Print Update*

All field data were collected and as-built drawings were generated and converted into **computer-**aided design and drafting format. Having accurate prints led to cost-effective planning and estimating, providing a solid foundation for generating construction specifications.

8. *Closed-Circuit Television Inspection*

Prior to construction, as part of Title I design the condition of all pipes to be replaced or rehabilitated was assessed. Closed-circuit television (CCTV) inspection of all LLNL main lines and laterals (96,580 linear feet) was performed before construction based on television inspection reports (see Figure 3). A field survey was conducted to establish the locations and invert elevations of all mains and laterals. Data were used to verify the appropriate type of rehabilitation of each pipe segment. The inspection was also used to locate and identify required point repairs that had to be performed before rehabilitation. Run numbers were assigned to laterals to enable easy identification and input.

Prior to CCTV inspection, the sewers were cleaned. For CCTV inspection in areas where high flows were expected, the CCTV inspection was scheduled for weekends or other periods of low flow. If inspection could not be performed during a low-flow period, bypass pumping was provided.

Upon completion of the sewer rehabilitation or replacement, the sewers were again inspected using CCTV to ensure the quality of the work.

9. *Prioritizing Required for Rehabilitation Efforts*

After analyzing all CCTV data, a scoring system was developed based on the severity of deficiencies. Lines were categorized into three groups: point repair, line replacement, and cured-in-place pipe (CIPP) lining, based on priority and accessibility. All manholes were evaluated and judged in much the same way. Line elevation (inflow) and age, however, weighed more heavily in the determination. LLNL selected 40 manholes for reconditioning, with 60 rings raised for inflow reasons. One hundred thirty point repairs were performed, and approximately 4,500 feet of line were replaced. The laterals were replaced from the building cleanout to the main. An outside contractor was solicited to provide lining services for 24,000 linear feet of both laterals and mains, with 42 lateral lines replaced.

10. *CIPP Lining*

With the comprehensive list and start date established, a carefully coordinated schedule was developed to ensure minimal disruption to the facilities. Inspection and direction were provided on a 24-hour basis, which included weekends when possible.

11. *Post-CCTV Inspection and Testing*

After closely reviewing the contractor's post-CCTV tapes, random areas of concern were selected and closely scrutinized with an in-house CCTV camera. LLNL paid close attention to line integrity, lateral cutouts, and grouting. No liners were installed before ensuring that the sewer lines were absolutely clean of debris. To further ensure quality repairs, LLNL randomly tested CIPP, manholes, point repairs, and all line replacements. Third-party evaluation of the CIPP liner material was also obtained. Upon completion of the sewer rehabilitation or replacement, the sewers were again inspected using CCTV to ensure the quality of the work.

12. *Post-Flow-Monitoring and Analysis*

LLNL currently has nine flow monitors installed in designated locations throughout the site. The monitors are checked once daily and electronically downloaded once a week. In-house data will be analyzed and evaluated to measure the success of the sanitary sewer rehabilitation project. The data will also be used as a benchmark for the future and to further document the project.

13. *Ongoing Operation and Maintenance*

As a result of this work, LLNL found it necessary to establish some standards for the operation and maintenance of the collection system. LLNL developed operational procedures for cleaning and videotaping sewer lines. Log sheets were developed for compiling and determining trends in the data gathered in the field.

The sanitary sewer survey form allows for prioritization of future clearing efforts by identifying areas subject to clogging (see Figure 4). All historical cleaning records are maintained on the sanitary sewer cleaning log (see Figure 5). LLNL developed a standard for direct connection or repair of CIPP pipe.

Innovative Approaches to Sanitary Sewer Rehabilitation

LLNL used three innovative approaches to accomplish this project:

- *Unit pricing:* Unit pricing allowed the project coordinator to schedule work throughout the site to minimize the impact on research activity. (The specific figures are proprietary information.) LLNL's contract specification (unit pricing) was a novel approach to

minimizing project cost exposure and allowed the laboratory to pay only for work that was required. Unit pricing was incorporated into the prioritization scheme, which was based on a point system.

- *In-house post-inspections:* Spot checks of contracted work were performed by videotape throughout the site. Water testing and air testing were performed and documented for newly installed lines.
- *Environmental restrictions:* During the liner curing process, special care was taken to prevent process water from discharging to the surface. Secondary containment was also required for all curing chemicals. Air emissions from construction and lining equipment were monitored and recorded daily.

SANITARY SEWER SURVEY

DATE	MANHOLE #	RED BADGE	BUILDING	CONDITION/COMMENTS
	236C		312 N	
	269h		153 w	
	59A		174 NW	
	287A		1889 N	
	147B		2801 NW	
	193A		295 w	
	65A		132 SE	
	172D		551 N	
	138D		4728 W	
	88C		298 NE	
	16E		511 SW	
	118F		661 NW	
	253F		663 E	
	208F		671N	
	91D		494 W	
	154A		196	
	Diversion Box		193	
DATE	MANHOLE #	GREEN BADGE	BUILDING	CONDITION/COMMENTS
	40B		231NW	
	208		212SW	
	44A		121 E	
	37B		5 & B ST.	

Figure 4. LLNL sanitary sewer survey form.

SANITARY SEWER CLEANING LOG

DATE	MANHOLE #		LOCATION	EQUIP. USED	APPROX. FT.	REMARKS/CONDITION	INITIALS
	Item	Is					
9/20/90	242D	28D	f	Herben	400	Hydro	G.O.
10/8/90	144E	191E	511 E.	Herben	350	Hydro	G.O.
10/10/90	28D	28D	415 S.	Herben	500	Hydro	G.O.
10/11/90	17B	58B	281 W.	Herben	400	Hydro	G.O.
10/11/90	106B	62A	292 S.	Herben	750	Hydro, heavy roots	G.O.
10/15/90	25C	332A	319 S.	Herben	1800	Hydro, roots/grass	G.O.
11/8/90	28D	28D	415 S.	ben	500	Hydro	G.O.
11/8/90	28D	28D	404 W.	Herben	1500		G.O.
11/7/90	252E	118E	683	Herben	600	Hydro	G.O.
11/13/90	BLD	131D	482	Herben	500	Hydro	G.O.
11/13/90	132D	131D	3724	Herben	250	Hydro	G.O.
11/13/90	133C	133D	3725	Herben	250	Hydro	G.O.
11/13/90	138D	216D	4675	Herben	500	Hydro	G.O.
11/13/90	29D	28D	415S	Herben	500	Hydro	G.O.
11/21/90	BLD	KC	314	Herben	1500		G.O.
11/21/90	BLD	J11C	445	Herben	100	Hydro	G.O.
11/21/90	BLD	27D	310	Herben	200	Hydro	G.O.
11/21/90	BLD	KC	314	Herben	60	Hydro/rodded	G.O.
11/21/90	BLD	KC	314	Herben	60		G.O.
11/28/90	131D	130C	481 E.	Herben	250	Hydro/rodded	G.O.
11/29/90	BLD	MAIN	261 H.	Herben	50	Hydro-roots	G.O.
12/5/90	131D	130C	481 E.	Herben	250	Hydro	G.O.
12/11/90	131D	130C	481 E.	Herben	250		G.O.
12/12/90	163A	259Q	111 W.	Herben	1100	Rodded	G.O.
12/15/90	54A	53A	1702 W.	Herben	300	Hydro/rodded	G.O.
12/15/90	58A	53A	1702 N.	Herben	300	Rock	G.O.
12/20/90	163A	259A	111 W.	Herben	1200	Hydro	G.O.

Figure 5. LLNL sanitary sewer cleaning log.

Summary

LLNL is pleased with the resulting benefits to the sanitary sewer collection system. These benefits include:

- An accurate site map prepared as a result of field verification and repair work.
- Lowered maintenance costs resulting from the sewer line cleaning and removal of obstructions in the system.
- Greater collection system accessibility and capacity due to the implementation of over 150 additional cleanouts.
- Increased flow velocity due to lined pipe.
- Minimized sanitary sewer overflows within the collection system resulting from the removal of all major infiltration sources.

Several issues that surfaced as a result of this project require the U.S. Environmental Protection Agency's (EPA's) attention:

- Standards for **CIPP** lateral connections
- Pre- and post-lining integrity testing standards
- Uniform training for workers involved in the sewer rehabilitation industry
- Determination of acceptable levels of exfiltration in collection system sewer piping

LLNL worked with other collaborators to develop unique expertise in sewer rehabilitation, and is interested in working with EPA to pursue these issues.

Additional Reading

Bible, D.W. 1992. Collection systems, trenchless sewer reconstruction in Nashville. *Water Environ. Tech.* May: 44-53.

Engineering Research Institute. 1993. Assessment of pollution and remediation alternatives for the dry cleaning industry. California State University, Fresno, CA.

Izzo, J.V. 1992. Dry cleaners-a major source of PCE in source water. California Regional Water Quality Control Board, Central Valley Region.

Lawrence Livermore National Laboratory, Sanitary Sewer Rehabilitation Project. 1992. Closed-circuit television inspection manual. Livermore, CA.

Lawrence Livermore National Laboratory, Sanitary Sewer Rehabilitation Project. 1990. Conceptual design report. Livermore, CA.

Lawrence Livermore National Laboratory. 1990. Sanitary sewer system mechanical utilities systems master plan. Livermore, CA.

Lawrence Livermore National Laboratory. 1992. Storm water inflow to the sanitary sewer system source detection program. Livermore, CA.

U.S. EPA. 1991, Handbook for sewer system infrastructure analysis and rehabilitation. NTIS **PB93116309**.

Vellinger, R., S. Newton, and F. Norton. 1993. Building drain investigation (BDI) project CADD documentation-a case study. Lawrence Livermore National Laboratory, Livermore, CA.

U.S. Environmental Protection Agency Urban Wet Weather Flow Research Program Overview on Sanitary Sewer Overflow Control

Richard Field and Thomas P. O'Connor
Urban Wet-Weather Flow Research Program, National Risk Management Research Laboratory,
Cincinnati, Ohio

Introduction

Sanitary sewer overflows (SSOs) and wastewater treatment plant (WWTP) overloads are the result of exceeding interceptor and/or WWTP capacity due to infiltration and inflow (I/I); increased population and water consumption in the service area above design allotments; clogged, blocked, or silted interceptors; and pumping station failures and WWTP malfunctions.

Historically, the U.S. Environmental Protection Agency (EPA) Urban Wet-Weather Flow Research Program's (UWWFRP's) state-of-the-art document (1) and manual of practice (2) identified a significant problem which led to national emphasis on I/I control and countermeasure research. The UWWFRP has produced other important I/I control references, including:

- *Infiltration-Inflow Analysis (3).*
- *Sewer Infiltration and Inflow Control Product and Equipment Guide (4).*
- *Economic Analysis, Roof Control, and Backwater Flow Control as Related to Infiltration/Inflow Control (5).*
- *Sewer System Evaluation, Rehabilitation and New Construction-A Manual of Practice (6).*
- *Assessment of Sewer Sealants (7).*
- *Selected Topics Related to Infiltration and Inflow in Sewer Systems (8).*

UWWFRP developments have included detection methodology and instrumentation (9-11); preventive installation (12), structural materials (13-15), construction techniques (16-20); and corrective techniques (9, 11, 21-23).

Because of the great lengths of sanitary sewer systems, it is often less expensive to use alternatives to sewerline rehabilitation for I/I and associated SSO control. Extensive sanitary sewer system rehabilitation is often relatively costly, time-consuming, and extremely disruptive to traffic, businesses, and property owners.

I/I control studies have found that only correcting I/I in street sewers will not necessarily correct the problem because building connections contribute as much as 70 to 80 percent of the infiltration load. Building connection rehabilitation can be infeasible economically because of the sheer number of connections, or impracticable because of the difficulty in dealing with property owners.

Inflow elimination or reduction, cost-effective sewer rehabilitation, and collection system inspection with associated cleanout and repair must be performed in all cases. In addition, an integrated economic and feasibility analysis must be considered that uses a combination of maximizing flow to the WWTP and maximizing treatment capacity for controlling the remaining SSOs.

SSO can be controlled using combined sewer overflow (CSO) control methods. SSOs and CSOs are both mixtures of municipal sewage and stormwater, although the average sanitary sewage to stormwater fraction is higher for SSOs.

Design Flow and Monitoring

Design flow rates and volumes should be determined by either long-term simulation or statistical modeling. SSO quantity and quality monitoring should begin immediately and be used in conjunction with the models for either their development, improvement, or calibration and verification. Flow estimates for future I/I reduction or addition should be subtracted or added to design flow values.

Samples should be analyzed for particle settling velocity, size distribution, and dissolved solids fraction as related to pollutants of concern. This will provide more appropriate treatment process selection and design parameters. In addition, correlating historical WWTP quality data with rainfall records could assist development of a wet weather flow quality database.

Because storm-induced SSO event volumes and flow rates and long-term volumes and average flow rates are significantly lower than the comparable values for CSOs it should be economically feasible to eliminate all SSOs but in the worst case allow no more than two SSOs per year. Partial treatment (by directing the excessive one to two SSOs through a storage facility) should also be strongly considered.

Recommended National Requirements

National SSO treatment requirements should be addressed with a technology-based approach coupled with more stringent human health and receiving water quality risk-based requirements. In other words, if the applied treatment technology results in receiving-water quality impairments, then higher treatment levels would be required. Exceptions should be allowed based on the community's showing of 1) no additional water quality impairment or health risks and 2) economic restraints that would give the community a longer time for compliance but would not affect the standard. EPA will need guidelines for economic distress and should encourage compliance by a granting mechanism. The technology-based approach should be based on national guidelines with the above-stated exceptions.

Maximizing Flow to the WWTP

Maximizing flow to the WWTP can be accomplished by two basic methods: 1) utilizing storage facilities and/or 2) increasing interceptor flow carrying capacity. These methods are based on previously demonstrated and evaluated CSO and SSO projects.

Storage/Surge/Equalization Facilities

Because of the high volume and variability associated with I/I, storage is considered a necessary control alternative for SSOs. Storage is the best documented abatement measure for wet weather flow. The concept is to capture the overflow and release it to the WWTP during low-flow dry weather periods. Project results and theory indicate that storage must be considered at all times in system planning because it allows for maximum use of existing dry weather and other treatment plant facilities, and results in the lowest cost in terms of pollutant removal. Storage facilities possess the favorable attributes of being simple in structural design and operation, responding without difficulty to random storm behavior. Frequently they can operate in concert with the regional WWTP. Disadvantages are their large size and land requirements. An important part of SSO control system planning is determination of the economic break-even point between the required storage volume versus treatment capacity.

The multipurpose functions of SSO storage facilities should be used whenever possible and include sedimentation treatment for excessive SSOs, dry weather flow equalization (by compartmentalizing the storage basin for dry weather flow capture and thereby reducing sludge handling problems), flood protection, and sewerline relief. Sedimentation treatment in storage can either relieve a WWTP's solids burden or remove a significant pollution fraction of an excessive wet weather flow that causes storage facility overflow.

Storage can be applied upstream, midstream, or downstream at the SSO point (either at the remote SSO location or at the WWTP). Upstream storage can offer the dual benefit of drainage and flood relief/control. Types of storage facilities include unused capacity in the existing interceptor and sewerlines, conventional concrete tanks and lined earthen basins, minimum land requirement tunnels and underground tanks, natural and mined under- and aboveground formations, and abandoned facilities. New sewers can be made larger for wet weather flow conveyance and storage. In-sewer storage and use of abandoned facilities for storage will be the least expensive types of storage and therefore should be considered first. Earthen basins should be considered next because they are relatively inexpensive.

As part of a demonstration of the dual use of storage tanks for equalizing peak dry weather flow as well as wet weather flow, the City of Rohnert Park, California (24) illustrated the economic advantages of such use as part of a regional wastewater handling scheme. Minneapolis (25), Detroit (26), and Seattle (27) are making use of unused storage capacity within the existing sewerage system for the purpose of reducing the frequency and volume of CSOs.

Interceptor Flow Carrying Capacity

Interceptor flow carrying capacity can be increased by:

- Cleaning out clogged and silted-up interceptors
- Increasing the pumping capacity for surcharged interceptors
- Installing larger or parallel interceptors
- Applying polymer injection or lining to reduce pipe roughness

The inspection of interceptors for blockages and siltation and the associated **cleanout** should be done first, because this is likely to be the least expensive way of gaining flow capacity.

Research has shown that polymer injection can increase flow capacity as much as 2.4 times at a constant head (28). This method can be used as a short- or long-term measure to correct troublesome pollution- and nuisance-causing conditions (e.g., localized flooding and SSOs). Along with relieving surcharge conditions, it has also proven effective in augmenting open channel flows (29). A cost comparison in Garland, Texas, indicated that polymer injection for SSO control would cost one-fourth as much as relief sewer construction (30). Additional cost verification is necessary for other locations as polymer has a relatively short shelf life and is thus not universally appropriate.

Polymer injection was demonstrated in Dallas, Texas (31). The existing sewerlines were relatively inaccessible but capable of handling normal DWF. An ongoing I/I abatement program had already begun; however, a quick low-cost solution was needed to eliminate SSOs in the interim. In the process of designing a full-scale automated injection system, portable and manned injection systems and the use of either dry or slurry polymer were demonstrated. Constant feed of polymer operated better than variable feed during wet weather flow, and polymer injection reduced or prevented SSOs.

Maximizing WWTP Treatment Capacity

Approaches to maximize WWTP capacity include:

- Increasing hydraulic loading to the existing treatment process
- Retrofitting primary settling tanks
- Installing parallel process trains

Increasing Hydraulic Loading

Increasing hydraulic loading to the existing primary/secondary treatment processes without modifications should be based on stress testing. This will be the least expensive method and should be considered first.

Retrofitting Primary Settling Tanks

Retrofitting of primary settling tanks can be accomplished with plate or tube settlers, chemical addition facilities, or dissolved air floatation (DAF). Consider an automated switching process for converting from settling during low flow to DAF during high-flow conditions to save power costs (32).

Installing Parallel Process Trains

Parallel process train scenarios include:

- Primary physical treatment at the WWTP
- Secondary biological treatment for new WWTP installations
- Disinfection

Consideration should be given to bypassing secondary treatment and providing only primary physical treatment and disinfection based on receiving water quality impacts and biochemical oxygen demand (BOD) dilution in the influent. This strategy is put forth as one of the nine minimum CSO control measures (33).

Primary Physical Treatment at the WWTP

Options for primary physical parallel processes include microscreens, plate and tube settlers, screening/dual-media high-rate filters, **screening/DAF**, conventional primary settlers, and swirl degritters (if treatment requirements are low). Chemical addition should be considered for these options to enhance removal.

The parallel process train effluent can be discharged directly to the receiving water, directed back to the WWTP influent, or both by using flow splitting. If it is directed to the influent, then a flow equalization basin could be needed. These flow discharge options should depend on water quality impacts and permit requirements.

The **Bachman WWTP** in Dallas (34) suffered from excessive I/I. Accordingly, tube settlers were retrofitted into the existing primary settling tanks to afford wet weather flow hydraulic loading. Although this settling concept works on a theoretical basis, there was insufficient wet weather flow to make an evaluation. The

improved crossflow plate settler variation can overcome the problems of clogging and adequate dispersion experienced by previous tube and plate settling (concurrent and countercurrent) modes. Plate settlers have been shown to allow five or more times the hydraulic loading of conventional settling tanks. Plate settlers are angled plates placed on top of each other to greatly increase the surface settling area. Advances in this technology have been demonstrated in Sweden.

Micrometer Microscreening (35, 36) has been demonstrated to be effective for CSO primary treatment in Philadelphia, Pennsylvania (37), and Syracuse, New York (38). In Philadelphia a 23-micrometer aperture Microstrainer attained average suspended solids (SS) removals of 70 percent with increased SS removals of 78 percent using polyelectrolyte addition. The hydraulic loading was 16 gallons per minute per square foot (gpm/ft²) without and 36 gpm/ft² with polyelectrolyte addition. The Department of Drainage and Sanitation, Onondaga County, New York demonstrated a Zurn 71-micrometer and a Crane 23-micrometer aperture microscreening unit, respectively. Average SS removals were 48 percent at hydraulic loadings between 5 and 62 gpm/ft², and 58 percent at hydraulic loadings between 3.3 and 13.7 gpm/ft², respectively.

A 30-inch diameter pilot-scale high-rate filter (HRF) was successfully demonstrated for the dual-purpose treatment of sanitary and combined sewage (39). As previously indicated, CSOs and SSOs have the same components; they are basically mixtures of sanitary sewage and stormwater. The system included a pretreatment 420-micrometer screen to enable longer filter run times. A deep-bed dual-media filter of either 48 or 60 inches of anthracite over 30 inches of sand was used. The deep bed with the coarser, lower specific gravity anthracite on top allowed greater pollutant capture effectiveness, longer run times, and effective backwashing. Chemical addition was also demonstrated. The HRF requires only 5 to 7 percent the area of conventional sedimentation.

Table 1 shows weighted average removals for CSOs and sanitary sewage with filter hydraulic loading of 16 gpm/ft² and 8 and 12 gpm/ft², respectively. The table does not distinguish between the separate CSO test runs, which employed both chemical addition and no chemical addition.

Table 1. Dual Dry/Wet Weather Flow Treatment, Newtown Creek WWTP, New York City

Treatment	System Removals (%)		
	SS	BOD	COD
CSO ^a	66	41	47
Sanitary sewage ^b	67	42	44

^aHydraulic loading = 16 gpm/ft².

^bHydraulic loading = 8 and 12 gpm/ft²; results based on limited plant influent data.

Removal values for this pilot-scale study were comparable to conventional sedimentation values. CSO removals were 66, 41, and 47 percent for SS, BOD, and chemical oxygen demand (COD), respectively. Sanitary sewage removals, which did not include chemical addition, were 67, 42, and 44 percent for SS, BOD, and COD, respectively.

Secondary Biological Treatment for New WWTP Installations

Secondary biological treatment options for new WWTP installations include high-rate trickling filtration (deep honeycomb plastic media) having two filters in parallel during wet water flow operation and automatically switching back to series during dry water flow operation (40); contact stabilization during wet water flow periods automatically switching to conventional activated sludge during dry water flow

periods (32, 41); rotating biological **contactors** (shaft-mounted rotating disks) (42); Biofor **upflow** biological/aerated filtration (fixed-film reactor); and **biological/fluidized-bed** filtration (43). These processes have been demonstrated to treat waste water flow at relatively high hydraulic and organic loadings.

A trickling filter WWTP was **constructed** in New Providence, New Jersey to alleviate WWTP hydraulic overloading and the resultant loss of treatment efficiency caused by excessive sanitary sewer infiltration (40). The plant uses two high-rate trickling filters, one with conventional rock media and the other with deep-bed honeycomb plastic media operating in parallel to treat wet water flow. During dry water flow periods, the plant is operated in series with a controlled flow to maintain an active biological slime on the filters, which also serves to improve dry water flow treatment efficiency. The trickling filter operation automatically switches from series to parallel when the wet water flow exceeds 2.8 million gallons per day and goes back to series when the flow goes below 2.0 million gallons per day.

This investigation has shown that it is both technically feasible and economical to construct and operate a treatment plant to process both the controlled dry water flow and the higher flows encountered during periods of excessive infiltration using a combination of series-parallel, high-rate trickling filters. Table 2 demonstrates that dry water flow BOD and SS removal efficiencies were approximately 94 and 93 percent, respectively. The corresponding concentrations of BOD and SS in the final effluent are 9 and 12 milligrams per liter, respectively. Wet water flow BOD and SS removal efficiencies were approximately 87 and 86 percent, respectively.

Table 2. Dual Dry/Wet Weather Flow, New Providence, New Jersey

	BOD		SS	
	Effluent (mg/L)	Removal (%)	Effluent (mg/L)	Removal (%)
Dry/wet weather flow	9	94	12	93
Wet weather flow		87		86

A drawback of the high-rate trickling filter process for the treatment of high flows is the tendency for colloidal suspended material to be discharged from the filters. Unless chemical precipitation and low secondary clarifier overflow rates or supplemental biological flocculation in the form of a pond are provided, high **SS** and BOD removal will not be obtained. It was found that hydraulic loading should be limited to 70 million gallons per acre per day and organic loading 85 pounds BOD per 1,000 cubic feet on the plastic media filter and 20 million gallons per acre per day and 40 pounds BOD per 1,000 cubic feet on the rock media filter to achieve an effluent containing 25 mg/L BOD or less during periods of excessive infiltration.

The plastic media trickling filter removed about 2.7 times more BOD than the rock media. Accordingly, it was recommended that the plant operate at two-to-one flow split between the plastic and rock media filters during wet water flow. While the initial cost of the plastic media filter was 25 percent more than the rock, the overall ratio of cost per pound of BOD removed per 1,000 cubic feet was two-to-one in favor of the plastic media.

In Clatskanie, Oregon, a full-scale dual-use facility was constructed to alleviate SSOs caused by excessive infiltration (32). The plant treats wet water flow as high as 6.6 times the dry water flow of 0.19 mgd. The plant's primary physical and secondary biological treatment processes are both modified to convert automatically from conventional sedimentation and activated sludge treatment for dry water flow periods to DAF and contact stabilization for wet water flow periods because DAF and contact stabilization can accommodate higher hydraulic loadings. Dry water flow BOD and SS removal

efficiencies as presented in Table 3 were both 94 percent and wet water flow BOD and SS removal efficiencies were 73 and 71 percent, respectively.

Contact stabilization sludge treatment relies on the sorptive ability of biological solids to remove biodegradable organic matter with short retention periods (32). These solids are settled out in the secondary clarifier, returned to the aerobic digester for stabilization, and recycled to mix with the influent of the contact chamber. The recycle flow determines the contact chamber time and aerobic stabilization time. The contact, aeration, and sludge reaeration compartments are further subdivided into operating zones to provide flexibility. In general, aeration volume requirements of contact stabilization, a completely mixed system, are typically 50 percent less than conventional plug flow (44). The DAF-contact stabilization capital

Table 3. Dual Dry/Wet Weather Flow, WWTP, Clatskanie, Oregon

	Flow (mgd)	Removals	
		BOD	ss
Dry water flow	0.19	94%	94%
Wet water flow ^a	1.25	<15 mg/L (98% ^c)	<20 mg/L (80% ^c)
Wet water flow ^b		73%	71%

^aFlow < 0.84 MGD 70% of the time.

^bLong- and short-term storm average removals.

^cPercentage of the time.

and total costs were only 14 percent and 10 percent higher, respectively than the costs of a standard dry water flow plant. In Clatskanie, it was estimated that dual treatment as an I/I control method costs less than half as much as either sewer rehabilitation or flow equalization.

A CSO demonstration project in Milwaukee, Wisconsin evaluated rotating biological contactors consisting of a series of shaft-mounted rotating disks (42). Removals can exceed those seen with trickling filters; however, a flow surge facility appeared essential.

The Biofor process is an upflow biological-aerated-filtration process. This fixed-film reactor is very compact. A New York City pilot investigation proved its ability to treat variable and high loadings.

Disinfection

If the existing unit cannot provide adequate disinfection, parallel high-rate disinfection processes are recommended because smaller contact tank volume is required. High-rate disinfection processes that have been successfully demonstrated to work for CSOs include (35, 36, 45):

- Increased mixing intensity
- Increased disinfectant concentration
- More rapid disinfection oxidants

- Two-stage dosing
- Combinations of the above

Ozone and chlorine dioxide are relatively rapid oxidants. Ozone also supplies additional oxygen to the wastewater. High-intensity mixing is accomplished by mechanical-flash mixers at the disinfection point. Slower static mixing using vanes and narrow corrugated pathways should also be considered. Adequate **SS** concentration and particle size reductions are necessary to kill microorganisms to a satisfactory degree (45).

High-chlorine dosing, while effective, creates toxic and carcinogenic residuals. Sequential addition of chlorine followed by chlorine dioxide at intervals of 15 to 30 seconds enhanced high-rate disinfection beyond the expected additive effect. A minimum effective combination of 8 milligrams per liter of chlorine followed by 2 milligrams per liter of chlorine dioxide was as effective as 25 milligrams per liter of chlorine alone.

Advanced Technologies

Innovative, advanced, and evolving treatment technologies should also be considered. For example, two high-rate treatment systems have been demonstrated to provide high levels of pollution removal efficiency for **CSOs**, and therefore should be applicable for the treatment of **SSOs**.

In Albany, New York (35, 46), a 0.1 million gallons per day pilot of a powdered activated carbon-alum coagulation unit was evaluated for treating sanitary and combined sewage. Both powdered carbon and alum were added in a static mixing/reaction pipelines; the resultant coagulated matter was flocculated downstream and separated by tube settlers. Average removals in excess of 94 percent COD and BOD and 99 percent **SS** were consistently achieved in treating **CSOs**.

High-gradient magnetic separation (HGMS) is an advanced treatment technology that has been applied using a pilot system for combined and sanitary sewage in Boston, Massachusetts (47). HGMS consists of an iron-framed canister packed with a fibrous ferromagnetic material that is magnetized by coils surrounding the canister. HGMS may be used to remove nonmagnetic contaminants by binding magnetic seed particles (e.g., magnetite with or without **coagulants**) to the contaminants. HGMS can provide rapid filtration at 100 gallons per minute per square foot. The Boston pilot demonstrated a high level of pollution removal, including 95 percent **SS**, 92 percent BOD, 74 percent COD, 99.2 percent fecal coliforms, and **99+** percent virus, respectively.

Satellite Treatment

Satellite treatment should comprise automatic physical processes with remote monitoring to reduce manpower requirements. Maintenance issues will be more pronounced, and potential failures at remote locations, along with associated water quality impacts, will exist. Location issues such as sensitive receiving stream segments and neighborhood aesthetics should be considered. Accordingly, physical treatment processes at satellite locations should be used only if the **WWTP** cannot handle all of the wet water flow. As previously stated, satellite storage should be used for dual-purpose treatment by settling for wet water flow volumes greater than the storage volume.

Conclusion

CSO control technology must be considered for **SSO** control in addition to inflow reduction, cost-effective sewer rehabilitation, and sewer system inspection and associated **cleanout** and repair. Conducting an economic/feasibility analysis of all alternatives that maximize flow to the **WWTP** and its treatment

capacity will determine whether I/I control or alternative methods are more cost effective, more practicable, or both.

To summarize, SSO control methods include:

- Removing inflow.
- Performing only cost-effective sewer rehabilitation on a continuing basis.
- Inspecting the interceptor, pumping station, and sewer system for blockages, siltation, and structural failures that cause SSO (and cleaning out or repairing as necessary).
- Maximizing flow to the WWTP by using surge or storage facilities and increasing interceptor flow carrying capacity.
- Maximizing the treatment capacity of the WWTP by retrofitting, installing parallel process trains, or constructing new high-rate **WWTPs**.
- Installing satellite treatment facilities.

References

1. American Public Works Association. 1970. Control of infiltration and inflow into sewer systems. Federal Water Pollution Control Administration. Rep. 11022EFF 12/70 (NTIS PB 200 827).
2. U.S. EPA. 1971. Prevention and correction of excessive infiltration and inflow into sewer systems-a manual of practice. Rep. 11022EFF01/71 (NTIS PB203208). Washington, DC.
3. Cesareo, D. J., and R. Field. 1975. Infiltration-inflow analysis. Journal of the Environmental Engineering Division, ASCE. Vol. 101, No. EE5 Proc. Paper 11645 (October). pp. 775-785.
4. U.S. EPA. 1977. Sewer infiltration and inflow control product and equipment guide. EPA/600/2-77/017c (NTIS PB272680). Cincinnati, OH.
5. U.S. EPA. 1977a. Economic analysis, root control as related to infiltration/inflow: volume I. final report. EPA/600/2-77/017a (NTIS PB280738). Cincinnati, OH.
6. U.S. EPA. 1977b. Sewer system evaluation rehabilitation and new construction-a manual of practice. EPA/600/2-77/017d (NTIS PB279248). Cincinnati, OH.
7. U.S. EPA. 1982. Assessment of sewer sealants. EPA/600/8-82/012 (NTIS PB82262718). Cincinnati, OH.
8. US. EPA. 1985. Selected topics related to infiltration and inflow in sewer systems. EPA/600/2-85/020 (NTIS PB85102523). Cincinnati, OH.
9. U.S. EPA. 1972. Ground water infiltration and internal sealings of sanitary sewers, Montgomery County, OH. Rep. 11020DHQ 06/72 (NTIS FB212267). Washington, DC.
10. U.S. EPA. 1983. Value of flow calibration for decision making in infiltration/inflow studies. EPA/600/2-83/087 (NTIS PB83259739). Cincinnati, OH.
11. U.S. EPA. 1985. Demonstration of service lateral testing and rehabilitation techniques. Rep. EPA/600/2-85/131 (NTIS PB86135647). Cincinnati, OH.

12. U.S. EPA. 1972. Sewer bedding and infiltration gulf coast area. Rep. **11022DEI05/72** (NTIS PB211282). Washington, DC.
13. U.S. EPA. 1971. Heat shrinkable tubing as sewer pipe joints. Rep. **11024FLY06/71** (NTIS **PB208816**). Washington, DC.
14. U.S. EPA. 1980. Impregnation of concrete pipe for corrosion resistance and strength improvement. **EPA/600/2-80/009** (NTIS **PB80190234**). Cincinnati, OH.
15. US. EPA. 1978. The construction, technical evaluation, and frictional determination of an aluminum storm sewer system. **EPA/600/2-78/025** (NTIS PB283458). Cincinnati, OH.
16. U.S. EPA. American Society of Civil Engineers. 1969. Combined sewer separation using pressure sewers. **11020EKO10/69** (NTIS PB 188511). Washington, DC.
17. U.S. EPA. Southwest Research Institute. 1971. Impregnation of concrete pipe. Rep. **11024EQE06/71** (NTIS PB21344). Washington, DC.
18. US. EPA. 1978. Evaluation of trenchless sewer construction at South **Bethany** Beach, Delaware. **EPA/600/2-78/022** (NTIS PB278776). Cincinnati, OH.
19. US. EPA. 1985. Insituform and other sewer rehabilitation techniques. **EPA/600/2-85/132** (NTIS PB 86130192). Cincinnati, OH.
20. US. EPA. 1972. A pressure sewer system demonstration. EPA-R2-72-091 (NTIS PB 214 409). Washington, DC.
21. The Western Company. 1969. Improved sealants for infiltration control. Federal Water Pollution Control Administration, Rep. **11020DIH06/69** (NTIS PB 185 950).
22. Hoffman and Fiske. 1969. Reduction of groundwater infiltration into sewers by zone pumping at Meridian, Idaho. Federal Water Pollution Control Administration. Rep. 11020 (NTIS PB187868) June.
23. U.S. EPA. 1983. Demonstration of sewer relining by the insituform process, Northbrook, Illinois. **EPA/600/2-83/064** (NTIS **PB83-245878**). Cincinnati, OH.
24. U.S. EPA. 1974. Surge facility for wet and dry weather flow control. **EPA/670/2-74/075** (NTIS **PB238905**). Cincinnati, OH.
25. U.S. EPA. 1971. Dispatching systems for control of combined sewer losses. Rep. **11020FAQ03/71** (NTIS PB203678). Washington, DC.
26. US. EPA. 1975. Sewerage system monitoring and remote control. **EPA/670/2-75/020** (NTIS **PB242107**). Cincinnati, OH.
27. US. EPA. 1974. Computer management of a combined sewer system. **EPA/670/2-74/022** (NTIS PB235717). Washington, DC.
28. The Western Company. **1969b**. Polymers for sewer flow control. Federal Water Pollution Control Administration, Rep. **11020DIG08/69** (NTIS **PB185951**).
29. U.S. EPA. 1973. Flow augmenting effects of additives on open channel flows. **EPA/R2-73/238** (NTIS PB222911). Washington, DC.

30. Field, R., and E.J. Struzeski. 1972. Management and control of combined sewer overflows. *JWPCF* **44(7)**: 1393-1 415 (July).
31. U.S. EPA. 1977. Control of sewer overflows by polymer injection. *EPA/600/2-77/189* (NTIS PB272654). Cincinnati, OH.
32. U.S. EPA. 1981. Joint dry/wet weather treatment of municipal wastewater at Clatskanie, Oregon. *EPA/600/2-81/061* (NTIS PB81187262). Cincinnati, OH.
33. U.S. EPA. CSO: guidance for nine minimum control measures. Draft report. *EPA/832/R-94/002*. Washington, DC.
34. U.S. EPA. 1977. **Bachman** treatment facility for excessive storm flow in sanitary sewers. *EPA/600/2-77/128* (NTIS PB269128). Cincinnati, OH.
35. Moffa, P.E., ed. 1989. Control and treatment of combined-sewer overflows. Combined-sewer overflows: control and treatment. New York, New York: Van Nostrand Reinhold.
36. U.S. EPA. 1977. Urban stormwater management and technology-update and users' guide. *EPA/600/8-77/014* (NTIS PB275654). Cincinnati, OH.
37. U.S. EPA. 1974. Microstraining and disinfection of combined sewer overflows-phase III. *EPA/670/2-74/049* (NTIS PB235771). Washington, DC.
38. U.S. EPA. 1979. Disinfection/treatment of combined sewer overflows, Syracuse, New York. *EPA/600/2-79/134* (NTIS PB80-113459). Cincinnati, OH.
39. U.S. EPA. 1979. Dual process high-rate filtration of raw sanitary sewage and combined sewer overflows. *EPA/600/2-79/015* (NTIS PB296626). Cincinnati, OH.
40. U.S. EPA. 1973. Utilization of trickling filters for dual treatment of dry and wet weather flows. *EPA/670/2-73/071* (NTIS PB231251). Washington, DC.
41. U.S. EPA. 1975. Biological treatment of combined sewer overflow at Kenosha, Wisconsin. *EPA/670/2-75/019* (NTIS PB242126). Cincinnati, OH.
42. U.S. EPA. 1974. Combined sewer overflow treatment by the rotating biological contactor process. *EPA/670/2-74/050* (NTIS PB231892). Cincinnati, OH.
43. U.S. EPA. 1988. Ultraviolet disinfection of wastewaters from secondary effluent and combined sewer overflows. *EPA/600/2-86/005* (NTIS PB86145182). Washington, DC.
44. Tchobanoglous, G., and F.L. Burton. 1991. Wastewater Engineering: Treatment disposal and reuse, 3rd ed. New York, NY: McGraw-Hill, Inc.
45. O'Shea, M.L., and R. Field. 1992. An evaluation of bacterial standards and disinfection practices used for the assessment and treatment of stormwater. *Advances in Applied Microbiology* 37.
46. U.S. EPA. 1973. Physical-chemical treatment of combined and municipal sewage. *EPA/R2-73/149* (NTIS PB219668). Washington, DC.
47. U.S. EPA. 1977. Treatment of combined sewer overflows by high gradient magnetic separation. *EPA/600/2-77/015* (NTIS PB264935). Cincinnati, OH.

Automated Treatment Plant Reduces Sanitary Sewer Overflows

Stephen R. Maney
RJN Group, Inc., Wheaton, Illinois

Background Information

The Village of Villa Park, located in DuPage County, Illinois, approximately 20 miles west of downtown Chicago, is a residential community with a population of 24,000. The village was required to expand its wastewater treatment facilities and reduce sanitary sewer overflows (SSOs) and combined sewer overflows (CSOs) in accordance with the Federal Water Pollution Control Act Amendments of 1972. SSO and CSO reduction involved the elimination of excessive infiltration and inflow (I/I) in the sewer systems.

Wastewater in Villa Park is collected by combined and separate sewer systems. The original sewer system was constructed in 1925 and consists completely of combined sewers. Approximately 45 percent of the village is served by the combined sewer system, comprising 30 miles of sewers ranging in size from 8 to 54 inches in diameter over approximately 1,100 acres. Construction of combined sewers in the village continued until 1950, when the State of Illinois disallowed the construction of new combined sewers. Since that time, only separate sanitary and storm sewers have been constructed. The original combined sewer system includes four overflow lines that discharge to nearby Salt Creek.

The separate sewer system of Villa Park currently consists of approximately 187,000 linear feet of sewer, ranging in size from 4 to 24 inches in diameter and serving an area of approximately 1,800 acres. Wastewater treatment for both the combined and separate sewer systems is provided by the Salt Creek Drainage Basin Sanitary District, a separate agency. The treatment plant, with an average daily design flow of 5 million gallons per day (mgd), is located on a site without room for expansion.

The resulting sewer system was generally adequate during dry weather conditions, but severe problems were experienced during wet weather conditions. During wet weather, excess flow from both the combined and separate sewer areas bypassed directly into Salt Creek. In addition, the overloaded sewer system caused sewage back-ups into basements and localized surface flooding. Sewage overflows violated state and federal regulations regarding pollution of the receiving stream. Downstream of Villa Park, Salt Creek extends through several public recreational lands, including Butler National Golf Course, the historic Graue Mill area, the Brookfield Zoo, and forest preserves containing hiking and biking trails. Not only did Salt Creek flood on a regular basis, but the flood waters contained sewer overflows that affected the surrounding recreational waters and land.

Faced with these environmental concerns and state and federal requirements, the Village of Villa Park retained RJN Group, Inc., to conduct preliminary studies, develop alternative solutions, perform final design, and monitor construction activity. The Federal Water Pollution Control Act required that each separate sewer collection system not be subject to excessive I/I, which is the extraneous clear water that enters the sanitary sewers that can be eliminated on a cost-effective basis.

Infiltration and Inflow Study

Numerous sources of I/I overloaded the separate sanitary sewer system, causing basement backups and sewage overflows to Salt Creek. Using I/I quantification criteria established by the U.S. Environmental Protection Agency (EPA), the separate sanitary sewer system was studied to determine which I/I sources were to be repaired and what additional sewer requirements were needed to transport the remaining flow. The degree of treatment required by the State of Illinois for excess flows from separate sewer systems is 30 milligrams per liter (mg/L) for biological oxygen demand (BOD₅), and 30 mg/L for suspended solids, on a monthly average.

As part of the study, 2,664 buildings were inspected in the separate sanitary sewer areas, and 1,077 I/I sources were identified as being cost-effective to remove. Because the public would benefit from removal of the excess flow from the sewer system, a program was established to pay a portion of the cost incurred by each homeowner for plumbing modification required to remove the excessive flow from the separate sanitary sewer system. Approximately 700 sources were storm sump pumps connected to the separate sanitary sewer system, which was a common arrangement when houses were originally constructed.

To minimize costs, EPA mandated that a cost analysis of the total present worth be conducted to ensure that the plant was properly sized. To ensure accuracy of the postrehabilitation flow, identified sources were assigned flow rates in ranges documented by field testing. This field testing consisted of measuring flow rates through a large number of similar defects and establishing a range of observed flow rates for each type of defect. These source rates were balanced with monitored flow data to calibrate the computer model. Leaving defects that were cost-effective to remove was not permitted because doing so postponed the inevitable need to rehabilitate defects later at a potentially higher cost. To ensure that reduction of excessive flow in the collection system was maintained after rehabilitation, EPA required that a continual maintenance and management program be implemented.

Several alternatives were analyzed for transport and treatment of I/I in the separate sewer areas. The cost-effective alternative, determined using EPA guidelines and procedures, recommended elimination of 24.7 percent of the infiltration, 64.9 percent of the inflow, construction of approximately 30,000 linear feet of sanitary relief sewers, and construction of a wet weather treatment facility.

Combined Sewer Overflow Study

A combined sewer overflow study was conducted in accordance with state and federal requirements to determine the level of treatment required for combined sewer overflows that previously entered Salt Creek without treatment. Federal and state EPA regulations also required the village to demonstrate that the proposed facility was in compliance with guidelines of cost/benefit analysis, so costs and benefits were analyzed for alternative combined sewer overflow management methods. A reduction in annual BOD₅ load on Salt Creek was chosen as the indicator of project benefits in accordance with state and federal regulations. A screening process was used to select a final set of feasible combined sewer overflow management methods, including complete sewer separation and several levels of combined sewer overflow transport and treatment.

Based on the data and analysis, the following conclusions were reached:

- Transport and treatment of combined sewer overflows was a viable alternative to complete sewer separation. Combined sewer overflow treatment can provide a level of pollution reduction in Salt Creek comparable to complete sewer separation, at a significantly lower cost.
- Costs for combined sewer overflow transport and treatment begin to exceed the additional benefit of pollution reduction at a level of treatment corresponding to approximately 10 times dry weather flow from combined sewer overflow areas. CSOs occurred when rainfall exceeded 0.2 inches per day, which equates to less than a 6-month frequency storm.
- Implementation of the 10 times dry weather flow transport and treatment alternative would require construction of transport sewers to convey combined sewer overflow from combined sewer overflow areas to a central combined sewer overflow treatment facility.
- Complete treatment would be provided for the first-flush flow from combined sewer overflow areas. Complete treatment would occur at the Salt Creek Drainage Basin

Sanitary District treatment plant. The treatment plant has an average daily design flow of 5 mgd. Its wastewater treatment processes include bar screens, a grit chamber, preaeration tanks, primary clarifiers, trickling filters, activated sludge, secondary clarifiers, rapid sand filters, and chlorination prior to discharge. Sludge is digested in anaerobic digesters and dewatered on sludge drying beds. Dewatered sludge is hauled to a landfill for ultimate disposal.

Treatment plant performance must meet effluent quality standards in accordance with National Pollution Discharge Elimination System (NPDES) Permit No. IL 0030953. Effluent limitations for BOD and suspended solids are 10 mg/L and 12 mg/L, respectively.

In accordance with these studies, the total required capacity of the wet weather treatment facility was 25.9 mgd (18.3 mgd for combined sewer overflows and 7.6 mgd from sanitary sewer overflows).

Although the Salt Creek Drainage Basin Sanitary District provides treatment of dry weather flow, land for additional facilities to treat wet weather flow was not available. An **offsite** facility was recommended that would treat wet weather flow while the Salt Creek Drainage Basin Sanitary District continued to provide dry weather treatment. Several treatment alternatives were evaluated during the preliminary design phase. Major considerations that were addressed included location of the plant, process requirements, odor control, and cost.

Wet Weather Flow Treatment Facility

The only suitable site available for construction of the wet weather flow treatment facility was a 1-acre parcel in a predominantly residential area of the village immediately adjacent to the Illinois Prairie Path. Given the residential character of the area, the new facility had to be aesthetically pleasing and architecturally compatible with the neighborhood. Several treatment alternatives were evaluated during the preliminary design phase.

Wastewater Collection and Treatment

New sanitary relief and combined sewer overflow transport sewers in Villa Park would convey wet weather flows for treatment. Depending on the quantity of flow, treatment would be provided either at the Salt Creek Drainage Basin Sanitary District or at the Villa Park wet weather flow treatment facility. To take advantage of different effluent criteria established by EPA for combined sewer overflows and excess flow from separate sanitary sewers, the wet weather flow treatment facility was designed to treat each flow stream separately.

The maximum flow that the Salt Creek Drainage Basin Sanitary District plant can successfully treat is 8 mgd; however, this flow cannot be sustained for periods exceeding 2 or 3 days without upsetting biological treatment processes.

The size of the facility was based on procedures outlined in Technical Advisory Number 3 as developed by the Illinois Environmental Protection Agency (IEPA) in May 1977. This procedure required sampling of wastewater flow during storm events to identify the first-flush volume, that is, the volume of water needed to carry solids or BOD concentrations in excess of the normal dry weather level.

Laboratory analysis of samples taken indicated that the suspended solids parameter was the best indicator for determining the first-flush volume (Figure 1). While unusual, BOD, was consistently below the normal dry weather concentration of approximately 200 mg/L, while suspended solids increased above the normal dry weather concentration level of approximately 240 mg/L and was followed by significant dilution in concentration as the wet weather flow traveled through the system.

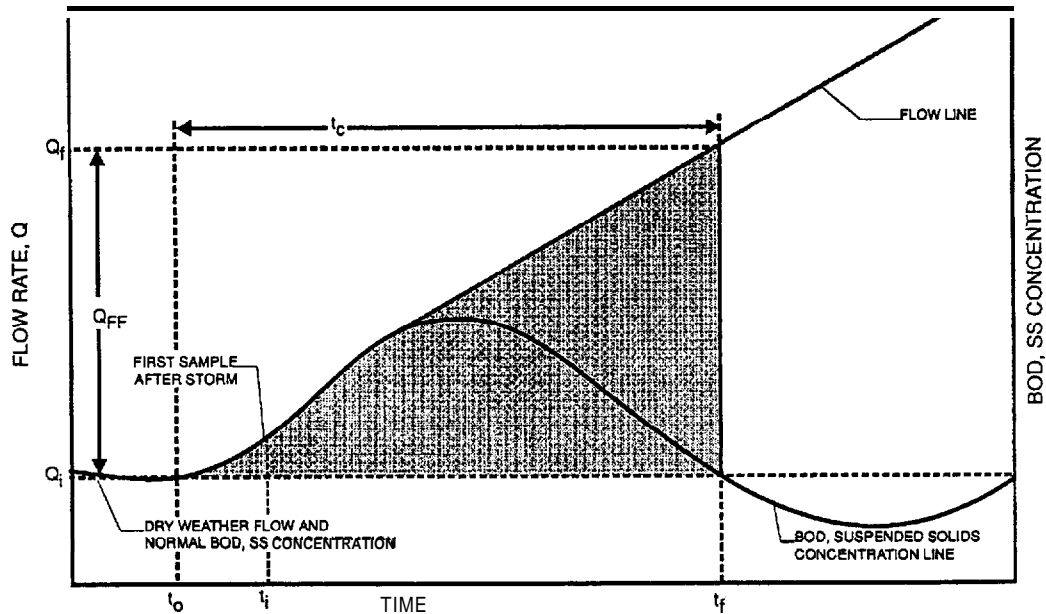

Figure 1. Theoretical first-flush volume.

The wet weather flow treatment facility activates when either of the following events occur:

- When the Salt Creek Drainage Basin Sanitary District receives peak flows in excess of 8 mgd, a timer mechanism at the Salt Creek Drainage Basin Sanitary District plant activates the wet weather flow treatment facility. The timer is located at the Salt Creek Drainage Basin Sanitary District, and the activation signal is telemetered to a programmable controller at the wet weather flow treatment facility.
- The quantity of wastewater directed to the wet weather flow treatment facility within the collection system is controlled by seven diversion and control structures. As wastewater flow increases within the system, a weir is jumped in the diversion structure, and flow is directed to the wet weather flow treatment facility. Because of the variable hydraulic conditions, adjustable weirs are used. A float switch is installed at seven diversion and control structures. Activation of a high liquid level switch in the combined sewer areas activates the combined sewer overflow portion of the wet weather flow treatment facility. Activation of a high liquid level switch in the separate sewer areas activates the separate sewer overflow portion of the wet weather flow treatment facility.

On receipt of signals from either Salt Creek Drainage Basin Sanitary District or the diversion structures, the programmable controller at the wet weather flow treatment facility opens the appropriate combined sewer overflow or separate sewer overflow influent sluice gates, and a signal is telemetered to Salt Creek Drainage Basin Sanitary District indicating that the wet weather flow treatment facility is in operation.

Flow treatment is initiated at the wet weather flow treatment facility, where the untreated combined sewer overflow and separate sewer overflow are routed separately through two mechanical bar screens. The raking mechanism at the screens operates intermittently to remove accumulated solids from the screens. Screenings are hauled to the sanitary landfill for disposal.

The screened combined sewer overflow and separate sewer overflow then discharge to the combined sewer overflow wetwell and separate sewer overflow wetwell for pumping to the combined sewer

overflow first-flush tank and separate sewer overflow first-flush tank. Flow is then transferred to combined sewer overflow settling tanks and separate sewer overflow settling tanks. The four combined sewer overflow pumps discharge a maximum flow of 18.3 mgd, and the three variable-speed separate sewer overflow pumps discharge a maximum flow of 7.55 mgd. Variable-speed pumps are used to improve the performance of primary treatment for the excess sanitary sewer flow.

The wet weather flow treatment facility consists of two separate aerated first-flush storage tanks. The volume of the combined sewer overflow first-flush tank is 337,000 gallons and the volume of the separate sewer overflow first-flush tank is 213,000 gallons. First-flush storage is pumped to gravity sewers and is conveyed to the Salt Creek Sanitary District for complete treatment. A summary of the design data for the wet weather flow treatment facility is given in Table 1.

Table 1. Design Data for Wet Weather Flow Treatment Facility

Description	Parameters
Seoarate Sanitary Overflow Wet Weather Treatment Facilities	
Dry weather flow (mgd)	1.49
Peak 5-year wet weather flow (mgd) ^a	1.55
Monthly average of all wet weather flow discharges:	
BOD₅ (mg/L)	30
Suspended solids (mg/L)	30
Bar screens	
Mechanically cleaned screen:	
Capacity (mgd)	7.55
Size opening (inches)	0.63
Backup manually cleaned roughing screen:	
Capacity (mgd)	7.55
Size opening (inches)	1.5
Raw wastewater pumps	
Pump type	Non-clog submersible
Number of pumps	3
Capacity of each pump (gallons per minute)	2,625
Capacity with largest unit out of service (mgd)	7.55
Excess flow flocculation clarifiers	
Number of tanks	2
Tank diameter (feet)	60
Side water depth (feet)	15
Surface area:	
Each tank (square feet)	2,827
Total square feet	5,655
Surface overflow rate:	
At 5-year storm peak inflow (gallons per day/square foot)	1,335
At 2-year storm peak inflow (gallons per day/square foot)	880
At 6-month storm peak inflow (gallons per day/square foot)	695

Description	Parameters
Detention time:	
At 5-year storm peak inflow (hours)	2.0
At 2-year storm peak inflow (hours)	3.1
At 6-month storm peak inflow (hours)	3.8
<hr/>	
Combined Sewer Overflow Treatment Facilities	
<hr/>	
Dry weather flow (mgd)	1.83
Peak instantaneous flow transported for treatment (mgd)	18.30
Primary clarification and chlorination prior to discharge; specific concentration limits do not apply	
Bar screens	
Mechanically cleaned screen:	
Capacity (mgd)	18.30
Size opening (inches)	1.0
Backup manually cleaned roughing screen:	
Capacity (mgd)	18.30
Size opening (inches)	1.5
Raw wastewater pumps:	
Pump type	Non-clog submersible
Number of pumps	4
Capacity of each pump (gallons per minute)	4,235
Capacity with largest pump out of service (mgd)	18.30
Combined sewer clarifiers:	
Number of tanks	8
Side water depth (feet)	10
Surface area:	
Each tank (square feet)	1,260
Each tank (feet)	70x 18
Surface overflow rate (gallons per day/square foot) ^b	1,800
Detention time (hours)	1.0
<hr/>	
Common Facilities	
<hr/>	
First-flush storage tank aerated:	
Side water depth (feet)	35.0
Volume (gallons)	550,000 ^c

Description	Parameters
Chlorination	
Plant effluent line to Salt Creek:	
Length (feet)	1,300
Detention time at peak flow (minutes) ^d	15.0
Diameter (inches)	72
Velocity at peak flow (feet per second)	1.44
Standby generator ^e	

^aAfter 64.9 percent inflow elimination.

^bAt peak flow of 18.3 mgd.

^cCombined sewer overflow of 337,000 gallons plus separate sewer overflow of 213,000 gallons = 550,000 gallons.

^dPeak flow of 18.3 mgd for combined sewer overflow area plus 7.55 mgd for separate sewer overflow area = 25.85 mgd.

^eCapacity adequate to power mechanically cleaned bar screens, raw wastewater pumps, lighting, chlorination, and ventilation equipment.

When flow exceeds the capacity of the first-flush storage tanks, flow is automatically diverted to the settling tanks. Four combined sewer overflow settling tanks and two separate sewer overflow settling tanks are provided in the wet weather flow treatment facility. The separate sewer overflow settling tanks are equipped with flocculation mechanisms, which mix in polymers to increase settling of solids in the tanks. Each tank has a sludge removal mechanism, which scrapes the sludge from the floor of the tanks using fiberglass flight scrapers. The sludge is scraped to sludge hoppers, where it is pumped to the Salt Creek Drainage Basin Sanitary District for treatment.

The treated effluent from combined sewer overflow settling tanks and separate sewer overflow settling tanks flows to an **84-inch** diameter outfall sewer, where it is chlorinated. Chlorine is added to the wastewater in a dose proportional to the flow rate. The final effluent then flows by gravity to Salt Creek.

As flow subsides to 5 mgd or less in the collection system, wastewater is no longer directed to the wet weather flow treatment facility. Personnel at the Salt Creek Drainage Basin Sanitary District and the wet weather flow treatment facility determine when sludge and first-flush storage can be pumped to Salt Creek Drainage Basin Sanitary District for treatment. The wet weather flow treatment facility is then hosed down to remove any sludge or debris remaining in the first-flush tanks or settling tanks. The plant is then ready for the next wet weather flow event.

Other Issues

The exterior of the structure is brick, accented with cedar siding and with a low-profile facade to maintain residential character. The entire treatment plant is enclosed and equipped with odor-removal equipment as part of the ventilation system. Odor-removal filters remove hydrogen sulfide and other sewage-related odors from the airstream. Sound-abatement materials control noise pollution.

Space limitations necessitated a "shoe-horn" design and prevented construction of a chlorine contact tank on the site. Therefore, the outfall had to be increased from a **48-** to an **84-inch** diameter pipe to provide necessary volume so that the chlorine had enough contact time for disinfection. Because the

structure covered approximately 90 percent of the site, stormwater detention for the facility itself was incorporated into the design of the structure's roof, with controlled release to Salt Creek.

Because the facility would be operated only intermittently by only one person, an innovative mix of electronic controls was included in the design of the facility. A programmable controller opens influent sluice gates, starts pumps, starts the mechanically cleaned bar screens, energizes the chlorine evaporators, controls air-cylinder-operated valves, activates the ventilation system, starts the influent and effluent wastewater samplers, and controls many additional operations. The programmable controller is also used to monitor valves, meters, and equipment. A graphic instrumentation panel is connected to the programmable controller so that the status of valves and equipment is indicated on the panel, along with indicators from the plant flowmeters. The panel gives the operator an instant update on the operating status of the facility. A telemetry system communicates information between the Villa Park wet weather flow treatment facility and the Salt Creek Drainage Basin Sanitary District. An automatic telephone dialer relays 13 customized alarm messages. For the convenience and safety of the operator, the facilities are supplied with an intercom system, oxygen detectors, combustible gas monitors, chlorine gas detectors, smoke detectors, and an illegal-entry security system. Each of these systems is connected to the programmable controller and the automatic dialer. When wet weather overflow subsides, the facility deactivates automatically.

Conclusions

This significant project was achieved through the cooperation of the Village of Villa Park, the Salt Creek Drainage Basin Sanitary District, U.S. EPA, the Illinois EPA, the Illinois Department of Transportation Division of Water Resources, and the U.S. Army Corps of Engineers. While the wet weather flow treatment facility treats excess wet weather flow, the sanitary district continues to provide primary, secondary, and tertiary treatment of first-flush volume and collected sludge from the wet weather flow treatment facility.

Construction of the wet weather flow treatment facility cost \$8 million. Installation of the combined sewer relief lines and separate sewer relief lines and sewer system rehabilitation cost \$4.7 million. The Village of Villa Park received 70 percent combined grant funding from the Illinois EPA and U.S. EPA for both projects.

Sewer overflows at Villa Park were many and varied. The U.S. EPA established strict guidelines for water quality for both separate sanitary sewer overflows and combined sewer overflows. An innovative design satisfied the constraints of space, location, and stormwater control, as well as demanded effective interagency coordination and communication. The environment was protected without an adverse impact on the adjacent residential community.

Innovative and Economical Sanitary Sewer Overflow Treatment Using Fine Screens and Chlorination

Darrel R. Gavle
Baxter & Woodman, Inc., Crystal Lake, Illinois

David G. Mitchell
Hycor Corporation, Lake Bluff, Illinois

Introduction

The Village of **Deerfield**, Illinois, was hit with two large rainstorms in 1982. These storms, which occurred in July and December, caused widespread flooding including sanitary sewer surcharging, overflows of sewage to the ground surface, and basement backups.

Deerfield is an affluent community with a 1990 population of 17,400. Located approximately 20 miles north of Chicago, Deerfield is primarily residential with some office and hotel buildings. At the time of the floods, Sara Lee Corporation operated a large bakery in the central portion of the village.

The severity of the 1982 floods was a significant concern to local residents and village officials. Later that year, Deerfield hired Baxter & Woodman, Inc., to complete an investigation of the sanitary sewer backups and overflows in nine specific areas of the village. One of the primary findings of that report was that the sanitary sewer problems were widespread throughout Deerfield, and were not confined to specific study areas. A full sewer system investigation of the entire community was recommended, and Baxter and Woodman was hired to conduct that study in 1984.

The following report describes the investigations, planning, design, construction, and operation and maintenance of the improvements to alleviate the sanitary sewer overflows (SSOs) and basement backup problems in Deerfield.

First, a review of the village's history is helpful. Many of the sanitary sewer problems resulted from construction practices and procedures that were commonly used before 1960, when most of the houses in the village were constructed.

The typical house has two significant sources of clear water into the sanitary sewer system. The most common source is a foundation or footing drain that is directly connected to the sanitary sewer system. Many of these connections are by gravity and are difficult to locate and expensive to disconnect. To determine the impact of the foundation drains on the sanitary sewer system, the village commissioned a sump pump study that was completed in 1975. For the study, 63 sump pumps that served foundation drains were randomly selected and monitored. The purpose of the study was to determine the amount of water that foundation drains contributed to the sanitary sewers. The results indicated that foundation drains were the largest single source of clear water entering the sanitary sewers.

The other common source is leakage into the house services. Many of these houses have separate storm and sanitary services that were installed adjacently in the same trench. Leakage between the two services allows large amounts of water to enter the sanitary sewers. During the sewer study, some of the sanitary services were found to be leaking at rates faster than 20 gallons per minute (gal/min). This type of leakage is also expensive to eliminate because the leak(s) may be located anywhere along the service between the main sanitary sewer in the street and the houses.

In 1959, the common practice of connecting the foundation drain to the sanitary sewer service pipe was discontinued. Instead, foundation drains were connected to a sump and sump pump. In 1961, the common practice of constructing separate storm and sanitary services in the same trench was also

discontinued. In the period between 1961 and 1968, a separate storm service was not generally required for each house, so both the runoff from the roof downspouts and the ground water from the foundation drains were simply discharged on the ground surface. In 1968, Deerfield began to require separate storm and sanitary sewer services (in separate trenches) for all houses. The storm sewer service receives the sump pump discharge from the foundation drains and the roof drainage, and the sanitary sewer service receives the wastewater from the house.

Houses that were constructed after 1968 do not contribute much stormwater to the sanitary sewer system; however, many houses in Deerfield were constructed when it was permissible to connect the foundation drain to the sanitary sewers. In addition to the foundation drains, many houses have separate but adjacent storm and sanitary services that leak substantial amounts of stormwater into the sanitary sewer system.

Planning

The 1982 Study

The 1982 stormwater and wastewater management study for the Village of Deerfield included an investigation of SSOs and basement backups in nine specific neighborhoods. The primary purpose of the sanitary sewer system investigation was to locate, identify, and quantify the infiltration and inflow (I/I) sources into the system in the study areas. The following investigative techniques were used: flow measurement, smoke testing, rainfall simulation, television inspection, and a building service connection survey.

The building service connection survey was divided into two parts: the first part was a questionnaire mailed to each resident of the village; the second part was a house-by-house inspection. Approximately 5,500 questionnaires were mailed to residents, and about 1,070 (19 percent) were returned. Each questionnaire was reviewed and classified by the type of flooding, date of flooding, and location of the house. A total of 577 basement backups were reported during the connection survey. About 56 percent of the reported backups were located outside of the nine neighborhoods, which indicated that the problem was more widespread than originally anticipated. The house inspections revealed that approximately two-thirds of the houses in the community have foundation drains connected to the sanitary sewer system.

The flow monitoring work revealed that the sanitary sewer system had adequate capacity for the normal dry weather flows but that the flow rate increased significantly during light to moderate rainstorms. Wet weather flow rates five to ten times the average dry weather flow rate were commonly measured. The highest measured ratio of wet weather flow to dry weather flow was over 20:1 during a 1-inch rainstorm.

The smoke testing, dyed water testing, and television inspection work in the nine areas resulted in the identification of the sources of approximately 8 million gallons per day (mgd) of I/I sources. Leaks in the village's main sewers and manholes were found to contribute about 12 percent of the I/I. Leaks in the house service pipes contributed about 46 percent of the total, and the remaining 42 percent was contributed by foundation drains, roof downspouts, and area drains that were directly connected to the sanitary sewer system.

The study results showed that the I/I problems were not confined to the nine study areas and that a sewer system investigation of the entire community was needed to effectively address the sanitary sewer problems.

The 1984 Study

Baxter & Woodman was hired in 1984 to prepare a sanitary sewer study in the entire village. The investigation consisted of flow monitoring, smoke testing, dyed water testing, television inspection and a physical inspection of the sanitary sewer manholes. The field investigative techniques resulted in the identification of sources of approximately 68 mgd of I/I. Leaks in the village's main sewers and manholes were found to contribute approximately 31 percent of the total I/I amounts, and leaks in the house services contributed an additional 25 percent of the total. The remaining 44 percent was contributed by downspouts (22 percent) and by foundation (19 percent) and area drains (3 percent) that were directly connected to the sanitary sewer system.

Based on the results of the study, the sources of an estimated 19 mgd were not located and identified. The peak estimated flow rate in the village's system was approximately 87 mgd, which was over 25 times the average daily sewage flow from the entire village.

The study included an evaluation of three main alternatives: 1) elimination of some of the sources, coupled with construction of relief sewers and additional wastewater treatment facilities to accommodate the remaining flows; 2) plumbing modifications to protect individual houses that are subject to basement backups; and 3) no action. After deliberation, the village selected the first alternative and four variations were developed and evaluated in depth. These alternatives were:

- Eliminate economical sources and treat all remaining flows at the existing wastewater treatment plant (WWTP).
- Eliminate economical sources, and treat all remaining flows at four separate treatment facilities.
- Eliminate economical sources plus sources of more than 10 gal/min, and treat remaining flows at the existing treatment plant.
- Eliminate economical sources plus sources of more than 10 gal/min, and treat remaining flows at four separate treatment facilities.

The second option was selected. The estimated total cost, including contingency allowance and engineering fees, was over \$10 million, more than \$2 million less than the other alternatives. In addition, three of the treatment facilities would be built at strategic sites in the sewer system, eliminating the need for downstream relief sewers.

Design and Construction

In 1985 Baxter & Woodman was hired to design the first of the satellite treatment facilities. The selected site was a village-owned lot on Deerfield Road that was approximately 90 feet by 180 feet. The lot was adjacent to the West Fork of the North Branch of the Chicago River, which is an intermittent stream.

The process flow diagram for the Deerfield Road Pumping Station is shown in Figure 1. Each of the components is described below:

- Bar screen: Illinois Environmental Protection Agency design standards require the installation of a bar screen in all pumping stations with incoming sanitary sewers 30-inch diameter and larger to collect large debris.
- *Dry* weather flow pumping station: The upstream relief sewers needed to convey wastewater to the treatment facilities were also designed at this time. A 36-inch diameter relief sewer replaced the existing 18-inch sewer. To alleviate sewer surcharging and

basement backups, the crown of the relief sewer was placed at or below the crown of the existing sewer. This lowered the elevation of the sewer inverts, which necessitated a full-time dry weather flow pumping station.

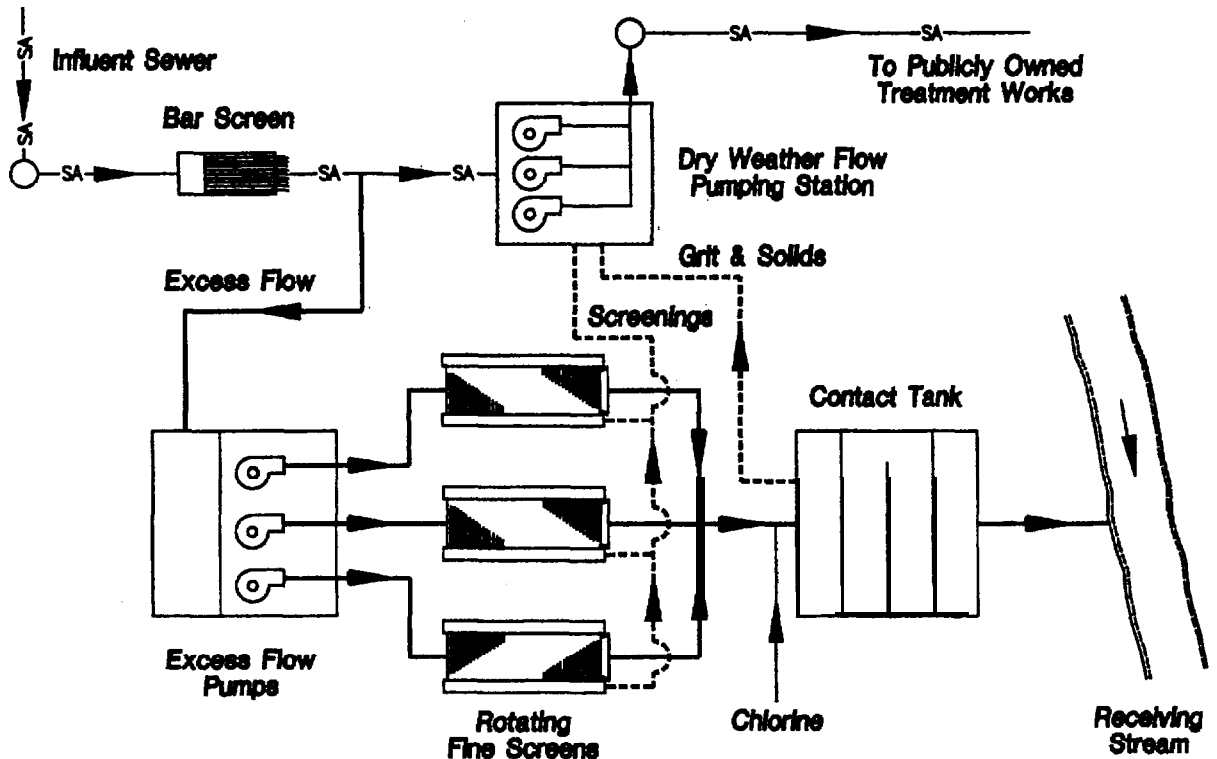

Figure 1. Process flow diagram, Deerfield Road Pumping Station.

- *Excess flow pumps:* Wemco-Hidrostral pumps were used as the excess flow pumps. Each pump was equipped with a “prerotation” basin, which is used to reduce the output of the pumps without varying the rotational speed of the motor and impeller. These variable output pumps were used to reduce the number of pump starts and stops resulting from rapid changes in influent flow rates. Each excess flow pump is rated at 10 mgd. It is piped directly to a rotating screen with the same nominal capacity.
- *Rotating fine screens:* Hycor horizontal rotating sewage screens were used to remove solids from the wastewater. The selected screen opening was 0.04 inches to remove all large solids and floatables. Wastewater is discharged inside the screen and is collected in a large trough below the screen. Captured solids are conveyed by internal flights to a discharge chute.
- *Chlorination:* A chlorine solution is injected into the wastewater immediately downstream of the rotating fine screens to disinfect the wastewater.
- *Contact tank:* The chlorinated wastewater is discharged into a contact tank to provide sufficient contact time for disinfection to occur. The contact tank also acts as a clarifier during low flow periods to remove some of the grit and heavier solids.

The effluent from the contact tank is discharged directly to the receiving stream, which in this case is the West Fork of the North Branch of the Chicago River.

During the design work, the village had three primary concerns: 1) automatic, safe, unattended operation; 2) ease and efficiency of operation and maintenance; and 3) the need to be a “good neighbor” to nearby residents.

Automatic, unattended operation was achieved through the electrical control design and equipment. As stated above, each pump discharges directly into a rotating sewage screen so they act as a single unit. A diesel powered generator is provided in the event of electric power failures. In addition, the critical equipment in the station is equipped with sensors to send alarms to the WWTP in the event of a failure.

Operation and maintenance work by the operating staff was carefully considered during the design. Proper ventilation is provided to each confined space. Convenient access with stairways rather than ladders was provided to the frequently used spaces. Solids collected in the wet well and chlorine contact tank are removed with high-pressure water hoses. The concrete floor is sloped to a central gullet, which conveys the solids to the pumping station. The pumping station discharges back into the sanitary sewer downstream of the treatment plant.

Being a good neighbor was very important to the village because the Deer-field Road Pumping Station is located about 20 feet from a single-family residence. The exterior of the building was designed to look as much as possible like a single-family house. A gable roof, residential-type windows, and some architectural design enhancements were used to improve appearance. The chlorine contact tank is completely enclosed so that fencing or other security measures are not needed. The exterior grounds are landscaped with trees and bushes to enhance the appearance of the building. The casual observer would not see a municipal building, much less a sewage treatment facility.

Unpleasant odors are controlled by the ventilation system, which takes fresh air from the resident's side of the building and discharges it toward the river. In addition, all of the solids that are collected in the screens, chlorine contact tank, and **wetwell** are removed and returned to the sanitary sewers. They are not collected in dumpsters or other types of collection devices, which could cause odors and attract flies and other pests. The staff thoroughly cleans the facility after each use so that it is ready for the next use. Cleanup work takes 45 to 60 minutes.

The diesel-engine generator is the largest single source of noise. It is exercised weekly, on Tuesdays. The other mechanical equipment and ventilating fans were selected to be as quiet as possible, which allows the station to operate quietly.

Regarding safety, **150-pound** chlorine cylinders are used in lieu of **2,000-pound** cylinders to minimize the danger should an accident occur with a leaking cylinder.

A public hearing was held after completion of the design work to answer questions from residents regarding the design features of the building and to provide information regarding the disruption that would occur during the construction work.

The Illinois EPA issued a permit for construction and operation of the project in 1986. Construction began in 1987 and was completed in 1988. The pumping station went into operation in February of 1988.

The Warwick Road Pumping Station and the Northeast Interceptor Sewer were designed in 1987 and 1988. The Warwick Road Pumping Station is similar to the Deerfield Road Pumping Station. It was bid in 1988 and went into operation in 1990.

The pump station capacities (with two of the three pump/screen units in operation) and construction costs of the two pumping stations are compared in Table 1.

Table 1. Pumping Station Capacities and Costs

	Rated Capacity	Construction cost
Deerfield Road Pumping Station	20.0 mgd	\$1,668,000
Warwick Road Pumping Station	14.7 mgd	\$1,570,000

Operation and Maintenance

The Deerfield Road and Warwick Road Pumping Stations were designed to meet effluent limitations of 30 milligrams per liter (mg/L) of biochemical oxygen demand (BOD) and 30 mg/L of suspended solids. The effluent requirements also included a reduction of fecal coliforms to 400 counts per 100 milliliters and a maximum chlorine residual concentration of 0.75 mg/L. Dechlorination of the effluent prior to discharge is not required.

The Deerfield Road Pumping Station has been in use for 60 months. The Warwick Road Pumping Station has been in operation for approximately 47 months. During the years of service at both stations, village residents made only one complaint. This was regarding chlorine odor and proved to be unrelated to the pumping station.

Graphs showing BOD and suspended solids concentrations are shown in Figures 2 and 3. A tabulation of the operating data for the two pumping stations appears in Figures 4 and 5. In 1992, the National Pollutant Discharge Elimination System (NPDES) permits were modified to raise the effluent limits for carbonaceous biochemical oxygen demand (CBOD) and suspended solids. The maximum allowable monthly concentrations are now based on the number of discharges that occur.

If discharges occur daily, the maximum allowable CBOD and suspended solids concentrations are 25 mg/L and 30 mg/L respectively. If a single discharge occurs in a month, the maximum allowable concentrations are approximately 44 mg/L and 49 mg/L.

The facilities can consistently meet the requirements for BOD and suspended solids. Occasionally, the fecal coliform counts do exceed 400 per 100 milliliters. These excursions result from the difficulty in maintaining a maximum chlorine residual concentration of 0.75 mg/L while obtaining the necessary disinfection efficiency.

These treatment facilities using fine screens and chlorination for treatment of excess sewage flow have successfully alleviated the sewer surcharging and basement backup problems in the Village of Deerfield. This has been done at an economical cost due to the choice of process and equipment. The rotating sewage screens provide high capacity and enough removal efficiency to meet the effluent limitations. Their compact size allows installation of a 20 mgd treatment facility on a residential lot of only one-third of an acre.

The totally enclosed pumping stations are "good neighbors" that can coexist in an affluent community. The average capital cost of the treatment facilities including engineering fees was less than \$0.12 per gallon per day of treatment capacity, which is a fraction of the treatment system cost of other alternatives. Moreover, building these facilities at strategic locations in the sewer system eliminated the need for costly and disruptive relief sewers extending to the village's WWTP.

NATIONAL CONFERENCE ON SANITARY SEWER OVERFLOWS
 INNOVATIVE AID ECONOMICAL SSO TREATMENT UTILIZING
 FINE SCREENS AND CHORINATION

OPERATING DATA AT DEERFIELD'S HAIR WWTP AND BOTH PUMPING STATIONS

MONTH	YEAR	MO.	MAIN WWTP			DEERFIELD RD. PUMPING STATION				WARWICK RD. PUMPING STATION						
			TOTAL FLOW (MGD)	EXCESS FLOW (MGD)	MO. DAILY AVER. FLOW (MGD)	BOB FLOW (MG/L)	SS FLOW (MG/L)	FECAL CL2 (MG/L)	MO. DAILY AVER. COLI. RESID. (MG/L)	BOB FLOW (MG/L)	SS FLOW (MG/L)	FECAL CL2 (MG/L)	MO. DAILY AVER. COLI. RESID. (MG/L)			
1	1994	1.60	74.60	0	N/D	0.27	17	28	126	0.75	0.18	0.27	9	18	927	0.66
3	1994	1.10	142.53	3.5	N/D						0.04	0.85	27	24	200	0.65
4	1994	2.90	103.06	0	N/D						B P					
6	1994	0.50	94.29	7.0	N/D	0.53	23	24	24	0.65	0.02	0.57	17	36	1400	0.65
4	1994	2.20	81.10	0	UP						N/D					
8	1994	0.95	73.26	0	N/D						N/D	N/A	17	38	N/A	0.65
10	1994	5.40	80.20	0	N/D						N/D	0.91	17	38	112	0.65
12	1993	2.80	137.59	4.90	N/A	0.30	14	42	14	0.45	N/A	0.56	21	30	1	1.6
3	1993	4.00	163.99	9.55	N/D	0.66	10	36	82	0.5	N/D	3.36	17	45	80	0.6
4	1993	4.75	164.94	27.413	0.06	0.66	11	24	200	0.5	0.23	4.53	9	21	70	0.77
5	1993	2.00	69.09	0	N/D						N/D					
6	1993	7.80	129.90	12.64	N/A	N/A	20	31	26	0.73	0.15	1.42	14	31	190	0.66
7	1993	3.15	95.51	2.75	N/D						N/D					
6	1993	4.65	61.03	5.58	N/D						0.03	0.72	16	57	47	0.65
9	1993	3.05	81.12	0	N/D						N/D					
10	1993	1.70	63.13	0	N/D						N/D					
11	1993	1.60	56.64	0	H/D						N/D					
12	1993	0.95	61.43	0	B/D						N/D					
1	1992	0.70	64.63	0	U/D						N/D					
2	1992	1.50	103.56	0	N/D						N/D					
3	1992	2.75	141.02	2.65	N/D						N/D					
4	1992	2.25	122.97	2.55	N/D						N/D					
5	1992	0.45	63.71	0	P/D						N/D					
6	1992	1.35	77.45	0	N/D						N/D					
7	1992	4.55	65.64	0	N/D						N/D					
8	1992	3.30	60.72	0	N/D						N/D					
9	1992	3.40	75.55	0	N/D						N/D					
10	1992	1.35	60.07	0	U/D						N/D					
11	1992	4.95	115.74	0.764	N/D						0.006	0.24	23	36	530	0.9
12	1992	2.10	94.76	0	N/D						0.04	1.35	30	40	100	0.6

Figure 4. Operating data at Deerfield's main WWTP and at both pumping stations, 1992 to 1994.

OPERATING DATA AT DEERFIELD'S MAIN WWTP AND BOTH PUMPING STATIONS

MONTH	YEAR	MO.	MAIN WWTP			DEERFIELD RD. PUMPING STATION				WARWICK RD. PUMPING STATION						
			RAIN (IN.)	TOTAL FLOW (MGD)	EXCESS FLOW (MGD)	MO. DAILY AVER. KAX. FLOW (MGD)	MD (MG/L)	SS (MG/L)	FECAL (CTS/100ML)	CL2 (MG/L)	MO. DAILY AVER. MAX. FLOW (MGD)	BOD (MG/L)	SS (MG/L)	FECAL (CTS/100ML)	CL2 (MG/L)	
1	1991	1.25	117.06	1.31	N/D					N/D						
2	1991	0.55	88.31	0	N/D					N/D						
3	1991	3.20	127.87	1.31	0.001	0.15	25	38	0	0.9	0.02	0.65	20	24	2100	0.5
4	1991	4.40	135.83	9.56	0.02	N/A	11	37	102	0.7	0.14	N/A	16	34	400	0.75
5	1991	3.05	100.15	0	N/D					N/D						
6	1991	1.65	60.34	0	N/D					N/D						
7	1991	0.90	74.61	0	N/D					N/D						
8	1991	2.65	77.62	0	N/D					N/D						
9	1991	3.35	72.12	0	N/D					N/D						
10	1991	8.36	97.03	3.09	N/D					0.713	0.71	12	160	6300	0.55	
11	1991	4.15	116.23	7.52	R/D					0.034	0.40	15	36	69200	0.69	
12	1991	1.45	121.76	1.5	N/D					N/D						
1	1990	2.20	104.38	0	N/D					N/A						
2	1990	2.05	111.72	0	N/D					N/A						
3	1990	2.90	154.16	9.48	N/D					N/A						
4	1990	1.90	118.25	0	N/D					N/D						
5	1990	6.25	155.53	6.49	0.03	0.57	13	34	326	0.63	0.15	3.98	17	52	520	0.53
6	1990	3.60	107.69	0	N/A					0.006	0.17	16	24	321	0.07	
7	1990	3.65	114.52	0	0.12	0.39	35	58	2000	0	0.23	0.13	34	132	793	0.3
8	1990	9.50	132.97	19.06	0.19	3.80	10	18	27	0.9	0.32	4.67	9	23	300	0.7
9	1990	2.00	85.05	0	N/D					N/D						
10	1990	4.55	109.21	1.5	N/D					0.03	0.88	20	25	364	0.3	
11	1990	5.50	122.69	6.4	0.12	0.37	25	56	2000	0	0.23	0.73	34	132	793	0.3
12	1990	1.40	136.04	0	N/D					N/D						
1	1989	0.45	96.04	0	N/D					N/A						
2	1989	0.60	81.89	0	N/D					N/A						
3	1989	1.40	123.66	0.87	N/D					N/A						
4	1989	1.25	95.92	0	N/D					N/A						
5	1989	2.36	93.87	0	N/D					N/A						
6	1989	1.35	97.18	0	N/D					N/A						
7	1989	3.90	98.61	0	N/D					N/A						
8	1989	5.15	107.14	2.77	0.02	0.06	35	57	320	0.6	N/A					
9	1989	2.25	101.16	0.648	N/A	0.43	25	106	500	0.45	N/A					
10	1989	1.65	69.51	0	N/D					N/A						
11	1989	1.80	92.55	0	N/D					N/A						
12	1989	0.42	63.32	0	N/D					N/A						

N/D = NO DISCHARGE
N/A = NOT AVAILABLE

Figure 5. Operating data at Deerfield's main WWTP and at both pumping stations, 1989 to 1991.

Total Catchment Management for Sanitary Sewer Overflows in Sydney, Australia

Patrick A. Hayes
ADS Environmental Services, Inc., San Diego, California

Introduction

Pollution of the various waterways in the Sydney metropolitan area is of great concern to residents, the State of New South Wales Environmental Protection Agency (EPA), and Sydney Water (SW), the agency responsible for sewage collection, treatment, and disposal. Concern has led to the implementation of a clean waterways program to determine the cause and nature of the pollution problems, and then apply appropriate solutions. Sanitary sewer overflows (SSOs) have been found to be a very significant component of the pollution problem. State-of-the-art solutions are being developed to successfully reduce and eliminate SSOs, using the best technology and methodology in the world, and should be of interest to municipalities everywhere.

SW administers one of the world's largest sanitary sewer systems, serving more than 3.7 million people in Australia's largest city. Sydney is located on the east coast of Australia on the south Pacific Ocean in a coastal depression intersected by numerous bays, rivers, and estuaries. A highly favorable climate leads many residents and tourists to make use of the region's water resources. Clean and healthy waterways are a major and highly valued community recreational resource.

SW owns and operates 36 separate sewer systems with more than 22,000 kilometers (72 million feet) of sewers, the square trunks of which range from 150 millimeters (6 inches) to 3.5 meters (11.5 feet). Approximately 90 percent of the region's sewerage travels through trunk sewers flowing parallel to the major estuaries in four major networks. In turn, these flows receive primary treatment and are discharged through four deep-water ocean outfalls. The remaining flows are collected and receive advance treatment at inland plants that discharge to the Hawkesbury-Nepean River system, which runs around the western perimeter of the Sydney basin.

Background ,

Average annual rainfall is 1200 millimeters (47 inches). Rainfall occurs primarily from early spring (October) through late fall (May), and the majority falls in high intensity storms. The region is primarily sandstone with 1 to 2 feet of topsoil. Most sewers are vitrified clay and were laid in rock trenches backfilled with native material. Apart from localized sandy areas, no free ground-water table exists. Unwanted inflow and infiltration (I/I) enter the sewers during and following rain events, causing hydraulic overloading of sewer lines and SSOs. The mechanism for rain-induced ground-water infiltration is drainage into the rock trench and through degraded pipe joints.

During and after the high intensity events, the I/I induced overflows have been measured at 15 times the average dry weather flows. The sewer system has at least an estimated 6,000 overflow points including surcharging manholes. More than 2,000 SSOs have been built into the system intentionally. The locations of the SSOs are recorded in SW's geographical information system (GIS). Through the program, it has been found that 80 percent of the overflow volume is coming from 200 of the overflows. The SSOs adversely affect receiving waters, causing beach pollution and affecting shell fisheries.

Clearly, SW had to deal with this very large problem. In 1990, SW initiated a **20-year** program to deal with the issues raised by the **SSOs** and created the Clean Waterways Programme. SW searched the technical world for expertise to handle its issues. Consultants were selected both locally and from overseas, including U.S. consultants who were chosen based on several decades of valuable experience they had gathered working under the Clean Water Act, administered by the Environmental Protection Agency (U.S. EPA), particularly in the area of I/I abatement. A state-of-the-art program was created using the concept of total **catchment** management. The most current U.S. and European strategies for dealing with sewer system I/I, **SSOs**, and rehabilitation were key elements of the strategy.

Problem Definition

The sewer overflow problem has two parts. The first is the trunk sewer overflow problem, with discharges directly to waterways. The second is the reticulation system (small diameter sewers, 6 to 8 inches) overflow problem, which discharges sewage onto roads and property. Although the former creates the most concern in the community and attracts the most criticism due to its more obvious impact, the latter affects the individual and is of equal concern to SW. Both problems must be addressed in a program to eliminate **SSOs**.

Initially, the major task was to prioritize the effort and determine the scope of work that must be addressed. A number of questions were posed:

- What is the magnitude of the SSO problem?
- Where does it occur, and how often?
- How significant is the problem of reticulation surcharge onto roads and private property compared with gross pollution of waterways during storms?
- Is the loss of available swimming time in the rivers and estuaries more significant than at the ocean beaches?
- How will the problem of privately owned house service sewers be addressed?
- Who will pay for the correction of these problems?

Strategic Plan

The nature of the topography, strata, and rainfall of the Sydney region precludes the direct adoption of strategies developed for Northern Hemisphere cities. In particular, the topography is a relatively flat, elevated coastal plain not commonly found in the Northern Hemisphere; the strata is typically sandstone, with only a **1- to 2-foot** overburden of topsoil. Consequently, **most** sewers are in rock trenches, and rainfall intensities are extremely high, exceeding Northern Hemisphere experiences in most cases. Consideration of the principles involved in these previous strategies and the adoption of ideas from both the United States and Europe have resulted in the development of a strategy designed to manage wet weather flows. More specifically, it will meet local needs. Figure 1 illustrates the issues to address and the proposed methodology.

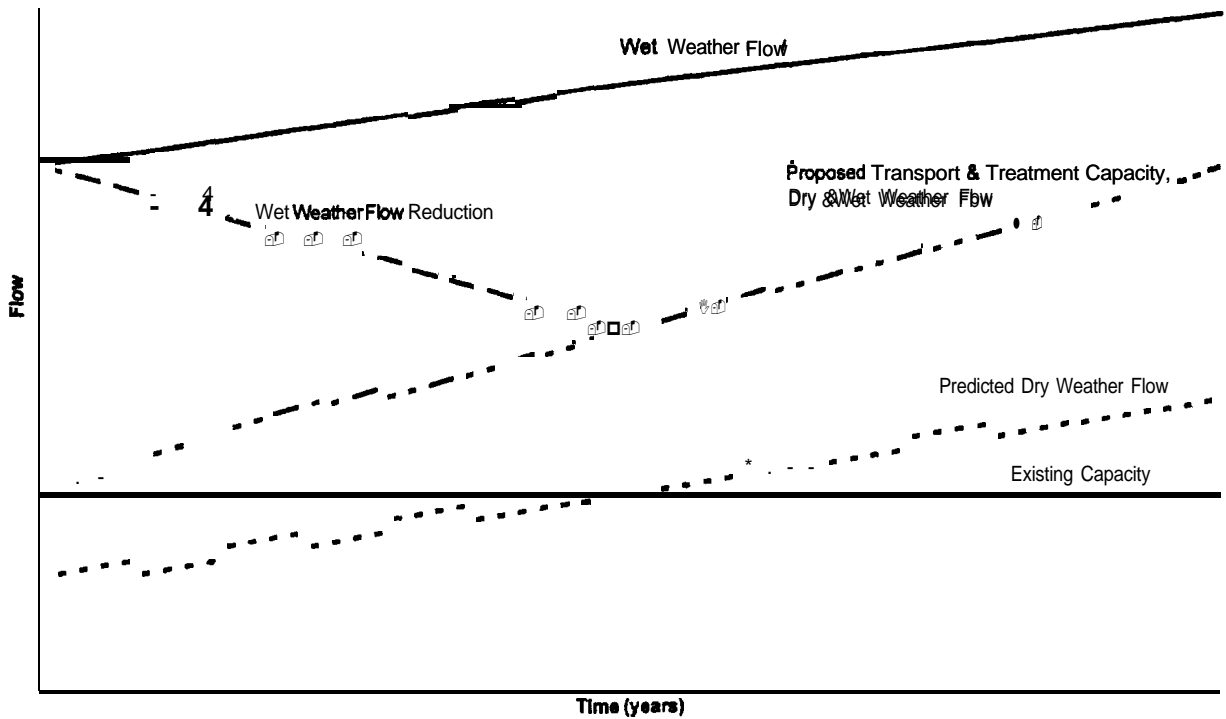

Figure 1. Wet weather flow strategy.

The traditional approach to these problems is to adopt a bigger pipe or end of pipe solution; that is, don't eliminate I/I, just build a bigger system to contain it. This results in continuing attempts to cure the symptoms while the disease remains.

As seen in Figure 1, the proposed strategy for Sydney involves the significant reduction of wet weather flows by an I/I program coupled with a targeted amplification of critical sewers. Additionally, the city plans to pursue some limited off-line storage and overflow treatment to balance existing sewer system capacity and attenuate peak flows. Transfer of SSO volume from critically affected areas to healthier receiving waters is also an option.

The tradeoff between costs and benefits associated with the application of this strategy is shown in Figure 2. This analysis indicates that the most cost-effective approach is a combination of I/I reduction and system amplifications. The overall cost of the program depends on the level of service based on overflow recurrence that the State of New South Wales Environmental Protection Agency and the public find acceptable. SSOs will then be licensed by the agency for a given frequency of overflow. This plan is being implemented through a number of phased tasks.

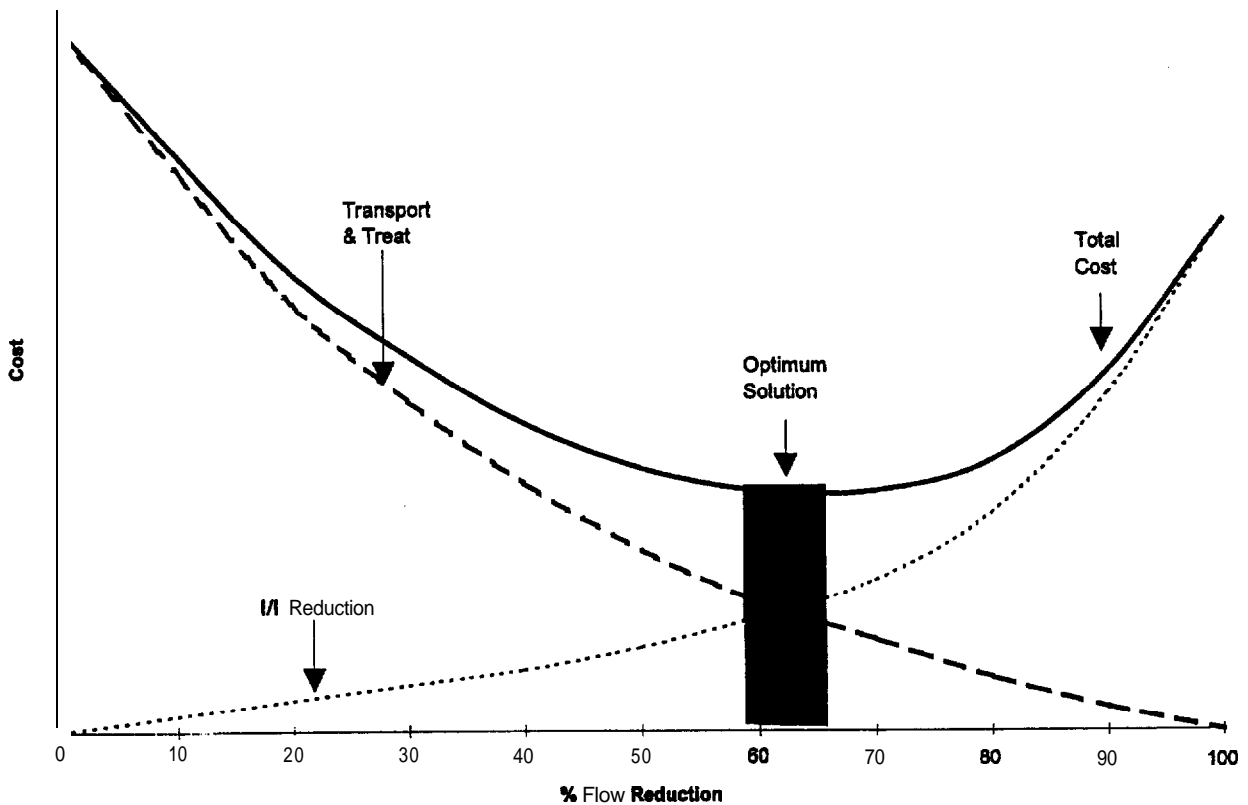

Figure 2. Cost benefits associated with the wet weather flow strategy.

Task 1

The first task was to measure the extent of the problem. To obtain baseline performance data on the sewerage system (e.g., its loadings and capacity), several initial steps were taken. Physical sewer system data, topography, strata, population density, and other data were collected and stored on an Intergraph GIS database.

At the same time a contract was established with ADS Environmental Services, Inc., to install 400 long-term sewer flow gauges in the existing network. Gauge spacing was selected at one per 50 kilometers of sewer or 10,000 population. Flow gauges were connected to a standard rotary telephone system and interrogated twice per week. Flow data were transmitted to SW's HYDSYS database for modeling and planning purposes. Rainfall data obtained from the New South Wales Public Works Department's rain gauges were also put into the HYDSYS database.

Task 2

The second task involved the compilation and analysis of the collected data. This involved the estimation of dry weather flows for the present and future from demographic data held in the GIS. A hydraulic flow model to determine the sewer system operational characteristics and capacities was required. To achieve this, detailed system models of all the catchments using the Danish Hydraulic Institute's (DHI) MOUSE model were constructed and calibrated from the actual flow data obtained from the 400 long-term sewer flow gauges. The calibrated models were used to determine the dry weather capacities of the various trunk sewer systems to both present and future loading conditions for the year 2021. A revised model is being developed using population projections for the year 2050.

For wet weather flow analysis, the first steps were to identify significant uniform rainfall events that did not activate overflows and to calculate, after subtracting dry weather diurnal variations, the extra flow, $Q_{I/I}$, at the system downstream gauge. The rainfall hyetographs and average catchment rainfall (R) were determined for each event, and the percentage I/I attributable to each event over the catchment area (A) was calculated by the equation:

$$I/I\% = (Q_{I/I} \times 100)/(R \times A)$$

where

$Q_{I/I}$ = quantity of I/I (cubic meters)

R = rainfall (meters)

A = area (square meters)

For each system, the event with the highest percentage I/I, or maximum yield condition, was selected as the maximum yield event for the system, and unit hydrographs were derived for this event. Results were plotted from the GIS to give a graphical presentation of the relative magnitude of I/I areas in the gauged catchments. The graph also indicates how I/I problems are grouped by characteristics such as by pipe material, age, strata, and land development.

On the completion of the rainfall-induced I/I study, the wet weather capacity and flows of various components of the system were determined. Design storms with varying temporal patterns were run through the MOUSE models to determine the critical duration storm that created the largest wet weather peak flow and volume. This was used to determine the capacity of flows in the sewer systems and overflows under the selected wet weather flow return periods. These return period capacities for 3- and 6-month and 1-, 2-, and 10-year events were plotted in various colors on a map of the Sydney sewers.

The underlying assumption in the decision to install the strategic gauging network and analyze the sewerage systems in detail was that a Pareto effect would exist, allowing precise targeting of problems rather than the previous hit-or-miss approach of fixing problems as they appear. The results of the analysis have clearly demonstrated the Pareto's effect, and the cost savings will return this investment on gauging by well over 100 to 1.

The monitoring, along with rain gauge information, allowed for complete calibration of the sewer system model to actual conditions, a first for a system this size. Further, SW has implemented a DHI receiving water-quality model linked to output from the hydraulic model. With this marriage, the impact of SSOs from various rain events on rivers, harbors, bays, and the ocean can be shown graphically.

Task 3

The third task of the program is the selection and assessment of options.

Flow Management Options

The performance of the sewerage systems draining into the ocean in dry and wet weather conditions is now very well understood; the detailed analysis above has allowed the development of an objective diagnosis. This diagnosis has allowed the questioning and disregarding of conventional wisdom on system performance. While the trunk systems do not have the nominal four times dry weather flow capacity, only small portions are at capacity in dry weather conditions. By amplifying these limited areas to allow them to cope with dry weather flows and modifying design standards, the existing trunk system can cope with present and future demands.

The critical option is to select criteria to address future dry weather SSO with the least capital expenditure. Currently, a trigger point of capacity less than 1.33 peak dry weather flow (PDWF) has been adopted as a minimum dry weather performance standard. It seems obvious, however, that dry weather amplifications cannot be carried out without factoring in wet weather **SSOs** and their impacts.

The available wet weather system performance data have allowed development of various scenarios, from transport and treat all flows, to attenuate all flows by storage, to complete wet weather flow elimination. A range of SSO containment scenarios will be assessed for health risk, social and environmental impact, asset management, and cost.

To look at all possible scenarios for all of the systems, a cost optimization program using a dynamic programming approach has been developed into a software model called SEEKER. This model looks at inputs such as existing infiltration rates, ranges of possible rehabilitated infiltration rates, flow inputs at gauge locations, and possible storage sites and treatment facilities. From these, the most cost-effective option will be determined.

In essence, the SEEKER model inputs catchment data such as PDWF, wet weather flow, and rain-induced infiltration and inflow I/I (**RDII**) from each gauged catchment, checks the capacity of the downstream transport system to the next node, adds the flow to the next section, and determines the upgrading cost. The model accumulates these data for each successive node. By then applying reductions to **RDII** flows and adding costs alternatively throughout the network, the nonoptimal combinations at each node are discarded. Performance parameters can also be set to evaluate a specific storage option. The model also produces a sensitivity analysis of the option of not undertaking any part of the work. All results are produced graphically on the GIS for easy interpretation {see Figure 3).

This new tool is immensely useful to screen out options. The best options are then run through the MOUSE flow model to ensure that the hydraulics work as predicted. SEEKER has provided a sound prioritization by identifying those early action projects with the highest cost-benefit ratios. At this stage, the most cost-effective option for wet weather flow reduction appears to be a combination of wet weather flow reduction and flow attenuation by storage to meet a given level of service. Some limited dry weather capacity amplification is **also required**.

The SSO abatement program is using I/I prototype correction projects and reducing the risk of dry weather SSO by selected amplifications. The MOUSE model has indicated high Manning "n" values in a number of sewers with PDWF capacity. These areas are being targeted for detailed inspections, cleaning, and reevaluation prior to any amplifications. The I/I prototype reduction projects implemented at the beginning of the job have demonstrated highly successful I/I removal. These projects are considered an essential component of any SSO abatement strategy.

As a new kind of SSO problem not previously studied, exfiltration may be worth targeting. Typical per-capita flows range from 200 to 300 liters per day. Some catchments experience flows far less than 100 liters per day. Further investigation of these areas has revealed significant exfiltration of sewage. Due to sandy soils conditions, these sewer flows have migrated to nearby storm drainage lines and infiltrated them. High levels of fecal coliform in dry weather have been recorded in these storm lines, which eventually discharge to sensitive receiving waters.

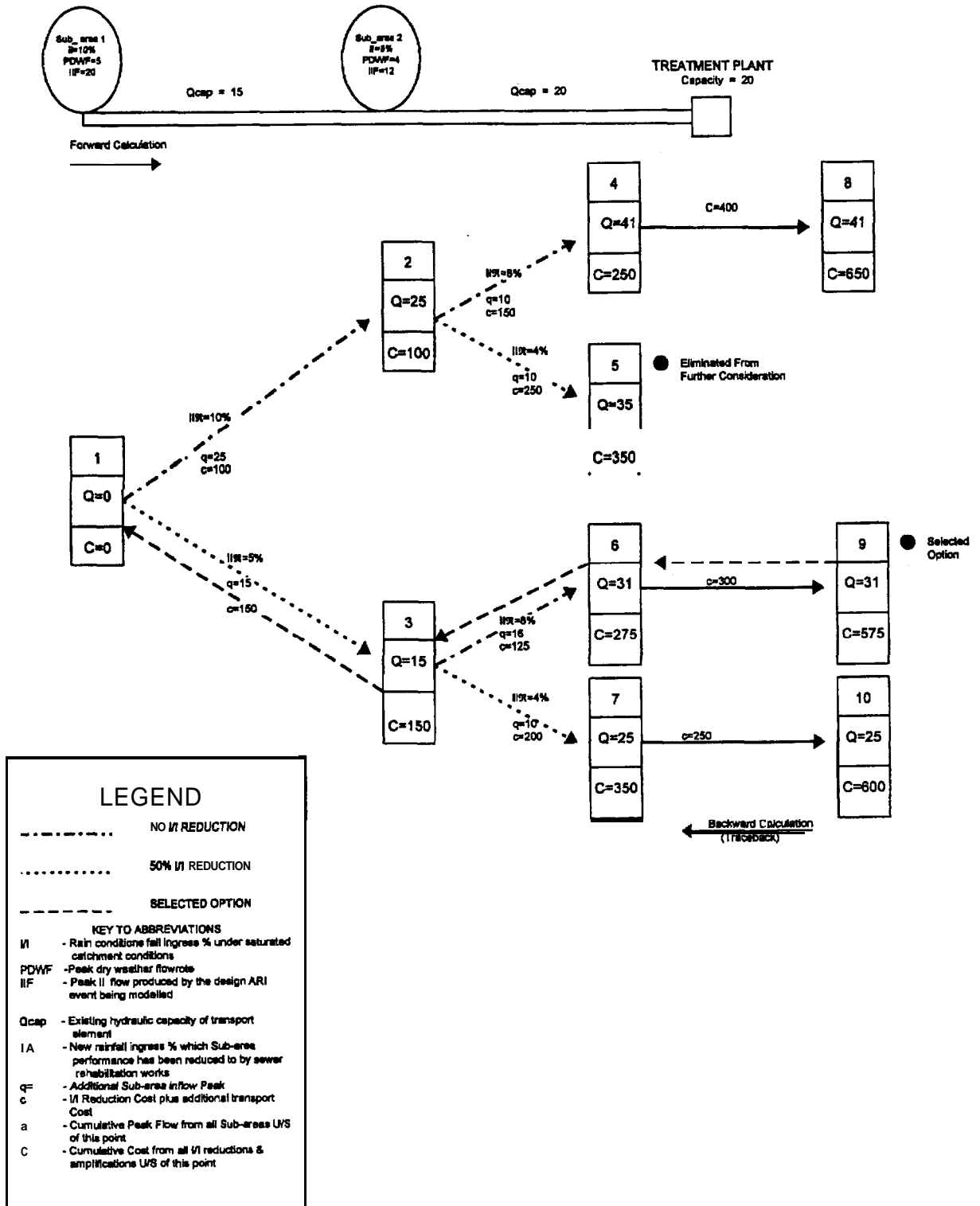

Figure 3. Typical SEEKER output run.

Wet Weather Flow Reduction

Catchment I/I reduction projects have three phases, which have been developed and validated in a number of pilot and prototype projects. The first phase is the selection of high I/I catchments from the 400 gauged catchments and the modeling results. In this phase, short-term flow gauging spaced at 3 to 5 kilometers is used to identify I/I on a mini-catchment basis. With these results, the next step is to detect individual sources of I/I through physical inspections of all manholes, inflow detection, smoke testing, and closed-circuit television inspection of the worst areas.

The second phase is rehabilitation **by** replacement, lining, and grouting, depending on structural conditions. According to the plan developed in the source detection phase, rehabilitation is carried out to reduce the catchment downstream hydrography by a specific cost-effective amount, to remove all peaks exceeding sewer capacity, and to reduce system leakiness to allow below 5 percent of the total rainfall volume. Ground-water reduction is targeted where excessive. The selection of the catchment and reduction rate is specified by the system option defined by the SEEKER program. A full range of rehabilitation technologies both from overseas and of Australian origin have been used in the early projects. These range from cured-in-place liners, slip liners, folded liners, short liners to pipe bursting, conventional packer grouting, and various flood grouting techniques for both main lines and house laterals.

The final phase is the reevaluation of the wet weather flows using existing long-term gauges analysis, intensive short-term gauging, and short-term flow gauging. This program is designed to determine the postrehabilitation hydrograph and compare it with the prerehabilitation hydrograph. The unrehabilitated control catchment concept is used to calibrate the pre- and postrehabilitation hydrographs to allow for the many uncontrollable variables, such as soil moisture and rainfall intensity and patterns. Figures 4 and 5 show the results obtained from this strategy on trial catchments of various sizes. In general, 30- to 50-percent rehabilitation was carried out in the larger catchments.

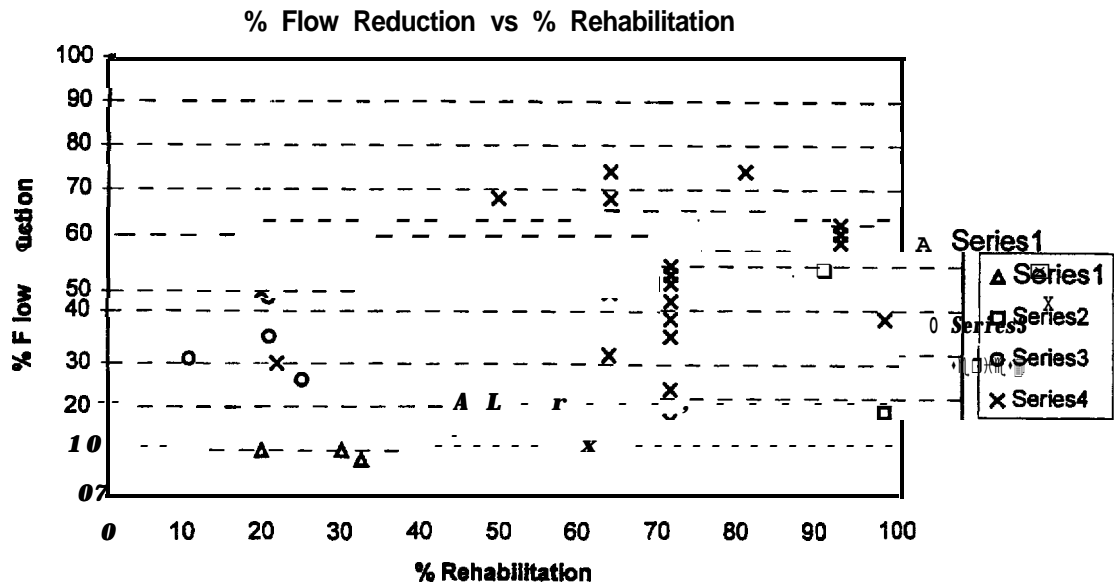

Figure 4. Flow reduction versus rehabilitation results.

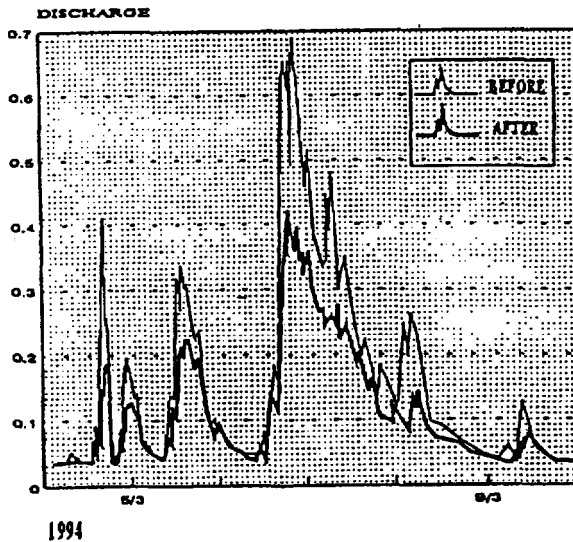

Figure 5. Flow reductions after rehabilitation; performance measurement using MOUSENAM.

The law of diminishing returns for extra work is demonstrated, and low reductions in wet weather flows with high renovation of main lines but no house lines illustrate the impact of defective house device sewers on the SSO problem. Figure 5 illustrates the flow reductions both in peak and total flows obtained in a catchment after rehabilitation. This figure is a MOUSENAM plot that compares the gauged flows in a postrehabilitated catchment with the estimated prerehabilitated flows based on a time series calibrated model of the catchment. Only 25 percent of the sewers in this particular catchment had been rehabilitated.

Program Evaluation

The selected SSO abatement strategy will be modeled in detail in MOUSE. New sewers, storage, I/I reduction, and dynamic operating protocols to drive the network will be progressively included in the calibrated models. Unit hydrographs for the systems, as they existed in the baseline 1992 case, and baseline MOUSENAM models will be used to generate sewer flows and SSO quantities following system improvements. The effect of I/I reduction, amplifications, and storage will be measured by comparison with the baseline case. Modeled flow, SSO volume, and SSO incidence reduction will be reported for a number of design events. The receiving water models will be recalibrated as program implementation progresses to verify receiving water improvements and to determine the effectiveness of the overall strategy.

System Understanding Delivers Solutions at Affordable Cost

Robert Serpente, Gerry Moss, and Phil Wildbore
Water Research Center, Huntingdon Valley, Pennsylvania

Introduction

Sewer System Evaluation Surveys (**SSESs**) in the United States are directed at maintaining the integrity of the sewer system so that extraneous water from infiltration and inflow (*I/I*) sources does not upset the wastewater treatment plant. Decisions on rehabilitation of a sewer are based on the quantity of extraneous flow entering the sewer.

While in the United Kingdom, the Water Research Centre (**WRC**) took a different approach to the relationship between collection systems and treatment plants. The *Sewerage Rehabilitation Manual* (SRM), published by **WRC**, has been widely adopted by the U.K. water industry and elsewhere in the world. The SRM provides the basic framework for a complete understanding of a collection system. To begin with, the manual recommends that levels of performance be selected for the collection system and that achievable standards of service be used to critically review collection system operation. Table 1 is an example of standards of service for a collection system.

Table 1. Standards of Service for a Collection System

	Level		
	Trigger for Early Reengineering	Target for Upgrading	New Design
Public Health			
Flooding frequency:			
- Inside occupied premises	Any sanitary flooding	Once in 30 years	Once in 50 years
- Streets	Twice in 2 years	Once in 20 years	Once in 25 years
Structural			
Frequency of surcharge	N/A	Once in 1 year	Once in 2 years
Performance grade of critical sewers	2-5	1	1
River Quality			
CSO operation	Dry weather Evidence of pollution	Water quality standards	Water quality standards

Where the standards of service are not met, an integrated approach including structural, hydraulic, and infiltration evaluation is cost justified. This analysis is achieved by:

- Truly understanding the system
- Actually managing flows
- Looking systemwide to save money

Note that traditional design concepts, such as hydraulic sizing (no surcharging) for a **5-year** design storm, have no place above. In addition, the above performance standards are no more costly to implement than traditional design oriented standards.

The primary purpose of any sewer is to carry flow. If the designed pipe capacity is exceeded, for example, due to I/I, the pipe goes into surcharge. I/I can lead to excess flows at the wastewater treatment plant, flooding, sanitary sewer overflows (SSOs), and accelerated structural deterioration. WRC's extensive research has shown that a better understanding of existing hydraulics is the key to **cost-effectively** solving any recognized problem. The main question is how much of a better understanding of hydraulics is justified? The answer usually depends on the scale of the anticipated long-term expenditure. In most cases, a verified hydraulic simulation model that replicates existing systems performance to 10 percent is cost justified.

I/I Hydraulic Evaluation

Most systems sewers must surcharge before SSO commences. To truly understand what is occurring in the existing collection systems, the latest computer model, representing every collection system pipe, is needed. The model needs to analyze all of the pipes, replicating real-life constraints such as sedimentation, drops at pipe junctions, and particularly surcharging.

Pressure waves generated during surcharging can travel at speeds approaching that of sound. Traditional evaluation approaches use time intervals of 10 minutes, allowing a pressure wave to travel over 100 miles between intervals. Errors in corresponding flow volume predictions can be substantial. The new approach reviews the system every second, making it up to 600 times more accurate. Advanced software can define collection systems to a level of detail and accuracy that permits identification of cost-saving solutions. The adequate representation of systems requires nodes at a maximum distance of every 1,500 feet. Such models can simulate actual rainfall and interact with other operational and maintenance issues-all at 1 -second intervals. The additional cost is readily justified by savings from the adopted solution and by the more confident understanding and management of the system.

Any model needs to be objectively proven accurate before it credibly promotes system understanding. Traditional approaches use simple models of a few hundred pipes, and then are calibrated. Calibration is a process where model data are arbitrarily adjusted to match observed data. For example, an impervious area might be adjusted to give matching flows to a flow survey. Forcing a fit is simple, but this may not reflect reality. How accurate are the flow data? The new approach requires building and running the model before measured flows are known. Comparing the flows then highlights the differences and independently checks all flow data for accuracy.

This verification exercise is a structured process to predetermine accuracy limits and assess the surcharge simulation model's ability to replicate factual data repeatedly. Where flows are within 10 percent, for example, there is little value in pursuing further accuracy. Where the discrepancy is greater, two courses of action can be taken:

- Independently check the flow survey. The theoretical relationship between depth and flow is well known. For many reasons, however, real flow data often produce wide variances of recorded flows for the same depth. If these data inaccuracies are perpetuated through the model into new facilities, the cost implications can be significant. Therefore, it is imperative to objectively check flow data at all sites throughout a survey.
- If validated data still disagree with the model by more than 10 percent, revisit the records-or the site, if necessary. Experience has shown that physical explanations can

nearly always be found for large discrepancies, and a high degree of correlation can be achieved through a model without forcing a fit.

Agreement to ± 10 percent variation between the measured and predicted flows at all sites (with respect to peaks, total volume, depths, and timing), confirms a truly verified model. Real measured rainfall is preferable to design storms. Only relevant historical rainfall can demonstrate failure incidents at sites such as **SSOs**.

The ability to generate historical rainfall data for use with a verified surcharge model that then replicates recorded events gives assured confidence in the model and its predictions.

Flow Management

A key feature of the successful approach used to control combined sewer overflows (**CSOs**) and **SSOs** in Europe is an emphasis on exhausting the storage potential within the existing collection system before considering building new facilities. This approach has been successfully applied to controlling **SSOs** in the United States. While improved understanding can identify hundreds of operational improvements, it is unlikely that these will fully eliminate the need for further action.

In over a decade of applying these proven simulation models, two common themes have emerged. First, the study must incorporate the entire catchment area, which enables infinite catchment-wide solutions to be evaluated, not just at the downstream end. By mobilizing available storage in existing pipes more efficiently, the model facilitates greater flexibility in siting supplementary storage. Second, by controlling the flows sequentially as they pass through the system, peaks can be significantly reduced. For example, two branches, each with 0.28 cubic meters (10 cubic feet) per second, may combine to give a peak of 0.56 cubic meters (20 cubic feet) per second. Confident re-engineering may mobilize enough upstream storage to attenuate the combined peak to 0.48 cubic meters (17.5 cubic feet) per second. If a downstream SSO operates at 0.5 cubic meters (18 cubic feet) per second, an overflow has been prevented without major capital investment. Real systems are rarely so simple-hence the need for the latest verified simulation models.

Through better management, then, immediate benefits can be gained in terms of containing flows within the existing system, thereby maximizing flows to the existing treatment facilities. Flows can be managed using attenuation techniques, for example, that have been practiced by river engineers for decades.

Managing flows can yield other benefits:

- Higher average velocities over longer periods
- Reduced maintenance costs
- Enhanced structural integrity
- Minimized flooding problems

Figures 1 and 2 very simply illustrate the concept. In a typical system (Figure 1), a storm produces two similar runoff hydrographs (flow versus time) in the upstream branches. These combine to provide a flood wave down to the overflow point. On arrival, the peak flow is diverted to the receiving water, leaving the truncated hydrograph to pass for treatment.

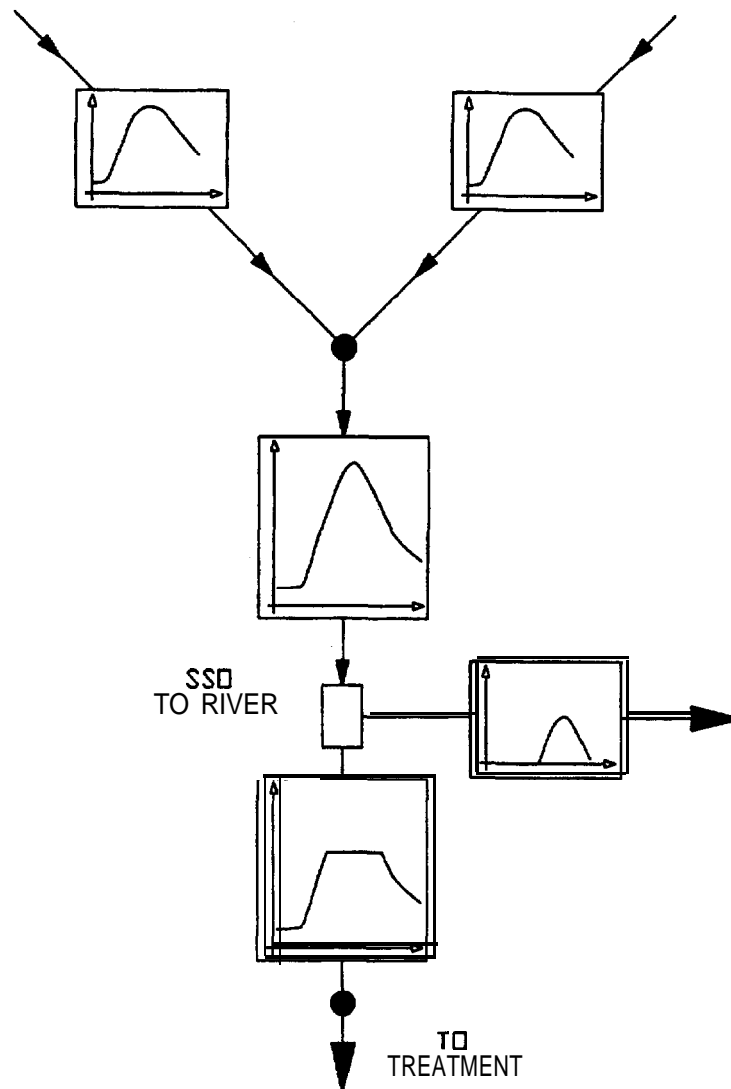

Figure 1. Hydrograph schematic of an SSO discharge.

In an understood and re-engineered system (Figure 2), a hydraulic model is built to understand how these flows are generated. With the same storm event, spare upstream storage capacity is located within the existing collection system. On the left input, a hydraulic control is able to attenuate peak flows within a steeply graded trunk sewer. On the right, a flatter catchment mobilizes the latent potential, both in the trunk sewer and in connecting local sewers. The siting of appropriate low-maintenance control devices (e.g., in-line vortex controls and hydrobrakes) has been optimized to mobilize sufficient in-system storage so that the combined downstream hydrograph passes through the overflow point without discharging.

In achieving this, two peripheral benefits become apparent. First, flows for treatment have a controlled peak velocity over a longer time. This ensures higher self-cleansing velocities and a cleaner system. Second, downstream of the hydraulic controls, the reduced peak flows greatly facilitated structural rehabilitation techniques, such as relining. Indeed, significant benefits have been established by combining structural rehabilitation with optimized locations of hydraulic control structures.

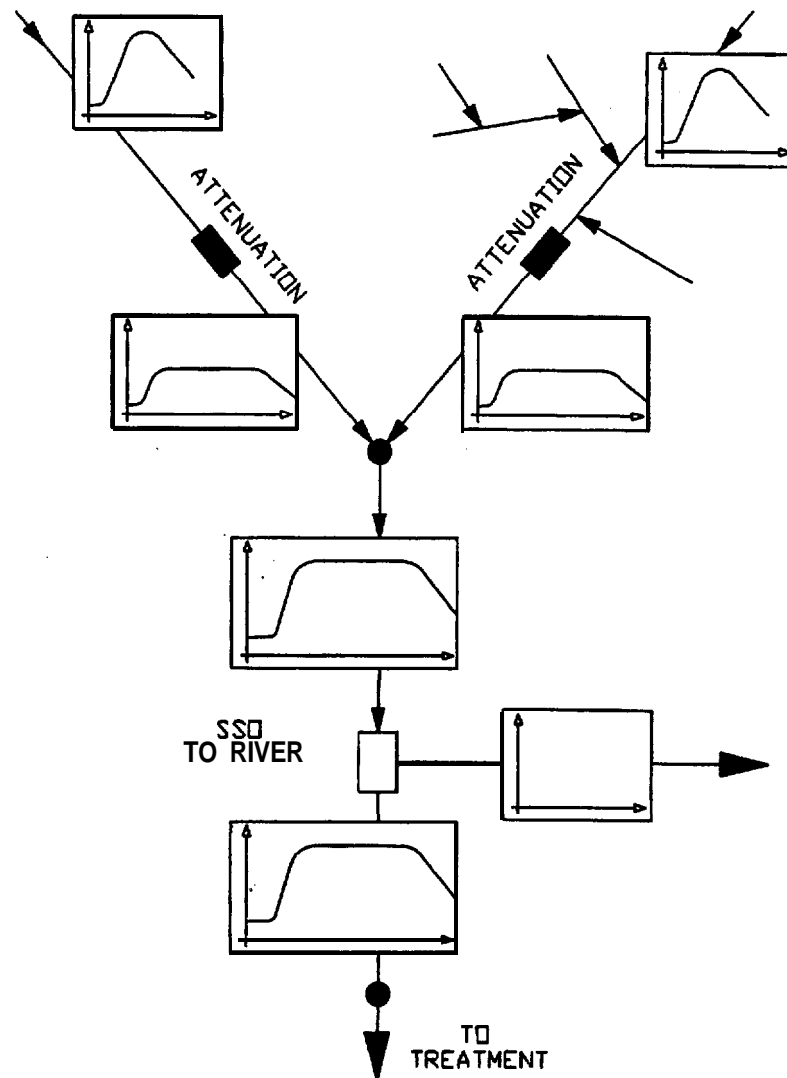

Figure 2. Hydrograph schematic showing effects of attenuation-no SSO discharge.

I/I in Structural Evaluation

When reviewing a videotape of an internal sewer inspection, keep in mind that infiltration can be causing structural deterioration on the pipe or brick sewer which will require rehabilitation before a collapse occurs. In addition, regular infiltration/exfiltration cycles occurring along a surcharged sewer can greatly accelerate structural deterioration, making it cost effective to rehabilitate the sewer before a collapse occurs.

It follows that assessment of the cost effectiveness of traditional I/I removal should consider the accelerated structural deterioration caused by infiltration and surcharging. The consequence and risk of failure of a sewer are the primary concerns in the WRc approach, for without the structure of the pipe, the savings of rehabilitation (compared with renewal) cannot be realized.

The following examples illustrate how infiltration and surcharging lead to accelerated structural deterioration.

Deformation of cracked pipes:

- *Stage 1:* Pipe cracking is caused by bad laying practice or subsequent overloading or disturbance. The sewer remains supported and held in position by the surrounding soil/bedding (see Figure 3A). Visible defects include cracks at soffit, invert and springing, and encrustation. (Encrustation is the process in which deposits containing dissolved salts, are left by the partial evaporation of infiltrating ground water. Infiltration may also be evident or visible.

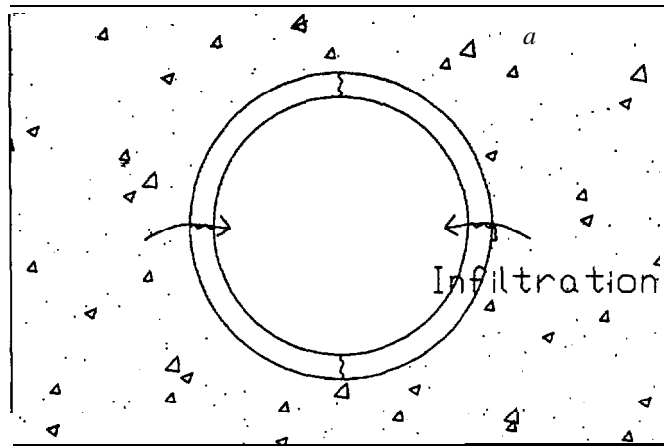

Figure 3A. Deformation of cracked pipes.

- *Stage 2:* Infiltration of ground water, or infiltration/exfiltration caused by surcharging of the sewer, washes in fine soil particles, creating voids (see Figure 3B). Side support is lost, allowing further deformation so that cracks develop into fractures. Side support may also be insufficient to prevent deformation if the original backfill was either poorly compacted or is of an unsuitable material. Visible defects include fractures, slight deformation, and encrustation. Infiltration may or may not be visible.

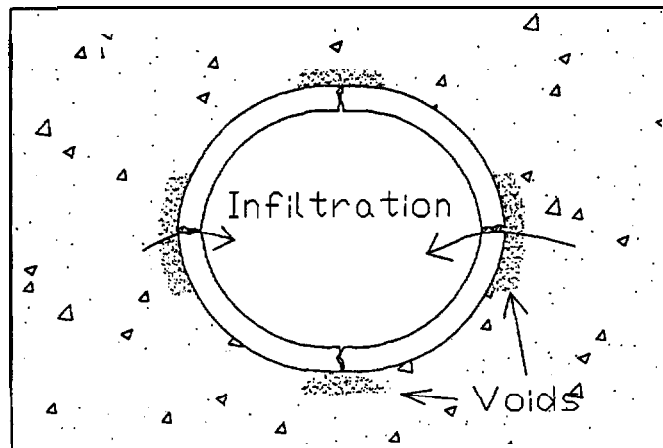

Figure 3B. Deformation of cracked pipes.

- Stage 3: Loss of side support allows the side of the pipe to move further outwards and the soffit to drop. Once the deformation exceeds 10 percent, the pipe becomes increasingly likely to collapse (see Figure 3C). Visible defects include fractures and deformation, possibly broken areas. Infiltration may or may not be visible.

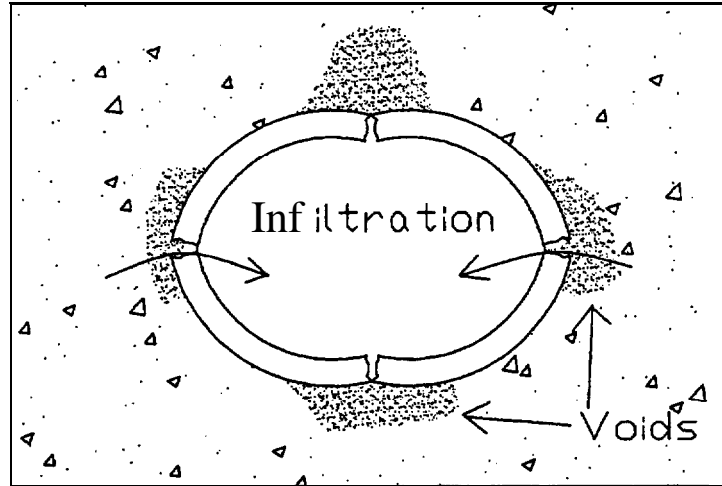

Figure 3C. Deformation of cracked pipes.

Subsidence of sewer:

- Stage 1: A gap occurs in sewer at a joint or a poor lateral connection (see Figure 4A). Visible defects include offset joint, badly made connection, and encrustation. Infiltration may or may not be visible.

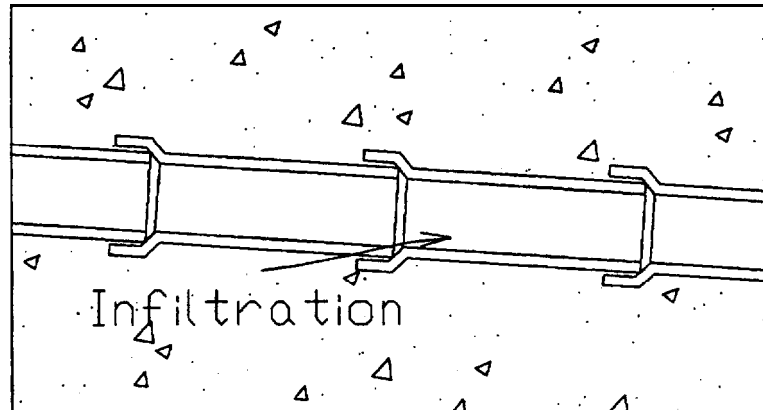

Figure 4A. Subsidence of sewer.

Stage 2: Infiltration of ground water or infiltration/exfiltration caused by surcharging of the sewer washes in soil particles. Loss of soil support around the sewer allows pipe to move, opening joints and increasing the inwash of soil (see Figure 4B). Visible defects include open and displaced joints and loss of line and level, Infiltration may or may not be visible.

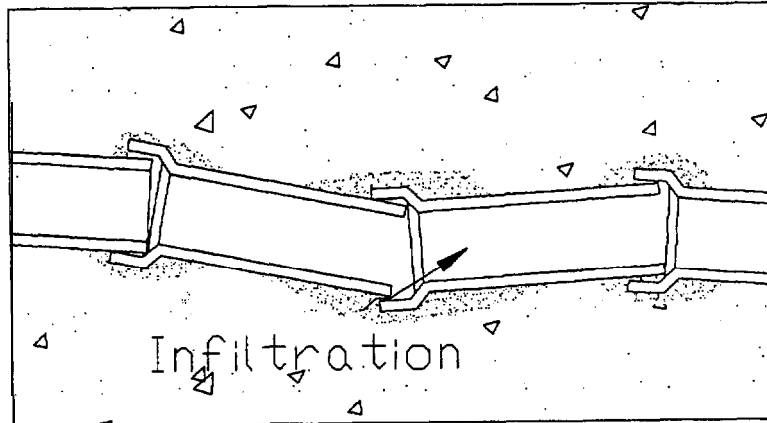

Figure 48. Subsidence of sewer.

- *Stage 3:* Uneven loading of pipes due to joint displacement causes cracking of pipes. The process then accelerates, and cracked pipes may also deform (see Figure 4C). Visible defects include open and displaced joints, cracked and fractured pipes, and loss of line and level. Infiltration may or may not be visible.

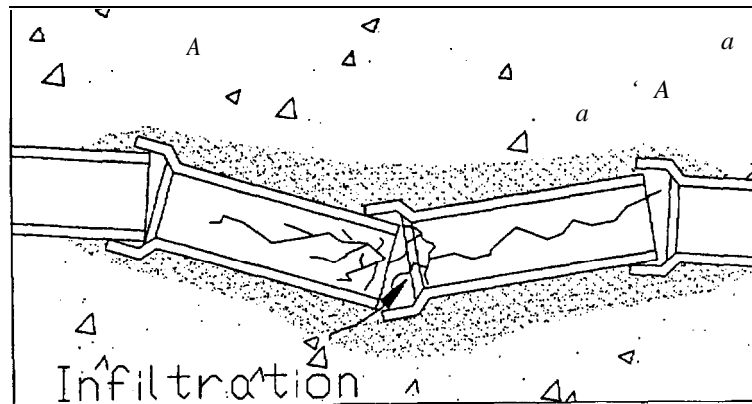

Figure 4C. Subsidence of sewer.

Integrated Approach

An up-to-date SSES to control and remove I/I must include:

- Understanding of how the structure of the sewer is affected by infiltration and surcharging.
- Evaluation of the entire drainage basin, not just where the overflow occurs.
- Modeling of flow at 1-second intervals.
- Development of hydraulic models that accurately replicate surcharging in the sewers.
- Integration of structural rehabilitation with hydraulic controls to use the latent storage of the upstream pipes.

- Use of sewer rehabilitation techniques to improve the structure and hydraulics, and to remove infiltration before collapse occurs.

A comprehensive and accurate understanding of any collection system will enable engineers to optimally manage peak flows and structural integrity.

The management of peak flows by redistributing the relatively short periods of high demand over a longer time makes the existing collection system work harder for longer and is preferable to the construction of new sewers. The inclusion of costs from accelerated structural deterioration due to infiltration and surcharging will make rehabilitation cost effective.

The implementation of this approach can be over the entire collection system; as new construction is minimized and the location of new works optimized, the least-cost solutions are achievable through this approach.

Sanitary Sewer Overflow Removal: The Approach Used by the Metropolitan Sewer District of Greater Cincinnati

Steve Donovan
Metropolitan Sewer District, Wastewater Collection Division, Cincinnati, Ohio

Background

Located within the hilly terrain of southwestern Ohio, the Metropolitan Sewer District of Greater Cincinnati (MSD) was created in 1968 with an agreement between the City of Cincinnati and Hamilton County. With this agreement the City of Cincinnati, the unincorporated areas of the county, and 33 municipalities became part of a countywide sewer district. Before this agreement, many of these political entities utilized the county sewerage system or their own municipal sewer systems.

MSD services 414 square miles containing over 3,150 miles of sanitary and combined sewers, more than 200,000 service connections, and six major treatment plants. The first combined sewer in Cincinnati came into service in the 1860s. New sewers are presently being designed for previously unsewered areas in the remote parts of Hamilton County.

Ohio Environmental Protection Agency Directors Final Findings and Orders

In 1992, the Ohio Environmental Protection Agency (OEPA) issued Directors Final Findings and Orders (DFFO) to MSD to identify, monitor, and submit a plan to eliminate sanitary sewer overflows (SSOs) from the separate sanitary sewer system within the district. MSD met the conditions and timetable set forth in the orders by submitting two separate reports to OEPA.

In the first report, submitted in March 1993, MSD was to identify all known SSOs and all sections of sewer that had reached or exceeded dry weather capacity. An initial investigation prior to the March 1993 report revealed 96 suspected overflow locations, but only 89 locations were confirmed to be SSOs. Several of the locations no longer existed or were verified to discharge into a combined sewer system. These locations were removed from the March report.

Field inspections of sewer sections suspected to have exceeded dry weather capacity confirmed only one system that had exceed capacity due to a large accumulation of debris.

A second report, entitled "General Compliance Plan To Eliminate Sanitary Sewer Overflows," was submitted in June 1993. In this report, each site was identified, and as the title indicates, a general plan to eliminate each site was described.

During the (i-month period prior to the submission of the June 1993 report, each site was monitored for frequency of overflow events to classify SSOs at each site into one of four categories of activity: highly active, generally active, generally inactive, or inactive. Classification depended on the overflow activity observed during the initial monitoring period.

Each SSO was found to have unique characteristics relating to its location; therefore, a site-specific plan for elimination was included in the June 1993 report. Although some sites required specialized remediation, common components of the preliminary plans included:

- Continue previously scheduled capital improvement projects (CIP).
- Perform sewer maintenance work.

- Perform site investigations.
- Perform storm water elimination investigations through the rain dependant inflow and infiltration (RDII) program.

A supplemental report was submitted in November 1994 to OEPA describing what MSD had done to minimize overflow events and which **SSOs** had been physically removed.

What Is an SSO?

SSOs are unique in characteristics, design, purpose and history. Therefore, each of these features needed to be identified before any remedial action could be taken. **SSOs** in Hamilton County are not merely manholes overflowing through the lid due to an overloaded collection system. In fact, only six of the initial 89 **SSOs** were overflowing manholes. Most of the **SSOs** were overflow pipes connected to a manhole at a strategic elevation that would best minimize damage to properties located near the **SSOs**.

In several areas, **SSOs** were found in "clusters," with multiple overflows within a few sewer sections of each other. In these locations the initial design elevation appears to have not properly protected the surrounding properties. Alternatively, as the neighborhoods became more developed, newer homes were built at a lower basement elevation than the existing homes in the vicinity, requiring a new overflow at a lower elevation. Evidence of this is seen in one location, where two overflows are less than 100 feet apart, with the lowest SSO elevation being less than a foot below the basement of the newest looking house on the street.

These **SSOs** may have acted as relief points by providing protection from flooding in the event of a catastrophic failure of the collection system or during emergency cleaning operations. Other locations appear to have been designed as short-term remedies to compensate for inadequate storm systems, with the intention of removing them after an upgraded storm system was built.

Two overflows initially reported to OEPA as **SSOs** were actually draining from a storm system into a sanitary system. These two locations have been bulkheaded and removed from the reporting list.

Of the 121 **SSOs** presently reported to OEPA, four are located in siphon manholes. In addition to the design of multiple pipes common to siphons, an overflow pipe was installed in the manhole to provide additional protection to property if both pipes become clogged. Typically these **SSOs** are not highly active.

Another common type of overflow found in Hamilton County is a pump station overflow (PSO). **PSOs** are not presently investigated as urgently as **SSOs** for several reasons. First, many **CIPs** are under way to provide backup power to existing stations without backup, or to replace the pump stations and force mains with gravity sewers. Second, the **PSOs** are installed in the event that there is a failure at the station, and they rarely overflow. Pump station maintenance is performed by the Treatment Division of MSD. **PSOs** are still monitored for overflow activity and reported to OEPA.

Fourteen sites identified as **SSOs** actually work as **PSOs**. These locations are several pipe sections upstream of a pump station, and would only activate if a failure occurred at the pump station.

Monitoring of SSOs

Each **SSOs** is visited at a minimum of once a week, and more frequently if a rain event occurs. A wooden block set in the overflow pipe indicates an overflow; simply stated, if the block is gone, the SSO is noted to have activated. Initially the blocks were laid loose in the overflow pipe, but as investigations of the sites became more involved, it was determined that each block should be attached to a string.

Doing this reveals whether the storm system is reversing into the sanitary system via the overflow connection. Attaching the block may also reveal any tampering.

Monthly Reporting

As required by the OEPA DFFOs, every month a report is submitted identifying each SSO and the number of days in the previous month that overflow appeared to occur. In addition, each health department in the affected areas is informed of overflow activity.

The original format of the monthly report, while retaining all the information required by OEPA, has been tailored to make the information more accurately reflect overflow activity. The present format also helps determine improvements from maintenance activities and storm water removal projects.

Original Results

Of the 89 confirmed SSO locations, only one was observed to have consistent dry weather activity. Elimination of this occurrence became the highest priority, prompting MSD to perform sonar and physical inspection to confirm a buildup of debris in the 42-inch pipe downstream of the SSO.

MSD spent several months modifying numerous manholes to facilitate large-diameter bucket cleaning equipment. At the same time, two grit pits were built under emergency contract. Upon the completion of these projects, MSD personnel proceeded to machine clean 7,700 lineal feet of sewer, removing an estimated 115 cubic yards of debris that had accumulated over 55 years. Concurrent with the cleaning activity, as many as four large basins tributary to this SSO were undergoing RDII elimination projects. The completion of the cleaning activity eliminated all dry weather overflows and, coupled with the RDII projects, minimized the wet weather impact on this structure.

The next priority was to reduce overflows in the group of SSOs classified as highly active, all of which were greatly affected by relatively small rain events. Based on the massive volume of storm inflow affecting these areas, each basin was automatically established as an RDII project area. By doing this, the district saved the time and expense involved with electronic flow monitoring while still moving toward eliminating the largest and most obvious sources of inflow. By removing these large sources first, greater accuracy can be achieved in identifying the impact that infiltration or less obvious inflow sources have on the collection system.

RDII Program

Stormwater identification and removal has long been a tool to help relieve overloaded collection systems from backing up into basements. Identifying these sources was relatively easy, but removal always became the greatest stumbling block. Every homeowner agrees basement flooding is not desirable. The average homeowner, however, is reluctant to dig in his or her front yard to alter plumbing that has been unchanged for as many as 50 years. Historically, MSD found that when dealing with the wide variety of political entities, it did not have the authority or enforcement power to require the removal of these easily identifiable inflow sources.

In 1991, armed with the OEPA DFFOs, the State of Ohio passed legislation that allowed MSD to reimburse homeowners up to a certain dollar amount to aid in the removal of illegal inflow sources. At a cost of over \$9 million, seven field investigation consultants have studied or are studying 36 areas tributary to SSOs. As of February 1995, 11,753 sources have been identified, and 6,757 have been removed. A total of \$6.3 million has been approved for reimbursement to homeowners for removal of inflow sources, which normally consist of downspouts, driveway drains, stairwell drains, or area drains connected directly to the sanitary sewer system. Exfiltration of storm systems, street inlet connections,

and vented manhole covers-all sources of storm water inflow-are not reflected in the numbers above because they are normally corrected by MSD personnel or the political entity responsible for the repair of the storm systems. The complete study and removal project is expected to continue into the year 2020.

As stated previously, the emphasis of the RDII program is to remove the obvious sources of storm inflow. If the amount of inflow removed does not eliminate overflows, the emphasis will shift to identifying less obvious sources of inflow and infiltration. Several areas presently being studied have necessitated the inspection of homes for sump pump use to help indicate the presence of foundation drains tied to the sanitary system.

Rain Gauge information

To help evaluate the effects rain has on SSOs, MSD has 11 mechanical and seven radio-controlled rain gauges installed throughout the county. Attempts to correlate rain events to overflow events prove difficult due to the localized nature of storms in the area (see Figure 1). The information provided does help track progress of stormwater removal projects, as well as maintenance work performed in the drainage area. Four additional radio-controlled rain gauges will soon be brought into service. These additional gauges will allow better coverage of rain events and more accurate correlation to overflow activity.

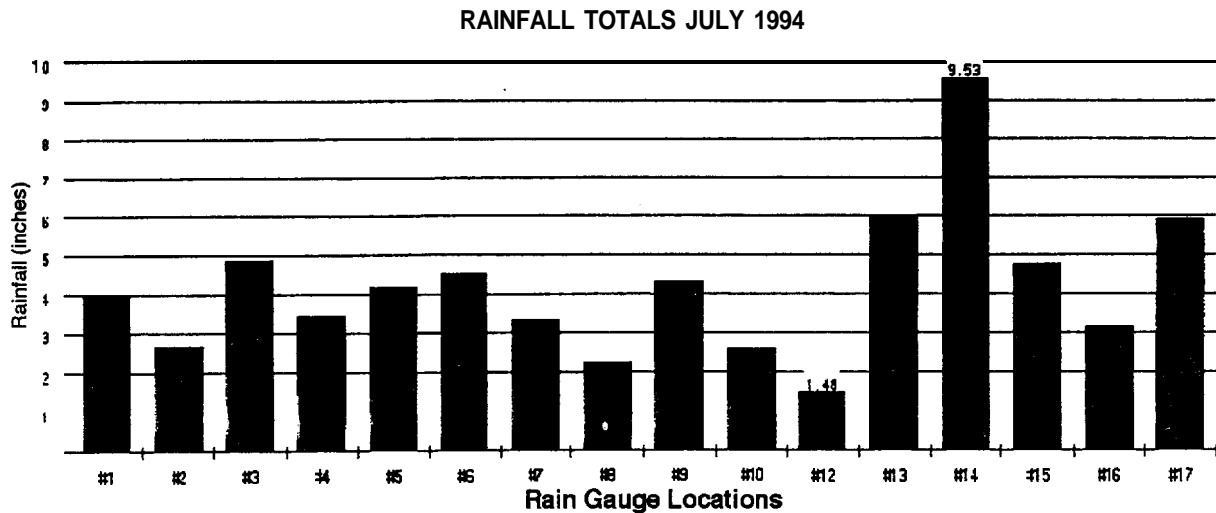

Figure 1. Example of variations in rain gauge locations.

Field Investigations

An effective investigation begins at the site of the SSO. Observations of the surrounding area are made noting the terrain, elevations of the homes, and indications of storm inflow. The manhole is physically inspected noting the overflow type, elevation, and characteristics of the discharge point. If there is an indication that the storm may reverse into the sanitary system, the pipe is fitted with a one-way flap gate. Several locations previously thought to have been SSOs were found to discharge directly to a combined sewer and were subsequently removed from the reporting list. The information relating to these locations has been retained in the event combined sewer separation projects are undertaken.

Also noted in the manhole inspection is the condition of the manhole, the flow characteristics, evidence of surcharge, and the condition of the pipe. Each manhole in a drainage basin should be inspected. Manhole inspections by MSD field crews and RDII consultants have found 32 previously unidentified

SSOs. In some cases, the existence of these additional **SSOs** directly affected the known **SSOs**. Attempts should be made to inspect the location during a rain event. Runoff and inflow characteristics can be observed at this time that would not otherwise be anticipated during dry weather inspection. Human involvement and physical observations are extremely valuable for collecting overflow data.

Research

Underground plans, customer complaints, and various historical records are researched in an attempt to discover the original purpose of the SSO. Unfortunately, due to inadequate records turned over to MSD at its formation, much of this information is speculative. Based on site considerations, the present behavior of the sewer system, and the behavior of the respective SSO, it is sometimes possible to make an educated guess as to what may have influenced the existence of an overflow at a particular location. By reviewing this information, there is a better opportunity to reverse the process that contributed to the overflow.

When records are available, trends in frequency and type of customer complaints are reviewed to determine what conditions existed prior to the overflow. Older underground records may show how an SSO originated. In one such example, a pipe that existed before the county interceptor sewer was built in the 1930s served as the sanitary discharge to a creek. Village drawings turned over to the district showed this pipe as the outfall of the existing collection system. In addition, the contract drawings for the county interceptor noted that this line should "serve as an overflow" after the collection system was connected to the interceptor. By studying the two prints, we were able to recreate the sequence of events that led to the creation of this overflow, but the reasoning is still unknown.

Maintenance Work

Television

The most valuable tool for determining the condition of the collection system is closed-circuit television inspection. MSD uses both closed circuit television and sonar inspections. In most cases, the sewer system is televised to a location where the rim elevation of a manhole is lower than the overflow elevation. Television inspections have revealed debris, roots, grease, and pipe defects that directly affect the **SSOs**. Field observations during a rain event may help pinpoint sections of sewer that need more immediate attention.

Cleaning

Cleaning of the sewer system downstream of an SSO has proven most effective in eliminating overflow events. This was illustrated earlier, in the reference to the single SSO that overflowed during dry weather. Additional yards of debris and various amounts of roots have been removed in small diameter pipes in an attempt to restore the capacity of the collection system.

Areas subject to pipe obstructions are placed on a yearly maintenance schedule until the sewer can be rehabilitated to eliminate the reoccurrence of problems.

In many sewer systems following creeks through heavily wooded areas, advances in off-road cleaning equipment have been utilized. A John Deere four-wheel-drive farm tractor, fitted with a hydraulic root cutting system, has proven extremely productive in these areas.

Repair and Rehabilitation

When television work or cleaning operations reveal minor pipe defects or root intrusion, the affected sections of sewer are routinely considered for internal rehabilitation or repairs. MSD has used cured-in-place pipe in many cases, while other areas have had point repairs or manhole-to-manhole replacement performed by means of open excavations, tunneling, or other pipe replacement processes. This type of work can be performed relatively quickly, usually within a year after the request is made for repair.

Capital Improvement Projects

On a much larger scale, replacement of major trunk lines are addressed through capital improvement projects (CIPs) administered by the Division of Planning and Program Management (PPM). Even prior to OEPA's issuance of DFFOs, several trunk lines were determined to be in disrepair and/or of insufficient size to service the rapid development tributary to these lines. Designs to replace these systems will affect as many as 58 SSO locations. Eleven locations were physically removed during CIP projects completed since the initial reporting to OEPA. The estimated cost of CIP in the planning and design phase is \$50 million with approximately \$5 million already spent to remove the aforementioned 11 SSOs. In addition to several locations submitted as an addendum to an existing CIP, completed SSO investigations have prompted requests to eliminate eight more SSOs through CIPs at an estimated cost of \$2 million (see Figure 2).

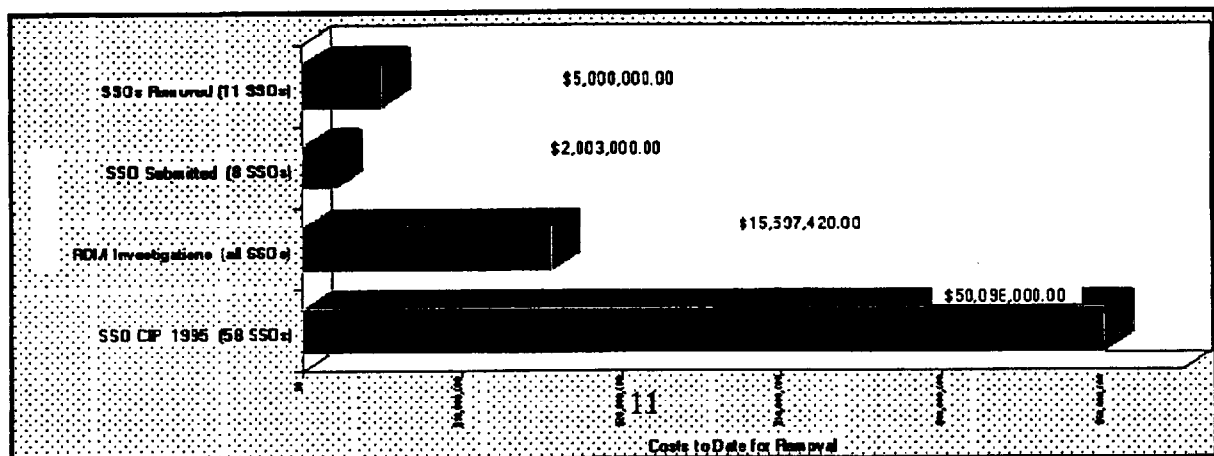

Figure 2. Cost of removal.

Modifications

Given the amount of time needed to complete removal of inflow sources identified by RDII projects and to complete sewer replacements, MSD has also chosen to implement short-term approaches to minimize overflows. At several locations, investigation revealed the SSO occurred at less than full pipe. If the elevations of nearby basements allowed, the overflow was raised to a higher elevation, thereby increasing the amount of flow needed to activate the overflow. Four locations have been altered in this way (see Figure 3), decreasing the total discharges to 21 since the modifications. This is a decrease from the 144 discharges that had occurred prior to modifications.

Current Results

MSD is presently reviewing information to determine which SSOs can be considered for removal from the reporting list to OEPA. Current customer complaints are being reviewed in areas where the SSOs have shown little or no activity since the beginning of the monitoring program. Once it is determined no chronic basement flooding is occurring, the drainage basin will be field investigated to ensure no unidentified SSOs are in the area. If no overflow points are found, a request for removal of the location from the reporting list will be submitted.

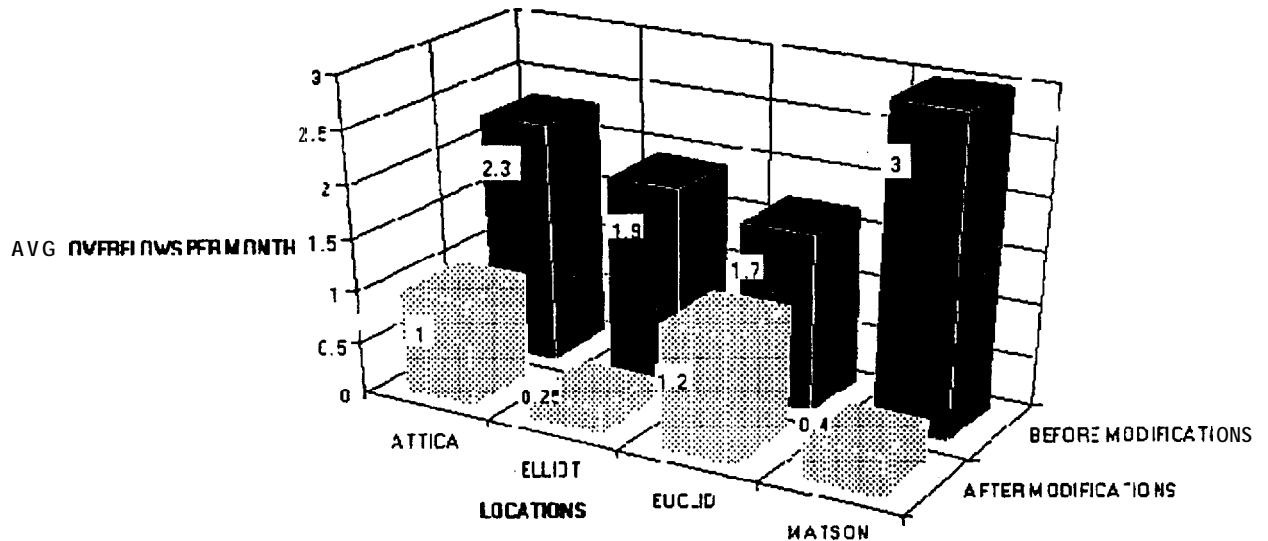

Figure 3. Average overflow of SSOs with modifications.

In the long term, once projects are completed that may remedy conditions contributing to SSO activity, the locations will be monitored for a given period to ensure the overflow is no longer a chronic problem. Based on prolonged inactivity, these locations will be submitted for consideration to be removed from the reporting list.

Presently MSD reports 121 SSOs, with an average of 59 overflows a month for the 12-month period in 1994. This average is slightly higher than the original average of 54 times a month for 89 SSOs monitored for a 6-month period in 1992. Storm conditions, months monitored (6 months versus 12 months), and the discovery of several highly active SSOs in 1993 and 1994 have contributed to the higher overflow average. As a comparison, in 1993 109 SSOs overflowed an average of 49 times a month for the 12-month period (see Figure 4).

MSD's focus is to minimize overflow events, not the elimination of the structures themselves. With further removal of inflow sources, repairs, and major sewer replacements, MSD expects to reduce the number of overflows in 1995 even more than in previous years.

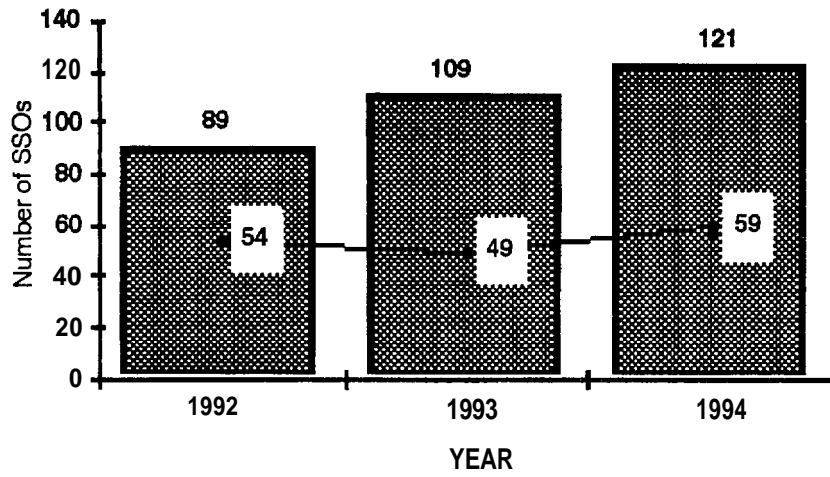

Figure 4. Average overflows per month, showing number of ssos.

The Facility Plan To Mitigate Sanitary Sewer Overflows in Charlotte, North Carolina

Jacqueline A. Townsend
Charlotte-Mecklenburg Utility Department, Charlotte, North Carolina

S. Wayne Miles
Camp Dresser & McKee, Inc., Raleigh, North Carolina

introduction

Many cities and metropolitan areas, such as Charlotte and Mecklenburg County in North Carolina, are identifying and assessing the need for improvements to the infrastructure, both to maintain existing facilities and to meet growth demands. There have been reports around the country of failing infrastructure due to age, lack of maintenance, system overloading, and lack of funding to support necessary improvements. Maintaining sanitary sewer systems and implementing a program to mitigate sanitary sewer overflows (SSOs) can be an overwhelming task. The Charlotte-Mecklenburg Utility Department (CMUD) has developed, with the assistance of Camp Dresser & McKee, Inc. (CDM), a cost-effective plan to address existing deficiencies as well as potential problem areas within the sanitary sewer system.

CMUD is a financially self-supported department within the City of Charlotte government. The department provides water and sanitary sewer services to Charlotte and Mecklenburg County. The sanitary sewer system consists of approximately 2,500 miles of sewer lines that range in diameter from 4 to 78 inches, with approximately 10 major pumping stations. CMUD operates and maintains five wastewater treatment plants with a total capacity of 79 million gallons per day. Plant expansions are under way to increase capacity to 92 million gallons per day. The current capital improvement program for the sanitary sewer system totals \$309.9 million for the next 5 years.

The rapidly growing Charlotte-Mecklenburg area is a major regional center for commercial and industrial development. The population, a little over a half million, is expected to increase 17 percent by the year 2000. This projected growth, coupled with an aging sewer infrastructure, presents CMUD with the serious challenge of how to economically identify, reduce, and eliminate SSOs.

In the mid-1980s, rainfall-induced overflows from major interceptors of the CMUD sewer system were reported. In 1987, ADS Environmental Services, Inc., performed an inflow and infiltration (I/I) study to identify excess sewer flows and determine the intensity of these flows. The study assessed a major portion of the CMUD sewer system, specifically the McAlpine, Sugar, and Irwin Creek basins (see Figure 1), and verified high-priority areas. There are 13 major subbasins within this 240-square-mile study area. The study concluded that approximately 80 percent of I/I was occurring in approximately 40 percent of the system.

As a result of this study and its second phase, CMUD decided to evaluate a portion of the system as a pilot and determine whether rehabilitation would be cost effective for reducing I/I and what methods would work best. CMUD also wanted to look at the sewer system as a whole and determine major facilities needs to mitigate SSOs and meet future growth. CMUD contracted with CDM to perform a Sewer System Evaluation Study (SSES) of the pilot areas and to complete a facility study for the system (McAlpine, Irwin, and Sugar Creek basins).

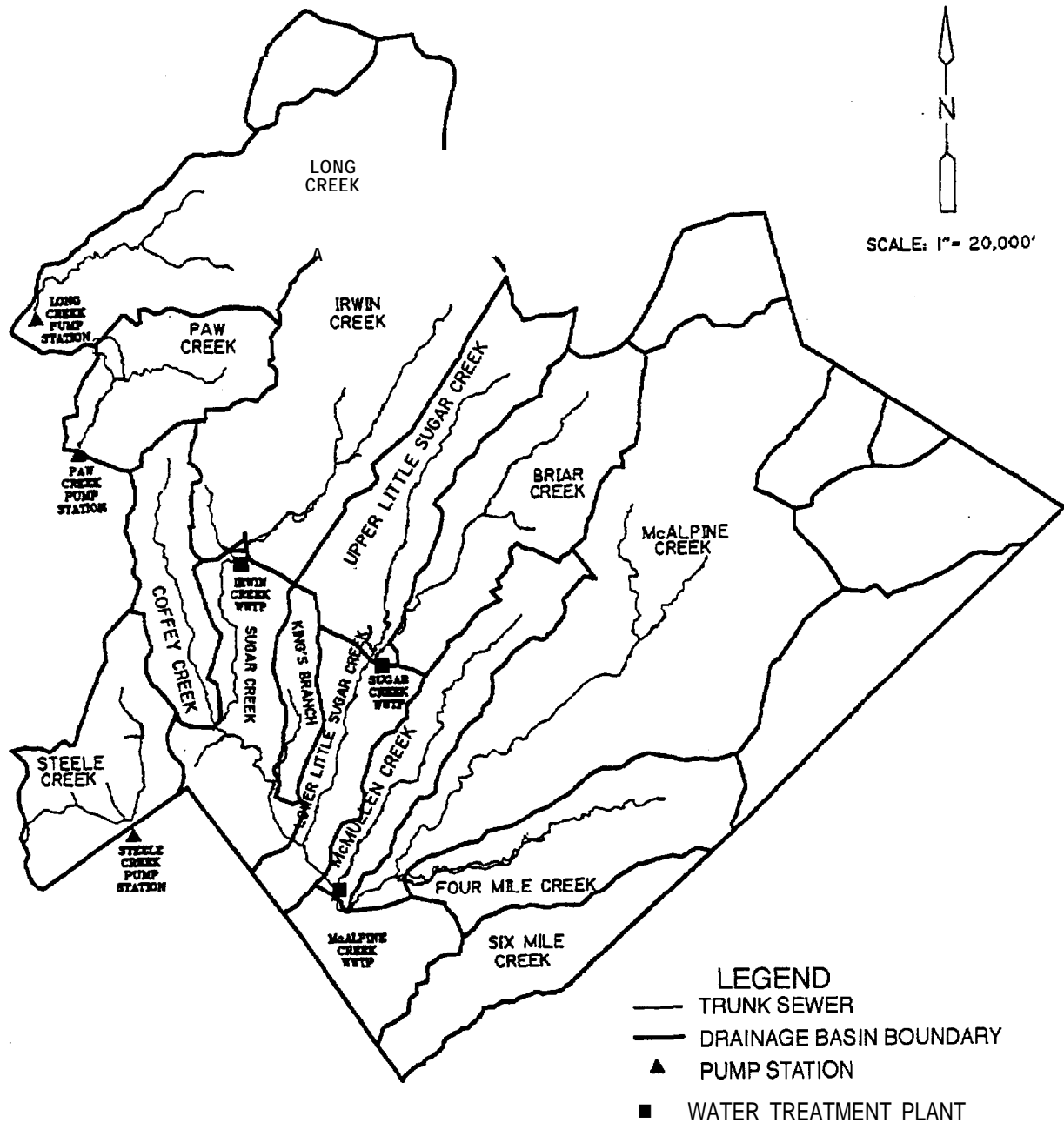

Figure 1. Location of major facilities and drainage basins.

The initial project was called "Sanitary Sewer Evaluation/Rehabilitation/Flow Equalization." The main objective of the project was to eliminate rainfall-induced overflows quickly and cost effectively. Individual goals of the project were to:

- Study the hydraulics of the sewer system to identify "bottlenecks" or restrictions and make recommendations for improvements.
- Determine whether flow equalization facilities were a feasible and cost-effective solution.

- Complete the SSES and rehabilitation in the pilot areas to determine whether this was a cost-effective solution.

The sanitary sewer facility plan completed by CDM addressed these goals, specifically identifying sanitary sewer system improvements necessary to reduce and or eliminate wet weather SSOs and to accommodate future growth in the study area in a phased, planned approach through the year 2025. The facility plan includes a combination of flow equalization, trunk relief sewers, and sanitary sewer system rehabilitation to accomplish CMUD's goals. A computer model of the sewer system for the study area was developed to complete the trunk sewer analysis. CMUD was provided with the model as a part of the project and is currently using it. The sewer system modeling is discussed further in this paper.

CMUD's project team included representatives from engineering, maintenance, treatment, and administration divisions to enable comprehensive communication of the goals and agreement with the program of improvements outlined in the sanitary sewer facility plan. This also assisted CDM in the collection of information, such as historical and maintenance data and past approaches to mitigating SSOs.

Sewer System Modeling

The approach taken to develop the program varied from the traditional SSES approach, which places heavy emphasis on system inspection and rehabilitation. Instead, the SSES was performed on a smaller scale in conjunction with flow monitoring and comprehensive computer modeling of the sewer system under wet weather conditions. Application of the trunk sewer system model allowed both identification of hydraulic bottlenecks in the system that caused overflows and evaluation of the effectiveness of various improvement alternatives to mitigate overflows (e.g., relief sewers, sewer rehabilitation, and system storage). Planning scenarios were developed and evaluated with the model that combined 5-, 10-, and 30-year planning horizons with wet weather planning criteria based on storm events with 2-year and 10-year return periods. These planning periods were selected by the project team as the range of conditions to be evaluated for control.

The hydraulic model of the major trunk sewers in the CMUD system was developed using the EXTRAN block of the Stormwater Management Model (SWMM) of the U.S. Environmental Protection Agency (EPA). EXTRAN was chosen for two primary reasons: 1) its ability to handle surcharging, backwater, and overflow conditions, which were common in the trunk sewer system; and 2) its ability to route hydrographs dynamically and predict a time-varying series of flows and water surface elevations throughout the system during a wet weather event. EXTRAN is a dynamic model that allows simulation of an entire storm event, in contrast to a steady-state or static model that models the system for only one point in time.

The use of a dynamic model was important in the evaluation of the alternative sanitary sewer system improvements to assess the impacts of different sizes and locations of flow equalization storage. The dynamic model also assisted in considering several other important factors, such as the timing of hydrograph peaks from the tributary sewers, the impacts of different line sizes on the shapes of hydrographs, and the benefits of sewer rehabilitation in reducing peak rainfall-dependent infiltration and inflow (RDII) flows and volumes. Because the model included the entire trunk sewer system, the analysis considered the impacts that improvements would have on the downstream portion of the system.

Wastewater flows in the system were projected by dividing flows into dry weather and wet weather components and analyzing each component independently. Dry weather flow projections were developed using unit flow factors (e.g., gallons per day per dwelling unit, or gallons per day per acre of commercial development) and local population and employment projections. Unit flow factors were calibrated using flow data gathered from short- and long-term flow monitors throughout the system and land-use data. Migration of I/I was addressed by examining antecedent rainfalls.

Wet weather flows in the system were predicted using a unit hydrograph method. The method relied on fitting three triangular unit hydrographs to develop RDII hydrographs that best simulated the RDII hydrograph recorded with flow monitors. An RDII model was developed based on this proven method (1). The unit hydrographs were calibrated by varying parameters that affect the peak flow and the shape of the hydrograph, such as the time to peak, the time of recession, and R value (the fraction of rainfall volume that enters the sewer system as RDII). The unit hydrograph model allowed an evaluation of sewer system performance synthetic rainfall events with 2-year and 1 O-year return periods. Future flow projections did not take increasing infiltration rates into account, although the pipes' age was initially evaluated.

Pilot Area Rehabilitation

The pilot area rehabilitation project provided an opportunity for evaluating whether rehabilitation of the collection system was a cost-effective solution for reducing I/I in the CMUD system. The project would further help CMUD determine which methods of rehabilitation were most effective for its system. The results of rehabilitation (discussed below) were incorporated into the facility plan. The pilot areas CMUD selected for analysis were located in the upper reaches of two major drainage basins: McMullen Creek and Four Mile Creek (see Figure 1). These areas were selected based on the 1987 ADS I/I study results, which indicated that they were major I/I contributors. The pilot areas were approximately 8.9 square miles in sewershed area and covered approximately 91 miles of sanitary sewer, which is about 4 percent of the CMUD sewer system. The pilot areas were divided into 59 mini-sewersheds, with an average of 8,200 feet of sewer in each. Pipe material, age, and land use in the pilot areas were similar.

Initially, extensive SSES work was completed in these areas. This included television inspection, smoke testing, manhole inspection, dye testing, and flow isolation. The mini-sewersheds were then placed in categories according to what each area was experiencing, such as high I/I or high inflow/low infiltration. Due to budget constraints, not all of the mini-sewersheds could be rehabilitated. The mini-sewersheds were prioritized and grouped according to which areas were most severe. In selecting areas to rehabilitate, consideration was given to the ability to facilitate post-flow-monitoring to gather data comparable with prerehabilitation monitoring data. Four mini-sewersheds were selected to perform rehabilitation work. In addition, CMUD sewer maintenance staff completed repairs in other mini-sewersheds within the pilot areas. This work consisted mainly of replacing manhole rings and covers, adding manhole inserts, line cleaning, and other point repairs. One of these mini-sewersheds was included in the post-flow-monitoring analysis.

Because a main goal of the pilot sewer rehabilitation project was to evaluate the effectiveness of various methods of rehabilitation to remove I/I in the CMUD system, comprehensive and point repair rehabilitation were used. A comprehensive approach involves continuous rehabilitation of every foot of sewer in each area rehabilitated, although not all manholes were rehabilitated. Comprehensive rehabilitation included repair of service connections and laterals to the private property line using inversion lining, sliplining, and comprehensive grout sealing of cracks and pipe joints. Taking a point repair approach would involve only repairing pipe segments and manholes that were identified as defects during the SSES and repairing or removing major inflow sources such as storm drain connections.

Each of the four areas were rehabilitated using one method throughout to measure the effectiveness of each technique. A comparison analysis of comprehensive rehabilitation versus point repair rehabilitation was also important. It was expected that the comprehensive methods would prove to be more effective but also more costly. Life-cycle analysis was not performed.

Flow monitoring was used to measure the effectiveness of each rehabilitation technique. Flow monitors were placed in the same locations as during prerehabilitation monitoring. Areas that were not rehabilitated were also selected for flow monitoring to act as control areas that would allow proper evaluation of the results. A variety of parameters affect the volume and peak flows entering the sewer system, such as ground-water levels, rainfall duration and intensity, and the duration between rainfalls.

The control areas take these parameters into account to give the truest possible comparison and evaluation of rehabilitation.

CDM's evaluation and subsequent selection of each control area also considered similarities to the rehabilitation areas, such as age of sewer, location of the control area to the rehabilitated area, land use, and a determined correlation coefficient. The correlation coefficient was determined by performing a linear correlation between each rehabilitation area and its corresponding control area. A total of 12 mini-sewersheds were monitored (five rehabilitated areas and seven control areas). Three rain gauges were placed in the pilot areas. Postrehabilitation flow monitoring was performed when ground-water tables were at levels similar to those during prerehabilitation flow monitoring.

During the analysis, several considerations were made in evaluating results. Some of these included the accuracy of the flow monitors, the rainfall variations, and changes in other conditions compared with the prerehabilitation monitoring period. Linear relationships were made based on the volume and peak RDII by comparing a determined RDII coefficient for each control and rehabilitated area. This analysis allowed the comparison of the areas before and after rehabilitation. Similar analysis was completed to evaluate the results of rehabilitation in reducing peak RDII into the sewer system (2).

The analysis indicated approximately a 60 to 70 percent reduction in RDII volume using the comprehensive rehabilitation approach and a 10 to 40 percent reduction using the point repair approach. Comprehensive rehabilitation demonstrated a range of about 40 to 60 percent reduction in peak RDII, and point repair demonstrated a range of about 0 to 25 percent. Although this analysis was limited by the number of areas rehabilitated as well as the number of rainfalls that could be compared, it was still helpful in guiding CMUD in future rehabilitation efforts. Postmonitoring evaluation of rehabilitated areas will continue as the pilot areas are completed to provide additional documentation and guidance.

CDM also completed a cost-effectiveness analysis of the type of rehabilitation methods and techniques used in the mini-sewersheds. The relative cost per foot of rehabilitated area compared with the size of the entire area and the percentage reduction in RDII is the true indicator of determining the best options for rehabilitation. This study determined that for the CMUD system, comprehensive rehabilitation was more effective in reducing RDII than point repair. This study also demonstrated, however, that the point repair approach was fairly effective. The relative construction costs were similar: the comprehensive approach cost \$45 to \$55 per foot, with a 60 to 70 percent reduction in RDII volume; the point repair approach cost \$30 to \$45 per foot actually rehabilitated, with a 10 to 40 percent reduction in RDII volume. The comprehensive approach, however, was considered more effective and worth the additional expense.

Overall, the results of the analysis indicated the following:

- Each area should be examined individually to determine the rehabilitation method and the reduction goal in that area.
- Rehabilitation of the collection system has a significant impact on reducing RDII volumes and peak flows that enter the main sanitary sewer system, and should be included as part of CMUD's long-range plan.

Long-Range Facility Plan

CMUD's long-range sewer facility plan outlines a phased, cost-effective approach to eliminating or reducing SSOs and meeting future growth needs. Each phase of the study-the sewer trunk analysis, flow monitoring, SSES, and pilot area rehabilitation-contributed to this comprehensive plan. CMUD needed to look at the system as a whole, from the treatment plants to the collection systems. In the past, CMUD had completed an SSES with no followup rehabilitation plan, or had completed "spot" rehabilitation throughout the system with no measurable results. The facility plan would provide a "map"

by which to implement needed improvements as well as continually monitor and analyze the system for future needs. Both dry weather conditions and wet weather conditions were studied. Rainfall duration, intensities, and variations proved to be key in evaluating the system and recommending improvements. During the study of the trunk sewer analysis and calibration of the hydraulic model, it was determined that the **2-year** and the 1 O-year storm events represented a reasonable range of planning storm events for evaluating the needs of the CMUD system. The **2-year** storm represented the minimum control goal for the CMUD system. The 1 O-year storm was considered the maximum practical control because of widespread roadway flooding that occurs beyond this event.

The recommended long-range sewer system improvements plan is summarized in Table 1. The plan is divided into four phases and recommends improvements to the year 2025 as follows:

- Phase *I*: Recommendations of improvements for the system to the year 2000 to mitigate **SSOs** and meet future needs.
- Phase *II*: Recommendations of improvements for the system to the year 2005, including improvements to mitigate overflows related to the **2-year** storm event (with 2025 dry weather conditions), which meets state regulatory requirements.
- Phase *III*: Recommendations of improvements to the year 2015.
- Phase *IV*: Recommendations of improvements to the year 2025.

The three basic type of improvements recommended were trunk relief sewers, flow equalization storage (both at the treatment plants and within the system), and sewer system rehabilitation. For each phase of the plan, a variety of options was provided for CMUD to evaluate. CDM and CMUD worked together to consider the best options for each drainage basin and major trunk system. In addition to the major system improvements proposed, sewer rehabilitation was recommended primarily to maintain the existing collection system infrastructure.

It was shown during the postrehabilitation monitoring of the pilot areas that collection system rehabilitation can contribute to a decrease in **RDII** entering the sewer system. The amount reduced will not accommodate the future growth capacity needed but may reduce or delay improvements necessary to meet wet weather conditions. The benefit to the system is also dependent on the type, amount, and area of rehabilitation completed. Certain areas may not contribute a substantial reduction in wet weather flows to justify comprehensive rehabilitation.

CMUD has incorporated the long-range facility plan into the **5-year** capital improvement plan and the **10-year** needs assessment plan for Charlotte-Mecklenburg. The costs are phased according to the time necessary to design and build the improvements. Recommended projects that are ongoing or have been completed include design of flow equalization facilities at the Sugar Creek Wastewater Treatment Plant and a completed flow equalization facility at **McAlpine** Wastewater Management Facility. CMUD will continue to use the computer model to evaluate the sewer system as improvements are implemented, or to evaluate problems within the system.

It became evident through the study that **SSOs** can be traced to a series of events within the sewer system and not necessarily one local problem. Careful evaluation of the system and proper planning will provide the most cost-effective approach to mitigating **SSOs** and meeting future capacity needs.

Table 1. Estimated Costs and Implementation Schedule of Recommended Sewer System Improvements

Project Description	Facility Description				Estimated Capital Cost			Phase Subtotals
	Sewer Length (Range of Dia.)	Storage Volume (MG)	When Needed for Dry Weather Flows	Planning Storm Event Controlled*	Relief	Storage/Pumping	Total	
<i>Phase I (completed by 2000):</i>								\$14,760,000
Irwin Creek Relief Sewer, Flaw Equalization Storage and Pumping Station	21,400 ft (3048 in.)	15 (at plant)	2000	P-year	\$4,850,000	\$4,550,000	\$9,400,000	
Four Mile Creek Relief Sewer	20,500 ft (24-30 in.)		2000	2-year	\$3,260,000		\$3,260,000	
Steele Creek Relief Sewer and Pump Station Upgrade	10,400 ft (18-21 in.)		2000	P-year	\$1,600,000	\$500,000	\$2,100,000	
<i>Phase II (completed by 2005):</i>								\$32,110,000
McAlpine Creek Relief Sewer	82,800 ft (24-78 in.)		2005	2-year	\$21,580,000		\$21,580,000	
Briar Creek Relief Sewer	56,900 ft (1848 in.)		2005	2-year	\$10,530,000		\$10,530,000	
<i>Phase III (completed by 2015):</i>								\$11,060,000
Taggart Creek Relief Sewer	14,500 ft (24-30 in.)		2025	2-year	\$2,370,000		\$2,370,000	
Paw Creek Relief Sewer	17,600 ft (18-21 in.)		>2025	P-year	\$2,540,000		\$2,540,000	
McMullen Creek Flow Equalization Storage and Uostream Relief Sewer	15,100 ft (18-24 in.)	2.2 (in system)	2025	2-year	\$2,200,000	\$3,950,000	\$6,150,000	
<i>Phase IV (completed by 2025):</i>								\$4,510,000
Lower Little Sugar Creek Relief Sewer	20,300 ft (18-36 in.)		2025	1 0-year	\$4,510,000		\$4,510,000	
TOTAL								\$62,440,000

*The return period of the storm event for which overflows are eliminated by the recommended sewer facility improvement.

References

1. Giguere, P.R., and G.C. Riek. 1983. Infiltration/inflow modeling for the East Bay (Oakland-Berkeley area) I/I study. Presented at the International Symposium on Urban Hydrology, Hydraulics, and Sediment Control. University of Kentucky, Lexington, KY (July).
2. Charlotte-Mecklenburg Utility Department. 1985. Results of pilot sewer rehabilitation project. Technical memorandum. Charlotte-Mecklenburg Utility Department, Charlotte, NC.

Correcting Sanitary Sewer Overflows: An Evaluation of the East Bay Infiltration/Inflow Correction Program

Thomas E. Harvey and Judith D. Parker
East Bay Municipal Utility District, Oakland, California

Paul R. Giguere
Montgomery Watson, Walnut Creek, California

Introduction

The East Bay Municipal Utility District, Special District No. 1, provides wastewater transport and treatment services to the seven communities of Alameda, Albany, Berkeley, Emeryville, Oakland, Piedmont and the Stege Sanitary District. Each of the communities owns and operates its own separate sanitary sewer collection system, which conveys wastewater to the District's interceptor system located along the East Bay shoreline. Wastewater is transported by the interceptor system to the District's main wastewater treatment plant. The District and the communities have been cooperating since 1975 to solve the regional wet weather problem.

The wet weather problem is caused by excessive quantities of infiltration/inflow (I/I) entering the collection system during periods of rainfall. Moderate to heavy rainfall can cause so much water to enter the collection system that backups occur and dilute raw sewage overflows to the streets, private property, and San Francisco Bay. Under saturated soil conditions, over 18 percent of the rain falling on the District's service area entered the sanitary sewer system. (In some areas, this was as high as 50 percent.)

Parts of the communities' collection systems would overflow virtually every time it rained due to capacity restrictions. In addition, the District's interceptors did not have sufficient capacity to handle all the flows delivered by the community sewers. Overflows were estimated to occur approximately 10 times per year from seven interceptor locations. These overflows discharged approximately 180 million gallons of diluted raw sewage directly to San Francisco Bay.

In 1975, the District prepared a report on the control of wet weather overflows. This brief I/I analysis led the District and the communities to enter into a joint powers agreement to conduct a sewer system study, the East Bay I/I Study. This state-of-the-art study began in 1980 and ended in 1985. The study included, among other analyses, flow monitoring at over 350 locations in the collection system, rainfall monitoring, physical manhole inspections, smoke testing of 4.3 million feet of sewers to detect inflow, lateral testing, remote televised inspections, and a cost-effectiveness analysis. The study determined where the collection system must be repaired and where additional wet weather capacity was required to eliminate overflows. The District also developed a wet weather facilities program to increase the capacity of the interceptor system and provide treatment for the wet weather flows.

The I/I study's key objective was to develop a program which combined community collection system rehabilitation and District improvements to prevent overflows at the lowest total regional cost. Study results revealed this cost to be at a point where:

- The communities reduce I/I by approximately 30 percent overall.
- The District builds larger facilities to accommodate the I/I corrected flows.

The communities' I/I correction program reduces peak wet weather flows from 1.1 billion gallons per day to 765 million gallons per day (mgd). Overall this program involves rehabilitating 39 percent of the community sewer system and constructing 87 miles of relief sewers. The District's wet weather facilities

program projects include an expansion of the main wastewater treatment plant, two new storage basins, four new remote treatment plants, new and upgraded pumping stations, and 7.5 miles of new interceptors. The wet weather facilities program increases the regional capacity to treat peak flows from 290 to 775 mgd.

Both the District and the communities were responding to regulatory requirements to eliminate overflows from their systems. National Pollutant Discharge Elimination System (NPDES) permits required compliance with discharge requirements by July 1988, as mandated by the federal Clean Water Act. In addition, the California Regional Water Quality Control Board (RWQCB) mandated the elimination of wet weather overflows through the issuance of a cease and desist order (CDO). Because it was not technically or economically feasible to implement either the communities' or the District's programs by that date, the District and the communities submitted compliance plans that presented the programs and schedules each would use to achieve compliance with discharge requirements. RWQCB accepted the compliance plans in 1986.

The I/I correction program initially required 20 years to implement. During the seventh year of implementation, the communities revised their compliance plans and schedules to better match their ability to execute the I/I correction. This resulted in extensions to the compliance schedules for some communities. I/I correction is proceeding in the East Bay, and progress can be seen in the reduction of overflows in areas where public health was a major concern. In addition, the majority of the District's wet weather facilities are operational and have effectively eliminated untreated wet weather overflows from the District's interceptor system.

I/I Correction

Infiltration is attributable to rainfall percolating through the soil to defective pipes, joints, and connections. The nature and magnitude of infiltration depend on soil moisture content, rainfall patterns, and the condition of the existing collection system. Because of this, a collection system will react differently to similar rainfall events, depending on the preceding rainfall and weather conditions. As an example, flows would differ greatly if the rainfall event were preceded by several weeks of dry weather as opposed to a prolonged period of wet weather. Therefore, a correlation of measured rainfall to infiltration entering a particular system is impossible to predict without several years of historical data. To accurately quantify extraneous flows entering a collection system, total flows must be measured. This includes flows that are contained within the system plus uncontrolled system overflows or bypasses. Complete and accurate flow monitoring is extremely important if I/I quantities are to be determined. To determine the effectiveness of I/I correction, sewer system flows must be measured both before and after rehabilitation.

Postrehabilitation Flow Monitoring

Postrehabilitation flow monitoring is used to quantify the effectiveness of I/I reduction. Monitors are installed at the start of the winter wet weather season and operated up to 120 days. This period is sufficient to establish the base wastewater flows and ground-water infiltration rates, as well as capture a number of rainfall events that will be used to evaluate rehabilitation effectiveness.

Postrehabilitation flow monitoring utilizes the control meter method. A "control" **subbasin** is found that responds to wet weather events in a similar manner as the **subbasin** to be rehabilitated. Procedures are available for establishing similarity. Postrehabilitation flow monitoring is conducted in both subbasins, and the amounts of infiltration for similar storm events are compared. Comparing flow data from the two subbasins reveals the reduction in I/I.

The control meter method provides a consistent means to evaluate I/I reduction. The control meter method works only if the control **subbasin** is not altered. If a control **subbasin** is not available, other methods for determining I/I reduction may include additional prerehabilitation flow monitoring, flow

isolation or envelope analysis. Envelope analysis requires a significant number of events in order to establish the I/I response for saturated soil conditions.

Results

I/I reduction for the projects monitored in the East Bay I/I correction program is summarized in Table 1. Of the 69 completed rehabilitation projects, 28 have been monitored and 26 were determined to have obtained the target infiltration reduction. Flow monitoring in the remaining 41 subbasins will be conducted basinwide once all of the cost-effective subbasins within a basin have been rehabilitated.

Table 1. I/I Reduction for the East Bay I/I Correction Program

Percent of Subbasin Rehabilitated	Reduction in Infiltration		
	Average	Without Upper Laterals	With Upper Laterals
80- 100%	71%	69%	86%
50-80%	54%	53%	56%
30-50%	56%	55%	63%

I/I reduction was evaluated with respect to the different rehabilitation techniques used by the communities. Upper lateral rehabilitation (comprehensive rehabilitation) was not widely conducted due primarily to the additional logistic, legal, and institutional problems associated with this work. Rehabilitation effectiveness did not appear to depend on the method of rehabilitation (replacement, sliplining, inversion lining, and extensive grouting), although grouting is no longer considered to be a viable rehabilitation technique. Rather, rehabilitation effectiveness is a function of the amount of subbasin rehabilitation and the level (comprehensive or not) to which it is performed (see Table 1). I/I reduction exceeded goals in all cases in which upper laterals were rehabilitated. In addition, subbasins that showed the most significant reductions in I/I were also those with the largest portion of their total area rehabilitated; however, most subbasins that did not incorporate upper lateral rehabilitation did not achieve the required reduction in I/I.

Lessons Learned

The East Bay I/I study assumed that 80 percent of a subbasin's I/I comes from the worst 50 percent of the subbasin. Though this assumption was based on flow isolation studies, the results of the I/I correction program indicate that some subbasins require more rehabilitation (20 to 30 percent more) to achieve the required I/I reductions. The lack of upper lateral rehabilitation may account for this extra work. Another explanation may be that rainwater migration was more extensive or covered a greater area than anticipated. Therefore, additional work must be performed in the subbasin to "tighten" the system to the point at which migration does not circumvent rehabilitation efforts.

The study also underestimated the cost of I/I correction. This increase was due to the preference of higher-cost rehabilitation techniques over those recommended for the I/I correction program, and the additional work required in some subbasins to achieve the desired reductions in infiltration. Also the cost of lateral rehabilitation was underestimated, as were the administrative, legal, and public outreach costs for implementing upper lateral rehabilitation. These costs were approximately 50 percent of the total cost of construction.

In 1993, an evaluation of the I/I correction program was performed that resulted in a revision to the communities' compliance plan. The justification for this revision was primarily financial, as the cost of implementing the projects was exceeding original estimates. Other factors that slowed progress included natural disasters. The 1989 Loma Prieta earthquake disrupted other services that the East Bay communities provide, directing resources away from the I/I correction program. Likewise, the 1991 Oakland Hills fire created a more urgent need for both staff and funds.

The RWQCB was amenable to the request to revise the communities' compliance schedule and allow for a longer period to implement the I/I correction program. A new compliance plan and schedule was issued in October 1993. In addition, compliance reporting was reduced from biannually to annually, because annual reporting was determined to be sufficient to meet the needs of the RWQCB and it significantly reduced the administrative burden of preparing these lengthy reports.

Wet Weather Treatment

The I/I correction program is expected to reduce the systemwide design peak flow from 1,046 to 775 mgd, still much more flow than could be conveyed by the District's interceptor system or treated at the main treatment plant at the start of the wet weather program (290 mgd peak hydraulic capacity). The cost-effective solution was to focus on upstream wet weather treatment, thus avoiding the need for major parallel interceptor construction in the sensitive Bayshore environment. Because receiving water studies showed that the major impact of SSOs was related to fecal bacteria, the wet weather facilities have been designed to provide chlorination and dechlorination at a minimum. The Oakport (158 mgd) and Point Isabel (100 mgd) wet weather facilities have been built on the south and north interceptors to provide primary sedimentation and disinfection. These facilities operate several times per year. The sedimentation basins provide about 3 million gallons of storage at each plant and capture the first flush of sediments and the entire volume of many smaller storms.

Two high-rate treatment facilities (about 50 mgd each) located farther downstream along the south interceptor will provide relief from the large storms (1-year return period and longer). These facilities will provide screening and disinfection. A minimal chlorine contact time of 5 minutes (at peak design flow) was shown to be effective in pilot studies when combined with high-energy mixing. One of the two high-rate facilities is currently under construction. The other high-rate treatment facility will not be needed until additional community relief sewers are built to deliver more flow to the interceptor. The District's wet weather facilities also include additional capacity (to 415 mgd) and storage (11 million gallons) at the main wastewater treatment plant, a 1 million gallon upstream storage basin to solve a local capacity problem in Alameda, and some minor additional pumping and interceptor improvements. Two new regional interceptors were also built upstream (away from the difficult construction environment near the Bayshore) to divert flow directly to the main treatment plant and the Oakport wet weather facility, providing immediate relief for several of the community's overflowing trunk sewers.

The Oakport wet weather facility has now been in operation for 4 years. Below-normal rainfall years and the fact that the community relief sewer projects have not yet been completed have combined to limit the number of discharge events over that period. Several small storms have been entirely captured and drained back to the interceptor for secondary treatment. The District's permit establishes targets for the annual frequency and volume of discharge, which have been met. Although no effluent water quality

'According to the discharge prohibitions of the District's wet weather NPDES permit, the District's wet weather treatment facilities must achieve a long-term average of 10 discharges per year per discharge location for a total of 100 million gallons per year. In addition, the District must maximize the volume of wastewater delivered to the main wastewater treatment plant and ensure that all wastewater entering the District's interceptor receives some treatment prior to discharge (floatables removal and disinfection/ dechlorination).

standards were established, the District is required to monitor the effluent and receiving waters. Flow-weighted composite samples of the influent and effluent are taken during each event.

The performance of the facility with respect to total suspended solids (TSS) removal is illustrated in Figure 1. The seven storms for which good composite influent and effluent TSS samples were collected reveal a wide range of influent TSS concentrations, from 44 to 170 milligrams per liter (mg/L). These variations are expected, TSS removal efficiency is generally better for storms that have lower surface loading rates and likely related to the size and intensity of the storms, as well as to the amount of time between storms. The effluent concentrations, on the other hand, have remained in the narrower range of 40 to 100 mg/L. As expected, TSS removal efficiency is generally better for storms that have lower surface loading rates and are generally in the 35 to 55 percent range. The basins were sized for a surface loading rate of 4,000 likely gallons per day per square foot (gpd/ft²) at peak design flow, but as seen in Figure 1 storm-averaged rates have been in the 200 to 1,400 gpd/ft² range.

It is especially noteworthy that two of the observed storm samples showed little or no removal of TSS despite moderate loading rates. The last plot in Figure 1 reveals that the unique characteristic of those two storms was very low influent concentration (between 40 and 80 mg/L). At such low influent concentrations, very little removal is apparently achieved, regardless of the surface loading rate. As a rule, the best removal efficiencies were achieved when the influent concentrations were highest and approached that of normal undiluted wastewater.

These findings must be regarded as preliminary and are based on a relatively small number of samples. The use of storm composite samples is also a limitation. Based on the available data, one would conclude that significant solids removal is achieved, but only when the influent is not too highly diluted. At high dilutions, solids removal may be very low. If a first flush of high-concentration influent was present in these events (and masked by the compositing), however, the facility may have removed a significant portion of this concentrated load. And again, the ability of the basins to completely contain smaller events is a significant benefit.

Designers of wet weather treatment facilities should consider the expected influent concentrations as well as peak flows when sizing sedimentation basins. Key criteria should be based on achieving good solids removal during more moderate typical storms having higher influent concentrations, and on providing enough storage to contain the first flush of solids and entire smaller events as well as sufficient contact time for reliable disinfection for all events.

The performance of the District's wet weather facilities with respect to disinfection has been mixed. The use of high-rate chlorination and dechlorination provides the treatment necessary to eliminate the public health threats associated with wet weather overflows. Maintenance of the remote facilities is complicated by intermittent operation, however; chemicals degrade and analyzers lose calibration. These problems result in the need for staff to be present during wet weather operation, which was not originally planned. In addition, arrangements must be made to ensure that remote facilities do not run out of chlorination or dechlorination agents during periods when chemical delivery may be complicated by weather conditions.

Remote facilities should also be designed to operate during dry weather to facilitate operational testing and startup. Facility testing and operator training could also be enhanced if the facility were run before the start of the wet weather season.

Computer Modeling of Facility Operation

The District developed a computer model of its interceptor system in the early 1970s. Over the years, the model has undergone modifications but continues to be a useful tool as the wet weather program has moved through planning, design, construction, and operation phases. Recent model applications have focused on performance verification and simulation of real-time control of the wet weather facilities.

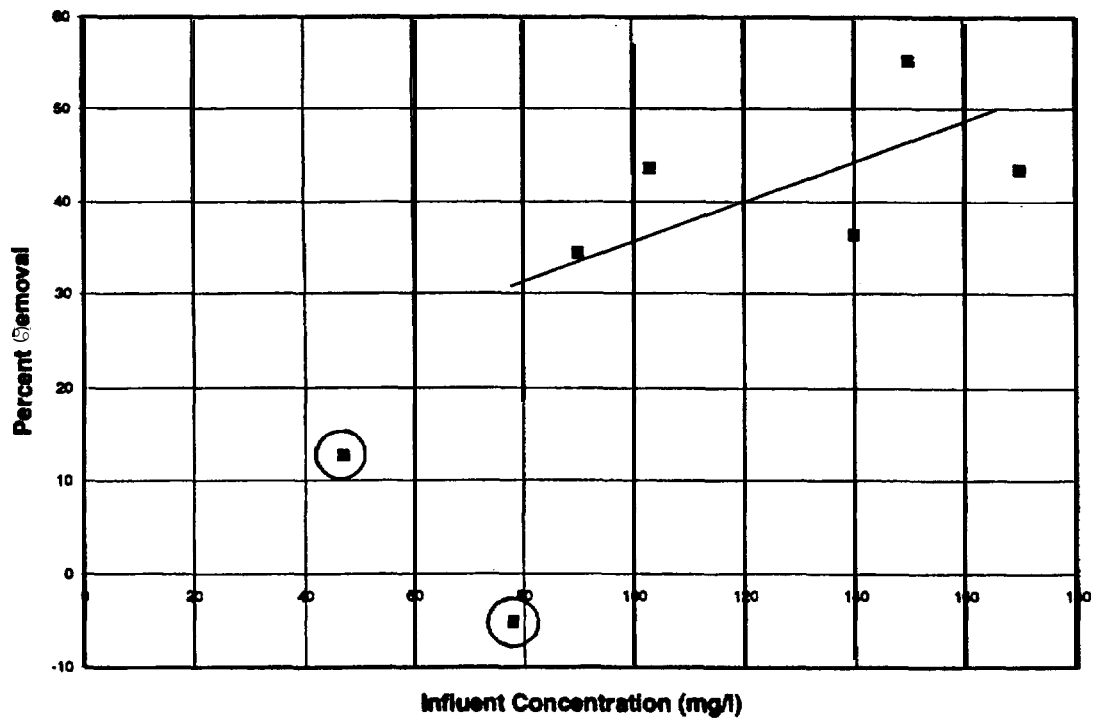
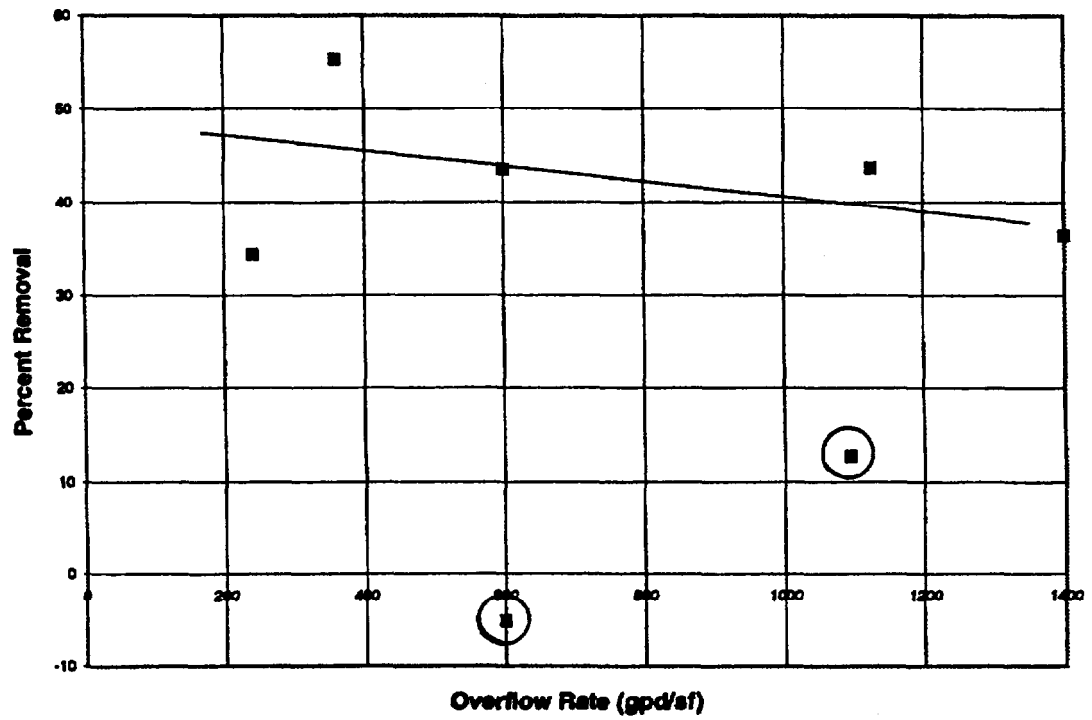

Figure 1. Flow-weighted composite samples of total suspended solids taken at the Oakport wet weather facility show that influent concentration is an important factor in removal efficiency.

The hydraulic engine of the District's model has been and continues to be the U.S. Environmental Protection Agency's SWMM EXTRAN. A special I/I hydrograph generator program is used instead of the SWMM RUNOFF block. Recent enhancements have included a new Windows-based front-end (using Microsoft Access software), the Model Turbo View EXTRAN (MTVE) graphic postprocessor, and code modifications to allow the simulation of real-time control of pumps and gates based on water levels and flows. Figure 2 shows examples of some of the new data entry screens and output graphics that have significantly enhanced modeling productivity.

The wet season of 1992 to 1993 broke a long string of below-average rainfall years and provided a good opportunity to verify the original design flows and the operation of the wet weather facilities built to date. Simulation of these events was also part of the certification of grant-funded projects required by the regulatory agency. The January 1993 storms were large enough and had sufficient antecedent rainfall to ensure that the I/I response would be maximized and should therefore correspond to design values (e.g., 18 percent of rainfall volume). The simulation results for the two storms that occurred under fully saturated soil conditions predicted that flows reaching the main wastewater treatment plant would be 12 to 14 percent of rainfall (depending on the event), flows reaching the wet weather treatment facilities in place at that time would be 1 to 2 percent of rainfall, upstream collection system overflows would be about 2 percent of rainfall, and I/I eliminated by the I/I correction programs would be 1 percent of rainfall. The measured volumes reaching the treatment facilities agreed with the simulated volumes by the equivalent of less than a half percent of rainfall volume, a very good verification.

The flow verification simulations also showed that the shape and volume of the hydrographs reaching the wet weather facilities was significantly affected by how the system was operated. In 1993, the system was manually controlled, and the simulations were adjusted to duplicate the control decisions that were actually made (primarily when certain pumps were shut down or turned on to divert flow to or away from wet weather facilities). Starting in late 1995, these decisions will be made automatically based on level set-points at several key locations in the interceptor system. The District's interceptor model has been modified to simulate these real-time controls and used to predict the outcome of alternative operating strategies under a range of storm conditions. Figure 2 includes a screen used to input a control rule and set-points, as well as an MTVE graphic that shows how the flow and depth in a critical pipe varied during a storm simulation. In this example, a series of facility activations occurred near Hour 30 as the level in the interceptor approached the surcharge point, but the facilities were not activated soon enough to prevent a few minutes of surcharging of about 1 foot over the pipe crown.

The primary operating objectives are to maximize the amount of flow that reaches the main wastewater treatment plant and thus minimize the amount of flow treated at the wet weather treatment facilities. This objective is best satisfied by waiting as long as possible to divert flow to the wet weather facilities. If activation is delayed too long or is not accomplished quickly enough, however, the interceptor surcharges. Since the collection system trunk sewers have all been designed based on the assumption that the interceptor will flow full but not surcharge, any interceptor surcharging could contribute to collection system overflows and must be avoided. Past simulations identified the critical locations on the interceptor, where level monitors have been placed. Set-points as high as 95 percent of pipe depth at these locations have been demonstrated to work well even in the design storm, provided the facilities can be activated very rapidly. This finding led to the conclusion that there would be virtually no benefit in using rainfall or flow predictions to further delay activation. Once the peak flows have passed, the wet weather facilities must be deactivated and drained as soon as possible. Simulations have shown, however, that immediate deactivation can cause the levels in the interceptor to rise too rapidly and force reactivation. Deactivation set-points from 60 to 80 percent of depth, depending on the specific facility, appear to be appropriate to avoid excessive pump on-off cycling during the storm recession. Additional simulations are planned to refine these set-points for each facility and test them under a variety of different types of storms.

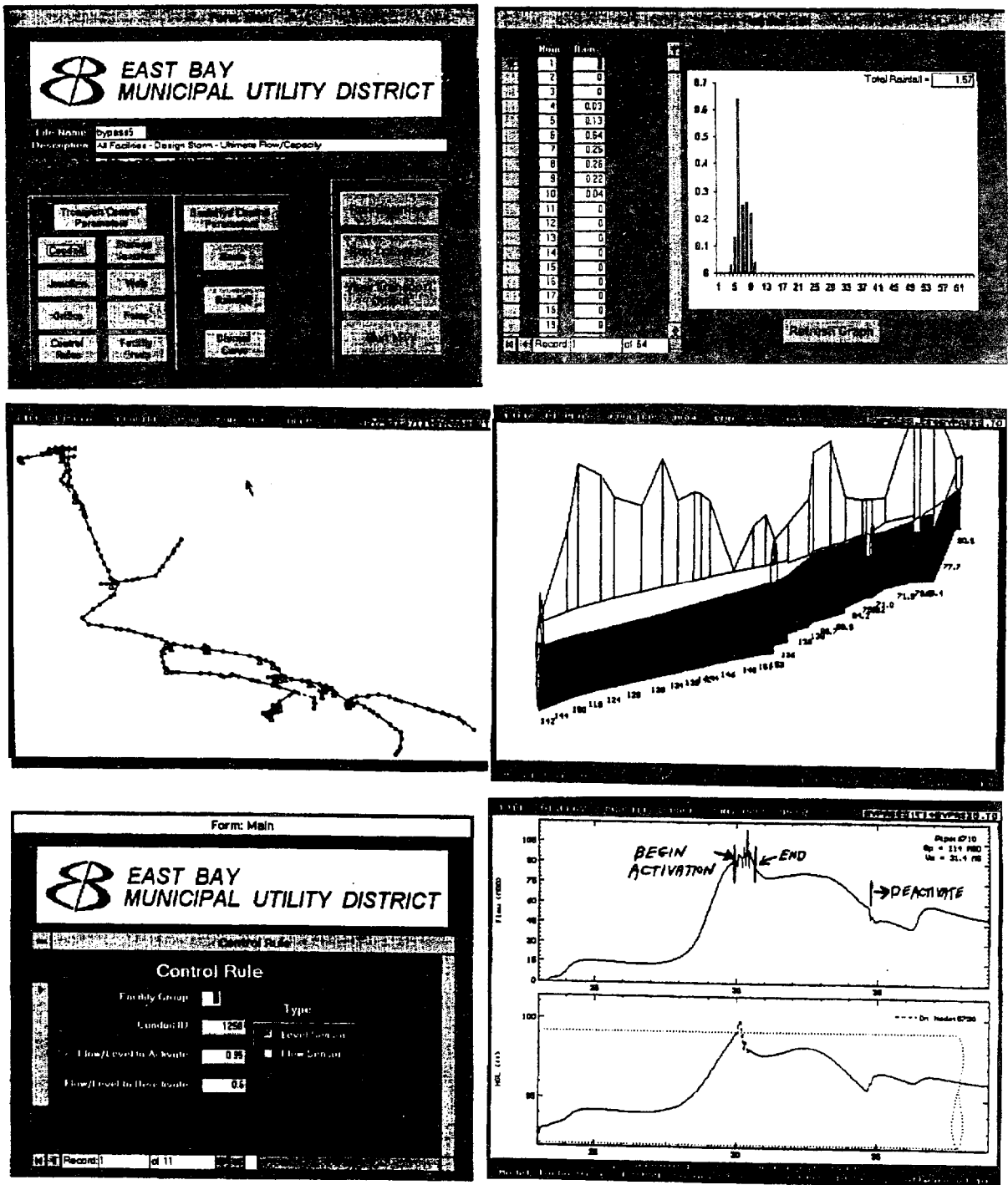

Figure 2. These examples of screens from the East Bay Municipal Utility District's computer model illustrate some of the enhancements made to the basic SWMM EXTRAN core: data entry screens in Access, MTVE output graphics, and new algorithms to simulate real-time control.

Conclusion

The wet weather sanitary sewer overflow problem in the East Bay is being addressed by the Districts wet weather facilities program and the communities' I/I correction program. The I/I correction program has demonstrated a positive correlation between rehabilitation and the amount of infiltration reduction. Likewise, operation of the Districts wet weather facilities has demonstrated that good solids removal can be achieved during moderate storms having higher influent concentrations than larger storms with more dilute flows.

The success of the East Bay I/I correction program and the District's wet weather facilities program has been demonstrated in the ability to verify the model used to simulate flows generated from wet weather events. Because this model was used to design the wet weather facilities and the I/I correction program, this analysis supports the overall regional approach developed for correcting wet weather sanitary sewer overflows in the East Bay.

Mill Creek Watershed Management: An Evaluation of Study Methods, Benefits, and Costs

Lester Stumpe
Northeast Ohio Regional Sewer District, Cleveland, Ohio

Art Hamid
Montgomery Watson, Cleveland, Ohio

Introduction

The Northeast Ohio Regional Sewer District believes strongly that the public interest is best served by a regulatory program that provides the flexibility for wastewater management agencies to control sanitary sewer overflows (SSOs) as one of many elements of a total watershed plan.

The benefit of using a watershed approach when developing a remediation plan is that it considers a broad range of factors affecting the ecosystem. There are two bases for watershed planning. The first is a recognition that environmental problems are typically complex. The second is a common-sense realization that single-issue remedial measures are often not cost effective.

A consensus seems to be developing within the regulatory community that, in general, wet weather issues are best dealt with in a watershed framework. There is not yet broad support, however, for regulating SSOs in the context of a watershed approach. Specifically, the District does not support an approach based on the belief that complete elimination of SSOs is a reasonable and cost-effective goal. Rather, it supports the development of a regulatory policy that allows all wet weather sources, including SSOs, to be treated with a measure of flexibility as is currently provided for in U.S. Environmental Protection Agency's (EPA's) combined sewer overflow (CSO) policy.

A principal reason for this view is the practical similarities between CSOs and SSOs. EPA, in a recent SSO discussion paper, suggested several key distinctions between SSOs and CSOs. In practice, real-life situations either blur these distinctions or offer stronger reasons to treat the two discharges with a degree of parity. Additionally, the District has been designing major separate sanitary sewer interceptor systems for 10 years on the premise that, at some point, it is neither cost-effective nor reasonable to prevent all SSOs.

The District is currently using a watershed approach to guide facilities planning in its Mill Creek service area. The watershed approach is believed to be an important step toward improving cost/benefit ratios. Will a watershed analysis recommend complete elimination of SSOs? Possibly not-the answer, of course, is site specific. Beyond the compelling reason of improved cost/benefit ratios, though, the District has confidence that using a watershed approach will have far greater environmental benefits. The total cost for a watershed plan may, in fact, be more than for a narrow meet-the-regulations plan; but, even if the watershed plan is more expensive, however, it will achieve greater benefits and be more salable because it meets the needs of the community. These principles are illustrated in Figure 1.

Watershed planning represents a paradigm shift for many in the practice of wastewater management. The objective is not so much to remove every pollution source but to restore the beneficial uses of the waterbody.

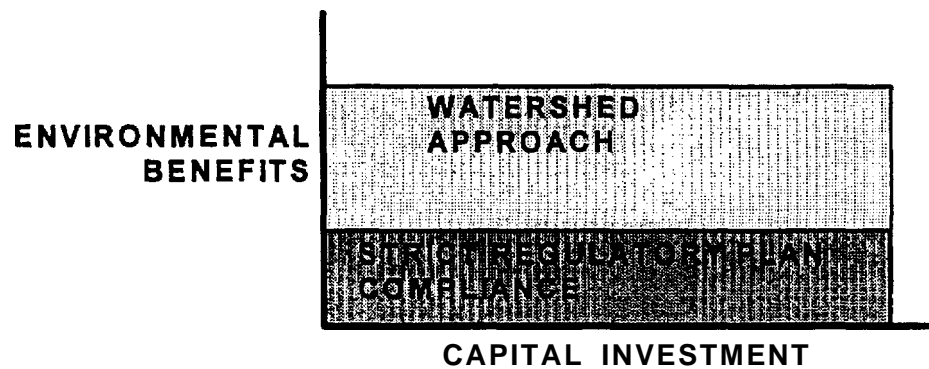

Figure 1. Watershed approach maximum return on investment.

The benefits of this big-picture approach are understood at the community level. Communities want value for their expenditures. For example, a community may not place great value on assurances that an urban stream is not affected by SSOs following a substantial rain event. The community is likely, however, to value a range of improvements that reduce flooding, improve stream aesthetics, contribute to the overall safety of stream contact recreation, and restore the stream to a reasonably attainable level of biological integrity.

The Northeast Ohio Regional Sewer District Service Area

The District was created in 1972 to operate and manage wastewater collection, treatment, and disposal facilities for the Cleveland metropolitan area. Today the District serves 53 communities, including the City of Cleveland. The service area encompasses 295 square miles and includes more than one million people. The District owns and operates three major wastewater treatment plants, as well as a system of interceptors and intercommunity relief sewers. Member communities retain ownership responsibility for the sewers within their community boundaries.

The combined sewers in the District's service area are primarily located in the older, urban center and the inner ring of older suburbs bordering Cleveland. Because of the location of the treatment plants in the older, central part of the service area, most of the flow from the newer, outlying **sewered** areas was originally routed through the combined sewer system to treatment.

In 1981, the District embarked on a major Sewer System Evaluation Survey (SSES) and design studies for two new major conveyance systems: the Heights/Hilltop and Southwest Interceptors. Both of these interceptors serve older separate sanitary areas. In the Heights/Hilltop area, common trench sewers are typical. The Heights/Hilltop Interceptor was designed for a 5-year storm, while the Southwest Interceptor was designed for a 1-year storm. Companion relief sewer and rehabilitation programs were designed for the collection systems of both these interceptors. Beyond the stated design storms, SSOs are expected to occur within the collection system. The facilities plans and SSES study recommendations for both projects were reviewed by both EPA and the Ohio Environmental Protection Agency and early portions of the projects were funded at a minimum of 75 percent by federal grants. Portions of both projects were also subjected to federal review through environmental impact studies.

Communities that discharge to these interceptor systems are regulated through the District's Community Discharge Permit System. These permits require communities to undertake controls to ensure that SSOs do not happen below the design storm event. Further, permits set limits for the peak rate of infiltration and inflow (I/I) at community boundaries and at connection points to the District's interceptors.

Finally, these permits require communities to prepare and operate under best management practices plan for a collection system.

While these requirements ensure the design integrity of the interceptor and collection systems, they provide a good deal of flexibility for the local community. Communities frequently develop designs to meet the objective using concepts that are different from that which the District envisioned in the facilities plan. Communities typically choose a different approach because they are responding to more than the single issue that the District had in mind during the SSSES. For example, a community may have been planning to reconstruct a street to promote economic development. Instead of rehabilitation, it may have chosen to completely replace the sewer system. In other cases, communities conclude after analysis of drainage patterns that some street flooding can be tolerated, and they elect to use storm sewer inlet controls to reduce the problem of I/I into the sanitary sewer system.

Mill Creek Background

The Mill Creek Interceptor (MCI) drainage basin makes up the southeastern tributary area of the District's southerly wastewater treatment plant. The basin includes all or parts of 11 communities. The service area tributary to the MCI consists of 17,000 acres, which is served by a mixture of combined, separate, and dual (common trench) sewers. The approximate distribution of existing sewer types is given in Table 1.

Table 1. Sewer Types in the MCI Service Area Tributary

Sewer Type	Lineal Feet	Proportion
Combined	588,000	38%
Separate sewers-common trench	684,000	45%
Separate sewers-separate trench	264,000	17%

The drainage system flows predominately east to west, starting as separate or common trench sewers and eventually joining with combined sewers.

Some of the problems in the Mill Creek area include basement flooding, insufficient wet weather capacity in the interceptor, and water quality problems (particularly bacteria) in the stream following rain events. Many of the sewers are old and in bad repair, and contribute to occasional dry weather overflows, which also affect stream water quality. Numerous landfills abut the stream, and several areas of septic systems are within the watershed. Mill Creek and its various tributaries are prone to flooding.

The Watershed Approach

The District has learned a great deal about the methods and value of a comprehensive watershed approach from 8 years of involvement in the development of the Cuyahoga River Remedial Action Plan (RAP). The Cuyahoga RAP is a part of the effort spearheaded by the International Joint Commission to address 43 "areas of concern" in the Great Lakes region. Use of a watershed approach is a central theme of RAPs in general and the Cuyahoga RAP in particular. Based on our experience, a comprehensive watershed approach:

- Strives for a thorough understanding of the ecology of the water system, the identification of desired uses of the water system, and the factors responsible for

impairment of those uses. Openness to understanding the problem from multiple perspectives is made part of the search for better solutions.

- Employs extensive public information and education efforts to promote understanding of the issues, to encourage participation in facilities planning, and to encourage commitment to an ongoing process of being a steward of the watershed.
- Sets goals for watershed restoration that are measurable and meaningful to the stakeholders.
- Evaluates a wide range of alternatives to achieve watershed goals, employs a rigorous process of evaluating the advantages and disadvantages of particular alternatives, and seeks to understand the tradeoffs represented by choosing one remedial approach over another.
- Results in the development of an implementation program responsive to chosen goals. The plan includes timelines and responsibilities and establishes a process for plan renewal and updating.
- Results in the establishment of a process to monitor progress towards achieving established watershed goals.

Watershed Planning in Mill Creek

At an early point in developing a scope of work for the current Mill Creek project, the District made a conscious decision to employ a watershed approach. Its 1991 Phase 1 CSO study had indicated that effective facilities planning in the Mill Creek area would have to consider a broad range of sources besides CSOs. In addition, the CSO Phase 1 study suggested that a tunnel structure for conveyance and storage could be a major element of an integrated plan to address issues of both CSOs and inadequacies of separate sanitary sewers in the eastern portion of the drainage basin.

As discussed above, the watershed approach is being used to understand the problems of the water system in a holistic sense. This new approach requires flexibility and led the District to decide not to use its standard process for procurement and contracting for facilities planning services. In place of a price-based procurement process and a cost-plus-fixed-fee contract, the District decided on a merit selection process and a cost-plus-percentage-of-cost contract. In addition, the District is emphasizing communication and partnering as cornerstones of interaction within the multiconsultant Mill Creek project team.

The process of designing new approaches to guide the project was made possible by being ahead of regulatory requirements. Mandated regulatory schedules often do not afford enough time to design innovative approaches. Additionally, not being under a direct regulatory mandate to conduct this study provides flexibility for the project to respond to new issues, and improves the overall climate of creativity within the project team.

The following discussion characterizes some of the specific approaches being used in the Mill Creek study.

Understanding the Problem

The Mill Creek scope calls for more comprehensive assessment studies and a greater level of model development than the District has undertaken in its previous facilities planning efforts. Elements include the following:

- Stream **assessment** studies and a use attainability analysis.
- Recreation use assessment studies.
- Source characterization studies (including stormwater).
- Development of a water quality model of Mill Creek.
- Development of an HEC-2 flood plain model for Mill Creek.
- Continuous Extran modeling of the CSO system, the sanitary system, and substantial portions of the storm sewers in the separate **sewered** area.

Involving the Public

The District's objectives for this project are to increase public awareness of various issues surrounding this study and to encourage sustained interest in the management of watershed issues. Due to the complexity of these issues, the District will implement an extensive public information program. Elements of the current program include:

- Production of a variety of project specific materials.
- Public meetings restructured as open houses, workshops, and expositions to promote education and interaction with the public.
- Individual meetings with community leaders and interested groups.
- Outreach efforts to involve residents of less affluent areas.
- Development of project-specific educational pieces for use in schools.
- Opinion research.
- Establishment of public advisory work groups.
- General public education to promote stream stewardship.

Particular emphasis will be placed on interacting with public officials and gaining information about area water quality problems from study-area residents. An initial phase of the public information program is educating the public on the findings of the Phase 1 CSO facilities planning.

Establishing Goals

Establishing effective goals for watershed management flows from a comprehensive understanding of the issues within the watershed. While watershed goals are typically bottom-line oriented and aimed at restoring uses, they can address a wider span of issues. Setting water quality goals in the watershed model, for example, requires looking beyond the sole issue of compliance with water quality standards. The following are some of the project's goals that go beyond strict water quality concerns:

- Provide a regional wastewater conveyance system that helps communities solve basement flooding problems.

- Look for ways to encourage and complement local initiatives to better manage stormwater and eliminate stream flooding.
- Improve the infrastructure to promote economic development.
- Establish a model for study in other watersheds.

Generating Ideas and Evaluating Alternatives

Again, a solid understanding of a watershed's problems is the key to developing solutions that are likely to have the greatest positive impact. Another key element, however, is listening for and being open to the small ideas that add real value to a project. Accordingly, the District is carefully documenting the comments and suggestions received during its dealings with the public.

Evaluating alternatives is a separate process from generating alternatives. Watershed planning is made more complex by the breadth of the problems and the multitude of potential solutions to consider. The District is evaluating decision support tools as an aid in assessing alternatives. These tools are expected to be useful both in narrowing the field of alternatives and in communicating with the public on the uncertainties and tradeoffs involved in selecting a final plan from a narrowed field of alternatives.

Developing the Implementation Plan

As a regional agency, the District has authority in the area of CSO and sanitary sewer improvements. Ideally, a watershed approach will lead to remedial management strategies that are beyond the District's authority to implement. It follows then, that a critical issue is the development of partnerships with other government agencies with responsibility to implement strategies important to the watershed. The District has been successful in forging these partnerships in the RAP process, and has designed the scope of work for the Mill Creek study to specifically include other partners, beginning with initial studies to define the problems.

Measuring Progress Toward Watershed Goals

To understand how far you have come, you must understand where you started. Following this reasoning the District is investing substantially in the documentation and quantitative measurement of current problems. In particular the District is investing in an initial assessment of the current condition of the stream. Fortunately the Ohio Environmental Protection Agency continues to be a leader in the development of biological and habitat indices which together paint a more complete picture of overall ecosystem health.

Similarities Between SSOs and CSOs in the Cleveland Area

As previously stated, one reason for treating SSOs and CSOs together with a single flexible regulatory policy is that they are similar in many respects. As this section will illustrate, in the real world of sewers, meaningful distinctions between separate and combined sewer overflows are not always easy to make. Separate sanitary sewers constructed in a common trench with storm sewers are prevalent within the District's service area and provide some clear examples of their similarities with combined sewers.

There are three typical variations on the common trench theme. The first variation is the common trench sewer with separate manholes (see Figure 2). The second variation is common trench construction with weir walls separating the sewer systems in common manholes (see Figure 3). The third variation is the

'over/under' system (see Figure 4), in which the storm sewer is placed directly above the sanitary sewer. Access to the sanitary sewer is via a removable plate in the bottom of the storm sewer.

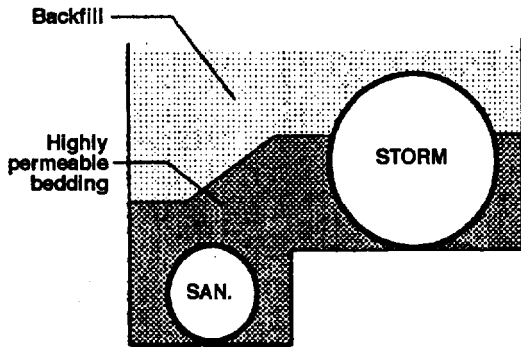

Figure 2. Common trench design.

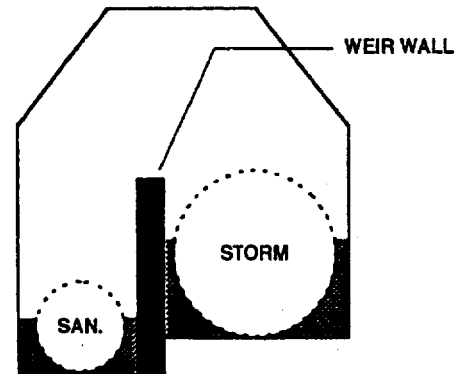

Figure 3. Weir wall design.

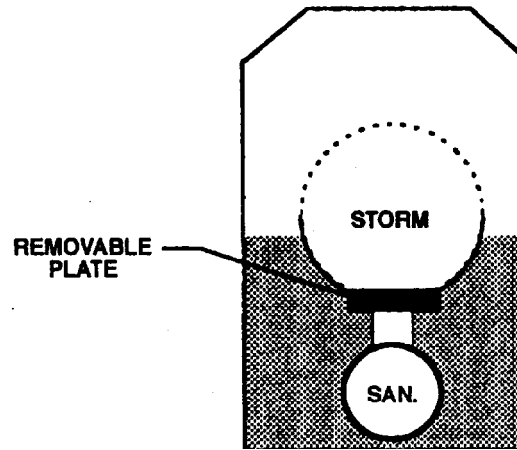

Figure 4. Over/Under design.

While any separate sewer system is likely to have some flow crossover, the opportunities for this greatly increase in common trench sewers. Regardless of manhole features, common trench sewers can be expected to have substantially higher rates of infiltration because of the closeness of the storm and sanitary sewer pipes. Common trenches for the two sewer systems are prevalent for house laterals as well as the main collection system. (In fact, the District's studies in the early 1980s suggested that as much as 60 percent of the system's infiltration was occurring on private property.) With time, channels tend to form within the highly permeable bedding between the pipes, increasing the infiltration process. In some cases, joint-to-joint transfer becomes substantial enough that the system begins to take on some of the characteristics of a combined sewer system.

Beyond the potential for common trench infiltration, certain manhole types, like the weir wall design, create flow transfer points that can operate in a manner similar to CSO regulators. Flow crossover is driven by the hydraulic grade lines of the individual sewer systems. The figures showing the storm sewer above the sanitary sewer might suggest that the hydraulic grade line for the storm sewer would always be higher than for the sanitary sewer. This can change quickly, however, as the storm sewer splits off from the common trench to discharge to a nearby stream or culvert,

The over/under design presents its own unique opportunity for flow crossover. In the classical situation, surcharging of the sanitary sewer system dislodges the access plate between the storm and sanitary sewer systems. Once the connection is opened, the system operates, in effect, as a combined sewer system.

Comparison of Wet to Dry Weather Flow Ratios

A common assumption about the difference between sewer systems is that sanitary systems experience substantially lower ratios of peak flow rates to average flow rates. The District's studies suggest that this is not always the case.

The District has compiled information about flow quantities in numerous separate sanitary sewer communities, some with recently built sewer systems and some with aging systems built 30 to 40 years ago. Data on flow quantities in combined sewer areas were collected during the District's recent Phase 1 CSO study. Comparisons of wet to dry weather flow show that while there is significant variability among ratios for different locations in a given system, there is also a great deal of overlap among ratios for different types of systems. Most significantly, similarities can be noted for wet to dry weather flow ratios for combined sewers and separate sewers. Table 2 summarizes these comparisons.

Table 2. Ratio of Peak Wet Weather Flow to Average Daily Dry Weather Flow

Combined Sewer Areas	High Observed Ratio
Easterly drainage	7.5:1
Southerly drainage	5:1
Westerly drainage	13:1
SSO discussion paper	10:1
Separate Sewer Areas	High Observed Ratio
Heights hilltop interceptor	7:1
Southwest interceptor	5:1

Similarities in Character Between SSOs and CSOs

Another common assumption is that **SSOs** have a higher strength of pollutants than **CSOs**. This is not always the case. The District performed a sampling program in 1993 that compared pollutant concentrations in a simulated CSO versus SSO situation. Wet weather samples were taken from combined sewers during periods of overflow. The characteristics of these samples were compared with samples from a sanitary sewer during an overflow period. As seen in Table 3, the biochemical oxygen demand (BOD) component of **SSOs** for the Cleveland area was similar to, if not "weaker than, that of the **CSOs** for the same area. Suspended solids were substantially lower in **SSOs** than in **CSOs**. Also listed are values from the Association of Metropolitan Sewerage Agencies (AMSA). These data suggest similar results. The District will be conducting more substantial sampling in the Mill Creek study to further characterize the nature of the Districts **SSOs** and **CSOs**.

Table 3. Water Quality of CSO VERSUS SSO in Cleveland and AMSA

	BOD (mg/L)	TSS (mg/L)	Coliform (MPN/100 mL)
Cleveland and CSO ^a	51	360	312,000
Cleveland and SSO ^a	45	55	Not sampled
AMSA and CSO ^b	63	275	10 ⁵ -10 ⁷
AMSA and SSO ^b	70	95	10 ⁵ -10 ⁷

^aEvent mean concentrations.

^bMedian values.

MPN = most probable number.

TSS = total suspended solids.

Impacts on Water Quality

Figure 5 illustrates, how, some cases, the distinction between a SSO and a CSO is little more than an abstraction as far as water quality is concerned. As originally designed, separate sanitary sewers typically discharge into combined sewers en route to the treatment plant. The first overflow in the figure is termed an SSO because it occurs in what is considered to be a separate sewer area. Rather than overflowing, if the wastewater continues down stream a short distance to the combined sewer, its discharge to the environment is considered a CSO.

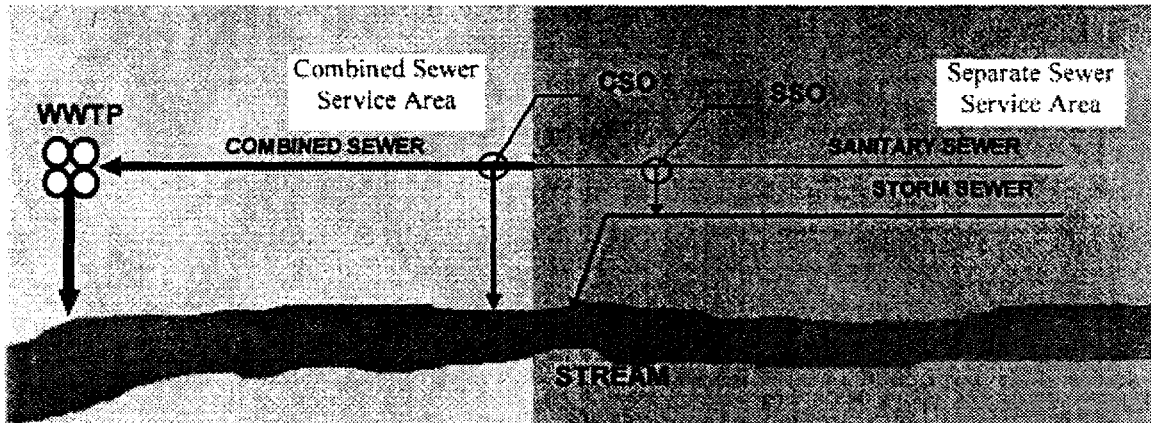

Figure 5. Combined CSO/SSO service area.

Perhaps the only real significance of the SSO in Figure 5 is its positive impact in reducing basement flooding. Obviously, a new, larger relief sewer could also eliminate both SSO and basement flooding, but if the downstream CSO conduit does not have the same design or carrying capacity, this expenditure might not provide any real benefits. Could the money be better used at some other point to control wet weather pollution sources?

Looking at SSO Control From a Local Perspective

The foremost wet weather environmental and public health concern at the community level is the prevention of flooding. Plainly stated, if the option exists, the preferred alternative is to allow overflow to the environment rather than to allow backups into basements. Further, experience has taught most engineers to think conservatively when dealing with issues of public health and safety. Logically, then, many engineers who design trunk sewers feel strongly about the need to provide a SSO point to prevent basement backups.

Figure 6 illustrates two different schools of thought about the relationship between the rate of I/I and rainfall intensity. How one views this relationship has much to do with the intensity of one's support for an SSO point.

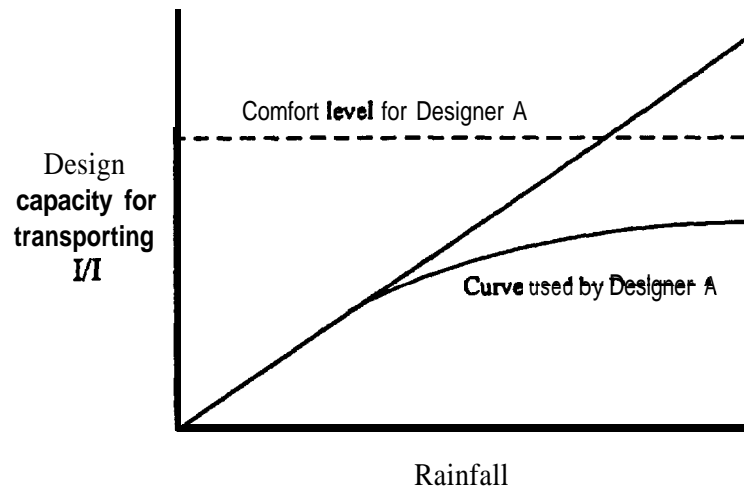

Figure 6. Methods for estimating infiltrating and inflow.

One view holds that the relationship between I/I rates and rainfall intensity is represented by an exponential curve. This response suggests that increases in the rate of I/I level off as the intensity of rainfall increases. With this view, the task of designing enough transport capacity to protect against basement flooding may be fairly easy. Figure 6 shows a comfortable level of safety for a designer who adopts the power curve relationship.

The conservative assumption that the rate of I/I is in direct, proportional relationship to rainfall intensity is shown by the straight line. Sewer systems represented by the straight line extrapolations might experience a substantial problem if they do not include a sanitary sewer relief point. Picking *any* reasonable design storm as the basis for an I/I carrying capacity opens one up to the probability that a bigger storm will surcharge the sewer and result in basement flooding. Every designer needs to be ready for the possibility that two 100-year design storms will occur the first year after the project is completed.

While many SSOs serve a very useful purpose in protecting against basement flooding, they can also contribute to backup problems. For example, this situation might occur in a common trench sewer system, where sanitary overflows are created with little engineering analysis of the impact of cross connection. The assumption made in creating the overflow point is that when the sanitary sewer surcharges, relief is provided through the storm sewer system. In fact, communities now realize this is not always the situation. When the storm sewer surcharges, the intended overflow point may become a massive inflow source that causes sanitary sewer surcharging and actually contributes to basement flooding.

Most of the discussion in this paper has focused on the transport and treatment approach to controlling **SSOs**. Obviously, *I/I* reduction is also a key strategy. Unfortunately, as illustrated by the previous discussion, the stormwater conveyance system may also be operating in a surcharged mode. If this is the case, what are the benefits of removing stormwater from the sanitary sewer only to further overload the storm conveyance system? The effect from a community perspective may simply be that of moving the flooding problem from one street to another.

Typically, the cost-effective analysis conducted under the construction grants program in the 1970s and 1980s did not consider upgrading storm sewer systems. Fortunately, the Ohio Water Pollution Control Loan Fund is now more available to assist with financing a broader range of solutions for water quality problems. This change is very much in alignment with the watershed approach to restoring water quality.

Looking at SSO Control From a Regional Perspective

One of the District's objectives as a regional agency is to maximize use of its treatment facilities to work most efficiently on the service area's total wet weather pollution load. An example that illustrates the logic of this approach is provided by the Mill Creek drainage basin Mill Creek as a stream discharges to the Cuyahoga River upstream of the District's southerly treatment facility. While dramatically improved, the Cuyahoga is still impaired to an extent by wet weather pollution sources. This impairment obviously has long-term implications for effluent limitations at the District's plant. While the District is not responsible for controlling many upstream sources of **nonpoint** pollution, those sources do create a problem when they affect water quality in the vicinity of the District's plant discharge. The watershed approach that is being advocated is the "downstream" view of the problem. The watershed approach asks the logical question of how the community can best use its resources to protect downstream water quality.

Interestingly, the issue of where intervention in the watershed can be most effective is not always as straightforward as it may first seem. It is probably close to a universal truth that *I/I* is undesirable in a separate sanitary sewer system. While that may be the case, one facet of the problem should be understood in the drive to make separate sanitary sewers operate in the manner in which they should. The District is aware from its Phase 1 CSO study that, on the basis of total pounds of pollution discharged from the urban watershed to the environment, its CSO systems may outperform sanitary sewers that operate as strict separate sewer systems. Continuous hydraulic models show that, on an annual basis, the amount of polluted stormwater that is captured and treated by combined sewers during small storms more than offsets the **CSOs** that occur during heavier rains. To the extent that sanitary sewers, operate like combined sewers, some of these same benefits may be occurring. Specifically, during small storms the *I/I* that is captured in the sanitary sewer is probably polluted stormwater.

Conclusion

The District is a strong proponent of understanding the costs and benefits of controls on wet weather sources such as **CSOs** and **SSOs** in the context of a site-specific watershed plan. Regulatory policies should have the flexibility to encourage control of wet weather sources in proportion to the environmental benefits that can be achieved. The current CSO policy is a good starting model for a comprehensive watershed policy.

Using a Watershed Management Approach To Evaluate the Effects of Sanitary Sewer Overflows on Creek Water Quality

T.R. "Buddy" Morgan
Water Works and Sanitary Sewer Board of the City of Montgomery, Montgomery, Alabama

William Kreutzberger
CH2M HILL, Charlotte, North Carolina

Introduction

When the quality of our nation's waters is less than favorable, often the permitted dischargers receive the blame and are required to improve their effluent. The permitted discharger, however, may not be the main culprits.

One approach to improving water quality is the watershed management approach, which looks at all point and nonpoint pollutant sources and determines the most cost-effective improvements to reduce the pollutant loading to the receiving waters. A range of hydrologic, land-use, and water quality data from point and nonpoint sources throughout the watershed are required to determine the relative pollutant loadings.

An example is a creek within the service area of the Water Works and Sanitary Sewer Board of the City of Montgomery, Alabama. The Board faced spending more than \$50 million for capital improvements to the "separate" sanitary sewer system over the next several years to eliminate sewer overflows that were occurring during wet weather events and that allegedly were affecting creek water quality. Instead of immediately designing sewer improvements, the Board requested and was granted permission by the state regulatory agency to conduct a water quality study to assess the effects of its overflows on creek water quality.

The study showed that the pollutant loading from the sewer overflows was only a small percentage of the total pollutant loading. Therefore, the Board requested that a watershed management approach be used to help improve the creeks water quality. This initial assessment is leading to a cooperative watershed management study which will include key "stakeholders" from regulatory and management agencies as well as contributors of pollutants. The potential benefits of this approach are improved water quality and less capital expenditure.

Study Background

In April 1990, the Alabama Department of Environmental Management (ADEM) issued Administrative Order No. 90-107-WP to the Board for violations of the National Pollutant Discharge Elimination System (NPDES) permit for the Catoma Water Pollution Control Plant (WPCP). The nature of the violations were overflows from the collection system as a result of excessive infiltration and inflow (I/I) during periods of precipitation. As with most regulatory approaches concerning separate sanitary overflows (SSOs), ADEM required the Board to:

- Conduct a flow monitoring program of the collection system
- Conduct a source detection survey
- Prepare plans and specifications of system improvements
- Complete improvements so that collection overflows are eliminated

Initial studies on improvements to the collection system indicated that elimination of overflows resulting from I/I was not feasible or affordable. A water quality study was recommended for assessing the effects of **SSOs** on Catoma Creek. **ADEM** concurred with this approach and reissued the Administrative Order in February 1992, allowing time for a water quality study to be conducted. Major objectives of the water quality study were:

- Evaluate water quality conditions in the portions of the creek influenced by **SSOs** under a range of hydrologic conditions.
- Determine the relative contribution of **SSOs** to various water quality indicators.
- Develop recommendation for collection system improvements to reduce the frequency and duration of **SSOs**.

The Administrative Order allowed the recommended scope of system improvements to be based on the “assimilative capacity” of Catoma Creek.

Catoma Creek Characteristics

Catoma Creek has a watershed of approximately 347 square miles, with the majority of the watershed within Montgomery County (Figure 1). The creek drainage area is predominantly rural but includes urban/suburban drainage from the city of Montgomery before it enters the Alabama River. Table 1 provides a general breakdown of land use within the Catoma Creek watershed.

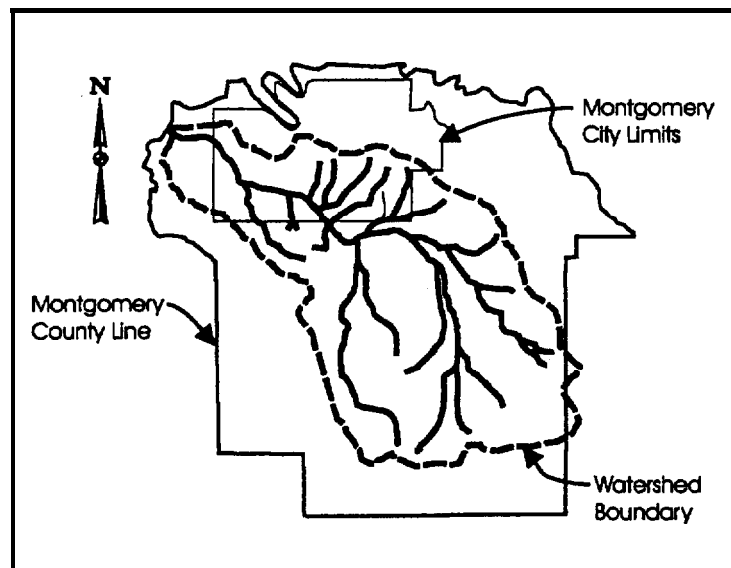

Figure 1. Catoma Creek watershed.

Table 1. Catoma Basin Land Use

Land-Use Category	Cover (acres)	Percentage of Cover
Forest	81,060	36.5
Open area (primarily floodplain)	65,070	29.3
Pasture	35,980	16.2
Low-density residential	15,990	7.2
Rural residential	8,880	4
Commercial	6,220	2.8
High-density residential	5,110	2.3
Industrial	3,780	1.7

The basin receives approximately 54 inches of precipitation per year. The average annual flow the watershed is about 440 cubic feet per second (ft^3/sec). The daily flow record (40 years) indicates that creek flows are less than 1 cfs about 8 percent of the time. The extreme flood flow was 49,100 ft^3/sec following 7.89 inches of rainfall in 1990.

Catoma Collection System

The Catoma collection system serves southern Montgomery and contains about 479 miles of sewer pipe. The WPCP is located next to Catoma Creek near the creek's confluence with the Alabama River.

Some portions of the collection system are old and have I/I problems. The installation practices used on some sections of the collection system may have led to the I/I problems. In addition, the flat slopes in some sections limit hydraulic capacity. The Board has conducted source detection studies to help identify excessive I/I areas, and the Board currently is expanding the Catoma WPCP hydraulic capacity.

Study Period

During the study period (from February 1992 through January 1993), total monthly average rainfall was higher than the historical monthly average values totaled for the months studied by about 4.5 inches. The excessive rainfall resulted in daily average creek flow for the study period that was about 11 percent greater than the historical daily average flow.

Eight sampling events were conducted for the study. Two of the sampling events were dry weather events that provided base flow data about the creek water quality. The other six sampling events were wet weather events, of which three events had no noted collection system overflows, and three events had overflows.

Data Analysis

The pollutant loadings for several key parameters were determined for base flow, rural runoff, urban runoff, and overflowing manholes for the various monitoring events. The data show that the pollutant loading from overflowing manholes is insignificant and that the loadings from urban and rural runoff predominate. Figure 2 illustrates the source breakdown for four pollutant categories for Event 7. This

monitoring event occurred from December 16 to December 19, 1992, when an average of 4.2 inches of rainfall fell across the watershed during a 30-hour period. The data show that rural runoff is the major contributor of nitrite/nitrate-nitrogen and that urban runoff is the major contributor of total phosphorus, fecal coliform, and lead.

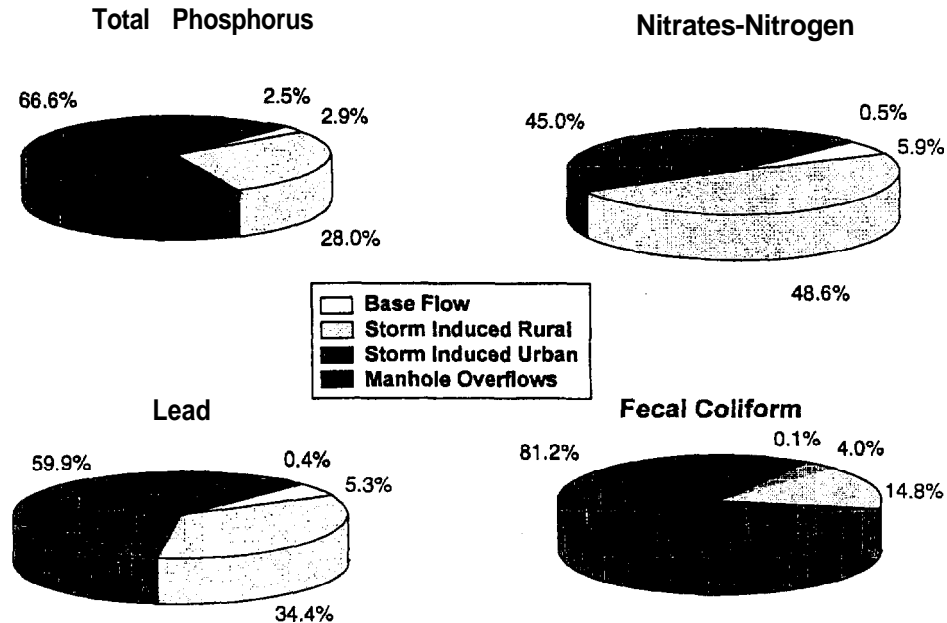

Figure 2. Event 7 loadings contribution.

Monitoring results from the study period indicate that water quality violations occurred during dry weather and wet weather, with and without overflows. The violations occurred for fecal coliform and lead. In almost all events, both urban and rural runoff contributed to the violations.

Regulatory Guidance

The data analyses conducted for this study show that eliminating sewer overflows will not bring Catoma Creek water quality into compliance with the appropriate standards. The analyses suggest that an innovative, collaborative, watershed-scale study and wet weather control program are suitable approaches to improving Catoma Creek water quality.

The most recent example of an approach to wet weather control is the US. Environmental Protection Agency's (EPA's) current National Combined Sewer Overflow (CSO) policy. The EPA recently established national guidance for state permitting authorities and permittees on how to address CSOs. National experience with CSOs demonstrates that total elimination of all overflows under all conceivable hydrologic conditions in a short time frame (3 to 5 years) is infeasible in most cases, and unnecessary, from a water quality perspective, in many cases.

EPA's recent advocacy of watershed-scale approaches to water quality management reflects the recognition that many of the country's remaining pollution problems are substantially controlled or affected by wet weather, nonpoint source inputs. The EPA advocates watershed-scale water quality management, and watershed management is important enough that it probably will be addressed when the Clean Water Act is reauthorized.

The EPA's CSO policy establishes considerable flexibility for control technologies, implementation schedules, and economic considerations. This policy is consistent with the national experience with wet weather controls. In many cases, permitting agencies have required sewerage authorities to commit to ongoing, long-term I/I reduction and system rehabilitation programs but have not mandated explicit, total elimination of overflows or specific design storm controls.

Results and Recommendations

The following paragraphs summarize the results of the study efforts and further recommendations for improving Catoma Creek water quality.

Results

For the field effort, the results of this study are summarized below:

- Rural and urban runoff cause Catoma Creek to exceed **ADEM** water quality criteria.
- Pollutant loadings from overflowing manholes are an insignificant percentage of total pollutant loadings to Catoma Creek.
- Overflows occur only at a limited number of locations in the sewer collection system a few times a year. During the study, overflows occurred at 12 known locations and were dependent on rainfall size, intensity, and duration, as well as on ground-water conditions and other factors.
- The water quality in the Catoma WPCP collection system is comparable with that of a typical CSO.

Recommendations

The following recommendations were developed to diminish potential health concerns resulting from public contact with untreated wastewater from collection system overflows and to assist in improving the Catoma Creek water quality:

- Discuss with **ADEM** the revision of the Administrative Order so that corrective actions and timetables are consistent with the National CSO policy.
- Discuss with **ADEM** the amendment of Catoma **WPCP's** NPDES permit to allow overflows at a few designated locations in the collection system, in keeping with the National CSO strategy.

Determine the scope of collection system improvements necessary to comply with the amended NPDES permit and to mitigate health risks to the public. A phased approach with phases such as those listed below is recommended for the sewer collection system improvements:

- Control overflows in sensitive areas.
- Minimize all overflows by maximizing flow to the Catoma WPCP.
- Continue overflow control consistent with recommendations of an overall management strategy.

- Establish ongoing sewer system monitoring.
- Discuss with **ADEM** the development of a watershed management plan to control the pollutant loadings to Catoma Creek from all sources, including rural and urban runoff (nonpoint sources).

Catoma Watershed Management Planning

The Board has recently initiated an effort to begin the development of a comprehensive watershed management planning effort. This project will focus on further definition of pollutant contribution from specific sources within the watershed and the formulation of alternative strategies to address these sources. This effort is being coordinated with a broad range of “stakeholder” groups to address required actions and achievable water quality improvements through a comprehensive planning effort.

Regional Flow Monitoring for Sewer Rehabilitation Performance Evaluation, Oakland County, Michigan

Michael D. Waring and Keith D. McCormack
Hubbell, Roth & Clark, Inc., Bloomfield Hills, Michigan

Introduction

The Evergreen-Farmington Sewage Disposal System (EFSDS) is a 130-square-mile regional sewer district serving 16 Oakland County communities in southeast Michigan (Figure 1). In 1992, the EFSDS member communities completed a major program of sewer rehabilitation and system improvements to remove extraneous infiltration/inflow (I/I) for control of sanitary sewer overflows (SSOs) and basement flooding.

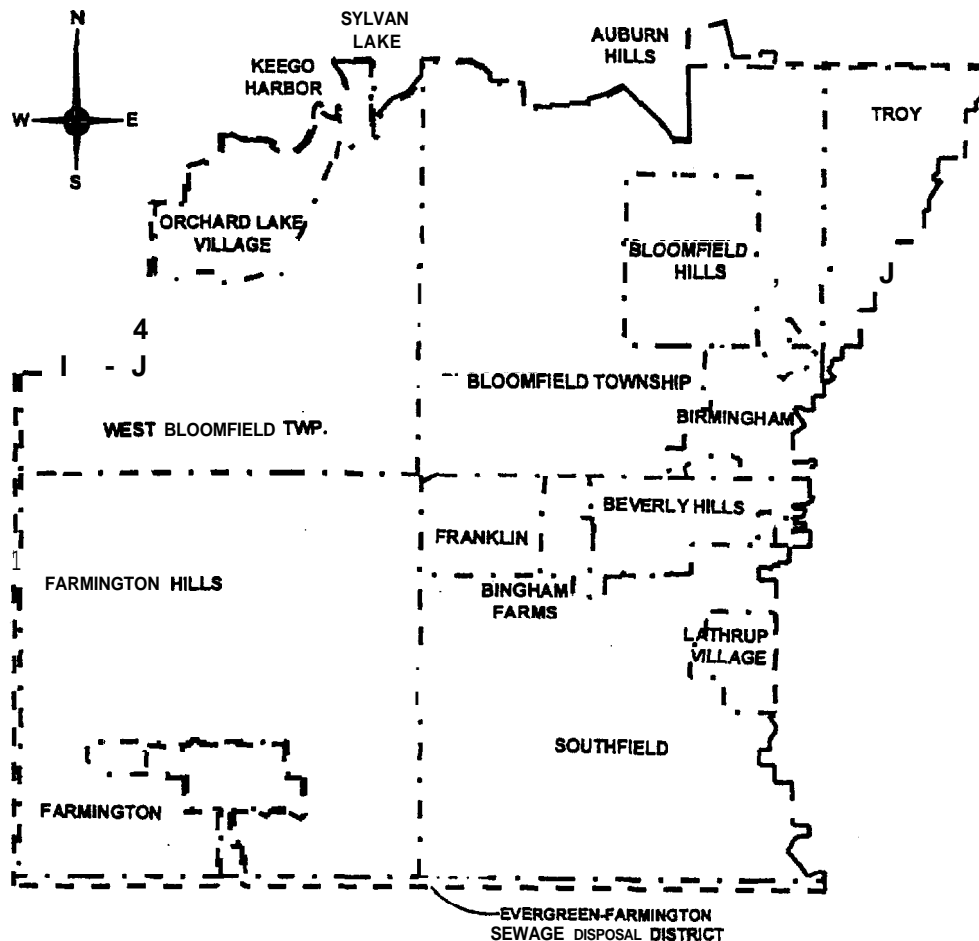

Figure 1. Evergreen-Farmington sewage disposal system.

In 1993, a regional flow monitoring program was conducted within the EFSDS to certify wet weather performance of the rehabilitation program and system improvements. Regional flow monitoring was provided on behalf of the member communities by the Oakland County Drain Commissioner (OCDC), owner and administrator of the EFSDS interceptor collection system.

Background

The EFSDS is part of the Greater Detroit Regional System (GDRS), which provides wastewater conveyance and treatment services for the EFSDS, as well as other regional districts, communities, and the City of Detroit. Wastewater flows within the EFSDS are collected and metered at the GDRS connection for conveyance and disposal at the Detroit Wastewater Treatment Plant.

The majority of sewers within the EFSDS are considered separate and were constructed after 1959, when the EFSDS was formed. Some sewer systems were constructed before 1959, however, including several combined sewer areas, some combined sewer areas that have been separated, and isolated older separate sewer areas that were connected to local treatment facilities. Predictably, some of the areas with the highest I/I incidence were identified in these older sewer areas.

During the late 1970s and 1980s, pollution control facility planning, I/I studies, and Sewer System Evaluation Surveys (SSESs) were conducted for the entire EFSDS. The following sewer system improvements were designed and constructed from 1988 to 1992:

- Relief sewers (106,000 linear feet, 8 to 54 inches in diameter)
- Pumping stations (one reconstruction, seven new facilities)
- Two sanitary retention tanks (SRTs) (2.2 and 3.0 million gallons)
- Manhole rehabilitation (4,000 manholes)
- Sewer grouting (46,000 linear feet, 8 to 24 inches in diameter)
- Sewer relining and replacement (90,000 linear feet)
- Private I/I reduction:
 - Downspout disconnection and/or extension
 - Sump pump disconnection
 - Stormwater cross connection removal

On behalf of the member communities, the OCDC undertook the construction of all public sewer system rehabilitation and improvements with financial assistance from federal grants. Individual communities were responsible for private I/I reduction activities.

The projected total peak wet weather I/I reduction was approximately 15 to 30 percent across the entire district. In general, areas with older, leakier sewer systems exhibited more I/I sources, resulting in several concentrated areas of rehabilitation, relief, and, in two locations, SRTs for storing excess residual I/I. These areas had previously exhibited regular SSOs and basement flooding during storm events.

All sewer system improvements (relief sewers, pump station expansions, SRTs) were designed based on estimated I/I reductions. The federal grant that funded construction required postrehabilitation certification of system performance through flow measurement during wet weather events. Certification was sought to confirm the design assumptions of the sewer system improvements and to demonstrate control of SSOs and basement flooding during a design storm event.

Each member community, and the EFSDS as a whole, is limited to a total peak wet weather flow rate known as "town outlet capacity" (TOC). The regional flow monitoring program was designed to evaluate

individual member community flows, as well as sewer subdistrict flows as they were analyzed during the original I/I and SSES studies.

Performance Certification Program

Flow monitoring for the EFSDS Performance Certification Program (PCP) was performed on a regional basis within the sewer district. This regional flow monitoring approach led to the following arrangements:

- Permanent flow meters and rain gauges installed for the 1993 PCP are owned and maintained by OCDC for future annual monitoring of member community TOCs and system operational flows.
- Temporary flow metering and PCP analysis were partially grant eligible; with a regional monitoring program, OCDC could function as sole grantee for the 16 member communities.
- Variations and/or commonalities of data within the EFSDS district (e.g., rainfall patterns during study, attenuation of peak flows, upstream meter influence) could be uniformly analyzed.

PCP flow metering consisted of 130 open-channel flow meters distributed over the EFSDS service area (Figure 2). Rainfall data were collected from six rainfall gauges. Eighty-two ground-water gauges were installed and monitored.

Both permanent and temporary flow meters were used for the study. Sixty-eight permanent flowmeters were installed for this project. Permanent flowmeter locations are generally at member community boundaries to isolate member community flow rates. The permanent meters are telemetered to the OCDC central offices to allow for computer downloading, data storage, and analysis of flow rates.

Sixty-two temporary meters were also installed for the duration of the 1993 flow metering period. The temporary meter locations isolate individual subdistricts within communities to allow comparison of postrehabilitation flows with flow data from the initial I/I studies.

Flow metering, rainfall, and ground-water data were collected from January 1993 through August 1993. This metering period was selected to include wastewater flows for winter, spring runoff, and major rainfall events. Figures 3 and 4 show examples of the dry and wet weather flow data collected. Figure 5 is an example of recorded ground-water measurements.

The primary metering goal was to measure the response in the sewers to wet weather conditions and to observe a relationship between rainfall and I/I. Figure 6 shows isolation of base flow and inflow at a typical meter.

The relationship between isolated inflow and the corresponding rainfall intensity was used to project the I/I to a peak wet weather value anticipated during a design rainfall event for the EFSDS. The design storm is 1.7 inches in 1 hour, generally regarded as the 10-year, 1-hour storm event. The design for sewer system improvements (relief sewers, pumping stations, SRTs) was based on this 10-year, 1-hour design storm. This design storm event was established by the Michigan Department of Natural Resources as a uniform criterion and assumes uniform distribution of the design storm over the study area.

Because a uniform 10-year design storm was unlikely to occur (and did not occur) during the 8-month metering period, metered flow rates had to be extrapolated up to the equivalent design storm. This was accomplished by comparing metered inflow rates with measured rainfall intensities (Figure 7). Best-fit projections were determined for each meter and were added to base flows for total metered operational

flows. The flow rates for all metered subdistricts and the summation of flows for member communities were determined for comparison with anticipated design flow rates.

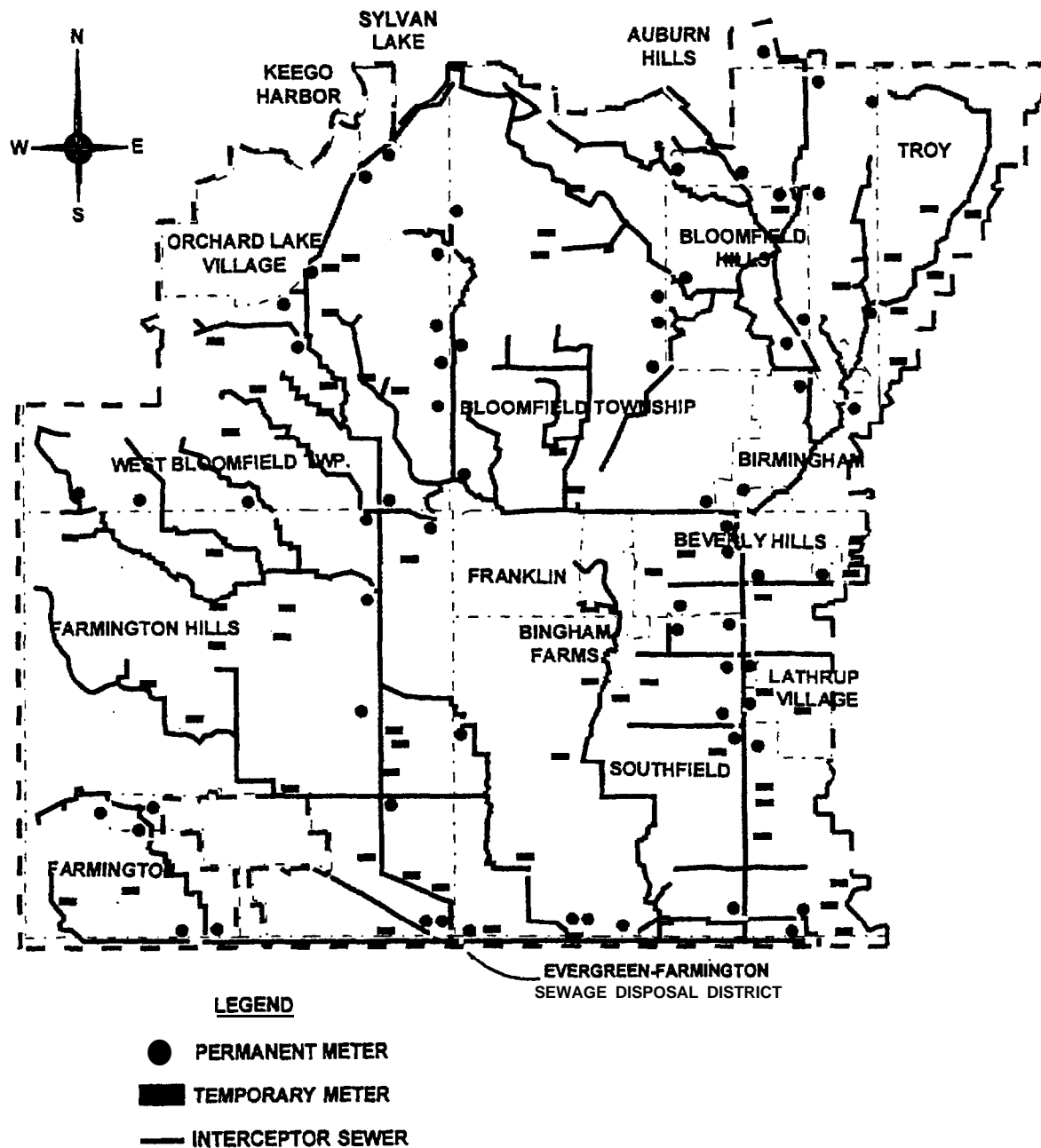
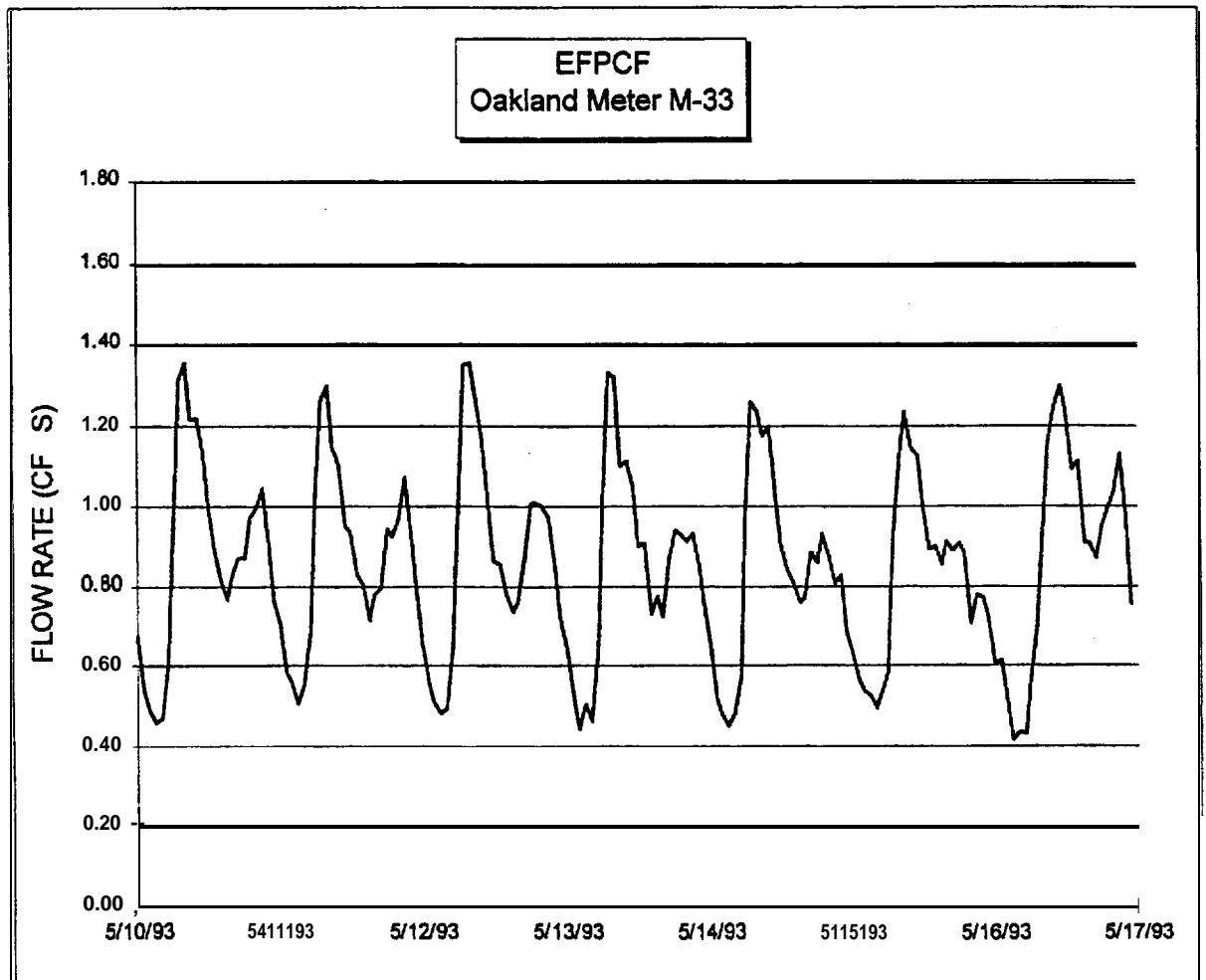

Figure 2. Meter locations, Evergreen-Farmington sewage disposal system.



FLOW	Monday 5/10/93	Tuesday 5/11/93	Wednesday 5/12/93	Thursday 5/13/93	Friday 5/14/93	Saturday 5/15/93	Sunday 5/16/93
Average (CFS)	0.681	0.570	0.668	0.848	0.832	0.821	a571
Maximum (CFS)	1.354	1.298	1.553	1.328	1.258	1.238	1.298
Minimum (CFS)	0.458	0.507	0.482	0.444	0.450	0.483	0.415
Total (MCF)	0.078	0.075	0.075	0.073	0.072	0.071	0.075

Figure 3. Typical dry weather hydrograph.

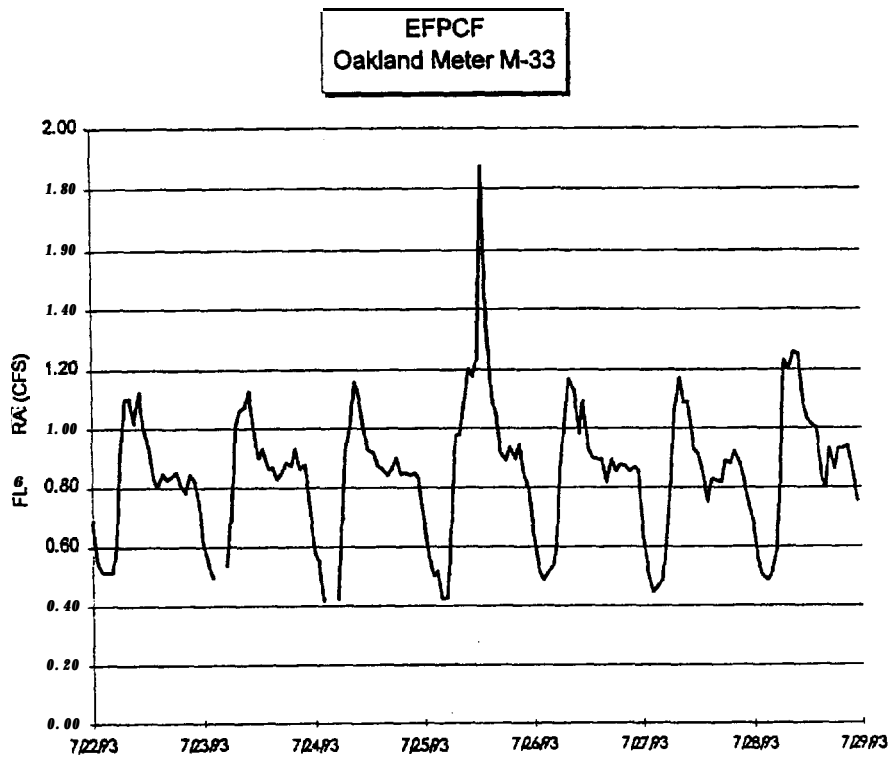

Figure 4. Wet weather hydrograph.

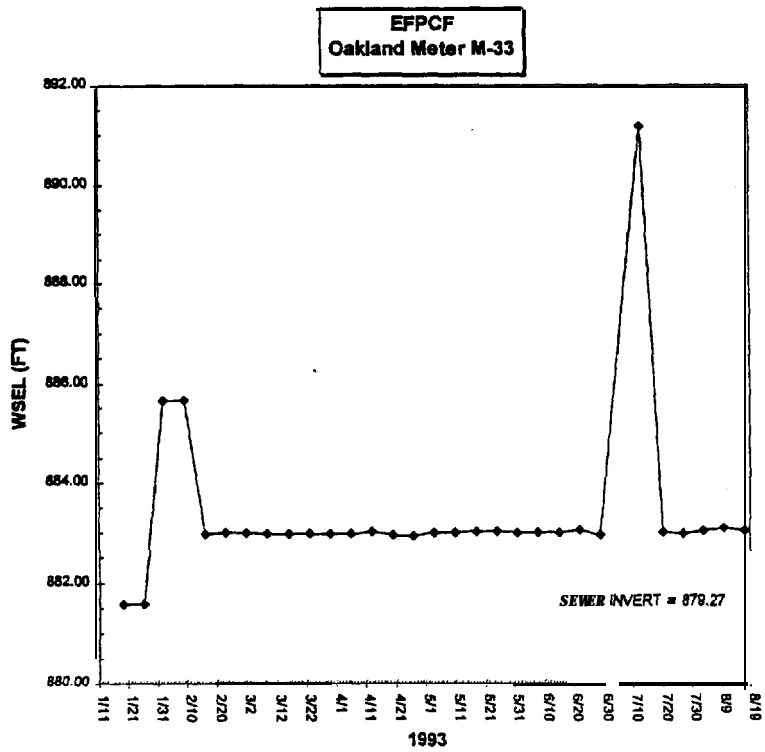

Figure 5. Ground-water monitoring data.

**EFPCF
Oakland Meter M-33**

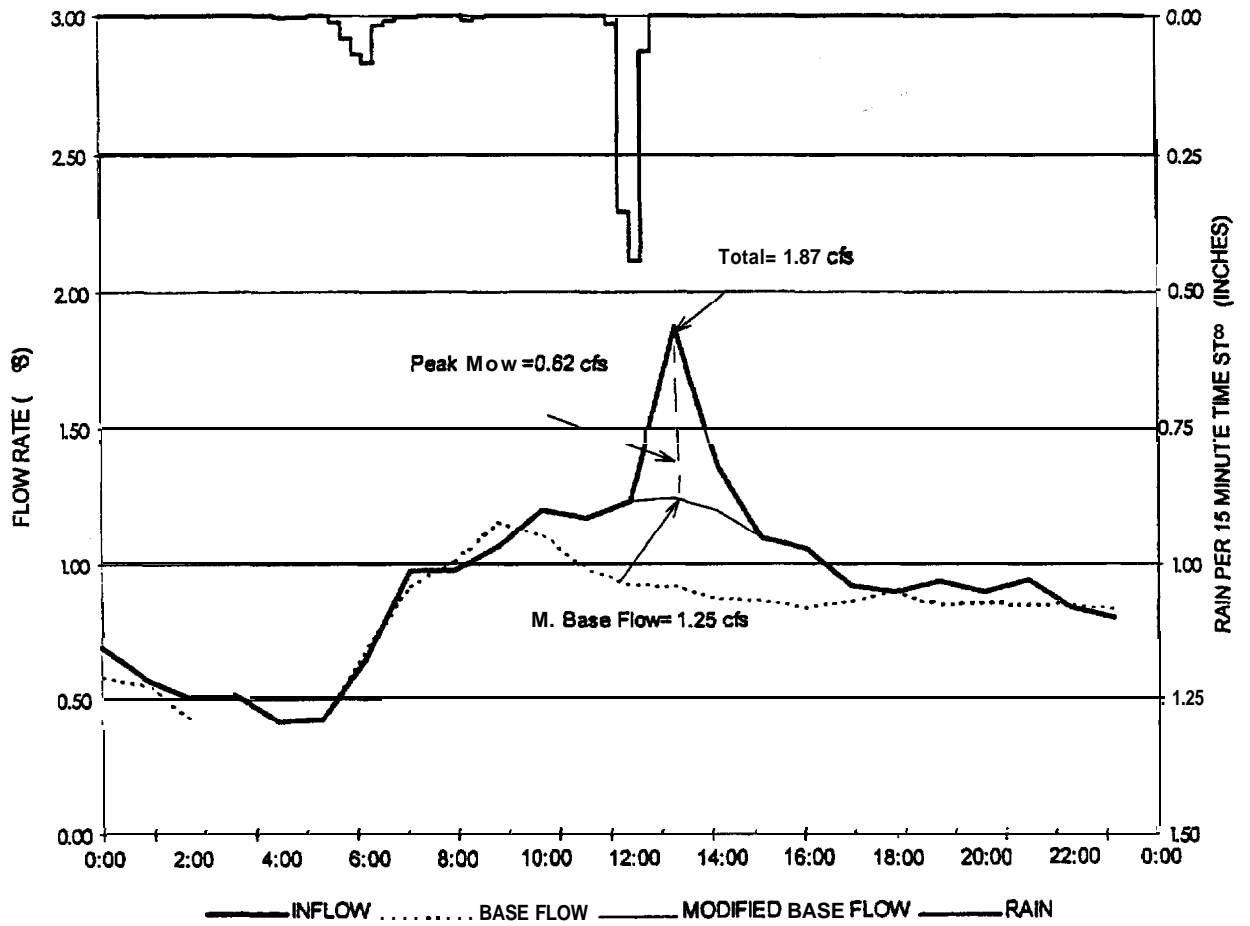

Figure 6. inflow analysis.

	<u>Intensity</u>	<u>Min. Inflow</u>
4/19/93	0.250	0.480
4/25/93	0.170	0.330
6/7/93	0.470	0.550
6/20/93pm	0.340	0.500
6/25/93	0.090	0.000
6/27/93	0.040	0.000
7/25/93	0.920	0.620
7/28/93	0.100	0.000
8/19/93	0.680	0.400
10-Yr Projected Inflow	1.700	0.77

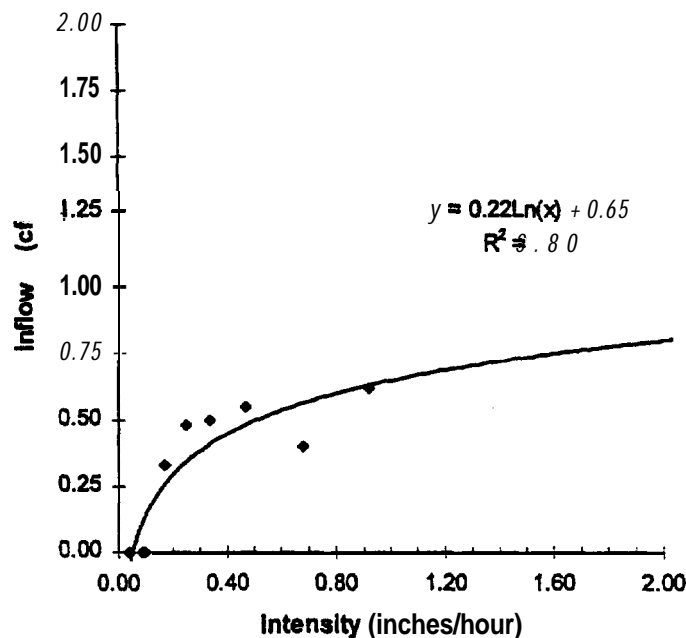

Figure 7. Design storm inflow projection.

The comparison of flows indicated variations of inflow reduction both above and below the reductions anticipated within specific subdistrict areas. Comparison of total community flows to TOC indicated 14 out of 16 communities were within TOC limits. Two communities require additional corrective action and remetering to verify compliance. I/I reductions varied between communities and within specific subdistricts within communities. The reductions within subdistricts and communities varied from approximately 5 to 50 percent, depending upon the local system.

Special Interest Areas

A variety of sewer systems exist within the EFSDS, including several with house footing drains connected. Four combined sewer overflow (CSO) areas also contribute restricted flows through regulators to the sanitary sewer system. The CSO areas have pollution control projects, scheduled for completion in 1997, that will further restrict and control flow contributions to the EFSDS.

Of special interest within the EFSDS is an 800-acre community sewer system which was originally combined and then separated in the 1950s, primarily for relief of basement flooding occurrences. This was one of the wettest areas identified within the EFSDS and required extensive rehabilitation (manholes, sewer grouting, sewer relining, private I/I reduction) to reduce I/I. Rehabilitation work that was done on private property consisted of downspout extensions and point source removal, but did not include footing drain removal or disconnection. Despite the extensive rehabilitation program, this area still required the construction of a 3.0 million gallon **SRT** to store residual I/I not removed and beyond the system's outlet capacity.

The tank was designed to retain wastewater volumes generated by a 25-year, 24-hour storm (4.0 inches/24 hours). No storm event has exceeded the design capacity during the first 2 years of service. The history of this area demonstrates the difficulty of successfully separating a combined sewer system when the outlet capacity is limited to flow rates representative of a modern separate sanitary sewer.

All communities within the EFSDS have adopted state approved operation and maintenance (O&M) programs with special emphasis on continued I/I control. I/I control activities (including regular system inspection and repair) center around manhole inflow sources that were identified as a major source of inflow during the SSES studies. These O&M activities, coupled with permanent flow monitoring provided for the regional system, allow for continued SSO pollution control for the EFSDS.

Acknowledgments

The authors wish to acknowledge the numerous hours of assistance that the Oakland County Drain Commissioner and staff provided during the course of this regional study.