

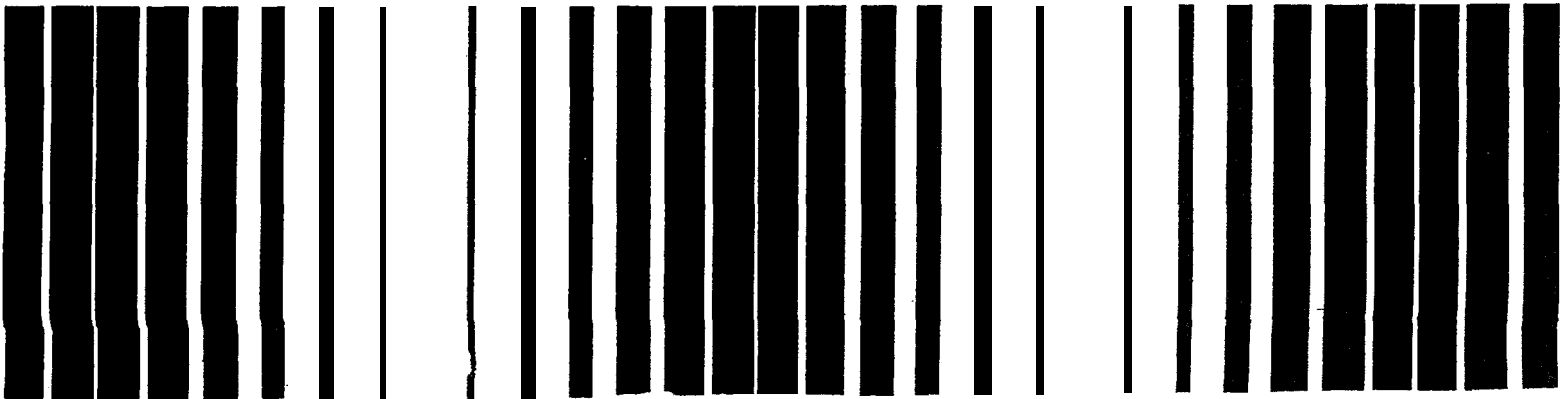

# Manual

## Best Management Practices for Pollution Prevention in the Slabstock and Molded Flexible Polyurethane Foam Industry



## **Manual**

# **Best Management Practices for Pollution Prevention in the Slabstock and Molded Flexible Polyurethane Foam Industry**

US. Environmental Protection Agency  
Office of Research and Development  
National Risk Management Research Laboratory  
Cincinnati, Ohio

## DISCLAIMER

---

The U.S. Environmental Protection Agency through its Office of Research and Development funded and managed the research **described** here under Contract **#68-3-0315** to Eastern Research Group, Inc. It has been subjected to the Agency's peer and administrative review and has been approved for publication as an EPA document. Mention of trade names or commercial products does not constitute endorsement or recommendation for use.

## FOREWORD

---

The U.S. Environmental Protection Agency is charged by Congress with protecting the Nation's land, air, and water resources. Under a mandate of national environmental laws, the Agency strives to formulate and implement actions leading to a compatible balance between human activities and the ability of natural systems to support and nurture life. To meet this mandate, EPA's research program is providing data and technical support for solving environmental problems today and building a science knowledge base necessary to manage our ecological resources wisely, understand how pollutants affect our health, and prevent or reduce environmental risks in the future.

The National Risk Management Research Laboratory is the Agency's center for investigation of technological and management approaches for reducing risks from threats to human health and the environment. The focus of the Laboratory's research program is on methods for the prevention and control of pollution to air, land, water and subsurface resources; protection of water quality in public water systems; remediation of contaminated sites and ground water; and prevention and control of indoor air pollution. The goal of this research effort is to catalyze development and implementation of innovative, cost-effective environmental technologies; develop scientific and engineering information needed by EPA to support regulatory and policy implementation of environmental regulations and strategies.

This publication has been produced as part of the Laboratory's strategic long-term research plan. It is published and made available by EPA's Office of Research and Development to assist the user community and to link researchers with their clients.

This manual, *Best Management Practices for Pollution Prevention in the Slabstock and Molded Flexible Polyurethane Foam Industry*, funded through the Center for Environmental Research Information, is a pollution prevention guidance manual for processes and waste reduction in the slabstock and molded flexible polyurethane foam industry.

E. Timothy Oppelt, Director  
National Risk Management Research Laboratory

## ABSTRACT

---

The 1990 Clean Air Act Amendments require EPA to develop standards for major emission sources of 189 hazardous air pollutants (HAPs). EPA has identified the flexible polyurethane foam industry as a large emitter of **HAPs** and has slated the industry for regulation under Title III, with standards scheduled to be promulgated no later than November 15, 1997.

This manual presents pollution prevention options for the two major sectors of the flexible polyurethane foam industry: slabstock and molded foam production. Designed for use by both polyurethane foam manufacturers and regulatory personnel, it:

- Provides an overview of the flexible foam industry and chemistry of foam production, common to both slabstock and molded industry segments.
- Details manufacturing processes and potential P2 measures for slabstock and molded foam production.
- Details pollution prevention opportunities for operations that are common to both.
- Provides worksheets for pollution prevention measures, emission and cost calculations, and lists additional resources.

This manual will be useful for those interested and/or involved in the industry: facility managers, regulators and environmental managers and engineers.

This report was submitted in fulfillment of Contract **#68-3-0315** by Eastern Research Group, Inc. under the sponsorship of the U.S. Environmental Protection Agency. This report covers a period from April, 1994, to September, 1996, and work was completed as of September **30, 1996**.

---

## Contents

	Page
<i>Foreword</i> .....	iii
<i>Abstract</i> .....	iv
<i>Figures</i> .....	viii
<i>Tables</i> .....	ix
<i>Conversion Factors</i> .....	x
<i>Acknowledgments</i> .....	xi
<b>Chapter 1 Introduction</b> .....	<b>1</b>
1.1 Overview of Pollution Prevention .....	1
1.2 Pollution Prevention and Flexible Polyurethane Foam Production .....	1
1.3 References.. .....	2
<b>Chapter 2 Flexible Polyurethane Foam Industry Profile</b> .....	<b>3</b>
2.1 Industry Description .....	3
2.2 Foam Grades and Applications .....	3
2.3 Foam Quality Measurements .....	4
2.4 Chemistry of Polyurethane Foam Production .....	4
2.4.1 Key Ingredients. ....	4
2.4.2 Foam-Producing Reactions. ....	5
2.4.3 Blowing Agents .....	5
2.5 Current Environmental Releases .....	6
2.6 References .....	7
<b>Chapter 3 Pollution Prevention in Slabstock Foam Manufacture</b> .....	<b>9</b>
3.1 Slabstock Foam Production .....	9
3.1.1 Typical Horizontal Foam Production Line. ....	9
3.1.2 Variations on the Horizontal Foam Production Line. ....	10
3.1.3 Foam Blowing and Use of Auxiliary Blowing Agents .....	12
3.1.4 Foam Curing and Storage .....	13
3.1.5 Foam Fabrication .....	13
3.1.6 Rebond Operation. ....	13

---

**Contents (continued)**

	<b>Page</b>
<b>3.2 Methods for Reducing Auxiliary Blowing Agent Emissions</b> .....	13
<b>3.2.1 Overview of Releases.</b> .....	13
3.2.2 Production of Water-Blown Foams. ....	13
3.2.3 Liquid CO <sub>2</sub> Blowing Technology. ....	17
3.2.4 Reduced Pressure Foaming. ....	17
3.2.5 Alternative Blowing Technology .....	18
3.2.6 Add-On Emission Control Equipment for Reclaiming Auxiliary Blowing Agents .....	18
3.2.7 Alternative Auxiliary Blowing Agents. ....	20
3.2.8 Comparison and Cost Information for Auxiliary Blowing Agent Emission Reduction Measures .....	20
<b>3.3 Methods for Reducing Toluene Diisocyanate Emissions,</b> .....	20
3.3.1 Impact of Process and Formulation Changes on Toluene Diisocyanate Emissions. ....	20
3.3.2 Add-On Controls for Toluene Diisocyanate Emissions .....	20
<b>3.4 Reducing Releases From Foam Fabrication, Chemical Storage and Handling, and Cleaning</b> .....	20
<b>3.5 References</b> .....	21
<b>Chapter 4 Pollution Prevention in Molded Foam Manufacture</b> .....	<b>23</b>
<b>4.1 Molded Foam Production</b> .....	23
4.1.1 Molded Foam Process Equipment. ....	23
4.1.2 Molding Process Cycle. ....	23
4.1.3 Molding Process Variations. ....	24
4.1.4 Cell Opening. ....	25
4.1.5 Repair Operations. ....	25
4.2 Overview of Releases. ....	25
4.3 Methods for Reducing Releases From Mix-Head Flushing. ....	25
4.3.1 High Pressure Mix Heads. ....	26
4.3.2 Self-Cleaning Mix Heads .....	26
4.3.3 Nonhazardous Flushing Agents .....	26
4.3.4 Solvent Recovery .....	26
4.3.5 Comparison and Cost Information for Measures To Reduce Mix Head Flushing Emissions .....	26
4.4 Methods for Reducing Releases of Mold Release Agent .....	27
4.4.1 Naphtha-Based Mold Release Agents .....	27
4.4.2 Reduced VOC Mold Release Agents. ....	27
4.4.3 Water-Based Mold Release Agents .....	27

---

**Contents (continued)**

	<b>Page</b>
4.4.4 Electrostatic Spray Guns .....	27
4.4.5 Comparison and Cost Information for Measures To Reduce Mold Release Agent Emissions .....	27
4.5 Methods for Reducing or Mitigating Releases of Auxiliary Blowing Agents .....	27
4.5.2 HFA-134a.. .....	28
4.5.2 Pentane .....	28
4.5.3 Water Blowing .....	28
4.6 Methods for Reducing Releases From Foam Repair, Chemical Storage and Handling, and Cleaning Processes .....	28
4.7 References.. .....	28
<b>Chapter 5 Pollution Prevention in Adhesive Usage, Chemical Storage and Handling, and Equipment Cleaning .....</b>	<b>31</b>
5.1 Reducing Emissions From Adhesives. ....	31
5.1.1 Hot-Melt Adhesives. ....	31
5.1.2 Water-Based Adhesives .....	31
5.1.3 Two-Component Water-Based Adhesives .....	32
5.1.4 Costs for Alternative Adhesives .....	32
5.2 Reducing Releases From Chemical Storage and Handling .....	32
5.3 Reducing Releases From Equipment Cleaning .....	32
5.3.1 Steam Cleaning. ....	32
5.3.2 Solvent Substitution .....	33
5.3.3 Solvent Recovery .....	33
5.4 References.. .....	33
<b>Appendix A Pollution Prevention Worksheets for Polyurethane Foam Manufacturing. ....</b>	<b>35</b>
<b>Appendix B Further Information .....</b>	<b>41</b>



---

## *Figures*

<b>Figure</b>	<b>Page</b>
2-1 Reactants typically used in the production of polyurethane foam.....	4
2-2 Polyurethane foam production reactions.....	. 5
3-1 Typical slabstock production line for flexible polyurethane foam.....	10
3-2 <b>Maxfoam</b> production process.....	11
3-3 Vertifoam foam production process. ....	12
3-4 Methylene chloride use rates for different foam grades. ....	12
3-5 Foam production as a function of density grade. ....	14
3-6 <b>EnviroCure</b> foam production process. ....	16
4-1 Typical molded foam production line.....	. 24

---

## *Tables*

<b>Table</b>	<b>Page</b>
2-1 Summary of 1992 Emissions From Flexible Polyurethane Foam Production .....	6
3-1 Summary of 1992 Emissions From Polyurethane Foam Production .....	14
3-2 Summary of Alternative Foam Softening Additives and Systems. ....	15
3-3 Summary of Costs and Requirements for Measures To Reduce HAP Emissions. ....	21
4-1 Summary of 1992 Emissions From Molded Flexible Polyurethane Foam Production .....	25
4-2 Summary of Costs To Reduce Mix-Head Flushing Releases.....	27
4-3 Summary of Costs To Reduce Emissions From Mold Release Agents .....	28
5-1 Summary of Costs of Alternative Adhesive Systems .....	32

---

## **Conversion Factors**

Units of measurement used throughout this document can be converted to SI units using the following conversion factors:

<b>To convert . . .</b>	<b>to . . .</b>	<b>multiply by . . .</b>
cubic feet	cubic meters	$2.831685 \times 10^{-2}$
degrees Fahrenheit	degrees Celsius	$t^{\circ C} = (t^{\circ F} - 32)/1.8$
feet	meters	<b>0.3048</b>
inches	centimeters	<b>2.54</b>
pounds	kilograms	<b>0.45354237</b>
pounds per cubic foot	kilograms per cubic meter	<b>16.0184634</b>
pounds per cubic foot	kiloPascals	<b>6.895</b>
square inches	square inches	<b>6.4516</b>
tons	metric tons	0.90718474
U.S. gallons	liters	<b>3.785</b>

---

## ***Acknowledgments***

This report is based on information gathered by EC/R Incorporated of Durham, North Carolina, on emissions and potential emission control measures as part of a U.S. Environmental Protection Agency (EPA) Emission Standards Division effort to develop background information on hazardous air pollutant emissions. The report also draws heavily on emission control assessments prepared by the Polyurethane Foam Association and the Center for Emission Control, as well as product literature from several foam chemical and equipment suppliers.

Doug Williams of EPA's Office of Research and Development, Center for Environmental Research Information, was responsible for the preparation and review of this document. William Battye, P.E., of EC/R served as the document's author under contract with Eastern Research Group, Inc. (ERG), Lexington, Massachusetts. Jeff **C**antin was ERG's project manager for the task. ERG also edited the document and prepared it for publication. David Svendsgaard of the Emission Standards Division provided review and technical guidance, and Amanda Williams and Philip **N**orwood of EC/R contributed additional information.

Special thanks go to the following industry representatives who carefully reviewed the document:

- Dr. Douglas Sullivan, Hickory Springs Manufacturing
- Dr. Herman Stone, General Foam Corporation
- Mr. Robert **H**eller, Future Foam Corporation
- Mr. James McIntyre, **M**cnair & Sanford
- Mr. Lou Peters, Polyurethane Foam Association

---

## **Chapter 1**

### **Introduction**

This manual presents pollution prevention options for the two major sectors of the flexible polyurethane foam industry: slabstock foam production and molded foam production. Designed for use by both polyurethane foam manufacturers and regulatory personnel, the manual is organized as follows:

- Chapter 2 gives an overview of the flexible foam industry and the chemistry of foam production, which is common to both the slabstock and molded industry segments.
- Chapter 3 discusses manufacturing processes and potential pollution prevention measures for slabstock foam production.
- Chapter 4 discusses manufacturing processes and potential pollution prevention measures for molded foam production.
- Chapter 5 discusses pollution prevention opportunities for operations that are common to both slabstock and molded foam plants.
- Appendix A contains worksheets for pollution prevention measures and emission and cost calculations.
- Appendix B lists additional resources.

#### **1.1 Overview of Pollution Prevention**

In the Pollution Prevention Act of 1990, Congress established a national policy that pollution should be prevented or reduced at the source whenever feasible, and pollutants that cannot be prevented should be recycled in an environmentally safe manner. Source reduction, a key component of pollution prevention, includes equipment or technology modifications, process or procedure modifications, reformulation or redesign of products, substitution of raw materials, and improvements in housekeeping, maintenance, training, or inventory control.

In accordance with the Pollution Prevention Act, the U.S. Environmental Protection Agency (EPA) is seeking to integrate pollution prevention concepts throughout its activities. Pollution prevention can be applied to nearly all areas of environmental management, including air pollution emissions, releases to surface water or publicly

owned wastewater treatment works, and pollutants managed by land disposal.

#### **1.2 Pollution Prevention and Flexible Polyurethane Foam Production**

The 1990 Clean Air Act Amendments require EPA to develop standards for major emission sources of 189 hazardous air pollutants (HAPs). EPA has identified the flexible polyurethane foam industry as a large emitter of HAPs and has slated the industry for regulation under Title III, with standards scheduled to be promulgated no later than November 15, 1997.

The flexible polyurethane foam industry reported total annual HAP emissions of almost 19,000 tons in a recent survey conducted by EPA's Emission Standards Division (1).<sup>1</sup> This total includes about 15,000 tons of methylene chloride, which is over 10 percent of total nationwide emissions of this HAP (2). Much of the methylene chloride emitted from the foam industry arises from the use of the chemical as an auxiliary blowing agent in the slabstock process. In addition to HAP emissions, nonhazardous volatile organic compound (VOC) emissions from the molded foam sector may amount to an additional 10,000 tons per year (3). Although these VOC emissions are not regulated as HAPs under Title III, they contribute to smog problems in urban areas and therefore may be regulated under Title I of the Clean Air Act.

Because of difficulties in capturing and treating emissions from flexible polyurethane foam production, pollution prevention strategies tend to be more cost effective than add-on controls. Any analyses of control strategies, however, must consider impacts on product properties and product quality. The industry has expressed concern that if the physical properties and production costs of the foam produced with pollution prevention measures are not comparable with those of the current products, the industry runs a substantial risk of losing market share (i.e., consumers might switch to substitute products); as a result, the industry would suffer adverse

---

<sup>1</sup> Williams, A. 1994. Updated estimate of HAP emissions from slabstock foam production. Personal communication from A. Williams, EC/R Inc., to Lou Peters, Polyurethane Foam Association. February 8.

---

economic impacts. Therefore, the industry and its equipment and chemical suppliers have been developing and implementing chemical and equipment modifications to reduce emissions without detrimental impacts on product quality.

This work began when chlorofluorocarbons (CFCs) were implicated in the destruction of the stratospheric ozone layer. The Montreal Protocol on Substances That Deplete the Ozone Layer, signed in 1987, phased out the use of CFCs. Until then, trichlorofluoromethane (CFC-11) had been the most important auxiliary blowing agent used in the flexible polyurethane foam industry. Although the slabstock industry had made a partial switch to methylene chloride for economic reasons well before the Montreal Protocol, a universal switch to methylene chloride had not occurred because CFC-11 was easier to use. After the Montreal Protocol, the slabstock industry switched completely to methylene chloride and other substitutes. The slabstock industry also recognized the need to reduce emissions of any auxiliary blowing agent whenever possible, which led to exploration of numerous source reduction measures based on chemical and equipment modifications.

The trade association for the flexible polyurethane foam industry, the Polyurethane Foam Association (PFA), has

been particularly active in publishing and making available information on source reduction measures (4, 5). In addition, both the PFA and the Polyurethanes Division of the Society for the Plastics Industries hold annual conferences to discuss source reduction developments.

### 1.3 References

1. Norwood, L.P., A. Williams, and W. Batty. 1994. Summary of flexible polyurethane foam information collection requests (ICRs). Presented at a meeting of the U.S. Environmental Protection Agency and the Polyurethane Foam Association. February 2.
2. U.S. EPA. 1993. Locating and estimating air emissions from sources of methylene chloride. EPA/454/R-93/006. Research Triangle Park, NC (February).
3. Whitfield, K. 1994. Some characterization and emissions estimates for mold release agents and roofing applications. Prepared by Southern Research Institute for the U.S. Environmental Protection Agency, Research Triangle Park, NC.
4. U.S. EPA/PFA. 1991. Handbook for reducing and eliminating chlorofluorocarbons in flexible polyurethane foams, 21A-4002. Joint project of the U.S. Environmental Protection Agency and the Polyurethane Foam Association, Washington, DC.
5. PFA. 1993. Flexible polyurethane foam (slabstock): Assessment of manufacturing emission issues and control technology. Wayne, NJ: Polyurethane Foam Association.

---

## **Chapter 2**

### **Flexible Polyurethane Foam Industry Profile**

#### **2.1 Industry Description**

The term "polyurethane" applies to a general class of polymers in which molecular chain segments are bound together with urethane linkages ( $R_1-NH-COO-R_2$ ). Polyurethanes are used to produce an extremely wide range of products, including solid plastics, adhesives, coatings, rigid foams, and flexible foams. Flexible foams represent by far the largest application for polyurethanes, accounting for over half of the total U.S. production of polyurethanes (1). Flexible polyurethane foam is used in furniture, bedding, automobile seats and cushions, packaging materials, carpet cushions, and many other applications (1).

The flexible polyurethane foam industry falls under standard industrial classification (SIC) code 3086, "Plastics Foam Products," which includes other manufacturers of plastic foams such as polystyrene foam and rigid polyurethanes. The flexible polyurethane foam industry is divided into two major sectors: those producing slabstock foam and those producing molded foam. In addition, products produced by the slabstock sector can be subdivided further into various "foam grades." These grades are defined by foam density and firmness. Slabstock foam represents about 75 percent of the flexible polyurethane foam industry.

The slabstock process is a continuous process that produces a series of large "buns," named for their resemblance to long, rectangular loaves of bread. Buns range in size from 50 to over 5,000 cubic feet. After they cure, the buns are cut into shapes, some of which are then glued to other pieces of foam or to other materials. The cutting, shaping, and gluing steps are termed "fabrication" operations. Either the slabstock plant or the foam purchaser may perform these operations. The largest uses of slabstock foams are in furniture, carpet cushions, and bedding (1).

In molded foam production, foam polymerization occurs in a mold the shape of the desired product. This minimizes the need for fabrication, although cutting and gluing operations are often required. Molded foam is used primarily in the transportation market, for car

seats and energy-absorbing trim panels (1). Other uses include furniture, bedding, packaging materials, toys, and novelty items.

Usually, a company produces either slabstock or molded foams, although a few companies produce both products. Almost all producers of slabstock foam belong to the Polyurethane Foam Association (PFA). This trade group has no members that exclusively produce molded foams. The Society of the Plastics Industries, Polyurethane Division (SPI), represents suppliers of raw materials to slabstock and molded foam producers.

Total slabstock foam production in 1993 was greater than 600,000 tons. At the end of 1993, 25 companies were engaged in slabstock foam production, operating about 78 foam plants. Three large companies account for over half of the total U.S. production (2). In addition, the slabstock industry is currently undergoing a further consolidation through corporate mergers and acquisitions.

Molded foam production is more difficult to quantify because many small plants produce this material. The SPI reported production of molded foam at 215,000 tons in 1989. Estimated production in 1993 was about 175,000 tons. A recent survey of the foam industry by the U.S. Environmental Protection Agency's (EPA's) Emission Standards Division (ESD) identified 49 plants producing molded foam; however, these plants accounted for only about half of the molded foam production reported by SPI in 1989. Molded foam producers tend to be either very large, with over 1,500 employees, or very small, with fewer than 100 employees (2). In the EPA/ESD survey, almost half of the 49 plants surveyed reported production rates less than 500 tons per year.

#### **2.2 Foam Grades and Applications**

Flexible polyurethane foam is produced in many grades. Foam grades are almost always identified by density and firmness, as well as by chemical type: polyether, polyester, high resiliency (HR), flame retardant (FR), or some other identifier. Flexible polyurethane foam grades of identical density and firmness made by varying chemical or mechanical techniques do not necessarily

have the same strength, durability, or other quality properties. The best way to determine comparability of quality properties is through in-use testing. This is of extreme importance as foams based on new chemistry or new manufacturing techniques become available in the marketplace.

Foam densities range from less than 1 to more than 6 pounds per cubic foot. Higher density foams are typically more durable than lower density foams because they contain more mass of polymer per unit volume (3). The higher density foams, however, require more raw material and hence have higher production costs.

The firmness of a foam defines its load-bearing ability. The most common measure of firmness is the indentation force deflection (IFD). IFD is the force required to indent a 50-square-inch section of a larger sample to a predetermined percent indentation. Most commonly, this is 25 percent of a 4-inch thick sample. Foam IFD can range from 10 pounds for soft foams to over 100 pounds for extra-firm foams (both at 25 percent).

Different grades of foam have different primary applications, although the relationship between grade and application is not strict. For instance, the density of foam used for seat cushioning can range from 1 to 3 pounds per cubic foot, depending on quality and other specifications. In general, lower density and softer foams are used for backs and armrests in upholstered furniture. Low density, stiff foams are well suited for packaging. Foams with higher densities are used for higher quality seat cushions, bedding, and carpet cushions.

In addition to density and IFD grades, polyurethane foam grades are specified based on additives that are used to achieve specific properties. Some additives are inert materials that become incorporated in the foam polymer matrix. Others are actually incorporated into the polyurethane polymer chains or increase cross-linking between polymer chains. The most important of these additives are combustion modifiers. Combustion modifiers operate by several different mechanisms; some simply provide a heat sink, others give off incombustible gases when heated, and still others actually modify the foam's mechanism of combustion (4).

## 2.3 Foam Quality Measurements

Physical properties measured as indicators of foam quality include resilience, hysteresis, dynamic fatigue, air flow, tensile strength, elongation, and tear strength. Resilience is determined by a ball rebound test. Compression set is a laboratory test used to determine the ability of a foam to return to its original shape after being compressed under specific laboratory conditions.

## 2.4 Chemistry of Polyurethane Foam Production

### 2.4.1 Key Ingredients

The reaction of three key ingredients produces flexible polyurethane foam: a polyol, a diisocyanate, and water. Figure 2-1 illustrates the chemical structure of the polyols and diisocyanates. Other ingredients are often added to modify the polymer, and catalysts are used to balance the principal foam production reactions. The amount of each ingredient used in a foam formulation varies depending on the grade of foam desired. Foam formulations are generally denoted in terms of the number of parts (by weight) of diisocyanate, water, and other components used per 100 parts polyol.

The polyol essentially forms the starting point for the foam polymer. A polyol is an organic polymer characterized by more than one terminal hydroxyl (OH) group. In flexible foams, the most commonly used polyols are trifunctional, with three terminal hydroxyl groups. Both polyether and polyester polyols are used in the production of slabstock foams, but polyether polyols are the most common and are used exclusively in molded foam production. Polyether polyols are produced by the polymerization of ethylene oxide and propylene oxide, starting with glycerine. The molecular weight of polyols used in foam production ranges from about 1,500 to

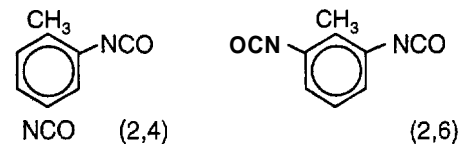

Toluene Diisocyanates

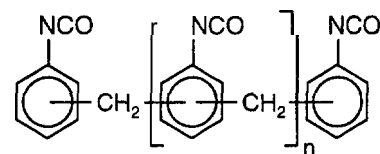

Polymeric Methylene Diphenyl Diisocyanates

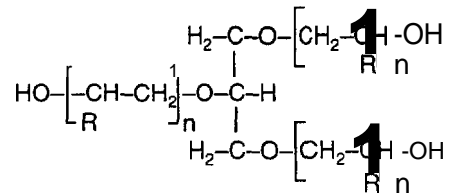

Polyether Polyol  
("R" is a methyl group or hydrogen)

Figure 2-1. Reactants typically used in the production of polyurethane foam.



about 6,000. Polyols may be modified with other polymers using a grafting process. The majority of slabstock foam is made using 3,000 molecular weight polyol.

The second key ingredient in foam formulation, **diisocyanate**, links polyol molecules to produce the foam polymer. The diisocyanates used in flexible foam production are primarily toluene diisocyanate (TDI) and, less often, polymeric methylene diphenyl diisocyanate (MDI). Typically, TDI used in foam manufacture is a mixture of the 2,4- and 2,6-isomers, at a typical ratio of 80 percent to 20. TDI is used primarily in slabstock production, and polymeric MDI is used primarily in molded foam production. Neither slabstock producers nor molded foam producers use one diisocyanate to the exclusion of another.

### 2.4.2 Foam-Producing Reactions

Both the polyol and the diisocyanate are liquids at room conditions prior to the foam-producing reaction. When they are mixed with water under carefully controlled conditions, two key reactions occur. These reactions are illustrated in Figure 2-2.

The faster reaction is that of the diisocyanate with water. This reaction has two important results: it produces polymer chains coupled by “urea” linkages (-R-NH(C=O)NH-R-), and it liberates carbon dioxide (CO<sub>2</sub>), which serves as a “blowing agent” to expand the reacting polymer mass. (Foam blowing agents are discussed further in the next section.)

The second key reaction is that of the polyol with unreacted isocyanate groups at the ends of urea chains, produced during the faster isocyanate-water reaction. The polyol-isocyanate reaction produces the characteristic “urethane” linkage from which the term “polyurethane” is derived (R<sub>1</sub>-NH-COO-R<sub>2</sub>), where R<sub>1</sub> is the urea chain segment and R<sub>2</sub> is the polyol. Other ingredients used as polymer chain modifiers also react with the isocyanate.

These reactions proceed quickly at the outset of the foam production process. CO<sub>2</sub> generated in the isocyanate reaction causes the foam to expand to its full volume within minutes after the ingredients are mixed and poured. Reaction rates must be balanced so that the polymer is strong enough at this point to maintain its shape. Reactions of isocyanate groups with water and polyol, however, continue after the foam reaches full volume.

Any isocyanate groups that do not react with water, polyol, or chain-modifying ingredients can form cross-linkages by reacting with hydrogen atoms at midchain urea or urethane groups (replacing amine hydrogens). These cross-link reactions are part of the foam curing process and affect the strength and elasticity of the foam polymer. Therefore, the amount of diisocyanate relative to other ingredients in the formulation is an important parameter in determining foam properties.

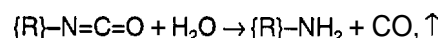

Reaction of Diisocyanate With Water

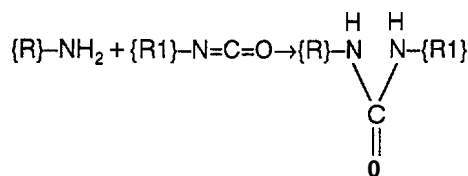

Reaction of Diisocyanate With Amine

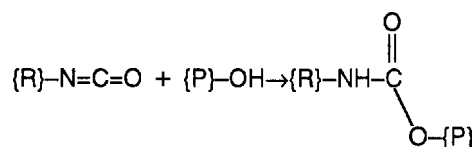

Reaction of Diisocyanate With Polyol

Figure 2-2. Polyurethane foam production reactions.

The isocyanate “index” determines the relative amount of isocyanate; this index is defined as the ratio, expressed in percent, of the number of moles of isocyanate groups to the number of moles of other chemical groups that react with isocyanate. An index of 105 indicates a 5-percent excess of isocyanate, while an index of 95 indicates a 5-percent shortfall of isocyanate. An isocyanate index of 100 reflects balanced stoichiometry.

All of the above reactions are exothermic, especially the reaction of isocyanate with water. This causes the temperature of the foam to rise to between 250°F and 350°F. Maximum temperature is reached 30 minutes to 1 hour after the mixing of foam ingredients; the temperature slowly declines as the ambient air interchanges with the gases in the foam cells. Full curing of the foam may require up to 48 hours (4).

### 2.4.3 Blowing Agents

Flexible polyurethane foam production is a carefully balanced chemical reaction that simultaneously combines in situ polymer formation with gaseous expansion of the nucleated polymer. Drainage from the cell windows in the rising foam mass forms the support struts, and at a crucial point the windows break open, releasing the entrapped blowing agent and thus leaving the open cellular strut structure as the final foam product. The primary blowing agent is CO<sub>2</sub> from the water/diisocyanate reaction. Auxiliary blowing agents (ABAs) can be used to supplement the action of the primary CO<sub>2</sub> blowing agent.

Many grades of foam are produced using only CO<sub>2</sub> gas as the blowing agent. Increasing the amount of water in

a formulation generally produces a lower density foam because this increases the production of CO<sub>2</sub> blowing agent. There is a practical limit, however, to the amount of water that can be used. First, an increased amount of water causes the number of urea linkages in the final polymer to increase; these linkages tend to make the polymer stiffer because they undergo hydrogen bonding. Increased stiffness is also noted from the urea structure that is rigid and tends to be crystalline. Second, the isocyanate-water reaction is extremely exothermic; therefore, too much water can cause high temperatures that can scorch the foam or even cause it to ignite.

As a result, some grades of foam require the use of an ABA. The ABA is mixed as a liquid with the foam reactants when the reactant mixture is first poured. As the exothermic polymerization reactions raise the temperature of the polymer mass, the ABA vaporizes, supplementing the blowing action of CO<sub>2</sub>. ABA vaporization also removes excess heat from the foam, reducing the potential for scorching or autoignition.

The amount of ABA required depends on the grade of foam being produced and the ABA used. ABAs are most important for low density and soft foams. For low density foams, ABAs are used in conjunction with water blowing to avoid overheating. In the case of soft foams, ABAs provide blowing action without increasing the foam's stiffness. ABAs are used most frequently in slabstock foam production.

Several chemicals have been used as ABAs in slabstock foam production, but methylene chloride (CH<sub>2</sub>Cl<sub>2</sub>) is by far the most widely used chemical for this application. Nearly 17,000 tons of methylene chloride were used for slabstock ABA applications in 1992. The second most frequently used ABA in 1992 was 1,1,1-trichloroethane (TCA or methyl chloroform), at about 2,000 tons. Trichlorofluoromethane (CFC-11) is used as a blowing agent for integral skin molded foams (4).

ABA gases are difficult to capture as they emanate from polyurethane foam during production and curing. During production, ventilation rates are high, yielding a low concentration stream. During curing, the foam is generally left in an open warehouse, and the ABA is released slowly over a 24-hour period; therefore, the concentration of ABA in the warehouse is low. ABA gases are thus simply vented to the atmosphere, either through roof exhausts or through fugitive means, at almost all foam plants in the United States.

Releases of ABAs to the atmosphere are substantial—almost 20,000 tons in 1992. Because of the difficulties of using add-on controls to treat ABA emissions, foam producers, equipment vendors, and foam chemical suppliers have been exploring pollution prevention methods for reducing or eliminating ABA use. These include alternative foam production technologies, mechanical

cooling methods, and alternative chemical formulations. In their evaluations of technologies to reduce or eliminate ABAs, however, foam producers are sensitive to any potential degradation in foam quality and increases in manufacturing costs.

## 2.5 Current Environmental Releases

Emissions to the atmosphere constitute the major environmental release from flexible polyurethane foam manufacturing. The bulk of emissions results from ABA use, mainly in the manufacture of slabstock foam. Substantial emissions also result, however, from the use of organic solvents in adhesives and equipment cleaning operations. Table 2-1 summarizes emissions from different operations in slabstock and molded foam production and fabrication. The emissions reported for hazardous air pollutants in Table 2-1 are based on a recent survey of these emissions by EPA/ESD (2).<sup>1</sup> Emissions are based on sales figures and company reports to EPA's Toxics Release Inventory (5). The volatile organic compound (VOC) emissions are mainly related to the

Table 2-1. Summary of 1992 Emissions From Flexible Polyurethane Foam Production

Emission Source	Total Emissions (tons/year)	Primary Chemicals
Slabstock foam		
Blowing agent	16,968	Methylene chloride, methyl chloroform
Fabrication	1,401	Methyl chloroform
Chemical storage and handling	49	Methylene chloride, TDI
Rebond operations	11	Methylene chloride, TDI
Slabstock foam total	18,430	
Molded foam		
Equipment flushing and cleaning	440	Methylene chloride
Blowing agent	60	CFC-11 (for integral skin foams)
Mold release	10,000	Naphtha solvent
Chemical storage and handling	43	TDI and MDI
Other	17	
Molded foam total	10,560	
<b>TOTAL</b>	<b>28,990</b>	

<sup>1</sup> Williams, A. 1994. Updated estimate of HAP emissions from slabstock foam production. Personal communication from A. Williams, EC/R Inc., to Lou Peters, Polyurethane Foam Association. February 8.

---

molded foam process and the use of mold release agents that contain high levels of VOC solvents.

There are no process wastewater discharges from this industry; the water used in the foam reaction is entirely consumed in that reaction. Water is used in some cases for noncontact cooling of foam reactants, but no discharges are reported from these systems.

Little solid waste is generated by either slabstock or molded foam production because most scrap is used in "rebond" operations. For this process, slabstock foam producers recycle scrap from cutting and fabrication operations. The scrap is chopped into small pieces, then reconstituted with a polyurethane adhesive to produce an aggregate polyurethane foam product widely used in the production of carpet cushions. About 27 percent of slabstock foam facilities include rebond operations, and some rebond operations are free-standing. These facilities also acquire bales of scrap from plants that do not have rebond operations.

Slabstock foam production lines occasionally produce bad batches, which are unsuitable even for rebonding. This material must be treated as a hazardous waste under the Resource Conservation and Recovery Act (RCRA) if it contains unreacted isocyanate. In addition, equipment cleaning operations at both slabstock and molded foam plants produce some solvent waste subject to RCRA regulations. These wastes are generally shipped off site for treatment or disposal. Polyethylene coated paper and polyethylene film are used to continuously line the foam machine conveyor during production. These liners are stripped off after the foam

has traversed the length of the foam tunnel or after the foam bun has cured. These materials are discarded as nonhazardous waste.

In all, the polyurethane foam industry (including both flexible and rigid foam manufacturing) reported shipment of wastes containing 353 tons of toxic chemicals to offsite waste treatment facilities in 1992. This figure includes 222 tons of methylene chloride, 104 tons of methyl chloroform, 21 tons of TDI, and 6 tons of polymeric MDI (5). The methylene chloride and methyl chloroform wastes are spent chemicals, typically shipped in drums. TDI and MDI wastes may include contaminated raw materials or may be present in off-specification foam product.

## 2.6 References

1. SPI. 1990. End-use market survey on the polyurethane industry in the U.S. and Canada. New York, NY: Society of the Plastics Industries, Polyurethanes Division.
2. Norwood, L.P., A. Williams, and W. Batty. 1994. Summary of flexible polyurethane foam information collection requests (ICRs). Presented at a meeting of the U.S. Environmental Protection Agency and the Polyurethane Foam Association. February 2.
3. Kreter, P.E. 1985. Polyurethane foam physical properties as a function of foam density. in: Proceedings of the Society of the Plastics Industries, 32nd Annual Technical/Marketing Conference. New York, NY: Society of the Plastics Industries, Polyurethanes Division. pp. 129-133.
4. Woods, G. 1987. The ICI polyurethanes book. New York, NY: ICI Polyurethanes and John Wiley & Sons.
5. U.S. EPA. 1992. Toxics Release Inventory. Washington, DC: Office of Toxic Substances.

---

## **Chapter 3**

### **Pollution Prevention in Slabstock Foam Manufacture**

Slabstock foam accounts for about 75 percent of the flexible polyurethane foam produced in the United States (1). Slabstock foam production is a continuous process that produces long, rectangular or cylindrical “buns” of foam. These are cut and shaped into the desired configuration. The largest markets for slabstock foam products are in furniture, bedding, automobile seats and cushions, packaging materials, and carpet cushions.

This section reviews slabstock foam production processes, identifies and quantifies the extent of emissions of pollutants, and describes pollution prevention options that can be implemented to reduce these emissions. A major focus of this section is on alternative auxiliary blowing agents (ABAs), or technologies that facilitate the use of alternative ABAs. In addition to ABA substitution, the section also covers the following pollution prevention options:

- Add-on controls for capturing and reclaiming ABAs.
- Control of toluene diisocyanate (TDI) emissions.
- Reducing releases during chemical handling, storage, foam fabrication, and equipment cleaning.

#### **3.1 Slabstock Foam Production**

Ingredients in slabstock foam production include diisocyanates, polyol, water, ABA, catalysts, and any fillers, chain modifying agents, or other additives. TDI is the most widely used diisocyanate, although polymeric methylene diphenyl diisocyanate (MDI) is used for some grades of foam. The most widely used ABA is methylene chloride. Methylene chloride and other solvents are also used to clean equipment and to form adhesives for foam fabrication operations.

##### **3.1.1 Typical Horizontal Foam Production Line**

The predominant commercial process for slabstock foam manufacture involves a continuous horizontal foam machine with a one-shot mixing system for the foam ingredients (see Figure 3-1). In the “one-shot” system, the raw materials are continuously metered to a single mix head that typically accommodates six or

more separate streams (2). The mixed raw material stream is dispensed to the foam line, which is essentially an enclosed conveyor system. The conveyor is 6 to 8 feet wide and up to 200 feet long, and moves at about 15 feet per minute (3-5). The initial section of the machine typically slopes downward so the foam does not fall backward as it rises.

The conveyor is housed in a foam machine tunnel, which is ventilated to the outside to remove the blowing agents and other gases that may be given off in the foam reaction. The foam tunnel generally is open at the beginning of the foam conveyor so that operators can monitor the initial foam rise. A roller system applies a plastic or paper lining sheet to the top of the conveyor, and the liquid raw material feed is dispensed onto this moving sheet. Roller systems also apply plastic or paper liners along the sides of the conveyor.

Reactions between the raw materials (discussed in Chapter 2) produce a polyurethane polymer, as well as blowing gases that form bubbles in the polymer. Within a few seconds after leaving the mix head, the raw materials begin to “cream.” The cream stage marks the beginning of the foam-producing reactions and an increase in the viscosity of the reacting mass. This is followed by the rise stage, in which the blowing agent causes the foam to rise to its full height. The foam polymer also begins to gel at or very close to the end of the rise.

The foam reaches its full height in 1 to 2 minutes, or about 25 feet down the conveyor. Full height is typically 2 to 4 feet, depending on the pour rate and the characteristics (especially density) of the foam being produced. After 5 to 10 minutes, polymerization reactions have progressed far enough for the foam to be cut and handled (6).

The foam is cut by a “flying saw,” which moves in tandem with the conveyor while the cut is being made to ensure a straight cut. The length of a bun ranges from less than 5 feet to as long as 200 feet. Each freshly cut bun is removed from the conveyor and transferred to a curing area.

Once the foam line starts up, it typically operates for 1 hour or longer, usually producing 10 or more buns with-

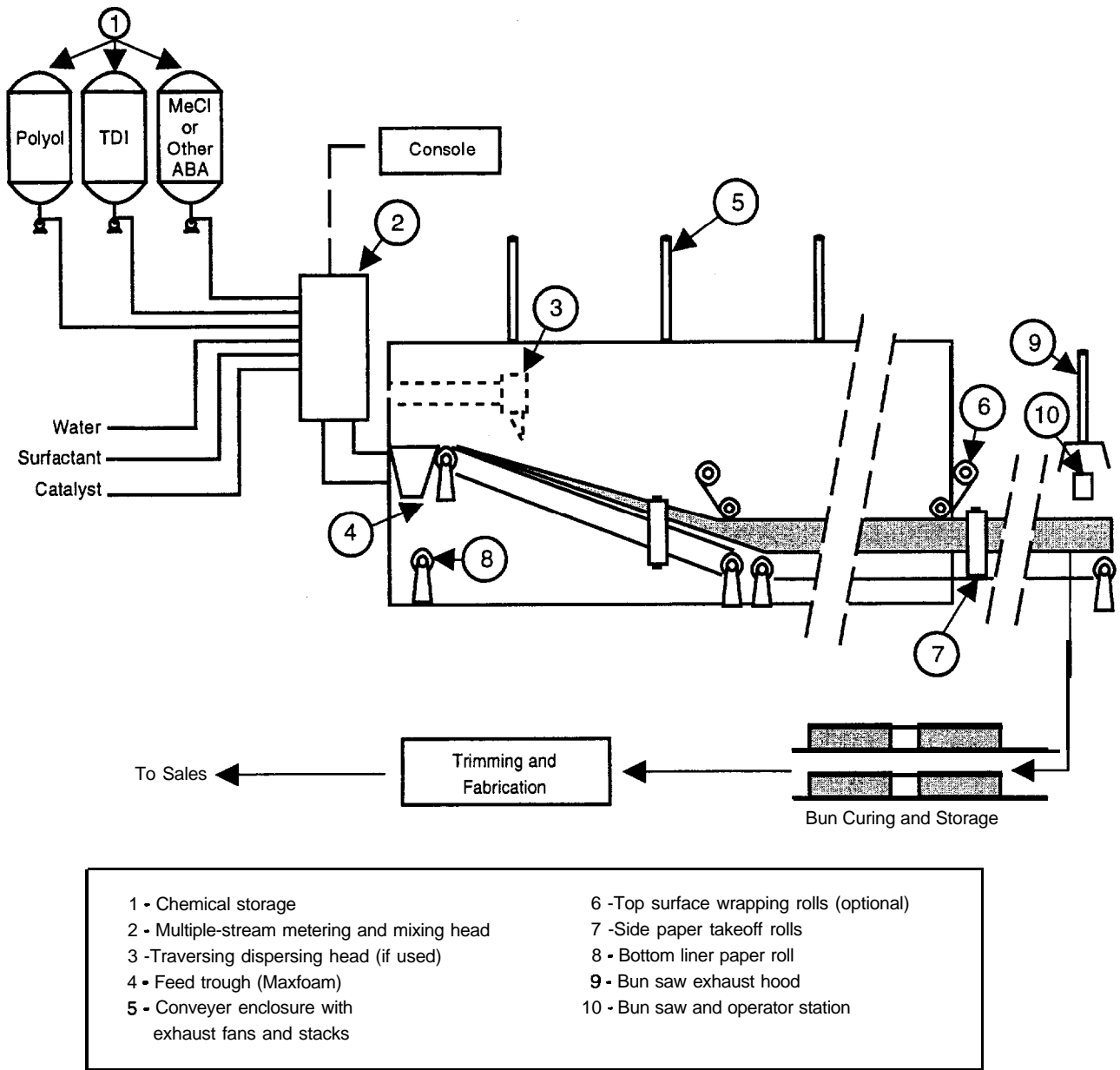

Figure 3-1. Typical slabstock production line for flexible polyurethane foam.

out any breaks in the raw material feed stream. An operating cycle of the foam line is called a “pour.” Changing the raw material mixture can produce different grades of foam in a single pour. Most plants have computerized controls at the mix head metering system that allow the raw material mixture to be changed at precise intervals (3-5). The width of the rectangular bun can be varied throughout the length of the pour to yield the optimum size for fabrication requirements.

### 3.1.2 Variations on the Horizontal Foam Production Line

Since the development of the slabstock process, foam producers have been modifying the foam equipment in an effort to produce a more uniform, flat-top bun, thereby

minimizing waste and raw material consumption. Although the industry’s goal in these modifications is process optimization, the changes also should be viewed as pollution prevention measures. The process optimization measures serve to reduce both the amount of solid waste generated and the amount of blowing agent that is used (and subsequently released to the atmosphere).

The basic slabstock foam production line can vary in several ways. First, the mix head is classified as either low pressure or high pressure. In a low-pressure system, a high-shear stirrer within the mix head combines the raw materials. In a high-pressure system, the raw materials are metered to the mix head at a pressure of 300 to 3,000 pounds per square inch, gauge (psig). Although the mix head contains a small stirrer, impinge-

ment of the high-pressure streams within the mix head mainly accomplishes mixing (6).

The method used to dispense the mixed raw material stream to the conveyor also varies. In older processes, the mix head nozzle directly dispenses raw material to the conveyor system. The mix head traverses the conveyor, spreading a uniform 1- to 2-inch layer of liquid ingredients that are in early stages of reaction.

Most plants in the United States have adopted a variation on the raw material dispensing technique called the Maxfoam process, illustrated in Figure 3-2 (7). In the Maxfoam process, the feed stream flows from the mix head to a trough located at the beginning of the machine. As the feed begins to cream and foam in the trough, it spills over onto the conveyor. This system produces a flatter bun, which reduces the amount of scrap foam.

Even with the trough feed system, however, the bun is not perfectly flat; the center tends to rise higher because of friction along the sides. Some process variations have been developed to mitigate this effect. For example, in the Draka-Petzetakis process, the side wall liners are forcibly lifted to produce a more even block profile.

Another modification of the basic slabstock foam production line, the Planibloc-Hennecke process, employs a liner, which is applied to the top of the bun to control the bun profile (8).

Some round foaming machines have also been developed to produce cylindrical foam blocks (8). Round foaming processes typically use moving, conveyor-mounted molds. Different methods are used to distribute the raw material mixture in the mold and to shape the rising foam into a cylinder. A peeling process is used to fabricate a thin sheet of foam from these cylinders. In this operation, the roll is positioned in contact with a thin knife blade, which runs parallel to the cylinder's axis. The cylinder is then turned and accurately adjusted toward the blade to continuously remove a uniform thin sheet. This sheet can be nearly as thin as 0.030 inches.

Horizontal foam production lines generally are operated at high production rates. The Vertifoam process, developed in England in the early 1980s, operates at lower production rates than typical horizontal processes. In the Vertifoam process, illustrated in Figure 3-3, the raw material mixture is placed at the bottom of a vertical expansion chamber. The sides of the chamber are lined with long sheets of either paper or plastic, which are

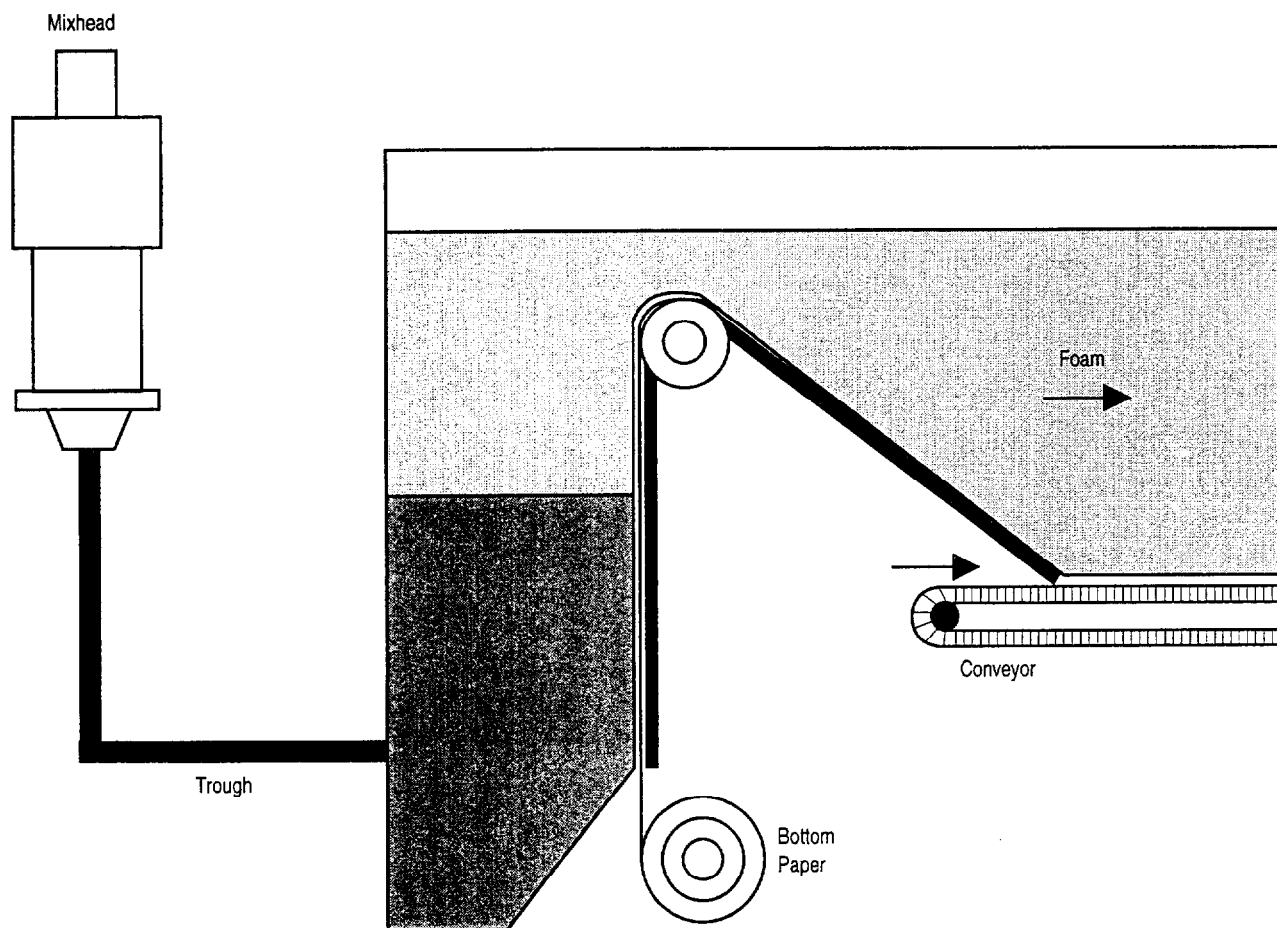

Figure 3-2. Maxfoam production process.

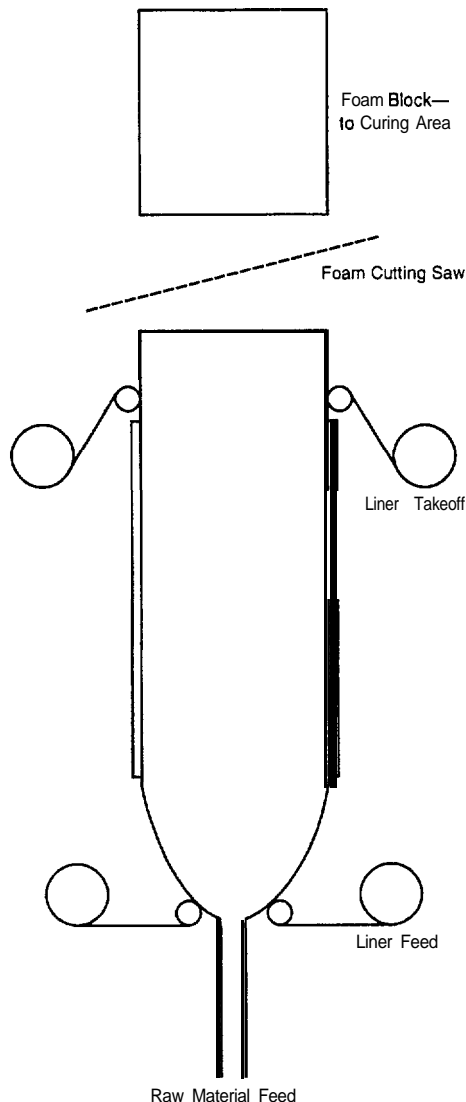

Figure 3-3. Vertifoam foam production process.

drawn upward by roller systems. The foam expands upward in the chamber and is cured enough to be cut by the time it reaches the chamber top. As it leaves the top of the chamber, the foam is cut horizontally into blocks up to 10 feet long.

A modification of the Vertifoam process, called the Hypercure or Enviro-Cure process, potentially allows the capture and recovery of blowing agent. Currently, no installations in the United States operate in this mode. This process and other modifications of the basic horizontal foaming process that allow ABA recovery or reduce ABA use are described later in this section.

### 3.1.3 Foam Blowing and Use of Auxiliary Blowing Agents

Carbon dioxide (CO<sub>2</sub>) gas liberated in the diisocyanate-water reaction serves as a blowing agent to produce foam (see Section 2.3). Many grades of slabstock foam, however, require the use of an ABA. The ABA is mixed with the

foam reactants as a liquid when the reactant mixture is first poured. As the exothermic polymerization reactions raise the temperature of the polymer mass, the ABA vaporizes.

ABAs serve two functions. First, they supplement the blowing action of CO<sub>2</sub> from the water-diisocyanate reaction. In vaporizing, ABAs also remove excess heat from the foam polymerization reactions.

ABA gases are difficult to capture during production and curing because of the low concentration of emissions. This use of ABA represents the largest opportunity for pollution prevention in the slabstock industry.

Figure 3-4 shows typical ABA use rates for different grades of foam. These values are derived from a recent survey of slabstock foam producers carried out by the U.S. Environmental Protection Agency's Emission Standards Division (EPA/ESD). ABA use ranges from 0 to over 20 pounds per 100 pounds of polyol (pph). The average ABA use for all grades of foam is about 5 pph. Low density, soft foams require the highest ABA use rate.

Until the mid-1980s, trichlorofluoromethane (CFC-11) was the preferred ABA for polyurethane foam production. CFC-11 is a potential stratospheric ozone depleting agent, and the slabstock industry achieved better than 99 percent reduction in its use by the end of 1992.

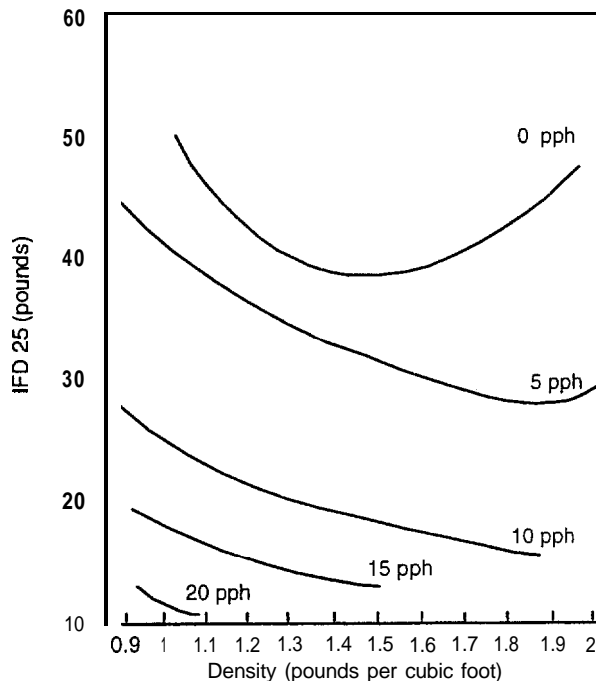

Figure 3-4. Methylene chloride use rates for different foam grades. Contours represent methylene chloride use in pounds per hundred pounds polyol (pph). Contour locations are approximate.

CFC-11 has been replaced largely by methylene chloride, currently the largest-volume ABA for slabstock foam production. Methylene chloride has been classified by EPA as a category B2 carcinogen (a "probable human carcinogen"). As a result, several states regulate methylene chloride as a toxic chemical. In addition, methylene chloride has been listed as a hazardous air pollutant (HAP) under Title III of the 1990 Clean Air Act Amendments.

TCA is used as an ABA in areas where methylene chloride is regulated by state air toxics programs; however, TCA is also listed as a HAP under Title III of the Clean Air Act Amendments. Acetone is used as an ABA in some instances where state air toxics programs limit methylene chloride use.

### **3.1.4 Foam Curing and Storage**

Conveyors or overhead cranes move the foam buns from the production line to a curing area. The curing area is ventilated to remove ABA, which continues to emanate from the curing bun. Typically, buns are cured for about 24 hours prior to fabrication or shipping. Buns may be transferred from the curing area to a separate storage area prior to shipping or fabrication; when fully cured, they may be stacked four to five buns deep.

### **3.1.5 Foam Fabrication**

Fabrication is the conversion of large slabstock foam buns into the sizes and shapes that customers order. A machine known as a slitter cuts the large bun into slabs of the desired thickness. Vertical bandsaws or hand-cutting techniques are used to convert these slabs into furniture components.

Many of the cushions supplied to the furniture industry are composites of two or more materials. One of the more common materials used with foam is polyester fiberfill. This spun product is applied to the cushion to provide cover fillout, initial softness, and, in some instances, compliance with United Furniture Action Council (UFAC) voluntary guidelines. Solvent-based adhesives are used to attach these materials to the foam pieces at glue stations. The glue stations are generally equipped with local ventilation to remove the solvent vapors emanating from the adhesives. The use of solvent-based adhesives represents another major opportunity for pollution prevention, accounting for 1,401 tons of HAP emissions per year. Water-based adhesives, hot melt adhesives, and other measures for reducing solvent emissions are discussed in Chapter 5.

### **3.1.6 Rebond Operation**

Slabstock foam production generates up to about 12 percent of waste offcut material (8). Foam producers recycle this scrap in the rebond operation. About 27 percent of US. foam plants have onsite rebond opera-

tions (9); in addition, some rebond facilities are free-standing. Plants operating rebond facilities also receive baled scrap from other plants and fabricating facilities, and even from other countries. Rebond foam is widely used for carpet cushions.

In the rebond operation, scrap foam is first reduced to 3/8- to 3/4-inch crumbs in a granulator or beetling mill. The crumb material is then loaded into a blender, where it is coated with a prepolymer binder of polyol and TDI. This coated mixture is then charged to either a cylindrical or rectangular mold, where it is compressed and treated with steam. The steam reacts with the prepolymer to produce a polyurethane polymer, which binds the foam crumbs together (8).

The rebond product is removed from the mold and allowed to cool and set for about 24 hours. The molded product is then peeled to produce a long, thin sheet of material up to 9/16 of an inch thick. This sheet is usually laminated on one side with a covering material and then rolled for shipment (4).

## **3.2 Methods for Reducing Auxiliary Blowing Agent Releases**

### **3.2.1 Overview of Releases**

Table 3-1 summarizes emissions from different slabstock foam production processes.<sup>1</sup> The bulk of emissions from the industry result from ABA use. About 40 to 75 percent of ABA emissions emanate from the foam machine tunnel itself, with the balance emitted from curing and storage areas (2, 10). Emissions also result from the use of organic solvents in adhesives in the fabrication process, as well as from equipment cleaning operations.

### **3.2.2 Production of Water-Blown Foams**

The blowing action of CO<sub>2</sub> gas in foam production is called "water blowing" because CO<sub>2</sub> arises from the reaction between water and diisocyanate groups. Higher density, moderate indentation force deflection (IFD) foams can be produced using CO<sub>2</sub> as the sole blowing agent (see Figure 3-4). Because higher density foams use more polymer material per unit volume, however, they are more expensive to produce than low density foams. Figure 3-5 shows 1992 production volumes for different foam density grades, illustrating the importance of low density foams.

For any particular grade of foam, there is range of possible "mixes" of water blowing and ABA blowing. Therefore, ABA usage can be reduced at some plants

<sup>1</sup> Williams, A. 1994. Updated estimate of HAP emissions from slabstock foam production. Personal communication from A. Williams, EC/R Inc., to Lou Peters, Polyurethane Foam Association. February 8.



Table 3-1. Summary of 1992 Emissions From Polyurethane Foam Production

Emission Source	Total Emissions (tons/yr)	Methylene Chloride	TCA	Propylene Oxide	TDI	Methyl Ethyl Ketone	Glycol Ethers	Other HAPs
Foam production	16,968	14,757	2,102	101	6	0	0	2
Fabrication	1,401	41	1,332	0	0	10	10	7
Chemical storage and handling	49	26	10	0	10	0	1	1
Rebond operations	11	10	0	0	1	0	0	1
Total	18,429	14,835	3,445	101	17	10	11	11

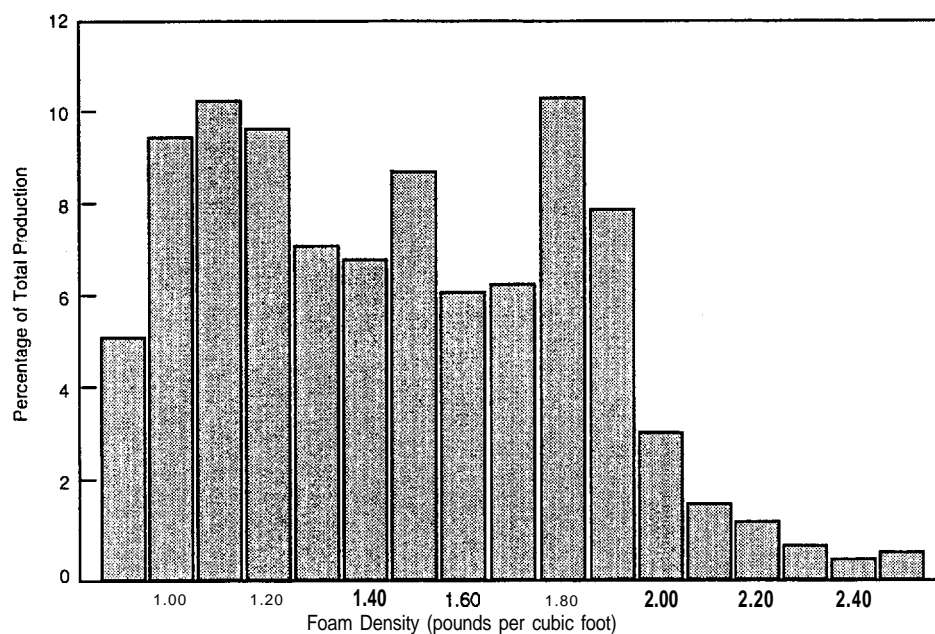

Figure 3-5. Foam production as a function of density grade, 1992. (Values are approximate.)

by altering the foam formulation and increasing the amount of water blowing; this generally involves reducing the isocyanate index. As noted in Chapter 2, the amount of water blowing that can be used is limited. Formulation changes, however, can reduce ABA usage by 10 percent on average (11). These changes can be implemented at little or no cost; therefore, many plants have already made these changes.

Foam softening agents and quick-cooling technologies can increase the amount of water that a given formulation can incorporate. These technologies are discussed below.

### 3.2.2.1 Foam Softening Additives and Systems

Additional water in a formulation reduces ABA use but also produces a stiffer foam by increasing the number of urea polymer linkages and, hence, the number of sites available for hydrogen bonding. Softening ingredients can counteract the influence of these additional urea linkages. Thus, these ingredients can be used as

a pollution prevention measure to reduce or eliminate the use of ABAs in many grades of foam.

Softening systems can be used without substantial add-on equipment. In some cases, there may be a small cost to install additional chemical piping (12). Additional chemical costs may be substantial for some foam grades, however. Estimates of the additional chemical costs range from \$2,500 to \$25,000 per ton of blowing agent saved (2, 9, 13).

Softening ingredients include polymer chain modifiers, stabilizing additives, and specialty polyols; the specialty polyols may replace all or part of the polyol used in the foam formulation. Softening ingredients generally are used in conjunction with changes in foam chemistry, such as a reduced isocyanate index and special catalysts. Special surfactants may also be used to control cell structure.

A variety of softening agents and systems are available from a number of different suppliers of foam chemicals.

Table 3-2 summarizes currently available softening additives and systems. For each system, the table gives applicable density and firmness ranges, and the name of the company licensing or selling the ingredients. As the table shows, systems are available to cover the full range of IFD grades without using ABAs, while achieving densities as low as 1.5 pounds per cubic foot. Lower densities can also be achieved for medium and firmer grades of foam.

**Table 3-2. Summary of Alternative Foam Softening Additives and Systems (7, 14-16)**

Description	Density	Firmness	Source or
	Limit (pcf)	Grades (IFD-25)	Licensing Company
High resilience systems			
Ultracel	1.3	All	ARCO Chemical
Resteasy Plus	1.5	Medium, firm	BASF Corporation
Extended range polyols <sup>a</sup>			
VORANOL 3583 XUS15216.01 XUS15241 .00	1.3 <sup>b</sup>	>15 <sup>c</sup>	Dow Chemical USA
XZ94532.00 CP 1421			Dow Chemical Europe
X282229.00			Dow Chemical Pacific
ARCOL F-1500 ARCOL DP-1022			ARCO Chemical
Additives			
Ortegel 310	1.5	>10 <sup>c</sup>	Goldschmidt Chemical Corp.
Geolite	1.0	>20 <sup>c</sup>	OSi Specialties
Enichem modifiers	1.1	>20 <sup>c</sup>	Enichem

<sup>a</sup> In general, these specialty polyols are tailored for specific applications. No particular product can be used to produce all foam grades. Rather, different polyols are best suited for different foam grades.

<sup>b</sup> Densities as low as 1.1 pounds per cubic foot can be achieved with some sacrifices in other foam properties.

<sup>c</sup> The minimum IFD achievable for these systems depends on the density of foam being produced. The noted IFD minimum cannot generally be achieved concurrently with the density minimum.

Research is ongoing into systems that can produce lower density and softer foams than those shown in Table 3-2. (Interim results of this research are frequently reported at conferences organized by both the Society of the Plastics Industries and the Polyurethane Foam Association.) For example, Dow Chemical reported in 1994 on ongoing research into a chemical system that would produce low density, soft foams in the range of 1.2 pounds per cubic foot with an IFD of 20 (17). In addition, several companies are researching the prospect of eliminating ABAs from all grades of foam by combining foam softening technologies and mechanical cooling technologies, discussed below.

### 3.2.2.2 Mechanical Cooling Technologies

Mechanical cooling systems force air through a slab-stock foam block after the block has left the foam tunnel. These technologies initially were developed to accelerate the foam curing process, thus reducing warehouse space requirements (18, 19). Forced cooling coupled with water blowing, however, can also reduce or eliminate the need for ABAs in the production of low density foams. Cooling of the foam block is one of the key functions of ABAs, and forced cooling can replace ABAs in this role.

Mechanical cooling has been used to produce low density foams over a wide range of IFD grades without ABAs (18-21). There are some adverse effects on foam properties, however, when mechanical cooling is used in conjunction with a high degree of water blowing. A particular drawback has been lower resilience and higher compression set.<sup>2</sup> Densities as low as 0.95 pounds per cubic foot and IFDs (25 percent) as low as 14 have been achieved concurrently (21). Mechanical cooling also has the added benefit of producing foam blocks with more uniform properties than standard curing methods produce. This results from the more uniform block temperature profile.

Some complications are associated with the mechanical cooling process. First, mechanically cooled foams generally require substantial formulation changes from traditional ABA-cooled foams because the forced cooling cuts short some of the foam curing reactions. These changes may necessitate some development costs. Second, equipment costs are substantial, from \$500,000 to \$2 million (7, 13). Finally, when low density foams are produced without ABAs, the reliability of the mechanical cooling system becomes critical. As previously discussed, foam polymerization reactions typically raise the temperature of the foam block to between 250°F and 350°F. Low density foams using a substantial amount of water blowing raise the block temperature even higher. Cooling system failure could result in scorching of the foam blocks or ignition, in some circumstances.

At least three companies are investigating variations in mechanical cooling technologies on a commercial scale. These processes are discussed below.

#### **Crain Enviro-Cure Process**

The Enviro-Cure process is illustrated in Figure 3-6 (22, 23). The process equipment consists of an enclosure with conveyor and ventilation systems designed to handle cut foam blocks. Blocks from the foam production line are allowed to cure for a predetermined delay pe-

<sup>2</sup> Peters, L.H. 1994. Personal communication from Lou Peters, Polyurethane Foam Association, to J. Cantin, Eastern Research Group, Inc. November 17.

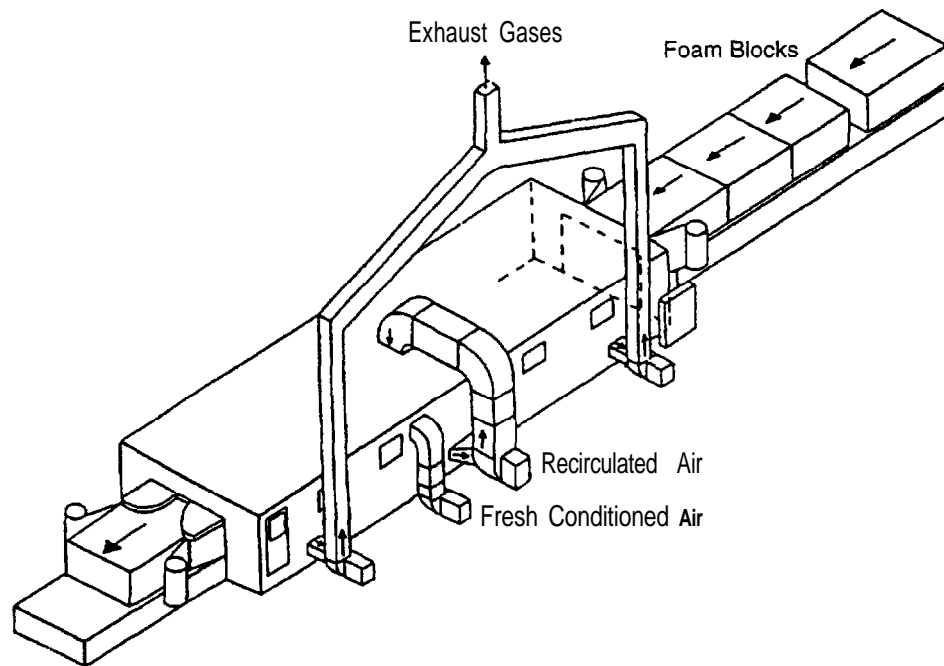

Figure 3-6. Enviro-Cure foam production process.

riod, which is essential to allow the blocks to stabilize. The length of this period is also important: if the block is cooled too early, the polymer will not be strong enough to produce a serviceable foam; too long a delay before cooling can scorch the block.

Following the curing period, foam blocks are conveyed end to end into the Enviro-Cure enclosure. The conveyor is a specially designed slat conveyor system with gaskets along the sides. This design allows air to be pulled from the bottom of the blocks. As each block enters the enclosure, its sides are lined with plastic. A ventilation system in the enclosure draws air through the blocks, producing the desired cooling effect.

The Enviro-Cure ventilation system draws air from beneath the blocks in three stages. Air from the first and third stages is exhausted to the atmosphere. Some of the air drawn from the second stage is recirculated to the top of the enclosure, while some is exhausted. Chilled ambient air is mixed with the recirculated air and introduced to the top of the enclosure. Regulating the relative amounts of fresh and recirculated air controls the temperature of air passing through the foam.

Crain Industries has used the Enviro-Cure process with both Maxfoam and Vertifoam production lines. When Enviro-Cure is used with Maxfoam equipment, the skin must be removed from the top and bottom of the Maxfoam block. This is unnecessary with Vertifoam lines; foams produced by Vertifoam equipment have little or no skin because it is peeled off when the polyethylene liner film is removed.

The Enviro-Cure process is licensed by Crain Industries of Fort Smith, Arkansas. The equipment is manufactured by Cannon USA, of Mars, Pennsylvania.

#### *General Foam Rapid Cure Process*

The Rapid Cure cooling process has been used on a commercial scale with a Maxfoam production line (19). The process can be used in configurations before or after the foam line cutoff saw. In either case, the foam must first undergo surface preparation, in which surface skins are removed and other steps are taken to ensure uniform airflow through the foam.

After surface preparation, the foam is passed over a number of cooling stages. In each cooling stage, gas is drawn from the foam into a collection chamber located below the foam conveyor. This causes air to flow through the foam, displacing  $\text{CO}_2$  from the water blowing reaction and cooling the foam polymer matrix.

Air and displaced gases drawn from the foam in the initial cooling stages are routed to a carbon adsorption system. The carbon removes contaminants such as antioxidants and diisocyanates, which are volatilized at the high initial foam temperatures. Air drawn through the foam in the later cooling stages is released to the atmosphere without treatment. These cooling stages reduce the foam temperature to 150°F or lower.

General Foam has been testing the Rapid Cure system on a commercial scale for more than a year (18). The company holds three patents on the system, as well as several pending patent applications.

### *Trinity Quick Cure Process*

The Trinity Quick Cure process consists mainly of an enclosure equipped with a ventilation system. The first step of the process is to prepare the surfaces on the two sides of the bun by slitting the sides with razor knives. The bun is then conveyed into the enclosure and pushed up against blower inlets located on one side of the enclosure. The ventilation system is then used to create suction at these inlets, drawing air through the foam. This air is conditioned and returned to the other side of the bun, along with some fresh makeup air (24).

The primary objectives of the Trinity Quick Cure process are to shorten processing time, to produce a more uniform profile of IFD, and to improve compression set properties (24). The process has the added benefit of reducing blowing agent requirements. Trinity is reluctant to use the process to eliminate blowing agent for low density foams, however, because of the high internal foam temperatures that would be produced and the fire hazard that would ensue if the cooling system failed.

### **3.2.3 Liquid CO<sub>2</sub> Blowing Technology**

As discussed above, many foam manufacturers are exploring formulation changes and technologies that would allow increased use of the water-diisocyanate reaction to generate additional CO<sub>2</sub> blowing agent. A new technology has recently been developed for introducing *liquid* CO<sub>2</sub> into the foam feed stream. In this process, called the CarDio process, the carbon dioxide liquid is added to the polyol stream before reaching the mix head. The CO<sub>2</sub> evaporates, serving as a blowing agent.

In its overall function, liquid CO<sub>2</sub> has some parallels with methylene chloride and other chemicals used as ABAs. CO<sub>2</sub> differs radically from "standard" ABAs, however, in that it has a much lower boiling point. ABAs are liquid at standard foam pouring temperatures and pressures, and evaporate as polymerization reactions raise the temperature of the foam mass. CO<sub>2</sub> is a vapor under standard pouring conditions. In fact, to remain liquid at pouring temperatures, CO<sub>2</sub> must be kept under a pressure of about 60 atmospheres. Thus, it vaporizes quickly, generating a rapidly expanding froth when the foam feed stream leaves the pouring nozzle.

The CarDio process controls this tendency toward rapid expansion through a special "laydown" device. The laydown device follows the mix head and deposits a homogeneous reacting mixture on the fall plate. The design of the laydown device results in a progressive release of blowing agent in the reacting foam mass. This prevents local concentrations of free gas that could cause pinholes, or "chimneys," in the foam (25).

CarDio technology can be retrofit to an existing horizontal foam line with the installation of the following equipment:

- CO<sub>2</sub> metering pump assembly with a mass flowmeter, as well as pipe work, valves, and controls.
- Polyol booster pump assembly.
- Premixing unit for CO<sub>2</sub> and polyol.
- CarDio mixing head and flushing system.
- CarDio laydown device.

Retrofit costs have been estimated at \$470,000 (13).

The CarDio process is built and licensed in the United States by Cannon USA, a manufacturer of foam equipment headquartered in Mars, Pennsylvania. The process has been demonstrated on a commercial scale at a plant in Italy. Although no U.S. plants are using the CarDio system as of this writing, a few plants are expected to install the system for pollution prevention over the next 6 months.

### **3.2.4 Reduced Pressure Foaming**

Lower barometric pressures tend to increase blowing efficiency and therefore to produce lower foam densities, if all other factors are equal. In fact, operators of plants located above sea level correlate their use of water and ABA with their elevation because of the reduced barometric pressure (7).

Efforts have been made recently to reduce or eliminate the need for ABAs with enclosed foam pouring systems that produce foams at a reduced pressure. At least two companies have developed and patented technology for reduced pressure foaming.

#### **3.2.4.1 Variable Pressure Foaming Process**

The variable pressure foaming (VPF) process can be used to produce slabstock foams at pressures either lower or higher than atmospheric (26). The VPF process is patented by Prefoam. The basic VPF process is very similar to the standard horizontal foam line; it differs in that a totally enclosed chamber replaces the open foam tunnel.

Foam chemicals are pumped into the enclosed chamber and deposited onto a conveyor system, as in the standard Maxfoam process. The pressure in the chamber is regulated by a fan, which draws air and CO<sub>2</sub> blowing gases from the chamber and through a carbon adsorber. The foam travels down the conveyor and is cut with an automatic cutoff saw. Following the cutoff saw, the foam block enters a second airlock chamber, which is maintained at the same pressure as the initial foaming chamber. The airlock chamber is opened to the atmosphere, and the foam block is removed. The airlock is then closed again and evacuated. During this time, foaming continues in the first chamber.

The VPF process is expected to allow production of all commercial grades of foam without the use of ABAs.

The process has been used on a commercial scale in the Netherlands and was recently installed in a commercial facility in the United States. The U.S. process, however, has not been in place long enough to assess its commercial viability. The main drawback of the process is a high initial capital cost, estimated at \$4 million to \$5 million (13).

### 3.2.4.2 Controlled Environment Foaming Process

The Foam 1 Company of Woodland, California, has developed a process called controlled environment foaming (CEF). Equipment for the process is manufactured by the Edge Sweets Company of Grand Rapids, Michigan. The process is essentially a batch process, in which slabstock foam is actually produced in molds (27). In its current embodiment, CEF process equipment consists of two molds and a containment vessel that accommodates one mold at a time. The containment vessel is connected to a carbon adsorber and a vacuum system.

In the CEF process cycle, one of the molds is placed inside the containment vessel, and the vessel is partially evacuated. Foam raw materials are poured into the mold, and the foam is allowed to form. The pressure in the containment vessel may be adjusted during the reaction. When the foam is fully formed, the full mold is removed from the vessel and replaced with the empty mold. The foam is then removed from the first mold, which is prepared for the next cycle.

The CEF process is expected to allow production of all commercial grades of foam without the use of ABAs; in fact, a paper on the process indicates that it can achieve densities as low as 0.55 pounds per cubic foot (at 7 pounds IFD) without ABAs (27). Retrofit costs are estimated at about \$340,000 (13). The main drawback of the process is that, as a batch process, its production rate is considerably less than standard foam lines. Again, the process has not been in use long enough to assess its potential for commercial success.

### 3.2.5 Alternative Blowing Technology

The alternative blowing (AB) system is based on the substitution of formic acid for some of the water in the foam formulation. Formic acid reacts with diisocyanates as follows:

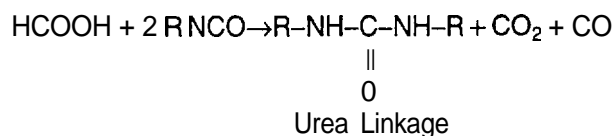

This reaction produces a urea polymer linkage as in the standard diisocyanate-water reaction. Both carbon monoxide (CO) and CO<sub>2</sub> are produced (one mole each), however, whereas the diisocyanate-water reaction produces

only CO<sub>2</sub>. Thus, the formic acid reaction doubles the amount of gas generated.

Although not currently in use in the United States, the AB system is licensed in the United States under the tradename TEGO AB-M30 by Goldschmidt Chemical Corporation of Hopewell, Virginia. AB-M30 is a mixture of formic acid and formic acid salts. The system also requires a proprietary amine catalyst (15).

The CO gas generated in the AB reaction is poisonous, and care must be taken to ensure operator safety. Existing ventilation systems are generally adequate to remove CO from the foam tunnel itself. Additional ventilation is generally required at the cutoff saw, however, as well as in foam cure and storage areas (7). Goldschmidt also recommends the use of CO monitors to ensure safety (15). Retrofit costs are not available. Corrosion problems are associated with the use of HCOOH. The use of formic acid salts lessens these problems somewhat, but they still must be considered.

The AB system can yield a foam density as low as 1 pounds per cubic foot at an IFD (25 percent) of 40 without any ABA. At a density of 1.3 pounds per cubic foot, an IFD of 30 can be achieved without any ABA (16). Problems with compression set have been reported, however, for very low density foams produced by the AB system without ABAs (7).

When used in conjunction with ABAs, the AB system can reduce ABA use by 33 to 66 percent (7). The AB system can also be used in conjunction with quick cooling systems to achieve foam densities under 1 pound per cubic foot (15). Foam producers are reluctant to rely on cooling systems in place of ABAs, however, because of the potential fire hazard.

### 3.2.6 Add-On Emission Control Equipment for Reclaiming Auxiliary Blowing Agents

#### 3.2.6.1 Application of Carbon Adsorption to Conventional Foam Processes

Carbon adsorption removes organic compounds from a wide variety of air emission streams. In a carbon adsorption system, exhaust gases are passed through a bed of activated carbon granules, and organic compounds are adsorbed onto the surface of the carbon granules. When the carbon is saturated, the captured organics are desorbed, usually using steam. Carbon adsorption systems usually consist of two beds used in tandem. While one bed is working, the second is being desorbed and prepared for the next cycle.

Over the past several years, foam producers, equipment manufacturers, and EPA have studied carbon adsorption as a means for reducing ABA emissions. In particular, EPA conducted a detailed feasibility assessment of

carbon adsorption and other potential controls for foaming operations (2). At least one plant is using carbon adsorption with a conventional Maxfoam line.<sup>3</sup> The system has not been in place long enough, however, to judge its long-term performance.

Most foam producers have considered such systems impractical for a number of reasons. First, a carbon adsorption system for the foam machine tunnel would require a substantial initial capital outlay, estimated at \$530,000 (2). In addition, only about 50 percent of the ABA emissions emanate from the foam tunnel. The balance of the ABA is emitted from the cutting, transport, curing, and storage areas at very low concentrations. Further, the foam machine tunnel is typically only operated for a few hours a day. Finally, diisocyanate emissions from the foaming operation would have a tendency to poison the activated carbon. Therefore, a sacrificial prefilter would need to be in place before the carbon filter.

### **3.2.6.2 E-Max Enclosed Process With Carbon Adsorption**

In the E-Max process, the foam pouring operation is carried out in a long, enclosed mold. The purpose of the enclosed mold is to facilitate the capture and control of emissions. The mold is exhausted to a sacrificial prefilter followed by a carbon adsorber.

The E-Max process is patented by Unifoam of Switzerland. Equipment is manufactured by Periphlex in the United States. One commercial-scale plant was operating in 1992 in the United States (7).

### **3.2.6.3 Application of Carbon Adsorption to Forced Cooling Systems and Other Systems**

Carbon adsorption has been applied to exhaust streams from the initial cooling stages of the Rapid Cure forced cooling process. In addition, the Crain Enviro-Cure cooling process can be equipped with carbon adsorption (21). The carbon adsorption systems are designed to remove contaminants such as diisocyanates and preservatives that are volatilized from the hot foam during the initial stage of the cooling process. Carbon adsorbers applied to these processes would also reduce emissions of ABAs, if ABAs are used. Both of these processes are expected to eliminate the need for ABAs. ABAs are still needed for some low density grades of foam, however, to obtain the desired foam properties.

Both the VPF and CEF reduced pressure processes are also designed to be vented to carbon adsorption systems. The carbon adsorbers remove contaminants that are vaporized from the foam under reduced pressure. Both VPF and CEF are expected to operate without ABAs, but the adsorption systems would reduce emissions of ABAs if any were used.

### **3.2.6.4 Other Potential Add-On Control Systems**

In addition to carbon adsorption, EPA assessed several other potential add-on control technologies for ABAs from foam production (2). These technologies included incineration, conventional refrigerated vapor condensation, Brayton-cycle vapor condensation, and liquid absorption. Combustion of ABAs in an incinerator was comparable with carbon adsorption in cost and effectiveness. The other techniques were found to be inferior to incineration and carbon adsorption.

Several other innovative control technologies have been developed in recent years that have not been evaluated for this industry. These include Photocatalytic destruction, biofiltration, and membrane separation.

### **3.2.7 Alternative Auxiliary Blowing Agents**

Because of air toxics rules, the phaseout of chlorofluorocarbons (CFCs), and the listing of methylene chloride and TCA as HAPs, foam producers have been exploring nontoxic, non-ozone-depleting blowing agents. Acetone is an alternative ABA that is currently being used successfully on a commercial scale. Hydrochlorofluorocarbons (HCFCs) have received attention as potential substitutes for CFCs in many applications, including foam blowing. HCFCs are banned, however, for use in flexible polyurethane foam.

#### **3.2.7.1 Acetone**

Acetone is currently being used on a commercial scale in slabstock production and is suitable for all commercial grades of foam. Acetone has some advantages over methylene chloride: it is less expensive, and it has a higher blowing efficiency than methylene chloride. Fifty percent less acetone (by weight) is needed to produce a given amount of foam, all other factors being equal.

The main drawback of acetone for foam blowing is its flammability. (Flammability limits for acetone in air are 2.6 to 12.8 percent.) Methylene chloride and the other ABAs discussed above are nonflammable. Therefore, the substitution of acetone as a blowing agent generally requires equipment modification to prevent fire hazards. Modifications include:

- Improvement of the foam tunnel to create total enclosure.

<sup>3</sup> Williams, A. 1994. Personal communication from A. Williams, EC/R Inc., to W. Janicek, Flexible Foam Products, Terrel, TX. May 17.

- Use of explosion-proof lighting.
- Movement of motors to outside the tunnel, or substitution of explosion-proof equipment.
- Increased tunnel ventilation.
- Installation of backup systems for tunnel ventilation.

Retrofit costs for a typical foam line are estimated at \$200,000. Once the system is installed, however, chemical costs for acetone are lower than for methylene chloride. As a result, the annualized cost of using acetone is estimated at only about \$12 per ton of emission reduction (13).

Acetone blowing technology is licensed by Hickory Springs Manufacturing Corporation of Hickory, North Carolina.

One company also uses alkanes (C5 and higher) as a substitute blowing agent for methylene chloride. Although this would greatly reduce HAP emissions, the alkanes may contain some n-hexane and i-octane, which are listed as HAPs. No details are available on the composition of the blowing agent, nor are details available on necessary process changes. The technical

issues associated with this blowing agent, however, are expected to be similar to issues associated with acetone.

### 3.2.8 Comparison and Cost Information for Auxiliary Blowing Agent Emission Reduction Measures

Table 3-3 summarizes technologies that can be used to reduce ABA emissions. The table gives approximate emission reductions (in percent), as well as capital costs and estimated cost-effectiveness values. Cost effectiveness is given in terms of dollars per ton of emissions reduced and is defined as the total annual operating cost divided by the magnitude of the projected reduction in emissions or total releases. The table also gives a qualitative comparison of retrofit equipment requirements, chemical costs, and other potential problems associated with the control measures.

### 3.3 Methods for Reducing Toluene Diisocyanate Emissions

Diisocyanate is a key ingredient in foam production reactions, in the formation of CO<sub>2</sub> blowing agent as well as in the formation of urea urethane polymer linkages.

**Table 3-3. Summary of Costs and Requirements for Measures To Reduce HAP Emissions**

Option	Potential Emission Reduction (%) <sup>a</sup>	Approximate Capital Cost	cost Effectiveness (\$/ton)	Equipment Needed	Additional Chemical Cost?	Other Problems
Water blowing	100	0	1,900-35,000 <sup>b</sup>	None	Substantial	Fire hazard
Foam softening systems (high resilience systems, extended-range polyols, other additives)		15-60 <sup>c</sup>	32,000 <sup>d</sup>	1,790 <sup>d</sup> -25,000 <sup>b</sup>	Minor	Yes
Mechanical cooling	85-90 <sup>e</sup>	500,000 <sup>f</sup> -2 million <sup>d</sup>	1,635 <sup>d</sup>	Substantial	No	Fire-equipment failure, degraded foam properties
Mechanical cooling with foam softening	100	500,000 <sup>f</sup> -2 million <sup>d</sup>	NA	Substantial	Yes	Development needed
Liquid CO <sub>2</sub> blowing	100	470,000 <sup>d</sup>	(263) <sup>d</sup>	Yes	No	
Reduced pressure foaming-VPF	100	4-5 million <sup>d</sup>	1,660 <sup>d</sup>	Substantial	No	Complexity
Reduced pressure foaming—CEF	100	340,000 <sup>d</sup>	(161) <sup>d</sup>	Moderate	No	Production rate limited
AB technology	~50 <sup>f</sup>	NA	NA	Minor	Some	Corrosion
Add-on controls	-50	2,900-4,300 <sup>b</sup>	Substantial	No		
Alternative ABAs—Acetone	100 <sup>e</sup>	200,000 <sup>d</sup>	(180) <sup>d</sup>	Some	No	Flammability

NA = not available.

( ) = cost savings.

<sup>a</sup> These savings are not additive if two or more options are used simultaneously.

<sup>b</sup> Farmer et al. (2); SRRP (12).

<sup>c</sup> SRRP (12).

<sup>d</sup> U.S. EPA (14).

<sup>e</sup> CEC (11); acetone is still released, but levels are reduced 45 percent from methylene chloride emission levels.

<sup>f</sup> U.S. EPA/PFA (7).

TDI is the primary diisocyanate used in slabstock foam production.

Most of the TDI used in foam production is consumed during the polymerization reactions; however, TDI has been detected in emissions from foam production. One study performed in Germany in 1980, commonly known in the foam industry as the Stuttgart study, measured TDI emissions at 0.1 pounds per ton of TDI used (28). This amounts to about 0.04 pounds of TDI per ton of foam produced. The Stuttgart study appears to overestimate emissions from today's slabstock industry in the United States because of the vastly different production equipment now in use.

TDI is highly toxic, producing headaches, nausea, and vomiting at concentrations as low as 0.1 ppm and more serious effects at higher concentrations (10). In addition, TDI has been listed as a HAP under the Clean Air Act Amendments.

### **3.3.1 Impact of Process and Formulation Changes on Toluene Diisocyanate Emissions**

Because of the high reactivity of TDI, the bulk of emissions probably originates during the early stage of the foam reaction. Modern production methods, such as Maxfoam and Vertifoam, have lower TDI emissions than earlier equipment (10), probably because they have more efficient systems for dispensing raw materials. In addition, TDI emissions are reduced at lower TDI indices. As a result of equipment and formulation changes, the PFA believes that emissions of TDI currently are about 40 percent less than in the 1970s (10).

Diisocyanate emissions are also reduced when MDI is used in place of TDI. Polymeric MDI is used in the production of molded foam, often in mixtures with TDI. The vapor pressure of MDI is about one-twentieth that of TDI. As a result, the amount of MDI volatilized in the foaming reaction is expected to be less than the amount of TDI volatilized.

### **3.3.2 Add-On Controls for Toluene Diisocyanate Emissions**

Scrubbers have been installed to control TDI emissions on a small number of commercial slabstock foam facilities in Great Britain, Canada, and the United States. Efficiencies of these systems range from 65 to 99.9 percent (10). One problem with these systems is that CO<sub>2</sub> builds up in the scrubber liquor as a result of the reaction of isocyanate with water, reducing system efficiency. Efficiency can be improved through the use of a sacrificial prefilter made of polyurethane foam or another high surface area material. All filtration media present a hazardous waste concern, which increases the overall pollution impact and affects industry economics.

## **3.4 Reducing Releases From Foam Fabrication, Chemical Storage and Handling, and Cleaning**

Emissions from fabrication result from the use of solvent-based adhesives in fabrication operations. The solvent carrier evaporates to the air as the adhesive dries. Section 5.1 presents information on alternative adhesive systems that can be used to reduce emissions from repair operations.

Sections 5.2 and 5.3 discuss methods for reducing releases from chemical storage and handling, and from solvent cleaning.

## **3.5 References**

1. SPI. 1990. End-use market survey on the polyurethane industry in the U.S. and Canada. New York, NY: Society of the Plastics Industries, Polyurethanes Division.
2. Farmer, R.W., T.P. Nelson, and C.O. Reuter. 1987. Preliminary control concepts for methylene chloride emissions from flexible polyurethane foam manufacturing. Draft report prepared by Radian Corp., Austin, TX, for the U.S. Environmental Protection Agency, Research Triangle Park, NC.
3. Norwood, L.P., and A. Williams. 1994. Site visit report (nonconfidential version), Hickory Springs, Conover, NC. January 14.
4. Williams, A., and L.P. Norwood. 1994. Site visit report (nonconfidential version), Foamex LP, Morristown, TN. January 18.
5. Williams, A., and L.P. Norwood. 1994. Site visit report (nonconfidential version), Trinity American, High Point, NC. January 19.
6. Herrington, R., and K. Hock, eds. 1991. Flexible polyurethane foams. Midland, MI: Dow Chemical Company.
7. U.S. EPA/PFA. 1991. Handbook for reducing and eliminating chlorofluorocarbons in flexible polyurethane foams, 21A-4002. Joint project of the U.S. Environmental Protection Agency and the Polyurethane Foam Association, Washington, DC.
8. Woods, G. 1987. The ICI polyurethanes book. New York, NY: ICI Polyurethanes and John Wiley & Sons.
9. Norwood, L.P., A. Williams, and W. Battye. 1994. Summary of flexible polyurethane foam information collection requests (ICRs). Presented at a meeting of the U.S. Environmental Protection Agency and the Polyurethane Foam Association. February 2.
10. PFA. 1993. Flexible polyurethane foam (slabstock): Assessment of manufacturing emission issues and control technology. Wayne, NJ: Polyurethane Foam Association.
11. CEC. 1991. Flexible polyurethane foam manufacture: An assessment of emission control options. Washington, DC: Center for Emissions Control.
12. SRRP. 1992. Source reduction and recycling of halogenated solvents in the flexible foam industry. Report on research performed by the Source Reduction Research Partnership for the Metropolitan Water District of Southern California and the Environmental Defense Fund (EDF).
13. U.S. EPA. 1995 Flexible polyurethane foam: Emission analysis. EPA/453/D-95/004. Research Triangle Park, NC (May).
14. ARCO Chemical. 1994. Product literature. Hinsdale, IL.
15. Goldschmidt Chemical Corp. 1994. Product literature. Hopewell, VA.



- 
16. Sam, F.O., D. Stefani, and G.F. **Lunardon** 1993. **A novel** approach to the production of low density, CFC-free flexible polyurethane foams. In: Proceedings of the Society of the Plastics Industries Polyurethanes World Conference. New York, NY: Society of the Plastics Industries, Polyurethanes Division. pp. **305-310**.
  17. Skorpenske, R.G., **R. Solis**, S.A. Moy, **E.P. Wiltz**, CD. McAfee, and K. **Brunner**. 1993. Novel technology for the manufacture of all-water-blown flexible slabstock foam. In: Proceedings of the Society of Plastic Industries Polyurethanes World Conference. New York, NY: Society of Plastics Industries, Polyurethanes Division. pp. 66-73.
  18. Stone, H., E. **Reinink**, S. Lichvan, W. **Carlson**, and C. Sikorsky. 1993. The rapid cure process: Industrial experience, engineering and formulation principles, In: Proceedings of the Society of the Plastic Industries Polyurethanes World Conference. New York, NY: Society of Plastics Industries, Inc., Polyurethanes Division. pp. **270-278**.
  19. Stone, H. 1992. Low density foams without auxiliary blowing agents for use with standard foam machines. In: Proceedings of the Polyurethane Foam Association Meeting. Wayne, NJ: Polyurethane Foam Association. October.
  20. McAfee, CD., **E.P. Wiltz**, R.G. Skorpenske, D.H. Ridgway, and J.V. **McClusky**. 1993. Understanding the fundamentals of forced cooling in the production of blowing agent free flexible slabstock polyurethane foams. In: Proceedings of the Society of Plastics Industries Polyurethanes World Conference. New York, NY: Society of Plastics Industries, Polyurethanes Division. pp. 279-287.
  21. Collins, **B.**, and C. Fawley. 1993. Cannon Enviro-Cure equipment applied to the Vertifoam and **Maxfoam** processes. In: Proceedings of the Society of Plastics Industries Polyurethanes **World** Conference. New York, NY Society of Plastics Industries, Polyurethanes Division. pp. 176-183.
  22. Ricciardi M.A., and D.G. Dai. 1992. Crain Industries Enviro-Cure technology applied to the Vertifoam and **Maxfoam** processes. In: Proceedings of the Polyurethane Foam Association Meeting. Wayne, NJ: Polyurethane Foam Association. October.
  23. Ricciardi, M.A., and D.G. Dai. 1992. Three-stage cooling of porous materials. U.S. Patent No. **5,171,756**.
  24. **Drye**, J.L., and G.C. Cavanaugh. 1993. Posttreatment of polyurethane foam. U.S. Patent No. **5,188,792**.
  25. **Florentini**, C., et al. 1992. Auxiliary blowing agent substitution in **slab**-stock foams. In: Proceedings of the Polyurethane Foam Association Meeting. Wayne, NJ: Polyurethane Foam Association. **October**.
  26. Spellmon, L.J. 1993. Alternative manufacturing technologies: Variable pressure foaming. Personal communication from L.J. Spellmon, Foamex, to B.C. Jordan, U.S. Environmental Protection Agency, Research Triangle Park, NC. October 25.
  27. Carson, S. 1993. Controlled environment foaming: Manufacturing a new generation of polyurethane foam. Prepared for the Foam 1 Company, Woodland, CA.
  38. Tu, D., and R. **Fetsch**. 1980. Emission of air contaminating harmful substances during the manufacture and processing of polyurethane products. Stuttgart, Germany: University of Stuttgart.

---

## **Chapter 4**

### **Pollution Prevention in Molded Foam Manufacture**

Molded foam accounts for about 25 percent of the flexible polyurethane produced in the United States (1). In molded foam production, the foam polymerization reaction occurs in a closed mold in the shape of the desired product. The largest market for molded foam products is the transportation industry, which uses molded foam for seat cushions and interior trim (e.g., sound-absorbing trim). Molded foam is also used in furniture, bedding, packaging materials, toys, and novelty items.

This chapter reviews molded foam production processes, identifies and quantifies the extent of emissions of pollutants, and describes pollution prevention options that can be implemented to reduce these emissions. The principle pollution prevention techniques available for molded foam include:

- Alternative mix head technology (high pressure and self-cleaning mix heads).
- Nonhazardous flushing agents.
- Recovery of solvent-based mix head flush.
- Alternative mold release agents (naphtha-based and reduced-VOC mold release agents).
- Electrostatic spray guns for applying mold release agents.
- Alternative auxiliary blowing agents (HFA-134a, pentane, water blowing)

#### **4.1 Molded Foam Production**

##### **4.1.1 Molded Foam Process Equipment**

Figure 4-1 illustrates a typical molded foam production line. The production line includes multiple molds, each consisting of top and bottom sections joined by hinges. The molds are mounted on a circular or oval track. Both the molds and the track can vary broadly in size. Mold sizes range from less than a foot (e.g., for novelty items) to several feet (e.g., for mattresses). The track can range from a small carousel with fewer than 10 molds to a large “racetrack” with as many as 75 to 100 molds. The molds travel around the track, and the necessary process operations are performed at fixed stations.

The raw material injection station is particularly important. Raw materials, including polyol, diisocyanate, water, catalyst, and surfactant are all pumped to a common mix head in predetermined amounts. Many of the ingredients are premixed to minimize the streams being fed to the head and to ensure precise measurement. The mix head injects a precisely measured “shot” of raw material into each mold. The industry used two types of mix heads: high pressure and low pressure. In a high pressure system, impingement of the high pressure streams within the mix head mixes the raw materials. The low pressure system relies on a rotating mixer within the mix head to blend the raw materials.

Low and high pressure mix heads have different cleaning requirements that result in dramatic differences between the two mix heads in overall emissions. Low pressure mix heads must be cleaned either after each shot or once every several shots to prevent clogging. Flushing with a solvent, generally methylene chloride, cleans the mix head. The volume of solvent used in mix-head flushing is substantial, about 440 tons nationwide. High pressure mix heads do not need to be flushed and thus can be viewed as a pollution prevention measure for mix-head flushing.

After the mix head charges the raw materials, the molds generally are heated to accelerate foam curing reactions. Heating can be accomplished by pumping hot water through tubes in the body of the mold or by passing the mold through a curing oven. The amount of heating required depends on the specific process.

Other operations include the application of mold release agent, closing and opening of the mold, removal of the molded product, and mold cleaning. A mixture of manual and automated equipment is used for these operations, with the degree of automation depending on the age and size of the production line. The following section describes a typical molding cycle.

##### **4.1.2 Molding Process Cycle**

The first step in the molding cycle is the application of mold release agent, a substance applied to the mold to facilitate removal of the foam product. The mold release agent is typically a wax in a solvent carrier, either a

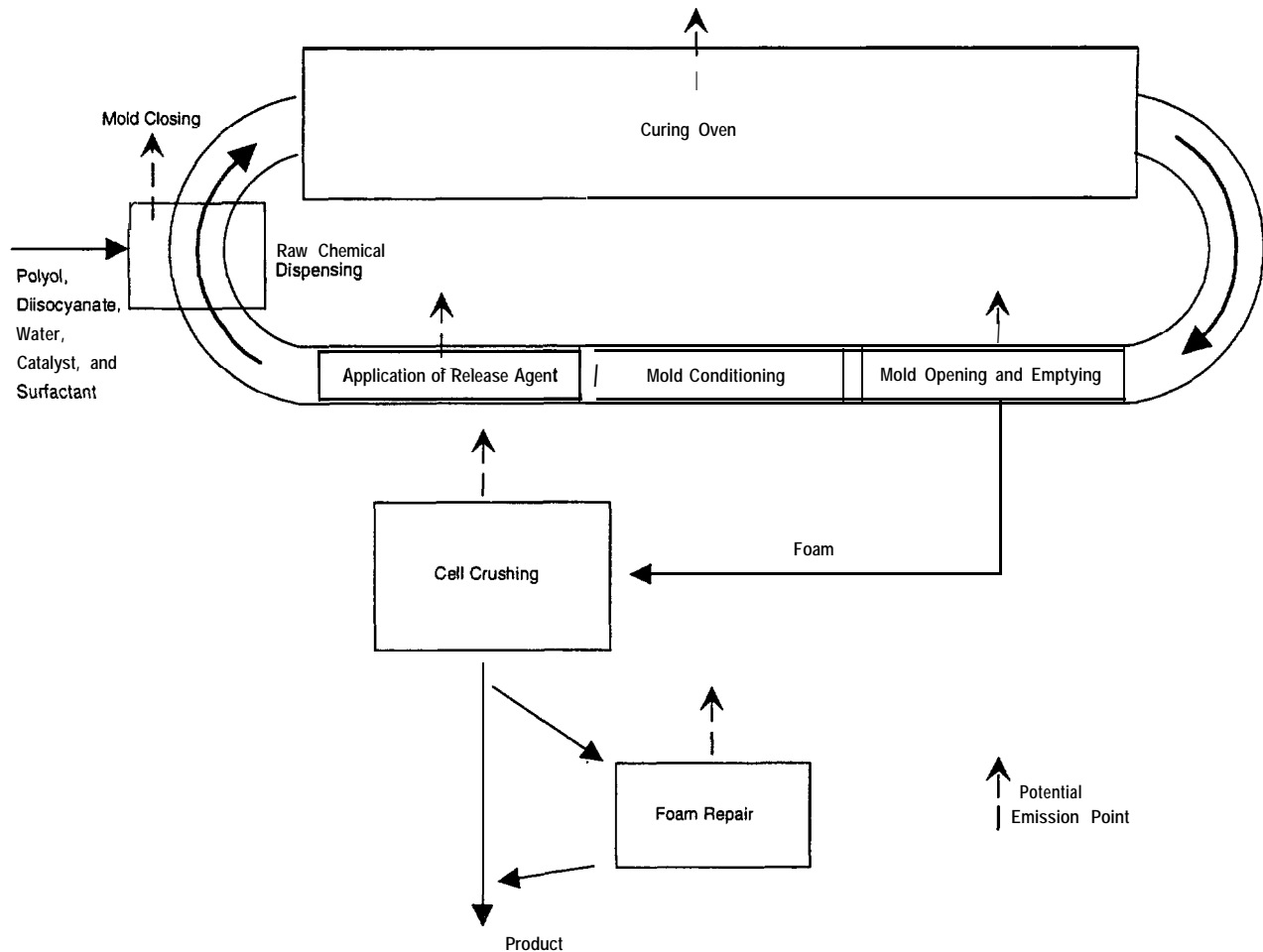

Figure 4-1. Typical molded foam production line.

chlorinated solvent or a naphtha petroleum solvent. The carrier evaporates, leaving the wax behind to prevent sticking. Mold release agent may be applied by a spray or a brush.

After the mold release agent is applied, any special components to be molded into the foam are placed in the mold; these include covers, springs, or reinforcing materials. The mold may then be preheated prior to the addition of raw materials to accelerate evaporation of the solvent carrier for the release agent.

As noted above, the mix head measures and pours a predetermined shot of raw materials into the mold. The mold is then closed. Polymerization and the gas forming reaction occur simultaneously, producing a foam product that fills the mold. (Foam forming and foam blowing reactions are discussed in detail in Chapter 2.) Most molded foams are produced without auxiliary blowing agents (ABAs), using only the blowing action of carbon dioxide (CO<sub>2</sub>) gas from the water-diisocyanate reaction (2-6).

The mold is heated to accelerate curing reactions in the foam polymer. After curing, the molds are opened, and the product is removed. The mold is then cleaned and

returned to the circuit. The entire cycle takes approximately 10 minutes.

#### 4.1.3 Molding Process Variations

Molded foam process operations are divided into two major categories: hot-cure processes and high resilience (HR) processes. Hot-cure processes require higher temperatures for foam curing. HR processes use higher reactivity ingredients so that less external heating is needed. HR technology is more prevalent in the United States because of its lower energy requirements (7).

There are several ways to increase reactivity in the foam formulation. One way is to use a higher reactivity polyol, such as an ethylene-oxide-capped (EtO-capped) polyol or a copolymer "graft" polyol (7). Another way to increase reactivity is to use polymeric methylene diphenyl diisocyanate (MDI) instead of toluene diisocyanate (TDI). Higher catalyst concentrations can also be used.

An important molded foam variation is integral skin foam, also known as self-skinning foam. Integral skin foam is a foam with a dense, tough outer surface. The skin is produced by overpacking the mold and using an ABA, usually trichlorofluoromethane (CFC-11). (Unlike

other types of molded foams, integral skin foams require an ABA.) The temperature gradient between the center of the foam mass and the relatively cooler surface of the mold causes the ABA to condense on the mold wall, driving skin formation. Integral skin foams are used in such products as steering wheels and footwear (8).

#### 4.1.4 Cell Opening

Most grades of molded foam, especially those formed from more reactive raw materials, have closed cells when they are initially removed from the mold. To prevent shrinkage, the cells are opened by mechanical or physical processes. At this point, CO<sub>2</sub> and any ABA are released to the atmosphere.

The most common method for opening the foam cells is to “crush” the foam by passing it through a set of rollers. Another method for opening the cells is to subject the foam to reduced pressure in a vacuum chamber. In some cases, cells can also be opened by timing the release of internal pressure from the mold (7, 9).

#### 4.1.5 Repair Operations

After a foam piece is removed from the mold and its cells are opened, it generally is trimmed and inspected for tears or holes. Any tears and holes are repaired. Repair operations are carried out at glue stations, which may be equipped with local ventilation systems to remove solvent vapors emanating from the glue.

### 4.2 Overview of Releases

Table 4-1 summarizes emissions from different operations in molded foam production. The table divides emissions

into hazardous air pollutants (HAPs), which are listed under Title III of the Clean Air Act; volatile organic compounds (VOCs), which participate in reactions to form urban smog; and chlorofluorocarbons (CFCs), which are regulated because of stratospheric ozone depletion.

Mold release agents account for all of the known VOC emissions and about 5 percent of HAP emissions from molded foam production. The bulk of HAP emissions—almost 75 percent—results from mix-head flushing, primarily with methylene chloride. ABA emissions are significant but not nearly as important as in slabstock foam production. In molded foam production, ABA use generally is confined to the production of integral skin foams. The primary blowing agent has been CFC-11, but its use has been almost completely phased out. As a result, foam producers have been exploring a variety of substitutes, including HAP blowing agents, VOC blowing agents (e.g., pentane), and water blowing.

### 4.3 Methods for Reducing Releases From Mix-Head Flushing

As shown in Table 4-1, about 75 percent of emissions from molded foam production result from mix-head flushing, with over 95 percent of these emissions from methylene chloride.

During mix-head flushing, the flushing agent generally is discharged through the head into an open barrel that sits beside the mold track; emissions come from the open barrel. One plant estimates that about 70 percent of the methylene chloride used for mix-head flushing evaporates. The balance of the flushing agent remaining

Table 4-1. Summary of 1992 Emissions From Molded Flexible Polyurethane Foam Production

Emission Source	Emissions (tons/year)			Comments
	HAPs <sup>a</sup>	VOCs	CFCs	
Mix head flushing	440 <sup>a</sup>	NA		HAP emission breakdown is 95% methylene chloride, 3% methanol, and 2% TCA
ABA use	NA <sup>b</sup>	NA <sup>b</sup>	60 <sup>b</sup>	CFC-11 <sup>b</sup>
Mold release and demolding	21 <sup>a</sup>	10,000 <sup>c</sup>		VOC emissions are mainly naphtha solvents; HAP emissions are mainly methylene chloride
Repair and fabrication	58 <sup>a</sup>	NA		HAP emissions are 96% methyl chloroform
Chemical handling and storage	43 <sup>a</sup>	NA		
Other <sup>d</sup>	17 <sup>a</sup>	NA		
Total	579 <sup>a</sup>	NA	60 <sup>b</sup>	

NA = not available

<sup>a</sup> Estimates are derived from a HAP emission survey of the flexible polyurethane foam industry by EPA/ESD (10). Plants included in the survey accounted for about 46 percent of molded foam production (1). Results have been scaled to cover the balance of the industry.

<sup>b</sup> CFC-11, used as a blowing agent for integral skin foams, is being phased out under the Montreal Protocol. Producers are exploring various avenues for replacing CFCs in integral skin foams, including VOC blowing agents, HAP blowing agents, and water-blowing; although HAPs are likely to be regulated, they are not currently being phased out.

<sup>c</sup> Based on a survey of mold release agent use, which measured emissions at about 29,000 tons for rigid and flexible molded polyurethane foams (11). This combined figure was apportioned using production data to derive an emissions estimate for flexible molded foams.

<sup>d</sup> Includes in-mold product coating and equipment cleaning.

in the barrel is ultimately covered and shipped off for treatment as a hazardous waste.

Several technologies are available to reduce or eliminate methylene chloride emissions from mix head flushing. These include high-pressure mix heads, self-cleaning mix heads, nonhazardous flushing agents, and solvent recovery.

#### **4.3.1 High Pressure Mix Heads**

High pressure mix heads do not require flushing because they contain no moving parts. Rather, the mix heads are designed so that the various inlet streams mix together when they impinge on one another at high pressure. Thus, replacing a low pressure mix head with a high pressure system can eliminate emissions from mix-head flushing. For an existing molded foam line, replacing a low pressure mix head with a high pressure system would also require that metering pumps and controls be replaced.

High pressure systems have already replaced low pressure mix heads in many molded foam plants. These systems cannot be used for all applications, however. For instance, the flow rate for high pressure systems is too high to produce small items. The cost of installing a high pressure mix head and ancillary equipment ranges from \$75,000 to \$200,000, depending on the size and throughput of the process line (12).

Four manufacturers of high pressure mixing equipment have been identified: Krauss Maffei Corporation of Florence, Kentucky; Cannon USA of Mars, Pennsylvania; Hennecke Machinery of Lawrence, Pennsylvania; and Admiral Corporation of Akron, Ohio.

#### **4.3.2 Self-Cleaning Mix Heads**

Another alternative to mix-head flushing is a self-cleaning mix head, which uses a tapered mixing screw in a tapered chamber. The screw rotates rapidly to mix the raw materials. For cleaning, the screw is rotated at a faster rate to expel residues from the mixing chamber (13).

This technology is only applicable for molded foam lines that manufacture small parts. The throughput for the head ranges from 2 to 16 pounds per minute.<sup>1</sup> The cost of retrofitting a self-cleaning mix head to an existing process line has been estimated at \$30,000 (12).<sup>2</sup> The system is sold in the United States by Klockner Ferromatik Desma of Erlanger, Kentucky.

<sup>1</sup> Lewis, G.D. 1995 Personal communication from George D. Lewis, Klockner Ferromatik Desma, to David Svendsgaard, U.S. Environmental Protection Agency. January 5.

<sup>2</sup> See footnote 1, above.

#### **4.3.3 Nonhazardous Flushing Agents**

Substitution of a nonhazardous flushing agent also reduces release of methylene chloride from mix-head flushing. Several alternative flushing agents are available, many of which are nonvolatile as well as non-HAP. For example, polyol can be used, or any of the nonhazardous flushing agents based on d-limonene, cyclic amide, ethyl ester, glutarate ester, and other esters.

In general, alternative flushing agents are more expensive than methylene chloride. In drum quantity, methylene chloride costs about \$3.20 per gallon, while costs of nonhazardous flushes range from \$7 to \$25 per gallon (12). These fluxes can be used multiple times, however, and higher purchase costs are also counterbalanced by a savings in disposal costs. In addition, the cost of flushing agents can be reduced substantially by distilling and reusing the flushing agent.<sup>3</sup> Spent methylene chloride flushing agent must be treated as a hazardous waste under the Resource Conservation and Recovery Act (RCRA), while the nonhazardous solvent residues can be treated simply as solid wastes,

Nonhazardous flushing agents are available from many vendors. In selecting a flushing agent, the user must check the solvent's performance with seals and o-rings. The U.S. Environmental Protection Agency (EPA) and other federal agencies have developed a number of electronic databases to assist solvent users in identifying nonhazardous substitutes. These are discussed in Appendix B.

#### **4.3.4 Solvent Recovery**

As noted above, the mix head flush stream is generally captured in a barrel located near the mold track. Overall release of methylene chloride from mix-head flushing can be reduced by immediately reclaiming the spent flushing agent; this is done by distilling the methylene chloride at 200°F to 250°F. Solvent vapors are condensed and reused. Solids from the still (still bottoms) remain a hazardous waste, but the waste volume is greatly reduced by recovering the solvent. Still bottoms can be either landfilled or incinerated.

The reclaiming operation can occur either on site or at a separate facility. Many companies contract to collect drums of spent solvent, distill the contents, and return reclaimed solvent to the client company. Generally, this recovery operation can be performed with no sacrifice in product quality.

<sup>3</sup> Esemplare, P. 1995. Personal communication from Pat Esemplare, Dynaloy, Inc., to Amanda Williams, EC/R, Inc. January 17.

### 4.3.5 Comparison and Cost Information for Measures To Reduce Mix Head Flushing Emissions

Table 4-2 summarizes available cost data for the various technologies that reduce releases from mix-head flushing. The table gives capital costs and estimated cost-effectiveness values. Cost-effectiveness is given in terms of dollars per ton of emissions reduced and is defined as the total annual operating cost divided by the magnitude of the projected reduction in emissions or total releases.

Table 4-2. Summary of Costs To Reduce Mix-Head Flushing Release

Technology	Total Capital Investment per Molded Foam Line (\$)	Estimated Cost Effectiveness (\$/ton of pollutant reduction) <sup>c</sup>
High-pressure mix heads	75,000-200,000 <sup>a</sup>	773
Self-cleaning mix heads	~40,000 <sup>a</sup>	(502)
Nonhazardous flushing agents	0	(79)
Reclaiming of spent flushing agents	9,000 <sup>b</sup>	(177)

( ) = overall savings (due to reduced chemical costs).

<sup>a</sup> U.S. EPA (12).

<sup>b</sup> SRRP (2).

## 4.4 Methods for Reducing Releases of Mold Release Agents

1,1,1-Trichloroethane (TCA) and methylene chloride have been widely used as mold release agent carriers. Because both of these solvents have been listed as HAPs under Title III of the Clean Air Act Amendments, molded foam manufacturers recently have been selecting nonhazardous carriers. Some of these are naphtha-based, reduced-VOC, or water-based carriers.

### 4.4.1 Naphtha-Based Mold Release Agents

Naphtha is a petroleum distillate consisting mainly of aliphatic hydrocarbons. These hydrocarbons evaporate during the molding process the same way the chlorinated mold release carriers do.

Naphtha-based carriers contain no HAPs. Nevertheless, they consist of reactive VOCs, which participate in the formation of photochemical smog. Thus, the use of naphtha-based mold release agents reduces HAP emissions but not VOC emissions.

### 4.4.2 Reduced-VOC Mold Release Agents

Reduced-VOC mold release agents are high-solids, solvent-based formulations (14). Because of their higher solids content, less solvent carrier is required

per mold cycle. This can reduce VOC emissions as much as 80 percent.

The cost of a typical reduced-VOC mold release agent is \$9.31 per gallon, about twice the cost per gallon of a standard solvent-based mold release agent. This cost is partially offset, however, because the reduced-VOC agent can be used in smaller quantities. No equipment changes are necessary, and no significant operator retraining is necessary to use these formulations (12).

### 4.4.3 Water-Based Mold Release Agents

Concerns over emissions from HAP-based and naphtha-based mold release agents have prompted the development of some water-based mold release agents (15), which have been used successfully at molded foam production plants. Unlike naphtha-based and reduced-VOC mold release agents, water-based agents eliminate mold release emissions (16, 17).

The cost of the typical water-based mold release agent is \$5 to \$6 per gallon.<sup>4</sup> This is about 5 to 30 percent more than the cost of a solvent-based agent. In addition, several factors complicate the use of water-based mold release agents. First, the selection of a water-based agent is specific to each particular application. Considerable time and many trials may be needed before the correct product and temperature are found. Second, mold release spray machine operators may require some retraining. Finally, additional drying time may be needed for the mold release agent, or the temperature of the mold may have to be increased to speed drying.

### 4.4.4 Electrostatic Spray Guns

Electrostatic spray guns have recently been developed for painting and other surface coating operations. These are designed to reduce coating consumption by reducing the amount of "overspray," or coating that does not adhere to the target surface. In reducing overspray, these systems also reduce solvent consumption, and hence emissions. Electrostatic spray systems have been used in the foam industry to apply mold release agents, reducing solvent emissions by 20 percent.

### 4.4.5 Comparison and Cost information for Measures To Reduce Mold Release Agent Emissions

Table 4-3 summarizes available cost data for the various technologies that reduce emissions from mold release agents. The table gives capital costs and estimated cost-effectiveness values in terms of dollars per ton of emissions reduced.

<sup>4</sup> Santo, R. 1995. Personal communication from Robert Santo, Air Products and Chemicals, to David Svendsgaard, U.S. Environmental Protection Agency. January 16.

Table 4-3. Summary of Costs To Reduce Emissions From Mold Release Agents (12)

Technology	Total Capital investment per Molded Foam Line (\$)	Estimated Cost Effectiveness (\$/ton of pollutant reduction)
Naphtha-based release agents	0	3,359
Reduced-VOC release agents	0	452
Water-based release agents	0	433
Alternative application methods	NA	NA

NA = not available

## 4.5 Methods for Reducing or Mitigating Releases of Auxiliary Blowing Agents

Although ABA use has been phased out in the manufacture of most molded foam, ABAs are still generally used to manufacture integral skin foams. The primary ABA historically used in this process was CFC-11. As a result, foam manufacturers have put considerable effort into finding a substitute. Methylene chloride, which has replaced CFC-11 in most slabstock ABA applications, has not proved adequate for integral skin foam production.

BASF has recently been researching CFC-11 substitutes for integral foam processes. Three substitutes have been explored: HFA-134a (1,1,1,2-tetrafluoroethane), pentane, and water blowing. All three substitutes have produced integral foams of acceptable quality (18). The following subsections discuss specific requirements and the effects of these substitutions.

### 4.5.1 HFA- 134a

HFA-134a contains no chlorine and therefore is not believed to participate in stratospheric ozone depletion reactions. Therefore, unlike other CFC substitutes such as hydrochlorofluorocarbons (HCFCs), HFA-134a probably will not be regulated by future updates of the Montreal Protocol.

The main disadvantage of HFA-134a is its cost compared with other blowing agents. In addition, HFA-134a has a low boiling point and is not as soluble as CFC-11 in polyurethane systems; therefore, HFA-134a use requires special processing.

### 4.5.2 Pentane

Pentane is not an ozone-depleting agent; it is a VOC, however. Therefore, substituting pentane for CFC-11 decreases emissions of ozone-depleting compounds while increasing emissions of VOCs.

## 4.5.3 Water Blowing

Historically, manufacturers have not had success in producing integral skin foams with water-blown systems. Skin formation is driven by condensation of the blowing agent on the mold wall, and this condensation does not occur with CO<sub>2</sub>. In addition, the urea linkages formed in the water-isocyanate reaction are detrimental to the physical properties of the foam core.

BASF overcame both of these problems by using additives in the formulation (16). Microcellular thermoplastic beads were added to enhance skin definition. In addition, a prepolymer additive was used to counteract the impact of urea linkages.

## 4.6 Methods for Reducing Releases From Foam Repair, Chemical Storage and Handling, and Cleaning Processes

Emissions from foam repair operations result from the use of solvent-based adhesives. The solvent carrier evaporates to the air as the adhesive dries. Section 5-1 presents information on alternative adhesive systems that can be used to reduce emissions from repair operations.

Sections 5-2 and 5-3 discuss methods for reducing releases from both chemical storage and handling and from solvent cleaning.

## 4.7 References

1. SPI. 1990. End-use market survey on the polyurethane industry in the U.S. and Canada. New York, NY: Society of the Plastics Industries, Polyurethanes Division.
2. SRRP. 1992. Source reduction and recycling of halogenated solvents in the flexible foam industry. Report on research performed by the Source Reduction Research Partnership for the Metropolitan Water District of Southern California and the Environmental Defense Fund (EDF).
3. Hayashida, S., A. Horie, Y. Yamagucki, and H. Morita. 1989. Polyol for CFC-free hot molded foam using high mold temperature process. In: Proceedings of the Society of the Plastics Industries Annual Polyurethanes World Conference. New York, NY: Society of the Plastics Industries, Polyurethanes Division. pp. 575-578.
4. Motte, P. 1989. CFC-free flexible molded foams with improved physical properties. In: Proceedings of the Society of the Plastics Industries Annual Polyurethanes World Conference. New York, NY: Society of the Plastics Industries, Polyurethanes Division. pp. 2-8.
5. Westfall, P.M. and J.L. Lambach. 1989. Hyperlite: High performance low density molded foam technology without CFCs. In: Proceedings of the Society of the Plastics Industries Annual Polyurethanes World Conference. New York, NY: Society of the Plastics Industries, Polyurethanes Division. pp. 9-1 5.
6. Lunardon, G.F., B. Gallo, and M. Brocci. 1989. Production of soft block foams and TDI-based cold cure-molded foams with no use of CFCs. In: Proceedings of the Society of the Plastics Industries Annual Polyurethanes World Conference. New York, NY: Society of the Plastics Industries, Polyurethanes Division. pp. 239-245.

- 
7. Herrington, R. and K. Hock, eds. 1991. Flexible polyurethane foams. Midland, MI: Dow Chemical Company.
  - a. Woods, G. 1987. The ICI polyurethanes book. New York, NY: ICI Polyurethanes and John Wiley & Sons.
  9. Cavender, K.D. 1985. Novel cell opening technology for HR molded foam. In: Proceedings of the Society of the Plastics Industries 28th Annual Technical/Marketing Conference. New York, NY: Society of the Plastics Industries, Polyurethanes Division. pp. 314-318.
  10. Norwood, L.P., A. Williams, and W. Battye. 1994. Summary of flexible polyurethane foam information collection requests (ICRs). Presented at a meeting of the US. Environmental Protection Agency and the Polyurethane Foam Association. February 2.
  11. Whitfield. K. 1994. Some characterization and emissions estimates for mold release agents and roofing applications. Prepared by Southern Research institute for the U.S. Environmental Protection Agency, Research Triangle Park, NC.
  12. U.S. EPA. 1995. Flexible polyurethane foam: Emission reduction technologies cost analysis. EPA/453/D-95/004. Research Triangle Park, NC (May).
  13. Lewis, G.D. 1993. Solvent free mechanical mixing. In: Proceedings of the Society of the Plastics Industries Annual Polyurethanes World Conference. New York, NY: Society of the Plastics Industries, Polyurethanes Division. pp. 171-175.
  14. Air Products. 1994. PURA sprayable concentrate release agents. Polyurethane Additives Product Bulletin.
  15. Fountas, G.N. 1990. Water-based release agents offer solution to processors' CFC problems. *Elastomerics*. December.
  16. Air Products. 1994. PURA water-based release agents. Polyurethane Additives Product Bulletin.
  17. Chem-Trend, Inc. 1994. RCTW-1151, release blend in water, Material Safety Data Sheet.
  18. Valoppi, V.L., R.P. Harrison, and C.J. Reichel. 1993. Non-ozone blowing agents for integral skin foam. In: Proceedings of the Society of the Plastics Industries Annual Polyurethanes World Conference. New York, NY: Society of the Plastics Industries, Polyurethanes Division. pp. 420-424.



---

## **Chapter 5**

### ***Pollution Prevention in Adhesive Usage, Chemical Storage and Handling, and Equipment Cleaning***

This chapter discusses methods for reducing emissions from operations that are common to both slabstock and molded foam production. These operations include adhesives application (Section 5.1), chemical storage and cleaning (Section 5.2), and equipment cleaning (Section 5.3).

#### **5.1 Reducing Emissions From Adhesives**

Adhesives are used in both slabstock and molded foam plants. In slabstock facilities, adhesives are used in fabrication operations to glue foam pieces to one another and to other materials. In molded foam plants, adhesives are used primarily to repair pieces that are found to be damaged when they are removed from the mold.

Adhesives used in the foam industry are mainly solvent-based systems, with about 20 to 40 percent solids. The bulk of the solvent carrier evaporates as the adhesive dries. Adhesives generally are applied at gluing stations by spraying with low pressure guns. At larger facilities, glue stations are equipped with local ventilation systems to remove solvent vapors.

Until 1993, 1,1,1-trichloroethane (TCA) was the most prevalent solvent used in foam adhesives, accounting for more than 90 percent of adhesive solvent use. Methylene chloride accounted for most of the remaining 10 percent. Total adhesive solvent emissions from foam fabrication were estimated at about 1,400 tons per year in 1993 (see Tables 3-I and 4-I). Adhesives suppliers, however, have moved strongly to methylene chloride in 1994.

TCA use is being phased out under the Montreal Protocol for stratospheric ozone-depleting agents. In addition, because TCA, methylene chloride, and other adhesive solvents have been listed as hazardous air pollutants (HAPs) under Title III of the Clean Air Act Amendments, adhesive manufacturers have been working to develop alternatives to solvent-based systems. Three of these alternatives are discussed in the following sections.

#### **5.1.1 Hot-Melt Adhesives**

Hot-melt adhesives are solids that can be melted and sprayed like solvent-based adhesives. Hot-melt adhesives contain no HAPs; however, small amounts of low molecular-weight hydrocarbons may be emitted when the adhesive is melted. These volatile organic compounds (VOCs) can participate in the formation of urban smog.

Major equipment changes are not necessary for a switch to hot-melt adhesives; the main change is the addition of a melt tank at a cost of under \$7,000. New spray guns and heated lines are also needed, which increase the cost of this approach. Hot-melt adhesives, however, are considerably more expensive than solvent-based adhesives. A typical hot melt adhesive costs about \$20.30 per gallon, compared with about \$8.50 per gallon for a TCA-based adhesive (1).

Operational hurdles are also associated with hot-melt adhesives. First, hot adhesives may present a burn hazard to glue station workers. Second, the "tack time" of hot-melt adhesives is very short. This is both an advantage and a disadvantage; although it allows faster production cycles, the adhesive may cease to be sticky before the assembly is complete. Tack time depends on the adhesive used, and adhesives with extended tack times can be obtained from some manufacturers. Some trials may be needed, however, before the most appropriate product is identified for a specific application. An additional problem noted with hot-melt adhesives is that they tend to produce hard seams, which is unacceptable in a soft, flexible foam product.

#### **5.1.2 Water-Based Adhesives**

Some water-based adhesives are available that contain no HAPs or VOCs (2). Thus, substituting water-based adhesives for solvent-based systems can eliminate both HAP and VOC emissions from adhesive solvents.

Water-based system substitution requires little modification to existing spray equipment. The cost of water-based adhesives is actually somewhat lower than the cost of solvent-based adhesives (about \$7 per gallon).

A major drawback to water-based systems is their slower drying time, which makes water-based systems impractical for some applications. In some cases, an external heat source is required to accelerate drying. The tack time of water-based adhesives can also be a problem in the fabrication process. A higher volume of water-based adhesive is generally needed to achieve the glue capability of a solvent-based adhesive, which effects any economic comparison.

Water-based adhesives are available from many vendors. The US Environmental Protection Agency (EPA) and other federal agencies have developed a number of electronic databases to assist solvent users in identifying nonhazardous and water-based substitutes. These are discussed in Appendix B.

### 5.1.3 Two-Component Water-Based Adhesives

There is a water-based adhesive variation that involves a two-component system: a water-based latex adhesive and a mild citric acid solution (3). These components are mixed when the adhesive is sprayed, causing the latex to coagulate. The adhesive dries almost instantly, and cleans up with soap and water. In addition, little adhesive penetrates into the surfaces being joined.

The cost of a two-component water-based adhesive is about \$8 per gallon, slightly less than a TCA-based adhesive (1). Special spray guns are needed, however, for the two-component water-based process at a cost of about \$2,000 to \$3,000 per glue station. In addition, operators may need training in the use of the two-component system. There are also some limitations on the products to which the adhesive can be applied, in that both of the surfaces being joined must be porous.

### 5.1.4 Costs for Alternative Adhesives

Table 5-1 summarizes available cost data for the various technologies that reduce emissions from adhesive usage in the foam industry. The table provides capital costs and estimated cost-effectiveness values. Cost-effectiveness is presented in terms of dollars per ton of emissions reduced and is defined as the total annual operating cost divided by the magnitude of the projected reduction in emissions or total releases.

## 5.2 Reducing Releases From Chemical Storage and Handling

In general, the larger-volume raw materials are received by either rail car or tank truck and are stored in fixed-roof tanks. These include toluene diisocyanate (TDI), polyol, and methylene chloride. Smaller-volume ingredients typically are received and stored in drums or totes.

Table 5-1. Summary of Costs of Alternative Adhesive Systems (1)

Technology	Total Capital Investment per Glue Station (\$)	Estimated Cost Effectiveness (\$/ton of pollutant reduction)	
		Slab-stock Plant	Molded Plant
Hot-melt adhesives	3,000	2,264	3,217
Water-base adhesives	Negligible	(365)	(380)
Two-component water-based adhesives	2,000-3,000	200	900

( ) = overall savings (due to reduce chemical costs).

Special precautions generally are taken in the handling of TDI because of its toxicity and reactivity with water. Generally, TDI is unloaded to storage tanks using a vapor-balanced system; that is, the vapors displaced by liquid flowing into the empty storage tank are piped back to the rail car or tank truck. This eliminates "working loss" emissions from the storage tank.

Measures may also be taken to mitigate the impact of tank "breathing," which occurs when the tank contents expand and contract with diurnal temperature changes. TDI tanks are often located indoors (although they are vented outdoors) to reduce diurnal temperature changes. The tank vents generally are equipped with either a carbon filter or an oil trap to prevent water vapor from entering the tank as it breathes. If a carbon filter is used, adsorption on the carbon also controls breathing losses of TDI vapor.

## 5.3 Reducing Releases From Equipment Cleaning

Small amounts of methylene chloride and other solvents are used as cleaners at flexible foam plants. The solvents are used to rinse or soak equipment such as mix heads, hoses, and foam troughs. Generally, much of the solvent that is used to clean equipment ultimately evaporates and is therefore emitted to the atmosphere. Any spent methylene chloride that is collected must be disposed of as hazardous waste under the Resource Conservation and Recovery Act (RCRA).

Three alternatives were identified to reduce or mitigate emissions and hazardous waste generation from solvent equipment cleaning: steam cleaning, substitution of nonhazardous solvents, and solvent recovery.

### 5.3.1 Steam Cleaning

Some slabstock foam plants use steam to flush and clean hoses, mix heads, and other foam-pouring equipment. Steam eliminates emissions from the evaporation of cleaning solvents. One potential problem with this

control measure is the potential burn hazard it presents for workers using the steam system. In addition, generating the steam increases energy requirements. Residual water could be a problem because it is an integral part of foam chemistry and could cause major and dramatic effects.

The cost of steam cleaning depends on the source of steam. In many cases, other operations at the plant may supply a ready source of low pressure steam. Alternatively, gas-fire mobile steam generators can be used. The initial cost of these units has been estimated at \$3,000 to \$5,000 (1).

### **5.3.2 Solvent Substitution**

Substituting a nonhazardous solvent can also mitigate releases of methylene chloride and other HAPs from equipment cleaning. Several nonhazardous cleaning solvents can be used for foam equipment and are based on d-limonene, cyclic amide, ethyl ester, glutarate ester, and other esters. While they eliminate HAP emissions, these solvent substitutes still contain VOCs. They have lower evaporation rates than methylene chloride, however, and they can be reclaimed and reused.

In general, the alternative solvents are more expensive than methylene chloride. In drum quantities, methylene chloride costs about \$3.20 per gallon, while costs for nonhazardous solvents range from \$6 to \$25 per gallon (1). The nonhazardous solvents, however, can be reused up to three times (1). Higher purchase costs are also partially balanced by a savings in disposal costs, because the spent solvent materials can be treated as simple solid wastes rather than hazardous wastes.

Vendors of nonhazardous urethane solvents include Dynaloy of Hanover, New Jersey (Dynaflush); Huron Tech-

nologies of Ann Arbor, Michigan; Urethane Technologies of Santa Ana, California; Florida Chemical of Lake Alfred, Florida; and ISP of Wayne, New Jersey (Foam Flush).

### **5.3.3 Solvent Recovery**

Another method of reducing both the emissions and the wastes that solvent cleaning operations produce is to collect and reclaim used solvents. The reclaiming operation typically involves distillation of the spent solvent. Solvent vapors are condensed and reused, and still bottoms can either be landfilled or incinerated. The reclaiming operation can be performed on site, or many companies contract to collect drums of spent solvent, distill the contents, and return reclaimed solvent to the client company.

The capital cost of a batch still to recover solvents at a foam plant has been estimated at about \$9,000 (4). Once purchased, the unit is expected to produce a cost savings (taking into account capital recovery costs) by reducing fresh solvent and waste disposal costs (4).

## **5.4 References**

1. U.S. EPA., 1995. Flexible polyurethane foam: Emission reduction technologies cost analysis. EPA/453/D-95/004. Research Triangle Park, NC (May).
2. Mid-West Industrial Chemical Co. 1993. 13-124-4 latex adhesive: Material safety data sheet. St. Louis, MO.
3. H.B. Fuller Co. 1994. Technical data sheet: Product N. WC-0686-A-770, two component water-based adhesive. St. Paul, MN.
4. SRRP. 1992. Source reduction and recycling of halogenated solvents in the flexible foam industry. Report on research performed by the Source Reduction Research Partnership for the Metropolitan Water District of Southern California and the Environmental Defense Fund (EDF).

---

***Appendix A***  
***Pollution Prevention Worksheets for Polyurethane Foam Manufacturing***

Firm _____	<b>Pollution Prevention Assessment</b>	Prepared by _____
Site _____		Checked by _____
Date _____	Proj. No. _____	Sheet ____ of ____ Page ____ of ____

WORKSHEET  
**1**

**POLLUTION PREVENTION  
Blowing Agent -  
Emission Factor Calculation**

**STEP 1: CALCULATION OF TOTAL WEIGHT PER HUNDRED PARTS POLYOL**

Ingredient	Amount used (pphp)		Product weight factor	=	Product weight contribution
Polyol	100	X	1	=	100
Isocyanate		X	1	=	
Water		X	-1.44	=	
Auxiliary blowing agent		X	0	=	0
Cross-linking agents, chain modifiers, and other additives		X	1	=	
		X	1	=	
		X	1	=	
		X	1	=	
Catalysts and surfactants		X	1	=	
		X	1	=	
		X	1	=	
Others		X	1	=	
		X	1	=	
		X	1	=	
<b>TOTAL WEIGHT PER 100 PARTS POLYOL</b>				<b>=</b>	

**STEP 2: CALCULATION OF EMISSION FACTORS**

Auxiliary blowing agent (pphp)	+	Total weight per 100 parts polyol	X	2,000 <b>lb/ton</b>	=	Pounds of ABA emitted per ton of foam
	+		X	2,000	=	
Auxiliary blowing agent (pphp)	+	Total weight per 100 parts polyol	X	Density (lb/ft <sup>3</sup> )	=	Pounds of ABA emitted per cubic foot
	+		X		=	

pphp = parts per hundred parts polyol

Firm _____	Pollution Prevention Assessment	Prepared by _____
Site _____		Checked by _____
Date _____	Proj. No. _____	Sheet ____ of ____ Page ____ of ____

**WORKSHEET  
2**

**POLLUTION PREVENTION  
Blowing Agent -  
Worksheet for Calculating  
Formulation Costs for Pollution  
Prevention Options**

CURRENT FORMULATION				ALTERNATE FORMULATION			
Ingredient	Amount used (pphp)	cost (\$/lb)	Ingredient cost (WOO lb polyol)	Ingredient	Amount used (pphp)	cost (\$/lb)	Ingredient cost (\$/100 lb polyol)
Polyol	100x	=		Polyol	100x	=	
Isocyanate		x	=	Isocyanate		x	=
Water		x	=	Water		X	=
ABA		x	=	ABA		X	=
Others		x	=	Others		X	=
		x	=			x	=
		x	=			x	=
		x	=			x	=
		x	=			x	=
TOTALS			cost	TOTALS			Cost total
	Ingre- dients total				Ingre- dients total		
Total ingredients - ABA - Water x Con- = Foam (pphp) (pphp) (pphp) stant (pphp)				Total ingredients - ABA - Water x Con- = Foam (pphp) (pphp) (pphp) stant (pphp)			
$\underline{\hspace{2cm}} - \{ \hspace{1cm} x \hspace{1cm} \} = \underline{\hspace{2cm}}$				$\underline{\hspace{2cm}} - \{ \hspace{1cm} x \hspace{1cm} \} = \underline{\hspace{2cm}}$			
cost (\$/100 lb polyol) + Foam produced (pphp) + Density (lb/ft <sup>3</sup> ) = cost (\$/ft <sup>3</sup> )				cost (\$/100 lb polyol) + Foam produced (pphp) + Density (lb/ft <sup>3</sup> ) = cost (\$/ft <sup>3</sup> )			
$\div \hspace{2cm} + \hspace{2cm} =$				$\div \hspace{2cm} + \hspace{2cm} =$			

pphp = parts per hundred parts polyol

Firm _____	Pollution Prevention Assessment	Prepared by _____
Site _____		Checked by _____
Date _____	Proj. No. _____	Sheet ____ of ____ Page ____ of ____

WORKSHEET  
**3a**

**OPTION GENERATION  
Slabstock Production**

Meeting Format \_\_\_\_\_

Meeting Coordinator \_\_\_\_\_

Meeting Participants \_\_\_\_\_

Suggested Pollution Prevention Option	Currently Done Y/N?	Rationale/Remarks on Option
<b>Auxiliary Blowing Agents</b>		
Formulation changes to reduce ABAs		
Foam softeners to reduce water foam effects		
Mechanical cooling technology		
Liquid CO <sub>2</sub> blowing		
Reduced pressure foaming		
Add-on controls		
Alternative nonhazardous ABAs		
<b>Adhesives</b>		
Hot melt adhesives		
Water-based adhesives		
Hydrofuse		
Equipment Cleaning		
Steam cleaning		
Nonhazardous solvent substitution		
Solvent recovery		

Firm \_\_\_\_\_

Pollution Prevention Assessment

Prepared By \_\_\_\_\_

Site \_\_\_\_\_

Checked By \_\_\_\_\_

Date \_\_\_\_\_

Proj. No. \_\_\_\_\_

Sheet \_\_\_\_ of Page \_\_\_\_ of \_\_\_\_

WORKSHEET

**3b**

**OPTION GENERATION  
Molded Foam Production**

Meeting Format \_\_\_\_\_

Meeting Coordinator \_\_\_\_\_

Meeting Participants \_\_\_\_\_

Suggested Pollution Prevention Option	Currently Done Y/N?	Rationale/Remarks on Option
<b>Mix Head Flushing</b>		
High-pressure mix head		
Self-cleaning mix head		
Nonhazardous flushing agents		
Reduced pressure foaming		
Solvent recovery		
<b>Mold Release Agents</b>		
Water-based agents		
Electrostatic spray guns		
Reduced VOC agents		
Nonhazardous agents		
<b>CFC ABAs</b>		
Water blowing		
Hydrofluorocarbons		
Pentane		
Adhesives		
Hot melt adhesives		
Water-based adhesives		
Hydrofuse		
Equipment Cleaning		
Steam cleaning		
Nonhazardous solvent substitution		
Solvent recovery		



---

## **Appendix B**

### **Further Information**

#### **Trade Associations**

Polyurethane Foam Association  
P.O. Box 1459  
Wayne, NJ 07474-1459  
(201) 633-9044

The Society of the Plastics Industries  
Polyurethane Division  
355 Lexington Avenue  
New York, NY 10017  
(212) 351-5425

#### **Publications**

##### **Slabstock Foam**

CEC. 1991. Flexible polyurethane foam manufacture—An assessment of emission control options. Washington, DC: Center for Emissions Control.

U.S. EPA/PFA. 1991. Handbook for reducing and eliminating chlorofluorocarbons in flexible polyurethane foams, **21A-4002**. A joint project of the U.S. Environmental Protection Agency and the Polyurethane Foam Association, Washington, DC.

Herrington, R., and K. Hock, eds. 1991. Flexible polyurethane foams. Midland, MI: The Dow Chemical Company.

Polyurethane industry directory and buyer's guide. 1994. **Saco**, ME: Larson Publishing.

PFA. 1993. Flexible polyurethane foam (slabstock)—Assessment of manufacturing emission issues and control technology. Wayne, NJ: Polyurethane Foam Association.

PFA. 1992, 1993, 1994. Proceedings of the Technical Program. Wayne, NJ: Polyurethane Foam Association. May and October.

SPI. Annual. Proceedings of the SPI Polyurethanes World Conference. The Society of the Plastics Industries, Polyurethanes Division.

SRRP, 1992. Source reduction and recycling of halogenated solvents in the flexible foam industry. A report on research performed by the Source Reduction Research Partnership for the Metropolitan Water District of Southern California and the Environmental Defense Fund (EDF).

Urethanes Technology (journal). Akron, OH: Crain Communications, Ltd. (216) 836-9180.

Woods, G. 1987. The ICI polyurethanes book. New York, NY: ICI Polyurethanes and John Wiley & Sons.

#### **Pollution Prevention-General**

U.S. EPA. 1993. A primer for financial analysis of pollution prevention projects. EPA/600/R-93/059.\*

#### **Adhesives**

Source Reduction Research Partnership (SRRP). Source reduction and recycling of halogenated solvents in the adhesives industry-Technical support document.

#### **Equipment Cleaning**

U.S. EPA. 1993. Alternatives to chlorinated solvents for cleaning and degreasing. EPA/625/R-93/016.\*

U.S. EPA. 1993. Cleaning and degreasing process changes. EPA/625/R-93/017.\*

Source Reduction Research Partnership (SRRP). Source reduction and recycling of halogenated solvents in parts cleaning-Technical support document.

#### **Add-On Controls**

U.S. EPA. 1991. Control technologies for hazardous air pollutants. EPA/625/6-91/014.\*

#### **On-Line and Off-Line Computer-Based Technical Assistance**

Reluctance to switch over to a new cleaning technology may stem from concern over cleaning performance, as well as from uncertainty in choosing an alternative from the large number of cleaning technologies and products now available. Users may be intimidated by the list of options and wonder how to begin selecting an alternative. Although trade journals provide technical literature

---

\* Available from the EPA Office of Research and Development Publications, National Risk Management Research Laboratory, Center for Environmental Research Information, 26 W. Martin Luther King Dr., Cincinnati, OH 45268; (513) 569-7562.

---

on alternative cleaning technologies, the subject may not be presented in a systematic form that facilitates making detailed comparisons among all the different attributes. To assist in making knowledgeable decisions, several online and offline computer databases are available that provide information searching in various ways.

## **ATTIC**

The ATTIC network is maintained by the Technical Support Branch of EPA's Risk Reduction Engineering Laboratory (RREL). This network has four online databases that can be searched by external users.

- The ATTIC database contains abstracts and bibliographic citations to technical reports, bulletins, and other publications produced by EPA, other federal and state agencies, and industry dealing with technologies for treatment of hazardous wastes. Performance and cost data, quality assurance information, and a contact name and phone number are given for the technologies.
- The Risk Reduction Engineering Laboratory (RREL) Treatability Database provides information about contaminants physicochemical properties, environmental data, treatment technologies, contaminant concentration, media or matrix, performance, and quality assurance.
- The Technical Assistance Directory lists experts from government, universities, and consulting firms who can provide guidance on technical issues or policy questions.
- A Calendar of Events list provides information on conferences, seminars, and workshops on treatment of hazardous wastes. International as well as U.S. events are covered.

There is no charge for the ATTIC service. It is available via modem over standard telephone lines. The phone number for the ATTIC modem contact is (301) 670-3808 (300-2400 baud), and the modem settings are no parity, 8 data bits, 1 stop bit, and full duplex. The user's manual also is available from EPA.

## **PIES**

PIES is a bulletin board system that links to several databases and provides massaging capabilities and forums on various topics related to pollution prevention. Through its link to the United Nation's International Cleaner Production Information Clearinghouse, it provides a communication link with international users. PIES is part of the Pollution Prevention Information Center (PPIC), which is supported by EPA's Office of Environmental Engineering and Technology

Demonstration and Office of Pollution Prevention and Toxics. PIES contains information about the following topics:

- Current events and recent publications relating to pollution prevention
- Summaries of federal, state, and corporate pollution prevention programs
- Case studies and general publications.

Searches can be performed by keywords related to specific contaminants, pollution prevention technologies, or industries. The phone number for dial-up access is (703) 506-1025; qualified state and local officials can obtain a toll-free number by calling the PPIC at (703) 821-4800. Modem settings are 2400 baud, no parity, 8 data bits, 1 stop bit, and full duplex.

## **SAGE**

SAGE has a question-and-answer format that lets the user input basic cleaning parameters about the parts to be cleaned and about the desired process outcome.\* The user-provided information is then applied, internally, to the SAGE database, which derives recommendations for chemical and process alternatives. Based on the information given, the alternatives are assigned a relative score that allows them to be compared. A brief summary of each recommendation can be presented on the screen. Other information, such as a representative MSDS and case studies, also is included.

SAGE is available through the Control Technology Center (CTC) of the EPA Air and Energy Engineering Research Laboratory (AEERL). A system operator at the CTC can be reached by calling (919) 541-0800. The SAGE software can be transferred on an electronic bulletin board system in a file named **SAGE.ZIP**. The bulletin board can be reached at (919) 541-5742 (9600 baud, no parity, 8 data bits, 1 stop bit).

## **Solvent Utilization Handbook**

The U.S. Department of Energy (DOE) has supported a solvent alternative utilization study through the Idaho National Engineering Laboratory. As a result, a program was established to develop an online electronic Solvent Utilization Handbook. The handbook helps users accomplish the following tasks:

- Identify solvents that are not restricted for use at DOE Defense Programs, U.S. Department of Defense (DoD) facilities, and private business.

---

\*Monroe, K.R., and E.A. Hill. 1993. SAGE (Solvent Alternatives Guide): Computer assisted guidance for solvent replacement. In: Proceedings of the 1993 International CFC and Halon Alternatives Conference. Washington, DC: Alliance for Responsible CFC Policy. pp. 431-439.

- Evaluate their cleaning performance needs.
- Identify potential problems, such as corrosivity, flammability (flash point), and hazardous material content (OSHA and NIOSH exposure limits).
- Evaluate potential concerns for air emissions.
- Decide whether solvent recovery and recycling are feasible.
- Determine whether the solvents are biodegradable.

The information provided in this database is based on results of actual experiments that included 16 different contaminants on 26 metal alloys. The database is accessible through Internet or by using a telephone modem. Further information can be obtained from the Idaho National Engineering Laboratory by calling (208) 526-7834.

### **Solvent Database**

The National Center for Manufacturing Sciences (NCMS) is developing an electronic Solvent Database that provides information on environmental fate, health and safety data, regulatory status, chemical and physical properties, and product suppliers. The database includes more than 320 pure solvents and trade name mixtures. A relational search capability enables users to identify potential alternative solvents by specifying search criteria. For example, solvent alternatives can be selected by minimum flash point or by a particular regulatory issue. Product performance data are not included in the current version.

The NCMS Solvent Database will be a stand-alone application that runs on the DOS platform. It will be distributed on floppy disks. The cost of the software has not been released. For further information contact Mike Wixom, Project Manager, Environmentally Conscious Manufacturing, NCMS; telephone (313) 9954910.

### **Waste Reduction Technical/Financial/Assistance Programs**

The EPA Pollution Prevention Information Clearinghouse (PPIC) was established to help reduce industrial pollutants through technology transfer, education, and public awareness. PPIC collects and disseminates technical and other information on pollution prevention through a telephone hotline and an electronic information exchange network. Indexed bibliographies and abstracts of reports, publications, and case studies about pollution prevention are available. PPIC also lists a calendar of pertinent conferences and seminars; information about activities abroad and a directory of waste exchanges. Its Pollution Prevention Information Exchange System (PIES) can be accessed electronically 24 hours a day without fees.

For more information, contact:

PIES Technical Assistance  
Science Applications International Corp.  
8400 Westpark Drive  
McLean, VA 22102  
(703) 821-4800

or

U.S. Environmental Protection Agency  
401 M Street SW.  
Washington, DC 20460

Myles E. Morse  
Office of Environmental Engineering and  
Technology Demonstration  
(202) 475-7161

Priscilla Flattery  
Pollution Prevention Office  
(202) 245-3557

The EPA's Office of Solid Waste and Emergency Response has a telephone call-in service to answer questions regarding RCRA and Super-fund (CERCLA). The telephone numbers are:

(800) 424-9346 (outside the District of Columbia)

(202) 382-3000 (in the District of Columbia)

### **State Pollution Prevention Programs**

The following state programs offer technical and/or financial assistance for waste minimization and treatment.

#### **Alabama**

Hazardous Material Management and Resources  
Recovery Program  
University of Alabama  
P.O. Box 6373  
Tuscaloosa, AL 35487-6373  
(205) 348-8401

#### **Alaska**

Alaska Health Project  
Waste Reduction Assistance Program  
431 West Seventh Avenue, Suite 101  
Anchorage, AK 99501  
(907) 276-2864

#### **Arkansas**

Arkansas Industrial Development Commission  
One State Capitol Mall  
Little Rock, AR 72201  
(501) 371-1370

---

**California**

Alternative Technology Division  
Toxic Substances Control Program  
California State Department of Health Services  
714-744 P Street  
Sacramento, CA 94234-7320  
(916) 324-1807

**Connecticut**

Connecticut Hazardous Waste Management Service  
Suite 360  
900 Asylum Avenue  
Hartford, CT 06105  
(203) 244-2007

**Florida**

Waste Reduction Assistance Program  
Florida Department of Environmental Regulation  
2600 Blair Stone Road  
Tallahassee, FL 32399-2400  
(904) 488-0300

**Georgia**

Hazardous Waste Technical Assistance Program  
Georgia Institute of Technology  
Georgia Technical Research Institute  
Environmental Health and Safety Division  
O'Keefe Building, Room 027  
Atlanta, GA 30332  
(404) 894-3806

Environmental Protection Division  
Georgia Department of Natural Resources  
Floyd Towers East, Suite 1154  
205 Butter Street  
Atlanta, GA 30334  
(404) 656-2833

**Guam**

Solid and Hazardous Waste Management Program  
Guam Environmental Protection Agency  
ITCE E. Harmon Plaza, Complex Unit D-107  
130 Rojas Street  
Harmon, Guam 96911  
(671) 646-8863

**Illinois**

Hazardous Waste Research and Information Center  
Illinois Department of Energy and Natural Resources  
1 East Hazelwood Drive  
Champaign, IL 61820  
(217) 333-8940

Illinois Waste Elimination Research Center  
Pritzker Department of Environmental Engineering  
Alumni Building, Room 102  
Illinois Institute of Technology  
3200 South Federal Street  
Chicago, IL 60616  
(313) 567-3535

**Indiana**

Environmental Management and Education Program  
Young Graduate House, Room 120  
Purdue University  
West Lafayette, IN 47907  
(317) 494-5036

Indiana Department of Environmental Management  
Office of Technical Assistance  
P.O. Box 6015  
105 South Meridian Street  
Indianapolis, IN 46206-6015  
(317) 232-8172

**Iowa**

Center for Industrial Research and Service  
205 Engineering Annex  
Iowa State University  
Ames, IA 50011  
(515) 294-3420

Iowa Department of Natural Resources  
Air Quality and Solid Waste Protection Bureau  
Wallace State Office Building  
900 East Grand Avenue  
Des Moines, IA 50319-0034  
(515) 281-8690

**Kansas**

Bureau of Waste Management  
Department of Health and Environment  
Forbesfield, Building 730  
Topeka, KS 66620  
(913) 269-1 607

---

## ***Kentucky***

Division of Waste Management  
Natural Resources and Environmental Protection Cabinet  
18 Reilly Road  
Frankfort, KY 40601  
(502) 564-6716

## ***Louisiana***

Department of Environmental Quality  
Office of Solid and Hazardous Waste  
P.O. Box 44307  
Baton Rouge, LA 70804  
(504) 342-1354

## ***Maryland***

Maryland Hazardous Waste Facilities Siting Board  
60 West Street, Suite 200 A  
Annapolis, MD 21401  
(301) 974-3432

Maryland Environmental Service  
2020 Industrial Drive  
Annapolis, MD 21401  
(301) 269-3291  
(800) 492-9188 (in Maryland)

## ***Massachusetts***

Office of Technical Assistance  
Executive Office of Environmental Affairs  
100 Cambridge Street, Room 1094  
Boston, MA 02202  
(617) 727-3260

Source Reduction Program  
Massachusetts Department of Environmental  
Protection  
1 Winter Street  
Boston, MA 02108  
(617) 292-5982

## ***Michigan***

Resource Recovery Section  
Department of Natural Resources  
P.O. Box 30028  
Lansing, MI 48909  
(517) 373-0540

## ***Minnesota***

Minnesota Pollution Control Agency  
Solid and Hazardous Waste Division  
520 Lafayette Road  
St. Paul, MN 55155  
(612) 296-6300

Minnesota Technical Assistance Program  
1313 5th Street SE., Suite 207  
Minneapolis, MN 55414  
(612) 627-4555  
(800) 247-0015 (Minnesota)

## ***Missouri***

State Environmental Improvement and Energy  
Resources Agency  
P.O. Box 744  
Jefferson City, MO 65102  
(314) 751-4919

## ***New Hampshire***

New Hampshire Department of Environmental  
Sciences  
Waste Management Division  
6 Hazen Drive  
Concord, NH 03301-6509  
(603) 271-2901

## ***New Jersey***

New Jersey Hazardous Waste Facilities  
Siting Commission  
Room 614  
28 West State Street  
Trenton, NJ 08608  
(609) 292-1459  
(609) 292-1026

Hazardous Waste Advisement Program  
Bureau of Regulation and Classification  
New Jersey Department of Environmental Protection  
401 East State Street  
Trenton, NJ 08625  
(609) 292-8341

Risk Reduction Unit  
Office of Science and Research  
New Jersey Department of Environmental Protection  
401 East State Street  
Trenton, NJ 08625  
(609) 984-6070

---

**New York**

New York State Environmental Facilities Corporation  
50 Wolf Road  
Albany, NY 12205  
(518) 457-3273

**North Carolina**

Pollution Prevention Pays Program  
Department of Natural Resources and  
Community Development  
P.O. Box 27687  
512 North Salisbury Street  
Raleigh, NC 27611  
(919) 733-7015

Governor's Waste Management Board  
325 North Salisbury Street  
Raleigh, NC 27611  
(919) 733-9020

Technical Assistance Unit  
Solid and Hazardous Waste Management Branch  
North Carolina Department of Human Resources  
P.O. Box 2091  
306 North Wilmington S.  
Raleigh, NC 27602  
(919) 733-2178

**Ohio**

Division of Solid and Hazardous Waste Management  
Ohio Environmental Protection Agency  
P.O. Box 1049  
1800 WaterMark Drive  
Columbus, OH 43266-I 049  
(614) 481-7200

Ohio Technology Transfer Organization  
Suite 200  
65 East State Street  
Columbus, OH 43266-0330  
(614) 466-4286

**Oklahoma**

Industrial Waste Elimination Program  
Oklahoma State Department of Health  
P.O. Box 53551  
Oklahoma City, OK 73152  
(405) 271-7353

**Oregon**

Oregon Hazardous Waste Reduction Program  
Department of Environmental Quality  
811 Southwest Sixth Avenue  
Portland, OR 97204  
(503) 229-5913

**Pennsylvania**

Pennsylvania Technical Assistance Program  
501 F. Orvis Keller Building  
University Park, PA 16802  
(814) 865-0427

Center of Hazardous Material Research  
320 William Pitt Way  
Pittsburgh, PA 15238  
(412) 826-5320

Bureau of Waste Management  
Pennsylvania Department of Environmental Resources  
P.O. Box 2063  
Fulton Building  
3rd and Locust Streets  
Harrisburg, PA 17120  
(717) 787-6239

**Rhode Island**

Office of Environmental Coordination  
Department of Environmental Management  
83 Park Street  
Providence, RI 02903  
(401) 277-3434  
(800) 253-2674 (in Rhode Island only)

Ocean State Cleanup and Recycling Program  
Rhode Island Department of Environmental  
Management  
9 Hayes Street  
Providence, RI 02908-5003  
(401) 277-3434  
(800) 253-2674 (in Rhode Island)

Center for Environmental Studies  
Brown University  
P.O. Box 1943  
135 Angell Street  
Providence, RI 02912  
(401) 863-3449

---

## **Tennessee**

Center for Industrial Services  
102 Alumni Hall  
University of Tennessee  
Knoxville, TN 37996  
(615) 974-2456

## **Virginia**

Office of Policy and Planning  
Virginia Department of Waste Management  
11th Floor, Monroe Building  
101 North 14th Street  
Richmond, VA 23219  
(804) 225-2667

## **Washington**

Hazardous Waste Section  
Mail Stop PV-11  
Washington Department of Ecology  
Olympia, WA 98504.8711  
(206) 459-6322

## **Wisconsin**

Bureau of Solid Waste Management  
Wisconsin Department of Natural Resources  
P.O. BOA-7921  
101 South Webster Street  
Madison, WI 53707  
(608) 267-3763

## **Wyoming**

Solid Waste Management Program  
Wyoming Department of Environmental Quality  
Hechler Building, 4th Floor, West Wing  
122 West 25th Street  
Cheyenne, WY 82002

## **Waste Exchanges**

Alberta Waste Materials Exchange  
Mr. William C. Kay  
Alberta Research Council  
P.O. BOA-8330  
Postal Station F  
Edmonton, Alberta  
CANADA T6H 5X2  
(403) 450-5408

British Columbia Waste Exchange  
Ms. Judy Toth  
2150 Maple Street  
Vancouver, BC  
CANADA V6J 3T3  
(604) 731-7222

California Waste Exchange  
Mr. Robert McCormick  
Department of Health Services  
Toxic Substances Control Program  
Alternative Technology Division  
P.O. BOA-942732  
Sacramento, CA 94234-7320  
(916) 324-1807

Canadian Chemical Exchange  
Mr. Philippe LaRoche  
P.O. BOA-I 135  
Ste-Adele, Quebec  
CANADA JOR ILO  
(514) 229-6511

Canadian Waste Materials Exchange  
ORTECH International  
Dr. Robert Laughlin  
2395 Speakman Drive  
Mississauga, Ontario  
CANADA LSK IB3  
(416) 822-4111, Ext. 265  
FAX: (416) 823-1446

Enstar Corporation  
Mr. J.T. Engster  
P.O. Box 189  
Latham, NY 12110  
(518) 785-0470

Great Lakes Regional Waste Exchange  
400 Ann Street, NW., Suite 201A  
Grand Rapids, MI 49505  
(616) 363-3262

Indiana Waste Exchange  
Dr. Lynn A. Corson  
Purdue University School of Civil Engineering  
Civil Engineering Building  
West Lafayette, IN 47907  
(317) 494-5036

Industrial Materials Exchange  
Mr. Jerry Henderson  
172 20th Avenue  
Seattle, WA 98122  
(206) 296-4633  
FAX: (206) 296-0188

Industrial Materials Exchange Service  
Ms. Diane Shockey  
P.O. Box 19276  
Springfield, IL 62794-9276  
(217) 782-0450  
FAX: (217) 524-4193

---

Industrial Waste Information Exchange  
Mr. William E. Payne  
New Jersey Chamber of Commerce  
S Commerce Street  
Newark, NJ 07102  
(201) 623-7070

Manitoba Waste Exchange  
Mr. James Ferguson  
c/o Biomass Energy Institute, Inc.  
1329 Niakwa Road  
Winnipeg, Manitoba  
CANADA R2J 3T4  
(204) 257-3891

Montana Industrial Waste Exchange  
Mr. Don Ingles  
Montana Chamber of Commerce  
P.O. Box 1730  
Helena, MT 59624  
(406) 442-2405

New Hampshire Waste Exchange  
Mr. Gary J. Olson  
c/o NHRRA  
P.O. Box 721  
Concord, NH 03301  
(603) 224-6996

Northeast Industrial Waste Exchange, Inc.  
Mr. Lewis Cutler  
90 Presidential Plaza, Suite 122  
Syracuse, NY 13202  
(315) 422-6572  
FAX: (315) 422-9051

Ontario Waste Exchange  
ORTECH International  
Ms. Linda Varangu  
2395 Speakman Drive  
Mississauga, Ontario  
CANADA LSK 1B3  
(416) 822-4111, Ext. 512  
FAX: (416) 823-1446

Pacific Materials Exchange  
Mr. Bob Smee  
South 3707 Godfrey Boulevard  
Spokane, WA 99204  
(509) 623-4244

Peel Regional Waste Exchange  
Mr. Glen Milbury  
Regional Municipality of Peel  
10 Peel Center Drive  
Brampton, Ontario  
CANADA L6T 4B9  
(416) 791-9400

RENEW  
Ms. Hope Castillo  
Texas Water Commission  
P.O. Box 13087  
Austin, TX 78711-3087  
(512) 463-7773  
FAX: (512) 463-8317

San Francisco Waste Exchange  
Ms. Portia Sinnott  
2524 Benvenue #35  
Berkeley, CA 94704  
(415) 548-6659

Southeast Waste Exchange  
Ms. Marie L. May  
Urban Institute  
UNCC Station  
Charlotte, NC 28223  
(704) 547-2307

Southern Waste Information Exchange  
Mr. Eugene B. Jones  
P.O. Box 960  
Tallahassee, FL 32302  
(800) 441-SWIX (7949)  
(904) 644-5516  
FAX: (904) 574-6704

Tennessee Waste Exchange  
Ms. Patti Christian  
226 Capital Boulevard, Suite 800  
Nashville, TN 37202  
(615) 256-5141  
FAX: (615) 256-6726

Wastelink, Division of Tencon, Inc.  
Ms. Mary E. Malotke  
140 Wooster Pike  
Milford, OH 45150  
(513) 248-0012  
FAX: (513) 248-1094

### **EPA Regional Offices**

Region 1 (VT, NH, ME, MA, CT, RI)  
John F. Kennedy Federal Building  
Boston, MA 02203  
(617) 565-3715

Region 2 (NY, NJ)  
26 Federal Plaza  
New York, NY 10278  
(212) 264-2525

Region 3 (PA, DE, MD, WV, VA)  
841 Chestnut Street  
Philadelphia, PA 19107  
(215) 597-9800



---

Region 4 (KY, IN, NC, SC, GA, FL, AL, MS)  
345 Courtland Street, NE  
Atlanta, GA 30365  
404) 347-4727

Region 5 (WI, MN, MI, IL, IN, OH)  
230 South Dearborn Street  
Chicago, IL 60604  
(312) 353-2000

Region 6 (NM, OK, AR, LA, TX)  
1445 Ross Avenue  
Dallas, TX 75202  
(214) 655-6444

Region 7 (NE, KS, MO, IA)  
756 Minnesota Avenue  
Kansas City, KS 66101  
(913) 236-2800

Region 8 (MT, ND, SD, WY, UT, CO)  
999 18th Street  
Denver, CO 80202-2405  
(303) 293-1 603

Region 9 (CA, NV, AZ, HI)  
75 Hawthorne Street  
San Francisco, CA 94105  
(415) 744-1 305

Region 10 (AK, WA, OR)  
1200 Sixth Avenue  
Seattle, WA 98101  
(206) 442-5810

U.S. Government Printing Office: 1997 - 549-001/60123

United States  
Environmental Protection Agency  
Center for Environmental Research Information  
Cincinnati, OH 45268

Please make all necessary changes on the below label,  
detach or copy, and return to the address in the upper  
left-hand corner.

If you do not wish to receive these reports CHECK HERE ;  
detach, or copy this cover, and return to the address in the  
upper left-hand corner.

BULK RATE  
POSTAGE & FEES PAID  
EPA  
PERMIT No. G-35

Official Business  
Penalty for Private Use  
\$300

EPA/625/R-96/005