

# Submerged Cultural Resources Site Report

CHARLES H. SPENCER  
MINING OPERATION AND  
PADDLE WHEEL STEAMBOAT

GLEN CANYON NATIONAL RECREATION AREA

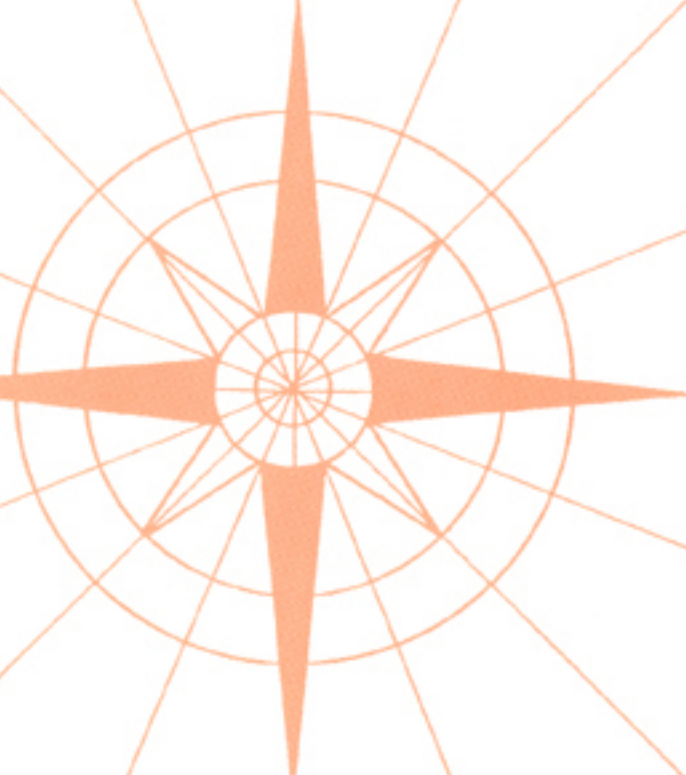

TONI CARREL, EDITOR  
SUBMERGED CULTURAL RESOURCES UNIT  
NATIONAL PARK SERVICE

GLEN CANYON NATIONAL RECREATION AREA





**SUBMERGED CULTURAL RESOURCES SITE REPORT:**

**CHARLES H. SPENCER'S MINING OPERATION  
AND  
PADDLE WHEEL STEAMBOAT**

Glen Canyon National Recreation Area

by

Toni Carrell, Editor  
Submerged Cultural Resources Unit

James E. Bradford  
Branch of Cultural Resources Management

W. L. Rusho  
Bureau of Reclamation

Illustrations by Ernesto Martinez and Jim Koza

Southwest Cultural Resources Center Professional Papers  
Number 13

Santa Fe, New Mexico  
1987

Submerged Cultural Resources Unit  
Southwest Cultural Resources Center  
Southwest Region  
National Park Service  
U.S. Department of the Interior

**PUBLISHED REPORTS  
OF THE  
SOUTHWEST CULTURAL RESOURCES CENTER**

1. Larry Murphy, James Baker, David Buller, James Delgado, Roger Kelly, Daniel Lenihan, David McCulloch, David Pugh; Diana Skiles; Brigid Sullivan. Submerged Cultural Resources Survey: Portions of Point Reyes National Seashore and Point Reyes-Farallon Islands National Marine Sanctuary. Submerged Cultural Resources Unit, 1984.
2. Toni Carrell. Submerged Cultural Resources Inventory: Portions of Point Reyes National Seashore and Point Reyes-Farallon Islands National Marine Sanctuary. Submerged Cultural Resources Unit, 1984
3. Edwin C. Bearss. Resource Study: Lyndon B. Johnson and the Hill Country, 1937-1963. Division of Conservation, 1984.
4. Edwin C. Bearss. Historic Structures Report: Texas White House. Division of Conservation, 1986.
5. Barbara Holmes. Historic Resource Study of the Barataria Unit of Jean Lafitte National Historical Park. Division of History, 1986.
6. Steven M. Burke and Marlys Bush Thurber. Southwest Region Headquarters Building, Santa Fe, New Mexico: A Historic Structure Report. Division of Conservation, 1985.
7. Toni Carrell. Submerged Cultural Resources Site Report: NOQUEBAY, Apostle Islands National Lakeshore. Submerged Cultural Resources Unit, 1985.
8. Daniel J. Lenihan, Toni Carrell, Thom Holden, C. Patrick Labadie, Larry Murphy, Ken Vrana. Submerged Cultural Resources Study: Isle Royale National Park. Submerged Cultural Resources Unit, 1987.
9. J. Richard Ambler. Archeological Assessment: Navajo National Monument. Division of Anthropology, 1985.
10. John S. Speaker, Joanna Chase, Carol Poplin, Herschel Franks, R. Christopher Goodwin. Archeological Assessment: Barataria Unit, Jean Lafitte National Historical Park. Division of Anthropology, 1986.
11. James E. Ivey, Marlys Bush-Thurber, James T. Escobedo, Jr., Tom Ireland. The Missions of San Antonio: A Historic Structures Report and Administrative History. Divisions of Conservation and History, 1987.

12. Roger E. Coleman. The Arkansas Post Story. Division of History, 1987.
13. Toni Carrell, James E. Bradford, W. L. Rusho. Submerged Cultural Resources Site Report: Charles H. Spencer Mining Operation and Paddle Wheel Steamboat, Glen Canyon National Recreation Area. Submerged Cultural Resources Unit, 1987.

## **SUBMERGED CULTURAL RESOURCES UNIT REPORT AND PUBLICATION SERIES**

The Submerged Cultural Resources Unit was established in 1980 to conduct research on submerged cultural resources throughout the National Park System with an emphasis on historic shipwrecks. One of the unit's primary responsibilities is to disseminate the results of research to National Park Service managers, as well as the professional community, in a form that meets resource management needs and adds to our understanding of the resource base. A report series has been initiated in order to fulfill this responsibility. The following are the categories of reports that comprise this series.

### Submerged Cultural Resources Assessment

First line document that consists of a brief literature search, an overview of the maritime history and the known or potential underwater sites in the park, and preliminary recommendations for long-term management. It is designed to have application to GMP/DCP's and to become a source document for a park's Submerged Cultural Resources Management Plan.

### Submerged Cultural Resources Survey

Comprehensive examination of blocks of park lands for the purpose of locating and identifying as much of the submerged cultural resources base as possible. A comprehensive literature search would most likely be a part of the Phase I report but, in some cases, may be postponed until Phase II.

Phase I -- Reconnaissance of target areas with remote sensing and visual survey techniques to establish location of any archeological sites or anomalous features that may suggest the presence of archeological sites.

Phase II -- Evaluation of archeological sites or anomalous features derived from remote sensing instruments to confirm their nature and, if possible, their significance. This may involve exploratory removal of overburden.

### Submerged Cultural Resources Study

A document that discusses, in detail, all known underwater archeological sites in a given park. This may involve test excavations. The intended audience is managerial and professional, not the general public.



### Submerged Cultural Resources Site Report

Exhaustive documentation of one archeological site which may involve a partial or complete site excavation. The intended audience is primarily professional and incidentally managerial. Although the document may be useful to a park's interpretive specialists because of its information content, it would probably not be suitable for general distribution to park visitors.

### Submerged Cultural Resources Special Report Series

These may be in published or photocopy format. Included are special commentaries, papers on methodological or technical issues pertinent to underwater archeology, or any miscellaneous report that does not appropriately fit into one of the other categories.

Daniel J. Lenihan

## TABLE OF CONTENTS

LIST OF FIGURES	xi
LIST OF TABLES	xiii
FOREWORD	xv
ACKNOWLEDGMENTS	xvii
EXECUTIVE SUMMARY	xix
I. INTRODUCTION – Toni Carrell	1
Project Objectives	2
Research Design	2
Funding	3
Project Mandate	3
Project Dates and Participants	4
II. THE PLACE OF CHARLIE SPENCER’S MINING OPERATION IN LEE’S FERRY HISTORY – W. L. Rusho and Toni Carrell	7
III. LEE’S FERRY HISTORIC SITE BACKGROUND – James E. Bradford	15
Historical Description	16
The Spencer Mining Years, 1910–1912	16
The Post–Spencer Decade, 1912–1921	28
U.S. Geological Survey Years, 1921–1963	34
The National Park Service, 1963–Present	47
Summary	50
Prior Research	53
Administrative Status	54
IV. LEE’S FERRY HISTORIC SITE DISCUSSION – James E. Bradford	57
Site Location	57
Research Methodology	57
Site Description	58
V. THE PLACE OF THE PADDLE WHEEL STEAMBOAT CHARLES H. SPENCER IN COLORADO RIVER MARITIME HISTORY AND PADDLE WHEEL VESSEL DEVELOPMENT – Toni Carrell	67
Colorado River Navigation	67

	Upper Colorado and Green River Navigation	74
	Riverine Shipwreck Resources	79
	Vessel Context and Development	82
	Paddle Wheel Steamboats	82
	Colorado River Paddle Wheel Steamboats – The Place of CHARLES H. SPENCER	84
VI.	CHARLES H. SPENCER BACKGROUND – Toni Carrell	99
	Vessel History	99
	Historical Description	105
	Description of Loss – The Wreck Event	107
	Post-Depositional Impacts	109
	Prior Research	111
	Administrative Status	112
VII.	CHARLES H. SPENCER SITE DISCUSSION – Toni Carrell	113
	Site Location	113
	Research Methodology	113
	Site Description	115
	Site Analysis	116
	Hull	117
	Paddle Wheel Assembly	132
	Machinery	137
	Miscellaneous Wreckage Scatter	144
	Summary	147
VIII.	CONCLUSIONS AND MANAGEMENT RECOMMENDATIONS – Toni Carrell and James E. Bradford	151
	REFERENCES CITED	159
	APPENDIX A: <i>Summary of CHARLES H. SPENCER’s Attributes</i>	165

## LIST OF FIGURES

1.1	Location of Project Area	5
2.1	Charles H. Spencer in Coconino Basin, 1911	9
2.2	Paria Creek Flume, circa 1909	11
2.3	Dredging Machinery Set Up at Lee's Ferry	11
3.1	Lee's Ferry Fort in 1910	17
3.2	Spencer Mining Area in 1915	18
3.3	Spencer Mining Area in 1914	20
3.4	Remains of Cellar	20
3.5	Boiler for Lovett Pipe Dredge in 1910	24
3.6	Lovett Pipe Dredge	25
3.7	Nozzle of Pipe Dredge in Operation	25
3.8	The Amalgamator Along the River	26
3.9	New Boilers Being Installed in 1911	26
3.10	Water Pump for Hydraulic Mining	27
3.11	Hydraulic Mining of the Chinle Formation	27
3.12	Map of Lee's Ferry After the Spencer Era	29
3.13	The Post Office at Lee's Ferry	31
3.14	Plan and Elevation Drawings of the Post Office	31
3.15	Plan and Elevation Drawings of the Chicken Coop	33
3.16	Panoramic View of Lee's Ferry After the USGS Period	35
3.17	Spencer's Bunkhouse/USGS Laboratory in 1986	38
3.18	Plan and Elevation Drawings of the Bunkhouse	38
3.19	Boiler as it Appeared in the 1960s	41
3.20	Side View of the Boiler as it Appeared in 1986	41
3.21	End View of the Boiler in 1986	42
3.22	Remains of Possible Amalgamator from the 1930s	42
3.23	Map of Lees' Ferry at the End of the USGS Era	45
3.24	View of Lee's Ferry in 1963-64	48
3.25	View of the Spencer Area in 1963	48
3.26	View of the East Portion of Spencer Area in 1964	49
3.27	View of the East Portion of Spencer Area in 1986	49
3.28	Lee's Ferry Fort in 1986	51
3.29	Lee's Ferry Fort and Spencer Addition in 1986	51
3.30	Plan and Elevation Drawings of Lee's Ferry Fort	52
3.31	Paddle Wheel from Southern California Edison gas-powered boat	52
3.32	Map of Lee's Ferry National Register District	55
4.1	Map of Lee's Ferry in 1986	63
4.2	Panoramic view of Spencer Area in 1986	65
5.1	Settlements and Steamboat Landings 1810-1910	69
5.2	Paddle Wheel Steamboat SEARCHLIGHT	73
5.3	Gasoline-powered AZTEC, circa 1893	73
5.4	Gold Dredge ADVANCE	75
5.5	Stanton's HOSKANINNI on the Upper Colorado River	75
5.6	Steamboats on the Colorado River System 1850-1920	85
5.7	Comparison of Steam-powered Sternwheelers	87

5.8	Gasoline-powered Boat Construction 1850-1920	87
5.9	Steam- and Gas-powered Boats 1850-1920	90
6.1	CHARLES H. SPENCER after Launching February, 1912	102
6.2	CHARLES H. SPENCER East of Lee's Fort, Spring 1912	102
6.3	Copy of CHARLES H. SPENCER Original Plans, 1911	Pocket Insert
6.4	CHARLES H. SPENCER Abandoned on Shore, 1915	108
6.5	The Bow of CHARLES H. SPENCER in 1963	110
6.6	The Bow of CHARLES H. SPENCER in 1973	110
7.1	CHARLES H. SPENCER Site Location.	114
7.2	CHARLES H. SPENCER Under Construction, View from Bow	118
7.3	Hull Cross-Section	120
7.4	Exploded View of Main Deck Construction	121
7.5	Detail of Overhanging Guard Construction Amidships	121
7.6	CHARLES H. SPENCER Waits for Launching, Spring 1912	122
7.7	CHARLES H. SPENCER Starboard Elevation	123
7.8	CHARLES H. SPENCER Site Map	Pocket Insert
7.9	Exploded View of Typical Stern Paddle Wheel Boat	127
7.10	CHARLES H. SPENCER Under Construction, View from Stern	131
7.11	Profile and Plan Photographs of Pitman Assembly	134
7.12	Detail Drawing of Paddle Wheel Hub	136
7.13	Detail Drawing of Boiler	138
7.14	Detail Drawing of Heater	143
7.15	Photograph of Heater Intake and Exhaust	143
7.16	Detail Drawing of Hooker No. 3 Bilge Pump	145
7.17	Photograph of Boiler and Pump in situ in 1962	145
7.18	Detail Drawing of Samson Post Cap	146
7.19	Disarticulated Samson Post Cap in situ	146

## LIST OF TABLES

4.1	List of Features Documented at Lee's Ferry Historic Site	59
5.1	Possible Steamboat Remains in the Colorado and Green Rivers	79
5.2	Comparison of Selected Attributes	93

## FOREWORD

This report is number thirteen in the Southwest Cultural Resources Center Professional Papers and is the fifth report in that series generated by the Submerged Cultural Resources Unit.

Our special expertise is in extending archeological methods and techniques to underwater environments. Shipwrecks and other cultural remains found in the sea, rivers, or lakes are significant only when their greater context is understood. In this site report Toni Carrell, Jim Bradford, and Bud Rusho integrated underwater and traditional land archeology in a manner that permits the reader to understand the full story told by the archeological record at Lee's Ferry.

Also, in keeping with NPS philosophy, the research was totally non-destructive. Information came from archives and archeological documentation of visible features, not excavation. The discussion is technical and detailed when it needs to be, but the authors take care to relate their discussions of old bottles and paddle wheel hubs to the social, environmental, and human dynamics that caused them to be there. It is a fascinating story that loses nothing in the telling.

Daniel J. Lenihan  
Chief, Submerged Cultural Resources Unit  
National Park Service

## ACKNOWLEDGMENTS

No field research project is successfully accomplished without the cooperation and support of each individual associated with the effort, from initial planning through the preparation of final graphics. Dave Wegner, manager of the Bureau of Reclamation Glen Canyon Environmental Studies Office, John O. Lancaster, Superintendent of Glen Canyon National Recreation Area, Adrienne Anderson, Rocky Mountain Regional Archeologist, and Daniel J. Lenihan, chief of the Submerged Cultural Resources Unit, provided extensive administrative support to this project.

Project funding was shared by the Bureau of Reclamation Glen Canyon Environmental Studies Office, and the National Park Service Submerged Cultural Resources Unit. Glen Canyon National Recreation Area made a non-monetary contribution of services and support personnel. Without the assistance of the Park staff, this project could not have been completed. John Benjamin, Glen Canyon Downlake District Ranger, coordinated all of the logistical support for the diving. Jon Dick, River District Ranger, and David Fowler, Seasonal Ranger, provided invaluable assistance transporting our diving equipment to and from the site each day. Thanks also goes to Grand Canyon Ranger Tom Workman, who provided us with a place to work and store equipment. The Glen Canyon diving team participated in a survey to determine the presence of additional cultural remains in the river channel. Surface documentation and support of this activity was provided by Larry Weise, Chief, Division of Interpretation, and Glen Gossard, Division of Interpretation, Glen Canyon NRA.

District Ranger Jon Dick oriented us to the historic site, provided information about impacts, and cheerfully answered numerous questions about the area. Archeological documentation of Lee's Ferry historic site was undertaken by John Stein, Branch of Cultural Resources Management, Southwest Regional Office. John was assisted by Glen Canyon NRA Volunteer-In-Parks Reilly Mitchell. Jim Bradford, acting chief of the Branch of Cultural Resources Management, tackled the task of interpreting the historic site and sorting out the various recent impacts from ground disturbance. Jim authored Chapters III and IV, and was a willing sounding board for the entire project and this publication including mapping the steamboat, completing the starboard profile, and two detail drawings included in Chapter VII.

A special note of appreciation goes to Jim Koza, Division of Ranger Services, Lake Mead National Recreation Area. Jim pieced together all of our field data from the paddle wheel steamboat to produce the site base map. Jim also carefully documented the vessel's boiler and produced the exploded construction detail drawings included in Chapter VII. The support of the Western Regional Director Howard Chapman, and the willingness of the Superintendent and the Assistant Chief Ranger, Lake Mead NRA, to loan Jim to us is an indication of the degree of tri-regional cooperation this project received.

Chris Kincaid, Glen Canyon NRA Park Archeologist, took an active interest in the project and provided us research materials and access to park files. Jim



Delgado, NPS Maritime Historian, provided information on naval engineer and builder James Robertson and the significance of his career. After considerable digging, Dottie House, Librarian at the Museum of Northern Arizona, located a fragile and faded copy of the original plans for the steamboat. Nancy Brian assisted in getting the plans to the USGS office in Flagstaff where Mr. Hugh Thomas, Supervisor of the Photographic Division, took over. The Photographic Division reproduced both photo-mylars, black line positives, and negatives for our use. This was no easy task given the poor condition of the original. Mike Snyder, Rocky Mountain Region Division of Planning, provided us with ortho-topos and aerial photo negatives of the Lee's Ferry area.

Jerry Livingston, who has participated in many Submerged Cultural Resources Unit projects in the past, contributed his skills to the steamboat documentation and produced a detail drawing included in Chapter VII. Jerry also spent the extra time necessary to put this report into publishable form by overseeing much of the graphic production needed for printing. Ernesto Martinez took the brunt of the job of inking the graphics for this report. His patience and willingness to accept changes to "finished" illustrations is sincerely appreciated.

Without the contribution of Bud Rusho this publication would be sadly lacking. When I contacted him about this project, he became whole-heartedly involved. Bud opened up his files on the Lee's Ferry area and gave us unlimited access to his years of research. Information from interviews, photographs he took and those from his personal collection, copies of documents he obtained, and copies of published articles were all freely provided. In addition, he was our contact for photographs from the Bureau of Reclamation historic photo file. Bud, along with his close friends Greg Crampton and Don Cecala, briefly visited the site. For two days we did nothing but talk about Lee's Ferry, Charlie Spencer, and the steamboat. Their ideas and enthusiasm about the region was infectious. Bud also provided the basic information needed to write Chapter II.

Edwin Bearss, Dan Lenihan, Larry Murphy, Jim Delgado, and Bud Rusho took the time to review the manuscript and each made several helpful suggestions. Their continual support is appreciated.

Any inaccuracies, misrepresentations, or downright errors in this publication are my sole responsibility. It is also my pleasant duty to thank the numerous contributors to the project and this report.

Toni Carrell

## EXECUTIVE SUMMARY

This study of the remains of a historic industrial mining site and a historic wooden vessel located in the downstream river corridor of Glen Canyon National Recreation Area has been designed within a park management framework. The project was geared toward generating information that would be useful in cultural resources site interpretation, visitor safety, protection, and conservation; in meeting Federal compliance requirements; in contributing to the story of the park and the maritime history of the region; and in answering questions of general archeological and historical interest.

The Charlie Spencer mining area has undergone many adverse impacts and destruction as a result of man's activities within the limited amount of space in this section of Lee's Ferry. The effects of USGS remodeling on what would have become historic buildings, however, is a moot point because most of the buildings were destroyed in 1967. This event is unfortunate because much of the physical evidence of an important chapter in regional history was removed with the structures.

The key to the situation today lies in preserving and interpreting the remaining features related not only to the Spencer mining operations, but also to the USGS years of survey and river monitoring at Lee's Ferry. Some physical evidence and adequate amounts of documentation for both periods survive today and provide us with the tools and information necessary to present a full interpretive program to the public and allow continued research into the history of the area by those whose interests have and will continue to bring them to Lee's Ferry.

The most detrimental impact to the paddle wheel steamboat is wet-dry cycling resulting from the fluctuations of the water level below the dam. In ideal conditions, the vessel would be best preserved and protected from the impact of wind- or boat-driven waves and wet-dry cycling if it remained underwater at all times. The lowered water level also invites human activity on the site and, therefore, an increase in adverse impacts. Inadvertent or purposeful vandalism are much more likely to occur at these times.

The wood used in construction of the vessel remains hard and well-preserved below the level of the water fluctuations. Piping, truss rod, turnbuckles, paddle wheel hubs, and the machinery present are all in good condition. A portion of the boiler and firebox, as well as wood in the bow, both exposed to wet-dry cycles, are in poor condition. Rusting of the boiler and firebox, along with loss of some of the historic fabric is evident.

The paddle wheel steamboat CHARLES H. SPENCER is both an interesting and well-preserved cultural resource. It is a significant site that could easily stand alone as a National Register of Historic Places property. The steamboat's inclusion in the Lee's Ferry Historic District in 1974, eliminates the need for a separate nomination.

However, additional documentation of the vessel using a National Register continuation sheet is recommended.

The history of the steamboat, the role that Charlie Spencer played in the region, and how the steamboat was later used to help decide a Supreme Court case, is a story that can meaningfully contribute to the interpretation of Glen Canyon and the upper Colorado River. Continued protection of this site will ensure a data bank for future researchers who have specific questions on maritime construction of the period or who wish to have a source of comparative data for other similar vessels.

## CHAPTER I. INTRODUCTION

This study of the remains of a historic industrial mining site and a historic wooden vessel located in the downstream river corridor of Glen Canyon National Recreation Area has been designed within a park management framework. The project was geared toward generating information that would be useful in submerged cultural resources site interpretation, visitor safety, protection, and conservation; in meeting Federal compliance requirements; in contributing to the story of the park and the maritime history of the region; and in answering questions of general archeological and historical interest.

Projects that are anticipated to run over several years, field sessions, or where funding, time constraints and park priorities dictate a segmented approach, require special attention in the planning phases and the organization of work undertaken. The results of each segment should meet specific management needs and be able to stand alone as individual management documents. The overall submerged cultural resources management approach may be conceptualized as distinct phases or steps; the ideal course of research leading in a logical sequence through initial assessment, survey of portions of a park, and then inventory of all known submerged resources in an area. Each of these steps is discussed in greater detail, as separate report formats of the Submerged Cultural Resources Unit, elsewhere in this report. This sequence of steps may be physically divided by time, space, and reporting, or conducted concurrently and reported on in one document when a project runs continuously.

Park funding, priorities, and other constraints rarely permit the ideal research sequence to occur. More commonly it is segmented and conducted in response to specific management needs. The Glen Canyon project falls into the latter category, being undertaken to document the remains of both a historic industrial mining site and a paddle wheel steamer used to support mining activities.

The results of research undertaken in 1986 and reported here, provides recommendations for the long term management, interpretation, protection, and conservation of the shipwreck remains identified as CHARLES H. SPENCER. This report also presents architectural information on the vessel and analysis of these remains. Further, this report addresses both the historical context and physical remains of the Spencer mining operations and the role that the vessel SPENCER played in this activity.

### Project Objectives

The goals of this project were fourfold in nature. They were: 1) to thoroughly document the remains of CHARLES H. SPENCER; 2) to evaluate the present condition of the site in order to provide an assessment of the vessel's short- and long-term management and conservation needs; 3) to evaluate the vessel's historical significance; and 4) to document the historic industrial mining location operated by Charles H. Spencer. The purpose for gathering this information is for the comprehensive management of the shipwreck site by the National Park Service and the Bureau of Reclamation.

In addition to the stated objectives above, one day was spent conducting a riverine survey from the area of Lee's Ferry crossing to below the present boat launch ramp. The purpose of the survey was to determine the nature and extent of cultural remains in the river channel.

### Research Design

The questions this research was designed to address were fall into four categories: 1) What is the nature of the construction and technology displayed by the historic wooden vessel, i.e. a paddle wheel steamer circa 1911; 2) How have shallow-water deposition, fluctuations in water level, and wet-dry cycling affected site deterioration/preservation and research potential; 3) What social, economic, and environmental conditions extant in the upper Colorado River affected the nature and potential deposition of vessel remains in the river and how does the vessel below Lee's Ferry crossing fit into this historical context; and 4) How does the Spencer mining operation fit into the history of the Lee's Ferry area and what role did the paddle wheel steamer play.

The primary objective of the project was site documentation and evaluation. Therefore, specific questions were posed addressing general vessel construction, that is, hull configuration and framing, internal or external strengthening, hatch arrangement, steam machinery, engines, and paddle wheel arrangement. These are addressed primarily in Chapter VII.

The question of shallow-water deposition, fluctuations in water level, and wet-dry cycling and their impacts to physical site integrity and research potential is addressed in chapters VII and VIII. The relationship between the loss of vessels on the upper Colorado River, particularly the vessel at Lee's Ferry, and the social, economic and environmental milieu in the region around the turn of the century is addressed in Chapters V and VI.

The role that Charlie H. Spencer played in exploration of and the impact of his mining activities on the upper Colorado River region is addressed in Chapters II and III. The results of nearly continual occupation of the Lee's Ferry area from before the turn of the century to the present day are addressed in Chapter III. Finally, the impacts resulting from land modification, multiple use, and reservoir construction and their effect on physical site integrity and interpretation are discussed in Chapter IV.

#### Funding

This project was jointly funded by the Bureau of Reclamation, Upper Colorado Region, Glen Canyon Environmental Studies Division, and the National Park Service, Southwest Cultural Resources Center, Submerged Cultural Resources Unit. A non-monetary contribution of services and support personnel was provided by Glen Canyon National Recreation Area.

#### Project Mandate

Glen Canyon National Recreation Area was established to "... Provide for public outdoor recreation use and enjoyment of Lake Powell and [adjacent] lands ... and to preserve the scenic, scientific, and historic features contributing to the

public enjoyment of the area ..." (Public Law 92-593, October 27, 1972). Further, the stated management objectives of the park regarding cultural resources are:

... To provide the richest possible interpretive experience to visitors of the recreation area.

... To interpret historical and archeological resources ... while centering interpretive themes around outdoor recreation.

[and] ... to survey the natural and cultural resources of the area to provide factual data on which to base development and management responses (Statement for Management 1985).

The field work undertaken in this initial effort to document a known vessel loss in the upper Colorado River, within Glen Canyon National Recreation Area and the Bureau of Reclamation downstream river corridor management area (Figure 1.1), meets cultural resources management objectives for both agencies. The study was designed to maximize data returns from a very limited time, funding, and personnel base in order to meet management needs.

#### Project Dates and Participants

Field work began on September 29 and concluded on October 9, 1986. All activities took place within the Recreation Area locality of Lee's Ferry. Eighteen National Park Service employees from the Rocky Mountain, Southwest, and Western Regions, a Volunteer-in-Park, and two Bureau of Reclamation employees participated in or provided direct support for the field operations. A total of 27 persondays of diving and approximately 25 persondays of work were completed, excluding donated preparation and planning time of key personnel in the three Regional Offices, the Park, and the Southwest Cultural Resources Center.

The following people contributed to the success of the 1986 research project at Glen Canyon National Recreation Area:

##### Administrative Support:

John O. Lancaster – Superintendent, Glen Canyon National Recreation Area

Daniel J. Lenihan – Chief, Submerged Cultural Resources Unit

Adrienne Anderson – Regional Archeologist, Rocky Mountain Region

David Wegner – Bureau of Reclamation, Glen Canyon Environmental Studies  
Manager

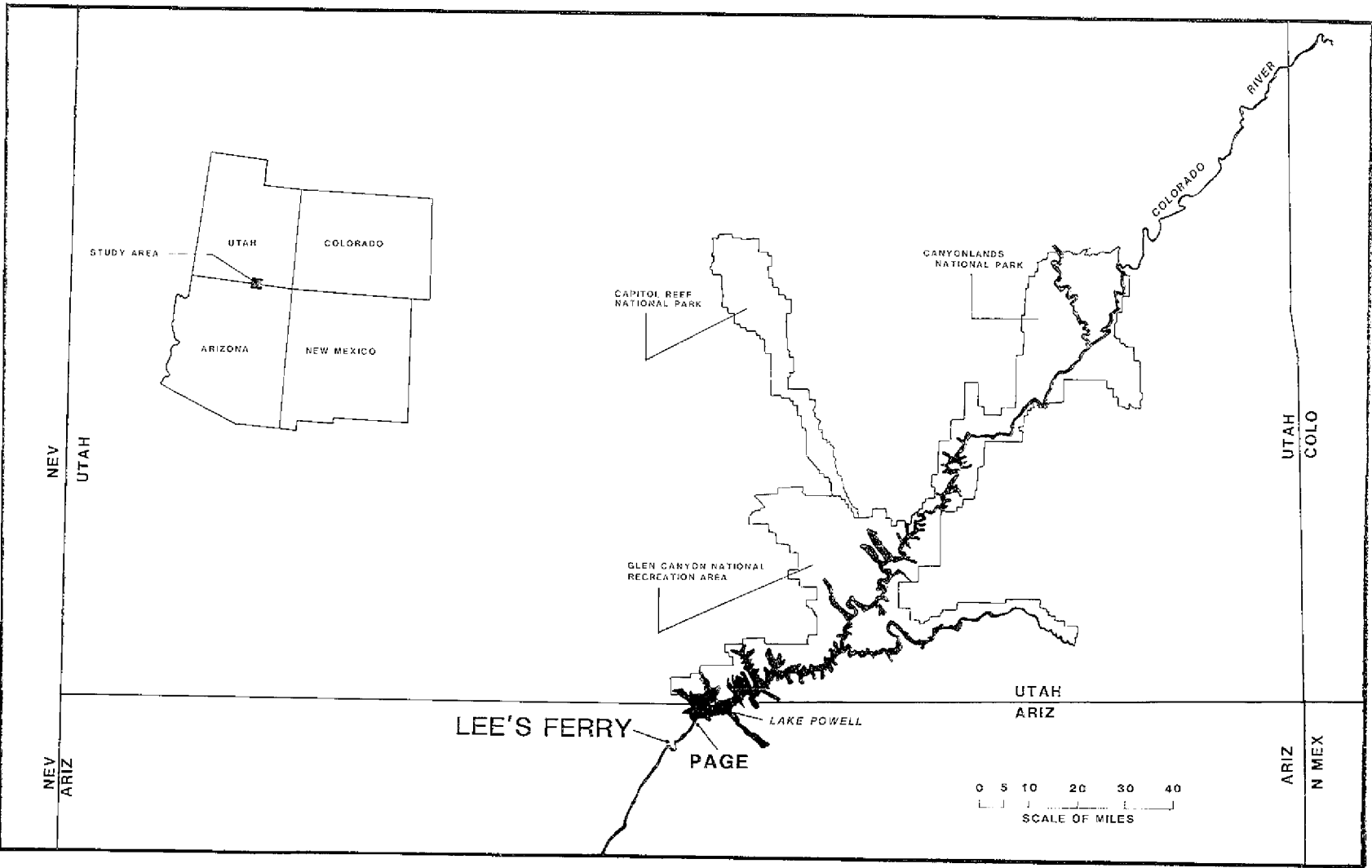

Figure 1.1 Location of project area.



Bureau of Reclamation:

Wilbur L. Rusho – Public Information Officer, Upper Colorado Regional Office;  
background information, historic photos

Glen Canyon National Recreation Area:

John Benjamin – Downlake District Ranger; logistics support, diving assistance  
riverine survey

Chris Kincaid – Park Archeologist

Jon Dick – River District Ranger; surface support

David Fowler – Seasonal Ranger, River District; surface support

Dick Kolbensschlag – Seasonal Ranger, Downlake District; boat support riverine  
survey

Chris Ward – Wahweap Subdistrict Ranger, Downlake District; logistics support

Brian Smith – Area Ranger, Downlake District; logistics support

Richard Obernesser – Area Ranger, Downlake District; logistics support

Robert Mullikin – Seasonal Ranger, Downlake District; diving assistance riverine  
survey

William Briggs – Rainbow Bridge Subdistrict Ranger, Downlake District; diving  
assistance riverine survey

Larry Wiese – Chief, Division of Interpretation; surface support and documentation  
riverine survey

Glen Gossard – Division of Interpretation; surface support and documentation  
riverine survey

Riley Mitchell – VIP; mining operation mapping assistance

Grand Canyon National Park:

Tom Workman – Division of Ranger Services; diving assistance riverine survey

Lake Mead National Recreation Area:

Jim Koza – Division of Ranger Services; diving assistance, graphics

Southwest Cultural Resources Center:

Jim Bradford – Branch of Cultural Resources Management; diving assistance,  
graphics

John Stein – Branch of Cultural Resources Management; mining operation site  
mapping

Jerry L. Livingston – Branch of Cultural Research; diving assistance, graphics

Toni Carrell – Submerged Cultural Resources Unit – principal investigator

## CHAPTER II. THE PLACE OF CHARLIE SPENCER'S MINING OPERATION IN LEE'S FERRY HISTORY

During the last two decades of the 1800s, a minor gold rush was running its course along the Colorado River and throughout many of its tributary canyons. Many prospectors passed through Glen Canyon and Lee's Ferry, either on their way in or out of the canyon country, concentrating their efforts on gravel bars lying several feet above the river. Initiated partly by Cass Hite, whose tales of gold discoveries were carried all over the region, the rush continued only long enough for the prospectors to learn that all the land near the river was composed of sedimentary strata, representing the disintegration of ancient mountains, and any concentration of minerals was unlikely. Gold was literally everywhere, embedded in minute amounts throughout almost every formation. Without massive equipment there was simply no way to extract the fine gold in commercial quantities (Crampton 1959:23).

No sooner had individual prospectors departed the region than the bigger companies, with investors, payrolls, and heavy equipment, began moving in. The Zahn Brothers set up a large gold dredge beside the San Juan River and began overturning gravel bars. In 1897 Robert B. Stanton formed the Hoskaninni Company to recover gold from the entire length of Glen Canyon.

Intrigued by the placer gold possibilities, Stanton began construction of HOSKANINNI, a massive 180-ton dredge to extract gold particles. During its construction, Stanton traveled up and down Glen Canyon staking out claims he expected to mine with a whole fleet of dredges (Crampton and Smith 1961:11). Stanton staked claims down to and including Lee's Ferry in 1898. The following year Stanton had his men build a road along the south river bank from the area of the ferry, upstream for a distance of 1 1/2 miles. The road served no other purpose than to meet assessorial requirements to prove his claim.

Both the Zahn brothers and Stanton's Hoskaninni Company failed. Gold was certainly present, however the particles of the metal were so fine that they would not settle on the amalgamators. By 1900 only an occasional prospector was seen along the river above Lee's Ferry (Crampton 1959:23). In late 1901 Stanton ceased all operations, abandoned the dredge, and placed the company into receivership.

During the years from 1905 to 1909, Charlie Spencer made several trips to investigate the gold mining potential of the San Juan River area (Figure 2.1). More importantly perhaps, he began to develop techniques for attracting investors who would bankroll his activities. One of the men who later worked for Spencer wrote:

His Western manners and the magnitude of his projects and their fabulous possibilities seemed to have an irresistible appeal to the small investor, and when one operation failed or was inconclusive, he always managed to raise more money and try again (Jones 1960:1).

Born November 12, 1872, at Walsenburg, Colorado, Charles Harvey Spencer moved with his parents and family to Farmington, New Mexico in 1879. Over the next several years Charlie spent much of his time at this father's trading post along the lower San Juan River learning how to cope with the desert and even to speak understandable Navajo. For the Spencer family, however, Navajo hostility resulted in a move into the Mancos, Colorado area in 1884, which had been recently cleared of Utes and had been opened to white settlement. Charlie saw little of schools; instead he spent his time farming and learning how to mine gold and coal in the nearby La Plata Mountains. Spencer's early involvement with gold was to influence the remainder of his life.

Spencer's interest in the San Juan-Glen Canyon area first developed in 1893 when he spent a few months mining copper in Copper Canyon, a tributary canyon to the San Juan. Returning to his Mancos home, he continued miscellaneous mining in Colorado until 1905. In that year he was hired to set up a boiler and a small mining operation on the San Juan. Spencer spent several months working at that operation before it was abandoned as unsuccessful (Spencer 1961:1).

By 1908 he had amassed enough investment capital to begin his own operation on the San Juan River. Spencer and his company hired a few trained mining specialists, many laborers, bullwhackers, and cooks. A small ore extraction plant consisting of crusher, drive motor, boiler, pumps, compressor, and



Figure 2.1. Charles H. Spencer in Coconino Basin, 1911. Courtesy Bureau of Reclamation.

amalgamators, was purchased and brought together along with wagons, oxen, and horses. Large samples of Wingate sandstone were dropped into the crusher, however tests and assays were run with negative results. The mining engineer hired by the Chicago-based investors declared that the operation had no commercial value and closed it down in 1909 (Jones 1960:1; Waller 1961:1).

Spencer traveled to Chicago in an effort to convince his former investors to allow him to try again. Undaunted by their refusal, he found new investors, put together another group of men and made ready to try again. In December 1909, the whole outfit left Mancos, Colorado, for a bone-chilling trip through Monument Valley and on to the San Juan River. The crusher and amalgamator were set up at Paria Creek, 125 miles above Lee's Ferry (Figure 2.2).

They tried their luck on the Wingate sandstone, the thick, reddish, broken rock that occurs widely throughout the canyon country. Once again, they met failure. During the testing, one of the mining engineers assayed a sample of the Chinle shale and found that it contained as much, if not more, gold than the Wingate. Even more importantly, the purple-hued Chinle was soft, crumbly when dry, but sluicable with high-pressure hoses.

A second discovery was equally important. A conversation during a chance encounter with two miners who had worked on the Colorado River disclosed that the Chinle shale occurred abundantly, not only on the San Juan River, but at a much more accessible location called Lee's Ferry, across the border in Arizona. Since wagon roads reached Lee's Ferry from Flagstaff, or from Utah, it would be relatively easy to bring in heavy mining equipment. Furthermore, coal deposits were known to exist in the cliffs a few miles to the northeast.

Without further debate, the decision was made to move the operation to Lee's Ferry. Spencer and his first crew arrived in May, 1910, and immediately began assembling additional men and the mechanical equipment needed to sluice the Chinle shale from the cliffside about 250 yards north of the Colorado River, behind the old Lee's Fort.

Even before locating the necessary deposits of coal to support a mining operation, Spencer began experiments on the shale at Lee's Ferry using driftwood

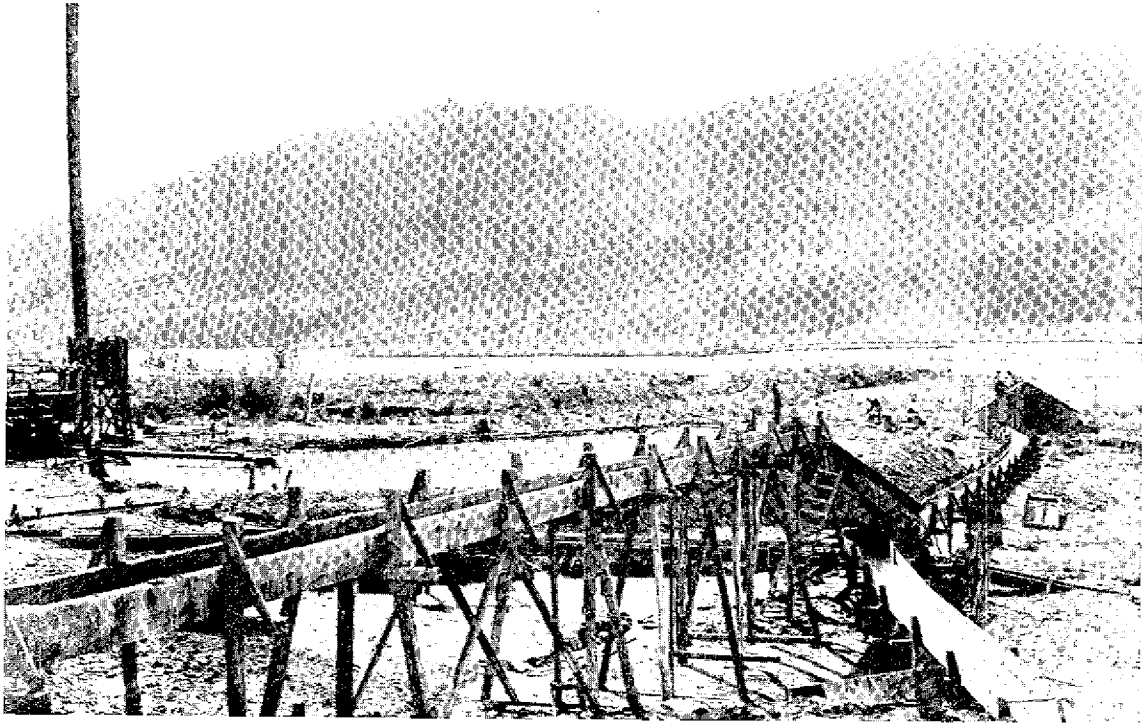

Figure 2.2. The long flume at Paria Creek, set up in late 1909 or early 1910, was used to carry the sluiced silts from the cliff to the amalgamators by the river. This arrangement was similar to the set up at Lee's Ferry. Courtesy W. L. Rusho.

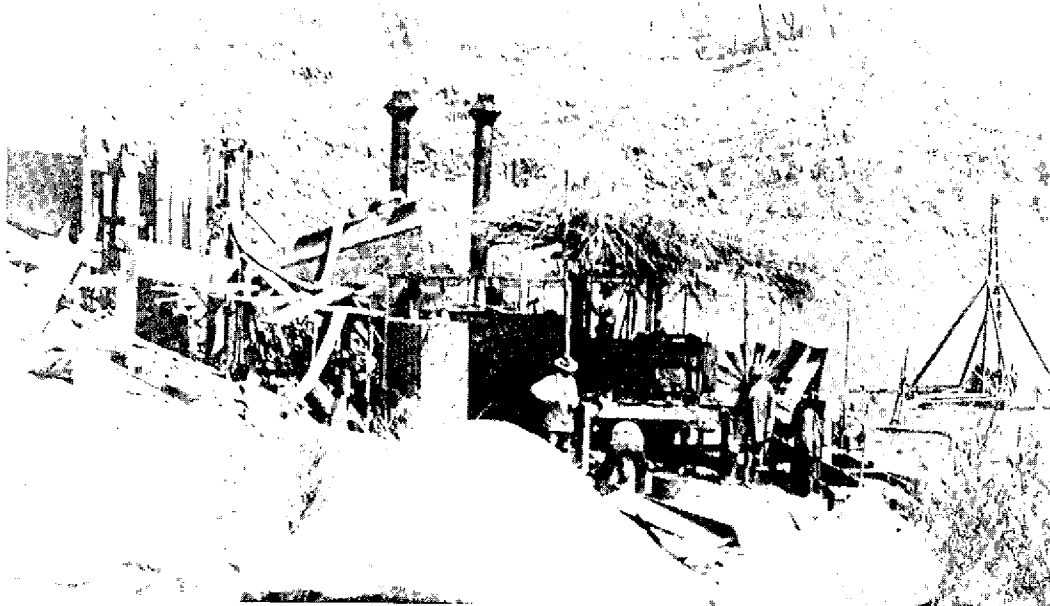

Figure 2.3. The boilers, pump, and amalgamator, set up on shore near the ramada, as well as a pipe dredge, were set up by Charles Spencer at Lee's Ferry in 1911 in an effort to extract gold from both the nearby cliffs and riverbed. National Archives Photo.

for fuel (Wilson 1961:24). A pipe dredge, a device that injected air and water under high pressure directly down into the ground forcing sand and fine particles up through a casing, was tried. The pipe dredge was set up on a gravel bed near the river bank, unfortunately just below the surface they hit coarse rock and the casing would sink no further. The experiment was given up as a failure.

Spencer went ahead with his plan to recover gold from the Chinle by sluicing. A large boiler and pumps were set up near the river and water was pumped through hoses to big pressure nozzles aimed at the shale (Figure 2.3). The dissolved Chinle was carried down a long flume back toward the river where an amalgamator was set up. Spencer's first "runs" at the mine were made in the spring of 1911. While everything worked fine at first, it soon became apparent that the mercury in the amalgamator was becoming clogged. The gold was passing on out with the tailings, instead of being absorbed by the mercury. Numerous efforts and tests were made to solve the problem with no success. Samples were even sent to outside experts who could not identify the "foreign" element present. It wasn't until many years later that the element was identified as rhenium.

While the chemists and mining engineers attempted to resolve the problems at the mine, Spencer continued to promote his enterprise. On at least one occasion, he used trail construction to impress a group of investors from Chicago. His men were instructed to put on a good, noisy show, by setting off sticks of dynamite. The investors left satisfied that Spencer's men were earning their money (Leach 1961).

In the mean time, the question of an adequate supply of fuel for the boilers was still unresolved. After examining several rugged canyons, eventually a sizeable vein of coal on a distant branch of Warm Creek was located, 28 miles upstream in Glen Canyon. At first Spencer thought that mules could be used to haul coal from the mines on Warm Creek to the mining site. Spencer and his men were familiar with Dominguez Pass, but judged it too difficult for convenient access to the mining area. Instead of using Dominguez Pass, Spencer ordered his men to build a trail up the Echo Cliffs immediately east of his mining operations at Lee's Ferry. The trail was built during the late summer and fall of 1910.

Company backers were convinced that the only economical way to move coal from Warm Creek to the mining location just below Lee's Ferry was by boat. A road from the coal mine down Warm Creek to the Colorado River was also started in late 1910. The miners lived in tents at the coal mine, approximately 6 miles up the canyon from the river. While the coal mine was being opened up and the road to the river constructed, work began on a barge at the mouth of Warm Creek. The first load of coal was sent down by wagon to the barge in the spring of 1911; the men were able to make the round trip from the mine to the river and back in a day (Spencer 1961:1). Three or four men drifted down on the barge from Warm Creek through Glen Canyon to Lee's Ferry with the first load of coal (Leach 1961:4).

The problem of how to get the barge back up to the mouth of Warm Creek was thought to be solved with the purchase of a launch, VIOLET LOUISE. Unfortunately, the launch was far too underpowered to push a barge against the current while negotiating the many sandbars. It was at this point that the Chicago backers decided upon a large steamboat to carry the coal from Warm Creek down to the mine operation.

A paddle wheel steamboat (discussed in detail elsewhere in this report) was ordered from San Francisco, constructed at the mouth of Warm Creek, and launched in late February 1912.

I heard that Spencer was having a steamboat built up the river someplace and that this boat was to carry coal down to our operation at Lee's Ferry. I don't know what the coal was to be used for. Nothing that I could see going on required much coal (Leach 1961:3).

While the value of the steamboat was questionable to many, nonetheless it was used to bring some coal from Warm Creek. Unfortunately, by the time that the vessel was operational and a means available to transport coal, the whole mining operation was on the verge of collapsing.

The fouling of the mercury plates in the amalgamator was an insurmountable problem, further, the value of the mercury required exceeded the value of the gold that was recovered (Jones 1961:8). About the same time the financial backers of the company:

...became greatly displeased with the management; account books were reported lost; many of the men



---

were not paid; law suits were brought; the bank account Spencer used for operating expenses and payroll was attached; etc. ...the proof that the silts were not a commercial enterprise definitely eliminated the group interested in that development... (Jones 1961:8).

Finally, in the Spring or Summer of 1912, the entire mining operation was shut down and the hired hands departed the area. By 1913, almost everyone associated with Spencer had left Lee's Ferry and Spencer had moved on to other business ventures. In the 1960's Spencer returned to his still valid claims at Paria to mine the rhenium, which is a highly valuable super-conductor of electricity. Once again, his efforts met with failure.

Mining activity continued sporadically in and around Lee's Ferry. In the 1930s, prospectors once again attempted to search for gold in Glen Canyon, and again their efforts proved fruitless (Crampton 1960). In the 1950s uranium was actively sought in the immediate vicinity of Lee's Ferry. The Shinarump conglomerate, often found to contain uranium, is prominent in Lee's Backbone, across the river from the mining site. Several claims were staked in the vicinity, mines were opened, and access roads were bulldozed. However, uranium mineralization in the Lee's Ferry area was found to be too low, and within a few years all of the mines were abandoned and prospecting had ceased (Phoenix 1963).

### CHAPTER III. LEE'S FERRY HISTORIC SITE BACKGROUND

When Charlie Spencer first viewed Lee's Ferry from atop the Buzzard Highline Trail on May 9, 1910, only one building stood in the large, boulder-studded bend of the river just downstream of the ferry. Lee's Ferry Fort, originally built on directions from Jacob Hamblin in June/July of 1874, was probably last used as a trading post by Joseph L. Foutz in the summer of 1877 (Crampton and Rusho 1965:22). The building was never again used as a trading post, but was utilized by various groups intermittently during the intervening 33 years until Spencer's arrival. Beginning with the fort, and with characteristic zeal and energy, Spencer lost no time in initiating the metamorphosis that would change the immediate area around Lee's Ferry Fort to one of the larger mining endeavors on this section of the Colorado River.

Soon after arriving at Lee's Ferry, Spencer took a party of men upstream to locate a reported vein of coal that could serve as a fuel source for the boilers necessary to operate his mining equipment. During the next six weeks another exploratory trip was made upriver while Charlie and others made a trip to Flagstaff to obtain supplies and equipment necessary for the venture. The second exploring party was sent upriver in search of the gold-bearing Wright Bar gravel bed and any sources of coal within a reasonable distance from Lee's Ferry. While some of the men were in Flagstaff, Spencer apparently made a trip to Chicago to find additional investors for the operation. By about June 20, 1910, most of the party was back at Lee's Ferry with some supplies and enough equipment to begin operation of the "Lovett pipe dredge" to be used in dredging the river bottom for gold. By this time, original crewman Albert H. Jones stated that they had "set up a camp in the willows on the south side of the river not far below the ferry, and subsequent operations were conducted from this base" (1960:6).

If Jones' statement on the location of the camp is correct, then his photographs at the time indicate a switch to the north bank of the river was

accomplished within the next few weeks. According to dates on several of Jones' photographs Lee's Ferry Fort had been adapted for Spencer's use by July, 1910. Taking advantage of the good condition of the building, Spencer added a 26-foot extension on the west end of the fort and utilized the structure as a cookhouse and mess hall for his miners (Figure 3.1).

A second mess hall was soon built and the fort was used to house two miners (Kolb 1914:178). The extension was converted to an office for Arthur C. Waller (Rusho, personal communication). The addition was still attached to the fort and in use during the 1935 reunion of pioneers who had crossed at Lee's Ferry (Rusho and Crampton 1981:85); however, by 1962 it was in ruin.

Although not recorded in the documents, the "down time" waiting for supplies and equipment was probably spent erecting the buildings necessary for the mining operation. Within a short span, Spencer's crew constructed at least seven major buildings in the immediate area. As listed by Crampton and Rusho, these included the Cook House, Laboratory, Blacksmith Shop, Cook's House, Bunkhouse, First Bunkhouse, and a Ruined Building (a building very similar to, and aligned with the two bunkhouses) (1965:25-26). A historical sequence of the Spencer mining community at Lee's Ferry, reconstructed through available documents, is presented in the following sections.

### Historical Description

#### The Spencer Mining Years (1910-1912)

A single road from the mouth of Paria Canyon snaked eastward along the right bank of the Colorado River to the upper ferry and its cluster of buildings. By early 1911, Spencer's mining community consisted of eight or nine structures located on either side of the ferry road (Figure 3.2). Actual mining operations were situated both to the south and north of the complex. Efforts to siphon gold from the riverbed gravels with the pipe dredge were carried out at locations along the north river bank just upstream and downstream of the blacksmith shop. In addition to dredging the river, mining the exposed Chinle formation several hundred feet north of the river was undertaken. Here, hydraulic methods were incorporated to wash the materials out of the ground and sluice them down to an amalgamator



Figure 3.1. Spencer's crew posing in front of Lee's Ferry Fort in July 1910. Note the new addition to the fort in the left background. Photo by A. H. Jones. Courtesy W. L. Rusko.



Figure 3.2. Panoramic view of the Spencer mining area at Lee's Ferry as it appeared in 1915. Major structures identified include (left to right) a small storage room, the laboratory, blacksmith shop, cook's house, mess hall, first bunkhouse, second bunkhouse, third bunkhouse, and Lee's Ferry Fort. Photo by E. C. LaRue. Courtesy W. L. Rusho.

along the river bank. Between these two mining areas was located the buildings necessary to support the mining operations. The reader is referred to Figures 3.2 and 3.3 for reference in the following discussion.

Bunkhouses: Spencer located the first of his new buildings east of Lee's Ferry Fort and between the road and the river (Figure 3.3). Here, he constructed three elongated, one-room stone buildings to house the miners. These first buildings were rock structures approximately 30 by 19 by 8 feet each, with a slightly pitched or rounded roof. Two of the three bunkhouses were crudely built and lacked the sophistication that subsequent buildings exhibited. The westernmost building was still in use in 1935 (Rusho and Crampton 1981: 85, photo) but was demolished sometime prior to 1962. The middle building was extant through 1963, although by this time it was described as "in poor condition and near collapse" (Crampton and Rusho 1965:25). The easternmost building is of good construction, was remodeled sometime after 1923, and is still standing and in good condition today.

As with all subsequent structures, these first buildings were made of roughly shaped sandstone blocks acquired locally within the talus slope on which the community was located. Roofs were originally made of poles and brush laid over three main support beams or vigas (running east to west) and were perhaps coated with mud plaster to help waterproof them. Interiors were apparently "plastered with adobe, or mud" (Kolb 1914:178). In all three bunkhouses, the doors were originally located in the east walls, with three windows in the south walls, one window in the west walls, and a single window located in the north walls. When first constructed, brush enclosures or ramadas were attached to the east sides of the two end buildings, thus providing at least minimal protection and shade at the entrances.

Mess Hall/Kitchen: Initially, all meals were eaten at the fort west of the bunkhouses. By 1911, however, a larger mess hall was constructed on the north side of the road, northeast of the bunkhouses, and faced south toward the river (Figure 3.3). Estimating from photographs of the period, this mess hall also measured about 30 by 15 by 8 feet and its walls and roof were of the same construction as the bunkhouses. A ramada was attached to the east exterior wall and extended about 8 feet beyond the south wall. A fireplace was built into the west wall. A back door was located near the east end of the north wall while one or two windows were also located in the north wall. The south wall contained the

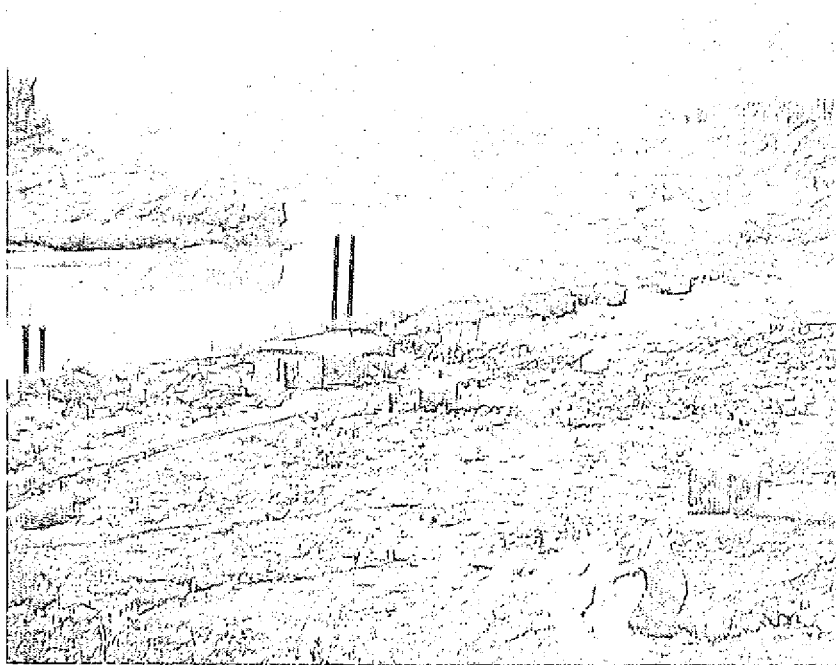

Figure 3.3. A view downstream of the mining area in December 1914. The large building near the smokestacks is the blacksmith shop with the laboratory in the center foreground. The small storage structure is in the right foreground while the mess hall and cook's house are just visible to the right. The row of bunkhouses appear in the background. Photo by Charles S. Russell. Courtesy W. L. Rusho.



Figure 3.4. The remains of what may be a cellar near the base of the cliffs as it appeared in 1986. Note Lee's Ferry Fort in the background. Photo by J. Bradford.

front door and, undoubtedly, more windows; however, it is not known exactly where in this wall these features were located. A large root cellar, measuring perhaps 12 feet on a side and of unknown depth, was located immediately behind (north) the east end of the mess hall and retained culinary supplies for the miners. The walls were constructed of dressed stone while the roof was finished off with a layer of dirt. A square, pitched-roof vent was located in the middle of the roof of the root cellar.

Cook's House: Approximately 100 feet northeast and upslope from the mess hall, Spencer had a single-room stone cabin built to house the cook. This structure measured about 12 feet on a side and had a stove in the northwest corner of the room. Windows were located in the middle of the north wall, near the south end of the west wall, and on the west end of the south wall. The door was located on the east end of the south wall. It is not known if a window was built into the east wall. In a manner similar to other structures in the complex, the roof was supported by a single viga centered on the north and south walls. Smaller saplings or stringers were then laid perpendicular to this central support and spanned the distance from the viga to the side walls. The final coating appears to have been dry soil or mud plaster.

Laboratory: The laboratory was also located on the north side of the ferry road and about 220 feet east of the mess hall (Figure 3.2). The lab was perhaps 15 feet on a side with the north portion being excavated into the slope. A chimney or vent protruded through the roof near the northwest corner. The roof was constructed with three vigas running east-west that supported the perpendicular stringers, giving the roof a rounded effect. The door of the lab was oriented to the east, while windows were located in the north, west and south walls. Approximately 40 feet northeast of the laboratory, near the base of the cliffs, was a small rock building measuring about 8 feet on a side. This small structure had a door in the east wall but no apparent windows. Figure 3.3 shows a path worn between the lab and this building. Due to the construction, size and location of this building, it is assumed that it served as storage for explosives or chemicals; however, this is speculative.

Blacksmith Shop: Immediately across the road from the laboratory was the blacksmith shop (Figure 3.3). This was the largest structure Spencer had built and



measured about 22 by 42 feet and perhaps 10 feet high. Double doors were located in both the east and west end walls. It does not appear that windows were constructed in the north wall but two or three may have originally been built into the south wall. A shed or lean-to was added onto the east end of the north wall soon after construction. The roof was similar to the laboratory and the bunkhouses.

Secondary Structures: Aside from the primary structures described above, and in addition to the root cellar behind the mess hall and the laboratory storage building, two other structures once existed that may have been associated with the Spencer operations. Both were located immediately west of the bunkhouses and south of the fort. One was a ramada or open-sided brush shade situated immediately southwest of the westernmost bunkhouse and appears to have been about as long as, and half as wide as, the bunkhouse. The other structure appears to have been a small, low construct located due south of the fort. The function of this latter feature is unknown. The location of the ramada is now where the deep gully cuts through to the river and the smaller enclosed structure location is now within the parking lot.

Although not proven, at least two other structures may have been constructed during the Spencer years. What appear to be two root cellars are located within the area utilized by Spencer. One occurs at the base of the slopes directly north of the mess hall (Figure 3.4), while the other occurs on the east boundary of the community just south of the ferry road. Although neither appear in photographs of the period, they may well represent the remains of small houses occupied by married men on Spencer's crew. A. H. Jones noted in his descriptions of photographs that several wives lived in camp during this time and it is suspected that they and their husbands did not share the bunkhouses with the rest of the crew.

Secondary Features: A number of minor activity areas occurred throughout the vicinity of the buildings; most directly related to mining activities. Just southeast of the blacksmith shop, at the river edge, were located the first two boilers that powered the mining equipment (see Figure 3.3). Both of these boilers were manufactured by the "Nagle Engine and Boiler Works" of Erie, Pennsylvania and were shipped from St. Louis to Flagstaff for Spencer's use at Lee's Ferry. Boilers such as these were in common use at the turn of the century and similar ones were used in

the Glen Canyon area for mining purposes (Crampton: 1986:116). One of these boilers (Figure 3.5) generated steam to run an air compressor and both the boiler and compressor were used to power the Lovett pipe dredge located at various places along the river bank. The second boiler was undoubtedly used to power pumps that pulled water from the river and piped it uphill to the location where the hydraulic mining of the Chinle silts was conducted. Wood, mostly driftwood gathered from the vicinity, was used to fuel the boilers (Rusho 1961:16).

The dredge itself was something of an experiment and consisted of a central discharge pipe (4 to 6 inches in diameter) held vertical by a single derrick and winch (Figure 3.6). Surrounding the discharge pipe were two smaller pipes that carried pressurized water and two pipes that carried compressed air to the nozzle at the bottom (Figure 3.7). The nozzle would be inserted into the sands and gravels along the river. Compressed air would then be released at the bottom of the discharge pipe and, along with the injected water, would force the sands up the discharge pipe and convey it through a flexible hose to the amalgamators located on a platform immediately downstream (Figure 3.8).

Spencer's hydraulic mining operation was basic. The second boiler was used to run the pumps set up near the river (Figures 3.9 and 3.10). Water was pulled from the river, through the pumps, and forced through the pipes and hoses to the hose racks located in the exposed Chinle clays north of the community. This operation is now evidenced not only in photos taken at the time (Figure 3.11), but also by a series of cairns and supports forming a line from near the cook's house to the top of the small ridge immediately to the north. From this ridge, the shales and clays of the Chinle were washed out, the slurry collected into a flume and, using gravity flow, taken down to the amalgamators located on the river (see Figure 3.11). Eighteen of these supports and one piece of high pressure hose were located during this investigation. Also located during this study were the remains of two small cuts or platforms constructed into the slopes of the ridges and on which the sleds or frames for the monitors or hydraulic nozzles were positioned. These stations were located as necessary in order to get the stream of water directed about 20 to 30 feet upslope.

A second set of boilers was purchased and installed just below the blacksmith shop in 1911 (see Figure 3.9). However, these boilers may never have

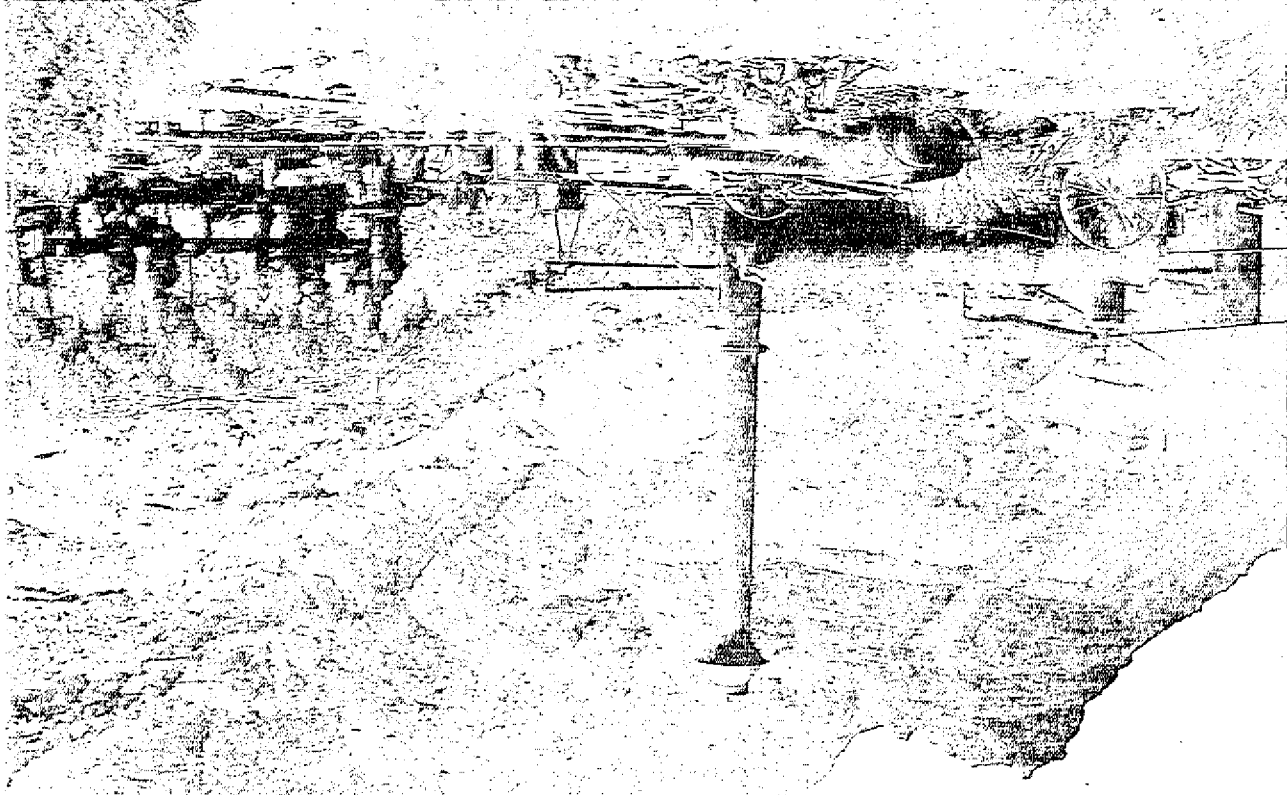

Figure 3.5. Boiler used to operate a small water pump and air compressor connected to the Lovett pipe dredge. The nozzle of the dredge can be seen extending out of the ramada. Photo by A. H. Jones, August 1910. Courtesy W. L. Russho.

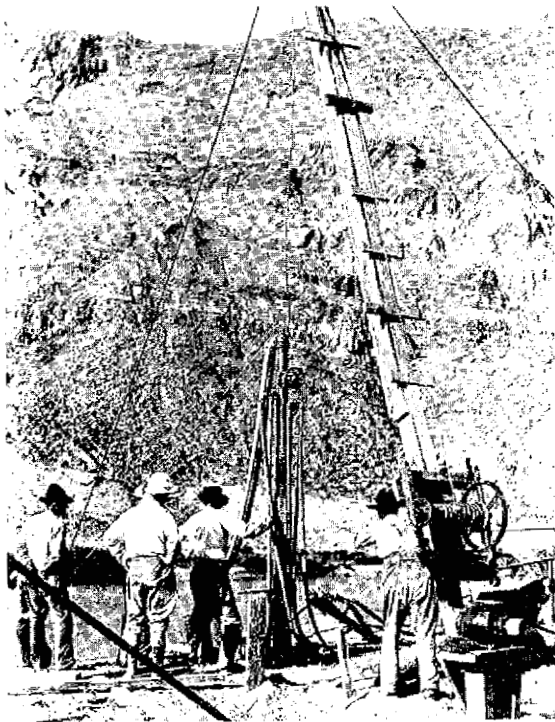

Figure 3.6. (Left) The Lovett pipe dredge in operation. C. H. Spencer (with hand on pipe) oversees nozzle withdrawal. Photo by A. H. Jones, August 1910. Courtesy W. L. Rusho.

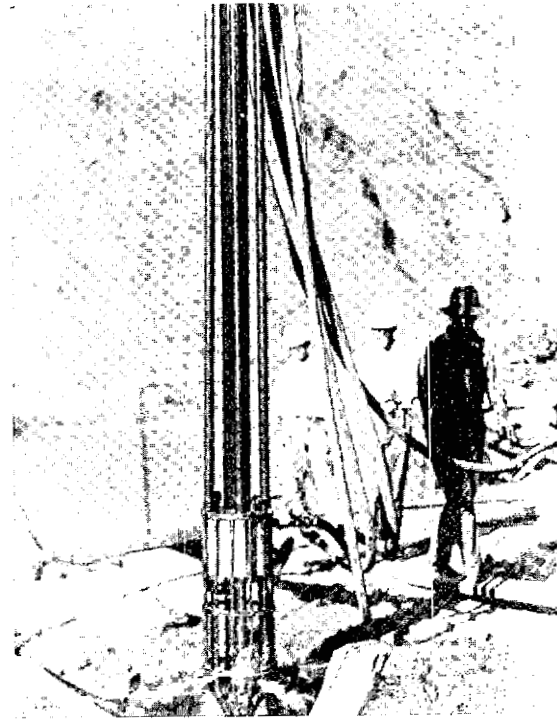

Figure 3.7. (Right) Closeup of the cage and nozzle of the Lovett pipe dredge. Note the horizontal jets of water near the tip. Photo by A. H. Jones, August 1910. Courtesy W. L. Rusho.

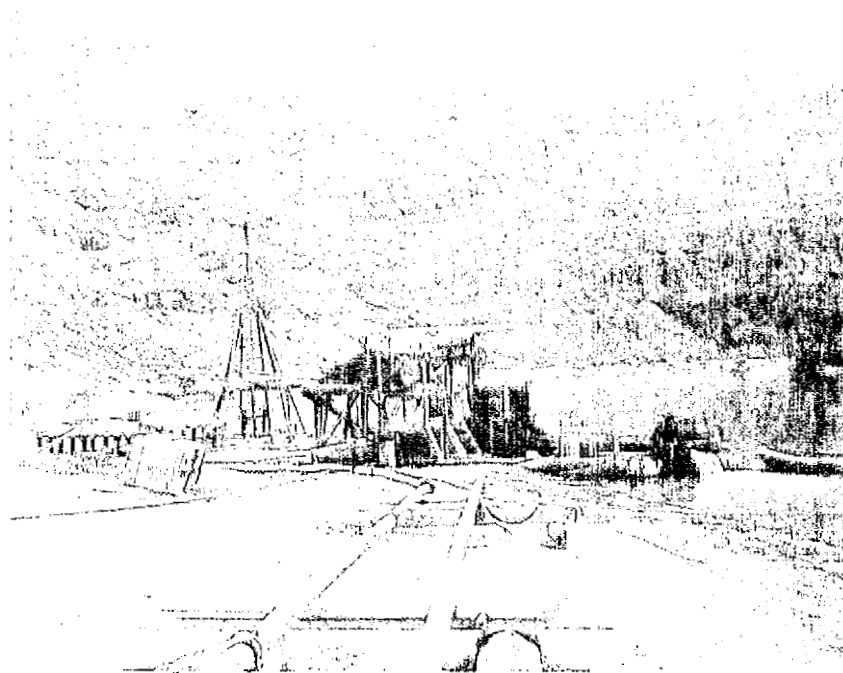

Figure 3.8. The amalgamator at Lee's Ferry. The pipes in the foreground connect the boiler/compressor to the pipe dredge in the left background. From the dredge, the discharged sand was fed to the amalgamator where efforts to extract the gold particles from the sand were carried out. Photo by Emery C. Kolb, November 1911. Special Collections Library, Northern Arizona, Northern Arizona University.

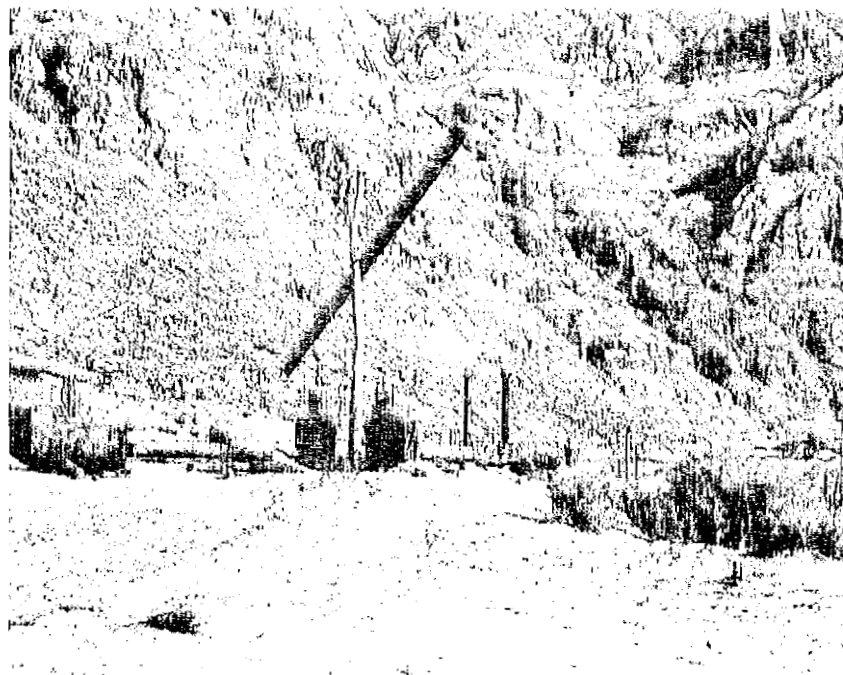

Figure 3.9. Installation of the second set of boilers below the blacksmith shop. In the background can be seen the smokestacks of the boilers that powered the dredge (extreme right) and the water pumps. Photo by A. H. Jones, August 1911. Courtesy W. L. Rusho.

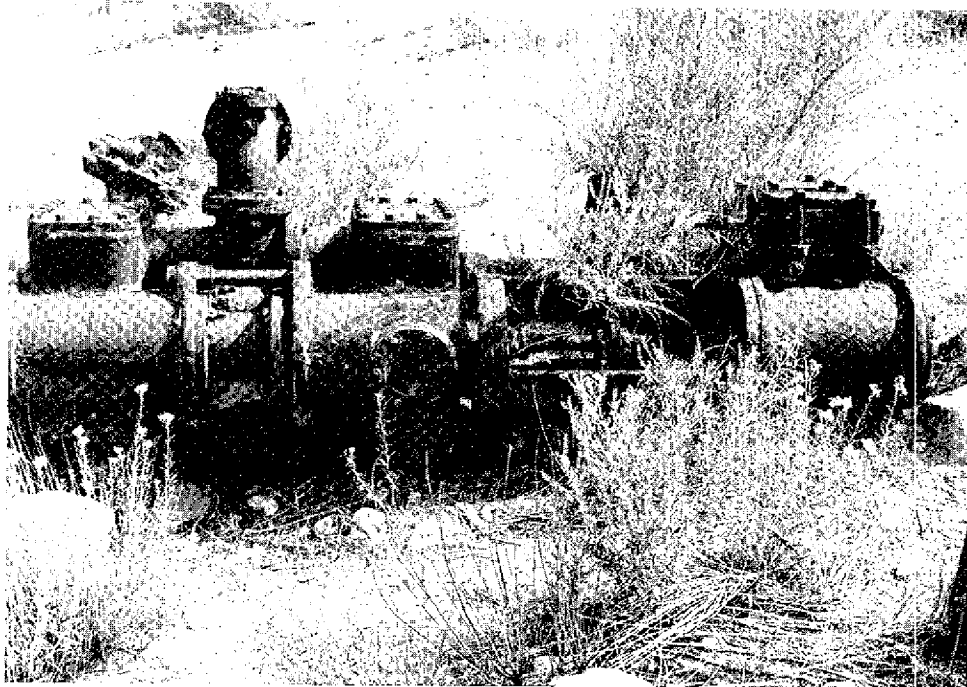

Figure 3.10. Closeup of the remains of one of Spencer's pumps used to convey water from the river to the hydraulic nozzles at the base of the cliffs. Photo by J. Bradford.

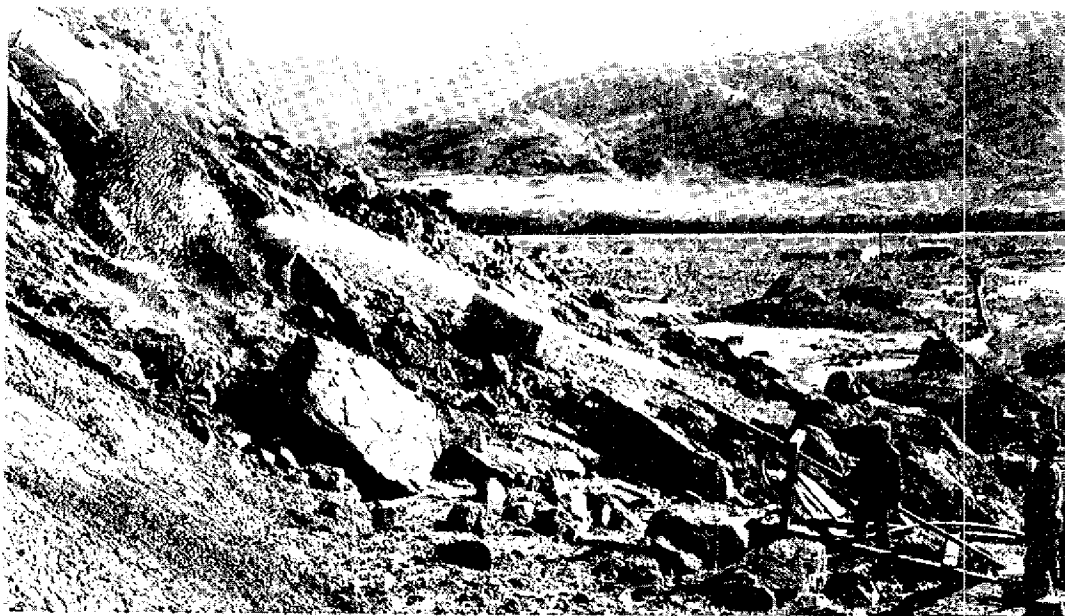

Figure 3.11. Hydraulic mining of the Chinle formation at Lee's Ferry in 1911. Water was pumped from the river, through the hose to the monitor or nozzle. The runoff was collected in a flume (right) and returned to the amalgamators at the river. Photo from Charles H. Spencer. Courtesy W. L. Rusho.

been fired before the operation was abandoned and no evidence of them was found during this study (Rusho: 1961:16).

The above inventory of buildings and associated features represent what still remains from Spencer's activities during the period of May 1910 to the summer of 1912 (Figure 3.12). During this time Spencer spent a considerable amount of money invested in the Chicago-based American Placer Corporation. Although the remoteness and geography of the area made mining efforts most difficult, Spencer succeeded in establishing a small community of several stone buildings and employed numerous people. As with all mining speculations in the Glen Canyon area, Spencer's was doomed to failure due to problems that the technology of the day could not overcome. Although a few men employed by Spencer stayed around Lee's Ferry and/or Paria after the operation went broke, the physical remains of the operation were, by late 1912, essentially abandoned by Spencer and left for other's use. As described by Mrs. Mary Harker who moved to Lee's Ferry in April 1913, "Spencer's mining venture had failed, and there was mining equipment all over the place, just rusting away. I remember that a steamboat was tied up along the river bank..." (Rusho 1965:1).

#### The Post-Spencer Decade (1912-1921)

Not much has been written about the history of the Spencer buildings at Lee's Ferry during this period. Photographs taken in 1914 and 1915 (Figures 3.2 and 3.3) corroborate Mrs. Harker's statement about the abandoned equipment, including the deterioration and eventual sinking of the CHARLES H. SPENCER (see Figure 6.4). It is assumed that the two later boilers brought to Lee's Ferry were removed during this period and that the property was in a state of general neglect. However, Lee's Ferry was not completely abandoned and at least one, and perhaps two, additions to the community's buildings may have taken place by 1913. Their method and materials of construction nearly duplicate those buildings constructed by Spencer's men. The two buildings are now known as the "Post Office" and the "Chicken Coop" and both are located west of Lee's Ferry Fort.

Post Office: Built of sandstone blocks two courses thick, this small (19 by 21 by 10 feet) single-room structure (Figures 3.13 and 3.14) is located 40 feet west of, and roughly aligned with, Lee's Ferry Fort. Built prior to 1915, the post office was

FIGURE 3.12

**SPENCER MINING AREA  
SPENCER AND POST-SPENCER ERAS: 1910-1923**

GLEN CANYON NATIONAL RECREATION AREA

NATIONAL PARK SERVICE  
SUBMERGED CULTURAL RESOURCES UNIT

J. STEIN/J. BRADFORD

0 25 50 75 100  
FEET

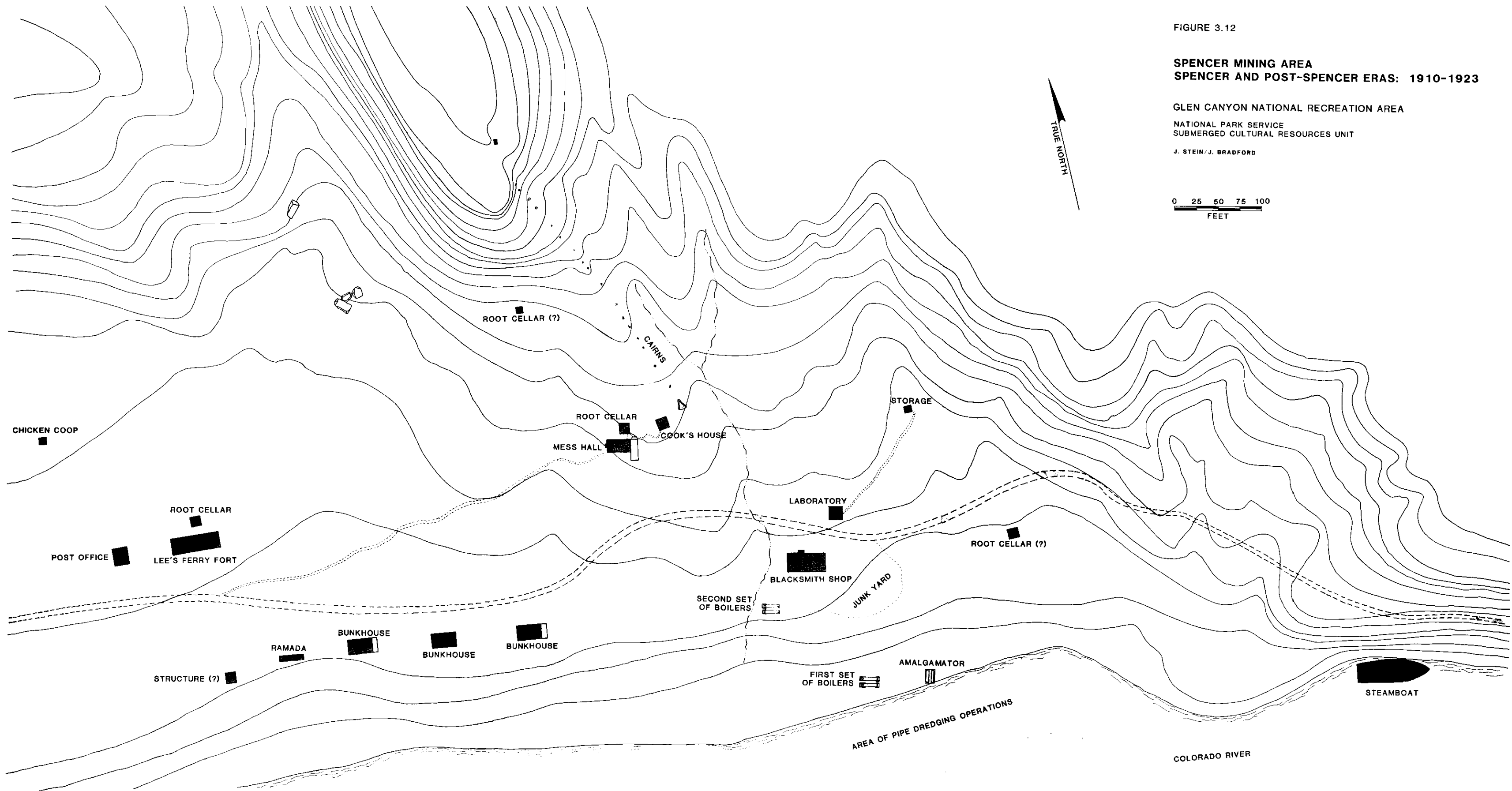

Figure 3.12. Map of the Spencer mining area depicting the location of all major features as they appeared at the end of the Spencer era and with additions from the post-Spencer decade.



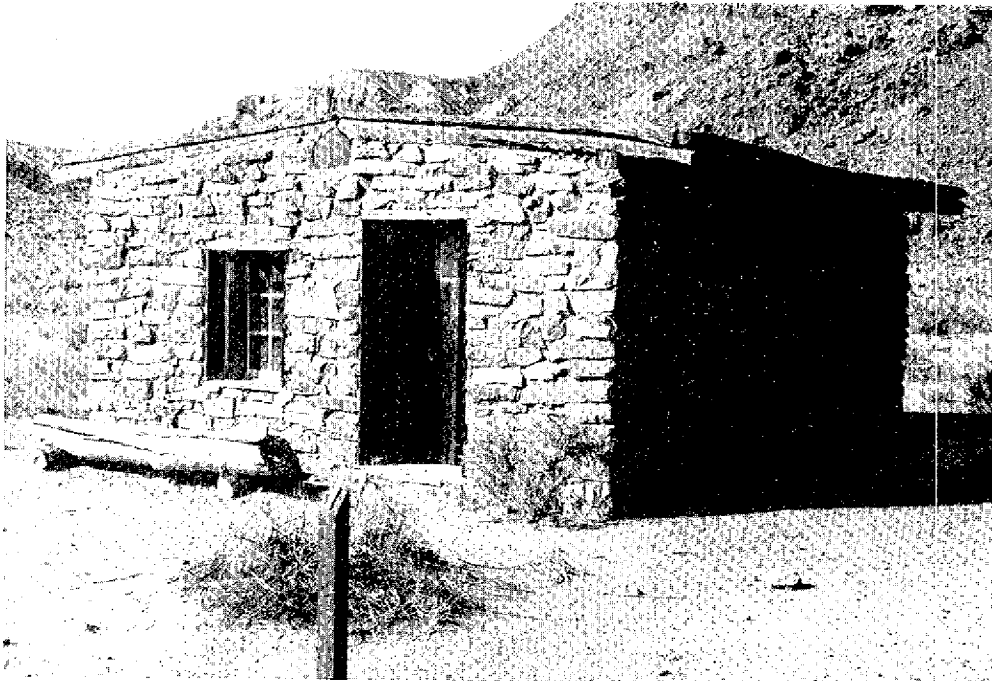

Figure 3.13. The post office as it appeared in 1986. Note the construction details. Photo by J. Bradford.

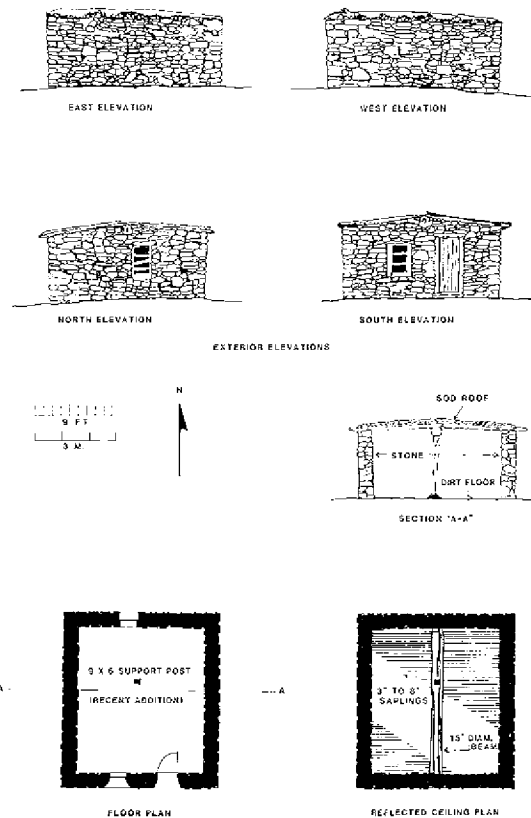

Figure 3.14. Plan and elevation drawings of the post office at Lee's Ferry. The construction methods exhibited in this building are very similar to those used to build the cook's house in 1910. Adapted from Historic American Buildings Survey records.

constructed much the same as the cook's house above; that is, sandstone block walls bracing a central viga that spans the north-south axis of the room, which supports perpendicularly set stringers. A single window occurs near the center of the north wall while another window occupies the west half of the south wall and the door stands in the east portion of the south wall. The structure served as a post office, perhaps from its inception but certainly in the latter 1910s (Anonymous 1983:8, photograph), until March 2, 1923 (Measeles 1981:90). The building was relegated to storage by the U.S. Geological Survey (USGS) in 1965. A more precise history of this building has not been developed.

Chicken Coop: A small structure (Figure 3.15) averaging 8 feet on a side and about 6 feet in height, this stone structure was also built prior to 1915. Purportedly used to house chickens (Rusho, personal communication), this small outbuilding was also constructed of sandstone, although the craftsmanship leaves something to be desired. Roof construction departs from the set pattern; it was built on four logs, one each set on a wall top. Upon the east and west logs was laid a viga that spans the width of the structure. This central beam supports a series of stringers that form the basis of the roof. Atop the outside stringer ends, as added roof weight, are two logs positioned on the south and north walls.

The construction methods and design of the two structures would suggest that they were built during the time Spencer was active in his operations at Lee's Ferry and one document implies that the chicken coop was built at the same time as Lee's Ferry Fort (National Park Service 1975:2). However, Spencer stated in 1962 that these two buildings were not present during his time there and must have been built after his departure in 1913 (Rusho, personal communication). Indications are that the post office, and perhaps the chicken coop, were built "around 1913" (Anonymous 1983:8) and may have been built either by employees of the Grand Canyon Cattle Company or Coconino County. The Grand Canyon Cattle Company had a "range cabin...at Lee's Ferry" and the ranch hand, Tom Caffall in 1913, helped in running the ferry operation (Rusho 1965:1). Whether they lived at the upper ferry location, the Spencer location, or Lonely Dell Ranch is uncertain.

Aside from the ferry, which was sold to and operated by Coconino County from 1913 to 1926, no major activities took place at Lee's Ferry during the 1910s. As it had been prior to the gold rush around the turn of the century, Lee's Ferry

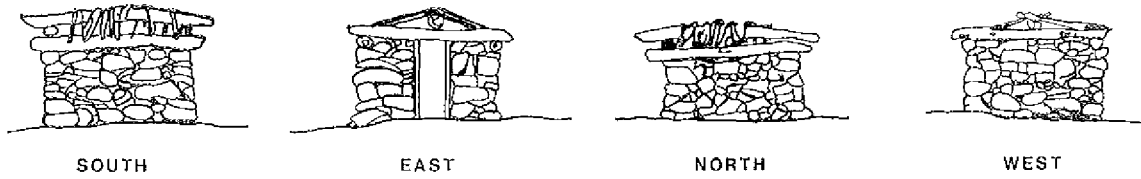

ELEVATIONS

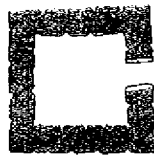

FLOOR PLAN

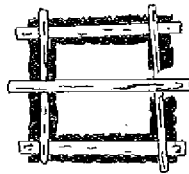

ROOF FRAMING PLAN

N

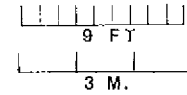

Figure 3.15. Plan and elevation drawings of the chicken coop located northwest of the fort. Adapted from Historic American Buildings Survey records.

continued to serve as the major crossing and access point to the Colorado River above the Grand Canyon and below Hite, Utah. Eugene C. LaRue of the USGS passed through Lee's Ferry in 1915 while conducting his survey of the Glen Canyon area in search of possible dam sites on the upper Colorado River. LaRue's party used Lee's Ferry as a base of operations and "lived in the rock cabins, some of which were among the seven built by Spencer" during their work upstream from the ferry (Measeles 1981:100). Rejection by the USGS of LaRue's choice of a site 4 miles above the ferry postponed any immediate activity by the government in the vicinity and, for the most part, the area remained dormant until renewed activity came to Lee's Ferry in 1921.

#### The U. S. Geological Survey Years (1921-1963)

The studies conducted by the government through the 1910s relative to flooding of the Imperial Valley in California and flood control for the Colorado River resulted in more studies in the early 1920s for a dam site in the upper river basin. In July, 1921, an unusual cooperative effort by Southern California Edison (SCE) and the USGS resulted in the establishment of a river gauging station at Lee's Ferry. The SCE crews were sent to the area to survey for a dam site and construct the gauging station, although the USGS, under E. C. LaRue's supervision, was actually in charge of the facility. At this time, Spencer's former mess hall was "remodeled into a residence and another [building] converted into a warehouse" (Rusho and Crampton 1981:77). From 1921 to 1923, SCE crews worked out of Lee's Ferry collecting data for a dam site at LaRue's mile 4 location and for a power plant to be located between the upper ferry location and the Spencer buildings (LaRue 1925:Plates IV, V).

Although LaRue's dam site was never selected, the USGS was to continue its presence at Lee's Ferry for the next 42 years. Even though personnel turnover was high because "few men, however dedicated, could stand the unrelieved isolation very long" (Rusho 1968:73), many changes to the larger structures Spencer had built occurred. All of Spencer's buildings were used in one manner or another. Those not used for daily activities were utilized for storage. Additions were built onto the mess hall and the laboratory and new roofs were constructed on these buildings as well as on the blacksmith shop and the eastern bunkhouse. Rusho's 1962 photograph of the area (Figure 3.16) illustrates the various changes made during the



Figure 3.16. Panoramic view of the Spencer area in 1962 after use by the U.S.G.S. Compare this with LaRue's 1915 photograph in Figure 3.2. Photo by W. L. Rusho.

USGS period and serves as the basis for the following descriptions of the more specific changes made to each structure.

Bunkhouses: By 1921, the superstructures attached to bunkhouses had been removed and only the more substantial portions of the buildings remained at this time (Measeles 1981:62, lower photo). As evidenced at the 1935 reunion at Lee's Ferry, all three bunkhouses were used up to about the time of World War II (Rusho and Crampton 1981:85, figure). During the next 25 years, however, the western bunkhouse fell into disrepair and was dismantled and removed while the middle bunkhouse fell into disuse but was still standing in 1964. The eastern bunkhouse continued to be used and was remodeled by the USGS sometime prior to 1962. During this remodel, the east doorway was partially sealed and converted into a window, the window in the north wall was converted into a doorway, and the entire structure was re-roofed with a more modern and higher pitched roof (Figures 3.17 and 3.18). A vent was also installed through the roof and the building was adapted for use as a laboratory for sediment studies (Rusho: personal communication.)

Mess Hall/Kitchen: This structure was remodeled into a residence for the USGS employees in the 1920s. During this period, an additional room was added to the west end of the structure enclosing the fireplace within the house. This addition measured about 18 by 10 feet and contained a window in the center of the north wall, another window in the north section of the west wall, and, undoubtedly, a window or door in the south wall. Exterior modifications included the attachment of an open front porch along most of the length of the south wall of the structure, a carport attached to the east wall, and an enclosed wooden porch, (measuring about 7 feet wide and extending outward toward the root cellar about five feet) at the rear entrance. The root cellar was apparently still in use during the 1960s. Additionally, a wooden shed (probably housing a generator) was constructed into the slope just northwest of the root cellar and a junk pile or "bone yard" located to the northwest. Finally, a small structure about the size of an outhouse was located immediately west of the junk pile and adjacent to a few large boulders that still remain there today. Outside modifications also included the formalization of a yard on both the east and west ends of the house and an access road from the west to the area of the junk pile or back yard.



Figure 3.17. Spencer's bunkhouse later remodeled into a laboratory by the U.S.G.S. The Survey's guest house is behind the laboratory. Photo by J. Bradford.

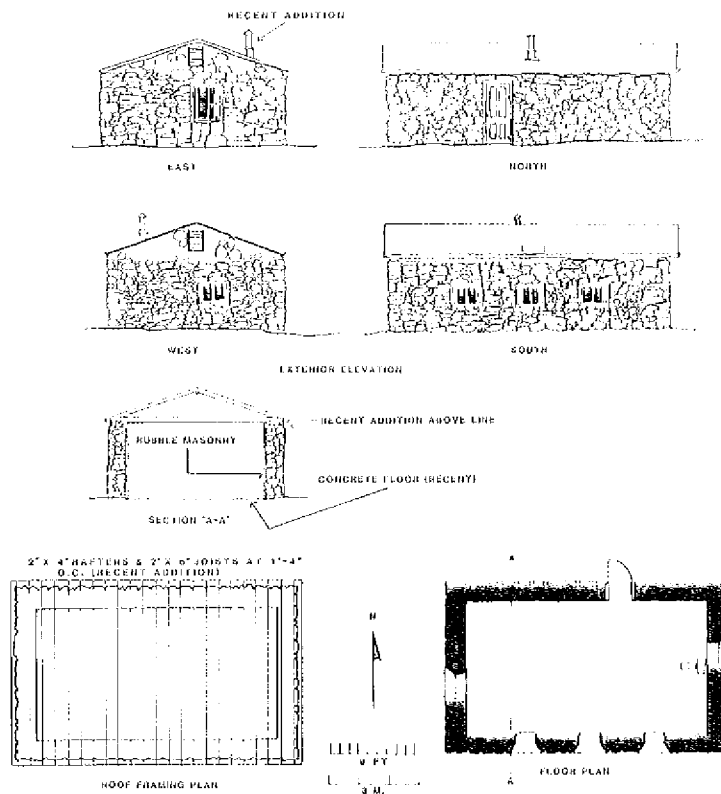

Figure 3.18. Plan and elevation drawings of Spencer's bunkhouse later remodeled into a laboratory by the USGS. Adapted from Historic American Buildings Survey records.

Cook's House: Very little modification appears to have taken place with the cook's house. This structure remained essentially in its original form throughout the years, including the roof. The interior features were removed, (as evidenced by the missing stove pipe through the roof) in order to utilize this space for storage by the USGS (Crampton and Rusho 1965:25).

Laboratory: This structure was also remodeled extensively and converted into a residence. The original length of the building was almost doubled with the attachment of another room to the west end. This changed the original orientation of the building from the east to the west. The new addition measured approximately 8 by 10 feet and included two windows on the north wall, a door and two windows on the west wall, and two windows on the south wall. The entire structure was re-roofed with a modern high-pitched roof. Exterior additions included the abutment of a wooden shed to the east end of the north wall. It measured about 6 feet on a side with the roof sloping to the north. In addition, a porch roof was attached to the west wall and extended the width of the building.

Blacksmith Shop: This building was converted to use as a garage by the USGS and received moderate remodeling (Crampton and Rusho 1965:25). A new high-pitched roof was added and double doors on either end of the structure were replaced. A series of three windows were installed equidistantly down the north wall. A wooden door was also added on the east end of the north wall. The windows on the south wall were replaced with standard size windows to match those on the north wall. The lean-to or shed that had been present during Spencer's time was removed during this period.

Guest House: In the 1950s, the USGS built a small rock house just to the northeast of the bunkhouse/laboratory. This structure is made of stone similar to the rest of the buildings, has a pitched roof and a small porch roof on the west side (see Figure 3.17). The date of construction is unknown. Crampton and Rusho described it as "consisting of one room and bath" (1965:26).

Post Office: This building was not remodeled by the USGS but was, according to Crampton and Rusho, used for storage by the Survey (1965:22).



Chicken Coop: Small, somewhat removed, and probably in bad condition, this structure apparently was not used for any purpose during the period under discussion here.

Lee's Ferry Fort: No mention is made of remodeling or use by the Survey of this building. Except for a new roof put on the fort by the NPS in 1969–1970, it has remained basically in its original form since it was constructed in 1874 (Rusho, personal communication).

Secondary Structures: The small rock structure northeast of Spencer's laboratory was dismantled sometime prior to 1962 and the remaining hole in the ground was used to dump trash. The ramada immediately southwest of the western bunkhouse was removed by this time, as was the small structure of unknown use due south of Lee's Ferry Fort. In its place, by 1962, was a short road connecting the flat terrace with the river.

Secondary Features: During the 42 years of USGS use of the Spencer area, the original two smaller boilers were stripped and overturned, one being almost completely buried in the river bank. The second boiler was turned on its side and remained below the blacksmith shop until sometime after 1970 (Figure 3.19) when it was moved up to its current location northeast of the USGS guest house (Figures 3.20 and 3.21). The second set of boilers were removed from the area at some time after 1915; the exact date being unknown. The bone yard behind Spencer's blacksmith shop was cleaned up and the materials removed prior to 1962. No mention has been found of when the pipe dredge and amalgamators were removed from the area but this must have been soon after the mining venture failure at Lee's Ferry. All of the pipe and hose running upslope to the hydraulic mining area was also removed during the USGS period.

Sometime before the early 1960s, the area between the fort and the bunkhouses had been eroded enough to warrant construction of a wooden bridge to afford crossing to the residence. The erosion was caused by runoff from mining activities north of the fort. This small plank bridge is still in use today.

The USGS left several features that are still present today. Remnants of the fence line running north–south and several feet east of the bridge near the fort can

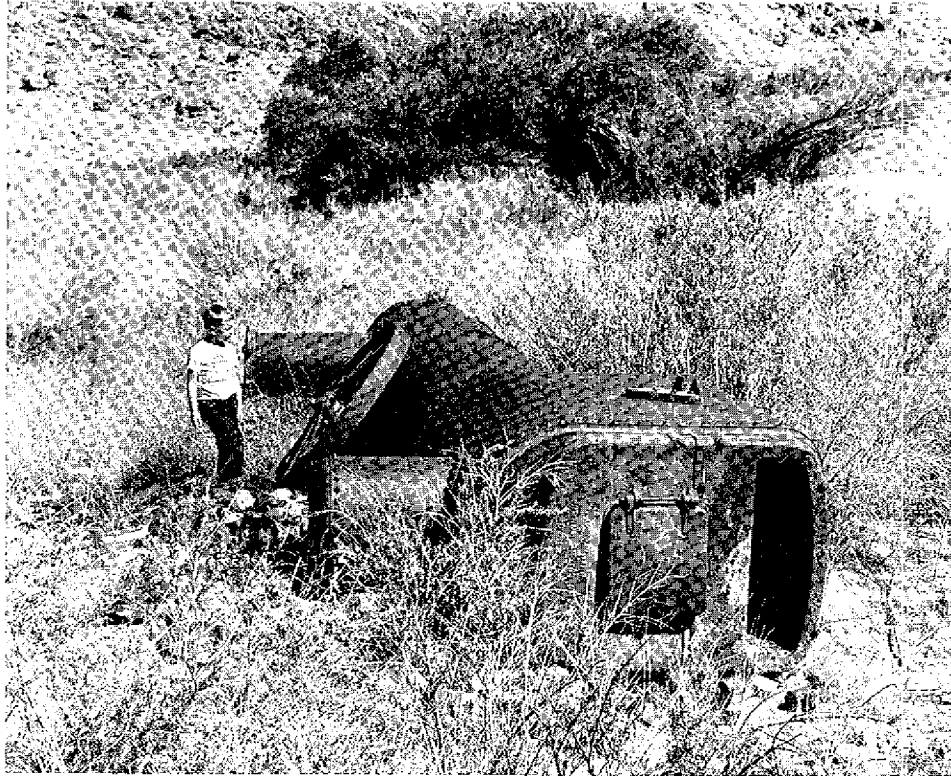

Figure 3.19. One of the two boilers located near the blacksmith shop in the 1960s. This boiler was later moved upslope to its present location. The wheel is currently located at the fort. Photo by W. L. Rusho.

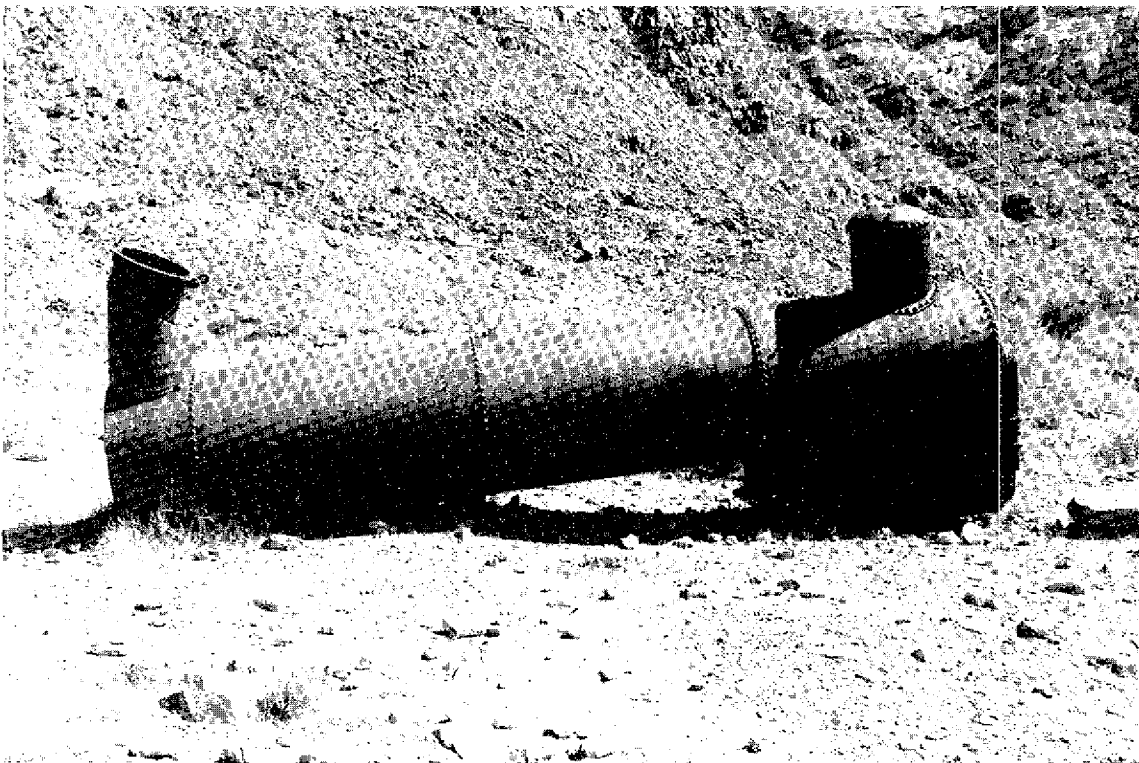

Figure 3.20. Side view of the boiler in its present condition. Photo by J. Bradford.

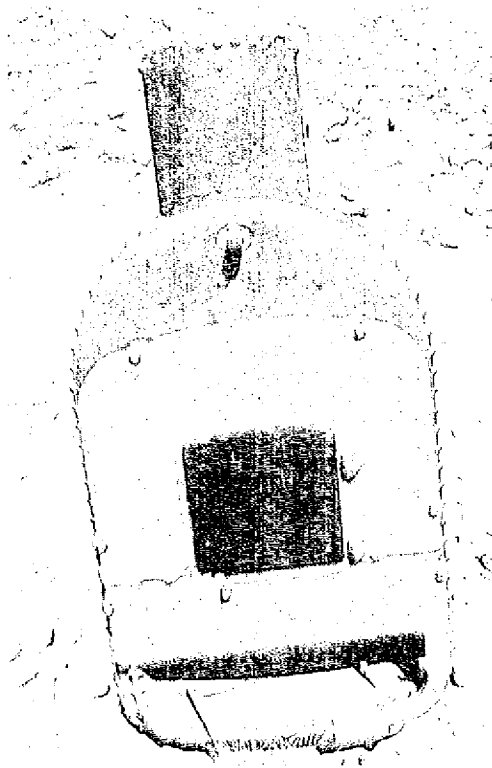

Figure 3.21. End view of the boiler showing the firebox, steam dome, and manufacturer's name. Photo by J. Bradford.



Figure 3.22. Remains of what may have been an amalgamator located northeast of the fort. The date of use of this feature is unknown. Photo by J. Bradford.

still be seen. In addition, the Survey had erected a small pole or rod within the fenced area about 300 feet northeast of the fort. Remains of the support wires were found during this study. Remnants of the secondary road to the back yard of the large residence is also visible.

Near the head of the drainage that runs under the small wooden bridge are the remains of further mining activities. One feature is the concrete base of what may have been an amalgamator set up in the bottom of the drainage (Figure 3.22). The concrete base measures 19.3 feet north-south by 31.2 feet east-west and appears to have been built in two phases: 1) the lower section being a thick stone foundation with cement mortar, and 2) the upper portion consisting of a finished concrete platform that may have accommodated four sluice boxes. A section of a wooden flume, located just north of this feature, is constructed of 1-by-6-inch lumber, and measures 10.4 feet long by 1 foot wide. Two cuts in the hillside to the west of the cement foundation indicate that hydraulic sleds were, at one time, located on the mined slope. Just downstream from the possible amalgamator is a partially buried piece of circular steel almost 5 feet in diameter. It appears to be a guard that covered a pulley wheel or gear. All of this material is located within an area of obvious past mining activity. No record indicating that this immediate area was worked during the Spencer era has been located, but Rusho (1986: personal communication) believes that Spencer returned to mine at Lee's Ferry in the 1930s and that this particular area represents those efforts. Figure 3.23 indicates the major features at Spencer's old mining community at the close of the USGS era.

The completion of the Navajo Bridge across Marble Canyon in 1929, just downstream from Lee's Ferry, relegated the ferry area to further isolation. Throughout the 1940s and 1950s, the lower end of Glen Canyon continued its pattern of isolation. The uranium boom of the the 1950s caused some activity within the general area but promising deposits of uranium-bearing formations were not to be found. Some exploration roads were cut into the surrounding hills but Lee's Ferry was to escape the main focus of this activity.

The primary activity at Lee's Ferry during this time was the development of the river running trade. Trips upriver to Rainbow Bridge, as well as down-river trips through Marble and Grand canyons originated here. Many colorful characters who would become legends in the local history frequented Lee's Ferry during this time.

FIGURE 3.23

**SPENCER MINING AREA  
U.S. GEOLOGICAL SURVEY ERA: 1923-1963**

GLEN CANYON NATIONAL RECREATION AREA  
NATIONAL PARK SERVICE  
SUBMERGED CULTURAL RESOURCES UNIT

J. STEIN/J. BRADFORD

0 25 50 75 100  
FEET

TRUE NORTH

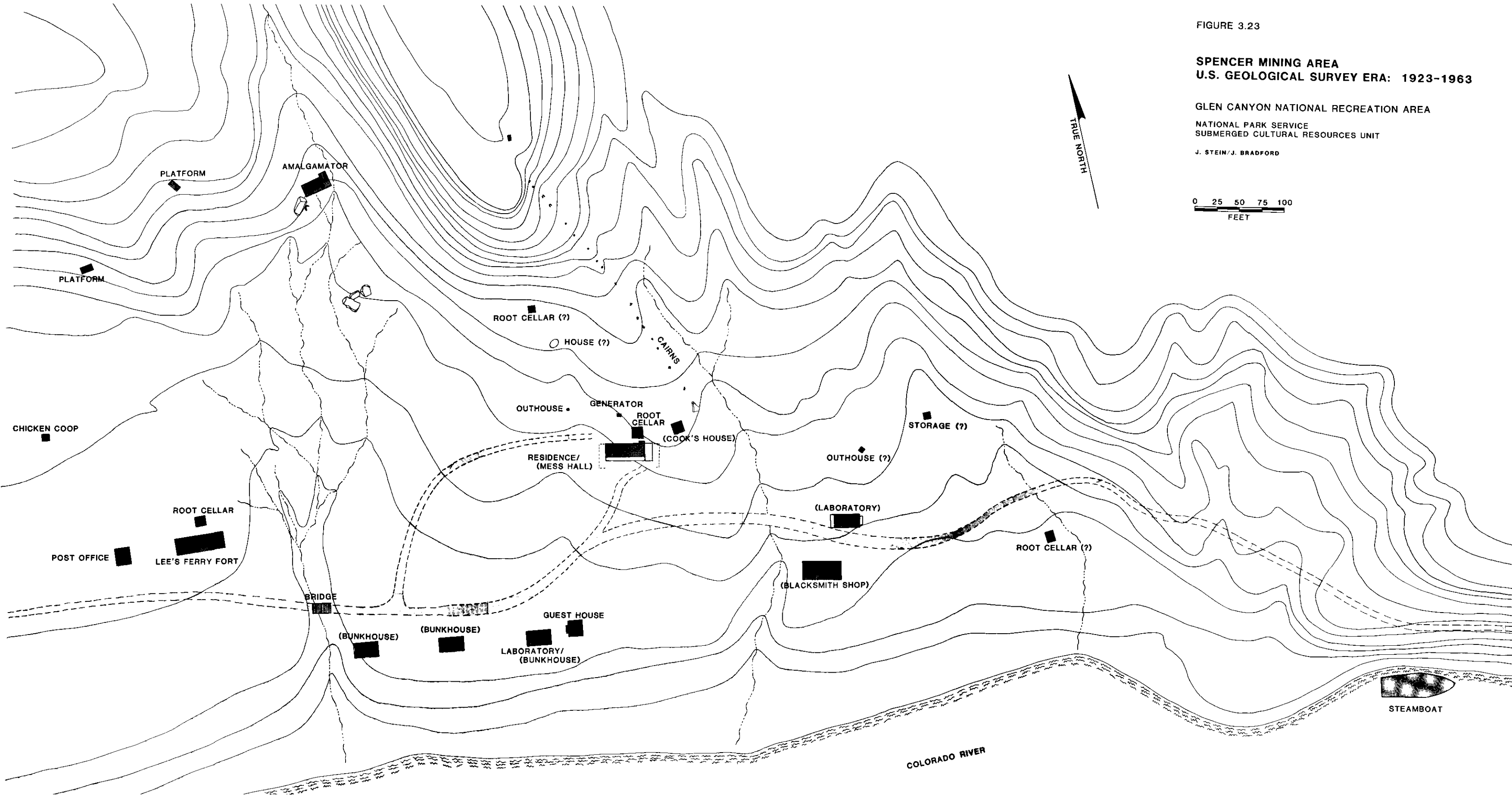

Figure 3.23. Map of the historic district as it appeared about 1963 at the end of the USGS era. Note the differences in the building configurations as compared to Figure 3.12.

Commercial development occurred at Marble Canyon on the north end of the bridge soon after it was constructed and increased during the 1940s when thousands of river floaters experienced the trip from Hite to Lee's Ferry. Just as the construction of the Navajo Bridge altered the importance of Lee's Ferry in the late 1920s, the construction of Glen Canyon Dam in the late 1950s was to change the pattern of river running.

#### The National Park Service (1963–Present)

The creation of Lake Powell behind Glen Canyon Dam resulted in the establishment of Glen Canyon National Recreation Area. Under cooperative agreements with the Bureau of Reclamation in 1958 and 1965, the National Park Service (NPS) began the task of land acquisition and management of the 1,193,671 acres of federal land within the recreation area boundary. The first decade or so was a time of acquisition, organization, inadequate staffing, and no shortage of problems to solve.

Although the task of managing the recreation area was focused on the lake and its surrounding environs, Lee's Ferry was to feel the impacts of development of public facilities early on. In 1963, the NPS began development of housing, a Ranger station and roads west of the Paria River and, by 1965, a bridge over the Paria and a new road to Lee's Ferry Fort. A large area between the post office/fort and the river was cleared and leveled for a parking lot and boat ramps (Figure 3.24). An L-shaped berm 300 feet in length was built several hundred feet behind the fort to divert water into the drainage under the wooden bridge (Turner and Karpiscak 1980:44). The road through Spencer's area remained, but forked east of the blacksmith shop; the new branch dead-ending at the river just downstream from the paddle wheel steamboat CHARLES H. SPENCER (Figure 3.25). All of Spencer's major buildings remained intact, as they had through the USGS era, except for the western bunkhouse which had been removed by this time.

In 1967, the last major changes occurred at Lee's Ferry. According to P. T. Reilly, several of the Spencer buildings were razed in February of that year (correspondence, 1986). The demolition was achieved with a bulldozer and resulted in the destruction of the laboratory, blacksmith shop, cook's house, mess hall/residence, and the middle bunkhouse. All of these structures were pushed into

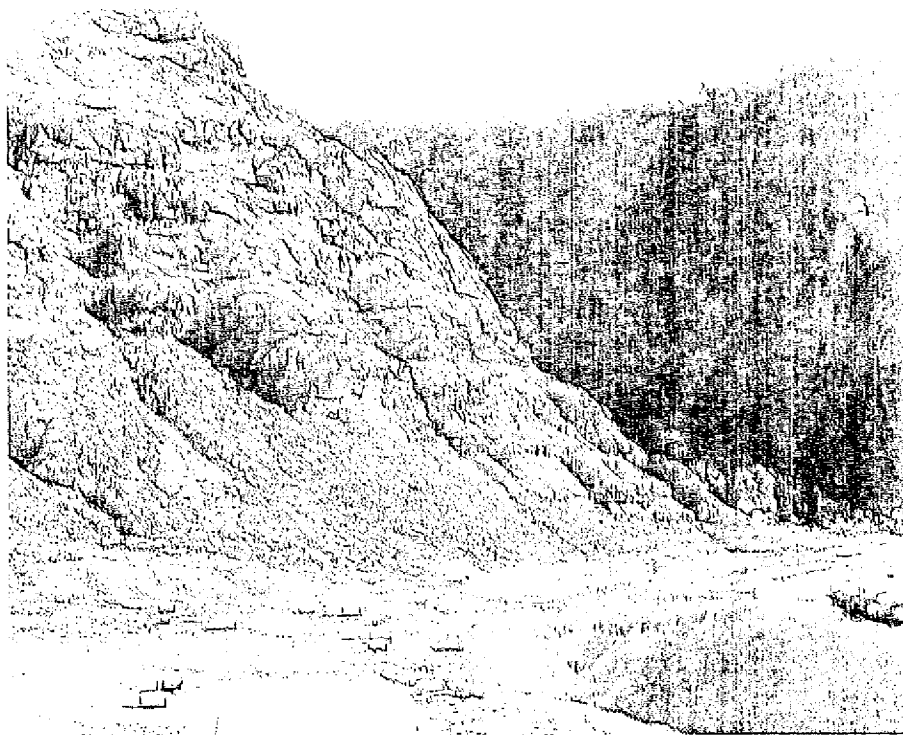

Figure 3.24. A view upstream of the Lee's Ferry area in 1963-64. The remodeled Spencer buildings occur in the background while the newly established parking lot and boat ramp area occurs in the foreground to the right of the fort and post office. Courtesy Glen Canyon National Recreation Area.



Figure 3.25. View downstream of the Spencer area as it appeared in 1963. Remains of the CHARLES H. SPENCER lay partially submerged in the foreground. The old road to the ferry is at right. Note the good condition of the USGS buildings. Photo by W. L. Rusho. Courtesy Bureau of Reclamation.



Figure 3.26. A view of the east portion of Spencer's area in 1964. Note the series of rock piles that parallel the drainage which cuts between the cook's house (right) and the laboratory (left). Compare with Figure 3.27. Photo by W. L. Rusho.



Figure 3.27. Nearly the same view as Figure 3.26 in 1986. Note the rock piles still in place but the absence of the buildings. Photo by J. Bradford.



the arroyo that cut between the cook's house and the laboratory (Figure 3.26). Scars of this action, as well as debris from the buildings, is evident today (Figure 3.27).

This left the post office, the fort, the USGS guest house and the bunkhouse/laboratory standing. In September of 1967, the NPS Ruins Stabilization Unit spent a week at Lee's Ferry conducting preservation work on the post office. The north wall of the structure had partially collapsed resulting in a loss of support for the central beam and the roof was near collapse. A 4 by 1/2 inch piece of steel was installed to support the beam and the collapsed section of the north wall was rebuilt. Other minor repairs may have been made to the other buildings at this time but, if so, were not mentioned in the monthly report.

In 1967 the Fort Lee Company purchased the concession at Lee's Ferry and ran boating and fishing operations at the fort. This made the parking lot and boat ramps the center of activity at Lee's Ferry. At least six mobile homes were brought in and set up in the area west of the post office and north of the parking lot (Turner and Karpiscak 1980:45). This situation continued through at least 1972. In order to protect the trailers, the post office, and the fort, two large berms were constructed behind the fort and post office to divert surface water runoff away from this area.

In order to provide some measure of interpretation of these remains to the public, the NPS marked a trail through the main part of the site from Lee's Ferry Fort (Figures 3.28-3.30), past the sunken boat, and on to the ferry crossing. Other minor features are also interpreted, including the pump shown in Figure 3.10 and the remains of a paddle wheel assembly (Figure 3.31) purportedly to be from the SCE boat COLORADO used in the early work assessing dam sites. A trail guide with information on the history of the remains is available for this tour.

### Summary

Lee's Ferry has, since prehistoric time, afforded people a reasonable access to, and a crossing over, the Colorado River. The location between Glen and Marble canyons has made it a strategic point throughout the history of the area and thus much history has been made here. When Charlie Spencer first arrived at Lee's Ferry in 1910, the ferry had been in operation for almost 40 years and the location not



Figure 3.28. View west of Lee's Ferry Fort in 1986. Note the good condition of the fort proper. Photo by J. Bradford.

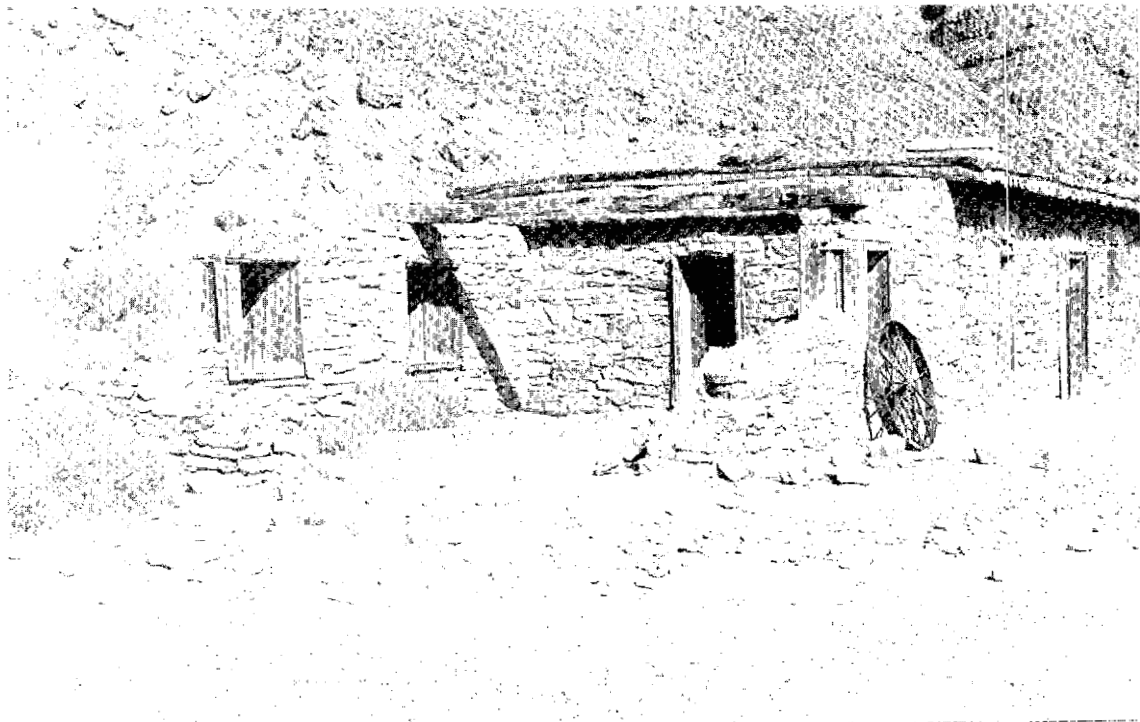

Figure 3.29. View north of Lee's Ferry Fort in 1986 showing the collapsed walls of the Spencer addition on the south end of the fort. Note the steel wheel from the boiler. Photo by J. Bradford.

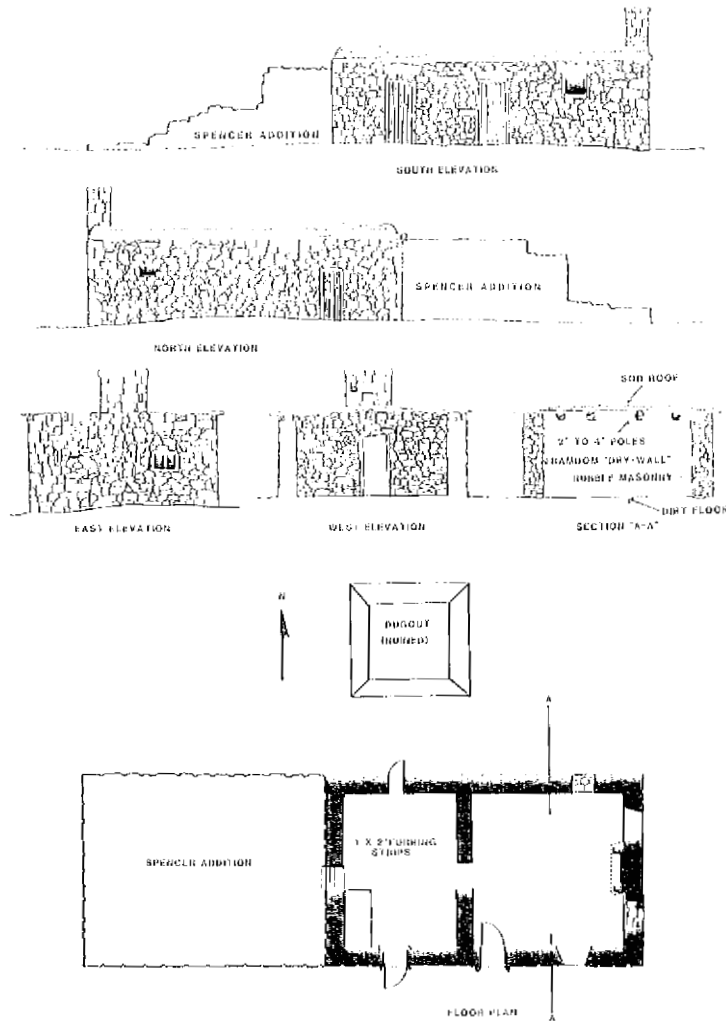

Figure 3.30. Plan and elevation drawings of Lee's Ferry Fort and the dugout immediately behind it. Adapted from Historic American Buildings Survey records.

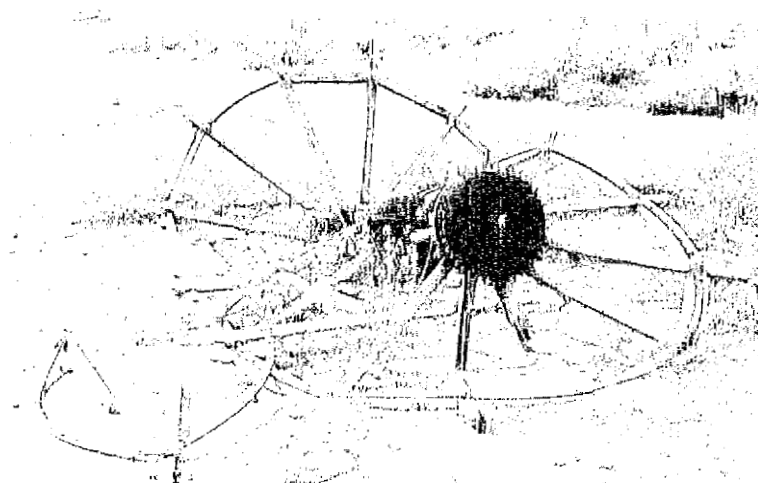

Figure 3.31. Closeup of paddle wheel near interpretive trail northwest of the USGS guest house. This wheel is reported to be from a Southern California Edison gasoline-powered boat used in the early 1920s at Lee's Ferry. Photo by J. Bradford.

only provided him with the geologic formation he was seeking, but it also provided him with the main access route to the river in this section of the canyon. Although not successful in his venture, Spencer was to have a major impact on the immediate vicinity. He created a small community at Lee's Ferry and provided a new, although limited, economy for the area. The rock structures built for his mining operations were to serve his men, river runners, scientists, and engineers for the next 50 years. The actual mining activity left a visual impact on the area and, although it too failed, the Lovett pipe dredge was tested at Lee's Ferry; one of hundreds of patented pieces of equipment developed for the Glen Canyon mining boom around the turn of the century.

Although the USGS period was one of isolation and limited activity for Lee's Ferry, life would have been more primitive for the employees stationed there had it not been for Spencer's structures. They adapted and improved the buildings Spencer had left and, in their own way, left a reminder of this period of history at the ferry.

With the advent of the NPS, it is now a time of preserving the remaining structures and interpreting the past events to the public. Although much history preceded Spencer's time there, the history of Lee's Ferry would not be complete without giving Spencer his credit. This can only be done, now, through the written record and through the recognition and preservation of those physical remains still at Lee's Ferry.

#### Prior Research

Published references to the Lee's Ferry area and Charlie Spencer's mining operation are numerous. The authors include: Kolb (1914), Haskett (1935), Colton (1957, 1962), Crampton (1959, 1960, 1986), Rusho (1962, 1968); Crampton and Smith (1961), Crampton and Rusho (1965), Lingenfelter (1978), Measeles (1981), Phoenix (1963), Rusho and Crampton (1981), Sykes (1937), Turner and Karpiscak (1980), among others.

The area has been photographed intermittently from 1910 through the present. The Bureau of Reclamation has an extensive collection of historical photographs, as does W. L. Rusho in his private collection.

Documentation of the historic site has been limited to a handful of unpublished manuscripts, and National Park Service administrative reports (Crampton and Rusho 1965, Dick 1985, Reynolds 1974, National Park Service 1985, Richert 1967). In December of 1985, District Ranger Jon Dick provided a preliminary map of the remains of CHARLES H. SPENCER and, in early 1986, he and seasonal ranger Dave Fowler prepared a sketch map of all known features in the Spencer mining area. Also in 1985, the Submerged Cultural Resources Unit was contacted to investigate the condition, history, and effects of differing water levels on the sunken vessel. That request led to the study reported on in this document.

#### Administrative Status

In October 1972, legislation formally establishing Glen Canyon National Recreation Area was passed (Public Law 92-593) and resulted in the application of all regulatory and preservation mandates for all resources contained within the boundaries. Most appropriate to this study are those laws and regulations providing protection and preservation to historic sites and structures. With the application of the National Historic Preservation Act of 1966 (as amended in 1980), the structures at Lee's Ferry were evaluated and determined eligible and qualified as a historic district. In 1976, the Lee's Ferry Fort/Spencer mining area and Lee's Ferry crossing were entered in the National Register of Historic Places. Lonely Dell Ranch, purchased for inclusion into the recreation area in 1976, was also listed as a separate district in the National Register in 1978 (Figure 3.32). These actions were positive steps in the preservation and protection of the physical remains at Lee's Ferry which are very important aspects of the regional history of Utah and Arizona.

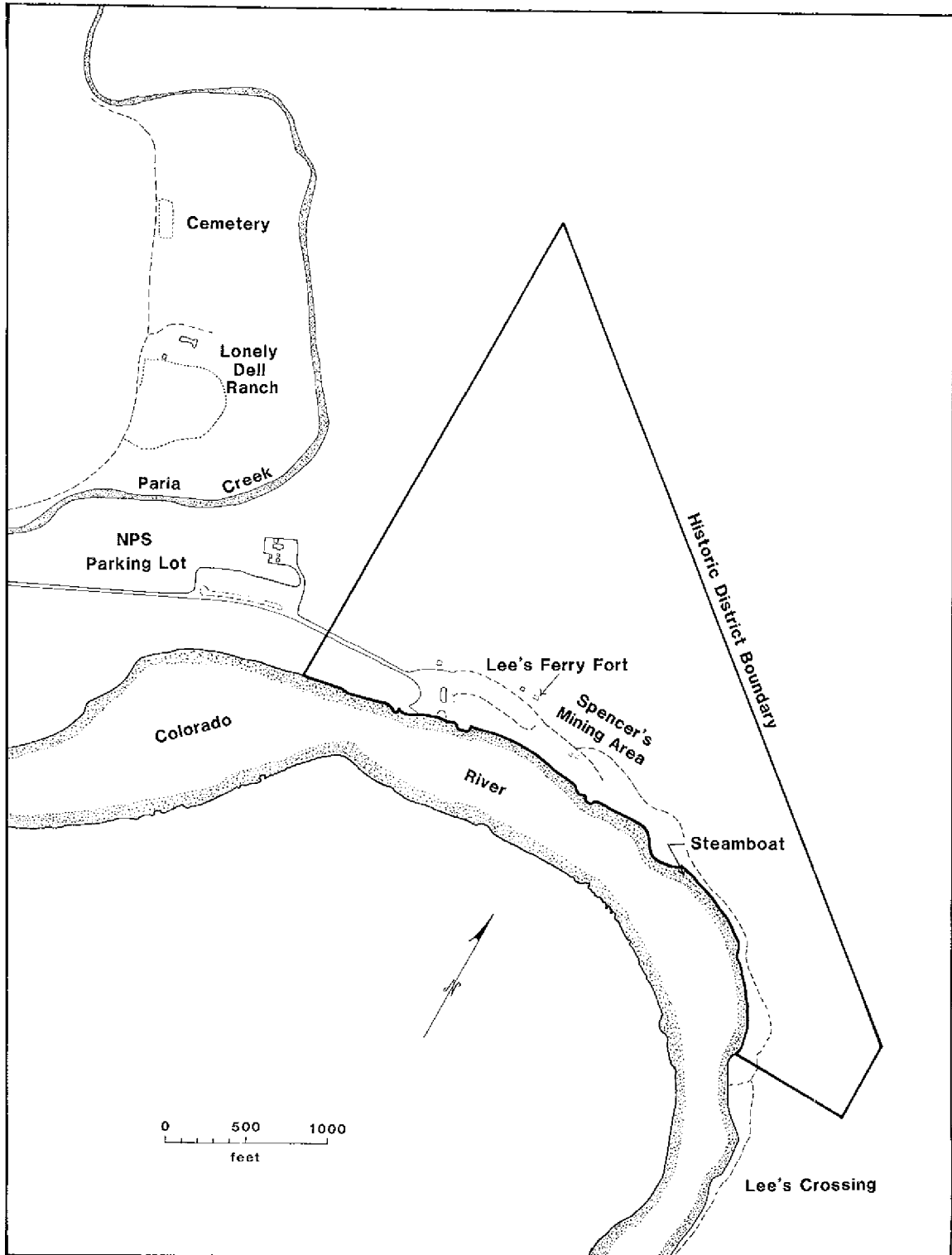

Figure 3.32. A map of the National Register of Historic Places district at Lee's Ferry.

## CHAPTER IV. LEE'S FERRY HISTORIC SITE DISCUSSION

### Site Location

Charlie Spencer's mining operation was located almost midway between the Paria River and Lee's Crossing (upper ferry) on the north bank of the Colorado River (see Figure 3.32). The community was located one mile upstream from the present confluence of the Colorado and Paria Rivers and encompassed an area of about 75 acres. General orientation of the site is to the south toward the river.

### Research Methodology

Field investigations of the historic site were conducted in conjunction with, and as an adjunct to, the study of the sunken paddle wheel steamboat CHARLES H. SPENCER. Documentation of the site consisted of conducting a pedestrian survey of the area and locating, with the help of the District Ranger, all visible remains of previous activities within the site. Site boundaries were determined by the evidence on the ground as well as by the use of historical photographs. All manifestations were designated with a feature number and marked for later reference. After location, the features were compared to historical photos and discussed with Mr. Rusho to confirm the time period they represented.

A measured map was then created using a plane table and alidade. Eight sheets of mapping paper were required to cover the entire area, and from these a composite map was generated at the scale used in the field and later reduced for inclusion in the final report. Contour intervals were taken from an orthophoto contour map of the Lee's Ferry area and overlaid onto the plane table map using a Map-o-Graph machine. Minor variations in the contours that appear in this report are based on the author's interpretation of landscape changes as shown in photographs of the area taken through time.

Interpretation of the changes in the structures and other features through time is also based on historical photographs and documentation made available by Mr. Rusho. The function or period of use of minor features cannot always be pinned down using this method. Other means of documentation (i.e. personal papers, diaries, etc.) concerning Lee's Ferry were not exhausted and would prove to be beneficial for a more detailed level of investigation.

### Site Description

A thorough description of the site through time is provided in the previous chapter. Today the structures and features are considerably different from the Spencer era and the latter USGS period. Only two of the buildings standing during Spencer's time are still intact and both have been modified to some extent. The bunkhouse was remodeled into a laboratory by the USGS and Lee's Ferry Fort has been re-roofed and the Spencer addition has fallen into ruin. Of the 12 structures that stood at various times during the USGS era, only 4 are still present: the guest house, the bunkhouse/laboratory, Lee's Ferry Fort, and the chicken coop.

Despite the loss of most of the buildings that were once present at this site, a closer examination of the area revealed the presence of numerous smaller features. These features represent the remains of activities carried out by the various people that lived and worked within the general Lee's Ferry vicinity from 1874 to the present. Table 4.1 lists the 49 feature designations assigned during the fieldwork for this project. These are listed in order by feature number and are followed by a short description according to information obtained on them during this study. The feature numbers assigned correspond to numerical data presented in Figure 4.1, a map of the Spencer mining area as it appeared in 1986. Comparison of this figure to Figures 3.12 and 3.23 will provide a graphic display of the changes that have been documented at the site. Figure 4.2, a panoramic photograph of the area in 1986, will also provide comparative information on the historical changes at Lee's Ferry through time when compared with Figures 3.2 and 3.16.



Table 4.1 List of Features Documented  
at Lee's Ferry Historic Site

No.	Feature	Comments
1	Spencer's Laboratory	Razed in 1967
1A	Trash Dump	Composed of coal clinker, kiln brick, and crucible fragments. 6.5 feet in diameter of which only one quarter remains. Disturbed during razing of the laboratory.
1B	Trash Dump	Same as 1A in character. 9 feet in diameter.
2	Spencer's Blacksmith Shop	Razed in 1967.
3	Spencer's Cook's House	Razed in 1967.
4	Spencer's Mess Hall/ Kitchen	Razed in 1967.
5	Spencer's Bunkhouse	Later remodeled by USGS.
6	Lee's Ferry Fort	Built in 1874. Remodeled by Spencer in 1911.
7	Post Office	Built prior to 1915. Good condition.
8	Burned Outhouse	Superstructure burned. Pit contains 2 x 4 inch runners spanned with 1 x 12 inch planks and weighted with rocks; 6.5 feet across.
9	Storage Building	Semi-subterranean building, razed. Possibly a powder magazine. Used as a trash dump in the 1950s by USGS.
10	Boiler	Horizontal, "locomotive type" boiler used by Spencer to operate mining equipment. Made by Nagle Engine and Boiler Works, Erie, Penn.
11	Machine Part	Possibly a piece off of Feature 12.
12	Water Pump	Cylinders of a steam-driven water pump.
13	Paddle Wheel	Remains of a chain drive paddle wheel.
14	USGS Guest House	Built in 1950s. Good condition.
15	Unassigned Number	
16	Spencer Bunkhouse	Razed in 1967

No.	Feature	Comments
17	Wooden Post Remnant	Remains of a wooden fence post.
18	Amalgamator	Concrete base for amalgamator.
19	Flume	Wooden flume remains.
20	Root Cellar	Superstructure gone. Unknown depth, 6.5 feet on a side. Pit lined with 2 x 6 inch boards and reinforced with sandstone blocks.
21	Root Cellar (?)	Roughly circular depression 15 feet across. Upright 2 x 8 inch board in center of depression, probably a roof support.
22	Trash Dumps	Two roughly circular piles of trash near the ferry road. Artifacts date to 1950s.
23	Boiler	Partially buried boiler. Same as Feature 10 but resting on its side.
24	Chicken Coop	Built prior to 1915.
25	Spencer's Bunkhouse	Razed prior to 1967.
26	Cairns & Supports	Eighteen rock cairns, steel rod and wooden post-supports associated with the hydraulic mining hose.
27	Surveyor's Brass Cap	Stamped with BISA
28	Wooden Pole Remnant	Appears to be a utility pole sawn off at ground level.
29	Wooden Post	Probably a wooden fence post now rotted off at ground level.
30	Former Road	Traces of road tracks.
31	Upright Slabs	Rock slabs set into the ground along with 2 x 4 inch posts suggest remains of a small structure. Historic artifacts include broken glass and a leather boot.
32	Iron Pipe	Not mapped.
33	Iron Pipe	Two segments of iron pipe driven into the ground and connected to heavy gauge wire. Probably support wires for an antenna.
34	Rock Cairn	Associated with electrical wire and suggests a support for a utility pole.

No.	Feature	Comments
35	Platform	Level platform cut into the side of the hill and supported by a rock retainer wall on the downslope side.
36	Platform	Similar to Feature 35.
37	Root Cellar (?)	Pit in ground measuring 6.5 feet on a side. Surrounded by earth berm 3 feet in width and containing beams and planking.
38	Root Cellar	Remains of root cellar behind Lee's Ferry Fort.
39	Low Berm	L-shaped berm constructed to redirect surface water away from Lee's Ferry Fort.
40	Concrete Platform	Built into the larger berm behind Lee's Ferry Fort and may have been associated with a trailer house located here in the late 1960s.
41	Large Berm	Massive berm constructed to redirect surface water away from the Fort Lee concession and housing area in the late 1960s.
42	Metal Guard	Appears to be a guard from a piece of machinery associated with the 1930s mining area.
43	Structural Debris	What appears to be the remains of the mess hall, laboratory, blacksmith shop bulldozed into the arroyo.
44	Structural Debris	Scattered remains indicating the former presence of a frame structure.
45	Paddle Wheel Boat	CHARLES H. SPENCER.
46	Unassigned Number	
47	Unassigned Number	
48	Mined Area	Slopes of hill mined in 1930s.
49	Mined Area	Slopes of hill mined in 1911-1912
50	Mined Area	Area of the Colorado River near the north bank where the Lovett pipe dredge was used.

Although most of the physical remains of the major structures in Spencer's mining area have been removed, information collected during this study will allow a

reconstruction of the major events at this location during Spencer's time there and to allow a history of those resources since. The USGS period itself lends a certain amount of history to the area and, within the historic record, provides a continuum of events related to the earlier Spencer era remains. With much of the primary resources since removed, it is more difficult to interpret to the public the events that helped shaped the history of Lee's Ferry during the early part of the twentieth century. However, the NPS has made a beginning in this interpretive endeavor and could, with the information provided in this study, expand and enhance the interpretive story at Lee's Ferry.

FIGURE 4.1

**SPENCER MINING AREA  
NATIONAL PARK SERVICE PERIOD: 1963-1986**

GLEN CANYON NATIONAL RECREATION AREA  
NATIONAL PARK SERVICE  
SUBMERGED CULTURAL RESOURCES UNIT

J. STEIN/J. BRADFORD

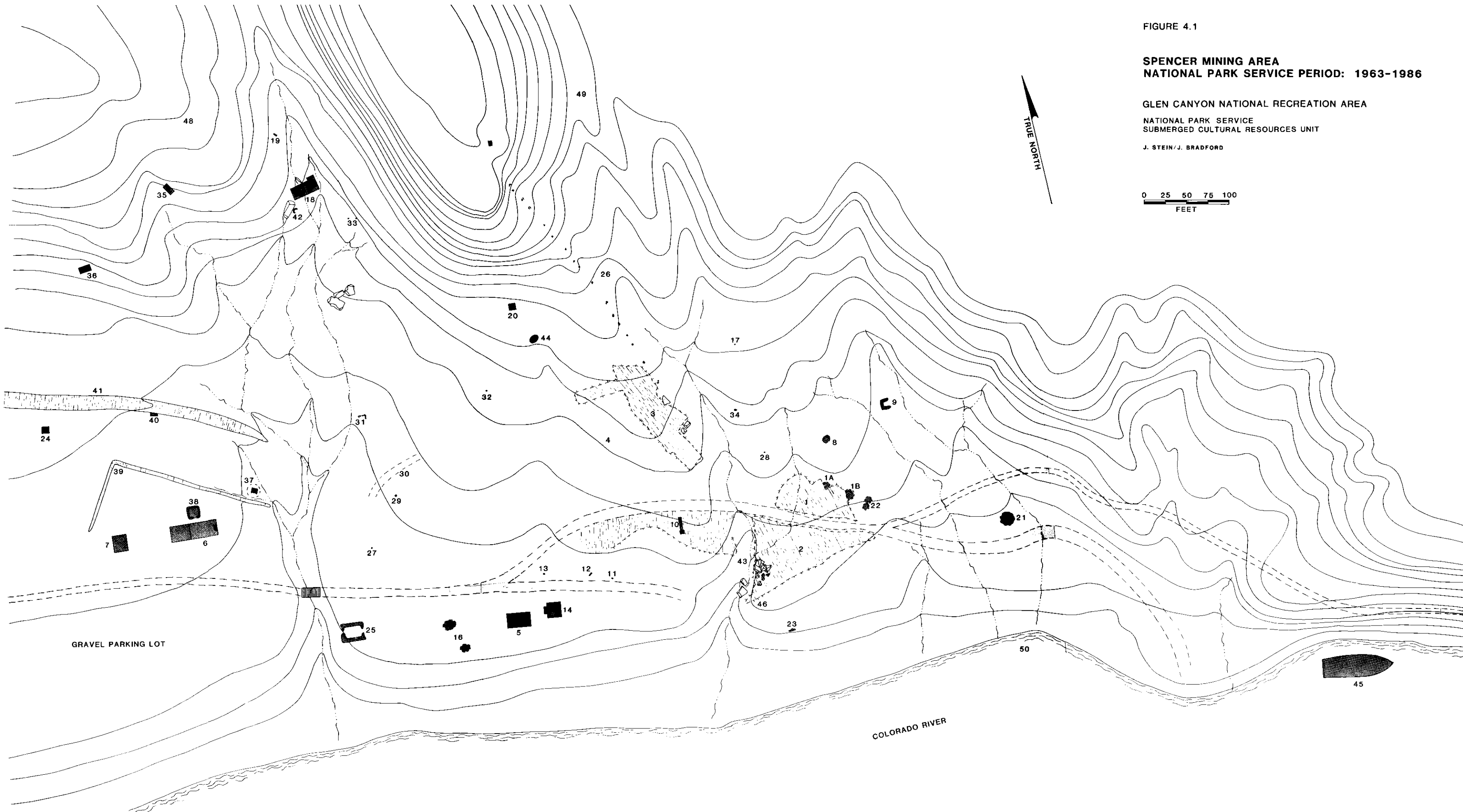

GRAVEL PARKING LOT

COLORADO RIVER



Figure 4.2 Panoramic view of Lee's Ferry Historic Site in 1986. Compare with Figures 3.2 and 3.16. Photo by J. Bradford.

**CHAPTER V. THE PLACE OF THE PADDLE WHEEL STEAMBOAT  
CHARLES H. SPENCER  
IN COLORADO RIVER MARITIME HISTORY AND  
PADDLE WHEEL VESSEL DEVELOPMENT**

Colorado River Navigation

Historically the Colorado, Sacramento, San Joaquin, and the Columbia River systems were the main thoroughfares for settlement and development in the Western interior. In the period from 1849 to nearly 1900, paddle wheel steamboats provided the cheapest and most efficient form of transportation and all three rivers supported thriving steamboat businesses. Despite the distances between them, there was an active interchange of men and boats. A pioneer of Colorado River steamboating eventually headed a monopoly on the Sacramento River, and Columbia River shipwrights built the last surviving steamboat on the Colorado (Yuma Sun June 17, 1910). Steam navigation on these four far Western river systems<sup>1</sup> was directly related and was intertwined with the development of transportation in the West.

The California Gold Rush of 1849 was the major impetus for expansion into the Colorado river country. That same year the first formally recognized ferry at Yuma crossing was established just below the junction of the Gila (Lingenfelter 1978:2). Fort Yuma was established in 1851 on a nearby bluff, and the need to support the garrison led to subsequent efforts to navigate the river. The first

---

<sup>1</sup>Although it is appropriate to refer to the Colorado, Sacramento, San Joaquin, and the Columbia Rivers as Western rivers in this discussion, it should not be confused with the general term "Western Rivers." This term has more commonly been used in discussions of maritime history to refer to riverine systems in the midwestern United States. The four far Western rivers discussed here are part of the Pacific drainage system and may be characterized as such.

attempt to reach Fort Yuma was made in 1850 by Captain Alfred Wilcox, in the schooner INVINCIBLE. Unreliable information on the distance of the fort from the mouth of the river and 6 foot tidal fluctuations forced the vessel to abandon river travel.

An army representative on INVINCIBLE was later to suggest using a steamboat. Lieut. George Horatio Derby, U.S.A., recommended "a small stern-wheel steamer with a powerful engine and thick bottom ... eighteen or twenty feet beam, drawing two and a half to three feet of water" (San Francisco Daily Herald, October 22, 1851). Derby's suggestion was ignored for nearly two years while sailing vessels were tried. The first paddle wheel steamboat on the Colorado was launched at the mouth of the river in November, 1852. The 65-foot sidewheeler UNCLE SAM, loaded with supplies for Fort Yuma, arrived nearly two weeks later. Newspapers on the west coast quickly announced that steam navigation on the Colorado River was established beyond doubt (Los Angeles Star, December 25, 1852).

Commerce on the Colorado followed and settlements up the river were established in rapid succession (Figure 5.1), and

Before the 1850s passed, steamboating over this one-hundred-fifty-mile stretch of river had assumed a regular schedule, and there had even been some exploratory steamboat navigation above the fort. Initiated as a means of supplying the military at Yuma, other opportunities for trade subsequently developed. Mormons in the Utah territory, in their efforts to import needed supplies, saw in this riverboat trade an opportunity to connect a ... water freighting route with wagon freighting lines from west coast points. Mineral developments in Southern Arizona also served as a stimulus as did the hauling of army supplies and such produce as wool, hides, pelts, farm machinery, household commodities, newsprint, and general dry goods (Winther 1964:82-83).

The discovery of silver in 1861, followed by the discovery of gold, triggered the Colorado River rush of 1862. In the boom years of the 1870s, Colorado River steamers were carrying more than 100 passengers a month, and freight was transported for \$40 per ton (Arizona Sentinel, September 1876). Recognizing the potential for profits, the Colorado Steam Navigation Company established regular routes from San Francisco to Port Isabel, at the mouth of the Colorado. By the



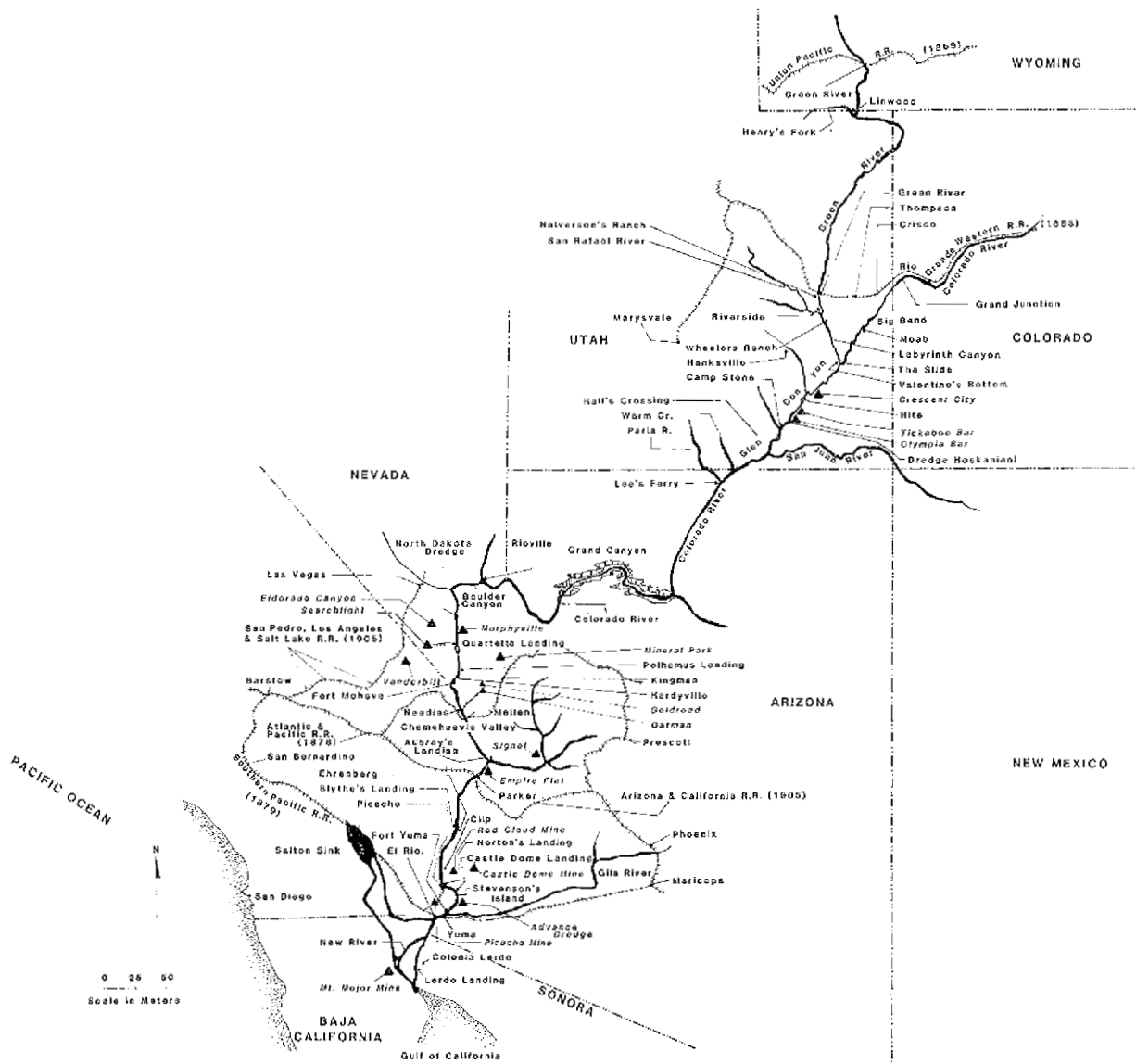

Figure 5.1. Settlements and steamboat landings on the Colorado and Green Rivers, 1880 to 1910. After Lingenfelter, 1978.

mid-1870s the company was handling 7,000 tons of freight and about 1,000 passengers annually (Lingenfelter 1978:71).

During the 1860s and 1870s, paddle wheel steamboats regularly traveled up the river as far as Hardyville, some 300 miles above Yuma. Hardyville was the practical head of navigation at this time and was the principal shipping center for northern Arizona. In the period from 1850 to the late 1870s steamboat landings nearly tripled, from less than a dozen to 35 (Lingenfelter 1978:10, 34).

Colorado River navigation was further aided by the fact that the mining operations produced large amounts of ore. So much so that it all could not be smelted locally; smelters during that period being small, individually owned operations. By 1867 the need for larger smelters was so great that Thomas H. Selby, of San Francisco, established the first major smelter on the Pacific Coast. Colorado River steamers carried ore down to the mouth of the river, where it was then freighted by ship and rail to San Francisco. Selby's operation was so large it handled Colorado copper and silver, Nevada silver and gold, as well as the ores extracted from Arizona and Utah. This smelter also provided gold for the U.S. Mint (Delgado, personal communication 1987).

The substantial profits made by shipping companies came to an abrupt halt in the late 1870s. In the spring of 1877, the Southern Pacific railroad reached Yuma, breaking the Colorado Steam Navigation Company's monopoly on the river trade. The company could not compete with the cheaper, faster railroad, and steamboating above Yuma slowed to a trickle. By 1879 the population of Yuma had fallen from approximately 1500 to 500, and the second largest town on the river, Ehrenberg, was virtually abandoned (Arizona Sentinel, June 1879).

Coincidentally, in July of that year the head of Colorado River navigation, the mouth of the Virgin River, was finally reached. Captain John Mellon navigated the 149-foot sternwheeler GILA from Eldorado Canyon, through the rapids in Black Canyon and Calleville, to the Mormon settlement of Rioville at the mouth of the Virgin on July 8, 1879 (Arizona Sentinel, July 1879). Navigation above Black Canyon was limited to a shallow-draft sloop during the dry summer months, while during high water GILA made the trip. steamboating above Eldorado Canyon was

short-lived however, and finally came to a halt in 1887 when mining operations at Eldorado ceased (U.S Congress, 56th Congress 1900:3, 6).

The railroad brought reduced shipping costs throughout most of the Arizona Territory and with it a boost to mining in the region. The reduction in rates was not reflected along the Colorado River however, where they remained nearly unchanged. As a result, mining efforts shifted away from the river country. Limited river commerce was reduced even further when the Atlantic and Pacific Railroad crossed the Colorado below Fort Mojave (Arizona Sentinel, January 1880). After the construction of the bridge across the Colorado at Needles in 1883, only one steamboat remained on the river; ironically, it was GILA (Arizona Sentinel, May - July 1885).

The Colorado River region languished until the repeal of the Sherman Silver Act in 1893 and the final collapse of silver prices. The decline of silver and the steady price of gold lured prospectors back and, in the early 1890s, several mining operations were opened along the Colorado. The Searchlight mines, just south of Eldorado Canyon, were discovered in 1897. Other mines near Yuma and Fort Mojave, discovered just after the turn of the century, further boosted river transportation. Several of the newly discovered mines were completely dependent upon river transportation, so once again steamboats began to appear on the river (Arizona Sentinel, October - December 1901, March - May 1902).

The introduction of the gasoline engine on Colorado River craft occurred about this time, and led to the appearance of gasoline-powered paddle wheel and propeller-driven boats. The first gasoline-powered boat on the Colorado River was launched in December 1891. ELECTRIC SPARK was an instant success, and in fact the gasoline engine was so powerful, the boat was rebuilt with a larger hull and re-named ELECTRIC in 1892 (Needles Eye, December 1891; Arizona Sentinel, January 1892). Smaller-sized, lighter-draft boats, such as the less than 60-foot ELECTRIC, were more cost-efficient than 149-foot GILA and its contemporaries. These boats were able to make a profit carrying smaller cargos and making more frequent and shorter trips.

Competition for trade heightened after the turn of the century. The Colorado River Transportation Company was organized in the fall of 1902. By December of

that year the company had contracted with Columbia River shipwrights for the construction of a 91-foot long, 18-foot beam, stern-wheel steamer (Figure 5.2). SEARCHLIGHT was equipped with a marine boiler and a 100-horsepower steam engine, had a cargo capacity of 60 tons, and was fitted out with six staterooms, a smoking room, and a galley to serve passengers (List of Merchant Vessels of the United States 1904:297). The boat was in regular service by April, 1903, carrying passengers and freight from the Needles railroad connection 60 miles up river. Despite its success, SEARCHLIGHT proved to be the last steamboat launched on the Colorado River below the Grand Canyon (Lingenfelter 1978:95).

Despite ELECTRIC's success, between 1890 and 1900 only 5 gasoline boats were placed on the river. Gasoline-powered boats peaked between 1900 and 1910 with 18 vessels; however, with the majority of them less than 40 feet long, they were no real threat to the steamboat in the competition for river trade (Figure 5.3). The gasoline-powered boats as a group also proved to be underpowered for the river currents (Lingenfelter 1978:88). Their limited utility resulted in a rapid decrease in numbers, and by 1912 there were only 5 boats still in use; by 1914 the last was put out of service (Lingenfelter 1978:118).

Along with the arrival of gasoline-powered boats after the turn of the century, the revival in mining along the river brought the introduction of the gold dredge. Dredges had profitably been used in various locations in the West since 1894, and by 1900 more than 75 dredges were working in the region. A dredge was being used in the upper Colorado basin, near present-day Breckenridge, on a tributary of the Colorado in 1896; and by 1900 gold dredges were being introduced on the Colorado River itself (Los Angeles Mining Review, December 1900).

ADVANCE was a typical Colorado River dredge. It had a beam of 30 feet, was 110 feet long, was equipped with a continuous chain of half-ton buckets, and was powered by a pair of 80-horsepower locomotive engines. Up to 4,000 cubic yards of gravel a day could be dumped into a revolving cylindrical processor, mounted amidships. The finer gold-bearing gravels were then run through an 80-foot sluice to remove the gold (Los Angeles Mining Review, February-September 1900). ADVANCE was unable to adequately collect the fine gold from the Yuma-area deposits. In 1909 NORTH DAKOTA, another dredge, also failed for the same reason; this time farther up river near the mouth of Eldorado Canyon and the once

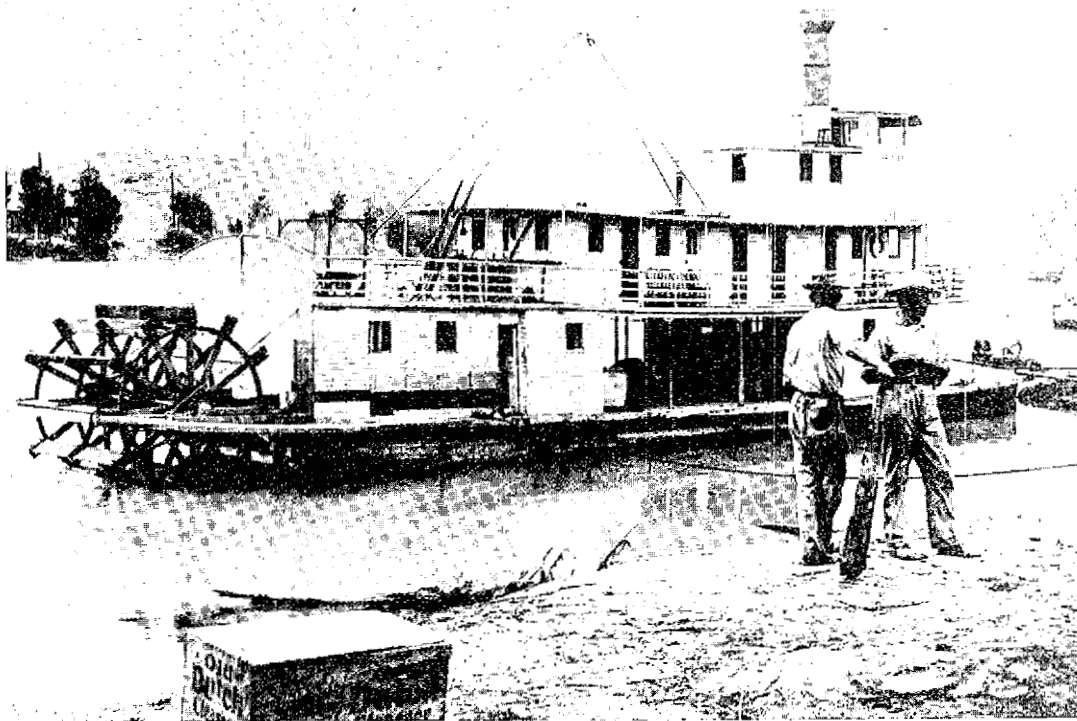

Figure 5.2. SEARCHLIGHT, built for F. L. Hawley of Needles in 1902, was one of the most commercially successful paddle wheel steamboats on the river. Photographer unknown. Courtesy Bureau of Reclamation.

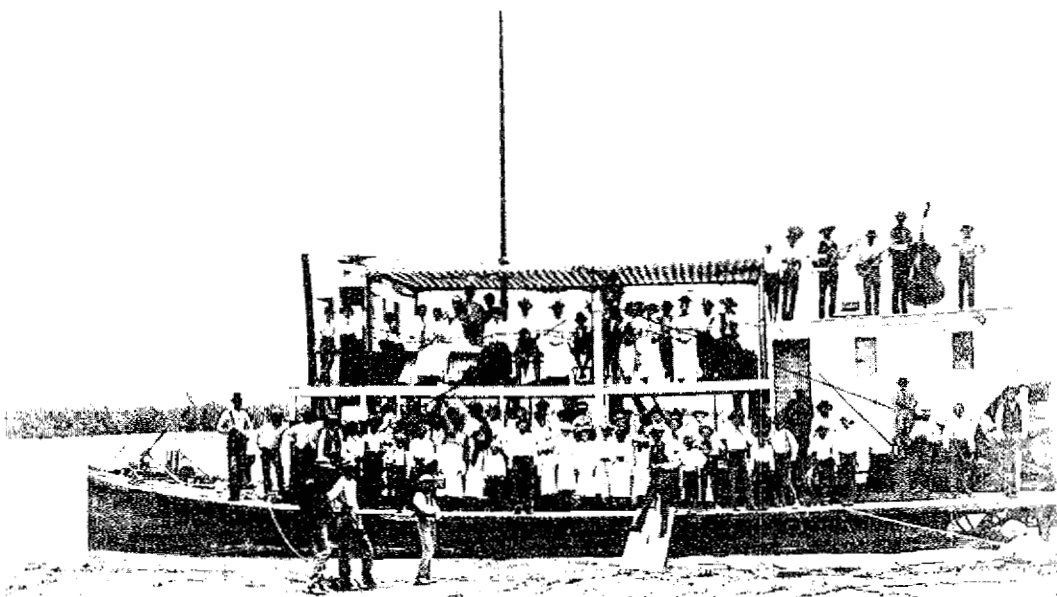

Figure 5.3. The gasoline-powered AZTEC carried passengers and light freight between Yuma and several of the up-river landings. The small boat also made frequent pleasure trips up the Gila and down to the estuary. Arizona Historical Society Library photo, circa 1893.

productive mines located there. In January, 1910 the dredge swamped and sank in a flood; the editor of the Searchlight Bulletin commented:

The monster barge seems to have solved the problem confronting the unfortunate stockholders of what to do with the "white elephant" by committing suicide (January 1910).

The failure of both ADVANCE (Figure 5.4) and NORTH DAKOTA to show a profit marked the end of gold dredging below the Grand Canyon and a decline in gold exploration. Dredges did continue to be used to both improve navigation on the river and, more importantly, to cut irrigation canals. Furthermore, by 1900 the general decline in mining in the region had reduced the number of steamboat landings down from the high of 35 in the 1860s and 1870s to 19 (Lingenfelter 1978:80).

#### Upper Colorado and Green River Navigation

Steamboating activity on the Colorado was not limited to the lower river. The idea of running steamers into the deep canyons of the upper Colorado had been discussed by entrepreneurs from the late 1860s. The coming of the Union Pacific Railroad to Green River, Wyoming in 1868, and the explorations of the canyon country by Major John Wesley Powell fueled ideas of canyon steamboating. Additionally, the Rio Grande Western Railroad established a station at Green River, Utah in 1883 (Crampton 1959:11, 20; Lingenfelter 1978:106). Ironically, the railroads and the establishment of several communities along the river provided new impetus for the use of paddle wheel steamboats. Between the 1890s and 1910 there were a total of 10 steamboat landings established on the Green and Colorado Rivers (see Figure 5.1) (Lingenfelter 1978:108).

It was the potential for immense profits, however, that finally brought about the launch of the first steamboat above the Grand Canyon.

Imagine the calliope [of a steamboat] piping its stentorian music through the canyons and labyrinths of this most beautiful and majestic scenic route on a moonlight night. The Colorado River Canyon country will be the Mecca of the world's wonders ... and billions of dollars will be spent by the traveling public for no other purpose than the novelty of its scenes (Grand Valley Times, February 1904).

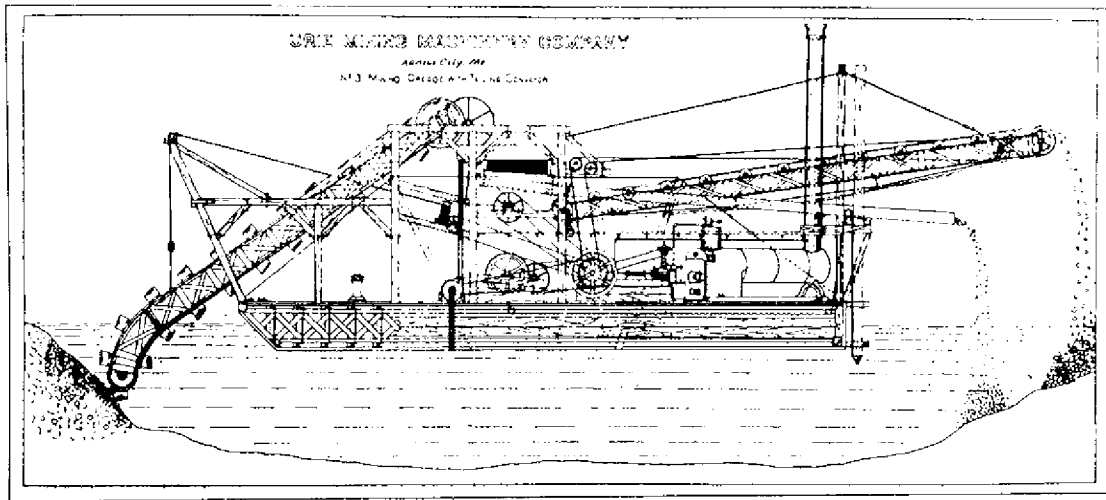

Figure 5.4. Although ADVANCE was technologically well-equipped to process the river silts for gold, it was an economic failure. Special Collections Library, University of California, Los Angeles.

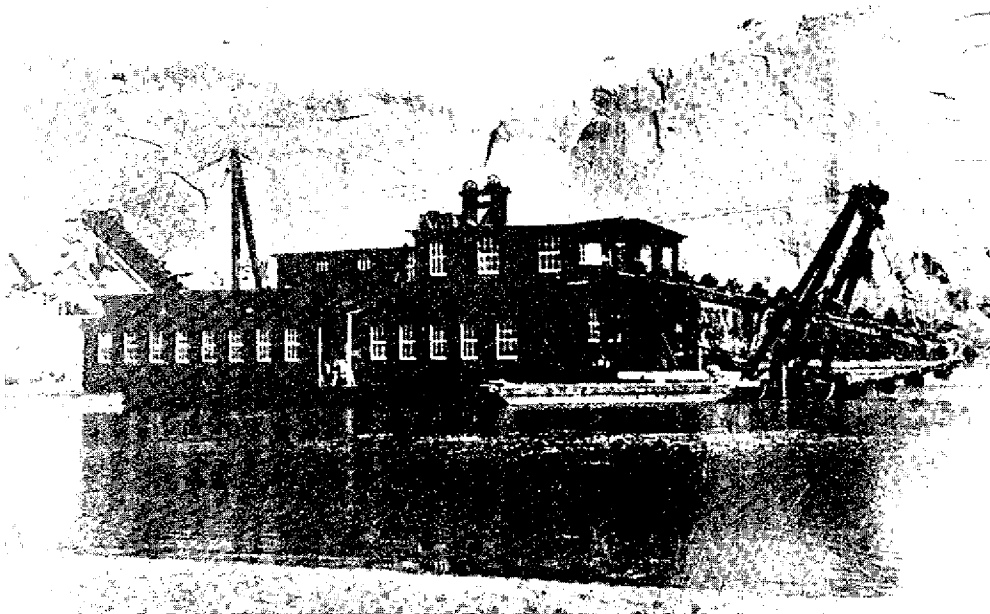

Figure 5.5. Stanton's HOSKANINNI on the upper Colorado River was no more successful than its lower Colorado counterparts. After three months of operation, less than \$70 worth of gold had been retrieved. New York Public Library.

The lead in steamboating in the upper Colorado region was taken by the community of Green River, Utah in the fall of 1890. B. S. Ross was impressed with the canyons of the Green River and, together with a few others, established the Green, Grand and Colorado River Navigation Company for the purpose of running a line of excursion boats down the Green River to just below its junction with the Colorado. At that location Ross and company planned to build a hotel. Their first purchase was a small steam launch in Chicago; the open-decked, 35-foot boat was shipped by railroad to Green River, Utah and launched in August 1891. MAJOR POWELL was equipped with two 6-horsepower steam engines and twin screws. While Ross had ordered a boat that would require no more than 20 inches of water when fully loaded, MAJOR POWELL had a 26-inch draft light, and needed a great quantity of coal for its boiler (Colorado Sun, July 1892; Cheyenne Sun Annual, November 1892).

MAJOR POWELL's first excursion down the river was short lived, smashing its ill-suited propellers on a bar just below the town. The following year the trip down the canyon was attempted again, but this time the propellers were protected by iron shields. With spring floods in their favor, the crew had no problem navigating the river passed Wheeler Ranch, through Labyrinth Canyon and down to the Colorado River to the first rapids, 4 miles below the junction with the Green River, and the lower limit of river navigation (W. F. Reeder, U.S. versus Utah, 1929, Abstract of Testimony 2:1242). Unfortunately the vessel was underpowered for the return and was abandoned at Wheeler Ranch (Colorado Sun, June 1892). MAJOR POWELL was run down the Green only twice more, both times in 1893 by William H. Edwards, who hoped to establish regular freight service to future settlers in the canyons (U.S. versus Utah, 1929, Abstract of Testimony 1:555-586). Edwards' hopes for regular service quickly faded, and in 1894 MAJOR POWELL was purchased and stripped of its engine.

The failure of MAJOR POWELL did not deter other entrepreneurs and subsequently other steamboats were launched from Green River, Utah. They included: *UNDINE* (1901), *CITY OF MOAB* (1905) later rebuilt as *CLIFF DWELLER*, and *BLACK RIVER* (1907). Each had limited success in navigating the river, mostly due to fluctuating water levels and shifting sandbars. During this same period, smaller gasoline-powered vessels were being tried. *WILMONT* (1904) a sternwheeler, *PADDY ROSE* (1905) a sidewheeler, *COLORADO* (1905), *MARGUERITE* (1906) a sternwheeler,



NAVAJO (1908) a propeller, IDA B. (1909) a propeller, BABY BLACK EAGLE (1909) a propeller, and much later a large open sternwheeler dubbed "THE BIG BOAT" (1925), were launched (Lingenfelter 1978:110-118).

Steamboating out of Green River, Wyoming lagged behind the rest of the upper Colorado River region until 1908, when Marius N. Larsen launched COMET, a 60-foot sternwheeler. He intended the vessel to support his general store and cut overland freight costs. Like other vessels on the river, so long as the water level was high enough no problem was encountered in navigation, however as the water level dropped, shifting sand bars limited or brought upstream progress to a halt (Green River Star, July 1908).

Gold dredges were also tried on the upper Colorado River. Robert Stanton's interest in placer mining in Glen Canyon was the impetus behind the organization of the Hoskaninni Company and his dream of a fleet of gold dredges. Stanton eventually located a suitable claim and, with backing from Eastern investors, obtained materials for the construction of the dredge HOSKANINNI in June 1900 (Figure 5.5). The dredge was 105 feet long, 36 feet in beam, had 46 buckets, and was powered by 5 gasoline engines that generated 168 horsepower (Crampton and Smith 1961:121-140). Like its predecessors ADVANCE and NORTH DAKOTA, the results were disappointing. In nearly two months work the dredge only recovered \$30.15 worth of gold; a second location resulted in recovery of \$36.80 (Crampton and Smith 1961:139, 143). Finally, in September 1901, the company went into receivership, and the dredge and other related company property were sold for \$200 (Crampton and Smith 1961:148).

Several gasoline-powered launches were used on the Upper Colorado River just after the turn of the century. Stanton used an 18-foot gasoline launch to supply his various camps on the river. Unfortunately, the vessel unable to make headway against the river currents. Branded the "white elephant", it was eventually abandoned (Crampton and Smith 1961:104).

The gasoline-powered sternwheel launch, LUCY B, was built at Hite in 1902 for the Moquie Mining Company. It was equipped with a 2-cylinder automobile engine and 2, 6-horsepower engines. The engines did not run at peak efficiency and the underpowered LUCY B was abandoned on Olympia Bar, upstream from

Stanton's dredge (Bennett, U.S. versus Utah, 1929, Abstract of Testimony 2:828-833). A second boat was built for the Moquie Mining Company at Green River in 1905. The 22-foot propeller-driven launch had a 12-horsepower gasoline engine and 16-inch propeller. While not underpowered, the propeller continually stuck on gravel bars. The vessel eventually sank at Tickaboo in 1906 (Chaffin, U.S. versus Utah, 1929, Abstract of Testimony 2:1249-1259).

For several years no efforts were made to navigate the upper Colorado and Green Rivers. The next vessels to appear were two gasoline launches, the 27-foot VIOLET LOUISE and 18-foot MULLINS. Both boats were used to support the American Placer Corporation operations just below Lee's Ferry. Charlie Spencer was the managing director of the corporation, and it was his need for coal to fire boilers for the placer operation that led to the last paddle wheel steamboat to be constructed on the Colorado River; CHARLES H. SPENCER was launched at Warm Creek in February 1912. The sternwheeler was 70 feet long between uprights (stempiece to sternpost, not including paddle wheel guard) and, according to the plans, had a 20 foot beam (Shultze, Robertson and Shultze, 1911).

Like many of SPENCER's predecessors on the river, the principal problems encountered were the changing levels of the river and shifting sand bars. The steamboat grounded on several occasions, and by the time the crew had worked out steering and navigational problems, the mining operation was collapsing. The steamboat was tied up and abandoned just below Lee's Ferry in 1912.

It was the completion of Laguna Dam, 14 miles above Yuma, that marked the end of steam navigation on the Colorado River. Officially opened on March 31, 1909, politicians hailed the completion of the dam as the beginning of a new era of agricultural prosperity for the lower Colorado region (Arizona Sentinel April 1909). While several dredges were involved in construction of the dam along with the paddle wheelers SEARCHLIGHT (1902) and ST. VALLIER (1899), no new vessels were built.

Ironically, it was the completion of Glen Canyon Dam and creation of Lake Powell in 1964 that ultimately led to the reappearance of a paddle wheeler on the upper Colorado River. A diesel-powered replica sternwheeler, CANYON KING, was launched from Moab, Utah, on April 30, 1972. A 93 foot long, 26 foot broad,

double-decked excursion boat, CANYON KING makes regular trips down the Colorado (Moab Times-Independent December 1971, February – May, 1972).

### Riverine Shipwreck Resources

The potential variety of historic vessel resources that lay along the Colorado and Green Rivers mirror the exploration, growth, and development of the region. Open rowed-boats used by various expeditions, sailing craft used in early attempts to reach Fort Yuma from the Gulf, ferries, steam- and gasoline-powered paddle wheelers, gasoline-powered prop launches, barges, and dredges, used for travel, commerce, mineral exploration, navigation, and agriculture, have contributed to the rich history of the region. The documented population of vessel remains includes a cross section of vessel types. These vessels, together with many associated land sites (mines, landings, ferry crossings), can contribute meaningfully to the story of the Colorado River and its tributaries and to the several National Parks that have the river as their focus.

Each of the various vessel types used on the river have contributed to the development of the region, although it was the steamboat that was used for the longest period, from 1854 to 1916. The potential population of steamboats that may exist in some form on the Colorado and Green Rivers are presented in Table 5.1, below.

Table 5.1 Possible Steamboat Remains in the Colorado and Green Rivers\*

Name(s)	Prop. Type	Place Built Dates of Use	Reason for Loss/ General Location
BLACK EAGLE	screw	Green River, Utah June 1907 – ? 1907	Explosion Valentine's Btm., Utah Green River
CHARLES H. SPENCER	stern wheel	San Francisco, Calif. reassembled Warm Creek, Ariz. Feb. 1912 – Summer 1912	Abandoned Lee's Ferry, Ariz. Colorado River
COCHAN	stern wheel	Yuma, Arizona Nov. 1899 – Spring 1910	Dismantled Yuma, Ariz. Colorado River

Name(s)	Prop. Type	Place Built Dates of Use	Reason for Loss/ General Location
COCOPAH II	stern wheel	Yuma, Arizona March 1867 - 1881	Dismantled Yuma, Ariz. Colorado River
COLORADO I (rebuilt as COLORADO II)	stern wheel	Estuary, Mexico Dec. 1855 - Apr. 1862	Dismantled Fort Yuma, Ariz.
COLORADO II	stern wheel	Yuma, Arizona May 1862 - Aug. 1882	Dismantled Yuma, Ariz. Colorado River
COMET	stern wheel	Green River, Wyoming July 1908 - ? 1908	Abandoned Green River, Wyo. Green River
ESMERALDA	stern wheel	San Francisco, Calif. 1862 - 1868	Dismantled Fort Yuma, Ariz. Colorado River
EXPLORER	stern wheel	Philadelphia, Penn. reassembled Robinson's Landing, Mex Dec. 1857 - 1864	Engine Removed 60 mi. below Pilot Knob, Calif. Colorado River
GENERAL JESUP	side wheel	Estuary, Mexico Jan. 1854 - 1859	Machinery Removed Minturn Slough Colorado River
GILA (rebuilt as COCHAN )	stern wheel	Port Isabel, Mexico Jan. 1873 - Nov. 1899	Dismantled
MAJOR POWELL	screw	Green River, Utah Aug. 1891 - 1894	Machinery Removed Halverson's Ranch, Utah Green River
MOHAVE (II)	stern wheel	Port Isabel, Mexico Feb. 1876 - Jan 1900	Dismantled Jaeger's Slough, Arizona Colorado River
RETTA	stern wheel	Yuma, Arizona 1900 - Feb. 1905	Sunk Between Mellen & William's Fork, Ariz. Colorado River
ST. VALLIER	stern wheel	Needles, Calif. 1899 - Mar. 1909	Sunk/Dynamited Yuma, Ariz. Colorado River

<u>Name(s)</u>	<u>Prop. Type</u>	<u>Place Built Dates of Use</u>	<u>Reason for Loss/ General Location</u>
SEARCHLIGHT	stern wheel	Needles, Calif. Dec. 1902 - Oct. 1916	Sunk Yuma, Ariz. Colorado River
UNCLE SAM	side wheel	Estuary, Mexico Nov. 1852 - May 1853	Sunk Fort Yuma, Ariz. Colorado River
UNDINE	stern wheel	Green River, Utah Nov. 1901 - May 1902	Wrecked Near Big Bend, Utah Colorado River

\*after Lingenfelter 1978:161-163

Table 5.1 is a useful tool insofar as it provides a framework for evaluating the potential population of steam-powered vessels that may be found along the Colorado and Green Rivers and the relative number of individual types, based upon propulsion employed. For example, of the 18 steam-powered boats listed, 2 are screw-driven, 2 are sidewheelers, and 14 are sternwheelers.

The remains of the screw-steamer BLACK EAGLE, may still be available for study on the Green River just above its confluence with the Colorado. Remains of the second screw-steamer MAJOR POWELL, located farther up the Green, may also exist. With such a limited population possibly available for study, the discovery of either of the screw-steamers, would be significant; their potential eligibility for the National Register is clear. The same reasoning can be applied to the two sidewheel steamboats, GENERAL JESUP and UNCLE SAM. GENERAL JESUP, abandoned in Minturn Slough near Fort Yuma, and UNCLE SAM, the first steamboat on the Colorado River, sunk below Fort Yuma, may exist in some form. However, it is highly possible that they have been impacted by river channelization.

Of the 14 sternwheel steamboats included in Table 5.1, 7 have been dismantled (COCHAN, COCOPAH II, COLORADO I, COLORADO II, ESMERALDA, GILA, MOHAVE II). The degree of destruction and final disposition of these vessels is unknown. Two dismantled vessels, COCHAN and COLORADO I, were rebuilt into larger vessels; those vessels were also later dismantled.

The remaining seven abandoned and sunk sternwheelers include three lost on the upper Colorado or Green Rivers. One vessel is below Glen Canyon Dam (CHARLES H. SPENCER), and two are above the upper reaches of Lake Powell (COMET, UNDINE). These three are not known to have been heavily salvaged and are representative of post-1900 paddle wheel construction.

The four final vessels, all lost on the lower Colorado River include: two sunk just below Yuma, Arizona, (ST. VALLIER, SEARCHLIGHT) that may have been impacted during channelization of the river; one lost near El Rio below Pilot Knob (EXPLORER) that is reported to have been heavily salvaged in the late 1920s (Sykes 1937:90-92); and one (RETTA) that may retain structural integrity but whose final location is unclear.

The potential for National Register eligibility of the dismantled sternwheelers is dependant upon their physical integrity, for criteria A, and potential to yield information, for criteria D, when and if they can be located. While impacts to physical integrity do not preclude nomination of a vessel, it does provide a tangible link to the identity of the vessel and a strong tie to the events or patterns of history with which it is associated. The same holds true for the three lost or sunk sternwheelers on the lower Colorado River. The impacts from river channelization and heavy salvage are impossible to evaluate. Four sternwheelers hold the most promise for future research; the two on the upper Colorado River (SPENCER, UNDINE), the one on the Green River (COMET), and the one whose location is unclear (RETTA). Based solely on the scarcity of resources of this type available to study, these four sternwheelers appear to be eligible for listing on the National Register of Historic Places. When other National Register requirements are considered, i.e. criteria B and C, the significance and eligibility of these vessels for listing may, of course, be enhanced.

### Vessel Context and Development

#### Paddle Wheel Steamboats

It has been well documented that the American river steamboat was a major contributing factor in the opening of both the midwest and western interior. Despite popularized misconceptions, "... gambling and small time theatrics ... were

negligible ... in the hey-day of steamboating. The true steamboat did a specific job in a particular manner and was ... a specialized craft" (Bates 1968:5). American paddle wheel steamers evolved to meet the need for movement of passengers, general cargo, and bulk freight through the Western river systems. They were at once floating palaces, general purpose packets, insignificant tow boats, ferries, dredge tenders and even Civil War gunboats. While there was a great variety among steamboats, they were limited in overall size and draft by the width and depth of Western Rivers and their tributaries during periods of low water.

The Ohio River ... had a way of drying up each year to the point that the boats drawing over 15 inches had to quit (Bates 1968:5).

The underlying necessity for an extremely shallow draft influenced the general development and specific character of the Western river steamboat.

The generally accepted form and style of steamboat is typically one that plied the Mississippi or its tributaries. Its early development resulted from the efforts of many individuals, with elements dating back to the Roman empire (Gilfillan 1935, in Murphy and Saltus 1981:91). As early as 1729, a prototypical steamboat was patented in England and experiments using steam power were being undertaken in America by 1763. The first boat to be powered by steam in the United States resulted from the efforts of John Rumsey in 1786. The first commercial use of a steamboat occurred in 1790, and finally in 1807 Robert Fulton's NORTH RIVER STEAMBOAT OF CLERMONT heralded in the era of steamboating as a commercially viable alternative to horse and wagon for interior travel (Gilfillan 1935; Thurston 1939, in Murphy and Saltus 1981:92-93).

By the arrival of the 20th Century, the paddle wheel steamboat had more than 100 years of refinement in hull form as well as dramatic improvement in steam machinery. In fact, the paddle wheel steamboat, whether ocean-going or river-running, had become generally standardized during the 1840s through the 1850s, had entered into a "classic" period in form and machinery during the 1860s and 1870s, saw some decline in use after 1880, and was entering a "modern" era with electric lights and generators by 1900 (Murphy and Saltus 1981:161-163).

## Colorado River Paddle Wheel Steamboats – The Place of CHARLES H. SPENCER

Socio-Economic Context: The steam-powered boat was the true workhorse of riverine commerce, transporting passengers, package and bulk freight such as ore and goods for mining communities. While never numerous, especially when compared to other riverine systems where steamboats were used, their numbers on the Colorado River and its tributaries reflect the shifting socio-economic trends in the region from 1850 through 1920. The hey-day of the steamboat coincided with the peak of commerce and mining, the period from the late 1850s through the 1870s and again at the turn of the century. Figure 5.6 tabulates the number of steam-powered vessels operating on the river for each 10 year period from 1850 to 1920.

The most prevalent steamboat configuration was, by far, the sternwheeler. Of the 24 steamboats used on the river from their introduction in 1852 to their demise in 1916, 18 were sternwheelers, that is, 75%. They ranged in size from only 45 feet in length to nearly 150 feet long, and from a breadth of only 6 feet to 31 feet. By the time that CHARLES H. SPENCER was built in 1912, the use of steamboats in the Colorado River system had already peaked and was declining.

In order to understand the place of the sternwheeler CHARLES H. SPENCER among Colorado River steamboats, two broad questions should be considered: how did economic factors in the region from 1850 to 1920 affect the rise, fall, and use of gasoline and steam-powered vessels; and, can the results of these economic factors be observed in the physical attributes of these vessels, their relative numbers, and types present?

An increase or decrease in the construction of vessels, logically enough, often parallels periods of regional or economic change; numbers, types, and sizes of vessels built reflecting perceived transportation and commercial needs. Based upon that axiom, then it follows that a known population of vessels, such as the Colorado River steamboats, and their dates of construction should be correlatable to the periods of social or economic change in this region. In addition, the sizes of these vessels should reflect extant transportation and commercial needs, taking into consideration environmental constraints.



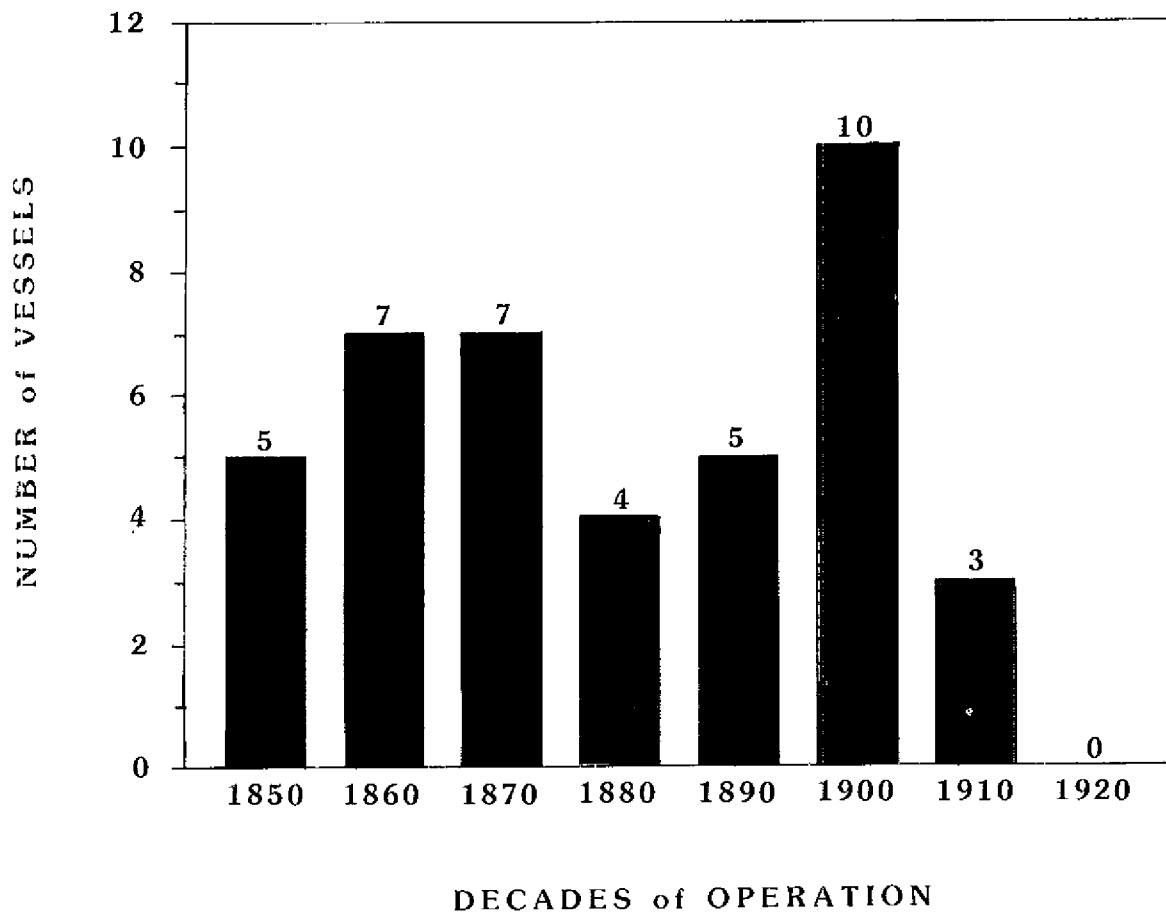

Figure 5.6. Steamboats operating on the Colorado River and tributaries from 1850 through the 1920s.

Chronicling the dates of construction for each of the 18 sternwheelers revealed two periods of activity, from 1856 to 1876, and from 1899 to 1912. Loosely sorting the vessels by size resulted in dividing the sternwheelers into two broad length categories, less than 75 feet (7 vessels) and 90 to 150 feet (11 vessels). Although not a one-to-one correlation, a comparison of the Colorado River steam-powered sternwheelers by year of construction and size revealed some interesting relationships. Figure 5.7 illustrates preferences in size of sternwheeler construction by decade.

The first period of growth and mining in the region was between 1855 and 1876; nine of the eleven sternwheelers 90 feet long or greater were built during that period. Not surprisingly, these vessels were constructed to handle bulk ore and general freight in order to support the growing number of mines, settlements, as well as Fort Yuma. The two exceptions, COCHAN and SEARCHLIGHT, were built in 1899 and 1902 on the eve of the second mining boom in the region and, like their earlier counterparts, these vessels were used to transport bulk ore and freight.

Six of the seven vessels less than 75 feet long were constructed in the second boom period, from 1899 through 1912. Despite the small resurgence in mining in the region, these vessels were primarily geared toward hauling light freight and for passenger excursions; reflecting a shift in use of the region from a predominantly industrial base to general commerce and tourism. The exception in the under 75 foot class is EXPLORER. This vessel was built in 1857 and was used for early riverine exploration. CHARLES H. SPENCER, built in 1912, was the only vessel of less than 75 feet constructed for bulk ore transport and the last such vessel built for this use on the river.

The shift away from heavy industrial use toward general commerce and tourism is also reflected in the numbers and commercial use of the smaller sized gasoline-powered boats. These boats first appeared in 1891, and continued in use until 1914; the second boom period in the region. Figure 5.8 graphically illustrates the numbers of gasoline-powered boats constructed for use on the river between 1890 and 1920.

The 25 documented gasoline-powered boats were all 60 feet or less in length and were principally involved in transportation of light freight, passengers,

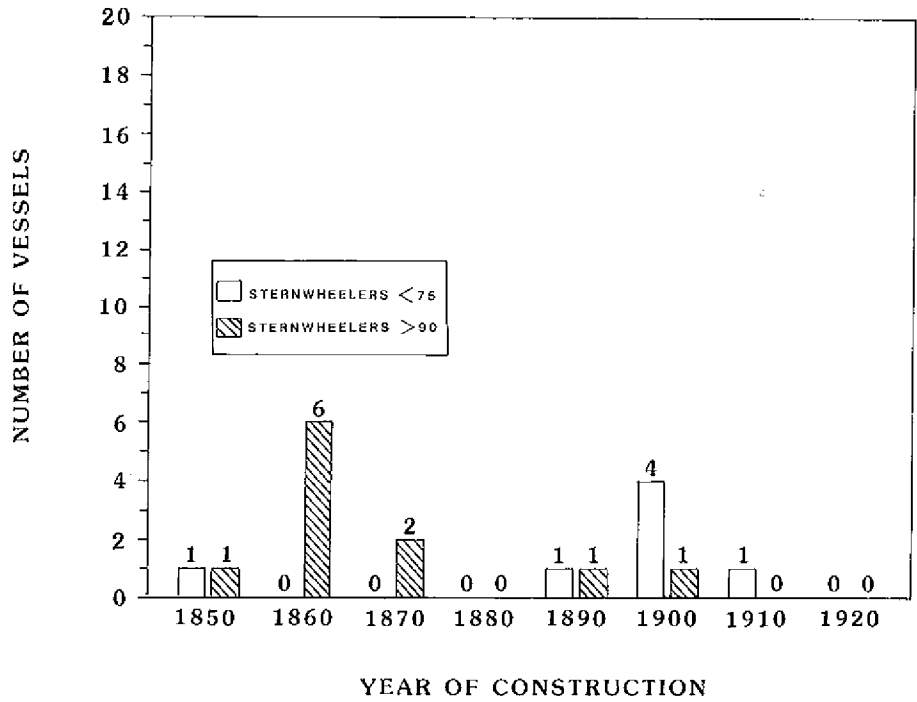

Figure 5.7. Comparison of steam-powered sternwheelers by size and year of construction.

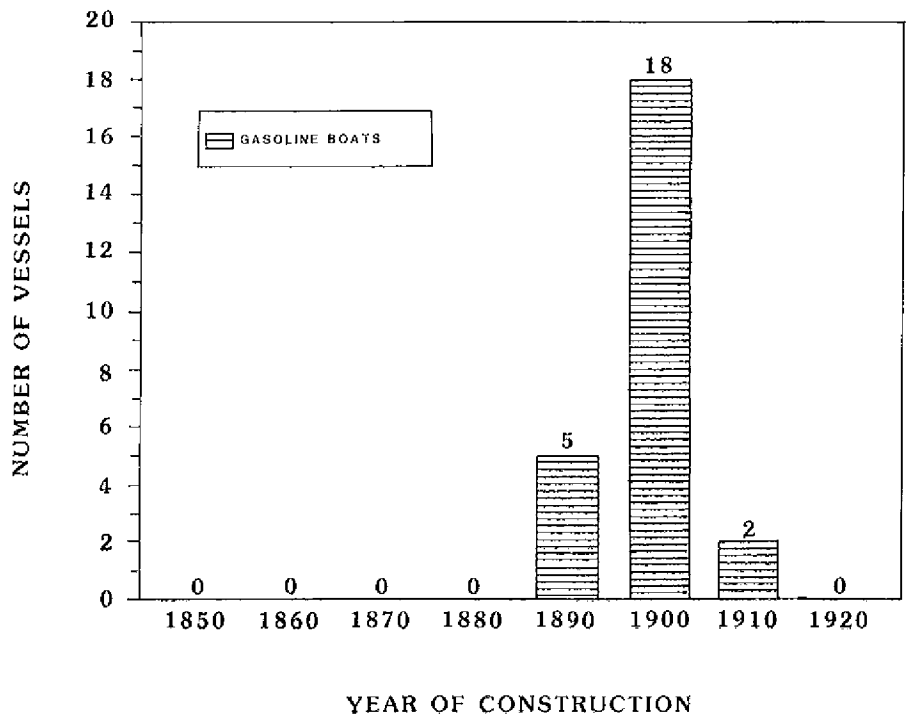

Figure 5.8. Gasoline-powered boat construction from 1850 through the 1920s.

and excursionists. Only MULLINS and VIOLET LOUISE, both associated with the Spencer mining operation, were used on an experimental basis to move bulk coal needed for mining at the Spencer site. However, these vessels were principally involved in the transport of light freight to support the small settlement at Lee's Ferry.

Other indicators of change in the region that directly impacted the presence of steamboats were the numbers of boat companies operating and freight rates in the region. During the first boom period (1852-1876), a total of nine steamboat companies were operating. In the decade from 1850 to 1860 four companies were in existence; this had increased to six companies in the mid-1860s.

Freight rates, not surprisingly fluctuated with the number of companies and the number of boats on the river. In 1855 overland rates were \$500 a ton; by 1862 overland rates were \$250 a ton and steamboat rates were \$100 a ton. In 1864 the number of operators were at their height and freight rates at their lowest, at \$65 a ton; the result of a freight war between two prominent companies (Lingenfelter 1978:33, 37, 47). As a result of the rate wars, there was a decline in the number of operators and the freight rates stabilized at \$250 a ton overland and \$100 a ton by steamboat, by the end of the decade.

Between 1870 and 1879 only 2 companies were still hauling freight. In 1873, again because of fierce competition, freight rates by steamer from Hardyville to San Francisco dropped to \$20 a ton. By comparison, the overland rate for the 35 miles to get the ore to Hardyville was \$20 a ton (Lingenfelter 1978:68). Finally, with the coming of the railroad in 1877, the combination of three day delivery from the freight landings to San Francisco and a rate of \$42 a ton, resulted in the further reduction of boat freighting companies. A decline in the productivity of the mines after the mid-1870s, further impacted those companies still in business and by 1880, only one company remained.

The second period of growth in the region began in 1889 and resulted in a slight increase in the number of boat operations. By 1900 the number had risen to five. During the peak of the second boom period, the decade from 1900 to 1910, there were 12 boat companies. These companies were using smaller, more economically feasible and commercially adaptable gasoline-powered boats. The use

of this type of boat supports the argument that the growth in the region was in the transport of light freight with a shift toward tourism and passenger transport. The boom and bust cycle was repeated after 1910; with the exception of the U.S. Reclamation service operating until 1916, there were no other boat operations in the region (Lingenfelter 1978:166).

When looked at together, the numbers, dates of construction, and sizes of both the steam-powered sternwheelers and gasoline-powered boats, clearly reflect the socio-economic trends in the region. Figure 5.9 graphically combines the construction data by decade on the steam-powered and gasoline powered vessels.

Based upon the above analysis, it is reasonable to state that the sternwheeler CHARLES H. SPENCER was a socio-economic anachronism. The vessel was built after the peak of steamboat and sternwheeler construction, it was small in comparison to the most successful sternwheelers on the river used for bulk ore, it was designed to support a rapidly dying mining industry, and was never adapted for use in general commerce, i.e. transport of light freight, or passengers and excursionists.

Technological Context: Was CHARLES H. SPENCER a technological anachronism as well? In order to evaluate the vessel in that context, that is, in the evolution of paddle wheel vessel construction, it is helpful to compare SPENCER's major attributes, i.e. boiler, engines, breadth, and length, to the "typical" western river vessel of the period as well as to similar Colorado River vessels constructed for similar duties at approximately the same time.

The "typical" post-1900 shallow-draft western river paddle wheel steamboat was briefly described by Charles E. Ward in a paper presented to the Society of Naval Architects and Marine Engineers in 1909. The following general discussion of hull form, boilers, engines, paddle wheel and shaft is based upon his presentation, unless otherwise indicated.

Hull: Like their predecessors, the majority of paddle wheel steamboats built in 1909 were constructed of wood, with thick bottom planking; often 4 inch oak. The use of steel was limited and was being used only about 10% of the time. Ward's description of the hull form indicates very little alteration from the 1860s.

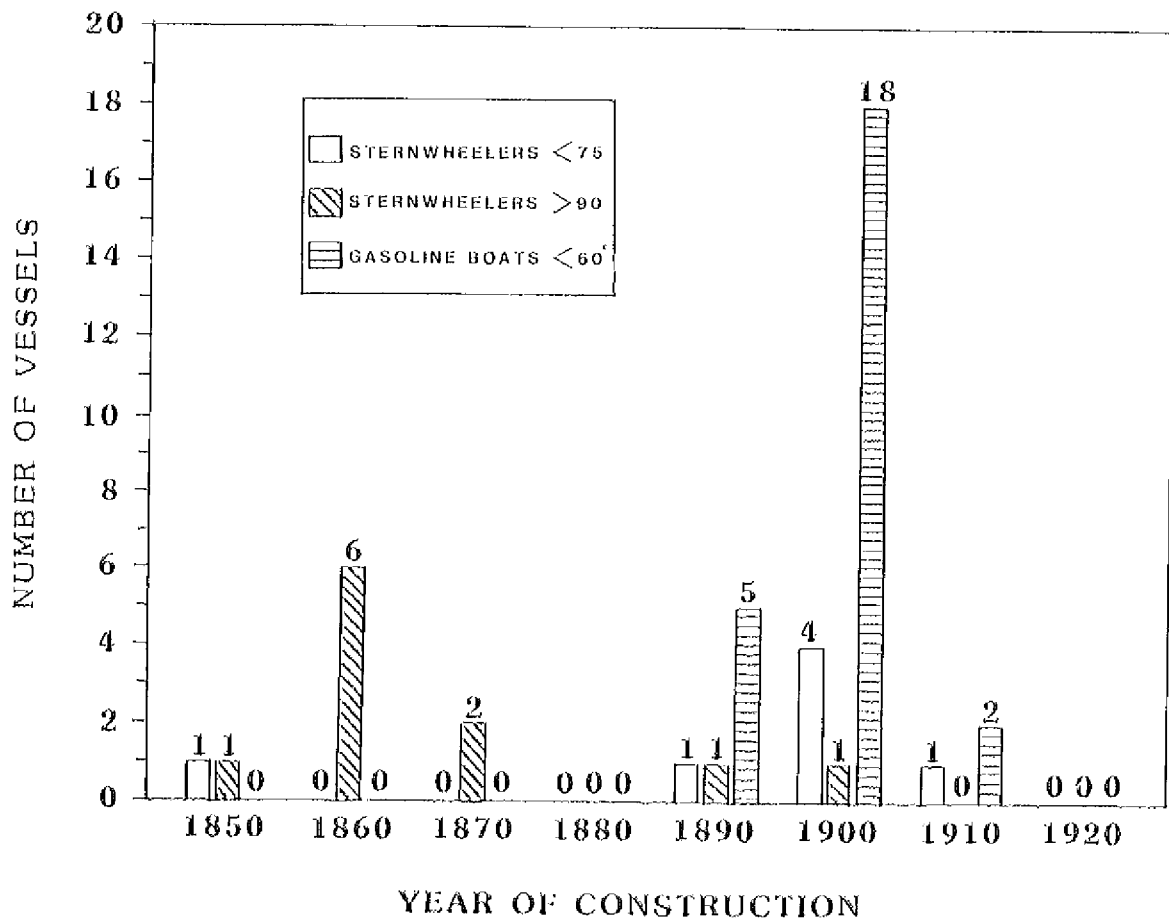

\* ALL LESS THAN 60 FEET

Figure 5.9. Comparison of steam-powered sternwheelers and gasoline-powered boat construction from 1850 through the 1920s.

The flat-bottomed hull was designed with a considerable flare in order to allow the current to run under the boat, rather than having the bow split the current in order to run through it. The very broad design of the stern and transom allowed the vessel to run almost on top of the river. The accepted system of bracing and trussing, that is, tying the deck, floor frames, and cylinder timbers together with metal rod and turnbuckles was still in use.

Boiler: The cylindrical flue, fire tube boiler was in general use by 1909. These ranged in diameter from 30 to 40 inches and in length from 15 to 30 feet. One of the attractions of the flue boiler was its external fire box. The fire box and fire bed were made from sheet iron, lined with firebrick and had very low combustion chambers. In addition they were felt to be the best for use in muddy water.

Engines: Low pressure condensing beam engines, used in east coast steamers, were too heavy for Western River, i.e. midwestern, steamboats. The high pressure engine, with no condenser, was preferred and quickly became the standard (Sawyer 1978:76). Early engines, of the slide-valve type, had a stroke about 4 times the diameter of the cylinder. The length of the pitman, the limberness of the hull, and the presence of muddy water, caused uncertain valve action and problems with these engines.

The lever-poppet-valve engine was adopted to correct problems associated with the slide-valve and was widely used after the turn of the century. These engines were equipped with two cams, one for reversing, the other, called a "cut-off," cut off steam at one-half, five-eighths or three-fourths of the stroke. This allowed the engineer to adjust the amount of steam entering the piston and therefore, the amount of power. Broken valve stems were a common problem, as a result, the Frisbee balanced valve was developed. These proved so successful, many of the older lever engines were retrofitted with the valve and new engines were automatically equipped with them. The horizontal configuration of both the slide-valve and lever engine were ideally suited to the sternwheeler. Dual engines, common by 1900, were mounted on pairs of cylinder timbers that were tied into the boat's frames.

The tandem compound engine was also used on Western river steamers and was mounted in the same manner as the lever engine. While the compound engine was more efficient, they were more commonly placed in only the larger vessels due to their weight and size.

Wheel and Shaft: Stern- and side-paddle wheels on western river boats were built of wood because of its availability and ease of repair. The general rule of thumb was one bucket for each foot of the wheel's diameter. One problem with paddle wheel boats was the great weight of the paddle wheel and shaft. By 1900 the solid shaft was either iron or steel, although iron was by far preferred. In an effort to alleviate the weight problem, a hollow shaft was tried in a few boats built after the turn of the century. The use of a hollow shaft eventually proved unsatisfactory and was abandoned (Ward 1909:79-92).

An evaluation of CHARLES H. SPENCER, based upon Ward's paper, clearly indicates that the San Francisco-built steamboat was technologically within the mainstream of paddle wheel vessel construction. This is not surprising given the reputation of the vessel's builder, Shultze, Robertson & Shultze, a highly respected shipbuilding company, and James Robertson's significant career as a naval architect, shipbuilder, and marine engineer.

How did CHARLES H. SPENCER compare to two of the most successful stern wheel wooden steamboats on the river system, SEARCHLIGHT and COCHAN, and a similarly-sized steel-hulled steamer ST. VALLIER? Both SEARCHLIGHT and COCHAN were engaged in the transport of general freight, passengers, and bulk ore, the latter being essentially the same activity that was anticipated for SPENCER. ST. VALLIER was engaged in the transport of light freight and passengers and is considered here because of its similarity in size to SPENCER.

COCHAN, built in 1899, was 135 feet long (overall), had a beam of 31 feet and drew just under 24 inches fully loaded to its maximum capacity of 125 tons. COCHAN was constructed to replace the 26 year old GILA and was outfitted using the engines and boiler from the older boat. COCHAN traveled the same route that GILA had followed, the run from Yuma to the Searchlight Mine and El Dorado Canyon, until 1910 when it was retired. While COCHAN was much larger than CHARLES SPENCER, there is nothing to suggest that it was technologically more



sophisticated than SPENCER. Indeed, COCHAN/GILA's machinery was built in 1873 and remained in continuous use until 1910, a period of 37 years. At the time of SPENCER's construction, COCHAN's machinery would have been considered old, but not outdated or technologically inadequate.

SEARCHLIGHT, built in 1902, was 91.2 feet long, had a beam of 18 feet, and a capacity of 60 tons. Very similar in size and capacity to SPENCER, it was more elaborate with three decks, six state rooms, a smoking room, and a galley. The boat was equipped with a marine boiler and engines rated at 100 horsepower (Lingenfelter 1978:95). SEARCHLIGHT was regularly used on the river between Needles and Quartette Landing until 1916. Once again, there is nothing to suggest that SEARCHLIGHT was superior in any way to SPENCER.

ST. VALLIER was built in 1899 and was used on the river until 1909. The vessel's length was 74 feet, its beam was 17 feet, and it had a capacity of approximately 50 tons. Although ST. VALLIER was steel-hulled, placing it well ahead of its contemporaries, in all other respects it was similar to SPENCER and nearly duplicated its size and capacity.

Table 5.2 Comparison of Selected Attributes

	COCHAN	SEARCHLIGHT	ST. VALLIER	SPENCER
Years of Operation	1899-1910	1902-1916	1899-1909	1912
Size	135 x 31	91.2 X 18	74 x 17	70 x 20
Draft	24" loaded	---	---	20" light
Capacity	125 tons	60 tons	50 tons	50 tons est
Engines	---	100 h.p.	---	100 h.p.

CHARLES H. SPENCER compares favorably with SEARCHLIGHT, COCHAN, and ST. VALLIER, vessels used for similar purposes and built about the same time. If SPENCER was technologically sound, and similar to successful Colorado River steamboats, why then has that vessel been generally referred to as a failure in contemporaneous and modern accounts? SEARCHLIGHT, COCHAN, and ST. VALLIER had highly successful careers, however, it was not because of their innate

superiority over other vessels plying the river. The major difference between them and SPENCER is environmental, that is, where on the river they were used. SPENCER was the only one of the four used on the upper Colorado River, it was also the largest boat used on that stretch of river until after the construction of Glen Canyon Dam.

From the 1860s through the 1920s, the most widely referred to problem with navigation on the upper Colorado and Green Rivers was the extreme variability of water levels coupled with the presence of sand bars. In the court case United States vs. Utah, 1929, numerous witnesses were called to testify to the condition of the upper Colorado, San Juan, and Green Rivers for navigation. Several witnesses gave testimony on the condition of the river from Lee's Ferry to just above Warm Creek. Frank Barnes, a mechanic and boat handler hired by Charlie Spencer, arrived at Lee's Ferry in 1910. He testified to the following:

Answer. We made one trip [of] ... twelve or fifteen miles [up from Lee's Ferry], and there were lots of short trips made, two or three miles. ... Well, we hitched the big boat on to this scow and started up stream; whenever we got stuck on a sand bar the crew got out and pulled it with ropes.

Question. How many times would you say you got stuck between Lee's Ferry and Warm Creek?

Answer. Oh, I would say about ten times.

Q. Did you have any difficulty in getting the boat down [river]?

A. Yes sir, we had some; run on to sand bars about twice, I believe.

Q. In that stretch of river from Dandy crossing down to Lee's Ferry, where did you get your best water, below or above Warm Creek?

A. Below Warm Creek .... (U.S. vs. Utah, 1929, Transcript of Testimony 13:2529-2539).

Bert Loper was on the Colorado River regularly from 1895 to 1921. On one occasion he traveled with two men in an open motor boat from the mouth of the San Juan down to Lee's Ferry. Loper testified that the principal difficulties encountered were sand bars, going both downstream to Lee's Ferry and on the return upstream. He further testified that during all of his years on the river he was

not able to develop a knowledge that would enable him to navigate the river without getting stuck on a sand bar (U.S. vs. Utah, 1929, Abstract of Testimony 1:623-638).

William Marrs, a boatman on the river for Edison Company in 1921, testified that from Lee's Ferry to Warm Creek they had the least trouble navigating because the river was wider and shallower, although they were never able to make a trip from Lee's Ferry up to Warm Creek in less than a day and a half (U.S. vs. Utah, 1929, Abstract of Testimony 1:638-644).

Finally, John W. Palmer, employed by Spencer as assistant fireman on CHARLES H. SPENCER, testified that he made one and a half trips on the boat between Warm Creek and Lee's Ferry. Palmer stated that they were stuck several times on sand bars going down to Lee's Ferry and back to Warm Creek. On another occasion, Palmer was on board when Charlie Spencer wanted to go upstream from Warm Creek. They went about a quarter of a mile when then ran into a large sand bar on the south side of the river, could not proceed any farther, and returned to Warm Creek (U.S. vs. Utah, 1929, Abstract of Testimony 2:807-814).

The boats used by Barnes, Loper, and Maars, none of which were steamboats, were smaller and less powerful than CHARLES H. SPENCER. All three men mention having problems with sand bars and the shallow water, however, they did not mention encountering currents so strong they were unable to make headway upstream. In addition, Charlie Spencer stated that the paddle wheel boat worked perfectly "providing there was sufficient water in the river" (Interview by W. L. Rusho, June 18, 1961). Clearly, with adequate water levels, the trip from Lee's Ferry to Warm Creek was possible by boat.

Two often repeated reasons for abandoning SPENCER, and therefore confirmation of the vessel as a failure, were first, that it was not powerful enough to make headway against the currents given adequate water levels, and second, it used up all of the coal it could carry just to make the round trip from Warm Creek to Lee's Ferry and return (Interview of Bert Leech, February, 1961; correspondence between P.T. Reilly and Bert Leech, July, 1964; Rusho and Crampton 1981:71 from interview with Bill Wilson, September, 1961).

Another way of examining the coal consumption and efficiency of SPENCER's boiler is to compare the paddle wheeler with Ohio, Upper Mississippi, Lower Mississippi, and Upper Missouri River steamboat average consumption. Average coal consumption was based upon the enrolled admeasurement ton, i.e. the gross registered tonnage, of the vessels in question. Purdy computed the average consumption of all vessels, running an average season, on the above rivers. The range, per gross ton, per year, was from a low of 2.70 tons to a high of 6.82 tons (Hunter 1969:657). A navigation season varied on Western Rivers from 5 months to year-round, the average being 7-1/2 months (Hunter 1969:223-224). If SPENCER was used on one of the above rivers, its average consumption would have ranged from a low of 158.76 tons to a high of 401.02 tons **per year**. Based upon an average season of 7-1/2 months, that would be a monthly consumption range of 21.17 to 53.47 tons **per month** of continuous operation. That is a far cry from 50 tons per trip.

There is little reason to believe, based upon all of the information available, that CHARLES H. SPENCER was under-powered. Machinery configurations very similar to SPENCER's were successful on other sections of the Colorado River and on other similar riverine systems in the far West, Pacific Northwest, and Alaska. Even lesser-powered boats were able to navigate the stretch of river between Lee's Ferry and Warm Creek given adequate water levels.

Herman Rosenfelt, the shipwright who supervised the assembly of the steamboat at Warm Creek, testified to the condition of the vessel's boiler and engines at the time of its launch.

Question: After you had the boat assembled, did you assist in launching it?

Answer. I launched it, and two United States inspectors, inspector of hulls and inspector of boilers, came out to inspect her and help me launch. As I wasn't ready to launch her when they arrived, the inspector of hulls went to work with me, and the inspector of boilers went to work with the machinist they brought out with them, to get her ready.

We launched her and got the boiler tested out to have water. We was [sic] a long ways from the water at the time, so we had to launch her, and **everything was tested and found satisfactory, everything perfect** [emphasis added]...

Q. Did the boat travel either up or down the river while you were there?

A. We had to try the engine before I could leave, and we went up and down there -- a kind of bight in the river -- we traveled up and down there ....

Q. How many miles above Warm Creek did this boat go?

A. We didn't go any miles; maybe one hundred yards or so up and down [to test the engine] (U.S. vs. Utah, 1929, Transcript of Testimony 16:3006-3014).

John W. Palmer's testimony, along with the statements of others who rode the boat from Lee's Ferry to Warm Creek on more than one occasion, provides sufficient evidence that SPENCER's machinery was powerful enough to make the return trip. If the engines were not powerful enough, the boat could not have made even one trip back to Warm Creek. In addition, because there is some question over the actual number of trips the boat made between Lee's Ferry and Warm Creek, the question of power is purely academic. Further, while currents existed in the river, they were not mentioned by Palmer or any one else as the principal problem in navigating the section of river between Lee's Ferry and Warm Creek (U.S. vs. Utah, 1929, Abstract of Testimony 2:807-814).

Bill Wilson stated that "... the boat couldn't have carried any more [coal] anyway. ...[and] when we got down there [to Lee's Ferry] we didn't take but very little coal off of the boat because we needed it all to get back up [to Warm Creek]" (Interview by W. L. Rusho, September, 1961). This statement has been interpreted to imply that the boat needed all of its 50 to 60 ton carrying capacity to make the 10 mile run from Lee's Ferry to Warm Creek. Herman W. Freeze testified that on its first trip down from Warm Creek, SPENCER only carried 3 or 4 tons of coal (U.S. vs. Utah, 1929, Abstract of Testimony 1:686-687). Jeremiah Johnson testified that SPENCER carried about 5 tons of coal on each of two trips down from Warm Creek (U.S. vs. Utah, 1929, Abstract of Testimony 2:786-787). John W. Palmer also stated that SPENCER was only loaded with 5 tons of coal on the trips he made (U.S. vs. Utah, 1929, Abstract of Testimony 2:808-809).

Most of the coal used by CHARLES H. SPENCER would have been on the upstream journey to Warm Creek. However, to suggest that the boat required all of

the coal it could carry to make the round trip is impossible. A hypothetical scenario regarding the quantity of coal used by the boat can be constructed based upon examination of the information provided by the individuals above. If the vessel carried the maximum amount reported on its first trip, that is 5 tons of coal, and if even 1 or 2 tons were unloaded at Lee's Ferry, that would mean the paddle wheel boat used 3 to 4 tons to make the round trip between Warm Creek and Lee's Ferry. The carrying capacity of SPENCER is estimated to have been 50 to 60 tons. A consumption rate of 3 to 4 tons, from a maximum capacity of 50 to 60 tons, figures out to be a use rate of 5% to 8%. Herman W. Freeze testified that on a later trip the boat carried 15 to 20 tons of coal (U.S. vs. Utah, 1929, Abstract of Testimony 1:686-689). Using the rate of 3 to 4 tons of coal to make that round trip, the result is 15% to 25% consumption. In either scenario, the rate of coal use is well below all that could be, or was reported to have been, carried by the boat.

The statement of Arthur C. Waller, a mining engineer and a contemporary of Charlie Spencer, echos my own opinion:

I never did believe that it [the paddle wheel boat] was so ineptly designed as to require all the coal it brought down to ascend on the return trip" (Comments by Arthur C. Waller, 7/15/61, on Charlie Spencer interview of 6/19/61).

Given all of the information available on CHARLES H. SPENCER, its place in the mainstream of paddle wheel maritime technology, its construction by a well-respected San Francisco firm, its attributes in comparison to successful paddle wheel steamboats on the Colorado River system, its mechanical engineering ability to make the round trip between Warm Creek and Lee's Ferry, and its coal consumption efficiency, it is difficult to accept the notion that the vessel was a technological failure.

The steamboat was and has been characterized as a failure by association rather than by a careful examination of the facts. CHARLES H. SPENCER became a scapegoat and was used as an excuse to help explain the collapse of a poorly-conceived mining operation. Charlie Spencer's steamboat was not abandoned because it was a technological failure, the steamboat was abandoned because the men and the mine were an economic failure.

## CHAPTER VI. CHARLES H. SPENCER BACKGROUND

### Vessel History

CHARLES H. SPENCER was built in 1911 by the South San Francisco shipyard of Shultze, Robertson, Shultze. The paddle wheel steamboat was designed to be framed up, temporarily pinned together, dismantled, transported to the mouth of Warm Creek, Utah, and there reassembled under the direction of a company shipwright. At the time of SPENCER's construction, James Robertson, an officer of the company, was serving as secretary, designer, and plant manager. Robertson is recognized as a regionally significant marine engineer (Delgado 1987:1-16).

Robertson was born in San Francisco in 1873 of Scotch parents who had immigrated to the United States in 1870. The Robertson family returned to Aberdeen, Scotland when James was only 6 weeks old. The death of his mother and subsequent remarriage of his father culminated in a return to the San Francisco bay area in 1886. Upon his return, James, then 13, apprenticed to the Union Iron Works, where he worked off and on until 1891. That year the family relocated to Puget Sound, and Robertson went to work for the well-known Hall Brothers shipyard at Port Blakely, Washington, to learn the wooden shipbuilding trade. In 1894 Robertson returned to San Francisco and the Union Iron Works where he was put in charge of building the tug FEARLESS. There, he began working closely with Hugo P. Frear, naval architect and chief designer of the company.

In 1903, as a naval engineer, Robertson was sent by the Union Iron Works to Vladivostock to supervise the construction of caissons for dry-docks at the Imperial Russian Naval Yard. Following completion of the dry-docks, Robertson was hired by the noted firm of Clarkson & Company to construct a graving dock, machine shops, and saw mills.

In 1906 Robertson returned to San Francisco and with a portion of his earnings bought into the firm of Shultze and Shultze, renaming it Shultze, Robertson, Shultze. From 1906 to 1912, Robertson designed and supervised the construction of a number of ferries and riverboats, including CAPITOL CITY, FORT SUTTER, DELTA KING, DELTA QUEEN, COLUSA, BRIDGET, CHARLES VAN DAMME, and CHARLES H. SPENCER. The partnership with the Shultze brothers was dissolved in 1912 when Robertson purchased the established Matthew Turner shipyard in Benicia (Russell Robertson 1961). Robertson continued his distinguished career in Benicia, and later in Alameda, building a number of impressive and significant vessels, including ocean-going 4- and 5-masted schooners, until his death in 1927.

Herman Rosenfelt, the Shultze-Robertson-Shultze company shipwright put in charge of construction of CHARLES H. SPENCER, began putting up the vessel's frame in the beginning of July, 1911. Framing and pinning was completed in August of that year. The vessel was dismantled, packed into two 40-foot automobile railroad cars and shipped to Marysville, Utah in September. Rosenfelt arrived in Marysville on September 9, and once the boat materials arrived supervised their transfer to four wagons for transport over-land to Warm Creek. The first team, loaded with four planks, took 39 days to make the trip from Marysville to Warm Creek. Three other teams loaded with parts of the vessel, took 23 days to deliver their cargos. The teams were forced to make several more trips before all of the pieces arrived at Warm Creek (U.S. vs. Utah, 1929, Transcript of Testimony 16:3006-3014).

At the same time the boat arrived, supplies for Lee's Ferry came in and were met by Bill Hunt with a wagon and five-yoke bull team. Hunt loaded his supplies and left, followed shortly by the horse-drawn wagon with the vessel's boiler on it. At one tight elbow turn near Circleville, Hunt negotiated the turn successfully, however the wagon with the boiler did not. The boiler and wagon fell over a ledge, rolling down a steep slope. After some time and numerous unsuccessful attempts to retrieve the boiler, the teamster who held the contract to deliver the boat materials was fired. Bill Hunt returned to the site, recovered the boiler, and delivered it to Warm Creek without further incident (Interview with Charlie Spencer by W. L. Rusho, September 27, 1963).

Finally, in late October or early November, 1911, all of the parts of the boat arrived at Warm Creek and the job of assembly began. Sometime in November,



during a trip through the Grand Canyon, the Kolb brothers photographed the vessel under construction (see Figures 7.2, 7.10). They described the scene at the mouth of Warm Creek:

... We rowed about twenty miles down the river before we learned what had caused the noises heard in the morning. On rounding a turn we saw the strange spectacle of fifteen or twenty men at work on the half-constructed hull of a flat-bottomed steamboat, over sixty feet in length. This boat was on the bank quite a distance above the water, with the perpendicular wall of a crooked side canyon rising above it. It was a strange sight, here in this out-of-the-way corner of the world. Some men with heavy sledges were under the boat, driving large spikes into the planking. This was the noise we had heard in that morning.

The blasting, we learned later, was at some coal mines, several miles up this little canyon, which bore the name of Warm Creek Canyon. A road led down through the canyon, making it possible to haul the lumber for the boat, clear to the river's edge. The nearest railroad was close to two hundred miles from this place, quite a haul considering the ruggedness of the country. The material for the boat had been shipped from San Francisco, all cut, ready to be put together. The vessel was to be used to carry coal down the river, to a dredge that had recently been installed at Lee's Ferry.

The dinner gong had just sounded when we landed, and we were taken along with the crowd. ... We resumed our rowing at once after dinner, for we wished to reach Lee's Ferry ... that evening. We had a good current, and soon left our friends behind us. We pulled with a will, and mile after mile was covered in record time, for our heavy boats (Kolb 1914:169-175).

While the exact date of the vessel's launch is not recorded, based upon Rosenfelt's testimony it was some time in late February, 1912. Prior to the shipwright's departure, the steamboat was tested, found to be satisfactory, and with the exception of completing a few details, ready for use (Figure 6.1). Rosenfelt returned to San Francisco on March 5, 1912, just two days short of six months from the date of his departure to Warm Creek (U.S. vs. Utah, 1929, Transcript of Testimony 16:3006-3014).

The number of trips that were made by CHARLES H. SPENCER is not clear. The evidence that was provided by several witnesses in U.S. vs. Utah is conflicting, as is the information provided through interviews. On the one hand there is the

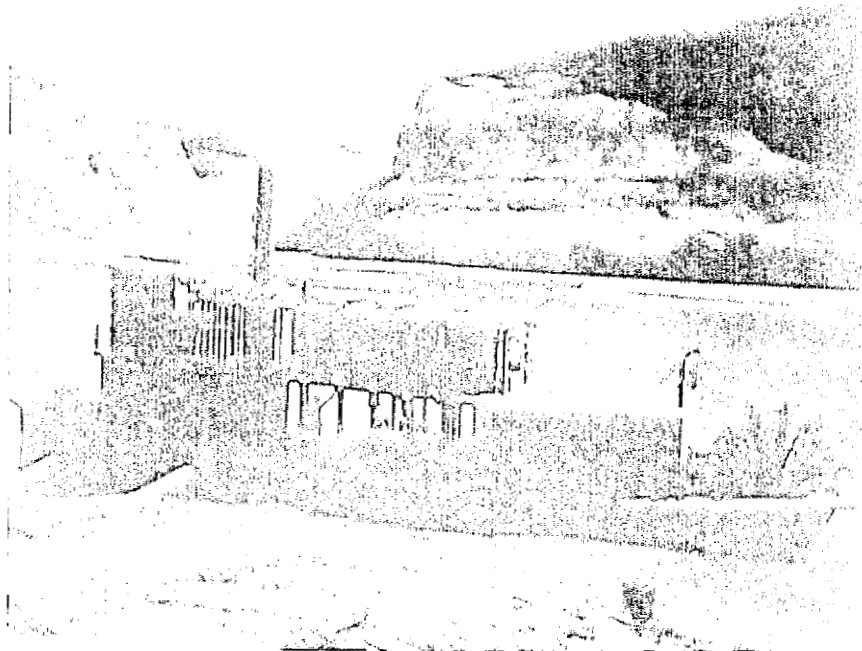

Figure 6.1 CHARLES H. SPENCER just after launching at Warm Creek, February, 1912. Photo courtesy W. L. Rusho.

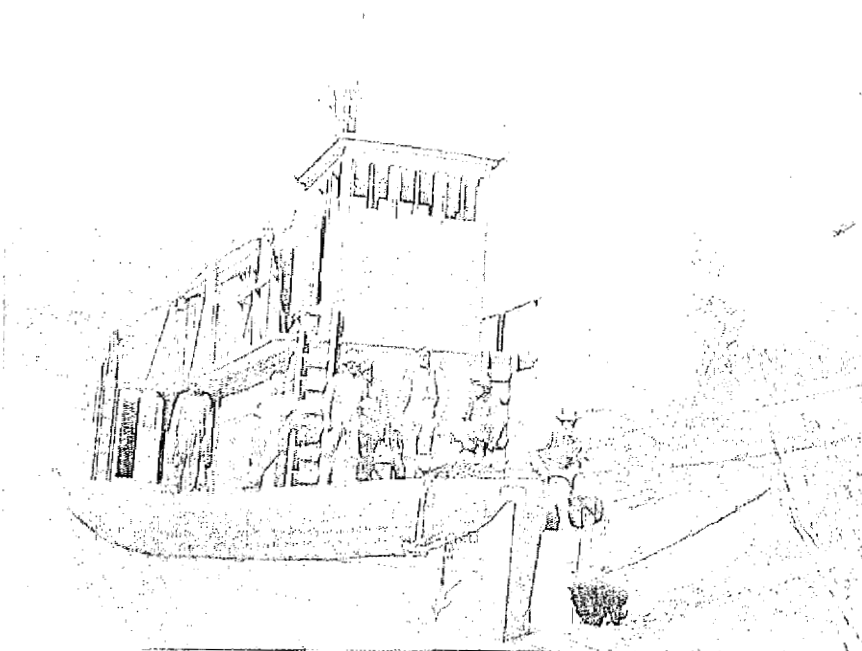

Figure 6.2 CHARLES H. SPENCER tied up east of Lee's Ferry Fort in the Spring of 1912. On board are (left to right) Pete Hanna, skipper; Staats, the mechanic; "Rip Van Winkle" Schneider, "Smithy" Smith, Jerry Johnson, Bert Leech, Al Byers. Special Collections Library, Northern Arizona University. Courtesy Bureau of Reclamation.

statement of Charlie Spencer, who claimed that during the summer of 1911 (sic) the boat made a trip from Lee's Ferry to Warm Creek and back almost every week (Interview by W. L. Rusho, June 18, 1961). Completely opposite is the statement of Bert Leech:

... I was asked to go to Warm Creek to clear the channel and to bring back the steamboat. We took the boat to Lee's Ferry without a load. Later men tried to get it to go back up the river, but found that the boat had insufficient power to run against the current (Interview by W. L. Rusho, February 18, 1961).

Bill Wilson, a packer and driver for the Spencer mining operation, provided a somewhat different answer, indicating the boat made one and one-half trips between Warm Creek and Lee's Ferry.

We went down to Lee's Ferry, back up to Warm Creek, then back to Lee's Ferry and they tied it up down there and that was all they was to it. That was the only move it ever made that I know of (Interview by W. L. Rusho, September 24, 1961).

When both Bill Wilson and Bert Leach were shown a photo of CHARLES H. SPENCER with a crew on board, Wilson did not recognize anyone, while Leech was able to identify all of the men (Figure 6.2). This suggests that there may have been two different crews, and supports additional statements made by Charlie Spencer:

After their trips, the first crew was broken up, some sent to other jobs and some discharged. In July, 1911 [sic], another crew was got together, the boat was taken up to Warm Creek and filled with coal. No barge was used; the coal was loaded on the decks. The July crew made three or four trips with the boat (Interview by W. L. Rusho, August, 1962).

Jeremiah Johnson, photographed on the boat with Bert Leech in 1912 (see Figure 6.2), stated that the boat made two and one-half trips.

They built the CHAS. H. SPENCER at Warm Creek, came down to the ferry and back to Warm Creek. That was one trip. Down to the Ferry and back to Warm Creek, and down to the Ferry and tied it up, and that was the last it was ever used. It sunk. [I] saw it sink (U.S. vs. Utah, 1929, Abstract of Testimony 2:785-797).

Johnson, a ferry boat operator at Lee's Crossing, was continuously at Lee's Ferry during this period, unlike many others who quit or were reassigned to other jobs by Spencer. His recollection of two and one-half trips is supported by the testimony of three other witnesses in the U.S. vs. Utah River Bed Case of 1929.

John W. Palmer, employed as assistant fireman on the steamboat, also stated that the boat made a total of two and one-half trips, and he made one and one-half trips on it. Palmer said that the boat carried about five tons of coal along with a cargo of wagons and machinery (U.S. vs. Utah, 1929, Abstract of Testimony 2:808-809).

Frank Johnson, who along with Jeremiah ran the ferry, reiterated his brother's assertion that SPENCER made two and one-half trips.

The first time ... [I] saw it, it had a few wagons and some machinery on it. ... [the] boat was tied up in the early part of 1912, with a plank from the boat to the shore to keep it from getting too close to the rocks. The boat was built at Warm Creek. It came down river to the ferry and made two round trips after that. There was some coal in bind on the last trip (U.S. vs. Utah, 1929, Abstract of Testimony 2:799-801).

Finally, there is the testimony of Herman W. Freeze, who was employed by the American Placer Corporation as superintendent of machinery at Lee's Ferry in 1911.

The CHARLES H. SPENCER boat was built up above Lee's Ferry while [I] was there. .... [I] didn't see it launched. It might have been a week or two after it was launched that ... [I] saw it. ... the boat made three round trips from Lee's Ferry up to Warm Creek.

On the first trip it looked ... as if there were three or four tons of coal brought down. ...They brought a little more coal on the second trip than on the first one ... about five or six tons the second time. ...The third time they had the front, the nose of the boat, pretty well covered with coal; ... about fifteen or twenty tons. They brought this fifteen or twenty tons about a month before [I] left (U.S. vs. Utah, 1929, Abstract of Testimony 1:686-689).

When taken together the preponderance of testimony, given 17 years after the fact, versus information from interviews nearly 50 years later, weighs strongly in favor of two and one-half trips for the paddle wheel steamboat. The initial trip down to Lee's Ferry, in late February or early March by one crew, then two round trips from Lee's Ferry to Warm Creek sometime later in the spring or summer by a second crew. Following the steamboat's last trip, it was tied up approximately 1/4 mile east of Lee's Ferry Fort, where it remains today (see Figure 3.32).

## Historical Description

No written records or documents of enrollment exist for CHARLES. H. SPENCER, further the vessel does not appear in the Annual List of Merchant Vessel of the United States for 1911 or 1912. Fortunately, several photographs of the boat were taken and have been widely circulated (see Figures 6.1, 6.2, 6.4, 7.2, 7.10). A reference to builder's plans, submitted as evidence in the River Bed Case of 1929, led to the discovery of a copy at the Museum of Northern Arizona. Working from a faded and fragile blueprint, the Photographic Division of the U.S. Geological Survey in Flagstaff, Arizona, was able to lift a photo mylar. The original plans were re-drawn for publication and have been reproduced as Figure 6.3, located in the back pocket of this report. Some additional elements were identified for clarity. The following brief description is based upon information from the historic photographs and the plans.

CHARLES H. SPENCER was designed to carry bulk cargos of coal and miscellaneous package freight. The length of the vessel has been erroneously reported to have been 90 feet 6 inches; this error has stemmed from Herman Rosenfelt's testimony in the River Bed Case of 1929:

Q. Have you got with you a blueprint of that boat?

A. Yes sir.

Q. Will you give me the dimensions of it please?

A. The hull is eighty foot long and a twelve foot wheel on the stern, and six inches clear, makes the whole over all ninety-two feet and a half.

Q. What is the beam?

A. About twenty-five feet.

Q. When fully equipped, how much water did that boat draw?

A. Drawed between eighteen and twenty inches, light.

Q. Light, you say?

A. That is, empty (U.S. vs. Utah, 1929, Transcript of Testimony 16:3007).

A part of the confusion on the vessel's size rests with terminology, the other with an error on the part of Mr. Rosenfelt in reporting the facts.

The length of a vessel, for classification and documentation purposes, is measured from the inside of the stem-post to the inside of the stern-post. This measurement on a stern wheel boat would exclude the paddle wheel and guard. Length over all is measured from the forward side of the bow to the aftermost point of the stern; this measurement would include the paddle wheel and guard. Mr. Rosenfelt quoted the latter measurement in his testimony. Others, using this testimony as a basis for description, have failed to add the critical phrase "over all" when giving the vessel's dimensions. The common practice, when giving vessel particulars of this type, is to reference classification length rather than length over all.

The length of CHARLES H. SPENCER, based upon the blue prints and confirmed by field measurements, was 70 feet (see Figure 6.3). The boat's length over all, that is, its length with stern wheel and guard, was 85 feet 6 inches. The discrepancy between the historic blue prints and archeological measurements, and Mr. Rosenfelt's testimony is attributed to his error.

The breadth of a vessel is its measurement from one side to the other at its widest point. Extreme breadth on a vessel is a measurement that includes the thickness of the outside planking or plating. The breadth, or statute width, for classification purposes is normally measured from inside the side planking at the deck. This measurement would exclude the overhanging guard on a paddle wheel boat. The breadth of CHARLES H. SPENCER, according to the what was written on the plans, was 20 feet. Scaling off the plans resulted in a breadth of 21 feet; field measurements confirmed 21 feet as the breadth. The discrepancy between what is written on the plans, versus the scaled measurement of the plans may have been clerical error. Rosenfelt's statement that the breadth of the vessel was 25 feet included the overhanging guard (see Figure 6.2).

The depth of a vessel is measured from inside the hull bottom planking to the top side of the deck beams amidships. The depth of SPENCER was 4 feet. The depth of a vessel should not be confused with the vessel's draft. Draft is the measured depth of the submerged part of the hull. The draft of a vessel changes

with the weight of its load and therefore determines its ability to pass through shallow water. Roosenfelt reported SPENCER's draft to be between 18 and 20 inches unloaded, this is, without cargo.

Charlie Spencer reported the steamboat's carrying capacity to be approximately 100 tons (Interview by W. L. Rusho, June 18, 1961). From keel to pilot house, the boat was built of wood; single frames were used throughout the hull. Based upon archeological observations, no ceiling planking was used above the turn of the bilge. SPENCER had two decks and long, unbroken hold (see Figure 6.3). It has a plain (straight) bow and a square stern. Like other paddle wheel boats, SPENCER's hull is reinforced with a system of braces and truss rods. The boiler is located forward, under the pilot house. The main deck cabin was open only amidships; the machinery spaces in the bow and stern were enclosed (see Figure 6.1, 6.2). The boiler deck, immediately above the boiler was also open, however there was an enclosed cabin aft of this space (see Figure 6.1, 6.3). CHARLES H. SPENCER appeared to be unpainted in historical photographs; no indication of paint was observed on the remains in 1986.

#### Description of Loss -- The Wreck Event

Following the boat's last run down from Warm Creek, sometime in the spring or summer of 1912, it was tied up to the bank approximately 1/4 mile east of Lee's Ferry Fort (see Figure 3.32). By the time the boat was photographed again in 1915, flood water had forced driftwood under the hull causing it to list to starboard (Figure 6.4).

Bill Wilson recalled seeing the boat sitting up on the bank at the time Lee's Ferry Bridge was dedicated in 1929 (Interview by W. L. Rusho, September 24, 1961). Wilson does not indicate whether the vessel was partially submerged at the time he saw it. Based upon the photograph and Wilson's recollection, it was some time after 1915 and possibly after 1929, that the vessel was lifted off the driftwood, or the driftwood became unstable, as a result of high water and slid sideways into the river. Frank Johnson reported that the boat tipped over and sank (Interview by W. L. Rusho, October 28, 1962). In fact, field observation confirmed that it did not tip over, rather as it slid sideways, it struck a large boulder just below the turn of the bilge, filled with water and sank.

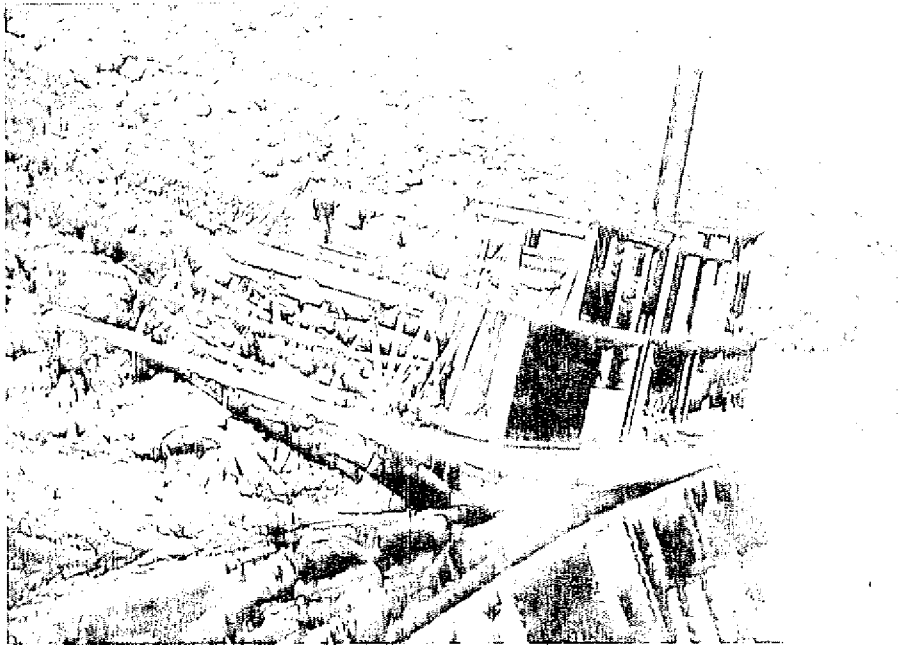

Figure 6.4 Abandoned east of Lee's Ferry Fort, CHARLES H. SPENCER was still in good condition in 1915. Photo by E. C. LaRue, courtesy of W. L. Rusho.



## Post-Depositional Impacts

After abandonment, CHARLES H. SPENCER was systematically stripped of its upper deckworks. Evidence of this removal was found during field investigations. The samson posts, which provided partial framing for the cabins, were found to have been sawn, not broken, near the point at where they pass through the main deck. Subsequent information confirmed salvage of the deckworks by local residents for building projects in the canyon and in the community of Hurricane. By the mid-1930s the vessel's hull is reported to have been only out of the water by 4 feet (P. T. Reilly, correspondence to Toni Carrell, November 3, 1986).

A photograph of the vessel's remains, taken by A. E. Turner in 1959 shows most of the port side still intact, along with the tip of the bilge pump and edge of the boiler exposed above the water. By that date the boiler had rolled over onto the starboard side, and top portions of the fire box were already gone as a result of rusting.

Photographs taken by W. L. Rusho in 1963 show the port side reasonably well intact, nearly up to the level of the overhanging guard (Figure 6.5). The boiler, rolled over onto the starboard side, shows some evidence of cracking in the firebox. The small hand pump is still in situ aft of the boiler.

Deterioration of the hull was more pronounced by 1973 (Figure 6.6). Three or four additional starboard planks were missing, two more were missing from the port side, and the forward end of the firebox had rusted open. Surprisingly, the hand pump was still in place. The depth of siltation appeared greater than in 1963, and the quantity of vegetation on and around the site had increased dramatically.

Thirteen years later, comparison of the 1973 photos with field observations in 1986 found that the starboard planks are now missing down to the level of the silt and the port side has lost at least one or two more planks. The level of the silt has changed very little since 1973, possibly having now reached a stable point in relation to the presently maintained water levels. The small hand pump is no longer on the deck, but has fallen or been pushed over the starboard side. The boiler firebox is greatly deteriorated with a large rusting hole at the forward end.

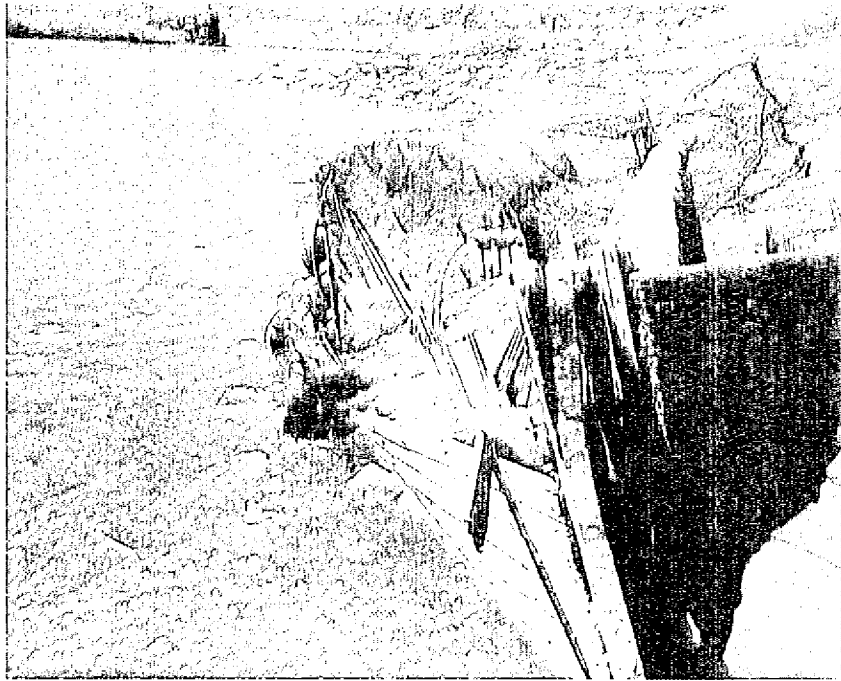

Figure 6.5 The bow of CHARLES H. SPENCER had deteriorated considerably by 1963. The small hand pump is still in place, however the boiler had rolled over onto the starboard side. Photo by W. L. Rusho.

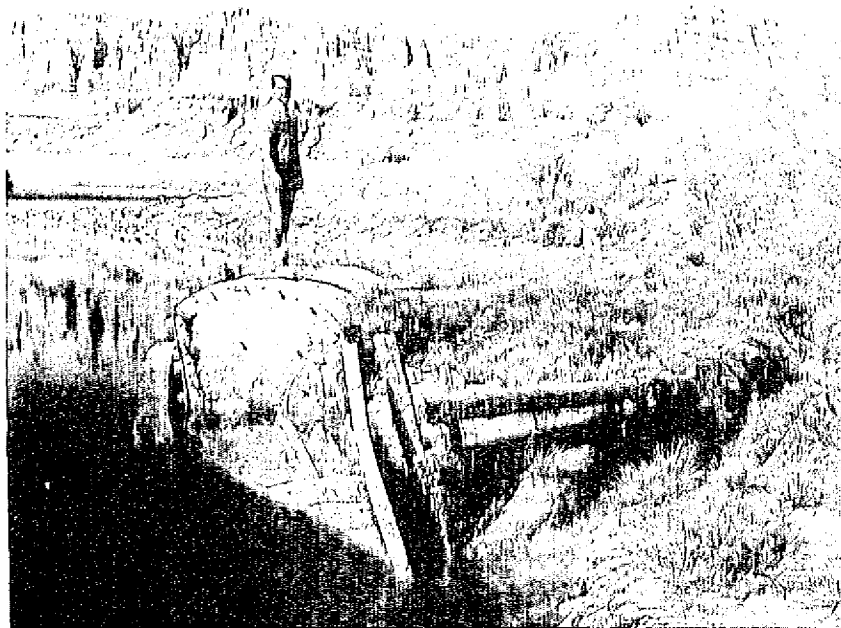

Figure 6.6 Ten years later, in 1973, the vessel was photographed from the same angle. Increased deterioration of the remains and extensive vegetative growth typified the site. Photo by W. L. Rusho

Deterioration of the steamboat from environmental causes has continued at a steady pace. Because photos have been taken at irregular intervals, the rate of deterioration can only be inferred. Silt now completely fills the hold aft of the boiler and nearly fills the bow forward of the boiler. Side hull planking is likely to be less impacted now that it is substantially buried. Only the exposed portions of the vessel, those not buried and those subjected to fluctuations in water level, will continue to deteriorate.

What is much more difficult to determine, is the degree of impact resulting from visitation to the site. At lowered water levels, fishermen have been observed walking on the site and climbing on the boiler, using that feature as a fishing pier. It is impossible to determine, for example, whether the hand pump was finally toppled by a large log or other floating debris, as is shown present on the site in Figure 6.5, or whether visitors pushed it over the edge. The latter is suspected simply because of the excellent condition of the wood on the site.

#### Prior Research

The remains of CHARLES H. SPENCER have been visited irregularly since it was abandoned 1912. The vessel was photographed by E. C. LaRue in 1915 (Figure 6.4), and was observed by Wilson in 1929. P. T. Reilly reported visiting the site in 1935 (Correspondence to Toni Carrell, 1986). A Bureau of Reclamation photographer, A. E. Turner, photographed the site in 1959. W. L. Rusko photographed the site in 1963 and 1973. Little documentation, other than photography, is known to have been completed at the site prior to 1963. That year P. T. Reilly, along with two others, took some general measurements of the vessel (Reilly 1964).

In August, 1981, Daniel J. Lenihan, Chief of the Submerged Cultural Resources Unit, and John Benjamin, Glen Canyon Downlake District Ranger, visited the site. Photographs and additional measurements of the boiler, paddle wheel shaft, and length over all of the boat were obtained. National Park Service interest in the steamboat continued, and in December, 1985, River District Ranger Jon Dick, prepared a brief report on his observations of the site at various water flows and sketch map of the site (Dick 1985). It was not until September, 1986, that a

concentrated documentation effort was made at the site. The results of that effort are reported on in this publication.

Published references to Charlie Spencer's mining activities and the steamboat at Lee's Ferry include: Through the Grand Canyon from Wyoming to Mexico (Kolb 1914:169-175), Arizona Highways (Haskett 1935(11):6-7, 17-18), Steamboat Bill (Colton 1957:6-7), Outline History of Glen Canyon (Crampton 1959:30-38), Historical Sites in Glen Canyon (Crampton 1960), Arizona Highways (Rusho 1962:34-39), Plateau (Colton 1962:57-59), Journal of the West (Rusho 1968:64-75), Steamboats on the Colorado River (Lingenfelter 1978:127-132), Desert River Crossing (Rusho and Crampton 1981:63-73), A Crossing on The Colorado, Lee's Ferry (Measeles 1981:44-47), Ghosts of Glen Canyon (Crampton 1986:130-133), among others.

#### Administrative Status

CHARLES H. SPENCER is included on the National Register of Historic Places as part of Lee's Ferry Historic District (Reynolds 1974). The shipwreck does not have a State of Arizona site number, however, it is recorded separately by the National Park Service. The site is managed by the National Park Service in cooperation with the Bureau of Reclamation. Sport diving is not prohibited, however to date the area has received diving attention only by the National Park Service.

## CHAPTER VII. CHARLES H. SPENCER SITE DISCUSSION

### Site Location

The remains of the historic wooden vessel lie in a small eddy below Lee's Ferry on the Colorado River (Figure 7.1). The steamboat is approximately 1/2-mile east of Lee's Ferry Fort, on the north side of the river. The site can be reached by walking east, approximately 2000 feet, along a National Park Service trail from the main parking lot adjacent Lee's Ferry Fort.

### Research Methodology

A total of 27 persondays of diving were completed on the wreck. The diving was geared toward several specific objectives, outlined for the Glen Canyon project. They included: 1) obtaining a verbal description and photographs of the site location; 2) determining the nature and extent of the wreckage present; 3) developing a base map, with photo and video documentation, of the site to aid in analysis, feature identification, and interpretation; 4) familiarizing the Recreation Area cultural resource and protection staff with the resource; and 5) providing preliminary recommendations for the vessel's short- and long-term management.

The methodology used to meet these objectives included trilateration measurements of all wreck elements from a physical base line; drawings of selected machinery and construction details; photographs of construction details; videotaping all significant features and major elements; reconnaissance of the general site area to determine the extent of wreckage; probing of overburden; and limited probing with close examination of wood to determine structural integrity and degree of impact from freshwater organisms. The impacts of changes in water flow, fluctuations in water level, and wave action were also recorded.

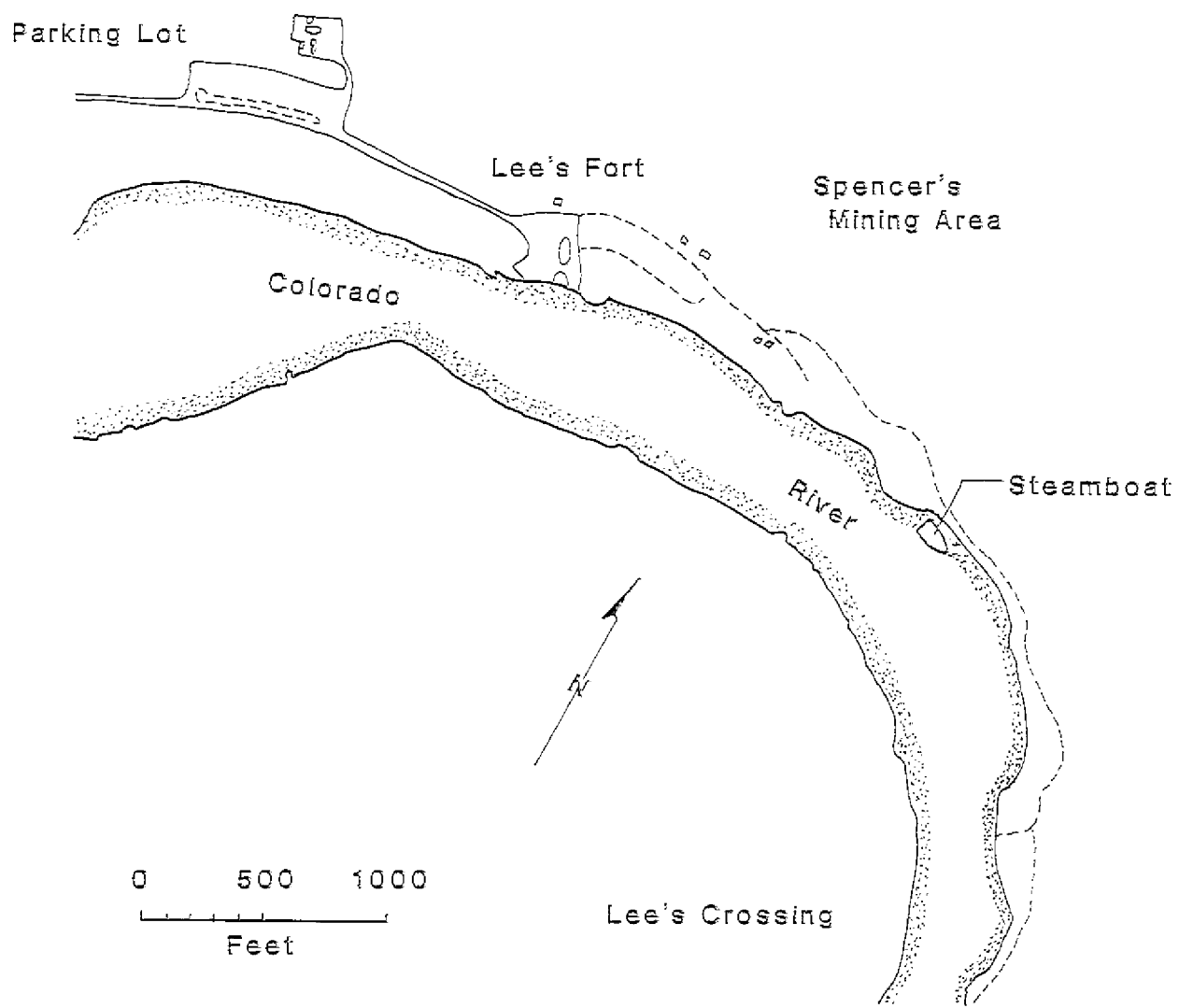

Figure 7.1 CHARLES H. SPENCER site location.

The policy of the Submerged Cultural Resources Unit is to conduct site research using a minimal impact approach. Only rarely is overburden removed, and then only to answer very specific questions. Substantial portions of the site were exposed and available for study, therefore no excavation was conducted, nor were any artifacts removed.

### Site Description

The paddle wheel steamboat lies directly offshore on a coarse sand and silt bottom that gradually slopes south toward the river channel. Depth of water over the site varies with the water flow released from Glen Canyon Dam. During normal operations, from 15,000 to 26,000 cfm, the water depth ranges from 2 to 3 feet along the bank and from 15 to 18 feet below the starboard side. At these flows the site is completely submerged. During periods of reduced flow, in some cases as low as 5,000 cfm, as much as 2/3 of the boiler, part of the deck, and the center and port paddle wheel hubs are exposed. During low flows it is possible to walk on the port side deck and climb on the boiler without getting wet. It is during these periods that visitors can do the most damage to the site.

The site trends in a Northwest–Southeast direction and is confined to an area approximately 90 feet long by 60 feet wide. The site covers an area of 5400 square feet, roughly 1/8 of an acre. The vessel's hull, from stempiece to sternpost, is substantially intact up to the level of the main deck. All of the upper deckworks are gone. The paddle wheel guard is intact and the vessel's three paddle wheel flanges are in place. Bits of wood, from the paddle wheel arms, were found in the arm pockets on the flanges. Several sections of the iron circle, the principal wheel bracing located just inside the buckets, were located on the site. The paddle wheel shaft is also intact and articulated with the pitman, pillow block and cylinder timber on the starboard site. The port side is buried.

The vessel is listing to starboard and appears to have settled stern first on the bottom as it sank it. The hull is completely silted in, although much of the decking on the port is only buried by a few inches of overburden. The overburden deepens to 1 1/2 to 2 feet on the starboard. The starboard side, from the bow to the rudder well and from the level of the main deck to the bottom below the turn of the bilge, is exposed.

The vessel's boiler has rolled and is resting on the gunnwhale, while much of the steam piping lies just below the starboard side on the sand and rock bottom. Other machinery present on the site includes the starboard engine, pitman eccentric rods, throttle, bilge pump, and heater. Truss rod and turnbuckles, part of the hull strengthening system, are well represented across the site, as are the samson post caps. None of the samson posts were located.

### Site Analysis

A verbal description of the site location (see above), video and photo documentation of the area were the first pieces of data generated. The steamboat's remains consist of the intact hull, including paddle wheel guard, and a scattering of machinery below the starboard side; these are indicated on the site base map (Figure 7.8, located in the back pocket of this report).

Evaluation of the general condition of the site suggests that it has undergone limited environmental impacts. Wave action, normally a major contributor to site deterioration, has been minimal. Water flow over the site has had little direct adverse impact, because of the site's location in an eddy well out of the river's main channel. As a result, rather than coming apart at points of structural weakness, as expected in most similar situations, the hull began filling in with silt. This served to firmly plant the hull in place and slow its deterioration.

The natural aspects of the site formation process, that is the dynamics that resulted in the present day condition of the site, were accelerated as a result of salvage by local inhabitants. The upper deckworks were removed, probably along with the supporting framework provided by the samson posts. The truss rod was either allowed to fall or may have been pushed over the side simply to get it out of the way during salvage of the deckworks. Salvage probably occurred prior to sinking, because of the ease of access at that time. Decking in the bow could have been removed during this same period.

Dry rot is likely to have weakened the exposed hull to some degree. When the vessel was partially re-floated off the piled up driftwood, seen in Figure 6.4, it slipped sideways listing slightly to starboard and settled on a boulder that



punctured the hull. It is probable that the boiler rolled over at this point, pulling the stack, breeching and piping with it.

For purposes of clarity, the site will be discussed by major structural features (hull, paddle wheel assembly), the machinery (boiler, pump, engines, throttle, heater, etc.), then the miscellaneous wreckage scatter below the starboard side. In addition a summary of CHARLES H. SPENCER's key construction attributes is provided in Appendix A.

## Hull

CHARLES H. SPENCER has a flat bottom, square stern, and a straight bow (see original plans Figure 6.3). The vessel's design is based upon a standard configuration for paddle wheel vessels of the period, with construction elements nearly identical to a "typical" boat. Generally speaking, these vessels were framed as lightly as possible to insure shallow draft; SPENCER is no exception. While it was impossible to verify the dimensions on many of the internal structural members, the plans do provide some details.

The steamboat was scheduled to have 12-inch keelsons, resting atop 8-inch floors. The plans do not indicate the width of these timbers, although it is reasonable to assume that the keelsons could have been 12 by 12 inches, and the floors 6 by 8 inches. A 6 by 8 inch floor timber would have readily articulated with the 4 by 6 inch single frames used throughout the boat. Frame spacing normally becomes tighter fore and aft to allow for curvature of the hull in the bow and the stern. SPENCER's frame spacing in the bow, and to a degree in the stern, reflected this construction technique. What is unusual, however, is that the steamboat's frames are irregularly spaced throughout the length of the hull, and varies from 16 to 24 inch centers.

A photograph of the vessel under construction at Warm Creek in the fall of 1911, clearly illustrates the framing (Figure 7.2). The stringer, or futtock, seen at the turn of the bilge provided longitudinal support for the hull. A centerline keelson provided support for stanchions, that in turn supported a top (longitudinal) stringer. The stanchion and stringer are evident in the interior of the hull. The deck beams are lying across the centerline stringer and on a shelf at either side of the hull. A

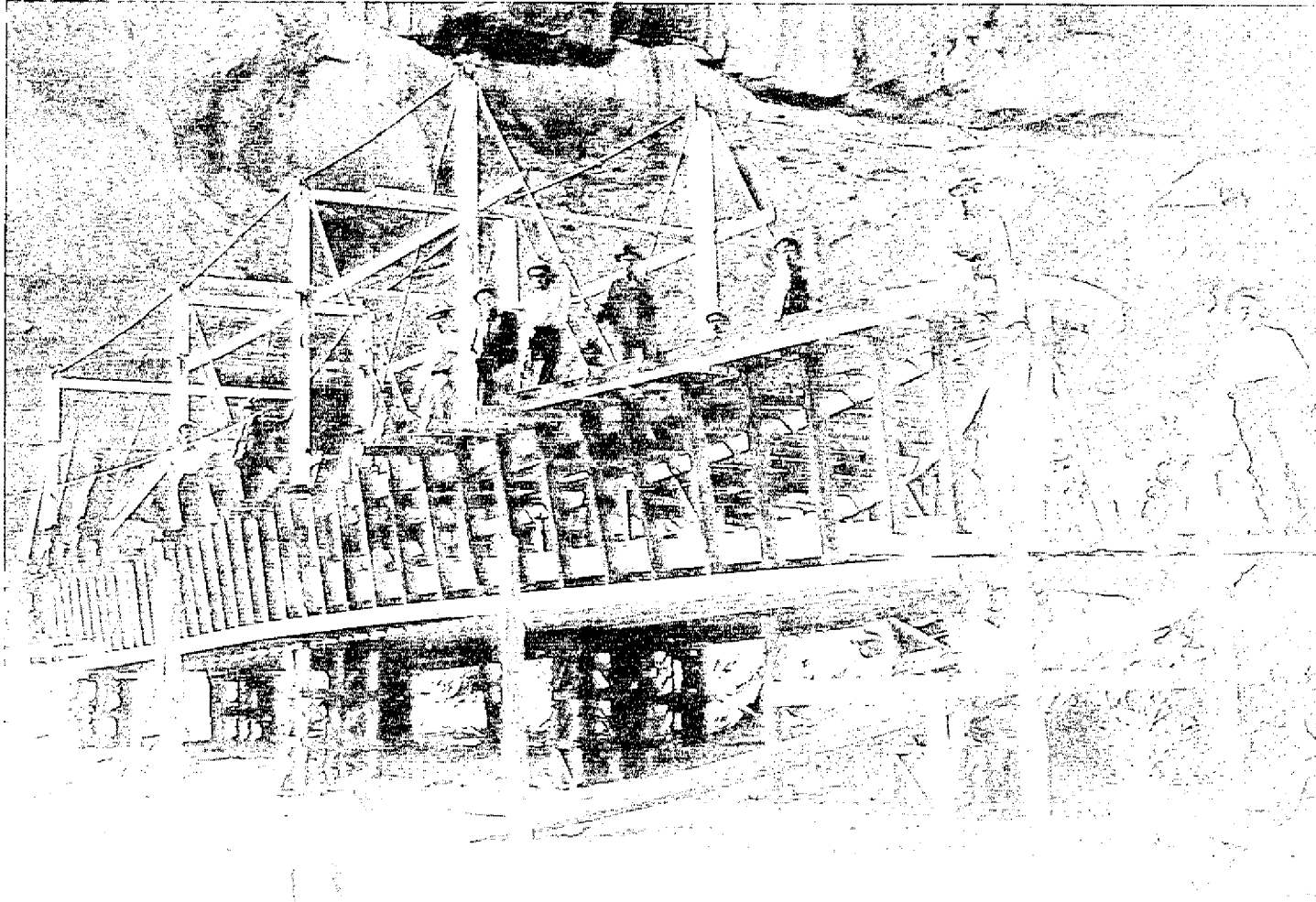

Figure 7.2 CHARLES H. SPENCER under construction at the mouth of Warm Creek, November, 1911. View from bow. Photo by C. Emery Kolb. Special Collection Library, Northern Arizona University. Courtesy of Bureau of Reclamation.

hull cross section was developed based upon field data, the plans, and historic photographs. The width of the keelsons, the size of the longitudinal stringer at the turn of the bilge, height of the centerline stanchion and top stringer are all speculative (Figure 7.3). Figure 7.4 illustrates the relationship of these various components at the level of the main deck. The deck beams do not lie on top of the frames, but are butted up against them and lie on the shelf. SPENCER's shelf consists of a 2 by 8 inch plank.

The deck beams extended beyond the hull to form an overhanging guard. Figure 7.5 details the construction of the guard found on SPENCER. The guard, designed to carry additional cargo on this type of vessel, extends 15 inches beyond the hull planking. It was constructed using 4 by 5 inch spreaders between deck beams, and faced with two 1 by 5 inch protective planks. With the exception of three heavier timbers, the deck beams were uniformly 2 by 4 inches. The three heavy deck beams, located at either end of the boiler hatch, and just forward of the engine space, are 4 by 5 inches. These beams are indicated on the original plans (Figure 6.3). The main deck planking would have continued out over the guards. The decking varies in width from 5-1/2 to 6 inches by 1 inch.

Side planking also varies from 5-1/2 to 6 inches by 1 inch, and is attached to the frames using 6 by 3/8 inch square spikes. Just above the turn of the bilge the planking is 9 inches wide. The planks are attached to the frames with a single spike; just above the turn of the bilge the 9 inch plank and the knuckle<sup>1</sup> are attached with two spikes each. The knuckle is a full inch thicker than the side and bottom planking, measuring 10 by 2 inches. Bottom planking consists of 12 inch planks; thickness could not be verified but is suspected to have been 1 inch. In order to accommodate the curve of the hull in the bow and stern, the planking was tapered and fitted together. The tapering is evident in a photograph of the vessel just prior to launch (Figure 7.6) and in a photograph taken at Lee's Ferry (Figure 6.2). The only evidence of tapering on the wreck was found in the bow, where planks that are broken out would have been tapered to articulate with those remaining (Figure 7.7).

---

<sup>1</sup>The knuckle is a plank that faces the cocked hat or futtock at the turn of the bilge. See Petsche 1974:76, figure 76.

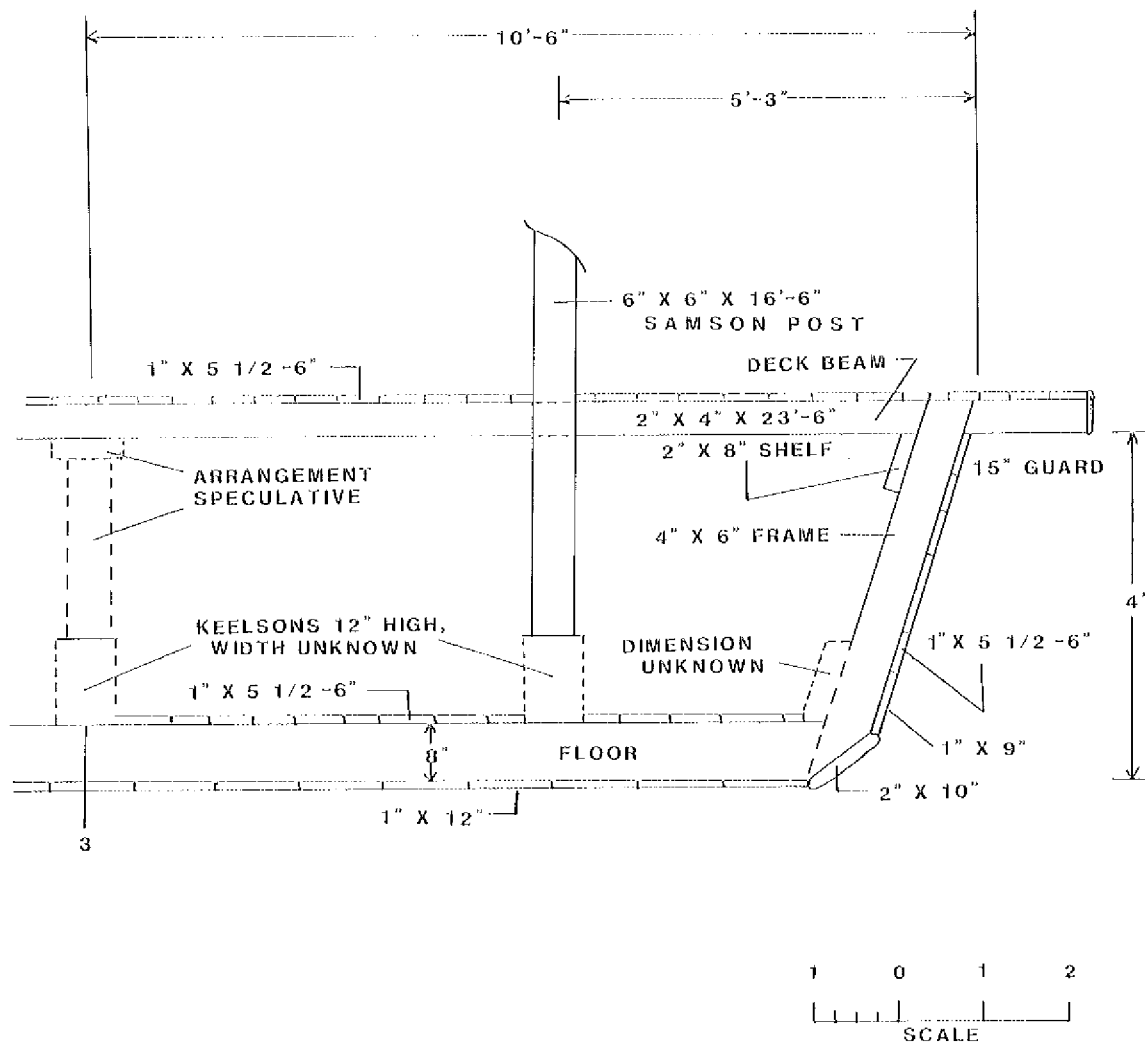
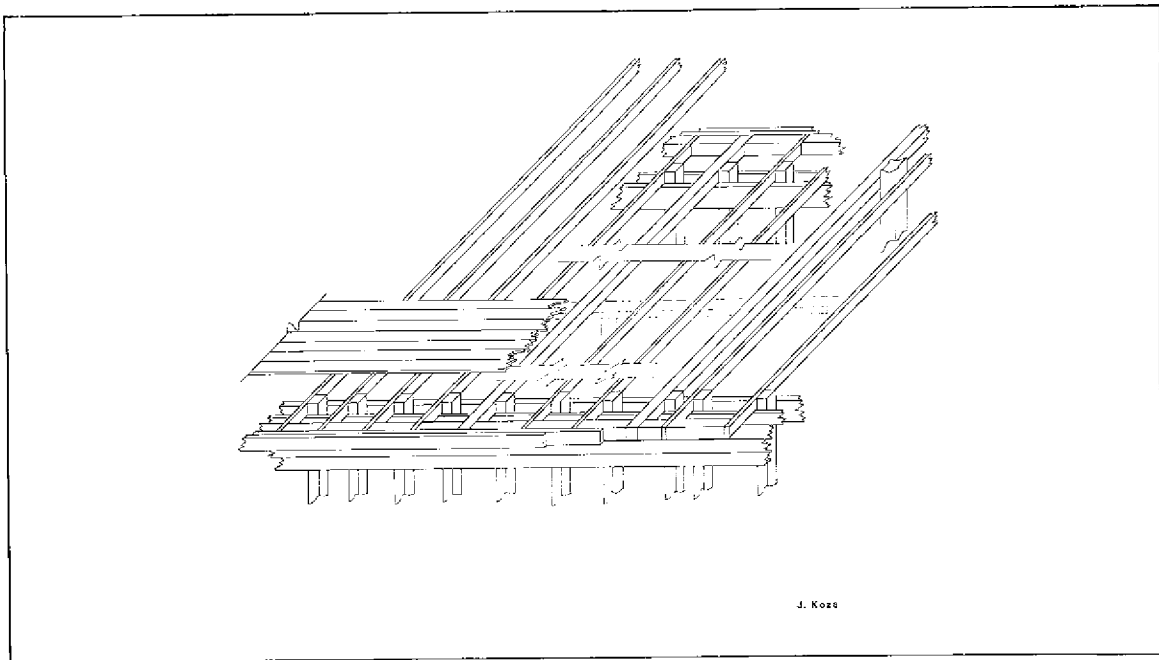
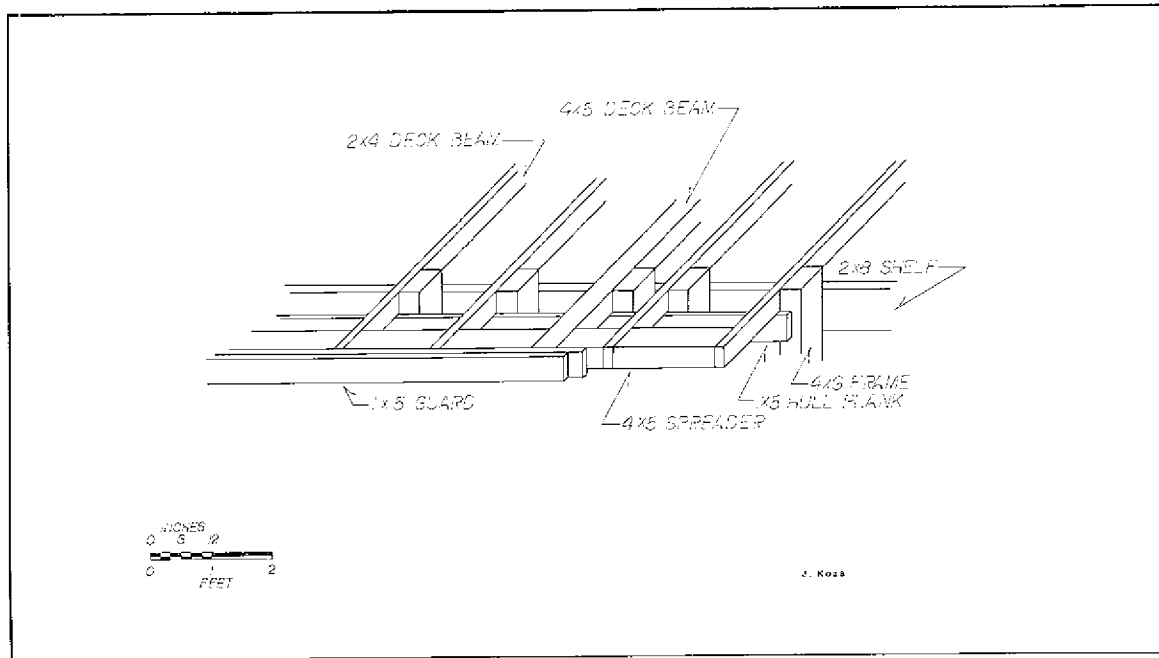

Figure 7.3 Hull cross-section, approximately amidships. View from stern.



J. Koss

Figure 7.4 Exploded view of main deck construction.



J. Koss

Figure 7.5 Detail of overhanging guard construction, approximately amidships.

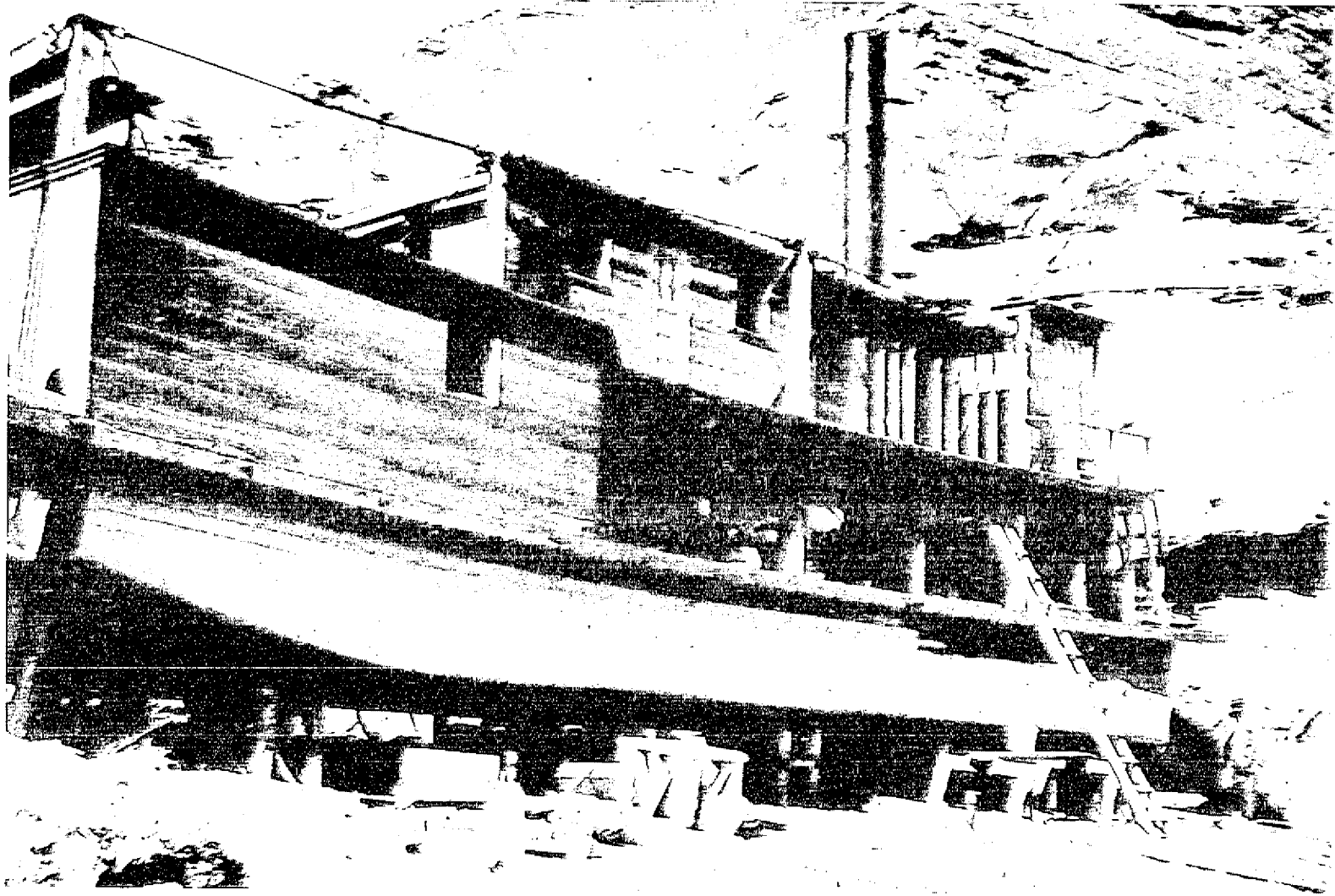
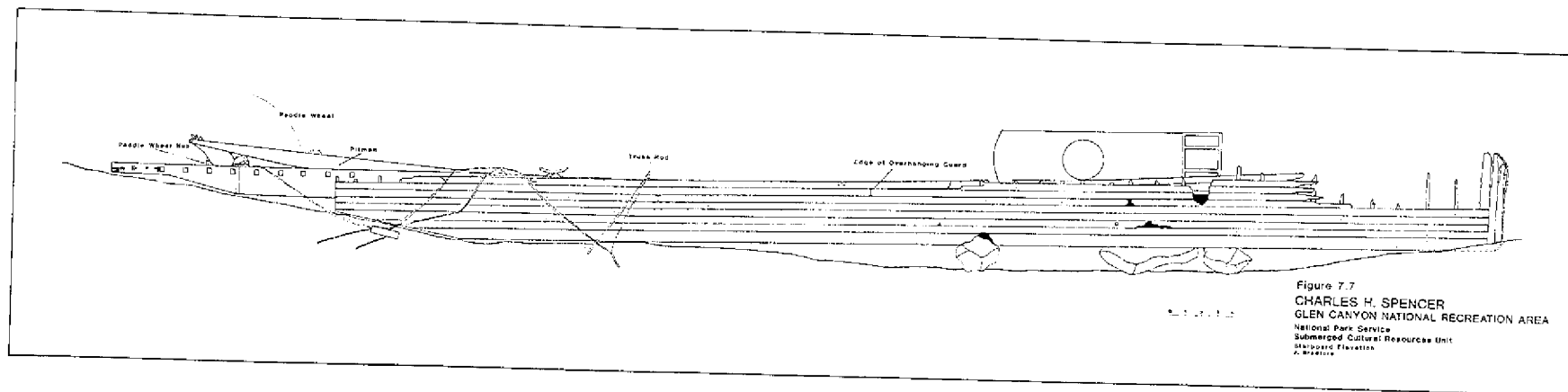

Figure 7.6 After reassembly at Warm Creek, CHARLES H. SPENCER waits for launching. Photographer unknown. Courtesy W. L. Rusho.



No ceiling was observed on the exposed inboard side of the vessel, and due to overburden it was impossible to verify the presence of ceiling on the bottom. The original plans do indicate that at least the engine room floor was planked.

Figure 7.8 (located in the back pocket of this report) is a plan map of the vessel as it existed in the fall of 1986. The following discussion is based upon that map.

The framing construction of SPENCER's bow was accomplished using three separate timbers. The stem piece is a trapezoid that measures 3 inches and 7 inches on the parallel sides (i.e., fore and aft) and 5 inches on the non-parallel sides (port and starboard). A 3 by 3/8 inch metal stem guard protects this piece from damage by floating debris. The stem guard is attached to the stem using the same type of fastener as found elsewhere on the vessel, these are 6 by 3/8 inch square spikes. Immediately behind the stem piece is the apron, another trapezoidal timber measuring 7 and 10 inches, fore and aft, and 5 inches port and starboard. A stemson is present and consists of three rectangular timbers that would have measured 6 by 8 inches each when the vessel was built. All three elements, the stem piece, apron, and stemson, are in deteriorated condition, showing the effects of wet/dry cycling (see also Figures 6.5 and 6.6). A portion of the deadwood is visible aft of the stemson, the exposed portion consists of a 6 by 10 inch timber butted up against the stemson. Hull planking extends only to the apron.

Immediately aft of the deadwood are remnants of the tow bitt. This feature is normally tied in to the keelson, and there is no reason to suspect otherwise in this instance. The bitt consists of three timbers, each 6 by 6 inches, forming a 6 by 18 inch base over all. At the time of construction, the outer timbers extended up through the main deck and were topped with a thick plank (also see Figure 6.2).

The port side is only partially exposed, while the starboard is exposed almost to the turn of the bilge (see Figure 7.7). Four frames remain on the port side, while the frames are intact back to the stern on the starboard. The shelf is completely missing in the bow on the port side, while it does appear just forward of the boiler on the starboard side. Sand and silt completely fill the bow, other than the tow bitt



and the upper portion of the deadwood, the only other exposed features are truss rod and turnbuckles, part of the vessel's internal strengthening system.

Truss rod, also called hogging chain, and turnbuckles were used in long wooden-hulled vessels like CHARLES H. SPENCER because there was little to provide internal stiffness. Western river steamboat hulls were very long in proportion to their depth and their width. The tendency of these hulls to take on a snake-like curve was very common. Internal structural support was needed to offset longitudinal and transverse strains that resulted in the ends of the boat drooping, or "hogging," and the middle rising or "sagging." This problem was solved in the 1840s with the development of a system of braces, also called samson posts, and rods. Figure 7.9 (top) illustrates the arrangement of braces and rods on a typical stern wheel steamboat.

The truss rod was designed to reduce longitudinal hogging, i.e. upward curvature, of the hull, . The turnbuckles were used to tighten sections of rod, pulling the vessel bow, stern, paddle wheel, and paddle wheel guard up. This would offset the weight of the boiler, engines, and paddle wheel located in the bow and stern, respectively (Figure 7.9 bottom). As the rod is tightened, it also exerts downward pressure on the samson posts. The samson posts are stepped into the keelsons, and where the truss rod is attached to the keelson, a clamp is used. The downward pressure of the samson post on the keelson forces the upward curve, or sagging, of the hull amidships to flatten out. The samson posts also press down on the cylinder timbers just below the engines, reducing sagging, i.e. downward curvature, in that area. The illustration on top of Figure 7.9, could very well be CHARLES H. SPENCER. It mirrors the truss rod and samson post arrangement used on the boat, involving two parallel rows of samson posts. The historical photo taken during the boat's construction also shows the truss rod and samson post arrangement (Figure 7.2).

Based upon the arrangement of samson posts, it is possible to determine that CHARLES H. SPENCER had three keelsons. As discussed earlier, the centerline keelson supported the stanchions, while the port and starboard sister keelsons supported the parallel rows of samson posts (refer to Figures 7.3, 7.9).

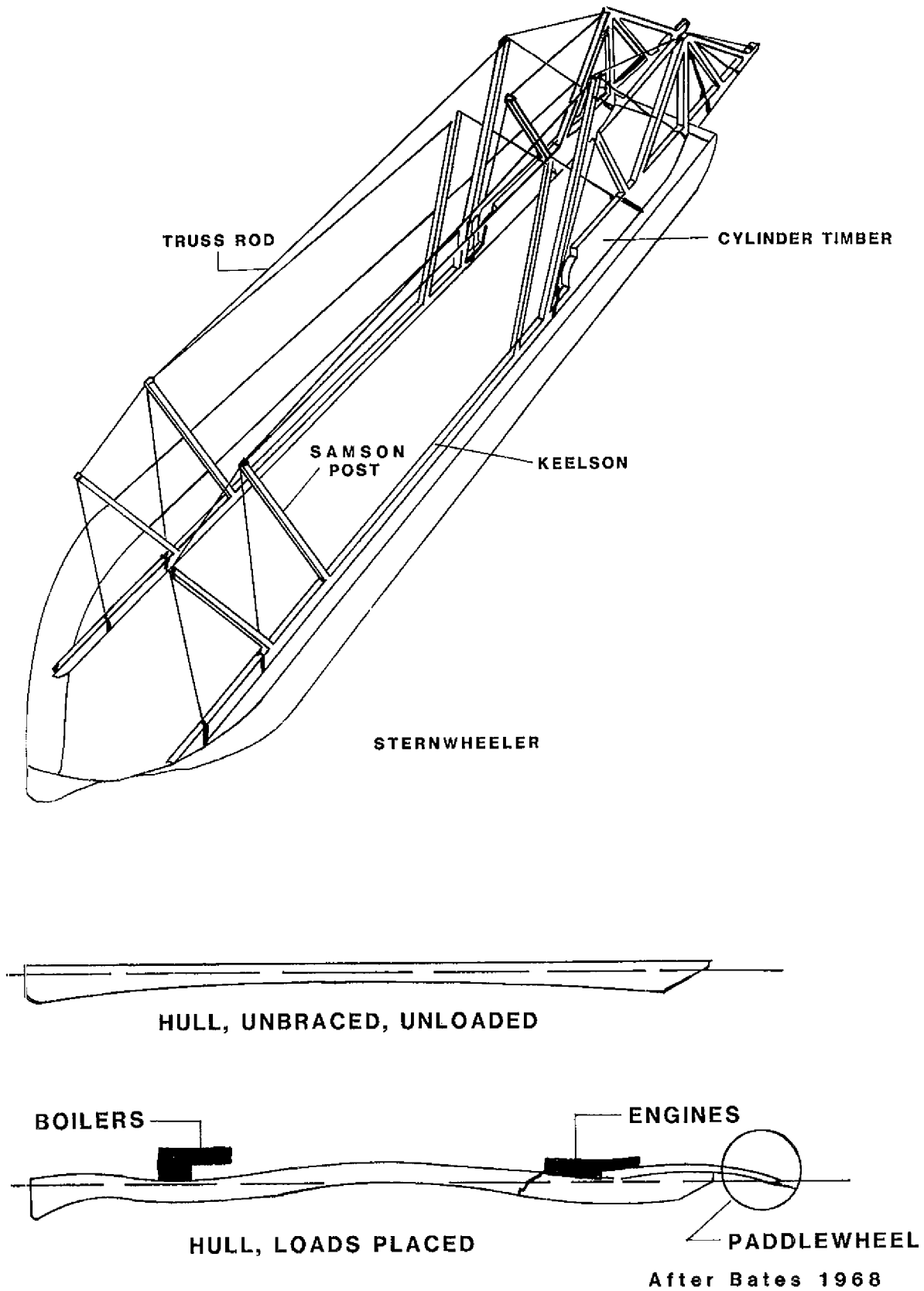

Figure 7.9 Typical arrangement of keelsons, cylinder timbers, samson posts, and truss rod on a stern paddle wheel boat and hull stresses as a result of boiler and engine loads.

In all, eight turnbuckles are exposed on the site; these measure 10 by 3 inches each. The two in the bow, in situ, still had sections of threaded truss rod protruding from both ends. The bow was the only area where it was possible to examine the portion of rod that extended below the level of the main deck. Two sizes of threaded truss rod were discovered; below the level of the main deck the rod was 2 inch diameter, while above the level of the deck it was 1-1/2 inch diameter.

The boiler sits immediately aft of the truss rods in the bow. That feature will be discussed in greater detail below. At the time of the vessel's construction, the boiler would have been sitting upright in the boiler space, a 19 foot by 7 foot 6 inch hold (see original plans, Figure 6.3). The entire forward part of this hold is now missing, the after end, however is still partially intact (refer to Figure 7.8, base map). Decking aft of the hatch opening is intact. Two sections of hatch coaming are present; one lying just behind the boiler, the second aft and to port of the boiler. That section of coaming to port of the boiler measures 7 feet 6 inches long, is 3 inches wide and 5 inches high. The ends of this section are sawn, not broken, suggesting this piece is intact and came from the aft edge of the hatch. The section of coaming immediately behind the boiler is broken; it too is a 3 by 5 inch plank, its length is just under 4 feet. This is probably a portion of the starboard coaming.

Decking on the starboard side, aft of the boiler, is broken as a result of the boiler rolling over out of place. Remains of the starboard hatch coaming are not visible under the boiler, nor is there any evidence of the forward starboard samson post. It is suspected that the post was removed by salvors shortly after the vessel's abandonment; its presence would have prevented the boiler from toppling over and crushing the starboard hatch coaming. The remnant of the forward port samson post is buried by deep sand and silt. Aft of the boiler along the starboard side, the remains of the overhanging guard are evident; the guard extends to the transom.

Immediately aft of the boiler hold the remains of the vessel's tow post is present. The 6 by 6 inch timber was sawn off, not broken, even with the level of the deck. According to the plans, this post was scheduled to be 17 feet 6 inches high. No other remains of the tow post were located elsewhere on the site.

Decking around the tow post is intact, with the exception of a small hole directly behind the post remnant. This is the former location of the hand operated bilge pump, as indicated in the original plans (Figure 6.3). The excellent condition of the decking in this area, coupled with the fact that until as recently as 1973 the pump was in place, suggests that the pump was forceably removed and pushed over the starboard side. The pump now lies below the boat, almost directly below its former location on deck (see Figure 7.8).

Approximately 6 feet aft of the tow post are the remains of the port and starboard mid-ships samson posts. Both of these were also sawn, not broken, off at the level of the deck. These 6 by 6 inch timbers were scheduled to be 16 feet 6 inches in high. No remains of either samson post were found elsewhere on the site. Just forward of the starboard samson post is a small hatch, measuring 2 feet 6 inches by 1 foot 3 inches. This opening provided access to the bilge. Decking around the starboard samson post and hatch is intact, and in good condition. The existence of a similar hatch forward of the port samson post could not be confirmed because no decking exists in that area. Approximately 124 square feet of deck is exposed; much of this is intact and in good condition.

Approximately 4 feet 9 inches behind the starboard mid-ships samson post, a section of truss rod protrudes through the deck. The rod is still articulated with the keelson below deck, the turnbuckle just above the deck, and eventually a samson post cap over the side of the boat. Immediately behind the truss rod, lying partially on the deck and partially on the sand, is an "L" shaped disarticulated section of 2-inch o.d. piping (refer to Figure 7.8). A union and two valves connect the various smaller sections. The piping, now lying in the general vicinity of the feed pipe to the heater, may have once been articulated to that feature, however this is entirely speculative.

From the mid-ships area aft, the deck is covered with an increasingly deeper layer of sand and silt. The depth increases rapidly moving from bow to stern and from port to starboard. Protruding from the sand approximately 4 feet aft of the port samson post remnant is a section of truss rod; behind that another 6 feet is a section of truss rod and an additional turnbuckle (Figure 7.8)

Completely to port, a 4 by 5 inch deck beam is partially exposed, as is a 6 foot section of shelf. No additional sections of hull along the port side are visible, although the shelf and decking are buried by only a few inches of sand. Inboard and slightly toward the stern, an eight foot section of decking is exposed. This is the area of the engine room. Aft of the decking a small section of truss rod is exposed.

According to the plans, the third pair of samson posts were located approximately 15 feet aft of the mid-ships pair. Located in the engine room, they should have been just inboard of the cylinders (refer to Figure 6.3). The position of the third pair could not be verified due to the depth of sand in that area.

A cleat is present on the overhanging guard outboard of the starboard engine cylinder head. Approximately 3 feet aft of the cleat is a chock. Both deck features can be seen in a historic photo of the vessel (Figure 6.4). Lying adjacent to and over the chock are two sections of truss rod. The rods are still attached below decks and to samson post caps lying over the side of the vessel (Figure 7.8).

As the overhanging guard nears the stern, it narrows down (Figure 7.8). Supporting construction for the after end of the guard is provided by an extension of the vessel's transom. This is clearly visible in Figure 7.10, a historic photo of the vessel under construction taken by the Kolb brothers in 1911. Additional bracing for the narrowed-down guard is provided by a 1 by 12 inch rod, connecting two longitudinal timbers, and a 1 inch by 4 foot rod connecting the guard to the cylinder timber. The transom is exposed from the outer edge of the guard to the starboard edge of the rudder well, a distance of just over 5 feet.

Only the edge of the rudder well is exposed; no other features associated with the rudder could be examined due to the depth of sand overburden. The Kolb photo (Figure 7.10) taken in 1911, and the E. C. LaRue photo (Figure 6.4) taken in 1915, both from the stern, provide additional construction detail on the stern and rudder configuration. In Figure 7.10, two sets of rudder gudgeons are visible bolted directly on the transom. The rudders, visible in LaRue's photo (Figure 6.4), were reinforced with iron strap.

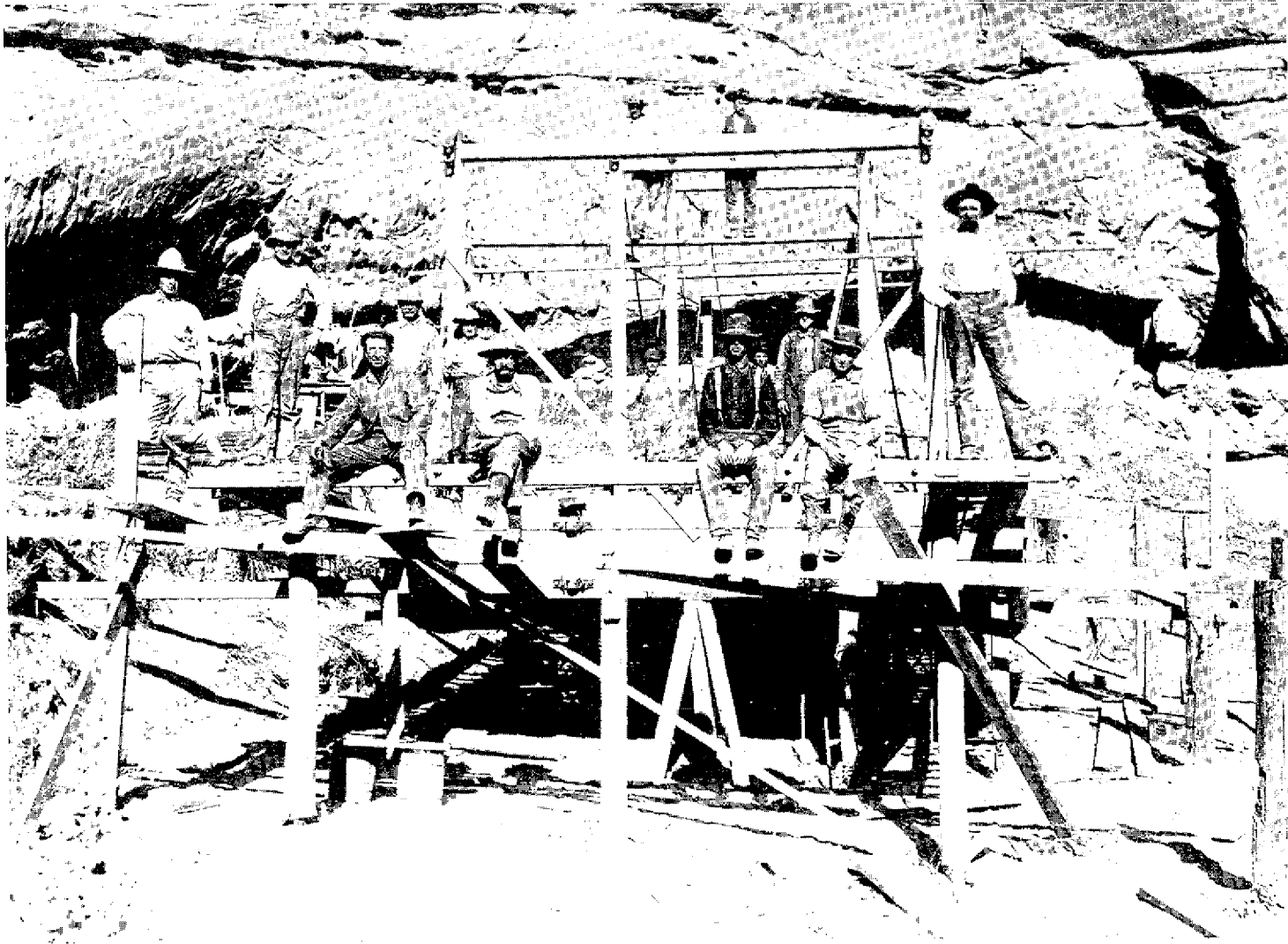

Figure 7.10 Construction of CHARLES H. SPENCER at the Mouth of Warm Creek in November 1911. View from stern. Kolb Brothers photo. Special Collection Library, Northern Arizona University. Courtesy Bureau of Reclamation.

## Paddle Wheel Assembly

For purposes of the following discussion, the paddle wheel assembly consists of these features: cylinder timber, pitman, crank, pillow block and cap, paddle wheel shaft, paddle wheel, and paddle wheel guard.

Cylinder Timbers: Two pair of cylinder timbers on the port and starboard sides of the vessel not only provide support for the engines, they extend out toward the stern to support the paddle wheels. Because of the weight of the engines and the vibrations caused by its functioning, these timbers are tied in to the vessel's sister keelsons (refer to Figure 7.9, top). Specifically, the inboard timbers rest on top of and are attached to the side keelsons. The cylinder timbers on CHARLES H. SPENCER were scheduled to be 6 by 12 inches each, tapering down to 6 inches high at the stern guard. Only the starboard pair are exposed on site; field measurements of the timbers found several discrepancies from the plans. The inboard timber, the one tied in to the keelson, is 6 inches wide as scheduled, however, it's height is 18 inches rather than 12 inches; it tapers down to 6 inches at the guard. The timber is exposed at the transom and continues toward the stern, unchanged, for 6 feet 3 inches; at this point a 2 inch wide strap encircles it. At the strap the timber begins a sharp taper down to 6 inches; the length of the timber from the beginning of the taper at the strap to its end is 8 feet 6 inches. The exposed section of inboard cylinder timber is 14 feet 9 inches, overall. The tapering of the cylinder timbers is visible in Figure 7.10.

The outboard cylinder timber, unlike the inboard timber, is only 3 inches wide. This is one-half the width that was anticipated, based upon the plans. In all other dimensions, the outboard timber mirrors the inboard timber. The outboard timber differs from the inboard timber in one other detail, a series of nine 4 by 4 inch holes are carved along a portion of its length (refer to Figure 7.7). The pitman, a long timber driving the paddle wheels, moved in the 13-inch space between the cylinder timbers. Its rotational movement caused water turbulence; the holes in the outer timber allowed the water to rush out laterally, rather than having to move out under the boat. The outboard timber forms the outer edge of the paddle wheel guard on the port and starboard sides, respectively.

It is impossible to determine, based upon archival or other documentary evidence, whether the change in the width of the outboard cylinder timber was made while the vessel was under initial construction in San Francisco or was the result of creative-adaptive boat building by the shipwright on site, possibly finding himself with only three, rather than four, cylinder timbers. The only fact that is indisputable, is that the plans called for 4 6-inch timbers and that is not what is represented on site.

Pitman, Crank, Pillow Block and Cap: The pitman serves as the connecting rod between the engine and the cylinder shaft. While a few were made of steel, the vast majority were made of wood (Bates 1968:96). The pitman on CHARLES H. SPENCER is a wooden timber 5 inches wide and varies from 3 inches high at the jaws to 12 inches in the center, forming a lozenge-shape feature (Figure 7.11, top). The pitman timber is encircled, longitudinally, by a 3 inch wide iron strap that is through-bolted to insure stability (Figure 7.11, bottom). The exposed portion of the pitman measures 15 feet 1 inch, overall.

The pitman is attached to the crank by an extension of the iron strap, called jaws, and a small shaft from the crank (Figure 7.11, top). The shaft rests in a bearing block in the pitman jaws and is held in place by a gib and a key. A grease cup on the jaws provides lubrication for the shaft and bearing block. The grease cup and brass knob are still in place, and it is possible to turn the knob.

The 3-foot crank on CHARLES H. SPENCER, visible inboard of the pitman in the Figure 7.11 (bottom), is articulated to the paddle wheel shaft. The rotational movement of the pitman and crank, turns the paddle wheel shaft and the paddle wheels.

A brass-bearing pillow block and cap provides support for the paddle wheel shaft. SPENCER's pillow block still has the grease cups and brass knobs in place (Figure 7.11, bottom). The brass knobs still moved easily after nearly 76 years. The pillow block and cap is through-bolted onto the inboard cylinder timber.

Paddle Wheel Shaft, Wheel, and Guard: The paddle wheel shaft, still securely resting in the pillow block, is partially exposed on the site. According to the plans, the



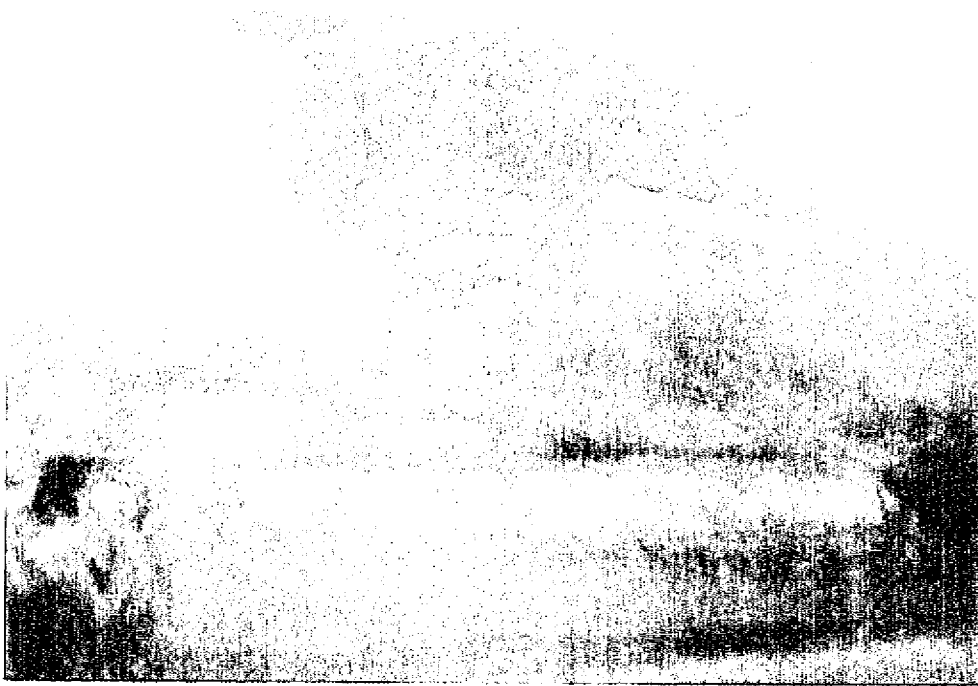
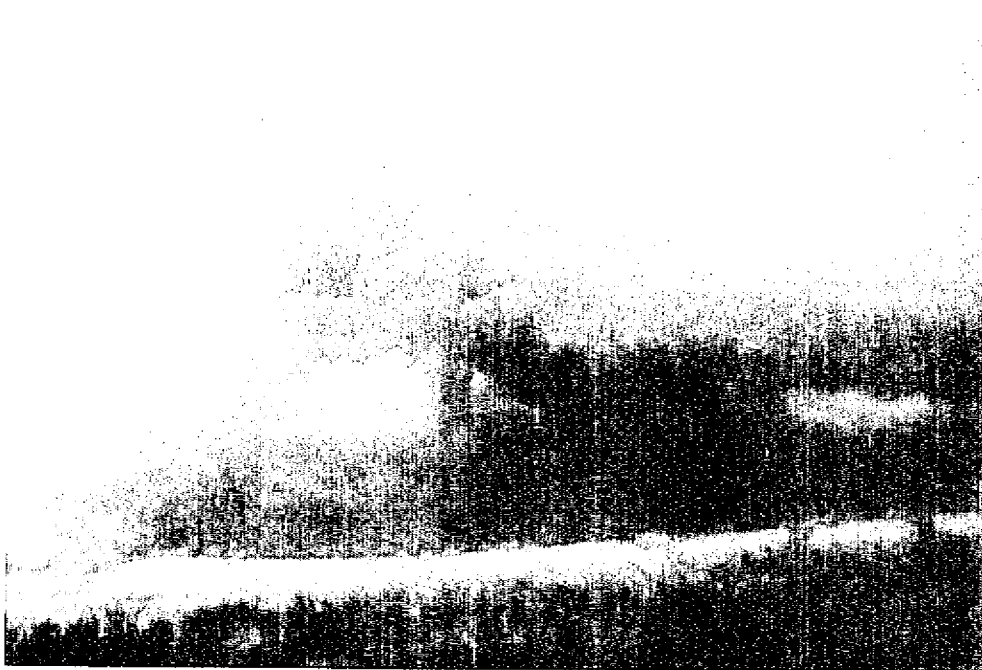

Figure 7.11 Profile view of pitman, pitman jaws, cylinder timber, and crank (top). Plan view of pitman, eccentric rods, crank, pillow block and cap, and paddle wheel hub (bottom). Photo by T. Carroll.

overall length of the hollow iron shaft was scheduled to be 15 feet 3 inches and be 4-1/2 inches in diameter. Field measurements confirmed these dimensions.

All three paddle wheel hubs are present and are in their original locations (Figure 7.8). The paddle wheel hubs measure 42-1/2 inches in diameter, and have 12 pockets for the spokes, or arms. Figure 7.12 (bottom) is a detail drawing of the hubs found on SPENCER. Remnants of the 7-by-2-inch wooden arms still exit in several pockets. The arm fragments are attached to the hub with a 3/4 by 5 inch bolt and hex-head nut. Paddle wheel arms were carefully cut then forced in the pocket; when wet the arms swelled insuring a tight fit.

In some instances, the arms were reinforced just outside the flange with a triangular block of wood, called a cocked hat. No evidence of cocked hats were found on the hubs, and it is not possible to verify from historic photographs whether SPENCER's wheels had this feature. One or more rings of additional wooden reinforcing, called blocking, was also used in paddle wheel construction. This blocking could be circular, forming an inner ring on the wheel, or, as in the case of SPENCER, be long square timbers running from wheel to wheel. The latter type of blocking is visible in the LaRue photograph of the boat, Figure 6.4.

The principal bracing for the wheel is at the outer ring, or circle. This wooden circle is located just inside the long planks, called buckets, that run from wheel to wheel (Figure 7.12, top). The wooden circle is sandwiched between two iron circles that are through-bolted. Three pieces of iron circle, measuring 2 inches wide by 1/2 thick, are present on the site. One long piece is lying adjacent to the starboard cylinder head, another is protruding from the sand just forward of the cylinder, while the third piece is just forward of the port paddle wheel hub.

The buckets were scheduled to be 10 inches wide by 12 feet long. No remains of the wooden circle, blocking, buckets, or disarticulated arm sections were identified on the site. However, based upon the information available, SPENCER's paddle wheels were composed of 12 arms and buckets, were 12 feet wide and measured 12 feet in diameter. The clearance from the outer edge of the wheel to the rudder was scheduled to be 9 inches. It was not possible to verify this measurement on site.

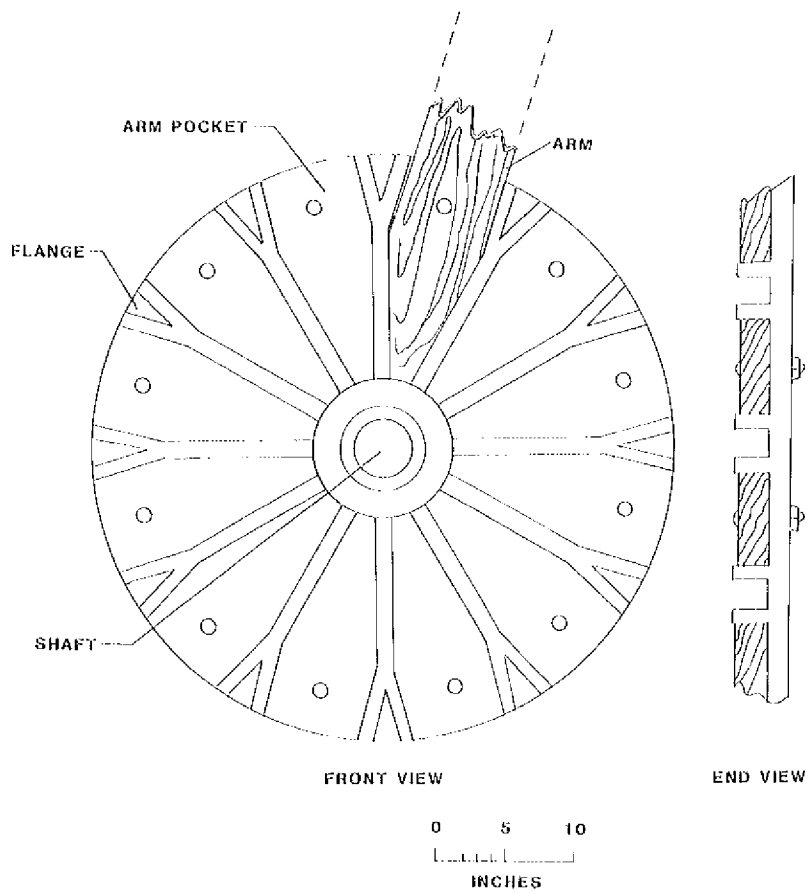
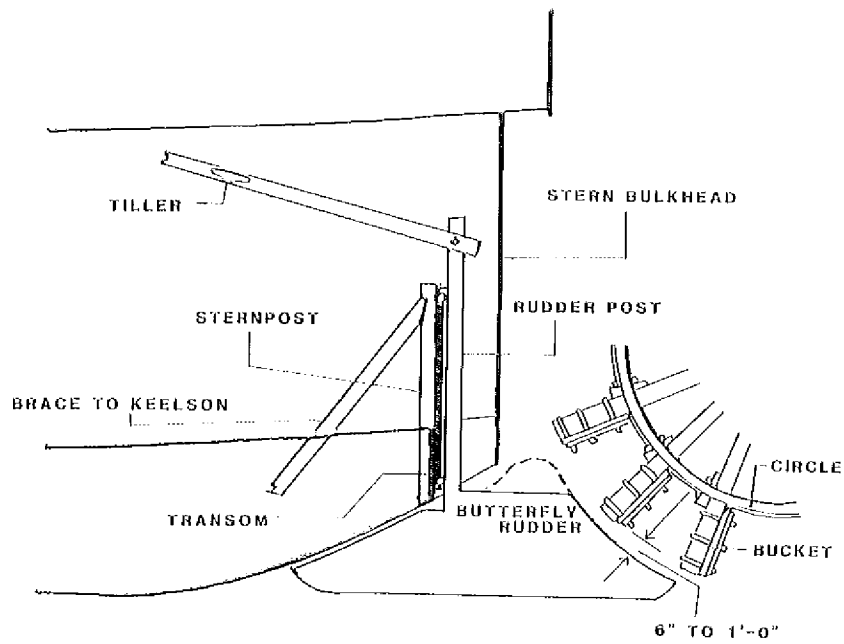

Figure 7.12 Typical arrangement of paddle wheel, rudder and transom on sternwheeler (top). The paddle wheel arms were strengthened by an iron-reinforced wooden circle. Detail drawing of CHARLES H. SPENCER's paddle wheel hub (bottom).

Decking from the overhanging guard would have extended to the stern, forming the port and starboard paddle wheel guards (see Figure 6.4). The deck level support structure for the overhanging guard is missing, on the starboard side, from the transom to the stern. Decking is present between the cylinder timbers, aft of the pitman, to the stern guard. A heavy timber, measuring 4 by 6 inches forms the stern guard. The cylinder timbers are fitted into the guard timber with a mortise and tenon joint. A 1 by 6 inch plank faces the inside of the stern guard and is attached by a series of bolts and nuts. The mortise and tenon joint and stern guard are clearly visible in the Kolb brothers historic photograph (Figure 7.10).

## Machinery

Boiler: Boilers used on paddle wheel steamboats around the turn of the century were typically the cylindrical flue, fire tube type. These boilers are externally fired, with the firebox and firebed constructed of sheet iron, and lined with firebrick. They generally had two furnace flues, but as many as six was not uncommon. The furnace flues ranged in diameter from 12 to 16 inches (Ward 1909:82).

In all respects CHARLES H. SPENCER was a typical paddle wheel steamboat of the period, therefore the expectation was for a boiler very similar to that described by Ward in 1909. Examination of the boiler on site confirmed the general configuration presented by Ward. However, when comparing the specifics found on site to the original plans some discrepancies were discovered. According to the original plans, the boiler on CHARLES H. SPENCER was scheduled to be 72 inches by 120 inches with a 35 inch firebox. In actual fact, the boiler on site is 77 inches by 131 inches with a 25 inch firebox. Figure 7.13 is a detail drawing of SPENCER's boiler, presently lying over on its starboard side. Overall, the boiler and firebox measure 13 feet long rather than the 12 feet 6 inches scheduled on the plans.

Boiler plate riveting is a good temporal indicator for construction dates. The riveting patterns on longitudinal seams changed through time and were also required, through legislation, to meet certain safety standards. Prior to 1873, the typical seam was single-riveted with an over-lapping joint (Jeter 1917:7). In 1873, the Supervising Board of Inspectors of Steamboats adopted rules specifying double-riveted longitudinal lap joints (Sweeny 1887, in Murphy and Saltus 1981:110). The double-riveted lap joint was used where the seams are not exposed

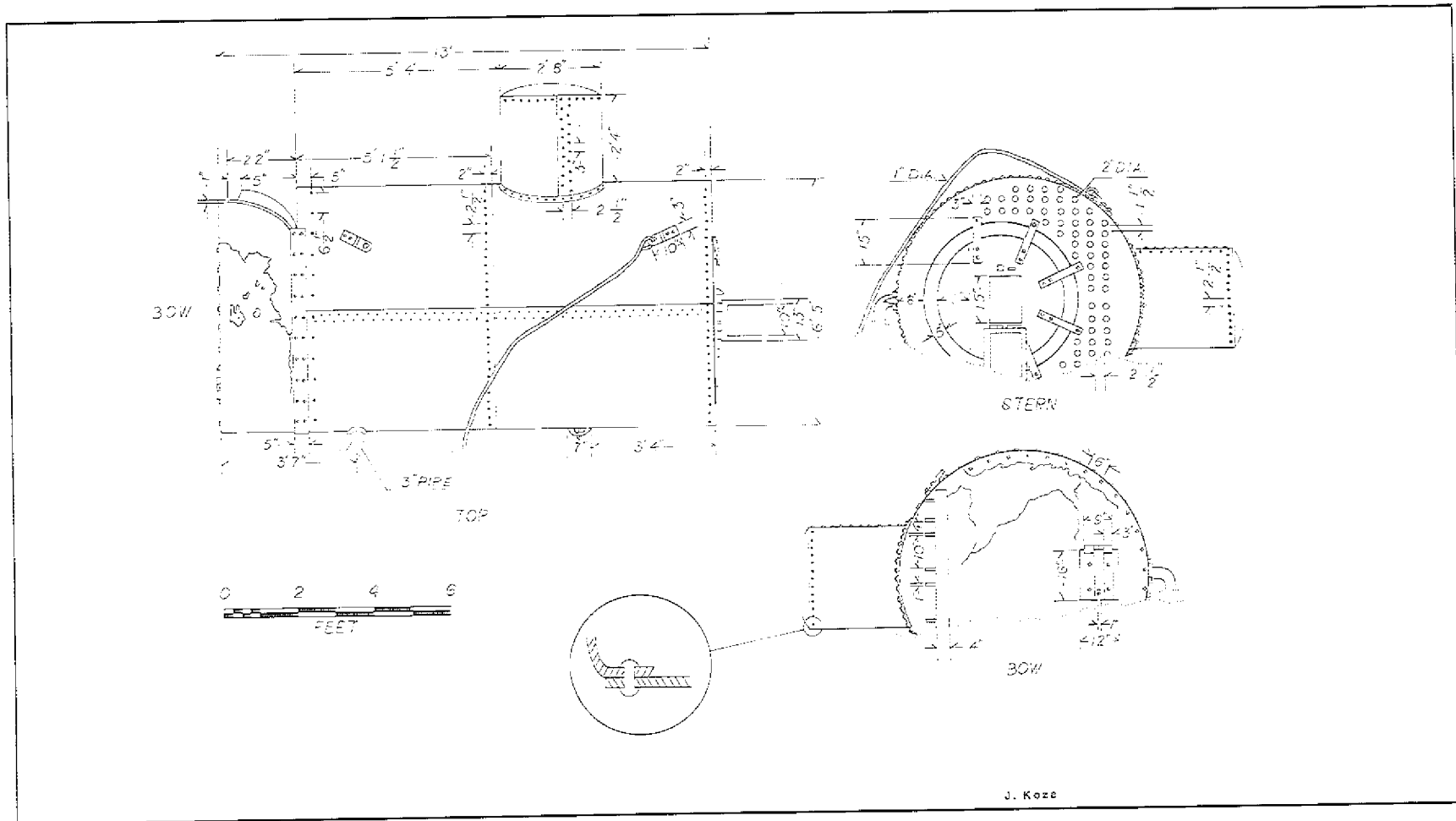

Figure 7.13 Detail drawing of boiler on CHARLES H. SPENCER.

to direct furnace heat. By the late 1880s the double-riveted lap joint was replaced by the butt joint with straps of unequal width. The last style in general use was the triple-riveted butt joint with straps of unequal widths. This style is common in post-1900 boilers (Jeter 1917:7-10).

The longitudinal boiler joints on CHARLES H. SPENCER are double-riveted lap seam, required after 1873, and commonly used only until the 1880s. This indicates that the style of boiler used was popular during this period, however it does not necessarily mean that the boiler was 25 years old. Boiler styles did not necessarily change rapidly, and local construction may have dictated the style. However it is reasonable to assume, based on this information, that it may not have been a new boiler, although Charlie Spencer's employees believed that it was new.

It had a brand new boiler, a good one, a marine boiler....  
(Bill Wilson interview by W. L. Rusho, September 24,  
1961).

This does not mean that the boiler was inadequate or in poor condition when it was put into SPENCER. By law at that time the boiler was inspected and tested by the Inspector of Boilers and found to be satisfactory (Rosenfelt, U.S. vs. Utah, 1919, Transcript of Testimony 16:3011). In addition, it was not uncommon to take the machinery from one vessel and re-use it in a second vessel. In fact, the machinery from other contemporaneous Colorado River steamboats was re-used; the machinery from COLORADO I was re-used in COLORADO II, and the machinery from GILA went into COCHAN (Lingenfelter 1978:41, 53, 91).

The original plans do not indicate new or used machinery on the boat. However, what is clear is that the boiler installed on the boat is not the same size as the boiler that was originally indicated in the plans. It would not be unusual that the equipment used would have varied somewhat from the plans. A decision to deviate from the plans, in this case, must have been made in San Francisco, when the various pieces and parts were crated up and packed into the two railroad cars for shipment to Marysville, Utah. No documentary or archival evidence has been located to explain the change, and it is pure speculation to suggest that installation of a possibly used boiler could have been directed toward cutting costs. Although, given Charlie Spencer's continual search for monetary backing, some cost cutting is to be expected.

Overall, the boiler is in reasonably good condition, given its continual exposure to the elements and wet/dry cycling due to the fluctuations in the water level in the river corridor. The greatest damage has been to the fire box, which is badly rusted. Fire brick still lines the box and several pieces of coal are still present. The bricks measure 4 by 9 by 2-1/2 inches and are stamped with the letters "N.C. & S.", the manufacturer's initials. Several bricks also lie below the starboard side on the sand and silt bottom. All appeared to be in excellent condition.

No evidence of the smoke box, or breeching, was located on the site. The smoke box, attached to the boiler at the after end, directs the smoke up to the smoke stack (refer to Figure 6.3). The only evidence found of remains from the smoke stack is a circular flange, or collar, that would have kept the stack from touching the wood decking as it passed up through the boiler deck and the pilot house. Its 2 inch base was bolted to the deck, and the 2-1/2 inch high collar was attached to the metal shield that formed the outer casing for the stack. The diameter of the collar is 3 feet 5 inches, matching the plans exactly. It is located off the starboard side of the boat lying on the sand bottom.

Engines: The slide-valve high pressure engine with no condenser was commonly used after the Civil War, especially in vessels of small tonnage (Hunter 1949:147). Quite long eccentric rods and pitmans were necessary with these engines because of their long stroke. The limberness of the hull resulted in uncertain valve action with these long-piston engines. The lever-poppet-valve engine was developed to correct problems with the slide-valve and was widely used after the turn of the century. These engines were equipped with two cams, one for reversing, the other, called a "cut-off", allowed the engineer to adjust the amount of steam entering the piston and the amount of power and save fuel (Ward 1909:84-85).

Prior to the turn of the century, reversing the engine in a steamboat was done by the manual operation of valve levers. It was described by Merrick:

The reversing gear ... was like nothing else of its kind, anywhere under the sun. ... The connecting-rod (cam-rod we called it) weighed at least fifty pounds ... In reversing, the end of the connecting-rod was lifted off its hook at the bottom, the lever thrown over ... the rod lifted about three feet, and dropped on to the upper hook. It was all right when you did this once or twice

in making a landing; but in a piece of "crooked river," the boat dodging about among reefs and bars, with the bells coming faster than you can answer them, it was another matter, and became pretty trying work for a stripling boy; his arms could not keep the pace .... (George B. Merrick, Old Times on the Upper Mississippi, 1854 to 1863 in Hunter 1948:148).

The adoption of an improved reversing gear, circa 1909, allowed the engineer to throw a lever at the center of the boat to operate the reversing gear on both engines at once (Hunter 1948:148). The presence of this feature provides temporal indicator on the construction of the engine.

The dual engines used in SPENCER were typical of the period. Scheduled to be 8 by 40 inches, indicating the diameter and stroke of the piston, their operating pressure should have been 174 psi. The starboard engine is partially exposed on the site (Figure 7.8). Comparison of the exposed portions of this feature with the plans resulted in verification of its general measurements. A small connecting rod coupled to a rocker lever is also exposed. Its location and general configuration reflect those indicated on the plans, and places the reverse lever in the middle of the boat. This dates the piston-valve engines, at the earliest, to 1909.

Heater: The heater, presently lying off the starboard side of the boat, was used to pre-heat the water that entered the boiler. This was accomplished by a system of piping and a small feed pump. The hot exhaust from each engine was carried upward to the heater via two 2-1/2 inch pipes. The hot air entered the heater through the after end, exited toward the bow, and traveled to the smoke stack through a 3-1/2 inch exhaust pipe (see Figure 6.3). A cold water pump, located on the deck between the engines, took water from the river and pumped it into the heater through a 1-1/2 inch feed pipe that also entered the heater from the after end. The water ran over a series of perforated plates or through a coil in the heater, warming nearly to the boiling point (Ward 1909:89). The heated water exited the heater through a 1 inch feed pipe, was separated into two feed pipes, and ran forward toward the boiler. At the boiler, it was fed into the top of the boiler, and filled the space between the fire tubes. The water was again heated and steam generated to power the engines.



Close examination of the heater and comparison of the field data to the plans resulted in the discovery of only minor discrepancies. Figure 7.14 is a detail drawing of the heater. The hot air exhaust pipe is 4-1/2 inch o.d. rather than the 3-1/2 inches called for on the plans. A short distance after the pipe exits the heater, it is buried by sand and rocks; it reappears under the bilge pump exposing a coupling flange (see Figure 7.8). The length of the exhaust pipe that remains attached to the heater, is 10 feet 2 inches, including a coupling at the partially buried end. A disarticulated section of similar pipe is lying nearby. The length on this piece is 7 feet 8 inches. The length overall of the exhaust pipe was scheduled to be 18 feet, not including a double reverse elbow shown on the plans. The two sections of pipe present on sight measure 17 feet 10 inches without the elbow.

The double reverse elbow is shown in the plans connecting the exhaust pipe to the smoke stack (refer to Figure 6.3). Rather than being attached at the smoke stack, the elbow is attached at the heater (Figure 7.15). All other pipes and connections shown in the plans matched those found on site.

Throttle Valve and Steam Pipes: Steam generated in the boiler exited through the steam dome and traveled to the throttle through a 3 inch extra heavy steam pipe. The throttle and lever were located overhead, between the engines and just forward from the reverse lever (refer to Figure 6.3). Two branch steam pipes exited from the throttle, passed overhead, then down to the engines. The engineer stood in the area between the reverse lever and throttle, stopping, starting, reversing, and powering the engines up or down as needed (Ward 1909:89-90).

The throttle is lying near the heater on the bottom off the starboard side of the boat. It is still articulated to a 16 foot section of extra heavy 3 inch steam pipe. The length of the steam pipe from the steam dome to the throttle was 33 feet; the section of pipe attached to the throttle represents approximately half of the original piping present on the vessel when constructed. A second section of 3 inch steam pipe with a coupling flange is protruding from the sand under the throttle; this is most likely the remainder of the steam pipe.

The throttle lever is missing although the "t" connection for the engine steam pipe is still attached. Steam was provided to the engines through 2 inch steam pipes; one section of 2 inch pipe is lying below the bilge pump on the sand

Figure 7.15 Heater head showing connections to steam pipes from engines (left). Heater exhaust with double reverse elbow attached (right). Photo by T. Carrell.

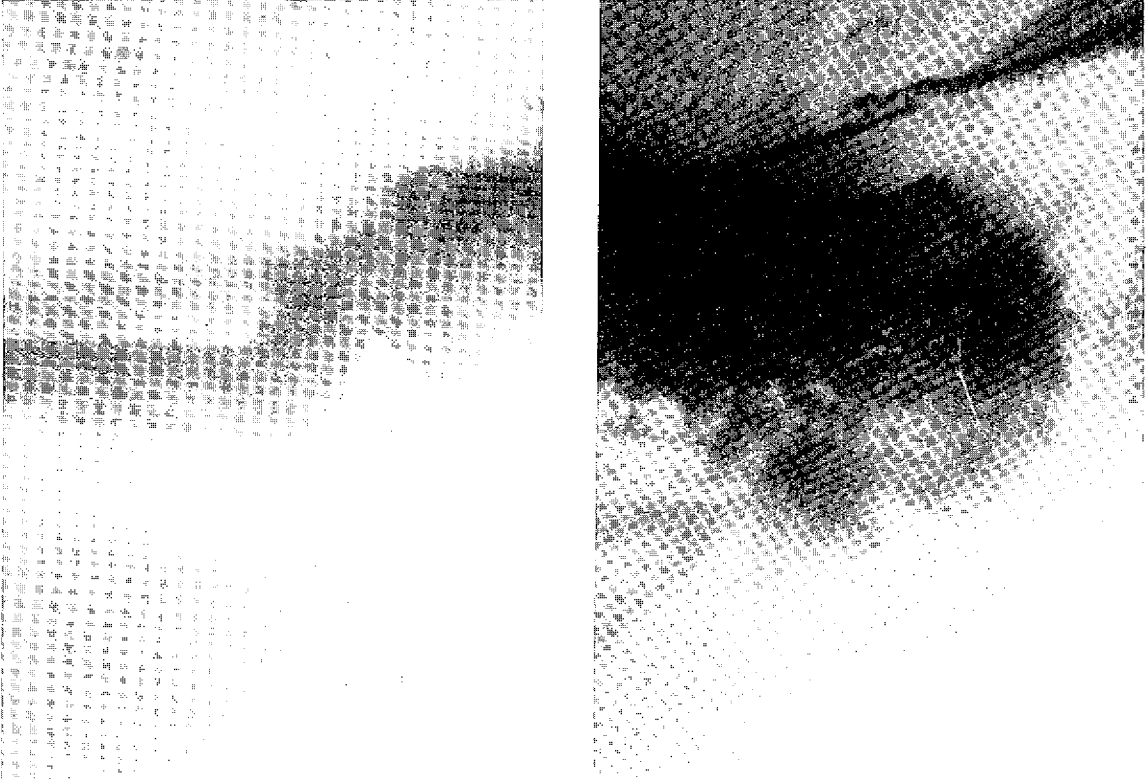
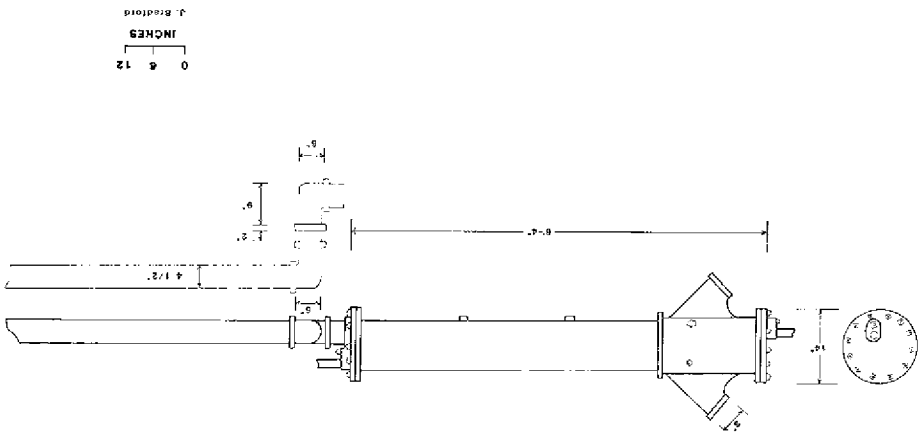

Figure 7.14 Detail drawing of heater with plan and profile views.



bottom. The length of this piece, 9 feet, matches the length of the port branch pipe from the throttle to the engine, and is most likely that piece.

Bilge Pump: Presently, the Hooker Number 3 pump is lying on the sand bottom (refer to Figure 7.8). The 33-inch pump is intact, with the exception of a broken rubber discharge hose, and a disarticulated pipe coupling to the iron pump log or suction pipes. A piece of the wooden decking is still bolted to the pump's base (Figure 7.16). The hand-operated bilge pump was located just behind the tow post, amidships of the vessel. It remained in situ until sometime after 1973, when it was thrown over the starboard side of the boat. Figure 7.17 shows the original location of the pump in relationship to the boiler.

#### Miscellaneous Wreckage Scatter

Only four of a possible eight samson post caps are exposed on the site. The caps are constructed of 3/4 inch steel, are 22 inches long, 6 inches wide, and have 4 arms (Figure 7.18). The two top arms are 8 inches long and ran perpendicular to the top of the samson posts, linking them together. The two lower arms are 9 inches long and angled down toward the deck. Rod from these arms ran through the deck and were attached to the keelsons. The four caps are in excellent condition with little evidence of deterioration, although, like other metal objects on the wreck, they are slightly encrusted with a thin layer of rust. Three of the four caps are still articulated to truss rod; the fourth is lying between large boulders (Figure 7.19).

Several disarticulated pieces of wood are scattered on the bottom below the starboard side. A piece of decking is protruding from the sand not far from the boiler and a broken 2 by 6, possibly used in framing the deck house, lies near the smoke stack collar. Also near the collar is a small section of deck shelf, presumably from the bow. Adjacent to the bow, a 1 by 3 inch plank is exposed. The lightness of this plank suggests it was deckhouse siding. Another piece of disarticulated decking is partially exposed aft of the throttle valve.

Two disarticulated sections of 1 inch pipe are lying approximate 10 feet from the throttle valve among several large boulders. According to the plans, 1 inch pipe was used for hot water feed line from the heater to the boiler and for cold water

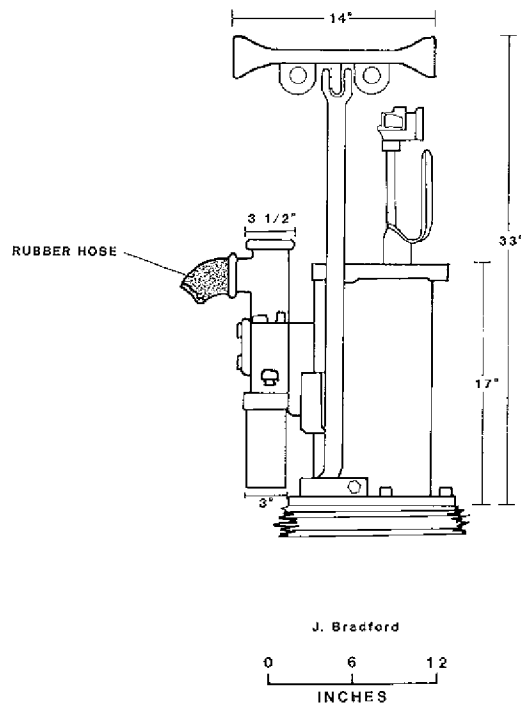

Figure 7.16 Detail drawing of hand-operated bilge pump.

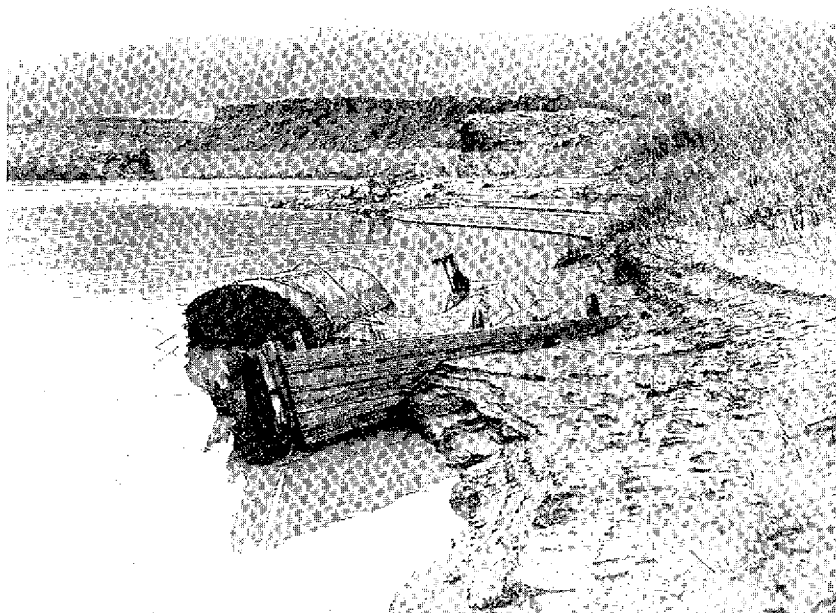

Figure 7.17 Condition of the boiler and the bilge pump in situ, March 1962. Photo by W. L. Rusho.

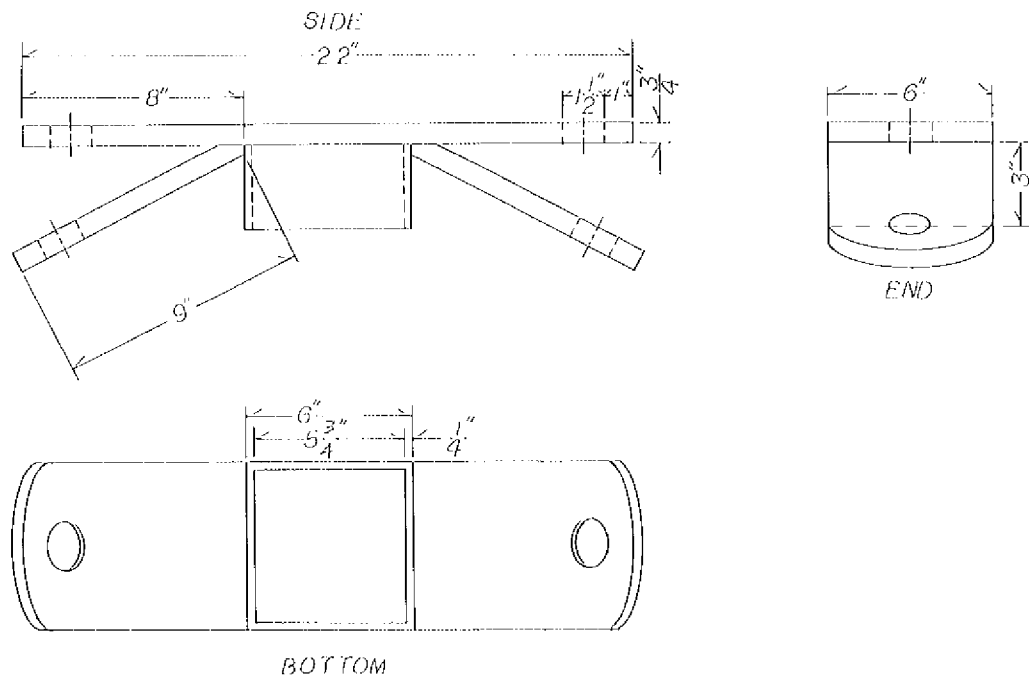

Figure 7.18 Detail drawing of samson post cap.



Figure 7.19 Disarticulated cap lying on the sand below the starboard side. Photo by T. Carrell.

feed line from the feed pump to the heater. Three separate sections of 2 inch pipe are lying below the boiler on the sand bottom. They are 24 inches, 30 inches, and 5 feet 9 inches long. The only indicated use of 2 inch pipe on the plans is steam line from the throttle to the engine, in the stern. The present location of this piping near the boiler does not preclude their original use in the engine room, although it is reasonable to assume that the piping was probably used in conjunction with the boiler.

### Summary

CHARLES H. SPENCER was not the first steamboat to be prefabricated by the Shultze, Robertson, Shultze Company, nor was that company the first to prefabricate vessels. The company shipwrights were, no doubt, familiar with the techniques used for such a job and the necessity for careful planning. The task of such an undertaking for Herman Rosenfelt, one of the company's shipwrights, must have been reasonably straightforward. The steamboat had been "put up" in San Francisco, that is the frame was constructed and temporarily put together with screw bolts, then disassembled for shipment to Marysville, Utah, and eventual delivery to Warm Creek (U.S. vs. Utah, 1929, Transcript of Testimony 16:3007). Upon arrival at Warm Creek, reassembly of the boat and the machinery would complete the task.

By the time of SPENCER's construction, the industry of shipbuilding was well established with foundries, boiler works, and machine shops, as well as ship's carpenters and other skilled tradesmen employed in the business. Removed from that work environment and in a remote location, Herman Rosenfelt must have felt some level of frustration during CHARLES H. SPENCER's construction at the mouth of Warm Creek.

The sources of Rosenfelt's frustration can reasonably be hypothesized from the statements of workers at the mining camp and from Charlie Spencer.

Optimism was apparently high among company officials, for they freely invested money in rather haphazard fashion and employed anyone who wanted a job. Not all wages, however, were paid.

The men were induced to work not only for the promise of future wages, but for a stake in an irrigation project to be built by the company. [Charlie] Spencer

told the men that the company pumps would be used to irrigate the lower Paria River valley at some indefinite future time. The men were to be allowed to homestead on the newly opened land. ... the ranch at Lee's Ferry was visible proof to the workmen of the fertility of the soil.

With the promise of land, [Charlie] cheated many out of almost all their wages. ...sometimes \$1400 to \$1500 (Bert Leach, interview by W. L. Rusho, February 18, 1961).

Leach was hired on as a miner, however, because the mining operation never really got under way he, like many of the other men, worked on a variety of other jobs. The men hired by Charlie Spencer included unskilled and semi-skilled laborers and miners. Obviously, some of the men hired were hopeful farmers, working for a plot of land and the possibility of a homestead. The miners, working for wages rather than for the promise of land, would have been quickly disillusioned by the lack of progress in the mining efforts and with the lack of pay. Many of these men would have had some carpentry and possibly some blacksmithing skills. Miners, almost by definition, had some carpentry skills particularly if their experience included working in underground mines. However, these men were far from skilled ship's carpenters and machinists, as were those men who built most of the Western River steamboats.

Working with semi-skilled and unskilled laborers, if nothing else, would have been a challenge for Rosenfett. It is entirely possible that the results of this challenge are reflected in the construction changes discovered on the vessel and changes in the installation of the piping for the machinery. When problems were discovered, it would have been extremely difficult to resolve them at Warm Creek.

For example, if the machinist's plans were not corrected to account for the change in the size of the boiler, alterations to the steam lines would have been necessary to accommodate the larger piece of equipment. There is every reason to suspect that the boiler alteration resulted in a variety of problems. Bill Wilson, a packer and freight team drover, had this to say about the construction of the steamboat:

I carried messages, drove freight teams and did the packing. They [the workers at the mining site and on the steamboat] had to pack a lot of things back and forth. All the pipefittings they'd get wrong. I don't know why. They'd send the pipe over and they'd cut

threads on it and cut it off or make it longer (Bill Wilson interview by W. L. Rusho, September 24, 1961).

The problem with the pipes can be attributed to any of three groups; either the workers at the site were unable to follow the machinists plans and made mistakes, or the pipefitters in Marysville were unable to correctly make adjustments to the pipes, or the pipefitters in San Francisco did not either adjust for the differences in the length of the boiler or did not put that portion of the vessel together to check for proper fit. It is important to keep in mind that the workers at Warm Creek were under the supervision of an experienced shipwright, who was equipped with both builder's and machinist's plans. Additionally, the inspector of boilers was on site near the end of re-assembly and supervised the completion of that aspect of the boat. This leads to an obvious question. If the boat was completely put together in San Francisco, why weren't the problems with the cylinder timbers, the connection for the heater, the adjustments of the steam lines for the larger boiler and other piping, found there and corrected prior to shipping?

The answer may lie in Rosenfelt's testimony. "The **frame** [emphasis added] was put up and put together temporarily with screw bolts, and then taken down"(U.S. vs. Utah, 1929, Transcript of Testimony 13:3007). Rosenfelt said nothing about complete assembly of the boat, only assembly of the frame.

Why wasn't the boat completely put together? Was it standard practice of the period, or was the remote location and the difficulty of transporting the boat not clearly understood by the contractor, the owners, and the shipwright? Some additional research in the company records might shed light on standard practices for prefabricated boats. If only limited assembly was standard practice, then the ability of the shipwright to be able to make corrections during construction was crucial. A thorough understanding of the remoteness of the construction site and the difficulty of access to lumber mills and machine shops becomes critical. The necessity for freighting piping back and forth from Warm Creek to Marysville suggests that the difficulties associated with the remote location were, at best, poorly understood.

The headaches of construction with an inexperienced crew, the remote location of the building site, and the inaccessibility of lumber mills and machine shops were not the only problems during the winter and spring of 1911-1912. One



of the biggest problems faced by Charlie Spencer was trying to keep his men from selling liquor to the Indians and, most likely, keeping them from drinking too much themselves. His teamsters even cached food and other goods along the trail, only to pick up the items later and sell them in town for liquor (Charlie Spencer interview by W. L. Rusho, August 18, 1962). The degree to which drinking contributed to the necessity for alterations from the plans is unknown, but can be surmised to have been a factor.

The successful completion of the steamboat CHARLES H. SPENCER, under the direction of Herman Rosenfelt, is even more amazing given the difficulties and obstacles overcome.

## CHAPTER VIII. CONCLUSIONS AND MANAGEMENT RECOMMENDATIONS

### Historic Site

The Charlie Spencer mining area has, through the years, undergone many adverse impacts and destruction as a result of man's activities within the limited amount of space in this section of Lee's Ferry. When Spencer abandoned his properties at Lee's Ferry in 1912, the idea of them becoming a historic district was never imagined by Charlie or those who utilized the properties in the following 60 years. For the purposes of the USGS, Spencer's building provided convenient housing for the survey crews and later employees stationed at the ferry. Rather than accrue the expense of building anew in a place of extreme isolation, the survey took advantage of the previous work provided and adapted the necessary buildings for their use.

Arguments over how much the USGS changed the character of the original buildings or what the possible historic components added by USGS may have been could keep historians and preservationists busy for years. The effects of this remodeling on what would have become historic buildings, however, is a moot point because most of the buildings were destroyed in 1967. This event is unfortunate because much of the physical evidence of an important chapter in regional history was removed with the structures.

The key to the situation today lies in preserving and interpreting the remaining features related not only to the Spencer mining operations, but also to the USGS years of survey and river monitoring at Lee's Ferry. Some physical evidence and adequate amounts of documentation for both periods survive today and provide us with the tools and information necessary to present a full interpretive program to the public and allow continued research into the history of

the area by those whose interests have and will continue to bring them to Lee's Ferry.

#### Recommendations

1. The National Park Service should continue to monitor the condition of the standing structures within the historic district at Lee's Ferry and provide, as necessary, any stabilization or preservation measures required to keep the structures in their current condition. Each building is an important part of the overall story at Lee's Ferry and, as such, relates to the overall interpretive story the NPS presents to the public.
2. Minor features located during this study should be kept in their current condition and left undisturbed. These features, too, contribute to the overall story of the Spencer mining complex and could be incorporated into the interpretive story of the area.
3. Additional research into the Lee's Ferry story, particularly the Spencer mining era and the USGS period, should be encouraged.
4. A more comprehensive interpretive program for the Spencer mining area at Lee's Ferry should be developed. Much information is available on the subject and a more complete story of this period of history at Lee's Ferry can be provided to park visitors.
5. No developments should occur within the area between the present boat ramp and Lee's crossing. Impacts to the Spencer mining area have been cumulative and have taken their toll on the cultural resources. To continue this pattern would only exacerbate the destruction of the remaining resources. The area has been designated as a nationally significant site and should be managed accordingly.

## Paddle Wheel Steamboat

### Vessel Preservation and Impacts

The wood used in the construction of the vessel remains hard and well preserved below the level of water fluctuations. Piping, truss rod, turnbuckles, paddle wheel hubs, and the machinery are all in good condition. All of the metal observed on the site has a small amount of encrustation. This is expected and, in fact, has probably contributed to stabilization of these remains. A portion of the boiler and firebox, as well as wood in the bow, both exposed to wet-dry cycles, are in poor condition. Rusting of the boiler and firebox, along with loss of some of the historic fabric, is evident. Several hull planks, present in 1963 and 1973 photos of the site, are gone from the bow.

The silt which has buried the vessel up to the level of the main deck has contributed to its overall good condition. Algae, which is present in abundance on the site, has had no obvious detrimental effect on the vessel's preservation.

During three days of lowered water levels, October 7-9, 1986, it was possible to observe the immediate effects of this action on the site. Several impacts were noted. The partial exposure of the boiler, a portion of the bow, and the lowered water over the main deck of the vessel, exposed these areas to both wind driven waves and boat wake wash. The lapping of the waves resulted in erosion of the bank and movement of sand and silt over the site. Splashing water alternately wet then exposed the bow and the boiler. Wet-dry cycling has been documented to be one of the most severe impacts to cultural remains in reservoirs and riverine environments (Lenihan et. al. 1981).

The lowered water level also invites more human activity at the site. The exposed boiler has been used as a convenient platform for local fishermen. With the main deck being under only a few inches of water, wading across the site has occurred. Inadvertent destruction of the vessel, or possibly purposeful vandalism, becomes much more likely during periods of low water flow. The removal of the bilge pump probably occurred during one of these periods.

Algae, which is growing on the upper areas of the vessel, principally on the metal remains, dries out and dies during lowered water levels; it is not clear whether the deterioration of algae would in the long term have a direct adverse impact on site preservation. Cultural remains in an anerobic environment have been found to be well preserved after many hundreds of years. The lowered water levels, increased exposure to sunlight and photosynthesis, and the decay of dead algae in an aerobic environment, contribute to the deterioration of many classes of cultural remains, particularly wood (Lenihan et. al. 1981).

While the vessel is located in a back eddy, and out of the current in the main river channel, movement of water over the site is steady. During the days of normal water flow, i.e. 20,000 to 25,000 cfs, the divers had to hold on or kick vigorously to maintain their position in the shallower areas of the vessel, but water flow was not sufficient to present any danger to the dive team or to the stability of the vessel. Debris steadily moved across the site and willow branches often lodged themselves around the boiler, only to collect algae and other small twigs. No readily observable adverse impacts occurred as a result of these processes, however the build-up of debris could adversely impact the unburied portions of the vessel by mechanical action, i.e., the grinding or bumping of the materials against fragile remains.

Perusal of photographs of the site dating from 1919, the early 1960s, and 1970s, along with our first-hand observations, suggest that the high water flow of 1982-83 had a negligible impact on the vessel. Its location in an eddy probably contributed to a reduction of potential impacts from flooding. It is impossible to determine when the hull planks were lost from the area of the bow. These changes to the site could have occurred at any time and cannot be attributed to high water flow.

CHARLES H. SPENCER, like so many vessels lost in marine and other freshwater environments, has become an artificial reef and fish habitat. Trout abounded as did small shrimp and worms. The presence of these freshwater organisms present no adverse impact to the site.

#### Recommendations

Clearly the most detrimental impact to the site is wet-dry cycling resulting from the fluctuations of the water level below the dam. In ideal conditions the vessel would be best preserved and protected from the impact of wind- or boat-driven waves and wet-dry cycling if it remained underwater at all times. Under less than ideal circumstances some other options present themselves:

1. Extend the no wake zone around the boat launch area to beyond the site of SPENCER. This would reduce splashing at the site and some of the steady bank erosion.
2. During periods of lowered water levels, prohibit visitors from walking around on the vessel and climbing on the boiler. Direct human impacts could be eliminated in this manner.
3. Gather additional background information on the vessel. W. L. Rusho and the Bureau of Reclamation have photographs of the site in the early 1960s and 1970s. Photographs from the 1920s through the 1950s, the late 1970s and 1980 to 1986, may be in the private collections of previous Park employees, residents, or visitors. A request for photographs of the vessel as well as the Spencer operation, published in local newspapers and spread word-of-mouth among the "old timers" who were recently interviewed, would contribute to the story of the park and aid in the development of interpretive programs. Further, a photo log of the vessel will help to document deterioration and narrow down the dates impacts occurred.
4. Develop a monitoring program for the vessel. Service divers should be encouraged to visit the site in order to become familiar with the resource. They should carefully review the maps, photographs, video tape and slides provided to the park, prior to such a visit. At minimum the site should be visited by divers following periods of very high or very low water. The site map and photographs generated as a result of the work in October, 1986, can be used as a baseline to measure and define impacts.
5. Develop an interpretive display on land near the site. While the research was being conducted, a steady flow of visitors passed by, often stopping to comment on the vessel remains. An interpretive display would result in a

better understanding of the role that the steamboat played in the local history and encourage a positive attitude toward other cultural remains in the park. Another possibility would be the establishment of a small wharf adjacent to the site with interpretive information. The shallow water over the site would permit visitors to see the site more clearly. A wharf would also provide access for those visitors who want to fish in the vicinity, without impacting the vessel.

6. The site should be checked regularly for the obvious build-up of debris or trash around the bow and the boiler. Regular removal of this build-up will prevent any potential adverse impacts from mechanical action.
7. The site should be documented through the completion of a National Register of Historic Places continuation sheet, appended to the existing historic district nomination. Documentation of the vessel's history and remains through this process will materially aid to the register's usefulness as an inventory of significant shipwreck sites and will clarify the contribution this feature makes to the district nomination.

## Conclusion

The paddle wheel steamer CHARLES H. SPENCER is both an interesting and well-preserved cultural resource which can meaningfully contribute to the interpretive programs in Glen Canyon National Recreation Area and the Colorado River downstream corridor. While there may be numerous examples of this type of vessel lost in the Western Rivers, there are only a few that are potentially available for study. Continued protection of this site will ensure a data bank for future researchers who have specific questions on maritime construction of the period or who wish to have a source of comparative data for other similar vessels.

Although the potential for additional remains, buried in the sand and silt bottom below the starboard side of the boat, is high, excavation of this site is not recommended. Information that may be gathered through such an effort would shed additional light on the construction of the vessel, but the data that could be gathered is negligible when weighed against the potential for adverse impacts to the hull, and the possibility of losing remains due to the current. If excavation is

ever considered for this site, the development of a comprehensive research design is strongly recommended. The research design should, among other items, indicate why it is in the best interest of the public and the resource to engage in such an activity. It should also make it clear why the posed research questions could not be answered without excavation or answered by examination of comparable sites or collections elsewhere.



## REFERENCES CITED

Anonymous

- 1983 Lees Ferry and Lonely Dell Ranch Historic Districts: A Walking Tour Guide. Grand Canyon Natural History Association.

Barnes, Frank

- 1929 U.S. vs. Utah, U.S. Supreme Court, October Term. Transcript of Testimony 13:2529-2539. U.S. Government Printing Office, Washington, D.C.

Bates, Alan

- 1968 The Western River Steamboat Cyclopoedum or American Riverboat Structure and Detail Salted with Lore. Hustle Press, Leonia.

Bennett, Frank

- 1929 U.S. vs. Utah, U.S. Supreme Court, October Term. Abstract of Testimony 2:826-837. U.S. Government Printing Office, Washington, D.C.

Chaffin, A. L.

- 1929 U.S. vs. Utah, U.S. Supreme Court, October Term. Abstract of Testimony 2:1244-1267. U.S. Government Printing Office, Washington, D.C.

Colton, Harold S.

- 1957 The Colorado River Steamboat "Charles H. Spencer." In Steamboat Bill 61:6-7. Steamship Historical Society of America, Flushing.

- 1962 Steamboating in Glen Canyon of the Colorado River. In Plateau 35(2):57-59.

Crampton, C. Gregory

- 1959 Outline History of the Glen Canyon Region, University of Utah Anthropological Papers, Number 42. University of Utah, Salt Lake City.

- 1960 Historical Sites in Glen Canyon - Mouth of San Juan River to Lee's Ferry, University of Utah Anthropological Papers, Number 46. University of Utah, Salt Lake City.

- 1986 Ghosts of Glen Canyon: History Beneath Lake Powell. Publishers Place, Inc., St. George.

Crampton, C. Gregory and Dwight L. Smith, eds.

- 1961 The Hoskaninni Papers: Mining in Glen Canyon 1897-1902, University of Utah Anthropological Papers, Number 54. University of Utah, Salt Lake City.

- Crampton, C. Gregory and W. L. Rusho  
 1965 A Report on the History of Lee's Ferry, Arizona. Unpublished manuscript. On file National Park Service, Glen Canyon National Recreation Area, Page.
- Delgado, James P.  
 1987 National Register of Historic Places Nomination, "Matthew Turner/James Robertson Shipyard, 1883-1918". On file, History Division, National Park Service, Washington, D.C.
- Dick, Jon  
 1985 Documentation of Charles H. Spencer Steam Boat at Lee's Ferry, Arizona. Unpublished document. On file Glen Canyon National Recreation Area, Page, and Submerged Cultural Resources Unit, Santa Fe.
- Edwards, William H.  
 1929 U.S. vs. Utah, U.S. Supreme Court, October Term. Abstract of Testimony 1:555-586. U.S. Government Printing Office, Washington, D.C.
- Freeze, Herman W.  
 1929 U.S. vs. Utah, U.S. Supreme Court, October Term. Abstract of Testimony 1:686-687. U.S. Government Printing Office, Washington, D.C.
- Harker, Mary  
 1965 Interview conducted by W. L. Rusho on March 18, 1965. In possession of W. L. Rusho.
- Haskett, Bert  
 1935 Steam Navigation on the Colorado River. Arizona Highways 11:6-7, 17-18.
- Hunter, Louis C.  
 1969 Steamboats on the Western Rivers. Octagon Books, New York.
- Jeter, S. F.  
 1917 Riveted Boiler Joints. McGraw-Hill Book Company, Inc., New York.
- Johnson, Frank  
 1929 U.S. vs. Utah, U.S. Supreme Court, October Term. Abstract of Testimony 2:799-801. U.S. Government Printing Office, Washington, D.C.  
 1962 Interview conducted by W. L. Rusho on October 28, 1962, In possession of W. L. Rusho.
- Johnson, Jeremiah  
 1929 U.S. vs. Utah, U.S. Supreme Court, October Term. Abstract of Testimony 2:786-787. U.S. Government Printing Office, Washington, D.C.
- Jones, Albert H.  
 1960 Review of Mining Operations on the San Juan and Colorado Rivers, Promoted and Conducted by Charles H. Spencer, et. al., 1908, 1909, 1910, 1911. Unpublished manuscript. In possession of W. L. Rusho.
- Kolb, Ellsworth L.  
 1914 Through the Grand Canyon from Wyoming to Mexico. The MacMillan Company, New York.

- Leach, Albert  
 1961 Interview conducted by W. L. Rusho on February 18, 1961. In possession of W. L. Rusho.
- Lenihan, Daniel J., Toni L. Carrell, Stephen Fosberg, Larry Murphy, Sandra L. Rayl, John A. Ware  
 1981 The Final Report of the National Reservoir Inundation Study, Volume I and II. Southwest Cultural Resources Center, National Park Service, U.S. Department of the Interior, Santa Fe.
- Lingenfelter, Richard E.  
 1978 Steamboats on the Colorado River 1852-1916. University of Arizona Press, Tucson.
- Loper, Bert  
 1929 U.S. vs. Utah, U.S. Supreme Court, October Term. Abstract of Testimony 1:623-638. U.S. Government Printing Office, Washington, D.C.
- Marrs, William  
 1929 U.S. vs. Utah, U.S. Supreme Court, October Term. Abstract of Testimony 1:638-644. U.S. Government Printing Office, Washington, D.C.
- Measeles, Evelyn Breck  
 1981 A Crossing on the Colorado: Lee's Ferry. Pruett Publishing Co., Boulder.
- Murphy, Larry and Allen R. Saltus  
 1981 Phase II Identification and Evaluation of Submerged Cultural Resources in the Tombigbee River Multi-Resource District, Alabama and Mississippi. Office of Archeological Research, University of Alabama, Tuscaloosa.
- National Park Service  
 1985 Statement for Management, Glen Canyon National Recreation Area. Glen Canyon NRA, National Park Service, U.S. Department of Interior, Page.
- Palmer, John W.  
 1929 U.S. vs. Utah, U.S. Supreme Court, October Term. Abstract of Testimony 2:807-814. U.S. Government Printing Office, Washington, D.C.
- Petsche, Jerome E.  
 1974 The Steamboat Bertrand: History, Excavation, and Architecture. National Park Service, Department of the Interior. U.S. Government Printing Office, Washington, D.C.
- Phoenix, David Allen  
 1963 Geology of the Lees Ferry Area, Coconino County, Arizona, U.S. Geological Survey Bulletin 1137. Government Printing Office, Washington, D.C.
- Reilly, P. T.  
 1964 Measurement of the Charels H. Spencer when exposed by a flow of 1000 cfs. Unpublished document. On file Submerged Cultural Resources Unit, Santa Fe.

1986 Letter to Southwest Regional Historian. On file National Park Service, Southwest Regional Office. Santa Fe.

Reynolds, Temple A.

1974 Lee's Ferry Historic District, National Register of Historic Places Nomination. On file Glen Canyon National Recreation Area, Page.

Richert, Roland

1967 Ruins Stabilization Unit Monthly Report for September 1967. Unpublished report. On file National Park Service, Western Archeological and Conservation Center, Tucson.

Robertson, Russell

1961 Manuscript History of the Robertson Family. Unpublished manuscript. On file National Maritime Museum, San Francisco.

Rosenfelt, Herman

1929 U.S. vs. Utah, U.S. Supreme Court, October Term. Transcript of Testimony 16:3006-3014. U.S. Government Printing Office, Washington, D.C.

Reeder, W. F.

1929 U.S. vs. Utah, U.S. Supreme Court, October Term. Abstract of Testimony 2:1236-1244. U.S. Government Printing Office, Washington, D.C.

Rusho, W. L.

1962 Charlie Spencer and his Wonderful Steamboat. In Arizona Highways 37(8):34-39.

1968 Living History at Lee's Ferry. In Journal of the West 2(1):64-75.

Rusho, W. L. and C. Gregory Crampton

1981 Desert River Crossing: Historic Lee's Ferry on the Colorado River. Peregrine Smith, Inc., Salt Lake City.

Sawyer, William D.

1978 The Western River Engine. In Steamboat Bill 146(Summer, Fall). Steamship Historical Society of America, Providence.

Spencer, Charles H.

1961 Interview conducted by W. L. Rusho on June 18, 1961. In possession of W. L. Rusho.

Sykes, Godfrey

1937 The Colorado Delta. Kennikat Press, Port Washington.

Turner, Raymond M. and Martin M. Karpiscak

1980 Recent Vegetation Changes Along the Colorado River Between Glen Canyon Dam and Lake Mead, Arizona. U.S. Geological Survey Professional Paper 1132. U.S. Government Printing Office, Washington, D.C.

U.S. Congress

1900 House Document 67, Preliminary Examination of the Colorado River, Nevada. 56th Congress, 2nd Session. U.S. Government Printing Office, Washington, D.C.

1972 P.L. 92-593, An Act to Establish Glen Canyon National Recreation Area in the States of Arizona and Utah (86 Stat. 1311), October 27, 1972.

U.S. Government

1904 List of Merchant Vessels of the United States. U.S. Government Printing Office, Washington, D.C.

Waller, Arthur C.

1961 Comments on Interview Between W. L. Rusho and Charles H. Spencer on June 19, 1961. Unpublished manuscript, July 15, 1961. In possession of W. L. Rusho.

Ward, Charles

1909 Shallow-Draught River Steamers. In Transactions of the Society of Naval Architects and Marine Engineers 17:79-107. Society of Naval Architects and Marine Engineers, New York.

Wilson, William

1961 Interview conducted by W. L. Rusho on September 24, 1961. In possession of W. L. Rusho.

Winther, Oscar Osburn

1964 The Transportation Frontier: Trans-Mississippi West, 1865-1890. Holt-Rinhart-Winston, New York.

Periodicals:

Arizona Sentinel, Arizona

Colorado Sun, Colorado

Cheyenne Sun Annual, Cheyenne, Wyoming

Grand Valley Times, Utah

Green River Star, Green River, Utah

Los Angeles Mining Review, Los Angeles, California

Los Angeles Star, Los Angeles, California

Moab-Times Independent, Moab, Utah

Needles Eye, Needles, California

San Francisco Daily Herald, San Francisco, California

Searchlight Bulletin, Arizona

Yuma Sun, Yuma, Arizona

## APPENDIX A: SUMMARY OF CHARLES H. SPENCER'S ATTRIBUTES\*

Length: 72'  
Beam: 21'  
Depth of Hold: 4'

Frame Arrangement: single, 2" by 4" each  
Frame Spacing: irregular from 14" to 29"  
Shelf Width/Height: 2" by 8"  
Deck Beam: 2" by 4" by 23' 6", amidships  
Main Keelson: 12" high, width unknown  
Side Keelsons: 12" high, width unknown  
Floors: unknown width, 8" high

Ceiling Planking: absent  
Floor Planking: 1" by 5-1/2" to 6"  
Hull Plank planking, above turn of bilge: 1" by 5-1/2" to 6"  
Hull Plank, above knuckle: 1" by 9"  
Hull Planking, at knuckle: 2" by 10"  
Bottom Plank Width: 12"  
Bottom Plank Thickness: 1"  
Deck Plank Width: 5-1/2" to 6"  
Deck Plank Thickness: 1"

Fastening Pattern above turn of bilge: 1, 6" by 3/8" spike  
Fastening Pattern at turn of bilge: 2, 6" by 3/8" spikes

Sampson Posts: 6" by 6" by 16'-6", amiships  
Cylinder Timbers, inboard: 6" by 18"  
Cylinder Timbers, outboard: 3" by 18"

Paddle wheel width: 12'  
Paddle wheel diameter: 12'  
Number of buckets: 12

\*Based upon original plans and field measurements

As the nation's principal conservation agency, the Department of the Interior has basic responsibilities to protect and conserve our land and water, energy and minerals, fish and wildlife, parks and recreation areas, and to ensure the wise use of all these resources. The Department also has major responsibility for American Indian reservation communities and for people who live in island territories under U.S. administration.

Figure 6.3

AFTER:

SHULTZE, ROBERTSON, SHULTZE

San Francisco, California, 1911

Length 70'-0"

Breadth 20'-0" (SIC 21' - 0")

Depth 4'-0"

Engines 8" X 40" X 174# B.P.

Boiler 72" X 120" X 174# H.S. (Corr. 77" X 130" X 174#)

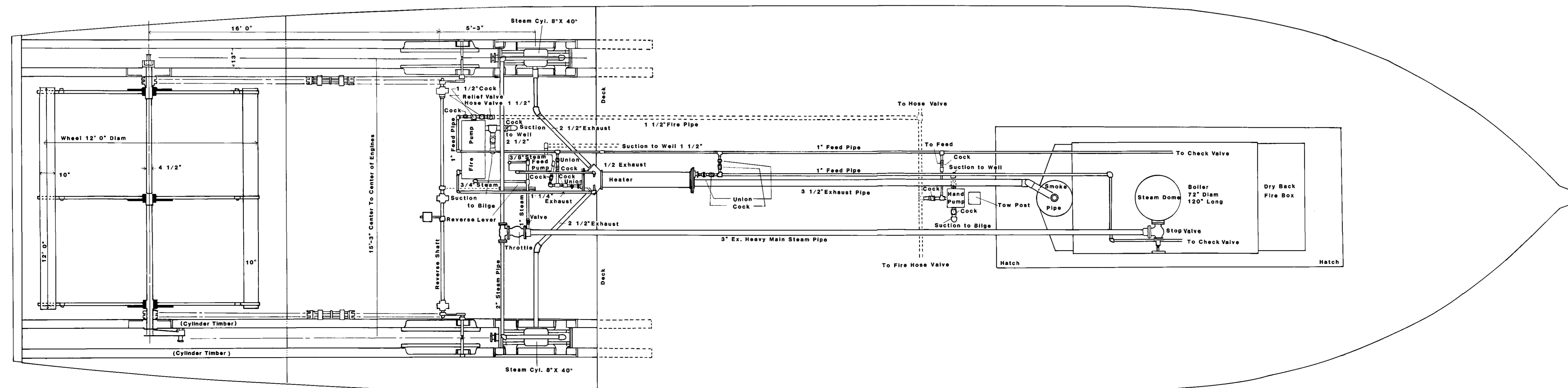
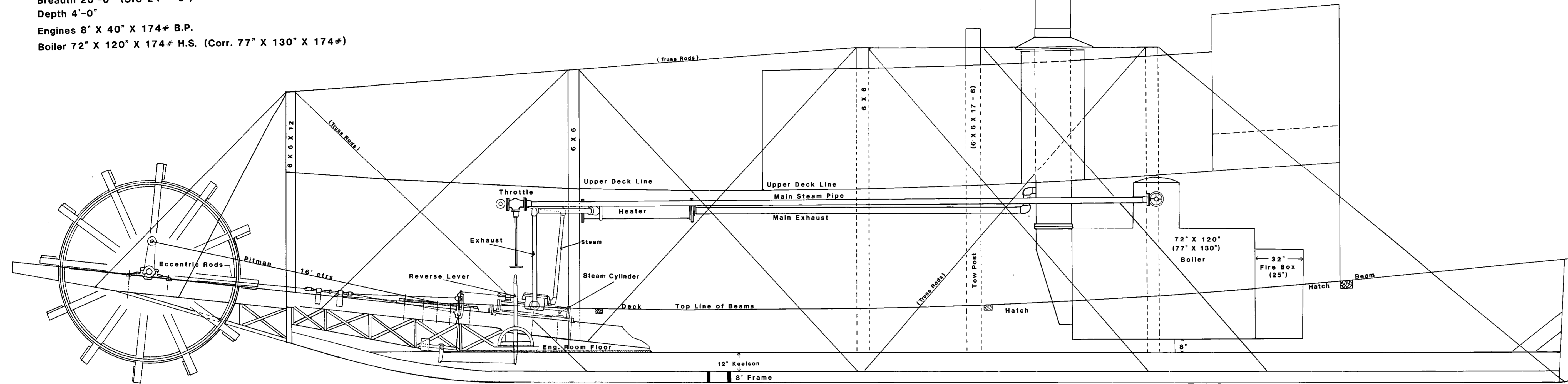



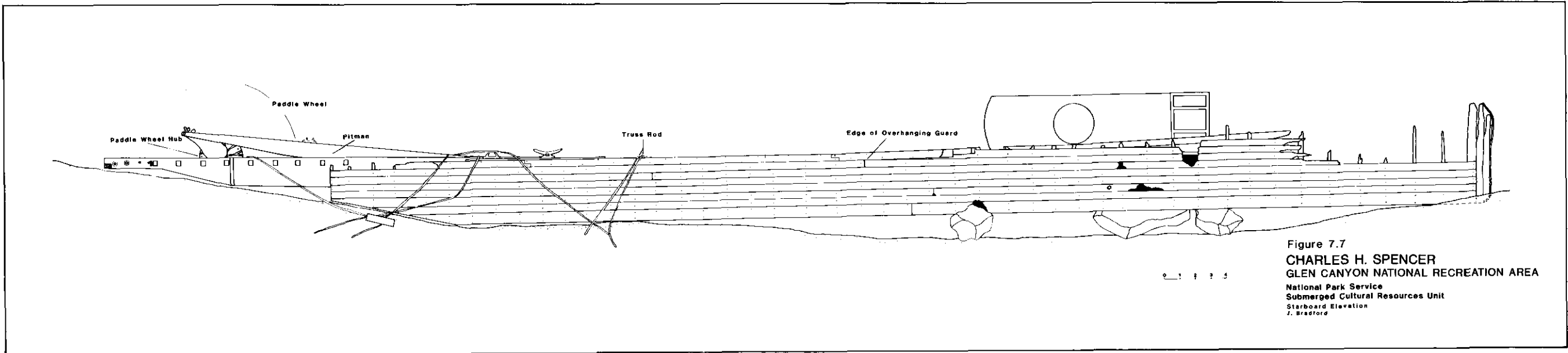

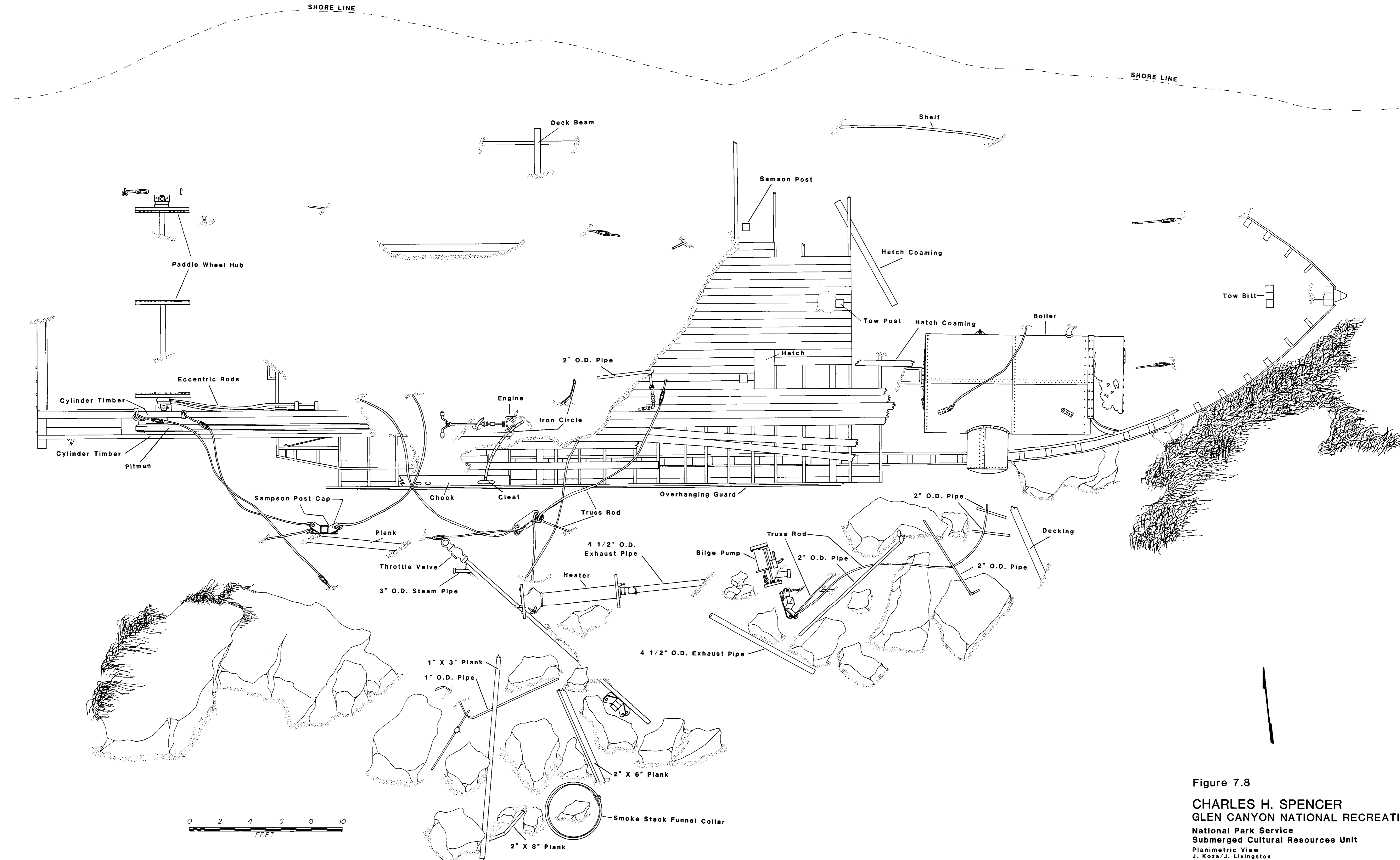

Figure 7.8  
**CHARLES H. SPENCER**  
 GLEN CANYON NATIONAL RECREATION AREA  
 National Park Service  
 Submerged Cultural Resources Unit  
 Planimetric View  
 J. Koza/J. Livingston