

D-1768

Box 3 /

historic structures report
architectural data section
volume two
may 1981

GATEWAY

FLOYD BENNETT FIELD



NATIONAL RECREATION AREA / NEW YORK-NEW JERSEY

ON MICROFILM

Color Scans

3/13/2003

HISTORIC STRUCTURES REPORT
ARCHITECTURAL DATA SECTION
FLOYD BENNETT FIELD
GATEWAY NATIONAL RECREATION AREA
VOLUME II

By
Susan Simpson

UNITED STATES DEPARTMENT OF THE INTERIOR
NATIONAL PARK SERVICE
DENVER SERVICE CENTER
MID-ATLANTIC/NORTH ATLANTIC TEAM
BRANCH OF HISTORIC PRESERVATION
DENVER, COLORADO

TABLE OF CONTENTS

List of Illustrations	/	.iii
List of Drawings	/	v
Acknowledgements	/	1
Background and Introduction	/	2
Hangar Complexes - General	/	111
Hangar Complex 3	/	147
Hangar Complex 4	/	171
Hangar Complex 5	/	199
Hangar Complex 6	/	209
Garage - Shops	26 /	227
Fire Pump House	29 /	251
Sewage Pump House	30 /	265
Electrical Vault	/	274
Transformer Building	120 /	291
Pump Station	176 /	303
Runway System	/	313
Appendices	/	315
A. Mortar Analysis	/	316
B. National Register of Historic Places Nomination Form	/	331

LIST OF ILLUSTRATIONS

1. Administrative Building, West Elevation / 67
2. Administrative Building, East Elevation / 67
3. Administration Building, Main Entry / 69
4. Administration Building, Entry Portico / 69
5. Administration Building, East Elevation at South End / 71
6. Administration Building, Southeast Corner / 71
7. Administration Building, Control Tower / 73
8. Administration Building, Control Tower Interior / 73
9. Administration Building, Interior, Women's Restroom, First Floor / 75
10. WPA Tunnel / 77
11. WPA Tunnel / 77
12. Administration Building, Lobby/Waiting Room / 79
13. Administration Building, Upper Corner of Lobby / 79
14. Administration Building, Second Floor / 85
15. Administration Building, Second Floor Stair Railing / 85
16. Administration Building, Plaster Damage, Basement / 93
17. Administration Building, Ceiling Damage, Basement / 93
18. Administration Building, Bedroom, Second Floor / 95
19. Administration Building, Room, First Floor / 95
20. Hangar Complex 3, Northeast Elevation / 161
21. Hangar Complex 3, South Elevation / 161
22. Hangar Complex 3, WPA Infill, North Elevation / 163
23. Hangar Complex 3, WPA Infill, South Elevation / 163
24. Hangar Complex 3, West Hangar Lean-to, South Elevation / 165
25. Hangar Complex 3, West Hangar, Interior / 165
26. Hangar Complex 3, Typical Window / 167
27. Hangar Complex 3, Sill Condition / 167
28. Hangar Complex 3, West Hangar, Ceiling Fabric / 169
29. Hangar Complex 3, East Hangar Lean-To / 169
30. Hangar Complex 4, Facade, Infill / 177
31. Hangar Complex 4, Detail, Infill Facade / 177
32. Hangar Complex 4, Detail, Infill Facade / 179
33. Hangar Complex 4, Detail, Infill Facade / 179
34. Hangar Complex 4, North WPA Infill / 181
35. Hangar Complex 4, Upper Wall / 181
36. Hangar Complex 4, Parapet / 183
37. Hangar Complex 4, Parapet / 183
38. Hangar Complex 4, East Hangar Lean-To / 185
39. Hangar Complex 4, East Hangar Lean-To / 185
40. Hangar Complex 4, Interior West Hangar / 187
41. Hangar Complex 4, Interior WPA Infill / 187
42. Hangar Complex 5, Roof, West Hangar Lean-To / 189
43. Hangar Complex 5, WPA Infill / 189
44. Hangar Complex 5, WPA Infill, South Elevation / 203
45. Hangar Complex 5, WPA Infill, North Elevation / 203
46. Hangar Complex 5, Lean-To, West Hangar / 205
47. Hangar Complex 5, Lean-To, West Hangar / 205
48. Hangar Complex 5, Interior, WPA Infill / 207
49. Hangar Complex 5, East Lean-To / 207

50. Hangar Complex 6, South Elevation / 215
51. Hangar Complex 6, Roof, WPA Infill / 215
52. Hangar Complex 6, Lean-To / 217
53. Hangar Complex 6, Lean-To / 217
54. Hangar Complex 6, WPA Infill / 219
55. Pump House, South Elevation / 243
56. Pump House, West Elevation / 243
57. Pump House, East Side of North Elevation / 259
58. Pump House, North Elevation / 259
59. Sewage Pump House, North Elevation / 261
60. Sewage Pump House, Scupper Detail / 261
61. Sewage Pump House, Roof Framing / 263
62. Sewage Pump House, Northeast Corner / 263
63. Electrical Vault, West Elevation / 287
64. Electrical Vault, East Elevation / 287
65. Electrical Vault, North Elevation / 289
66. Electrical Vault, South Elevation / 289
67. Transformer Building, Southwest Elevation / 299
68. Transformer Building, East Elevation / 299
69. Transformer Building, Roof of Later Wing / 301
70. Transformer Building, Interior Wall / 301
71. Pump Station 176, South Elevation / 309
72. Pump Station 176, North Elevation / 309
73. Pump Station 176, Northeast Elevation / 311

LIST OF DRAWINGS

- 1 Location map / 5
- 2-18 Administration Buildings, November 17, 1930 / 25-59
- 19-21 Electrical Drawings for Administration Buildings,
February 16, 1931 / 61-65
- 22-28 Repairs and Partial Restoration of the Administration
Building, 1978 / 99-109
- 29-35 Hangar Buildings, November 15, 1929 / 121-133
- 36-38 Construction Drawings for Hangar Lean-Tos, 1931 / 137-141
- 39 Details for Inscriptions for Hangars, March 30, 1931 / 145
- 40-42 Plans for Installation of Boiler Room and Machine Shop
Between Hangars 3 and 4 (WPA Infill), 1935 / 193-197
- 43-44 Drawings for WPA Infill, Hangar 6, 1935 / 223-225
- 45-46 Construction Drawings, Sewage Disposal Plant, Outfall
Pipeline and Transformer Vault, February 16, 1931 / 281-285

ACKNOWLEDGEMENTS

Thanks are gratefully made to Gateway Superintendent Herbert S. Cables and the park personnel of Floyd Bennett Field, who have been more than helpful and generous with their time during the preparation of this report. A special thanks is given to Mr. Sam Holmes for being especially helpful.

Mention and thanks must also be given to John Behan, director of aviation for the city of New York, who loaned valuable original drawings to the Denver Service Center (DSC) for reproduction purposes. The assistance provided by John Baker of Federal Hall in securing and protecting those originals is much appreciated.

At the DSC, appreciation is given to Barry Sulam, who aided in the preparation of this report, and to Porter Blakemore and Frank Williss who completed primary research in the documentary evidence for the structures included herein.

A special thanks is given to Loyce Whist, Helen Athearn, Beverly Sons, and Evelyn Steinman who typed the report.

BACKGROUND AND INTRODUCTION

The General Management Plan (GMP) for Gateway National Recreation Area, now pending approval, calls for the development of a Gateway Village in and around Hangar Row at Floyd Bennett Field. It states that "most of the incorporated buildings (shall be) adaptively reused historic structures, but mixed with new features so that the whole reflects the latest thinking in urban design." The buildings and the historic central runway system which are included in this report and are part of Floyd Bennett Field Historic District.

According to the GMP, the historic structures are scheduled for adaptive reuse. What the specific uses will be, however, is as yet unknown. The document which will plan for and recommend new uses, the Design Concept Plan (DCP), will not be completed for some three to five years.

As the DCP for Floyd Bennett Field is not scheduled to be completed for some time, there is not yet a basis for the detailed recommendations and preliminary plans for preservation and/or adaptive uses which would normally be found in the architectural data section of a historic structures report. This Architectural Data Section, then, will be mainly concerned with historical and existing conditions. Recommendations will be of a general nature.

Each of the structures included on the National Register Nomination Form are the subject of a chapter in this report. Each chapter will include: A. Historical Description, B. Existing Conditions, C. Recommendations, and D. Cost Estimates.

Although more detailed discussions will be found in the Recommendations Section in the chapter for each specific building, some general recommendations apply to all historic structures. The following are very general guidelines which should be taken as absolute minimum considerations which should be given to any historic structure: (The following recommendations are adapted from "The Secretary of the

Interior's Standards for Rehabilitation and Guidelines for Rehabilitating Historic Buildings.")

GENERAL GUIDELINES FOR PRESERVATION/ADAPTIVE USE

1. Compatible uses requiring minimal alteration should be provided for each building. A structure may be used for its originally intended purpose (i.e. the two transformer vaults on either end of Hangar Row which are still in operation).
2. Distinguishing original qualities or character of a building, site, or the historic scene shall not be destroyed. The removal or alteration of any historic material or distinctive architectural features should be avoided when possible.
3. The buildings shall be recognized as products of their own time. Alterations having no historical basis, especially those that would be considered irreversible, are discouraged.
4. Certain changes which may have taken place in the course of time are evidence of the history and development of a building or the site. If these changes have acquired significance in their own right, such significance shall be recognized and respected (such an example would be the more modern (existing) control tower of the Administration Building).
5. Distinctive stylistic features or examples of skilled craftsmanship which characterize a building shall be treated with sensitivity. (Refer to the stained glass skylight and stencils in the Administration Building or the Art Deco panels on the north of the infill structure of Hangar Complex 4.)
6. Deteriorated architectural and structural features shall be repaired rather than replaced, wherever possible. In the event replacement is necessary, the new material should match the material being replaced in color, texture, and other visual qualities. Composition and/or design of

detailing may vary from that of the material being replaced as long as it is similar in appearance, and such a variance aids in the long-term structural integrity of the building. Repair or replacement of missing architectural features should be based on accurate duplications of features, substantiated by historical, physical, or pictorial evidence rather than on conjectural designs or the availability of different architectural elements from other buildings.

7. The surface cleaning of structures shall be undertaken with the gentlest means possible. Sandblasting and other cleaning methods that will damage the historic building materials shall not be undertaken.

8. Every reasonable effort shall be made to protect and preserve archeological resources affected by or adjacent to any construction project.

9. Contemporary designs for alterations to the historic structures must not destroy significant historical or architectural material, and must be compatible with the size, scale, color, material, and character of the building. Alterations or additions to the exterior of any structure will be considered an infringement on the historic scene of this district. If they are found to be necessary to meet code or planning needs, they shall be minimal and in keeping with the historic scene.

10. New additions or alterations to structures shall be done in such a manner that if such additions or alterations were to be removed in the future, the essential form, integrity, and architectural detailing of the structure would remain unimpaired.

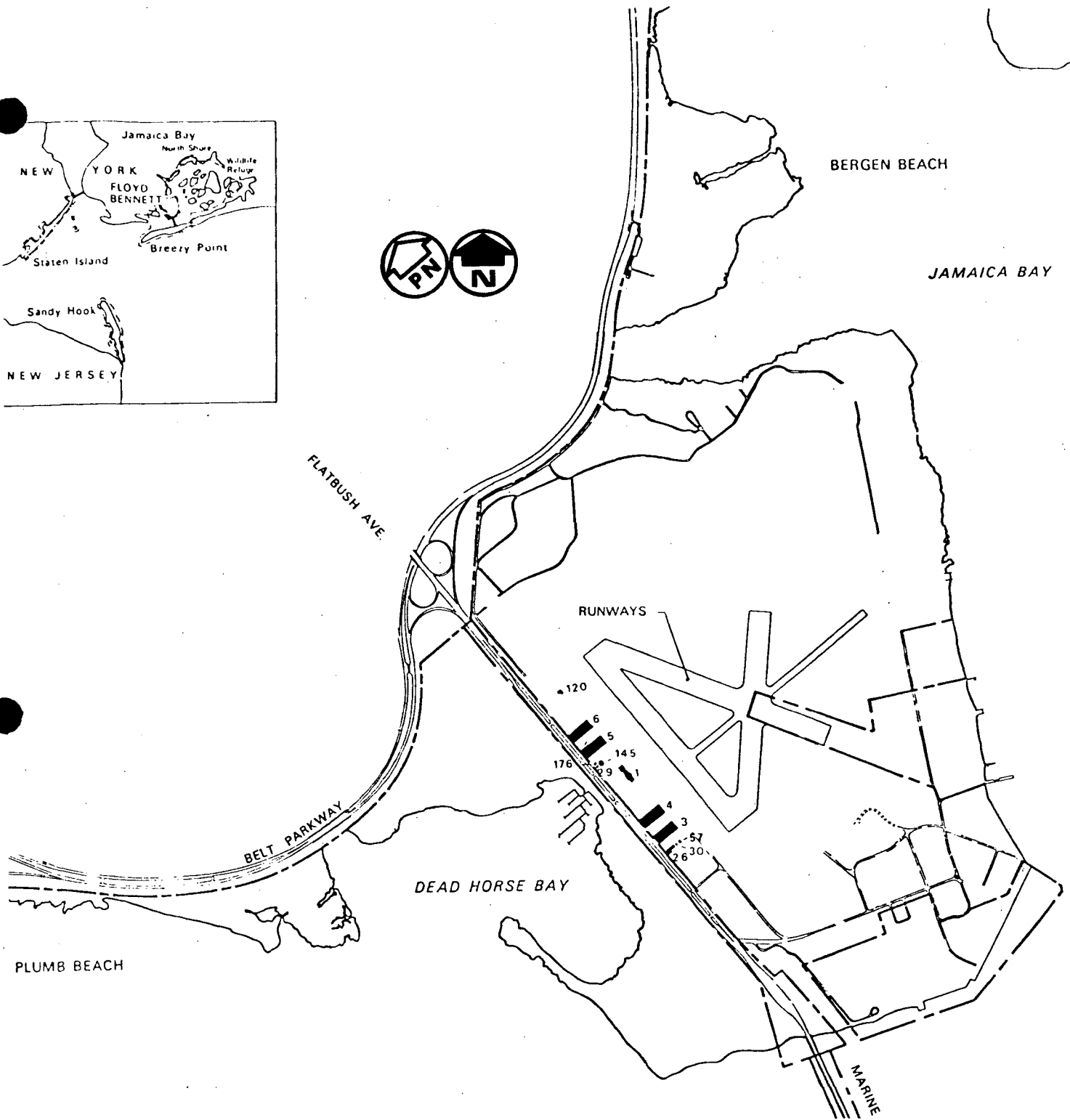
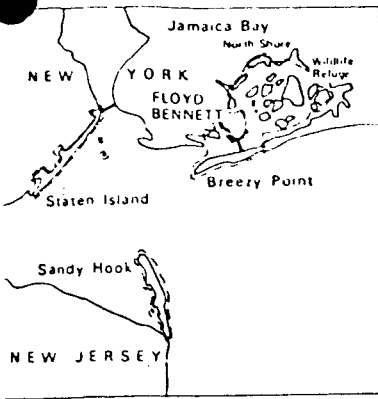

FLOYD BENNETT FIELD

LOCATION MAP SHOWING STRUCTURES INCLUDED IN THE ARCHITECTURAL DATA SECTION.

NOTE: For purposes of clarity, project north (PN) in this report will be considered to run parallel to Flatbush Avenue.

ADMINISTRATION BUILDING I

It is fortunate that the original drawings made by the New York City Department of Docks for this building are extant. They provide excellent documentation and have been included at the end of this chapter. These drawings are accurate for the most part, excepting two major variances:

1. The passenger tunnel built during the WPA period was not planned at the time of these drawings, and so is not included.
2. The drawings show that elevators were to be installed at the western portion of the tower area. Although these were planned (and the marble trim is still evident around the would-be doors at the second floor), they were not installed and the space intended for the elevator shaft was put to other uses.

A. Historical Description

This building was constructed in the Georgian Revival style, had two stories plus a basement, and measured 182 by 74 feet in plan (see Historical Data Section Photograph No. 19, early 1930s view of the Administration Building from the field side. Note original control tower).

1. Exterior
 - a. Site

The Administration Building was sited about 250 feet east of, and with its long axis parallel to, Flatbush Avenue. It was the focal point of the airport, located just north of the main runway axis, and was the only building along Hangar Row with formal landscaping. Its official front was turned toward Flatbush Avenue. Access to a parking lot at this side was gained by two drives flanked by planting strips which angled away from the building in each direction to connect with Flatbush Avenue. A flagpole, surrounded by a circular concrete walk, was placed near the avenue at equal distant between the drives and aligned with the center of the building's entry. The area bounded by Flatbush Avenue, the two drives, and parking lot, was grass covered. A grass strip was also planted in the area immediately surrounding the building.

b. Steel Framing System

The framing system is documented on Sheets 14-17 of the drawings for Contract No. 2000 following this chapter. Steel columns were spaced around the perimeter at 16 feet on center. Interior framing was provided by a double row of columns flanking the north-south axis. The central floor area was left open, with support provided by columns in the corners of the square-shaped space. According to the drawings, girders spanned columns east to west with beams spanning girder to girder at 5 feet on center (o.c.). The whole assembly was riveted together.

c. Masonry

(1) Foundation, Walls, and Trim

The building perimeter rested on a 2-foot 4-inch wide continuous concrete pile cap. Below each of the columns of the steel frame, both interior and exterior, the pile cap measured 5 feet by 5 feet (6 foot 3-inch square caps were used at the central double row of east-west columns). Reinforced concrete piles supported the structure at points approximately 8 feet apart along the exterior wall cap, and at each corner of the square caps. Piles were 35-feet long and 14-inches square. Support for exterior stairs and ramps was by way of a wall footing (pile cap) and wooden piles.

The 12-inch thick partially bearing common brick walls were faced with red Harvard brick laid in Flemish bond. This brick color and bond were different from all other Hangar Row buildings. Stone quoins were placed at each corner.

(2) Entablature

The entablature was of cast stone, consisting of an architrave, frieze, and cornice that ran the full perimeter of the building except at the tower. From bottom to top were double fascia, cyma reversa, and fillet in the architrave; plain frieze, fascia, dentil course, fascia, fillet, cyma recta, and two fillets in the cornice. Interspersed at regular intervals along the dentil course were larger dentils (about double size).

The frieze served as a background for copper letters which spelled out "DEPARTMENT OF DOCKS - FLOYD BENNETT FIELD - MUNICIPAL AIRPORT" across the west elevation. Across the east frieze were "CITY OF NEW YORK" at the south side of the tower and "FLOYD BENNETT FIELD" at the north.

(3) Porches, Stairs, and Ramps

The main entry, from the west, was up a 30-foot wide set of granite central stairs to a portico two stories in height and enclosed on three sides. The pediment-like cornice was supported on the open side (west) by two freestanding tuscan columns which served to frame the Palladian facade. The three walls and ceiling were finished with a white stucco coating, and the floor was red-colored concrete scored to look like tiles (see Historical Data Section Photograph 20).

At the first-floor level of the east elevation, a terrace ran almost the full length, stopping 16-feet short of the north end of the building. The terrace here was also topped with red-colored concrete scored to look like 2-foot by 2-foot tiles. A railing was formed by alternating a small section of brick wall with cast stone balustrades. An 8- by 12-foot concrete platform was installed at the north end of the terrace for pickup and delivery of mail to the post office located in the northeast corner of the first floor. Stairs at either side of the tower led to the terrace and the entry doors. Stairs led to central entries at both north and south elevations. Two concrete ramps at the west and three at the east led down into the basement level from grade. Stair walls were faced with cast stone, railings for stairs and ramps were copper pipe set into stone copings, and steps were faced with granite slate.

(4) Trim (general comment)

Although most of the white-colored trim on this building was designated as "white marble" on the original drawings, cast stone was applied at the time of construction. This discrepancy between drawings and construction occurred at the quoining, coping, entablature, half-moon panels above the windows, window keystones, window sills, tuscan columns, terrace railing, decorative globe above the main entry,

semi-ellipses above west entry doors, and borders around north and south entries.

(4) Control Tower

The control tower was the focal point at the field side of the building. It projected about 20-feet above the top of the parapet, seated on the 33-foot wide, three-story building bay. A decorative aluminum railing was placed at the perimeter of the bay, protecting a walkway that surrounded the control tower. The steel frame and brick walls were covered with aluminum sheeting. Aluminum frame and sash windows with arched heads were spaced continuously around the tower (see Historical Data Section Photograph 21 - mid-1930s).

d. Doors and Windows

Windows were generally wood frame and sash, multi-paned 9 over 9 or 12 over 12 lights, with steel lintels spanning the head, and cast stone sills. Second-level windows were decorated at the head with a flat brick arch and cast stone keystone. Those at the first-floor level had half-moon shaped cast stone panels above the lintel with a border of brick and a cast stone keystone. (These were typical fenestration styles used in Georgian Revival buildings of this era.)

Doors had a variety of decorative elements. Above the two entries facing the airfield were quarter-sphere protective canopies of leaded translucent glass and a leaded glass transom. The three main west entry doors were headed with semi-elliptical cast stone designs. (A cast bronze eagle was placed in the center semi-ellipse.) Doors at north and south elevations were bordered with cast stone, used leaded glass transoms of the same design as those above the east entries, with a small cornice-type design above.

e. Roof and Roof Drainage

The roof structure consisted of a 4-inch reinforced cinder concrete slab, into which the upper flanges of the girders were embedded to provide composite action. The concrete slab was waterproofed and the whole assembly was finished with 6- by 6- by

1-inch red quarry tile set in a 1-inch thick cement grout. A 10- by 10-foot vault light at the center of the roof allowed for the entry of natural lighting to the stained glass skylight directly below.

The flat roof was slightly sloped to roof drains which led the rainwater down through the building in interior concealed iron leaders. All exposed leaders, gutters, and flashing were copper.

A wooden flagpole with a brass ball at the top was installed at the center of the west parapet.

2. Interior

a. Tunnel

The passenger tunnel, constructed during the WPA period, centered on the east-west axis of the building. It led 124 feet to the east (toward the runway) at a 12-foot width, then branched north and south at right angles. This north-south branch was 10-feet wide and 240-feet long. Floors, walls, and roof were of reinforced concrete construction. Tile wainscoting finished the lower walls and slate was placed over the floors. Access to the first floor was possible via a set of stairs (which flanked the tunnel's main axis) placed in the space that had been designated for the elevator.

b. Basement

(1) General Description and Layout

Interior access to the basement was provided by two steel stairways, one each at opposite corners of the first floor lobby area. Two ramps at the east and three at the west exterior led down to double doors which opened into the basement. The plan included a large open space centrally located, and a north to south corridor with rooms off each side. Uses of these rooms varied with the needs of the building's occupants. Entry into the tunnel was at the center of the tower base, down a flight of stairs from the basement level.

(2) Floor

According to the Contract No. 2000 drawings, the floor was 4-inch reinforced cinder concrete slab with a 2-inch granolithic finish. Linoleum flooring was used throughout, except for the men's toilet room which used tile, and rooms left unfinished at the north end.

(3) Walls

Interior partitions were of terra cotta throughout with a plaster finish. Exterior brick walls were also finished with plaster. A simple wood base trim was used in all but the "unfinished" areas at the north end.

(4) Ceiling

Steel channels, furred down below the steel beams, provided the support for diamond metal lath and plaster finish, used throughout.

c. First Floor

(1) General Description and Layout

The focus of this main floor was a large, open lobby/waiting area at the center. The main entry (west) opened directly into this central space, while the two eastern entries were slightly removed and to either side of it. A central north-south corridor led from entries at either end of the building and emptied into the lobby. A restaurant at the southeast corner was entered through the southern corridor, with access to the terrace by two sets of large double doors. There was a small post office in the northeast corner. Immediately south of the post office was the lounge and baggage area. Entering the building from the west, a telephone room was at the left and a radio room at the right. Turning right, down the southern corridor, were entries to a news stand, women's toilet, and two offices along the west wall. Turning left, one could enter the telegraph room, press room, men's toilet, and barber shop from the west side of the northern corridor (see Historical Data Section, Page 96).

(2) Floor

The floor consisted of a 4-inch reinforced cinder concrete slab with 1-inch granolithic finish. Linoleum was placed on top in all areas but the men's and women's toilet, where tile was used.

(3) Walls

As with the basement, interior partitions were terra cotta. Plaster finish was used on these and the inside of exterior brick walls. A buff marble wainscot with black marble base was used in the corridors and at the walls around the lobby/waiting area. The plaster above these wainscotted areas was scored to give the appearance of caen stone. A decorative band of plaster around the top of the walls and picture molding were used in the women's restroom (see Contract 2000, Sheet 4).

(4) Ceiling

Plaster over diamond metal lath, attached to steel channels hung from the beams was used to finish the ceiling. The lobby/waiting area ceiling was two stories high with a stained glass skylight centrally located. The ceiling area here was extensively stenciled in yellows and browns.

d. Second Floor

(1) General Description and Layout

The central area of this level was open to the lobby/waiting area below. North-south central corridors were flanked by dormitories and bedrooms. Office spaces were located across the hall around the open area. To the southeast of the open area was the men's toilet (see Historical Data Section, Page 97).

(2) Floor

The floor was 4-inch reinforced cinder concrete with a 1-inch granolithic finish. Linoleum flooring was used throughout, except for the men's toilet, where the flooring was tile.

(3) Walls

Interior partitions were terra cotta. These, and the inside of the exterior brick walls, were finished with plaster. Plaster was scored to imitate caen stone, and a buff marble wainscot with black marble base was used at the walls and railing around the central open area. The walls of the railing that faced in toward the open lobby space were decorated with plaster ornament, top and bottom, and wood mouldings. Empty spaces were left for mural canvases to be applied later. The short band of wall above the railing was also decorated with plaster ornament and small murals depicting the development of travel.

(4) Ceiling

Plaster on diamond metal lath was hung from the steel beams. The ceiling was extensively stenciled in the area directly above the lobby/waiting area, and above the halls encircling the open space.

e. Third and Fourth Floors at Tower

The control tower extended two levels above the main part of the building. A metal stairway provided access at the southwest corner of the tower area. Both floor plans were open, but the top floor was smaller in area to provide room for an exterior perimeter walkway.

B. Existing Conditions

1. Exterior

This building retains much of its historic appearance. The major changes have been the installment of glass block lights at the first floor of the east elevation and the exchange of the top story of the original control tower for a more modern all-glass design.

a. Site

After original construction, a wood-frame structure was built directly north of the Administration Building, and connected to it by a short covered hallway. This addition has recently been demolished. A large blue metal nose hangar now stands between the Administration Building and Hangar Complex 5.

It is no longer possible to enter the site via the roads connecting with Flatbush Avenue, although they are extant, as the avenue fence continues across the entry points.

b. Steel Framing System

The framing system is in very good condition.

c. Foundation, Walls, and Trim

There appear to be no problems at the foundation.

Approximately 5 percent of the brickwork and 25 percent of the mortar is deteriorated.

Ghosts of the recently removed (1979) wood-frame annex can be seen around the entry on the north elevation. The wall surface in this area has been punctured twice to allow for access of groups of pneumatic tubes (probably installed during the U.S. Navy period).

Several cracks in the wall surface appear to have been filled with a white-colored caulking, as have the vertical joints of the tower walls. The caulking is dried-out and cracking.

About 10 percent of the cast stone entablature is deteriorated. The worst damage is apparent at the northwest, and approximately 80 percent of the mortar joints have deteriorated.

Stone facing at the building base and stair walls is cracked or missing. Damage occurs over approximately 10 percent of the area.

Copper letters were removed from the front frieze at an unknown date. Across the east elevation, the words (in the same style) "City of New York" were replaced with "Naval Air Station."

The present control tower retains the upper and lower wall portions, roofing, and framing of the original. The center wall section was removed around the whole perimeter to allow for the installation of an outward projecting band of glass.

Dirt has collected and vegetation has grown in the large joints of the west entry stairs.

Stair wing walls are loose and some are tilting outward (exfoliating).

The original terrace paving of red-colored concrete is now covered with a bituminous coating.

Masses of hairline cracks are apparent over the areas of stone facing and in the cement topping over the walls of the west entry porch.

d. Doors and Windows

All frames are in poor condition due to exposure and lack of maintenance. The frame in the port manager's office (first floor) has actually fallen in. Paint is peeling badly and putty has deteriorated. Much glass is broken or missing.

Steel shelf angles (lintels) are generally rusting and expanding.

About 50 percent of the windows and doors at the first floor east elevation have been infilled with glass block.

The leaded glass canopies that once hung above the two main east entries are no longer present.

e. Roof and Roof Drainage

The original red quarry tile which surfaced the roof is now coated with an asphaltic material which is peeling and cracking.

The condition of the interior leaders is unknown as they are concealed from view in the walls.

Some water damage is evident inside the building. However, the leaking should be corrected by the C-B proposal.

2. Interior

a. Tunnel

The tunnel structure is basically sound. The wainscotting is in good condition, but the slate flooring is very worn and exfoliating. Openings off of the main tunnel branches, used for ventilation, have been sealed with concrete. The heads of the stairwells connecting to the first floor have been sealed to allow foot traffic over the area, but access to the basement is still open.

b. Basement

Parts of the ceiling and walls are deteriorating. Most of the deterioration is caused by water which has rusted the channels and lath. This damage is severe at the east, along the area beneath the first floor terrace.

c. First Floor

No irreversible structural changes have been made to this plan. Stud partitions were added in the old southeast restaurant space and in the lobby/waiting room area, but these are relatively easy to remove.

Some of the marble wainscotting has been removed, leaving that part of the walls unfinished.

Plaster walls are in fair condition, the major damage being peeling paint. The later wood-frame partitions are in poor condition.

Extreme ceiling deterioration occurs at the west wall, to the south side of the main entry stairs. Again, the problem is water.

Ceiling stenciling at the lobby/waiting room area is rapidly deteriorating. It is already difficult to discern much of the pattern.

About 50 percent of the glass in the high skylight is broken.

Vinyl tile flooring which replaced the original linoleum flooring is rotting.

d. Second Floor

This level basically retains its original layout. Walls are in good condition, except for peeling paint.

Water has damaged the ceiling at the east side, at a spot just south of the entry (right above the large area of deterioration at the first floor ceiling). Another large area of water-caused plaster damage occurs just north of the tower at the east wall.

The remainder of the ceiling area is structurally sound with severely peeling paint. The paint of the stenciled area above and around the space open to the lobby is extremely deteriorated.

Mural walls are sound, but paint is flaking and no murals remain in place.

Vinyl tile flooring is in poor condition.

e. Third and Fourth Floors at Tower

Both levels are in poor condition, the upper being worse. Steel columns and window frames are exfoliating. Broken windows and leakage are prevalent. The remains of Navy equipment used during World War II are still present in the control tower.

C. Recommendations

According to the GMP, the site of the William Fitts Ryan Memorial Visitor Center is to be within the Floyd Bennett Field Gateway Village. The Administration Building, as the focal point of the historic district, provides an excellent space for this visitor center. It has the potential, if properly restored, to be one of the most interesting structures at the Gateway National Recreation Area.

Construction drawings for repairs and partial restoration of the Administration Building were prepared in 1978 by Castro-Blanco, Piscioneri, and Feder, Architects. This contract, and that for actual construction work, is being managed by Jack Lovell, architect at the Denver Service Center (DSC). It involves some emergency stabilization and some preservation on the exterior, and work to adaptively use the interior (at the south end of the first floor) for staff space. Drawings 1 through 6 (of 18) of the drawings for the contract are included at the end of this chapter to show the basic scope of work intended.

1. Exterior

a. Site

If a major use is assigned to this structure by the GMP, access via the diagonal roads from Flatbush Avenue should be opened. Lawn around the building and beside the roads should be replanted if necessary and cared for.

The blue nose hangar to the north of the Administration Building should be demolished or moved, as it greatly distracts from the historic scene. Its demolition, however, must not take place until comparable space is made available in one of the historic hangars or outside the historic district.

b. Steel Framing System

With the forthcoming exterior stabilization, the framing will be even better protected against corrosion. At present there are no major problems with the system.

c. Foundation, Walls, and Trim

See Castro-Blanco, Piscioneri, and Feder drawings 1 through 6. These show the most vital work needed on the exterior.

Aside from the stabilization, it is recommended that:

The ghosts of the northern annex be removed and holes around and near the area be patched.

All cast stone trim be repaired or replaced to match existing (in color and composition).

The copper letters across the front and rear frieze be reinstalled to match the original wording.

Although the terrace is being patched with bituminous material, if much visitor use and interpretation is to take place in this building, the whole asphalt covering should be removed and the red-colored scored concrete should be restored or reconstructed to its original appearance.

The cement topping over walls at the west entry be repaired.

d. Doors and Windows

Again, emergency stabilization is anticipated for the openings and intended work can be seen in the Castro-Blanco, Piscioneri, and Feder drawings.

Recommendations that go beyond the stabilization are:

Remove the glass block infills at the east openings and rebuild windows and doors to match historic appearance.

Rebuild leaded glass canopies according to original drawings and install.

All doors and windows not included in the stabilization work should be refurbished to match original and be made workable.

e. Roof and Roof Drainage

Drawing by Castro-Blanco, Piscioneri, and Feder indicates the intended work on the roof. This type of roofing, although not historic, provides an economical long lasting covering that is not visible from the ground. However, if much use and interpretation is intended to take place at the roof level, it is recommended that the original quarry tiles be uncovered (or reconstructed) so that the appearance of the roof be historical.

Interior water damage may be caused in part by corroding interior downspouts. Their condition was not surveyed. They should be inspected and repaired before any interior preservation work begins.

2. Interior

a. Tunnel

The current contract calls for sealing the tunnel opening. If future use and interpretation warrants, the tunnel could be cleaned and used in its "as-is" condition.

b. Basement

Plaster damage at walls and ceiling should be repaired. Any exposed steel members should be cleaned and painted before recovering.

Partitions can be added to provide for varying uses, but it is recommended that no historic partitions or fixtures be removed, and that no changes be made that are irreversible.

Historic lighting fixtures and plumbing fixtures should be retained and reused when possible.

c. First Floor

The current contract calls for the addition and deletion of partitions. These are acceptable because the partitions to be added can easily be removed without harming historic fabric, and the partitions to be deleted are not historic.

It is recommended that particular care be taken with the lobby/waiting room area. Later stud partitions should be removed to open the space up again. All plaster damage at the mural areas should be repaired. As complete as possible recording should be made of the stenciling so that it can be restored. This should be done immediately as the paint is rapidly deteriorating and the patterns are becoming indiscernible. The skylight above should be repaired to match original. As the most important area in the whole building, this space should be preserved and/or reconstructed to match its original appearance as closely as possible. Further inspection and study will be needed in this area to record the stenciling, take paint samples, reconstruct original light fixtures, and linoleum design, etc.

Damage to plaster at walls and ceilings should be repaired, and marble wainscoting should be reinstalled, matching existing, where it has been removed.

Outside of the lobby/waiting room area, partitions may be added and changes made as long as they can be installed, and removed in the future without damaging the historic fabric.

All repairs should match the existing fabric of the item or area being repaired.

All remaining plumbing and lighting fixtures should be retained and reused when possible.

d. Second Floor

Recommendations made for the first floor are basically the same here.

The halls and open area relating to the lobby/waiting room below should be preserved and/or restored to original condition.

The remaining spaces may be adaptively used as long as no alterations are irreversible.

All repairs should be done in such a manner as to match the surrounding historic fabric.

All remaining plumbing and lighting fixtures should be retained and reused when possible.

e. Third and Fourth Floors at Tower

These areas were extensively altered by the U.S. Navy during World War II, and have become interpretative instruments in their own right. It is recommended that they be preserved/restored to the World War II period, as this represents an important and exciting part of the building's history.

Columns and window framing need repair or replacement.

UNITED STATES DEPARTMENT OF THE INTERIOR
NATIONAL PARK SERVICE

PACKAGE ESTIMATING DETAIL

REGION North Atlantic	PARK Gateway N.R.A.
PACKAGE NUMBER 109 (Portion)	PACKAGE TITLE Administration Building

(If more space is needed, use plain paper and attach)

ITEM	QUANTITY	COST
Reconstruct two leaded glass canopies above east entry doors, remove glass block infills (eight windows and two doors). Reconstruct and install doors and windows. Uncover original quarry tiles on roof. Repair and replace quarry tiles, restore ceiling stenciling at lobby/waiting room area, repair stained glass skylight, restore decorative plasterwork, repair/replace damaged cast stone trim, remove asphaltic covering from terrace and repair area.	LS	\$329,000
H.S.R. Estimate R. Borras 3/30/81		

SUMMARY OF CONSTRUCTION ESTIMATES		CLASS OF ESTIMATE		
		<input type="checkbox"/> A Working Drawings	<input type="checkbox"/> B Preliminary Plans	<input checked="" type="checkbox"/> C Similar Facilities
Proj. Type				Totals from Above B & U R & T
52	Museum Exhibits			XXXXX
55	Wayside Exhibits			XXXXX
62	Audio-Visual			XXXXX
89	Ruins Stabilization			XXXXX
91	Construction		\$329,000	
92	Utility Contracts			XXXXX
ESTIMATES APPROVED (Signature)		(title)	(date)	

POST PROFESSIONAL SERVICES ESTIMATES AND SCHEDULING ON BACK OF FORM

Original Drawings for Contract No. 2,000
for the construction of
Administration Building with appurtenances
at the site of The Municipal Airport,
Floyd Bennett Field
November 17, 1930

SUMMARY OF SHEETS	
	TITLE
1	EAST & WEST ELEVATIONS
2	NORTH ELEVATION & CROSS SECTION OF WING
3	CROSS SECTION THROUGH CENTRE PAVILION
4	LONGITUDINAL SECTION
5	BASEMENT PLAN
6	1 ST FLOOR PLAN
7	2 ND FLOOR PLAN
8	ROOF
9	DETAILS OF EXTERIOR DOORS
10	DETAILS OF EXTERIOR WINDOWS
11	DOOR SCHEDULE & TOILET PART.
12	STAIR DETAILS
13	FOUNDATION PLAN
14	FIRST FLOOR FRAMING PLAN
15	SECOND FLOOR FRAMING PLAN
16	THIRD FLOOR, ROOF, ETC. FRAMING PLAN
17	COLUMN SCHEDULE

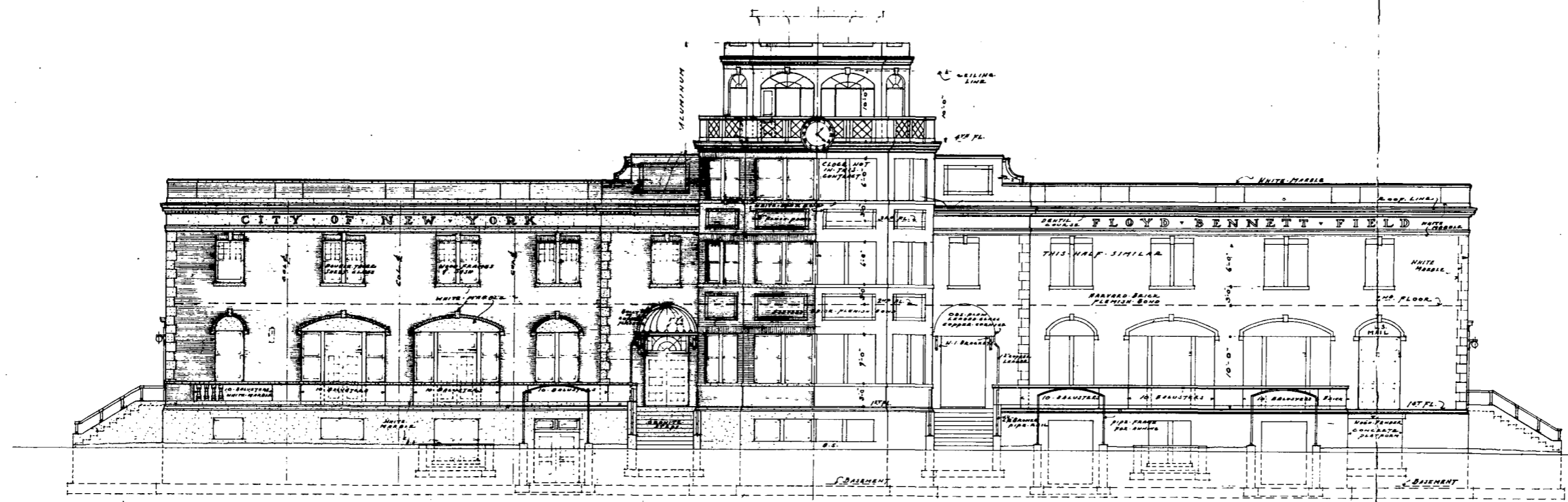

EAST ELEVATION
(FACING FIELD)
CONTROL TOWER (ON FIELD SIDE)
1/8" SCALE

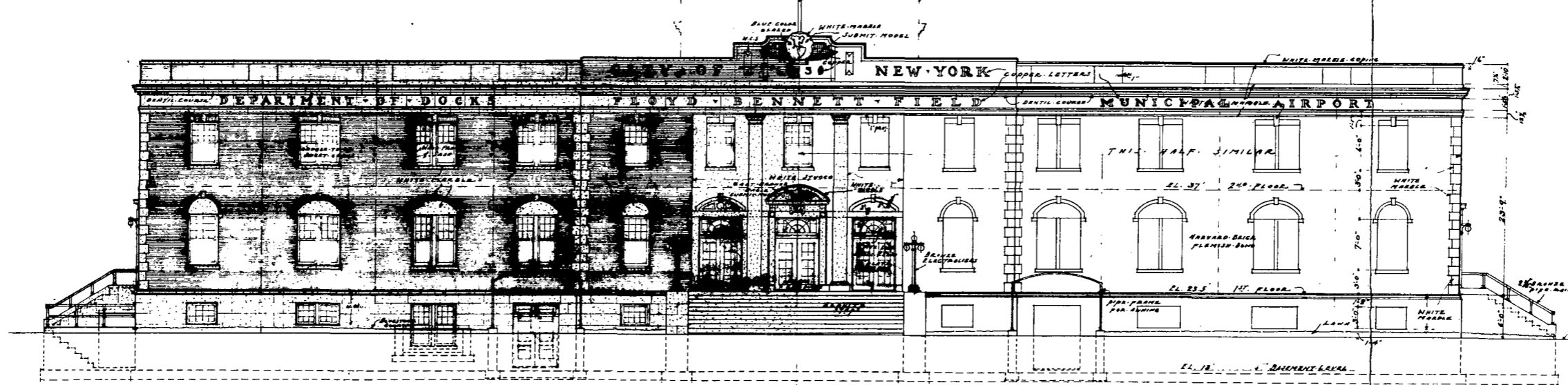

WEST ELEVATION
(FACING FLATBUSH AVENUE)
1/8" SCALE

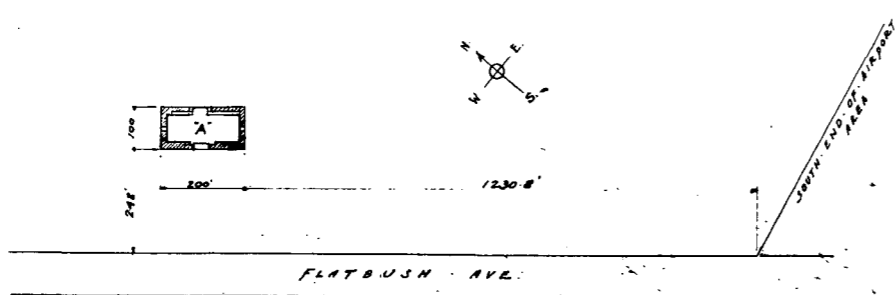

DRAWN BY H.F.M.B.
TRACED BY

LOCATION KEY
A - ADMINISTRATION BUILDING

THE CITY OF NEW YORK
DEPARTMENT OF DOCKS
DIVISION OF PORT PLANNING
CONTRACT NO. 2000
FOR THE CONSTRUCTION OF ADMINISTRATION
BUILDING WITH APPURTENANCES AT THE SITE
OF
THE MUNICIPAL AIRPORT
FLOYD BENNETT FIELD
FLATBUSH AVE BOROUGHS OF BROOKLYN
SUBMITTED BY *[Signature]* DIVISION ENGINEER
APPROVED BY *[Signature]* CHIEF ENGINEER
APPROVED BY *Michael Casgrove* COMMISSIONER
DATE - Nov. 17, 1930

43

43

6A6/ 63038

1 of 17

ON MICROFILM

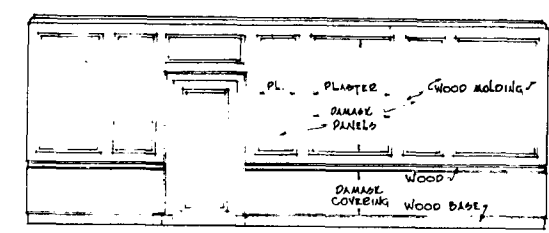

TYPICAL FINISH OF PARLOR
2ND FLOOR
1/8" scale

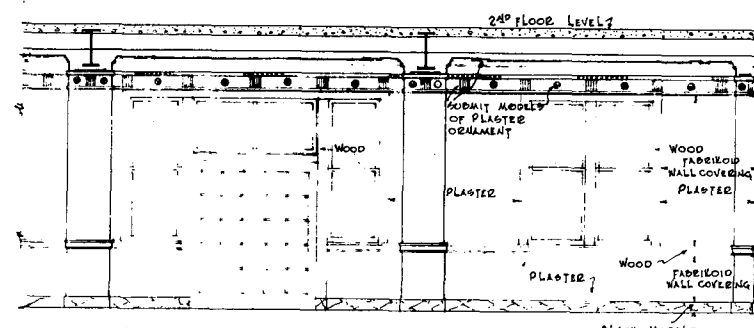

PART ELEVATION OF NORTH WALL
TYPICAL FINISH OF RESTAURANT
1/8" scale

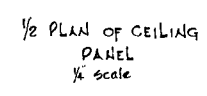

1/2 PLAN OF CEILING
PANEL
1/8" scale

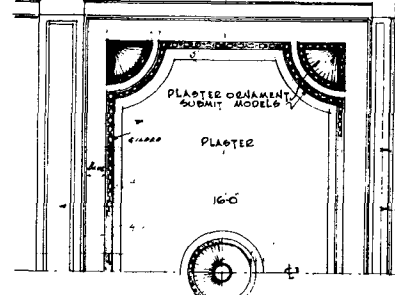

PLASTER ORNAMENT
WOOD
PLASTER

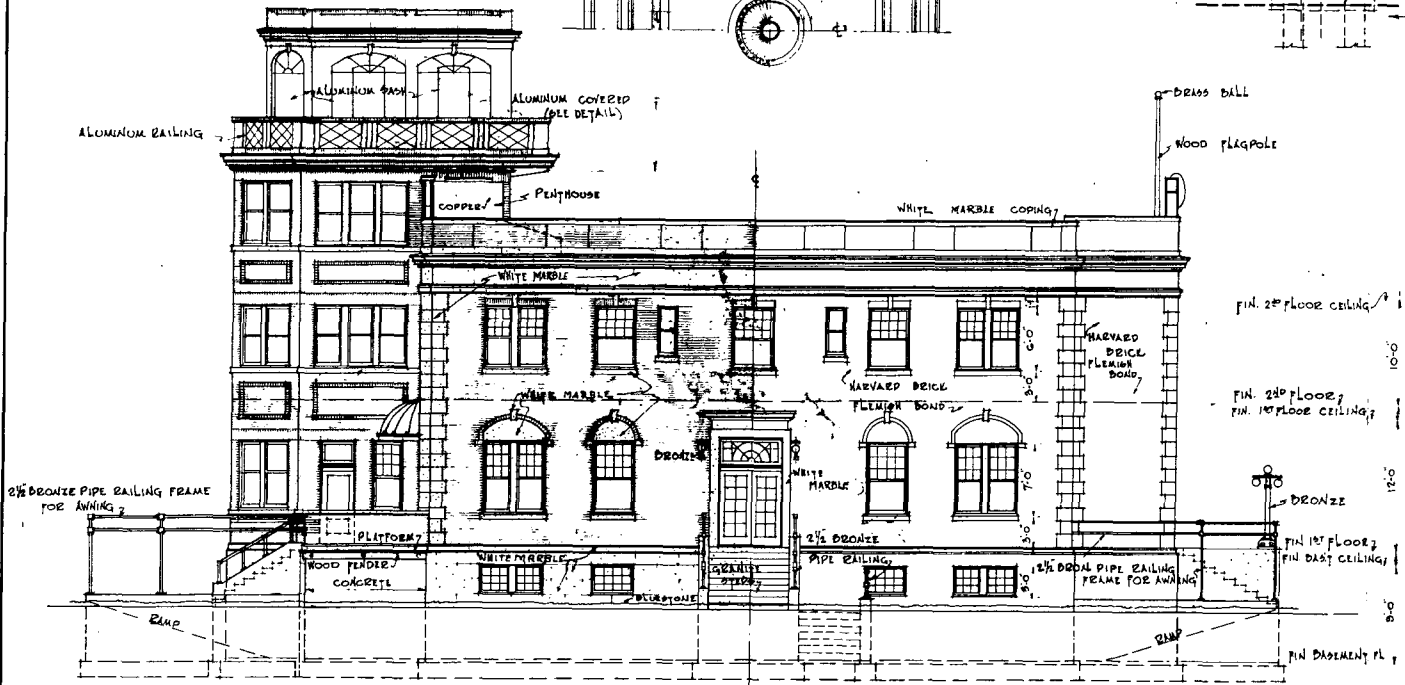

NORTH END ELEVATION
[SOUTH END SIMILAR REVERSED]
scale 1/8"=1'-0"

DRAWN BY H. F. MEL
TRACED BY D. A.

HIGH POINT OF ROOF
FIN 2ND FL CEILING
FIN 2ND FLOOR
FIN 1ST FL CEILING
FIN 1ST FLOOR
FIN BASEMENT CEILING
FIN BASEMENT FLOOR

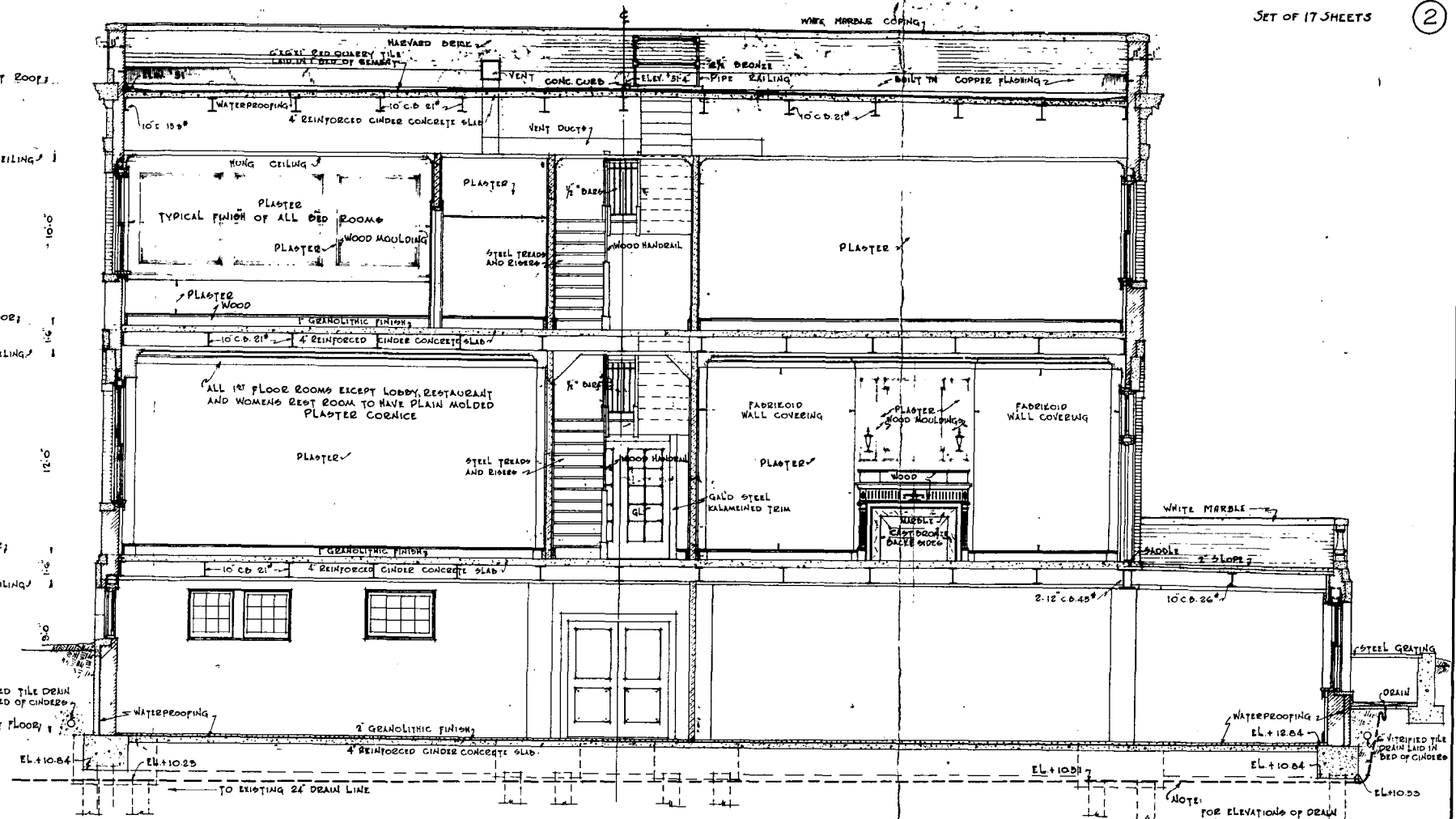

CROSS SECTION THRU WINGS
scale 1/8"=1'-0"

NOTE: FOR ELEVATIONS OF DRAIN LINE THRU OPPOSITE WING SEE BASEMENT PLAN.

ON MICROFILM

THE CITY OF NEW YORK
DEPARTMENT OF DOCKS
DIVISION OF PORT PLANNING
CONTRACT NO. 2000
FOR THE CONSTRUCTION OF ADMINISTRATION
BUILDING WITH APPURTENANCES AT THE SITE
OF
THE MUNICIPAL AIRPORT
FLOYD BENNETT FIELD
FLATBUSH AVE. BOROUGH OF BROOKLYN

SUBMITTED BY *[Signature]* DIVISION ENGINEER
APPROVED BY *[Signature]* CHIEF ENGINEER
APPROVED BY *[Signature]* COMMISSIONER
DATE - Nov. 17, 1930

6046/63038 2 of 17

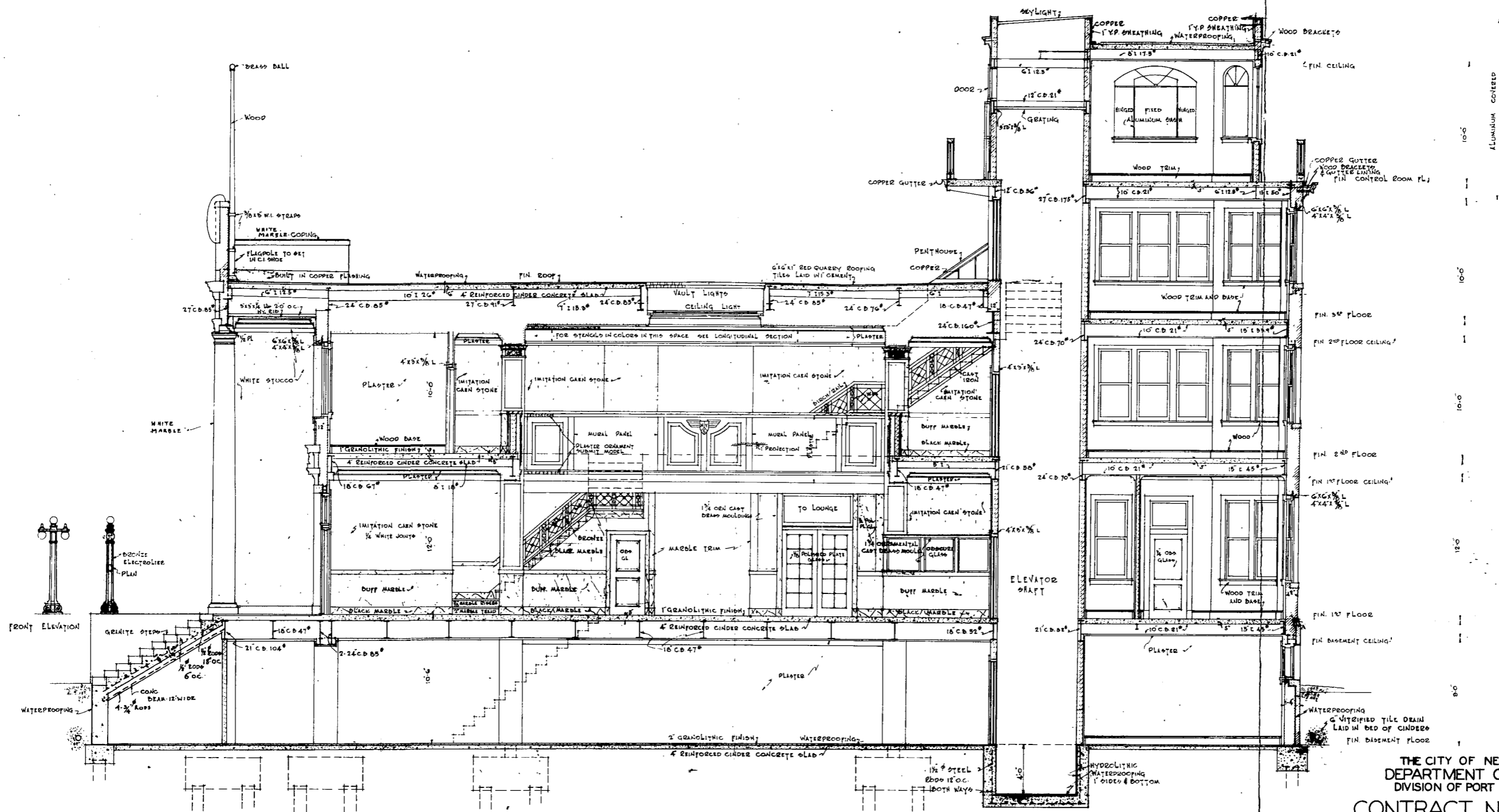

ON MICROFILM

CROSS SECTION
THRU CENTER PAVILION
Scale 1/4" = 1'-0"

THE CITY OF NEW YORK
DEPARTMENT OF DOCKS
DIVISION OF PORT PLANNING

CONTRACT NO. 2000

FOR THE CONSTRUCTION OF ADMINISTRATION
BUILDING WITH APPURTENANCES AT THE SITE
OF

THE MUNICIPAL AIRPORT
FLOYD BENNETT FIELD
FLATBUSH AVE. BOROUGH OF BROOKLYN.

SUBMITTED BY *[Signature]* DIVISION ENGINEER
APPROVED BY *[Signature]* CHIEF ENGINEER
APPROVED BY *[Signature]* COMMISSIONER

DATE - Nov. 17, 1930.

DRAWN BY H.F.M.L.
TRACED BY D.A.

45

45

646/63038

3 of 17

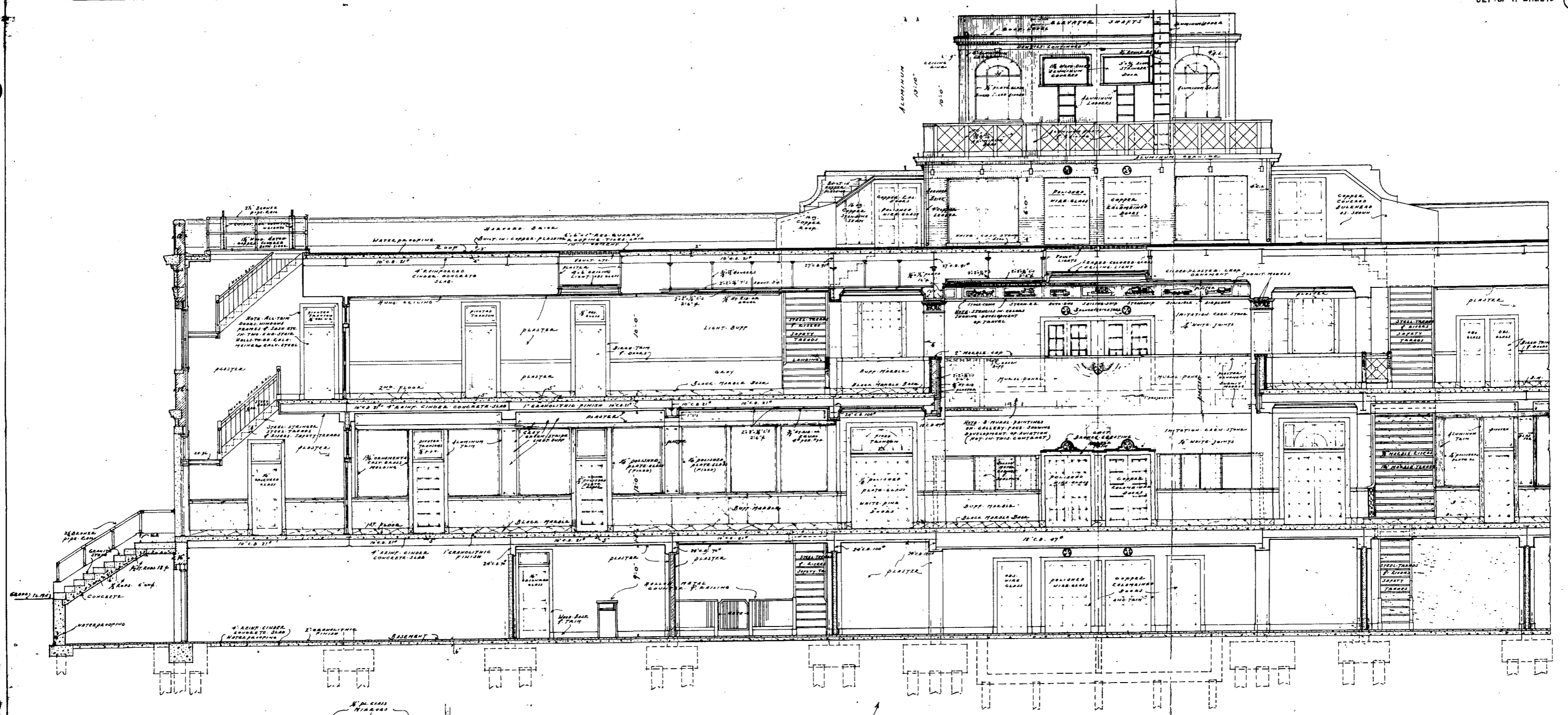

LONGITUDINAL SECTION
(THROUGH CORRIDORS & LOBBY)
1/4" SCALE

NOTE: ELEVATOR DOORS, SADDLES
& INDICATORS NOT IN THIS CONTRACT

ON MICROFILM

THE CITY OF NEW YORK
DEPARTMENT OF DOCKS
DIVISION OF PORT PLANNING
CONTRACT NO. 2000
FOR THE CONSTRUCTION OF ADMINISTRATION
BUILDING WITH APPURTENANCES AT THE SITE
OF
THE MUNICIPAL AIRPORT
FLOYD BENNETT FIELD
FLATBUSH AVE. BOROUGHS OF BROOKLYN
SUBMITTED BY *[Signature]* DIVISION ENGINEER
APPROVED BY *[Signature]* CHIEF ENGINEER
APPROVED BY *[Signature]* COMMISSIONER
DATE - Nov. 17, 1930

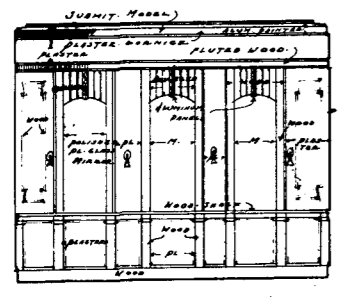

WEST WALL
1/4" SCALE PLAN
& ELEVATIONS OF
WOMEN'S REST ROOM

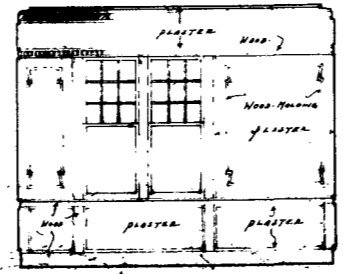
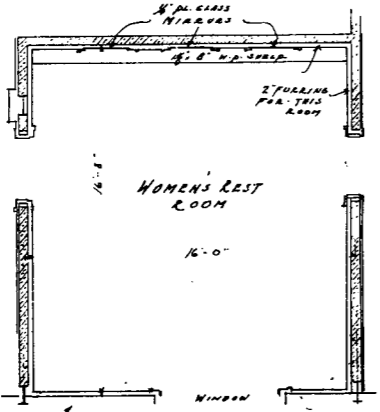

WEST WALL

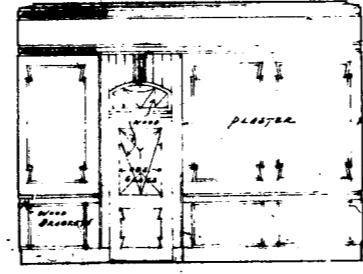

SOUTH WALL

DRAWN BY H.P. MEL
TRACED BY

646/63038 4 of 17

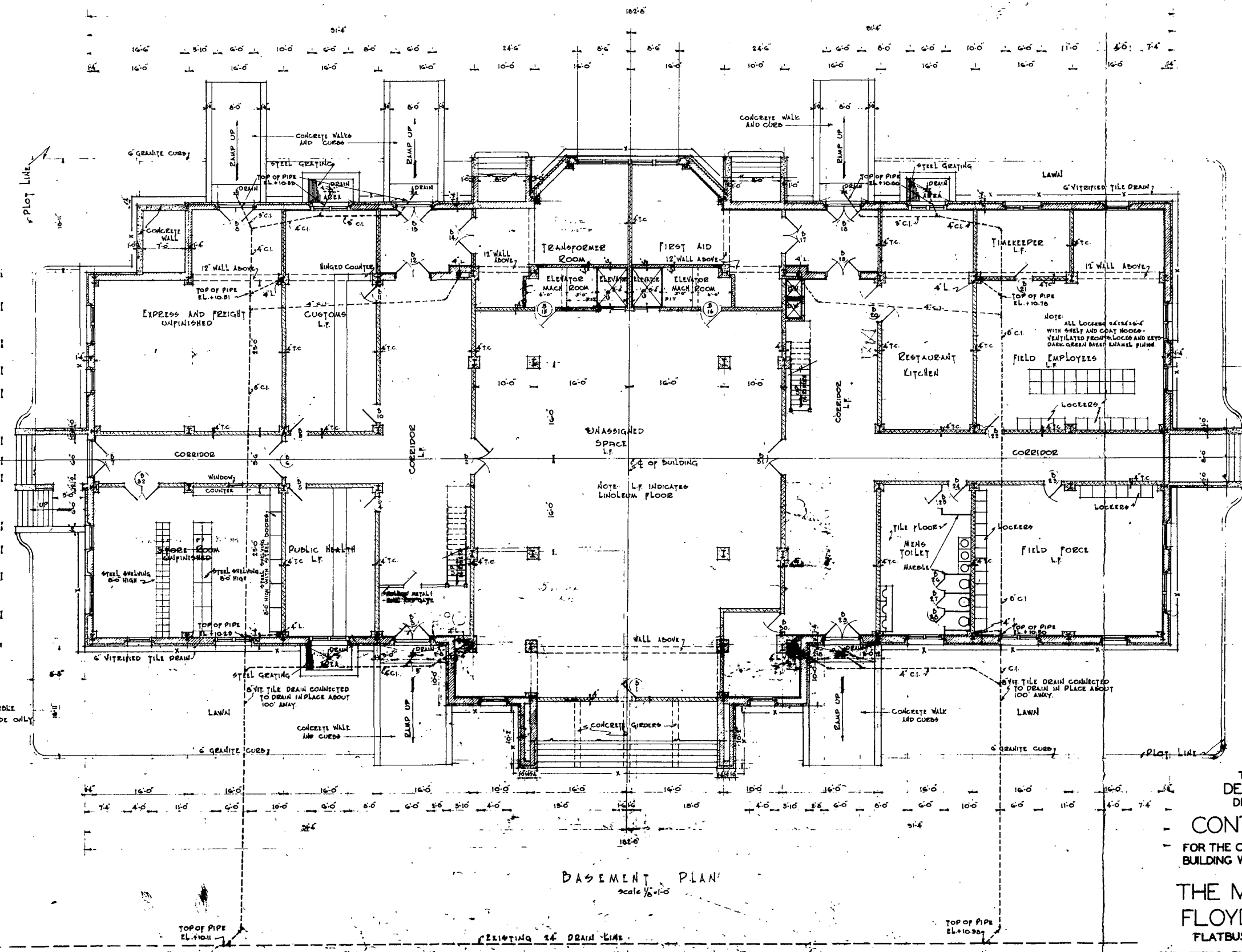
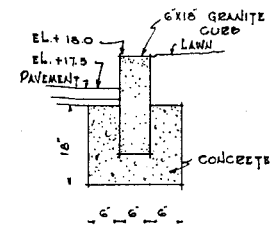

INDEX OF MATERIALS

[Symbol]	WOOD
[Symbol]	BRICK
[Symbol]	WHITE MARBLE
[Symbol]	GLASS SLAB NO. IN PLAN
[Symbol]	TERRA COTTA
[Symbol]	CONCRETE
[Symbol]	MARBLE WOOD IN SECTION

ON MICROFILM

BASEMENT PLAN
scale 1/8"=1'-0"

DRAWN BY H.F.M.S.L.
TRACED BY D.A.

THE CITY OF NEW YORK
DEPARTMENT OF DOCKS
DIVISION OF PORT PLANNING
CONTRACT NO. 2000
FOR THE CONSTRUCTION OF ADMINISTRATION
BUILDING WITH APPURTENANCES AT THE SITE
OF
THE MUNICIPAL AIRPORT
FLOYD BENNETT FIELD
FLATBUSH AVE. BOROUGH OF BROOKLYN
SUBMITTED BY *[Signature]* DIVISION ENGINEER
APPROVED BY *[Signature]* CHIEF ENGINEER
APPROVED BY *[Signature]* COMMISSIONER
DATE *[Signature]*

646/63038 5 of 17

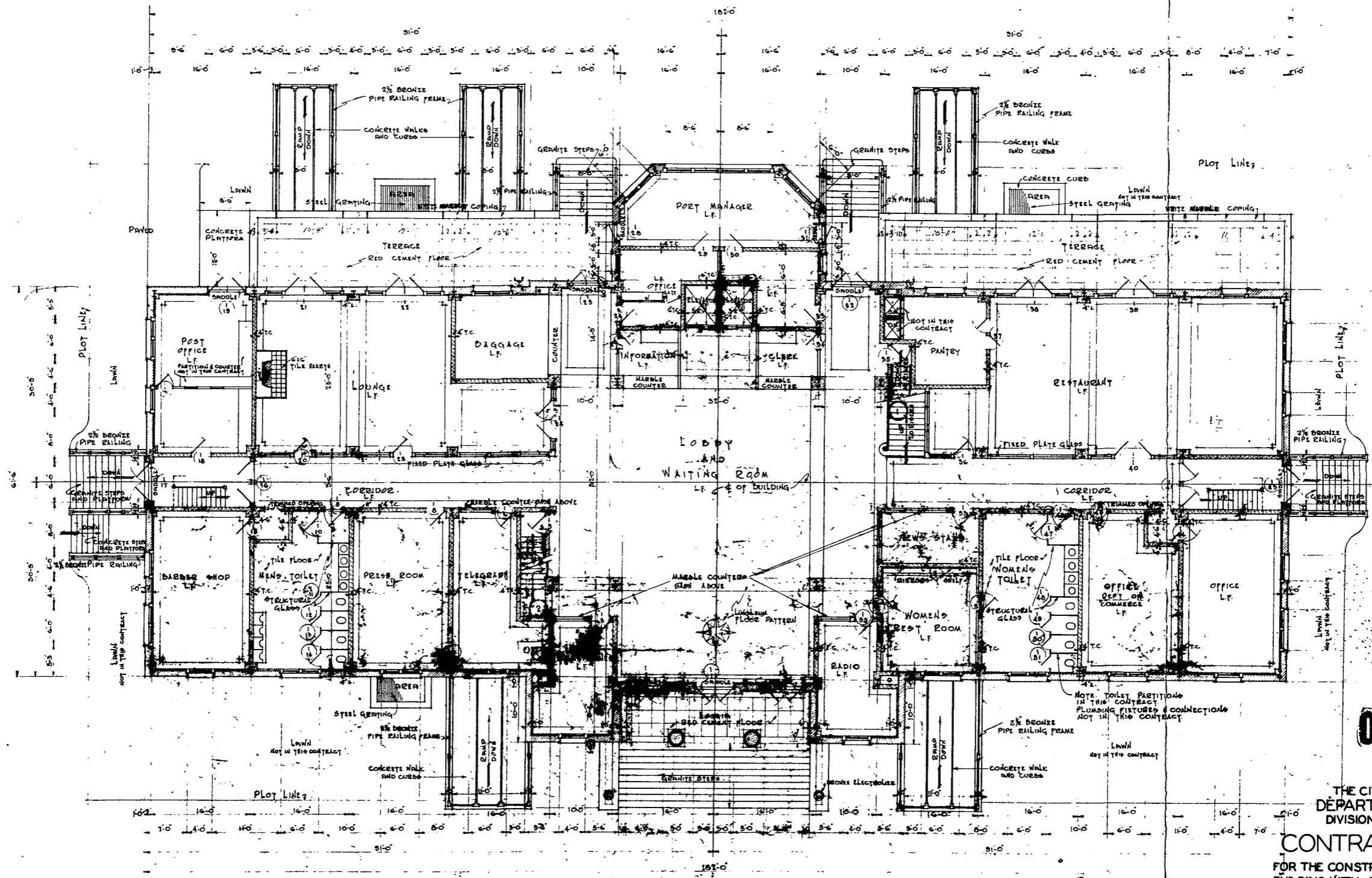

FIRST FLOOR PLAN
Scale 1/8" = 1'-0"

ON MICROFILM

THE CITY OF NEW YORK
 DEPARTMENT OF DOCKS
 DIVISION OF PORT PLANNING
 CONTRACT NO. 2000
 FOR THE CONSTRUCTION OF ADMINISTRATION
 BUILDING WITH APPURTENANCES AT THE SITE
 OF

THE MUNICIPAL AIRPORT
 FLOYD BENNETT FIELD
 FLATBUSH AVE, BOROUGH OF BROOKLYN.

SUBMITTED BY *[Signature]* DIVISION ENGINEER
 APPROVED BY *[Signature]* CHIEF ENGINEER
 APPROVED BY *[Signature]* CONTRACTOR

DRAWN BY W.H.M.L.
 TRACED BY D.S.

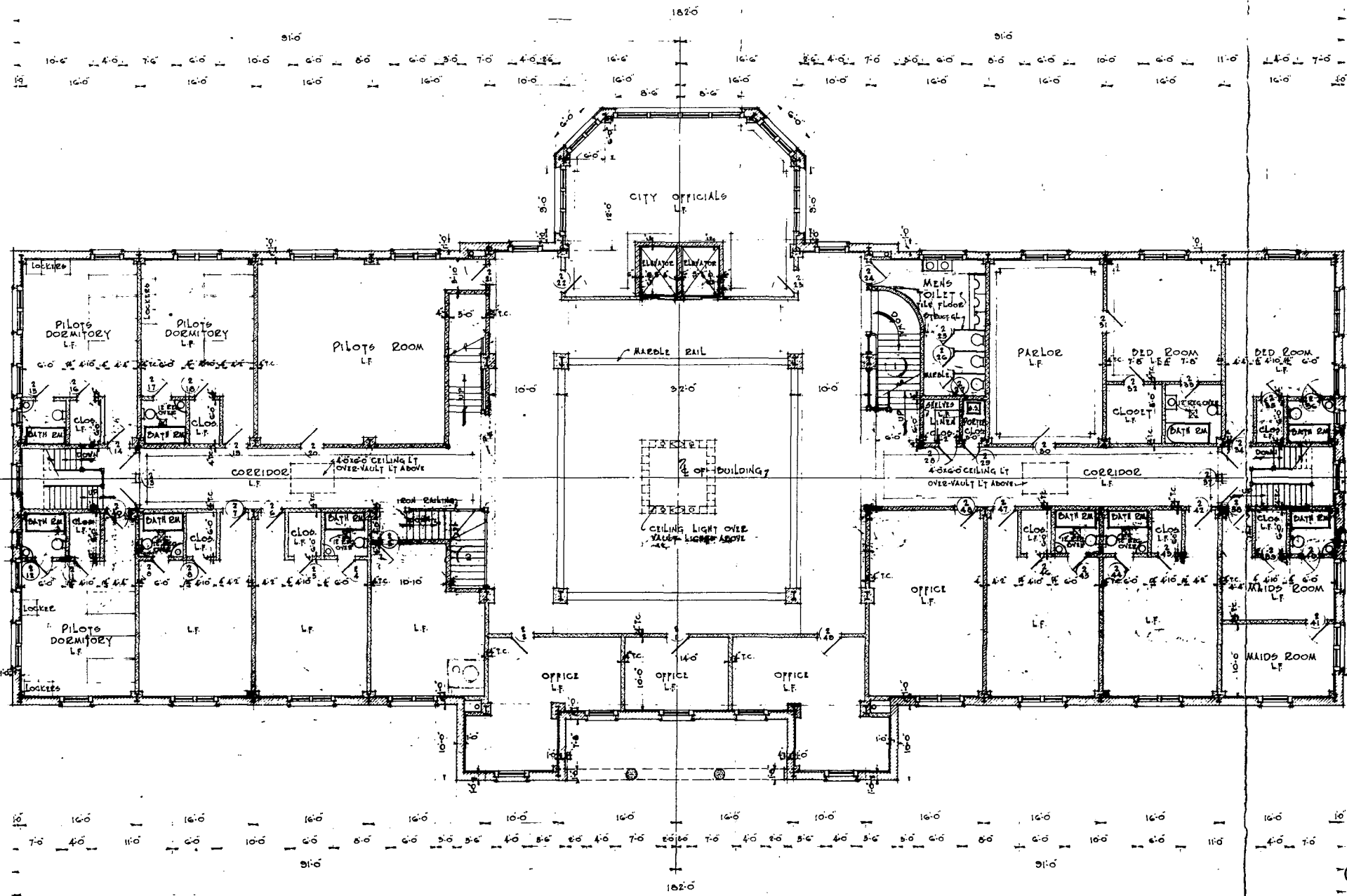

2ND FLOOR PLAN
Scale 1/8" = 1'-0"

ON MICROFILM

THE CITY OF NEW YORK
DEPARTMENT OF DOCKS
DIVISION OF PORT PLANNING

CONTRACT NO. 2000
FOR THE CONSTRUCTION OF ADMINISTRATION
BUILDING WITH APPURTENANCES AT THE SITE
OF

THE MUNICIPAL AIRPORT
FLOYD BENNETT FIELD
FLATBUSH AVE, BOROUGH OF BROOKLYN.

SUBMITTED BY *[Signature]* DIVISION ENGINEER
APPROVED BY *[Signature]* CHIEF ENGINEER
APPROVED BY *[Signature]* COMMISSIONER
DATE - Nov. 17, 1930.

64676303B

DRAWN BY H.F.M.L.P.O.A.
TRACED BY D.A.

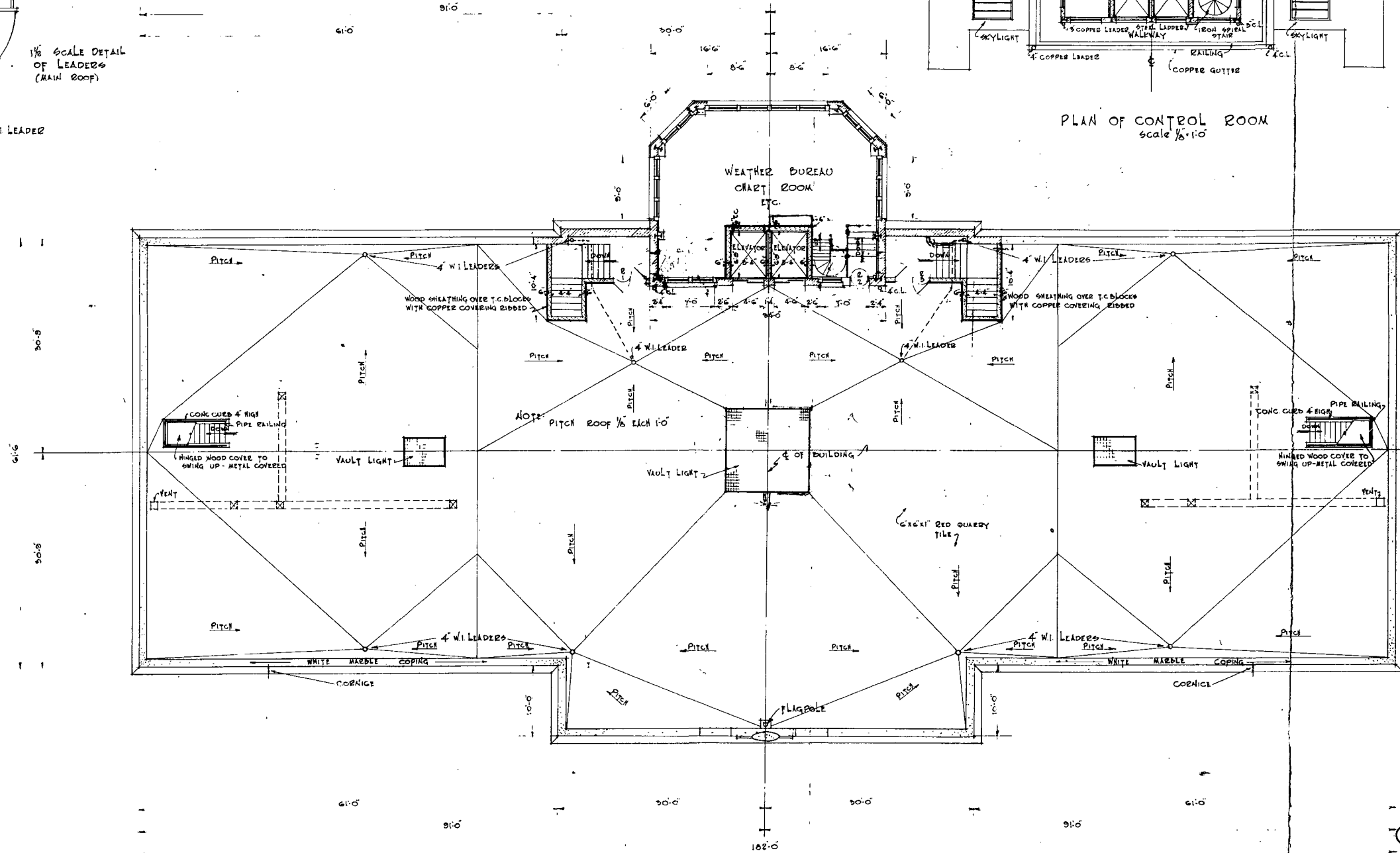
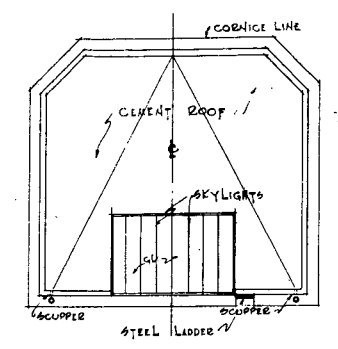
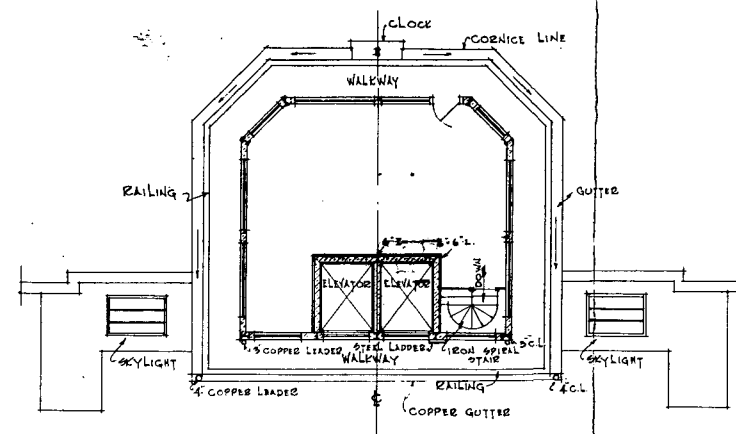
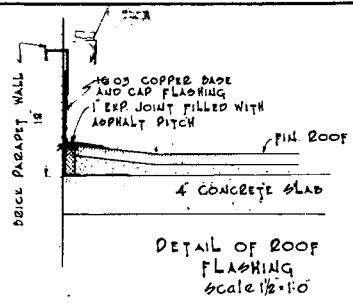
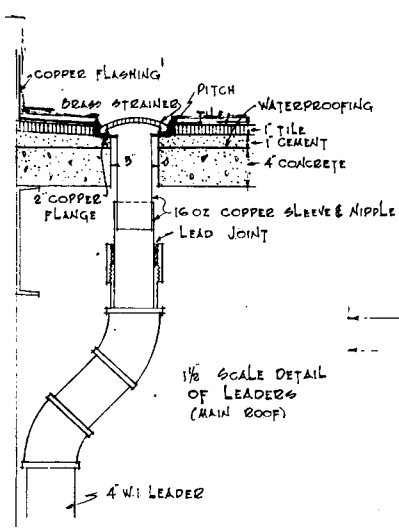

ROOF PLAN scale 1/8"=1'-0"

ON MICROFILM

THE CITY OF NEW YORK
 DEPARTMENT OF DOCKS
 DIVISION OF PORT PLANNING
 CONTRACT NO. 2000
 FOR THE CONSTRUCTION OF ADMINISTRATION
 BUILDING WITH APPURTENANCES AT THE SITE
 OF
 THE MUNICIPAL AIRPORT
 FLOYD BENNETT FIELD
 FLATBUSH AVE, BOROUGH OF BROOKLYN
 SUBMITTED BY *[Signature]* DIVISION ENGINEER
 APPROVED BY *[Signature]* CHIEF ENGINEER
 APPROVED BY *Michael Cosgrove* COMMISSIONER
 DATE - Nov. 7, 1930.

DRAWN BY H.F. MEL P.D.A.
TRACED BY D.A.

646/63038 8 of 17

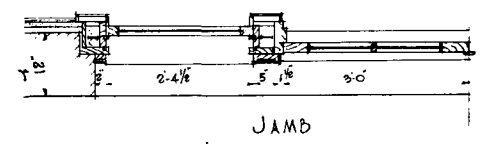
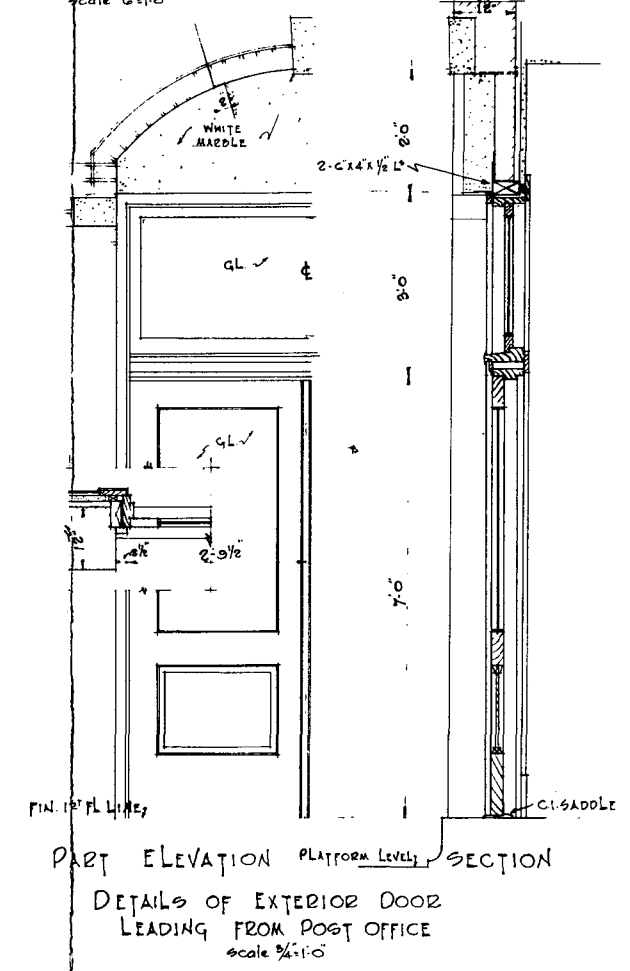
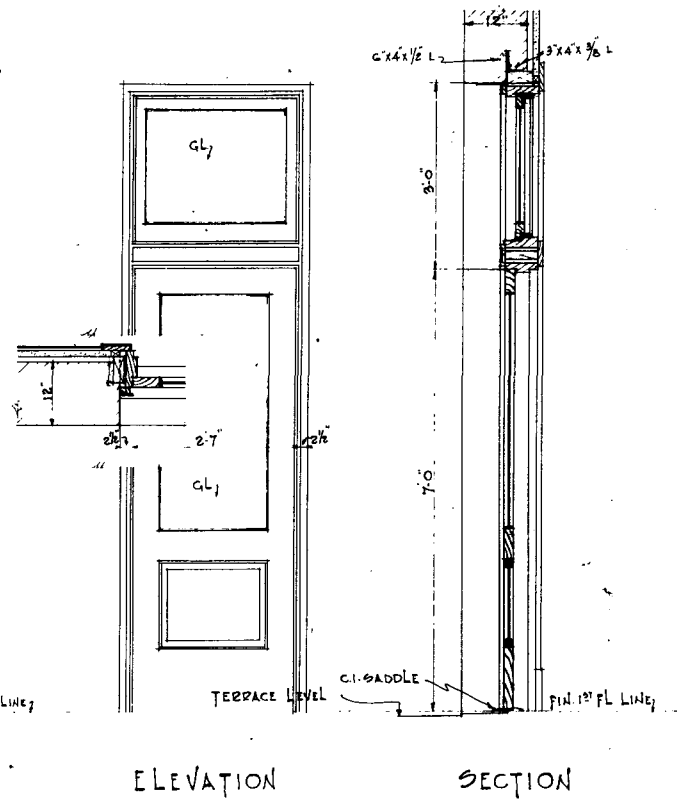
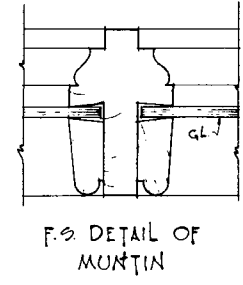
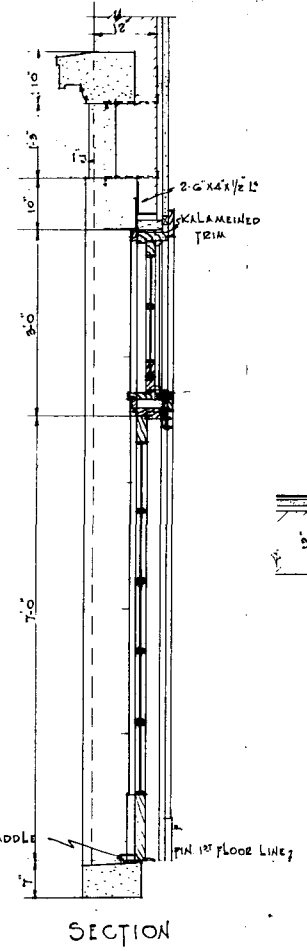
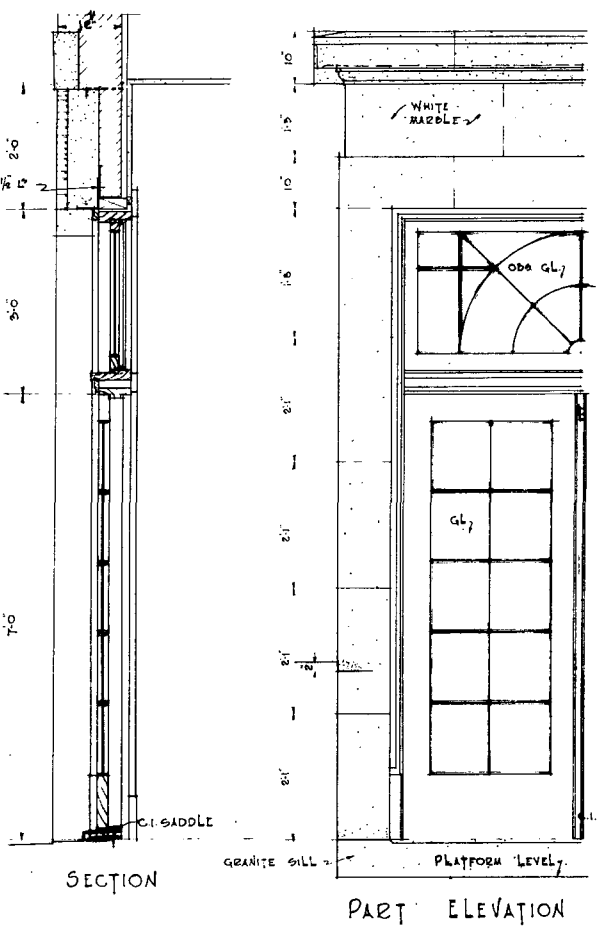
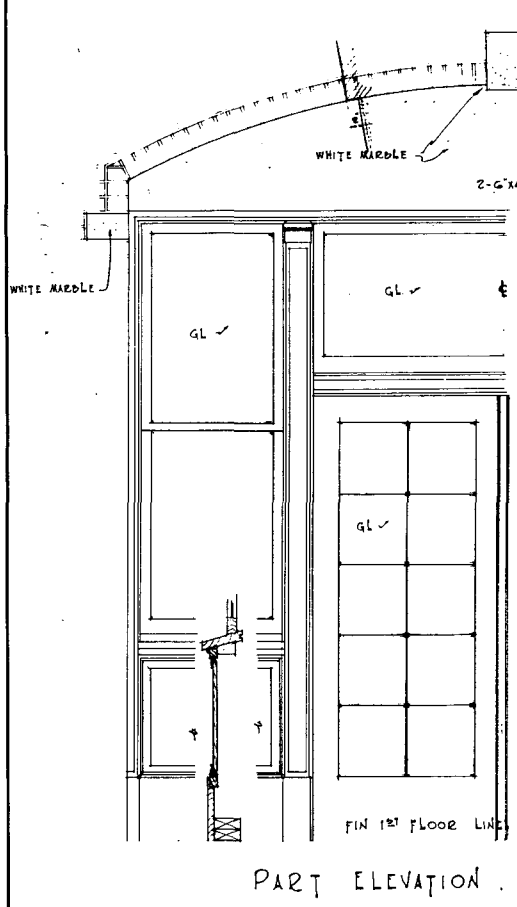
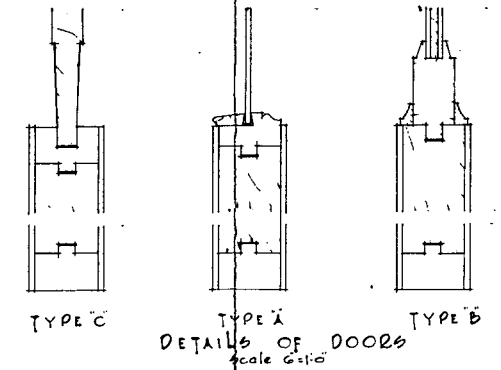
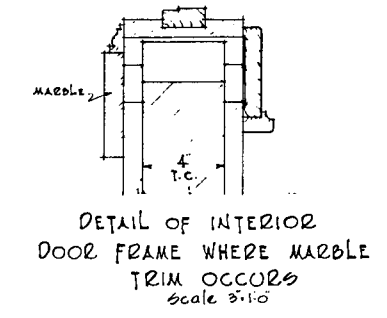
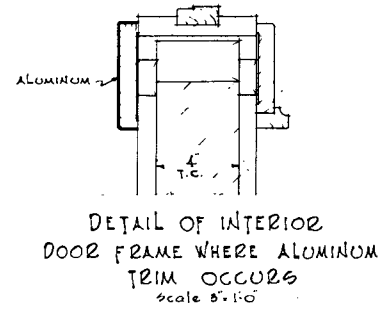
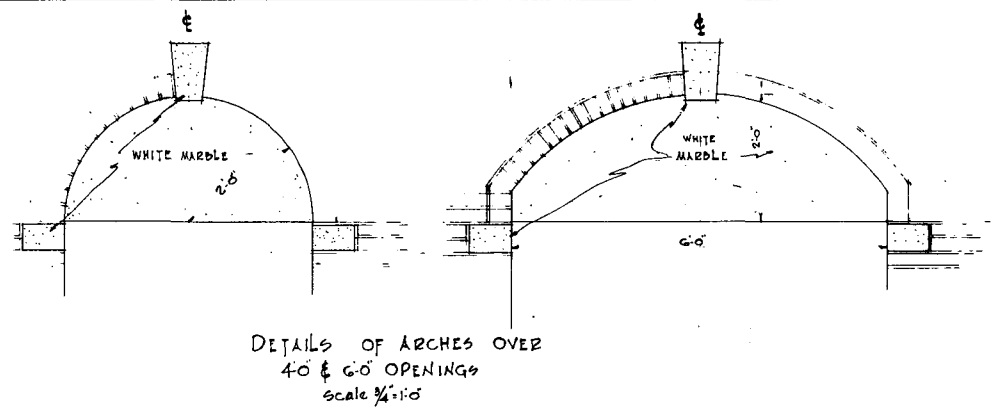

DETAIL OF DOORS & WINDOWS LEADING
FROM RESTAURANT & LOUNGE TO TERRACES
Scale 3/4"=1'-0"

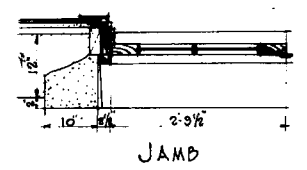

DETAILS OF EXTERIOR DOORS
AT NORTH & SOUTH EN OF BLDG
Scale 3/4"=1'-0"

DETAILS OF EXTERIOR DOORS LEADING
FROM PORT MANAGERS OFFICE TO TERRACES
Scale 3/4"=1'-0"

DRAWN BY: D.A.
TRACED BY: D.A.

ON MICROFILM

THE CITY OF NEW YORK
DEPARTMENT OF DOCKS
DIVISION OF PORT PLANNING
CONTRACT NO. 2000
FOR THE CONSTRUCTION OF ADMINISTRATION
BUILDING WITH APPURTENANCES AT THE SITE
OF
THE MUNICIPAL AIRPORT
FLOYD BENNETT FIELD
FLATBUSH AVE, BOROUGH OF BROOKLYN
SUBMITTED BY: *[Signature]* DIVISION ENGINEER
APPROVED BY: *[Signature]* CHIEF ENGINEER
APPROVED BY: *Michael Casgrove* COMMISSIONER
DATE - Nov. 17, 1930.

6646/63038 9 of 17

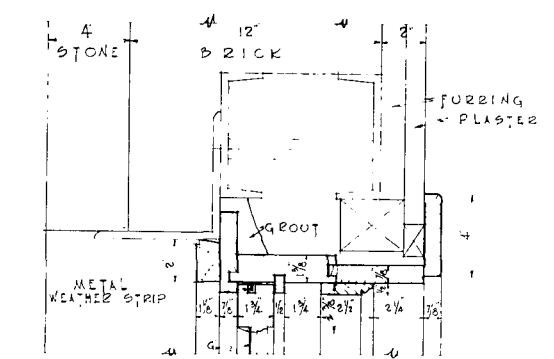

HEAD

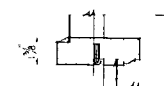

MEETING RAILS

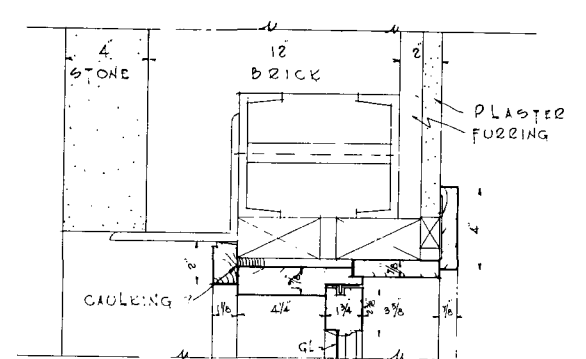

HEAD

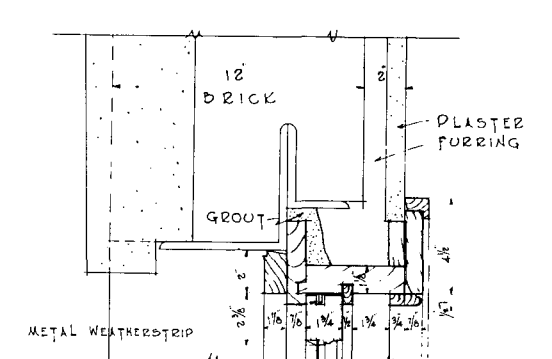

HEAD

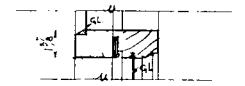

MEETING RAILS

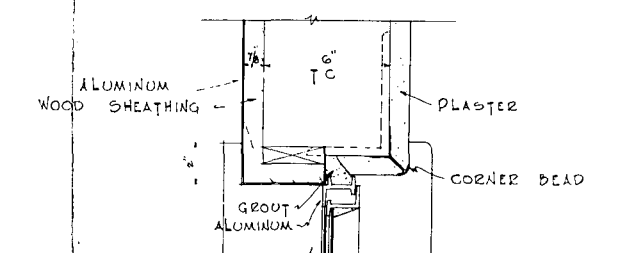

JAMB HEAD SIMILAR

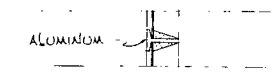

MUNTIN

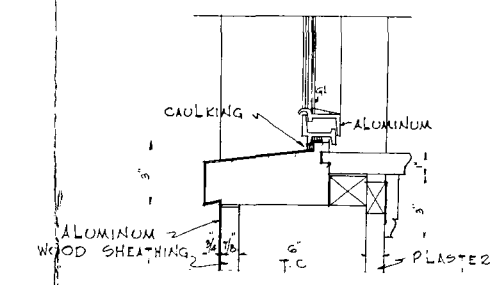

SILL
SECTIONS THRU ALUMINUM WINDOWS
IN CONTROL ROOM
Scale 3/16"

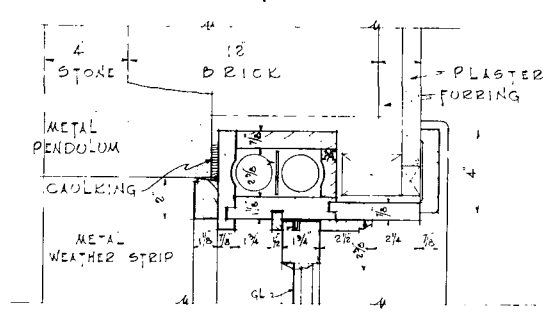

JAMB

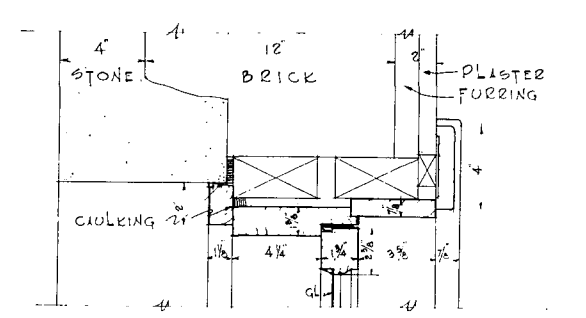

JAMB

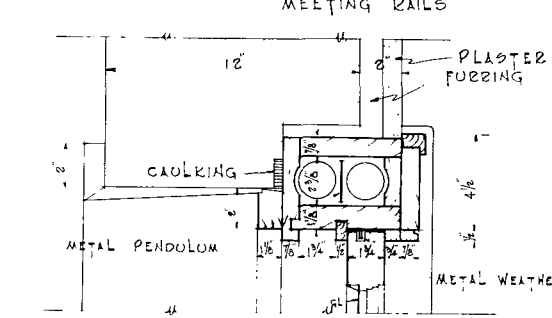

JAMB

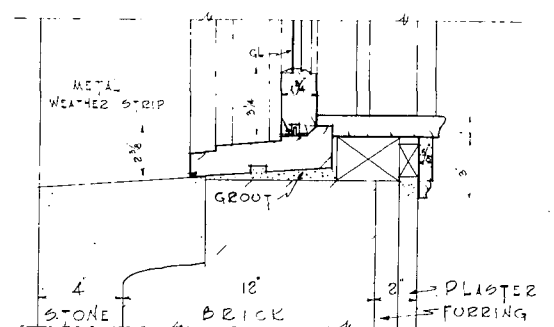

SILL

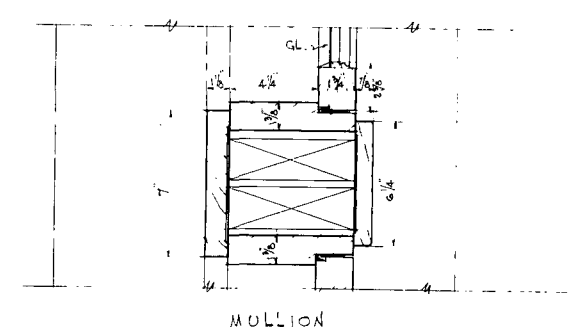

MULLION

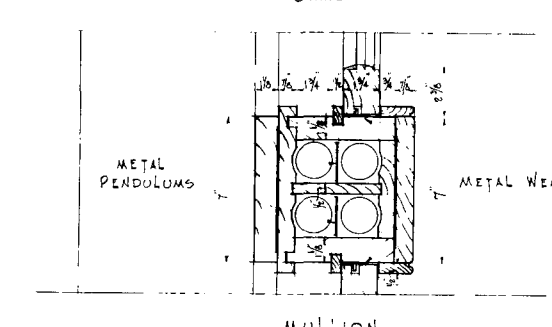

MULLION

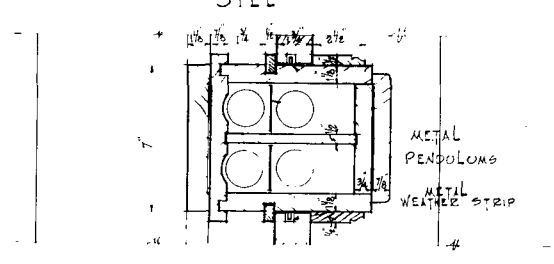

MULLION

SECTIONS THRU DOUBLE HUNG
WINDOWS IN BASEMENT
Scale 3/16"

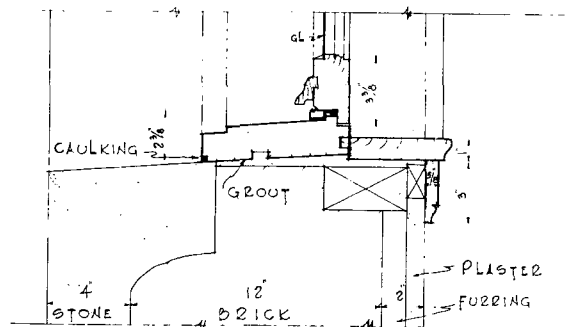

SILL

SECTIONS THRU HINGED
WINDOWS IN BASEMENT
Scale 3/16"

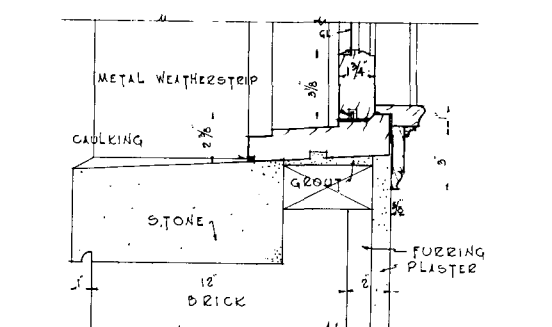

SILL

SECTIONS THRU DOUBLE HUNG
WINDOW IN 12" WALL
Scale 3/16"

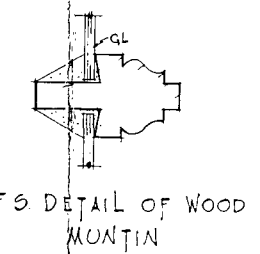

FS DETAIL OF WOOD
MUNTIN

ON MICROFILM

THE CITY OF NEW YORK
DEPARTMENT OF DOCKS
DIVISION OF PORT PLANNING
CONTRACT NO. 2000
FOR THE CONSTRUCTION OF ADMINISTRATION
BUILDING WITH APPURTENANCES AT THE SITE
OF
THE MUNICIPAL AIRPORT
FLOYD BENNETT FIELD
FLATBUSH AVE BOROUGH OF BROOKLYN
SUBMITTED BY [Signature] DIVISION ENGINEER
APPROVED BY [Signature] CHIEF ENGINEER
APPROVED BY Michael Casgrave COMMISSIONER
DATE - Nov. 17, 1930.

DRAWN BY D.A.
TRACED BY D.A.

6046/6303B

10 of 17

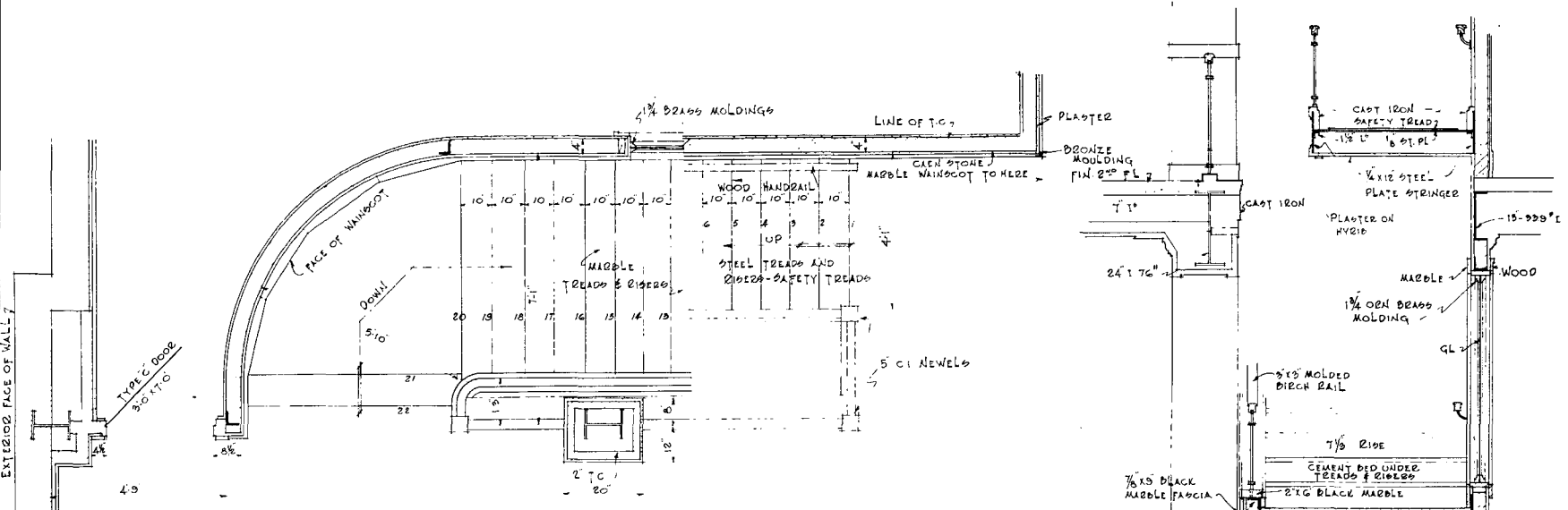

PLAN OF STAIR NO. 1 AT 2ND FLOOR LEVEL
Scale 1/8"=1'-0"

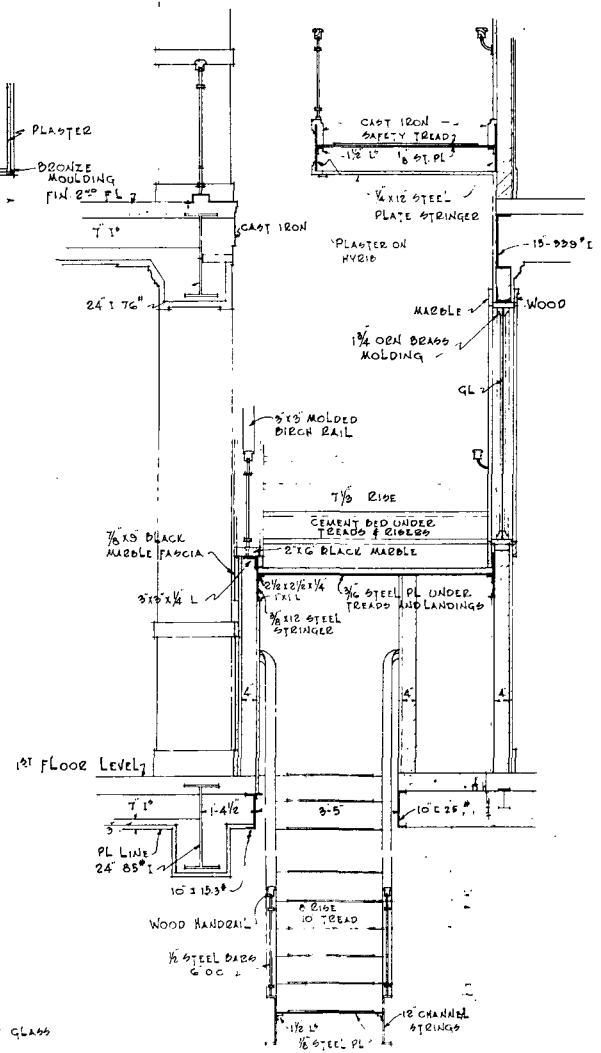

SECTION THRU STAIR NO. 1
Scale 1/8"=1'-0"
STAIR NO. 2 OF SIMILAR CONSTRUCTION

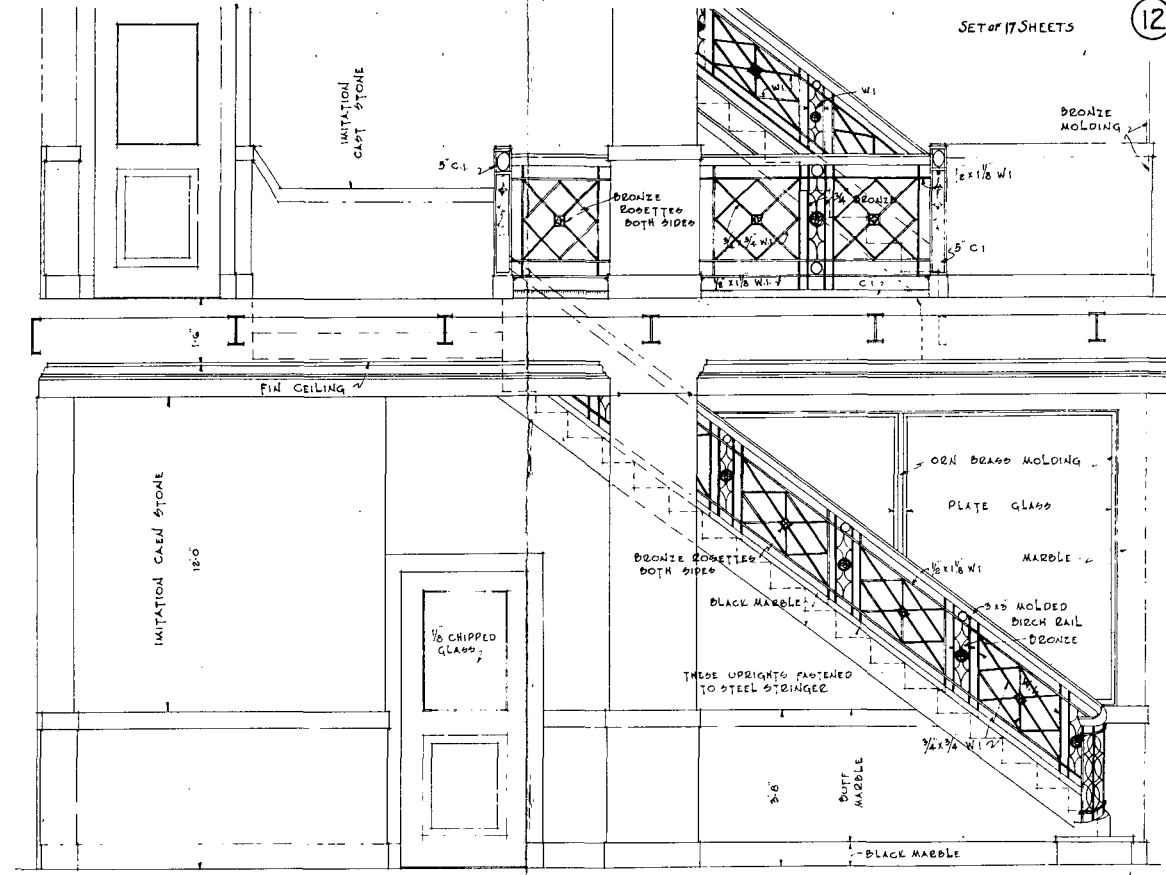

SIDE ELEVATION OF STAIR NO. 1 AT 1ST & 2ND FLOORS
Scale 1/8"=1'-0"

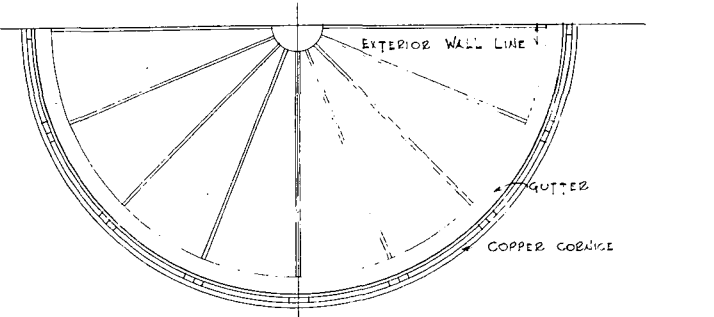

PLAN

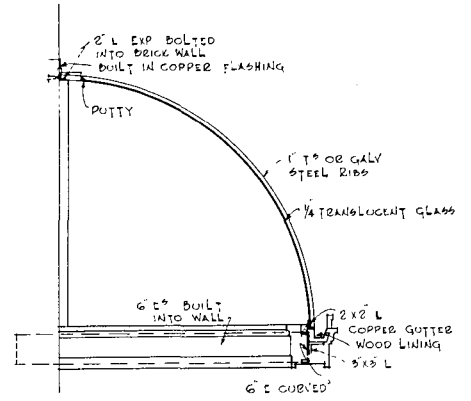

SECTION

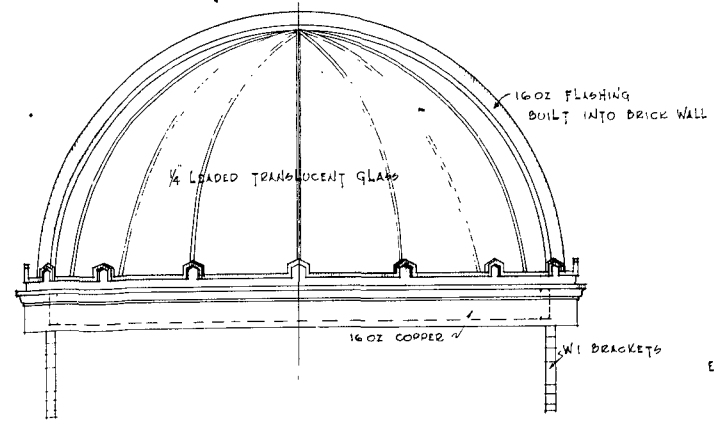

FRONT ELEVATION

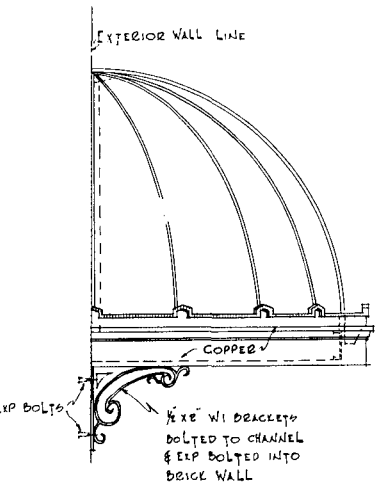

SIDE ELEVATION

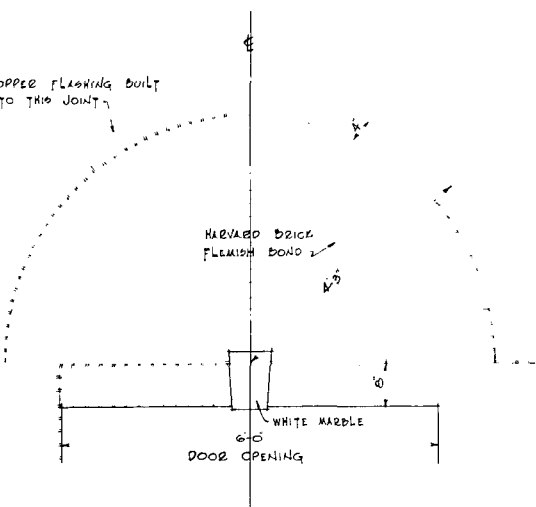

ELEVATION OF BRICKWORK OVER DOORS 25 AND 32
Scale 3/4"=1'-0"

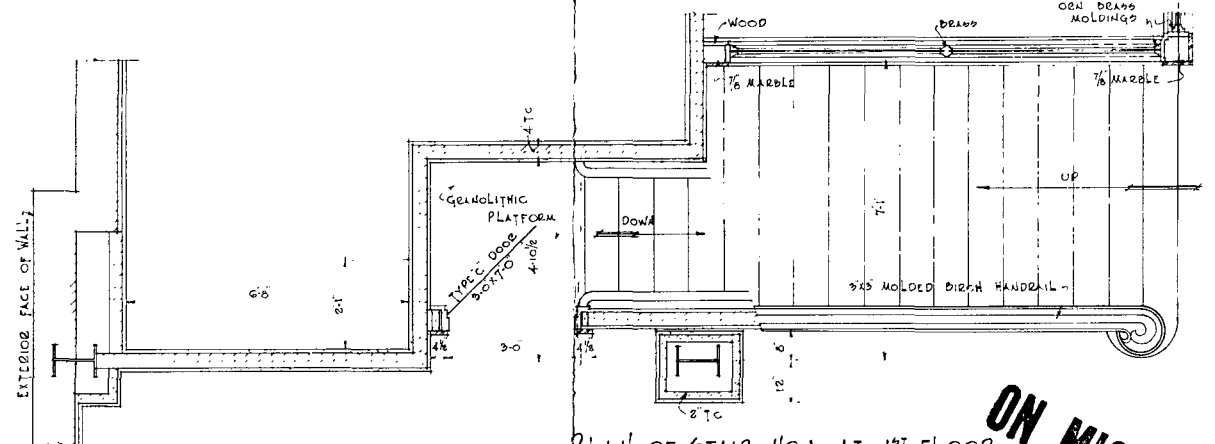

PLAN OF STAIR NO. 1 AT 1ST FLOOR
STAIR NO. 2 OF SIMILAR CONSTRUCTION
Scale 1/8"=1'-0"

DRAWN BY H.F.M.S.
TRACED BY D.A.

DETAILS OF MARQUESE OVER DOORS NO. 25 & NO. 32
Scale 3/4"=1'-0"

ON MICROFILM

THE CITY OF NEW YORK
DEPARTMENT OF DOCKS
DIVISION OF PORT PLANNING
CONTRACT NO. 2000
FOR THE CONSTRUCTION OF ADMINISTRATION
BUILDING WITH APPURTENANCES AT THE SITE
OF
**THE MUNICIPAL AIRPORT
FLOYD BENNETT FIELD**
FLATBUSH AVE BOROUGH OF BROOKLYN
SUBMITTED BY *[Signature]* DIVISION ENGINEER
APPROVED BY *[Signature]* CHIEF ENGINEER
APPROVED BY *[Signature]* COMMISSIONER
DATE - Nov. 17, 1930.

64

COLUMN FOOTING SCHEDULE

SET OF 17 SHEETS (13)

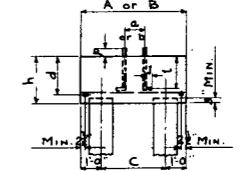

UNDER COL. NO.	FOOTING DIMENSIONS		PILES		ANCHOR BOLTS		REINFORCEMENT PERPENDICULAR		ELEVATION TOP OF FOOTING
	A or B	h	NUMBER	C	NUMBER	P	TO SIDE A	TO SIDE B	
1 & 51	5'-0"	2'-6"	4	3'-0"	4	3/8"	6-1" Rods	6-1" Rods	2'-1"
2 & 52	2'-0"	2'-6"	2		2	1/2"			1'-8"
3 & 53	2'-0"	2'-6"	2		2	1/2"			1'-8"
4 & 54	2'-0"	2'-6"	2		2	1/2"			1'-8"
5 & 41	2'-0"	2'-6"	2		2	1/2"			1'-8"
6 & 48	2'-0"	2'-6"	2		2	1/2"			1'-8"
7 & 49	2'-0"	2'-6"	2		2	1/2"			1'-8"
8 & 50	2'-0"	2'-6"	2		2	1/2"			1'-8"
9 & 43	2'-0"	2'-6"	2		2	1/2"			1'-8"
10 & 44	2'-0"	2'-6"	2		2	1/2"			1'-8"
11 & 45	2'-0"	2'-6"	2		2	1/2"			1'-8"
12 & 46	2'-0"	2'-6"	2		2	1/2"			1'-8"
13 & 31	2'-0"	2'-6"	2		2	1/2"			1'-8"
14 & 40	2'-0"	2'-6"	2		2	1/2"			1'-8"
15 & 41	2'-0"	2'-6"	2		2	1/2"			1'-8"
16 & 42	2'-0"	2'-6"	2		2	1/2"			1'-8"
17 & 55	2'-0"	2'-6"	2		2	1/2"			1'-8"
18 & 36	2'-0"	2'-6"	2		2	1/2"			1'-8"
19 & 37	2'-0"	2'-6"	2		2	1/2"			1'-8"
20 & 38	2'-0"	2'-6"	2		2	1/2"			1'-8"
21 & 25	2'-0"	2'-6"	2		2	1/2"			1'-8"
22 & 30	2'-0"	2'-6"	2		2	1/2"			1'-8"
23 & 31	2'-0"	2'-6"	2		2	1/2"			1'-8"
24 & 32	2'-0"	2'-6"	2		2	1/2"			1'-8"
25 & 33	2'-0"	2'-6"	2		2	1/2"			1'-8"
26 & 34	2'-0"	2'-6"	2		2	1/2"			1'-8"
27 & 28	2'-0"	2'-6"	2		2	1/2"			1'-8"

FOR GENERAL DIMENSIONS UNDER COLUMNS NO. 14, 30, 12, 13, 16, 17, 35, 39, 42, 43, 46, 47, 50, 51 & 54 SEE COL. NO. 1 ON PLAN.
 6, 7, 10, 11, 14, 15, 18, 19, 20, 36, 37, 38, 40, 41, 44, 45, 48 & 49
 2, 3, 52 & 53 SEE COL. NO. 2 ON PLAN.
 21, 27, 28 & 29
 22, 26, 30 & 34
 23, 24, 25, 31, 32 & 33

WALL FOOTING SCHEDULE

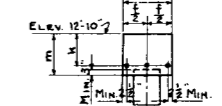

MARK	IDENTIFICATION MARK	REINFORCEMENT
WF-1	2'-4" x 2'-3" x 1'-11"	3-1" Rods
WF-2	" " " " " "	" " " "
WF-3	" " " " " "	" " " "
WF-4	" " " " " "	" " " "
WF-5	" " " " " "	3-3/4" Rods
WF-6	" " " " " "	" " " "
F-1	4'-4" x 1'-6" x 1'-2"	5-1" Rods
F-2	2'-4" x " " " "	3-3/4" Rods
F-3	" " " " " "	" " " "
F-4	2'-0" x 1'-0" x 8"	" " " "
F-5	" " " " " "	" " " "
F-6	" " " " " "	" " " "

NOTE: IDENTIFICATION MARKS WF-1, WF-2, ETC., DENOTE MAIN WALL FOOTINGS.
 F-1, F-2, ETC., MISCELLANEOUS

ON MICROFILM

GENERAL NOTE:
 REINFORCING RODS SHALL BE GOOD DEFORMED RODS CONFORMING TO THE REQUIREMENTS OF THE SPECIFICATIONS FOR BILLET-STEEL CONCRETE REINFORCEMENT BARS OF THE AMERICAN SOCIETY FOR TESTING MATERIALS.
 REINFORCE ALL CONCRETE WALLS ON EARTH SIDE WITH PLAIN 1/2" VERTICAL RODS SPACED 12" ON CENTERS, PLACED AT LEAST 1" FROM FACE OF WALL AND IMBEDDED 6" FROM TOP OF FOOTING; PROVIDE PLAIN 1/2" HORIZONTAL TEMPERATURE RODS SPACED 18" ON CENTERS.

THE CITY OF NEW YORK
 DEPARTMENT OF DOCKS
 DIVISION OF PORT PLANNING
 CONTRACT NO. 2000
 FOR THE CONSTRUCTION OF ADMINISTRATION
 BUILDING WITH APPURTENANCES AT THE SITE
 OF
 THE MUNICIPAL AIRPORT
 FLOYD BENNETT FIELD
 FLATBUSH AVE. BOROUGH OF BROOKLYN

SUBMITTED BY *[Signature]* DIVISION ENGINEER
 APPROVED BY *[Signature]* CHIEF ENGINEER
 APPROVED BY *Michael Cosgrove* COMMISSIONER
 DATE - Nov. 17, 1930.

55

646/63038 13 of 17

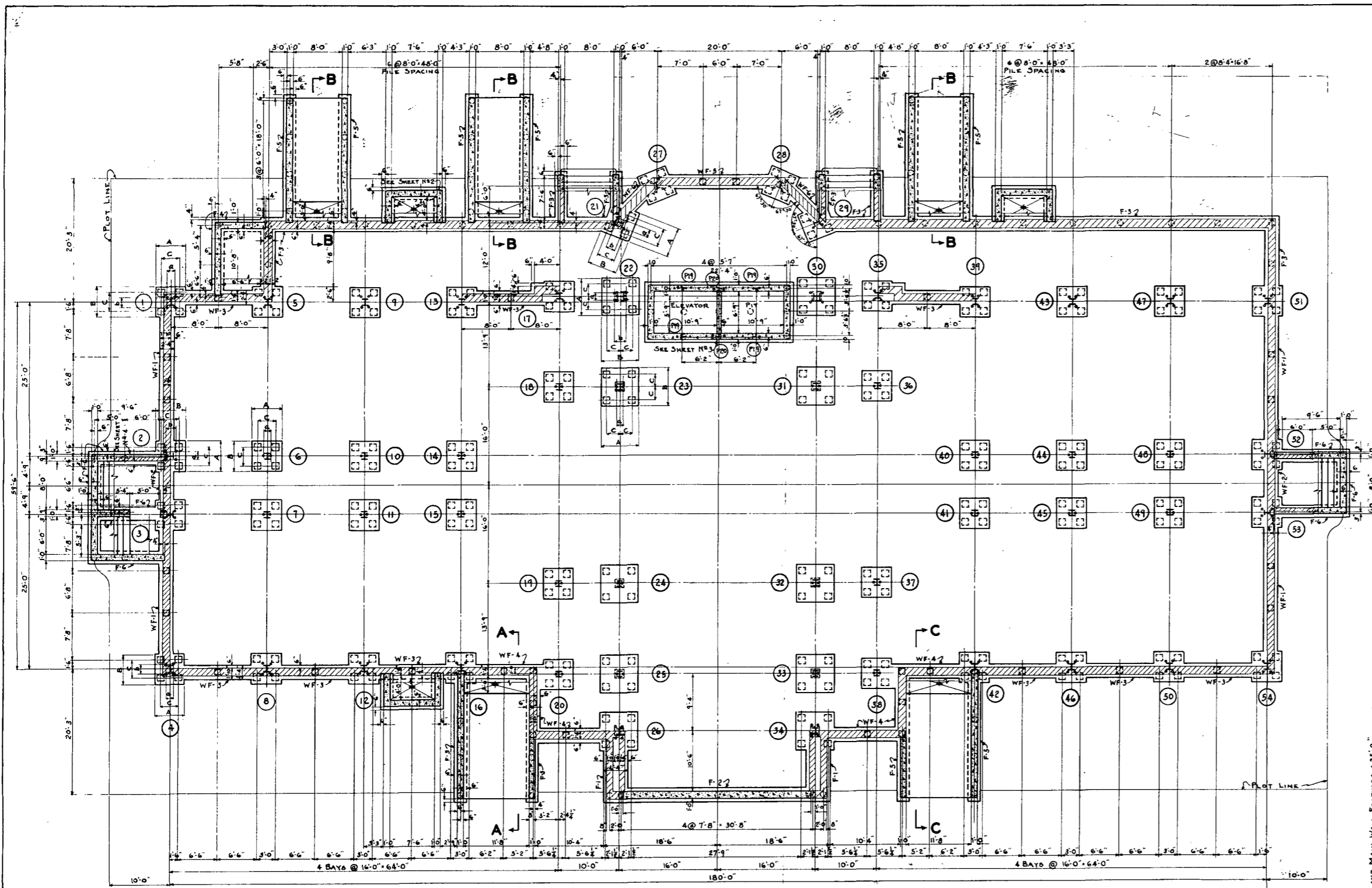

FOUNDATION PLAN

□ DENOTES CONCRETE PILES.
 ○ DENOTES WOODEN PILES.
 NOTE: WALL FOOTINGS SHALL HAVE THEIR REINFORCEMENT IMBEDDED A DISTANCE OF 6" INTO COLUMN OR OTHER WALL FOOTINGS WHICH THEY MAY JOIN.
 SCALE: 1/4" = 1'-0"

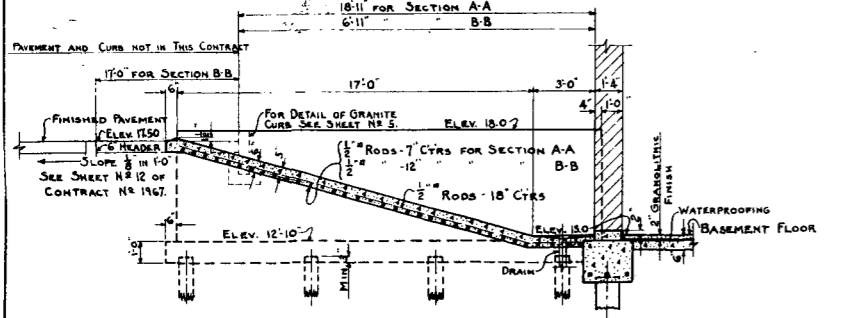

DRWN. BY W.H.
 TRACED BY W.H.

SECTION A-A & B-B AS SHOWN & NOTED.
 CC OPP. HAND TO SECTION A-A
 SCALE: 1/4" = 1'-0"

ELEVATION OF REINFORCED CONCRETE PILES
 OR EQUIVALENT - SEE SPECIFICATIONS.
 SCALE: 1/4" = 1'-0"

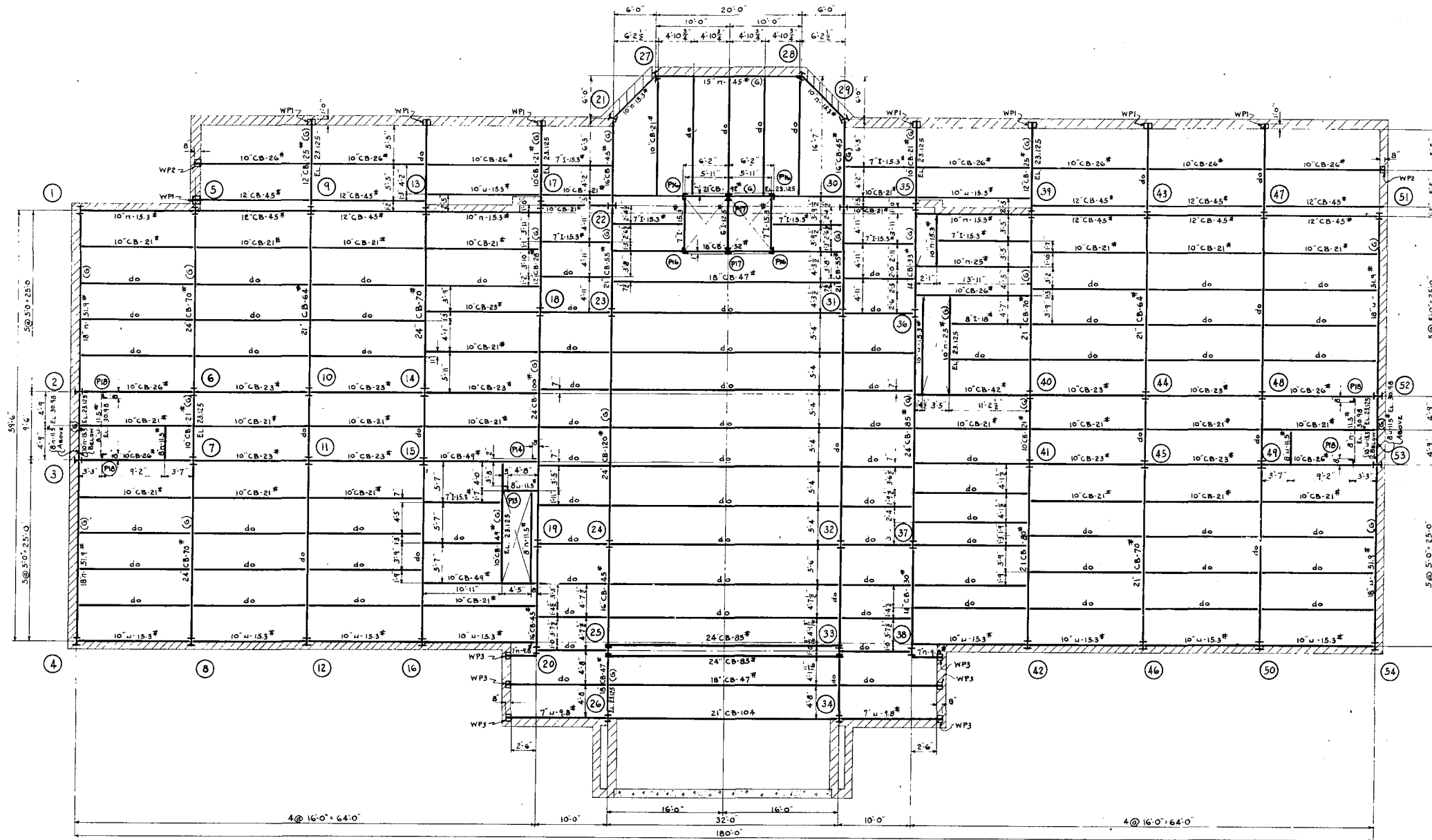

FIRST FLOOR STEEL FRAMING PLAN

NOTE: ELEVATION TOP OF GIRDER STEEL, MARKED (G), TO BE 23.29, UNLESS OTHERWISE NOTED
 " " BEAM " NOT MARKED " 23.125
 SIZE OF WALL BEARINGS, STEEL PLATES MARKED WPL 12" x 12" x 3/4"
 " " " " " WPL 8" x 12" x 3/4"
 " " " " " WPL 8" x 8" x 5/8"
 ALL RIVETS 3/4" φ, HOLES 13/16" φ, UNLESS OTHERWISE NOTED.

ON MICROFILM

THE CITY OF NEW YORK
 DEPARTMENT OF DOCKS
 DIVISION OF PORT PLANNING
 CONTRACT NO. 2000
 FOR THE CONSTRUCTION OF ADMINISTRATION
 BUILDING WITH APPURTENANCES AT THE SITE
 OF
 THE MUNICIPAL AIRPORT
 FLOYD BENNETT FIELD
 FLATBUSH AVE BOROUGH OF BROOKLYN
 SUBMITTED BY *[Signature]* DIVISION ENGINEER
 APPROVED BY *[Signature]* CHIEF ENGINEER
 APPROVED BY *[Signature]* COMMISSIONER
 DATE - Nov. 17, 1930. 6A16/63038 14 of 17

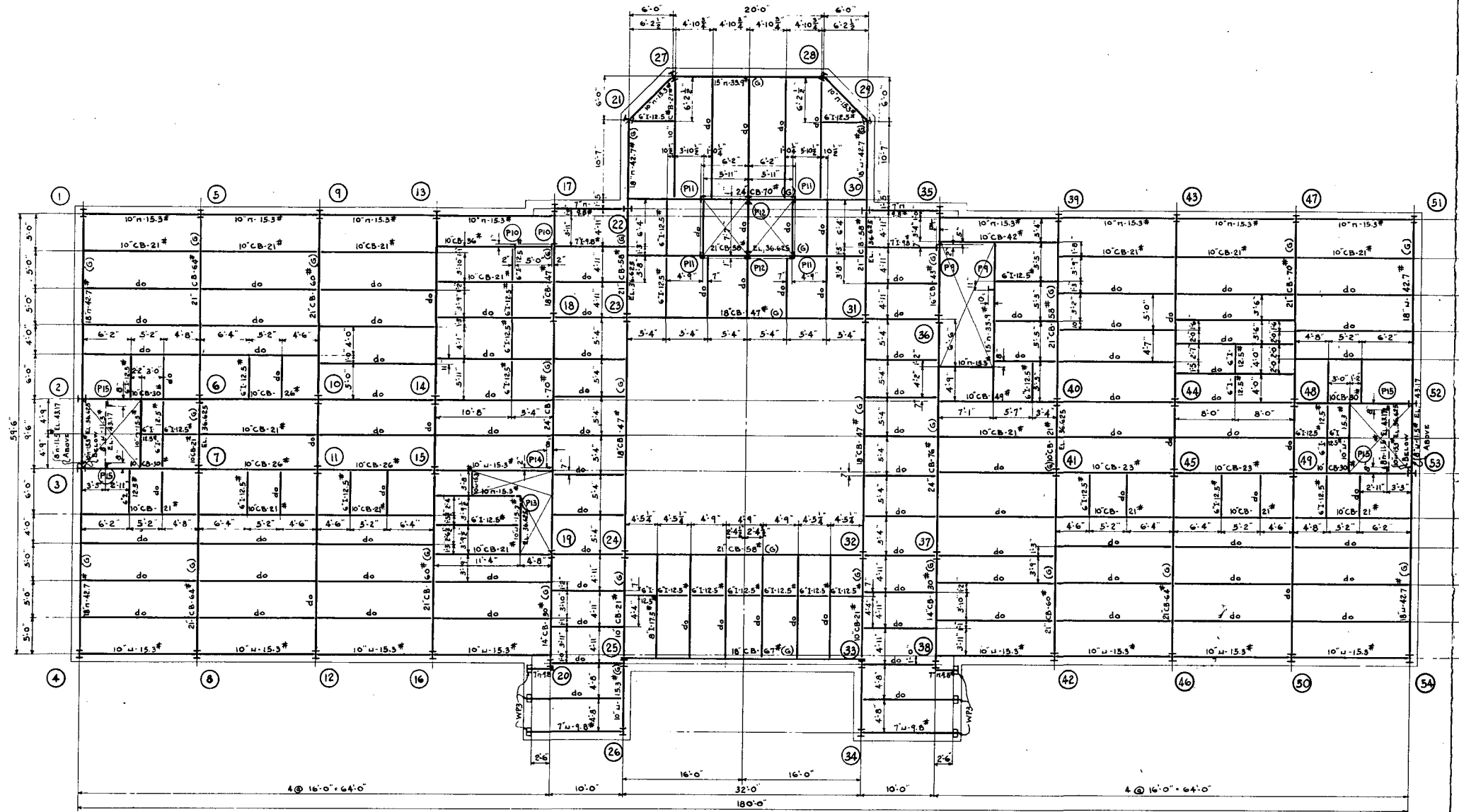

SECOND FLOOR FRAMING PLAN

NOTE: ELEVATION TOP OF GIRDER STEEL MARKED (G) TO BE 36.792, UNLESS OTHERWISE NOTED.
 BEAM (NOT MARKED) " 36.625,
 SIZE OF WALL PLATES MARKED WP3 - 8" x 8" x 1/2"
 ALL RIVETS 3/4", HOLES 13/16", UNLESS OTHERWISE NOTED.

ON MICROFILM

THE CITY OF NEW YORK
 DEPARTMENT OF DOCKS
 DIVISION OF PORT PLANNING

CONTRACT NO. 2000
 FOR THE CONSTRUCTION OF ADMINISTRATION
 BUILDING WITH APPURTENANCES AT THE SITE
 OF

THE MUNICIPAL AIRPORT
 FLOYD BENNETT FIELD

FLATBUSH AVE, BOROUGH OF BROOKLYN
 SUBMITTED BY *[Signature]* DIVISION ENGINEER
 APPROVED BY *[Signature]* CHIEF ENGINEER
 APPROVED BY *Michael Cosgrave* COMMISSIONER
 DATE - Nov. 17, 1930.

646/63038 15 of 17

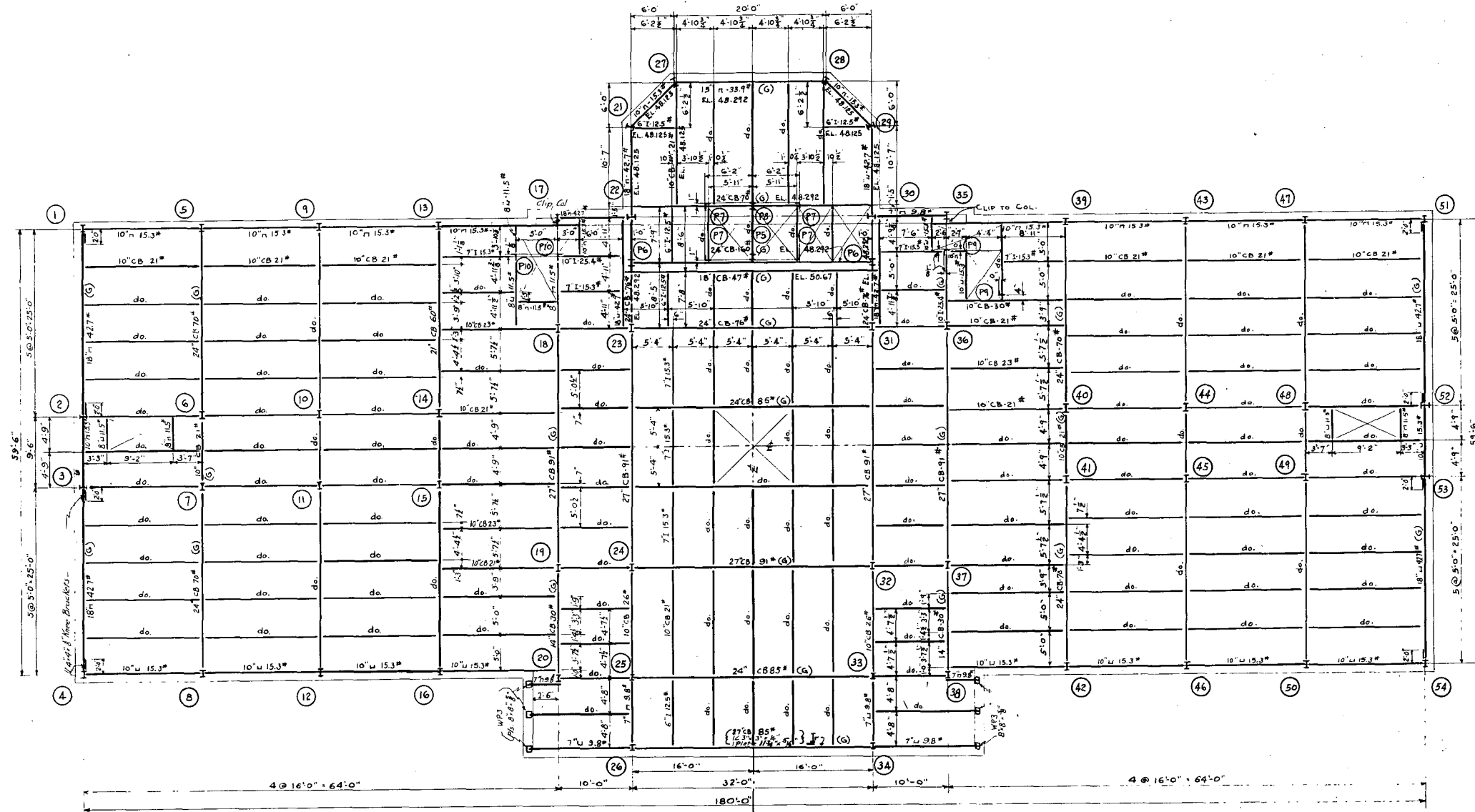

ROOF & THIRD FLOOR FRAMING PLAN.
 NOTE: ELEVATION TOP OF GIRDER STEEL MARKED (G) TO EXTEND 2 1/2" INTO CONCRETE.
 BEAM (NOT MARKED) 59425.
 SIZE OF WALL PLATES MARKED WP3 - 8" x 8" x 5/8".
 ALL RIVETS 3/4", HOLES 13/16", UNLESS OTHERWISE NOTED.

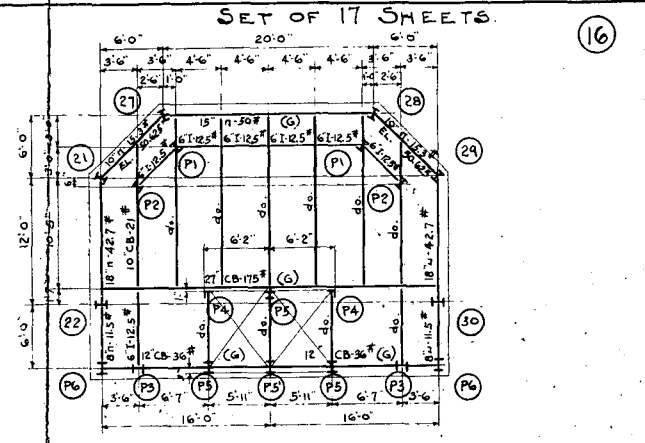
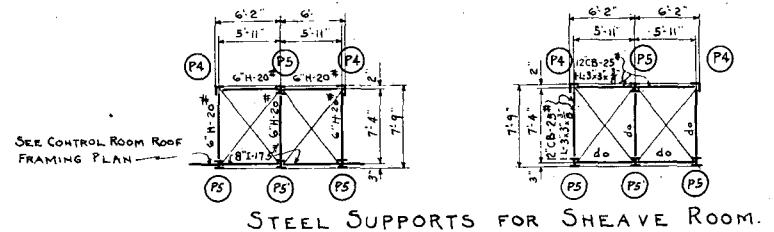

CONTROL ROOM FLOOR FRAMING PLAN.
 NOTE: ELEVATION TOP OF GIRDER STEEL MARKED (G) TO BE 59772, UNLESS OTHERWISE NOTED.
 BEAM (NOT MARKED) 59425.

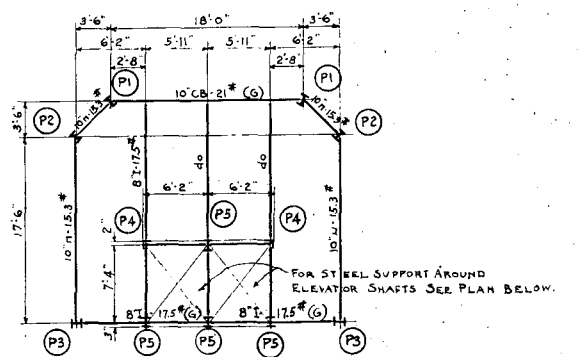

CONTROL ROOM ROOF FRAMING PLAN.
 NOTE: ELEVATION TOP OF GIRDER STEEL MARKED (G) TO BE 71208.
 BEAM NOT MARKED 71042.

ON MICROFILM

THE CITY OF NEW YORK
 DEPARTMENT OF DOCKS
 DIVISION OF PORT PLANNING

CONTRACT NO. 2000
 FOR THE CONSTRUCTION OF ADMINISTRATION BUILDING WITH APPURTENANCES AT THE SITE OF
 THE MUNICIPAL AIRPORT
 FLOYD BENNETT FIELD
 FLATBUSH AVE. BOROUGH OF BROOKLYN

SUBMITTED BY *[Signature]* DIVISION ENGINEER
 APPROVED BY *[Signature]* CHIEF ENGINEER
 APPROVED BY *[Signature]* COMMISSIONER
 DATE - Nov. 17, 1930.

438

646/63038 16 of 17

CONTROL ROOM ROOF EL. +71.57

CONTROL ROOM FLOOR EL. +60.07

TOP OF MAIN ROOF STEEL GIRDERS EL. +50.837

3RD FLOOR EL. +48.57

2ND FLOOR EL. +37.07

1ST FLOOR EL. +23.57

FINISHED PAVEMENT EL. +15.07

BSMT. FLOOR EL. +13.07

UNDERSIDE OF BASE FL. EL. +12.00

MAIN ROOF

COLUMN NUMBERS	BASE MATERIAL	SECTION	HEIGHT
1	18" x 18" x 1/2" R	12" CB-20#	12' 0"
2	24" x 24" x 1/2" R	do	do
3	24" x 24" x 1/2" R	do	do
4	24" x 24" x 1/2" R	do	do
5	24" x 24" x 1/2" R	12" CB-45#	12' 0"
6	24" x 24" x 1/2" R	12" CB-50#	12' 0"
7	do	do	do
8	18" x 18" x 1/2" R	12" CB-36#	12' 0"
9	24" x 24" x 1/2" R	12" CB-60#	12' 0"
10	18" x 18" x 1/2" R	12" CB-50#	12' 0"
11	18" x 18" x 1/2" R	do	do
12	SEE COL. 8	12" CB-36#	12' 0"
13	18" x 18" x 1/2" R	12" CB-50#	12' 0"
14	SEE COL. 10	do	do
15	SEE COL. 6	do	do
16	SEE COL. 8	12" CB-36#	12' 0"
17	SEE COL. 3	do	do
18	SEE COL. 11	12" CB-50#	12' 0"
19	do	do	do
20	SEE COL. 1	10" CB-21#	10' 0"
21	do	do	do
22	18" x 18" x 1/2" R	14" CB-85#	14' 0"
23	24" x 24" x 1/2" R	12" CB-66#	12' 0"
24	do	14" CB-61#	14' 0"
25	do	12" CB-60#	12' 0"
26	SEE COL. 8	12" CB-36#	12' 0"
27	SEE COL. 2	12" CB-25#	12' 0"
28	3/4" R	do	do
29	3/4" R	do	do
30	3/4" R	do	do
31	3/4" R	do	do
32	3/4" R	do	do
33	3/4" R	do	do
34	3/4" R	do	do
35	3/4" R	do	do
36	3/4" R	do	do
37	3/4" R	do	do
38	3/4" R	do	do
39	3/4" R	do	do
40	3/4" R	do	do
41	3/4" R	do	do
42	3/4" R	do	do
43	3/4" R	do	do
44	3/4" R	do	do
45	3/4" R	do	do
46	3/4" R	do	do
47	3/4" R	do	do
48	3/4" R	do	do
49	3/4" R	do	do
50	3/4" R	do	do
51	3/4" R	do	do
52	3/4" R	do	do
53	3/4" R	do	do
54	3/4" R	do	do
55	3/4" R	do	do
56	3/4" R	do	do
57	3/4" R	do	do
58	3/4" R	do	do
59	3/4" R	do	do
60	3/4" R	do	do
61	3/4" R	do	do
62	3/4" R	do	do
63	3/4" R	do	do
64	3/4" R	do	do
65	3/4" R	do	do
66	3/4" R	do	do
67	3/4" R	do	do
68	3/4" R	do	do
69	3/4" R	do	do
70	3/4" R	do	do
71	3/4" R	do	do
72	3/4" R	do	do
73	3/4" R	do	do
74	3/4" R	do	do
75	3/4" R	do	do
76	3/4" R	do	do
77	3/4" R	do	do
78	3/4" R	do	do
79	3/4" R	do	do
80	3/4" R	do	do
81	3/4" R	do	do
82	3/4" R	do	do
83	3/4" R	do	do
84	3/4" R	do	do
85	3/4" R	do	do
86	3/4" R	do	do
87	3/4" R	do	do
88	3/4" R	do	do
89	3/4" R	do	do
90	3/4" R	do	do
91	3/4" R	do	do
92	3/4" R	do	do
93	3/4" R	do	do
94	3/4" R	do	do
95	3/4" R	do	do
96	3/4" R	do	do
97	3/4" R	do	do
98	3/4" R	do	do
99	3/4" R	do	do
100	3/4" R	do	do

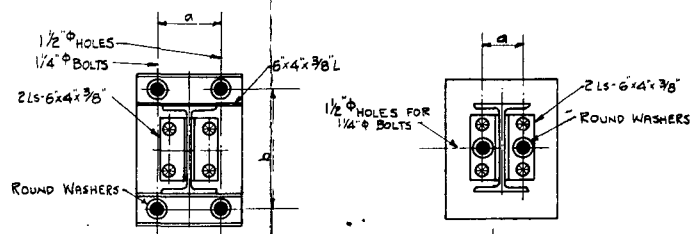

BASES FOR COL'S 1, 2, 3, 4, 5, 8, 9, 12, 13, 16, 17, 20, 21, 22, 26, 27, 28, 29, 30, 34, 35, 38, 39, 42, 43, 46, 47, 50, 51, 52, 53, & 54

BASES FOR COL'S 6, 7, 10, 11, 14, 15, 18, 19, 23, 24, 25, 31, 32, 33, 36, 37, 40, 41, 44, 45, 48, & 49

SCALE: 1" = 1'-0"

COLUMN SCHEDULE

NOTE:
ELEVATIONS OF TOPS OF ALL COLUMNS & POSTS APPROXIMATE.
ELEVATIONS TO BE DETERMINED BY DETAILS.

ON MICROFILM

THE CITY OF NEW YORK
DEPARTMENT OF DOCKS
DIVISION OF PORT PLANNING
CONTRACT NO. 2000
FOR THE CONSTRUCTION OF ADMINISTRATION
BUILDING WITH APPURTENANCES AT THE SITE
OF
THE MUNICIPAL AIRPORT
FLOYD BENNETT FIELD
FLATBUSH AVE. BOROUGH OF BROOKLYN
SUBMITTED BY *[Signature]* DIVISION ENGINEER
APPROVED BY *[Signature]* CHIEF ENGINEER
APPROVED BY *Michael Cosgrove* COMMISSIONER
DATE - Nov. 17, 1932

59

646/63038 17 of 17

Electrical Drawings for the Administration Building

Contract No. 2028C

February 16, 1931

See Historical Data Section, Photo No. 15 - The bottom portion of the railing lamp (Type A) can be seen in place. These fixtures are no longer in the buildings.

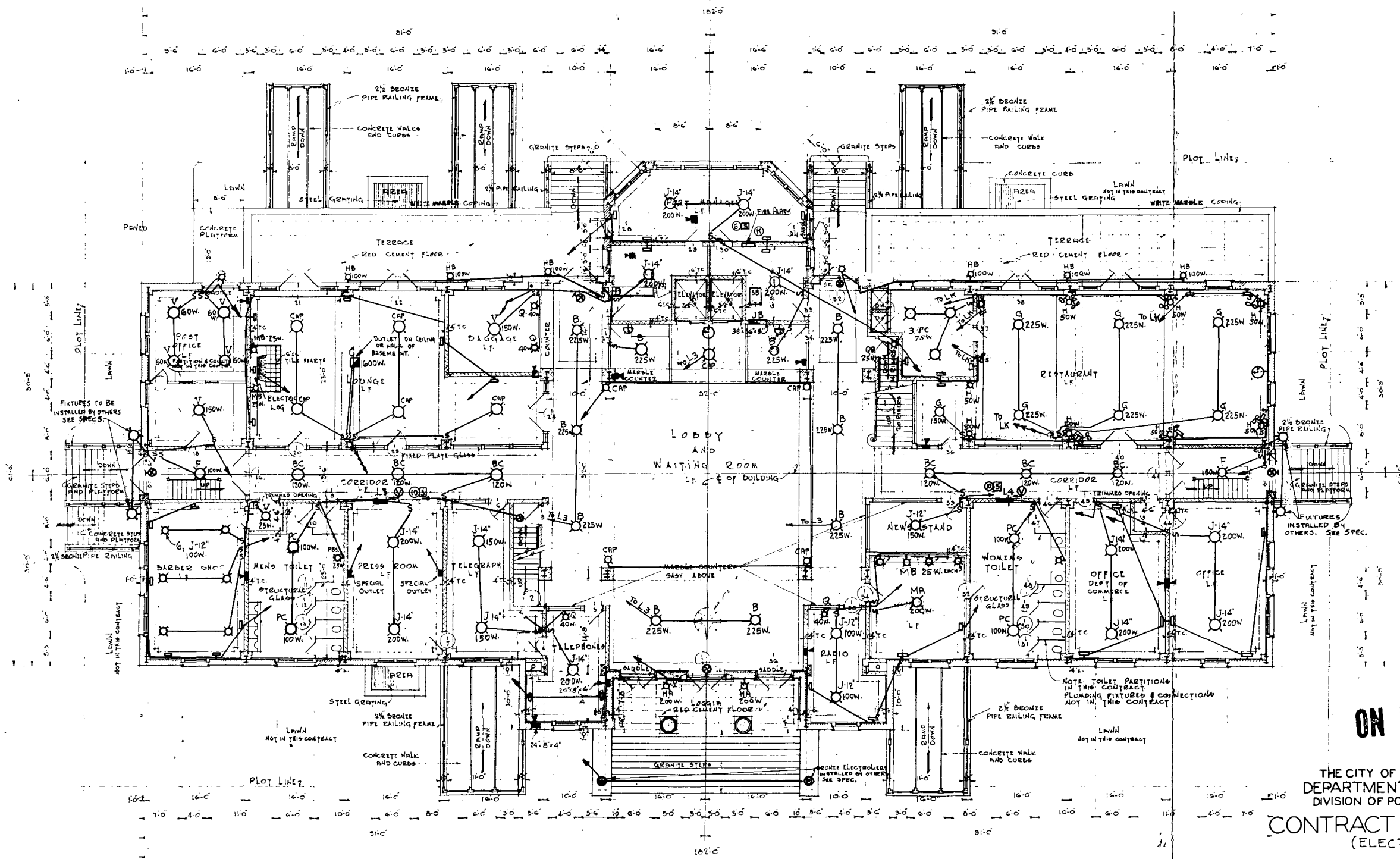

FIRST FLOOR PLAN
Scale 1/8" = 1'-0"

ELECTRIC WORK
JOB NO. 3014

ON MICROFILM

THE CITY OF NEW YORK
DEPARTMENT OF DOCKS
DIVISION OF PORT PLANNING
CONTRACT NO. 2028C
(ELECTRIC)

ADMINISTRATION BUILDING
THE MUNICIPAL AIRPORT
FLOYD BENNETT FIELD
FLATBUSH AVE, BOROUGH OF BROOKLYN.

SUBMITTED BY *[Signature]* DIVISION ENGINEER
APPROVED BY *[Signature]* CHIEF ENGINEER
APPROVED BY *Michael Cosgrove* COMMISSIONER
DATE - FEB. 16, 1931.

DRAWN
TRACED

646/63035 4 of 8

NOTES - ELECTRICAL SYMBOLS

⊕	DESIGNATES BEACON
⊕	" WIND-DIRECTION INDICATOR
⊕	" OBSTRUCTION LIGHTS
⊕	" BOUNDARY LIGHTS
⊕	" HANGAR FLOODLIGHTS
⊕	" CEILING PROJECTOR
⊕	" CEILING LIGHT INDICATOR
⊕	" LANDING AREA FLOODLIGHT
⊕	" MANHOLE
⊕	" HIGH TENSION FEEDER
⊕	" L.T. FEEDER
⊕	" SERIES CIRCUIT (CABLE)
⊕	" CONTROL CABLE

ELECTRICAL SYMBOLS - ADMINISTRATION BLD'G. & HANGARS (INTERIORS) OTHER THAN NOTED ON DWG. C1

⊕	CEILING OUTLET
⊕	" WALL "
⊕	FLOOR OR PARAPET OUTLET
⊕	" OUTLET
⊕	CEILING OUTLET WITH LAMP RECEPTACLE PG.
⊕	WALL " " PG
⊕	CEILING " " TYPE PD (PROP. CORD)
⊕	WALL NIGHT LIGHT
⊕	" OUTLET & EXIT LIGHT
⊕	BASE PLUG RECEPTACLE, INSERTION
⊕	" " " 3 POLE, "
S	SWITCH
S 3WY	3WAY SWITCH
SY	SWITCH WITH BULL'S EYE
⊕	CONDUIT IN FLOOR
⊕	PLUG ON CLOCK SYSTEM
⊕	CLOCK
⊕	MOTOR MAIN LINE SYSTEM
⊕	TELEPHONE OUTLET
⊕	" PULL BOX
⊕	" BOX
⊕	" JUNCTION BOX
⊕	" SWITCH BOARD
⊕	POWER PANEL
⊕	LIGHT PANEL
⊕	JUNCTION BOX
⊕	FIRE ALARM GONG
⊕	" STATION
⊕	" KEY

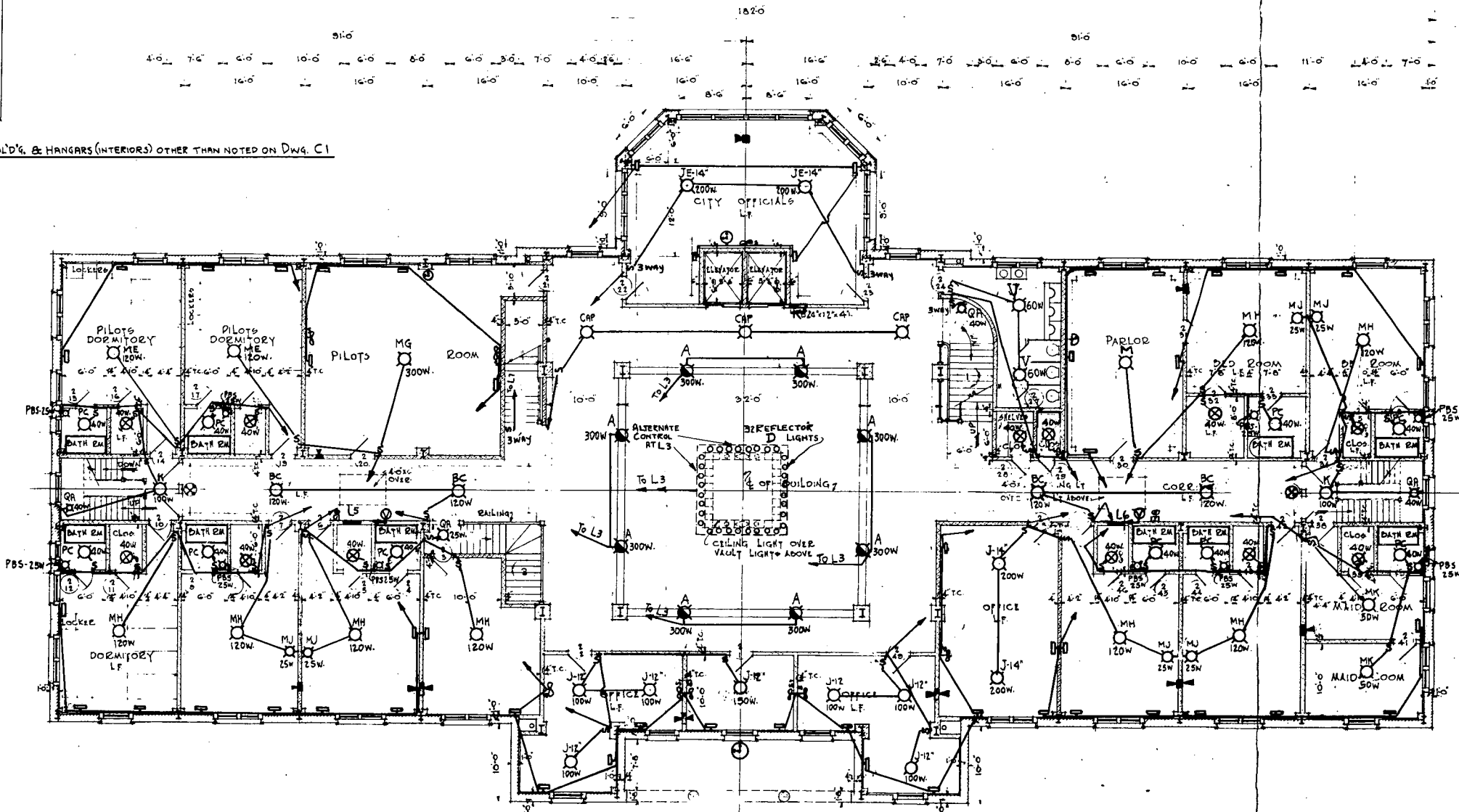

2ND FLOOR PLAN
scale 1/8" = 1'-0"

ELECTRIC WORK
JOB NO. 2014

ON MICROFILM

THE CITY OF NEW YORK
DEPARTMENT OF DOCKS
DIVISION OF PORT PLANNING

CONTRACT NO. 2028C
(ELECTRIC)

ADMINISTRATION BUILDING
THE MUNICIPAL AIRPORT
FLOYD BENNETT FIELD
FLATBUSH AVE, BOROUGH OF BROOKLYN.

SUBMITTED BY *[Signature]* DIVISION ENGINEER
APPROVED BY *[Signature]* CHIEF ENGINEER
APPROVED BY *Michael Cosgrove* COMMISSIONER
DATE - FEB. 16, 1931.

62

646/63035 5 of 8 file 7

DRAWN BY H.F.M.L.P.D.A.
TRACED BY D.A.

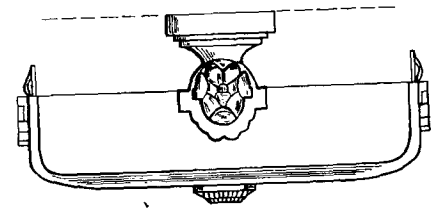
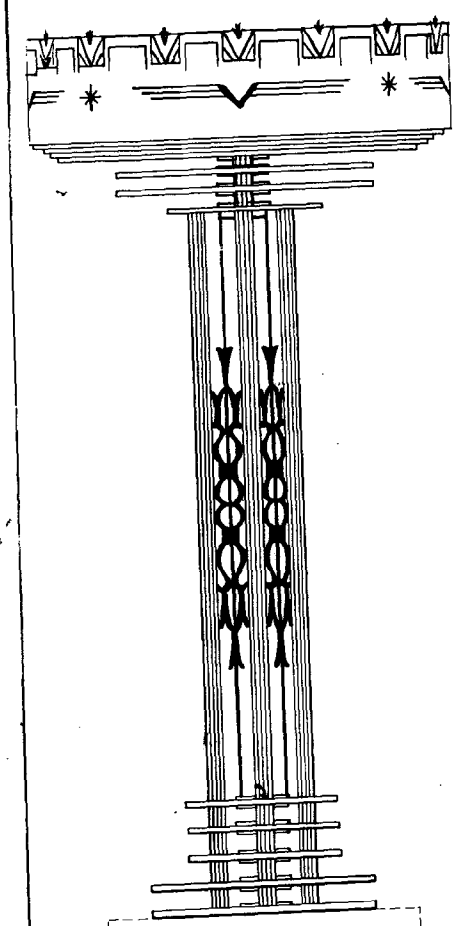

TYPE B

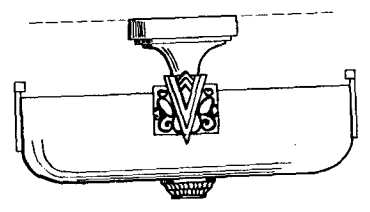

TYPE G

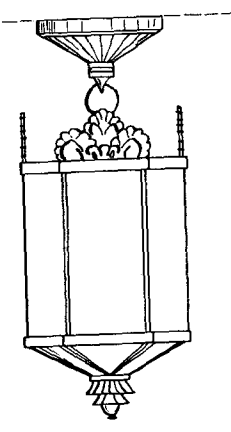

TYPE F

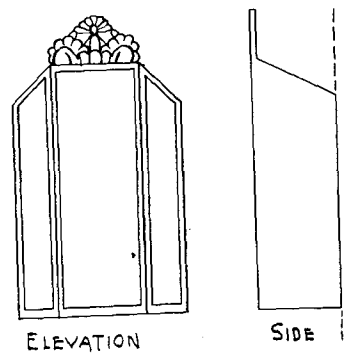

ELEVATION

SIDE



PLAN

TYPE H

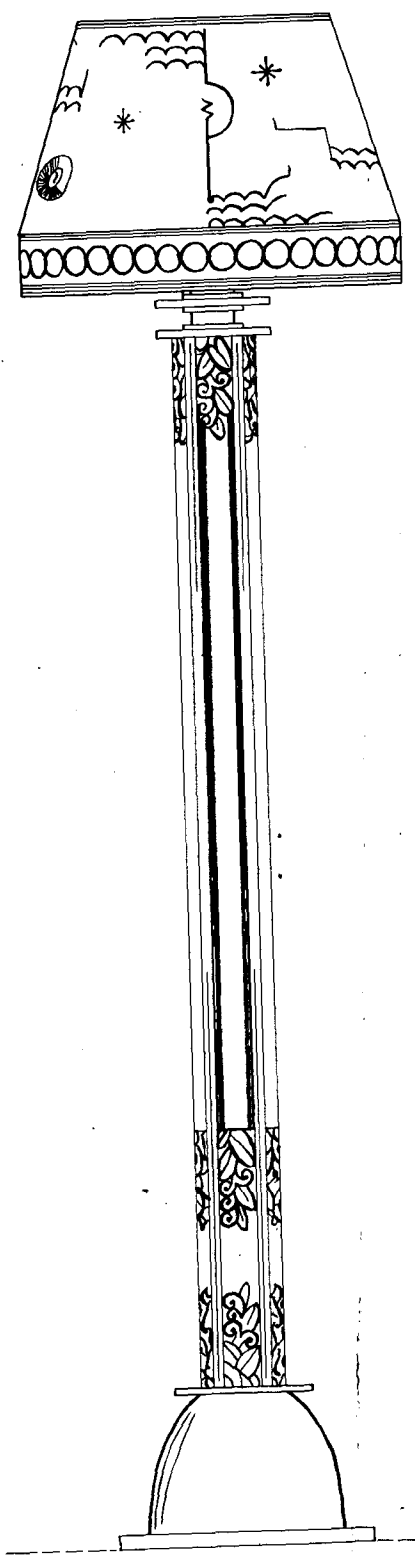

TYPE E

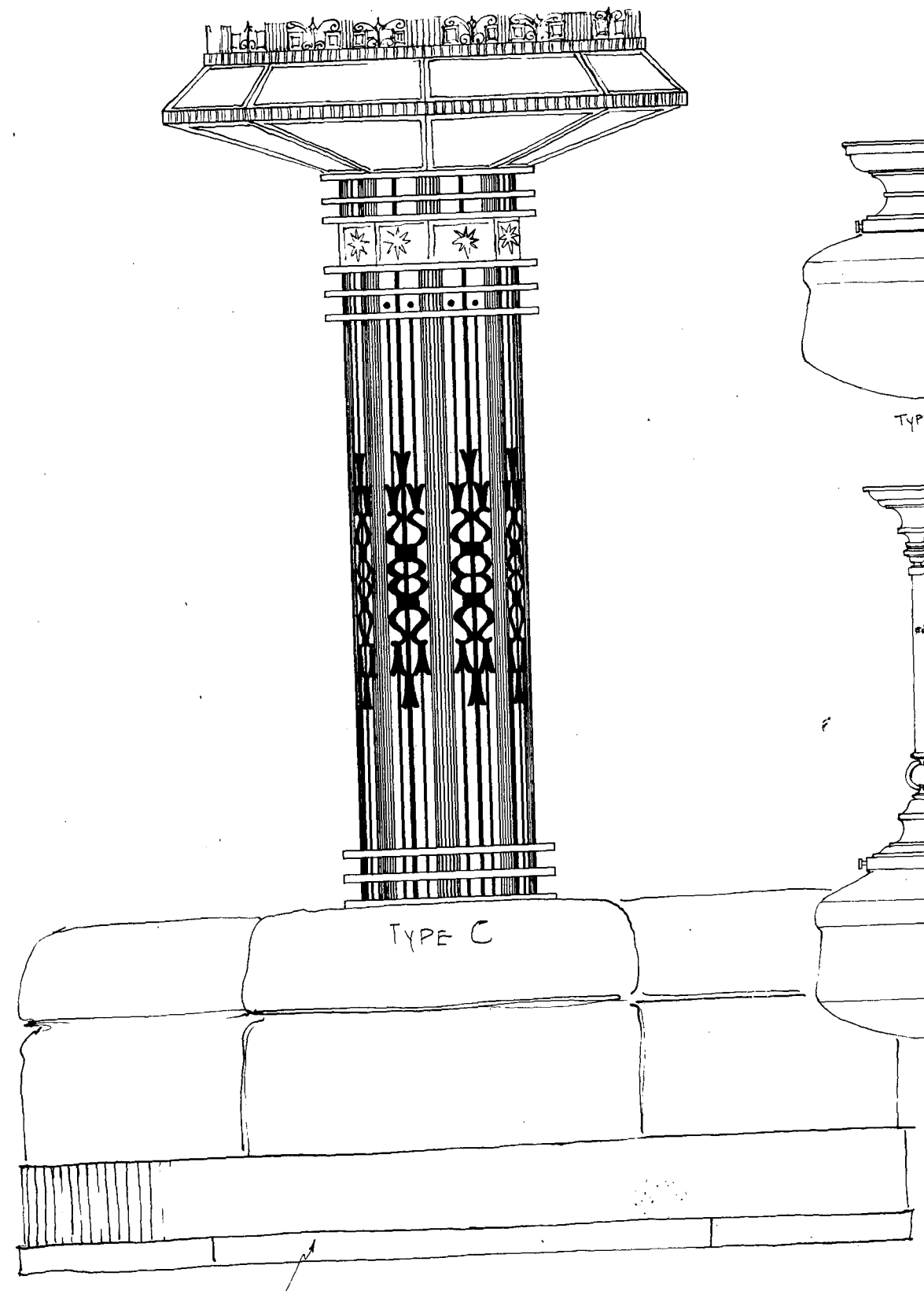

TYPE C

SEAT BY OTHERS

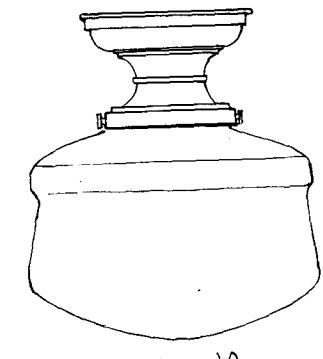

TYPE JA

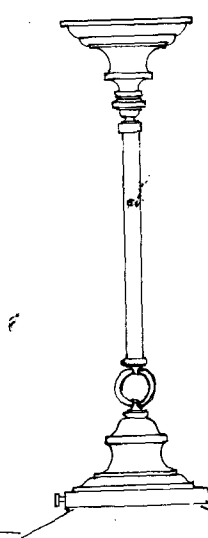

TYPE J

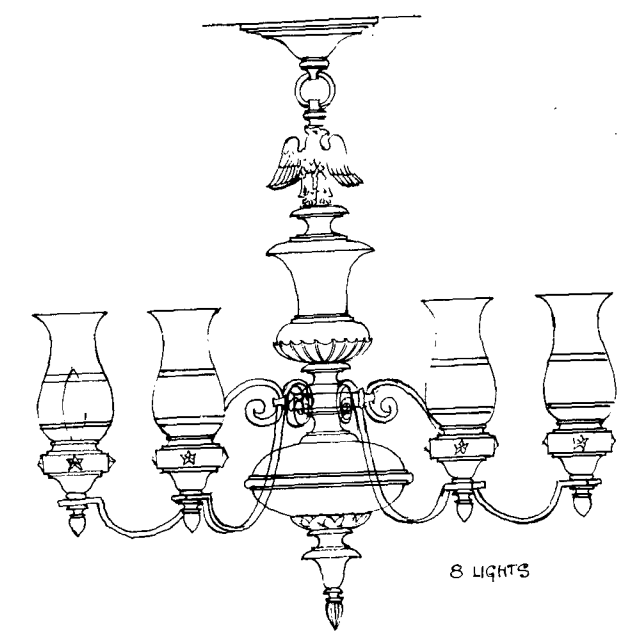

8 LIGHTS

TYPE M

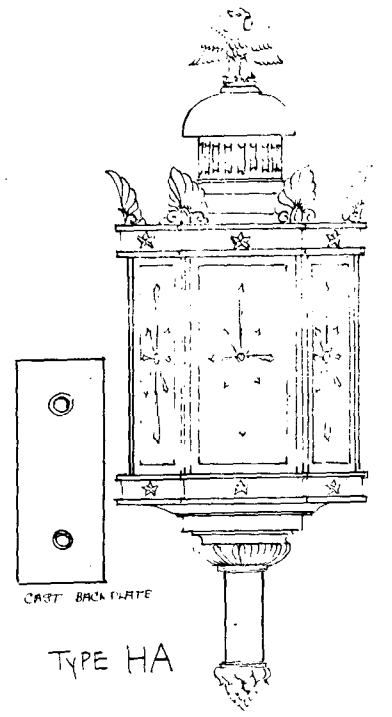

TYPE HA

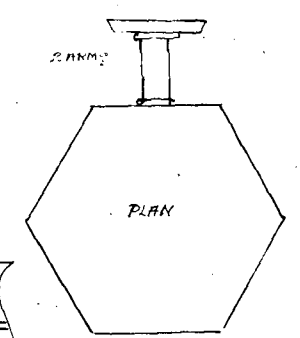

PLAN

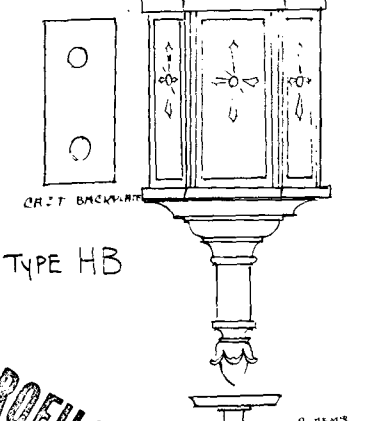

TYPE HB

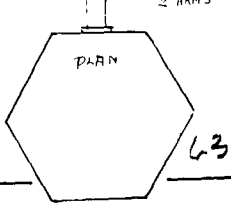

PLAN

43

TYPE A

FIXTURE SKETCHES

ELECTRIC WORK
JOB NO. 3014

THE CITY OF NEW YORK
DEPARTMENT OF DOCKS
DIVISION OF PORT PLANNING
CONTRACT NO. 2028C
MUNICIPAL AIRPORT (FLOYD BENNETT FIELD)
FLATBUSH AVENUE, BOROUGH OF BROOKLYN.
LIGHTING FIXTURES

SUBMITTED BY
APPROVED BY
APPROVED BY
DATE - FEB. 16, 1931.

DIVISION ENGINEER
CHIEF ENGINEER
COMMISSIONER

ON MICROFILM

646/63035 6 of 8



Administration Building - West Elevation, 1979



Administration Building - East Elevation, 1979
Note half circle ghosts above entry doors at
either side of the tower where leaded glass
canopies were attached.



Main entry from Flatbush Avenue. Copper letters and bronze eagle have been stripped from this elevation. October 1978.



Entry Portico

Cement coating is stained and cracked.



East Elevation at South End - Note later copper letters ("Naval Air Station") and glass block windows (Compare with Sheet 1 of Contract 2000 following). October 1978.

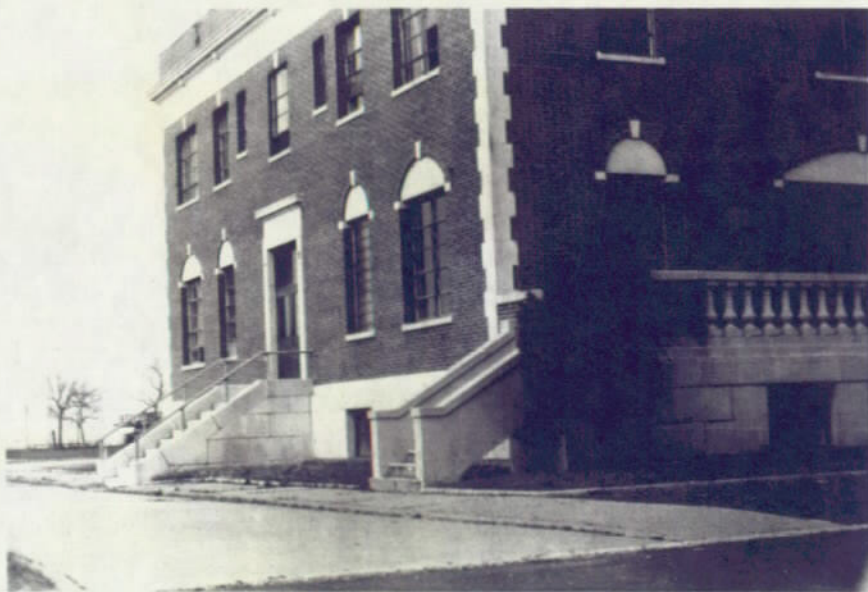

Southeast Corner of Building. Concrete stairs at end of terrace were installed after original construction phase. April 1979.



Present Control Tower - (See Historical Data Section
Photo No. 19 for comparison with original tower.)
October 1978.



Control Tower Interior 1979



Interior of Women's Rest Room on First Floor. January 1979.



North Wall - Note ghost of recently removed wood-frame addition and pneumatic tubes above left side of door. January 1979.



Entry out of WPA Tunnel into Administration Building. Stairs, once leading up to the first floor, have been sealed at their heads to allow for a first floor hallway across that area. Access to the basement is still possible via the barely discernible opening to the right of the stair openings. April 1979.



WPA Tunnel - Old wall openings have been sealed with concrete, and no documentation as to what was behind them was found. April 1979.

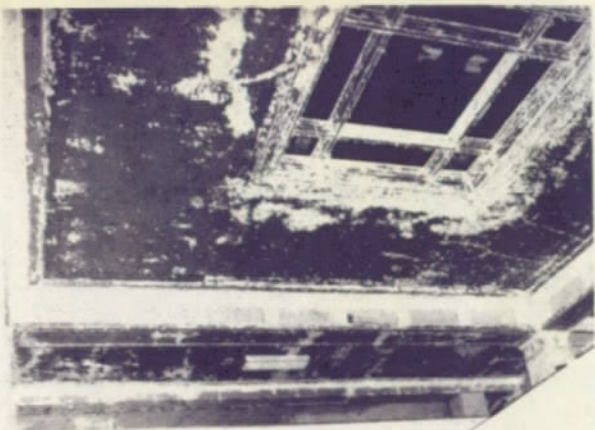

Lobby/Waiting Room Area
looking north. Wood-frame
partition at right has cut
the space in two.



The ceilings of this lobby
area and the surrounding
second-floor halls were
brightly stencilled.

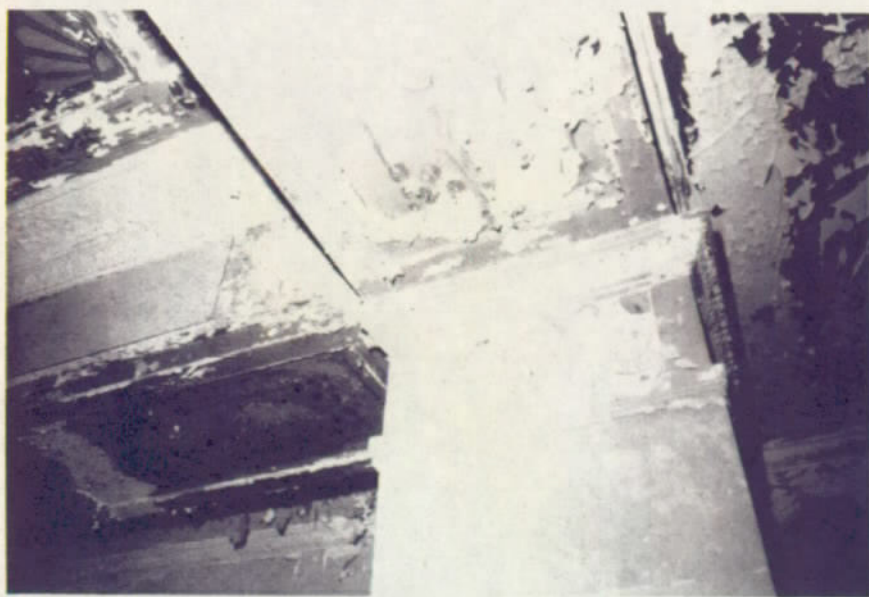

Upper Corner of Lobby/Waiting Room area showing plaster-
ornamented column and ceiling stencilling.

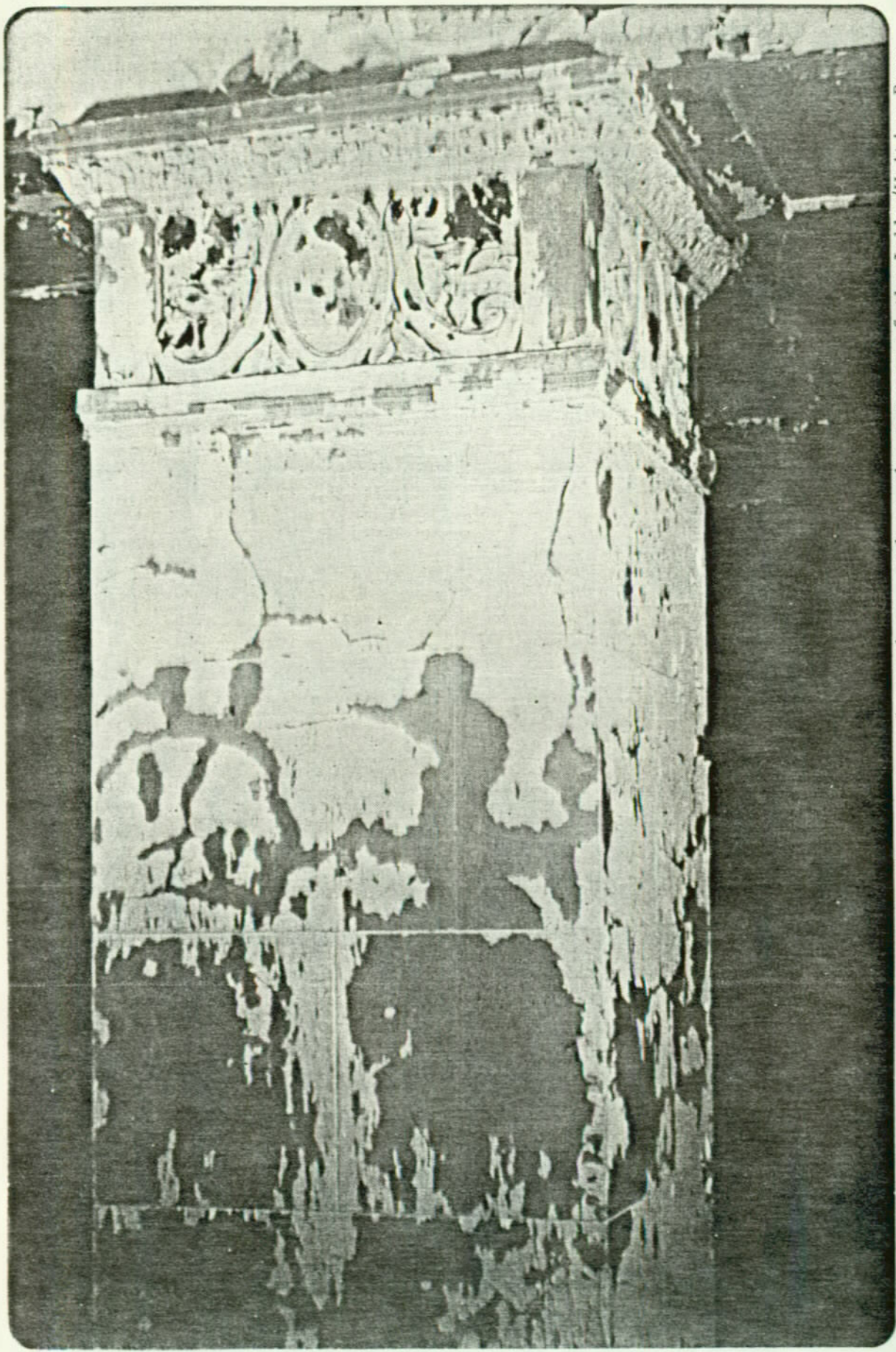

Plaster ornamented column capital - Four columns located one each at the corners of the Lobby/Waiting Room space, Administration Building. (Photo courtesy of Brooks Vaughn - Gateway NRA - Ext. Affairs)

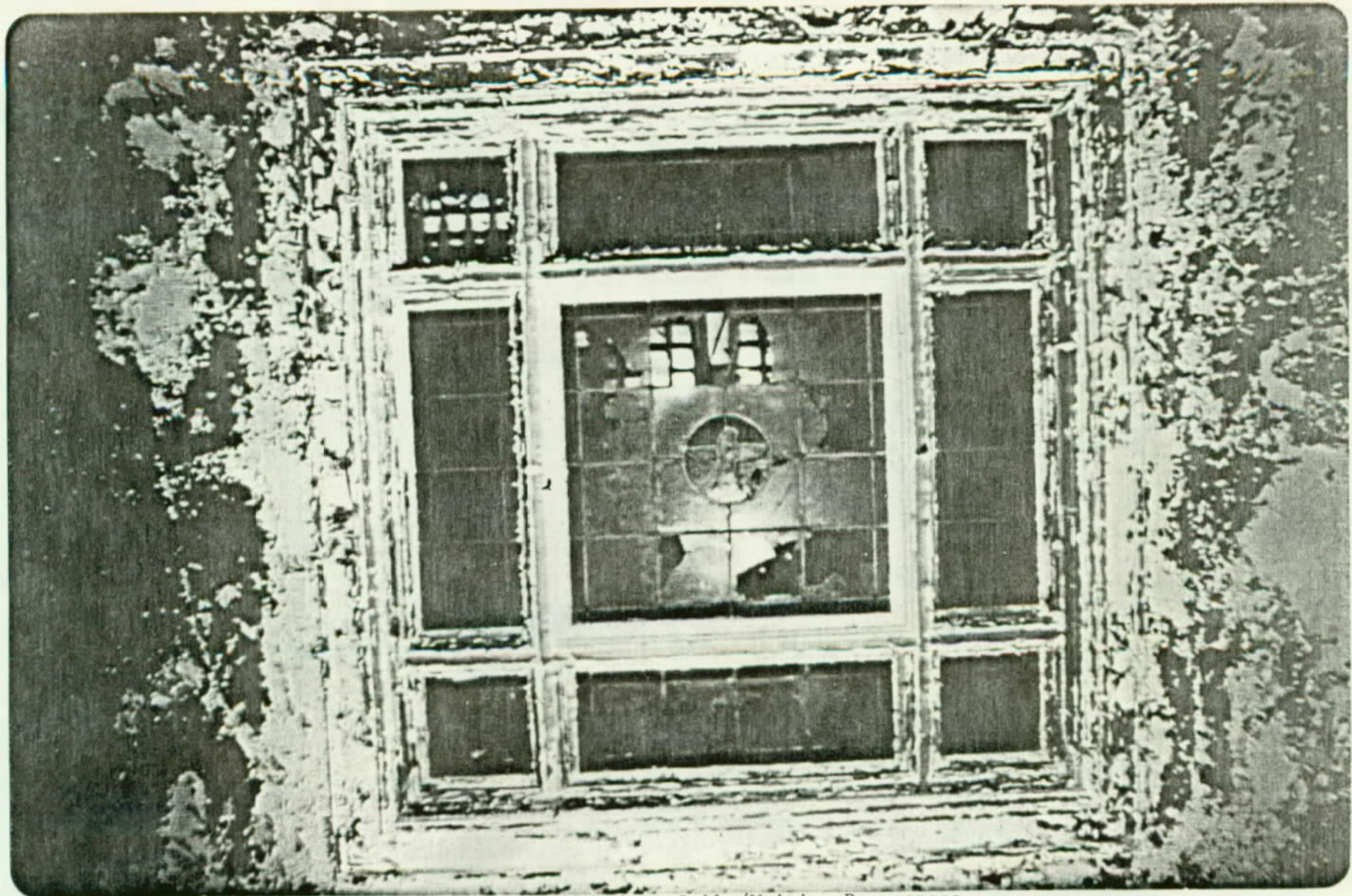

Administration Building 1 - Skylight centered above Lobby/Waiting Room space
(Photo courtesy of Brooks Vaughn - Gateway NAR - Ext. Affairs)



Second floor looking south across open area above Lobby/
Waiting Room Area.



Second floor iron stair railing. Plaster walls are scored
to imitate caen stone and wainscoting is buff-colored marble.

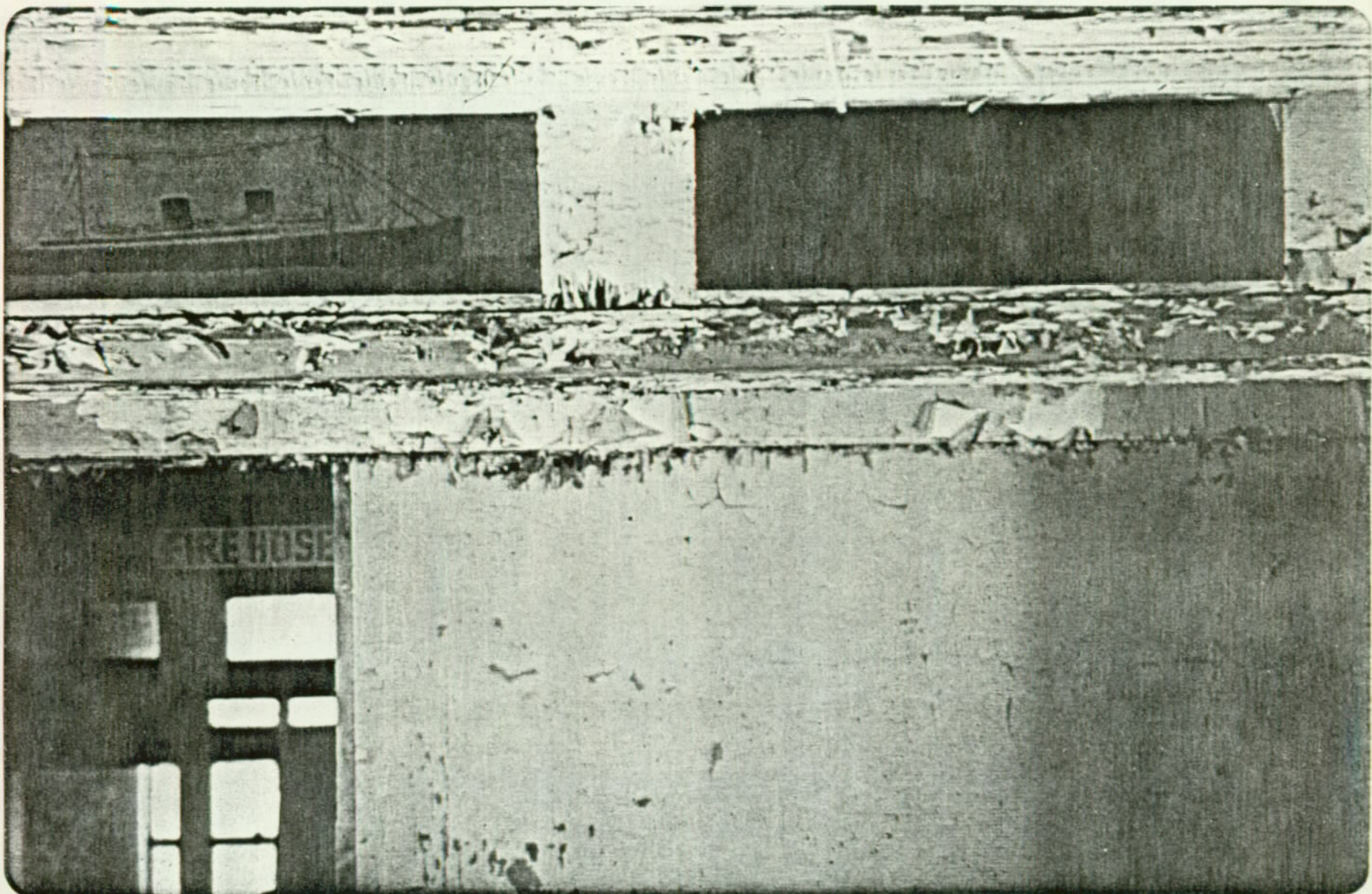

Mural panels bordering top of two-story Lobby/Waiting Room space in Administration. Steamship and Dirigible (Stolen, recovered, and now located at Police Headquarters) are two of the few remaining canvases. (Photo courtesy of Brooks Vaughn - Gateway NAR - Ext. Affairs)

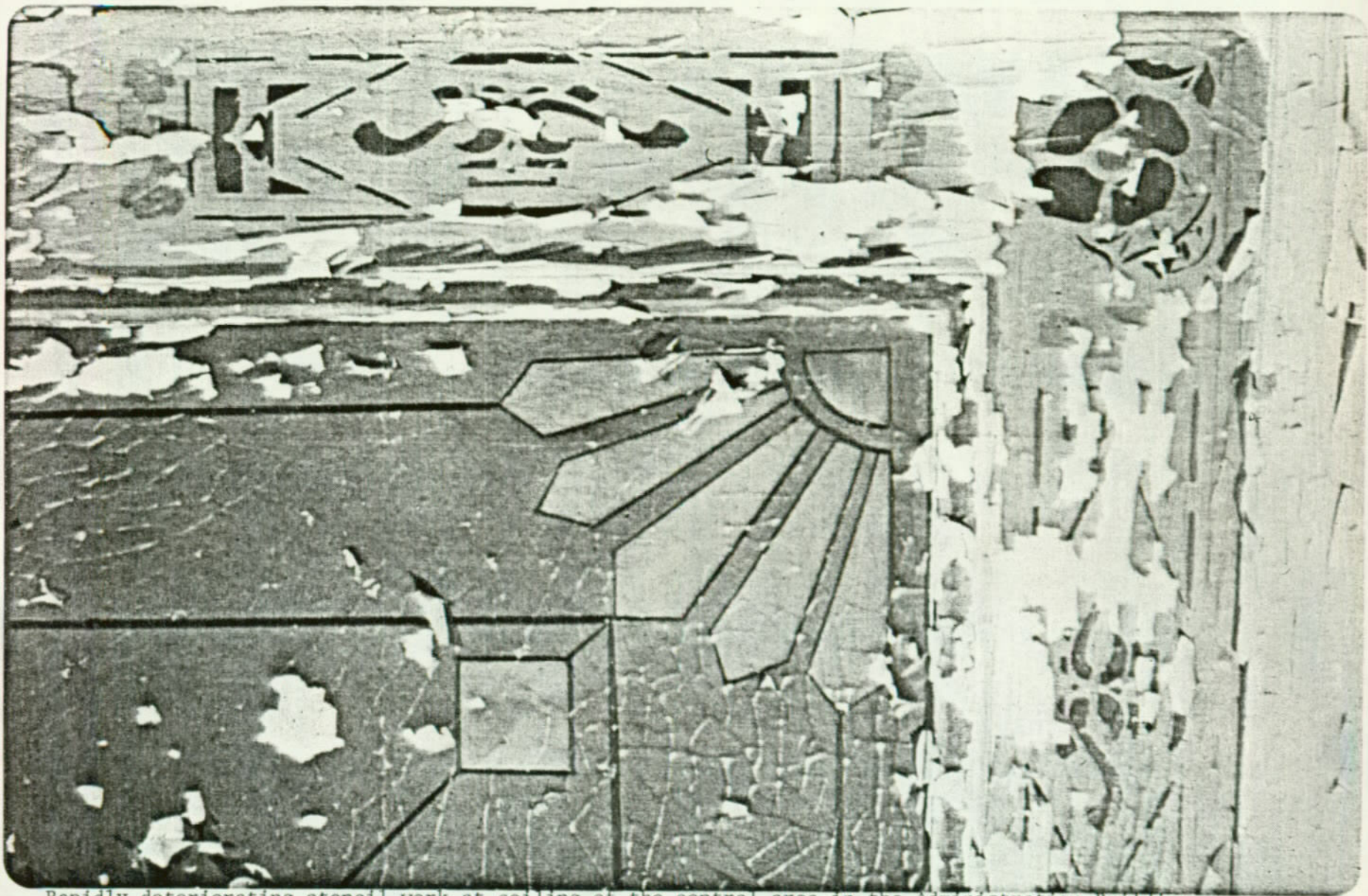

Rapidly deteriorating stencil work at ceiling of the central area in the Administration Building
(Photo courtesy of Brooks Vaughn - Gateway NAR - Ext. Affairs)

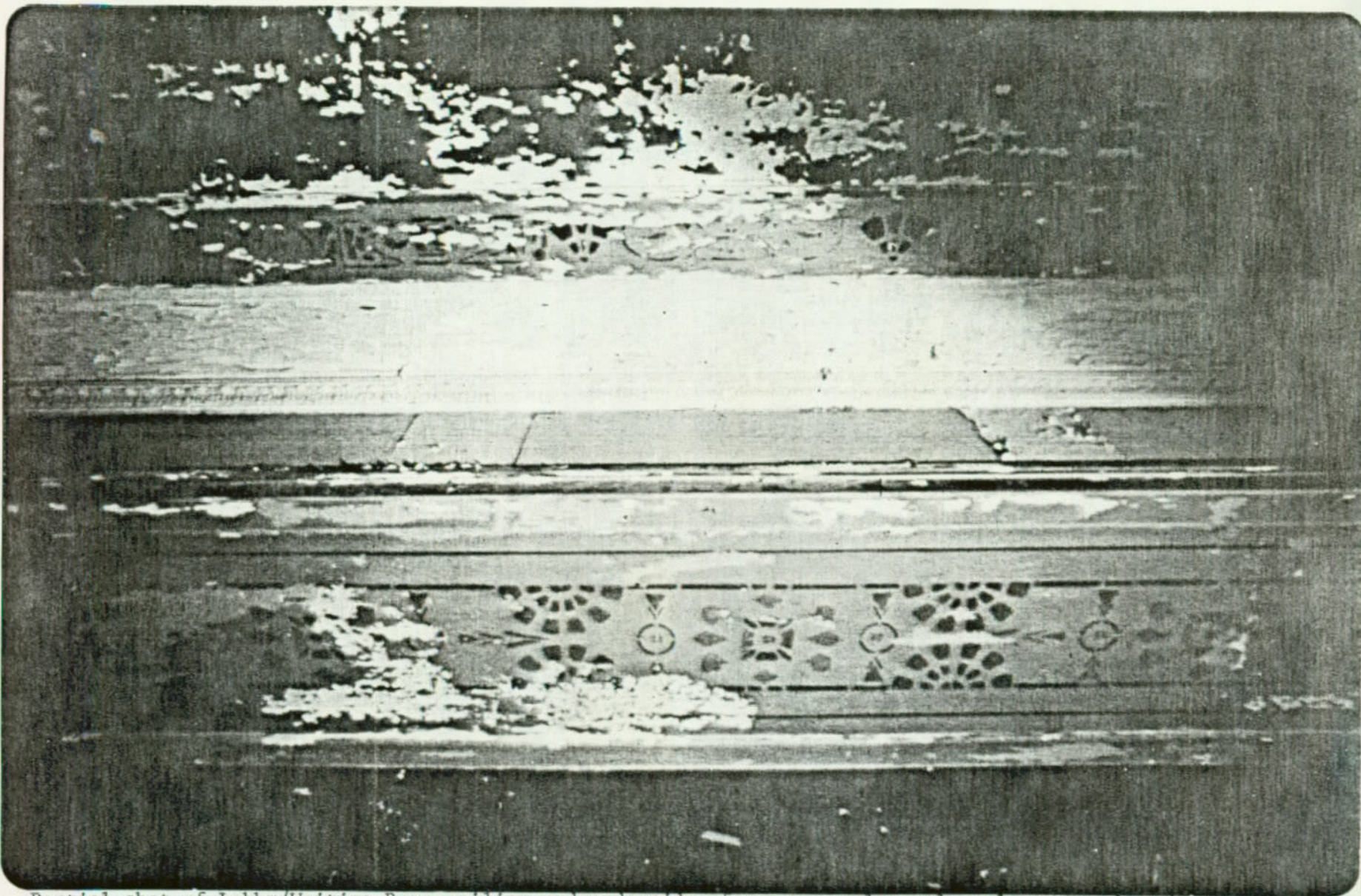

Partial shot of Lobby/Waiting Room ceiling and underside of upper mural panel - plaster work and stenciling rapidly deteriorating. Administration Building. (Photo courtesy of Brooks Vaughn - Gateway NAR - Ext. Affairs)



Plaster damage in basement
in room beneath first-floor
level terrace.
April 1979.

Ceiling damage in basement
reveals construction detailing.
April 1979.





Second Floor - Typical bedroom



First-floor room at east side of building.

Repairs and Partial Restoration of the
Administration Building

Castro-Blanco, Piscioneri, and Feder, Architects

Drawings 1 through 6 have been included (out of
a set of 18 sheets) to show the basic work
intended by this contract.

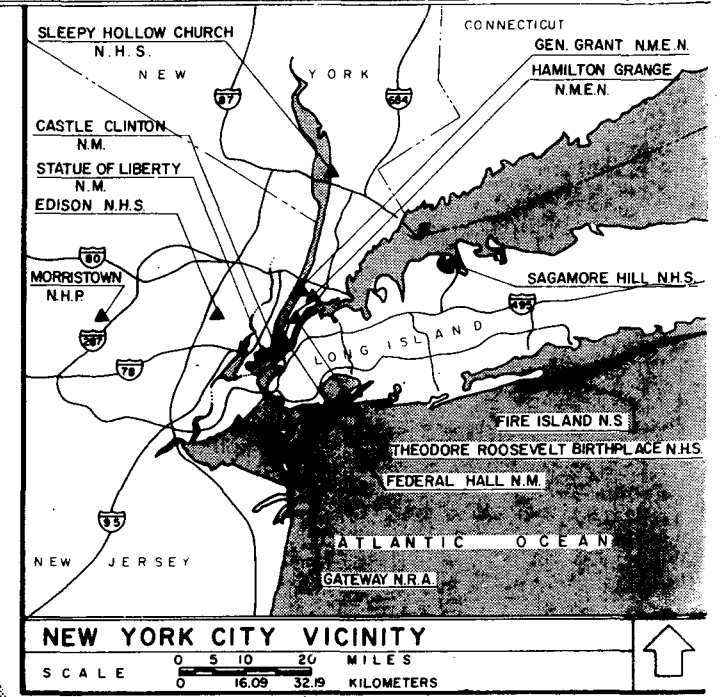
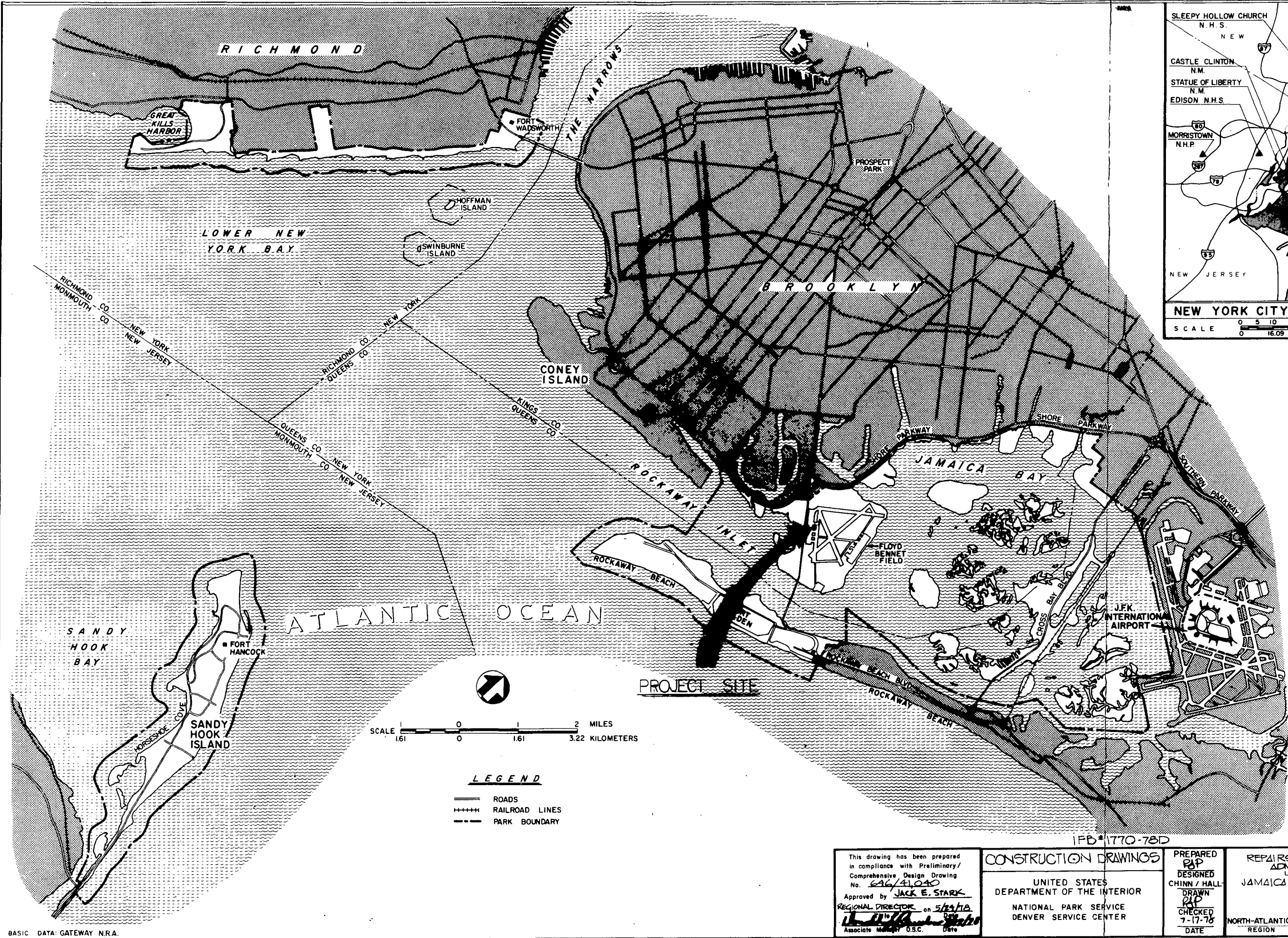

INDEX OF DRAWINGS

1. TITLE SHEET
2. BASEMENT PLAN
3. FIRST FLOOR PLAN
4. ROOF PLANS
5. NORTH & SOUTH ELEVATIONS & NOTES
6. EAST & WEST ELEVATIONS
7. ROOF DETAILS
8. DECK & MISCELLANEOUS DETAILS
9. PLUMBING: BASEMENT FLOOR
10. PLUMBING: FIRST FLOOR
11. PLUMBING: SECOND FLOOR
12. PLUMBING: ROOF
13. HEATING & VENTILATION: BASEMENT FLOOR
14. HEATING & VENTILATION: FIRST FLOOR
15. HEATING & VENTILATION: SECOND FLOOR
16. HEATING & VENTILATION: ROOF PLANS
17. ELECTRIC: PART PLANS
18. ELECTRIC: WORK NOTES

ON MICROFILM

**CASTRO-BLANCO
 PISCIONERI and
 FEDER architects**

IFB #1770-78D

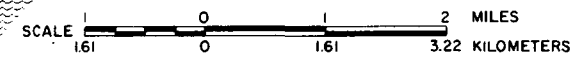

LEGEND

- ROADS
- RAILROAD LINES
- PARK BOUNDARY

This drawing has been prepared in compliance with Preliminary/Comprehensive Design Drawing No. 646/41040
 Approved by **JACK E. STARK**
 REGIONAL DIRECTOR on 5/23/78
 Associate Manager O.S.C. Date

CONSTRUCTION DRAWINGS
 UNITED STATES
 DEPARTMENT OF THE INTERIOR
 NATIONAL PARK SERVICE
 DENVER SERVICE CENTER

PREPARED
 R.P.P.
 DESIGNED
 CHINN / HALL
 DRAWN
 R.P.P.
 CHECKED
 7-17-78
 DATE

TITLE OF DRAWING
**REPAIRS & PARTIAL RESTORATION
 ADMINISTRATION BUILDING**
 LOCATION WITHIN PARK
JAMAICA BAY - FLOYD BENNETT FIELD
 NAME OF PARK
GATEWAY N.R.A.
 MONMOUTH, QUEENS & KINGS COUNTY
 NORTH-ATLANTIC REGION NY - N.J. STATE

DRAWING NO
646
41,040 A
 PCIF PKG SHEET
109 **1**
 of 18

BASIC DATA: GATEWAY N.R.A.

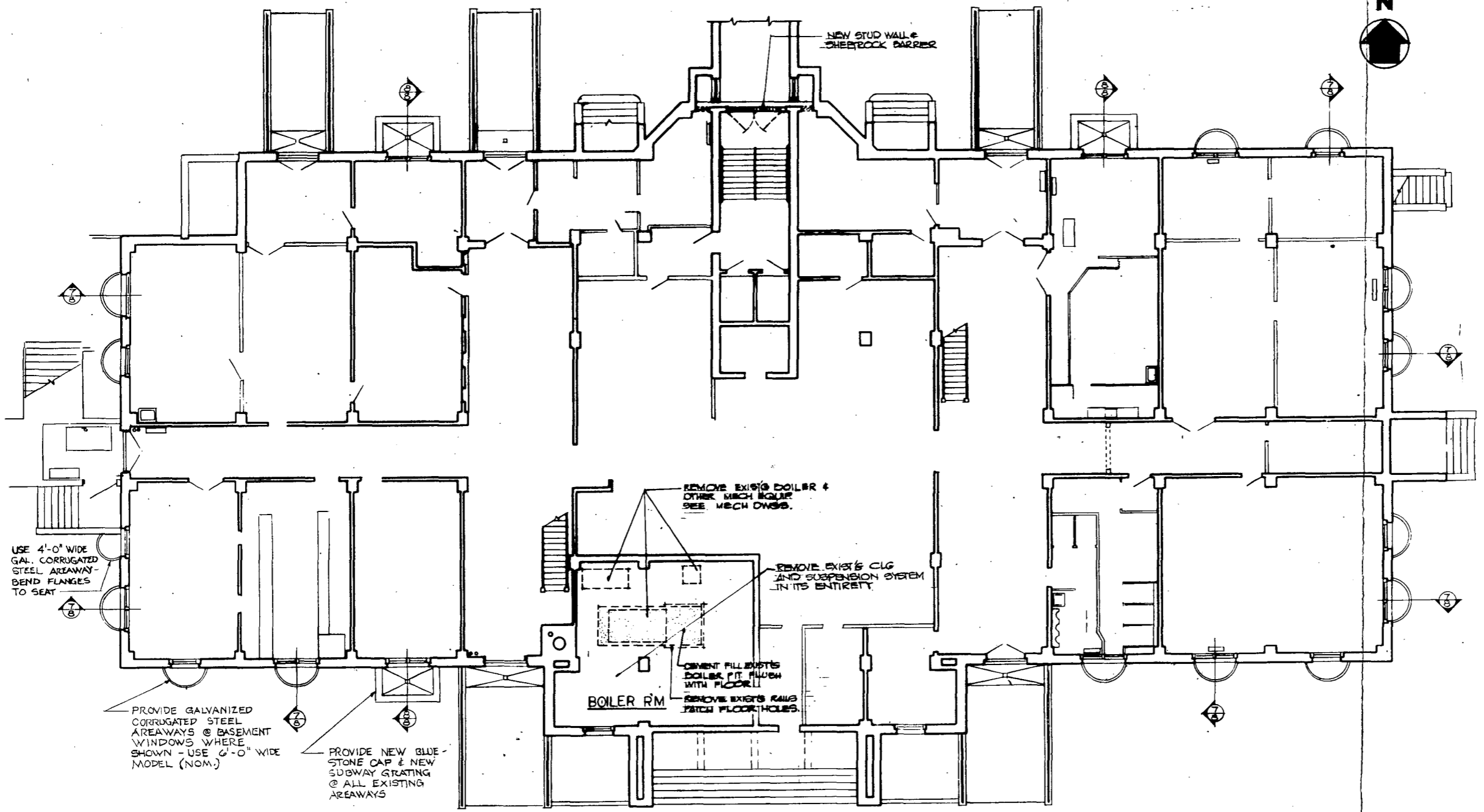

BASEMENT FLOOR

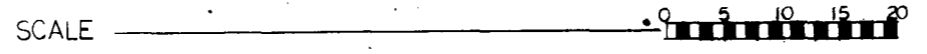

ON MICROFILM

PREPARED RIP	DRAWING NO. GAG
DESIGNED SS	41040A
DRAWN RIP	PCIP PKG SHEET
CHECKED 7-17-78	101 2
DATE	OF 18

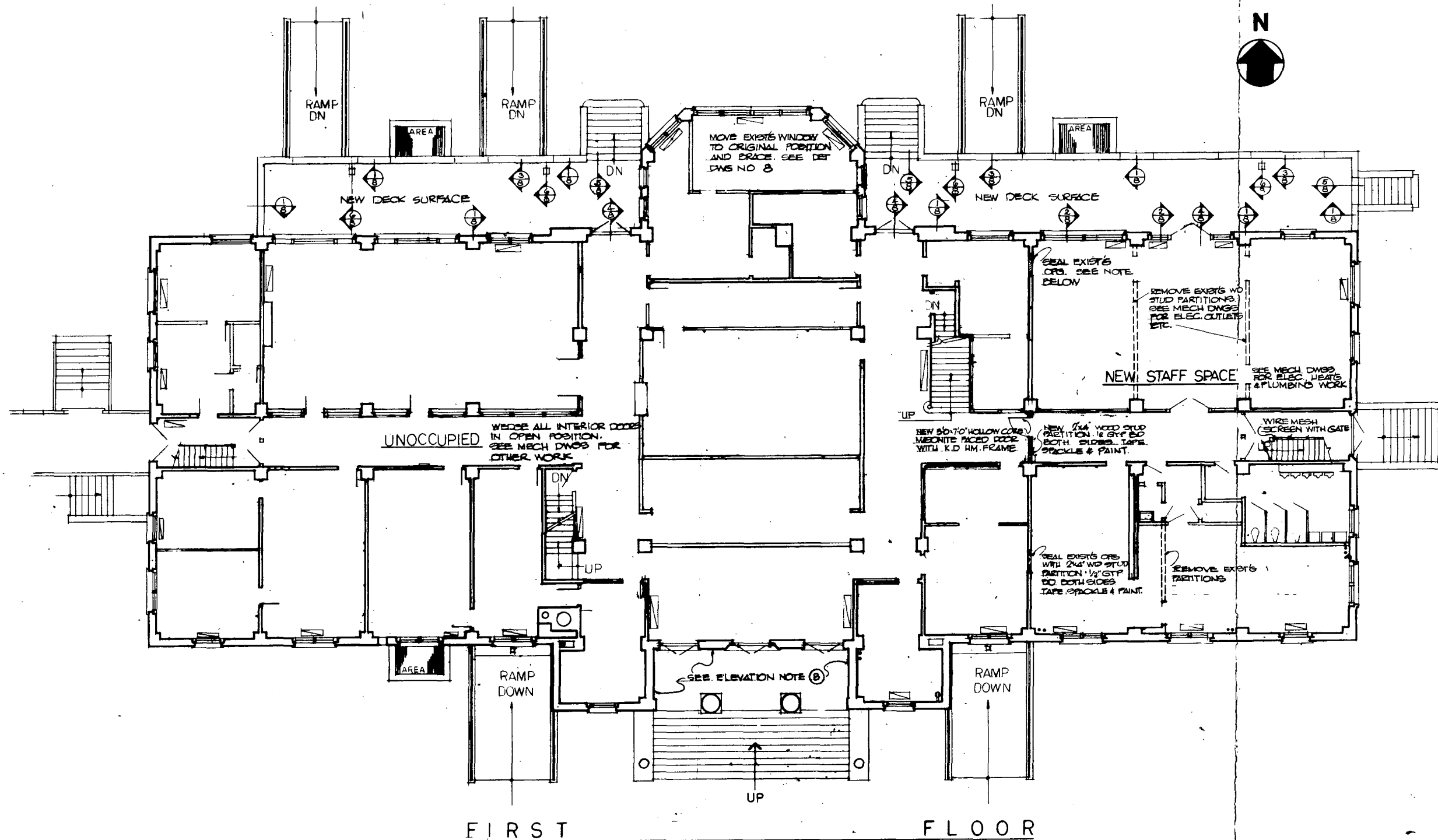

FIRST FLOOR

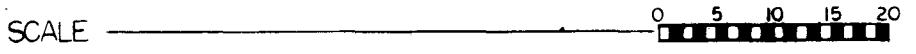

NOTE
 SECOND FLOOR PLAN NOT SHOWN. WEDGE ALL INTERIOR DOORS
 IN OPEN POSITION. SEE ELEVATIONS & MECH DWGS FOR OTHER
 WORK REQUIRED.

ON MICROFILM

PREPARED RIP	DRAWING NO. 646
DESIGNED RIP	41090A
DRAWN RIP	PCIP SHEET
CHECKED 7-17-78	102 3
DATE	OF 18

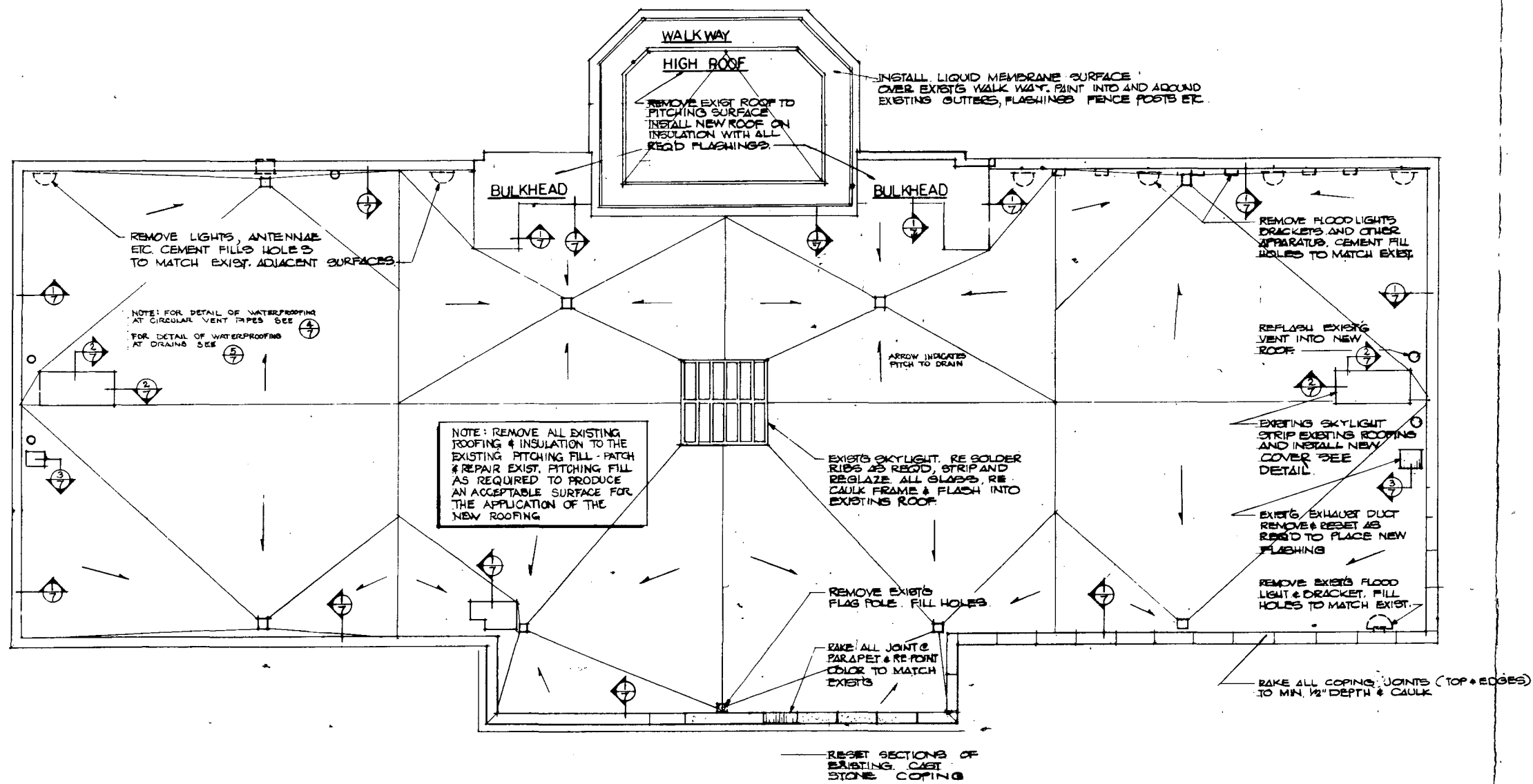

ROOF PLAN

SCALE 0 5 10 15 20

ON MICROFILM

PREPARED DO	DRAWING NO. 646
DESIGNED LM	41040A
DRAWN PP	PCIP PKG. SHEET
CHECKED 7-17-78	109 4
DATE	OF 18

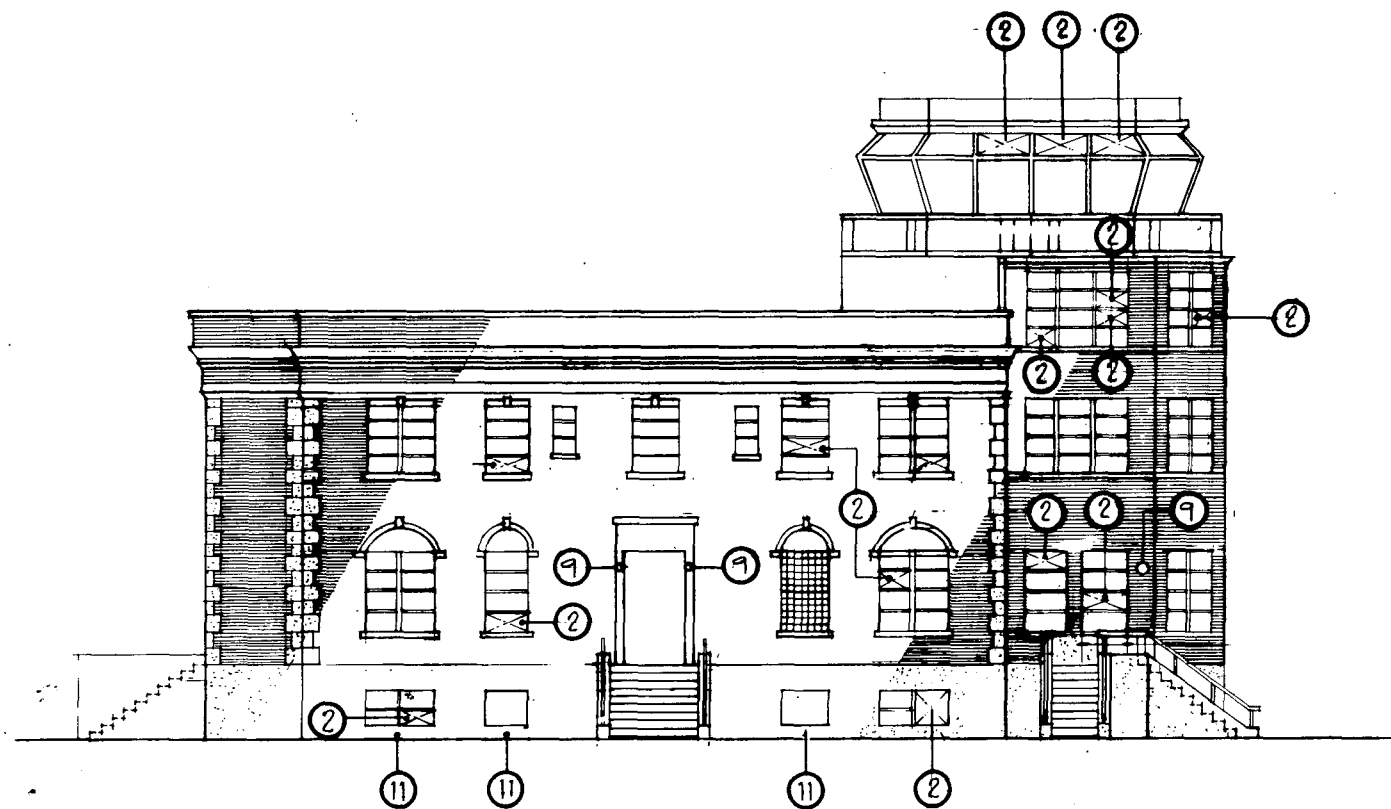

NORTH ELEVATION
SCALE: 1/8" = 1'-0"

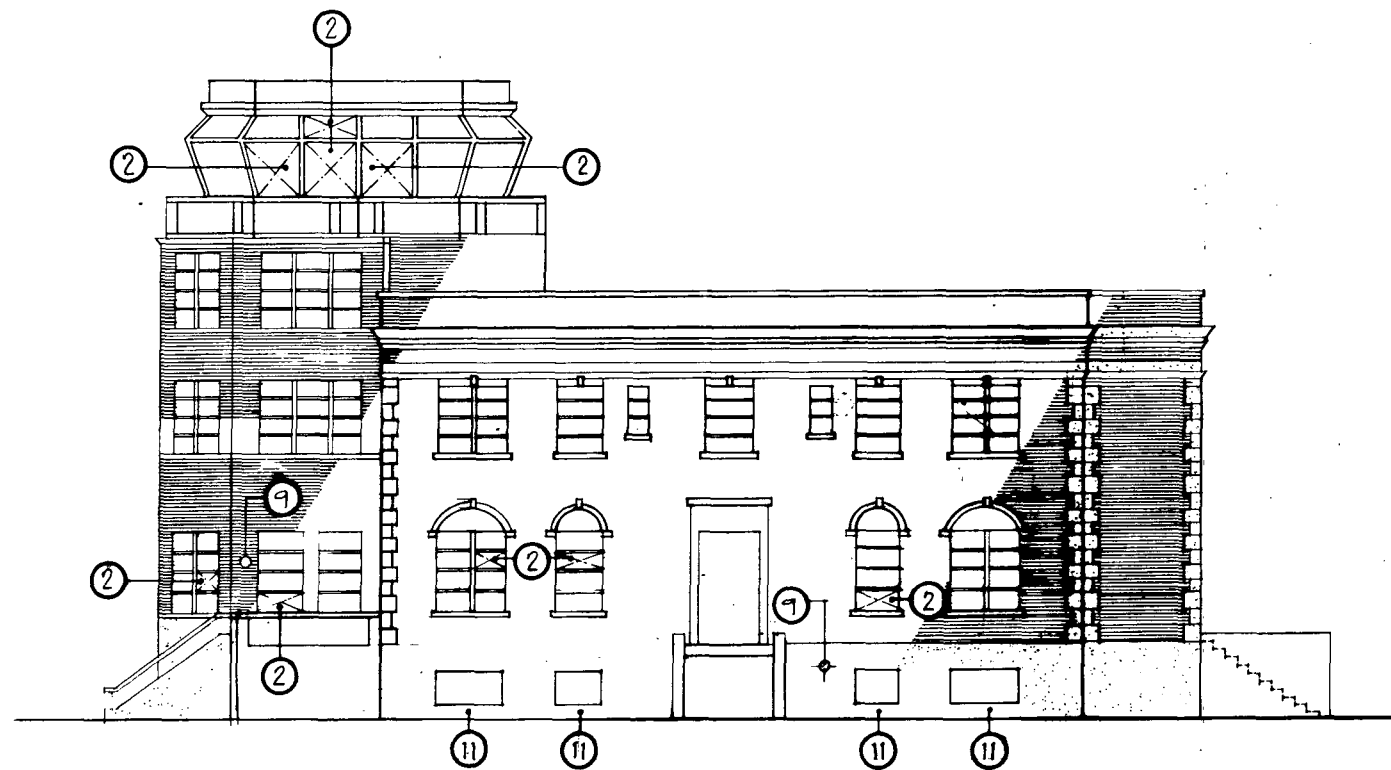

SOUTH ELEVATION
SCALE: 1/8" = 1'-0"

GENERAL REPAIR NOTES

THE CONTRACTOR MUST VISIT THE JOB SITE AND VERIFY THE EXISTING CONDITIONS AND CAREFULLY ESTABLISH THE QUANTITIES OF THE ITEMS MENTIONED HEREIN. NO CLAIMS FOR ADDITIONAL COMPENSATION WILL BE CONSIDERED DUE TO THE CONTRACTOR'S FAILURE IN THIS REGARD.

- A) ALL CAST STONE JOINTS TO BE RAKED FOR A MINIMUM OF 3/8" AND POINTED INCLUDING JOINTS UNDER SILLS. (COLOR OF POINTING MORTAR TO MATCH EXISTING STONE AS APPROVED BY THE CONTRACTING OFFICER).
- B) ALL CRACKS IN EXTERIOR WALL SHALL BE RAKED CLEAN AND CAULKED. COLORS TO MATCH EXISTING ADJACENT SURFACES.
- C) CAST STONE COPING AND SILL JOINTS SHALL BE RAKED FOR A MINIMUM OF 1/2", CAULKED AND A CLEAR WATERPROOFING AGENT APPLIED IN ACCORDANCE WITH THE SPECIFICATION.
- D) ALL EXISTING EXTERIOR PAINTED METAL SHALL BE SCRAPED CLEAN OF FLAKING AND LOOSE PAINT, SANDED SMOOTH, PRIMED AND PAINTED.
- E) ALL JOINTS BETWEEN EXTERIOR METAL AND MASONRY SHALL BE RAKED CLEAN OF EXISTING CAULKING AND ANY OTHER MATERIAL AND RECAULKED. (USE PROPYLENE ROPE CAULKING STOPS AS REQUIRED.)
- F) ALL EXISTING EXTERIOR LIGHTS SHALL BE CAREFULLY SCRAPED CLEAN OF RUST AND PAINT, PRIMED AND REPAINTED. PAINT AS REQUIRED.
- G) ALL EXISTING EXTERIOR WOOD, INCLUDING FASCIAS, SOFFITS AND TRIMS SHALL BE SCRAPED CLEAN OF ALL FLAKING AND LOOSE PAINT, AND REPAINTED.
- H) ALL BROKEN GLASS BLOCK IS TO BE CAREFULLY REMOVED AND REPLACED TO MATCH EXISTING. WHERE GLASS BLOCK IS CRACKED, THE CRACK SHALL BE FILLED WITH A CLEAR SEALANT. THE CONTRACT PRICE SHOULD INCLUDE THE SCRAPING AND POINTING OF 40% OF THE GLASS BLOCK JOINTS.
- I) AT ALL WINDOWS, GLAZING MATERIAL SHALL BE SCRAPED CLEAN FROM EXISTING SASH, NEW POINTS INSTALLED AS REQUIRED AND NEW GLAZING MATERIAL APPLIED. (SEE PARAGRAPH E FOR CAULKING REQUIREMENTS.) PAINT AS SPECIFIED.

ELEVATION NOTES

REFER TO DWG NO 5 & 6

- 1. INSTALL NEW CAST IRON VENT SCREEN OVER EXISTING V.E.T.
- 2. PROVIDE AND INSTALL NEW GLASS TO MATCH EXISTING. REMOVE WOOD BARRIER IF PRESENT. (GLAZE AS PER GENERAL REPAIR NOTE (I).)
- 3. REMOVE EXISTING DAMAGED LOUVER. CLOSE OPENING WITH NEW METAL PANEL.
- 4. REMOVE EXISTING GRATING, SUPPORT AND CEMENT COPING. PROVIDE AND INSTALL NEW GRATING COMPLETE WITH SUPPORTS AND NEW STONE COPING TO MATCH EXISTING.
- 5. REPAIR EXISTING DAMAGED WINDOW. REMOVE A PORTION OF INTERIOR PLASTER AS REQUIRED TO EXAMINE AND RESET WINDOW FRAME ANCHORS.
- 6. REMOVE EXISTING CLOCK AND MEDALLION AT START OF CONSTRUCTION. STORE UNTIL COMPLETION OF WORK AND REHANG IN EXISTING LOCATION.
- 7. PROVIDE AND INSTALL NON-CORROSIVE METAL CAP OVER EXISTING ELECTRICAL OUTLETS.
- 8. CLEAN EXISTING STUCCO SURFACE OF ALL LOOSE MATERIAL. REPAIR CRACKS AND PAINT WITH CEMENTITIOUS WATERPROOFING AS SPECIFIED. COLOR AS SELECTED.
- 9. RAKE ALL JOINTS OF STEPS CLEAR OF DIRT PLANTING AND OTHER MATERIAL AND CAULK. USE CAULKING STOPS AS REQUIRED.
- 10. RAKE ALL LOOSE MORTAR JOINTS A MINIMUM OF 1/2" AND POINT. (COLOR OF MORTAR TO MATCH EXISTING).
- 11. CUT BACK ALL VEGETATION AND LOWER GRADE IN FRONT OF WINDOW MINIMUM 12" BELOW SILL LINE. PROVIDE AND INSTALL NEW GALVANIZED STEEL AREAWAY WALL WITH GRAVEL BASE. SEE DETAIL.
- 12. RESET DISPLACED WINDOW. RAPE AND BARRICADE AS DETAILED.

SEE DWG 5

ON MICROFILM

PREPARED	AP	DRAWING NO.	646
DESIGNED	LJ	PROJECT	41,040A
DRAWN	DP	PKG	SHEET
CHECKED			5
DATE	7-17-78		OF 18

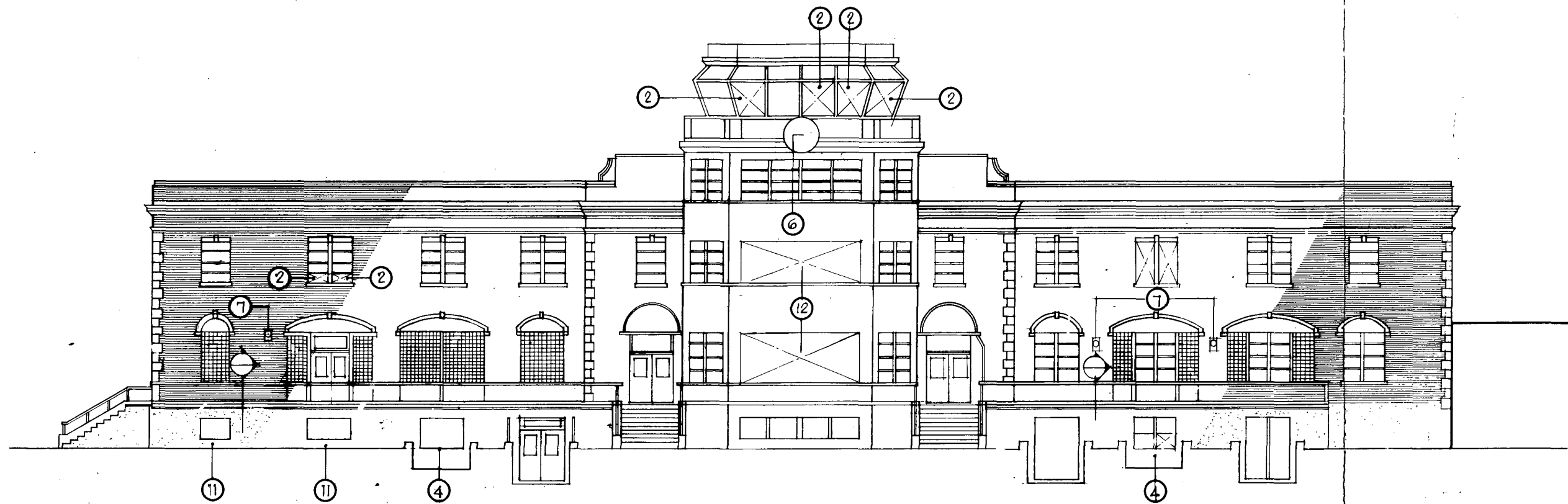

EAST ELEVATION
SCALE: 1/8" = 1'-0"

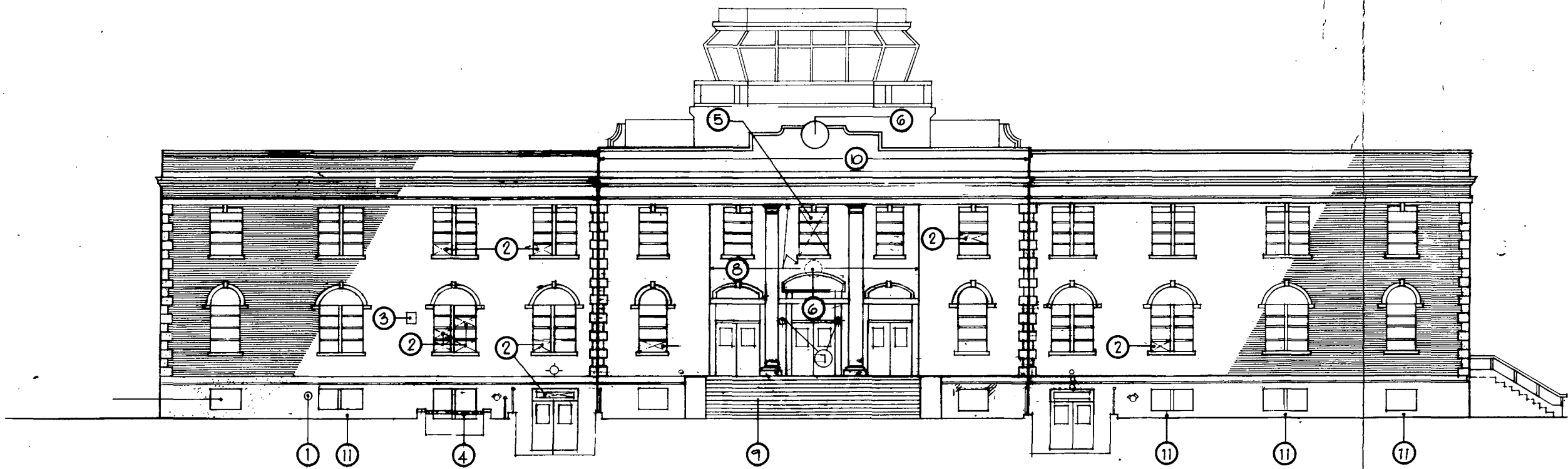

WEST ELEVATION
SCALE: 1/8" = 1'-0"

ON MICROFILM

PREPARED DHP	DRAWING NO. 646
DESIGNED L.J.	41 CACA
DRAWN DHP	PCIP SHEET
CHECKED 7-17-78	109 6
DATE	OF 18

HANGAR COMPLEXES - GENERAL

The historical descriptions of the four hangar complexes are virtually identical. This section will deal with the historic appearance of a typical complex. Individual hangar complexes, their existing conditions, general recommendations, and costs will be discussed in the sections immediately following.

A. Historical Description

1. Exterior

a. General Site

Each hangar measured 120 feet in the east-west direction and 140 feet in the north-south direction. A single story lean-to, 30-feet 4-inches wide, was constructed as part of each hangar at either the west or east side; hangars nearer Flatbush Avenue had a lean-to at the avenue (west) elevation, while hangars nearer the runway had a lean-to at their east elevation. Hangars were sited in four pairs, parallel to Flatbush Avenue. Individual pairs were projected on an axis perpendicular to that avenue with 50 feet of clearance left between each pair. Two hangar complexes/pairs (Complex 4 and Complex 3) were positioned approximately 600 and 750 feet respectively, to the south of the Administration Building. The other two were located approximately 350 and 500 feet (Complex 5 and Complex 6, respectively) away from the Administration Building to the north.

During the WPA era, each pair of hangars became joined by the addition of a two-story infill, constructed in the 50-foot wide area between the once separate structures.

b. Steel Framing System

Steel columns, approximately 32-1/2-feet high, were spaced 20-feet apart along the east and west wall foundation of each hangar, and centered on 5-foot square by 3-foot deep pile caps. Steel trusses (12-feet deep at the center sloping to 10-feet deep at the ends) spanned columns in the east to west direction, with vertical bracing

between. The lean-to shared the I-beam columns of its adjacent hangar. Framing of the lean-to roof consisted of 18-inch steel I-beams, which spanned from the steel columns at the hangar side (at a height of approximately 13 feet) to the exterior brick bearing walls (at a height of approximately 12 feet). Channel purlins, 8-inches deep, were placed perpendicularly across the beams at 6 feet on center.

c. Masonry

(1) Foundation

Hangar foundation design was similar to that of the Administration Building. It consisted of what was essentially a continuous reinforced concrete spread footing/pile cap supporting the bearing walls. Deep concrete piles were driven to further stabilize the structure in the sandy soils. This perimeter footing, serving basically as a grade beam, was 4 feet below grade; the first 3 feet being 16 inches in width, the fourth foot spreading to 22 inches in width. At 10 feet on center, around the perimeter, 14-inch square reinforced concrete piles were driven to a depth of 35 feet into the sandy subsoils. Extra reinforcement was provided every 20 feet on center under the columns at the east and west walls of the hangar, where the footing spread to a 5-foot square pile cap, 3-feet deep, with a pile at each corner. Hangar flooring consisted of steel fabric-reinforced concrete.

According to the typical hangar drawings dated 1929 (Contract No. 1967) the lean-to floor was left unfinished. Later drawings dated 1931 (Contract No. 2028A) show that a floor of 6-inch cinder concrete was laid at that time.

(2) Walls

The superstructure consisted of steel framing members and partially-bearing brick walls. Face brick was reddish/orangish in color, laid in Flemish bond, with a header row every sixth course. A 35-foot high brick pilaster supported on a high concrete base reinforced each corner of the hangar. Pilasters were reinforced by bands of cast stone, located just above the concrete base, at the top, and about 8-feet below the top. A single line of headers projected 1/2

inch and formed the outline of a square between the two upper bands and the outline of a long rectangle between the base and the cast stone trim high above.

A graduation in height from the tall hangar to the one-story lean-to was successfully accomplished by means of continuing the north and south elevations of the lean-to into a high parapet. The outline of the parapet curved and stepped down from a height near the top of the hangar pilaster, ran parallel to the ground, then curved and stepped down twice again in a pattern which rounded the corner and met the shorter parapet of the longer elevation of the lean-to.

The major elevation of the lean-to (either east or west) was divided into seven bays with simple pilasters to further stabilize the bearing walls and support the steel beams of the roof structure.

d. Openings

(1) Doors

The north and south elevations of the hangar were dominated by 22-foot high by 10-foot wide aluminum alloy doors which could be slid open to reveal the whole hangar interior. Doors nearer the lean-to were the straight sliding type which could be retracted into pockets built in the lean-to. The other half of the doors could be slid the other direction and around the corner. Door rails were embedded in the concrete of the hangar floor and door guide angles were placed beneath the bottom chords of trusses to allow for this movement. They were roughly divided into thirds vertically--the bottom third solid and the upper two-thirds smaller panes of wired glass. Standard, human-scale doors, were employed elsewhere. In the end section of each sliding door unit was a standard sized "pilot" door for easy passage. One exterior door into each end of the lean-to was provided. These lean-to doors were wood, multi-paneled. Above each door was a nine-light window with a semicircular arch. The arch was emphasized by an outlining header course with cast stone keystone.

The door arrangement at each elevation of the infill structures was generally similar. A large central opening housed oversized double doors and was framed in a simple design of brick and cast stone. This central opening was flanked either by single doors or windows, one each near either side of the elevation.

(2) Windows

Wood frame, one over one, double hung sash windows were installed at the south and north ends of the long exterior elevation of the lean-to, while steel frame windows were used elsewhere. The steel windows were multipaned and fixed with interior panes framed to pivot open. Openings were plain on their interior sides, but on the exterior, had cast stone sills and flat arches with a soldier course and cast stone keystone. The hangar elevations which were later joined by the WPA addition originally were dominated by multi-paned window infills which spanned between the seven bays. Above the lean-tos, at the opposite elevations, similarly designed window infills were installed.

e. Roof and Roof Drainage

The roof structure of the main hangar space consisted of: steel Warren trusses 10 feet in depth at the supports to 12 feet at the center running east-west at 20 feet on center with vertical cross bracing; 10-inch channel purlins with 3-inch by 4-inch spruce nailers above and perpendicular to the trusses; and 1-1/2-inch thick by 8-inch wide T&G sheathing. A simpler roof structure was above the lean-to space. It consisted of T&G sheathing over steel channels with nailers, which in turn rested on 18-inch deep steel I-beams. The hangar roof sloped slightly down from the center to the east and west (1 in 30), while the roof of its lean-to sloped away from the hangar at the same rate (1 in 30). Roof covering (according to original drawings) was originally composition roofing with a mineralized surface.

Rainwater furniture was of copper and wrought iron. Copper gutters ran the length of the east and west hangar elevations. Water was carried into subterranean drain pipes via wrought iron leaders which ran down the exterior face of the hangar, across the roof of the

lean-to, and down the face of the lean-to into the drains. Leaders on the elevation opposite the lean-to (this was before the infill structure was built to tie the two hangars together, and there was still 50 feet of space between the two) ran straight down the wall from the gutter. Copper flashing was used throughout.

f. WPA Work

Various additions and changes were made to the structures by the WPA. Work done varied from building to building, but some general, typical modifications were made to the hangar complexes. In the 50-foot wide clearance between each pair of hangars, an infill building, which connected the two hangars along the full length of their facing elevations, was constructed. The infill structure was compatible with the existing structures, using the same types of brick and bond, and parapets of approximately the same height as the hangars it connected. The parapet configuration varied from structure to structure, but all were capped with a band of cast stone. There were also variations in the elevations as a whole, the floor plan layouts, and roof structure. Individual in-fill structures will be discussed and shown graphically in their appropriate sections.

2. Interior - Hangar Complex - General Description

The term "hangar complex," as used in this and the following sections, refers to a pair of hangars, their lean-tos, and the WPA infill structure combined as one unit. Typical interiors of hangar, lean-to, and WPA infill will be discussed here, while any specific details of each hangar complex will be described in the four sections immediately following.

a. Hangar

(1) Flooring

The typical hangar floor was a 6-inch concrete slab, reinforced by welded steel fabric placed 2-inches below the upper surface. The large expanse of flooring was comprised of a series of 10-foot wide by 70-foot long slabs connected by 4-foot long, No. 5 tie rods at 4 feet on center, located 3-inches below the slab surface.

(2) Walls and Ceiling

North and south walls were formed by the interior side of the tall sliding doors described in the exterior section. There initially was no wall separating the hangar from the lean-to, but when the brick wall was filled in between the columns, it was left unfinished with the brickwork exposed. The wall opposite the lean-to wall was originally dominated by glass. Glass was removed at the lower levels and the openings were bricked up as part of the WPA infill construction work.

There were no ceilings in the hangar. The Warren trusses and the 8-inch T&G planking were exposed to view from below.

(3) Doors and Windows

Because there were no interior partitions, no interior doors or windows were used. When the space between the columns which divided the hangar from the lean-to area was bricked-up, steel frame windows, and tin clad gravity fire doors were installed in the new wall.

b. Lean-to

The lean-tos were not finished during the original construction. The exterior walls and roof structure were erected, but floors, interior partitions and finishes were not installed until a few years later, under a separate contract.

(1) Flooring

A note on the 1929 drawings at the lean-to area states: "cement floor omitted in lean-to." Apparently the floors of the lean-tos were not installed until several years later when construction drawings appear for completion of the lean-to interiors. These showed the floor construction of the office spaces to be 6-inch cinder concrete with 3- by 4-inch beveled spruce sleepers embedded at 16 inches on center and 1-inch thick wood flooring over. The remainder of the lean-to floor construction was similar, using 5-1/2-inch cinder concrete slab,

similarly designed sleepers, and 1-1/2-inch thick wood flooring. Toilet areas had 5-1/2-inch cinder concrete slab with tile covering over.

(2) Walls and Ceilings

Under the original contract, the hangars were left open to their lean-tos, with the only separation provided by the exposed structural steel columns. As the lean-tos were finished, a new brick wall was constructed along the line of the columns to clearly divide the two areas (hangar and lean-to).

The lean-tos varied in use. In general, the southern ends were divided into four office spaces with locker and toilet rooms to their north. The central portions and the northern ends were left basically open, the two divided by storage and toilet space.

Interior partitions were terra cotta with a plaster finish. Brick-bearing walls, and the brick wall dividing the lean-to from the hangar, were left exposed in the large open areas and finished with plaster in the offices and smaller areas.

Ceilings consisted of plaster applied to wire lath hung from the steel channels by 3/8- by 12-inch hangers at 5 feet on center.

(3) Doors and Windows

Access from the hangar space into the lean-to was afforded by several standard 3-foot by 7-foot swinging doors and one or two 10-foot wide tin clad gravity fire doors. Originally, the only doors to the exterior were those located, one each, at the short north and south elevations. Later, doors replaced the original window openings along the longer exterior elevation.

Windows between the hangar and lean-to were steel frame and sash.

c. WPA Infill

(1) Flooring

In general, floors were 6-inch concrete slab laid at the same elevation as those of the hangar. Two of the four infill structures (those of Complexes 4 and 5) contained boiler rooms in which the floor elevation dropped 2 feet.

(2) Walls and Ceilings

The long walls adjacent to the hangar portion and the exterior elevations were usually left with the brick surface exposed. Where terra cotta interior partitions were constructed, they were finished smooth with plaster.

The main ceilings usually consisted of the exposed tongue and groove roof sheathing supported on steel Warren trusses, with scattered skylights.

(3) Doors and Windows

Access from the hangar spaces on either side of the infill was afforded by 10-foot wide metal rollup door centered in the adjoining wall. Metal sliding doors (approximately 3 feet by 7 feet) flanked this roll-up door at a distance of about 40 feet to either side.

Solid brick walls filled in around the doors, with no other openings.

Original Drawings - Hangar Buildings

The City of New York, Department of Docks
Contract No. 1967
Sheets 3 5, 6, 7, 8, 9, and 11

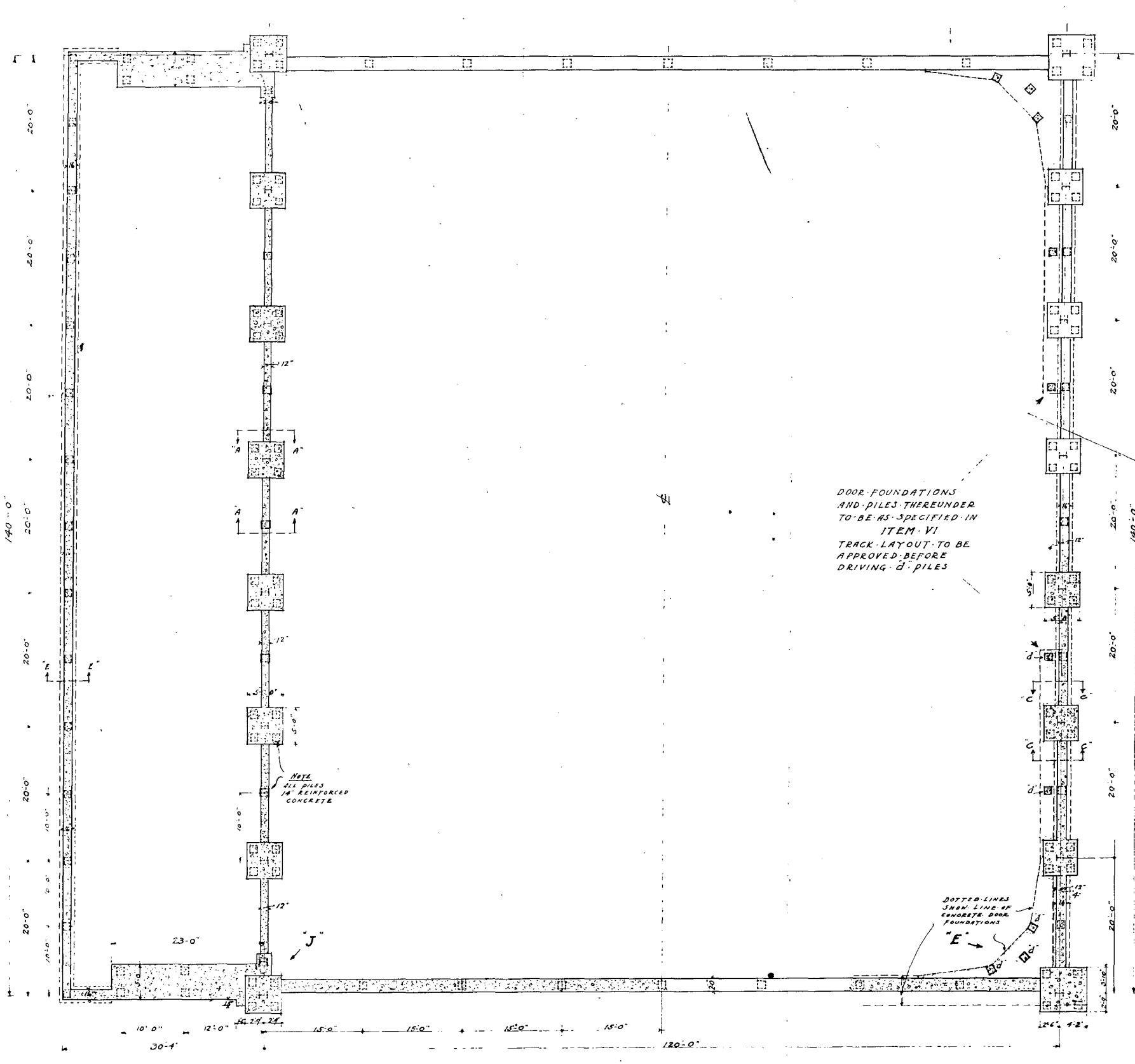
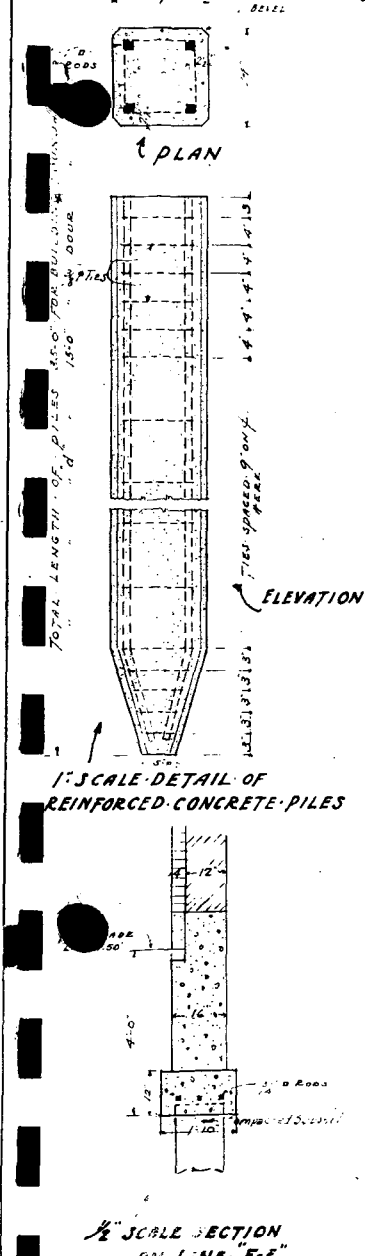

FOUNDATION PLAN
1/2\"/>

DOOR FOUNDATIONS AND PILES THEREUNDER TO BE AS SPECIFIED IN ITEM VI TRACK LAYOUT TO BE APPROVED BEFORE DRIVING OF PILES

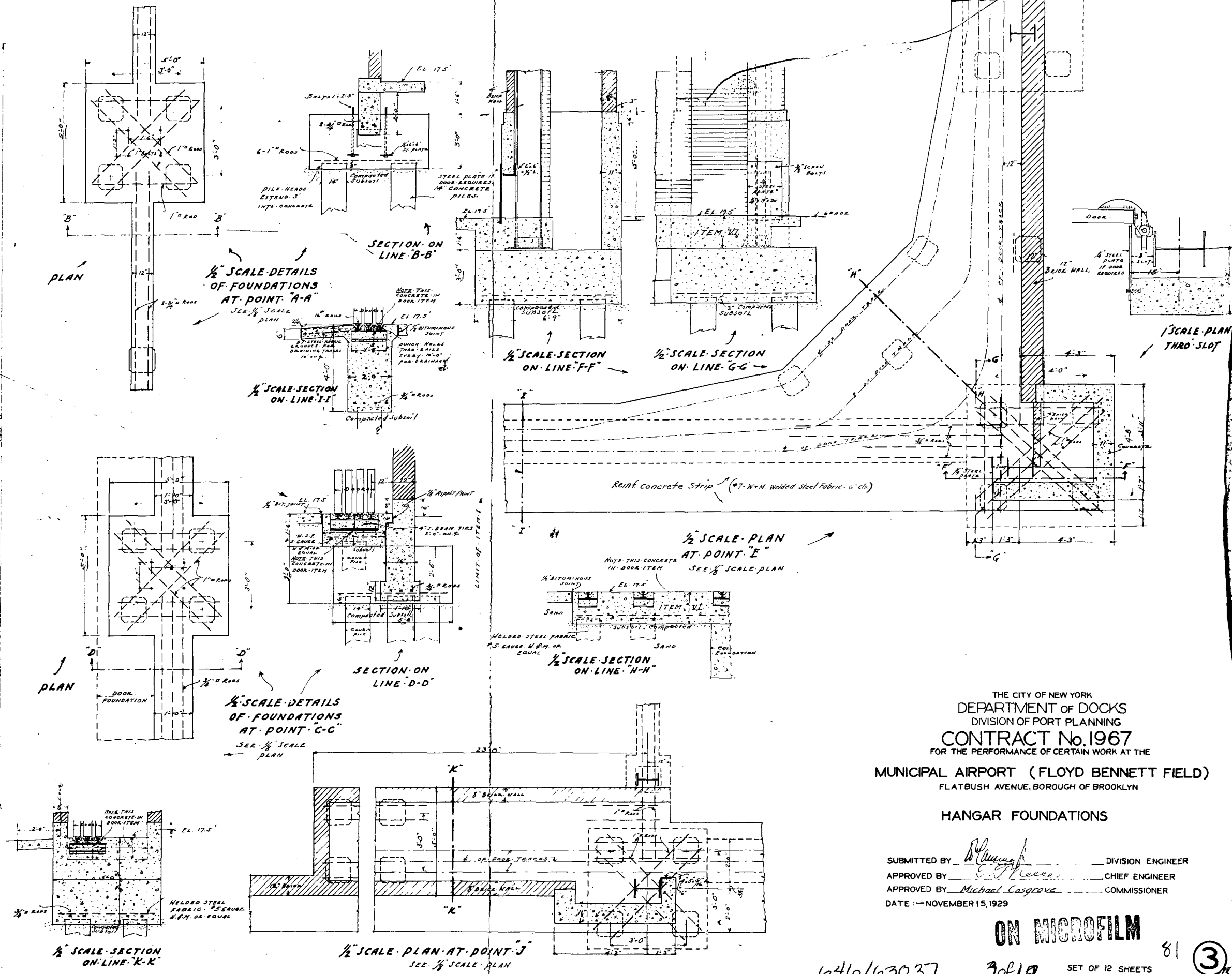

THE CITY OF NEW YORK
DEPARTMENT OF DOCKS
DIVISION OF PORT PLANNING
CONTRACT No. 1967
FOR THE PERFORMANCE OF CERTAIN WORK AT THE
MUNICIPAL AIRPORT (FLOYD BENNETT FIELD)
FLATBUSH AVENUE, BOROUGH OF BROOKLYN

HANGAR FOUNDATIONS

SUBMITTED BY *[Signature]* DIVISION ENGINEER
APPROVED BY *[Signature]* CHIEF ENGINEER
APPROVED BY *Michael Casgrove* COMMISSIONER
DATE: NOVEMBER 15, 1929

ON MICROFILM

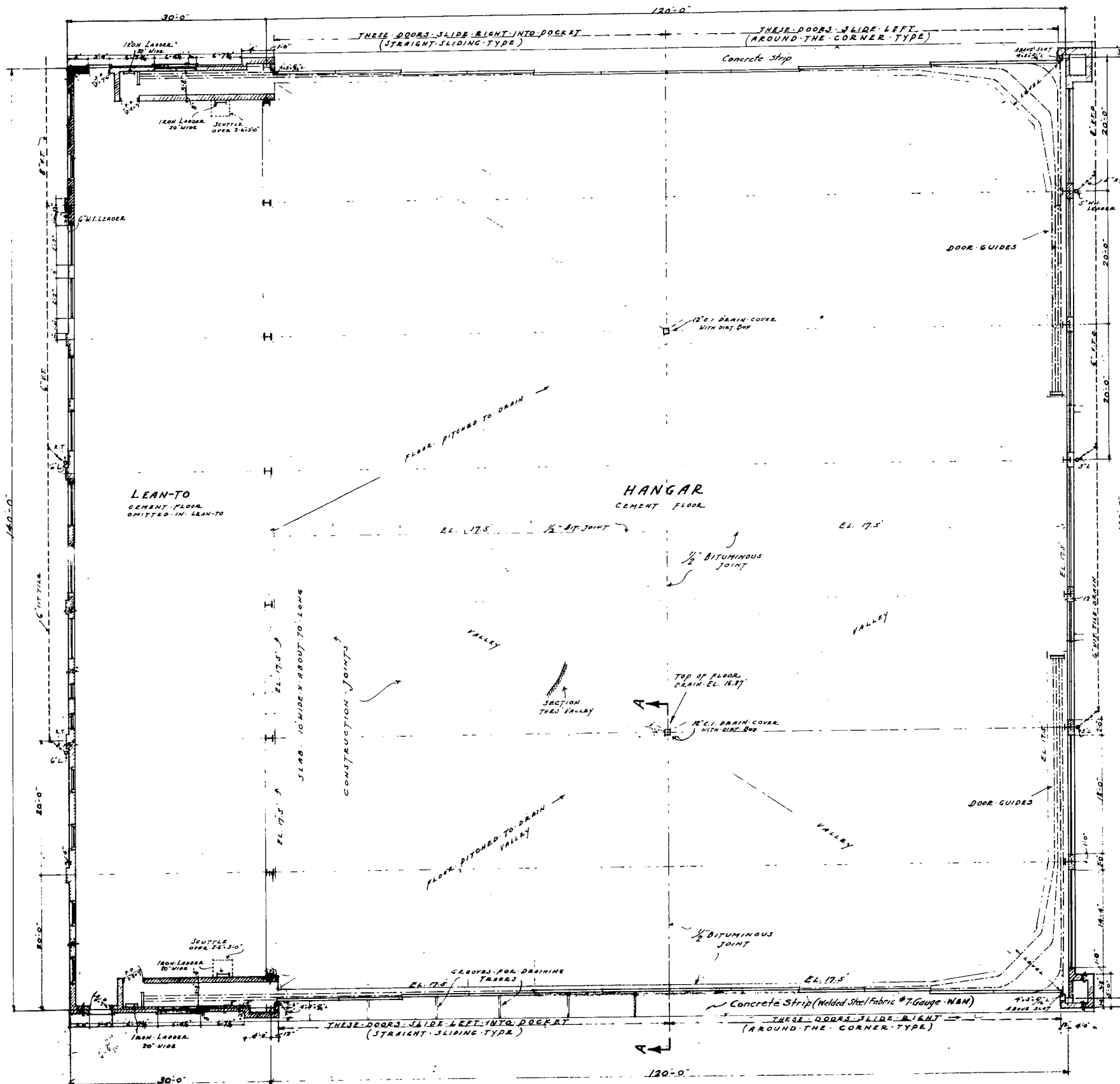

HANGAR FLOOR PLAN
1/4" SCALE

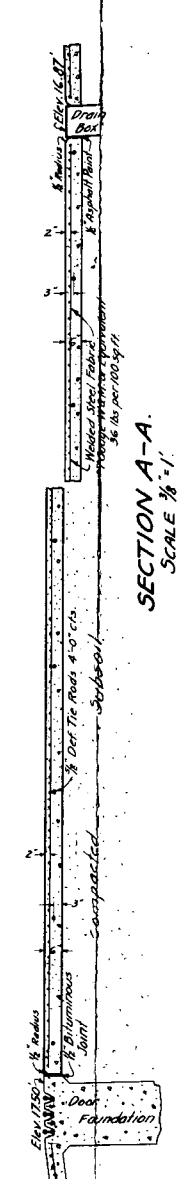

SECTION A-A
SCALE 3/8" = 1'

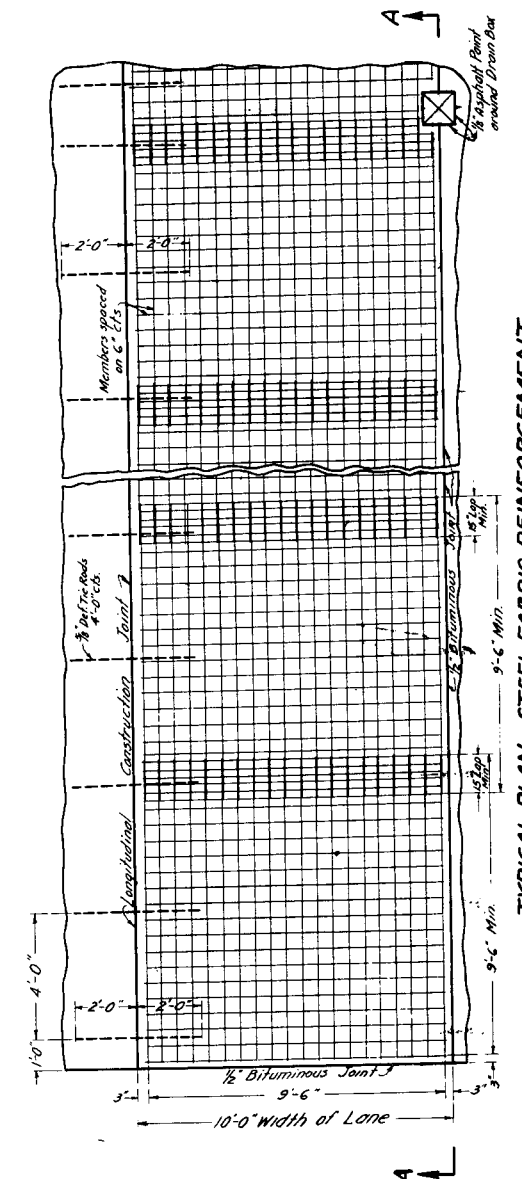

TYPICAL PLAN - STEEL FABRIC REINFORCEMENT
SCALE 3/8" = 1'-0"

ON MICROFILM

THE CITY OF NEW YORK
DEPARTMENT OF DOCKS
DIVISION OF PORT PLANNING
CONTRACT No. 1967
FOR THE PERFORMANCE OF CERTAIN WORK AT THE
MUNICIPAL AIRPORT (FLOYD BENNETT FIELD)
FLATBUSH AVENUE, BOROUGH OF BROOKLYN

HANGAR FLOOR PLAN

SUBMITTED BY *[Signature]* DIVISION ENGINEER
APPROVED BY *[Signature]* CHIEF ENGINEER
APPROVED BY *[Signature]* COMMISSIONER
DATE - NOVEMBER 15, 1929

646/63037 5 of 12 SET OF 12 SHEETS



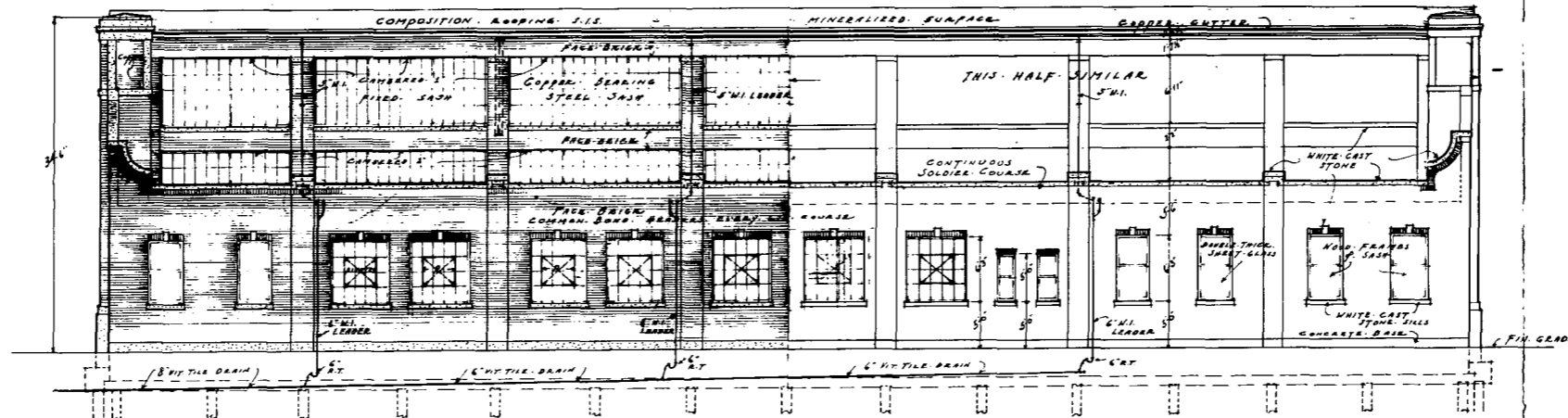

SIDE ELEVATION
(LEANTO SIDE) 1/8" SCALE

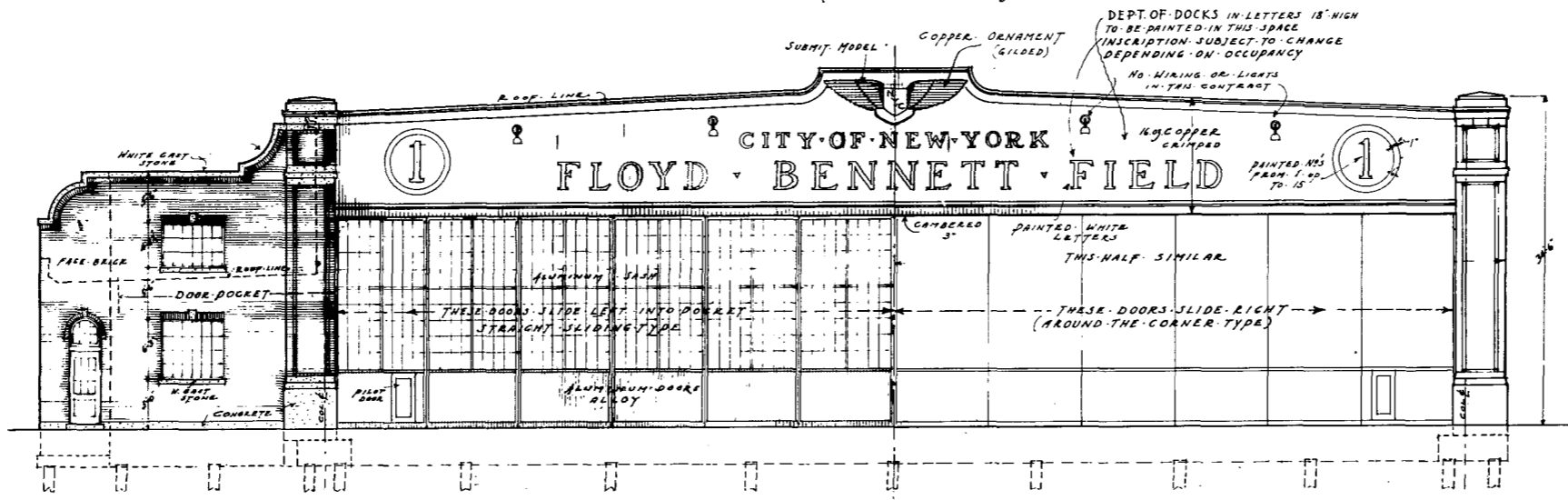

2 END ELEVATIONS
(OTHER END REVERSED)

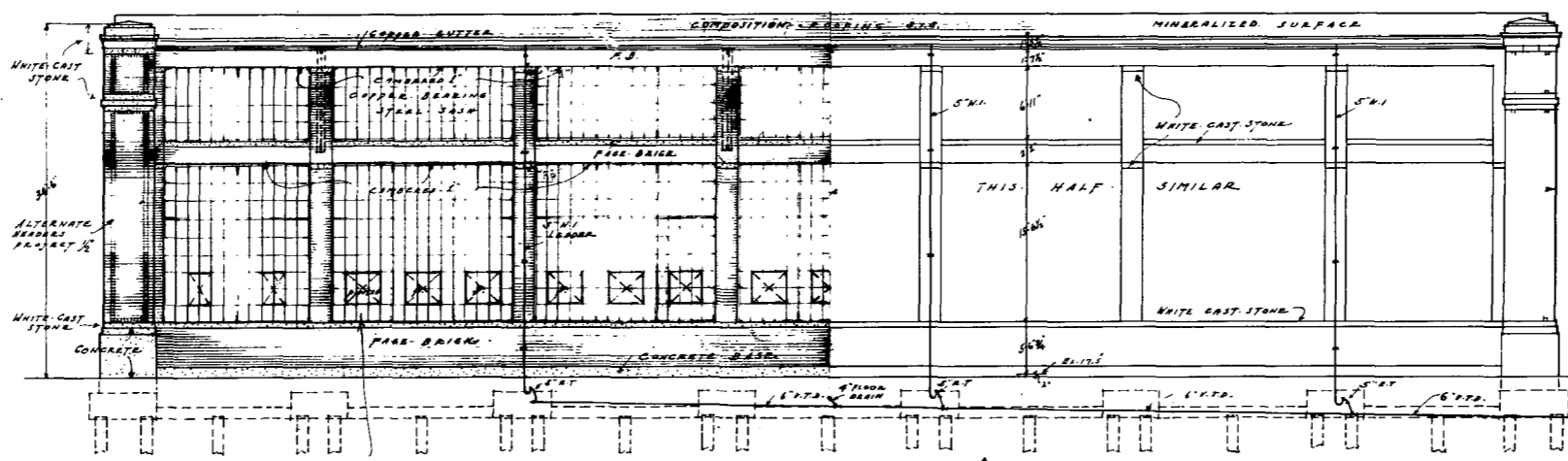

SIDE ELEVATION
1/8" SCALE

ON MICROFILM

THE CITY OF NEW YORK
DEPARTMENT OF DOCKS
DIVISION OF PORT PLANNING
CONTRACT No. 1967
FOR THE PERFORMANCE OF CERTAIN WORK AT THE
MUNICIPAL AIRPORT (FLOYD BENNETT FIELD)
FLATBUSH AVENUE, BOROUGH OF BROOKLYN
HANGAR ELEVATIONS

SUBMITTED BY *[Signature]* DIVISION ENGINEER
APPROVED BY *[Signature]* CHIEF ENGINEER
APPROVED BY *[Signature]* COMMISSIONER
DATE: NOVEMBER 15, 1929

646/63037 6 of 12 SET OF 12 SHEETS 6

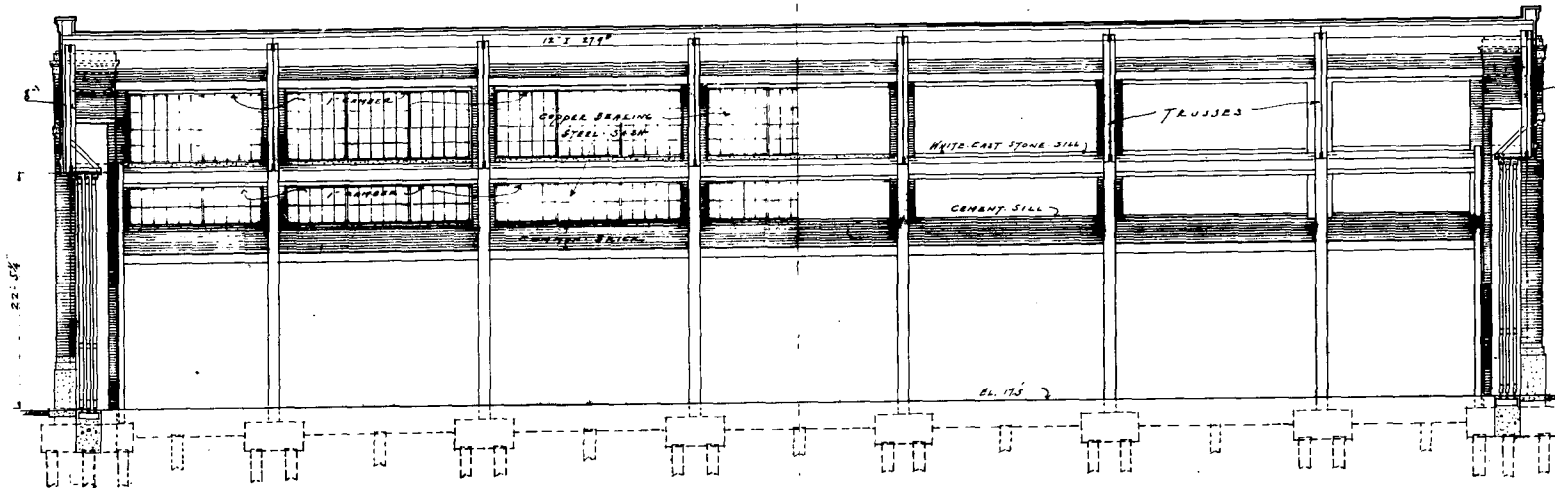
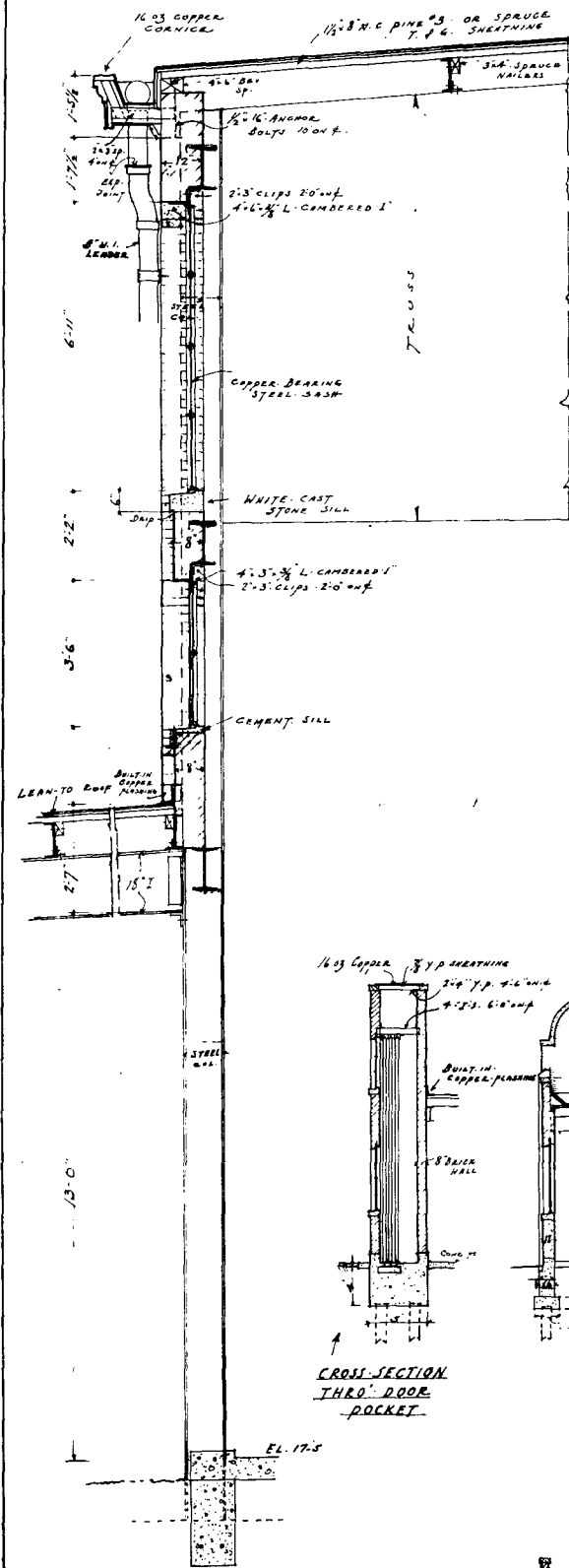

LONGITUDINAL SECTION
 1/8" SCALE
 ON LINE "B-B"

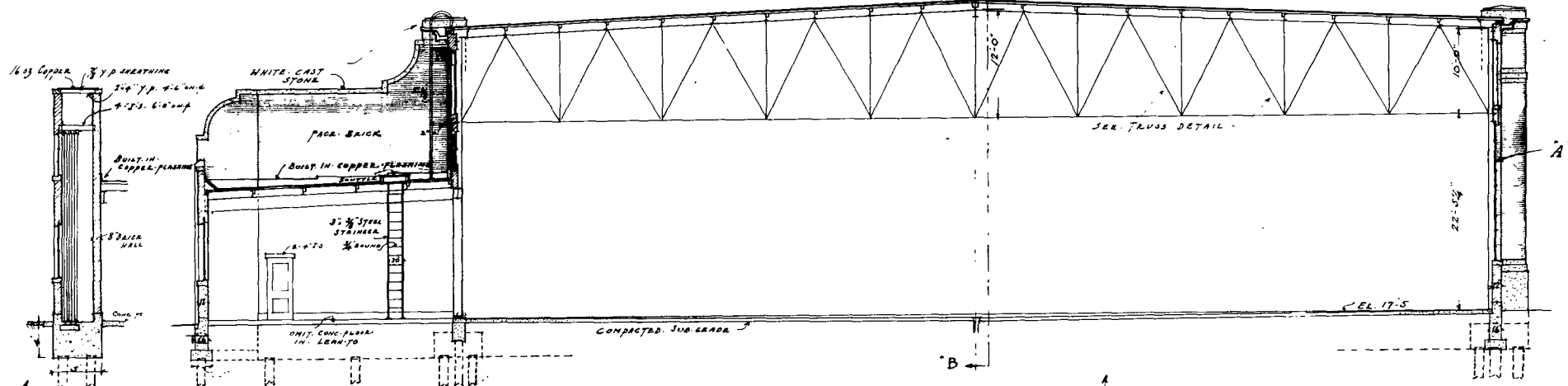

CROSS SECTION
 1/8" SCALE

CROSS SECTION
 THRO' DOOR
 POCKET

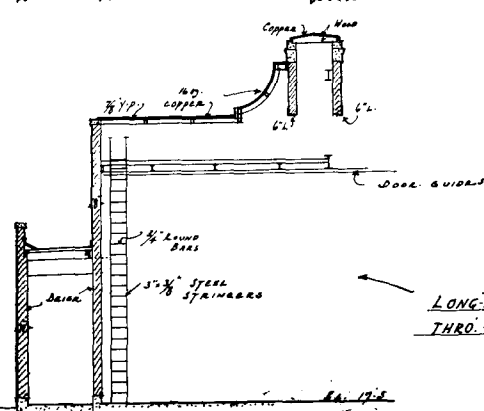

LONG'L SECTION
 THRO' DOOR POCKET
 1/8" SCALE

1/8" SCALE SECTION
 OF WALL BETWEEN
 LEAN-TO & MAIN BLDG.

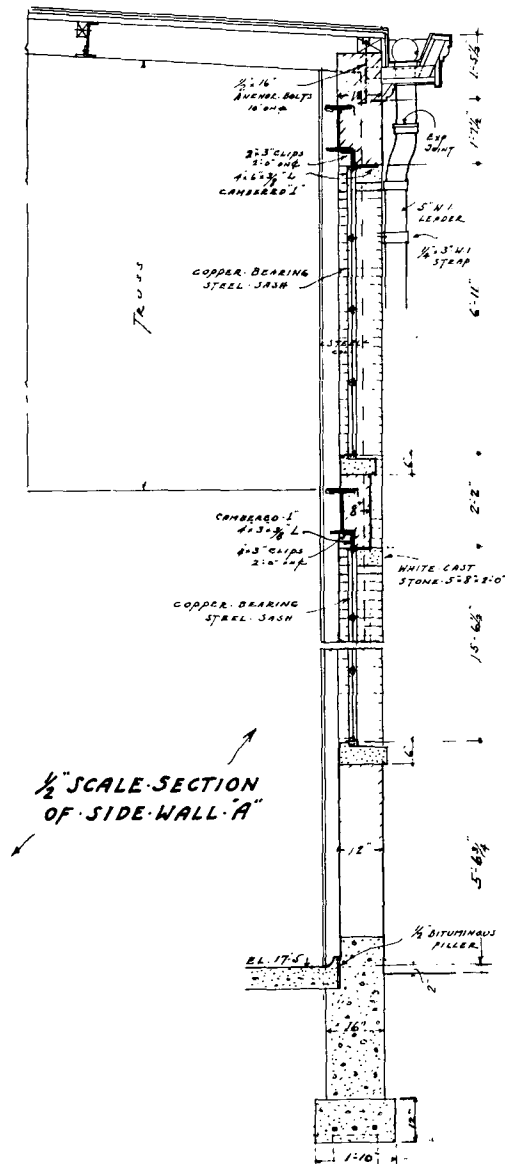

1/2" SCALE SECTION
 OF SIDE WALL "A"

ON MICROFILM

THE CITY OF NEW YORK
 DEPARTMENT OF DOCKS
 DIVISION OF PORT PLANNING
 CONTRACT No. 1967
 FOR THE PERFORMANCE OF CERTAIN WORK AT THE
 MUNICIPAL AIRPORT (FLOYD BENNETT FIELD)
 FLATBUSH AVENUE, BOROUGH OF BROOKLYN

HANGAR SECTIONS

SUBMITTED BY *[Signature]* DIVISION ENGINEER
 APPROVED BY *[Signature]* CHIEF ENGINEER
 APPROVED BY *[Signature]* COMMISSIONER
 DATE - NOVEMBER 15, 1929

6046/63037 7 of 12

SET OF 12 SHEETS

7

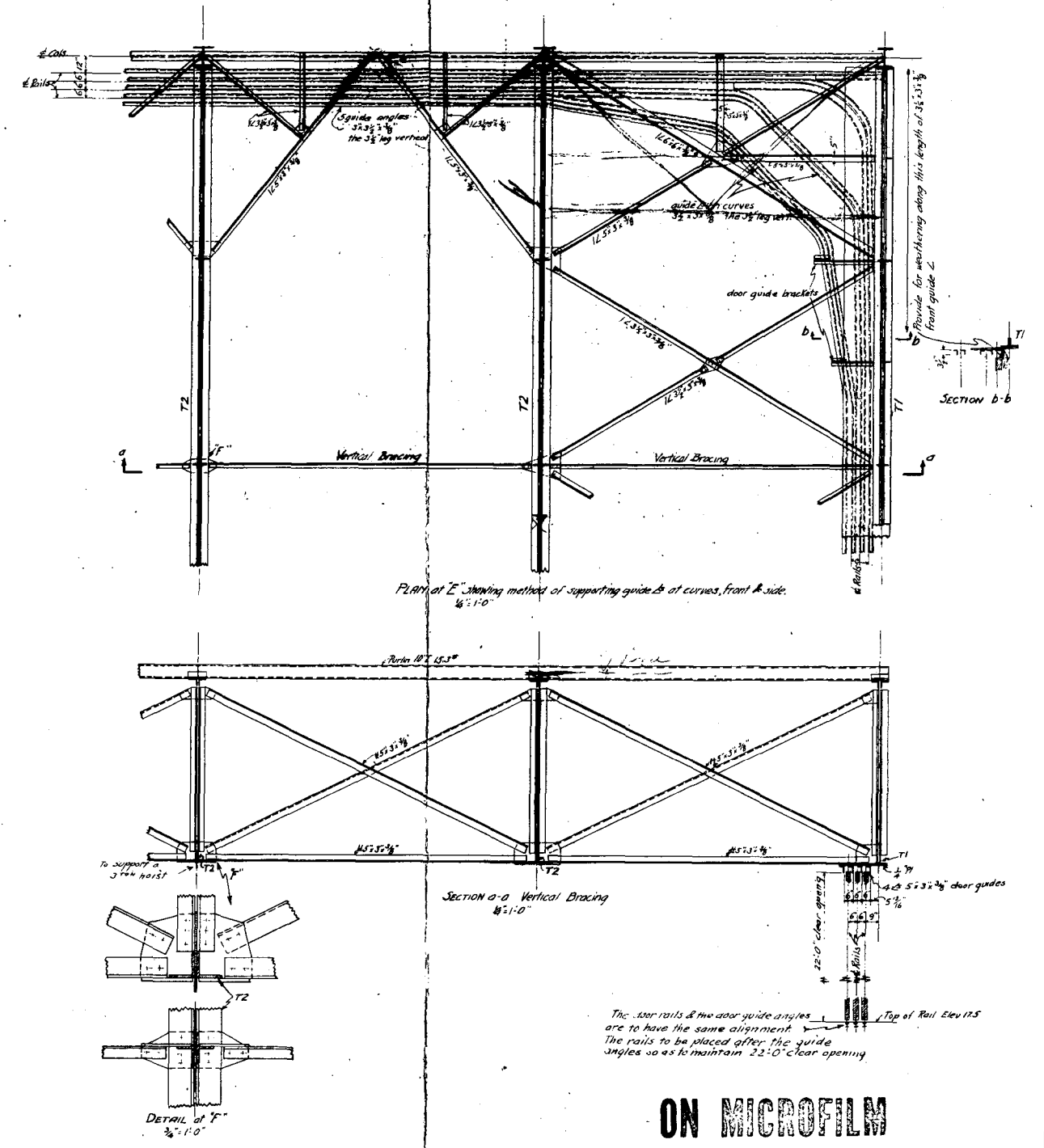
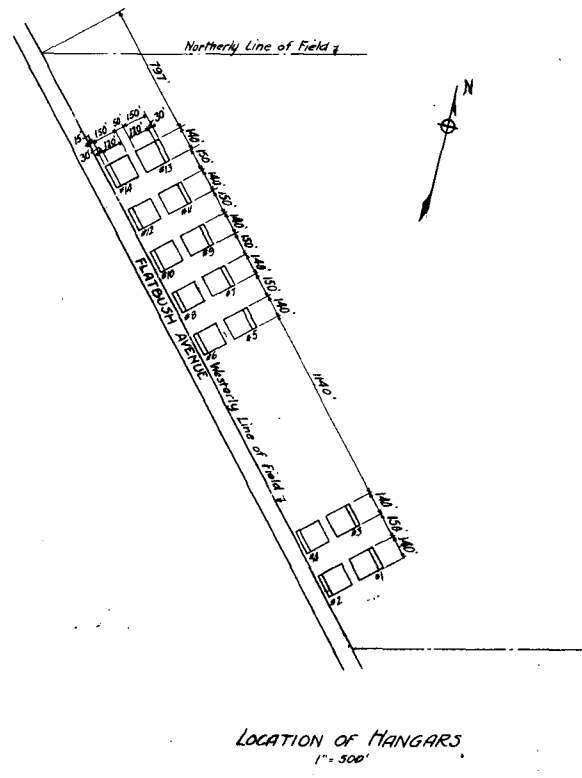
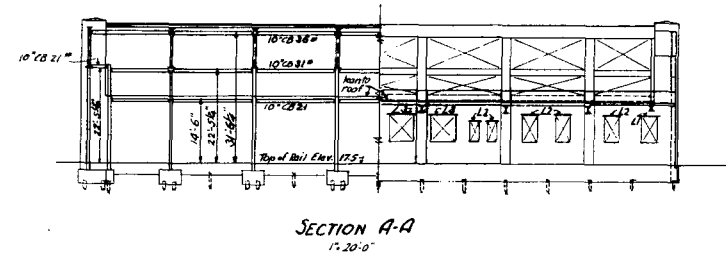
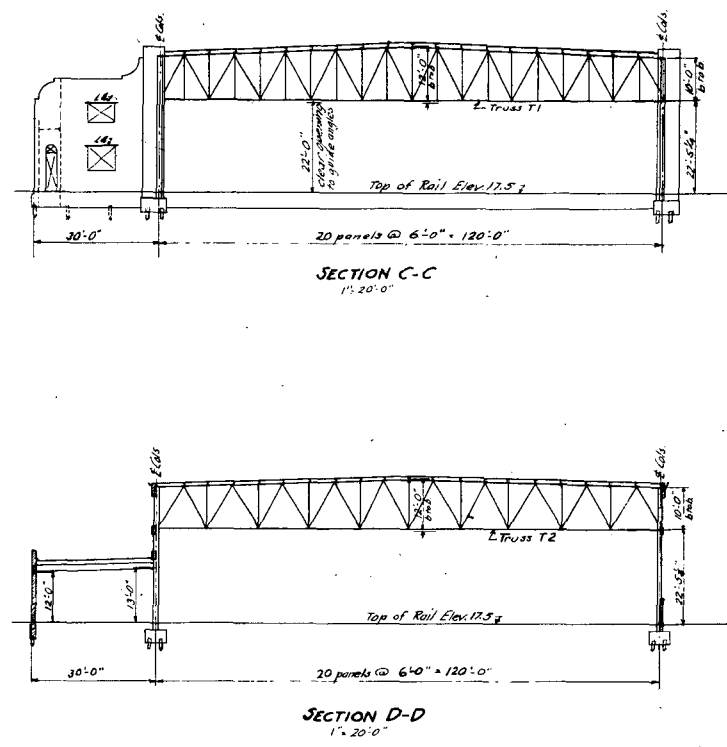
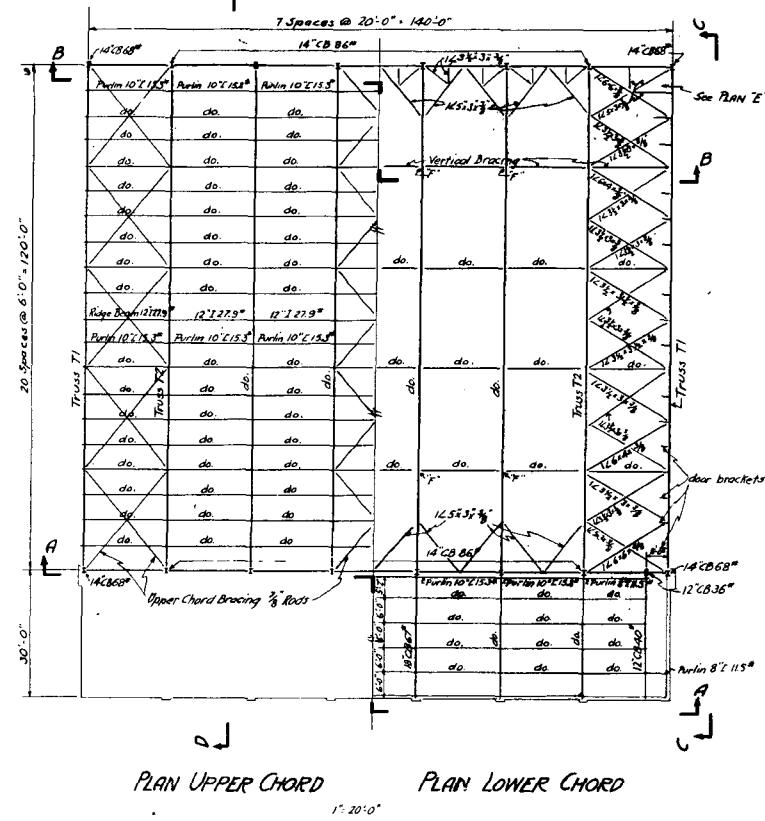

Schedule of Lintels		
L1	2-6"x10.5"	2#2
L2	1-2.5"x4.5"	2#2
L3	1-2.5"x4.5"	2#2
L4	1-2.5"x4.5"	2#2

ON MICROFILM

THE CITY OF NEW YORK
DEPARTMENT OF DOCKS
DIVISION OF PORT PLANNING

CONTRACT No. 1967
FOR THE PERFORMANCE OF CERTAIN WORK AT THE
MUNICIPAL AIRPORT (FLOYD BENNETT FIELD)
FLATBUSH AVENUE, BOROUGH OF BROOKLYN

STEEL FRAMING PLAN

SUBMITTED BY *[Signature]* DIVISION ENGINEER
APPROVED BY *[Signature]* CHIEF ENGINEER
APPROVED BY *[Signature]* COMMISSIONER
DATE: - NOVEMBER 15, 1929

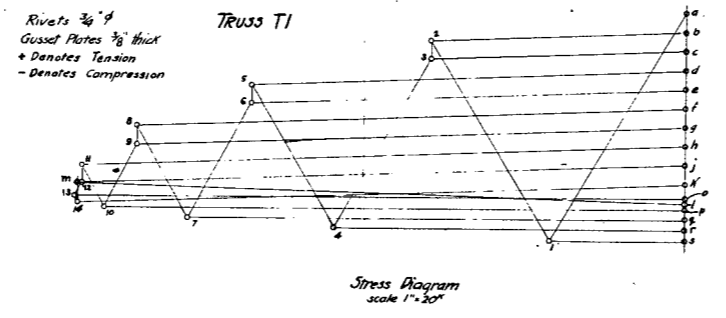
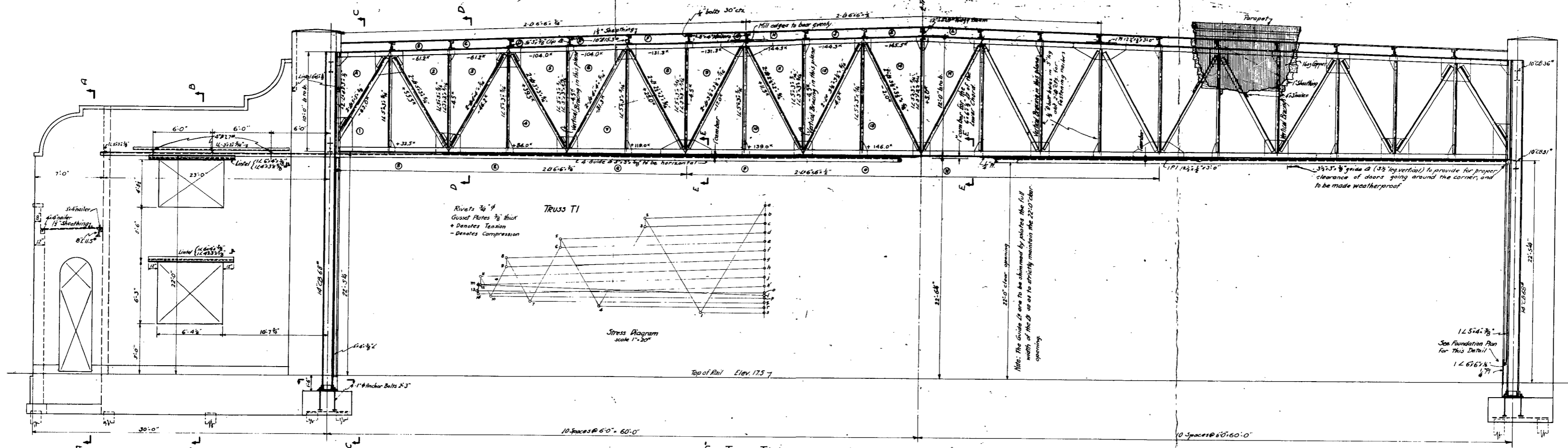

END TRUSS TI (Other Side Opposite)
scale 1/2"=1'-0"

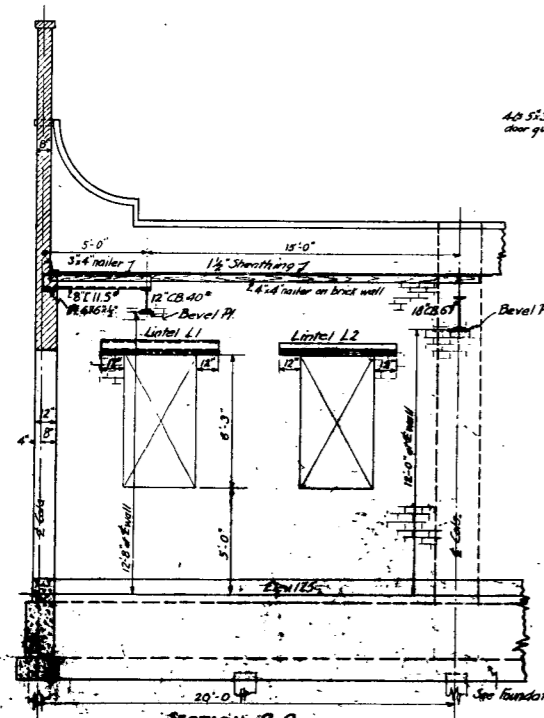

SECTION A-A

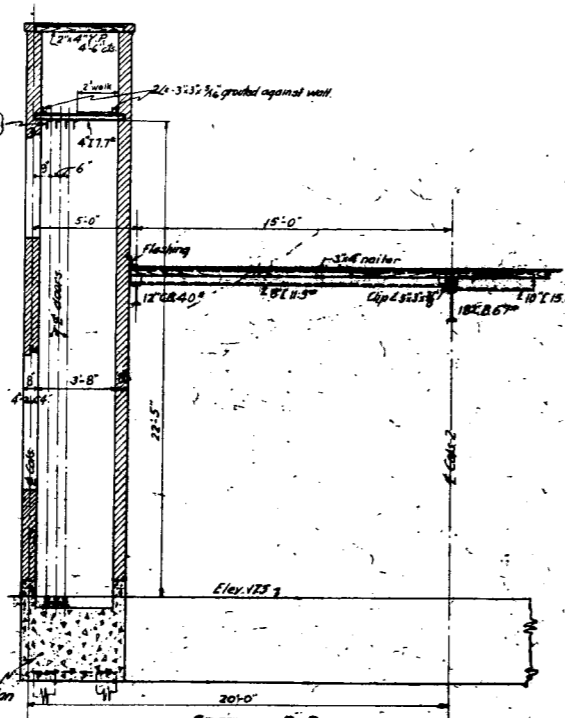

SECTION B-B

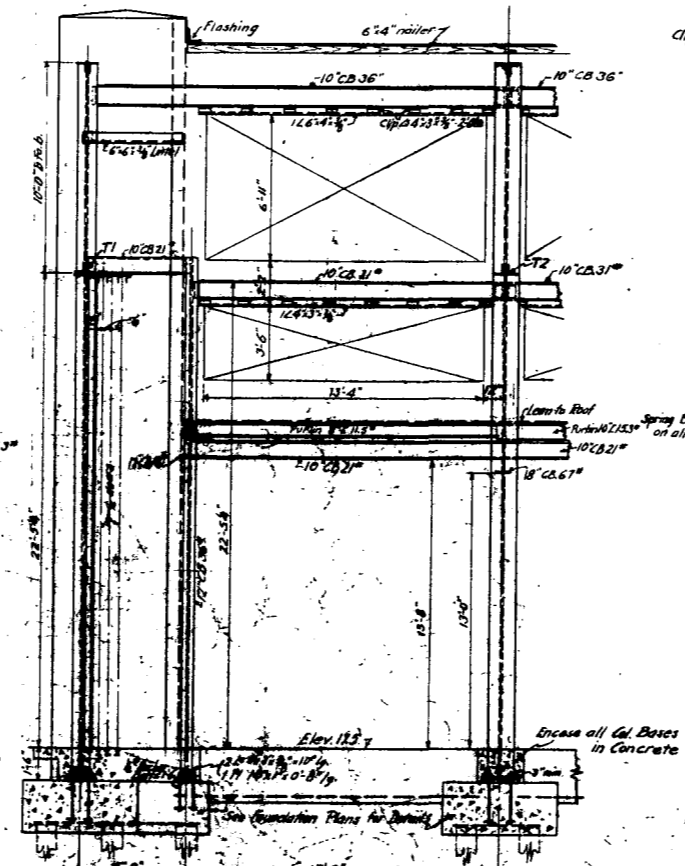

SECTION C-C

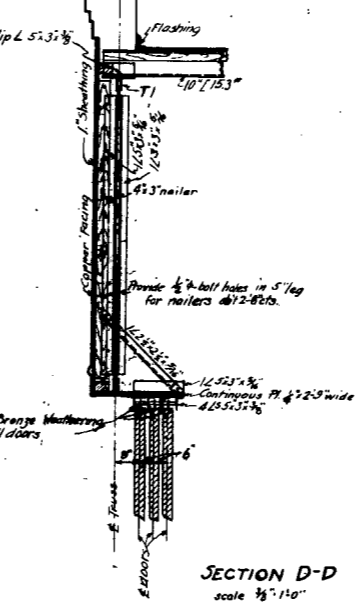

SECTION D-D
scale 1/2"=1'-0"

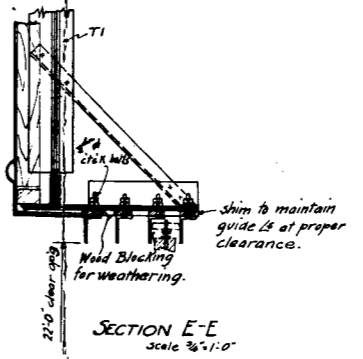

SECTION E-E
scale 1/2"=1'-0"

ON MICROFILM

THE CITY OF NEW YORK
DEPARTMENT OF DOCKS
DIVISION OF PORT PLANNING
CONTRACT No. 1967
FOR THE PERFORMANCE OF CERTAIN WORK AT THE
MUNICIPAL AIRPORT (FLOYD BENNETT FIELD)
FLATBUSH AVENUE, BOROUGH OF BROOKLYN

STEEL - END TRUSSES

SUBMITTED BY *[Signature]* DIVISION ENGINEER
APPROVED BY *[Signature]* CHIEF ENGINEER
APPROVED BY *[Signature]* COMMISSIONER
DATE - NOVEMBER 15, 1929

646/63037

9 of 12

SET OF 12 SHEETS

86 (9)

Drawings for the construction
of the Hangar Lean-tos. 1931

Drawing A-2 could be used to
repair or reconstruct original
toilet partitions.

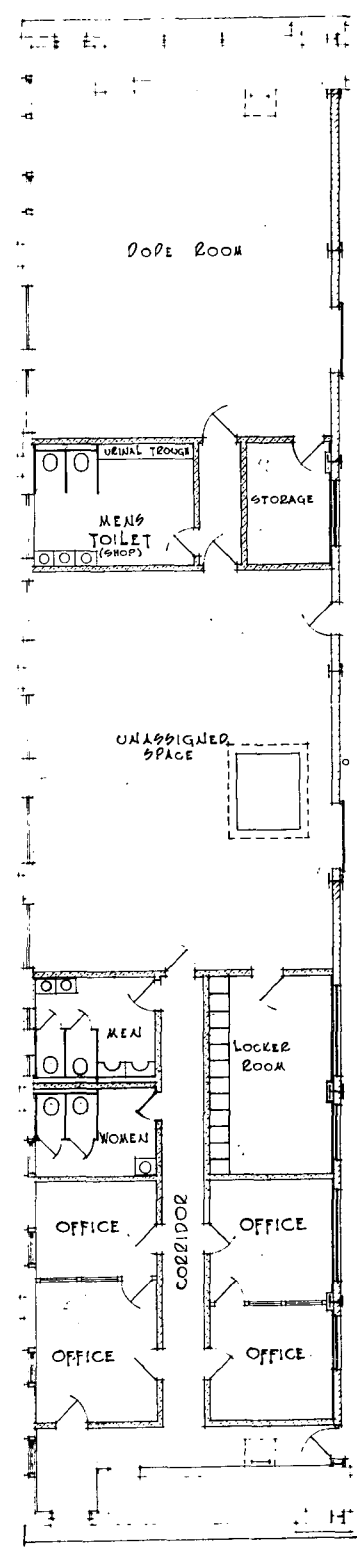

LEANTO PLAN HANGAR #6 scale 1/8"=1'-0"

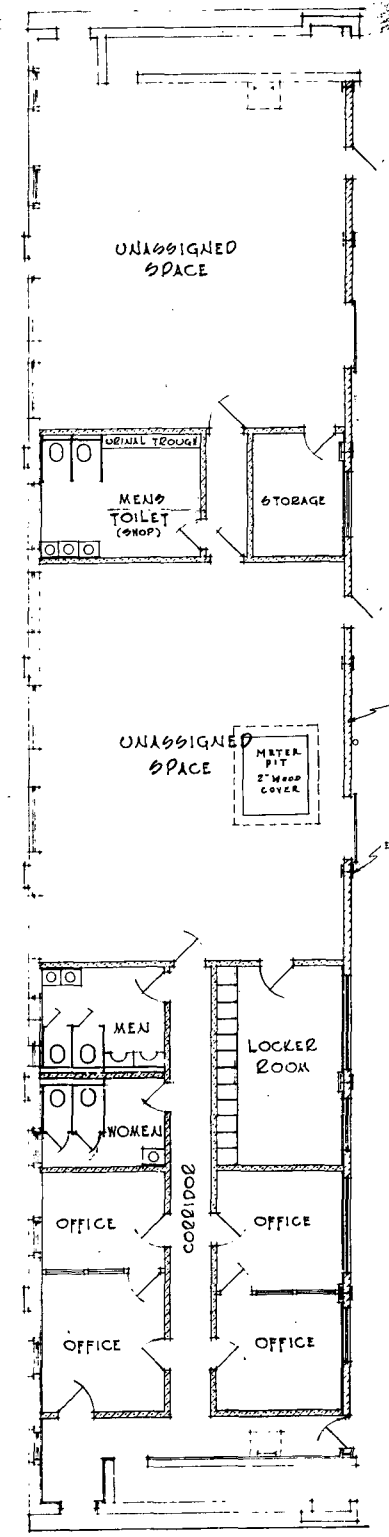

LEANTO PLAN HANGAR #4 scale 1/8"=1'-0"

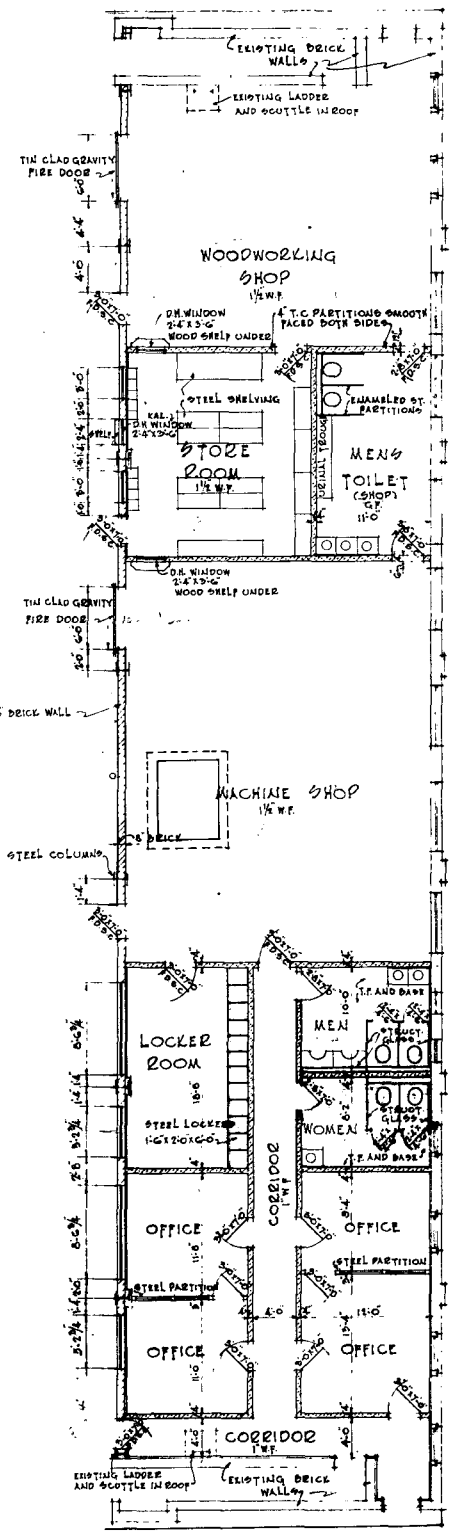

LEANTO PLAN HANGAR #3 scale 1/8"=1'-0"

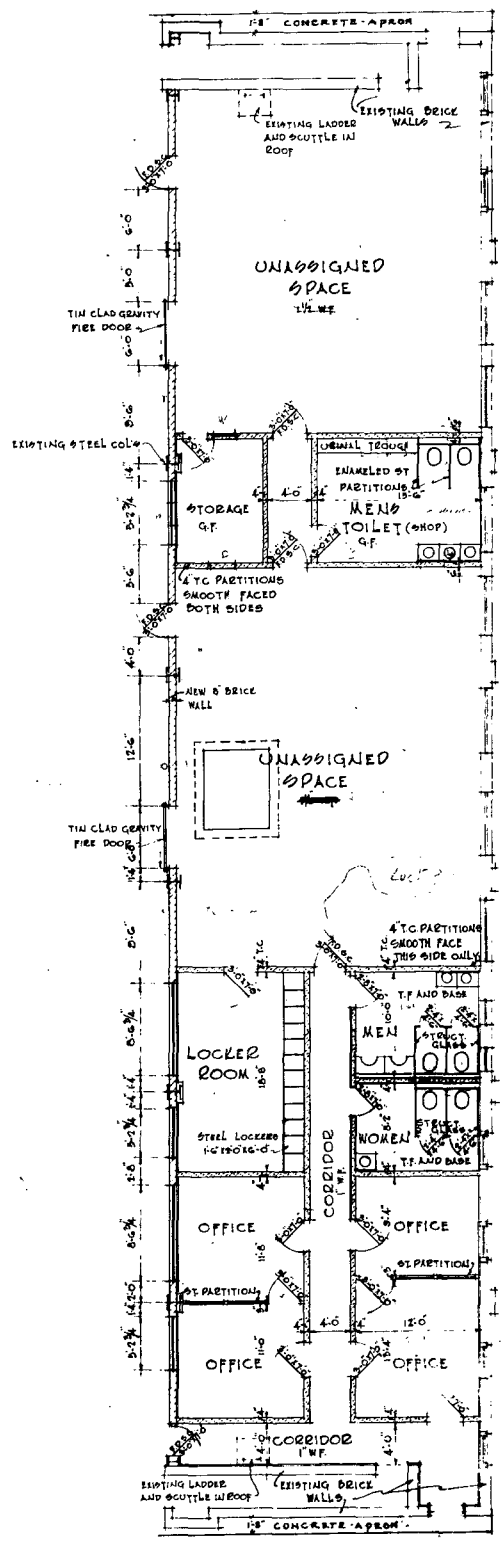

LEANTO PLAN HANGAR #2 scale 1/8"=1'-0"

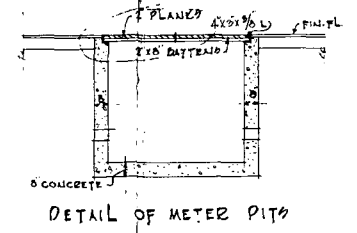

DETAIL OF METER PIT

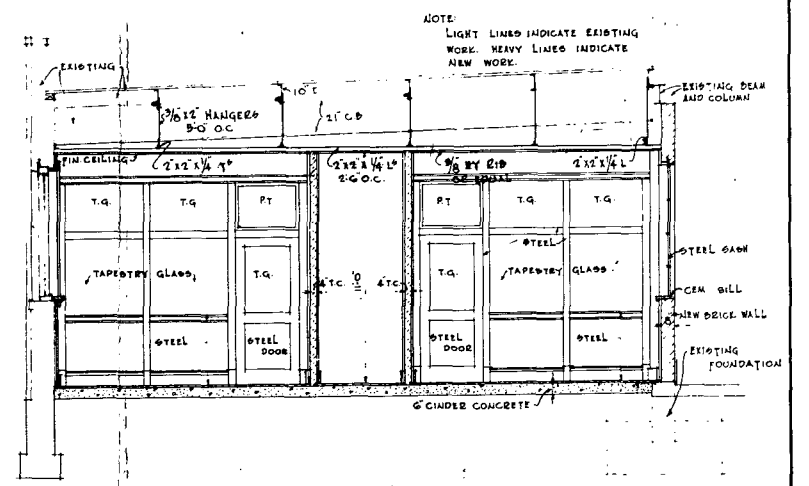

CROSS SECTION THRU LEANTO scale 1/4"=1'-0"

KEY TO MATERIALS

NOTE: LIGHT LINES INDICATE EXISTING WORK. HEAVY LINES INDICATE NEW WORK.

- WOOD
- BRICK
- TERRA COTTA
- CONCRETE
- STRUCTURAL GLASS IN PLAN
- WHITE TILE

- ABBREVIATIONS
- D.H. - DOUBLE HUNG
 - T.C. - TERRA COTTA
 - W.F. - WOOD FLOOR
 - T.F. - TILE FLOOR
 - G.F. - GRANOLITHIC FINISH

ON MICROFILM

THE CITY OF NEW YORK
 DEPARTMENT OF DOCKS
 DIVISION OF PORT PLANNING
 CONTRACT NO. 2028 A
 FOR THE CONSTRUCTION OF OFFICES, SHOPS
 ETC. IN FOUR HANGAR LEANTOS AT THE SITE
 OF

THE MUNICIPAL AIRPORT
 FLOYD BENNETT FIELD
 FLATBUSH AVE. BOROUGH OF BROOKLYN
 SUBMITTED BY *[Signature]* DIVISION ENGINEER
 APPROVED BY *[Signature]* CHIEF ENGINEER
 APPROVED BY *Michael Cosgrove* COMMISSIONER
 DATE - Feb. 16, 1931

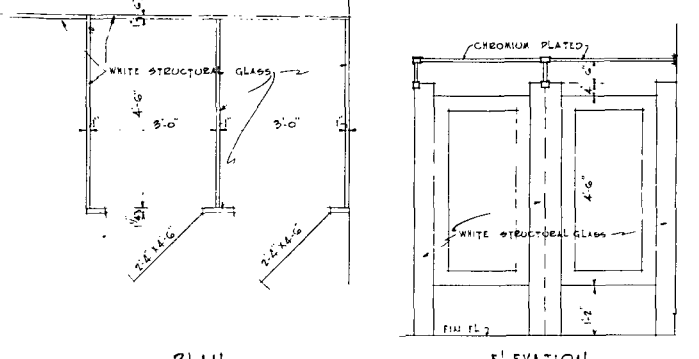

PLAN
ELEVATION
TYPICAL DETAILS OF TOILET PARTITIONS WITH DOORS
Scale 1/2"=1'-0"

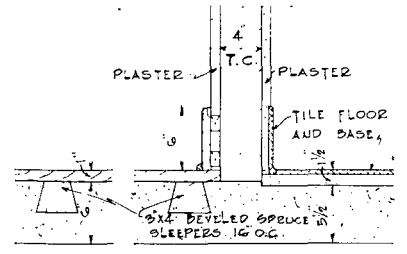

DETAIL OF FLOOR CONSTRUCTION
Scale 1/2"=1'-0"

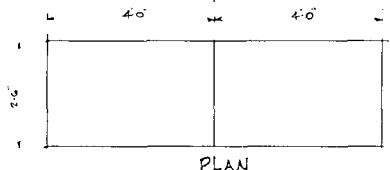
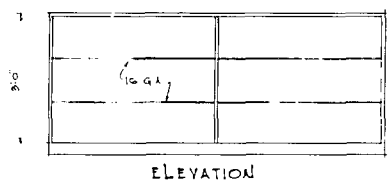

ELEVATION
PLAN
DETAILS - METAL SHELVING
HANGAR NO 5
Scale 1/2"=1'-0"

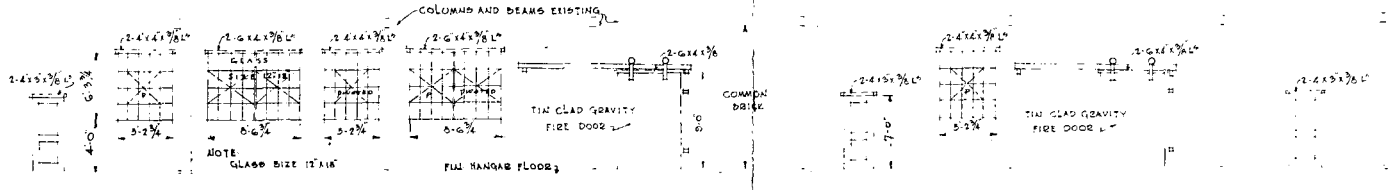

TYPICAL ELEVATION OF WALL BETWEEN HANGAR AND LEANTO
LOOKING FROM HANGAR SIDE
Scale 1/2"=1'-0"

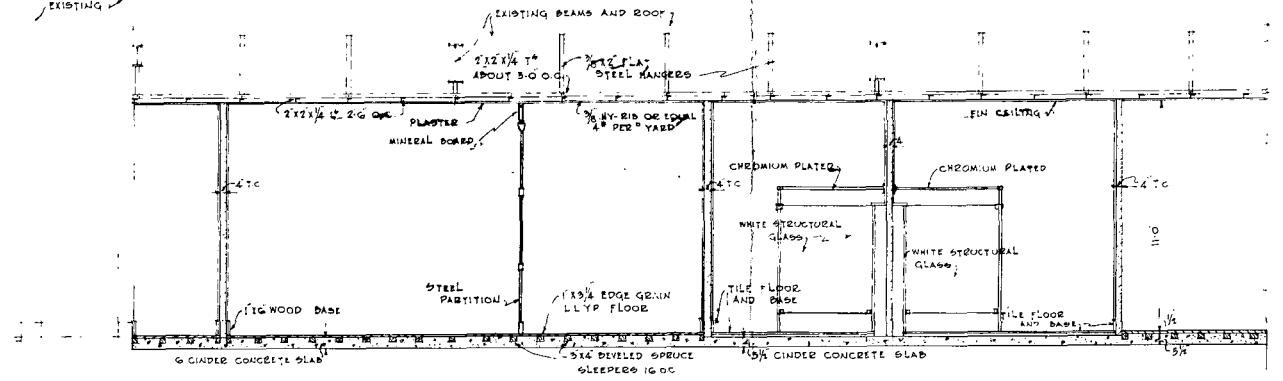

PART LONGITUDINAL SECTION THRU LEANTO
Scale 1/4"=1'-0"

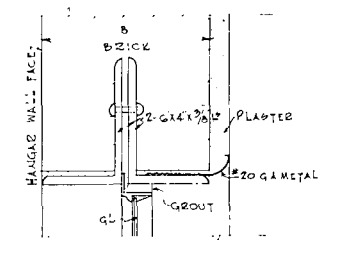

SECTION THRU HEAD

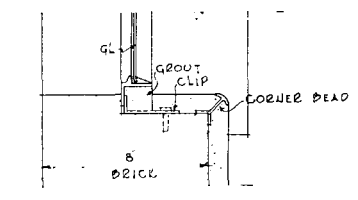

JAMB

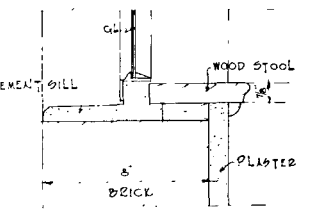

SECTION THRU SILL

DETAILS OF STEEL SASH IN BRICK WALL BETWEEN HANGARS AND LEANTOS
Scale 3/8"=1'-0"

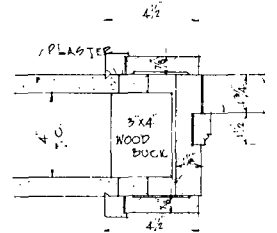

DETAILS OF DOOR FRAMES AND TRIM - INTERIOR
Scale 3/8"=1'-0"

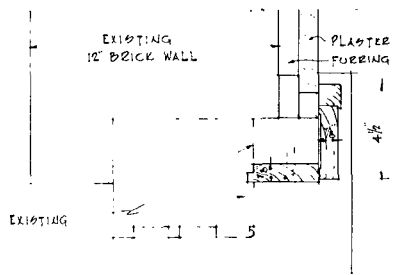

JAMB - HEAD SIMILAR

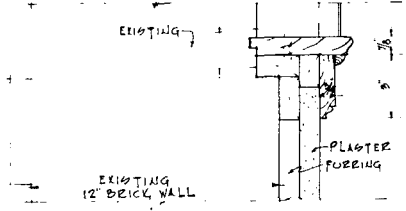

SECTION THRU SILL

DETAILS OF TRIM FOR DOUBLE HUNG WINDOWS IN OUTSIDE WALLS
Scale 3/8"=1'-0"

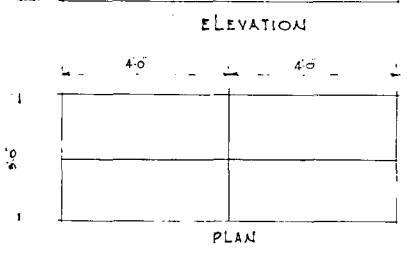
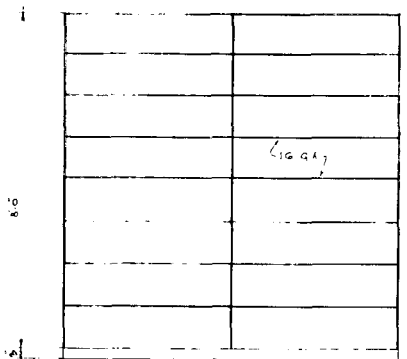

ELEVATION
PLAN

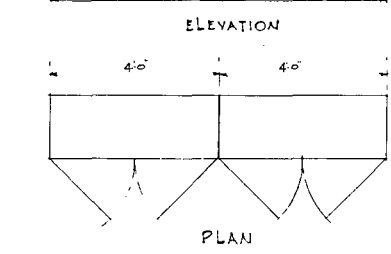
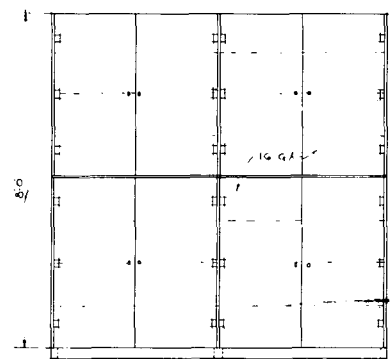

ELEVATION
PLAN

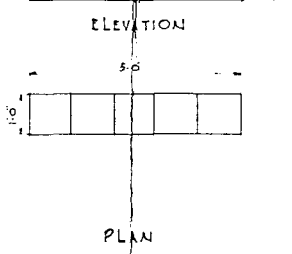
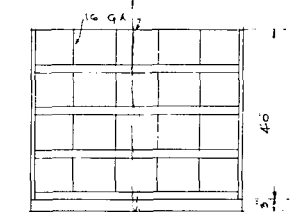

ELEVATION
PLAN

DETAILS OF METAL SHELVING, CABINETS AND BINS IN STOREROOM HANGAR NO. 5
Scale 1/2"=1'-0"

ON MICROFILM

THE CITY OF NEW YORK
DEPARTMENT OF DOCKS
DIVISION OF PORT PLANNING
CONTRACT NO. 2028A
FOR THE CONSTRUCTION OF OFFICES, SHOPS,
ETC. IN FOUR HANGAR LEANTOS AT THE SITE
OF
THE MUNICIPAL AIRPORT
FLOYD BENNETT FIELD
FLATBUSH AVE. BOROUGH OF BROOKLYN

SUBMITTED BY *[Signature]* DIVISION ENGINEER
APPROVED BY *[Signature]* CHIEF ENGINEER
APPROVED BY *Michael Cosgrove* COMMISSIONER
DATE - Feb. 16, 1931

DRAWN BY KML:EDA
TRACED BY DA

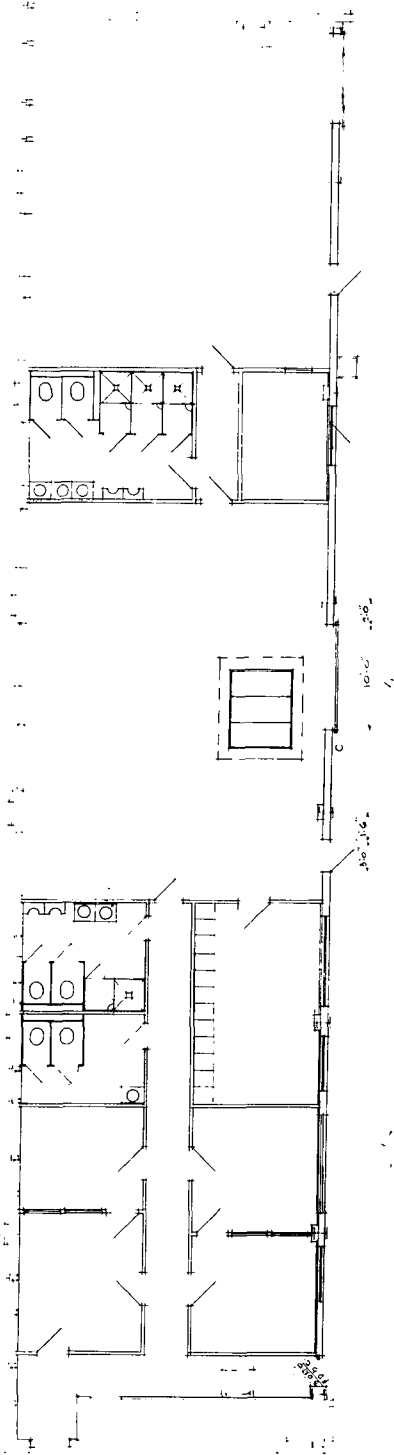

LEANTO PLAN
HANGAR #2
scale 1/8"=1'-0"

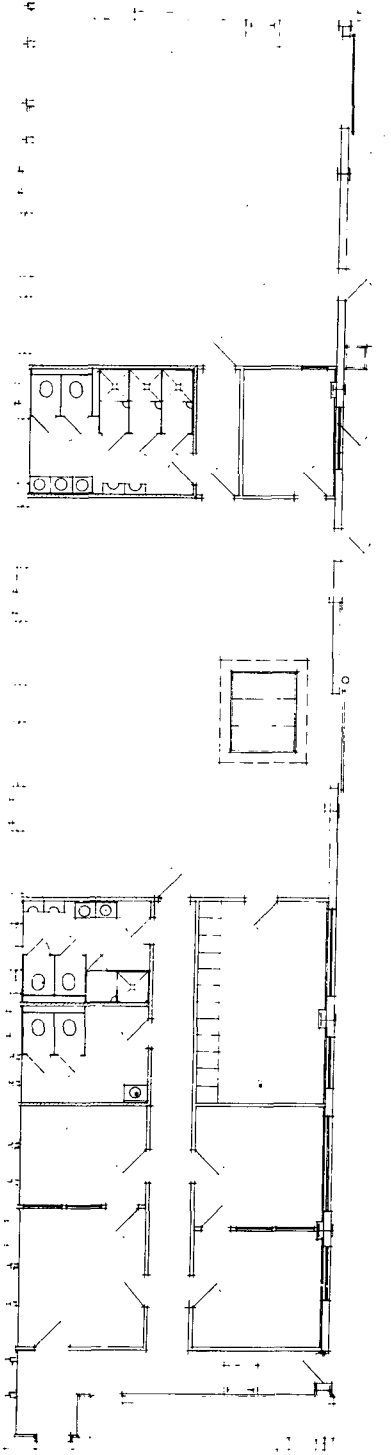

LEANTO PLAN
HANGAR #3
scale 1/8"=1'-0"

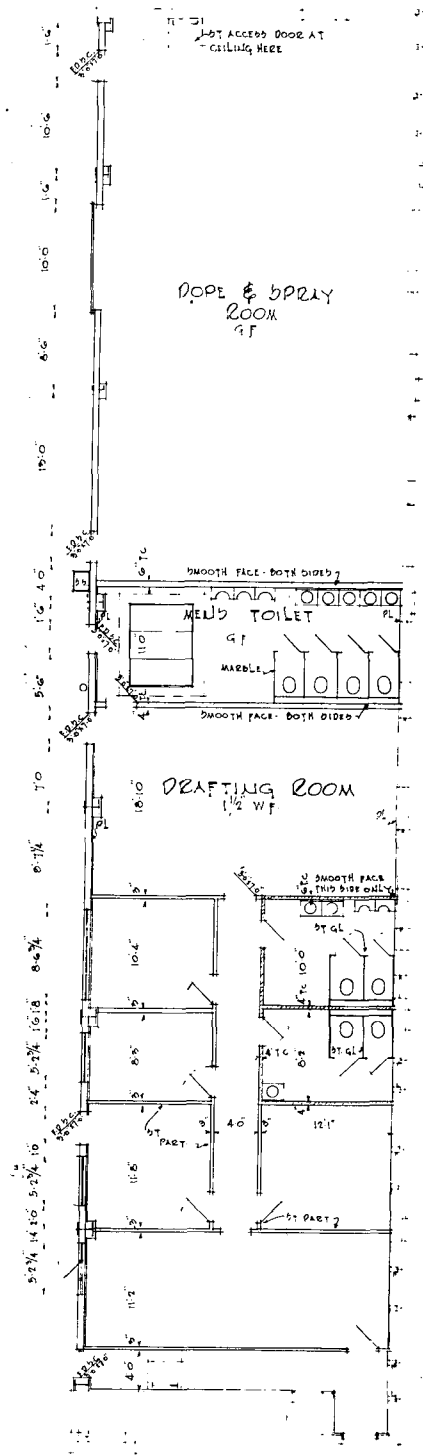

LEANTO PLAN
HANGAR #1
scale 1/8"=1'-0"

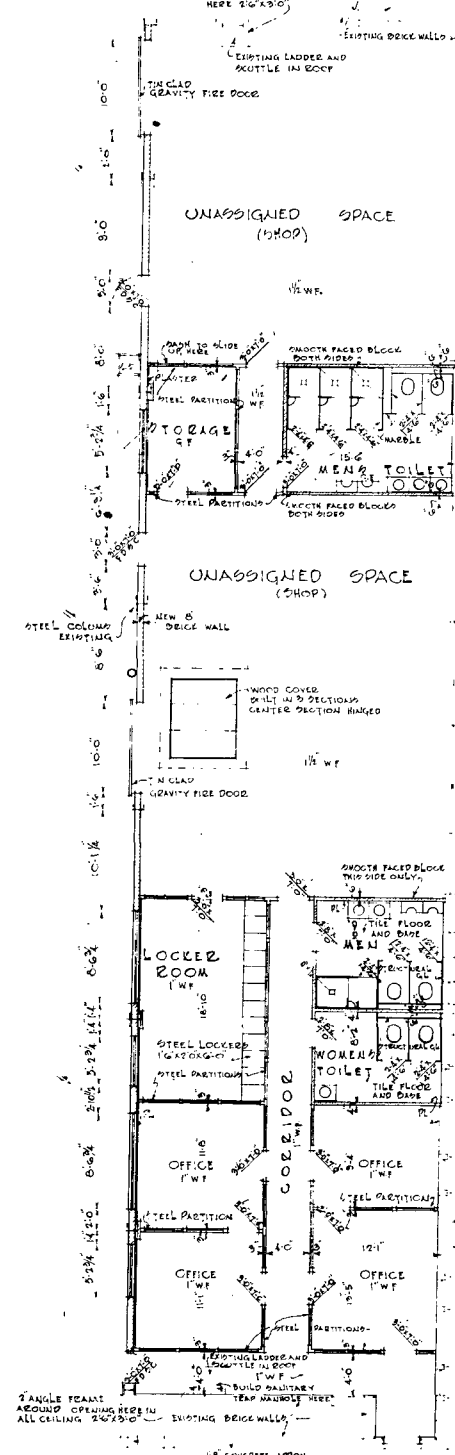

LEANTO PLAN
HANGAR #7
scale 1/8"=1'-0"

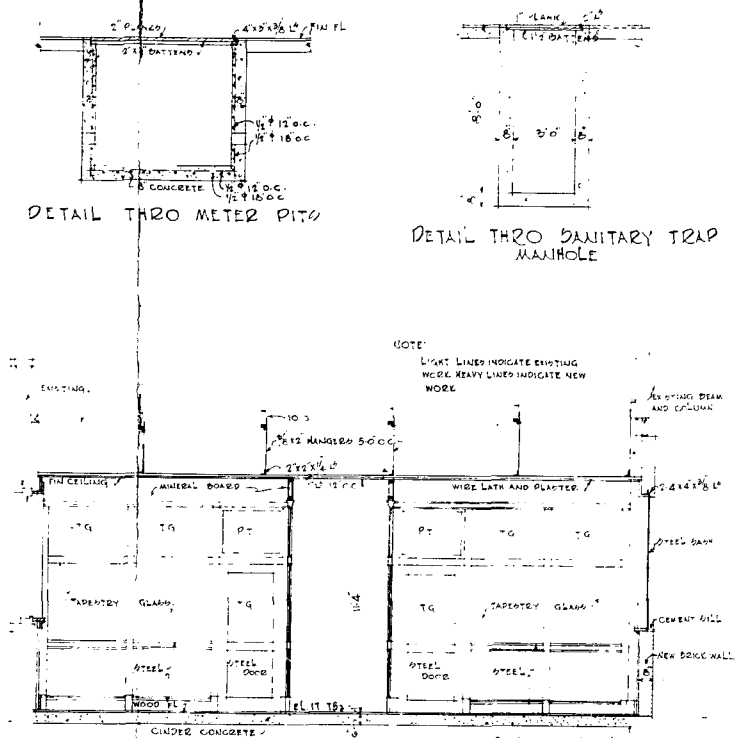

CROSS SECTION
THRO LEANTO
scale 1/8"=1'-0"

ABBREVIATIONS KEY TO MATERIALS

TC - TERRA COTTA	WOOD
WF - WOOD FLOOR	CONCRETE
TF - TILE FLOOR	STRUCTURAL GLASS OR MARBLE
GF - GRANULITIC FINISH	BRICK
PL - PLASTER	TERRA COTTA
	PLASTER
	WHITE TILE

NOTE:
LIGHT LINES INDICATE EXISTING WORK
HEAVY LINES INDICATE NEW WORK
INTERIOR FINISH OF LEANTOS #1, 2 & 3
SIMILAR TO LEANTO #7 EXCEPT
AS OTHERWISE NOTED

ON MICROFILM

2061A

PORT PLANNING
CONSTRUCTION DRAWINGS OF OFFICES, SHOPS ETC.
IN FOUR HANGAR LEANTOS.
BROOKLYN

Submitted by: DEPUTY CHIEF
Approved by: [Signature]
Date: 2/22/41
AB. 2061A (A1)

DRAWN BY DA
TRACED BY DA

646/63030

Details of Inscriptions for Hangars
March 20, 1931

Inscriptions were subject to change
depending on occupancy.

Hangar inscriptions are now invisible
beneath a coat of light yellow paint,
but the original inscriptions can be
seen in Photo No. 7 of the Historical
Data Section.

CITY OF NEW YORK, DEPARTMENT OF DOCKS,
 Division of PORT PLANNING
DETAILS OF INSCRIPTIONS
FOR HANGARS
 BOROUGH OF BROOKLYN
 Submitted by WM. LAUSING JR. Designer
 Approved by T. F. KELLER Chief Engineer
MICHAEL COEGER Commissioner of Docks
 DATE MAR 20 1951 SUPPLEMENTARY
 DRAWN BY RR CHECKED BY RM SET OF DRG. (7)

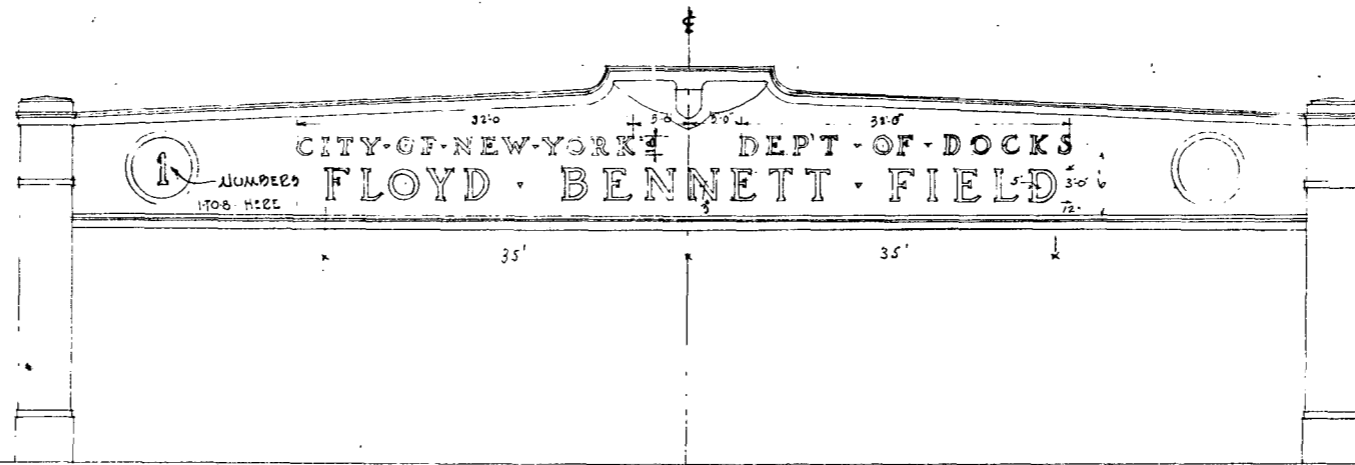

TYPICAL ELEVATION OF HANGAR
 scale 1/8"=1'-0"

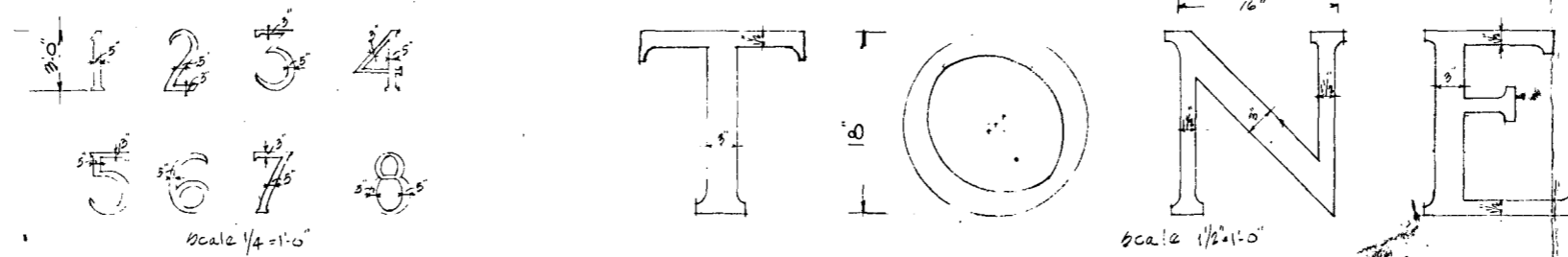

TYPICAL LETTERS AND NUMBERS
 FOR HANGARS

-646/63031

93

ON MICROFILM

HANGAR COMPLEX 3

A. Historical Description

See "Hangar Complexes General."

B. Existing Conditions

1. Exterior

a. Site

Some low vegetation has grown in close to the building perimeter.

b. Steel Framing System

The steel frame, though deteriorating in certain areas, can still be considered structurally sound.

Several of the pilasters have lines of brickwork separation. The separation usually occurs along the vertical at the trim formed by the projecting headers. This separation is most severe at the far east and far west pilasters of the north elevation. It is probable that the separation occurred as follows: the steel section imbedded in the pilaster was subjected to mild rusting. Since the masonry butted directly against the steel, even a small amount of rusting and expansion by the steel caused the pilaster to crack. Once cracked, the pilaster became the victim of the elements, especially the freeze-thaw action of water, which caused the cracks to widen. However, after limited visual inspection, and because of the absence of rust stains which would accompany extensive rusting, it is believed that the structural steel is still sound.

c. Masonry

This is the only hangar complex with a two-story lean-to. Photographs taken during the Work Progress Administration (WPA) era show the east lean-to with its parapet in an incomplete stage and at a height of about one story. It appears as if the trim and upper part of the one-story wall had been removed to allow for the "keying in" and addition of the second story. The change was completed by reusing

the original cast stone pilaster caps and coping on the new wall (see Photograph No. 31 - Historic Data Section).

A new one-story 10-foot wide bay was added at the same time about 22 feet in from the south end of this elevation. The seventh first story window from the north end was partially infilled with brick to frame around a new door at that location.

The masonry walls of the complex have become deteriorated and damaged. Approximately 75 percent of the mortar is deteriorating throughout, with damage being especially severe at the high parapets of the lean-tos. Large areas of loose brick are found at the northwest and southwest parapets.

Horizontal separation lines appear at the heads of virtually every window, where the steel lintels have rusted and expanded, displacing the brickwork.

Cast stone coping and pilaster trim has not been immune to deterioration and staining, although to a lesser degree than that of the other hangars.

d. Openings

The aluminum alloy sliding doors which dominate north and south elevations are in fair condition, the main damage being many broken panes of glass and exfoliation at the corners and ends.

At the north elevation, approximately 10 percent of the glass is missing from the doors of the east hangar (Hangar 1) and 20 percent from the doors at the west (Hangar 2). At the south, 5 percent of the panes of the west doors are missing and 20 percent of those at the east end.

Most of the "human-scale" doors have been altered in some way or have been replaced. Doors into the lean-tos have greatly deteriorated. The original arch-framed lights above these doors have

been bricked in, except for that of the southwest corner door. This door retains its arch window, but the proportions have been altered using a shorter door and longer window than the original (compare existing condition to original drawing).

The pilot doors into the main hangar spaces are relatively new, and do not match those of historic photographs or original drawings.

All exterior doors into the WPA infill are in poor condition. At the north, the large central opening has been framed down to provide for a standard set of double doors. The left flanking door is completely gone, the opening sealed with plywood. The right flanking door is still fairly sound with its arch light still intact. Plywood veneers on the three doors at the south infill elevation are warping and splitting. (Though no solid evidence has been found, it is probable that these, and the infill doors of the other hangar complexes, were kalamein.) The central opening has not been framed down in size, but the double doors and plain rectangular lights above are modern versions. The flanking doors are in poor condition, but the framing of the original arched lights is intact.

Windows are generally deteriorating. The main problem is that of the rusting and expansion of the steel lintels. Metal and wood frames are corroding and flaking; approximately 15 percent are not refurbishable. The cast stone sills are cracking, spalling and stained. Those along the east and west elevations suffering the worst deterioration. Approximately 20 percent of the glazing is broken or missing.

Identification and/or advertising messages which were historically (and until recently) painted on the deep metal facias above the large hangar doors are now painted over.

e. Roof and Roof Drainage

The roof framing system is still in basically sound condition.

Roof decking above Hangar 2 (west hangar) is basically sound. Other areas, however, have some trouble spots. Approximately 25 percent of the WPA infill and west lean-to decking is rotted. About 30 percent of the decking of Hangar 1 and its lean-to is rotted, with damage prevalent near the juncture of the two.

Roofing and flashing are in poor condition.

Copper scuppers and downspouts were installed at the east lean-to at the time of its second floor addition. These are now all missing. The iron rainwater furniture at the west lean-to is basically sound, missing only small sections.

2. Interior

a. East Hangar

The concrete floor remains in sound, acceptable condition. Brick walls are generally sound, but paint finish is peeling and flaking. The center steel column at both east and west walls is rusting and staining. The rotted roof boards are allowing water to penetrate along the length of the east wall and causing water staining at the central ceiling area.

b. East Hangar Lean-to

This section of the complex is in extremely poor condition. Vinyl tiles, installed to finish the wood floor structure of the second level, are warped and rotted. The concrete slab of the first floor is serviceable. Both the original partitions and later partitions are in poor condition. Original plaster on diamond mesh lath, applied to finish the interior common brick face of the east wall, is extremely deteriorated with large portions cracked or fallen. Similarly, exposure to the elements and rainwater leakage have caused extensive damage at the ceilings of both the first and second levels.

c. West Hangar

This hangar is in good condition except for deteriorating paint finish on the brick walls.

d. West Hangar Lean-to

This part of the complex is generally open in plan.

Sections of the floor slab have settled in this lean-to. As with the other lean-to, plaster walls and ceiling are in poor condition, and paint finish on the exposed brick walls is flaking and peeling. Plumbing stub outs are extant, but all fixtures are gone.

e. WPA Infill

This infill has two levels, both in fair to poor condition.

C. Recommendations

1. Comments Concerning All Hangars

General deterioration of each of the hangar complexes continues at a rapid, ever-increasing pace. It is most likely that areas of damage and thus cost estimates will have increased by the time preservation/adaptive use work begins. Interior work will be partially dependent on the results of the DCP. It should be stressed, however, that no work, interior or exterior, should be allowed that would have an irreversible effect on the building's historic fabric, and all work should follow the "Guidelines for Preservation/Adaptive Use" included at the front of this report.

The main importance of these buildings lies in their contribution to the historic scene of the airfield. As such, the overall visual impact and historic authenticity of the exteriors play a leading role, with the interiors more in the background. It is fortunate that few alterations have been made to the hangar complexes. Alterations, additions, and changes to the exteriors have been minor and the buildings basically retain their historic appearance and an authentic visual impact.

It is the overall ambiance and feeling that is sought here. The most important immediate step is to make these buildings watertight, safe, and sound either by emergency stabilization or full-fledged preservation. (Currently a contract is being prepared at the DSC which will provide for a beginning to the preservation of Hangar Complex 5 and stabilization work on the other three hangars.)

It is recommended that the soundest roofing design be used - (probably 100 percent recoverage with 4 ply built up roofing) - instead of trying to recreate an exact duplicate of the original roof covering (which was similar in appearance to the more modern materials and not even visible to the casual observer on the ground).

Copper flashing was used throughout. In areas where the copper is visible, repair and replacement should be with copper. In non-visible areas, it is more important that the material or design methods used be sound and durable. Similarly, original copper or iron gutters and downspouts should be replaced in kind when visible.

A problem recurring throughout is the rusting and expanding of the steel lintels at the heads of all openings. Eventually all of the lintels will need to be replaced, but a high percentage need replacement now. An exact assessment of condition will be needed at the time their repair/replacement is to begin. It is preferable, in the long run, that the replacement material be other than steel, as steel corrodes rapidly and must be kept painted at all times (a maintenance factor that has proven difficult to attain). Materials such as fiberglass and stainless steel should be investigated for their potential use in these structures. Though a modern material may be employed, its appearance-in-place must still match the historic.

The original steel window frames should be refurbished wherever possible. Continuous maintenance and paint application is absolutely necessary with this material as steel is particularly susceptible to weathering. As with the lintels, research should be undertaken to find viable alternative materials which would prove more maintenance free and yet still appear historic.

Parts of the large hangar doors may need replacement but the doors as a whole are still in good condition. Glazing used should match original glass, some of which is still in place. Parts of the doors needing replacement can be easily matched to the historic, as the part is sure to be extant on one or more of the sixteen sets along Hangar Row.

Where lean-to doors have been bricked in, it is not of the foremost importance that the original transom be duplicated and installed. At least one photograph of World War II vintage shows that space with a wood infill painted with the inscriptions of the building's occupant. Further research will be needed to try and determine how each of these doors were constructed and used if a full restoration is desired. However, until more funding is available, it is recommended that the existing doors be stabilized or refurbished. It is speculated that the doors were constructed as per the original drawings and then changed later to fit the needs of the Navy occupancies.

2. Recommendations - Hangar Complex 3

a. Exterior

1. Site

Remove surrounding vegetation.

b. Steel Framing System

Where steel members have corroded and caused damage to the brickwork, that brickwork will have to be repaired. The steel should be inspected, cleaned, inspected for damage, and repaired if necessary. All steel should be painted with a rust-inhibitive paint.

c. Masonry

Repoint approximately 75 percent of the brickwork.

Several pilasters and parts of the high parapet walls may need to be rebuilt. These areas should be closely inspected by a structural engineer at the time preservation work is considered to determine precise extent of damage.

Brickwork above many openings will be relaid when corroded lintels are replaced.

Clean and repair cast stone coping and trim.

d. Openings

Reglaze large sliding doors: 10 percent at north of east hangar, 20 percent at south of east hangar, 20 percent at north of west hangar, and 5 percent at south of west hangar.

Check condition at time of preservation work to determine method and number of steel lintels that will need replacement. Replace approximately 15 percent of the steel frames and reglaze approximately 20 percent of the window areas.

Remove wood overhang assemblies from doors of East hangar lean-to.

Refurbish or install new single doors in the WPA infill. Leave semi-circular overhead fan lights intact or install copy of historic.

e. Roof and Roof Drainage

At time of preservation work, inspect roof structure to determine the minimum area of decking which will need replacing. At present approximately 25 percent of the decking of the WPA infill and west hangar lean-to and 30 percent of that of the east hangar and its lean-to is rotted.

Completely reroof with modern 4 ply built up roofing.

Repair flashing, installing new where necessary. Install three new copper scuppers and downspouts at the east side. Make small repairs to remaining rainwater furniture.

2. Interior

Most of the interior deterioration is a result of the poor condition of the exterior of this building. Once the exterior is made sound and watertight, the interior deterioration will halt. Much more liberty can then be taken on the interiors of the hangar complex than on the exteriors when designing for an adaptive use. However, historic fabric, including mechanical and electrical systems and fixtures, should be used when possible.

D. Cost Estimate

The type of interior work is yet to be determined, and the extent of exterior damage and much of the designing of details will be re-examined at the time of actual preservation. Because of this, it is difficult to arrive at an exact estimate of preservation/adaptive use costs. The cost estimate on the following page is based on a cost per square foot for this type and extent of preservation work in the New York area. It can be applied to each of the four hangar complexes and does not include any construction for interior adaptive use.

UNITED STATES DEPARTMENT OF THE INTERIOR
NATIONAL PARK SERVICE

PACKAGE ESTIMATING DETAIL

REGION North Atlantic	PARK Gateway N.R.A.
PACKAGE NUMBER 109 (Portion)	PACKAGE TITLE Rehab Hangar Complex No. 3

(If more space is needed, use plain paper and attach)

ITEM	QUANTITY	COST
Rehabilitate exterior and interior as required of hangar complex Number 3, Hangars 1 and 2, Floyd Bennett Field. H.S.R. Estimate R. Borrás 3/30/81	LS	\$2,000,000

SUMMARY OF CONSTRUCTION ESTIMATES		CLASS OF ESTIMATE		
		<input type="checkbox"/> A Working Drawings	<input type="checkbox"/> B Preliminary Plans	<input checked="" type="checkbox"/> C Similar Facilities
Proj. Type				Totals from Above B & U R & T
52	Museum Exhibits			XXXXX
55	Wayside Exhibits			XXXXX
62	Audio-Visual			XXXXX
89	Ruins Stabilization			XXXXX
91	Construction			\$2,000,000
92	Utility Contracts			XXXXX
ESTIMATES APPROVED (Signature)		(title)	(date)	

POST PROFESSIONAL SERVICES ESTIMATES AND SCHEDULING ON BACK OF FORM

Original Drawings for Contract No. 2,000
for the construction of
Administration Building with appurtenances
at the site of The Municipal Airport,
Floyd Bennett Field
November 17, 1930

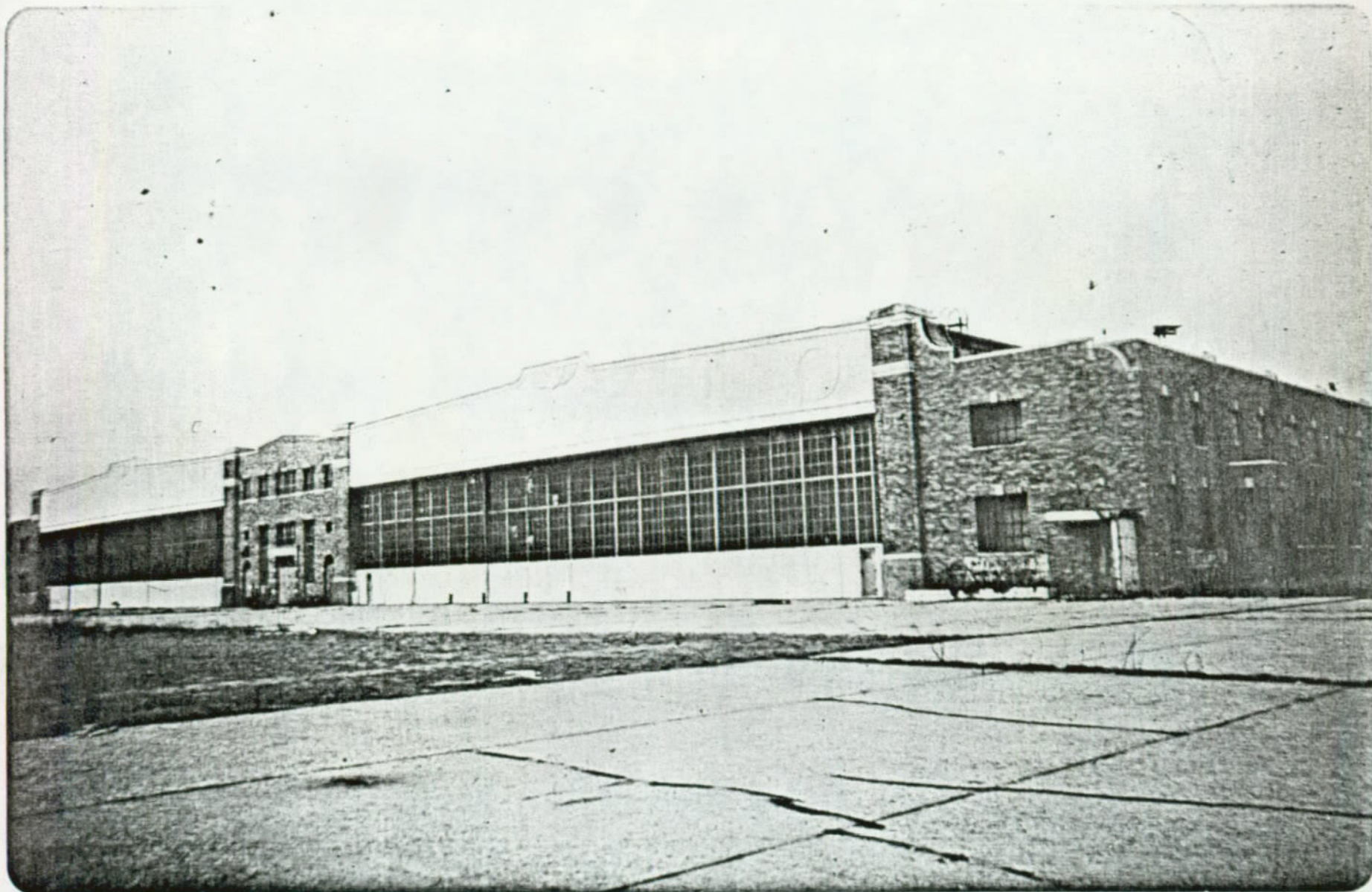

Hangar Complex 3 South Elevation



Hangar Complex 3 - Northeast elevation
January 1979.



Hangar Complex 3 - South elevation
October 1978.



Hangar Complex 3 - WPA infill - North elevation
October 1978.

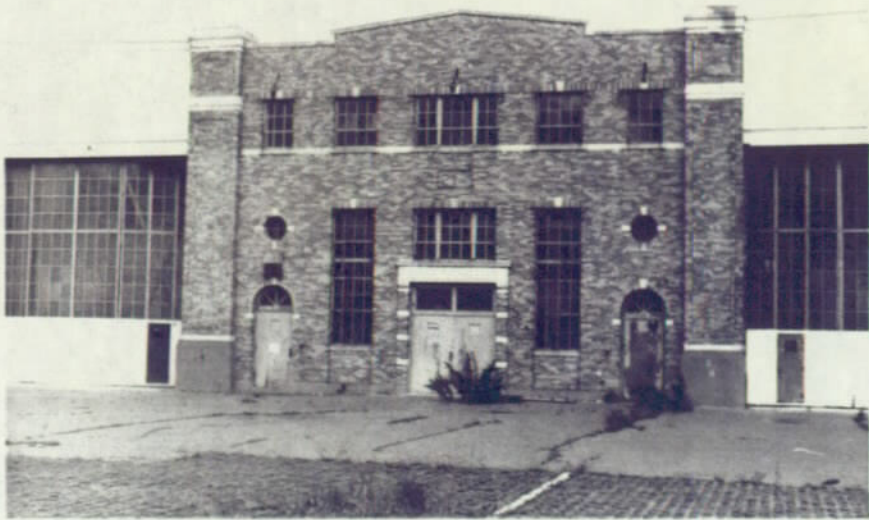

WPA infill - South elevation
October 1978.



West Hangar Leanto - South elevation
note loose and missing bricks at
the parapet
January 1979

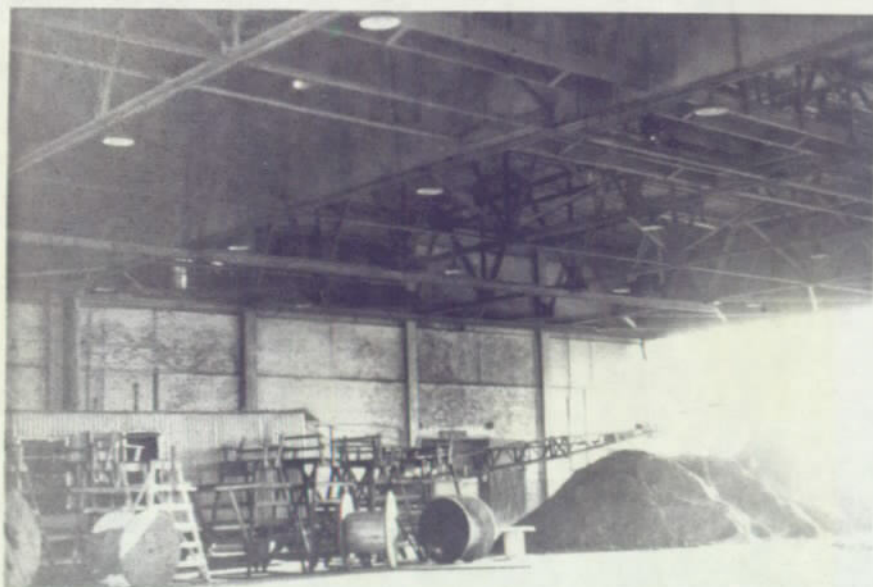

Interior West Hangar
January 1979



Typical window head condition
note rusting, expanding lintel
January 1979



Sill condition - cast stone extremely deteriorated
January 1979



Extreme deterioration of ceiling fabric
found in West Hangar Lean-To
January 1979



Typical condition at second story of
East Hangar Lean-To
January 1979

HANGAR COMPLEX 4

A. Historical Description

See "Hangar Complexes General."

The north elevation of the WPA Infill of this complex was more intricate in design than the other infills (probably because it faced toward the Administration Building). It had a cast stone propellor/wing design at the center of the parapet, three large cast stone Art Deco panels, and six pilasters with cast stone bands across the upper portions.

B. Existing Conditions

1. Exterior

a. Site

A small concrete structure now stands very close to the complex at its northeast corner.

b. Steel Framing System

The frame is structurally sound. As with those of Hangar Complex 3, some pilasters have cracks due to the expansion of steel columns and, to a lesser degree the freeze-thaw action of water.

c. Masonry

It is ironic that while the brickwork of this complex is in the worst condition of that of all four hangars, its interior is the least deteriorated. All four of its high end parapets have spots of loose brick and deteriorating mortar, and a large part of the southeast corner parapet has actually fallen.

A major portion of the exterior mortar (80 percent) is deteriorating.

Coping along the west elevation is deteriorated in spots.

d. Openings

About 10 percent of the glass at the large hangar doors is damaged or missing.

The door at the north end of the east hangar lean-to has obviously been altered. The upper opening is now square in shape. One of the windows at the east elevation had been converted to a door and now both door and old window openings are bricked in.

The problem of corroding expanding steel lintels recurs here. It is extremely serious along the whole west elevation where a wide horizontal line of brick separation occurs along the heads of all openings.

Metal and wood window frames are weathering, but in better condition than those of Complex 3.

Cast stone sills are stained and cracking throughout.

About 5 percent of the window glazing is damaged.

e. Roof and Roof Drainage

Roof framing is basically sound, but roof decking is beginning to deteriorate at the WPA Infill and the east hangar lean-to, where about 50 percent has rotted.

Gutters and leaders are in poor condition, especially along the east elevation where long lengths of gutter are missing.

Flashing is in fair to poor condition.

2. Interior

a. East Hangar

Presently occupied, this space is in good condition.

b. East Hangar Lean-to

This space is in fair condition except for ceiling damage due to the rotted roof decking.

c. & d. West Hangar and West Hangar Lean-to

Occupied by the New York Police Department (NYPD), these spaces are in very good condition. The roof has been patched and is maintained by NYPD.

e. WPA Infill

The floor is sound, though covered with deteriorated vinyl tiles. Walls and ceiling are in fair condition, although a leaking roof in this area is causing staining and damage to the roof boards and brick wall.

Many quasi-temporary wood frame one-story partitions were constructed in this infill. They are in poor to fair condition and of minimal historic value.

C. Recommendations

See "Comments Concerning All Hangars", Recommendations, Hangar Complex 3.

1. Site

Demolish concrete structure at the northeast corner of the complex.

2. Steel Framing System

Any steel that has corroded severely enough to cause damage to the brickwork will need to be cleaned, inspected, and repaired, if necessary, at the time the brickwork is repaired. All steel should be painted with rust inhibitive paint.

3. Masonry

Build back the southeast corner parapet with brick, bond and mortar which match the surrounding area. The remaining three

corner parapets are intact, but will need careful inspection to determine whether they will need rebuilding or if repointing will suffice to make them sound and stable.

Repoint 80 percent of the mortar.

Clean and repair cast stone trim. Most work is needed along the west elevation.

Special care should be taken to preserve and protect the Art Deco cast stone trim at the north end of the Infill.

4. Openings

Reglaze 10 percent glass area of hangar doors.

Remove wood overhang assembly from the north door of the east hangar lean-to.

Reglaze 5 percent of the window area.

Clean and repair/replace cast stone sills and keystones.

A high percentage of the steel lintels will need replacement. Inspect all openings at the time of preservation work to determine the exact number. Replace approximately 5 percent of the steel window frames.

Refurbish existing wood window frames.

Install new door at south end of west hangar lean-to. Repair remaining doors until a final design is determined.

5. Roof and Roof Drainage

At time of preservation work, inspect roof structure to determine minimum area of decking needing replacement. This should be approximately 50 percent of the decking located at the WPA infill and the east hangar lean-to.

Repair or replace approximately 40 percent of the flashing.

D. Cost Estimate

See D. Cost Estimate for Hangar Complex 3.



Decorative facade of infill's north elevation -
note art deco cast stone panels and propellor
January 1979



Propellor detail
October 1978

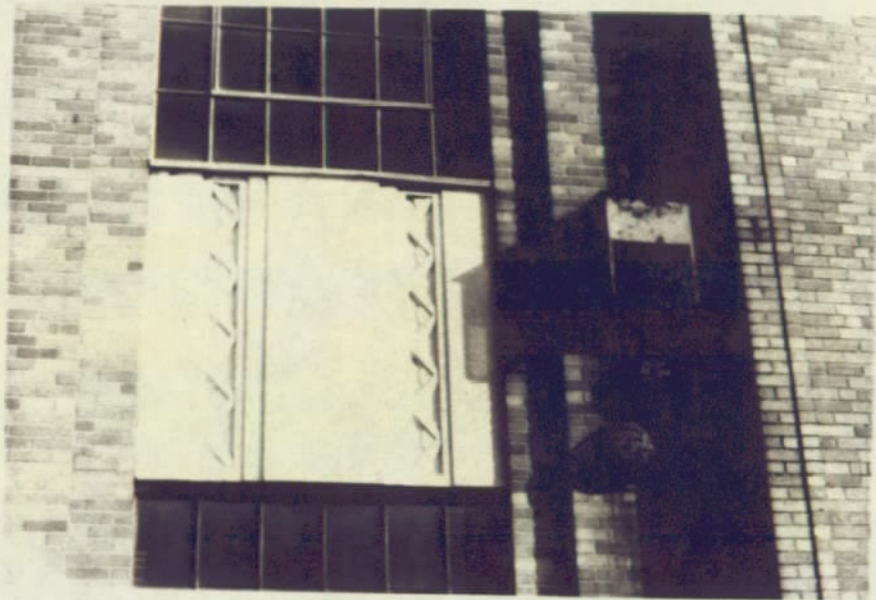

Panel detail from north elevation of infill
April 1979

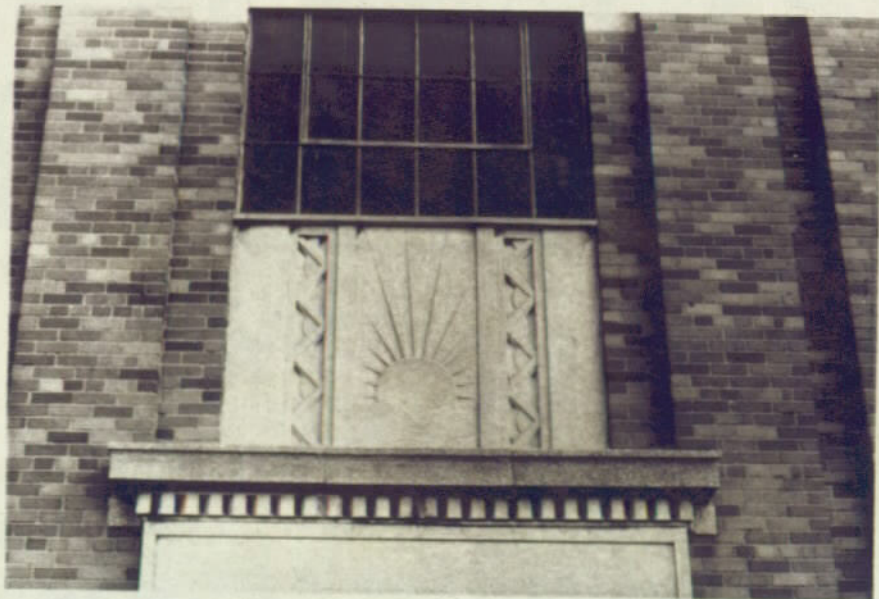

Panel detail
April 1979

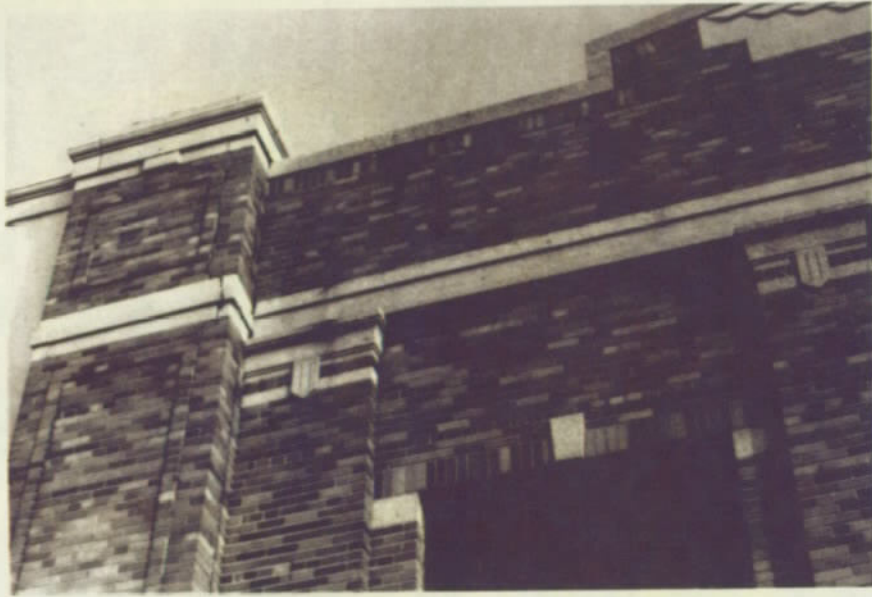

North WPA infill - note typical pilaster damage.
April 1979



Upper wall at west elevation - note separation along
lintel lines and extremely deteriorated mortar.
April 1979

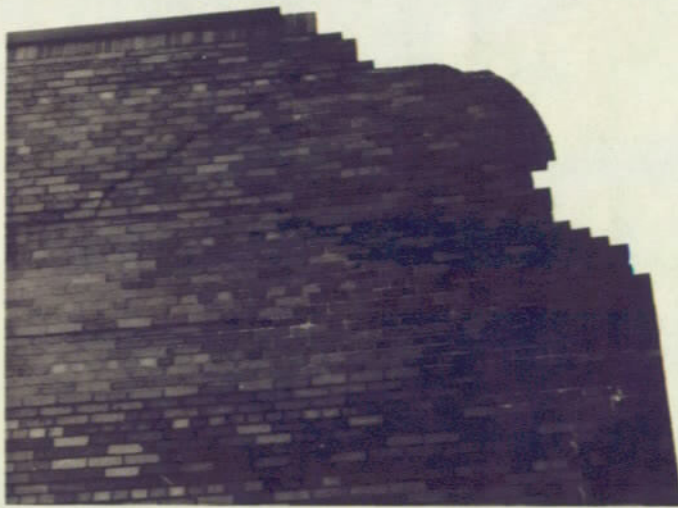

High parapet at southeast corner.
April 1979



Northwest corner parapet - typical parapet condition.
April 1979



East Hangar Leanto - south
door original arched light
above door
April 1979



East Hangar Leanto - north door - arch above
has been flattened and opening sealed , April 1979



Interior West Hangar - NYPD helicopters



Interior WPA infill



Roof of Hangar Complex 5, West Hangar Lean-to
January 1979



Roof of Hangar Complex 5, WPA Infill
January 1979

Plans for the installation of Boiler Room
and Machine Shop between Hangars 3 and 4

(WPA Infill - Hangar Complex 4)

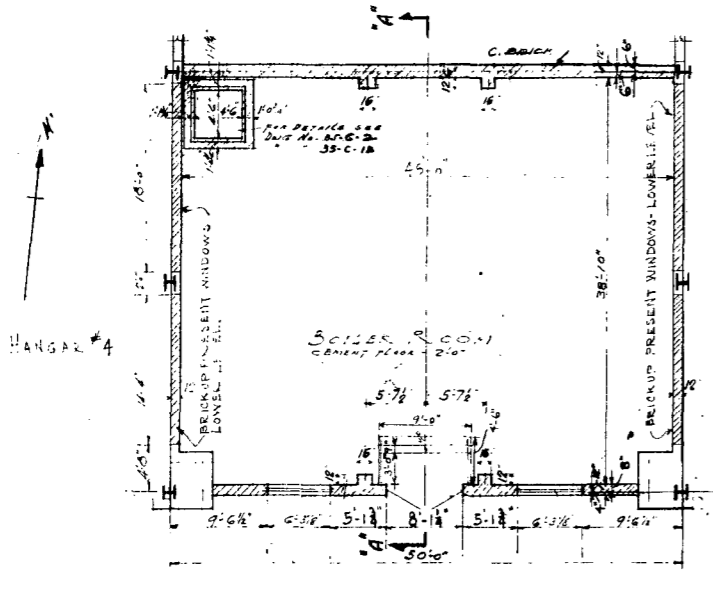
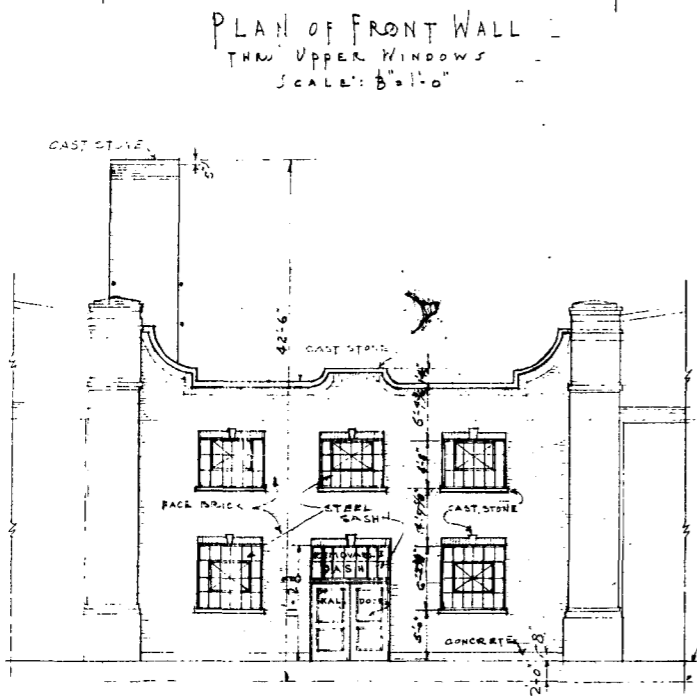
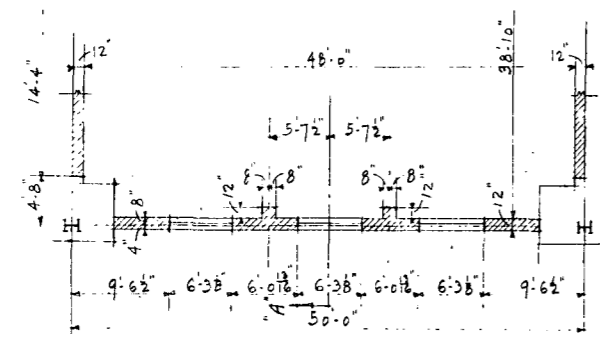

NOTE:
FOR LOCATION OF BOILERS,
FOUNDATIONS, TRENCHES, ETC.,
SEE DWG. # 35-M-1

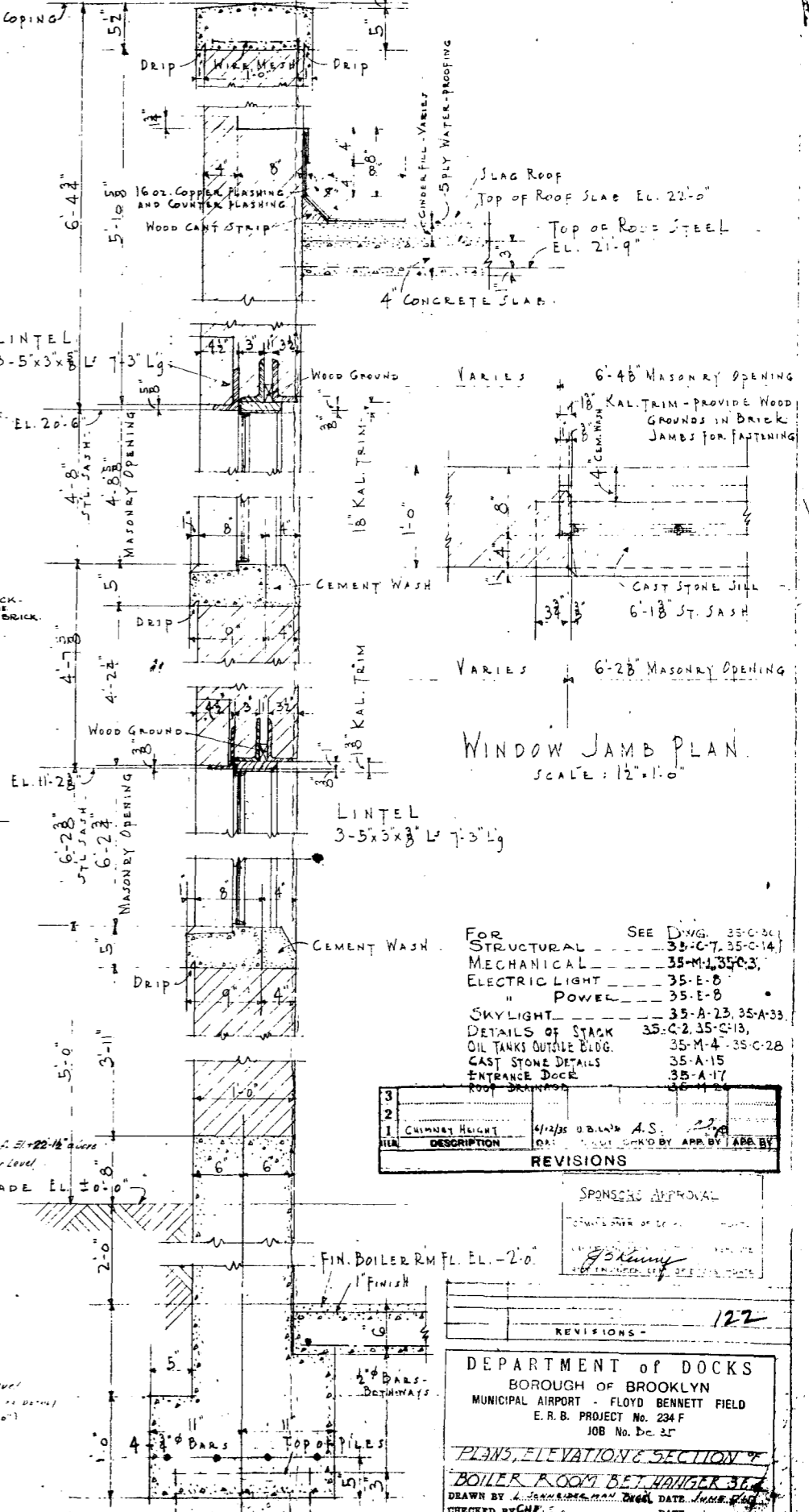
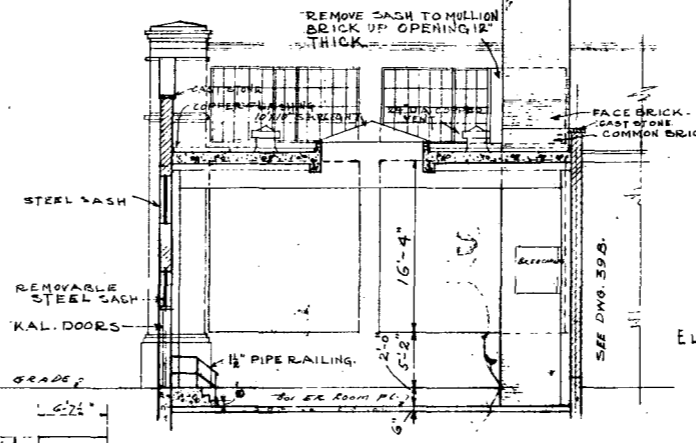
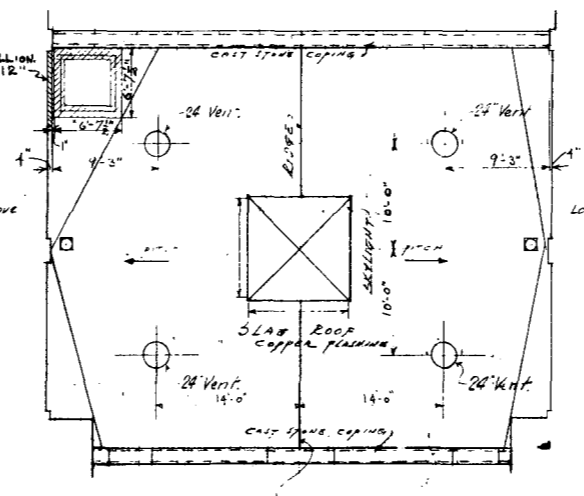

FOR STRUCTURAL	SEE DWG. 35-C-5, 35-C-7, 35-C-14
MECHANICAL	35-M-1, 35-C-3
ELECTRIC LIGHT	35-E-8
" POWER	35-E-8
SKYLIGHT	35-A-23, 35-A-33
DETAILS OF STACK	35-C-2, 35-C-13
OIL TANKS OUTSIDE BLDG.	35-M-4, 35-C-28
CAST STONE DETAILS	35-A-15
ENTRANCE DOOR	35-A-17
ROOF SKYLIGHT	35-A-12

NO.	DESCRIPTION	DATE	BY	APP. BY	APP. BY
1	CHIMNEY HEIGHT	4/2/35	U.S.A.S.		

SPONSOR'S APPROVAL	
[Signature]	
122	
REVISIONS -	

DEPARTMENT OF DOCKS
BOROUGH OF BROOKLYN
MUNICIPAL AIRPORT - FLOYD BENNETT FIELD
E. R. B. PROJECT No. 234 F
JOB No. Dc 35

PLANS, ELEVATIONS & SECTION
BOILER ROOM BETWEEN HANGAR 3 & 4

DRAWN BY L. J. [Signature] DATE June 1935
CHECKED BY [Signature] DATE [Signature]
APPROVED BY [Signature] DATE [Signature]
SCALE 1/8"=1'-0"
Dwg. No. 35-P-302

ON MICROFILM

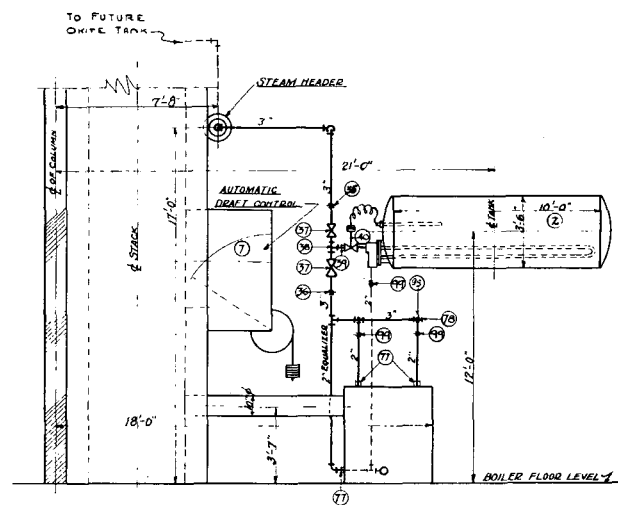
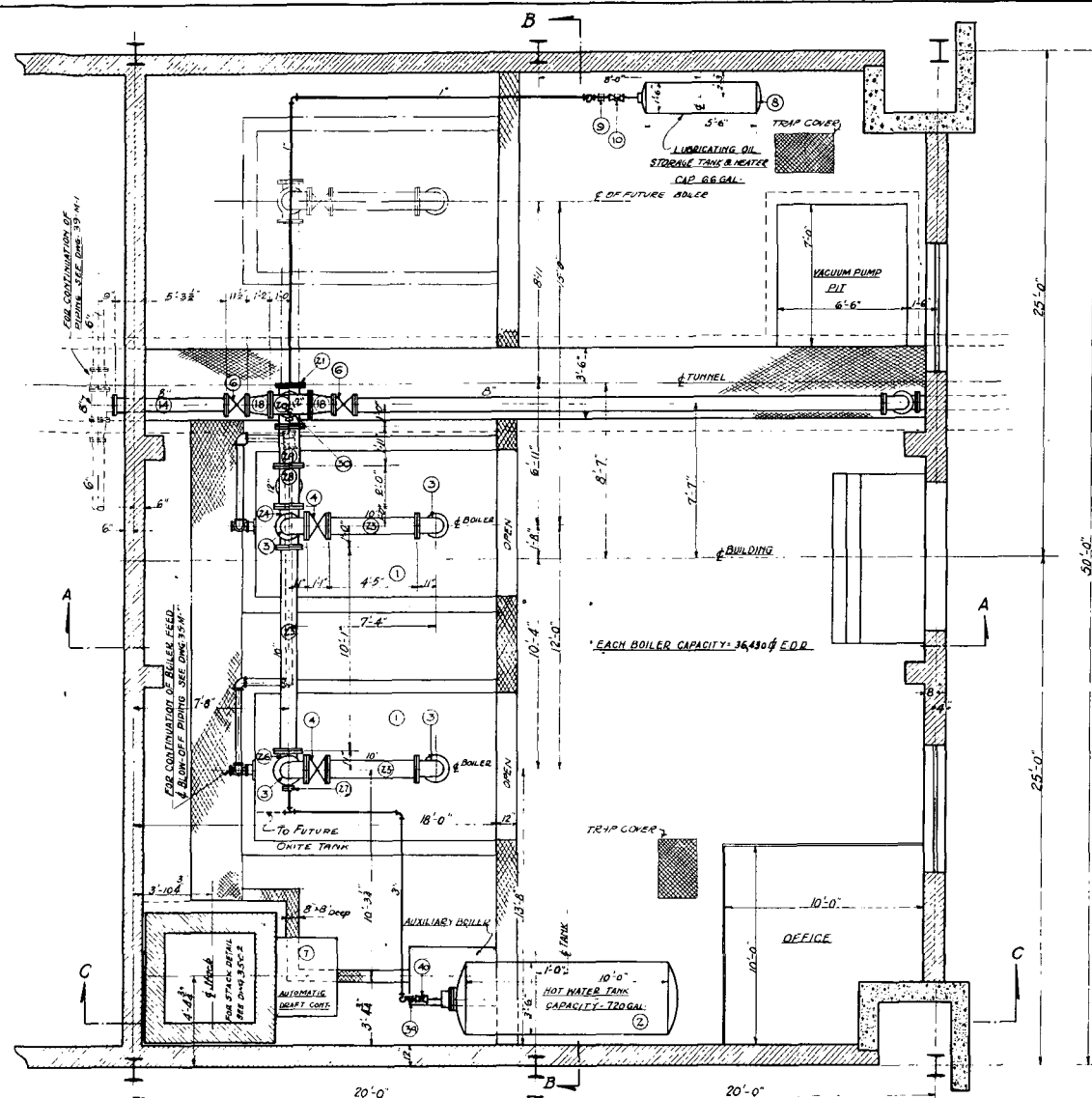

SECTION C-C
AT AUXILIARY BOILER & HOT WATER TANK

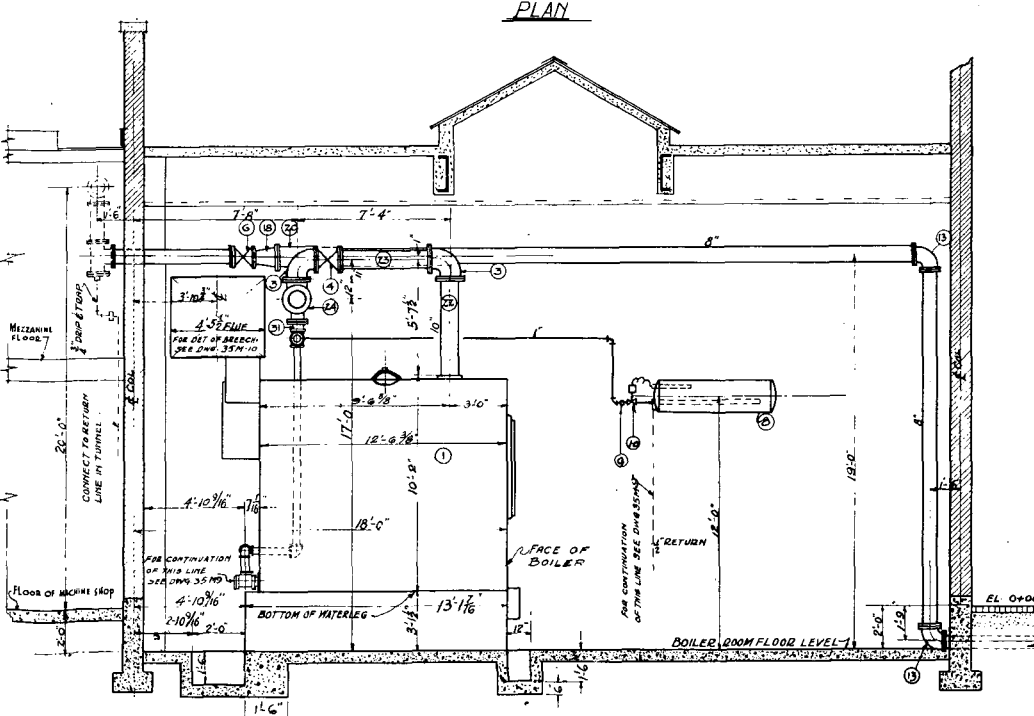

SECTION AA

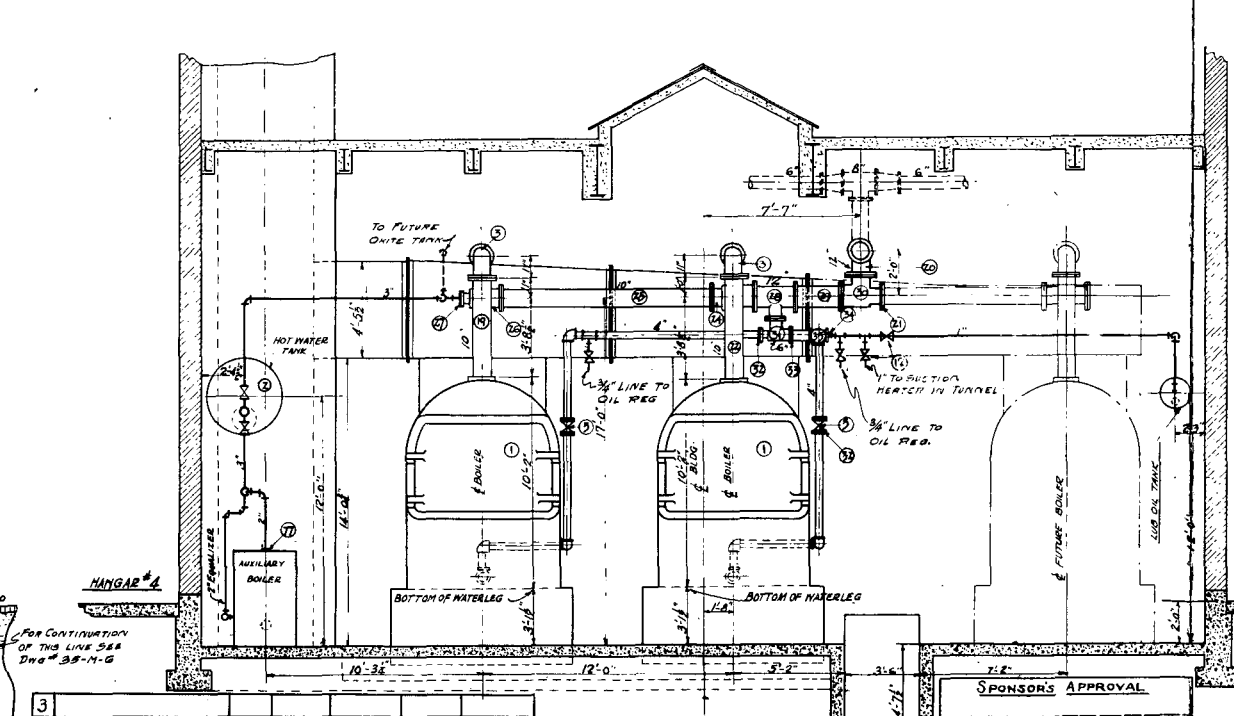

SECTION B-B

LIST of MATERIAL

NO	REQD	DESCRIPTION	REMARKS	NO	REQD	DESCRIPTION	REMARKS
1	2	STEAM BOILER	ORDERED ON REQ. 531	51	20	3/4" DIA. 5' LONG BOLTS WITH NUTS	ORDERED ON REQ. 553
2	1	140' WATER STORAGE TANK	ORDERED ON REQ. 579	52	50	7/8" DIA. 5'	ORDERED ON REQ. 553
3	4	10" STD. C.I. ELBOW	ORDERED ON REQ. 572	53	24	1" - 85% MANGNESE BRICK 6"x6"	ORDERED ON REQ. 553
4	2	10" STD. C.I. FLANGED & DRILLED	ORDERED ON REQ. 572	54	7	BAGS #352 ASBESTOS CEMENT (WGT)	ORDERED ON REQ. 553
5	2	4" DITTO	ORDERED ON REQ. 572	55	175	2" 30 GAL. MESH WIRE 36" WIDE	ORDERED ON REQ. 553
6	2	8" STD. C.I. VALVE 3/4" F.L.	ORDERED ON REQ. 572	56	300	2" GAL. HEX. MESH WIRE 36" WIDE	ORDERED ON REQ. 553
7	1	AUTOMATIC DRIFT CONTROL	SEE DWG. 35-B	57			
8	1	LUBRICATING OIL STORAGE TANK	ORDERED ON REQ. 561	58			
9	1	1/2" STRAINER	ORDERED ON REQ. 574	59			
10	1	3/4" REG. VALVE	ORDERED ON REQ. 574	60	30'-0"	10" PIPE COVERING	ORDERED ON REQ. 553
11	1	1" UNION (FEMALE) MALL. IRON GALV.	ORDERED ON REQ. 572	61	5'-0"	8"	ORDERED ON REQ. 553
12	1	1" GATE VALVE, SCREWED	ORDERED ON REQ. 572	62	6'-0"	12"	ORDERED ON REQ. 553
13	3	8" STD. C.I. FLANG. & DRILLED	ORDERED ON REQ. 572	63	3'-0"	6"	ORDERED ON REQ. 553
14	1	8" PIPE WITH FLANGES F.A.D.	ORDERED ON REQ. 572	64	5'-0"	1"	ORDERED ON REQ. 553
15	1	AUX. STEAM BOILER	ORDERED ON REQ. 572	65	5'-0"	4"	ORDERED ON REQ. 553
16	1	8" STD. C.I. TEE	ORDERED ON REQ. 572	66	30'-0"	3"	ORDERED ON REQ. 553
17	1	8" STD. C.I. FLANG. & DRILLED	ORDERED ON REQ. 572	67	30'-0"	2"	ORDERED ON REQ. 553
18	2	12" TOB. REDUCED 12" STD. C.I. FLANG. & DRILLED	ORDERED ON REQ. 572	68	15	GASKETS FOR 10" PIPE	ORDERED ON REQ. 577
19	1	10" PIPE-FLANGE & THREAD 4'-9 1/2" LONG	ORDERED ON 854	69	8	12"	ORDERED ON REQ. 577
20	1	12" STD. C.I. TEE FLANGED & DRILLED	ORDERED ON REQ. 572	70	12	8"	ORDERED ON REQ. 577
21	1	10" STD. C.I. FLANGED BLIND	ORDERED ON REQ. 572	71	5	5"	ORDERED ON REQ. 577
22	1	10" PIPE-FLANGE & THREAD 4'-10 1/2" LONG	ORDERED ON 854	72	5	4"	ORDERED ON REQ. 577
23	2	10" PIPE WITH FLANGE EACH END 4'-5 1/2" LONG	ORDERED ON 854	73	1	6"	ORDERED ON REQ. 577
24	1	12" 10" STD. C.I. TEE FLANG. F.A.D.	ORDERED ON REQ. 572	74	3	2"	ORDERED ON REQ. 577
25	1	10" PIPE WITH FLANGES F.A.D.	ORDERED ON REQ. 572	75	20	50 LBS. BAGS INSULATING MATERIAL	ORDERED ON REQ. 578
26	1	10" 5/4" STD. C.I. TEE FLANG. F.A.D.	ORDERED ON REQ. 572	76	10	100 LBS. BAGS HARD FINISH CEMENT	ORDERED ON REQ. 578
27	1	5" 7/8" FLANGE STD. C.I. F.A.D.	ORDERED ON REQ. 572	77	3	3" x 2" BUSHINGS	ORDERED ON REQ. 572
28	1	12" 1/2" STD. C.I. TEE FLANG. F.A.D.	ORDERED ON REQ. 572	78	1	3" PLUG	ORDERED ON REQ. 572
29	1	12" PIPE WITH FLANGE F.A.D.	ORDERED ON REQ. 854	79	1	2" GATE VALVE, SCREWED	ORDERED ON REQ. 572
30	1	12" 1/2" STD. C.I. TEE FLANG. F.A.D.	ORDERED ON REQ. 572	80	1	100 LBS. BAG PASTE FOR COVERING	ORDERED ON REQ. 578
31	1	6" 4" STD. C.I. TEE FLANG. F.A.D.	ORDERED ON REQ. 572	81	1	100 YD. ROLL OF BOL. CANVAS 6" WIDE	ORDERED ON REQ. 578
32	5	4" 9" FLANGE STD. C.I. F.A.D.	ORDERED ON REQ. 572	82	24	8PLY COTTON BOWING TWINE BALLS	ORDERED ON REQ. 578
33	1	6" 11" FLANGE STD. C.I. F.A.D.	ORDERED ON REQ. 572	83	5	18 LBS. CLAMP STAPLES	ORDERED ON REQ. 578
34	1	4" 1" ECCENTRIC BUSHING	ORDERED ON REQ. 572	84	2	3/4" GATE VALVE-BRONZE SCREWED	ORDERED ON 795
35	1	6" 4" STD. C.I. SCREWED TEE	ORDERED ON REQ. 572	85	1	1" GATE VALVE-BRONZE SCREWED	ORDERED ON 791
36	2	3" FLANGED UNIONS	ORDERED ON REQ. 572	86			
37	3	3" GATE VALVES - SCREWED	ORDERED ON REQ. 572	87			
38	2	3" STD. C.I. SCREWED TEE	ORDERED ON REQ. 572	88			
39	1	2 1/2" STRAINER	ORDERED ON REQ. 574	89			
40	1	2 1/2" REGULATING VALVE	ORDERED ON REQ. 574	90			
41	6	1" NIPPLES - 5" LONG	ORDERED ON REQ. 572	91			
42	6	1" ELBOWS STD. C.I. SCREWED	ORDERED ON REQ. 572	92			
43	7	4" DITTO	ORDERED ON REQ. 572	93			
44	3	3" DITTO	ORDERED ON REQ. 572	94	2	1" x 1/2" BUSHINGS	ORDERED ON 795
45	6	3" NIPPLES - 5" LONG	ORDERED ON REQ. 572	95	2	3" x 2 1/2" BUSHINGS	ORDERED ON 795
46	50 FT	1" PIPE	TAKE FROM STOCK	96	30'-0"	3" PIPE	TAKE FROM STOCK
47	50 FT	4" PIPE	TAKE FROM STOCK	97	4	2" STD. C.I. SCREWED ELBOWS	ORDERED ON REQ. 572
48	100	3/4" DIA. 3L' LONG BOLTS WITH NUTS	ORDERED ON REQ. 553	98	2	3" 5/2" STD. C.I. SCREWED TEES	ORDERED ON REQ. 572
49	250	7/8" DIA. 3L'	ORDERED ON REQ. 553	99	3	2" FLANGED UNIONS	ORDERED ON REQ. 572
50	20	3/4" DIA. 2L'	ORDERED ON REQ. 553	100	30'-0"	2" PIPE	TAKE FROM STOCK

OFFICIAL PROJECT NO. 65-97-1661 PROJECT AUTH. ADVICE NO. 160
ALLOTMENT ADVICE NO. 108 WORKS PROJECT NO. 234-F34

REFERENCE DRAWINGS	
DESCRIPTION	DWG. NO.
CONDENSATE RETURN, BOILER FEED & BLOW-OFF PIPING	35-M-3
STEAM RETURN PIPING IN TUNNEL	35-M-6
HOT WATER SUPPLY & CIRCULATING SYSTEM	
BOILER SETTING	35-C-3
CHIMNEY	35-C-2
BREECHING	35-M-2
OIL PIPING SYSTEM	35-M-6
PIPE HANGERS	35-M-25
BOILER ROOM FLOOR - CONCRETE CONTR.	35-C-14

GENERAL NOTES:-
STANDARD WT. BLACK PIPE TO BE USED THROUGHOUT, WITH CAST IRON FITTINGS. ALL PIPES AND FITTINGS ABOVE 6" DIA. TO BE FLANGED, FACED AND DRILLED FOR 1/2" TO 1". ALL PIPES AND FITTINGS 6" DIA. AND UNDER TO BE SCREWED, UNLESS SHOWN OTHERWISE.
PIPE COVERING TO BE 85% MAGNEISIA ASBESTOS. BOILER UNIT TO BE OF THE WELDED STEEL, OIL BURNING TYPE, FOR LOW PRESSURE STEAM.
ACTUAL RATING FOR EACH BOILER = 36430 LBS.
REQUIRED RADIATION:-
18' x 12' 3 1/2" HANGAR @ 10,000 BTU EACH = 40,000 BTU
4' x 12' 3 1/2" HANGAR @ 1300 BTU EACH = 32,000 BTU
4' BUILDING BETWEEN HANGARS = 3,000 BTU
HOT WATER SUPPLY - 600 G.P.H. @ 160°F = 2500 BTU
PIPING LOSSES @ 10% = 3700 BTU
5580 BTU
+ 13850 BTU
ADD 25% EXCESS CAPACITY
TOTAL = 63750 BTU

NO.	DESCRIPTION	DATE	REV. BY	CHKD BY	APP. BY	APP. BY
3						
2						
1						

REVISIONS

SPONSOR'S APPROVAL
COMMISSIONER OF DOCKS - DATE
CHIEF ENGINEER DEPT. OF DOCKS - DATE
ASST. ENGINEER DEPT. OF DOCKS - DATE

DEPARTMENT OF DOCKS
BOILER HOUSE
bet HANGARS #3 & 4
STEAM PIPING
DATE: 7-1-35
DATE: 7-6-35
BOILER #35-M-1
Rec. 11-230 P.P.
35-A

646/63034 3094

ON MICROFILM

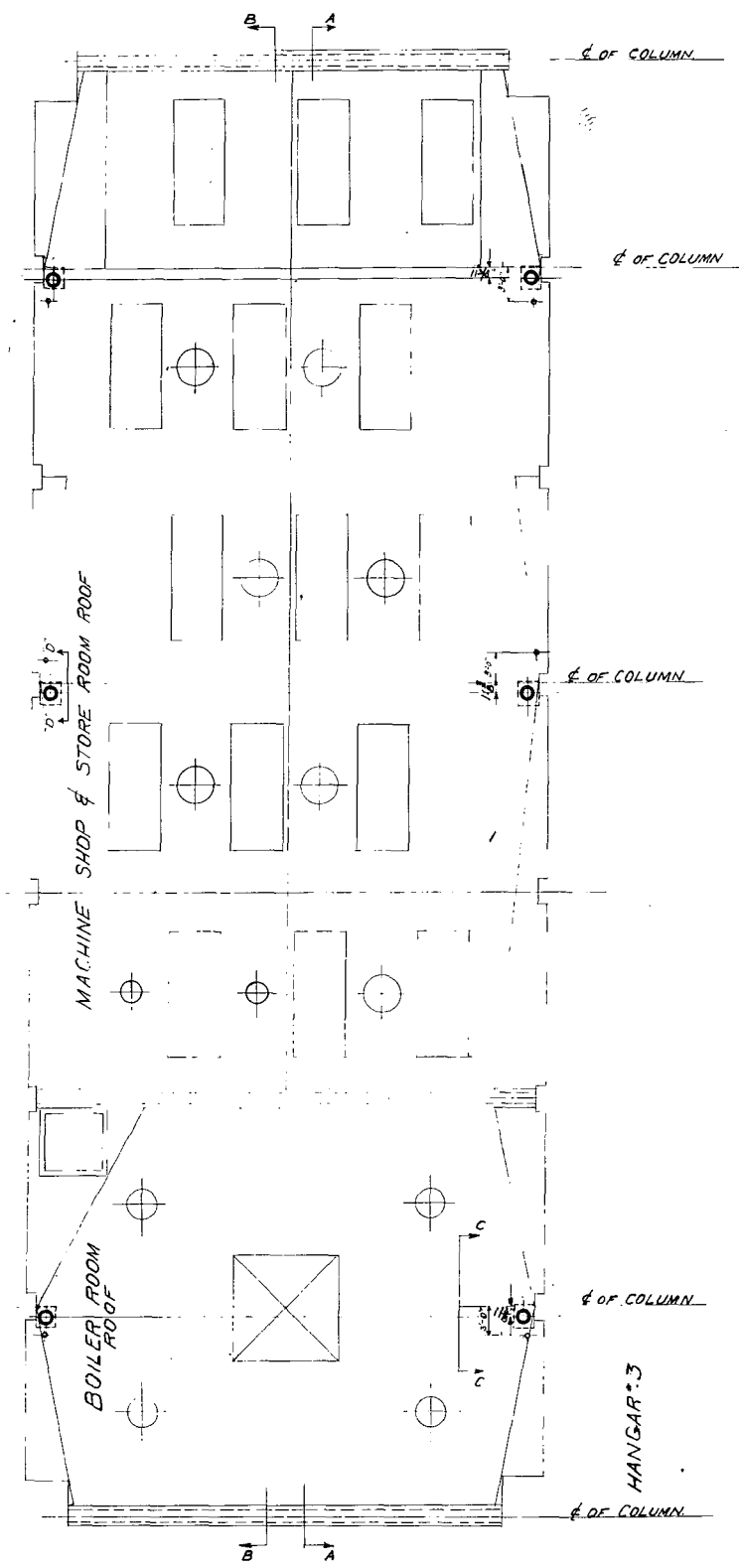

NOTE:
FOR UNDERGROUND DRAINAGE CONNECTIONS, SEE DWG. NO 39-M-21

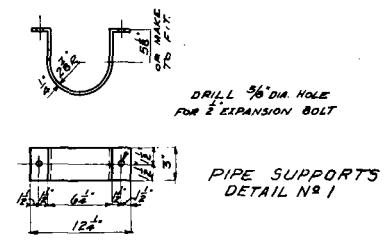
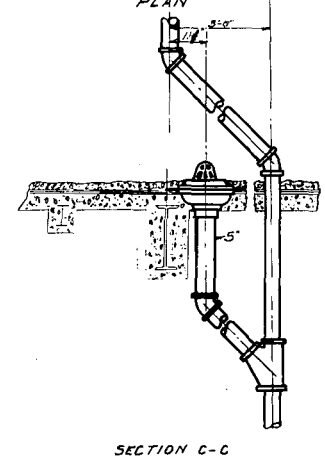
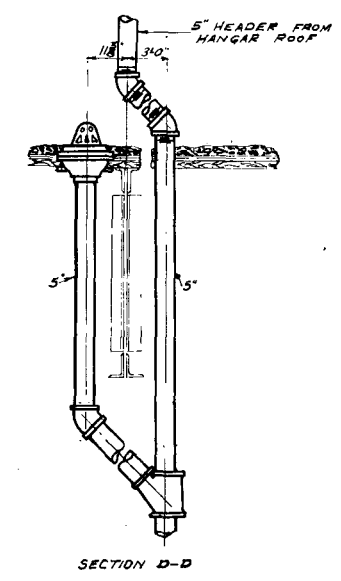
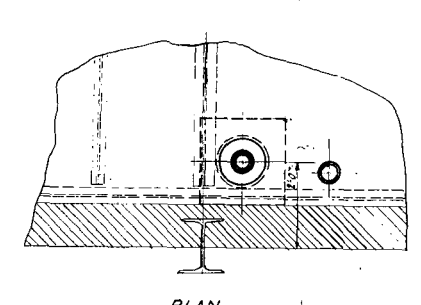
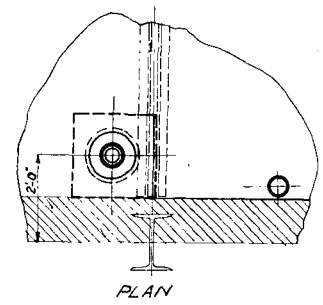
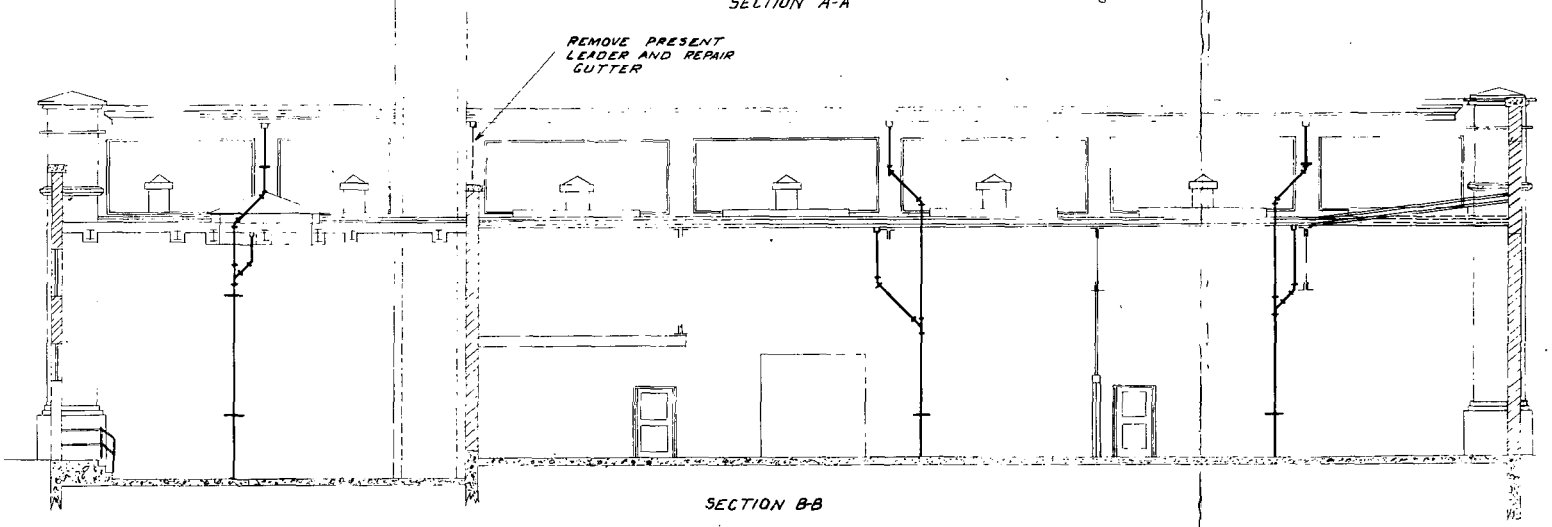
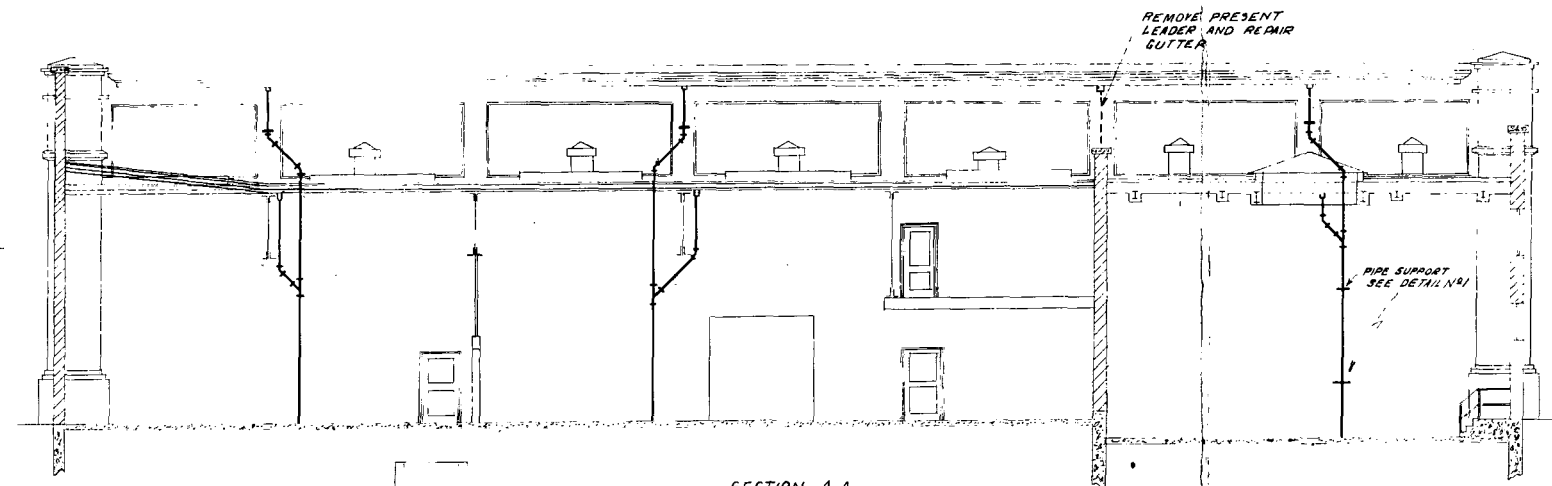

ITEM	NUMBER REQUIRED	DESCRIPTION	REMARKS
1	4	CAST IRON ROOF LEADER CONNECTION FOR 2\"/>	
2	2	CAST IRON ROOF LEADER CONNECTION FOR 2\"/>	
3	26	SCREWED GALV. DRAINAGE ELBOW	ORDERED - REQ. 566
4	4	DOUBLE 45° BRANCH CAST	ORDERED - REQ. 566
5	6	45° BRANCH 5\"/>	
6	8	SCREWED GALV. DRAINAGE FITTING 5\"/>	
7	50	5\"/>	
9	200'-0"	5\"/>	
10	4	5\"/>	
11	50	1/2\"/>	
12	50	5\"/>	
13	32	18'-0\"/>	

SPONSORS APPROVAL
COMMISSIONER OF DOCKS DATE _____
CHIEF ENGINEER DEPT. OF DOCKS DATE _____
ASST. ENGINEER DEPT. OF DOCKS DATE _____

DEPARTMENT OF DOCKS - CITY OF NEW YORK
DEVELOPMENT AND IMPROVEMENT OF AIRPORTS
FLOYD BENNETT AIRPORT
NAME OF AIRPORT
BROOKLYN N.Y.
LOCATION
OFFICIAL PROJECT NO 65-97-1661 PROJECT AUTH. ADVICE NO 166
ALLOTMENT ADVICE NO 108 WORKS PROJECT NO 254-F-34
W.P.A. JOB NO BC-35
ROOF DRAINING SYSTEM - MACHINE SHOP AND BOILER ROOM

DRAWN BY THOMAS DATE 9-21-35 DESIGNED BY THOMAS DATE 9-21-35
CHECKED BY M.G.B. DATE 10-1-35 APPROVED BY _____ DATE _____
RECORD NO 21-250 DEPT. MECH DWG. NO 35-M-26

ITEM	DESCRIPTION	DATE	REV. BY	CHKD. BY	APP. BY	APP. BY
1	REARRANGE PIPE	9-21-35	TH	M.G.B.	TH	

124

646/63034 4 of 4

ON MICROFILM

HANGAR COMPLEX 5

A. Historical Description

See "Hangar Complexes General."

The south elevation of the WPA Infill of this complex, the side facing the Administrative Building, had the same cast stone propellor design as that of the Infill of Hangar Complex 4. The cast stone Art Deco panels, however, were not applied here.

B. Existing Conditions

1. Exterior

a. Site

In general, the exterior condition of this complex is much better than that of Hangar Complex 6, and damage due to lintel erosion is not as severe as that of the other complexes.

b. Steel Framing System

The frame is structurally sound. Some of the plasters have been cracked, however, due to the corrosion and expansion of the steel columns and water freeze-thaw action.

c. Masonry

All four of the high lean-to parapets have damaged and eroded masonry work. The two at the west hangar lean-to are leaning slightly out away from the building.

About 65 percent of the exterior mortar is deteriorating.

Four of the pilasters have long vertical brick separation cracks.

d. Openings

About 35 percent of the glazing at the large hangar doors is damaged or missing.

Corroding and expanding steel lintels are a problem at this hangar complex, but to a lesser degree than that at the other three. An attempt was made to patch some of the damage and this probably slowed down the deterioration process.

Three of the lean-to doors have been bricked in at their overhead light.

At the center bay of the east elevation a window opening has been altered to form a new opening for a door.

Some erosion of steel frames and rotting of wood frames is occurring.

e. Roof and Roof Drainage

The roof framing is still basically sound but the wood decking is rapidly deteriorating. Deterioration occurs at about 60 percent of the east hangar lean-to, 15 percent of the east hangar, 30 percent of the WPA infill, 15 percent of the west hangar, and 50 percent of the west hangar lean-to.

Gutters, leaders and flashing are in fair to poor condition.

2. Interior

a. East Hangar

This portion is generally sound except for leaking and damaged roof planking and deteriorated paint.

b. East Hangar Lean-to

This space is extremely deteriorated. Plaster on ceilings and walls is falling, paint is flaking, and flooring is rotted.

c. West Hangar

The hangar is generally sound (presently used for roller hockey) except for deteriorated paint and leaking/damaged roof planking.

d. West Hangar Lean-to

Though in better condition than the east hangar lean-to, there is deterioration of plaster paint, and flooring due to water penetration from the roof.

e. WPA Infill

This is in fair condition (better than either lean-to). Roof leakage is also apparent here, and skylights have broken glass and weathered flashing.

C. Recommendations

See "Comments Concerning All Hangars," Recommendations, Hangar Complex 3.

Work on this complex for preservation/adaptive use is scheduled for 1980 and 1981. The A/E Manager for contracts concerning this work is Jeff Bentz of the Denver Service Center. As now planned, a major part of the allocated funds will be invested in exterior preservation with much of the remainder going toward preparing the interior for indoor recreational uses.

This work should follow the "Guidelines for Preservation/Adaptive Use" included in the front of this report and involves the continuous input and consultation of the members of the branch of historic preservation, Mid-Atlantic/North Atlantic Team, Denver Service Center.



WPA Infill - South Elevation
January 1979



WPA Infill - North Elevation
January 1979



West Lean-to
Hangar Complex 5
June 1979



West Lean-to
Hangar Complex 5
June 1979



Interior WPA Infill, Hangar Complex 5
June 1979



East Lean-to
Hangar Complex 5
June 1979

HANGAR COMPLEX 6

A. Historical Description

See "Hangar Complexes General." The major difference between this complex and the other three is in the sawtooth roof design of the WPA infill.

B. Existing Conditions

1. Exterior

a. Site

There is a large caved-in section of asphalt around the center downspout at the east wall. A small concrete structure was built near the complex at the north end of the east elevation.

b. Steel Framing System

The frame is still structurally sound, but the long cracks due to column corrosion and water freeze-thaw expansion appear here to a drastic degree.

c. Masonry

Most of the pilasters have long vertical cracks due to the corrosion of the steel columns and water freeze-thaw expansion. Continued expansion could lead to serious damage.

The high parapets at the south elevation are loose with deteriorated mortar.

About 75 percent of the mortar is deteriorated.

d. Openings

The aluminum alloy hangar doors are exfoliating at the edges.

A comparatively large percent of glass is broken or missing at the hangar doors. At the north elevation, 20 percent of that

of the east hangar and 30 percent of that of the west hangar is damaged. Forty percent of the glazing of the east hangar and 20 percent of that of the west hangar at the south elevation is damaged.

A bay with windows on three sides was added shortly after initial construction at the far end of the east elevation.

All four of the lean-to doors are bricked in at the area of their arched heads, and the sixth window from the north at the west elevation has been infilled with concrete.

The problem of lintel deterioration and expansion is especially severe at this complex. Steel window frames are also deteriorating. Most of the windows along the east and west elevations are in extremely poor condition, as are the upper windows at the south end of the WPA infill. Others are in fair to poor condition.

A wood frame covered entry was constructed at the door of the north side of the WPA infill.

e. Roof and Roof Drainage

The roof framing is still sound, but wood decking is deteriorated in areas. This damage occurs over approximately 50 percent of the east hangar lean-to, 30 percent of the east hangar, 50 percent of the WPA infill, 30 percent of the west hangar, and 50 percent of the west hangar lean-to.

Roofing and flashing are in poor condition. A cap of lead coated copper was placed over the cast stone coping around the perimeter at an unknown date.

The iron rainwater furniture appears basically sound, missing only small sections.

2. Interior

a. East Hangar

This hangar is in fairly sound condition, with only peeling paint on the brick walls and small areas of roof deck damage allowing entry of rainwater.

b. East Hangar Lean-to

Plaster finish on roof and walls is badly deteriorated.

c. West Hangar

The hangar is in fair condition.

d. West Hangar Lean-to

The lean-to is in better condition than the eastern lean-to. Roof decking is exposed and the brick walls are sound with only some peeling paint. (Plaster finishes were never applied to these areas.)

e. WPA Infill

This area was constructed to include a boiler room at the south end with a mezzanine level above. Walls at the main level were exposed painted brick, while the interior partitions of terra cotta and the main walls of the mezzanine were covered with a plaster finish. Similarly, the sawtooth roof structure was exposed at the main level, while the mezzanine had a plaster ceiling. The plaster finishes at the mezzanine level are cracking and deteriorating, and the paint is peeling. Paint at the main level is also deteriorating. Decking and skylights at the sawtooth roof are in poor condition.

C. Recommendations

See Comments Concerning All Hangars, and Recommendations Exterior Hangar Complex 3.

1. Exterior

a. Site

Fill the caved-in section of asphalt at the east wall and cover with bituminous material after repairing the downspout in that area.

Demolish the concrete shed located at the northwest corner of the complex.

b. Steel Framing System

As repairs are made to the masonry work, inspect any exposed framework for signs of serious damage. Clean and/or repair and recover. Paint with rust inhibitive paint.

c. Masonry

Repoint approximately 75 percent of the brickwork.

Carefully inspect pilasters at time of preservation work to determine which can be repaired in place and which will need to be rebuilt.

Inspect the high parapet walls at time of preservation to determine exact extent of work required. (It is likely that the end parapets at the south elevation will need to be rebuilt.)

Clean and repair all cast stone trim.

d. Openings

Repair the exfoliating edges of the hangar doors. (This can be done by sandblasting the loose material, priming, and painting. If a more finished appearance is then required, the edges can be finished with auto body filler.)

Reglaze broken and missing glass at the hangar doors. This includes approximately 20 percent at the east hangar and 30 percent at the west hangar at the north and 20 percent of the west hangar and 40 percent of the east hangar at the south.

Check condition at time of preservation to determine the number of steel lintels and window frames that will need replacement and the number that can be refurbished in place. Most of the east and west windows will need replacement.

At time of preservation, demolish the wood frame entry shed at the north door of the WPA infill.

e. Roof and Roof Drainage

Inspect wood decking to determine the minimum area needing replacement. This will be approximately 40 percent.

Reroof total roof area.

Repair flashing and rainwater furniture.

D. Cost Estimate

See D. Cost Estimate for Hangar Complex 3.



South Elevation - Hangar Complex 6
June 1979

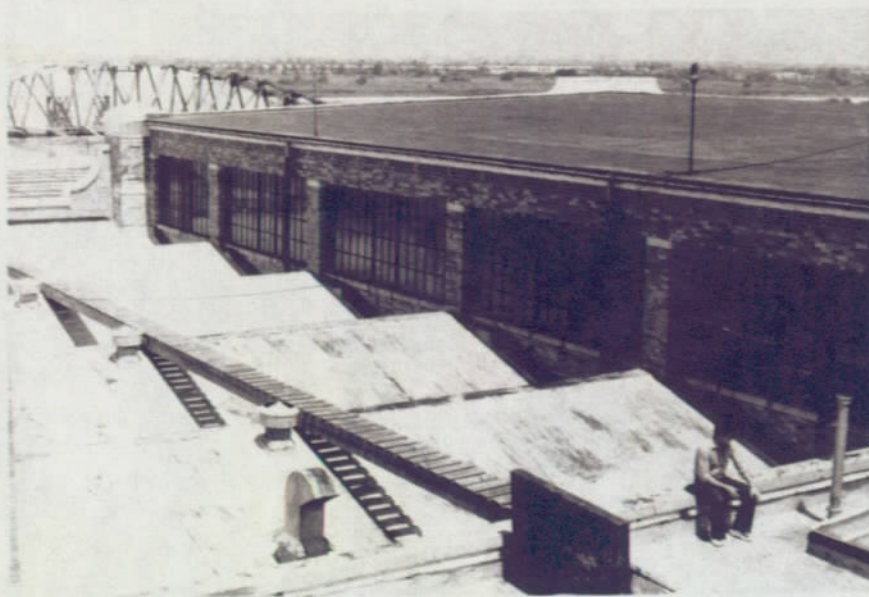

Roof at WPA Infill - Hangar Complex 6
June 1979



Hangar Complex 6 - Lean-to
June 1979



Hangar Complex 6 - Lean-to
June 1979

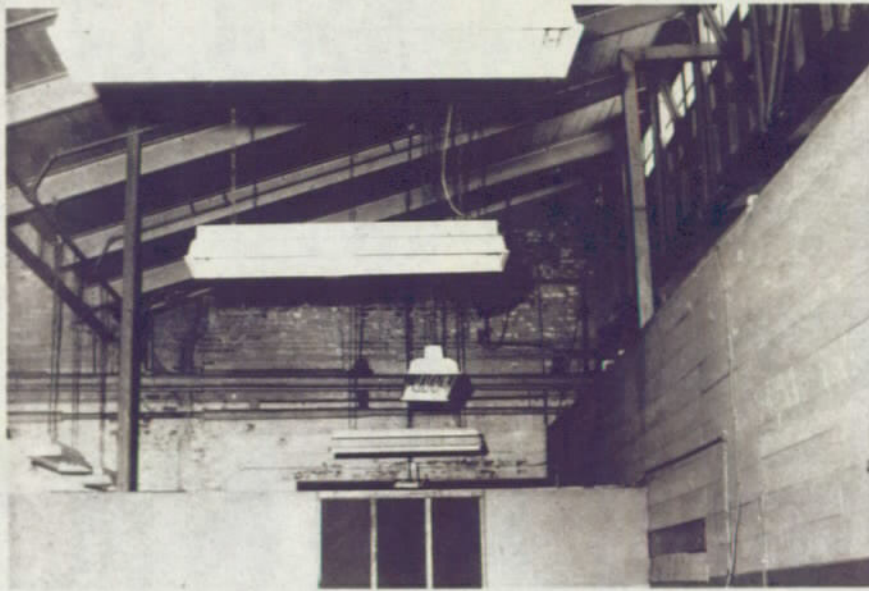

Hangar Complex 6 - WPA Infill
June 1979

HANGAR COMPLEX 6

Drawings for WPA Infill, 1935

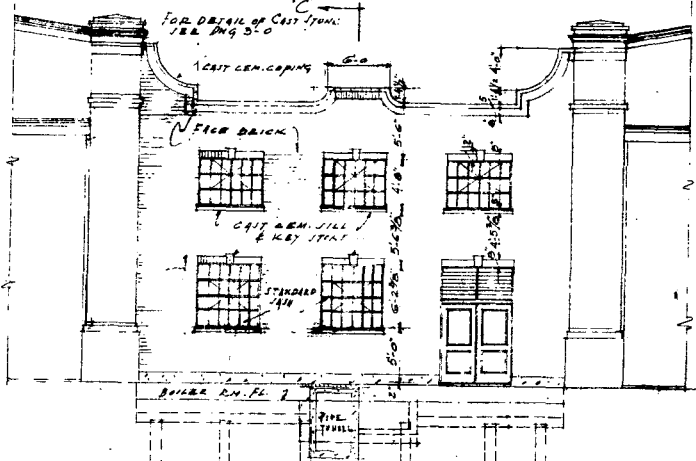

SOUTH ELEVATION

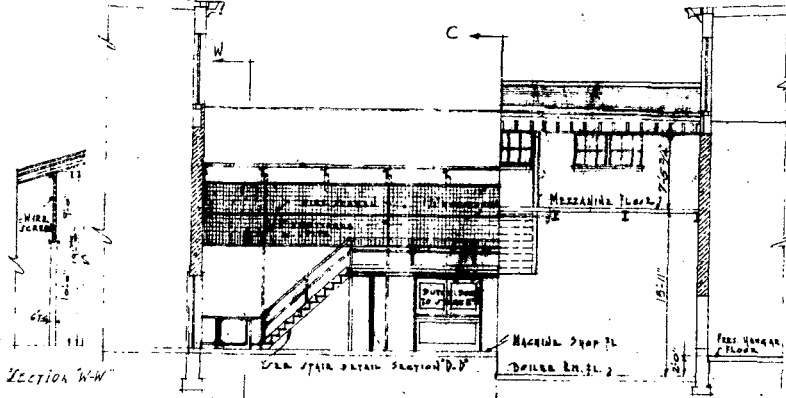

CROSS SECTION D-B

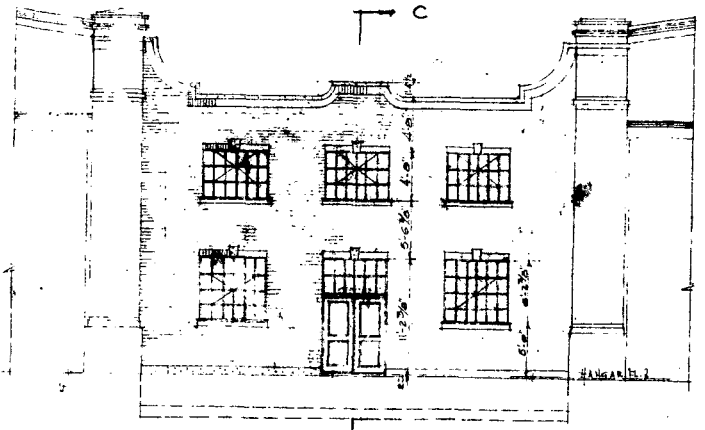

NORTH ELEVATION

DOOR & WINDOW SCHEDULES			
MASONRY OPENING FOR DOORS		MASONRY OPENING FOR WINDOWS	
LOCATION	N ^o OPENING	LOCATION	N ^o OPENING
NORTH WALL	1 6'-4" x 11'-2 3/8"	NORTH WALL	2 6'-3 3/8" x 6'-2 3/8"
SOUTH	1 7'-4" x "	SOUTH	1 4'-8" x 4'-8"
BOILER RM. CURTAIN WALL	1 4'-6" x 7'-6"	BOILER RM. CURTAIN WALL	3 6'-2" x 4'-8"
MACHINE SHOP	2 3'-4" x 7'-4"	BOILER RM. CURTAIN WALL	3 6'-2" x 4'-8"
STOR. RM.	2 10'-0" x 10'-0"	WINDOWS IN TRUSSES	4 4'-2 3/8" x "
			4 3'-0" x "

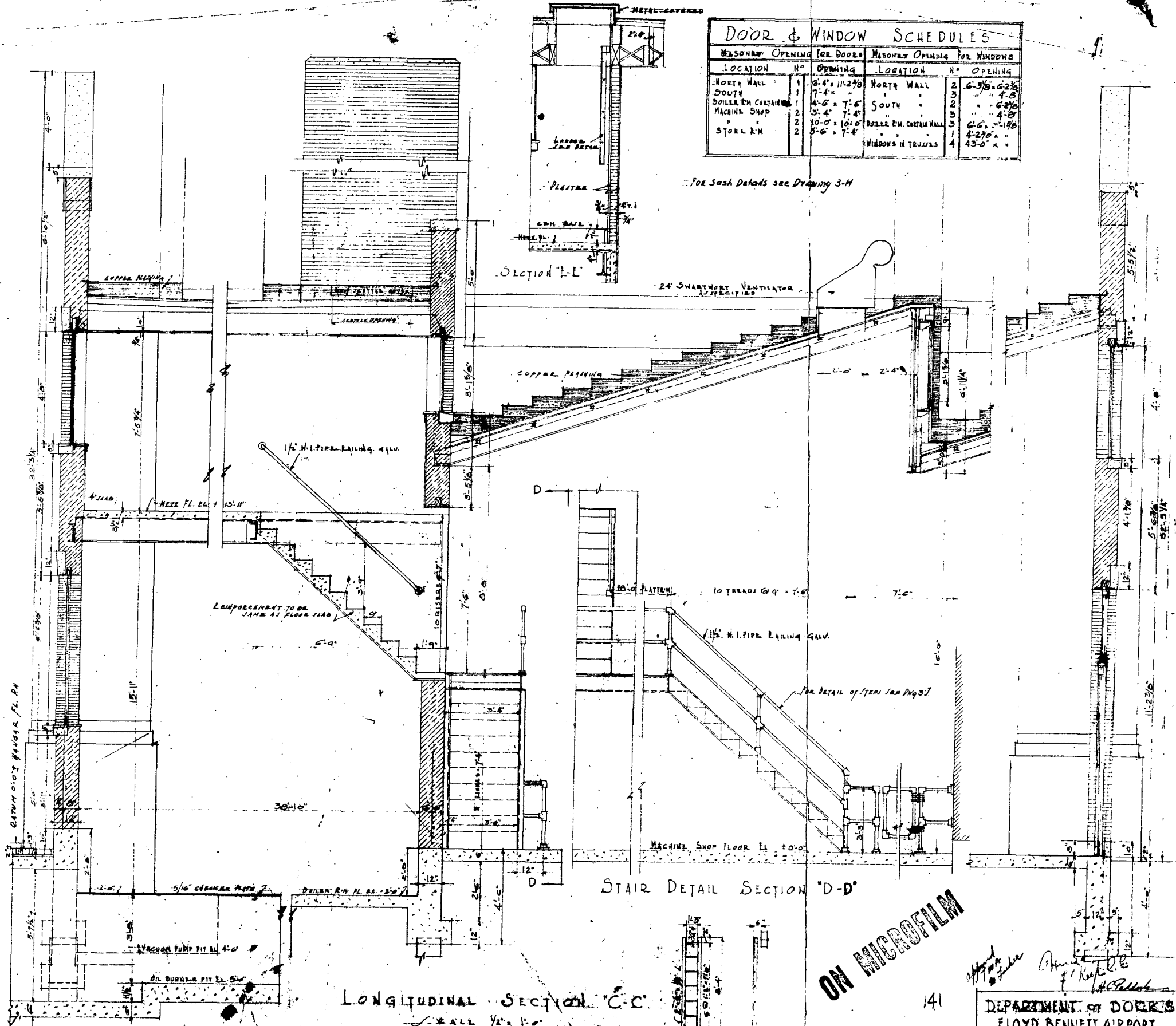

LONGITUDINAL SECTION C-C

STAIR DETAIL SECTION D-D

ON MICROFILM

DEPARTMENT OF DOCKS
 FLOYD BENNETT AIRPORT
 TERA PROJECT NO. 89 - BR. 458
 JOB NO. 3
 ELEVATION & SECTION

DRAWN BY H. A. BELLACK, DATE 1/10/50
 CHECKED BY J. H. KELLEY, DATE 1/10/50
 APPROVED BY J. H. KELLEY, DATE 1/10/50

646141932

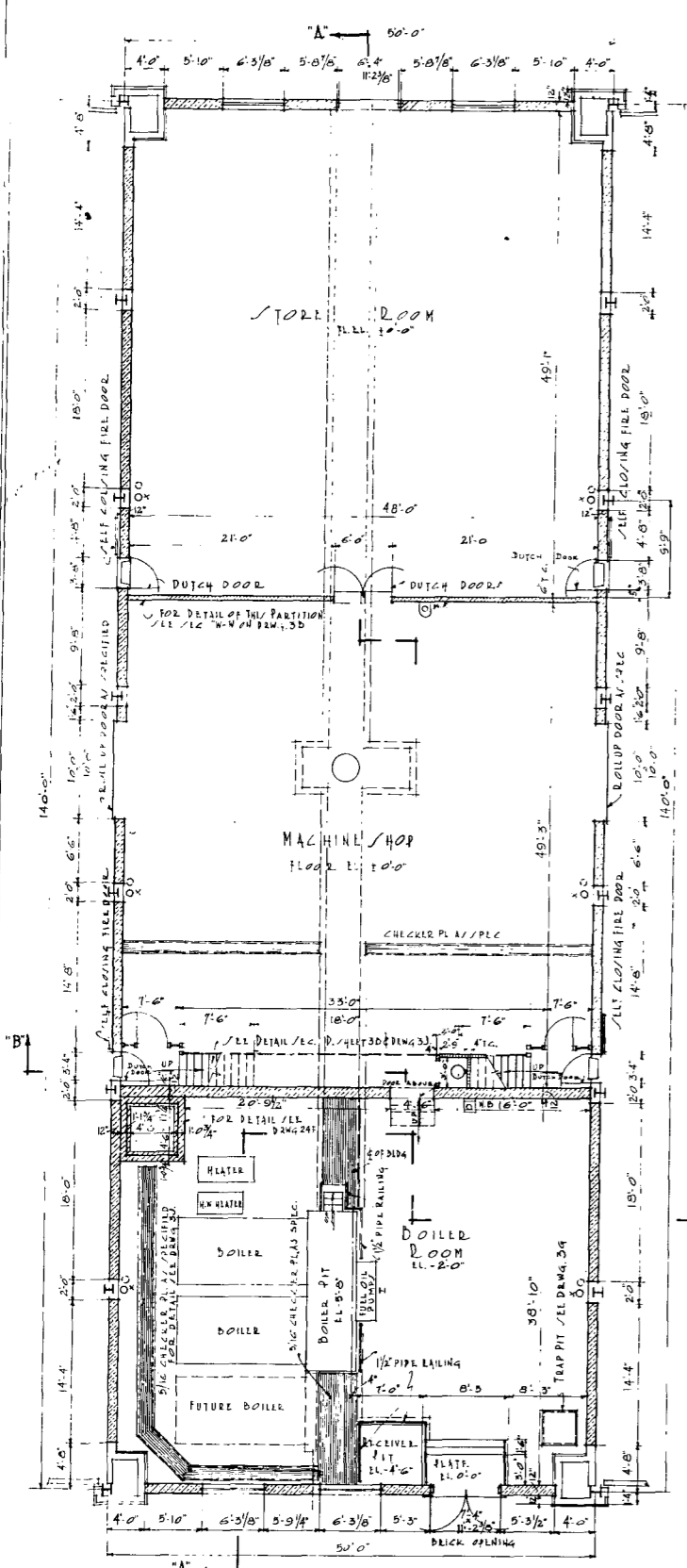

FIRST FLOOR PLAN

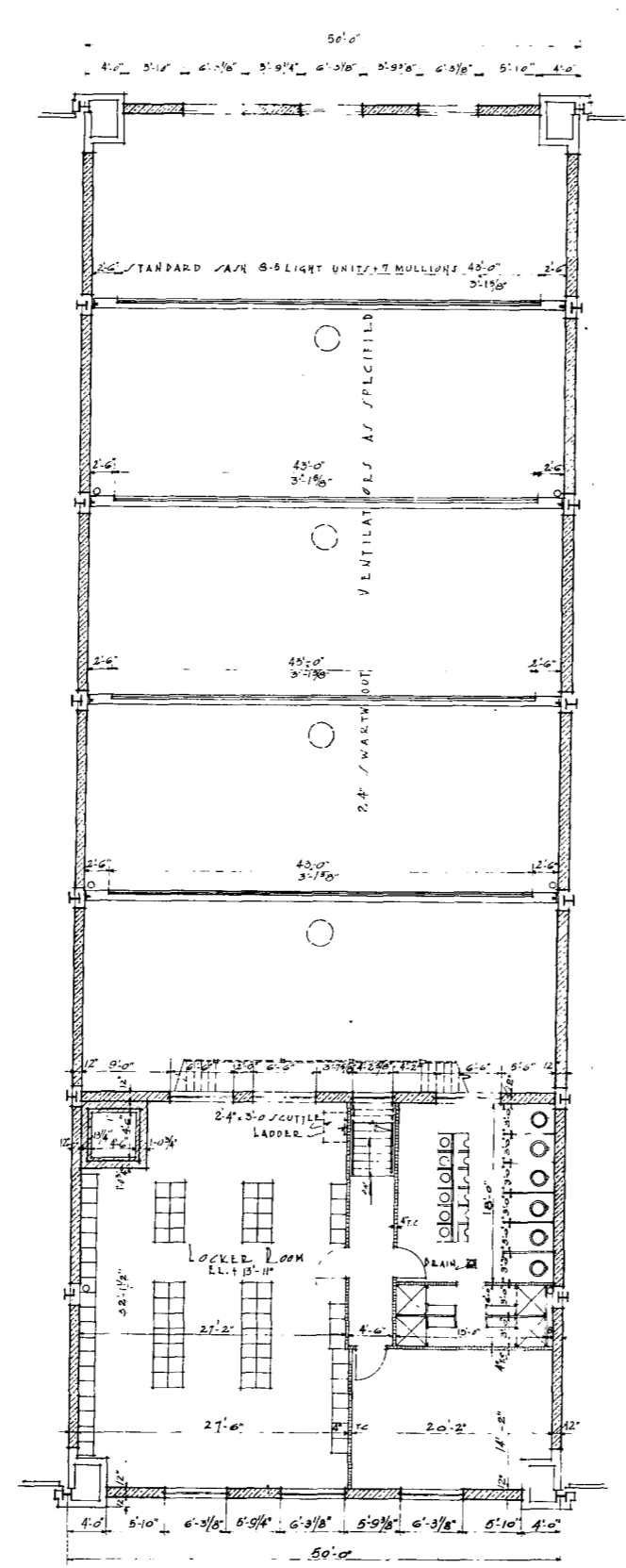

MEZZANINE FLOOR PLAN

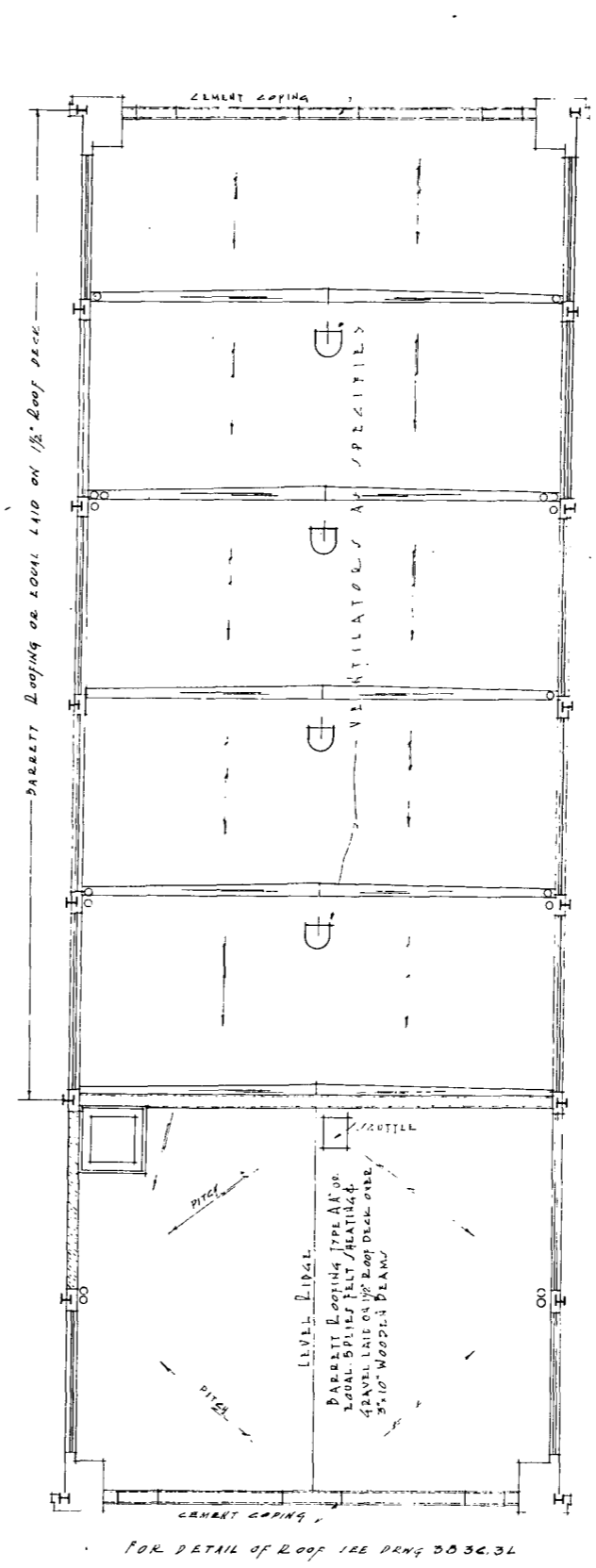

ROOF PLAN

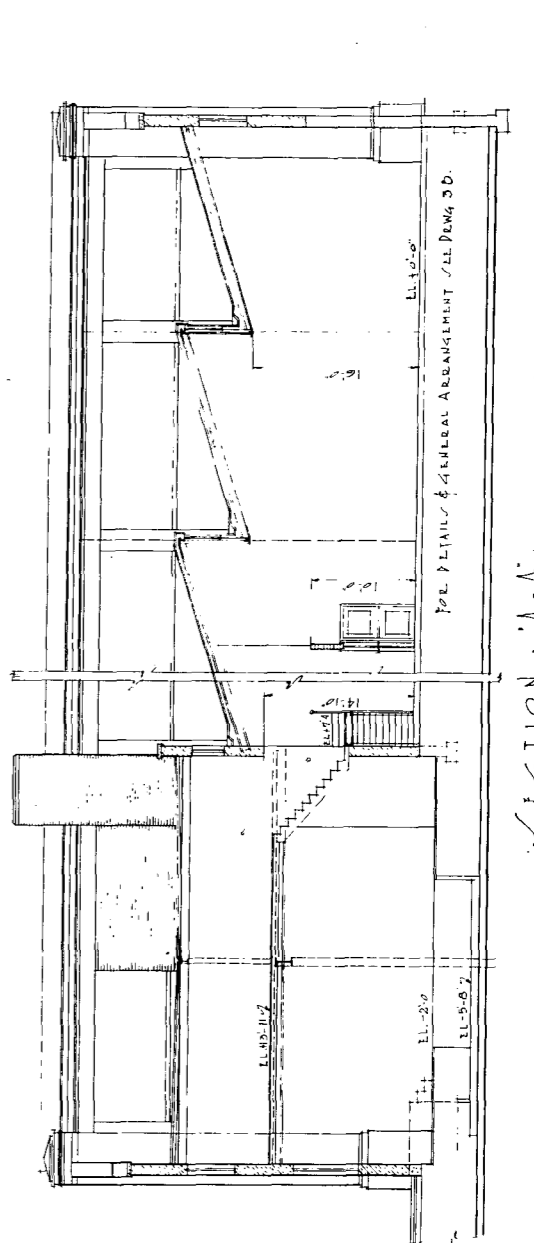

SECTION A-A

NOTE: SEE PLAN FOR ROOF DRAINAGE
SEE PLUMBING DRAWING FOR DETAIL

ON MICROFILM

NO.	DESCRIPTION	DATE	BY	CHK'D BY	APP'D BY
3					
2	DUTCH DOOR DRAWING	12-28-36	J.W.M.		
1	REVISED	12-28-36	J.W.M.		

POWER HOUSE & SHOP
PLANS AND SECTION
D.L.R.
C.W.P.
AUG 20 1935
AUG 20 1935
3-4-1
Record No. 99

6416/63034 1 of 4

GARAGE-SHOPS 26

This structure was erected at the south end of Hangar Row to provide a dope shop and garage for the field. It measured approximately 125 feet by 50 feet (see Historical Data Section Photograph No. 32 - Construction of Dope House).

A. Historical Description

1. Exterior

a. Site

The structure was sited about 10-feet west of Pumphouse 30 with its long axis in the east-west direction. Its north elevation, the front, faced Hangar Complex 3, and the west paralleled Flatbush Avenue. Asphalt block paving was used in front of the building, while concrete and asphalt concrete was used at the three remaining sides. (Asphalt materials were in use at the time of this building's construction, but there is no conclusive evidence that the existing material is the original fabric.)

b. Masonry

(1) Foundation and Walls

Original drawings were not found for this structure, but visual evidence indicates that the structural system is similar to that of the hangars. It can be assumed that with this large of a building, piles may have been spaced beneath a spread footing to aid anchorage beneath bearing walls. From the exterior pilaster design and simpler interior pilasters, it is assumed that the superstructure consisted of steel framing members with brick and terra cotta tile infill and partially bearing walls.

Walls consisted of the typical "Hangar Row" orangish face brick laid in common bond with headers every sixth course. Brick was placed against the thicker wall of structural clay tile.

Pilasters, one header thickness in depth, but wide, were spaced across the elevations: four at the north, eight at the south, and four each at east and west.

(2) Parapet and Trim

The walls, crowned by a cast stone coping, extended approximately 2-feet above the roof line to form a parapet. At the center of each elevation the parapet stepped up about a foot and arched elliptically. Between this center statement and the end of both north and south elevations, the parapet rose one step.

Pilasters were capped with a band of cast stone. Another band of cast stone encircled the structure about 3-1/2-feet below the cap, just above a soldier course which surrounded the building at the head of openings. A small flat diamond or square shape of cast stone was centered on each pilaster between the cap and lower trim, and centered and below each parapet elevation change.

c. Doors and Windows

Openings spanned between pilasters at the north (main) elevation. This facade was divided into a narrow center entry bay, flanked by a long bay in east and west which opened into the large garage and shop spaces. East and west bays were similar, with a large expanse of small panes of glazing in a steel frame. A large overhead sliding door was centered in each glazed bay. The existing multi-paneled wood doors are not original. Though no photographs or plans were found to document their original appearance, the doors were probably of a design similar to the surrounding glazing. Each of these end bays had one standard sized (3- by 7-foot) door located at the far side near the center bay. Between the central pilasters was the main entry door flanked by expanses of small glass lights. This door was framed with cast stone and a wide cast stone band spanned the central bay at the level of the door's head.

East and west elevations were similar with three large steel frame-and-sash windows set in bays formed by four wide

pilasters. The height of the opening was from a level about 3 feet above grade to the soldier course which was continuous around the building. There were six lights along the horizontal and seven lights along the vertical. Two inner sections of eight lights each could be pivoted open within the fixed framing system. Sills were cast stone.

A door-window assembly similar to that of the center front entry was used at the center rear elevation (south). Six-light sections pivoted open within the larger fixed frame. Five-light-wide by seven-light-high windows were situated in each bay to either side of the center and in each end bay. The bay between these window bays (the second bay in from each end) contained a secondary entry. The eastern of these is now partially boarded over and the western has been infilled with masonry so it is difficult to be sure of the original fabric and arrangement. The openings are still visible, however, and it can be speculated that the door was flanked by a triple row of steel-framed lights with a steel-framed transom over.

Steel lintels were used as support above all wall openings.

d. Roof and Roof Drainage

The roof structure consisted of steel trusses with wood decking laid perpendicular. The roof was divided into three sections nearly equal in width running eastwest, with the center section rising about 4 feet above the level side sections. This center section was flat except at the east and west where it sloped down to meet the end walls parapet at the level of the side sections. Roofing was asphalt roll and the vertical walls of the center section were covered with asphalt siding.

Drainage was provided by a gutter/leader system which directed water down through pipes in the interior of the structure at each of its four corners. A copper gutter ran along both sides of the higher center roof portion. Downspouts dumped the collected water onto the side sections which in turn were slightly sloped toward the corner

roof drains. From the roof drains, water was guided to underground pipes through large downspouts exposed to the interior of the structure.

2. Interior

a. Flooring and Floor Plan

Flooring was concrete slab on grade. An asphalt topping was applied over at an unknown point in time. Partial mezzanines were of concrete. Floor raceways, about a foot wide and with flush rectangular concrete cover plates, were located around the perimeter of the two large spaces along their exterior walls.

The floor plan consisted of two large open spaces (about 60 by 50 feet each), one each at the east and west, and a core area of smaller spaces between. Main entry into the large spaces was via the overhead doors which were centered in the north walls of the rooms in a 35-foot wide opening.

The central core area was accessible from the exterior by a door at either north or south ends. From the north end, one entered into a small vestibule from which access to the large spaces was available via doors at east and west. The south end door led through a short hall to an iron ships ladder located against the west wall of the core area. The ships ladder provided access to the mezzanine above, from which access to the roof could be gained via an iron ladder attached to the wall surface. At the other side of the east and west hall walls at the south end were small toilet facilities. These were accessible from the large space to which one each was adjacent.

The central portion of the core area leaves room for speculation, as its arrangement and use varies in its appearance on different drawings. Another ships ladder against the west wall in this area certainly appears original, although it does not show up on any drawings. The ladder leads to a second mezzanine at the north end of the core area. Again, access to the roof is provided by an iron built-in ladder. The mezzanine and ladders may be assumed original because of their similarity to those aforementioned and because of an original-appearing roof hatch above.

The western of the large spaces appears to have always been left basically open, though its uses varied from metal shop to garage. The eastern large space varied from dope shop to a later use for paint spray.

b. Walls

The structural clay tile was left exposed, and so was visible on the interior of the building's perimeter walls. Walls of the central core area were of common brick, also uncovered. These wall surfaces have been painted but dating the layering is not possible without further investigation.

A small room was erected with metal partitions, again at an unknown time, in the southeast corner of the east large space.

c. Ceiling

The ceiling finish was cement plaster or diamond mesh lath. It was higher at the center, generally following the profile of the roof structure.

d. Equipment

Electrical and mechanical equipment was surface mounted. An overhead sprinkler system was used.

B. Existing Conditions

1. Exterior

The exterior remains in overall fair condition, and basically retains its historic appearance. The major visual alteration has been a concrete block shed-roofed addition which was attached to the west end of the south elevation in 1944 for the U.S. Naval Air Station. The block walls of the addition were given a Portland cement finish and the woodframed roof was covered with 1-inch gypsum laminated roof deck and mineral surfaced roofing. The still extant 10 by 20 foot old paint storage building located just southeast of Building 26 was constructed at the same time as this addition and of the same materials.

a. Site

Vegetation has grown up around the east and south areas of the structure and between joints in the asphalt block at the north.

b. Masonry

Foundation and walls appear to be in basically sound condition. Steel columns have apparently not begun to deteriorate as no damage is apparent in the brickwork.

Intermittent hairline cracks are present and about 30 percent of the mortar is deteriorating.

Cast stone coping and trim are spotted in appearance, black from misplaced bituminous roofing material, and white from weathering of the concrete finish.

c. Doors and Windows

Steel lintels and framing at doors and windows are severely deteriorated and exfoliating.

Many glass panes are broken and openings at the south elevation have been sealed with plywood. Exhaust fans for the Dope Shop half of the building were installed at an unknown point in time (after 1944). They pierce through boarded up openings at the south elevation at a height of approximately 8 feet.

The kalamein overhead doors at the north side are in poor condition, the structure of the western being damaged at the lower left corner.

Headers (at the underside) of the overhead door openings are damaged, the western being in the worse condition. Though the cause of the damage is not immediately apparent, the cracking, bulging, and staining of the cement coating implies corroding steel above.

d. Roof and Roof Drainage

Approximately 30 percent of the wood decking is rotted.

The builtup bituminous roofing on the main structure is in deteriorated condition, with a bubbling and cracking surface.

The wood-frame roof of the addition is in poor condition. Fascia boards are rotted or missing and framing ends are exposed.

The copper gutters and downspouts draining the main roof are stained with tar and have many small dents and leaks. Interior downspouts are corroding.

2. Interior

a. Flooring and Floor Plan

Floors are in fair condition, but the asphalt topping material is very deteriorated.

None of the available drawings showing this building show the same floor plan for the rooms in the core area. Apparently small changes were made at various periods. If documentation of these changes is deemed important, further study is necessary.

The open space of the western large area was cut into by the construction of a wood-framed room along the east wall.

b. Walls

Brick and structural tile walls are in sound condition, but paint is deteriorated.

The steel partition in the east space is badly rusted.

An original opening at the south wall of the western large space has been sealed with concrete block.

c. Ceiling

The cement plaster finish is in poor condition.

d. Equipment

Original unit heaters are still present but in poor condition.

Mechanical and electrical piping and conduit are rusting and deteriorating.

One toilet and one washbasin in poor condition are the only plumbing fixtures that remain.

C. Recommendations

The size of this structure and its contribution to the historic scene and story of Floyd Bennett Field dictate that it be preserved. The concrete block addition should be demolished as it detracts from the original appearance of the structure, and would demand part of the already sparse funding allocated to Hangar Row.

A temporary adaptive use was proposed for Building 26 via a memorandum dated August 15, 1978, from the Superintendent, Gateway National Recreation Area, to the Regional Director, North Atlantic Regional Office. The proposal was to use Building 26 as a temporary interior Gateway Recycling Center. The interior was to be broom swept and painted. No exterior work was planned except for repairs to roof, doors, and windows. Although this scheme was reviewed and approved by the proper officials, it was dropped when a costly reroofing job was found necessary for its implementation. Still, it does appear to be a viable approach, in keeping with national energy objectives, which would help in the preservation of this structure while awaiting completion of the DCP. If the structure is to be preserved in the end, money for roofing and repairs will be very well spent, and will aid in arresting further deterioration.

As more funding becomes available, work to preserve the exterior would include:

1. Site

Remove vegetation and brush from around building.

Demolish concrete block addition.

2. Masonry

Repoint 30 percent of brickwork.

Clean and/or repair cast stone trim and brickwork.

3. Doors and Windows

Remove all steel lintels and replace with new (of non-corrosive material).

Clean and paint steel window frames when sound. Many will need repair or replacement.

Replace all broken, damaged panes of glass with new matching wire glazing.

Install new doors and windows in those openings at the south elevation that were sealed for installation of the exhaust fans. A more modern material may be considered but must match the appearance of those existing historic.

Repair kalamein doors at the north elevation. Eventually, a more compatibly designed overhead door should be installed. Further research would be needed to try to find the original appearance and construction of these doors.

The underside of the heads of the large openings at the north elevation should be further inspected to find the cause of deterioration and the problem remedied. Recoat with matching cement.

4. Roof and Roof Drainage

Replace approximately 30 percent of the wood roof decking. Matching of historic fabric is preferred.

Remove old roof surface and install built-up roofing.

Repair/replace gutters and downspouts in kind.

It is repeated here that this structure makes an important and interesting contribution to the historic scene and that its historic exterior should be preserved. The interior spaces are large and open and allow for the possibility of a wide variety of adaptive uses. Interior work should follow the "Guidelines for Preservation/Adaptive Use" at the front of this report.

UNITED STATES DEPARTMENT OF THE INTERIOR
NATIONAL PARK SERVICE

PACKAGE ESTIMATING DETAIL

REGION North Atlantic		PARK Gateway N.R.A.	
PACKAGE NUMBER 109 (Portion)	PACKAGE TITLE Exterior Preservation Garage/Dope Shop 26		

(If more space is needed, use plain paper and attach)

ITEM	QUANTITY	COST
Demolish concrete block addition, repoint 30 percent brickwork, clean and repair cast stone trim and brickwork, replace 13 steel lintels, clean and paint five windows and two doors, reglaze as necessary, install new door/window entry, repair underside of heads at north openings, replace 30 percent roof deck, install roofing, repair/replace gutters and downspouts, replace five steel window frames, install three large steel windows at south.	LS	\$91,000
H.S.R. Estimate R. Borrás 3/30/81		

SUMMARY OF CONSTRUCTION ESTIMATES		CLASS OF ESTIMATE		
		<input type="checkbox"/> A Working Drawings	<input type="checkbox"/> B Preliminary Plans	<input checked="" type="checkbox"/> C Similar Facilities
Proj. Type		Totals from Above		
		B & U		R & T
52	Museum Exhibits			XXXXX
55	Wayside Exhibits			XXXXX
62	Audio-Visual			XXXXX
89	Ruins Stabilization			XXXXX
91	Construction		\$91,000	
92	Utility Contracts			XXXXX
ESTIMATES APPROVED (Signature)		(title)	(date)	

POST PROFESSIONAL SERVICES ESTIMATES AND SCHEDULING ON BACK OF FORM

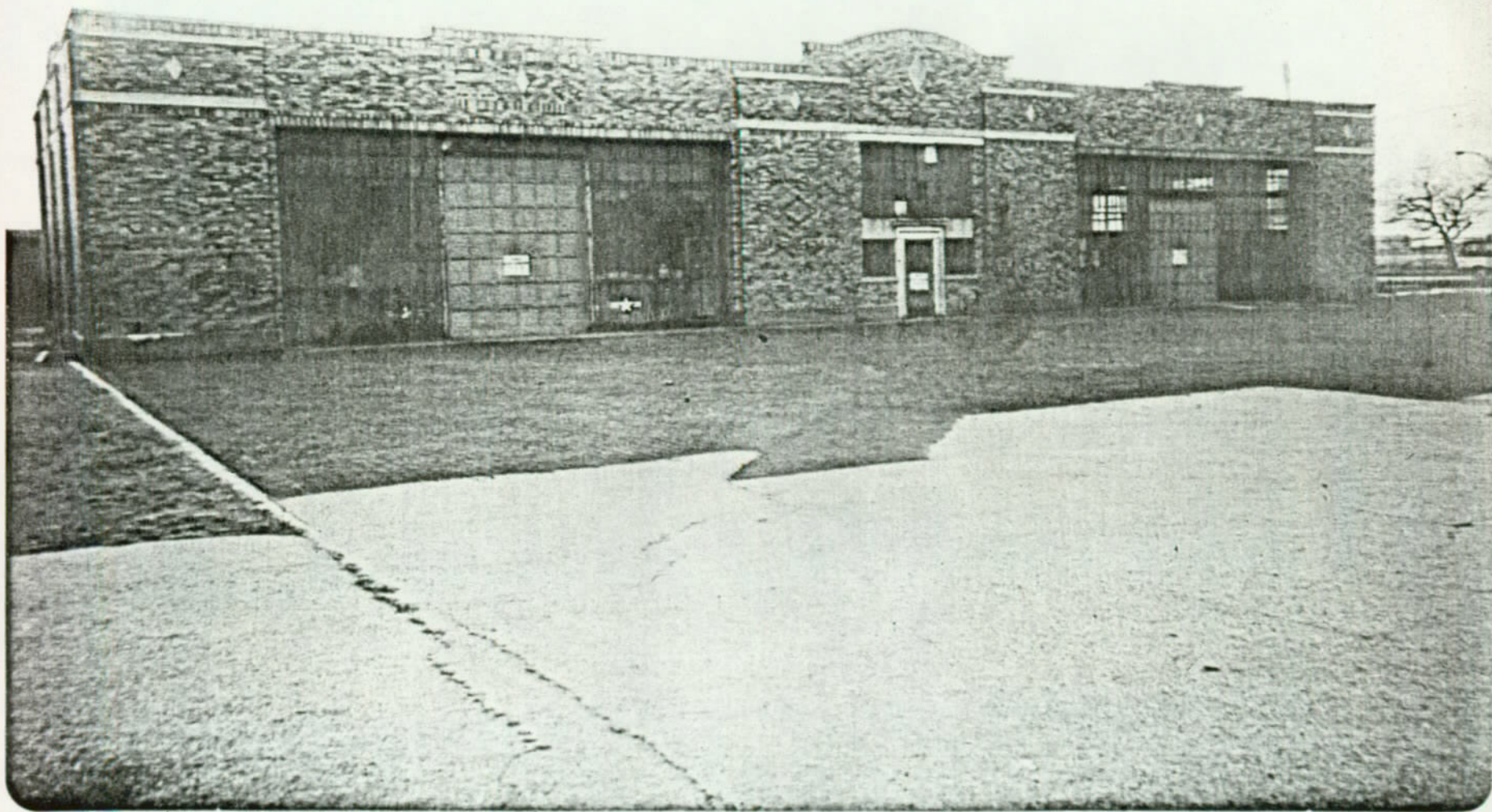

Garage/Shops 26 North Elevation

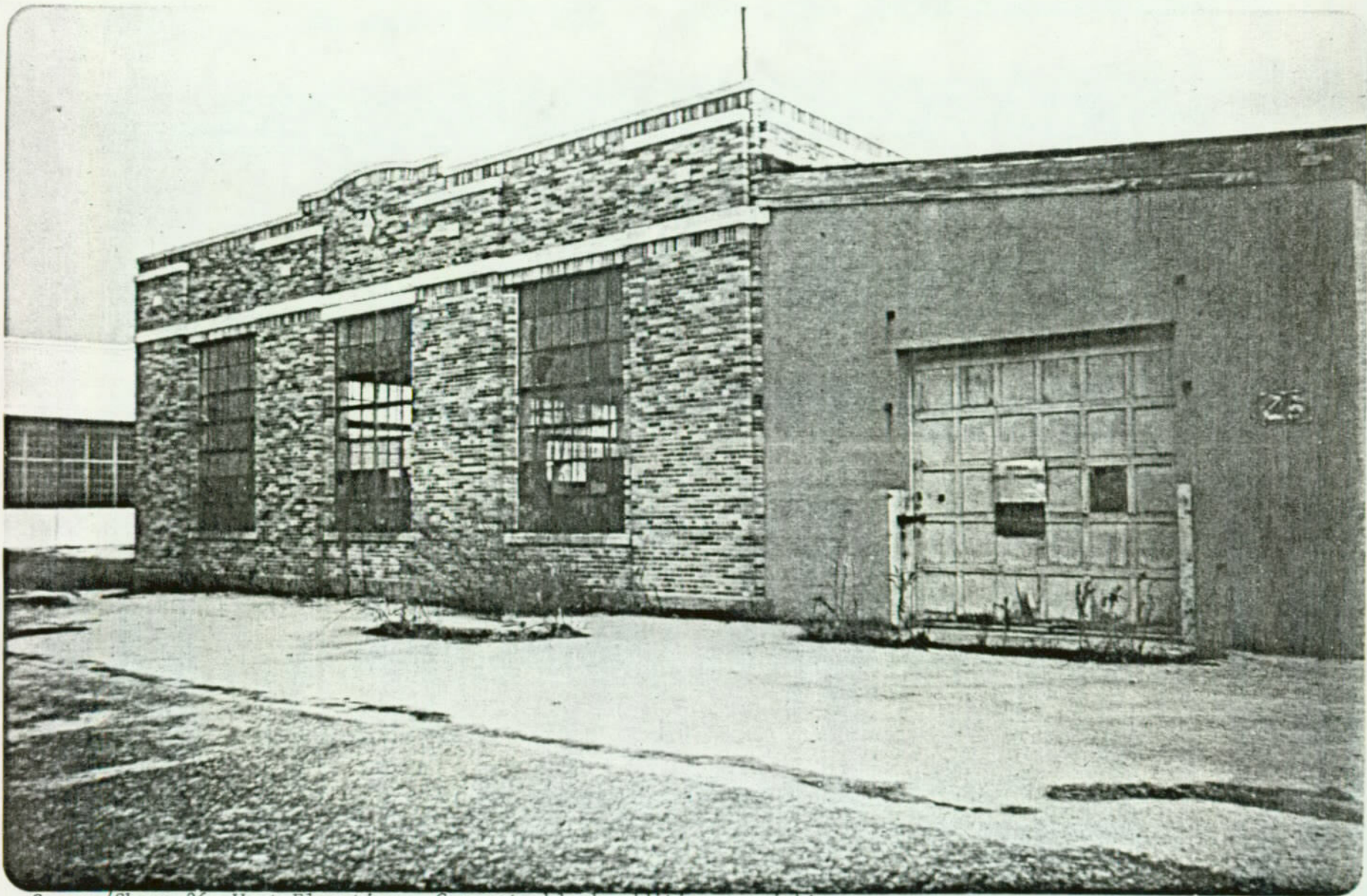

Garage/Shops 26 West Elevation - Concrete block addition on right



East Elevation - Note Pump House 30 to the left.
October 1978

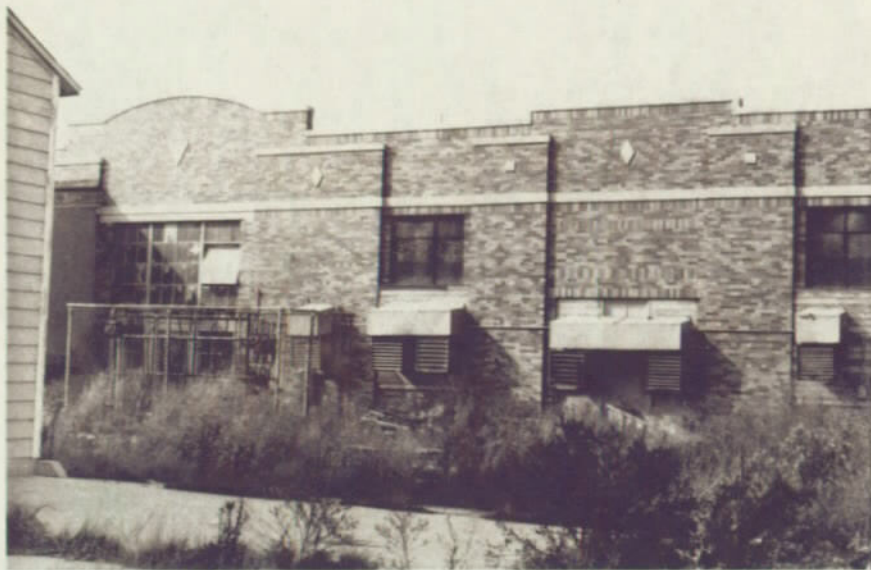

Partial South Elevation - Note openings which have been
infilled to allow installation of exhaust fans. The
corner of the block addition can be seen at the far left.
October 1978

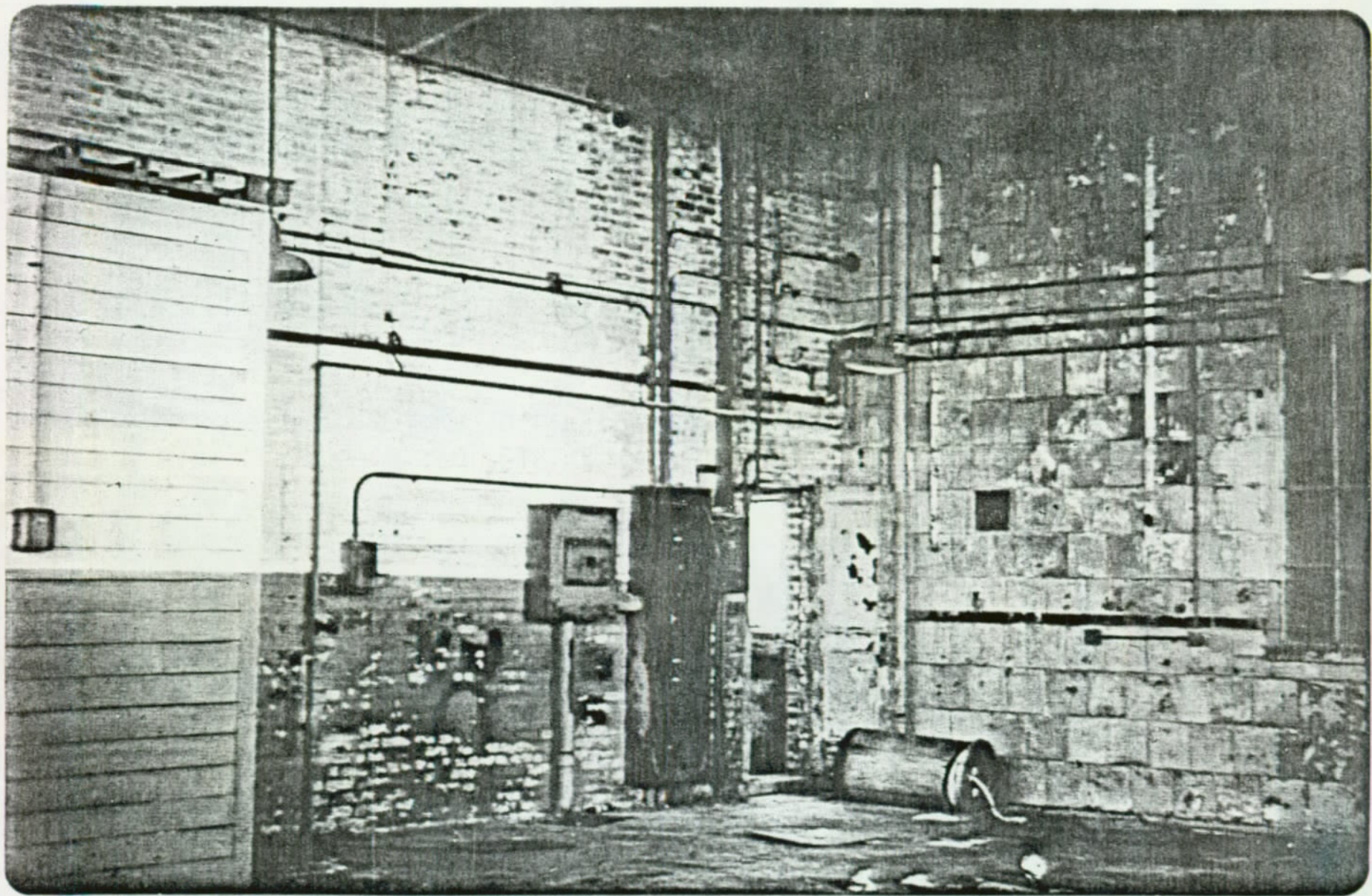

Garage/Shops 26 Interior at Large west space

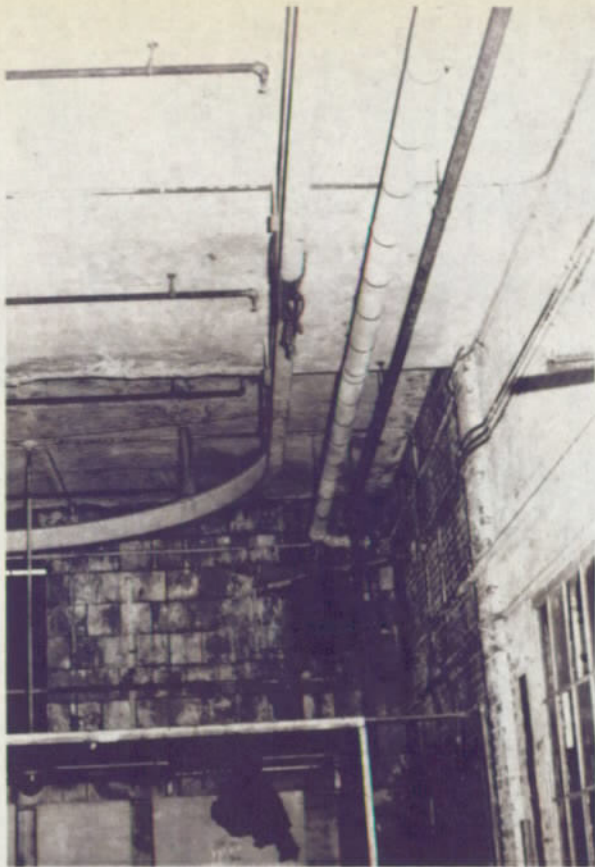

Southwest corner of east large space. Note original unit heater in corner and upper portion of paint spray hoods.
October 1978

Typical Ceiling condition
October 1978

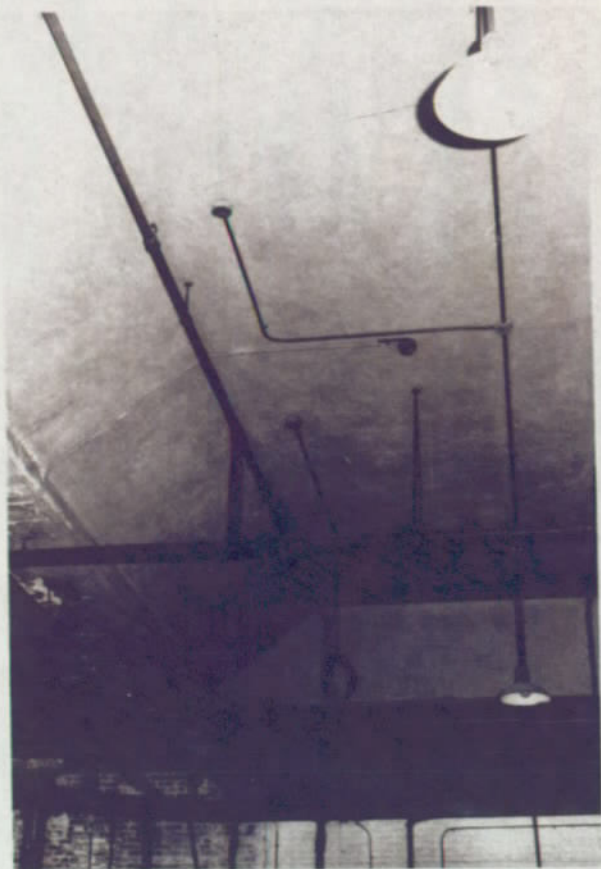

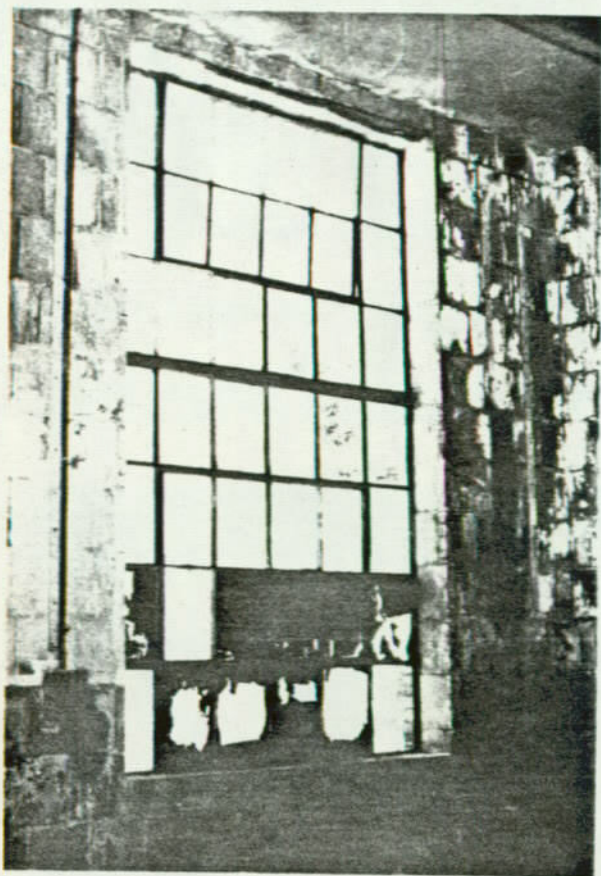

Interior at window - typical
head condition

June 1979

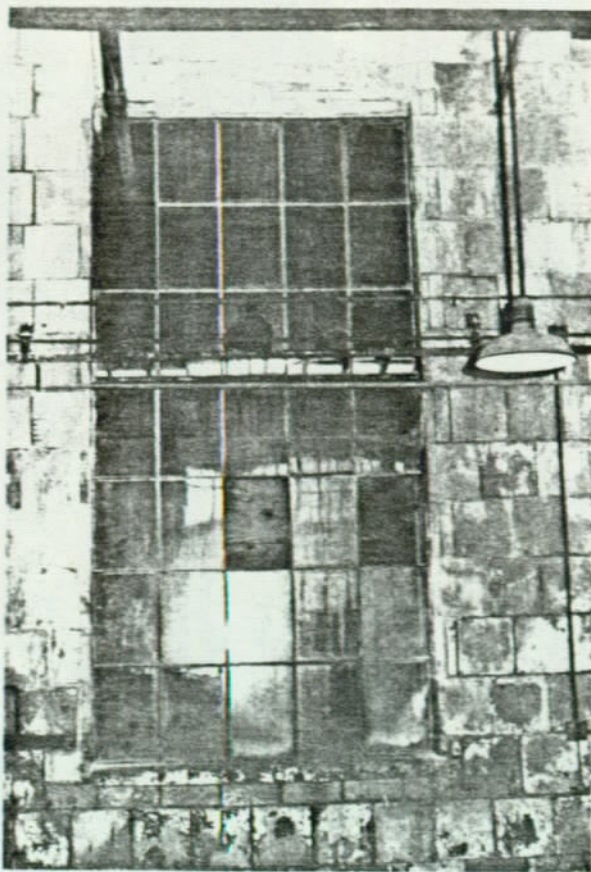

Previous exterior window now
looks into the interior of
the concrete block addition.

June 1979

FIRE PUMP HOUSE 29

A. Historical Description

1. Exterior

a. Site

The structure was located near Flatbush Avenue between and west of Hangar 5 and the Administration Building. A road ran east-west between this building and Pump Station 176 ending at another structure.

b. Foundation and Walls

The foundation consisted of perimeter concrete spread footing which reached approximately 4 inches above grade to form a water table.

Walls were orange-buff colored brick laid in common bond with headers every sixth course. A concrete parapet crowned the wall forming a sort of bond beam. The words "PUMP HOUSE" were imprinted into the parapet and centered at the north and south elevations.

c. Doors and Windows

One kalamein door led into the structure at the west side of the north elevation. It was headed by a slim band of concrete which projected slightly from the bottom level of the parapet, the door stopping with the brick.

One window was centrally located at the east elevation, two at the south, and one at the north, balancing the door. They were headed with the slim concrete band, matching the door opening, and had a header course of brick serving as their sills. They were steel frame with four lights.

d. Roof and Roof Drainage

The roof was concrete hip with standing seam copper roofing and was partially obscured by the parapet. Drainage was by means of four copper scuppers, one at each end of the north and south parapet. Copper downspouts led down into an underground drainage system.

2. Interior

The interior consisted of one room until the addition of the concrete block structure added another. Concrete slab was used at the floor and the ceiling consisted of the exposed underside of the concrete roof structure. Walls were left exposed except for a paint finish. It is not known if the walls and ceiling were painted originally.

B. Existing Conditions

1. Exterior

Originally rectangular and symmetrical in plan, an addition was constructed at the west side which projected slightly to the south. It was of concrete block and had a frame shed roof which sloped toward the west. The addition houses a water storage tank.

a. Site

The site remains historical except for unchecked vegetation and Beacon Tower 145 which stands in the middle of the old road.

b. Foundation and Walls

The northeast foundation corner has sunken to the extent that the entire corner section of brick wall has cracked away from the rest of the building.

Mortar has deteriorated over about 60 percent of the brickwork.

Concrete parapet and brick wall are stained at the northeast beneath the copper scupper opening.

The concrete block walls of the addition are only in fair condition. There is vertical cracking near the main structure at the north elevation.

c. Doors and Windows

Steel window frames are rusting slightly.

The sill of the north window is cracked and separated vertically due to the foundation settlement at that corner.

d. Roof and Roof Drainage

The northeast scupper and all of the downspouts are missing.

The wood-frame roof on the addition is deteriorating. Fascia boards are unpainted and warped and the southern board has fallen off.

2. Interior

The interior is in basically sound condition although some interior wall damage does occur at the northeast corner due to the foundation settlement. Damage will be arrested if the poor condition of the exterior is remedied.

C. Recommended Treatment

1. Exterior

a. Site

Remove vegetation from building site and make sure ground slopes slightly away from its perimeter.

b. Foundation and Walls

Reinforce foundation at northeast corner. Exact detailing of this process will need further inspection. Excavate around corner, and underpin the footing. Chip mortar out of cracks, and repoint in existing position.

Repoint 60 percent of the mortar and clean brickwork.

Refurbish and paint existing window frames.

c. Windows and Doors

Scrape and paint window frames.

d. Roof and Roof Drainage

Install copper scupper and copper downspouts to match original.

Repair roof deck and fascia of addition and paint fascia boards.

Reroof addition.

2. Interior

No action is necessary on the interior.

UNITED STATES DEPARTMENT OF THE INTERIOR
NATIONAL PARK SERVICE

PACKAGE ESTIMATING DETAIL

REGION North Atlantic	PARK Gateway N.R.A.
PACKAGE NUMBER 109 (Portion)	PACKAGE TITLE Preservation Fire Pump House 29

(If more space is needed, use plain paper and attach)

ITEM	QUANTITY	COST
Reinforce foundation at northeast corner, repoint 60 percent of brickwork, and clean masonry, refurbish and paint five windows, install copper scuppers and downspouts, repair additions roof deck, reroof additions. H.S.R. Estimate R. Borrás 3/30/81	LS	\$14,000

SUMMARY OF CONSTRUCTION ESTIMATES		CLASS OF ESTIMATE		
		<input type="checkbox"/> A Working Drawings	<input type="checkbox"/> B Preliminary Plans	<input checked="" type="checkbox"/> C Similar Facilities
Proj. Type		Totals from Above		
		B & U	R & T	
52	Museum Exhibits			XXXXX
55	Wayside Exhibits			XXXXX
62	Audio-Visual			XXXXX
89	Ruins Stabilization			XXXXX
91	Construction	\$14,000		
92	Utility Contracts			XXXXX
ESTIMATES APPROVED (Signature)		(title)	(date)	

POST PROFESSIONAL SERVICES ESTIMATES AND SCHEDULING ON BACK OF FORM

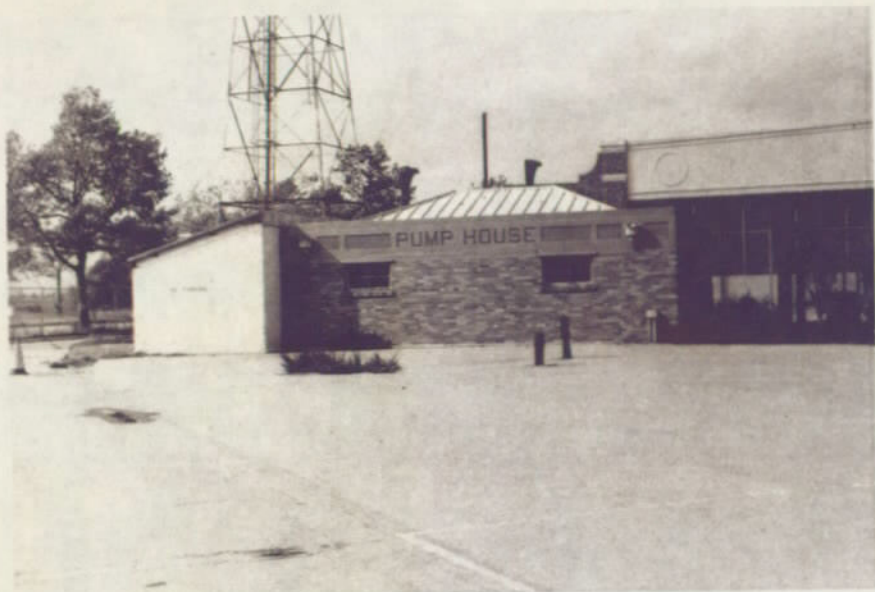

South Elevation - Downspouts missing. Note Beacon Tower 145 at left rear and Hangar Complex 5 at right. October 1978



West Elevation - Concrete block addition. October 1978



East Side of North Elevation

Foundation has sunken at this corner (probably due to excess water saturating the earth at this point). October 1978



North Elevation. January 1979

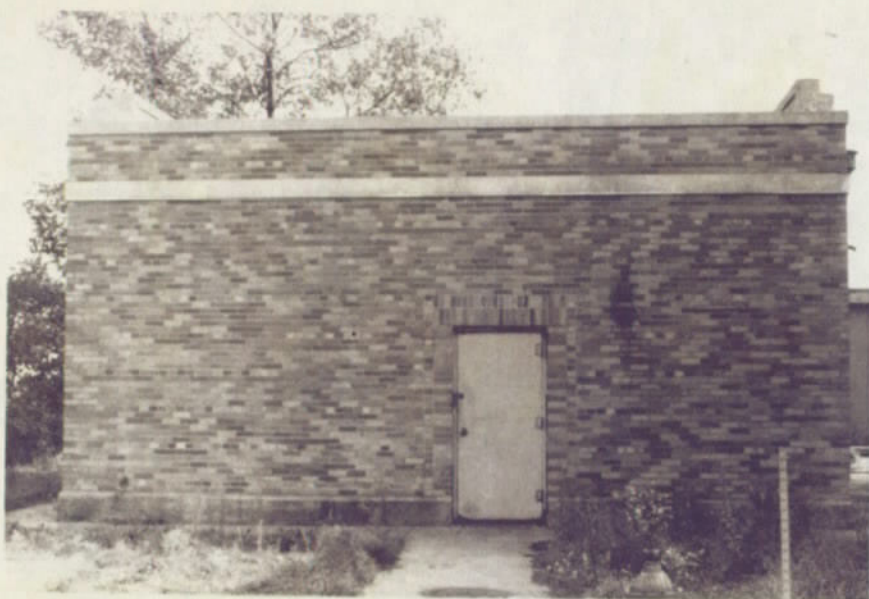

North elevation. October 1978



Northwest - scupper detail. October 1978

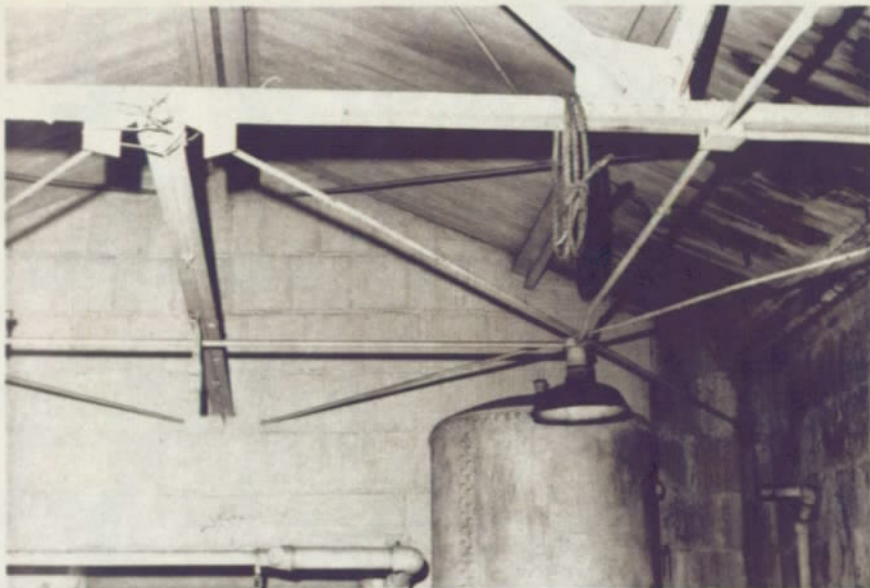

Roof framing - looking west. Note rotted roof boards at north slope. June 1979



Northeast corner - typical wall and railing condition. June 1979

SEWAGE PUMP HOUSE 30

The main purpose of this small structure (20 by 26 feet) was to provide shelter for two sewage ejectors and their auxiliary equipment. An 8-inch inlet pipe carried sewage collected from along Hangar Row into two 300 gallon-per-minute ejectors which were located well below grade in a deep pit. Once there, the sewage was pumped up to a discharge pipe approximately 10-1/2-feet above its entry point. The sewage is then pumped by a series of lift stations to a treatment plant on site.

A. Historical Description

1. Exterior

a. Site

The Pump House was sited at the southern end of Hangar Row between Vault 57 and Garage-Shops 26 with its long axis in the east-west direction. Although there was no formal landscaping, it was surrounded by a concrete walk and its entry was connected to the asphalt paving to the north by a concrete path.

b. Masonry

(1) Foundation and Walls

According to the New York City Department of Docks 1931 drawing, the building perimeter rested on a 12-inch thick reinforced concrete foundation wall which descended 3 feet, then spread into a 2-foot wide by 1-foot deep footing. The two ejectors housed within the structure were seated approximately 20-feet below grade in a reinforced concrete pit, which had an opening of 14 by 14 feet. Pit walls were 1-1/2-feet thick at the upper 10 feet, then belled out at the earth side to a thickness of approximately 3 feet for the second half of the descent. The base of this pit was 3-1/2-foot thick heavily reinforced concrete, from which twenty 12-inch diameter wood piles descended another 15 feet into the earth.

Exterior walls were constructed of the orangish face brick found in most of the Hangar Row structures. Bricks were laid

in common bond with headers every sixth course. Interior walls were terra cotta clay units. The 1931 drawing directs the walls to be constructed using steel framing members sheathed with No. 24 painted corrugated steel. As no evidence of this system can be seen, the existing masonry walls are apparently the original fabric. (A steel frame would be likely to show signs of rusting and corrosion, similar to others along Hangar Row, and would have implied the use of brick pilasters around the column members.)

(2) Parapet and Coping

The parapet, a continuation of the same wall fabric, ran horizontal across the north and south at a height approximately 2 feet above the roof level, then stepped up at the east and west elevations. A cast stone coping crowned the parapet, and a cast stone band encircled the building at the same height as the lower level of the roof.

c. Doors and Windows

Interior access was by way of a single metal door at the north or through double metal doors at the east. Door frames were metal. Brick openings for the doors were framed in a brick pattern consisting of a row of soldiers topped by a rowlock course at the head, and bordered at the sides by a stack of stretchers then a stack of headers. (The rowlock course was actually of a height halfway between the width of the standard header and the height of the soldier.)

The three windows, two at the south elevation and one at the west, had steel frame and sash and pivoted out. Though the windows now have four lights each, they look out of place and it is likely that they are not original. Evidence from the 1931 drawing and comparison with neighboring structures would imply that they originally had eight lights and were sashed to fill the whole opening provided in the brick wall. (A 9-inch strip of metal now "fills in" a space between the upper sash and the window head.) Cast stone was used for the sills, and a flat-arched soldier course headed the openings.

Each door and window opening had a supporting steel lintel at the head.

d. Roof and Roof Drainage

The roof structure consisted of wood plank decking over steel framing members. From the north and south walls, the decking members extended up and over an intermediate support to rest on ridge supports, the whole assembly forming a gable shape. A steel truss spanned north to south at the midpoint of the walls. Lower chord cross bracing of 3/4-inch diameter rods was used at this level as well as along the sloping surface of the roof.

The 1931 drawings are fairly accurate in their depiction of the roof framing. Here, as with the walls, the drawings show that No. 24 corrugated steel was to be placed on the framing. It is possible, though unlikely, that the building was constructed as per the drawings and made more permanent soon after by building masonry walls and replacing the metal roof with one of wood and asphalt.

Asphalt roll roofing was placed on the exterior surface, and the roof was screened from full view by the parapet.

Roof water drained to the west from either side of the gable. At either end of the west elevation the water collected in copper scuppers and was routed to underground drainage via copper downspouts. Decorative copper straps fastened each downspout to the wall at two points.

2. Interior

a. Flooring and Floor Plan

Flooring, assuming that part of the 1931 drawings is correct, was a 6-inch concrete slab on compacted fill. The ejector pit was off-center, located toward the east wall, and the pit opening was surrounded by a railing of 2-inch galvanized pipe. Entering from the north door, the pit opening was directly to the east. (The width of the pit actually extended further to the west than the pit opening, but the

western portion was covered with a concrete slab to allow for maximum useable floor area. In the northwest corner, a tall cylindrical (3-foot 6-inch by 10-foot) steel air tank was placed. Two rectangular concrete piers were located in the southwest corner to seat the air compressors.

b. Walls

Walls were exposed terra cotta tile units.

c. Ceiling

The roof structure was completely exposed to the interior. Looking up, truss, framing, tie rods, and wood planking were all visible.

d. Ejector Pit

The pit was 14 by 14 feet square and approximately 20 feet deep. It was reinforced concrete with concrete exposed at walls and floor. The 1931 drawings show access via a built-in steel ladder at the east side. The access that was installed, however, was a steep steel stairway at the northwest pit corner.

B. Existing Conditions

1. Exterior

The structure basically retains its historic appearance. As a whole, it is in sound condition and still operating.

a. Site

Tall grassy vegetation has grown up around the structure. Concrete walks are in fair condition.

b. Masonry

Walls are in generally good condition, although about 25 percent of the mortar joints have deteriorated to a point where they are no longer providing proper protection.

The perimeter foundation appears sound on the exterior, but interior evidence shows that there has been some settlement

along the eastern wall. The east side of the ejector pit is a few inches higher than the surface of the adjacent floor slab. Since the pit foundation is thick and deep, and further anchored by long piles, it is more likely that the building foundation is settling rather than the pit rising.

Several through-wall steel bolts are corroded and could cause damage due to expansion.

c. Doors and Windows

All lintels are corroded.

Doors are operable, but along with their frames, show signs of weathering and corrosion.

Existing windows are in generally good condition, with the exception of some flaking paint and exposed metal.

d. Roof and Roof Drainage

A minimum of 50 percent of the wood roof planks have rotted. Damage is especially severe along the lower half of the gable slope, where water collects.

The asphalt roofing is severely deteriorated. Large piles of leaves and debris which accumulate near the mouth of each scupper speed the decay.

Scuppers are original and in sound condition. Upper strap fasteners for the downspouts are also extant. Both downspouts and their lower straps, however, are missing.

2. Interior

a. Flooring and Floor Plan

Floor slab is sound except for the area along the east edge of the pit previously mentioned, where the slab has sunken away from the outer pit wall.

b. Walls

Walls are basically sound, but paint finish (probably applied sometime after the original construction period) is extremely deteriorated.

c. Ceiling

The rotting, deteriorating wood planks are visible from the interior. Damage and staining is especially severe at the lower half of the slope.

Paint is generally peeling at interiorly exposed roof structure members.

d. Ejector Pit

The paint on the pit opening railing is deteriorated.

C. Recommendations

The following recommendations are all important steps in preserving the structural and historical integrity of the building. However, the most vital work, and that which should be done first, is that of repointing walls and repairing the roof and rainwater furniture. Such action is mandatory to arrest further damage and deterioration.

1. Exterior

a. Site

Remove vegetation from building perimeter and walks.

b. Masonry

Repoint 25 percent of the brickwork. Use mortar mix as per mortar analysis page 220.

The foundation settlement poses no serious structural threat and no treatment at this time is necessary.

Through wall bolts should be removed. They should either be replaced with a noncorrosive material or the holes should be grouted and an alternative design to bolted supports provided.

c. Doors and Windows

Replace all lintels with supporting members of noncorrosive material. The possibilities of using fiberglass or stainless steel instead of steel should be investigated at the time of replacement.

Doors and frames should be cleaned and painted immediately, but completely replaced as soon as feasible. Replacement members should be of a galvanized metal and should be painted for further protection.

Scrape clean and paint window sash and frames. Future consideration might be given to reconstructing windows to match probable historic appearance: Pivoted steel sash with eight lights (double row or four lights each).

d. Roof and Roof Drainage

Replace a minimum of 50 percent of the roof boards. Replacements should match original existing boards.

Reroof with sound materials. Roofing need not be asphalt roll, but should match in general appearance.

Refurbish existing original scuppers and upper downspout straps. Install copper downspouts, matching historic (original stubs are still extant in scupper). Fix with existing upper straps and new matching lower straps.

2. Interior

a. Flooring

No work is necessary at this time. If foundation settlement continues, however, underpinning or other arrestive action may be called for some years in the future.

b. Walls

Wire brush, clean, and paint.

c. Ceiling
After wood planking is replaced, paint entire exposed
roof structure.

d. Ejector Pit
Scrape railing clean and paint.

UNITED STATES DEPARTMENT OF THE INTERIOR
NATIONAL PARK SERVICE

PACKAGE ESTIMATING DETAIL

REGION North Atlantic	PARK Gateway N.R.A.
PACKAGE NUMBER 109 (Portion)	PACKAGE TITLE Preservation Pump House 30

(If more space is needed, use plain paper and attach)

ITEM	QUANTITY	COST
Repoint 25 percent of exterior brickwork, replace five lintels (doors/windows), replace 50 percent roof boards, reroof, refurbish or replace scuppers and downspouts, paint interior walls, ceiling and railing. H.S.R. Estimate R. Borrás 3/30/81	LS	\$16,000

SUMMARY OF CONSTRUCTION ESTIMATES		CLASS OF ESTIMATE		
		<input type="checkbox"/> A Working Drawings	<input type="checkbox"/> B Preliminary Plans	<input checked="" type="checkbox"/> C Similar Facilities
Proj. Type				Totals from Above B & U R & T
52	Museum Exhibits			XXXXX
55	Wayside Exhibits			XXXXX
62	Audio-Visual			XXXXX
89	Ruins Stabilization			XXXXX
91	Construction		\$16,000	
92	Utility Contracts			XXXXX
ESTIMATES APPROVED (Signature)		(title)	(date)	

POST PROFESSIONAL SERVICES ESTIMATES AND SCHEDULING ON BACK OF FORM

ELECTRICAL VAULT 57

This small building measures 10 feet by 12 feet in plan by 11 feet in height. It was constructed to house transformers which supplied low voltage power to various structures along Hangar Row.

A. Historical Description

1. Exterior

a. Site

Located at the south end of Hangar Row, this building had no formal landscaping. It was positioned between Pump House 30 to the west and a wood-frame structure to the east.

An 8-foot high chain link fence, projecting 3 feet from the east elevation and running the length of the wall, was erected to protect two sets of three oil-filled fused switches, and two high voltage potheads which terminated two sets of three phase high voltage underground cables. This was apparently the original arrangement, although the 1931 drawings directed the placing of six cable sleeves in the concrete foundation at the east side, which would imply a subterranean cable entry into the building. Neither the chain link fence nor any exterior electrical attachments are noted on these drawings. It would seem that a change of plans was made sometime before or during actual construction.

b. Masonry

(1) Foundation and Walls

According to the 1931 Department of Dock's drawings, and evidence visible above ground, the foundation consisted of a continuous perimeter concrete spread footing which extended approximately 3-feet below grade. It was 13-inches wide, spreading 10 inches on either side at its base.

Walls were 12-inch thick brick bearing. Face bricks were variations of orange in color and laid in common bond with

headers every sixth course. A stamped impression in one of the corner bricks stated "CONTINENTAL FALLSTONE-made in U.S.A."

(2) Parapet and Coping

White cast stone coping, 4-inches high and set in 4-foot lengths, crowned the structure. A matching band of cast stone, 5-inches thick and projecting slightly, encircled the building about 1-1/2-feet below the coping, at the same level as, and at the opposite side of the parapet from, the roof slab. Between the two bands of cast stone, the 10-inch thick brick parapet rose five courses in height.

c. Doors and Windows

A 4-foot 4-inch wide opening at the west side was left to allow for the double, fixed louver, kalamein doors (using galvanized steel) which were installed. Identical openings, 3-feet 4-inches wide by 3-feet 4-5/8-inches high, were centered one each in the north and south elevations. These housed fixed steel sash windows with six lights of 1/4-inch clear wire glass. A 2-foot 2-inch by 2-foot 2-inch opening with 16-ounce copper louvers was centrally located at the east wall to provide general ventilation.

At the head of each of the four openings was a flat arch, formed by a row of brick soldiers, which concealed the supporting steel lintel. A large cast stone keystone was centered in the flat arch above each opening, and cast stone sills were used at the north and south windows.

d. Roof and Roof Drainage

The roof was a simple steel wire reinforced concrete slab with 4 ply tar and gravel roofing. The slab was 8-inches thick at the west, sloping down to a 6-inch thickness at the east, for drainage at that side.

According to original drawings, rainwater was to be drained from the roof via a 3-inch square tile spout which projected through the lower part of the parapet at the midpoint of the east wall.

This original intent, however, does not match what exists today. A quick visual investigation finds the brickwork in that part of the parapet seemingly undisturbed, pointing out that the spout was probably not installed as originally intended.

2. Interior

The 12-inch thick walls were exposed brick on the interior and left a clear space measuring 8 feet by 10 feet. Flooring was 8-inch thick steel wire reinforced concrete slab with a 1-inch granulated finish. The concrete slab roof was left exposed to the interior. A 1931 electrical drawing shows three transformers, 25 KVA each, located within this structure.

B. Existing Conditions

1. Exterior

a. Site

The structure is now surrounded by tall grass and weeds and the wood frame structure that served as a border to the east has been removed.

b. Masonry

A long vertical crack runs from the east side of the window head to the top of the structure at both north and south elevations, serving to divide the small building virtually in two. The damage is probably due to foundation settlement along the east side of the building.

Horizontal cracks appear above each of the wall openings, caused by the rusting and expansion of the steel lintels. Cracks are along the horizontal mortar joint lines with the upper face of wall bulging out beyond the lower.

Cast stone at coping and roof-level trim has cracked and deteriorated. The damage is especially severe at north and west areas of the trim where portions have disintegrated back to the face of the wall.

c. Doors and Windows

Steel lintels, frames, and sashes are in poor condition due to exposure and oxidation. Expansion of the lintels has partially caused the wall damage previously described, and window frames/sashes are expanding and flaking around the perimeter of the openings.

Caulking and glazing putty have deteriorated and ten of the twelve glass window panes are cracked.

The original double doors at the west have been replaced with one large metal clad, upper louvered door. This remains in sound condition (except for the lintel).

d. Roof and Roof Drainage

It is to be assumed that the concrete slab roof has suffered some damage from the foundation settlement that has caused the long vertical cracks in the structure.

Drainage is provided through the north end of the east parapet. Water drains to a metal cubeshaped scupper and is discharged through a short horizontal tube to free fall to the ground at the northeast corner of the building.

2. Interior

Because of the high voltage, park maintenance deems the interior inaccessible to all but an electrician. Therefore, interior conditions cannot be discussed in this report.

C. Recommendations

Due to the age and condition of the electrical system at Floyd Bennett Field, a major decision must be made concerning its status. Either the existing system needs to be upgraded or an entirely new system installed. The system is now owned by the National Park Service (NPS) and such questions as possible ownership by Consolidated Edison and possible system voltage changes will affect whether or not Electrical Vault 57 may be needed in the future to contain transformers. If

desired, pad-mounted transformers could be installed outside the building and the building not be used at all for high voltage distribution.

Following are two main alternatives concerning action on the structure. Alternative 1 is the action recommended in this report.

Alternative 1

No action. Building to remain in existing condition until a decision concerning the field's electrical system is made. At the time of the upgrading of or the installation of a new system, underground cables will be rerouted to a nearby site of relocated transformers and switches. Care should be taken to insure that pad-mounted transformers are properly screened and landscaped to blend into the historic scene. Electrical Vault 57, no longer serving a purpose, other than that of adding to the overall historic scene of Hangar Row, will then be allowed to disintegrate. It will be left to add its historic presence, with preservative action taken, until it falls to the earth.

Alternative 2

This alternative involves taking the necessary action to preserve the structure. It is costly and extensive when compared to the size and visual impact of the building. Four walls of brickwork would need to be taken down to a height of the lintel lines at each elevation. Next, excavation and underpinning would be needed along the eastern foundation. Window frames and sash would be refurbished or replaced, and new glazing installed. All lintels would be replaced. The walls and roof would then be rebuilt, repairing original fabric or replacing where necessary.

UNITED STATES DEPARTMENT OF THE INTERIOR
NATIONAL PARK SERVICE

PACKAGE ESTIMATING DETAIL

REGION North Atlantic		PARK Gateway N.R.A.	
PACKAGE NUMBER 109 (Portion)	PACKAGE TITLE Preservation Electrical Vault 57		

(If more space is needed, use plain paper and attach)

ITEM	QUANTITY	COST
Rebuilt masonry wall, replace two windows, replace four lintels, linder pin east foundation, rebuild concrete roof slab, roofing, replace one door. H.S.R. Estimate R. Borrás 3/30/81	LS	\$17,000

SUMMARY OF CONSTRUCTION ESTIMATES		CLASS OF ESTIMATE		
		<input type="checkbox"/> A Working Drawings	<input type="checkbox"/> B Preliminary Plans	<input checked="" type="checkbox"/> C Similar Facilities
Proj. Type				Totals from Above B & U R & T
52	Museum Exhibits			XXXXX
55	Wayside Exhibits			XXXXX
62	Audio-Visual			XXXXX
89	Ruins Stabilization			XXXXX
91	Construction		\$17,000	
92	Utility Contracts			XXXXX
ESTIMATES APPROVED (Signature)		(title)	(date)	

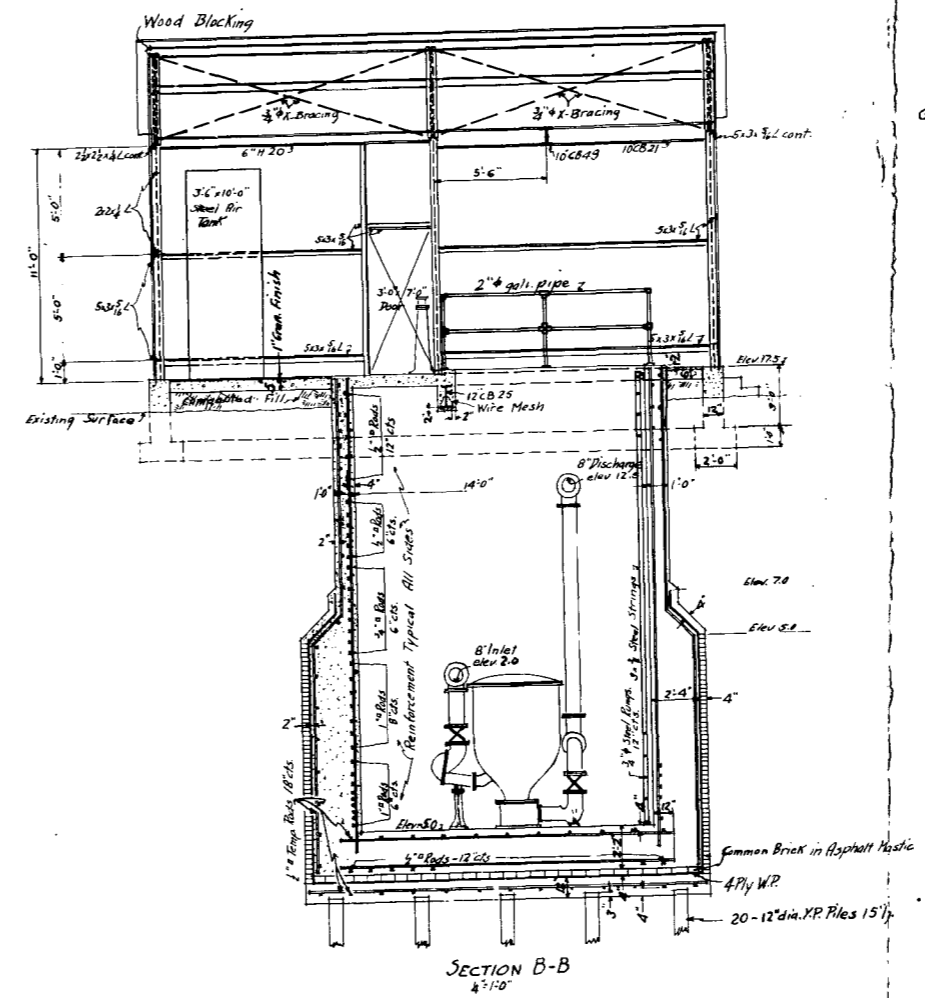
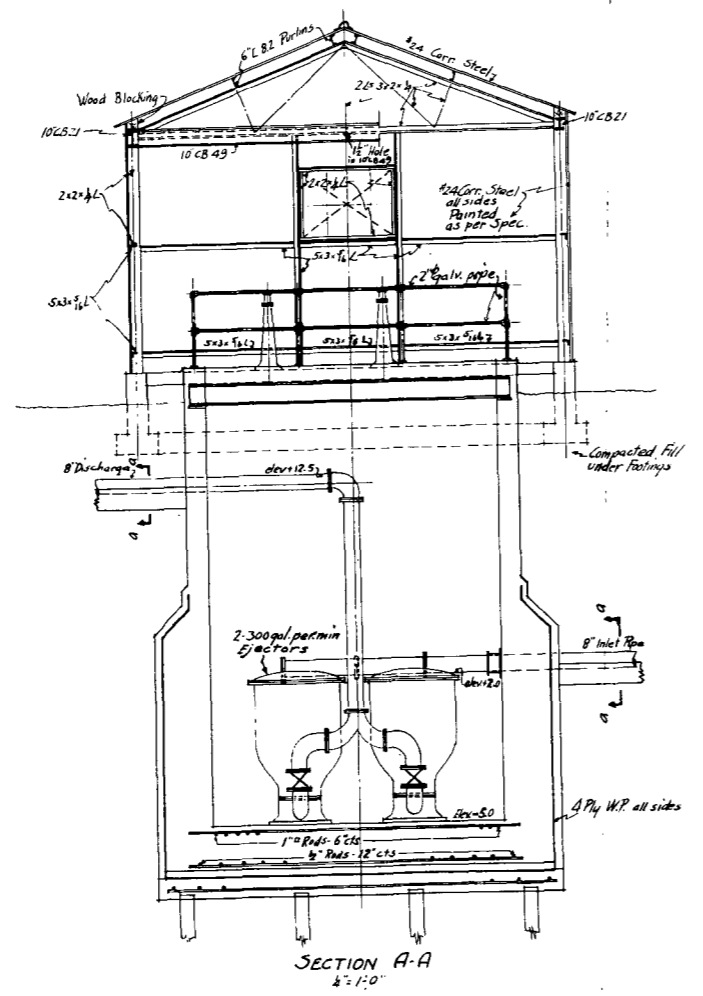
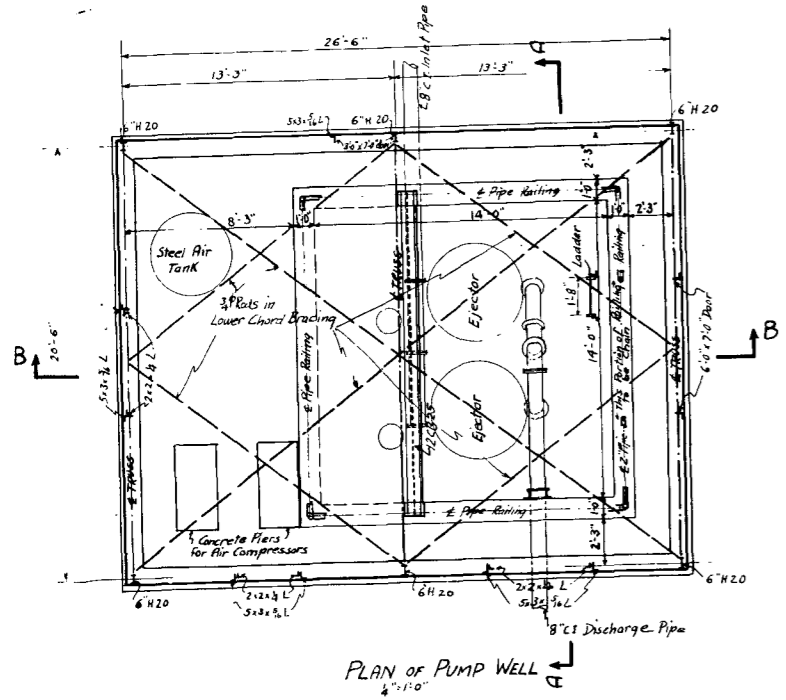
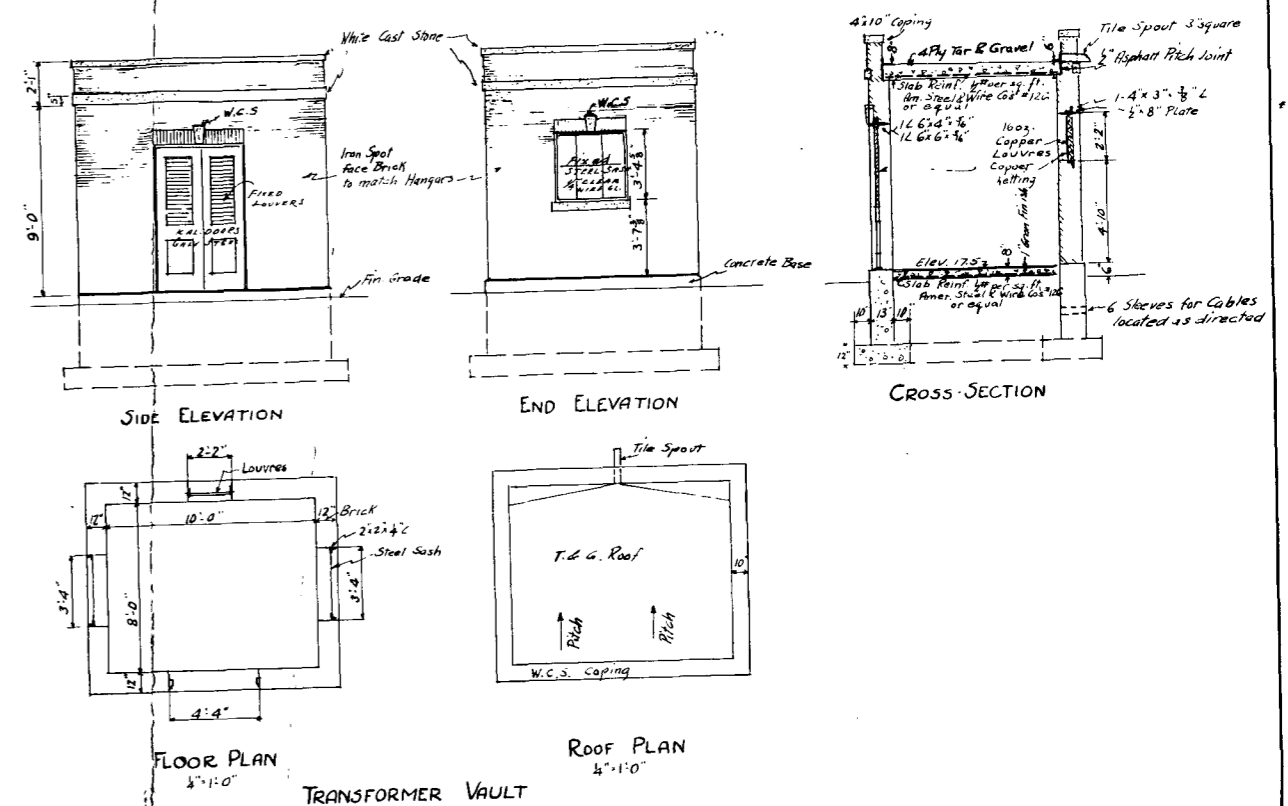
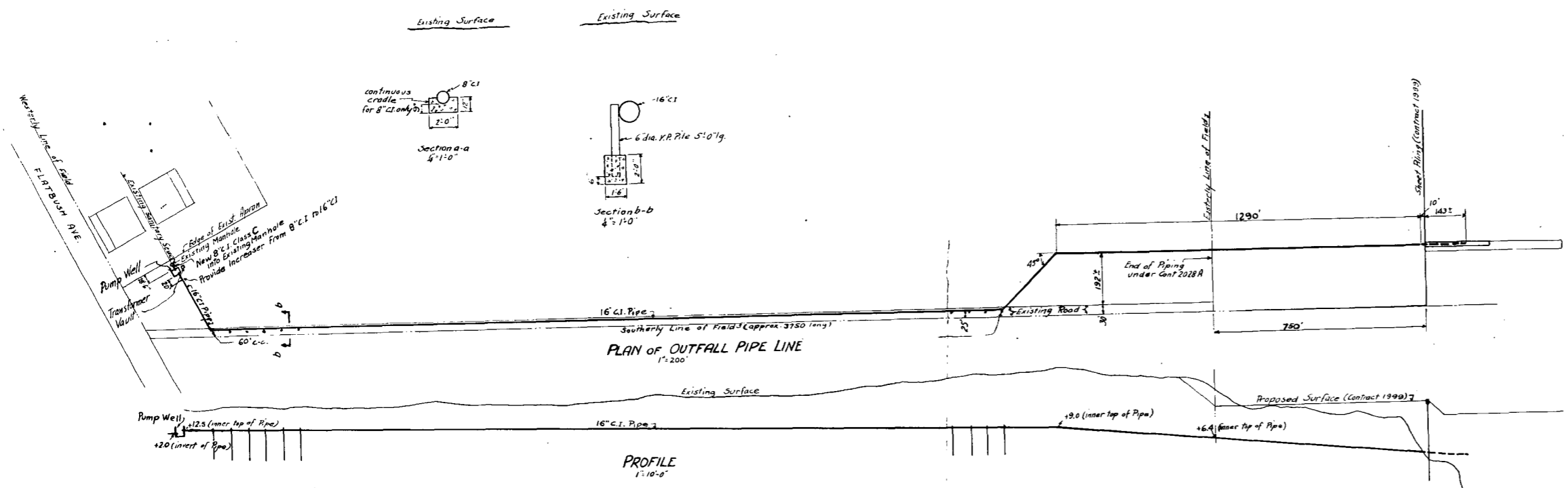

GENERAL NOTE:
Pump Well: Use 1:2:4 concrete; 20 L.L.P. piles 15ft long at least 12" at bell & 6" at other end; reinforcing rods shall be deformed rods conforming to the requirements of the Specifications for Billet-Steel Concrete Reinforcing Bars of the A.S.T.M.
Pump Well Superstructure: Use O.H. steel, 5/8" rivets, 1/2" holes unless otherwise noted. Trusses to be shop riveted, all other structural parts to be bolted where possible; 3/8" thick base plates under columns to be held down by 4-3/8" x 1-1/2" anchor bolts with 3" hooks; posts to be held down by 2-3/8" x 1-1/2" anchor bolts with 3" hooks; roof & sides covered with #24 corr. steel sheets fastened with standard clips to structural members; Use 2" galv'd pipe handrail around Pump Well opening, also use suitable chain as indicated on plan.

THE CITY OF NEW YORK
DEPARTMENT OF DOCKS
DIVISION OF PORT PLANNING
CONTRACT NO. 2028 A
FOR THE CONSTRUCTION OF SEWER DISPOSAL PLANT,
OUTFALL PIPE LINE AND TRANSFORMER VAULT
AT
THE MUNICIPAL AIRPORT
FLOYD BENNETT FIELD
FLATBUSH AVE., BOROUGH OF BROOKLYN
SUBMITTED BY *[Signature]* DIVISION ENGINEER
APPROVED BY *[Signature]* CHIEF ENGINEER
APPROVED BY *[Signature]* COMMISSIONER
DATE: Feb. 16, 1931

ON MICROFILM

646/63035 3 of 8 151

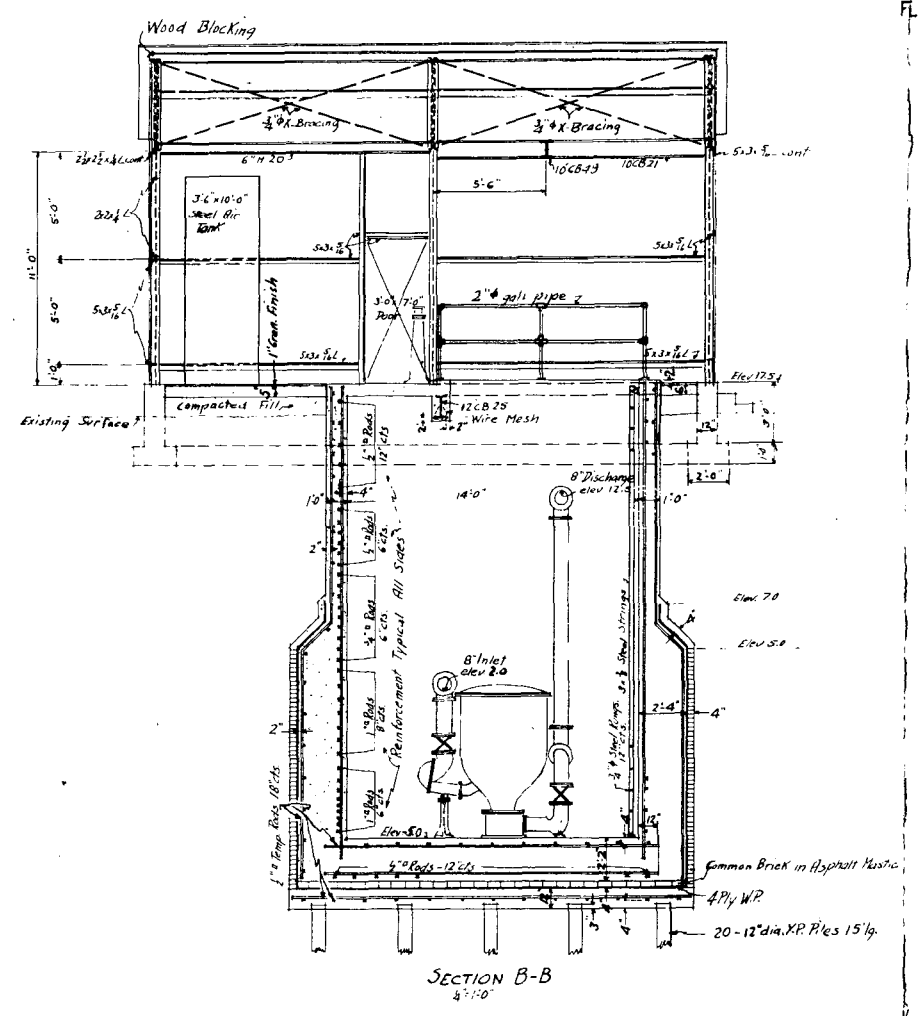
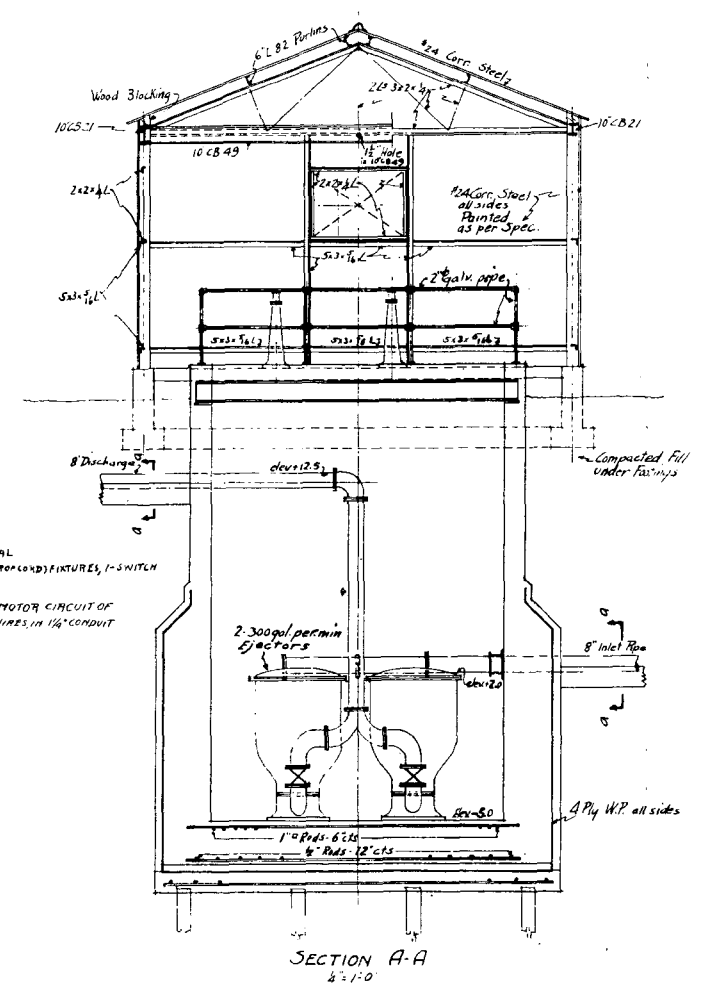
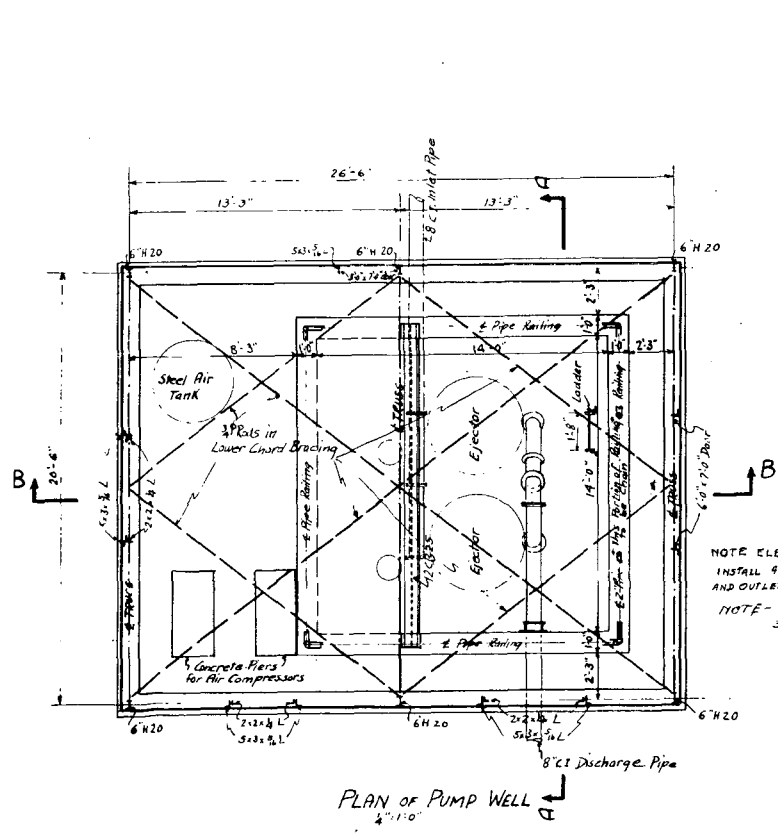
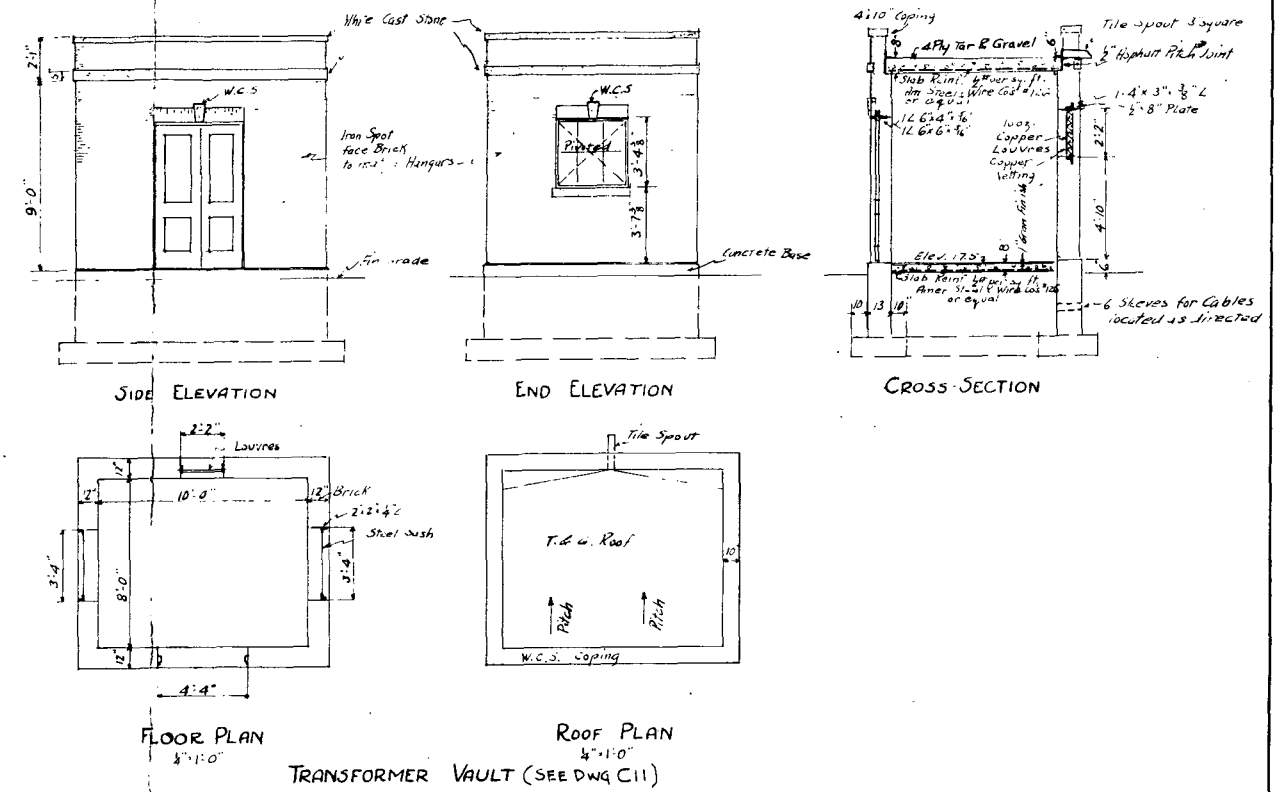
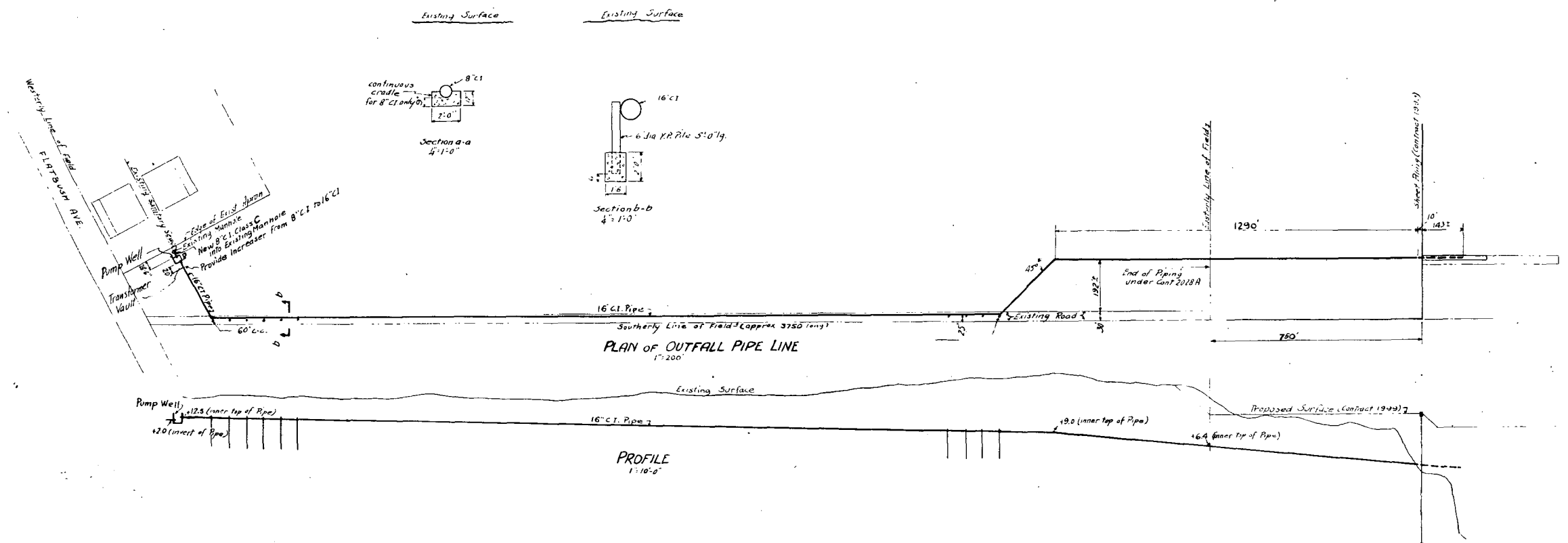

ON MICROFILM

ELECTRIC WORK
JOB NO. 3014

THE CITY OF NEW YORK
DEPARTMENT OF DOCKS
DIVISION OF PORT PLANNING
CONTRACT NO. 2028 C
(ELECTRIC)

SEWAGE PLANT
THE MUNICIPAL AIRPORT
'FLOYD BENNETT FIELD
FLATBUSH AVE., BOROUGH OF BROOKLYN

SUBMITTED BY *[Signature]* DIVISION ENGINEER
APPROVED BY *[Signature]* CHIEF ENGINEER
APPROVED BY *[Signature]* COMMISSIONER
DATE: Feb. 16, 1931

646/63035 70FB

191

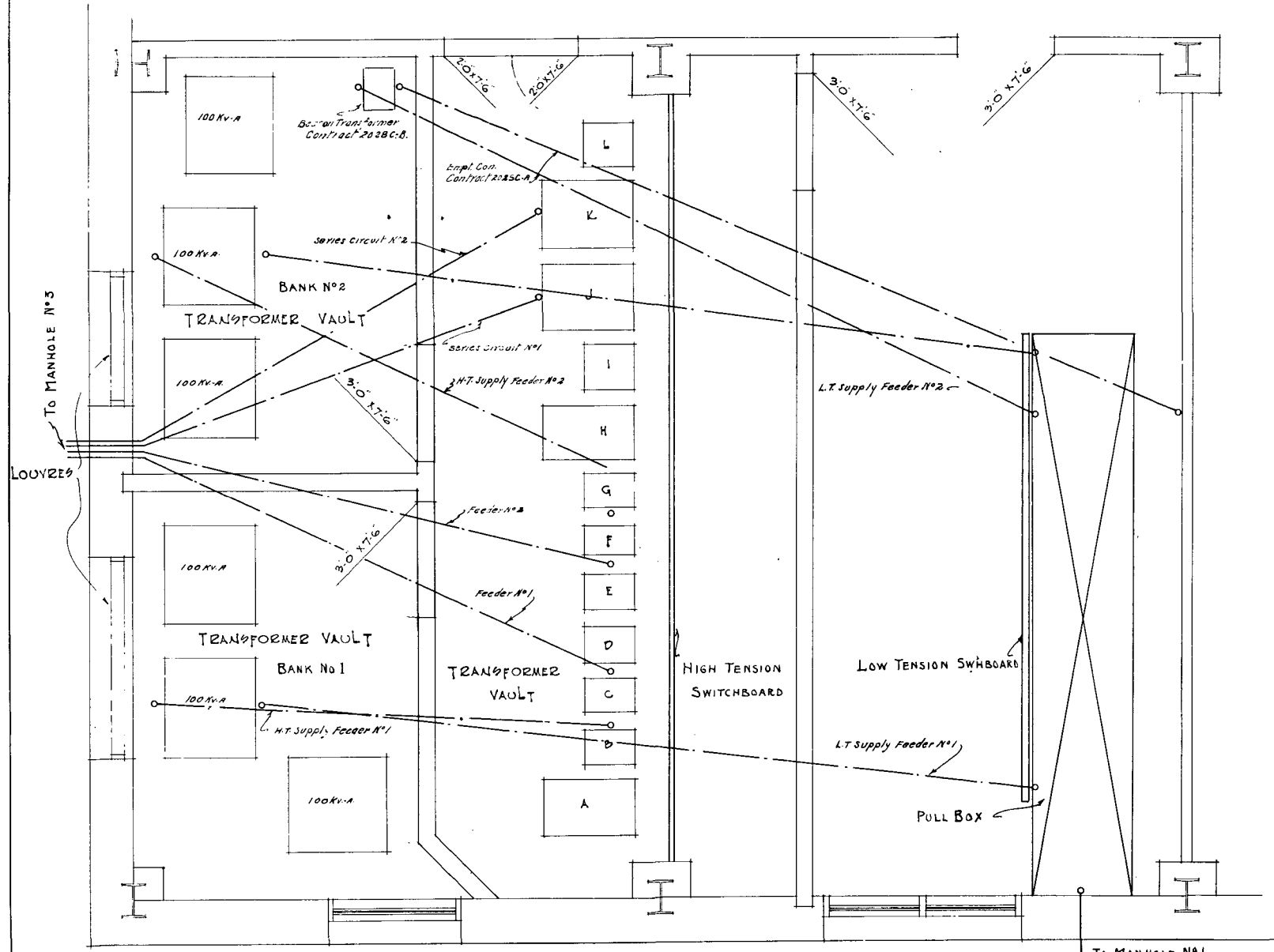

NOTE: Install as directed & ceiling out of 14' 0" in vaults, small switches, & no. 14 wire.

SWITCH BOARD ROOMS AND MAIN TRANSFORMER VAULT ADMINISTRATION BLDG. SCALE: 1/2" = 1'-0"

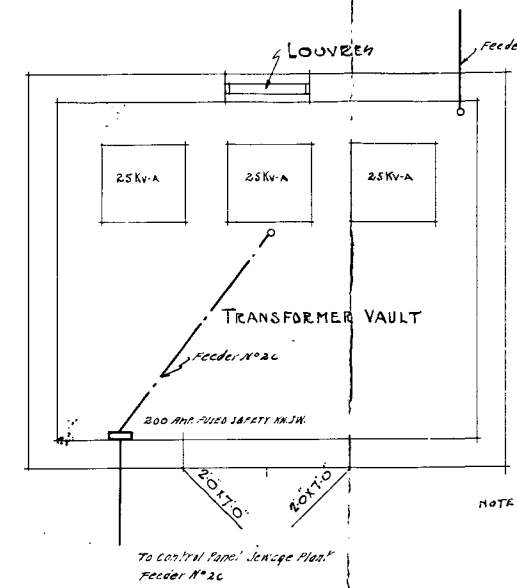

NOTE: INSTALL 1-OUTLET AND RL FIXTURE, AND 1-SWITCH FOR CONTROL

SEWAGE PLANT (SEE DWG. C7)

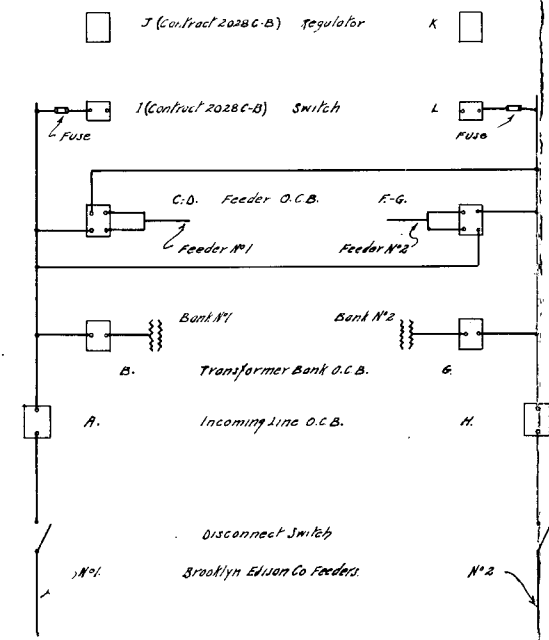

HIGH TENSION SWITCHBOARD DIAGRAM.

ELECTRIC WORK JOB NO. 3014.

ON MICROFILM

THE CITY OF NEW YORK
DEPARTMENT OF DOCKS
DIVISION OF PORT PLANNING
CONTRACT NO. 2028C
(ELECTRIC)
TRANSFORMER VAULTS
ADMIN. BLDG. & SEWAGE PLANT
THE MUNICIPAL AIRPORT
FLOYD BENNETT FIELD
FLATBUSH AVE BOROUGH OF BROOKLYN
SUBMITTED BY *[Signature]* DIVISION ENGINEER
APPROVED BY *[Signature]* CHIEF ENGINEER
APPROVED BY MICHAEL COSGRIVE COMMISSIONER
DATE: FEB. 16, 1931.

191

646/63035 8 of 8



North elevation - structure is cracked both vertically and horizontally. October 1978



South elevation - vertical separation continues parallel to that at north. Horizontal separation continuous along lintel heights. October 1978



West elevation - note cast iron trim deterioration and bulge at lintel. October 1978

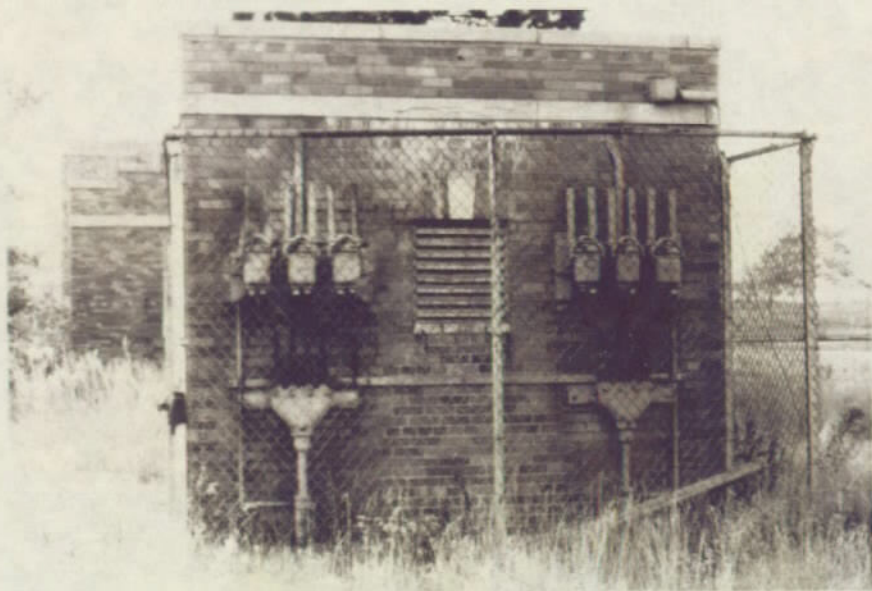

East elevation - Two sets of three-phase high-voltage underground cables terminate in two high-voltage potheads. From the potheads, insulated cables extend up to two sets of three oil-filled fused switches. From the switches, power is fed into the building. October 1978

TRANSFORMER BUILDING 120

This small structure was located at the far north end of Hangar Row. It was built in two sections at two different times. The initial structure was 14 feet by 21 feet in plan, with a long axis in the north-south direction, and entry from the west. A later addition at the north end measured 12 feet by 26 feet, with its long axis running east-west, and its entry on the east side of the north elevation. These two building sections were equal in height (12 feet), used the same brick facade, and presented a cohesive appearance (except for the absence of rectangular decorative cast stone panels at the parapet level of the later wing). Access into either wing was only possible from the exterior, as no opening was made through the interior adjoining wall, and in that sense they acted as two separate structures. (See Historic Data Section Photograph No. 17 - Original Building 120 in Early WWII surrounded by aircraft.)

A. Historical Description

1. Exterior

a. Site

The site was flat with no formal landscaping.

b. Masonry

(1) Foundation and Walls

Though no plans were found to document the construction methods used on this building, from its size and similarity to other small Hangar Row structures it can be assumed that its concrete foundation extended approximately 3 feet below grade in a perimeter spread footing design. It projected 1 foot above grade, forming a water table. Walls of both wings were brick bearing, and used the orangish face brick laid in common bond with headers every sixth course. Cast stone quoins were placed, with five courses between, at each corner of both the original and later wings.

(2) Parapet and Coping

The parapet on the original wing was approximately 1-foot 10-inches high, including a cast stone coping approximately 4-inches deep and a 7-inch cast stone trim placed at the roof level. Between the coping and trim were decorative cast stone panels, each about 2-feet wide and evenly spaced with three each at east and west elevations and two each at north and south.

The later wing was constructed with a higher slab-roof and had no parapet. The slab, however, was placed at the same height at the coping of the other wing and projected slightly at the same thickness. A matching band of cast stone encircled the later wing at the same elevation as that of the original wing. The two wings were visually tied together by the matching bands of cast stone, even though this later wing had no decorative panels between the bands.

c. Doors and Windows

One steel door led into the original structure at the west side. Access into the later wing was provided by a steel door at the east end of the north elevation. Steel lintels were used above both openings behind a row of soldiers.

Window openings measuring 4 feet by 4 feet, were provided with their head heights level with those of the doors. One was placed at the west side of the original structure, with the later wing having one centered in the east elevation and one at the east side of the south elevation. All three were fixed, had steel frames, cast stone sills, and steel lintels covered by a row of soldiers.

d. Roof and Roof Drainage

A concrete slab on four concrete east-west beams was used as the roof of the original structure. A 1-foot by 1-foot opening was left in the center to provide for a ceiling vent. Rainwater on this section was all directed to one copper scupper and downspout at the center of the east elevation.

A concrete slab roof was also used at the later wing. It was placed directly on top of the walls, without a parapet, and water was allowed to fall off any of the sides undirected. A metal strip (perhaps a gravel stop) was visible around the upper perimeter of the projecting slab and a water drip was cast into the perimeter of the underside.

2. Interior

a. Flooring and Floor Plan

The two wings were really separate structures as interior access from one to the other was not possible. Exposed concrete slab floors were used in both.

b. Walls

The structures brick walls were exposed on the interior. They were pointed at one time, though it is not known whether or not they were painted originally.

c. Ceilings

Ceilings were formed by the underside of the concrete slab roofs. A couple of feet more head room in the later wing was allowed by the higher placement of the roof slab.

B. Existing Conditions

According to an electrical survey taken as part of an inventory of structures for Gateway National Recreation Area made the DSC, the aerial wires outside the structure feed power to exterior lighting and Building 238 nearby. Transformers and other electrical equipment housed in the structure are original but still operating.

1. Exterior

a. Site

Asphaltic concrete paving butts up against the structure at the north and part of the west sides. A slight separation of the building's foundation and the paving material has developed. This allows moisture to penetrate and become trapped in this area. The

moisture and the freeze-thaw cycle could potentially damage the foundation.

b. Masonry

The foundation appears sound. One small spot at the south side has spalled off, probably due to deterioration and expansion of the now exposed steel rebar behind.

Mortar is generally deteriorating. Rusting/expansion of lintels has caused horizontal mortar separation along the head lines of the window and door openings. Mortar separation is especially severe at the east side of the later wing, where the crack extends across the whole elevation and around each corner.

Interior corner joints, where original wing and later wing join together were caulked. The sealant has become brittle and deteriorated.

Masonry is stained from areas of exposed steel and has several spots of splashed paint.

Parapet trim is separating along joints spaced about 4 feet apart and is spalling at the south side of the original wing. Minor deterioration is occurring at the remainder of the trim, and the coping and decorative parapet panels of the original wing.

The greatest deterioration occurs at the slight overhang of the roof of the later wing. Concrete is spalling and leaving many small areas of unprotected steel reinforcing.

c. Doors and Windows

The bottom panel of the west door is missing leaving a space large enough for a grown person to crawl through. This creates a dangerous situation, especially as the electrical equipment inside is still in operation. The north door is somewhat rusted, but still in sound condition.

Lintels above all doors and windows are severely deteriorated.

Window frames are slightly corroded but basically sound.

Caulking around all openings is old, cracked, and deteriorated.

d. Roof and Roof Drainage

The roof of the original wing seems basically sound, but the roofing material has probably deteriorated.

No large problems are apparent at the roof of the later wing, but it also probably has deteriorated roofing. As mentioned above, the slight overhang is spalling and leaving rusted steel reinforcing exposed.

Scupper and downspout are gone.

2. Interior

a. Flooring and Floor Plan

The concrete floor slab is in fair condition.

b. Walls

Old paint is deteriorating and flaking throughout.

c. Ceiling

The ceiling is basically sound. One of the concrete beams is cracked along the length of its underside.

C. Recommendations

The pending decision to either upgrade or replace the existing electrical system at Floyd Bennett Field will have an effect on the future of this structure. Alternatives for this building are very similar to those for Electrical Vault 57, even though Building 120 is not as severely

deteriorated. In this case, however, due to the larger size and better condition of the structure involved, Alternative 2 is the action recommended.

Alternative 1

This is the no action alternative. The building will remain in its present condition until a decision concerning the field's electrical system is made. (The exception to its no action status would be the patching or replacement of the east door, which should be done immediately.) At the time of the upgrading or installation of a new system, underground cables will be rerouted to a nearby site of relocated transformers and switches. Care should be taken to insure that pad-mounted transformers are properly screened and/or landscaped to blend into the historic scene. As the site in the immediate vicinity offers little possibility for naturally screening a historically intrusive element, consideration might be given to rerouting underground electrical equipment to a designated portion inside nearby Hangar Complex 6. With Building 120 no longer serving its original purpose, it can be allowed to stand against the elements without maintenance or repair until it decays naturally.

If some action resembling Alternative 1 is taken, and bricks which match the larger building are difficult to find, consideration might be given to reusing bricks from this structure in repair work on others.

Alternative 2

This alternative involves taking the necessary action to preserve the structure. It is still feasible to preserve most of the fabric of the building. The case becomes even stronger for preservation if the upgraded or new electrical system can incorporate Building 120 so that it still serves as a shelter for electrical equipment, or if the structure can be adaptively used for some other purpose.

Preservation will involve:

Caulk along line of separation of building from adjacent paving.

Clean all exposed steel reinforcement (foundation, parapet trim, and roof overhang of later addition) and patch with material matching in color and composition.

Remove steel lintels above doors and windows (five total) by taking out soldier course and bricks to 1 foot on either side of the opening, and replace with historic-appearing lintel of a more corrosion-resistant material.

Clean and paint window frames in place.

Replace west door and clean and paint north door.

Clean out all old caulking at door and window openings and the joining of the two building wings and recaulk. New caulking should be more plastic (use oil base or polysulfide).

Install new copper scupper and downspout. The design should match that gleaned from the still existant portions on the west side of Garage-Shops 26.

Reroof with built-up roofing.

Clean crack in interior concrete beam down to steel and reincase.

Scrape interior painted surfaces and repaint. Restrict painting to areas which already have a painted surface.

UNITED STATES DEPARTMENT OF THE INTERIOR
NATIONAL PARK SERVICE

PACKAGE ESTIMATING DETAIL

REGION North Atlantic	PARK Gateway N.R.A.
PACKAGE NUMBER 109 (Portion)	PACKAGE TITLE Preservation Transformer Building 120

(If more space is needed, use plain paper and attach)

ITEM	QUANTITY	COST
<p>Caulking, cleaning, and repair cast stone, replace five steel lintels, refurbish three window frames, replace one door, caulk windows/doors and joining of wings, install copper gutter and downspout, roofing, clean and reencase interior concrete beam. Paint interior walls and ceiling, refurbish one door.</p> <p>H.S.R. Estimate R. Borrás 3/30/81</p>	LS	\$12,000

SUMMARY OF CONSTRUCTION ESTIMATES		CLASS OF ESTIMATE		
		A	B	C
		<input type="checkbox"/> Working Drawings	<input type="checkbox"/> Preliminary Plans	<input checked="" type="checkbox"/> Similar Facilities
Proj. Type		Totals from Above		
		B & U		R & T
52	Museum Exhibits			XXXXX
55	Wayside Exhibits			XXXXX
62	Audio-Visual			XXXXX
89	Ruins Stabilization			XXXXX
91	Construction		\$12,000	
92	Utility Contracts			XXXXX
ESTIMATES APPROVED (Signature)		(title)	(date)	

POST PROFESSIONAL SERVICES ESTIMATES AND SCHEDULING ON BACK OF FORM



Southwest Elevation - Original wing at right and later wing at left. Note decorative cast stone panels at parapet of original wing. Quoins at the north end of this wing were obscured by the abutment of the south wall of the later wing.
January 1979

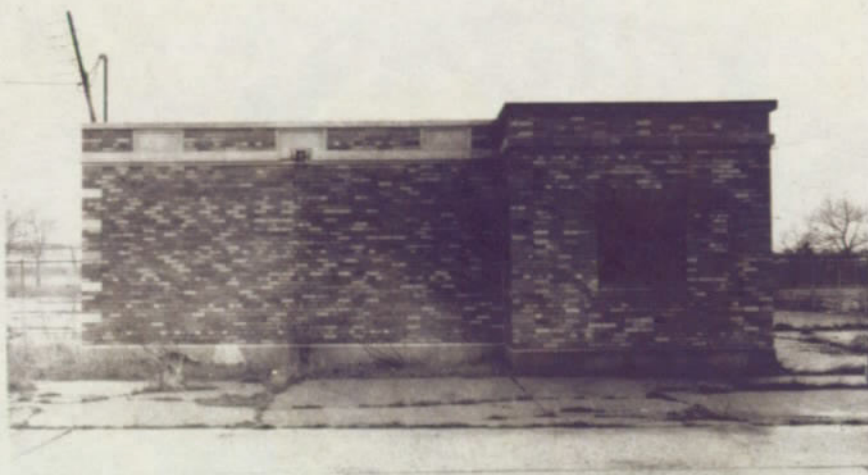

East Elevation - As seen from the airfield. Note opening beneath the center cast stone parapet panel for missing scupper and horizontal separation at window head line.
January 1979



Roof of later wing - Note spalled concrete and exposed steel reinforcement.



Typical interior wall - inside original wing.

PUMP STATION 176

The small structure (measuring approximately 13 feet by 15 feet in plan) was built very near Flatbush Avenue and to the northwest of the Administration Building to serve as a gasoline station. Four underground tanks were installed just north of the structure for gasoline storage.

A. Historical Description

1. Exterior

a. Site

No formal landscaping was used near the building. A bituminous frontage road passed it on the west, separating it from Flatbush Avenue. The remaining three sides were surrounded by bituminous paving. The gasoline storage tanks were located to the north, with rectangular concrete access lids flush to the paved surface. (Two access lids per tank were used, one at either end of each long tank). An access road passed between this building and Pump House 29 to the south.

b. Masonry

Although no plans showing the foundation design of this structure were found, it may be assumed that it was similar to that of the other small structures along Hangar Row; a continuous concrete spread footing around the building perimeter, extending about 3 feet below grade and 1 foot above grade to form a water table.

Walls were brick bearing. The typical Hangar Row orangish face brick laid in common bond with headers every sixth course was used on the exterior. The exterior elevation measured 11 feet in height from the ground to top of cast stone coping, which marked the top of the parapet. A course of soldiers surrounded the exterior at the elevation marking the roof level behind.

c. Doors and Windows

The one door to this structure was of steel, centered in the east elevation, and had a concrete threshold at its base. A row of soldiers marked its head.

Two windows flanked this door. Another window was altered in the west elevation. Windows were six light with steel frame and wire glass. Each had a row of projecting rolaks for a sill and a row of soldiers marking its head.

Both door and window openings were spanned by steel lintels.

d. Roof and Roof Drainage

The roof consisted of a flat concrete slab with some sort of bituminous protective covering and copper flashing. One copper scupper and downspout provided drainage at the north side.

e. Miscellaneous

The electric equipment for the building and its operation was probably installed around 1937, as a drawing showing intended work by the WPA indicates. Much of the equipment was mounted on the exterior.

Two large wooden loading posts were located east of the structure and provided for high overhead lighting.

Four vertical metal pipes secured to the north elevation provided ventilation for the underground tanks.

2. Interior

a. Flooring and Floor Plan

Flooring was concrete slab. The floor plan had no interior partitions and was open, except for two, one horsepower motors floor mounted near the west wall.

b. Walls

Interior walls were exposed brick which may or may not have been painted.

c. Ceiling

The ceiling consisted of the underside of the concrete roof slab.

B. Existing Conditions

Except for general deterioration, this structure remains in original condition.

1. Exterior

a. Site

A 1950s vintage steel frame beacon tower was erected in the center of the old road directly to the south of the structure. The bituminous paving surrounding the building has been disturbed by weeds and grass growing up through small cracks. Fuel storage tanks are still extant and readily accessible, but dry.

b. Masonry

Walls are cracked horizontally at the lintel line above all four openings. The damage at the east elevation extends around the corners to the north and south elevations (steps up to run along beneath the soldier row at the south). At the west wall, the portion above the window bulges slightly over the lower where the lintel has corroded and expanded.

Staining of the brick surface occurs where steel ports attached or adjacent to the walls have corroded and "bled" down, and under window sills.

Approximately 70 percent of the mortar has deteriorated.

c. Doors and Windows

Lintels above all openings have rusted, corroded, and expanded, thus displacing the surrounding brickwork as described in Foundations and Walls - 1.

Steel frames at windows and doors are in poor condition, rusting and corroding.

Fifty percent of the window panes are broken.

d. Roof and Roof Drainage

The bituminous roof covering is in fair condition.

The original scupper remains in sound condition, but the downspout is missing.

e. Miscellaneous

The wooden loading posts are extant in location. They are in poor but refurbishable condition.

2. Interior

a. Flooring and Floor Plan

The concrete slab is in sound condition. Motors are not present.

b. Walls

Walls have been painted at some point in time and the paint is presently flaking and greatly deteriorated.

c. Ceiling

The ceiling is in good condition.

C. Recommendations

This building is in fair to poor condition. Preservation/adaptive use is still feasible for the structure and is recommended, as it would add to the story of the field.

1. Exterior

a. Site

Fill fuel tanks with sand.

b. Masonry

Repoint 70 percent of the brickwork, patch holes of old steel fastenings, and realign brickwork along north and south cracks.

Clean masonry.

c. Doors and Windows

Replace lintels above all openings.

Refurbish steel frames of door and windows.

Reglaze 50 percent windowpanes.

d. Roof and Roof Drainage

Check and spot patch roof covering.

Install copper downspout (match original).

2. Interior

Scrape and repaint walls.

UNITED STATES DEPARTMENT OF THE INTERIOR
NATIONAL PARK SERVICE

PACKAGE ESTIMATING DETAIL

REGION North Atlantic		PARK Gateway N.R.A.	
PACKAGE NUMBER 109 (Portion)	PACKAGE TITLE Preservation Pump Station 176		

(If more space is needed, use plain paper and attach)

ITEM	QUANTITY	COST
Fill four fuel tanks with sand, repoint 70 percent of walls, replace steel lintels, refurbish three window frames and one door frame, regulate 50 percent of window panes, spot patch roofing install copper downspout, paint interior walls. H.S.R. Estimate R. Borrás 3/30/81	LS	\$54,000

SUMMARY OF CONSTRUCTION ESTIMATES		CLASS OF ESTIMATE		
		<input type="checkbox"/> A Working Drawings	<input type="checkbox"/> B Preliminary Plans	<input checked="" type="checkbox"/> C Similar Facilities
Proj. Type				Totals from Above
				B & U
				R & T
52	Museum Exhibits			XXXXX
55	Wayside Exhibits			XXXXX
62	Audio-Visual			XXXXX
89	Ruins Stabilization			XXXXX
91	Construction		\$54,000	
92	Utility Contracts			XXXXX
ESTIMATES APPROVED (Signature)		(title)	(date)	

POST PROFESSIONAL SERVICES ESTIMATES AND SCHEDULING ON BACK OF FORM



South Elevation - Note crack from lintel expansion at east extending around corner to south side. October 1978



North Elevation - Missing downspout - crack at west lintel level - crack at east lintel extends around corner and up at north elevation. Note loading post at left, lower part of beacon tower behind. October 1978



Northeast Elevation - Gas tank vents at north wall. October 1978



Southeast corner
October 1978

RUNWAY SYSTEM

A. Historical Description

The original runway system consisted of two reinforced concrete runways placed at right angles to each other, with one axis parallel to Flatbush Avenue. It was originally intended that each be 50 feet in width, but before completion they were widened to measure 100 feet across in order to meet the requirements for an A1A rating (see Historical Data Section Photograph 18 - showing the completed airport, September, 1931, which show layout and details of the runways).

In mid-1929, when hydraulic filling and grading was completed, the runways were laid out on compacted sand fill. They were 8 inches thick and heavily reinforced with bar mat and steel fabric. The bar mat was spaced to lay in rectangles measuring 12 inches by 18 inches and had a lap of 15 inches. The steel fabric was meshed, each direction spaced 6 inches o.c., and lapped 18 inches. Longitudinal construction joints were spaced every 12 feet 6 inches and joined by 4-foot long, 5/8-inch diameter, deformed tie rods.

In 1937, the runway was expanded by the WPA. (See Historic Data Section - Photograph No. 13.)

The summer of 1941 found the three runways being widened to 300 feet and lengthened to 5,000 feet, immediately after the field was leased by the Navy. A fourth runway was constructed at this time, 300 feet wide and 5,000 feet long, at the north side of the field.

B. Existing Conditions

The runways are still in sound condition. Some buckling and cracking occurs over the surface and vegetation has grown up in and around the paved surfaces.

C. Recommendations

According to the GMP the field will not be used for aviation. This means that extensive repairs will not be necessary to make the runways operational. The GMP also states that "a runway configuration approximately that of the aviation field will be established, and all other runways and taxiways will be removed." The GMP goes on to say that "the new configuration will not be identical to that of the original runways, but the general concept would be conveyed to visitors. In order to relate the runway configuration to the natural landscape, vegetation will be planted to enclose the vistas formed by the configuration."

The GMP does not dictate that the exact configuration of the original runway be outlined, and it is herein concurred that the runways' size be somewhat contingent on the uses planned for the areas. It will probably not be necessary to completely restore the existing surfaces. It is recommended, however, that all vegetation that has grown up through the runway surfaces planned for use be removed in a permanent manner, and spot repairs be made to any large damaged areas.

APPENDICES

MORTAR ANALYSIS

FLOYD BENNETT FIELD

During the present architectural investigation of Floyd Bennett Field, six samples of the mortar used in the exterior brick masonry walls were collected by Gary Higgins. Two samples were from the Administration Building and four samples were from Complex #6. Analysis was performed by Ted Van Dyne of Community Services Collaborative, Boulder, Colorado utilizing the testing methodology developed by E. Blaine Cliver, Regional Historical Architect of the North Atlantic Region of the National Park Service. The results of the investigation indicate the original formula used in mixing the mortar. Variables such as on-site conditions at the time of construction, as well as the curing and aging processes along with industrial air pollution affect the samples such that only an approximation of the original formula can be ascertained. The small size of the samples collected for use in the analysis can also have an added effect on the final mortar mixture.

Sample one, of the Administration Building, consisted of bedding mortar taken from the west side of the building, adjacent to the steps. It revealed a ratio of approximately two parts lime for every five parts sand.

Sample two, of the Administration Building, consisted of bedding mortar taken from the south side of the building, adjacent to the steps. It revealed a ratio approximately of two parts lime for every five parts sand.

Sample one, of Complex #6, consisted of bedding mortar taken from the east wall of the southeast corner of the building. It revealed a ratio of approximately four parts lime for every fifteen parts sand.

Sample two, of Complex #6, consisted of bedding mortar taken from the south wall, east end of the sill at west window. It revealed a ratio of approximately one part for every seven parts sand. This Portland Cement sample was very hard and gray colored giving evidence of being a Portland Cement.

Sample three, of Complex #6, consisted of bedding mortar taken from three joints above sample two. It revealed a ratio of approximately one part Portland Cement for every ten parts sand. Like sample two in hardness and color, this is also a Portland Cement.

Sample four, of Complex #6, consisted of bedding mortar taken from the south wall, east end of the window sill. It had a ratio of approximately three parts lime for every eight parts sand.

In conclusion, the quality of the samples was poor but using the information obtained from the analysis, the following was found.

The first two samples from the Administration Building were identical, both having the same characteristics of light, evenly grained sand, relatively hard material, light colored and most importantly both having approximately the same ratios of two parts lime to five parts sand. The four samples from Complex #6 displayed similar characteristics between samples two and three. Samples one and four were light colored and most noticeably the similarity of the sand, which was poorly sorted with large aggregates visible. The ratio of four parts lime to fifteen parts sand of sample one had more sand in its mixture as compared to sample four with a ratio of three parts lime to eight parts sand. Samples two and three were the most similar in characteristics both being Portland Cements. With that they were gray colored, very hard and the sand was darker and more evenly grained than samples one and four. Sample three had a ratio of one part of Portland Cement for every ten parts of sand while sample two had a ratio of one part Portland Cement for every seven parts of sand. Sample three had a larger proportion of sand in its mixture than sample two. A couple of other observations made from all six samples is that these modern mortar mixes had no hair or fiber used as a binder, as did earlier mortars. Also on all of the samples except sample two from Complex #6, had a large percentage (75%-100%) of CO₂ gain.

MORTAR ANALYSIS

IDENTIFICATION:	
Project: <u>NORTH ATLANTIC</u>	
Location: <u>FLOYD BENNETT FIELD</u> Structure: <u>ADMIN BLDG.</u>	
Sample #: <u>1</u>	Date Examined: <u>JULY 30, 1979 11:00 A.M.</u>
Date Taken: <u>-</u>	By: <u>TED VAN DYNE</u>
By: <u>GARY HIGGINS</u>	
Location of Sample: <u>ADJACENT TO STEPS (N) ON W. SIDE OF BLDG.</u>	
Sample Description (Before Testing): <u>VERY LIGHT COLORED, MED GRAINED, NO HAIR OR FIBER, RELATIVELY HARD, SOME LARGER AGGREGATES</u>	
TEST: <u>SOLUBLE FRACTION</u>	
DATA:	
1. <u>165.44</u> wt. of container A	8. <u>No</u> hair or fiber present; type: _____
2. <u>173.64</u> wt. of container A & sample	9. <u>3.48</u> wt. of sample fines w/paper
3. <u>630.18</u> barometric pressure	10. <u>2.56</u> wt. of filter paper
4. <u>93.38</u> temperature	11. <u>170.53</u> wt. of sand & container A
5. <u>0.600</u> l. of CO ₂ released	12. <u>3.4</u> cc of sand
6. <u>light yellow</u> filtrate color	13. <u>11.44</u> wt. of graduated cylinder w/sand
7. <u>light gray</u> fines color	14. <u>6.36</u> wt. of graduated cylinder
COMPUTATIONS:	
15. <u>8.20</u> g starting wt. of sample = No. 2 _____ - No. 1 _____	
16. <u>.92</u> g wt. of fines = No. 9 _____ - No. 10 _____	
17. <u>5.09</u> g wt. of sand = No. 11 _____ - No. 1 _____	
18. <u>0.66929</u> sand density = $1.0 \div [(No. 13 \text{ } ______ - No. 14 \text{ } ______) \div No. 12 \text{ } ______]$	
19. <u>2.19</u> g wt. of soluble content = No. 15 _____ - (No. 16 _____ + No. 17 _____)	
20. <u>0.02040</u> mols of CO ₂ = No. 5 _____ x No. 3 _____ mm x 0.016 \div (No. 4 _____ C + 273.16C.)	
21. <u>2.04</u> g wt. of CaCO ₃ = 100 x No. 20 _____	
22. <u>.15</u> g wt. of Ca(OH) ₂ = No. 19 _____ - No. 21 _____	
23. <u>0.00203</u> mols of Ca(OH) ₂ = No. 22 _____ \div 74	
24. <u>1.66</u> g total wt. of Ca(OH) ₂ = 74 x (No. 20 _____ + No. 23 _____)	
25. <u>.90</u> g wt. CO ₂ = No. 20 _____ x 44	
26. <u>.99</u> g wt. total possible CO ₂ = 44 x (No. 20 _____ + No. 23 _____)	
27. <u>90.91</u> % CO ₂ gain = No. 25 _____ \div No. 26 _____ x 100%	

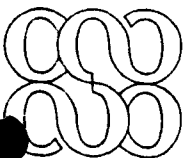

Community
Services
Collaborative

Offering the following preservation services: Architecture - Building Analysis - Federal Programs and Government Liaison - Grantsmanship - Landscape Architecture - Municipal and Local Government Services - Planning - Historic Materials Analysis

1315 Broadway - Boulder, Colorado 80302 - 303 442 3601

Form Date: 7/1/79

CONCLUSIONS:

28. 7.30 g wt. of sample = No. 15 _____ - No. 25 _____
29. 12.60 fines parts/vol. = No. 16 _____ ÷ No. 28 _____ = _____ x 100%
30. 46.67 sand parts/vol. = No. 17 _____ ÷ No. 28 _____ = _____ x 100% x No. 18 _____
31. 25.01 lime parts/vol. = No. 24 _____ ÷ No. 28 _____ = _____ x 100% x 1.1
32. 1:2.37 lime:sand by vol. = No. 29 _____ + No. 30 _____ ÷ No. 31 _____

CEMENT (if present)

33. portland cement parts/vol. = (If fines from portland cement)
 No. 16 _____ x 1.0 = a. _____ wt. of cement ÷ No. 28 _____ = b. _____
 100% x 0.78
34. natural cement parts/vol. = (If fines from natural cement)
 No. 16 _____ x 1.0 = a. _____ wt. of cement ÷ No. 28 _____ = b. _____
 100% x 0.86
35. lime w/cement parts/vol. = Cement may not account for total soluble
 weight of lime in such a mix. No. 24 _____ - (No. 16 _____ x 0.2) =
 a. _____ ÷ No. 28 _____ = b. _____ 100 % x 1.1 (Quicklime (CaO) factor
 = 1.97)

Courtesy of: E. Blaine Cliver, Historical Architect
 North Atlantic Historic Preservation Center
 North Atlantic Region
 National Park Service

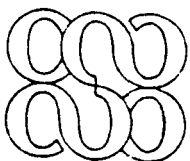

Community
 Services
 Collaborative

Offering the following preservation services: Architecture -
 Building Analysis - Federal Programs and Government Liaison -
 Grantsmanship - Landscape Architecture - Municipal and Local
 Government Services - Planning - Historic Materials Analysis

1315 Broadway - Boulder, Colorado 80302 - 303 442 3601

MORTAR ANALYSIS

IDENTIFICATION:

Project:

NORTH ATLANTIC

Location:

FLOYD BENNETT FIELD

Structure:

ADMIN. BLDG.

Sample #: 2

Date Taken:

By: GARY HIGGINS

Date Examined: 7-31-79

(2000)
11:30 A.M.

By: TED VAN DYNE

Location of Sample: ADJACENT TO STEPS (E) ON S. SIDE OF BLDG.

Sample Description (Before Testing): VERY LIGHT COLORED, SMALL SAMPLE, med grained, NO hair or fiber present, relatively hard material.

TEST: SOLUBLE FRACTION

DATA:

- | | |
|--|--|
| 1. <u>167.81</u> wt. of container A | 8. <u>No</u> hair or fiber present; type: _____ |
| 2. <u>193.10</u> wt. of container A & sample | 9. <u>3.18</u> wt. of sample fines w/paper |
| 3. <u>632.97</u> barometric pressure | 10. <u>2.56</u> wt. of filter paper |
| 4. <u>20.56</u> temperature | 11. <u>171.14</u> wt. of sand & container A |
| 5. <u>0.400</u> l. of CO ₂ released | 12. <u>2.6</u> cc of sand |
| 6. <u>light yellow</u> filtrate color | 13. <u>9.70</u> wt. of graduated cylinder w/sand |
| 7. <u>light gray</u> fines color | 14. <u>6.38</u> wt. of graduated cylinder |

COMPUTATIONS:

15. 5.29 g starting wt. of sample = No. 2 _____ - No. 1 _____
16. .62 g wt. of fines = No. 9 _____ - No. 10 _____
17. 3.33 g wt. of sand = No. 11 _____ - No. 1 _____
18. 0.7833 sand density = $1.0 \div [(No. 13 \text{ _____} - No. 14 \text{ _____}) \div No. 12 \text{ _____}]$
19. 1.34 g wt. of soluble content = No. 15 _____ - (No. 16 _____ + No. 17 _____)
20. 0.01379 mols of CO₂ = No. 5 _____ x No. 3 _____ mm x 0.016 \div (No. 4 _____ C + 273.16C.)
21. 1.38 g wt. of CaCO₃ = 100 x No. 20 _____
22. 0 g wt. of Ca(OH)₂ = No. 19 _____ - No. 21 _____
23. 0 mols of Ca(OH)₂ = No. 22 _____ \div 74
24. 1.02 g total wt. of Ca(OH)₂ = 74 x (No. 20 _____ + No. 23 _____)
25. .61 g wt. CO₂ = No. 20 _____ x 44
26. .61 g wt. total possible CO₂ = 44 x (No. 20 _____ + No. 23 _____)
27. 100 % CO₂ gain = No. 25 _____ \div No. 26 _____ x 100%

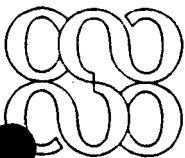

Community
Services
Collaborative

Offering the following preservation services: Architecture - Building Analysis - Federal Programs and Government Liaison- Grantsmanship - Landscape Architecture - Municipal and Local Government Services - Planning - Historic Materials Analysis

1315 Broadway - Boulder, Colorado 80302 - 303 442 3601

Form Date: 7/1/79

CONCLUSIONS:

28. 4.68 g wt. of sample = No. 15 ___ - No. 25 ___
29. 13.25 fines parts/vol. = No. 16 ___ ÷ No. 28 ___ = ___ x 100%
30. 55.72 sand parts/vol. = No. 17 ___ ÷ No. 28 ___ = ___ x 100% x No. 18 ___
31. 23.97 lime parts/vol. = No. 24 ___ ÷ No. 28 ___ = ___ x 100% x 1.1
32. 1:2.87 lime:sand by vol. = No. 29 ___ + No. 30 ___ ÷ No. 31 ___

CEMENT (if present)

33. portland cement parts/vol. = (If fines from portland cement)
 No. 16 ___ x 1.0 = a. ___ wt. of cement ÷ No. 28 ___ = b. ___
 100% x 0.78
34. natural cement parts/vol. = (If fines from natural cement)
 No. 16 ___ x 1.0 = a. ___ wt. of cement ÷ No. 28 ___ = b. ___
 100% x 0.86
35. lime w/cement parts/vol. = Cement may not account for total soluble
 weight of lime in such a mix. No. 24 ___ - (No. 16 ___ x 0.2) =
 a. ___ ÷ No. 28 ___ = b. ___ 100 % x 1.1 (Quicklime (CaO) factor
 = 1.97)

Courtesy of: E. Blaine Cliver, Historical Architect
 North Atlantic Historic Preservation Center
 North Atlantic Region
 National Park Service

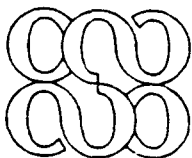

Community
 Services
 Collaborative

Offering the following preservation services: Architecture -
 Building Analysis - Federal Programs and Government Liaison-
 Grantsmanship - Landscape Architecture - Municipal and Local
 Government Services - Planning - Historic Materials Analysis

1315 Broadway - Boulder, Colorado 80302 - 303 442 3601

MORTAR ANALYSIS

IDENTIFICATION:	
Project: <u>NORTH ATLANTIC</u>	
Location: <u>FLOYD BENNETT FIELD</u>	Structure: <u>COMPLEX 6</u>
Sample #: <u>3</u>	Date Examined: <u>JULY 31, 1979 4:00 P.M.</u>
Date Taken: -	By: <u>TED VAN DYNE</u>
By: <u>GARY HIGGINS</u>	
Location of Sample: <u>3 JOINTS ABOVE SAMPLE #2</u>	
Sample Description (Before Testing): <u>DARK GRAY COLORED, MEDIUM GRAINED WITH SOME LARGE AGGREGATES, VERY HARD; PORTLAND CEMENT? NO HAIR</u>	
TEST: SOLUBLE FRACTION	
DATA:	
1. <u>166.00</u> wt. of container A	8. <u>No</u> hair or fiber present; type: _____
2. <u>167.97</u> wt. of container A & sample	9. <u>2.68</u> wt. of sample fines w/paper
3. <u>632.46</u> barometric pressure	10. <u>2.54</u> wt. of filter paper
4. <u>24.44</u> temperature	11. <u>167.31</u> wt. of sand & container A
5. <u>0.135</u> l. of CO ₂ released	12. <u>.9</u> cc of sand
6. <u>light yellow</u> filtrate color	13. <u>7.63</u> wt. of graduated cylinder w/sand
7. <u>light gray</u> fines color	14. <u>6.39</u> wt. of graduated cylinder
COMPUTATIONS:	
15. <u>1.97</u> g starting wt. of sample = No. 2 _____ - No. 1 _____	
16. <u>.14</u> g wt. of fines = No. 9 _____ - No. 10 _____	
17. <u>1.31</u> g wt. of sand = No. 11 _____ - No. 1 _____	
18. <u>0.72581</u> sand density = $1.0 \div [(No. 13 \text{ } ______ - No. 14 \text{ } ______) \div No. 12 \text{ } ______]$	
19. <u>.52</u> g wt. of soluble content = No. 15 _____ - (No. 16 _____ + No. 17 _____)	
20. <u>0.00459</u> mols of CO ₂ = No. 5 _____ x No. 3 _____ mm x 0.016 \div (No. 4 _____ C + 273.16C.)	
21. <u>.46</u> g wt. of CaCO ₃ = 100 x No. 20 _____	
22. <u>.06</u> g wt. of Ca(OH) ₂ = No. 19 _____ - No. 21 _____	
23. <u>0.00081</u> mols of Ca(OH) ₂ = No. 22 _____ \div 74	
24. <u>.40</u> g total wt. of Ca(OH) ₂ = 74 x (No. 20 _____ + No. 23 _____)	
25. <u>.20</u> g wt. CO ₂ = No. 20 _____ x 44	
26. <u>.74</u> g wt. total possible CO ₂ = 44 x (No. 20 _____ + No. 23 _____)	
27. <u>82.33</u> % CO ₂ gain = No. 25 _____ \div No. 26 _____ x 100%	

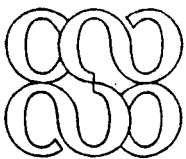

Community
Services
Collaborative

Offering the following preservation services: Architecture - Building Analysis - Federal Programs and Government Liaison- Grantsmanship - Landscape Architecture - Municipal and Local Government Services - Planning - Historic Materials Analysis

1315 Broadway - Boulder, Colorado 80302 - 303 442 3601

Form Date: 7/1/7

CONCLUSIONS:

28. 1.77 g wt. of sample = No. 15 _____ - No. 25 _____
29. 2.91 fines parts/vol. = No. 16 _____ ÷ No. 28 _____ = _____ x 100%
30. 53.72 sand parts/vol. = No. 17 _____ ÷ No. 28 _____ = _____ x 100% x No. 18 _____
31. 24.86 lime parts/vol. = No. 24 _____ ÷ No. 28 _____ = _____ x 100% x 1.1
32. 1:2.48 lime:sand by vol. = No. 29 _____ + No. 30 _____ ÷ No. 31 _____

CEMENT (if present)

33. 6.17 portland cement parts/vol. = (If fines from portland cement)
 No. 16 _____ x 1.0 = a. _____ wt. of cement ÷ No. 28 _____ = b. _____
 100% x 0.78
34. _____ natural cement parts/vol. = (If fines from natural cement)
 No. 16 _____ x 1.0 = a. _____ wt. of cement ÷ No. 28 _____ = b. _____
 100% x 0.86
35. _____ lime w/cement parts/vol. = Cement may not account for total soluble
 weight of lime in such a mix. No. 24 _____ - (No. 16 _____ x 0.2) =
 a. _____ ÷ No. 28 _____ = b. _____ 100 % x 1.1 (Quicklime (CaO) factor
 = 1.97)

Courtesy of: E. Blaine Cliver, Historical Architect
 North Atlantic Historic Preservation Center
 North Atlantic Region
 National Park Service

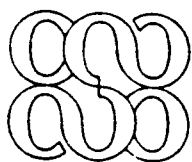

Community
 Services
 Collaborative

Offering the following preservation services: Architecture -
 Building Analysis - Federal Programs and Government Liaison-
 Grantsmanship - Landscape Architecture - Municipal and Local
 Government Services - Planning - Historic Materials Analysis

1315 Broadway - Boulder, Colorado 80302 - 303 442 3601

MORTAR ANALYSIS

IDENTIFICATION:	
Project: <u>NORTH ATLANTIC</u>	
Location: <u>FLOYD BENNET FIELD</u>	Structure: <u>COMPLEX 6</u>
Sample #: <u>2</u>	Date Examined: <u>JULY 31, 1979 3:30 P.M.</u>
Date Taken: <u>-</u>	By: <u>TED VAN DYNE</u>
By: <u>GARY HIGGINS</u>	
Location of Sample: <u>WPA SOUTH WALL, EAST END OF SILL AT WEST WINDOW.</u>	
Sample Description (Before Testing): <u>GRAY COLORED, VERY HARD, NO HAIR OR FIBER. MEDIUM GRAINED WITH SOME LARGE AGGREGATES; ABOUT 1/2" THICK - PORTLAND CEMENT?</u>	
TEST: SOLUBLE FRACTION	
DATA:	
1. <u>165.37</u> wt. of container A	8. <u>No</u> hair or fiber present; type: _____
2. <u>178.02</u> wt. of container A & sample	9. <u>3.68</u> wt. of sample fines w/paper
3. <u>632.46</u> barometric pressure	10. <u>2.52</u> wt. of filter paper
4. <u>24.44</u> temperature	11. <u>172.55</u> wt. of sand & container A
5. <u>0.220</u> l. of CO ₂ released	12. <u>5.1</u> cc of sand
6. <u>light yellow</u> filtrate color	13. <u>13.54</u> wt. of graduated cylinder w/sand
7. <u>light gray</u> fines color	14. <u>6.58</u> wt. of graduated cylinder
COMPUTATIONS:	
15. <u>12.65</u> g starting wt. of sample = No. 2 _____ - No. 1 _____	
16. <u>1.16</u> g wt. of fines = No. 9 _____ - No. 10 _____	
17. <u>7.18</u> g wt. of sand = No. 11 _____ - No. 1 _____	
18. <u>0.71229</u> sand density = $1.0 \div [(No. 13 \text{ } ______ - No. 14 \text{ } ______) \div No. 12 \text{ } ______]$	
19. <u>4.91</u> g wt. of soluble content = No. 15 _____ - (No. 16 _____ + No. 17 _____)	
20. <u>0.00748</u> mols of CO ₂ = No. 5 _____ x No. 3 _____ mm x 0.016 \div (No. 4 _____ C + 273.16C.)	
21. <u>.75</u> g wt. of CaCO ₃ = 100 x No. 20 _____	
22. <u>3.56</u> g wt. of Ca(OH) ₂ = No. 19 _____ - No. 21 _____	
23. <u>0.04811</u> mols of Ca(OH) ₂ = No. 22 _____ \div 74	
24. <u>4.11</u> g total wt. of Ca(OH) ₂ = 74 x (No. 20 _____ + No. 23 _____)	
25. <u>.33</u> g wt. CO ₂ = No. 20 _____ x 44	
26. <u>7.45</u> g wt. total possible CO ₂ = 44 x (No. 20 _____ + No. 23 _____)	
27. <u>13.47</u> % CO ₂ gain = No. 25 _____ \div No. 26 _____ x 100%	

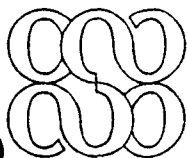

Community
Services
Collaborative

Offering the following preservation services: Architecture - Building Analysis - Federal Programs and Government Liaison- Grantsmanship - Landscape Architecture - Municipal and Local Government Services - Planning - Historic Materials Analysis

1315 Broadway - Boulder, Colorado 80302 - 303 442 3601

Form Date: 7/1/77

CONCLUSIONS:

28. 12.32 g wt. of sample = No. 15 _____ - No. 25 _____
29. 9.42 fines parts/vol. = No. 16 _____ ÷ No. 28 _____ = _____ x 100%
30. 41.51 sand parts/vol. = No. 17 _____ ÷ No. 28 _____ = _____ x 100% x No. 18 _____
31. 36.70 lime parts/vol. = No. 24 _____ ÷ No. 28 _____ = _____ x 100% x 1.1
32. 1:1.39 lime:sand by vol. = No. 29 _____ + No. 30 _____ ÷ No. 31 _____

CEMENT (if present)

33. 7.34 portland cement parts/vol. = (if fines from portland cement)
 No. 16 _____ x 1.0 = a. _____ wt. of cement ÷ No. 28 _____ = b. _____
 100% x 0.78
34. _____ natural cement parts/vol. = (if fines from natural cement)
 No. 16 _____ x 1.0 = a. _____ wt. of cement ÷ No. 28 _____ = b. _____
 100% x 0.86
35. _____ lime w/cement parts/vol. = Cement may not account for total soluble
 weight of lime in such a mix. No. 24 _____ - (No. 16 _____ x 0.2) =
 a. _____ ÷ No. 28 _____ = b. _____ 100 % x 1.1 (Quicklime (CaO) factor
 = 1.97)

Courtesy of: E. Blaine Cliver, Historical Architect
 North Atlantic Historic Preservation Center
 North Atlantic Region
 National Park Service

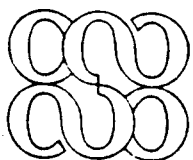

Community
 Services
 Collaborative

Offering the following preservation services: Architecture -
 Building Analysis - Federal Programs and Government Liaison-
 Grantsmanship - Landscape Architecture - Municipal and Local
 Government Services - Planning - Historic Materials Analysis

1315 Broadway - Boulder, Colorado 80302 - 303 442 3601

MORTAR ANALYSIS

IDENTIFICATION:

Project:

NORTH ATLANTIC

Location:

FLOYD BENNETT FIELD

Structure:

HANGER #20? COMPLEX

Sample #: 1

Date Taken: -

By: GARY HIGGINS

Date Examined: JULY 31, 1979 2:00 PM.

By: TED VAN DYNE

Location of Sample: EAST WALL, SE CORNER

Sample Description (Before Testing): VERY LIGHT COLORED, CRUSHED UP SAMPLE, MEDIUM GRAINED WITH SOME LARGE AGGREGATES, NO HAIR OR FIBER PRESENT

TEST: SOLUBLE FRACTION

DATA:

- | | |
|--|---|
| 1. <u>164.93</u> wt. of container A | 8. <u>NO</u> hair or fiber present; type: _____ |
| 2. <u>173.43</u> wt. of container A & sample | 9. <u>3.03</u> wt. of sample fines w/paper |
| 3. <u>637.72</u> barometric pressure | 10. <u>2.74</u> wt. of filter paper |
| 4. <u>23.89</u> temperature | 11. <u>171.66</u> wt. of sand & container A |
| 5. <u>0.350</u> l. of CO ₂ released | 12. <u>4.6</u> cc of sand |
| 6. <u>light yellow</u> filtrate color | 13. <u>13.13</u> wt. of graduated cylinder w/sand |
| 7. <u>light gray</u> fines color | 14. <u>6.39</u> wt. of graduated cylinder |

COMPUTATIONS:

15. 8.50 g starting wt. of sample = No. 2 _____ - No. 1 _____
16. 29 g wt. of fines = No. 9 _____ - No. 10 _____
17. 6.73 g wt. of sand = No. 11 _____ - No. 1 _____
18. 0.68249 sand density = $1.0 \div [(No. 13 \text{ _____} - No. 14 \text{ _____}) \div No. 12 \text{ _____}]$
19. 1.48 g wt. of soluble content = No. 15 _____ - (No. 16 _____ + No. 17 _____)
20. 0.0193 mols of CO₂ = No. 5 _____ x No. 3 _____ mm x 0.016 \div (No. 4 _____ C + 273.16C.)
21. 1.19 g wt. of CaCO₃ = 100 x No. 20 _____
22. .29 g wt. of Ca(OH)₂ = No. 19 _____ - No. 21 _____
23. 0.00392 mols of Ca(OH)₂ = No. 22 _____ \div 74
24. 1.17 g total wt. of Ca(OH)₂ = 74 x (No. 20 _____ + No. 23 _____)
25. .52 g wt. CO₂ = No. 20 _____ x 44
26. .70 g wt. total possible CO₂ = 44 x (No. 20 _____ + No. 23 _____)
27. 74.29 % CO₂ gain = No. 25 _____ \div No. 26 _____ x 100%

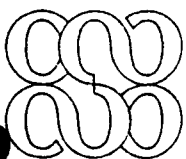

Community
Services
Collaborative

Offering the following preservation services: Architecture - Building Analysis - Federal Programs and Government Liaison- Grantsmanship - Landscape Architecture - Municipal and Local Government Services - Planning - Historic Materials Analysis

1315 Broadway - Boulder, Colorado 80302 - 303 442 3601

Form Date: 7/1/79

CONCLUSIONS:

28. 7.98 g wt. of sample = No. 15 _____ - No. 25 _____
29. 3.63 fines parts/vol. = No. 16 _____ ÷ No. 28 _____ = _____ x 100%
30. 57.56 sand parts/vol. = No. 17 _____ ÷ No. 28 _____ = _____ x 100% x No. 18 _____
31. 16.13 lime parts/vol. = No. 24 _____ ÷ No. 28 _____ = _____ x 100% x 1.1
32. 1:3.79 lime:sand by vol. = No. 29 _____ + No. 30 _____ ÷ No. 31 _____

CEMENT (if present)

33. portland cement parts/vol. = (If fines from portland cement)
 No. 16 _____ x 1.0 = a. _____ wt. of cement ÷ No. 28 _____ = b. _____
 100% x 0.78
34. natural cement parts/vol. = (If fines from natural cement)
 No. 16 _____ x 1.0 = a. _____ wt. of cement ÷ No. 28 _____ = b. _____
 100% x 0.86
35. lime w/cement parts/vol. = Cement may not account for total soluble
 weight of lime in such a mix. No. 24 _____ - (No. 16 _____ x 0.2) =
 a. _____ ÷ No. 28 _____ = b. _____ 100 % x 1.1 (Quicklime (CaO) factor
 = 1.97)

Courtesy of: E. Blaine Cliver, Historical Architect
 North Atlantic Historic Preservation Center
 North Atlantic Region
 National Park Service

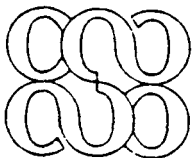

Community
 Services
 Collaborative

Offering the following preservation services: Architecture -
 Building Analysis - Federal Programs and Government Liaison-
 Grantsmanship - Landscape Architecture - Municipal and Local
 Government Services - Planning - Historic Materials Analysis

1315 Broadway - Boulder, Colorado 80302 - 303 442 3601

MORTAR ANALYSIS

IDENTIFICATION:	
Project: <u>NORTH ATLANTIC</u>	
Location: <u>FLOYD BENNETT FIELD</u>	Structure: <u>HANGAR #22</u>
Sample #: <u>4</u>	Date Examined: <u>AUGUST 24, 1979</u>
Date Taken: <u>—</u>	By: <u>TED VAN DYNE</u>
By: <u>GARY HIGGINS</u>	
Location of Sample: <u>SOUTH WALL, EAST END OF WINDOW SILL</u>	
Sample Description (Before Testing): <u>CRUSHED MORTAR, LIGHT COLORED, MEDIUM GRAINED, NO HAIR PRESENT, SOME LARGER AGGREGATES</u>	
TEST: SOLUBLE FRACTION	
DATA:	
1. <u>167.82</u> wt. of container A	8. <u>No</u> hair or fiber present; type: <u>—</u>
2. <u>171.87</u> wt. of container A & sample	9. <u>2.74</u> wt. of sample fines w/paper
3. <u>627.25</u> barometric pressure	10. <u>2.47</u> wt. of filter paper
4. <u>24.44</u> temperature	11. <u>170.67</u> wt. of sand & container A
5. <u>0.300</u> l. of CO ₂ released	12. <u>1.9</u> cc of sand
6. <u>CLEAR</u> filtrate color	13. <u>9.19</u> wt. of graduated cylinder w/sand
7. <u>light gray</u> fines color	14. <u>6.38</u> wt. of graduated cylinder
COMPUTATIONS:	
15. <u>4.05</u> g starting wt. of sample = No. 2 <u>—</u> - No. 1 <u>—</u>	
16. <u>.27</u> g wt. of fines = No. 9 <u>—</u> - No. 10 <u>—</u>	
17. <u>2.05</u> g wt. of sand = No. 11 <u>—</u> - No. 1 <u>—</u>	
18. <u>0.67616</u> sand density = $1.0 \div [(No. 13 \text{ — } - No. 14 \text{ —}) \div No. 12 \text{ —}]$	
19. <u>.93</u> g wt. of soluble content = No. 15 <u>—</u> - (No. 16 <u>—</u> + No. 17 <u>—</u>)	
20. <u>0.01012</u> mols of CO ₂ = No. 5 <u>—</u> x No. 3 <u>—</u> mm x 0.016 \div (No. 4 <u>—</u> C + 273.16C.)	
21. <u>1.01</u> g wt. of CaCO ₃ = 100 x No. 20 <u>—</u>	
22. <u>0</u> g wt. of Ca(OH) ₂ = No. 19 <u>—</u> - No. 21 <u>—</u>	
23. <u>0</u> mols of Ca(OH) ₂ = No. 22 <u>—</u> \div 74	
24. <u>.75</u> g total wt. of Ca(OH) ₂ = 74 x (No. 20 <u>—</u> + No. 23 <u>—</u>)	
25. <u>.45</u> g wt. CO ₂ = No. 20 <u>—</u> x 44	
26. <u>.45</u> g wt. total possible CO ₂ = 44 x (No. 20 <u>—</u> + No. 23 <u>—</u>)	
27. <u>100</u> % CO ₂ gain = No. 25 <u>—</u> \div No. 26 <u>—</u> x 100%	

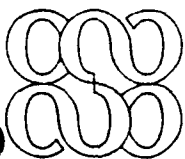

Community
Services
Collaborative

Offering the following preservation services: Architecture - Building Analysis - Federal Programs and Government Liaison - Grantsmanship - Landscape Architecture - Municipal and Local Government Services - Planning - Historic Materials Analysis

1315 Broadway - Boulder, Colorado 80302 - 303 442 3601

Form Date: 7/1/79

CONCLUSIONS:

28. 3.60 g. wt. of sample = No. 15 _____ - No. 25 _____
29. 7.50 fines parts/vol. = No. 16 _____ ÷ No. 28 _____ = _____ x 100%
30. 53.53 sand parts/vol. = No. 17 _____ ÷ No. 28 _____ = _____ x 100% x No. 18 _____
31. 27.92 lime parts/vol. = No. 24 _____ ÷ No. 28 _____ = _____ x 100% x 1.1
32. 1:2.66 lime:sand by vol. = No. 29 _____ + No. 30 _____ ÷ No. 31 _____

CEMENT (if present)

33. portland cement parts/vol. = (if fines from portland cement)
 No. 16 _____ x 1.0 = a. _____ wt. of cement ÷ No. 28 _____ = b. _____
 100% x 0.78
34. natural cement parts/vol. = (if fines from natural cement)
 No. 16 _____ x 1.0 = a. _____ wt. of cement ÷ No. 28 _____ = b. _____
 100% x 0.86
35. lime w/cement parts/vol. = Cement may not account for total soluble
 weight of lime in such a mix. No. 24 _____ - (No. 16 _____ x 0.2) =
 a. _____ ÷ No. 28 _____ = b. _____ 100 % x 1.1 (Quicklime (CaO) factor
 = 1.97)

Courtesy of: E. Blaine Cliver, Historical Architect
 North Atlantic Historic Preservation Center
 North Atlantic Region
 National Park Service

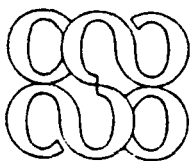

Community
 Services
 Collaborative

Offering the following preservation services: Architecture -
 Building Analysis - Federal Programs and Government Liaison-
 Grantsmanship - Landscape Architecture - Municipal and Local
 Government Services - Planning - Historic Materials Analysis

1315 Broadway - Boulder, Colorado 80302 - 303 442 3601

NATIONAL REGISTER OF HISTORIC PLACES
INVENTORY -- NOMINATION FORM

FOR FEDERAL PROPERTIES

FOR NPS USE ONLY

RECEIVED

DATE ENTERED

SEE INSTRUCTIONS IN HOW TO COMPLETE NATIONAL REGISTER FORMS
TYPE ALL ENTRIES -- COMPLETE APPLICABLE SECTIONS

1 NAME

HISTORIC

Floyd Bennett Field Historic District

AND/OR COMMON

Floyd Bennett Field

2 LOCATION

STREET & NUMBER

Flatbush Avenue

NOT FOR PUBLICATION

CITY, TOWN

CONGRESSIONAL DISTRICT

New York

VICINITY OF

11

STATE

CODE

COUNTY

CODE

New York

36

Kings

47

3 CLASSIFICATION

CATEGORY	OWNERSHIP	STATUS	PRESENT USE	
<input checked="" type="checkbox"/> DISTRICT	<input checked="" type="checkbox"/> PUBLIC	<input checked="" type="checkbox"/> OCCUPIED	<input type="checkbox"/> AGRICULTURE	<input type="checkbox"/> MUSEUM
<input type="checkbox"/> BUILDING(S)	<input type="checkbox"/> PRIVATE	<input type="checkbox"/> UNOCCUPIED	<input type="checkbox"/> COMMERCIAL	<input checked="" type="checkbox"/> PARK
<input type="checkbox"/> STRUCTURE	<input type="checkbox"/> BOTH	<input type="checkbox"/> WORK IN PROGRESS	<input type="checkbox"/> EDUCATIONAL	<input type="checkbox"/> PRIVATE RESIDENCE
<input type="checkbox"/> SITE	<input type="checkbox"/> PUBLIC ACQUISITION	<input type="checkbox"/> ACCESSIBLE	<input type="checkbox"/> ENTERTAINMENT	<input type="checkbox"/> RELIGIOUS
<input type="checkbox"/> OBJECT	<input type="checkbox"/> IN PROCESS	<input checked="" type="checkbox"/> YES: RESTRICTED	<input checked="" type="checkbox"/> GOVERNMENT	<input type="checkbox"/> SCIENTIFIC
	<input type="checkbox"/> BEING CONSIDERED	<input type="checkbox"/> YES: UNRESTRICTED	<input type="checkbox"/> INDUSTRIAL	<input type="checkbox"/> TRANSPORTATION
		<input type="checkbox"/> NO	<input type="checkbox"/> MILITARY	<input type="checkbox"/> OTHER

4 AGENCY

REGIONAL HEADQUARTERS (If applicable)

National Park Service, North Atlantic Regional Office

STREET & NUMBER

15 State Street

CITY, TOWN

STATE

Boston

VICINITY OF

Mass

5 LOCATION OF LEGAL DESCRIPTION

COURTHOUSE,
REGISTRY OF DEEDS, ETC

Kings County Courthouse

STREET & NUMBER

Flatbush Avenue

CITY, TOWN

STATE

New York

New York

6 REPRESENTATION IN EXISTING SURVEYS

TITLE Tony P. Wren and Richard E. Greenwood prepared survey reports that were used in the preparation of the National Register forms.

DATE

9/31/75 & 6/28/76

FEDERAL STATE COUNTY LOCAL

DEPOSITORY FOR
SURVEY RECORDS

North Atlantic Region

CITY, TOWN

STATE

Boston

Mass

DESCRIPTION

CONDITION		CHECK ONE	CHECK ONE
<input type="checkbox"/> EXCELLENT	<input type="checkbox"/> DETERIORATED	<input type="checkbox"/> UNALTERED	<input checked="" type="checkbox"/> ORIGINAL SITE
<input type="checkbox"/> GOOD	<input type="checkbox"/> RUINS	<input checked="" type="checkbox"/> ALTERED	<input type="checkbox"/> MOVED DATE _____
<input checked="" type="checkbox"/> FAIR	<input type="checkbox"/> UNEXPOSED		

DESCRIBE THE PRESENT AND ORIGINAL (IF KNOWN) PHYSICAL APPEARANCE

Floyd Bennett Field Historic District, located within the Jamaica Bay Unit of Gateway National Recreation Area, retains the layout and surface appearance of the 1931-1941 airport. The efforts of its planners to follow the 1928 Department of Commerce guidelines for airport construction are readily apparent. As directed, not only are the hangars and support buildings arranged linearly to one side of the runways, they are also easily accessible from a major highway, Flatbush Avenue, which passes directly behind them.

Floyd Bennett Field, the first municipal airport of the City of New York, was constructed between 1928-1931. Following the opening of Idlewild Airport in 1939, Bennett Field was closed to commercial use and eventually conveyed to the U.S. Navy in 1941. The airport was renamed the Naval Air Station, New York or the Brooklyn Naval Air Station, New York and it was enlarged from 387 acres to 1,288 acres. The Navy continued to operate the field for thirty years. In 1971 it became a Naval Air Reserve Training Detachment where ground crews received technical training. With the establishment of Gateway National Recreation Area, Floyd Bennett Field was acquired by the National Park Service.

The historic structures dating from the 1928-1931 period and the 1936-1938 period, include eight hangars with attached service wings, the administration building, the garage, two pump houses, an electrical vault, a transformer building, and a pump station. With the exception of the steel framed hangars, these buildings are all constructed of brick. There are a small number of later and less significant buildings, constructed during the Navy occupation of the field, in this area. These later buildings are concrete block, wood frame or concrete and corrugated metal structures. (see enclosed Site plans). The most significant structures are the hangars, the administration building, the taxiway, and the runways.

1. Hangar Complex (No. HS 3,4,5,6)

The first and most important buildings to be erected at the field were the complex of four pairs of hangars built between 1929 and 1931. The basically identical hangars are of steel frame construction with steel trussed arched roofs with wooden decks. Each hangar has a concrete slab floor and is supported by forty-five foot long precast concrete piles which were sunk into the ground. The inside dimensions of each hangar are one hundred and twenty feet by one hundred and forty feet. Large glass and aluminum alloy doors which have an overhead clearance of twenty-two feet enclose the north and south ends of each hangar. The interiors are open to the roof and have no dividing partitions. The hangars are arranged inside by side pairs which face another pair across a composition block apron. There are two such pairs to the north of the administration building and two to the south. Attached to the exterior side of each hangar is a two story service wing, constructed of buff colored brick, which measures twenty feet by one hundred and twenty feet. These flat roofed wings contain office and maintenance space. Banks of steel framed windows run the length of these wings and there are steel framed doors in the north and south ends. Before the WPA work, 1936-1938, each hangar was a separate structure, but during the second period of construction, central service wings, constructed of the same brick and along the same lines as the side wings, were erected between the paired hangars, creating one continuous structure

UNITED STATES DEPARTMENT OF THE INTERIOR
NATIONAL PARK SERVICE

FOR NPS USE ONLY

RECEIVED

DATE ENTERED

NATIONAL REGISTER OF HISTORIC PLACES
INVENTORY -- NOMINATION FORM

CONTINUATION SHEET

ITEM NUMBER 7 PAGE 2

out of two hangars. These two story wings were built to house machine shops and other maintenance facilities. The four hangar pairs have some Art Deco ornamentation in concrete panels on the central wings and in stamped metal on the hangar gables. The hangar gables bear winged medallions with the initials "NYC". The central wings have varying ornamentation; some have geometrically decorated concrete panels, as well as winged emblems with crossed propellers, while others have no decoration whatsoever. With the exception of some minor alterations, such as bricked in windows and removed hoods, the hangars are basically unchanged. Only Hangars 3 and 4 are presently occupied. These two are in use by the New York City Police Department.

2. Administration Building (No. HS 1)

The administration building, constructed in 1931, is a red and black brick building, two stories high and constructed in a neoGeorgian style. It has white stone quoins, water table and entablature. The structure, which also rests on sunken concrete pilings, has a partially raised basement. The eastern facade, which faces the runway, is dominated by a semi-octagonal projecting bay, three stories tall and topped with the steel framed and glass enclosed control booth. There is a small deck, enclosed with aluminum railing surrounding the control booth. On either side of the projecting bay, at the first story level, there is an observation deck, enclosed by balustrades and reached by a granite stairway. Outside entryways to the basement pass below these decks. "Naval Air Station" and "Floyd Bennett Field" are spelled out in bronze letters across the entablature on the east facade. The west facade, which faces the original entrance to the field from Flatbush Avenue, is composed of a central projection, flanked by symmetrical sections. This central projection houses a recessed full portico supported by Ionic columns. There are three doorways under the portico, and over the central door is the Naval Air Station clock. In the center of the cornice of the portico is a polychrome winged globe. As originally designed, the administration building housed a restaurant, cafeteria, a post office, dormitories, lounge, weather bureau and a Department of Commerce office. The building underwent repairs and alterations during the WPA work and was then adapted for use by the Navy. Today the building is unoccupied and in need of general rehabilitation. The interior is generally plain, with occasional ornamentation such as marble panelling. A nonsignificant frame addition attached to the northern end of the building during the Navy occupancy is scheduled to be removed by the Park Service.

3. Runways and Taxiway (No. HS 7)

In 1929-31, following the creation of the 387 acre area, two reinforced concrete runways were laid. Both runways were one hundred feet wide; one was 4200' long and oriented on a northeast - southwest axis and the other was 3,110' long and oriented on a north-northwest-south-southwest axis. The runways, located to the east of the building complex, formed a T, with the intersection slightly south of the administration building site.

UNITED STATES DEPARTMENT OF THE INTERIOR
NATIONAL PARK SERVICE

FOR NPS USE ONLY

RECEIVED

DATE ENTERED

NATIONAL REGISTER OF HISTORIC PLACES
INVENTORY -- NOMINATION FORM

CONTINUATION SHEET

ITEM NUMBER 7 PAGE 3

A concrete taxiway was also constructed at this time. It was parallel to the shorter of the runways and located to the west of it and east of the hangars. Two more runways were constructed by the WPA in 1937 to 1938. The shorter of these runways was laid on an approximately north - south axis, extending 4000' feet north from its intersection with the southern end of the earlier, 3,110' runway. The longer of the new runways extended southeast for 5,500' from the northern terminus of the 3,100' runway. The rest of the airfield was planted with grass, to prevent drifting. With the expansion of the airfield and its continuing maintenance by the Navy, the original runways have been extended, widened and presumably resurfaced. Except for the newer northern-most runway presently at Bennett Field, which runs from east to west, the modern runways have followed the general layout of the originals. The best preserved runway, in terms of scale, is the longer of the first two runways (labelled as "f" on the enclosed site plan) hence the historic runway pattern is an integral part of the current runway system.

There are additional historic structures of less importance that relate to the use of Floyd Bennett Field during the historic period (1931-1941):

The garage and maintenance shop (#26), constructed circa 1931, is a one story, rectangular buff brick building similar in silhouette to the hangar complexes. It consists of a central core of offices flanked on either side by shops, which are reached through overhead metal doors. There is a small, stuccoed attachment on the southwest corner of the garage. The building has a flat, steel reinforced roof and concrete flooring. It is in fair condition and is not presently occupied. It is located in the southwest corner of the airport, below the hangars, just east of Flatbush Avenue.

To the east of the garage and shops are two other small buff brick buildings, one story tall and rectangular in shape. The western structure is a pump house (#30) and contains operating pumping machinery and tanks. The other, smaller building houses electrical equipment (#57). Its brickwork is not in good condition and requires some patching.

The fire pump house (#29) and the gasoline pump station (#176), are located to the west of the administration building. The fire pump house is a partially sunken, single story buff brick building with a sheet copper-covered, concrete hip roof. There is a wide concrete cornice which is imprinted with "Pump House" on the north facade. There is a small stuccoed attachment on the west end of the building. The structure houses pumping machinery which is presently in use. To the west of this building is the gasoline pump station, which is also a single story, rectangular buff brick building. It has a flat concrete roof and concrete flooring. The building is not occupied, is missing its door and its underground tanks have been filled with sand.

The transformer building (#120) is located to the north of the hangars, along the taxiway. It is a single story, roughly L-shaped building, constructed of buff brick with white stone trim. The flat roof and the floor are concrete. The building has steel framed windows and doors. It is still used to house transformer facilities.

UNITED STATES DEPARTMENT OF THE INTERIOR
NATIONAL PARK SERVICE

NATIONAL REGISTER OF HISTORIC PLACES
INVENTORY -- NOMINATION FORM

FOR NPS USE ONLY

RECEIVED

DATE ENTERED

CONTINUATION SHEET

ITEM NUMBER 7 PAGE 4

Within the original boundaries of the municipal airport there are several structures built after 1941 which are intrusions. Some of these were constructed in the main complex of buildings, while other more recent ones are located on the eastern side of the field on what was open flying field during the 1931-1941 period. None of these more recent buildings contribute to the historic significance of the district. The intrusive buildings within the main building complex include: Hangars 9 and 10, wood frame attached hangars built by the Navy circa 1942; Structures 44, 45, 266, 238, small single-story concrete block buildings used as storehouses; Structure 265, the Blue Nose hangar, a large, steel frame building with concrete foundations and corrugated siding; Structure 265A, a small shed; Structure 171, the wood frame addition to the administration building; Structures 48 and 50, single-story wood frame building which formerly housed the Navy training facilities and a garage and shop, respectively; Structures 126 and 236, small single-story sheds used for storage.

The above intrusions are indicated unshaded on the enclosed sketch map of "Floyd Bennett Field Historic District".

As can be seen in a comparison between the 1940 site plan and the current map, the majority of formerly unsurfaced land around the runways has been surfaced with runways, taxiways, aprons and roads. However, this land has remained open, otherwise, and the post 1941 developments do not constitute a major intrusion.

A portion of the runway, shown with dotted lines on the sketch map of Floyd Bennett Field Historic District, is under the jurisdiction of the U.S. Coast Guard and has been excluded from the nomination acreage, although historically it is part of the proposed historic district. The Coast Guard runway tract is used as a landing strip and does not intrude into the historic district.

The lower part of Floyd Bennett Field covers a land area previously known as Barren Island which has had an ample history of occupation by prehistoric and historic settlers. It is believed that a Canarsie Indian Village, Enquendito, once was located in close proximity to the present Park Headquarters. During the nineteenth century, a small village grew on Barren Island because of a large fertilizer and glue factory. By the mid 1880's, 500 workers and families associated with the factory lived in the area now occupied by part of Floyd Bennett Field. The district contains, therefore, potentially significant archeological deposits.

SIGNIFICANCE

PERIOD	AREAS OF SIGNIFICANCE -- CHECK AND JUSTIFY BELOW			
<input type="checkbox"/> PREHISTORIC	<input type="checkbox"/> ARCHEOLOGY-PREHISTORIC	<input type="checkbox"/> COMMUNITY PLANNING	<input type="checkbox"/> LANDSCAPE ARCHITECTURE	<input type="checkbox"/> RELIGION
400-1499	<input type="checkbox"/> ARCHEOLOGY HISTORIC	<input type="checkbox"/> CONSERVATION	<input type="checkbox"/> LAW	<input type="checkbox"/> SCIENCE
500-1599	<input type="checkbox"/> AGRICULTURE	<input type="checkbox"/> ECONOMICS	<input type="checkbox"/> LITERATURE	<input type="checkbox"/> SCULPTURE
<input type="checkbox"/> 1600-1699	<input type="checkbox"/> ARCHITECTURE	<input type="checkbox"/> EDUCATION	<input checked="" type="checkbox"/> MILITARY	<input type="checkbox"/> SOCIAL/HUMANITARIAN
<input type="checkbox"/> 1700-1799	<input type="checkbox"/> ART	<input type="checkbox"/> ENGINEERING	<input type="checkbox"/> MUSIC	<input type="checkbox"/> THEATER
<input type="checkbox"/> 1800-1899	<input type="checkbox"/> COMMERCE	<input type="checkbox"/> EXPLORATION/SETTLEMENT	<input type="checkbox"/> PHILOSOPHY	<input checked="" type="checkbox"/> TRANSPORTATION
<input checked="" type="checkbox"/> 1900-	<input type="checkbox"/> COMMUNICATIONS	<input type="checkbox"/> INDUSTRY	<input type="checkbox"/> POLITICS/GOVERNMENT	<input type="checkbox"/> OTHER (SPECIFY)
		<input type="checkbox"/> INVENTION		

SPECIFIC DATES

1928-31

BUILDER/ARCHITECT

New York City Department of Docks

STATEMENT OF SIGNIFICANCE

Floyd Bennett Field on Barren Island, Jamaica Bay, is significant in the evolution of aviation history and municipal airport construction. The Field was the first municipal airport in New York City. Constructed between 1928 and 1931 by the City Department of Docks, the airport was designed to attract the increasing volume of air traffic directly to New York City, rather than to Newark Airport where the vast majority of New York bound flights terminated. In 1933, Floyd Bennett Field was the second busiest airport in the country, with 51,323 landings and takeoffs, but only a minor percentage of this activity consisted of the mail, freight and commercial passengers which generated revenue. Following the opening of Idlewild Airport in 1939, Bennett Field was closed to commercial use and conveyed to the U.S. Navy in 1941. Although the Navy enlarged the Field after conveyance in 1941, the original complex of steel frame and brick hangars and support buildings has not been substantially altered. The layout and construction followed the guidelines indicated in the Construction of Airports by the U.S. Department of Commerce. Floyd Bennett Field thus retains architectural design and historic cohesion of an early municipal airport.

Floyd Bennett Field is historically significant also for its association with individual significant in early aviation. Due to its unusually long runways and fair weather conditions, Bennett Field became noted as a prime airport for the experimental fliers who sought to establish speed and distance records. For example, in 1933, Wiley Post broke his previous record for an around the world flight landing at Floyd Bennett seven days, eighteen hours and forty-nine minutes after he took off from there on July 15. Several women's transcontinental speed records began or ended at Bennett Field. In 1938, Howard Hughes with a crew of four made an around-the-world flight starting and finishing at Bennett Field. This flight, which covered 14,791 miles in three days, nineteen hours, eight minutes and ten seconds, was made to collect navigational data.

Shortly after Hughes's flight, Douglas Corrigan embarked from Bennett Field supposedly on a flight to California. However, Corrigan flew instead to Ireland, thus fulfilling his wish to make a transAtlantic flight. For this apparent lack of orientation, Corrigan lost his experimental license and earned the nickname "Wrong-Way." Interest in these records reflected public enthusiasm about aviation and contributed to improving technical aspects and piloting skills.

Most municipal airports have been modernized. Floyd Bennett Field thus presents an unusual value because it retains much of its original structures and setting which tell the story of the early years of aviation. Nearby Miller Army Air Field, which retains structures dating from immediately after World War One, gives an indication of how a military airfield appeared thus allowing a comparative study between non-commercial and commercial airfields.

MAJOR BIBLIOGRAPHICAL REFERENCES

- Abernathy, Charles, Final Report of the Works Progress Administration for the City of New York (New York, W.P.A., 1943).
- Department of Commerce, Construction of Airports (Washington, GPO, 1928).
- National Aeronautical Chamber of Commerce, Aircraft Yearbook for 1932 (n.p., 1932).
- New York City, Department of Docks, Sixty First Annual Report (New York, 1932).
- ann, Tony, General History of the Jamaica Bay, Freezy Point and Staten Island Units nearby National Recreation Area, NY, NY. (n.p. 1975).

GEOGRAPHICAL DATA

ACREAGE OF NOMINATED PROPERTY 328.5 acres

UTM REFERENCES

A	1,8	5,9,4	44,0	4,4	9,4	3,2,0	B	1,8	5,9,4	73,0	4,4	9,3	2,60
	ZONE	EASTING		NORTHING				ZONE	EASTING		NORTHING		
C	1,8	5,9,3	6,0,0	4,4	9,2	0,4,0	D	1,8	5,9,2	6,20	4,4	9,4	0,60
	ZONE	EASTING		NORTHING				ZONE	EASTING		NORTHING		

VERBAL BOUNDARY DESCRIPTION

LIST ALL STATES AND COUNTIES FOR PROPERTIES OVERLAPPING STATE OR COUNTY BOUNDARIES

STATE	CODE	COUNTY	CODE
STATE	CODE	COUNTY	CODE

FORM PREPARED BY

NAME/TITLE

Richard Greenwood, Survey Historian; Ricardo Torres, NAR

ORGANIZATION

North Atlantic Region

STREET & NUMBER

15 State Street

CITY OR TOWN

Boston

DATE

6/30/76, 4/78

TELEPHONE

617-223-3778

STATE

MA

CERTIFICATION OF NOMINATION

STATE HISTORIC PRESERVATION OFFICER RECOMMENDATION

YES _____ NO _____ NONE _____

STATE HISTORIC PRESERVATION OFFICER SIGNATURE

In compliance with Executive Order 11593, I hereby nominate this property to the National Register, certifying that the State Historic Preservation Officer has been allowed 90 days in which to present the nomination to the State Review Board and to evaluate its significance. The evaluated level of significance is _____ National _____ State _____ Local

FEDERAL REPRESENTATIVE SIGNATURE

TITLE

DATE

FOR NPS USE ONLY

I HEREBY CERTIFY THAT THIS PROPERTY IS INCLUDED IN THE NATIONAL REGISTER

DATE

DIRECTOR, OFFICE OF ARCHEOLOGY AND HISTORIC PRESERVATION

ATTEST

DATE

KEEPER OF THE NATIONAL REGISTER

■ Significant Structures

□ Structures

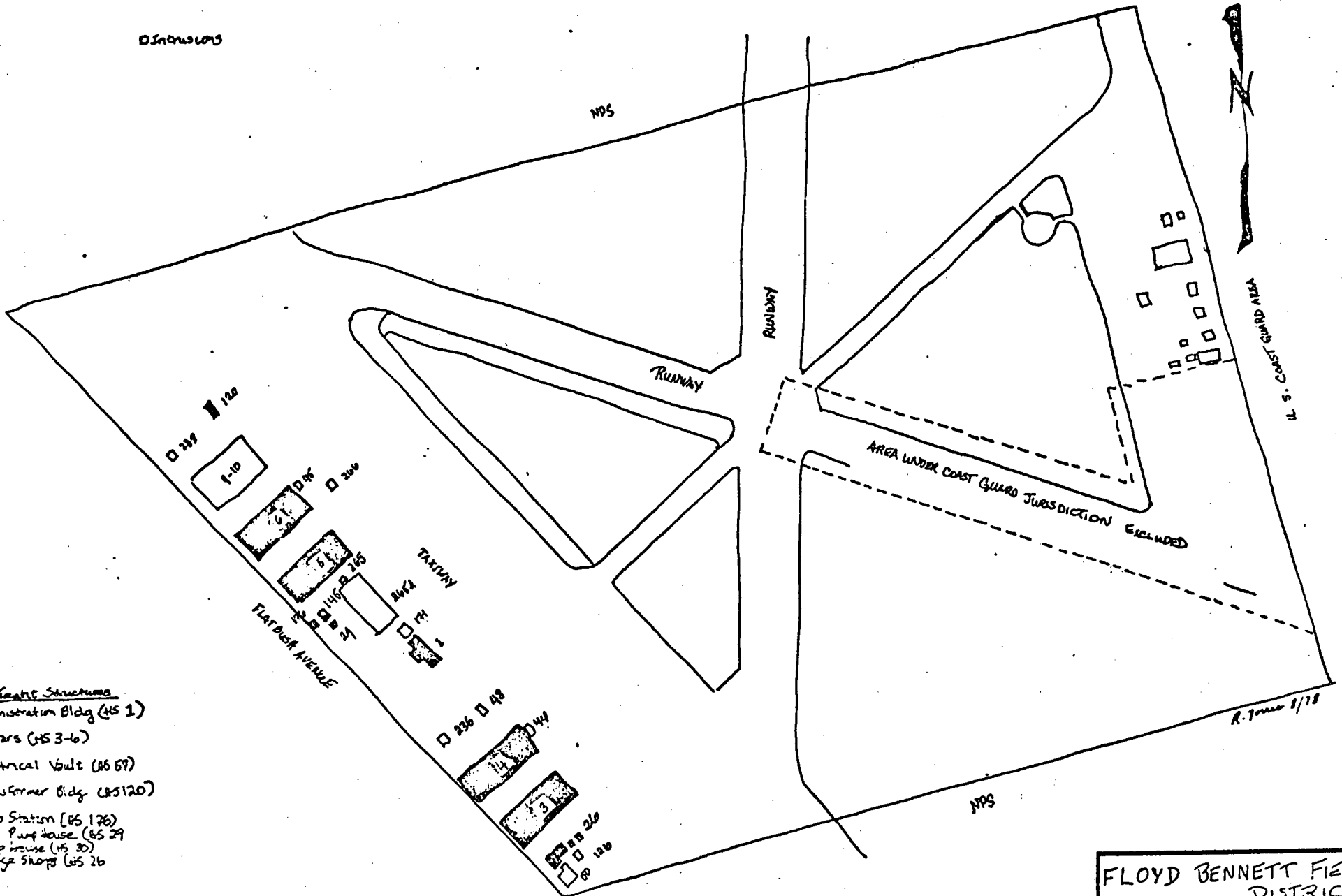

- Significant Structures
 Administration Bldg (HS 1)
 Hangars (HS 3-6)
 Electrical Vault (HS 87)
 Transformer Bldg (HS 120)
 Pump Station (HS 176)
 Fire Pump house (HS 29)
 Pump house (HS 35)
 Garage Shops (HS 26)

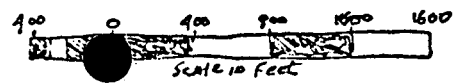

FLOYD BENNETT FIELD DISTRICT

SCALE	APPROVED BY
DATE	

FLOYD BENNETT-FIELD HISTORIC
 DISTRICT
 GATEWAY NATIONAL RECREATION AREA
 JAMAICA BAY

UTM References

A	18 594 440	44 94 320
B	18 594 730	44 93 260
C	18 593 600	44 92 040
D	18 592 620	44 94 060

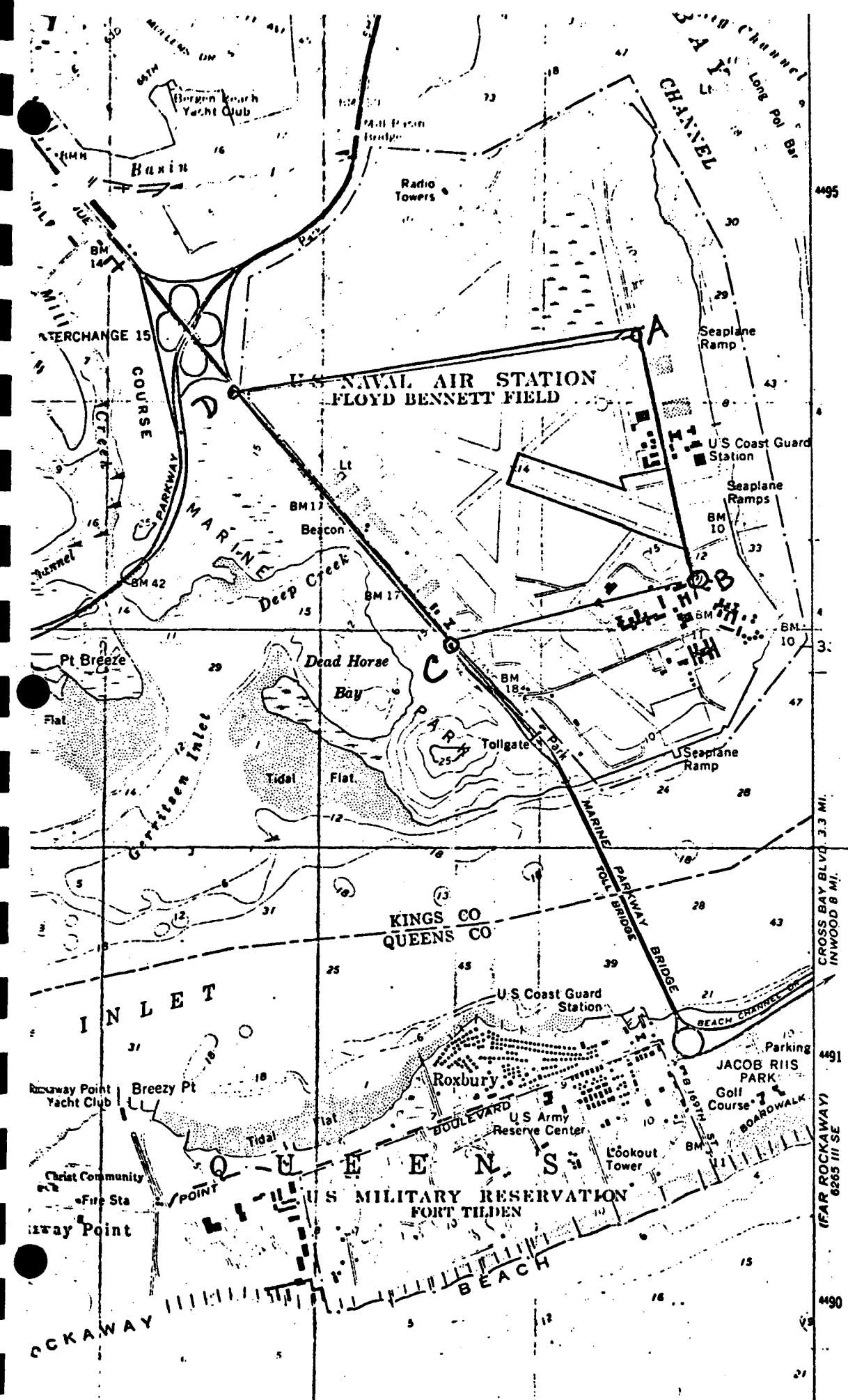

CROSS BAY BLVD 3.3 MI.
 INWOOD 8 MI.

4491

(FAR ROCKAWAY)
 6265 III SE

4490

As the nation's principal conservation agency, the Department of the Interior has basic responsibilities to protect and conserve our land and water, energy and minerals, fish and wildlife, parks and recreation areas, and to ensure the wise use of all these resources. The department also has major responsibility for American Indian reservation communities and for people who live in island territories under U.S. administration.

Publication services were provided by the graphics staff of the Denver Service Center. NPS 1768