

NHI Course No. 132042

**MECHANICALLY STABILIZED EARTH WALLS AND
REINFORCED SOIL SLOPES
DESIGN & CONSTRUCTION GUIDELINES**



NOTICE

The contents of this report reflect the views of the authors, who are responsible for the facts and the accuracy of the data presented herein. The contents do not necessarily reflect policy of the Department of Transportation. This report does not constitute a standard, specification, or regulation. The United States Government does not endorse products or manufacturers. Trade or manufacturer's names appear herein only because they are considered essential to the objective of this document.

| | | | | | |
|----------------------------------------------------------------------------------------------------------------------------------------------------------------------------------------------------------------------------------------------------------------------------------------------------------------------------------------------------------------------------------------------------------------------------------------------------------------------------------------------------------------------------------------------------------------------------------------------------------------------------------------------------------------------------------------------------------------------------------------------------------------------------------------------------------------------------------------------------------------------------------|--|---------------------------------------|--|------------------------------------------------|--|
| 1. REPORT NO. FHWA-NHI-00-043 | | 2. GOVERNMENT ACCESSION NO. | | 3. RECIPIENT'S CATALOG NO. | |
| 4. TITLE AND SUBTITLE Mechanically Stabilized Earth Walls and Reinforced Soil Slopes Design and Construction Guidelines | | | | 5. REPORT DATE March 2001 | |
| | | | | 6. PERFORMING ORGANIZATION CODE | |
| 7. AUTHOR(S) Victor Elias, P.E.; Barry R. Christopher, Ph.D., P.E. and Ryan R. Berg, P.E. | | | | 8. PERFORMING ORGANIZATION REPORT NO. | |
| 9. PERFORMING ORGANIZATION NAME AND ADDRESS Ryan R. Berg & Associates, Inc. 2190 Leyland Alcove Woodbury, MN 55125 | | | | 10. WORK UNIT NO. | |
| | | | | 11. CONTRACT OR GRANT NO. DTFH61-99-T-25041 | |
| 12. SPONSORING AGENCY NAME AND ADDRESS National Highway Institute Federal Highway Administration U.S. Department of Transportation Washington, D.C. | | | | 13. TYPE OF REPORT & PERIOD COVERED | |
| | | | | 14. SPONSORING AGENCY CODE | |
| 15. SUPPLEMENTARY NOTES FHWA Technical Consultant: J.A. DiMaggio, P.E. (HIBT-20) <i>This manual is the updated version of FHWA SA96-071 prepared by E2Si.</i> | | | | | |
| 16. ABSTRACT This manual is the reference text used for the FHWA NHI course No. 132042 on Mechanically Stabilized Earth Walls and Reinforced Soil Slopes and reflects current practice for the design, construction and monitoring of these structures. This manual was prepared to enable the engineer to identify and evaluate potential applications of MSEW and RSS as an alternative to other construction methods and as a means to solve construction problems. The scope is sufficiently broad to be of value for specifications specialists, construction and contracting personnel responsible for construction inspection, development of material specifications and contracting methods. With the aid of this text, the engineer should be able to properly select, design, specify, monitor and contract for the construction of MSE walls and RSS embankments. | | | | | |
| 17. KEY WORDS Design, analysis, performance criteria, Mechanically Stabilized Earth Walls (MSEW), Reinforced Soil Slopes (RSS), soil reinforcement, geosynthetics, geotextiles, geogrids, specifications, contracting methods | | | | 18. DISTRIBUTION STATEMENT No restrictions. | |
| 19. SECURITY CLASSIF. Unclassified | | 20. SECURITY CLASSIF. Unclassified | | 21. NO. OF PAGES 394 | |
| | | | | 22 22 | |

| SI CONVERSION FACTORS | | | | |
|----------------------------------------------|--------------------------|--------------------|--------------------------|-----------------|
| APPROXIMATE CONVERSIONS FROM SI UNITS | | | | |
| Symbol | When You Know | Multiply By | To Find | Symbol |
| LENGTH | | | | |
| mm | millimeters | 0.039 | inches | in |
| m | meters | 3.28 | feet | ft |
| m | meters | 1.09 | yards | yd |
| km | kilometers | 0.621 | miles | mi |
| AREA | | | | |
| mm ² | square millimeters | 0.0016 | square inches | in ² |
| m ² | square meters | 10.764 | square feet | ft ² |
| m ² | square meters | 1.195 | square yards | yd ² |
| ha | hectares | 2.47 | acres | ac |
| km ² | square kilometers | 0.386 | square miles | mi ² |
| VOLUME | | | | |
| ml | milliliters | 0.034 | fluid ounces | fl oz |
| l | liters | 0.264 | gallons | gal |
| m ³ | cubic meters | 35.71 | cubic feet | ft ³ |
| m ³ | cubic meters | 1.307 | cubic yards | yd ³ |
| MASS | | | | |
| g | grams | 0.035 | ounces | oz |
| kg | kilograms | 2.202 | pounds | lb |
| TEMPERATURE | | | | |
| ?C | Celsius | 1.8 C + 32 | Fahrenheit | ?F |
| WEIGHT DENSITY | | | | |
| kN/m ³ | kilonewton / cubic meter | 6.36 | poundforce / cubic foot | pcf |
| FORCE and PRESSURE or STRESS | | | | |
| N | newtons | 0.225 | poundforce | lbf |
| kN | kilonewtons | 225 | poundforce | lbf |
| kPa | kilopascals | 0.145 | poundforce / square inch | psi |
| kPa | kilopascals | 20.9 | poundforce / square foot | psf |

PREFACE

Engineers and specialty material suppliers have been designing reinforced soil structures for the past 25 years. During the last decade significant improvements have been made to design methods and in the understanding of factors affecting the durability of reinforcements.

In order to take advantage of these new developments the FHWA developed a manual (in connection with Demonstration Project No. 82, Ground Improvement), FHWA SA96-071, which is the basis for this updated version. The primary purpose of this manual is to support educational programs conducted by FHWA for transportation agencies.

A second purpose of equal importance is to serve as the FHWA standard reference for highway projects involving reinforced soil structures.

This Mechanically Stabilized Earth Walls (MSE) and Reinforced Soil Slopes (RSS), Design and Construction Guidelines Manual which is a current update of FHWA SA-96-071, has evolved from the following AASHTO and FHWA references:

- ! *Reinforced Soil Structures - Volume I, Design and Construction Guidelines - Volume II, Summary of Research and Systems Information*, by B.R. Christopher, S.A. Gill, J.P. Giroud, J.K. Mitchell, F. Schlosser, and J. Dunicliff, FHWA RD 89-043.
- ! *Geosynthetic Design and Construction Guidelines*, by R.D. Holtz, B.R. Christopher, and R.R. Berg, FHWA HI-95-038.
- ! AASHTO, 1992, 1996, 1997, 1998 and 1999 Interims, Section 5.8.
- ! *Design and Construction Monitoring of Mechanically Stabilized Earth Structures*, by J.A. DiMaggio, FHWA, March 1994.
- ! *Guidelines for Design, Specification, and Contracting of Geosynthetic Mechanically Stabilized Earth Slopes on Firm Foundations*, by R.R. Berg, FHWA-SA-93-025, January 1993.
- ! AASHTO Bridge T-15 Technical Committee unpublished working drafts for the update of Section 5.8 of the AASHTO Bridge Design Specifications.

The authors recognize the efforts of Mr. Jerry A. DiMaggio, P.E. who was the FHWA Technical Consultant for this work, and served in the same capacity for most of the above referenced publications. Mr. DiMaggio's guidance and input to this and the previous works has been invaluable.

The authors further acknowledge the efforts of Mr. Tony Allen, Washington DOT, members of the AASHTO T-15 committee and the following Technical Working Group members who served as a review panel listed in alphabetical order:

| | | |
|-----------------------|---|---------------------------------|
| Dr. Donald Bruce | - | ECO Geosystems Inc. |
| Dr. James Collin | - | The Collin Group |
| Mr. Albert DiMillio | - | FHWA |
| Mr. Richard Endres | - | Michigan DOT |
| Mr. John Hooks | - | FHWA |
| Dr. John Horvath | - | Manhattan College |
| Mr. Richard Sheffield | - | Mississippi DOT |
| Mr. Michael Simac | - | Ground Improvement Technologies |
| Mr. Ed Tavera | - | Louisiana DOT |

Lastly, the authors wish to thank the clerical and computer graphics staff of Earth Engineering and Sciences, Inc. for their vital contributions and significant effort in preparing the earlier version of this manual.

TABLE OF CONTENTS

| | |
|------------------------------------------------------------|------|
| CHAPTER 1 INTRODUCTION | -1- |
| 1.1 OBJECTIVES | -1- |
| a. Scope | -1- |
| b. Source Documents | -2- |
| c. Terminology | -2- |
| 1.2 HISTORICAL DEVELOPMENT | -4- |
| CHAPTER 2 SYSTEMS AND PROJECT EVALUATION | -9- |
| 2.1 APPLICATIONS | -9- |
| 2.2 ADVANTAGES AND DISADVANTAGES | -15- |
| a. Advantages of Mechanically Stabilized Earth (MSE) Walls | -15- |
| b. Advantages of Reinforced Soil Slopes | -15- |
| c. Disadvantages | -16- |
| 2.3 RELATIVE COSTS | -17- |
| 2.4 DESCRIPTION OF MSE/RSS SYSTEMS | -20- |
| a. Systems Differentiation | -20- |
| b. Types of Systems | -20- |
| c. Facing Systems | -21- |
| d. Reinforcement Types | -25- |
| e. Reinforced Backfill Materials | -26- |
| f. Miscellaneous Materials of Construction | -26- |
| 2.5 SITE EVALUATION | -27- |
| a. Site Exploration | -27- |
| b. Field Reconnaissance | -27- |
| c. Subsurface Exploration | -28- |
| d. Laboratory Testing | -29- |
| 2.6 PROJECT EVALUATION | -30- |
| a. Structure Selection Factors | -30- |
| b. Geologic and Topographic Conditions | -31- |
| c. Environmental Conditions | -32- |
| d. Size and nature of structure | -33- |
| e. Aesthetics | -33- |
| f. Questionable Applications | -34- |
| 2.7 ESTABLISHMENT OF PROJECT CRITERIA | -34- |
| a. Alternates | -35- |
| b. Facing Considerations | -35- |
| c. Performance Criteria | -36- |
| d. Design Life | -40- |
| 2.8 CONSTRUCTION SEQUENCE | -40- |
| a. Construction of MSEW systems with precast facings | -41- |
| b. Construction of MSE systems with Flexible Facings | -42- |
| c. RSS Construction | -46- |

| | | |
|-----------------------------------------|-------------------------------------------------------------------------------|-------|
| 2.9 | PROPRIETARY ASPECTS | -46- |
| a. | Materials | -46- |
| b. | Special Applications | -46- |
| CHAPTER 3 SOIL REINFORCEMENT PRINCIPLES | | |
| | AND SYSTEM DESIGN PROPERTIES | -51- |
| 3.1 | OVERVIEW | -51- |
| 3.2 | REINFORCED SOIL CONCEPTS | -51- |
| 3.3 | SOIL REINFORCEMENT INTERACTION USING NORMALIZED CONCEPTS | -54- |
| a. | Evaluation of Pullout Performance | -54- |
| b. | Estimate of the Reinforcement Pullout Capacity in RSS and MSE Structures | -56- |
| c. | Interface Shear | -61- |
| 3.4 | ESTABLISHMENT OF ENGINEERING PROPERTIES BASED ON SITE EXPLORATION AND TESTING | -61- |
| a. | Foundation Soils | -61- |
| b. | Reinforced Backfill Soil | -62- |
| c. | Retained Fill | -65- |
| d. | Electrochemical Properties | -65- |
| 3.5 | ESTABLISHMENT OF STRUCTURAL DESIGN PROPERTIES | -66- |
| a. | Geometric Characteristics | -66- |
| b. | Strength Properties | -67- |
| CHAPTER 4 DESIGN OF MSE WALLS | | |
| 4.1 | DESIGN METHODS | -81- |
| a. | Analysis of Working Stresses for MSEW Structures | -82- |
| b. | Limit Equilibrium Analysis | -82- |
| c. | Deformation Evaluations | -82- |
| d. | Design Methods, Inextensible Reinforcements | -83- |
| e. | Design Methods, Extensible Reinforcements | -83- |
| 4.2 | SIZING FOR EXTERNAL STABILITY | -83- |
| a. | Define wall geometry and soil properties | -85- |
| b. | Select performance criteria | -86- |
| c. | Preliminary Sizing | -86- |
| d. | Earth Pressures for External Stability | -86- |
| e. | Sliding Stability | -92- |
| f. | Bearing Capacity Failure | -95- |
| g. | Overall Stability | -96- |
| h. | Seismic Loading | -98- |
| i. | Settlement Estimate | -102- |
| 4.3 | SIZING FOR INTERNAL STABILITY | -102- |
| a. | Critical Slip Surfaces | -104- |
| b. | Calculation of Maximum Tensile Forces in the Reinforcement Layers | -104- |
| c. | Internal Stability with Respect to Pullout Failure | -112- |

| | | | |
|---------------------------------------------------------------------------|----|--------------------------------------------------------------------------|-------|
| | d. | Seismic Loading | -113- |
| | e. | Connection Strength | -116- |
| | f. | Reinforcement Spacing | -120- |
| 4.4 | | DESIGN OF FACING ELEMENTS | -121- |
| | a. | Design of Concrete, Steel and Timber Facings | -121- |
| | b. | Design of Flexible Wall Facings | -121- |
| 4.5 | | DESIGN DETAILS | -122- |
| | a. | Traffic Barriers | -122- |
| | b. | Drainage Systems | -124- |
| | c. | Termination to Cast-in-place Structures | -124- |
| | d. | Hydrostatic Pressures | -124- |
| | e. | Obstructions in Reinforced Soil Zone | -124- |
| | f. | Internal Details | -127- |
| 4.6 | | DESIGN EXAMPLE – Steel Strip Reinforcement | -131- |
| | a. | Hand Calculation Example | -131- |
| | b. | Computer-Aided Solution | -136- |
| 4.7 | | DESIGN EXAMPLE – Geosynthetic Reinforcement | -145- |
| | a. | Hand Calculation Example | -145- |
| | b. | Computer-Aided Solution | -155- |
| 4.8 | | STANDARD MSEW DESIGNS | -165- |
| CHAPTER 5 DESIGN OF MSE WALLS WITH COMPLEX GEOMETRICS | | | -169- |
| 5.1 | | BRIDGE ABUTMENTS | -171- |
| | a. | MSEW Abutments on Spread Footings | -171- |
| | b. | MSEW Abutments on Pile Foundations | -173- |
| 5.2 | | SUPERIMPOSED WALLS | -175- |
| 5.3 | | WALLS WITH UNEVEN REINFORCEMENT LENGTHS | -177- |
| 5.4 | | BACK-TO-BACK WALLS | -178- |
| 5.5 | | DETAILS | -180- |
| 5.6 | | DESIGN EXAMPLE, BRIDGE ABUTMENT | -181- |
| | a. | Hand Calculation Example | -181- |
| | b. | Computer-Aided Solution | -189- |
| CHAPTER 6 REINFORCED (STEEPENED) SOIL SLOPES PROJECT EVALUATION | | | -193- |
| 6.1 | | INTRODUCTION | -193- |
| 6.2 | | REINFORCED SOIL SLOPE SYSTEMS | -193- |
| | a. | Types of Systems | -193- |
| | b. | Construction Materials | -193- |
| 6.3 | | DESIGN APPROACH | -194- |
| | a. | Use Considerations | -194- |
| | b. | Design of Reinforcement for Compaction Aid | -195- |
| | c. | Design of Reinforcement for Steepening Slopes and Slope Repair | -195- |
| | d. | Computer-Assisted Design | -197- |
| | e. | Evaluation of External Stability | -199- |
| 6.4 | | CONSTRUCTION SEQUENCE | -201- |

| | | |
|-------------------------------------------------------------------------------------|---------------------------------------------------------------------------------------------------|-------|
| 6.5 | TREATMENT OF OUTWARD FACE | -205- |
| a. | Grass Type Vegetation | -205- |
| b. | Soil Bioengineering (Woody Vegetation) | -206- |
| c. | Armored | -209- |
| 6.6 | DESIGN DETAILS | -210- |
| a. | Guardrail and Traffic Barriers | -210- |
| b. | Drainage Considerations | -210- |
| c. | Obstructions | -211- |
| 6.7 | CASE HISTORIES | -211- |
| a. | The Dickey Lake Roadway Grade Improvement Project | -211- |
| b. | Salmon-Lost Trail Roadway Widening Project | -214- |
| c. | Cannon Creek Alternate Embankment Construction Project | -216- |
| d. | Pennsylvania SR 54 Roadway Repair Project | -217- |
| e. | Massachusetts Turnpike - Use of Soil Bioengineering | -219- |
| 6.8 | STANDARD RSS DESIGNS | -221- |
| CHAPTER 7 DESIGN OF REINFORCED SOIL SLOPES | | -223- |
| 7.1 | INTRODUCTION | -223- |
| 7.2 | REINFORCED SLOPE DESIGN GUIDELINES | -225- |
| | Step 1. Establish the geometric, loading, and performance requirements for design | -225- |
| | Step 2. Determine the engineering properties of the in situ soils | -225- |
| | Step 3. Determine the properties of reinforced fill and, if different, the retained fill. | -227- |
| | Step 4. Evaluate design parameters for the reinforcement. | -227- |
| | Step 5. Check unreinforced stability. | -228- |
| | Step 6. Design reinforcement to provide a stable slope. | -229- |
| | Step 7. Check external stability. | -237- |
| | Step 8. Seismic stability. | -241- |
| | Step 9. Evaluate requirements for subsurface and surface water runoff control. | -243- |
| 7.3 | COMPUTER ASSISTED DESIGN | -245- |
| 7.4 | DESIGN EXAMPLES | -246- |
| a. | Example 1. Reinforced Slope Design -Road Widening | -246- |
| b. | Example 2. Reinforced Slope Design -New Road Construction | -253- |
| c. | Example 3. Computer-Aided Solution | -261- |
| d. | Example 4. Facing Stability Calculation | -270- |
| 7.5 | PROJECT COST ESTIMATES | -273- |
| CHAPTER 8 CONTRACTING METHODS AND SPECIFICATIONS FOR MSE WALLS AND SLOPES | | -275- |
| 8.1 | POLICY DEVELOPMENT | -276- |
| 8.2 | SYSTEM OR COMPONENT APPROVALS | -276- |
| 8.3 | DESIGN AND PERFORMANCE CRITERIA | -279- |
| 8.4 | AGENCY OR SUPPLIER DESIGN | -279- |
| a. | Plan and Elevation Sheets | -280- |

| | | |
|-----------------------------------------------------------------|-----------------------------------------------------------------------------------------------|-------|
| b. | Facing/Panel Details | -281- |
| c. | Drainage Facilities/Special Details | -281- |
| d. | Design Computations | -281- |
| e. | Geotechnical Report | -281- |
| f. | Construction Specifications | -282- |
| 8.5 | END RESULT DESIGN APPROACH | -282- |
| a. | Geometric Requirements | -282- |
| b. | Geotechnical Requirements | -283- |
| c. | Structural and Design Requirements | -283- |
| d. | Performance Requirements | -283- |
| 8.6 | STANDARD DESIGNS | -284- |
| a. | MSEW Standard Designs | -284- |
| b. | RSS Standard Designs | -285- |
| 8.7 | REVIEW AND APPROVALS | -287- |
| 8.8 | CONSTRUCTION SPECIFICATIONS AND SPECIAL PROVISIONS FOR MSEW AND RSS CONSTRUCTION | -287- |
| 8.9 | GUIDE SPECIFICATIONS FOR MSE WALLS WITH SEGMENTAL PRECAST CONCRETE FACINGS | -288- |
| 8.10 | GUIDE SPECIFICATIONS FOR CONCRETE MODULAR BLOCK (MBW) FACING AND UNIT FILL | -296- |
| 8.11 | GUIDE SPECIFICATIONS FOR GEOSYNTHETIC REINFORCEMENT MATERIALS | -300- |
| 8.12 | CONSTRUCTION SPECIFICATIONS FOR REINFORCED SLOPE SYSTEMS | -303- |
| a. | Specification Guidelines For RSS Construction (Agency Design) | -303- |
| b. | Specification for Erosion Control Mat or Blanket | -308- |
| c. | Specification for Geosynthetic Drainage Composite | -310- |
| d. | Specification Guidelines for Geosynthetic Reinforced Soil Slope Systems | -314- |
| CHAPTER 9 FIELD INSPECTION AND PERFORMANCE MONITORING | | -317- |
| 9.1 | PRECONSTRUCTION REVIEWS | -317- |
| a. | Plans and Specifications | -319- |
| b. | Review of Site Conditions and Foundation Requirements | -319- |
| 9.2 | PREFABRICATED MATERIALS INSPECTION | -320- |
| a. | Precast Concrete Elements | -320- |
| b. | Reinforcing Elements | -322- |
| c. | Facing Joint Materials | -324- |
| d. | Reinforced Backfill | -324- |
| 9.3 | CONSTRUCTION CONTROL | -324- |
| a. | Leveling Pad | -324- |
| b. | Erection of Facing Elements | -326- |
| c. | Reinforced Fill Placement, Compaction | -330- |
| d. | Placement of Reinforcing Elements | -333- |
| e. | Placement of Subsequent Facing Courses (Segmental Facings) | -335- |

| | | |
|-------|------------------------------------------------------------------------------------------------------------------------------|-------|
| 9.4 | PERFORMANCE MONITORING PROGRAMS | -340- |
| a. | Purpose of Monitoring Program | -340- |
| b. | Limited Monitoring Program | -342- |
| c. | Comprehensive Monitoring Program | -342- |
| d. | Program Implementation | -343- |
| e. | Data Interpretation | -346- |
| | REFERENCES | -347- |
| | APPENDIX A DETERMINATION OF PULLOUT RESISTANCE FACTORS | -351- |
| A.1 | EMPIRICAL PROCEDURES TO DETERMINE F^* AND a | -351- |
| A.2 | EXPERIMENTAL PROCEDURES TO DETERMINE F^* AND a | -352- |
| A.3 | CONNECTION RESISTANCE AND STRENGTH OF PARTIAL AND FULL FRICTION SEGMENTAL BLOCK/REINFORCEMENT FACING CONNECTIONS | -355- |
| | APPENDIX A REFERENCES | -361- |
| | APPENDIX B DETERMINATION OF CREEP STRENGTH REDUCTION FACTOR | -363- |
| B.1 | BACKGROUND | -363- |
| B.2 | STEP-BY-STEP PROCEDURES FOR EXTRAPOLATING STRESS RUPTURE DATA | -365- |
| B.3. | USE OF CREEP DATA FROM "SIMILAR" PRODUCTS | -370- |
| B.4 | CREEP EXTRAPOLATION EXAMPLES USING STRESS RUPTURE DATA | -370- |
| B.4.1 | Stress Rupture Extrapolation Example 1 | -371- |
| B.4.2 | Stress Rupture Extrapolation Example 2 | -373- |
| | APPENDIX B REFERENCES | -380- |
| | APPENDIX C APPROXIMATE COST RANGE OF GEOTEXTILES AND GEOGRIDS .. | -383- |
| | APPENDIX D TYPICAL DIMENSIONS OF STEEL REINFORCEMENTS | -385- |
| | APPENDIX E EXAMPLE REINFORCED SOIL SLOPE ANALYSIS with RSS COMPUTER PROGRAM | -387- |

LIST OF FIGURES

| | | |
|------------|---------------------------------------------------------------------------------------------------------------------------|-------|
| Figure 1. | Generic cross section of a MSE structure. | -3- |
| Figure 2. | MSE walls, urban applications. | -11- |
| Figure 3. | MSE wall applications, abutments, and marine. | -12- |
| Figure 4. | Slope reinforcement using geosynthetics to provide slope stability. | -13- |
| Figure 5. | Application of reinforced soil slopes. | -14- |
| Figure 6. | Cost comparison for retaining walls | -17- |
| Figure 7. | Cost evaluation of reinforced soil slopes. | -19- |
| Figure 8. | MSE wall surface treatments. | -22- |
| Figure 9. | Examples of commercially available MBW units | -23- |
| Figure 10. | Empirical curve for estimating probable anticipated lateral displacement during construction for MSE walls | -37- |
| Figure 11. | Erection of precast panels. | -43- |
| Figure 12. | Fill spreading and reinforcement connection. | -44- |
| Figure 13. | Compaction of backfill | -45- |
| Figure 14. | Lift construction sequence for geosynthetic faced MSE walls. | -47- |
| Figure 15. | Typical geosynthetic face construction detail. | -48- |
| Figure 16. | Types of geosynthetic reinforced soil wall facing | -49- |
| Figure 17. | Reinforced slope construction | -50- |
| Figure 18. | Stress transfer mechanisms for soil reinforcement. | -53- |
| Figure 19. | Definition of grid dimensions for calculating pullout capacity. | -59- |
| Figure 20. | Parameters for metal reinforcement strength calculations. | -69- |
| Figure 21. | Potential external failure mechanisms for a MSE wall | -84- |
| Figure 22. | Computational procedures for active earth pressures (Coulomb analysis). | -88- |
| Figure 23. | External analysis: earth pressures/eccentricity; horizontal backslope with traffic surcharge. | -89- |
| Figure 24. | External analysis: earth pressure/eccentricity; sloping backfill case. | -90- |
| Figure 25. | External analysis: earth pressure/eccentricity; broken backslope case. | -91- |
| Figure 26. | Calculation of vertical stress s_v at the foundation level | -93- |
| Figure 27. | Seismic external stability of a MSE wall. | -99- |
| Figure 28. | Location of potential failure surface for internal stability design of MSE walls | -107- |
| Figure 29. | Variation of stress ratio with depth in a MSE wall. | -107- |
| Figure 30. | Calculation of vertical stress for sloping backslope conditions. | -108- |
| Figure 31. | Distribution of stress from concentrated vertical load P_v for internal and external stability calculations. | -110- |
| Figure 32. | Distribution of stresses from concentrated horizontal loads | -111- |
| Figure 33. | Seismic internal stability of a MSE wall. | -115- |
| Figure 34. | Bodkin connection detail. | -117- |
| Figure 35. | Determination of hinge height for modular concrete block faced MSE walls | -119- |
| Figure 36. | Impact load barrier. | -123- |
| Figure 37. | Drainage blanket detail. | -125- |
| Figure 38. | Impervious membrane details. | -125- |
| Figure 39. | Reinforcing strip or mesh bend detail. | -126- |

| | | |
|------------|----------------------------------------------------------------------------------------------------------------------------|-------|
| Figure 40. | Connection detail of junctures of MSE walls and CIP structure. | -126- |
| Figure 41. | Obstruction details: a) conceptual; b) at inlet. | -128- |
| Figure 42. | MBW drainage detail. | -129- |
| Figure 43. | Drain fill placement for MBW with cores or tails. | -130- |
| Figure 44. | Example of standard MSEW design. | -167- |
| Figure 45. | Types of complex MSE structures. | -170- |
| Figure 46. | Location of maximum tensile force line in case of large surcharge slabs | -172- |
| Figure 47. | Pile supported MSE abutment. | -174- |
| Figure 48. | Design rules for superimposed walls. | -176- |
| Figure 49. | Dimensioning a MSE wall with uneven reinforcement lengths. | -177- |
| Figure 50. | Back-to-back wall | -179- |
| Figure 51. | Abutment seat detail. | -180- |
| Figure 52. | MSE abutment design example. | -183- |
| Figure 53. | Failure modes for reinforced soil slopes. | -195- |
| Figure 54. | Modified limit equilibrium analysis for reinforced slope design. | -196- |
| Figure 55. | External failure modes for reinforced soil slopes. | -200- |
| Figure 56. | Construction of reinforced soil slopes. | -203- |
| Figure 57. | Components of a vegetated reinforced slope (VRSS) system | -208- |
| Figure 58. | Dickey Lake site. | -213- |
| Figure 59. | Salmon Lost Trail site. | -215- |
| Figure 60. | Cannon Creek project. | -216- |
| Figure 61. | Pennsylvania SR54. | -218- |
| Figure 62. | Massachusetts Turnpike during construction, immediately after construction and after the second growing season. | -220- |
| Figure 63. | Example of standard RSS design. | -222- |
| Figure 64. | Requirements for design of reinforced soil slopes. | -226- |
| Figure 65. | Critical zone defined by rotational and sliding surface that meet the required safety factor. | -228- |
| Figure 66. | Rotational shear approach to determine required strength of reinforcement | -230- |
| Figure 67. | Chart solution for determining the reinforcement strength requirements | -232- |
| Figure 68. | Reinforcement spacing considerations for high slopes. | -233- |
| Figure 69. | Developing reinforcement lengths. | -236- |
| Figure 70. | Sliding stability analysis. | -238- |
| Figure 71. | Failure through the foundation | -240- |
| Figure 72. | Seismic stability analysis. | -241- |
| Figure 73. | Subsurface drainage considerations. | -242- |
| Figure 74. | Design example 1. | -251- |
| Figure 75. | Design example 2: stability analysis. | -256- |
| Figure 76. | Design example 2: global stability | -260- |
| Figure 77. | Casting yard for precast facing elements. | -321- |
| Figure 78. | Inspect reinforcing elements. | -323- |
| Figure 79. | Leveling pads: a) concrete pad; b) compacted gravel pad. | -325- |
| Figure 80. | Checking facing element batter and alignment. | -327- |
| Figure 81. | Full height facing panels require special alignment care. | -328- |
| Figure 82. | Setting first row of precast facing elements. | -329- |
| Figure 83. | Placement of reinforced backfill. | -331- |

| | | |
|------------|-----------------------------------------------------------------------------------------------------------------------------------------|-------|
| Figure 84. | Compaction equipment showing: a) large equipment permitted away from face; and b) lightweight equipment within 1 m of the face. | -332- |
| Figure 85. | Facing connection examples | -334- |
| Figure 86. | Geotextile joint cover and neoprene pads. | -337- |
| Figure A.1 | Experimental procedure to determine F^* and a for soil reinforcement using pullout test. | -354- |
| Figure A.2 | Creep Rupture Envelope for Geosynthetic Reinforcement | -356- |
| Figure A.3 | Connection Strength verses Normal Load | -358- |
| Figure A.4 | Connection Strength verses Displacement | -359- |
| Figure A.5 | Connection Strength Rupture Curve | -360- |
| Figure B.1 | Typical stress rupture data and the determination of shift factors for time-temperature superposition. | -366- |
| Figure B.2 | Extrapolation of stress rupture data and the determination of creep limit load. | -369- |
| Figure B.3 | Wide width load-strain data for PET geosynthetic at 20°C. | -372- |
| Figure B.4 | Stress rupture data for PET geosynthetic at 20°C. | -374- |
| Figure B.5 | Wide width load-strain data for polyolefin geosynthetic at 20°C. | -375- |
| Figure B.6 | Stress rupture data for polyolefin geosynthetic. | -376- |
| Figure B.7 | Stress rupture data for polyolefin geosynthetic after time/load shifting. | -377- |

[BLANK]

LIST OF TABLES

| | | |
|------------|------------------------------------------------------------------------------------------------------------------------|-------|
| Table 1. | Summary of reinforcement and face panel details for selected MSE wall systems. | -6- |
| Table 2. | Representative list of Geotextile and Geogrid manufacturers and suppliers. | -7- |
| Table 3. | Relationship between joint width and limiting differential settlements for MSE precast panels | -40- |
| Table 4. | Basic aspects of reinforcement pullout performance in granular and cohesive soils of low plasticity | -55- |
| Table 5. | Summary of pullout capacity design parameters. | -58- |
| Table 6. | Recommended limits of electrochemical properties for backfills when using steel reinforcement. | -65- |
| Table 7. | Recommended limits of electrochemical properties for backfills when using geosynthetic reinforcements. | -66- |
| Table 8. | Anticipated resistance of polymers to specific environments. | -72- |
| Table 9. | Aging reduction factors, PET. | -75- |
| Table 10. | Installation damage reduction factors. | -76- |
| Table 11. | Minimum requirements for use of default reduction factors for primary geosynthetic reinforcement. | -79- |
| Table 12. | Bearing Capacity Factors | -97- |
| Table 13. | RSS slope facing options | -205- |
| Table 14. | Estimated Project Costs. | -274- |
| Table 15. | MSE/RSS field inspection checklist. | -318- |
| Table 16. | Out-of-Tolerance conditions and possible causes. | -338- |
| Table 17. | Possible instruments for monitoring reinforced soil structures. | -344- |
| Table B-1: | Stress Rupture Data Before and After Time/Load Shifting to Equivalent 20° C Data for Polyolefin Geosynthetic | -378- |

[BLANK]

TERMINOLOGY

| | | |
|-----------|---|-------------------------------------------------------------------------------------------------------------------------------------------------------------------|
| A | = | maximum ground acceleration coefficient |
| AASHTO | = | American Association of State Highway and Transportation Officials |
| AOS | = | apparent opening size of geotextile filter |
| A_c | = | design cross section area of the steel, defined as the original cross section area minus corrosion losses anticipated to occur during the design life of the wall |
| A_m | = | maximum wall acceleration coefficient at the centroid of the wall mass |
| A_t | = | tributary area for calculations |
| b | = | gross width of the strip, sheet or grid |
| c | = | soil cohesion |
| c' | = | effective soil cohesion |
| c_f | = | soil cohesion of foundation soil |
| c_u | = | undrained shear strength of soft soil beneath slope |
| C | = | reinforcement effective unit perimeter; e.g., $C = 2$ for strips, grids, and sheets |
| CEG | = | Carboxyl End Group |
| C.I.P. | = | cast-in-place concrete |
| CR_{cr} | = | ratio of strength determined from appendix A.3 testing to roll specific ultimate strength |
| CR_u | = | ratio of strength determined from ASTM 4884 to roll specific ultimate strength |
| C_i | = | interaction factor between reinforcement and soil |
| C_u | = | the uniformity coefficient of the backfill (D_{60}/D_{10}) |
| D | = | the moment arm of T_s about the center of failure circle |

| | | |
|------------------|---|-----------------------------------------------------------------------------------------------------------------------------------------------------------------|
| D_s | = | depth of soft soil beneath slope base of the embankment |
| d | = | depth of water flow |
| d_w | = | depth to water |
| E_c | = | thickness of the reinforcement at the end of the design life |
| E_n | = | nominal thickness of the reinforcement at time of construction |
| E_R | = | sacrificial thickness of metal expected to be lost by uniform corrosion during the service life of the structure |
| e | = | eccentricity |
| F_y | = | yield stress of steel |
| F^* | = | the pullout resistance (or friction-bearing-interaction) factor |
| F_g | = | summation of geosynthetic resisting force |
| F_H | = | horizontal earth pressure force |
| F_q | = | embedment (or surcharge) bearing capacity factor |
| F_T | = | total earth pressure force |
| FS | = | overall factor of safety to account for uncertainties in the geometry of the structure, fill properties, reinforcement properties, and externally applied loads |
| FS_{MIN} | = | minimum factor of safety |
| FS_{PO} | = | factor of safety against pullout |
| FS_R | = | required slope stability factor of safety |
| $FS_{squeezing}$ | = | factor of safety against failure by squeezing |
| FS_U | = | unreinforced slope stability factor of safety |
| f_b | = | fraction of transverse grid member on which bearing can be fully developed |
| H | = | vertical wall or slope height |

| | | |
|------------|---|----------------------------------------------------------------------------------|
| HDPE | = | high density polyethylene |
| HITEC | = | Highway Innovative Technology Evaluation Center of the Civil Research Foundation |
| K_a | = | active lateral earth pressure coefficient |
| K_{af} | = | active lateral earth pressure coefficient of retained fill soil |
| k_h | = | horizontal seismic coefficient |
| k_v | = | vertical seismic coefficient |
| L | = | total length of reinforcement |
| L_a | = | length of reinforcement in the active zone |
| L_e | = | embedment or adherence length in the resisting zone behind the failure surface |
| M_D | = | driving moment about the center of the failure circle |
| M_n | = | number molecular weight |
| M_R | = | resisting moment provided by the strength of the soil |
| MBW | = | masonry modular block wall facing unit |
| MDOT | = | Montana Department of Transportation |
| MN/DOT | = | Minnesota Department of Transportation |
| MSE | = | mechanically stabilized earth |
| MSEW | = | mechanically stabilized earth wall |
| N_c | = | dimensionless bearing capacity coefficient |
| N_q | = | dimensionless bearing capacity coefficient |
| N_γ | = | dimensionless bearing capacity coefficient |
| NCMA | = | National Concrete Masonry Association |
| NHI | = | National Highway Institute |

| | | |
|-----------|---|-------------------------------------------------------------------------------------------------------------------------------------------------------------------------------|
| PPM | = | parts per million |
| P_{AE} | = | seismic thrust |
| P_{IR} | = | horizontal seismic inertia force |
| P_r | = | pullout resistance of the reinforcement per unit width |
| q_a | = | allowable bearing capacity |
| q_{ult} | = | ultimate bearing capacity |
| R | = | the moment arm of T_s about the center of failure circle |
| R_c | = | reinforcement coverage ratio b/s_h |
| RF | = | the product of all applicable reduction factors to reinforcement tensile strength |
| RF_{CR} | = | creep reduction factor, is the ratio of the ultimate strength (T_{ULT}) to the creep limit strength obtained from laboratory creep tests for each product |
| RF_D | = | durability reduction factor, is dependent on the susceptibility of the geosynthetic to attack by microorganisms, chemicals, thermal oxidation, hydrolysis and stress cracking |
| RF_{ID} | = | installation damage reduction factor |
| ROR | = | relative orientation of reinforcement force |
| RSS | = | reinforced soil slope |
| s | = | the vertical to horizontal angle of slope face |
| s_h | = | center-to-center horizontal spacing between strips, sheets, or grids |
| S_t | = | spacing of transverse bar of grid reinforcements |
| S_{rs} | = | reinforcement strength needed to resist the static component of load |
| S_{rt} | = | reinforcement strength needed to resist the dynamic or transient component of load |
| t | = | thickness of the transverse bar of grid reinforcement |

| | | |
|----------------|---|----------------------------------------------------------------------------------------------------------------------------------------------------------------------------------------------------------------------------|
| T_a | = | the design long term reinforcement tension load for the limit state, considering all time dependent strength losses over the design life period |
| T_{ac} | = | the design long term connection strength |
| T_{al} | = | long-term tensile strength on a load per unit width of reinforcing basis |
| T_{max} | = | maximum reinforcement tension |
| T_{MD} | = | dynamic increment of tensile load |
| T_S | = | sum of required tensile force per unit width of reinforcement (considering rupture and pullout) in all reinforcement layers intersecting the failure surface, in slope stability analysis |
| T_{S-MAX} | = | largest T_S calculated and establishes the total design tension |
| T_{ULT} | = | ultimate (or yield) tensile strength from wide strip test (ASTM D 4595) for geotextiles and wide strip (ASTM D 4595) or single rib test (GR1:GG1) for geogrids, based on minimum average roll value (MARV) for the product |
| w_{opt} | = | optimum moisture content of soil |
| W_A | = | weight of the active zone |
| W_u | = | front to back width of modular concrete block facing unit |
| VRSS | = | vegetated reinforced soil slope |
| z | = | vertical depth |
| α | = | a scale effect correction factor to account for a non linear stress reduction over the embedded length of highly extensible reinforcements, based on laboratory data |
| α_β | = | a bearing factor for passive resistance which is based on the thickness per unit width of the bearing member |
| β | = | surcharge slope angle (MSEW) |
| β | = | slope angle (RSS) |
| δ | = | wall friction angle |
| ξ | = | $\arctan (K_h / 1 - K_v)$ |

| | | |
|---------------|---|----------------------------------------------------------------------------------------------------------------------------------|
| γ_b | = | unit weight of the retained backfill |
| γ_f | = | unit weight of soil |
| γ_g | = | saturated unit weight of soil |
| γ_r | = | unit weight of the reinforced backfill |
| γ_w | = | unit weight of water |
| ϕ | = | the peak friction angle of the soil |
| ϕ' | = | effective friction angle |
| ϕ_b | = | friction angle of retained fill |
| ϕ_{\min} | = | minimum angle of shearing friction either between reinforced soil and reinforcement or the friction angle of the foundation soil |
| θ | = | the face inclination from a horizontal |
| λ | = | tractive shear stress |
| ρ | = | the soil-reinforcement interaction friction angle |
| σ'_v | = | the effective vertical stress at the soil-reinforcement interfaces |

CHAPTER 1

INTRODUCTION

1.1 OBJECTIVES

New methods and technologies of retention and steepened-slope construction continue to be developed, often by specialty contractors and suppliers, to solve problems in locations of restricted Right-of-Way (ROW) and at marginal sites with difficult subsurface conditions and other environmental constraints. Professionals charged with the responsibility of planning, designing, and implementing improvements and additions in such locations need to understand the application, limitations and costs associated with a host of measures and technologies available.

This manual was prepared to assist design engineers, specification writers, estimators, construction inspectors and maintenance personnel with the selection, design and construction of Mechanically Stabilized Earth Walls (MSEW) and Reinforced Soil Slopes (RSS), and the monitoring of their long-term performance.

The design, construction and monitoring techniques for these structures have evolved over the last two decades as a result of efforts by researchers, material suppliers and government agencies to improve some single aspect of the technology or the materials used. This manual is the first single, comprehensive document to integrate all design, construction, materials, contracting and monitoring aspects required for successful project implementation.

This manual has been developed in support of FHWA educational programs on the design and construction monitoring of MSEW retaining structures and RSS construction. Its principal function is to serve as a reference source to the materials presented. The manual serves as FHWA's primary technical guideline on the use of this technology on transportation facilities.

a. Scope

The manual addresses in a comprehensive manner the following areas:

- ! Overview of MSE development and the cost, advantages, and disadvantages of using MSE structures.
- ! Available MSE systems and applications to transportation facilities.
- ! Basic soil-reinforcement interaction.
- ! Design of routine and complex MSE walls.
- ! Design of steepened RSS.

- ! Design of steepened RSS over soft foundations.
- ! Specifications and contracting approaches for both MSE walls and RSS construction.
- ! Construction monitoring and inspection.
- ! Design examples as case histories with detailed cost savings documented.
- ! A separate companion Manual addresses the long-term degradation of metallic and polymeric reinforcements. Sections of the Degradation manual address the background of full-scale, long-term evaluation programs and the procedures required to develop, implement, and evaluate them. These procedures have been developed to provide practical information on this topic for MSE users for non corrosion or polymer specialists, who are interested in developing long-term monitoring programs for these types of structures.

As an integral part of this Manual, several student exercises and workshop problems are included with solutions that demonstrate individual design aspects.

b. Source Documents

The majority of the material presented in this Manual was abstracted from FHWA RD89-043 *"Reinforced Soil Structures, Volume I Design and Construction Guidelines"*, 1996 AASHTO Specifications, both Division I, Design and Division II, Construction, and direct input from the AASHTO Bridge T-15 Technical Committee as part of their effort to update Section 5.8 of the AASHTO Bridge Specifications which resulted in the 1997, 1998, 1999 and 2000 AASHTO Interims.

Additional guidance, where not available from other sources, was specifically developed for this Manual.

c. Terminology

Certain interchangeable terms will be used throughout this Manual. For clarity, they are defined as follows:

Inclusion is a generic term that encompasses all man-made elements incorporated in the soil to improve its behavior. Examples of inclusions are steel strips, geotextile sheets, steel or polymeric grids, steel nails, and steel tendons between anchorage elements. The term *reinforcement* is used only for those inclusions where soil-inclusion stress transfer occurs continuously along the inclusion.

Mechanically Stabilized Earth Wall (MSEW) is a generic term that includes reinforced soil (a term used when multiple layers of inclusions act as reinforcement in soils placed as fill). Reinforced Earth is a trademark for a specific reinforced soil system.

Reinforced Soil Slopes (RSS) are a form of reinforced soil that incorporate planar reinforcing elements in constructed earth-sloped structures with face inclinations of less than 70 degrees.

Geosynthetics is a generic term that encompasses flexible polymeric materials used in geotechnical engineering such as geotextiles, geomembranes, geonets, and grids (also known as geogrids).

Facing is a component of the reinforced soil system used to prevent the soil from raveling out between the rows of reinforcement. Common facings include precast concrete panels, dry cast modular blocks, metal sheets and plates, gabions, welded wire mesh, shotcrete, wood lagging and panels, and wrapped sheets of geosynthetics. The facing also plays a minor structural role in the stability of the structure. For RSS structures it usually consists of some type of erosion control material.

Retained backfill is the fill material located between the mechanically stabilized soil mass and the natural soil.

Reinforced backfill is the fill material in which the reinforcements are placed.

Generic cross sections of a mechanically stabilized soil mass in its geotechnical environment is shown in figures 1 and 4.

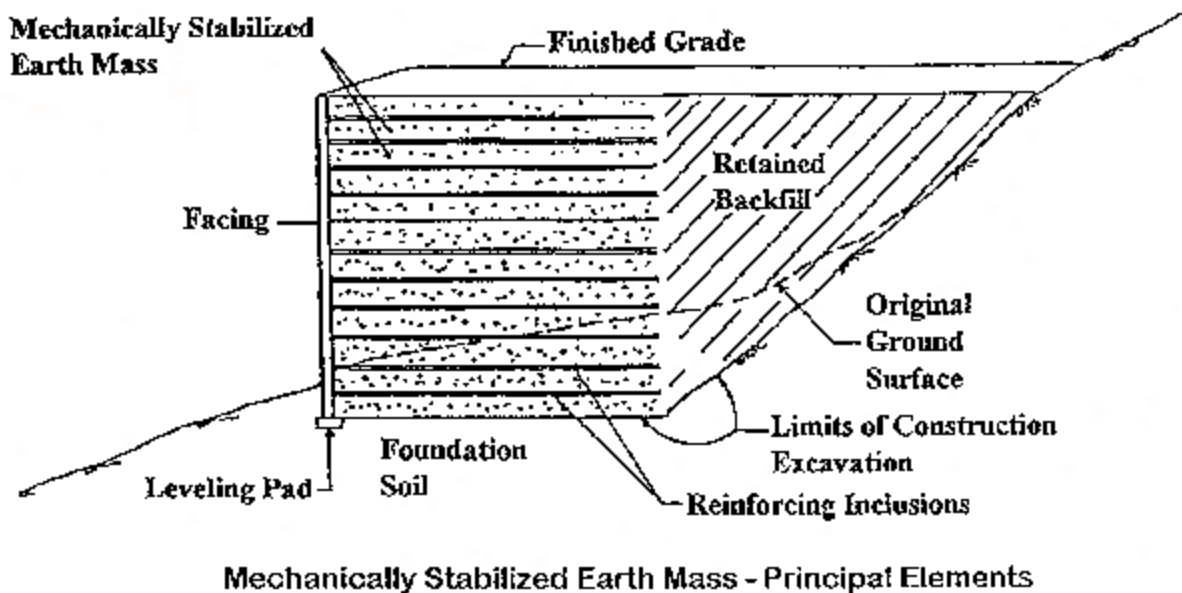

Figure 1. Generic cross section of a MSE structure.

1.2 HISTORICAL DEVELOPMENT

Retaining structures are essential elements of every highway design. Retaining structures are used not only for bridge abutments and wing walls but also for slope stabilization and to minimize right-of-way for embankments. For many years, retaining structures were almost exclusively made of reinforced concrete and were designed as gravity or cantilever walls which are essentially rigid structures and cannot accommodate significant differential settlements unless founded on deep foundations. With increasing height of soil to be retained and poor subsoil conditions, the cost of reinforced concrete retaining walls increases rapidly.

Mechanically Stabilized Earth Walls (MSEW) and Reinforced Soil Slopes (RSS) are cost-effective soil-retaining structures that can tolerate much larger settlements than reinforced concrete walls. By placing tensile reinforcing elements (inclusions) in the soil, the strength of the soil can be improved significantly such that the vertical face of the soil/reinforcement system is essentially self supporting. Use of a facing system to prevent soil raveling between the reinforcing elements allows very steep slopes and vertical walls to be constructed safely. In some cases, the inclusions can also withstand bending from shear stresses, providing additional stability to the system.

Inclusions have been used since prehistoric times to improve soil. The use of straw to improve the quality of adobe bricks dates back to earliest human history. Many primitive people used sticks and branches to reinforce mud dwellings. During the 17th and 18th centuries, French settlers along the Bay of Fundy in Canada used sticks to reinforce mud dikes. Some other early examples of man-made soil reinforcement include dikes of earth and tree branches, which have been used in China for at least 1,000 years and along the Mississippi River in the 1880s. Other examples include wooden pegs used for erosion and landslide control in England, and bamboo or wire mesh, used universally for revetment erosion control. Soil reinforcing can also be achieved by using plant roots.

The modern methods of soil reinforcement for retaining wall construction were pioneered by the French architect and engineer Henri Vidal in the early 1960s. His research led to the invention and development of Reinforced Earth[®], a system in which steel strip reinforcement is used. The first wall to use this technology in the United States was built in 1972 on California State Highway 39, northeast of Los Angeles. In the last 25 years, more than 23,000 Reinforced Earth structures representing over 70 million m² (750 million ft²) of wall facing have been completed in 37 countries. More than 8,000 walls have been built in the United States since 1972. The highest wall constructed in the United States was on the order of 30 meters (98 feet).

Since the introduction of Reinforced Earth[®], several other proprietary and nonproprietary systems have been developed and used. Table 1 provides a partial summary of some of the current systems by proprietary name, reinforcement type, and facing system.

Currently, most process patents covering soil-reinforced system construction or components have expired, leading to a proliferation of available systems or components that can be separately purchased and assembled by the erecting contractor. The remaining patents in force generally cover only the method of connection between the reinforcement and the facing.

For the first 20 years of use in the United States an articulating precast facing unit 2 to 2.25 m² (21 to 24 ft²) generally square in shape, was the facing unit of choice. More recently, larger precast units of up to 5 m² (54 ft²) have been used as have much smaller dry-cast units, generally in conjunction with geosynthetic reinforcements.

The use of geotextiles in MSE walls and RSS started after the beneficial effect of reinforcement with geotextiles was noticed in highway embankments over weak subgrades. The first geotextile-reinforced wall was constructed in France in 1971, and the first structure of this type in the United States was constructed in 1974. Since about 1980, the use of geotextiles in reinforced soil has increased significantly.

Geogrids for soil reinforcement were developed around 1980. The first use of geogrid in earth reinforcement was in 1981. Extensive use of geogrid products in the United States started in about 1983, and they now comprise a growing portion of the market.

The first reported use of reinforced steepened slopes is believed to be the west embankment for the great wall of China. The introduction and economy of geosynthetic reinforcements has made the use of steepened slopes economically attractive. A survey of usage in the mid 1980s identified several hundred completed projects. At least an order of magnitude more RSS structures have been constructed since that study. The highest constructed RSS structure in the U.S. to date has been 43 m (141 ft).

A representative list of geosynthetic manufacturers and suppliers is shown in table 2.

Current Usage

It is believed that MSE walls have been constructed in every State in the United States. Major users include transportation agencies in Georgia, Florida, Texas, Pennsylvania, New York, and California, which rank among the largest road building States.

It is estimated that more than 700,000 m² (7,500,000 ft²) of MSE retaining walls with precast facing are constructed on average every year in the United States, which may represent more than half of all retaining wall usage for transportation applications.

The majority of the MSE walls for permanent applications either constructed to date or presently planned use a segmental precast concrete facing and galvanized steel reinforcements. The use of geotextile faced MSE walls in permanent construction has been limited to date. They are quite useful for temporary construction, where more extensive use has been made.

Recently, modular block dry cast facing units have gained acceptance due to their lower cost and nationwide availability. These small concrete units are generally mated with grid reinforcement, and the wall system is referred to as modular block wall (MBW). It has been reported that more than 200,000 m² (2,000,000 ft²) of MBW walls have been constructed yearly in the United States when considering all types of transportation related applications. The current yearly usage for transportation-related applications is estimated at about 50 projects per year.

The use of RSS structures has expanded dramatically in the last decade, and it is estimated that several hundred RSS structures have been constructed in the United States. Currently, 70 to 100 RSS projects are being constructed yearly in connection with transportation related projects in the United States, with an estimated projected vertical face area of 130,000 m²/year (1,400,000 ft²/yr).

Table 1. Summary of reinforcement and face panel details for selected MSE wall systems.

| <u>System Name</u> | <u>Reinforcement Detail</u> | <u>Typical Face Panel Detail¹</u> |
|-------------------------------------------------------------------------------------------------------------------------------------------------------------------|---------------------------------------------------------------------------------------------------------------------------------------------------------|--------------------------------------------------------------------------------------------------------------------------------------------------|
| Reinforced Earth The Reinforced Earth Company 2010 Corporate Ridge McLean, VA 22102 | Galvanized Ribbed Steel Strips: 4 mm thick, 50 mm wide. Epoxy-coated strips also available. | Facing panels are cruciform shaped precast concrete 1.5 x 1.5 m x 140 mm thick. Half size panels used at top and bottom. |
| Retained Earth Foster Geotechnical 1600 Hotel Circle North San Diego, CA 92108-2803 | Rectangular grid of W11 or W20 plain steel bars, 610 x 150 mm grid. Each mesh may have 4, 5 or 6 longitudinal bars. Epoxy-coated meshes also available. | Hexagonal and square precast concrete 1.5 x 1.5 m x 140 mm thick. Half size panels used at top and bottom. |
| Mechanically Stabilized Embankment Dept. of Transportation, Division of Engineering Services 5900 Folsom Blvd. P.O. Box 19128 Sacramento, CA 95819 | Rectangular grid, nine 9.5 mm diameter plain steel bars on 610 x 150 mm grid. Two bar mats per panel (connected to the panel at four points). | Precast concrete; rectangular 3.81 m long, 610 mm high, 200 mm thick. |
| ARES Tensar Earth Technologies 5883 Glenridge Drive, Suite 200 Atlanta, GA 30328 | HDPE Geogrid | Precast concrete panel; rectangular 2.74 m wide, 1.52 m high, 140 mm thick. |
| Welded Wire Wall Hilfiker Retaining Walls P.O. Drawer L Eureka, CA 95501 | Welded steel wire mesh, grid 50 x 150 mm of W4.5 x W3.5, W9.5 x W4, W9.5 x W4, and W12 x W5 in 2.43 m wide mats. | Welded steel wire mesh, wrap around with additional backing mat 6.35 mm wire screen at the soil face (with geotextile or shotcrete, if desired). |
| Reinforced Soil Embankment Hilfiker Retaining Walls, P.O. Drawer L Eureka, CA 95501 | 15 cm x 61 cm welded wire mesh: W9.5 to W20 - 8.8 to 12.8 mm diameter. | Precast concrete unit 3.8 m long, 610 mm high. |
| ISOGRID Neel Co. 6520 Deepford Street Springfield, VA 22150 | Rectangular grid of W11 x W11 4 bars per grid | Diamond shaped precast concrete units, 1.5 by 2.5 m, 140 mm thick. |
| MESA Tensar Earth Technologies, Inc. 5883 Glenridge Drive, Suite 200 Atlanta, GA 30328 | HDPE Geogrid | MESA HP (high performance), DOT ³ OR Standard units (203 mm high by 457 mm long face, 275 mm nominal depth). (dry cast concrete) |
| PYRAMID The Reinforced Earth [®] Company 2010 Corporate Ridge McLean, VA 22102 | Galvanized WWM, size varies with design requirements or Grid of PVC coated, Polyester yarn (Matrex Geogrid) | Pyramid [®] unit (200 mm high by 400 mm long face, 250 mm nominal depth) (dry cast concrete) |
| Maccaferri Terramesh System Maccaferri Gabions, Inc. 43A Governor Lane Blvd. WilliamSPORT, MD 21795 | Continuous sheets of galvanized double twisted woven wire mesh with PVC coating. | Rock filled gabion baskets laced to reinforcement. |
| Strengthened Earth Gifford-Hill & Co. 2515 McKinney Ave. Dallas, Texas 75201 | Rectangular grid, W7, W9.5 and W14, transverse bars at 230 and 450 mm. | Precast concrete units, rectangular or wing shaped 1.82 m x 2.13 m x 140 mm. |
| MSE Plus SSL 4740 Scotts Valley Drive Scotts Valley, CA 95066 | Rectangular grid with W11 to W24 longitudinal bars and W11 transverse. Mesh may have 4 to 6 longitudinal bars spaced at 200 mm. | Rectangular precast concrete panels 1.5 m high, 1.82 m wide with a thickness of 152 or 178 mm |
| KeySystem - Inextensible Keystone Retaining Wall Systems 4444 W. 78 th Street Minneapolis, MN 55435 | Galvanized welded wire ladder mat of W7.5 to W17 bars with crossbars at 150 mm to 600 mm | KeySystem concrete facing unit is 203 mm high x 457 mm wide x 305 mm deep (dry cast concrete) |

Table 1. Summary of reinforcement and face panel details for selected MSE wall systems (cont).

| <u>System Name</u> | <u>Reinforcement Detail</u> | <u>Typical Face Panel Detail¹</u> |
|-----------------------------------------------------------------------------------------------------------------------|-------------------------------------------------------------------------------------------------------|--------------------------------------------------------------------------------------------------------------------------------------|
| KeySystem - Extensible Keystone Retaining Wall Systems 4444 W. 78 th Street Minneapolis, MN 55435 | Stratagrid high tenacity knit polyester geogrid soil reinforcement by Strata Systems, Inc. PVC coated | Keystone Standard and Compac concrete facing units are 203 mm high x 457 mm wide x 457 mm or 305 mm deep (dry cast concrete) |
| Versa-Lok Retaining Wall Systems 6348 Highway 36 Blvd. Oakdale, MN 55128 | PVC coated PET or HDPE geogrids | Versa-Lok concrete unit 152 mm high x 406 mm long x 305 mm deep (dry cast concrete) |
| Anchor Wall Systems 5959 Baker Road Minnetonka, MN 55345 | PVC coated PET geogrid | Anchor Vertica concrete unit 200 mm high x 450 mm long x 300 mm deep and Anchor Vertica Pro which is 500 mm deep (dry cast concrete) |

¹Additional facing types are possible with most systems.

Table 2. Representative list of Geotextile and Geogrid manufacturers and suppliers.¹

| | | |
|--------------------------------------------------------------------------------------|-----------------------------------------------------------------------------------|--------------------------------------------------------------------------------------------------------|
| Amoco Fabrics and Fibers Co. 260 The Bluff Austelle, GA 30168 | BBA Nonwovens - Reemay, Inc. 70 Old Hickory Blvd. Old Hickory, TN 37138 | Carthage Mills 4243 Hunt Road Cincinnati, OH 45242 |
| Colbond Geosynthetics (Akzo) 95 Sand Hill Road Enka, NC 28728 | Contech Construction Products 1001 Grove Street Middletown, OH 45044 | Huesker, Inc. 11107 A S. Commerce Blvd. Charlotte, NC 28241 |
| LINQ Industrial Fabrics, Inc. 2550 West 5th North Street Summerville, SC 29483 | Luckenhaus North America 841 Main Street Spartanburg, SC 29302 | TC Mirafi 365 S. Holland Drive Pendegrass, GA 30567 |
| Nicolon Corporation 3500 Parkway Lane, Suite 500 Norcross, GA 30092 | Strata Systems, Inc. 425 Tribble Gap Road Cummings, GA 30130 | Synthetic Industries Construction Products Division 4019 Industry Drive Chattanooga, TN 37416 |
| Tenax Corporation 4800 East Monument Street Baltimore, MD 21205 | Tensar Earth Technologies 5883 Glenridge Drive, Suite 200 Atlanta, GA 30328 | TNS Advanced Technologies 681 Deyoung Road Greer, SC 29651 |

¹List is from the Geosynthetic Materials Association membership list.

[BLANK]

CHAPTER 2

SYSTEMS AND PROJECT EVALUATION

This chapter initially describes available MSEW and RSS systems and components, their application, advantages, disadvantages and relative costs.

Subsequently, it outlines required site and project evaluations leading to the establishment of site specific project criteria and details typical construction sequence for MSEW and RSS construction.

2.1 APPLICATIONS

MSEW structures are cost-effective alternatives for most applications where reinforced concrete or gravity type walls have traditionally been used to retain soil. These include bridge abutments and wing walls as well as areas where the right-of-way is restricted, such that an embankment or excavation with stable side slopes cannot be constructed. They are particularly suited to economical construction in steep-sided terrain, in ground subject to slope instability, or in areas where foundation soils are poor.

MSE walls offer significant technical and cost advantages over conventional reinforced concrete retaining structures at sites with poor foundation conditions. In such cases, the elimination of costs for foundation improvements such as piles and pile caps, that may be required for support of conventional structures, have resulted in cost savings of greater than 50 percent on completed projects.

Some additional successful uses of MSE walls include:

- ! Temporary structures, which have been especially cost-effective for temporary detours necessary for highway reconstruction projects.
- ! Reinforced soil dikes, which have been used for containment structures for water and waste impoundments around oil and liquid natural gas storage tanks. (The use of reinforced soil containment dikes is economical and can also result in savings of land because a vertical face can be used, which reduces construction time).
- ! Dams and seawalls, including increasing the height of existing dams.
- ! Bulk materials storage using sloped walls.

Representative uses of MSE walls for various applications are shown in figures 2 and 3.

Reinforced Soil Slopes, are cost-effective alternatives for new construction where the cost of fill, right-of-way, and other considerations may make a steeper slope desirable. However, even if

foundation conditions are satisfactory, slopes may be unstable at the desired slope angle. Existing slopes, natural or manmade, may also be unstable as is usually painfully obvious when they fail. As shown in figure 4, multiple layers of reinforcement may be placed in the slope during construction or reconstruction to reinforce the soil and provide increased slope stability. Reinforced slopes are a form of mechanically stabilized earth that incorporate planar reinforcing elements in constructed earth sloped structures with face inclinations of less than 70 degrees. Typically, geosynthetics are used for reinforcement.

There are two primary purposes for using reinforcement in engineered slopes.

- ! To increase the stability of the slope, particularly if a steeper than *safe* unreinforced slope is desirable or after a failure has occurred as shown in figure 4a.
- ! To provide improved compaction at the edges of a slope, thus decreasing the tendency for surface sloughing as shown in figure 4b.

The principal purpose for using reinforcement is to construct an RSS embankment at an angle steeper than could otherwise be safely constructed with the same soil. The increase in stability allows for construction of steepened slopes on firm foundations for new highways and as replacements for flatter unreinforced slopes and retaining walls. Roadways can also be widened over existing flatter slopes without encroaching on existing right-of-ways. In the case of repairing a slope failure, the new slope will be safer, and reusing the slide debris rather than importing higher quality backfill may result in substantial cost savings. These applications are illustrated in figure 5.

The second purpose for using reinforcement is at the edges of a compacted fill slope to provide lateral resistance during compaction. The increased lateral resistance allows for an increase in compacted soil density over that normally achieved and provides increased lateral confinement for the soil at the face. Even modest amounts of reinforcement in compacted slopes have been found to prevent sloughing and reduce slope erosion. Edge reinforcement also allows compaction equipment to more safely operate near the edge of the slope.

Further compaction improvements have been found in cohesive soils through the use of geosynthetics with in-plane drainage capabilities (e.g., nonwoven geotextiles) that allow for rapid pore pressure dissipation in the compacted soil.

Compaction aids placed as intermediate layers between reinforcement in steepened slopes may also be used to provide improved face stability and to reduce layers of more expensive primary reinforcement as shown in figure 4a.

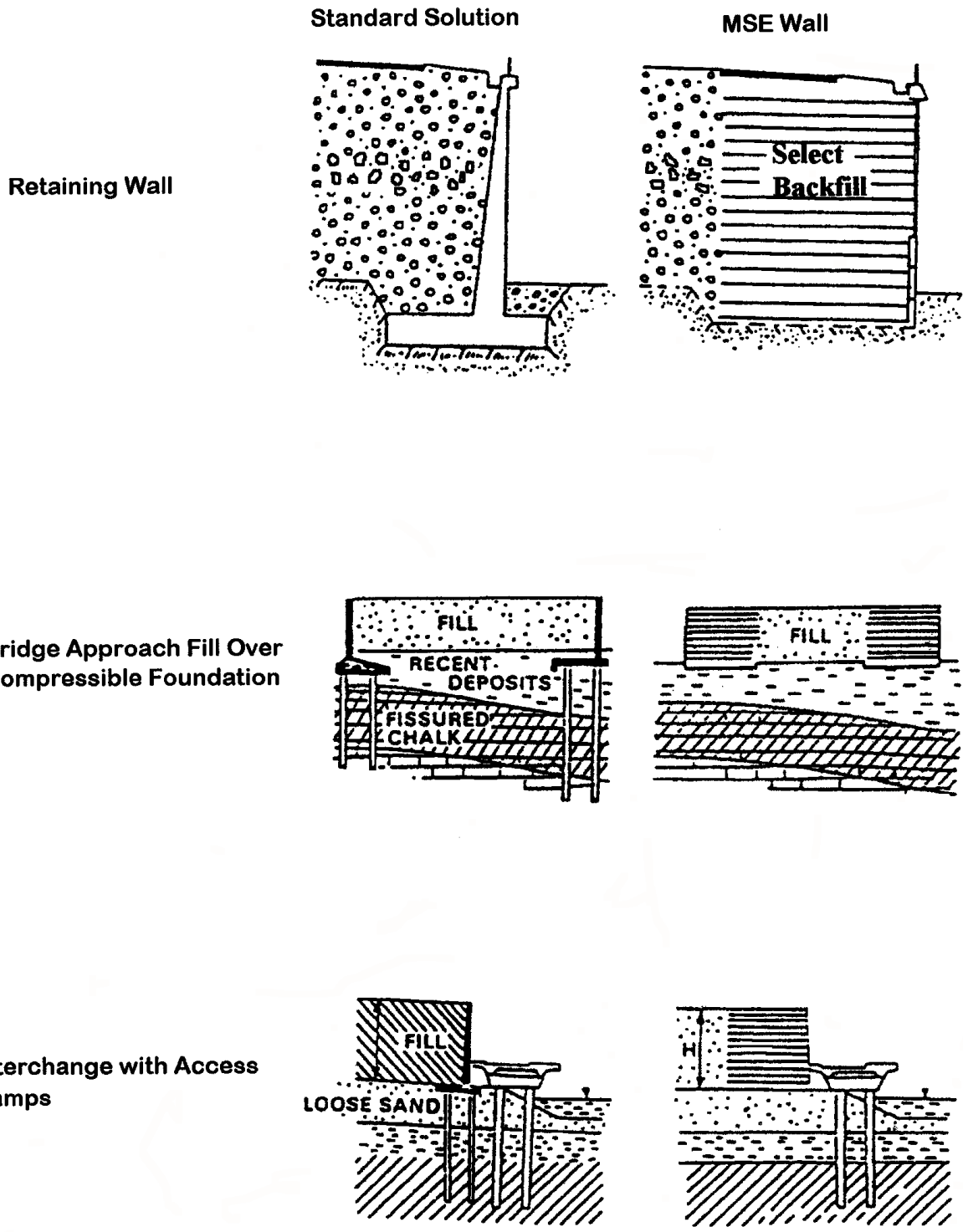

Figure 2. MSE walls, urban applications.

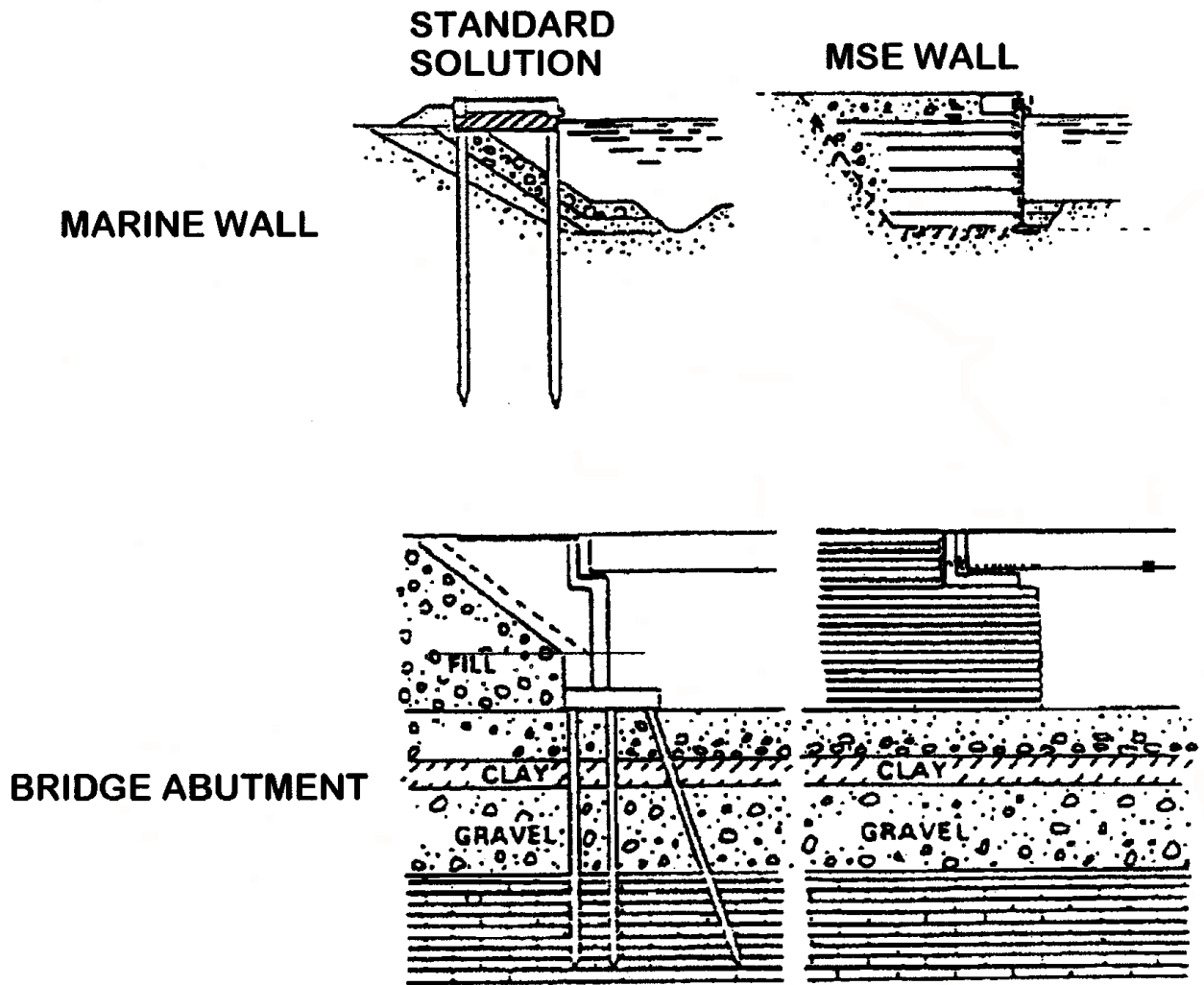
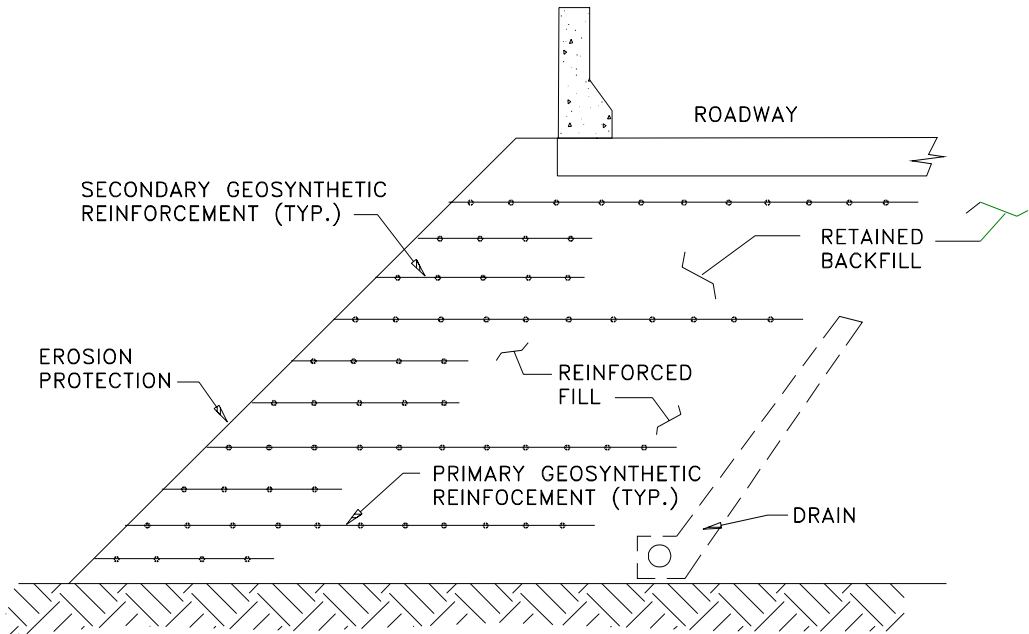
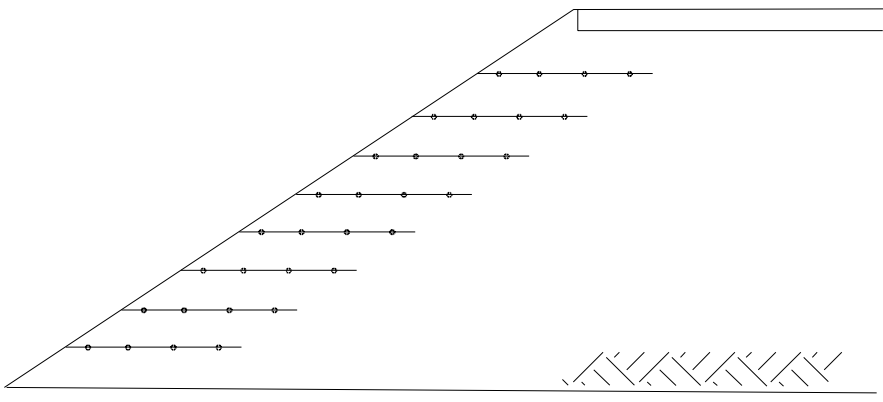

Figure 3. MSE wall applications, abutments, and marine.



(a)



(b)

Figure 4. Slope reinforcement using geosynthetics to provide slope stability.

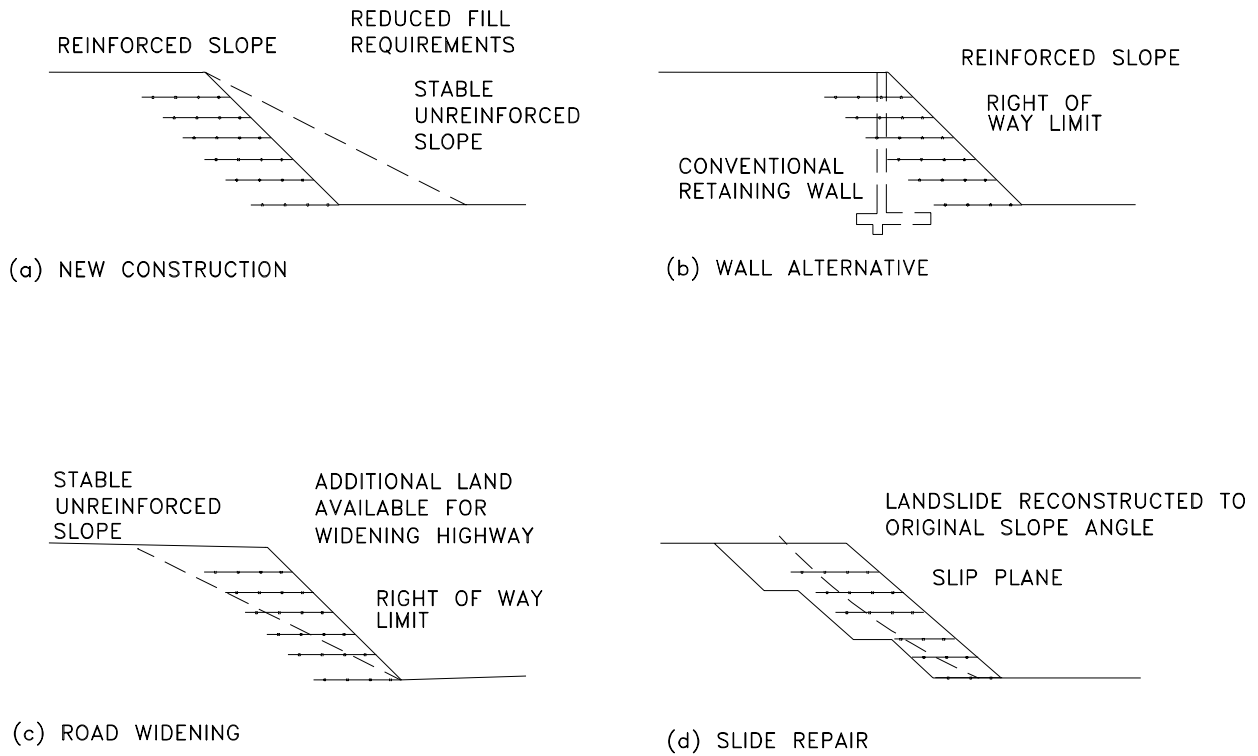

Figure 5. Application of reinforced soil slopes.

Other applications of reinforced slopes have included:

- ! Upstream/downstream face improvements to increased height of dams.
- ! Permanent levees.
- ! Temporary flood control structures.
- ! Decreased bridge spans.
- ! Temporary road widening for detours.
- ! Prevention of surface sloughing during periods of saturation.
- ! Embankment construction with wet, fine-grained soils.

2.2 ADVANTAGES AND DISADVANTAGES

a. Advantages of Mechanically Stabilized Earth (MSE) Walls

MSE walls have many advantages compared with conventional reinforced concrete and concrete gravity retaining walls. MSE walls:

- ! Use simple and rapid construction procedures and do not require large construction equipment.
- ! Do not require experienced craftsmen with special skills for construction.
- ! Require less site preparation than other alternatives.
- ! Need less space in front of the structure for construction operations.
- ! Reduce right-of-way acquisition.
- ! Do not need rigid, unyielding foundation support because MSE structures are tolerant to deformations.
- ! Are cost effective.
- ! Are technically feasible to heights in excess of 25 m (80 ft).

The relatively small quantities of manufactured materials required, rapid construction, and competition among the developers of different proprietary systems has resulted in a cost reduction relative to traditional types of retaining walls. MSE walls are likely to be more economical than other wall systems for walls higher than about 3 m (10 ft) or where special foundations would be required for a conventional wall.

One of the greatest advantages of MSE walls is their flexibility and capability to absorb deformations due to poor subsoil conditions in the foundations. Also, based on observations in seismically active zones, these structures have demonstrated a higher resistance to seismic loading than have rigid concrete structures.

Precast concrete facing elements for MSE walls can be made with various shapes and textures (with little extra cost) for aesthetic considerations. Masonry units, timber, and gabions also can be used with advantage to blend in the environment.

b. Advantages of Reinforced Soil Slopes (RSS)

The economic advantages of constructing a safe, steeper RSS than would normally be possible are the resulting material and rights-of-way savings. It also may be possible to decrease the quality of materials required for construction. For example, in repair of landslides it is possible to reuse the slide debris rather than to import higher quality backfill.

Right-of-way savings can be a substantial benefit, especially for road widening projects in urban areas where acquiring new right-of-way is always expensive and, in some cases, unobtainable. RSS also provide an economical alternative to retaining walls. In some cases, reinforced slopes can be constructed at about one-half the cost of MSEW structures.

The use of vegetated-faced reinforced soil slopes that can be landscaped to blend with natural environments may also provide an aesthetic advantage over retaining wall type structures. However, there are some potential maintenance issues that must be addressed such as mowing grass-faced steep slopes, however, these can be satisfactorily handled in design.

In terms of performance, due to inherent conservatism in the design of RSS, they are actually safer than flatter slopes designed at the same factor of safety. As a result, there is a lower risk of long-term stability problems developing in the slopes. Such problems often occur in compacted fill slopes that have been constructed to low factors of safety and/or with marginal materials (e.g. deleterious soils such as shale, fine grained low cohesive silts, plastic soils, etc.). The reinforcement may also facilitate strength gains in the soil over time from soil aging and through improved drainage, further improving long-term performance.

c. Disadvantages

The following general disadvantages may be associated with all soil reinforced structures:

- ! Require a relatively large space behind the wall or outward face to obtain enough wall width for internal and external stability.
- ! MSEW require select granular fill. (At sites where there is a lack of granular soils, the cost of importing suitable fill material may render the system uneconomical). Requirements for RSS are typically less restrictive.
- ! Suitable design criteria are required to address corrosion of steel reinforcing elements, deterioration of certain types of exposed facing elements such as geosynthetics by ultra violet rays, and potential degradation of polymer reinforcement in the ground.
- ! Since design and construction practice of all reinforced systems are still evolving, specifications and contracting practices have not been fully standardized, especially for RSS.
- ! The design of soil-reinforced systems often requires a shared design responsibility between material suppliers and owners and greater input from agencies geotechnical specialists in a domain often dominated by structural engineers.

2.3 RELATIVE COSTS

Site specific costs of a soil-reinforced structure are a function of many factors, including cut-fill requirements, wall/slope size and type, in-situ soil type, available backfill materials, facing finish, temporary or permanent application. It has been found that MSE walls with precast concrete facings are usually less expensive than reinforced concrete retaining walls for heights **greater** than about 3 m (10 ft) and average foundation conditions. Modular block walls (MBW) are competitive with concrete walls at heights of **less** than 4.5 m (15 ft).

In general, the use of MSE walls results in savings on the order of 25 to 50 percent and possibly more in comparison with a conventional reinforced concrete retaining structure, especially when the latter is supported on a deep foundation system (poor foundation condition). A substantial savings is obtained by elimination of the deep foundations, which is usually possible because reinforced soil structures can accommodate relatively large total and differential settlements. Other cost saving features include ease of construction and speed of construction. A comparison of wall material and erection costs for several reinforced soil retaining walls and other retaining wall systems, based on a survey of state and federal transportation agencies, is shown in figure 6. Typical total costs for MSE walls range from \$200 to \$400 per m² (\$19 to \$37 per ft²) of face, generally as function of height, size of project and cost of select fill.

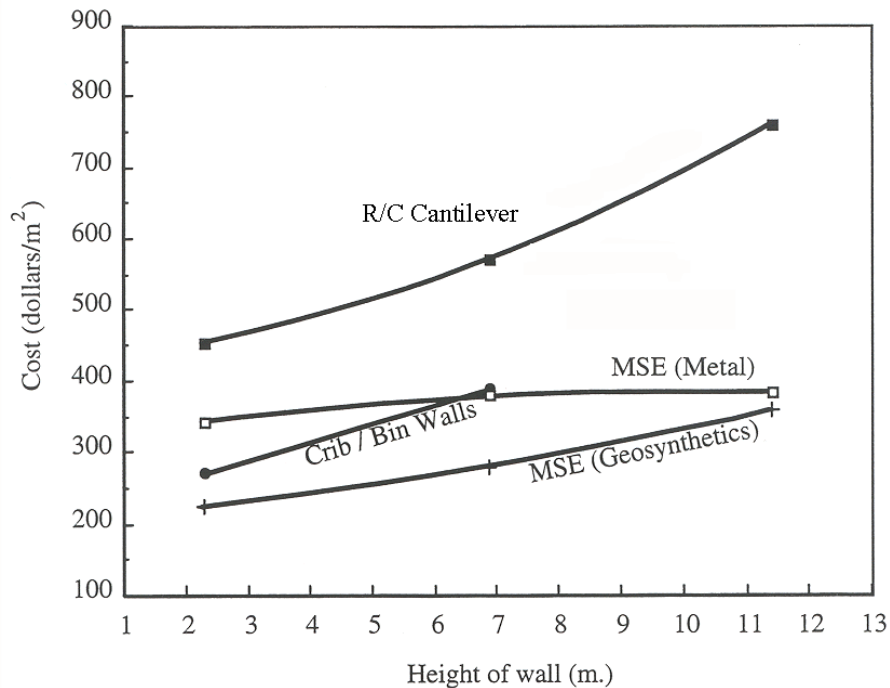

Figure 6. Cost comparison for retaining walls. ^(after 23)

The actual cost of a specific MSEW structure will depend on the cost of each of its principal components. For segmental precast concrete faced structures, typical relative costs are:

- ! Erection of panels and contractors profit - 20 to 30 percent of total cost.
- ! Reinforcing materials - 20 to 30 percent of total cost.
- ! Facing system - 25 to 30 percent of total cost.
- ! Backfill materials including placement - 35 to 40 percent of total cost, where the fill is a select granular fill from an off site borrow source.

The additional cost for panel architectural finish treatment ranges from \$5 to \$15 per m² (\$0.50 to \$1.50 per ft²) depending on the complexity of the finish. Traffic barrier costs average \$550 per linear meter (\$170 per linear foot). In addition, consideration must be given to the cost of excavation which may be somewhat greater than for other systems. MBW faced walls at heights less than 4.5 m (15 ft) are typically less expensive by 10 percent or more.

The economy of using RSS must be assessed on a case-by-case basis, where use is not dictated by space constraints. For such cases, an appropriate benefit to cost ratio analysis should be carried out to see if the steeper slope with the reinforcement is justified economically over the alternative flatter slope with its increased right-of-way and materials costs, etc. It should be kept in mind that guardrails or traffic barriers are often necessary for steeper embankment slopes and additional costs such as erosion control systems for slope face protection must be considered.

With respect to economy, the factors to consider are as follows:

- ! Cut or fill earthwork quantities.
- ! Size of slope area.
- ! Average height of slope area.
- ! Angle of slope.
- ! Cost of nonselect versus select backfills.
- ! Temporary and permanent erosion protection requirements.
- ! Cost and availability of right-of-way needed.
- ! Complicated horizontal and vertical alignment changes.
- ! Need for temporary excavation support systems.
- ! Maintenance of traffic during construction.

- ! Aesthetics.
- ! Requirements for guardrails and traffic barriers.

The actual bid cost of a specific RSS structure depends on the cost of each of its principal components. Based on limited data, typical relative costs are:

- ! Reinforcement - 45 to 65 percent of total cost
- ! Backfill - 30 to 45 percent of total cost
- ! Face treatment - 5 to 10 percent of total cost

High RSS structures have relatively higher reinforcement and lower backfill costs. Recent bid prices suggest costs ranging from \$110/m² to \$260/m² (\$10/ft² to \$24/ft²) as a function of height.

For applications in the 10 to 15 m (30 to 50 ft) height range bid costs of about \$170/m² (\$16/ft²) have been reported. These prices do not include safety features and drainage details.

Figure 7 provides a rapid, first-order assessment of cost items for comparing a flatter unreinforced slope with a steeper reinforced slope.

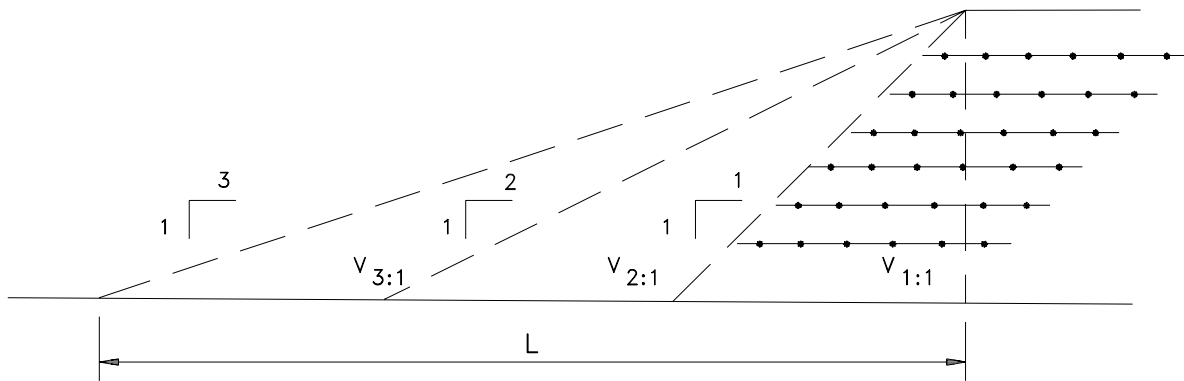

$$\begin{aligned} V_{3:1} &= V \\ V_{2:1} &= \mathbf{b}V \\ V_{1:1} &= \mathbf{a}V \end{aligned}$$

$$\begin{aligned} V_{3:1} &= L \\ V_{2:1} &= \mathbf{b}L \\ V_{1:1} &= \mathbf{a}L \end{aligned}$$

COST:

$$3H:1V = V_{SOIL} + L_{LAND} + \text{Guardrail* (?) + Hydroseeding (?)}$$

$$2H:1V = \mathbf{b}V_{SOIL} + \mathbf{b}L_{LAND} + \text{Guardrail + Erosion Control + High Maintenance}$$

$$1H:1V = \mathbf{a}V_{SOIL} + \mathbf{a}L_{LAND} + \text{Reinforcement + Guardrail + Erosion Control}$$

* Include guardrail or traffic barrier cost if required.

Figure 7. Cost evaluation of reinforced soil slopes.

2.4 DESCRIPTION OF MSE/RSS SYSTEMS

a. Systems Differentiation

Since the expiration of the fundamental process and concrete facing panel patents obtained by the Reinforced Earth Co. for MSEW systems and structures, the engineering community has adopted a generic term *Mechanically Stabilized Earth* to describe this type of retaining wall construction.

Trademarks, such as Reinforced Earth[®], Retained Earth[®], Genesis[®] etc., describe systems with some present or past proprietary features or unique components marketed by nationwide commercial suppliers. Other trademark names appear yearly to differentiate systems marketed by competing commercial entities that may include proprietary or novel components or for special applications.

A system for either MSEW or RSS structures is defined as a complete supplied package that includes design, specifications and all *prefabricated* materials of construction necessary for the complete construction of a soil reinforced structure. Often technical assistance during the planning and construction phase is also included. Components marketed by commercial entities for integration by the owner in a coherent system are not classified as systems.

b. Types of Systems

MSE/RSS systems can be described by the reinforcement geometry, stress transfer mechanism, reinforcement material, extensibility of the reinforcement material, and the type of facing and connections.

Reinforcement Geometry

Three types of reinforcement geometry can be considered:

- ! **Linear unidirectional.** Strips, including smooth or ribbed steel strips, or coated geosynthetic strips over a load-carrying fiber.
- ! **Composite unidirectional.** Grids or bar mats characterized by grid spacing greater than 150 mm (6 inches).
- ! **Planar bidirectional.** Continuous sheets of geosynthetics, welded wire mesh, and woven wire mesh. The mesh is characterized by element spacing of less than 150 mm (6 inches).

Reinforcement Material

Distinction can be made between the characteristics of metallic and nonmetallic reinforcements:

- ! **Metallic reinforcements.** Typically of mild steel. The steel is usually galvanized or may be epoxy coated.
- ! **Nonmetallic reinforcements.** Generally polymeric materials consisting of polypropylene, polyethylene, or polyester.

The performance and durability considerations for these two classes of reinforcement vary considerably and are detailed in the companion Corrosion/Degradation document.

Reinforcement Extensibility

There are two classes of extensibility:

- ! **Inextensible.** The deformation of the reinforcement at failure is much less than the deformability of the soil.
- ! **Extensible.** The deformation of the reinforcement at failure is comparable to or even greater than the deformability of the soil.

c. **Facing Systems**

The types of facing elements used in the different MSE systems control their aesthetics because they are the only visible parts of the completed structure. A wide range of finishes and colors can be provided in the facing. In addition, the facing provides protection against backfill sloughing and erosion, and provides in certain cases drainage paths. The type of facing influences settlement tolerances. Major facing types are:

- ! **Segmental precast concrete panels** summarized in table 1 and illustrated in figure 8. The precast concrete panels have a minimum thickness of 140 mm (5-½ inches) and are of a cruciform, square, rectangular, diamond, or hexagonal geometry. Temperature and tensile reinforcement are required but will vary with the size of the panel. Vertically adjacent units are usually connected with shear pins.
- ! **Dry cast modular block wall (MBW) units.** These are relatively small, squat concrete units that have been specially designed and manufactured for retaining wall applications. The mass of these units commonly ranges from 15 to 50 kg (30 to 110 lbs), with units of 35 to 50 kg (75 to 110 lbs) routinely used for highway projects. Unit heights typically range from 100 to 200 mm (4 to 8 inches) for the various manufacturers. Exposed face length usually varies from 200 to 450 mm (8 to 18 inches). Nominal width (dimension perpendicular to the wall face) of units typically ranges between 200 and 600 mm (8 and 24 inches). Units may be manufactured solid or with cores. Full height cores are filled with aggregate during erection. Units are normally dry-stacked (i.e. without mortar) and in a running bond configuration. Vertically adjacent units may be connected with shear pins, lips, or keys. They are referred to by trademarked names such as Keystone[®], Versa-Lok[®], Allan[®] etc. They are illustrated in figure 9.

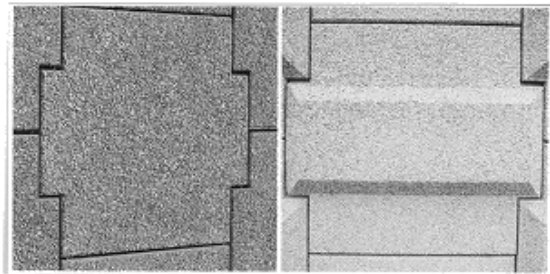
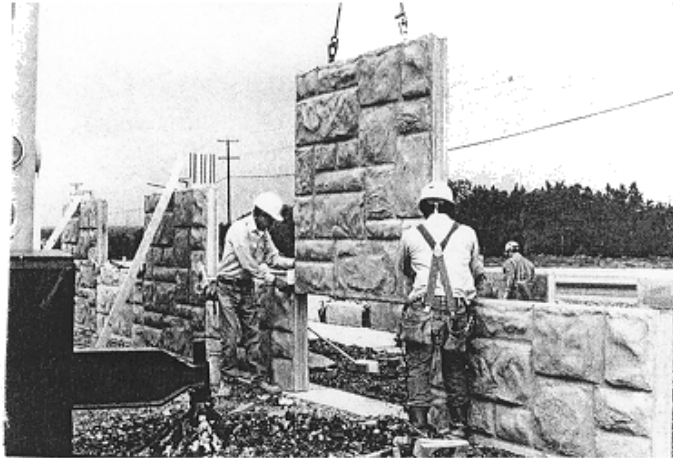
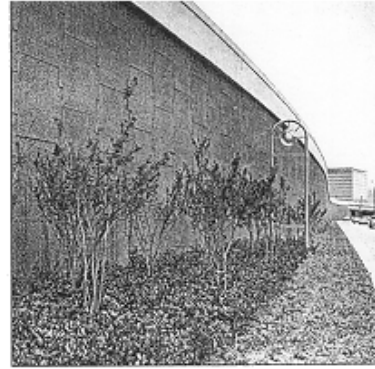
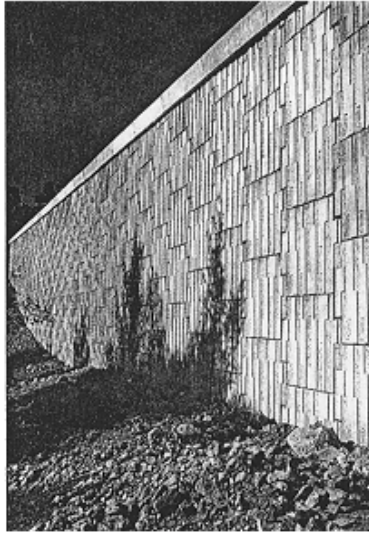
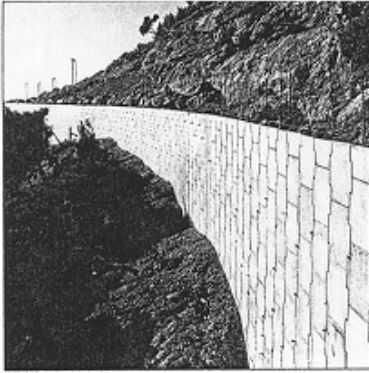

Figure 8. MSE wall surface treatments.

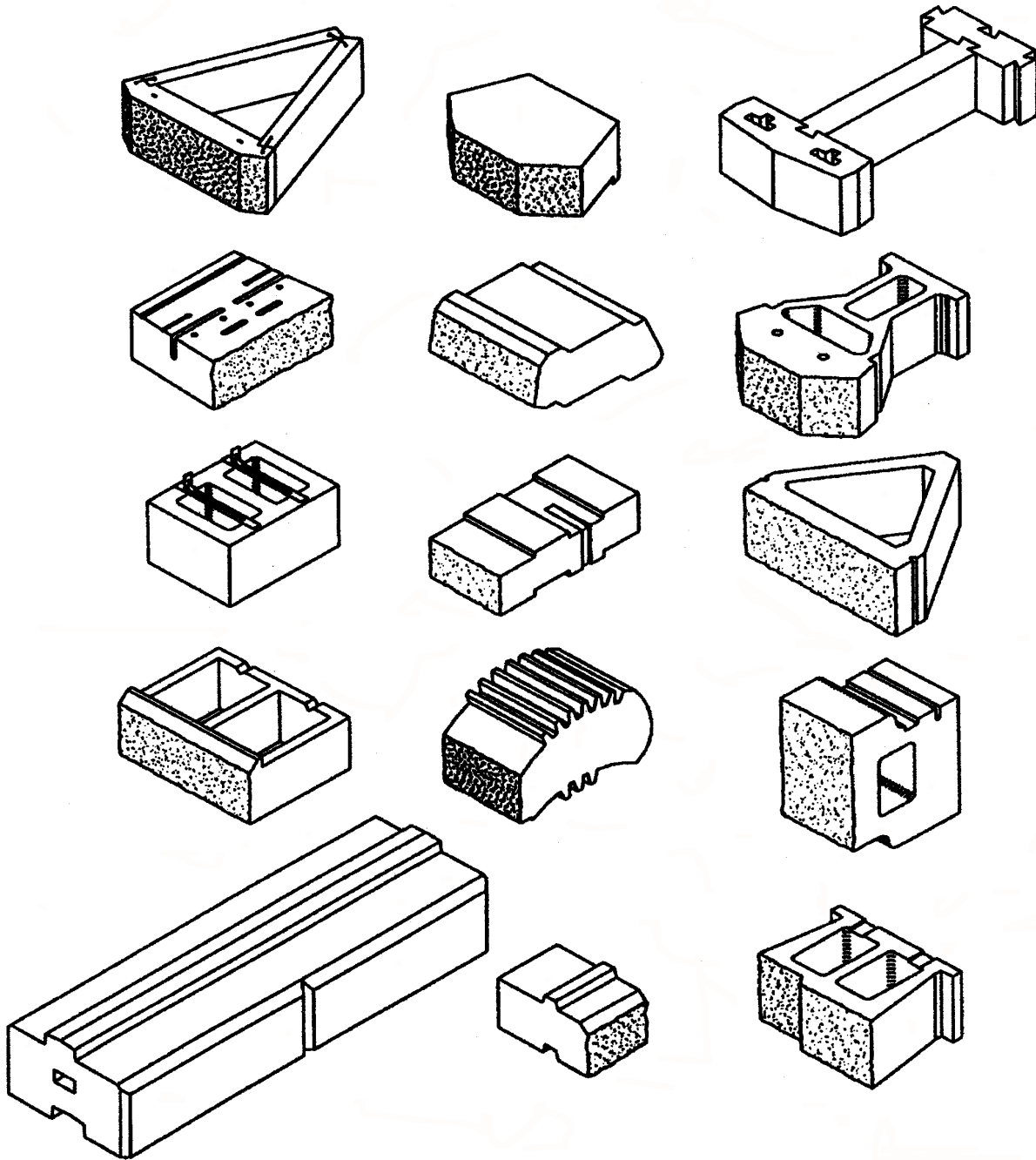

Figure 9. Examples of commercially available MBW units (from NCMA Design Manual for Segmental Retaining Walls).

- ! **Metallic Facings.** The original Reinforced Earth® system had facing elements of galvanized steel sheet formed into half cylinders. Although precast concrete panels are now commonly used in Reinforced Earth walls, metallic facings may be appropriate in structures where difficult access or difficult handling requires lighter facing elements.
- ! **Welded Wire Grids.** Wire grid can be bent up at the front of the wall to form the wall face. This type of facing is used in the Hilfiker, Tensar, and Reinforced Earth wire retaining wall systems.
- ! **Gabion Facing.** Gabions (rock-filled wire baskets) can be used as facing with reinforcing elements consisting of welded wire mesh, welded bar-mats, geogrids, geotextiles or the double-twisted woven mesh placed between or connected to the gabion baskets.
- ! **Geosynthetic Facing.** Various types of geotextile reinforcement are looped around at the facing to form the exposed face of the retaining wall. These faces are susceptible to ultraviolet light degradation, vandalism (e.g. target practice) and damage due to fire. Alternately, a geosynthetic grid used for soil reinforcement can be looped around to form the face of the completed retaining structure in a similar manner to welded wire mesh and fabric facing. Vegetation can grow through the grid structure and can provide both ultraviolet light protection for the geogrid and a pleasing appearance.
- ! **Postconstruction Facing.** For wrapped faced walls, the facing – whether geotextile, geogrid, or wire mesh – can be attached after construction of the wall by shotcreting, guniting, cast-in-place concrete or attaching prefabricated facing panels made of concrete, wood, or other materials. This multi-staging facing approach adds cost but is advantageous where significant settlement is anticipated.

Precast elements can be cast in several shapes and provided with facing textures to match environmental requirements and blend aesthetically into the environment. Retaining structures using precast concrete elements as the facings can have surface finishes similar to any reinforced concrete structure.

Retaining structures with metal facings have the disadvantage of shorter life because of corrosion, unless provision is made to compensate for it.

Facings using welded wire or gabions have the disadvantages of an uneven surface, exposed backfill materials, more tendency for erosion of the retained soil, possible shorter life from corrosion of the wires, and more susceptibility to vandalism. These disadvantages can, of course, be countered by providing shotcrete or by hanging facing panels on the exposed face and compensating for possible corrosion. The greatest advantages of such facings are low cost, ease of installation, design flexibility, good drainage (depending on the type of backfill) that provides increased stability, and possible treatment of the face for vegetative and other architectural effects. The facing can easily be adapted and well-blended with natural country

environment. These facings, as well as geosynthetic wrapped facings, are especially advantageous for construction of temporary or other structures with a short-term design life.

Dry cast segmental block MBW facings may raise some concerns as to durability in aggressive freeze-thaw environments when produced with water absorption capacity significantly higher than that of wet-cast concrete. Historical data provide little insight as their usage history is less than two decades. Further, because the cement is not completely hydrated during the dry cast process, (as is often evidenced by efflorescence on the surface of units), a highly alkaline regime may establish itself at or near the face area, and may limit the use of some geosynthetic products as reinforcements. Freeze-thaw durability is enhanced for products produced at higher compressive strengths and low water absorption ratios. The current specifications in Chapter 8 have been developed to address this issue.

The outward faces of slopes in RSS structures are usually vegetated if 1:1 or flatter. The vegetation requirements vary by geographic and climatic conditions and are therefore, project specific. Details are outlined in chapter 6, section 6.5.

d. Reinforcement Types

Most, although not all systems using precast concrete panels use steel reinforcements which are typically galvanized but may be epoxy coated. Two types of steel reinforcements are in current use:

59. Steel strips. The currently commercially available strips are ribbed top and bottom, 50 mm (2 inches) wide and 4 mm (5/32-inch) thick. Smooth strips 60 to 120 mm (2-**d** to 4¾-inch) wide, 3 to 4 mm (**C** to 5/32-inch) thick have been used.
60. Steel grids. Welded wire grid using 2 to 6 W7.5 to W24 longitudinal wire spaced at either 150 or 200 mm (6 or 8 inches). The transverse wire may vary from W11 to W20 and are spaced based on design requirements from 230 to 600 mm (9 to 24 inches). Welded steel wire mesh spaced at 50 by 50 mm (2 by 2-inch) of thinner wire has been used in conjunction with a welded wire facing. Some MBW systems use steel grids with 2 longitudinal wires.

Most MBW systems use geosynthetic reinforcement, principally geogrids. The following types are widely used and available:

1. High Density Polyethylene (HDPE) geogrid. These are of uniaxial manufacture and are available in up to 6 styles differing in strength.
2. PVC coated polyester (PET) geogrid. Available from a number of manufacturers. They are characterized by bundled high tenacity PET fibers in the longitudinal load carrying direction. For longevity the PET is supplied as a high molecular weight fiber and is further characterized by a low carboxyl end group number.
3. Geotextiles. High strength geotextiles can be used principally in connection with reinforced soil slope (RSS) construction. Both polyester (PET) and polypropylene (PP) geotextiles have been used.

e. Reinforced Backfill Materials

MSEW Structures

MSE walls require high quality backfill for durability, good drainage, constructability, and good soil reinforcement interaction which can be obtained from well graded, granular materials. Many MSE systems depend on friction between the reinforcing elements and the soil. In such cases, a material with high friction characteristics is specified and required. Some systems rely on passive pressure on reinforcing elements, and, in those cases, the quality of backfill is still critical. These performance requirements generally eliminate soils with high clay contents.

From a reinforcement capacity point of view, lower quality backfills could be used for MSEW structures; however, a high quality granular backfill has the advantages of being free draining, providing better durability for metallic reinforcement, and requiring less reinforcement. There are also significant handling, placement and compaction advantages in using granular soils. These include an increased rate of wall erection and improved maintenance of wall alignment tolerances.

RSS Structures

Reinforced Soil Slopes are normally not constructed with rigid facing elements. Slopes constructed with a flexible face can thus readily tolerate minor distortions that could result from settlement, freezing and thawing, or wet-drying of the backfill. As a result, any soil meeting the requirements for embankment construction could be used in a reinforced slope system. However, a higher quality material offers less durability concerns for the reinforcement, and is easier to handle, place and compact, which speeds up construction.

f. Miscellaneous Materials of Construction

Walls using precast concrete panels require bearing pads in their horizontal joints that provide some compressibility and movement between panels and preclude concrete to concrete contact. These materials are either neoprene, SBR rubber or HDPE.

All joints are covered with a polypropylene (PP) geotextile strip to prevent the migration of fines from the backfill. The compressibility of the horizontal joint material should be a function of the wall height. Walls with heights greater than 15 m (50 ft) may require thicker or more compressible joints to accommodate the larger vertical loads due to the weight of panels in the lower third of the structure.

2.5 SITE EVALUATION

a. Site Exploration

The feasibility of using an MSEW, RSS or any other type of earth retention system depends on the existing topography, subsurface conditions, and soil/rock properties. It is necessary to perform a comprehensive subsurface exploration program to evaluate site stability, settlement potential, need for drainage, etc., before repairing a slope or designing a new retaining wall or bridge abutment.

Subsurface investigations are required not only in the area of the construction but also behind and in front of the structure to assess overall performance behavior. The subsurface exploration program should be oriented not only towards obtaining all the information that could influence the design and stability of the final structure, but also to the conditions which prevail throughout the construction of the structure, such as the stability of construction slopes that may be required.

The engineer's concerns include the bearing capacity of the foundation materials, the allowable deformations, and the stability of the structure. Necessary parameters for these analyses must be obtained.

The cost of a reinforced soil structure is greatly dependent on the availability of the required type of backfill materials. Therefore, investigations must be conducted to locate and test locally available materials which may be used for backfill with the selected system.

b. Field Reconnaissance

Preliminary subsurface investigation or reconnaissance should consist of collecting any existing data relating to subsurface conditions and making a field visit to obtain data on:

- ! Limits and intervals for topographic cross sections.
- ! Access conditions for work forces and equipment.
- ! Surface drainage patterns, seepage, and vegetation characteristics.
- ! Surface geologic features, including rock outcrops and landforms, and existing cuts or excavations that may provide information on subsurface conditions.
- ! The extent, nature, and locations of existing or proposed below-grade utilities and substructures that may have an impact on the exploration or subsequent construction.
- ! Available right-of-way.
- ! Areas of potential instability such as deep deposits of weak cohesive and organic soils, slide debris, high groundwater table, bedrock outcrops, etc.

Reconnaissance should be performed by a geotechnical engineer or by an engineering geologist. Before the start of field exploration, any data available from previous subsurface investigations and those which can be inferred from geologic maps of the area should be studied. Topographic maps and aerial photographs, if available, should be studied. Much useful information of this type is available from the U.S. Geological Survey, the Soil Conservation Service, the U.S. Department of Agriculture, and local planning boards or county offices.

c. Subsurface Exploration

The subsurface exploration program generally consists of soil soundings, borings, and test pits. The type and extent of the exploration should be decided after review of the preliminary data obtained from the field reconnaissance, and in consultation with a geotechnical engineer or an engineering geologist. The exploration must be sufficient to evaluate the geologic and subsurface profile in the area of construction. For guidance on the extent and type of required investigation, the 1988 AASHTO "*Manual on Foundation Investigations*", should be reviewed.

The following minimum guidelines are recommended for the subsurface exploration for potential MSE applications:

! Soil borings should be performed at intervals of:

- 30 m (100 ft) along the alignment of the soil-reinforced structure
- 45 m (150 ft) along the back of the reinforced soil structure

The width of the MSE wall or slope structure may be assumed as 0.8 times the anticipated height.

! The boring depth should be controlled by the general subsurface conditions. Where bedrock is encountered within a reasonable depth, rock cores should be obtained for a length of about 3 m (10 ft). This coring will be useful to distinguish between solid rock and boulders. Deeper coring may be necessary to better characterize rock slopes behind new retaining structures. In areas of soil profile, the borings should extend at least to a depth equal to twice the height of the wall/slope. If subsoil conditions within this depth are found to be weak and unsuitable for the anticipated pressures from the structure height, then the borings must be extended until reasonably strong soils are encountered.

! In each boring, soil samples should be obtained at 1.5-m depth intervals and at changes in strata for visual identification, classification, and laboratory testing. Methods of sampling may follow AASHTO T 206 or AASHTO T 207 (*Standard Penetration Test* and *Thin-Walled Shelby Tube Sampling*, respectively), depending

on the type of soil. In granular soils, the Standard Penetration Test can be used to obtain disturbed samples. In cohesive soils, undisturbed samples should be obtained by thin-walled sampling procedures. In each boring, careful observation should be made for the prevailing water table, which should be observed not only at the time of sampling but also at later times to obtain a good record of prevailing water table conditions. If necessary, piezometers should be installed in a few borings to observe long-term water levels.

- ! Both the Standard Penetration Test and the Cone Penetration Test, ASTM D- 3441, provide data on the strengths and density of soils. In some situations, it may be desirable to perform in situ tests using a dilatometer, pressuremeter, or similar means to determine soil modulus values.
- ! Adequate bulk samples of available soils should be obtained and evaluated as indicated in the following testing section to determine the suitability of the soil for use as backfill in the MSE structures. Such materials should be obtained from all areas from which preliminary reconnaissance indicates that borrow materials will be used.
- ! Test-pit explorations should be performed in areas showing instability or to explore further availability of the borrow materials for backfill. The locations and number of test pits should be decided for each specific site, based on the preliminary reconnaissance data.

The development and implementation of an adequate subsurface investigation program is a key element for ensuring successful project implementation. Causes for distress experienced in projects are often traced to inadequate subsurface exploration programs, that did not disclose local or significant areas of soft soils, causing significant local differential settlement and distress to the facing panels. In a few documented extreme cases, such foundation weakness caused complete foundation failures leading to catastrophic collapses. Where the select backfill is to be obtained from on-site sources, the extent and quality must be fully explored to minimize contractor claims for changed conditions.

d. Laboratory Testing

Soil samples should be visually examined and appropriate tests performed for classification according to the Unified Soil Classification System (ASTM D 2488-69). These tests permit the engineer to decide what further field or laboratory tests will best describe the engineering behavior of the soil at a given project site. Index testing includes determination of moisture content, Atterberg limits, compressive strength, and gradation. The dry unit weight of representative undisturbed samples should also be determined.

Shear strength determination by unconfined compression tests, direct shear tests, or triaxial compression tests will be needed for external stability analyses of MSE walls and slopes. At sites where compressible cohesive soils are encountered below the foundations of the MSE structure, it is necessary to perform consolidation tests to obtain parameters for making

settlement analyses. Both undrained and drained (effective stress) parameters should be obtained for cohesive soils, to permit evaluation of both long-term and short-term conditions.

Of particular significance in the evaluation of any material for possible use as backfill are the grain size distribution and plasticity. The effective particle size (D_{10}) can be used to estimate the permeability of cohesionless materials. Laboratory permeability tests may also be performed on representative samples compacted to the specified density. Additional testing should include direct shear tests on a few similarly prepared samples to determine shear strength parameters under long and short-term conditions. The compaction behavior of potential backfill materials should be investigated by performing laboratory compaction tests according to AASHTO T 99 or T 180.

Properties to indicate the potential aggressiveness of the backfill material and the in-situ soils behind the reinforced soil zone must be measured. Tests include:

- ! pH.
- ! Electrical resistivity.
- ! Salt content including sulfate, sulfides, and chlorides.

The test results will provide necessary information for planning degradation protection measures and will help in the selection of reinforcement elements with adequate durability.

2.6 PROJECT EVALUATION

a. Structure Selection Factors

The major factors that influence the selection of an MSE/RSS alternative for any project include:

- ! Geologic and topographic conditions.
- ! Environmental conditions.
- ! Size and nature of the structure.
- ! Aesthetics.
- ! Durability considerations.
- ! Performance criteria.
- ! Availability of materials.

! Experience with a particular system or application.

! Cost.

Many MSEW systems have proprietary features. Some companies provide services including design assistance, preparation of plans and specifications for the structure, supply of the manufactured wall components, and construction assistance.

The various wall systems have different performance histories, and this sometimes creates difficulty in adequate technical evaluation. Some systems are more suitable for permanent walls, others are more suitable for low walls, and some are applicable for remote areas while others are more suited for urban areas. The selection of the most appropriate system will thus depend on the specific project requirements.

RSS embankments have been constructed with a variety of geosynthetic reinforcements and treatments of the outward face. These factors again may create an initial difficulty in adequate technical evaluation. A number of geosynthetic reinforcement suppliers provide design services as well as technical assistance during construction.

Specific technical issues focused on selection factors are summarized in the following sections.

b. Geologic and Topographic Conditions

MSE structures are particularly well-suited where a "fill type" wall must be constructed or where side-hill fills are indicated. Under these latter conditions, the volume of excavation may be small, and the general economy of this type of construction is not jeopardized.

The adequacy of the foundation to support the fill weight must be determined as a first- order feasibility evaluation.

Where soft compressible soils are encountered, preliminary stability analyses must be made to determine if sufficient shear strength is available to support the weight of the reinforced fill. As a rough first approximation for vertically faced MSE structures, the available shear strength must be equal to at least 2.0 to 2.5 times the weight of the fill structure. For RSS embankments the required foundation strength is somewhat less and dependent on the actual slope considered.

Where these conditions are not satisfied, ground improvement techniques must be considered to increase the bearing capacity at the foundation level. These techniques include but are not limited to:

! Excavation and removal of soft soils and replacement with a compacted structural fill.

! Use of lightweight fill materials.

! In situ densification by dynamic compaction or improvement by use of surcharging with or without wick drains.

! Construction of stone columns.

Where marginal to adequate foundation strength is available, preliminary settlement analyses should be made to determine the potential for differential settlement, both longitudinally along a proposed structure as well as transverse to the face. This second- order feasibility evaluation is useful in determining the appropriate type of facing systems for MSE walls and in planning appropriate construction staging to accommodate the settlement.

In general, concrete-faced MSE structures using discrete articulating panels can accommodate maximum longitudinal differential settlements of about 1/100, without the introduction of special sliding joints between panels. Full-height concrete panels are considerably less tolerant and should not be considered where differential settlements are anticipated.

The performance of reinforced soil slopes generally is not affected by differential longitudinal settlements.

c. Environmental Conditions

The primary environmental condition affecting reinforcement type selection and potential performance of MSE structures is the aggressiveness of the in situ ground regime that can cause deterioration to the reinforcement. Post construction changes must be considered where de-icing salts or fertilizers are subsequently used.

For steel reinforcements, in situ regimes containing chloride and sulfate salts generally in excess of 200 PPM accelerate the corrosive process as do acidic regimes characterized by a pH of less than 5.⁽¹⁾ Alkaline regimes characterized by pH > 10 will cause accelerated loss of galvanization. Under these conditions, bare steel reinforcements could be considered.

Certain in situ regimes have been identified as being potentially aggressive for geosynthetic reinforcements. Polyester (PET) degrade in highly alkaline or acidic regimes. Polyolefins appear to degrade only under certain highly acidic conditions.

For additional specific discussions on the potential degradability of reinforcements, refer to the companion Corrosion/Degradation reference document and chapter 3, section 3.5.

A secondary environmental issue is site accessibility, which may dictate the nature and size of the facing for MSEW construction. Sites with poor accessibility or remote locations may lend themselves to lightweight facings such as metal skins; modular blocks (MBW) which could be erected without heavy lifting equipment; or the use of geotextile or geogrid wrapped facings and vegetative covers.

RSS construction with an organic vegetative cover must be carefully chosen to be consistent with native perennial cover that would establish itself quickly and would thrive with available site rainfall.

d. Size and nature of structure

Theoretically there is no upper limit to the height of MSEW that can be constructed. Structures in excess of 25 m (80 ft) have been successfully constructed with steel reinforcements although such heights for transportation-related structures are rare. RSS embankments have been constructed to greater heights.

Practical limits are often dictated by economy, available ROW, and the tensile strength of commercially available soil reinforcing materials. For bridge abutments there is no theoretical limit to the span length that can be supported, although the longer the span, the greater is the area of footing necessary to support the beams. Since the bearing capacity in the reinforced fill is usually limited to 200 kPa (4000 psf), a large abutment footing further increases the span length, adding cost to the superstructure. This additional cost must be balanced by the potential savings of the MSE alternate to a conventional abutment wall, which would have a shorter span length. As an option in such cases, it might be economical to consider support of the bridge beams on deep foundations, placed within the reinforced fill zone.

The lower limit to height is usually dictated by economy. When used with traffic barriers, low walls on good foundations of less than 3 to 4 meters are often uneconomical, as the cost of the overturning moment leg of the traffic barrier approaches one-third of the total cost of the MSE structure in place. For cantilever walls, the barrier is simply an extension of the stem with a smaller impact on overall cost.

The total size of structure (square meters of face) has little impact on economy compared with other retaining wall types. However, the unit cost for small projects of less than 300 m² (3,000 ft²) is likely to be 10 to 15 percent higher.

RSS may be cost effective in rural environments, where ROW restrictions exist or on widening projects where long sliver fills are necessary. In urban environments, they should be considered where ROW is available, as they are always more economical than vertically faced MSEW structures.

e. Aesthetics

Precast concrete facing panels may be cast with an unlimited variety of texture and color for an additional premium that seldom exceeds 15 percent of the facing cost, which on average would mean a 4 to 6 percent increase on total in place cost.

Modular block wall facings are often comparable in cost to precast concrete panels except on small projects (less than 400 m² (4,000 ft²)) where the small size introduces savings in erection equipment cost and the need to cast special, made-to-order concrete panels to fit

what is often irregular geometry. MBW facings may be manufactured in color and with a wide variety of surface finishes.

The outward face treatment of RSS, generally is by vegetation, which is initially more economical than the concrete facing used for MSE structures. However, maintenance costs may be considerably higher, and the long-term performance of many outward face treatments has not been established.

f. Questionable Applications

The current AASHTO *Interim Specifications for Highway Bridges*, indicates that MSE walls should not be used under the following conditions:

- ! When utilities other than highway drainage must be constructed within the reinforced zone where future access for repair would require the reinforcement layers to be cut. A similar limitation should be considered for RSS structures.
- ! With galvanized metallic reinforcements exposed to surface or ground water contaminated by acid mine drainage or other industrial pollutants as indicted by low pH and high chlorides and sulfates.
- ! When floodplain erosion may undermine the reinforced fill zone, or where the depth to scour cannot be reliably determined.

2.7 ESTABLISHMENT OF PROJECT CRITERIA

The engineer should consider each topic area presented in this section at a preliminary design stage and determine appropriate elements and performance criteria.

The process consists of the following successive steps:

- ! Consider all possible alternatives.
- ! Choose a system (MSEW or RSS).
- ! Consider facing options.
- ! Develop performance criteria (Loads, design heights, embedment, settlement tolerances, foundation capacity, effect on adjoining structures, etc.).
- ! Consider effect of site on corrosion/degradation of reinforcements.

a. Alternates

Cantilever, gravity, semi gravity or counterforted concrete walls or soil embankments are the usual alternatives to MSE walls and abutments and RSS.

In cut situations, in situ walls such as tieback anchored walls, soil nailed walls or nongravity cantilevered walls are often more economical, although where limited ROW is available, a combination of a temporary in situ wall at the back end of the reinforcement and a permanent MSE wall is often competitive.

For waterfront or marine wall applications, sheetpile walls with or without anchorages or prefabricated concrete bin walls that can be constructed in the wet are often, if not always, both more economical and more practical to construct.

b. Facing Considerations

The development of project-specific aesthetic criteria is principally focused on the type, size, and texture of the facing, which is the only visible feature of any MSE structure.

For permanent applications, considerations should be given to MSE walls with precast concrete panels. They are constructed with a vertical face and cannot accommodate small, uniform front batters. Currently, the size of panels commercially produced varies from 1.8 to 4.5 m² (20 to 50 ft²). Full height panels may be considered for walls up to 4 to 5 m (13 to 16 ft) in height on foundations that are not expected to settle. The precast concrete panels can be manufactured with a variety of surface textures and geometrics, as shown in figure 8.

MBW facings are available in a variety of shapes and textures as shown in figure 9. They range in facial area from 0.05 to 0.1 m² (0.5 to 1 ft²). An integral feature of this type of facing is a front batter ranging from nominal to 15 degrees. Project geometric constraints, i.e., the bottom of wall and top of wall horizontal limits, may limit the amount of permissible batter and, thus, the types of MBW units that may be used. Note that the toe of these walls step back as the foundation elevation steps up, due to the stacking arrangement and automatic batter.

At more remote locations, gabion, timber faced, or vegetated MSE may be considered.

For temporary walls, significant economy can be achieved with geosynthetic wrapped facings or wood board facing. They may be made permanent by applying gunite or cast-in-place concrete in a postconstruction application.

For RSS structures, the choice of slope facing may be controlled by climatic and regional factors. For structures of less than 10 m (33 ft) height with slopes of 1:1 or flatter, a vegetative "green slope" can be usually constructed using an erosion control mat or mesh and local grasses. Where vegetation cannot be successfully established and/or significant run-off

may occur, armored slopes using natural or manufactured materials may be the only choice to reduce future maintenance. For additional guidance see chapter 6, section 6.5.

c. Performance Criteria

Performance criteria for MSE structures with respect to design requirements are governed by design practice or codes such as contained in Article 5.8 of 1996 AASHTO Specifications for Highway Bridges. These requirements consider the required margins of safety with respect to failure modes. They are equal for all types of MSEW structures. No specific AASHTO guidance is presently available for RSS structures.

With respect to lateral wall displacements, no method is presently available to definitely predict lateral displacements, most of which occur during construction. The horizontal movements depend on compaction effects, reinforcement extensibility, reinforcement length, reinforcement-to-panel connection details, and details of the facing system. A rough estimate of probable lateral displacements of simple structures that may occur during construction can be made based on the reinforcement length to wall-height ratio and reinforcement extensibility as shown in figure 10.

This figure indicates that increasing the length-to-height ratio of reinforcements from its theoretical lower limit of 0.5H to 0.7H, decreases the deformation by 50 percent. It further suggests that the anticipated construction deformation of MSE structures constructed with polymeric reinforcements (extensible) is approximately three times greater than if constructed with metallic reinforcements (inextensible).

Performance criteria are both site and structure-dependent. Structure-dependent criteria consist of safety factors or a consistent set of load and resistance factors as well as tolerable movement criteria of the specific MSE structure selected.

Recommended minimum factors of safety with respect to failure modes are as follows:

- ! External Stability
 - Sliding : F.S. \geq 1.5 (MSEW); 1.3 (RSS)
 - Eccentricity e, at Base : \leq L/6 in soil L/4 in rock
 - Bearing Capacity : F.S. \geq 2.5
 - Deep Seated Stability : F.S. \geq 1.3
 - Compound Stability : F.S. \geq 1.3
 - Seismic Stability : F.S. \geq 75% of static F.S. (All failure modes)

- ! Internal Stability
 - Pullout Resistance : F.S. \geq 1.5 (MSEW and RSS)
 - Internal Stability for RSS : F.S. \geq 1.3
 - Allowable Tensile Strength
 - for steel strip reinforcement : $0.55 F_y$
 - for steel grid reinforcement: $0.48 F_y$ (connected to concrete panels or blocks)
 - for geosynthetic reinforcements : T_a - See design life, below

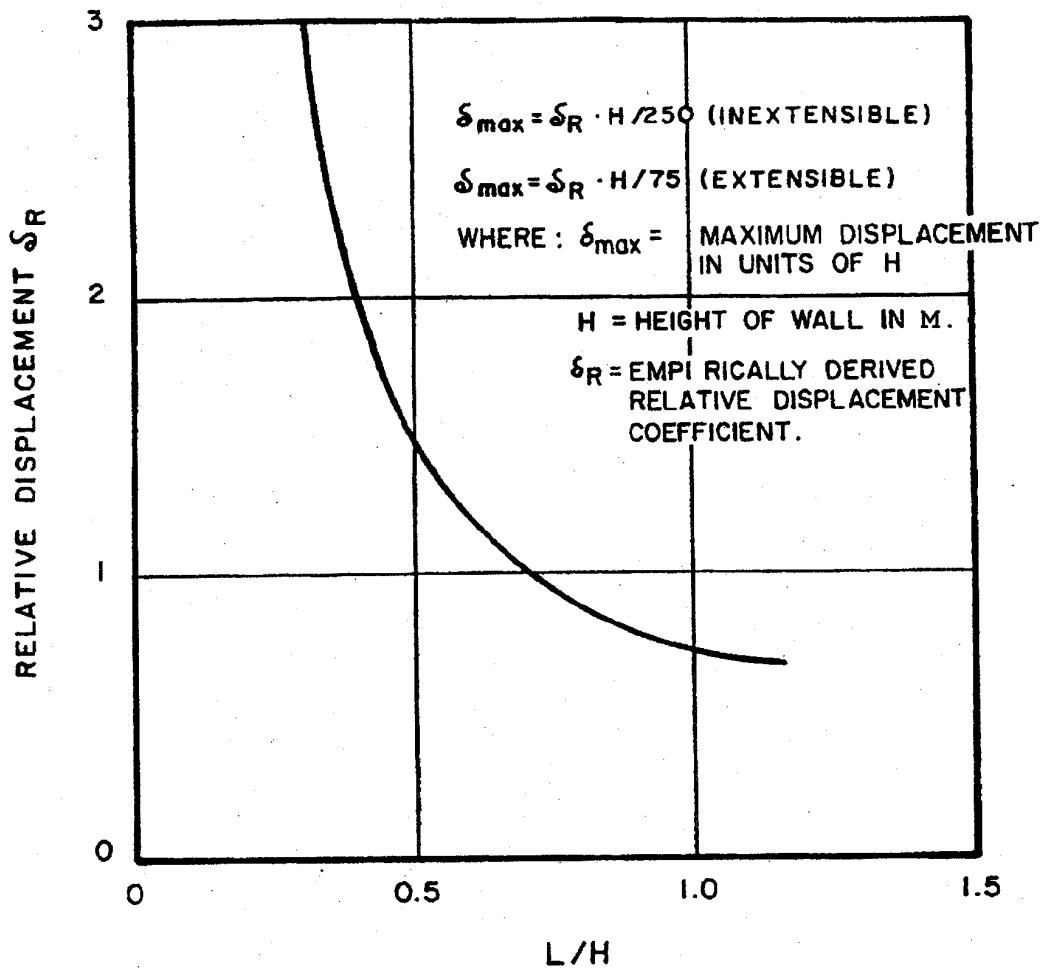

NOTE: INCREASE RELATIVE DISPLACEMENT 25% FOR EVERY 20 kPa OF SURCHARGE.

Based on 6 m high walls, relative displacement increase approximately 25% for every 20 kPa of surcharge. Experience indicates that for higher walls, the surcharge effects may be greater.

Note that actual displacements will also depend on soil characteristics, compaction effort and contractor workmanship.

Figure 10. Empirical curve for estimating probable anticipated lateral displacement during construction for MSE walls (FHWA RD 89-043).

A number of site specific project criteria need to be established at the inception of design:

- ! **Design limits and wall height.** The length and height required to meet project geometric requirements must be established to determine the type of structure and external loading configurations.
- ! **Alignment limits.** The horizontal (perpendicular to wall face) limits of bottom and top of wall alignment must be established as alignments vary with batter of wall system. The alignment constraints may limit the type and maximum batter, particularly with MBW units, of wall facing.
- ! **Length of reinforcement.** A minimum reinforcement length of 0.7H is recommended for MSE walls. Longer lengths are required for structures subject to surcharge loads. Shorter lengths can be used in special situations.
- ! **External loads.** The external loads may be soil surcharges required by the geometry, adjoining footing loads, line loads as from traffic, and/or traffic impact loads. Traffic line loads and impact loads are applicable where the traffic lane is located horizontally from the face of the wall within a distance less than one half the wall height. The magnitude of the minimum traffic loads outlined in Articles 3.20.3 and 5.8 of current AASHTO, is a uniform load equivalent to 0.6 m (2 ft) of soil over the traffic lanes.
- ! **Wall embedment.** The minimum embedment depth for walls from adjoining finished grade to the top of the leveling pad should be based on bearing capacity, settlement and stability considerations. Current practice based on local bearing capacity considerations, recommends the following embedment depths:

| <u>Slope in Front of Wall</u> | <u>Minimum to Top of Leveling Pad</u> |
|-------------------------------|-------------------------------------------|
| horizontal (walls) | H/20 |
| horizontal (abutments) | H/10 |
| 3H:1V | H/10 |
| 2H:1V | H/7 |
| 3H:2V | H/5 |

Larger values may be required, depending on depth of frost penetration, shrinkage and swelling of foundation soils, seismic activity, and scour. Minimum in any case is 0.5 m, except for structures founded on rock at the surface, where no embedment may be used. Alternately, frost-susceptible soils could be overexcavated and replaced with non frost susceptible backfill, hence reducing the overall wall height.

A minimum horizontal bench 1.2 m (4 ft) wide as measured from the face shall be provided in front of walls founded on slopes.

For walls constructed along rivers and streams where the depth of scour has been reliably determined, a minimum embedment of 0.6 m (2 ft) below this depth is recommended.

Embedment is not required for RSS unless dictated by stability requirements.

- ! **Seismic Activity.** Due to their flexibility, MSE wall and slope structures are quite resistant to dynamic forces developed during a seismic event, as confirmed by the excellent performance in several recent earthquakes.

The peak horizontal ground acceleration for each site can be obtained from Section 3 of AASHTO Division 1-A, Seismic Design. For sites where the Acceleration Coefficient "A" in AASHTO is less or equal to 0.05, static design considerations govern and dynamic performance or design requirements may be omitted.

For sites where the Acceleration Coefficient is greater than 0.05, significant total lateral structure movements may occur, and a seismic design specialist should review the stability and potential deformation for the structure. All sites where the "A" coefficient is greater than 0.05 should be designed/checked for seismic stability. For RSS structures, seismic analyses should be included regardless of acceleration.

- ! **Tolerance of precast facing panels to settlement.** MSE structures have significant deformation tolerance both longitudinally along a wall and perpendicular to the front face. Therefore, poor foundation conditions seldom preclude their use. However, where significant differential settlements are anticipated (greater than 1/100) sufficient joint width and/or slip joints must be provided to preclude panel cracking. This factor may influence the type and design of the facing panel selected.

Square panels generally adapt to larger longitudinal differential settlements better than long rectangular panels of the same surface area. Guidance on minimum joint width and limiting differential settlements that can be tolerated is presented in table 3, for panels with a surface area typically less than 4.5 m² (50 ft²)

MSE walls constructed with full height panels should be limited to differential settlements of 1/500. Walls with drycast facing (MBW) should be limited to settlements of 1/200. For walls with welded wire facings, the limiting differential settlement should be 1/50.

Where significant differential settlement perpendicular to the wall face is anticipated, the reinforcement connection may be overstressed. Where the back of the reinforced soil zone will settle more than the face, the reinforcement could be placed on a sloping fill surface which is higher at the back end of the reinforcement to compensate for the greater vertical settlement. This may be the case where a steep

Table 3. Relationship between joint width and limiting differential settlements for MSE precast panels.

| <u>Joint Width</u> | <u>Limiting Differential Settlement</u> |
|--------------------|-----------------------------------------|
| 20 mm | 1/100 |
| 13 mm | 1/200 |
| 6 mm | 1/300 |

surcharge slope is constructed. This latter construction technique, however, requires that surface drainage be carefully controlled after each day's construction. Alternatively, where significant differential settlements are anticipated, ground improvement techniques may be warranted to limit the settlements, as outlined in geological conditions.

d. Design Life

MSE walls shall be designed for a service life based on consideration of the potential long-term effects of material deterioration, seepage, stray currents and other potentially deleterious environmental factors on each of the material components comprising the wall. For most applications, permanent retaining walls should be designed for a minimum service life of 75 years. Retaining walls for temporary applications are typically designed for a service life of 36 months or less.

A greater level of safety and/or longer service life (i.e., 100 years) may be appropriate for walls which support bridge abutments, buildings, critical utilities, or other facilities for which the consequences of poor performance or failure would be severe.

The quality of in-service performance is an important consideration in the design of permanent retaining walls. Permanent walls shall be designed to retain an aesthetically pleasing appearance, and be essentially maintenance free throughout their design service life.

For RSS structures, similar minimum design life ranges should be adopted.

2.8 CONSTRUCTION SEQUENCE

The following is an outline of the principal sequence of construction for MSEW and RSS. Specific systems, special appurtenances and specific project requirements may vary from the general sequence indicated.

a. **Construction of MSEW systems with precast facings**

The construction of MSEW systems with a precast facing is carried out as follows:

- ! **Preparation of subgrade.** This step involves removal of unsuitable materials from the area to be occupied by the retaining structure. All organic matter, vegetation, slide debris and other unstable materials should be stripped off and the subgrade compacted.

In unstable foundation areas, ground improvement methods, such as dynamic compaction, stone columns, wick drains, or other foundation stabilization/improvement methods would be constructed prior to wall erection.

- ! **Placement of a leveling pad for the erection of the facing elements.** This generally unreinforced concrete pad is often only 300 mm (1 ft) wide and 150 mm (6 inches) thick and is used for MSEW construction only, where concrete panels are subsequently erected. A gravel pad has been often substituted for MBW construction.

The purpose of this pad is to serve as a guide for facing panel erection and is not intended as a structural foundation support.

- ! **Erection of the first row of facing panels on the prepared leveling pad.** Facings may consist of either precast concrete panels, metal facing panels, or dry cast modular blocks.

The first row of facing panels may be full, or half-height panels, depending upon the type of facing used. The first tier of panels must be shored up to maintain stability and alignment. For construction with modular dry-cast blocks, full sized blocks are used throughout with no shoring.

The erection of facing panels and placement of the soil backfill proceed simultaneously.

- ! **Placement and compaction of backfill on the subgrade to the level of the first layer of reinforcement and its compaction.** The fill should be compacted to the specified density, usually 95 to 100 percent of AASHTO T-99 maximum density and within the specified range of optimum moisture content. Compaction moisture contents dry of optimum are recommended.

A key to good performance is *consistent* placement and compaction. Wall fill lift thickness must be controlled based on specification requirements and vertical distribution of reinforcement elements. The uniform loose lift thickness of the reinforced backfill should not exceed 300 mm (12 inches). Reinforced backfill should be dumped into or parallel to the rear and middle of the reinforcement and bladed toward the front face. Random fill placement behind the reinforced volume should proceed simultaneously.

- ! **Placement of the first layer of reinforcing elements on the backfill.** The reinforcements are placed and connected to the facing panels, when the compacted fill has been brought up to the level of the connection they are generally placed perpendicular to back of the facing panels. More detailed construction control procedures associated with each construction step are outlined in chapter 9.
- ! **Placement of the backfill over the reinforcing elements to the level of the next reinforcement layer and compaction of the backfill.** The previously outlined steps are repeated for each successive layer.
- ! **Construction of traffic barriers and copings.** This final construction sequence is undertaken after the final panels have been placed, and the backfill has been completed to its final grade.

A complete sequence is illustrated in figures 11 through 13.

b. Construction of MSE systems with Flexible Facings

Construction of flexible-faced MSE walls, where the reinforcing material also serves as facing material, is similar to that for walls with precast facing elements. For flexible facing types such as welded wire mesh, geotextiles, geogrids or gabions, the erection of the first level facing element requires only a level grade. A concrete footing or leveling pad is not usually required unless precast elements are to be attached to the system after construction.

Construction proceeds as outlined for segmental facings with the following exceptions:

- ! **Placement of first reinforcing layer.** Reinforcement with anisotropic strength properties (i.e., many geosynthetics) should be placed with the principal strength direction perpendicular to face of structure. It is often convenient to unroll the reinforcement with the roll or machine direction parallel to the face. If this is done, then the cross machine tensile strength must be greater than the design tension requirements.

Secure reinforcement with retaining pins to prevent movement during reinforced fill placement.

Overlap adjacent sheets a minimum of 150 mm (6 inches) along the edges perpendicular to the face. Alternatively, with geogrid or wire mesh reinforcement, the edges may be butted and clipped or tied together.

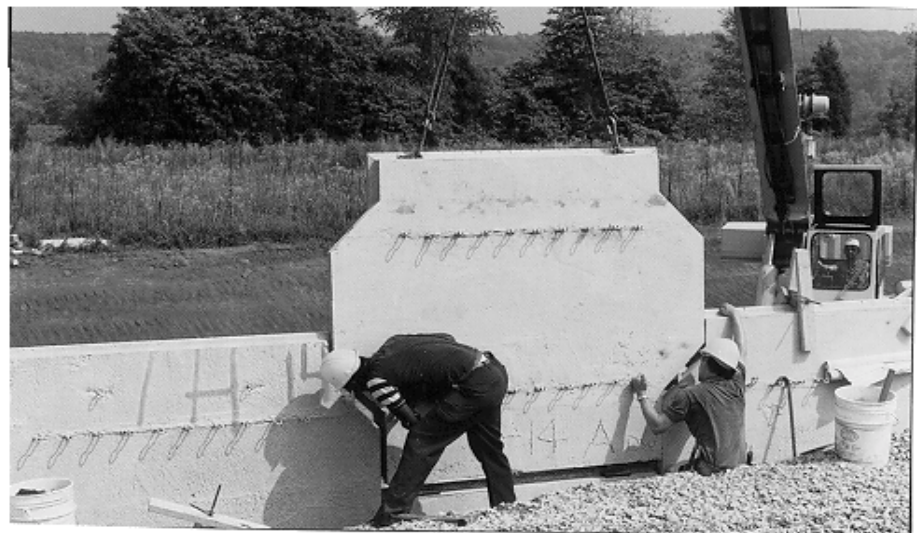

Figure 11. Erection of precast panels.



Figure 12. Fill spreading and reinforcement connection.

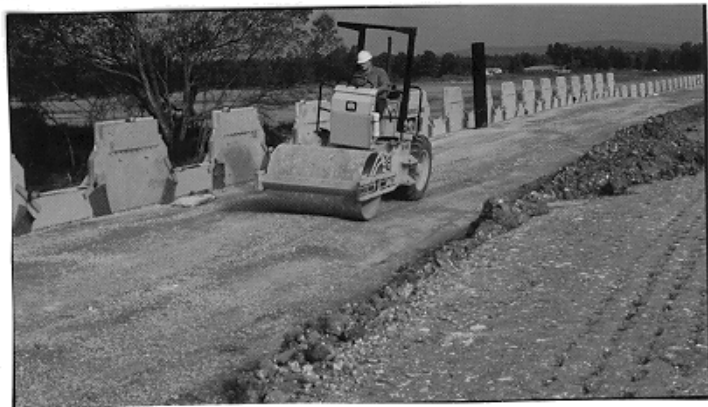
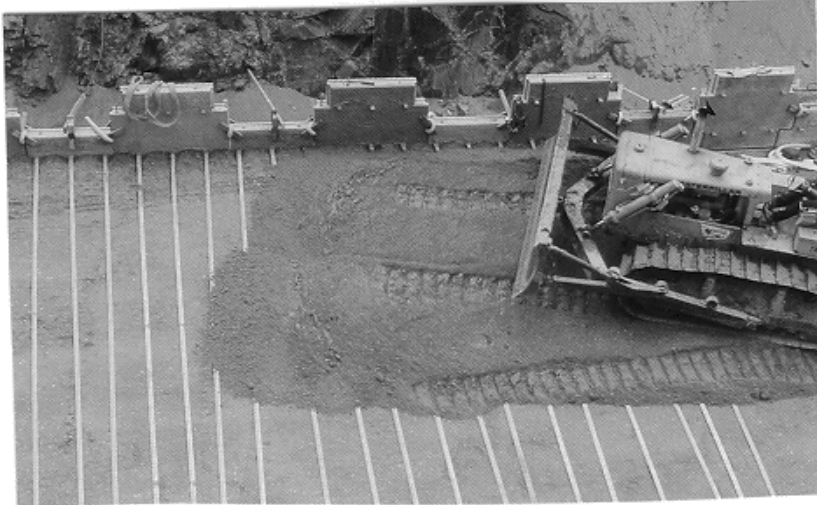

Figure 13. Compaction of backfill.

- ! **Face Construction.** Place the geosynthetic layers using face forms as shown in figure 14. For temporary support of forms at the face, form holders should be placed at the base of each layer at 1.20 m (4 ft) horizontal intervals. Details of temporary form work are shown in figure 15. These supports are essential for achieving good compaction. When using geogrids or wire mesh, it may be necessary to use a geotextile to retain the backfill material at the wall face.

When compacting backfill within 1 m (3 ft) of the wall face, a hand-operated vibratory compactor is recommended.

The return-type method or successive layer tie method as shown in figure 15 can be used for facing support. In the return method, the reinforcement is folded at the face over the backfill material, with a minimum return length of 1.25 m (4 ft) to ensure adequate pullout resistance. Consistency in face construction and compaction is essential to produce a wrapped facing with satisfactory appearance.

Apply facing treatment (shotcrete, precast facing panels, etc.). Figure 16 shows some alternative facing systems for flexible faced walls and slopes.

c. RSS Construction

The construction of RSS embankments is considerably simpler and consists of many of the elements outlined for MSEW construction. They are summarized as follows:

- ! Site preparation.
- ! Construct subsurface drainage (if indicated).
- ! Place reinforcement layer.
- ! Place and compact backfill on reinforcement.
- ! Construct face. Details of the available methods are outlined in chapter 6, construction.
- ! Place additional reinforcement and backfill.
- ! Construct surface drainage features.

Key stages of construction are illustrated in figure 17, and the complete sequence is fully outlined in Chapter 6.

2.9 PROPRIETARY ASPECTS

a. Materials

The distinguishing characteristics of MSE trademarked systems from generic systems are patented features or materials of construction.

At present the following significant components are known to be covered by unexpired patents:

- ! Connection details between grid reinforcement and precast panel covered by a number of patents issued to various suppliers. In general, these patents cover a specific design for the concrete-embedded portion of connecting member only.
- ! Most MBW facing units are covered by recent design patents.

b. Special Applications

A number of patents may be in force for specific MSE construction methods under water, specific types of traffic barriers constructed over MSE walls, and facing attachments to temporary facings.

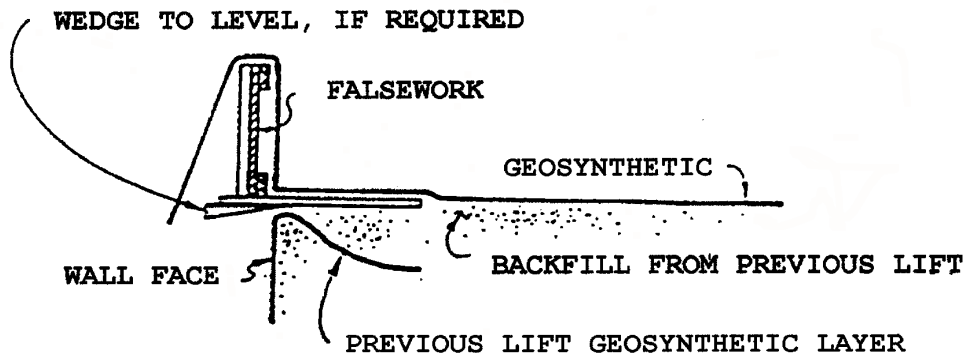

(1) PLACE FALSEWORK AND GEOSYNTHETIC ON PREVIOUS LIFT

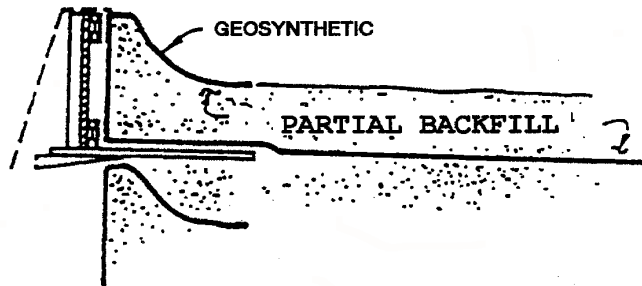

(2) PLACE/COMPACT PARTIAL BACKFILL AND OVERLAP GEOSYNTHETIC

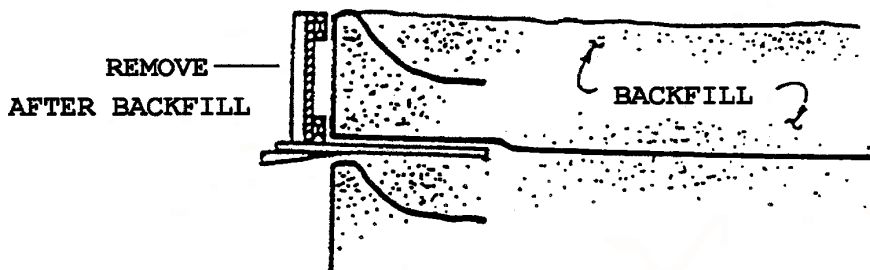

(3) PLACE/COMPACT REMAINDER OF BACKFILL LIFT

Figure 14. Lift construction sequence for geosynthetic faced MSE walls.

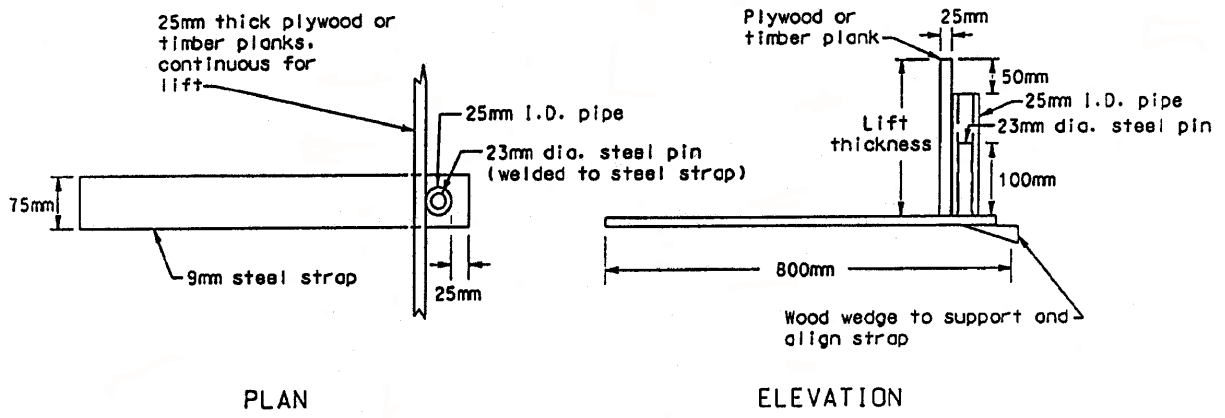

NOTE: Place straps at 1.2m to 1.8m centers along wall face.

GEOTEXTILE TEMPORARY FORM SYSTEM DETAIL

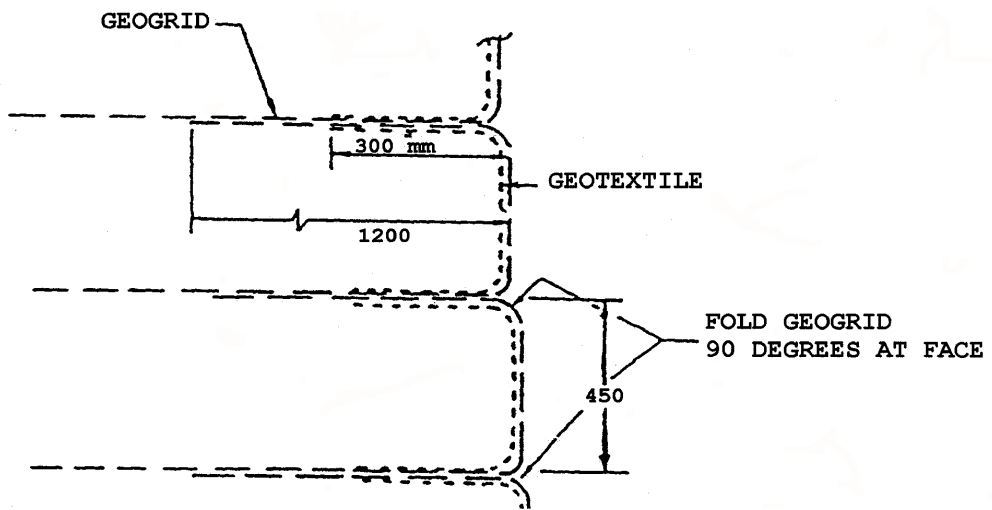

Figure 15. Typical geosynthetic face construction detail.

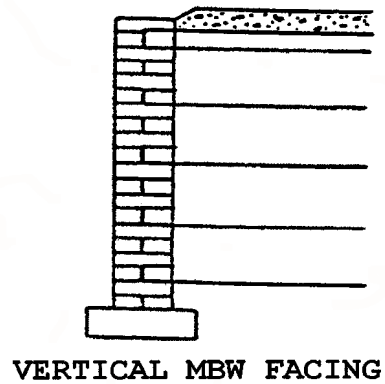
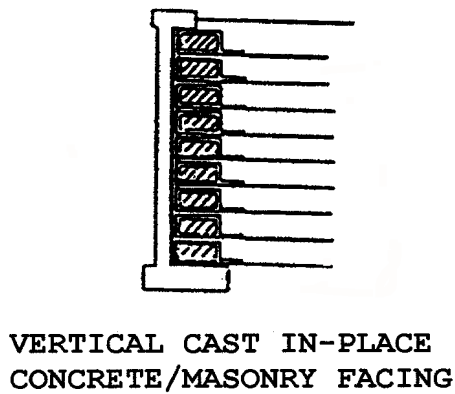
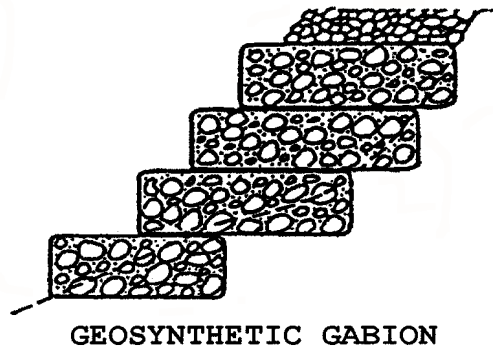
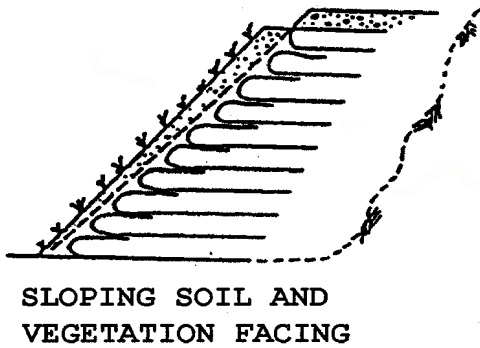
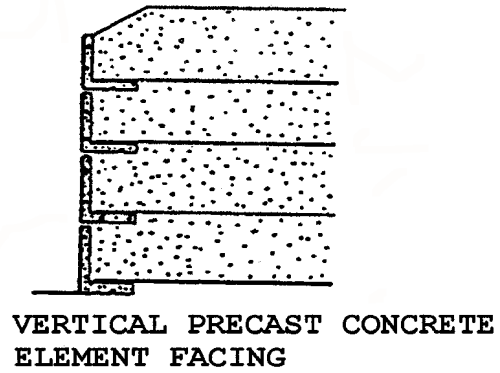
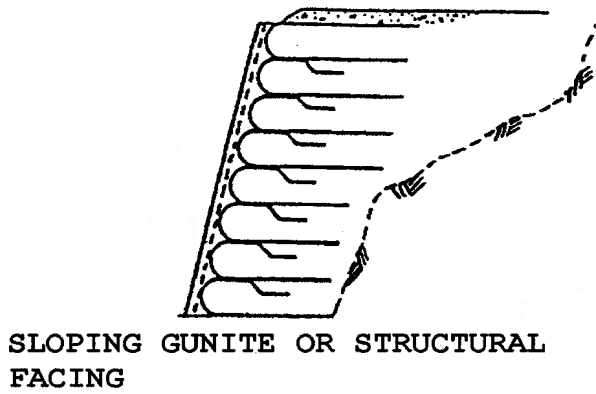
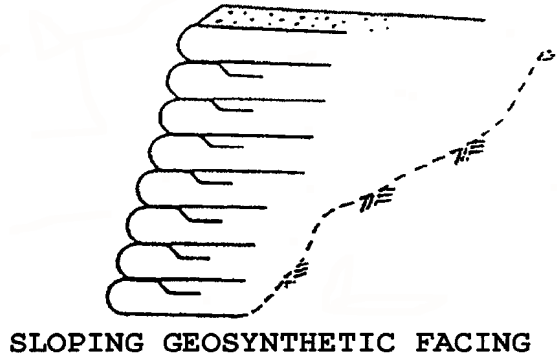
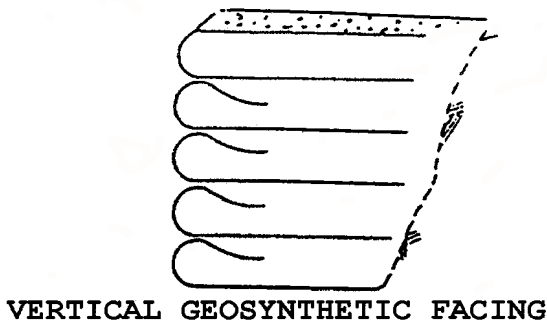

Figure 16. Types of geosynthetic reinforced soil wall facing.

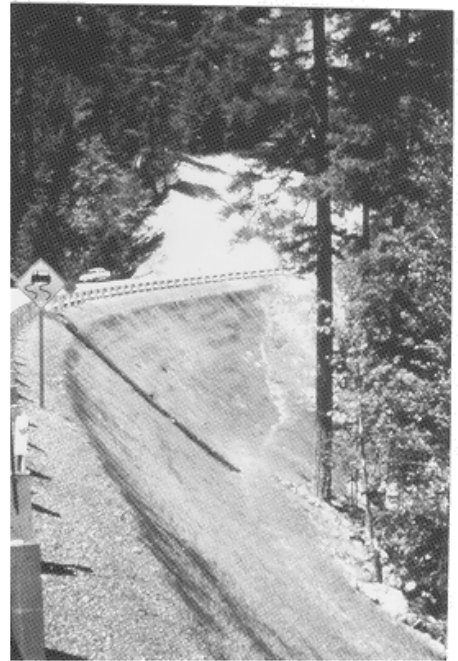

Figure 17. Reinforced slope construction; a) geogrid and fill replacement; b) soil fill erosion control mat placement; and c) finished, vegetated 1:1 slope.

CHAPTER 3

SOIL REINFORCEMENT PRINCIPLES AND SYSTEM DESIGN PROPERTIES

This chapter outlines the fundamental soil reinforcement principle that governs structure behavior, and develops system design parameters which are used for specific MSEW and RSS design, detailed in chapters 4, 5 and 7.

The objectives of this chapter are to develop:

- ! An understanding of soil-reinforcement interaction.
- ! Introduce normalized pullout capacity concepts.
- ! Develop design soil parameters for select backfill, retained fill and foundation bearing capacity.
- ! Establish structural design properties.

3.1 OVERVIEW

As discussed in chapter 2, mechanically stabilized earth systems (MSEW and RSS) have three major components: reinforcing elements, facing system, and reinforced backfill. Reinforcing elements may be classified by stress/strain behavior and geometry. In terms of stress/strain behavior, reinforcing elements may be considered inextensible (metallic) or extensible (polymeric). This division is not strictly correct because some newer glass-fiber reinforced composites and ultra high modulus polymers have moduli that approach that of mild steel. Likewise, certain metallic woven wire mesh reinforcements, such as hexagon gabion material, will deform more than the soil at failure and are thus considered extensible. Based on their geometric shapes, reinforcements can be categorized as strips, grids or sheets. Facing elements, when employed, can be precast concrete panels or modular blocks, gabions, welded wire mesh, cast-in-place concrete, timber, shotcrete, vegetation, or geosynthetic material. Reinforced backfill refers to the soil material placed within the zone of reinforcement. The retained soil refers to the material, placed or in situ, directly adjacent to the reinforced backfill zone. The retained soil is the source of earth pressures that the reinforced mass must resist. A drainage system below and behind the reinforced backfill is also an important component especially when using poorly draining backfill.

3.2 REINFORCED SOIL CONCEPTS

A reinforced soil mass is somewhat analogous to reinforced concrete in that the mechanical properties of the mass are improved by reinforcement placed parallel to the principal strain direction

to compensate for soil's lack of tensile resistance. The improved tensile properties are a result of the interaction between the reinforcement and the soil. The composite material has the following characteristics:

- ! Stress transfer between the soil and reinforcement takes place continuously along the reinforcement.
- ! Reinforcements are distributed throughout the soil mass with a degree of regularity and must not be localized.

Stress Transfer Mechanisms

Stresses are transferred between soil and reinforcement by friction (figure 18a) and/or passive resistance (figure 18b) depending on reinforcement geometry:

Friction develops at locations where there is a relative shear displacement and corresponding shear stress between soil and reinforcement surface. Reinforcing elements where friction is important should be aligned with the direction of soil reinforcement relative movement. Examples of such reinforcing elements are steel strips, longitudinal bars in grids, geotextile and some geogrid layers.

Passive resistance occurs through the development of bearing type stresses on "transverse" reinforcement surfaces normal to the direction of soil reinforcement relative movement. Passive resistance is generally considered to be the primary interaction for rigid geogrids, bar mat, and wire mesh reinforcements. The transverse ridges on "ribbed" strip reinforcement also provide some passive resistance.

The contribution of each transfer mechanism for a particular reinforcement will depend on the roughness of the surface (skin friction), normal effective stress, grid opening dimensions, thickness of the transverse members, and elongation characteristics of the reinforcement. Equally important for interaction development are the soil characteristics, including grain size, grain size distribution, particle shape, density, water content, cohesion, and stiffness.

Mode of Reinforcement Action

The primary function of reinforcements is to restrain soil deformations. In so doing, stresses are transferred from the soil to the reinforcement. These stresses are carried by the reinforcement in two ways: in tension or in shear and bending.

Tension is the most common mode of action of tensile reinforcements. All "longitudinal" reinforcing elements (i.e., reinforcing elements aligned in the direction of soil extension) are generally subjected to high tensile stresses. Tensile stresses are also developed in flexible reinforcements that cross shear planes.

Shear and Bending. "Transverse" reinforcing elements that have some rigidity, can withstand shear stress and bending moments.

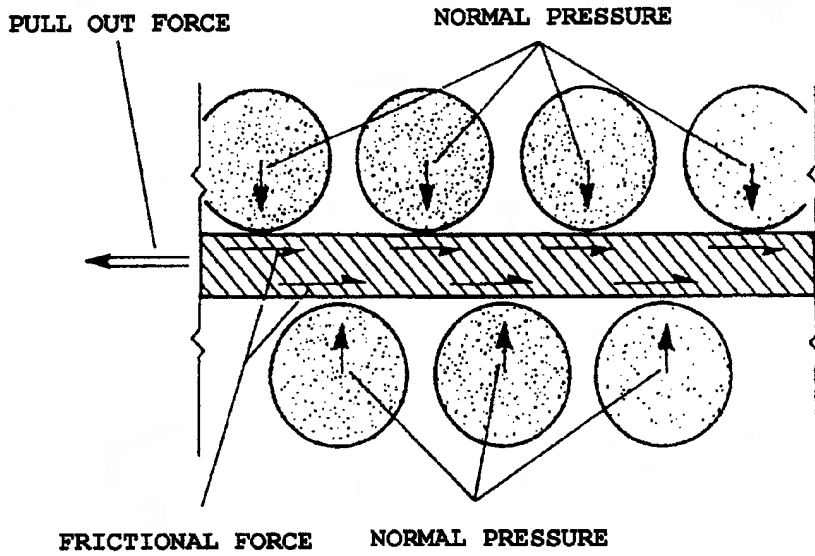

A) FRICTIONAL STRESS TRANSFER BETWEEN SOIL AND REINFORCEMENT SURFACES.

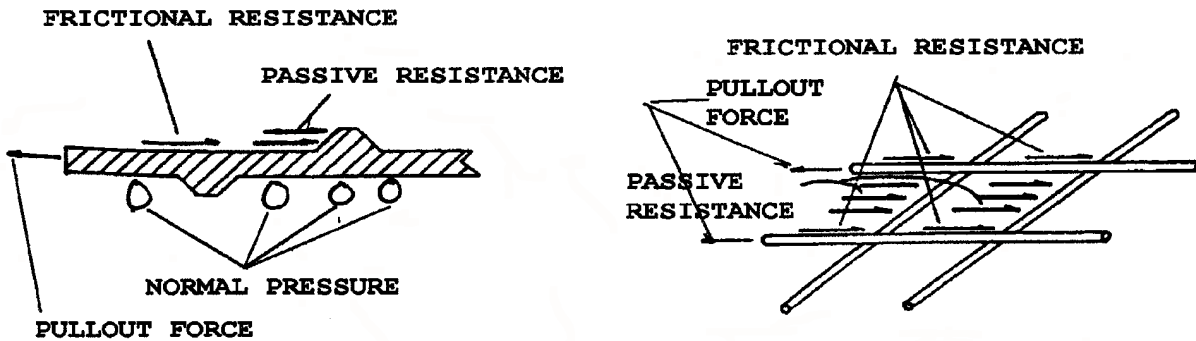

B) SOIL PASSIVE (BEARING) RESISTANCE ON REINFORCEMENT SURFACES

Figure 18. Stress transfer mechanisms for soil reinforcement.

3.3 SOIL REINFORCEMENT INTERACTION USING NORMALIZED CONCEPTS

Soil-interaction (pullout capacity) coefficients have been developed by laboratory and field studies, using a number of different approaches, methods, and evaluation criteria. A unified normalized approach has been recently developed, and is detailed below.

a. Evaluation of Pullout Performance

The design of the soil reinforcement system requires an evaluation of the long-term pullout performance with respect to three basic criteria:

- ! Pullout capacity, i.e., the pullout resistance of each reinforcement should be adequate to resist the design working tensile force in the reinforcement with a specified factor of safety.
- ! Allowable displacement, i.e., the relative soil-to-reinforcement displacement required to mobilize the design tensile force should be smaller than the allowable displacement.
- ! Long-term displacement, i.e., the pullout load should be smaller than the critical creep load.

The pullout resistance of the reinforcement is mobilized through one or a combination of the two basic soil-reinforcement interaction mechanisms, i.e., interface friction and passive soil resistance against transverse elements of composite reinforcements such as bar mats, wire meshes, or geogrids. The load transfer mechanisms mobilized by a specific reinforcement depends primarily upon its structural geometry (i.e., composite reinforcement such as grids, versus linear or planar elements, thickness of transverse elements, and aperture dimension). The soil-to-reinforcement relative movement required to mobilize the design tensile force depends mainly upon the load transfer mechanism, the extensibility of the reinforcement material, the soil type, and confining pressure.

The long-term pullout performance (i.e., displacement under constant design load) is predominantly controlled by the creep characteristics of the soil and the reinforcement material. Soil reinforcement systems will generally not be used with cohesive soils susceptible to creep. Therefore, creep is primarily an issue of the type of reinforcement. Table 4 provides, for generic reinforcement types, the basic aspects of pullout performance in terms of the main load transfer mechanism, relative soil-to-reinforcement displacement required to fully mobilize the pullout resistance, and creep potential of the reinforcement in granular (and low plasticity cohesive) soils.

Table 4. Basic aspects of reinforcement pullout performance in granular and cohesive soils of low plasticity.

| Generic Reinforcement Type | Major Load Transfer Mechanism | Range of Displacement at Specimen Front | Long Term Deformation |
|-------------------------------------|------------------------------------|---------------------------------------------------------|------------------------------------------------------------------------|
| Inextensible strips | | | |
| smooth ribbed | Frictional Frictional + passive | 1.2 mm 12 mm | Noncreeping |
| Extensible composite plastic strips | Frictional | Dependent on reinforcement extensibility | Dependent on reinforcement structure and polymer creep |
| Extensible sheets | | | |
| geotextiles | Frictional | Dependent on reinforcement extensibility (25 to 100 mm) | Dependent on reinforcement structure and polymer creep characteristics |
| Inextensible grids | | | |
| bar mats | Passive + frictional | 12 to 50 mm | Noncreeping |
| welded wire meshes | Frictional + passive | 12 to 50 mm | Noncreeping |
| Extensible grids | | | |
| geogrids | Frictional +passive | Dependent on extensibility (25 to 50 mm) | Dependent on reinforcement structure and polymer creep characteristics |
| woven wire meshes | Frictional +passive | 25 to 50 mm | Noncreeping |

b. Estimate of the Reinforcement Pullout Capacity in RSS and MSE Structures

The pullout resistance of the reinforcement is defined by the ultimate tensile load required to generate outward sliding of the reinforcement through the reinforced soil mass. Several approaches and design equations have been developed and are currently used to estimate the pullout resistance by considering frictional resistance, passive resistance, or a combination of both. The design equations use different interaction parameters, and it is, therefore, difficult to compare the pullout performance of different reinforcements for a specific application.

For design and comparison purposes, a normalized definition of pullout resistance will be used throughout the manual. The pullout resistance, P_r , of the reinforcement per unit width of reinforcement is given by:

$$P_r = F^* \cdot \alpha \cdot \sigma'_v \cdot L_e \cdot C \quad (1)$$

where: $L_e \cdot C$ = the total surface area per unit width of the reinforcement in the resistive zone behind the failure surface

L_e = the embedment or adherence length in the resisting zone behind the failure surface

C = the reinforcement effective unit perimeter; e.g., $C = 2$ for strips, grids, and sheets

F^* = the pullout resistance (or friction-bearing-interaction) factor

α = a scale effect correction factor to account for a non linear stress reduction over the embedded length of highly extensible reinforcements, based on laboratory data (generally 1.0 for metallic reinforcements and 0.6 to 1.0 for geosynthetic reinforcements, see table 5).

σ'_v = the effective vertical stress at the soil-reinforcement interfaces.

The correction factor α depends, therefore, primarily upon the strain softening of the compacted granular backfill material, the extensibility and the length of the reinforcement. For inextensible reinforcement, α is approximately 1, but it can be substantially smaller than 1 for extensible reinforcements. The α factor (a scale correction factor) can be obtained from pullout tests on reinforcements with different lengths as presented in appendix A or derived using analytical or numerical load transfer models which have been "calibrated" through numerical test simulations. In the absence of test data, $\alpha = 0.8$ for geogrids and $\alpha = 0.6$ for geotextiles (extensible sheets) is recommended (see table 5).

The pullout resistance factor F^* can be obtained most accurately from laboratory or field pullout tests performed in the specific backfill to be used on the project. Test procedures for determining pullout parameters are presented in appendix A. Alternatively, F^* can be derived from empirical or theoretical relationships developed for each soil-reinforcement interaction mechanism and provided by the reinforcement supplier. For any reinforcement, F^* can be estimated using the general equation:

$$F^* = \text{Passive Resistance} + \text{Frictional Resistance}$$

or,
$$F^* = F_q \cdot \alpha_\beta + \tan \rho \quad (2)$$

where: F_q = the embedment (or surcharge) bearing capacity factor

α_β = a bearing factor for passive resistance which is based on the thickness per unit width of the bearing member.

ρ = the soil-reinforcement interaction friction angle.

The pullout capacity parameters for equation 2 are summarized in table 5 and figure 19 for the soil reinforcement systems considered in this manual.

A significant number of laboratory pullout tests have been performed for many commonly used reinforcement backfill combinations and correlated to representative field pullout tests. Therefore, the need for additional laboratory and/or field pullout tests, should be limited to reinforcement/backfill combinations, where this data is sparse or non-existent. Where applicable, laboratory pullout tests should be made in a device consisting of a test box with the following minimum dimensions: 760 mm (30 inches) wide, 1210 mm (48 inches) long, and 450 mm (18 inches) deep. The reinforcement samples should be horizontally embedded between two, 150-mm (6-inch) layers of soil. The reinforcement specimen should be pulled horizontally out the front of the box through a split removable door. The test normal load should be applied vertically to the sample by pressurizing an air bag placed between a cover plate and a reaction plate resting on the soil. The pullout movement should be approximately 1.0 mm (0.04-inch) per minute and monitored using dial gauges mounted to the front of the specimen. Note that this test procedure provides a short-term pullout capacity and does not account for soil or reinforcement creep deformations, which may be of significance in RSS structures utilizing fine grained backfills.

When using laboratory pullout tests to determine design parameters, vertical stress variations and reinforcement element configurations for the actual project should be used. Tests should be performed on samples with a minimum embedded length of 600 mm (24 inches). The pullout resistance is the greater of the peak pullout resistance value prior to or the value achieved at a maximum deformation of 20 mm (3/4-inch) as measured at the front of the embedded section for inextensible reinforcements and 15 mm (5/8-inch) as measured at the end of the embedded sample for extensible reinforcements. This allowable deflection criteria is based on a need to limit the structure deformations, which are necessary to develop sufficient pullout capacity.

Table 5. Summary of pullout capacity design parameters.

| Reinforcement Type | S_{opt} | Grid Spacing | Tan ρ | F_q | α_β | α Default Value |
|-----------------------------------------------|---------------------------|--------------------|-----------------------------------------------------|------------------------------------------------|------------------------|------------------------|
| Inextensible strips | | NA | Obtain Tan ρ from tests, or use default values | NA | NA | 1.0 |
| Inextensible grids (bar mats and welded wire) | $\frac{t(F_q)}{2Tan\phi}$ | $S_t \leq S_{opt}$ | Obtain Tan ρ from tests | NA | NA | 1.0 |
| | $\frac{t(F_q)}{2Tan\phi}$ | $S_t > S_{opt}$ | NA | Obtain F_q from tests, or use default values | $t/(2S_t)$ | 1.0 |
| Extensible grids: | | | | | | |
| (Min. grid opening)/ $d_{50} > 1$ | $\frac{t(F_q)}{2Tan\phi}$ | $S_t \leq S_{opt}$ | Obtain Tan ρ from tests | NA | NA | 0.8 |
| | $\frac{t(F_q)}{2Tan\phi}$ | $S_t > S_{opt}$ | NA | Obtain F_q from tests, or use default values | $\frac{(f_b t)}{2S_t}$ | 0.8 |
| (Min. grid opening)/ $d_{50} < 1$ | | NA | Obtain Tan ρ from tests | NA | NA | 0.8 |
| Extensible sheets | | NA | Obtain Tan ρ from tests | NA | NA | 0.6 |

NOTES:

It is acceptable to use the empirical values provided in or referenced by this table to determine F^* in the absence of product and backfill specific test data, provided granular backfill as specified in Article 7.3.6.3 of Division II of 1996 AASHTO Standard Specifications for Highway Bridges is used and $C_u \geq 4$. For backfill outside these limits, tests must be run.

Pullout testing to determine α is recommended if α shown in table is less than 1.0. These values of α represent highly extensible geosynthetics.

For grids where Tan ρ is applicable, apply Tan ρ to the entire surface area of the reinforcement sheet (i.e., soil and grid), not just the surface area of the grid elements.

NA means "not applicable." ϕ is the soil friction angle. ρ is the interface friction angle mobilized along the reinforcement. S_{opt} is the optimum transverse grid element spacing to mobilize maximum pullout resistance as obtained from pullout tests (typically 150 mm or greater). S_t is the spacing of the transverse grid elements. t is the thickness of the transverse elements. F_q is the embedment (or surcharge) bearing capacity factor. α_β is a structural geometric factor for passive resistance. f_b is the fraction of the transverse member on which bearing can be fully developed (typically ranging from 0.6 to 1.0) as obtained from an evaluation of the bearing surface shape. d_{50} is the backfill grain size at 50% passing by weight. α is the scale effect correction factor. Definition of the geometric variables are illustrated in figure 19.

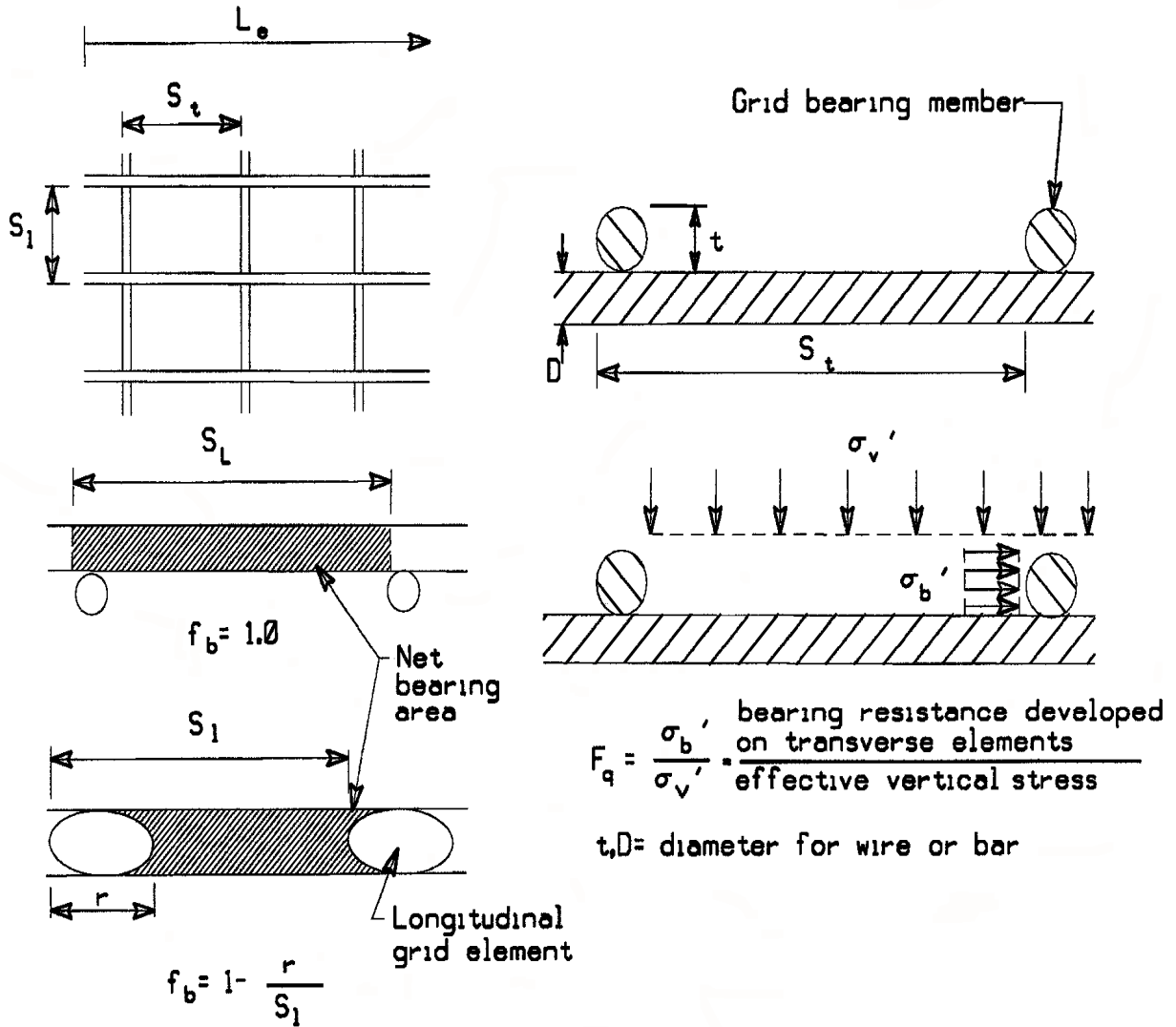

S_1 = Distance between longitudinal bars

S_t = Distance between transverse bars

Figure 19. Definition of grid dimensions for calculating pullout capacity.

Long-term pullout tests to assess soil/reinforcement creep behavior should be conducted when silt or clay reinforced backfill is being used. Soil properties and reinforcement type will determine if the allowable pullout resistance is governed by creep deformations. The placement and compaction procedures for both short-term and long-term pullout tests should simulate field conditions. The allowable deformation criteria in the previous paragraph should be applied.

A summary of the procedures for evaluating laboratory tests to obtain pullout design parameters is outlined in appendix A of this manual.

Most specialty system suppliers have developed recommended pullout parameters for their products, when used in conjunction with the select backfill detailed in this chapter for MSEW and RSS structures. The semi empirical relationships summarized below are consistent with results obtained from laboratory and field pullout testing at a 95 percent confidence limit, and generally consistent with suppliers developed data. Some additional economy can be obtained from site/product specific testing, where the source of the backfill in the reinforced volume has been identified during design.

In the absence of site specific pullout testing data, it is reasonable to use these semi empirical relationships in conjunction with the standard specifications for backfill to provide a conservative evaluation of pullout resistance.

For steel ribbed reinforcement, the Pullout Resistance Factor F^* is commonly taken as:

$$F^* = \tan \rho = 1.2 + \log C_u \text{ at the top of the structure} = 2.0 \text{ maximum} \quad (3)$$

$$F^* = \tan \phi \text{ at a depth of 6 m (20 ft) and below} \quad (4)$$

where C_u is the uniformity coefficient of the backfill (D_{60}/D_{10}). **If the specific C_u for the wall backfill is unknown at design time a C_u of 4 should be assumed (i.e., $F^* = 1.8$ at the top of the wall), for backfills meeting the requirements of section 3.4 of this chapter.**

For steel grid reinforcements with transverse spacing $S_t \geq 150$ mm (6 inches) (see figure 19), F^* is a function of a bearing or embedment factor (F_q), applied over the contributing bearing α_β , as follows:

$$F^* = F_q \alpha_\beta = 40 \alpha_\beta = 40 (t/2S_t) = 20 (t/S_t) \text{ at the top of the structure} \quad (5)$$

$$F^* = F_q \alpha_\beta = 20 \alpha_\beta = 20 (t/2S_t) = 10 (t/S_t) \text{ at a depth of 6 m (20 ft) and below} \quad (6)$$

where t is the thickness of the transverse bar. S_t shall be uniform throughout the length of the reinforcement rather than having transverse grid members concentrated only in the resistant zone. For sloping backfills see figure 30 in Chapter 4.

For geosynthetic (i.e., geogrid and geotextile) sheet reinforcement, the pullout resistance is based on a reduction in the available soil friction with the reduction factor often referred to as an Interaction Factor, C_i . In the absence of test data, the F^* value for geosynthetic reinforcement should conservatively be taken as:

$$F^* = 2/3 \tan \phi \quad (7)$$

Where used in the above relationships, ϕ is the peak friction angle of the soil which for MSE walls using select granular backfill, is taken as 34 degrees unless project specific test data substantiates higher values. For RSS structures, the ϕ angle of the reinforced backfill is normally established by test, as a reasonably wide range of backfills can be used. A lower bound value of 28 degrees is often used.

c. Interface Shear

The interface shear between sheet type geosynthetics (geotextiles, geogrids and geocomposite drains) and the soil is often lower than the friction angle of the soil itself and can form a slip plane. Therefore the interface friction coefficient $\tan \rho$ must be determined in order to evaluate sliding along the geosynthetic interface with the reinforced fill and, if appropriate, the foundation or retained fill soil. The interface friction angle ρ is determined from soil-geosynthetic direct shear tests in accordance with ASTM D 5321. In the absence of test results, the interface friction coefficient can be conservatively taken as $\frac{1}{3} \tan \phi$ for geotextiles, geogrids and geonet type drainage composites. Other geosynthetics such as geomembranes and some geocomposite drain cores may have much lower interface values and tests should accordingly be performed.

3.4 ESTABLISHMENT OF ENGINEERING PROPERTIES BASED ON SITE EXPLORATION AND TESTING

a. Foundation Soils

Determination of engineering properties for foundation soils should be focused on establishment of bearing capacity, settlement potential, and position of groundwater levels. For bearing capacity determinations, frictional and cohesive parameters (ϕ , c) as well as unit weights (γ_T) and groundwater position are normally required in order to calculate bearing capacity in accordance with Article 4.4.7 for soil and 4.4.8 for rock in 1996 AASHTO Standard Specifications for Highway Bridges. The effects of load inclination and footing shape may be omitted and the minimum Factor of Safety may be taken as 2.5 for Group I loading.

For foundation settlement determinations, the results of conventional settlement analyses using laboratory time-settlement data, coefficients of consolidation C_c , in conjunction with approximate value for compression index C_v , obtained from correlations to soil index tests (moisture content, Atterberg limits) should be used. The results of settlement analyses, especially with respect to differential settlement should be used to determine the ability of the facing and connection system to tolerate such movements or the necessity for special details or procedures to accommodate the differential movement anticipated.

Major foundation weakness and compressibility may require the consideration of ground improvement techniques to achieve adequate bearing capacity, or limiting total or differential

settlement. Techniques successfully used, include surcharging with or without wick drains, stone columns, dynamic compaction, and the use of lightweight fill to reduce settlement. Additional information on ground improvement techniques can be found in the FHWA's Ground Improvement Manual DP116. As an alternate, MSE structures with faces constructed of geosynthetic wraps, welded wire mesh or gabion baskets, which will tolerate significant differential settlement, could be constructed and permanent facings such as concrete panels attached after the settlement has occurred. Of particular concern, are situations where the MSEW structure may terminate adjacent to a rigidly supported structure such as a pile supported abutment at the end of a retained approach fill.

Evaluation of these foundation related issues are typically beyond the scope of services provided by wall/slope system suppliers. Evaluations of this type are the responsibility of agency engineers or consultant geotechnical designers.

b. Reinforced Backfill Soil

The selection criteria of reinforced backfill should consider long-term performance of the completed structure, construction phase stability and the degradation environment created for the reinforcements. Much of our knowledge and experience with MSE structures to date has been with select, cohesionless backfill. Hence, knowledge about internal stress distribution, pullout resistance, and failure surface shape is constrained and influenced by the unique engineering properties of these soil types. Granular soils are ideally suited to MSE structures. Many agencies have adopted conservative backfill requirements for both walls and slopes. These conservative properties are suitable for inclusion in standard specifications or special provisions when project specific testing is not feasible and when the quality of construction control and inspection may be in question. **It should be recognized, however, that reinforced backfill property criteria cannot completely replace a reasonable degree of construction control and inspection.**

In general, these select backfill materials will be more expensive than lower quality materials. The specification criteria for each application (walls and slopes) are somewhat different primarily based on performance requirements of the completed structure (allowable deformations) and the design approach. Material suppliers of proprietary MSE systems each have their own criteria for reinforced backfills. Detailed project backfill specifications, which **uniformly apply to all MSE systems, should be provided by the contracting agency.**

The following requirements are consistent with current practice:

Select Granular Fill Material for the Reinforced Zone. All backfill material used in the structure volume for MSEW structures shall be reasonably free from organic or other deleterious materials and shall conform to the following gradation limits as determined by AASHTO T-27.

| | | |
|----|--------------------------------|---------------------------------------|
| 1) | <u>U.S. Sieve Size</u> | <u>Percent Passing</u> ^(a) |
| | 102 mm (4 in) ^(a,b) | 100 |
| | 0.425 mm (No. 40) | 0-60 |
| | 0.075 mm (No. 200) | 0-15 |

Plasticity Index (PI) shall not exceed 6.

^(a) In order to apply default F* values, C_u, should be greater than or equal to 4.

^(b) As a result of recent research on construction survivability of geosynthetics and epoxy coated reinforcements, it is recommended that the maximum particle size for these materials be reduced to 19 mm (¾-inch) for geosynthetics, and epoxy and PVC coated reinforcements unless tests are or have been performed to evaluate the extent of construction damage anticipated for the specific fill material and reinforcement combination.

- 2) **Soundness.** The materials shall be substantially free of shale or other soft, poor durability particles. The material shall have a magnesium sulfate soundness loss (or a sodium sulfate value less than 15 percent after five cycles) of less than 30 percent after four cycles. Testing shall be in accordance with AASHTO T-104.

The fill material must be free of organic matter and other deleterious substances, as these materials not only enhance corrosion but also result in excessive settlements. The compaction specifications should include a specified lift thickness and allowable range of moisture content with reference to optimum. The compaction requirements of backfill are different in close proximity to the wall facing (within 1.5 to 2 m). Lighter compaction equipment is used near the wall face to prevent buildup of high lateral pressures from the compaction and to prevent facing panel movement. Because of the use of this lighter equipment, a backfill material of good quality in terms of both friction and drainage, such as crushed stone is recommended close to the face of the wall to provide adequate strength and tolerable settlement in this zone. It should be noted that granular fill containing even a few percent fines may not be free draining and drainage requirements should always be carefully evaluated.

For RSS structures, less select backfill can be used as facings are typically flexible and can tolerate some distortion during construction. Even so, a high quality embankment fill meeting the following gradation requirements to facilitate compaction and minimize reinforcement requirements is recommended. The following guidelines are provided as recommended backfill requirements for RSS construction:

| <u>Sieve Size</u> | <u>Percent Passing</u> |
|--------------------|------------------------|
| 20 mm* | 100 |
| 4.76 mm (No. 4) | 100 - 20 |
| 0.425 mm (No. 40) | 0 - 60 |
| 0.075 mm (No. 200) | 0 - 50 |

Plasticity Index (PI) ≤ 20 (AASHTO T-90)

Soundness: Magnesium sulfate soundness loss less than 30% after 4 cycles, based on AASHTO T-104 or equivalent sodium sulfate soundness of less than 15 percent after 5 cycles.

- * The maximum fill size can be increased (up to 100 mm) provided field tests have been or will be performed to evaluate potential strength reduction due to construction damage. In any case, geosynthetic strength reduction factors for site damage should be checked in relation to the maximum particle size to be used and the angularity of the larger particles.

Backfill compaction should be based on 95% of AASHTO T-99, and $\pm 2\%$ of optimum moisture, w_{opt} .

The reinforced fill criteria outlined above represent materials that have been successfully used throughout the United States and resulted in excellent structure performance. Peak shear strength parameters are used in the analysis. For MSE walls, a lower bound frictional strength of 34 degrees would be consistent with the specified fill, although some nearly uniform fine sands meeting the specifications limits may exhibit friction angles of 31 to 32 degrees. Higher values may be used if substantiated by laboratory direct shear or triaxial test results for the site specific material used or proposed. However, extreme caution is advised for use of friction angles above 40 degrees for design due to a lack of field performance data and questions concerning mobilization of shear strength above that value.

Fill materials outside of these gradation and plasticity index requirements have been used successfully; however, problems including significant distortion and structural failure have also been observed. While there may be a significant savings in using lower quality backfill, property values must be carefully evaluated with respect to influence on both internal and external stability. For MSE walls constructed with reinforced fill containing more than 15% passing a 0.075 mm (#200) sieve and/or the PI exceeds 6, both total and effective shear strength parameters should be evaluated in order to obtain an accurate assessment of horizontal stresses, sliding, compound failure (behind and through the reinforced zone) and the influence of drainage on the analysis. Both long-term and short-term pullout tests as well as soil/reinforcement interface friction tests should be performed. Settlement characteristics must be carefully evaluated, especially in relation to downdrag stresses imposed on connections at the face and settlement of supported structures. Drainage requirements at the back, face and beneath the reinforced zone must be carefully evaluated (e.g., use flow nets to evaluate influence of seepage forces and hydrostatic pressure).

Electrochemical tests should be performed on the backfill to obtain data for evaluating degradation of reinforcements and facing connections. Moisture and density control during construction must be carefully controlled in order to obtain strength and interaction values. Deformation during construction also must be carefully monitored and maintained within defined design limits. Performance monitoring is also recommended for backfill soils that fall outside of the requirements listed above, as detailed in chapter 9.

For RSS structures, where a considerably greater percentage of fines (minus #200 sieve) is permitted, lower bound values of frictional strength equal to 28 to 30 degrees would be reasonable for the backfill requirements listed. A significant economy could again be achieved if laboratory direct shear or triaxial test results on the proposed fill are performed, justifying a higher value. Likewise, soils outside the gradation range listed should be carefully evaluated and monitored.

c. Retained Fill

The key engineering properties required are strength and unit weight based on evaluation and testing of subsurface data. Friction angles (ϕ) and unit weight (γ_T) may be determined from either drained direct shear tests or consolidated drained triaxial tests. If undisturbed samples cannot be obtained, friction angles may be obtained from in-situ tests or by correlations with index properties. The strength properties are required for the determination of the coefficients of earth pressure used in design. In addition, the position of groundwater levels above the proposed base of construction must be determined in order to plan an appropriate drainage scheme. For most retained fills lower bound frictional strength values of 28 to 30 degrees are reasonable for granular and low plasticity cohesive soils. For highly plastic retained fills ($PI > 40$), even lower values would be indicated and should be evaluated for both drained and undrained conditions.

d. Electrochemical Properties

The design of buried steel elements of MSE structures is predicated on backfills exhibiting minimum or maximum electrochemical index properties and then designing the structure for maximum corrosion rates associated with these properties. These recommended index properties and their corresponding limits are shown in table 6.

Reinforced fill soils must meet the indicated criteria to be qualified for use in MSE construction using steel reinforcements.

Where geosynthetic reinforcements are planned, the limits for electrochemical criteria would vary depending on the polymer. Tentative limits, based on current research are shown in table 7.

Table 6. Recommended limits of electrochemical properties for backfills when using steel reinforcement.

| <u>Property</u> | <u>Criteria</u> | <u>Test Method</u> |
|-----------------|-----------------|--------------------|
| Resistivity | >3000 ohm-cm | AASHTO T-288-91 |
| pH | >5<10 | AASHTO T-289-91 |
| Chlorides | <100 PPM | AASHTO T-291-91 |
| Sulfates | <200 PPM | AASHTO T-290-91 |
| Organic Content | 1% max. | AASHTO T-267-86 |

Table 7. Recommended limits of electrochemical properties for backfills when using geosynthetic reinforcements.

| <u>Base Polymer</u> | <u>Property</u> | <u>Criteria</u> | <u>Test Method</u> |
|------------------------|-----------------|-----------------|--------------------|
| Polyester (PET) | pH | >3<9 | AASHTO T-289-91 |
| Polyolefin (PP & HDPE) | pH | >3 | AASHTO T-289-91 |

3.5 ESTABLISHMENT OF STRUCTURAL DESIGN PROPERTIES

The structural design properties of reinforcement materials are a function of geometric characteristics, strength and stiffness, durability, and material type. The two most commonly used reinforcement materials, steel and geosynthetics, must be considered separately as follows:

a. Geometric Characteristics

Two types can be considered:

- ! **Strips, bars, and steel grids.** A layer of steel strips, bars, or grids is characterized by the cross-sectional area, the thickness and perimeter of the reinforcement element, and the center-to-center horizontal distance between elements (for steel grids, an element is considered to be a longitudinal member of the grid that extends into the wall).
- ! **Geotextiles and geogrids.** A layer of geosynthetic strips is characterized by the width of the strips and the center-to-center horizontal distance between them. The cross-sectional area is not needed, since the strength of a geosynthetic strip is expressed by a tensile force per unit width, rather than by stress. Difficulties in measuring the thickness of these thin and relatively compressible materials preclude reliable estimates of stress.

The coverage ratio R_c is used to relate the force per unit width of discrete reinforcement to the force per unit width required across the entire structure.

$$R_c = b/S_h \quad (8)$$

where: b = the gross width of the strip, sheet or grid; and

S_h = center-to-center horizontal spacing between strips, sheets, or grids

($R_c = 1$ in the case of continuous reinforcement, i.e., each reinforcement layer covers the entire horizontal surface of the reinforced soil mass.)

b. Strength Properties

Steel Reinforcement

For steel reinforcements, the design life is achieved by reducing the cross-sectional area of the reinforcement used in design calculations by the anticipated corrosion losses over the design life period as follows:

$$E_c = E_n - E_R \tag{9}$$

where E_c is the thickness of the reinforcement at the end of the design life, E_n the nominal thickness at construction, and E_R the sacrificial thickness of metal expected to be lost by uniform corrosion during the service life of the structure.

The allowable tensile force per unit width of reinforcement, T_a , is obtained as follows:

$$T_a = 0.55 \frac{F_y A_c}{b} \tag{10}$$

for steel strips

and

$$T_a = 0.48 \frac{F_y A_c}{b} \tag{11}$$

for steel grids connected to concrete panels or blocks

(Note: $0.55 F_y$ may be used for steel grids with flexible facings)

- where:
- b = the gross width of the strip, sheet or grid
 - F_y = yield stress of steel
 - A_c = design cross section area of the steel, defined as the original cross section area minus corrosion losses anticipated to occur during the design life of the wall.

The allowable tensile stress for steel reinforcements and connections for permanent structures is developed in accordance with Article 10.32, in particular table 10.32.1A of AASHTO Standard Specifications for Highway Bridges. These requirements result in an allowable tensile stress for steel strip reinforcement, in the wall backfill away from the wall face connections, of $0.55 F_y$. The 0.55 factor applied to F_y for permanent structures accounts for uncertainties in structure geometry, fill properties, externally applied loads, the potential for local overstress due to load nonuniformities, and uncertainties in long-term reinforcement strength and is equivalent to a factor of safety of 1.82 (i.e. $1/0.55$). For grid reinforcing members connected to a rigid facing element (e.g., a concrete panel or block), the allowable

tensile stress is reduced to a $0.48 F_y$ providing an implied factor of safety of 2.08 to account for the greater potential for local overstress due to load nonuniformities for steel grids than for steel strips or bars. Transverse and longitudinal grid members are sized in accordance with ASTM A-185. For temporary structures (i.e., design lives of 3 years or less), AASHTO permits an increase to the allowable tensile stress by 40 percent.

The quantities needed for determination of A_c for steel strips and grids are shown in figure 20. Typical dimensions for common steel reinforcements are provided in appendix D. The use of hardened and otherwise low strain (very high strength) steels may increase the potential for catastrophic failure, therefore, a lower allowable material stress may be warranted with such materials.

For metallic reinforcement, the life of the structure will depend on the corrosion resistance of the reinforcement. Practically all the metallic reinforcements used in construction of embankments and walls, whether they are strips, bar mats, or wire mesh, are made of galvanized mild steel. Woven meshes with PVC coatings provide some corrosion protection, provided the coating is not significantly damaged during construction. Epoxy coatings can be used for corrosion protection, but are susceptible to construction damage, which can significantly reduce its effectiveness. When PVC or epoxy coatings are used, the maximum particle size of the backfill should be restricted to 19 mm ($\frac{3}{4}$ -inch) or less to reduce the potential for construction damage. For a more detailed discussion of requirements, refer to the Corrosion/Degradation document.

Several State transportation departments have used resin-bonded epoxy coated steel reinforcing elements. The effectiveness of these coatings in MSEW structures has not been sufficiently demonstrated and their widespread use cannot be presently endorsed. If used a minimum coating thickness of 0.41 mm (16 mils) is recommended applied in accordance with ASTM A-884 for grid reinforcement and AASHTO M-284 for strip reinforcement. Their in-ground life is presently estimated at 20 years. Where other metals, such as aluminum alloys or stainless steel have been used, corrosion, unexpectedly, has been a severe problem, and their use has been discontinued.

The in-ground degradation resistance of PVC coated mesh has not been sufficiently demonstrated. Anecdotal evidence of satisfactory performance in excess of 25 years does not exist.

Extensive studies have been made to determine the rate of corrosion of galvanized mild steel bars or strips buried in different types of soils commonly used in reinforced soil. Based on these studies, deterioration of steel strips, mesh, bars and mats can be estimated and accounted for by using increased metal thickness.

The majority of MSE walls constructed to date have used galvanized steel and backfill materials with low corrosive potential. A minimum galvanization coating of 0.61 kg/m^2 (2.0 oz/ft^2) or $86 \text{ }\mu\text{m}$ (3.4 mils) thickness applied in accordance with AASHTO M 111 (ASTM A 123) for strip type reinforcements or ASTM D 641 for bar mat or grid type steel

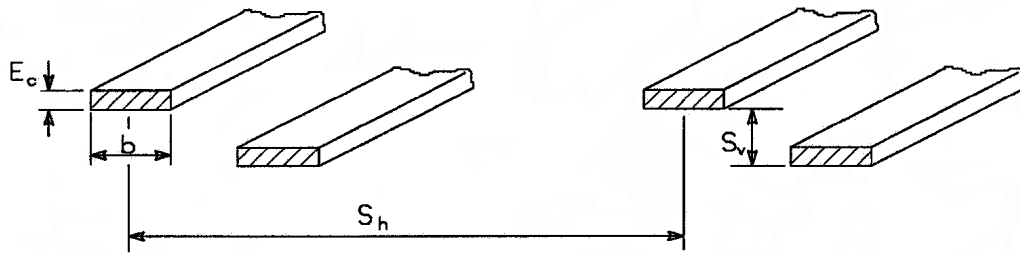

$$A_c = b E_c$$

E_c = strip thickness corrected for corrosion loss.

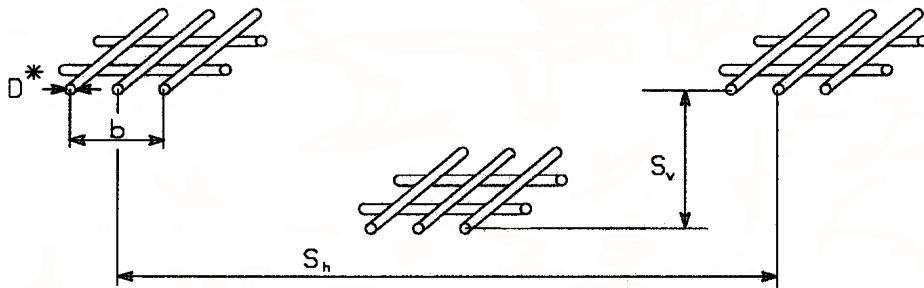

$$A_c = (\text{No. of longitudinal bars}) \cdot \pi \frac{D^*{}^2}{4}$$

D^* = diameter of bar or wire corrected for corrosion loss.

b = unit width of reinforcement (if reinforcement is continuous count number of bars for reinforcement width of 1 unit).

$$T_{\max} \leq T_a R_c = \frac{FS A_c F_y R_c}{b}$$

Where T_a = allowable long-term tensile strength of reinforcement (strength/unit reinforcement width)

FS = factor of safety (= 0.55 or 0.48)

F_y = yield strength of steel

R_c = reinforcement coverage ratio = $\frac{b}{S_h}$

Use $R_c = 1$ for continuous reinforcement (i.e., $S_h = b = 1$ unit width).

T_{\max} = maximum load applied to reinforcement (load/unit wall width).

Figure 20. Parameters for metal reinforcement strength calculations.

reinforcements is required, per AASHTO Standard Specifications for Highway Bridges. The zinc coating provides a sacrificial anode that corrodes while protecting the base metal. Galvanization also assists in preventing the formation of pits in the base metal during the first years of aggressive corrosion. After the zinc is oxidized (consumed), corrosion of the base metal starts.

The corrosion rates presented below are suitable for conservative design. **These rates assume a mildly corrosive backfill material having the controlled electrochemical property limits** that are discussed under electrochemical properties in this chapter.

Corrosion Rates - mildly corrosive backfill

For zinc/side

15 $\mu\text{m}/\text{year}$ (0.6 mils/yr) (first 2 years)

4 $\mu\text{m}/\text{year}$ (0.16 mils/yr) (thereafter)

For residual carbon steel/side

12 $\mu\text{m}/\text{year}$ (0.5 mils/yr) (thereafter)

Based on these rates, complete corrosion of galvanization with the minimum required thickness of 86 μm (3.4 mils) (AASHTO M 111) is estimated to occur during the first 16 years and a carbon steel thickness or diameter loss of 1.42 mm to 2.02 mm (0.055 in to 0.08 in) would be anticipated over the remaining years of a 75 to 100 year design life, respectively. The designer of an MSE structure should also consider the potential for changes in the reinforced backfill environment during the structure's service life. In certain parts of the United States, it can be expected that deicing salts might cause such an environment change. For this problem, the depth of chloride infiltration and concentration are of concern.

For permanent structures directly supporting roadways exposed to deicing salts, limited data indicate that the upper 2.5 m (8 ft) of the reinforced backfill (as measured from the roadway surface) are affected by higher corrosion rates not presently defined. Under these conditions, it is recommended that a 30 mil (minimum) geomembrane be placed below the road base and tied into a drainage system to mitigate the penetration of the deicing salts in lieu of higher corrosion rates as shown in the Design Details section in Chapter 4.

The following project situations lie outside the scope of the previously presented values:

- ! Structures exposed to a marine or other chloride-rich environment. (Excluding locations where de-icing salts are used.) For marine saltwater structures, carbon steel losses on the order of 80 μm (3.2 mils) per side should be anticipated in the first few years, reducing to 17 to 20 μm (0.67 to 0.7 mils) thereafter. Zinc losses are likely to be quite rapid as compared to losses in backfills meeting the MSE electrochemical criteria. Total loss of zinc (86 am) should be anticipated in the first year.
- ! Structures exposed to stray currents, such as from nearby underground power lines, and structures supporting or located adjacent to electrical railways.

Each of these situations creates a special set of conditions that should be specifically analyzed by a corrosion specialist.

Geosynthetic Reinforcement

Selection of T_a for geosynthetic reinforcement is more complex than for steel. The tensile properties of geosynthetics are affected by environmental factors such as creep, installation damage, aging, temperature, and confining stress. Furthermore, characteristics of geosynthetic products manufactured with the same base polymer can vary widely, and the details of polymer behavior for in-ground use are not completely understood. Ideally, T_a should be determined by thorough consideration of allowable elongation, creep potential and all possible strength degradation mechanisms.

Polymeric reinforcement, although not susceptible to corrosion, may degrade due to physicochemical activity in the soil such as hydrolysis, oxidation, and environmental stress cracking depending on polymer type. In addition, these materials are susceptible to installation damage and the effects of high temperature at the facing and connections. Temperatures can be as high as 50° C compared with the normal range of in-ground temperature of 12° C in cold and temperate climates to 30° C in arid desert climates.

Degradation most commonly occurs from mechanical damage, long-term time dependent degradation caused by stress (creep), deterioration from exposure to ultraviolet light, and chemical or biological interaction with the surrounding environment. Because of varying polymer types, quality, additives and product geometry, each geosynthetic is different in its resistance to aging and attack by different chemical and biological agents. Therefore, each product must be investigated individually.

Typically, polyester products (PET) are susceptible to aging strength reductions due to hydrolysis (water availability) and high temperatures. Hydrolysis and fiber dissolution are accelerated in alkaline regimes, below or near piezometric water levels or in areas of substantial rainfall where surface water percolation or capillary action ensures water availability over most of the year.

Polyolefin products (PP and HDPE) are susceptible to aging strength losses due to oxidation (contact with oxygen) and or high temperatures. The level of oxygen in reinforced fills is a function of soil porosity, ground water location and other factors, and has been found to be slightly less than oxygen levels in the atmosphere (21 percent). Therefore, oxidation of geosynthetics in the ground may proceed at an equal rate than those used above ground. Oxidation is accelerated by the presence of transition metals (Fe, Cu, Mn, Co, Cr) in the backfill as found in acid sulphate soils, slag fills, other industrial wastes or mine tailings containing transition metals. It should be noted that the resistance of polyolefin geosynthetics to oxidation is primarily a function of the proprietary antioxidant package added to the base resin, which differs for each product brand, even when formulated with the same base resin.

The relative resistance of polymers to these identified regimes is shown in table 8 and a choice can be made, therefore, consistent with the in-ground regimes indicated.

Most geosynthetic reinforcement is buried, and therefore ultraviolet (UV) stability is only of concern during construction and when the geosynthetic is used to wrap the wall or slope face. If used in exposed locations, the geosynthetic should be protected with coatings or facing units to prevent deterioration. Vegetative covers can also be considered in the case of open weave geotextiles or geogrids. Thick geosynthetics with ultraviolet stabilizers can be left exposed for several years or more without protection; however, long-term maintenance should be anticipated because of both UV deterioration and possible vandalism.

Damage during handling and construction, such as from abrasion and wear, punching and tear or scratching, notching, and cracking may occur in brittle polymer grids. These types of damage can only be avoided by care during handling and construction. Track type construction equipment should not travel directly on geosynthetic materials.

Damage during backfilling operations is a function of the severity of loading imposed on the geosynthetic during construction operations and the size and angularity of the backfill. For MSEW and RSS construction, light weight, low strength geotextiles should be avoided to minimize damage with ensuing loss of strength.

Table 8. Anticipated resistance of polymers to specific environments.

| <u>Soil Environment</u> | <u>Polymer</u> | | |
|------------------------------|----------------|-----------|-----------|
| | <u>PET</u> | <u>PE</u> | <u>PP</u> |
| Acid Sulphate Soils | NE | ? | ? |
| Organic Soils | NE | NE | NE |
| Saline Soils pH < 9 | NE | NE | NE |
| Calcareous Soils | ? | NE | NE |
| Modified Soils/Lime, Cement | ? | NE | NE |
| Sodic Soils, ph > 9 | ? | NE | NE |
| Soils with Transition Metals | NE | ? | ? |

NE = No Effect

? = Questionable Use, Exposure Tests Required

For geosynthetic reinforcements, the design life is achieved by developing an allowable design load which considers all time dependent strength losses over the design life period as follows:

$$T_a = \frac{T_{ULT}}{RF \cdot FS} = \frac{T_{al}}{FS} \quad (12)$$

where T_a is the design long-term reinforcement tension load for the limit state, T_{ULT} the ultimate geosynthetic tensile strength and RF is the product of all applicable reduction factors and FS the overall factor of safety. T_{al} is the long-term material strength or more specifically:

$$T_{al} = \frac{T_{ULT}}{RF_{CR} \cdot RF_D \cdot RF_{ID}} \quad (13)$$

where:

T_{al} = Long-term tensile strength on a load per unit width of reinforcing basis.

T_{ULT} = Ultimate (or yield) tensile strength from wide strip test (ASTM D 4595) for geotextiles and wide strip (ASTM D 4595) or single rib test (GR1:GG1) for geogrids (note, that the same test shall be used for definition of the geogrid creep reduction factor), based on minimum average roll value (MARV) for the product.

RF_{CR} = Creep Reduction Factor is the ratio of the ultimate strength (T_{ULT}) to the creep limit strength obtained from laboratory creep tests for each product. Typical ranges of reduction factors as a function of polymer type, are indicated below:

| <u>Polymer Type</u> | <u>Creep Reduction Factors</u> |
|---------------------------|--------------------------------|
| Polyester | 2.5 to 1.6 |
| Polypropylene | 5 to 4.0 |
| High Density Polyethylene | 5 to 2.6 |

RF_D = Durability reduction factor. It is dependent on the susceptibility of the geosynthetic to attack by microorganisms, chemicals, thermal oxidation, hydrolysis and stress cracking, and can vary typically from 1.1 to 2.0. The minimum reduction factor shall be 1.1.

RF_{ID} = Installation Damage reduction factor. It can range from 1.05 to 3.0, depending on backfill gradation and product mass per unit weight. The minimum reduction factor shall be 1.1 to account for testing uncertainties.

FS = Overall factor of safety to account for uncertainties in the geometry of the structure, fill properties, reinforcement properties, and externally applied loads. For permanent, MSEW structures only, a minimum factor of safety of 1.5 has been typically used (thus $T_a = T_{al} / 1.5$).

For RSS structures, it is taken as 1.0, as the required factor of safety, is accounted in the stability analysis (thus $T_a = T_{al}$).

T_{al} is typically obtained directly from the manufacturer. It typically includes reduction factors but does not include a design or material factor of safety, FS. The determination of reduction factors for each geosynthetic product require extensive field and/or laboratory testing, briefly summarized as follows:

Creep Reduction Factor, RF_{CR} .

The creep reduction factor is obtained from long term laboratory creep testing as detailed in appendix B. This reduction factor is required to limit the load in the reinforcement to a level known as the creep limit, that will preclude creep rupture over the life of the structure. Creep in itself does not degrade the strength of the polymer. Creep testing is essentially a constant load test on multiple product samples, loaded to various percentages of the ultimate product load, for periods of up to 10,000 hours. The creep reduction factor is the ratio of the ultimate load to the extrapolated maximum sustainable load (i.e., creep limit) within the design life of the structure (e.g., several years for temporary structures, 75 to 100 years for permanent structures).

For temporary structures, the maximum sustainable load is defined at a time equal to the temporary life of the structure.

Durability Reduction Factor, RF_D .

The protocol for testing to obtain this reduction factor have been proposed and are detailed in FHWA RD-97-144. In general, it consists of oven aging polyolefins (PP and HDPE) samples to accelerate oxidation and measure their strength reduction, as a function of time, temperature and oxygen concentration. This high temperature data must then be extrapolated to a temperature consistent with field conditions. For polyesters (PET) the aging is conducted in an aqueous media at varying pH's and relatively high temperature to accelerate hydrolysis, with data extrapolated to a temperature consistent with field conditions.

For more detailed explanations, see the companion Corrosion/Degradation document. The following recommendations are stated in this companion document in regards to defining a RF_D factor.

With respect to aging degradation, current research results suggest the following:

Polyester geosynthetics

PET geosynthetics are recommended for use in environments characterized by $3 < \text{pH} < 9$, only. The following reduction factors for PET aging (RF_D) are presently indicated for a 100 year design life in the absence of product specific testing:

Table 9. Aging reduction factors, PET.

| No. | Product* | Reduction factor, RF_D | |
|-------------------------------------------------------------------------------------------------------------------------|--------------------------------------------------------------------|---------------------------------|--------------------------------------------------------|
| | | $5 \leq \text{pH} \leq 8$ | $3 \leq \text{pH} \leq 5$ $8 \leq \text{pH} \leq 9$ |
| 1 | Geotextiles $M_n < 20,000$, $40 < \text{CEG} < 50$ | 1.6 | 2.0 |
| 2 | Coated geogrids, Geotextiles $M_n > 25,000$, $\text{CEG} < 30$ | 1.15 | 1.3 |
| M_n = number average molecular weight CEG = carboxyl end group | | | |
| * Use of materials outside the indicated pH or molecular property range requires specific product testing. | | | |

Polyolefin geosynthetics

To mitigate thermal and oxidative degradative processes, polyolefin products are stabilized by the addition of antioxidants for both processing stability and long term functional stability. These antioxidant packages are proprietary to each manufacturer and their type, quantity and effectiveness varies. Without residual antioxidant protection (after processing), PP products are vulnerable to oxidation and significant strength loss within a projected 75 to 100 year design life at 20°C. Current data suggests that unstabilized PP has a half life of less than 50 years.

Therefore the anticipated functional life of a PP geosynthetic is to a great extent a function of the type and remaining antioxidant levels, and the rate of subsequent antioxidant consumption. Antioxidant consumption is related to the oxygen content in the ground, which in fills is only slightly less than atmospheric.

At present, heat aging protocols for PP products, at full or reduced atmospheric oxygen, with subsequent numerical analysis are available for PP products which exhibit no initial cracks or crazes in their as manufactured state, typically monofilaments.⁽²⁴⁾ For PP products with initial crazes or cracks, typically tape products, or HDPE, heat aging testing protocols may change the nature of the product

and therefore may lead to erroneous results. Alternate testing protocols using oxygen pressure as a time accelerator are under study and development.

Since each product has a unique and proprietary blend of antioxidants, product specific testing is required to determine the effective life span of protection at the in-ground oxygen content. Limited data suggests that certain antioxidants are effective for up to 100 years in maintaining strength for in-ground use.

Installation Damage Reduction Factor, RF_{ID} .

Protocols for field testing for this reduction factor is detailed in the companion Corrosion/Degradation document and in ASTM D-5818. The protocol requires that the geosynthetic material is subjected to a backfilling and compaction cycle, consistent with field practice. The ratio of the initial strength, to the strength of retrieved samples defines this reduction factor. For reinforcement applications a minimum weight of 270 g/m^2 (7.9 oz/yd^2) for geotextiles is recommended to minimize installation damage. This roughly corresponds to a Class 1 geotextile as specified in AASHTO M-288-96.

The following recommendations are stated in this companion document in regards to defining a RF_{ID} factor. For more detailed explanations, see the companion Corrosion/Degradation document.

To account for installation damage losses of strength where full-scale product-specific testing is not available, Table 10 may be used with consideration of the project specified backfill characteristics. In absence of project specific data the largest indicated reduction factor for each geosynthetic type should be used.

Table 10. Installation damage reduction factors⁽³⁶⁾.

| Reduction Factor, RF_{ID} | | | |
|-----------------------------------------------|-----------------------------------------------|-------------------------------------------------------------------------------|-------------------------------------------------------------------------------|
| No. | Geosynthetic | Type 1 Backfill Max. Size 102mm D_{50} about 30mm | Type 2 Backfill Max. Size 20mm D_{50} about 0.7mm |
| 1 | HDPE uniaxial geogrid | 1.20 - 1.45 | 1.10 - 1.20 |
| 2 | PP biaxial geogrid | 1.20 - 1.45 | 1.10 - 1.20 |
| 3 | PVC coated PET geogrid | 1.30 - 1.85 | 1.10 - 1.30 |
| 4 | Acrylic coated PET geogrid | 1.30 - 2.05 | 1.20 - 1.40 |
| 5 | Woven geotextiles (PP&PET) ⁽¹⁾ | 1.40 - 2.20 | 1.10 - 1.40 |
| 6 | Non woven geotextiles (PP&PET) ⁽¹⁾ | 1.40 - 2.50 | 1.10 - 1.40 |
| 7 | Slit film woven PP geotextile ⁽¹⁾ | 1.60 - 3.00 | 1.10 - 2.00 |

⁽¹⁾ Minimum weight 270 g/m^2 (7.9 oz/yd^2)

Durability Reduction Factor, RF_D , at Wall Face Unit.

As noted in section 4.3.e Connection Strength, the long-term environmental aging factor (RF_D) may be significantly different than that used in computing the allowable reinforcement strength T_a . Of particular concern is the use of polyester geogrid and geotextile reinforcements with concrete facings because of the potential high pH environment. It is recommended that the use of polyesters be limited to a pH range of > 3 and < 9 , as noted in table 7.

It is also noted in Section 4.3.e, that PET geogrids and geotextiles should not be cast into concrete for connections, due to potential chemical degradation. Use of PET reinforcements connected to dry-cast MBW units by laying the reinforcement between units may be subject to additional strength reductions.

An FHWA sponsored field monitoring study to examine pH conditions within and adjacent to MBW units has been concluded.⁽³⁵⁾ This study provided a large database of pH measurements of 25 MSEW structures in the United States.

The results indicated that the pH regime within the blocks in the connection zone is only occasionally above 9 and then for only the first few years. The pH subsequently decreases to the pH of the ambient backfill.⁽³⁵⁾ It therefore appears that for coated PET geogrids no further reduction is warranted. For geotextiles a small further reduction should be considered to account for a few years at a pH in excess of 9.

Caution is advised in situations where the MBW units will be saturated for extended periods of time such as structures in lakes or streams. For such cases, long-term pH tests should be performed on saturated block and if the pH exceeds 9, polyester reinforcements should not be used in the section of the structure.

Factor of Safety, FS.

This is a global factor of safety which accounts for uncertainties in externally applied loads, structure geometry, fill properties, potential for local overstress due to load nonuniformity and uncertainties in long-term reinforcement strength. For limit state conditions, a F.S. of 1.5 has been traditionally used. This is lower than the implied current F.S. of 1.82 ($1/0.55 F_y$) for steel reinforcements due to the ductile nature of geosynthetics systems versus the brittle nature of steel systems at failure.

The recommended F.S. of 1.5 can be further justified by considering the following:

- ! For geosynthetic reinforcements, the backfill soil controls the amount of strain in the reinforcement which for granular backfills is limited to considerably less than the rupture strain of the reinforcement. Therefore even at a limit state, overstress of the geosynthetic reinforcement would cause visible time dependent strain in the wall system rather than sudden collapse.
- ! The long-term properties of geosynthetics, based on limited data, are significantly improved when confined in soil. Confinement is presently not considered in developing allowable strength.
- ! Measurement of stress levels in structures, has consistently indicated lower stress levels than used for design as developed in chapter 4.

For preliminary design of permanent structures or for applications defined by the user as not having severe consequences should poor performance or failure occur, the allowable tensile strength T_a , may be evaluated without product specific data, as:

$$T_a = \frac{T_{ULT}}{7 \cdot FS} \quad (14)$$

Further, this reduction factor $RF = 7$, should be limited to projects where the project environment meets the following requirements:

- ! Granular soils (sands, gravels) used in the reinforced volume.
- ! $4.5 \leq \text{pH} \leq 9$
- ! Site temperature $< 30^\circ \text{C}$
- ! Maximum backfill particle size of 19 mm
- ! Maximum MSEW height is 10 m (33 ft) and
- ! Maximum RSS height is 15 m (50 ft)

Site temperature is defined as the temperature which is halfway between the average yearly air temperature and normal daily air temperature for the highest month at the site.

The total reduction factor of 7 has been established by multiplying lower bound partial reduction factors obtained from currently available test data, for products which meet the minimum requirements in table 11.

It should be noted that the total Reduction Factor may be reduced significantly with appropriate test data. It is not uncommon for products with creep, installation damage and aging data, to develop total Reduction Factors in the range of 3 to 6.

For temporary applications not having severe consequences should poor performance or failure occur, a default value for RF of 3 rather than 7 could be considered.

Serviceability

Serviceability requirements for geosynthetic reinforcements are met through the use of low allowable stress levels resulting from reduction factors combined with the inherent constraining effects of granular soils. With regard to strain limits on the reinforcement, methods for determination of strain vary widely with no present consensus on an appropriate analytical method capable of modeling strains in the structure. Measurements from instrumented field structures have consistently measured much lower strain levels in the reinforcement (typically less than 1 percent) than predicted by most current analytical methods. *Therefore, until an appropriate method of determination is agreed upon, it is recommended that strain limit requirements not be imposed on the reinforcement.*

Table 11. Minimum requirements for use of default reduction factors for primary geosynthetic reinforcement.

| Type | Property | Test Method | Criteria to Allow Use of Default RF |
|---------------|---------------------------------------------|--------------------------------------------------------------------------------------------------------------------|------------------------------------------------------------|
| Polypropylene | UV Oxidation Resistance | ASTM D-4355 | Min. 70% strength retained after 500 hrs. in weatherometer |
| Polyethylene | UV Oxidation Resistance | ASTM D-4355 | Min. 70% strength retained after 500 hrs. in weatherometer |
| Polyester | Hydrolysis Resistance | Inherent Viscosity Method (ASTM D-4603) with Correlation or Determine Directly Using Gel Permeation Chromatography | Min. Number (Mn) Molecular Weight of 25,000 |
| Polyester | Hydrolysis Resistance | GRI GG7 | Max. Carboxyl End Group Number of 30 |
| All Polymers | Survivability | Weight per Unit Area, ASTM D-5261 | Min. 270 g/m ² (7.9 oz/yd ²) |
| All Polymers | % Post Consumer Recycled Material by Weight | Certification of Material used | Maximum 0% |

[BLANK]

CHAPTER 4

DESIGN OF MSE WALLS

This chapter details general and simplified design guidelines common to all MSEW systems. It is limited to MSE walls having a near-vertical face, and uniform length reinforcements. Design guidelines for complex structures, or structures with unusual features are covered in chapter 5.

This chapter is organized sequentially as follows:

- ! Overview of design methods.
- ! Sizing for external stability.
- ! Sizing for internal stability.
- ! Design details.
- ! Design example.

4.1 DESIGN METHODS

Since the development of soil reinforcement concepts and their application to MSEW structure design, a number of design methods have been proposed, used, and refined. Current practice consists of determining the geometric and reinforcement requirements to prevent internal and external failure using limit equilibrium methods of analysis.

External stability evaluations for MSEW structures treat the reinforced section as a composite homogeneous soil mass and evaluate the stability according to conventional failure modes for gravity type wall systems. Differences in the present practice exist for internal stability evaluations which determines the reinforcement required, principally in the development of the internal lateral stress and the assumption as to the location of the most critical failure surface.

Internal stability is treated as a response of discrete elements in a soil mass. This suggests that deformations are controlled by the reinforcements rather than total mass, which appears inconsistent given the much greater volume of soil in such structures. Therefore, deformation analyses are generally not included in current methods.

Given the availability of different methods and research in the last decade, general agreement has been reached that a complete design approach should consist of the following:

- ! Working Stress analyses.

! Limit Equilibrium analyses.

! Deformation Evaluations.

a. Analysis of Working Stresses for MSEW Structures

An analysis of working stresses consists of:

- Selection of reinforcement location and a check that stresses in the stabilized soil mass are compatible with the properties of the soil and inclusions.
- Evaluation of local stability at the level of each reinforcement and prediction of progressive failure.

b. Limit Equilibrium Analysis

A limit equilibrium analysis consists of a check of the overall stability of the structure. The types of stability that must be considered are external, internal, and combined:

- External stability involves the overall stability of the stabilized soil mass considered as a whole and is evaluated using slip surfaces outside the stabilized soil mass.
- Internal stability analysis consists of evaluating potential slip surfaces within the reinforced soil mass.
- In some cases, the critical slip surface is partially outside and partially inside the stabilized soil mass, and a combined external/internal stability analysis may be required.

c. Deformation Evaluations

A deformation response analysis allows for an evaluation of the anticipated performance of the structure with respect to horizontal and vertical displacement. In addition, the influence and variations in the type of reinforcement on the performance of the structure can be evaluated. Horizontal deformation analyses are the most difficult and least certain of the performed analyses. In many cases, they are done only approximately or it is simply assumed that the usual factors of safety against external or internal stability failure will ensure that deformations will be within tolerable limits. Vertical deformation analyses are obtained from conventional settlement computations, with particular emphasis on differential settlements, longitudinally along the wall face, and transversely from the face to the end of the reinforced soil volume. The results may impact the choice of facing, facing connections or backfilling sequences.

d. Design Methods, Inextensible Reinforcements

The current method of limit equilibrium analysis uses a coherent gravity structure approach to determine external stability of the whole reinforced mass, similar to the analysis for any conventional or traditional gravity structure. For internal stability evaluations, it considers a bi-linear critical slip surface that divides the reinforced mass in active and resistant zones and requires that an equilibrium state be achieved for successful design.

The state of stress for **external stability**, is assumed to be equivalent to a Coulomb state of stress with a wall friction angle δ equal to zero. For **internal stability** a variable state of stress varying from a multiple of K_a to an active earth pressure state, K_a are used for design. Recent research (FHWA RD 89-043) has focused on developing the state of stress for internal stability, as a function of K_a , type of reinforcement used (geotextile, geogrid, metal strip or metal grid), and depth from the surface. The results from these efforts have been synthesized in a *simplified coherent gravity method*, which will be used throughout this manual.

e. Design Methods, Extensible Reinforcements

For **external stability** calculations, the current method assumes an earth pressure distribution, consistent with the method used for inextensible reinforcements.

For **internal stability** computations using the *simplified coherent gravity method*, the internal coefficient of earth pressure is again a function of the type of reinforcement, where the minimum coefficient (K_a) is used for walls constructed with continuous sheets of geotextiles and geogrids. For internal stability, a Rankine failure surface is considered, because the extensible reinforcements can elongate more than the soil, before failure.

4.2 SIZING FOR EXTERNAL STABILITY

As with classical gravity and semigravity retaining structures, four potential external failure mechanisms are usually considered in sizing MSE walls, as shown in figure 21. They include:

- ! Sliding on the base.
- ! Limiting the location of the resultant of all forces (overturning).
- ! Bearing capacity.
- ! Deep seated stability (rotational slip-surface or slip along a plane of weakness).

Due to the flexibility and satisfactory field performance of MSE walls, the adopted values for the factors of safety for external failure are in some cases lower than those used for reinforced concrete cantilever or gravity walls. For example, the factor of safety for overall bearing capacity is 2.5 rather than a higher value, which is used for more rigid structures.

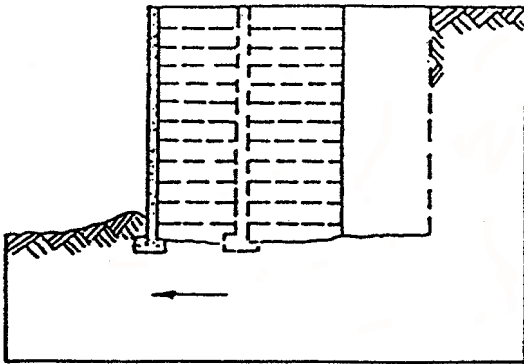

(a) Sliding

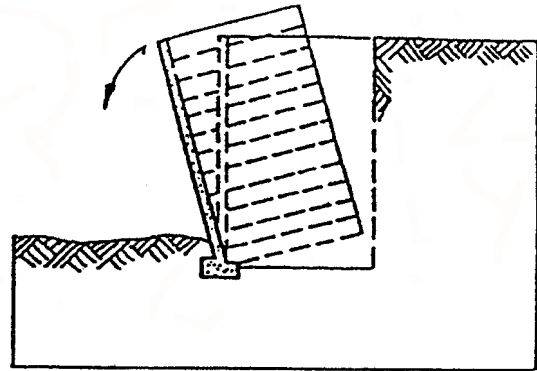

(b) Overturning (eccentricity)

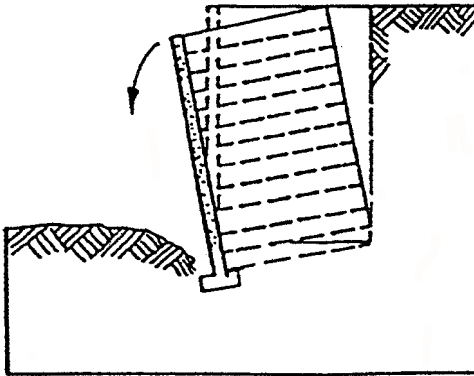

(c) Bearing capacity

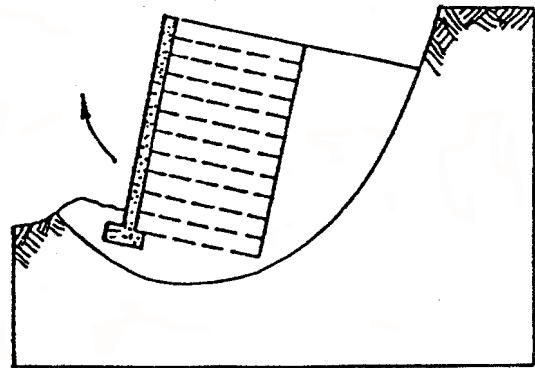

(d) Deep seated stability (Rotational)

Figure 21. Potential external failure mechanisms for a MSE wall.

Likewise, the flexibility of MSE walls should make the potential for overturning failure highly unlikely. However, overturning criteria (maximum permissible eccentricity) aid in controlling lateral deformation by limiting tilting and, as such, should always be satisfied.

External stability computational sequences are schematically illustrated as follows:

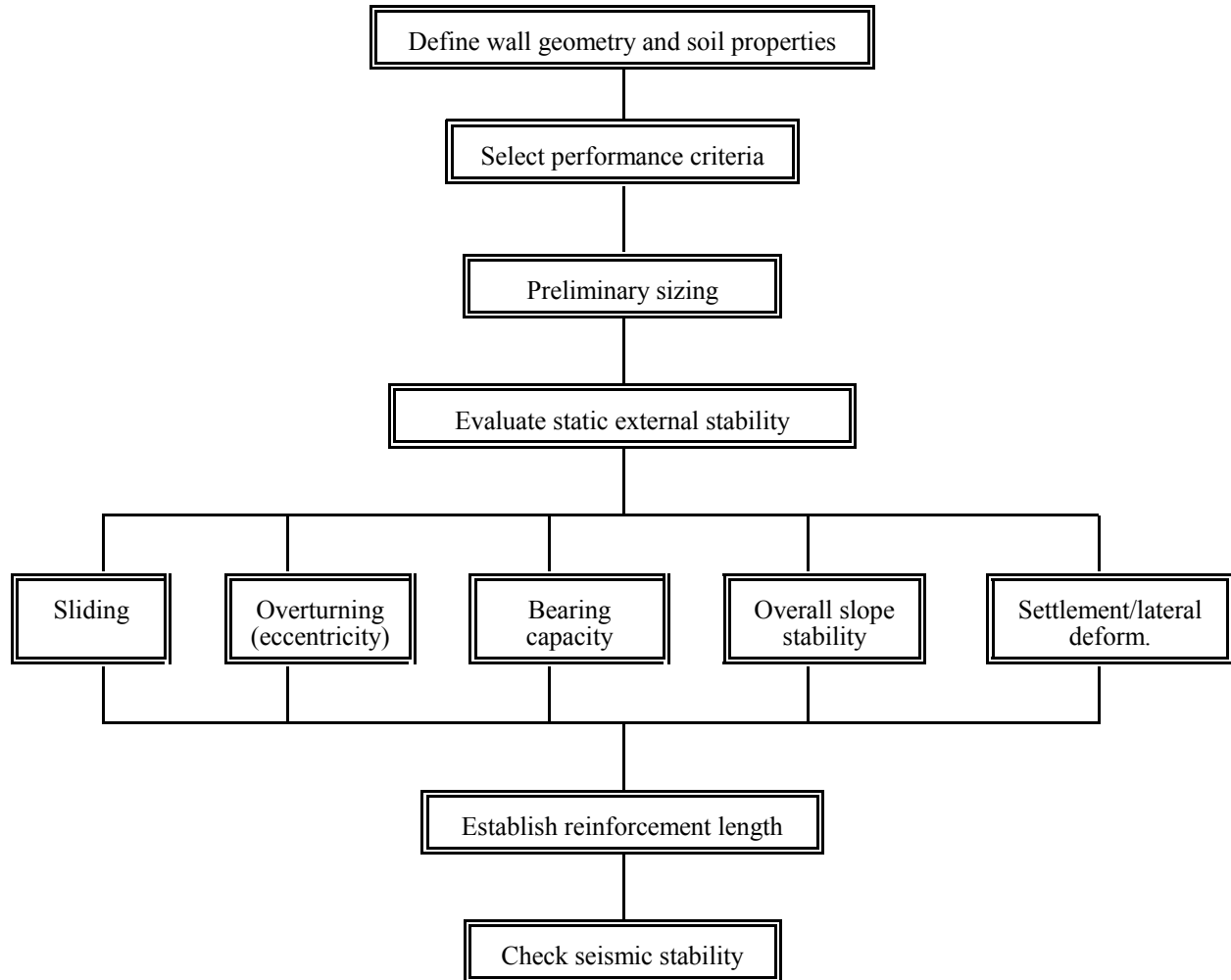

Each of the sequential steps are discussed as follows:

a. Define wall geometry and soil properties

The following must be defined or established by the designer:

- ! Wall height, batter.
- ! Soil surcharges, live load surcharges, dead load surcharges, etc.
- ! Seismic loads.

- ! Engineering properties of foundation soils (γ , c , ϕ).
- ! Engineering properties of the reinforced soil volume (γ , c , ϕ).
- ! Engineering properties of the retained fill (γ , c , ϕ).
- ! Groundwater conditions.

b. Select performance criteria

The chosen performance criteria should reflect site conditions and agency or AASHTO code requirements, which are discussed in detail in chapters 2 and 3.

- ! External stability factors of safety (Sliding, bearing capacity location of resultant force).
- ! Global stability factor of safety.
- ! Maximum differential settlement.
- ! Maximum horizontal displacement.
- ! Seismic stability factor of safety.
- ! Design life.

c. Preliminary Sizing

The process of sizing the structure begins by adding the required embedment, established under Project Criteria (Section 2.7.c), to the wall height in order to determine the design heights for each section to be investigated. Since the structure is constructed from the bottom up, this condition may prevail at least to the end of construction.

A preliminary length of reinforcement is chosen that should be greater of $0.7H$ and 2.5 m, where H is the design height of the structure. Structures with sloping surcharge fills or other concentrated loads, as in abutment fills, generally require longer reinforcements for stability, often on the order of $0.8H$ to as much as $1.1H$. Special structures with lesser reinforcement lengths at the base are covered in chapter 5.

d. Earth Pressures for External Stability

Stability computations for walls with a vertical face are made by assuming that the MSE wall mass acts as a rigid body with earth pressures developed on a vertical pressure plane arising from the back end of the reinforcements, as shown in figures 23 to 25.

The active coefficient of earth pressure is calculated for vertical walls (defined as walls with a face batter of less than 8 degrees) and a horizontal backslope from:

$$K_a = \tan^2 \left(45 - \frac{\phi}{2} \right) \quad (15)$$

for vertical wall with a surcharge slope from:

$$K_a = \cos \beta \left[\frac{\cos \beta - \sqrt{\cos^2 \beta - \cos^2 \phi}}{\cos \beta + \sqrt{\cos^2 \beta - \cos^2 \phi}} \right] \quad (16)$$

where β = surcharge slope angle.

For broken back surcharge conditions, the angle I (see figure 25) is substituted for the infinite surcharge slope angle β .

For an inclined front face equal or greater than 8 degrees, the coefficient of earth pressure can be calculated from the general Coulomb case as:

$$K_a = \frac{\sin^2 (\theta + \phi)}{\sin^2 \theta \sin(\theta - \delta) \left[1 + \sqrt{\frac{\sin(\phi + \delta) \sin(\phi - \beta)}{\sin(\theta - \delta) \sin(\theta + \beta)}} \right]^2} \quad (17)$$

where θ is the face inclination from a horizontal, and β the surcharge slope angle as shown in figure 22. The wall friction angle δ is assumed to be equal to a maximum of β , but less than or equal to ϕ .

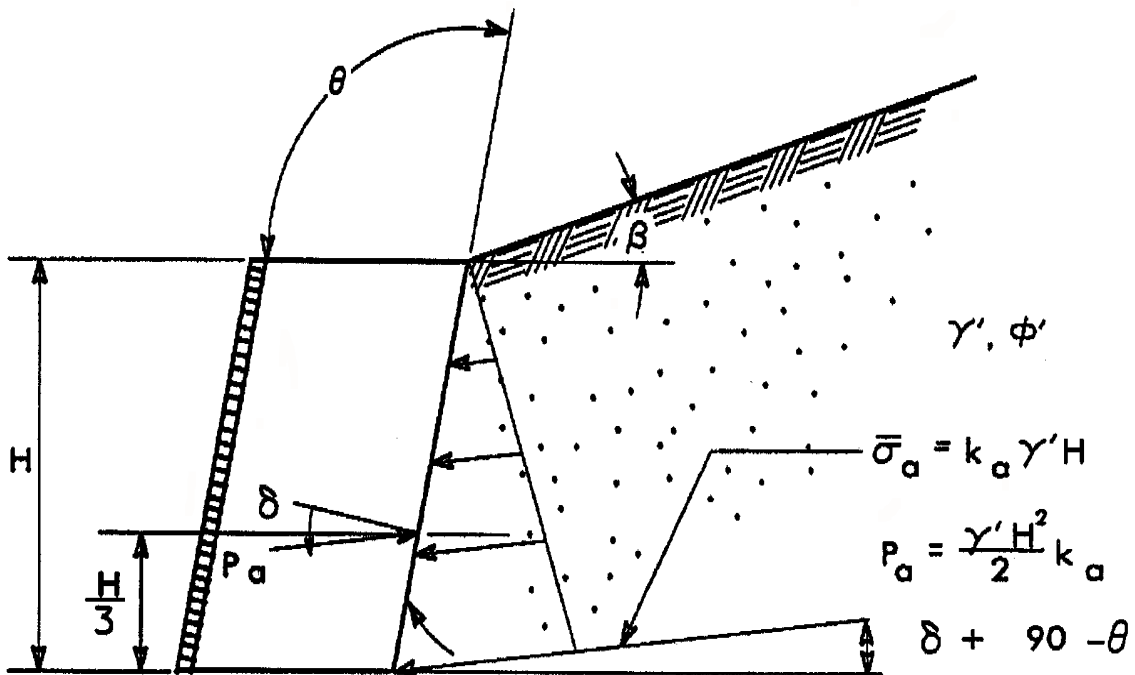

$$k_a = \frac{\sin^2 (\theta + \phi')}{\sin^2 \theta \sin (\theta - \delta) \left[1 + \sqrt{\frac{\sin (\phi' + \delta) \sin (\phi' - \beta)}{\sin (\theta - \delta) \sin (\theta + \beta)}} \right]^2}$$

γ' = EFFECTIVE UNIT WEIGHT

ϕ' = EFFECTIVE ANGLE OF INTERNAL FRICTION

δ = ANGLE OF WALL FRICTION

ALL ANGLES ARE POSITIVE (+) AS SHOWN

Figure 22. Computational procedures for active earth pressures (Coulomb analysis).

Horizontal Backslope With Traffic Surcharge

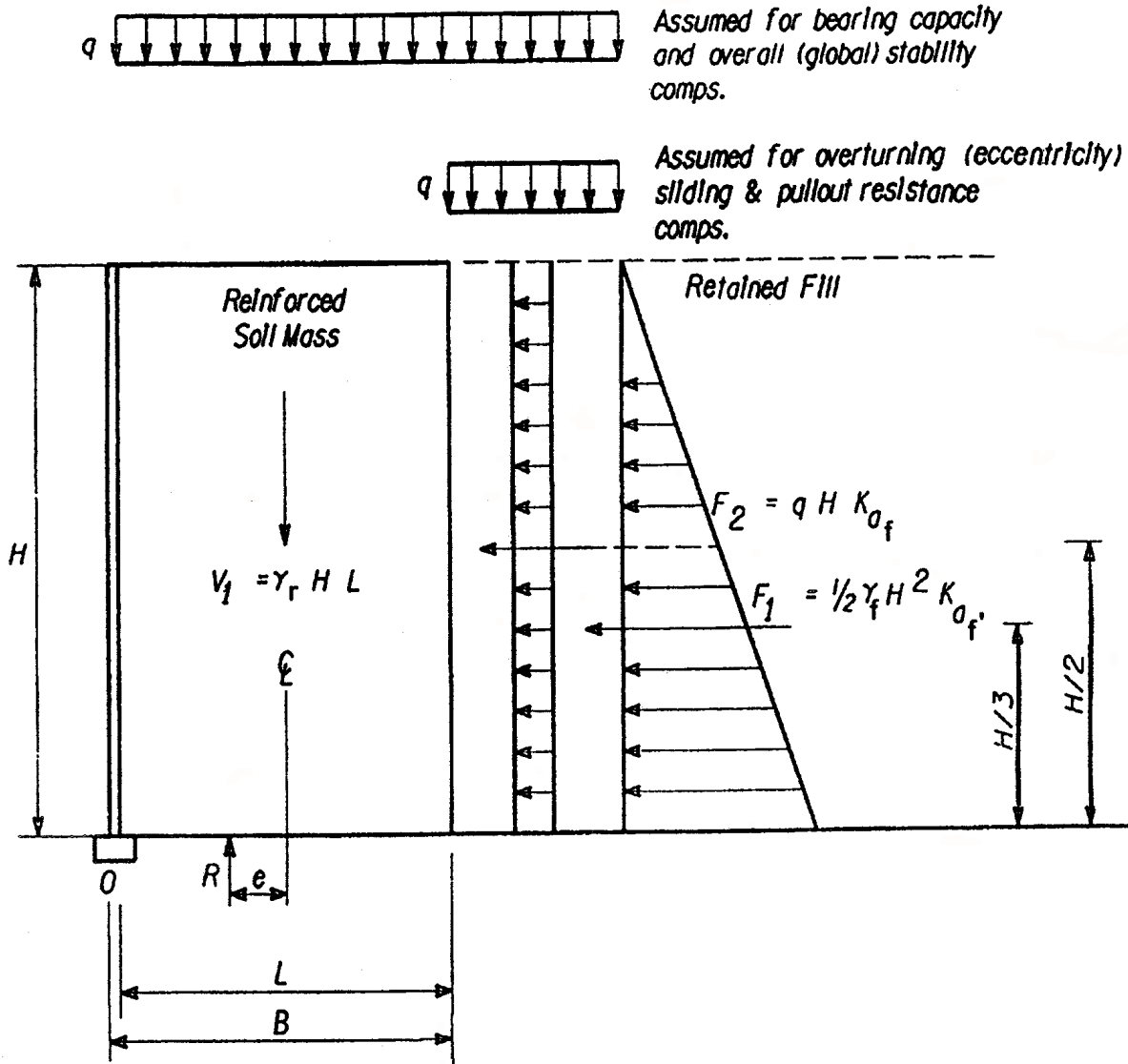

where: e = Eccentricity R = Resultant of vertical forces ($V_1 + qL$)
 q = Traffic surcharge

Figure 23. External analysis: earth pressures/eccentricity; horizontal backslope with traffic surcharge.

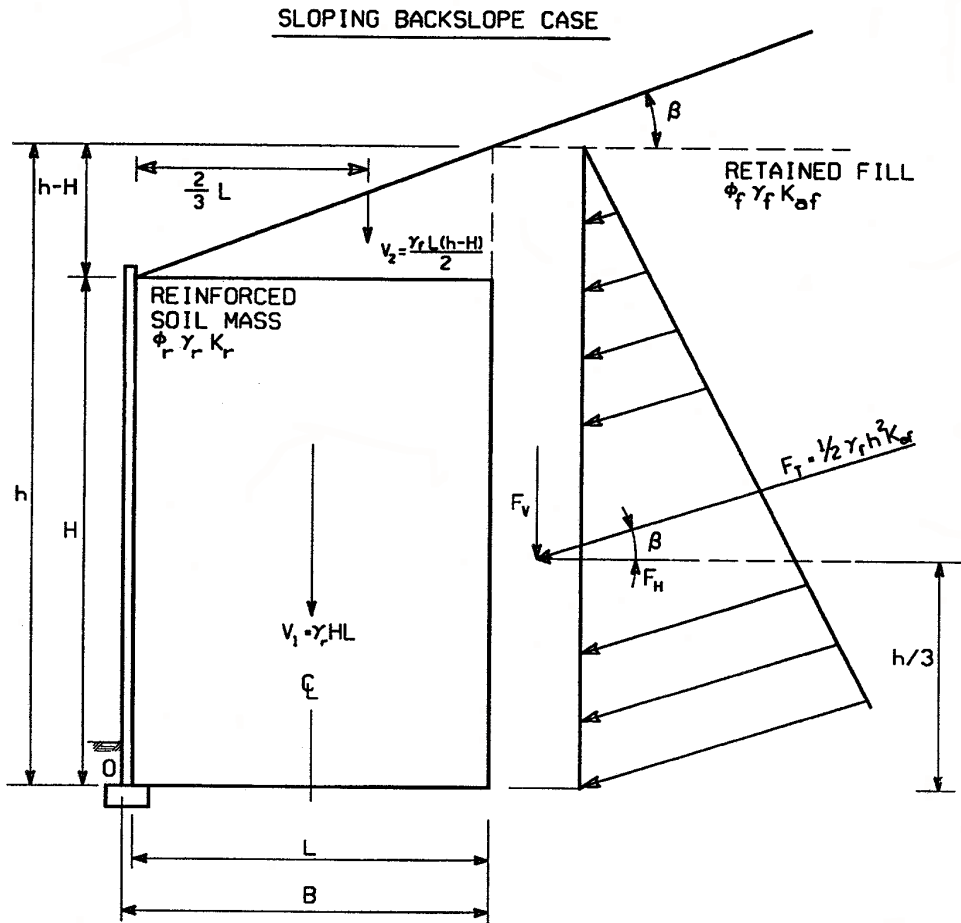

Note: For relatively thick facing elements (e.g., segmental concrete facing blocks) it may be desirable to include the facing dimensions and weight in sliding and overturning calculations (i.e. use "B" in lieu of "L").

Figure 24. External analysis: earth pressure/eccentricity; sloping backfill case.

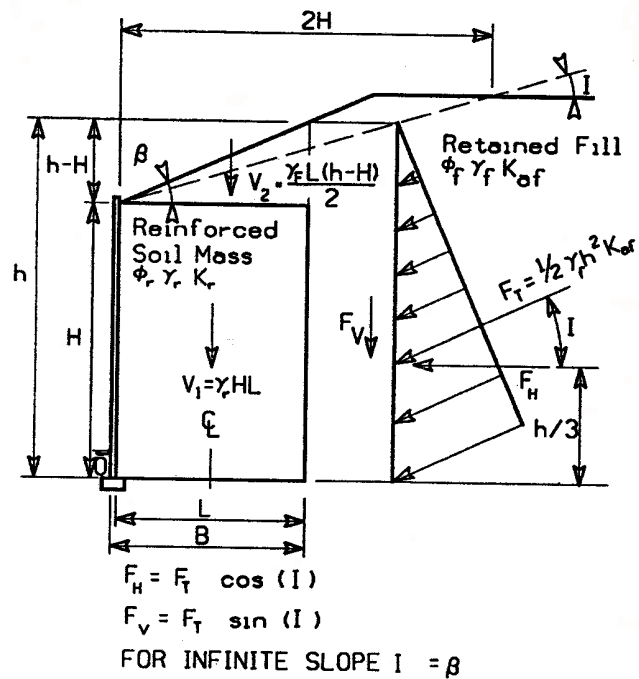

K_o For Retained Fill Using $\delta = \beta = I$

$$K_o = \frac{\sin^2(\theta + \phi')}{\sin^2 \theta \sin(\theta - \delta) \left[1 + \frac{\sin(\phi' + \delta) \sin(\phi' - I)}{\sin(\theta - \delta) \sin(\theta + I)} \right]^2}$$

Note: For relatively thick facing elements (e.g., segmental concrete facing blocks) it may be desirable to include the facing dimensions and weight in sliding and overturning calculations (i.e. use "B" in lieu of "L").

Figure 25. External analysis: earth pressure/eccentricity; broken backslope case.

Vertical Pressure Computations

Computations for vertical stresses at the base of the wall defined by the height h are shown on figure 26. It should be noted that the weight of any wall facing is typically neglected in the calculations. Calculation steps for the determination of a vertical bearing stress are:

(1) Calculate $F_T = \frac{1}{2} K_{af(\phi, \beta)} \gamma_f h^2$ (18)

- (2) Calculate eccentricity, e , of the resulting force on the base by summing the moments of the mass of the reinforced soil section about the center line of mass. Noting that R in figure 26 must equal the sum of the vertical forces on the reinforced fill, this condition yields:

$$e = \frac{F_T (\cos\beta) h/3 - F_T (\sin\beta) L/2 - V_2 (L/6)}{V_1 + V_2 + F_T \sin\beta} \quad (19)$$

- (3) e must be less than $L/6$ in soil or $L/4$ in rock. If e is greater, than a longer length of reinforcement is required.

- (4) Calculate the equivalent uniform vertical stress on the base, σ_v :

$$\sigma_v = \frac{V_1 + V_2 + F_T \sin \beta}{L - 2e} \quad (20)$$

This approach, proposed originally by Meyerhof, assumes that eccentric loading results in a uniform redistribution of pressure over a reduced area at the base of the wall. This area is defined by a width equal to the wall width less twice the eccentricity as shown in figure 26.

- (5) Add the influence of surcharge and concentrated loads to σ_v , where applicable.

e. Sliding Stability

Check the preliminary sizing with respect to sliding at the base layer, which is the most critical depth as follows:

$$FS_{sliding} = \frac{\sum \text{horizontal resisting forces}}{\sum \text{horizontal driving forces}} = \frac{\sum P_R}{\sum P_d} \geq 1.5 \quad (21)$$

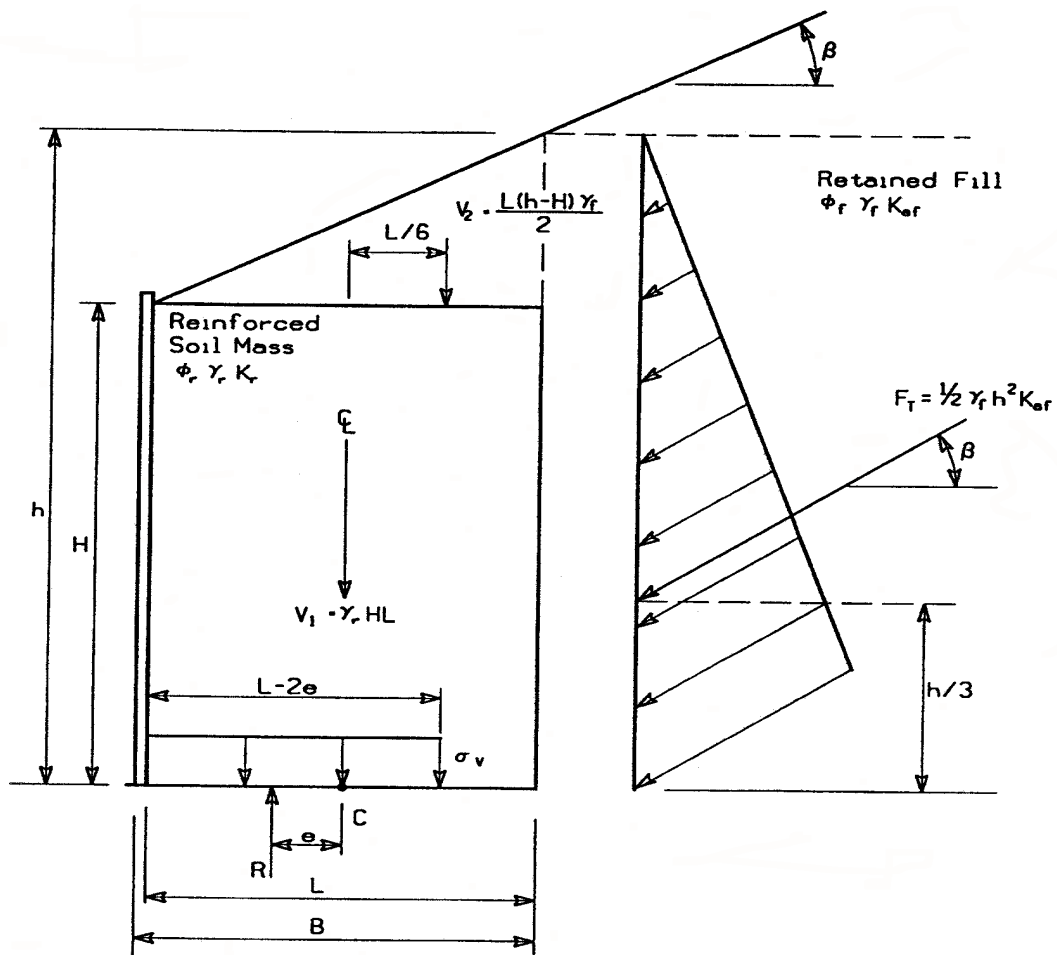

R = Resultant of vertical forces

Note: For relatively thick facing elements (e.g., segmental concrete facing blocks) it may be desirable to include the facing dimensions and weight in bearing capacity calculations (i.e., use "B" in lieu of "L").

Figure 26. Calculation of vertical stress σ_v at the foundation level.

where the resisting force is the lesser of the shear resistance along the base of the wall or of a weak layer near the base of the MSE wall, and the sliding force is the horizontal component of the thrust on the vertical plane at the back of the wall (see figures 23 through 25).

Note that any soil passive resistance at the toe due to embedment is ignored due to the potential for the soil to be removed through natural or manmade processes during its service life (e.g. erosion, utility installation, etc.). The shear strength of the facing system is also conservatively neglected.

Additional surcharge loads may include live and dead load surcharges.

The calculation steps for an MSE wall with a sloping surcharge are (figure 26):

$$(1) \text{ Calculate thrust } F_T = K_{af(\phi, \beta)} \frac{1}{2} \gamma_f h^2 \quad (22)$$

$$\text{where } h = H + L \tan \beta \quad (23)$$

(2) Calculate the driving force:

$$P_d = F_H = F_T \cos \beta. \quad (24)$$

(3) Determine the most critical frictional properties at the base. Choose the minimum ϕ for three possibilities:

- Sliding along the foundation soil, if its shear strength (c_f, ϕ_f) is smaller than that of the backfill material.
- Sliding along the reinforced backfill (ϕ_r).
- For sheet type reinforcement, sliding along the weaker of the upper and lower soil-reinforcement interfaces. The soil-reinforcement friction angle ρ , should preferably be measured by means of interface direct shear tests. Alternatively, it may be taken as $\rho \tan \phi$.

(4) Calculate the resisting force per unit length of wall:

$$P_R = (V_1 + V_2 + F_T \sin \beta) \cdot \mu \quad (25)$$

where

$$\mu = \min [\tan \phi_f, \tan \phi_r, \text{ or (for continuous reinforcement) } \tan \rho]$$

The effect of external loadings on the MSE mass, which increases sliding resistance, should only be included if the loadings are permanent. For example, live load traffic surcharges should be excluded.

(5) Calculate the factor of safety with respect to sliding and check if it is greater than the required value, using equation 21.

(6) If Not:

- Increase the reinforcement length, L , and repeat the calculations.

f. Bearing Capacity Failure

Two modes of bearing capacity failure exist, general shear failure and local shear failure. Local shear is characterized by a "squeezing" of the foundation soil when soft or loose soils exist below the wall.

! General Shear

To prevent bearing capacity failure, it is required that the vertical stress at the base calculated with the Meyerhof-type distribution, as discussed in (d) above, does not exceed the allowable bearing capacity of the foundation soil determined, considering a safety factor of 2.5 with respect to Group I loading applied to the ultimate bearing capacity:

$$\sigma_v \leq q_a = \frac{q_{ult}}{FS} \quad (26)$$

A lesser FS of 2.0 could be used if justified by a geotechnical analysis which calculates settlement and determines it to be acceptable.

Calculation steps for an MSE wall with a *sloping surcharge* are as follows:

(1) Obtain the eccentricity e of the resulting force at the base of the wall. Remember that under preliminary sizing if the eccentricity exceeded $L/6$, the reinforcement length at the base was increased.

(2) Calculate the vertical stress σ_v at the base assuming Meyerhof-type distribution:

$$\sigma_v = \frac{V_1 + V_2 + F_T \sin\beta}{L - 2e} \quad (27)$$

(3) Determine the ultimate bearing capacity q_{ult} using classical soil mechanics methods, e.g. for a level grade in front of the wall and no groundwater influence:

$$q_{ult} = c_f N_c + 0.5 (L)\gamma_f N_\gamma \quad (28)$$

where c_f is the cohesion, γ_f the unit weight and N_c and N_γ are dimensionless bearing capacity coefficients. The dimensionless bearing capacity factors can be obtained from 4.4.7.1A of 1996 AASHTO and, for convenience, are shown in table 12. Modifications to q_{ult} (equation 28) for a ground surface slope and for high groundwater level are provided in 4.4.7.1.1.4 and 4.4.7.1.1.6, respectively, of 1996 AASHTO. Again, the beneficial effect of wall embedment is neglected. (Note: for excessive embedment, some partial embedment may be considered in the determination of q_{ult} . Bearing capacity is addressed in detail in the NHI course 132037 Shallow Foundations and course reference manual.

(4) Check that:

$$\sigma_v \leq q_a = q_{ult} / FS \quad (26)$$

(5) As indicated in step (2) and step (3), σ_v can be decreased and q_{ult} increased by lengthening the reinforcements. If adequate support conditions cannot be achieved or lengthening reinforcements significantly increases costs, improvement of the foundation soil is needed (dynamic compaction, soil replacement, stone columns, precompression) etc.

! Local Shear

To prevent large horizontal movements of the structure on weak cohesive soils:

$$\gamma H \leq 3c \quad (29)$$

If adequate support conditions cannot be achieved, ground improvement of the foundation soils is indicated.

g. Overall Stability

Overall stability is determined using rotational or wedge analyses, as appropriate, which can be performed using a classical slope stability analysis method. Computer programs are available for these analyses as illustrated by the design example at the end of this chapter. The reinforced soil wall is considered as a rigid body and only failure surfaces completely outside a reinforced mass are considered. For simple structures with rectangular geometry, relatively uniform reinforcement spacing, and a near vertical face, compound failures passing both through the unreinforced and reinforced zones will not generally be critical. **However, if complex conditions exist such as changes in reinforced soil types or reinforcement lengths, high surcharge loads, sloping faced structures, significant slopes at the toe or above the wall, or stacked structures, compound failures must be considered.**

If the minimum safety factor is less than the usually recommended minimum FS of 1.3, increase the reinforcement length or improve the foundation soil.

Table 12. Bearing Capacity Factors

| ϕ | N_c | N_q | N_γ | ϕ | N_c | N_q | N_γ |
|--------|-------|-------|------------|--------|--------|--------|------------|
| 0 | 5.14 | 1.00 | 0.00 | 26 | 22.25 | 11.85 | 12.54 |
| 1 | 5.38 | 1.09 | 0.07 | 27 | 23.94 | 13.20 | 14.47 |
| 2 | 5.63 | 1.20 | 0.15 | 28 | 25.80 | 14.72 | 16.72 |
| 3 | 5.90 | 1.31 | 0.24 | 29 | 27.86 | 16.44 | 19.34 |
| 4 | 6.19 | 1.43 | 0.34 | 30 | 30.14 | 18.40 | 22.40 |
| 5 | 6.49 | 1.57 | 0.45 | 31 | 32.67 | 20.63 | 25.90 |
| 6 | 6.81 | 1.72 | 0.57 | 32 | 35.49 | 23.18 | 30.22 |
| 7 | 7.16 | 1.88 | 0.71 | 33 | 38.64 | 26.09 | 35.19 |
| 8 | 7.53 | 2.06 | 0.86 | 34 | 42.16 | 29.44 | 41.06 |
| 9 | 7.92 | 2.25 | 1.03 | 35 | 46.12 | 33.30 | 48.03 |
| 10 | 8.35 | 2.47 | 1.22 | 36 | 50.59 | 37.75 | 56.31 |
| 11 | 8.80 | 2.71 | 1.44 | 37 | 55.63 | 42.92 | 66.19 |
| 12 | 9.28 | 2.97 | 1.69 | 38 | 61.35 | 48.93 | 78.03 |
| 13 | 9.81 | 3.26 | 1.97 | 39 | 67.87 | 55.96 | 92.25 |
| 14 | 10.37 | 3.59 | 2.29 | 40 | 75.31 | 64.20 | 109.41 |
| 15 | 10.98 | 3.94 | 2.65 | 41 | 83.86 | 73.90 | 130.22 |
| 16 | 11.63 | 4.34 | 3.06 | 42 | 93.71 | 85.38 | 155.55 |
| 17 | 12.34 | 4.77 | 3.53 | 43 | 105.11 | 99.02 | 186.54 |
| 18 | 13.10 | 5.26 | 4.07 | 44 | 118.37 | 115.31 | 224.64 |
| 19 | 13.93 | 5.80 | 4.68 | 45 | 133.88 | 134.88 | 271.76 |
| 20 | 14.83 | 6.40 | 5.39 | 46 | 152.10 | 158.51 | 330.35 |
| 21 | 15.82 | 7.07 | 6.20 | 47 | 173.64 | 187.21 | 403.67 |
| 22 | 16.88 | 7.82 | 7.13 | 48 | 199.26 | 222.31 | 496.01 |
| 23 | 18.05 | 8.66 | 8.20 | 49 | 229.93 | 265.51 | 613.16 |
| 24 | 19.32 | 9.60 | 9.44 | 50 | 266.89 | 319.07 | 762.89 |
| 25 | 20.72 | 10.66 | 10.88 | - | - | - | - |

h. Seismic Loading

During an earthquake, the retained fill exerts a dynamic horizontal thrust, P_{AE} , on the MSE wall in addition to the static thrust. Moreover, the reinforced soil mass is subjected to a horizontal inertia force $P_{IR} = M A_m$, where M is the mass of the active portion of the reinforced wall section assumed at a base width of $0.5H$, and A_m is the maximum horizontal acceleration in the reinforced soil wall.

Force P_{AE} can be evaluated by the pseudo-static Mononobe-Okabe analysis as shown in figure 27 and added to the static forces acting on the wall (weight, surcharge, and static thrust). The dynamic stability with respect to external stability is then evaluated. Allowable minimum dynamic safety factors are assumed as 75 percent of the static safety factors. The equation for P_{AE} (equation 32a only) was developed assuming a horizontal backfill, a friction angle of 30 degrees and may be adjusted for other soil friction angles using the Mononobe-Okabe method with the horizontal acceleration equal to A_m and vertical acceleration equal to zero.

The seismic external stability evaluation is performed as follows:

! Select a peak horizontal ground acceleration based on the design earthquake. The ground acceleration coefficient may be obtained from Division 1A of current AASHTO where it is given as A , Acceleration Coefficient.

! Calculate the maximum acceleration A_m developed in the wall:

$$A_m = (1.45 - A) A \quad (30)$$

where: A = max. ground acceleration coefficient, AASHTO, Division 1A.

A_m = max. wall acceleration coefficient at the centroid of the wall mass.

! Calculate the horizontal inertia force P_{IR} and seismic thrust P_{AE} :

$$P_{IR} = 0.5 A_m \gamma_t H^2 \quad (\text{Horizontal backslope}) \quad (31)$$

$$P_{AE} = 0.375 A_m \gamma_t H^2 \quad (\text{Horizontal backslope}) \quad (32a)$$

! Add to the static forces (see figure 27) acting on the structure, 50 percent of the seismic thrust P_{AE} and the full inertial force P_{IR} . The reduced P_{AE} is used because these two forces are unlikely to peak simultaneously.

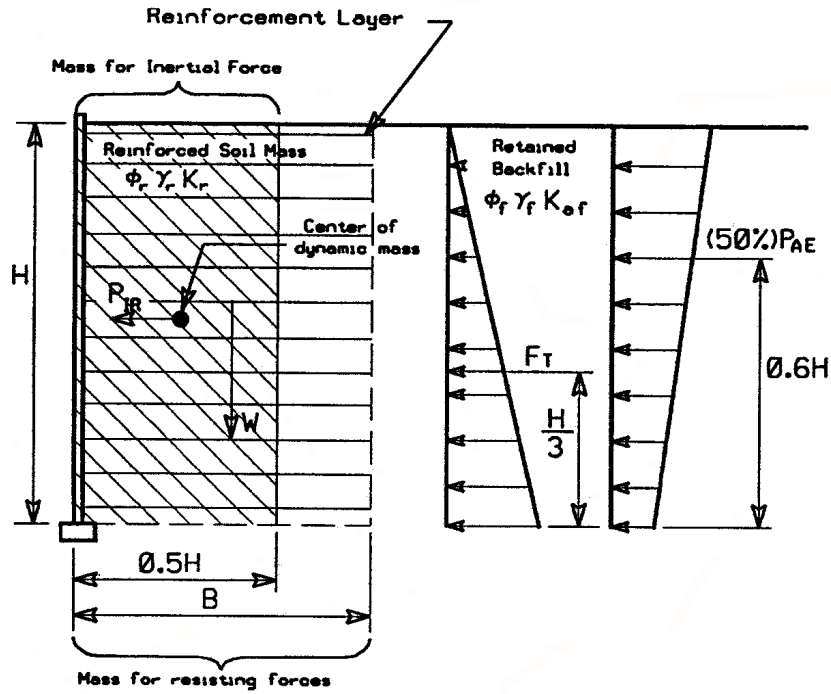

(a) Level backfill condition

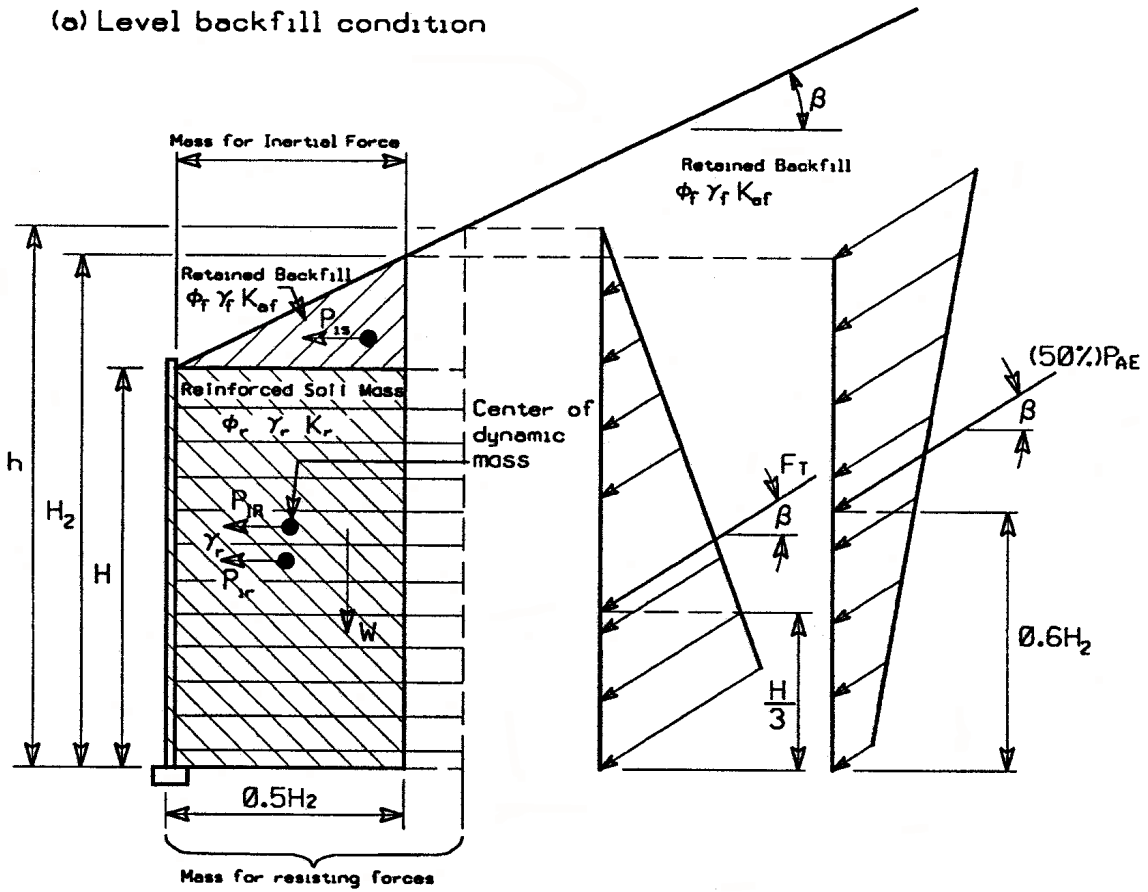

(b) Sloping backfill condition

Figure 27. Seismic external stability of a MSE wall.

- ! For structures with sloping backfills, the inertial force (P_{IR}) and the dynamic horizontal thrust (P_{AE}) shall be based on a height H_2 near the back of the wall mass determined as follows:

$$H_2 = H + \frac{\tan\beta \cdot 0.5H}{(1 - 0.5\tan\beta)} \quad (33)$$

P_{AE} may be adjusted for sloping backfills using Mononobe-Okabe method, with the horizontal acceleration k_h equal to A_m and k_v equal to zero. A height of H_2 should be used to calculate P_{AE} in this case. P_{IR} for sloping backfills should be calculated as follows:

$$P_{IR} = P_{ir} + P_{is} \quad (34)$$

$$P_{ir} = 0.5 A_m \gamma_f H_2 H \quad (35)$$

$$P_{is} = 0.125 A_m \gamma_f (H_2)^2 \tan \beta \quad (36)$$

and

$$P_{AE} = 0.5 \gamma_f (H_2)^2 \Delta K_{AE} \text{ (sloping backfill)} \quad (32 b)$$

where P_{ir} is the inertial force caused by acceleration of the reinforced backfill and P_{is} is the inertial force caused by acceleration of the sloping soil surcharge above the reinforced backfill, with the width of mass contributing to P_{IR} equal to $0.5H_2$. P_{ir} acts at the combined centroid of P_{ir} and P_{is} as shown on figure 27. The total seismic earth pressure coefficient K_{AE} based on the Mononobe-Okabe general expression is computed from:

$$K_{AE} = \frac{\cos^2(\varphi - \xi - 90 + \theta)}{\cos \xi \cos^2(90 - \theta) \cos(I + 90 - \theta + \xi) \left[1 + \sqrt{\frac{\sin(\varphi + I) \sin(\varphi - \xi - I)}{\cos(I + 90 - \theta + \xi) \cos(I - 90 + \theta)}} \right]^2} \quad (37a)$$

where:

- I = the backfill slope angle = β (See Figures 24 and 25)
- ξ = $\arctan(K_h/1 - K_v)$
- φ = the soil angle of friction
- θ = the slope angle of the face (See Figure 22)

To complete design:

- ! Evaluate sliding stability, eccentricity and bearing capacity as detailed in the previous sections.
- ! Check that the computed safety factors are equal to or greater than 75 percent of the minimum static safety factors, and that the eccentricity falls within $L/3$ for both soil and rock.

Relatively large earthquake shaking (i.e. $A \geq 0.29$) could result in significant permanent lateral and vertical wall deformations even if limit equilibrium criteria are met. In seismically active areas where such strong shaking could exist, a specialist should be retained to evaluate the anticipated deformation response of the structure.

The use of the full value of A_m for K_h in the Mononobe-Okabe method assumes that no wall lateral displacement is allowed. When using the Mononobe-Okabe method, this assumptions can result in excessively conservative wall designs. To provide a more economical structure, design for a small tolerable displacement rather than no displacement may be preferred. The 1996 AASHTO Specifications for Highway Bridges (with 1998 Interims), Article 5.2.2.4, in combination with Division 1A, Articles 6.4.3 and 7.4.3, allow Mononobe-Okabe earth pressure to be reduced to a residual seismic earth pressure behind the wall resulting from an outward lateral movement of the wall. This reduced seismic earth pressure is calculated through the use of reduced acceleration coefficient for K_h , which accounts for the allowance of some lateral wall displacement. This reduced K_h can be determined through a Newmark sliding block analysis, though the complexity of this type of analysis is beyond the scope of this manual.⁽²⁸⁾ A reduced K_h can be used for any gravity or semi-gravity wall if the following conditions are met:

- ! The wall system and any structures supported by the wall can tolerate lateral movement resulting from sliding of the structure.
- ! The wall is unrestrained regarding its ability to slide, other than soil friction along its base and minimal soil passive resistance.
- ! If the wall functions as an abutment, the top of the wall must also be unrestrained, e.g., the superstructure is supported by sliding bearings.

The 1996 AASHTO Specifications for Highway Bridges (with 1998 Interims), Division 1A, Articles 6.4.3 and 7.4.3, provide an approximation of this reduction to account for lateral wall displacement. The K_h used for Mononobe-Okabe analysis of gravity and semi-gravity free standing and abutment walls may be reduced to $0.5A$, provided that displacements up to $250 A$ mm are acceptable. Kavazanjian et al.⁽²⁹⁾ developed an expression for K_h (i.e., N , the peak seismic resistance coefficient sustainable by the wall before it slides), and further simplified the Newmark analysis by assuming the ground velocity in the absence information on the time history of the ground motion, to be equal to $30A$. For MSE walls the maximum wall acceleration coefficient at the centroid of the wall mass, A_m (eq. 30), is used with this expression, and K_h is computed as:

$$K_h = 1.66A_m \left(\frac{A_m}{d} \right)^{0.25} \quad (37b)$$

where, “d” is the lateral wall displacement in mm. It should be noted that this equation should not be used for displacements of less than 25 mm (1 inch) or greater than approximately 200 mm (8 inches). It is recommended that this reduced acceleration value only be used for external stability calculations, to be consistent with the concept of the MSE wall behaving as a rigid block. Internally, the lateral deformation response of the MSE wall

is much more complex, and at present it is not clear how much the acceleration coefficient could decrease due to the allowance of some lateral deformation during seismic loading.

In general, typical practice among states located in seismically active areas is to design walls for reduced seismic pressure corresponding to 50 to 100 mm (2 to 4 inches) of displacement. However, the amount of deformation which is tolerable will depend on the nature of the wall and what it supports, as well as what is in front of the wall.

By applying Equation 37b to an allowable displacement and a site specific A_m values, K_h can be determined as a fraction of A_m for use in design.

It is recommended that this simplified approach not be used for walls which have a complex geometry, such as described in Chapter 5, for walls which are very tall (over 15 m), nor for walls where peak ground acceleration A is 0.3 g or higher.

i. Settlement Estimate

Conventional settlement analyses should be carried out to ensure that immediate, consolidation, and secondary settlement of the wall are less than the performance requirements of the project (See FHWA, *Soils and Foundations Reference Manual*).⁽²⁰⁾ Significant total settlements at the end of construction, indicate that the planned top of wall elevations need to be adjusted. This can be accomplished by increasing the top of wall elevations during design, but more practically, by delaying the casting of the top row of panels to the end of erection. The required height of the top row, would then be determined with possible further allowance for continuing settlements. Significant differential settlements (greater than 1/100), indicate the need of slip joints, which allow for independent vertical movement of adjacent precast panels. Where the anticipated settlements and their duration, cannot be accommodated by these measures, consideration must be given to ground improvement techniques such as wick drains, stone columns, dynamic compaction, the use of lightweight fill or the implementation of multistage construction in which the first stage facing is typically a wire facing.

4.3 SIZING FOR INTERNAL STABILITY

Internal failure of a MSE wall can occur in two different ways:

- ! The tensile forces (and, in the case of rigid reinforcements, the shear forces) in the inclusions become so large that the inclusions elongate excessively or break, leading to large movements and possible collapse of the structure. This mode of failure is called failure by elongation or breakage of the reinforcements.

- ! The tensile forces in the reinforcements become larger than the pullout resistance, i.e., the force required to pull the reinforcement out of the soil mass. This, in turn, increases the shear stresses in the surrounding soil, leading to large movements and possible collapse of the structure. This mode of failure is called failure by pullout.

The process of sizing and designing to preclude internal failure, therefore, consists of determining the maximum developed tension forces, their location along a locus of critical slip surfaces and the resistance provided by the reinforcements both in pullout capacity and tensile strength.

Schematically, the design process can be illustrated as follows:

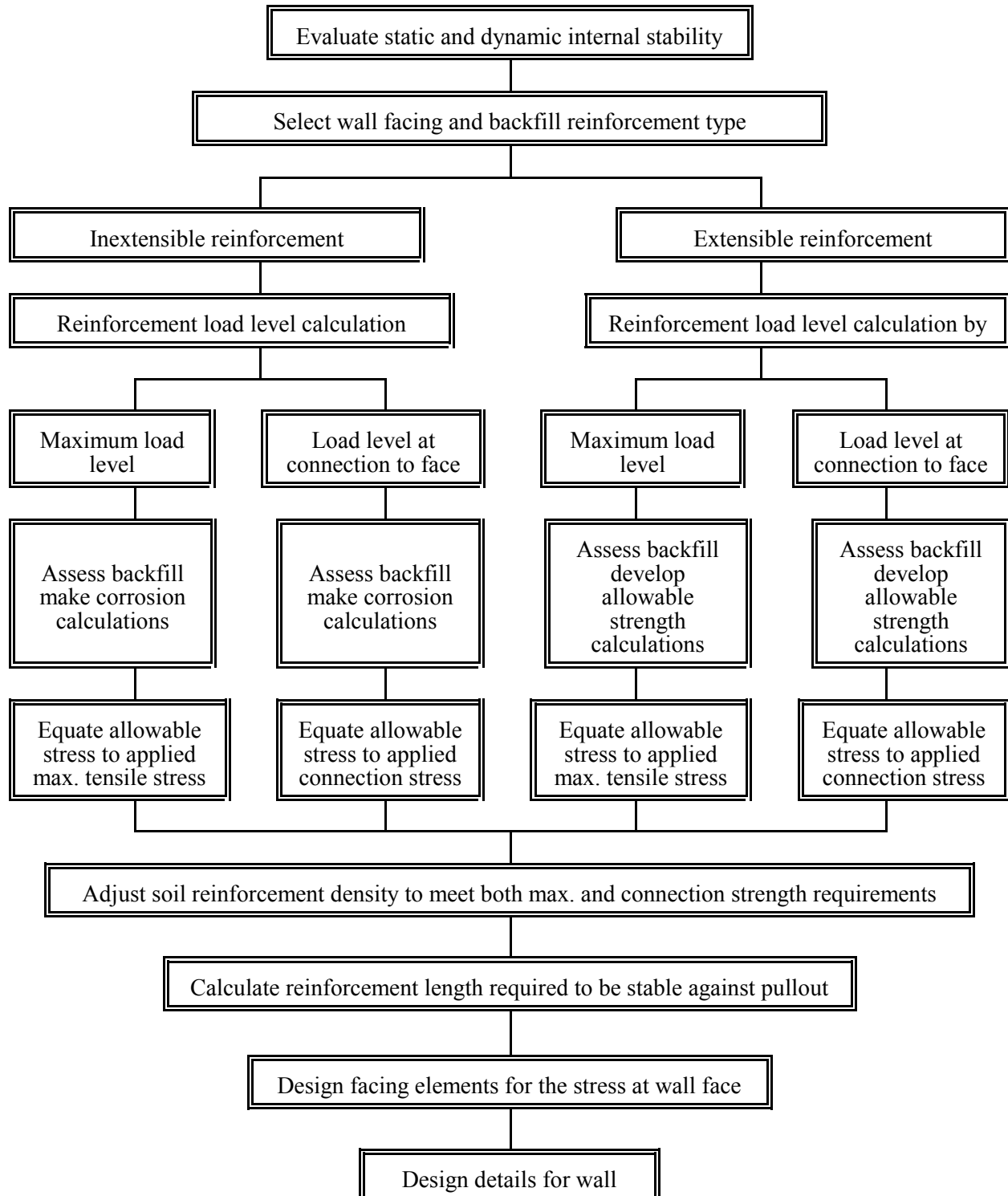

The step by step internal design process is as follows:

- ! Select a reinforcement type (inextensible or extensible).
- ! Select the location of the critical failure surface.
- ! Select a reinforcement spacing compatible with the facing.
- ! Calculate the maximum tensile force at each reinforcement level, static and dynamic.
- ! Calculate the maximum tensile force at the connection to the facing.
- ! Calculate the pullout capacity at each reinforcement level.

a. Critical Slip Surfaces

The most critical slip surface in a simple reinforced soil wall is assumed to coincide with the maximum tensile forces line (i.e., the locus of the maximum tensile force, T_{max} , in each reinforcement layer). The shape and location of this line is assumed to be known for simple structures from a large number of previous experiments and theoretical studies.

This maximum tensile forces surface has been assumed to be approximately bilinear in the case of inextensible reinforcements (figure 28), approximately linear in the case of extensible reinforcements (figure 28), and passes through the toe of the wall in both cases.

When failure develops, the reinforcement may elongate and be deformed at its intersection with the failure surface. As a result, the tensile force in the reinforcement would increase and rotate. Consequently, the component in the direction of the failure surface would increase and the normal component may increase or decrease. Elongation and rotation of the reinforcements may be negligible for stiff inextensible reinforcements such as steel strips but may be significant with geosynthetics. Where the wall front batter is greater than 8 degrees the Coulomb earth pressure relationship shown on figure 28b may be used to define the failure surface.

b. Calculation of Maximum Tensile Forces in the Reinforcement Layers

Recent research studies have indicated that the maximum tensile force is primarily related to the type of reinforcement in the MSE mass, which, in turn, is a function of the modulus, extensibility and density of reinforcement. Based on this research, a relationship between the type of the reinforcement and the overburden stress has been developed, and shown in figure 29. The resulting K/K_a for inextensible reinforcements ratio decreases from the top of wall to a constant value below 6 m (20 ft).

The simplified approach used herein was developed in order to avoid iterative design procedures required by some of the complex refinements of the available methods i.e., the coherent gravity method (AASHTO, 1994 Interims) and the structure stiffness method

(FHWA RD 89-043). The *simplified coherent gravity* method is based on the same empirical data used to develop these two methods.

This graphical figure was prepared by back analysis of the lateral stress ratio K from available field data where stresses in the reinforcements have been measured and normalized as a function of an active earth pressure coefficient, K_a . The ratios shown on figure 29 correspond to values representative of the specific reinforcement systems that are known to give satisfactory results assuming that ***the vertical stress is equal to the weight of the overburden (γH)***. This provides a simplified evaluation method for all cohesionless reinforced fill walls. Future data may lead to modifications in figure 29, including relationships for newly developed reinforcement types, effect of full height panels, etc.

The lateral earth pressure coefficient K is determined by applying a multiplier to the active earth pressure coefficient. The active earth pressure coefficient is determined using a Coulomb earth pressure relationship, assuming no wall friction and a β angle equal to zero. For a vertical wall the earth pressure therefore reduces to the Rankine equation:

$$K_a = \tan^2 (45 - \phi'/2) \quad (15)$$

For wall face batters equal to or greater than 8 degrees from the vertical, the following simplified form of the Coulomb equation can be used:

$$K_a = \frac{\sin^2 (\theta + \phi')}{\sin^3 \theta \left[1 + \frac{\sin \phi'}{\sin \theta} \right]^2} \quad (38)$$

where θ is the inclination of the back of the facing as measured from the horizontal starting in front of the wall.

The vertical stress (γH) is the result of gravity forces from soil self weight within and immediately above the reinforced wall backfill, and any surcharge loads present. Vertical stress for maximum reinforcement load calculations are shown on figure 30.

Calculations steps are as follows:

- (1) Calculate at each reinforcement level the horizontal stresses σ_H along the potential failure line from the weight of the retained fill $\gamma_r Z$ plus, if present, uniform surcharge loads q concentrated surcharge loads $\Delta\sigma_v$ and $\Delta\sigma_h$.

$$\sigma_H = K_r \sigma_v + \Delta\sigma_h \quad (39)$$

where

$$\sigma_v = \gamma_r Z + \sigma_2 + q + \Delta\sigma_v$$

where: $K_r = K(z)$ is shown in figure 29 and Z is the depth referenced below the top of wall, excluding any copings and appurtenances and σ_2 as shown in figure 30.

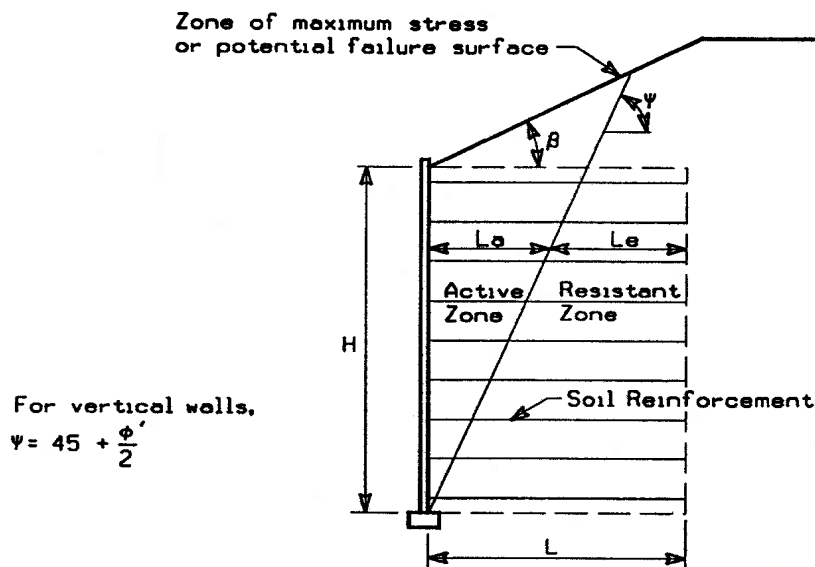
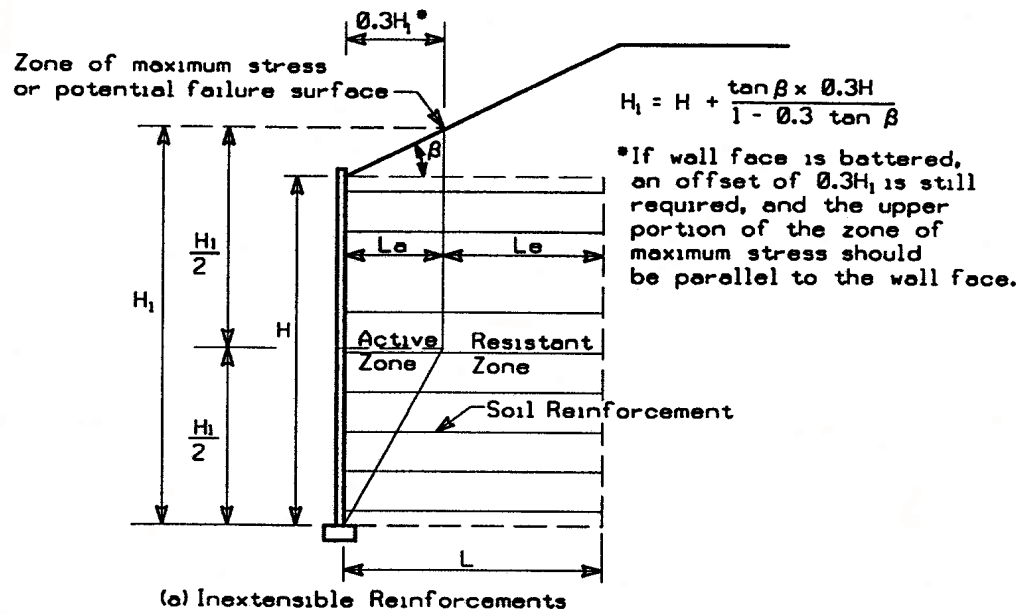

For walls with a face batter 10° or more from the vertical,

$$\tan(\psi - \phi) = \frac{-\tan(\phi - \beta) \cdot \sqrt{\tan(\phi - \beta) [\tan(\phi - \beta) + \cot(\phi + \theta - 90)] [1 + \tan(\delta + 90 - \theta) \cot(\phi + \theta - 90)]}}{1 + \tan(\delta + 90 - \theta) [\tan(\phi - \beta) + \cot(\phi + \theta - 90)]}$$

with $\delta = \beta$

(b) Extensible Reinforcements

Figure 28. Location of potential failure surface for internal stability design of MSE walls.

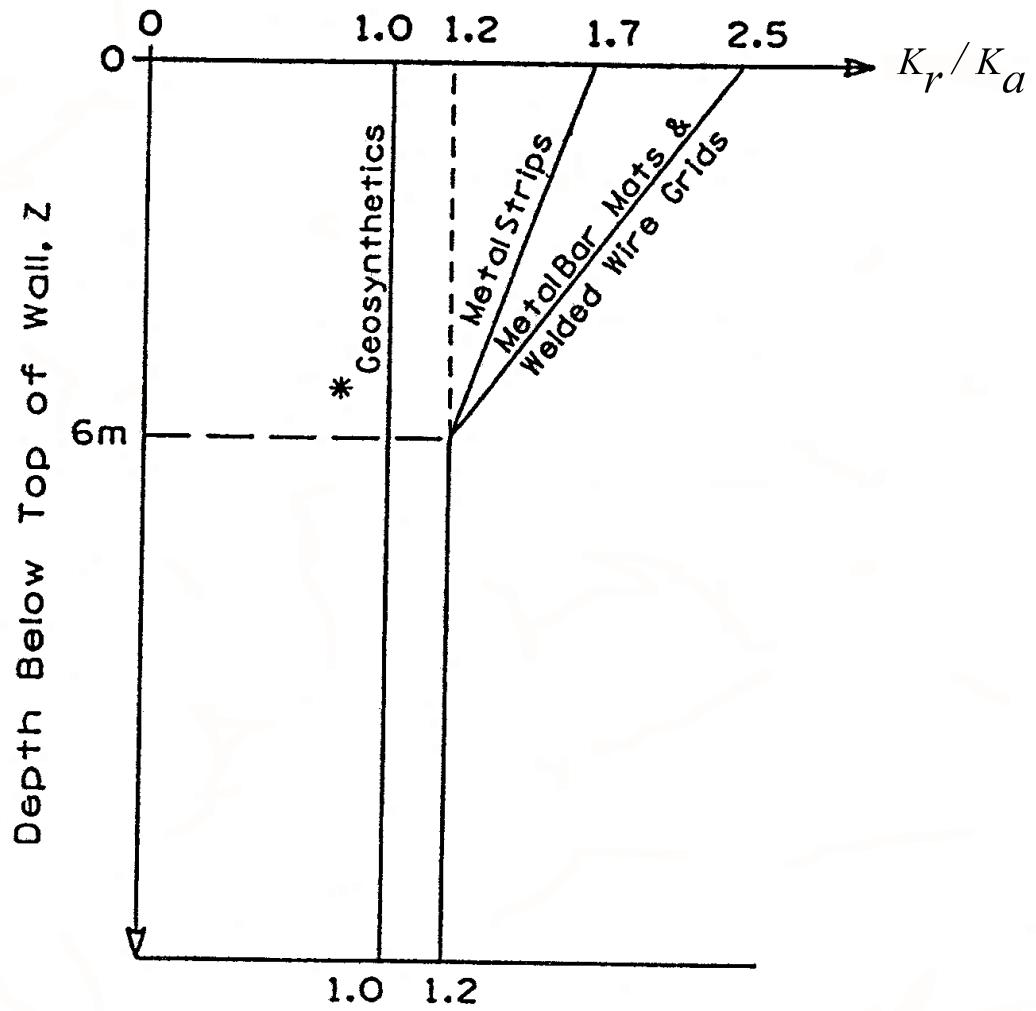

*Does not include polymer strip reinforcement

Figure 29. Variation of stress ratio with depth in a MSE wall.

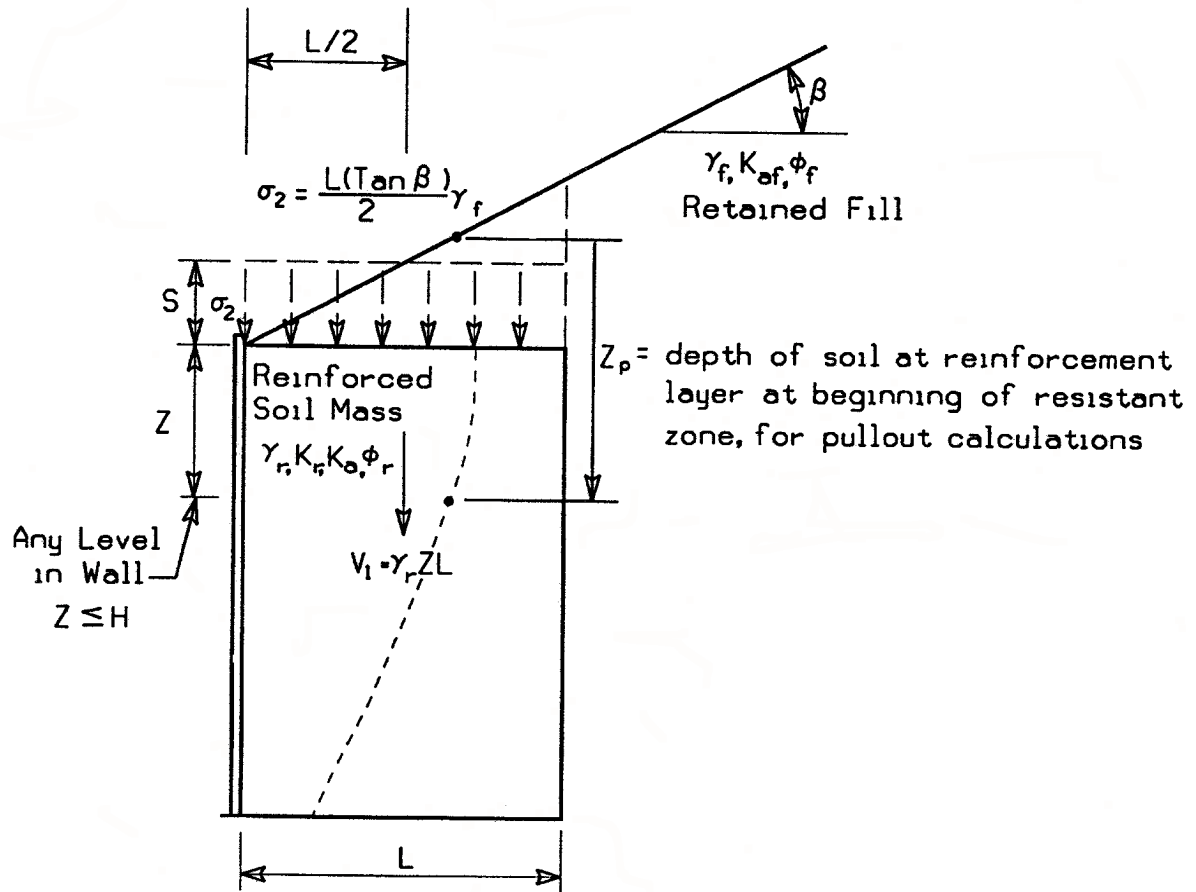

Max Stress: $S = \frac{1}{2} L \text{Tan } \beta$
 $\sigma_v = \gamma_r Z + \frac{1}{2} L (\text{Tan } \beta) \gamma_r$
 Determine K_a using a slope angle of β .
 Determine K_r from figure 29.

Pullout: $\sigma_v = \gamma_r Z_p$ and $Z \geq Z_p + s$

Note: H is the total height of the wall at the face.

Figure 30. Calculation of vertical stress for sloping backslope conditions.

$\Delta\sigma_v$ is the increment of vertical stress due to concentrated vertical loads using a 2V:1H pyramidal distribution as shown in figure 31.

$\Delta\sigma_h$ is the increment of horizontal stress due to horizontal concentrated surcharges, if any, and calculated as shown in figure 32. Static equivalent loads for traffic barriers should be included based on current AASHTO, Section 5.8.

- (2) Calculate the maximum tension T_{\max} in each reinforcement layer per unit width of wall based on the vertical spacing S_v from:

$$T_{\max} = \sigma_H \cdot S_v \quad (40a)$$

T_{\max} may be also be calculated at each level for discrete reinforcements (metal strips, bar mats, geogrids, etc.) per a defined unit length of wall face, from:

$$T_{\max} = \frac{\sigma_H \cdot S_v}{R_c} \quad (40b)$$

Alternatively for discrete reinforcements and segmental precast concrete facing, T_{\max} is often more conveniently calculated per tributary area A_t , defined as the area equal to the two (2) panel widths times the vertical spacing s_v .

$$T_{\max} = \sigma_H \cdot A_t \quad (40c)$$

- (3) Calculate internal stability with respect to breakage of the reinforcement. Stability with respect to breakage of the reinforcements requires that:

$$T_a \geq \frac{T_{\max}}{R_c} \quad (41)$$

where R_c is the coverage ratio b/S_h , with b the gross width of the reinforcing element, and S_h is the center-to-center horizontal spacing between reinforcements (e.g., $R_c = 1$ for full coverage reinforcement). T_a is the allowable tension force per unit width of the reinforcement.

The connection of the reinforcements with the facing, shall be designed for T_{\max} for all loading conditions (1998 AASHTO Interim).

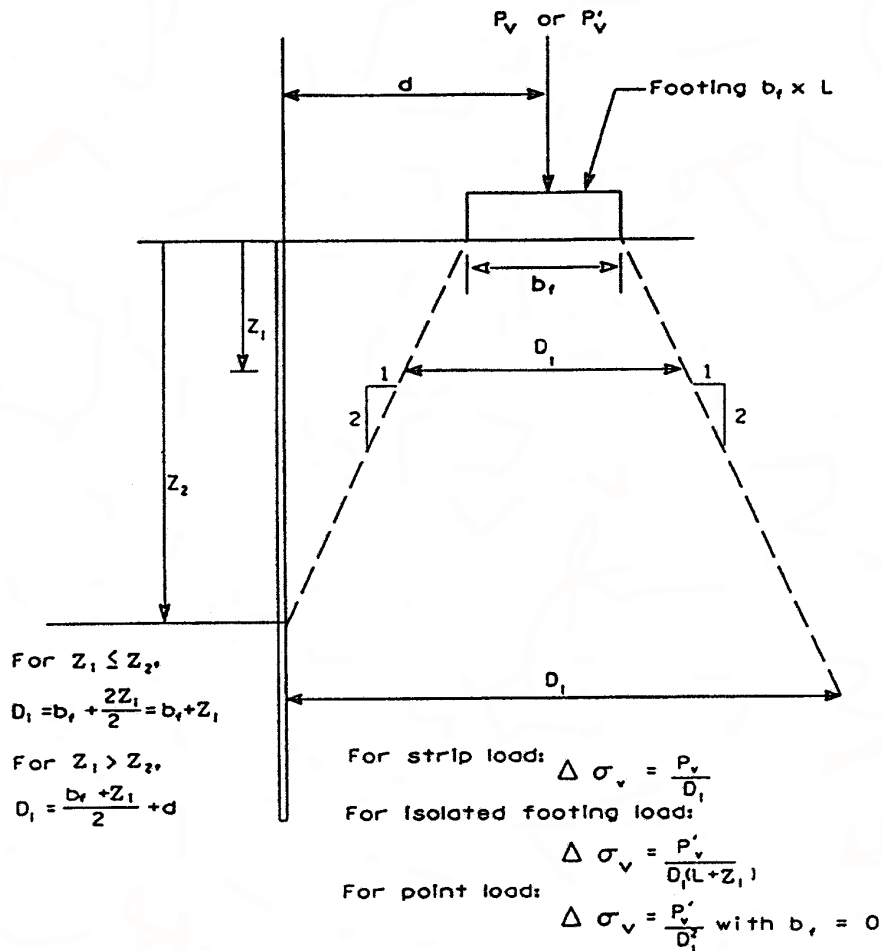

Where: D_1 = Effective width of applied load at any depth, calculated as shown above

b_f = Width of applied load. For footings which are eccentrically loaded (e.g., bridge abutment footings), set b_f equal to the equivalent footing width B' by reducing it by $2e'$, where e' is the eccentricity of the footing load (i.e., $b_f - 2e'$).

L = Length of footing

P_v = Load per linear meter (foot) of strip footing

P'_v = Load on isolated rectangular footing or point load

Z_2 = depth where effective width intersects back of wall face = $2d - b$

Assume the increased vertical stress due to the surcharge load has no influence on stresses used to evaluate internal stability if the surcharge load is located behind the reinforced soil mass. For external stability, assume the surcharge has no influence if it is located outside the active zone behind the wall.

Figure 31. Distribution of stress from concentrated vertical load P_v for internal and external stability calculations.

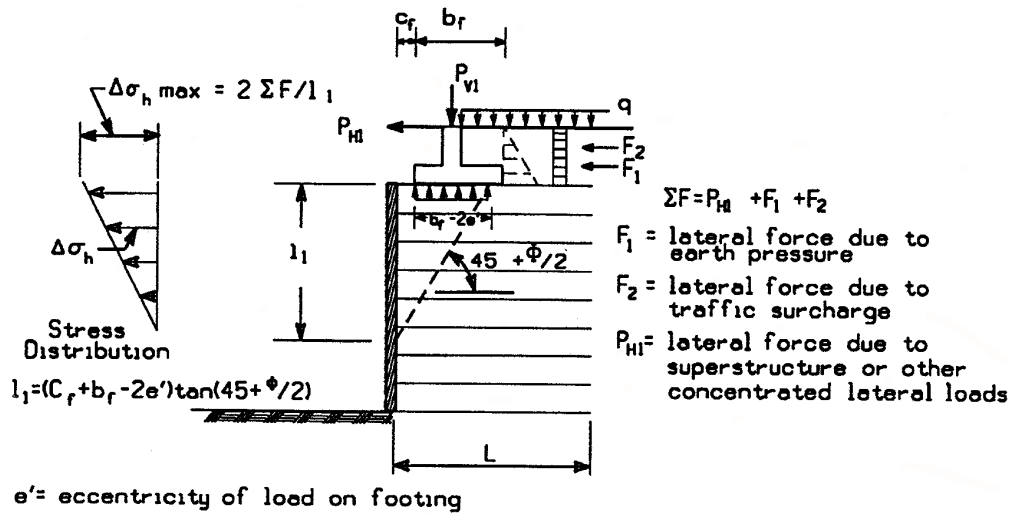

a. Distribution of Stress for Internal Stability Calculations.

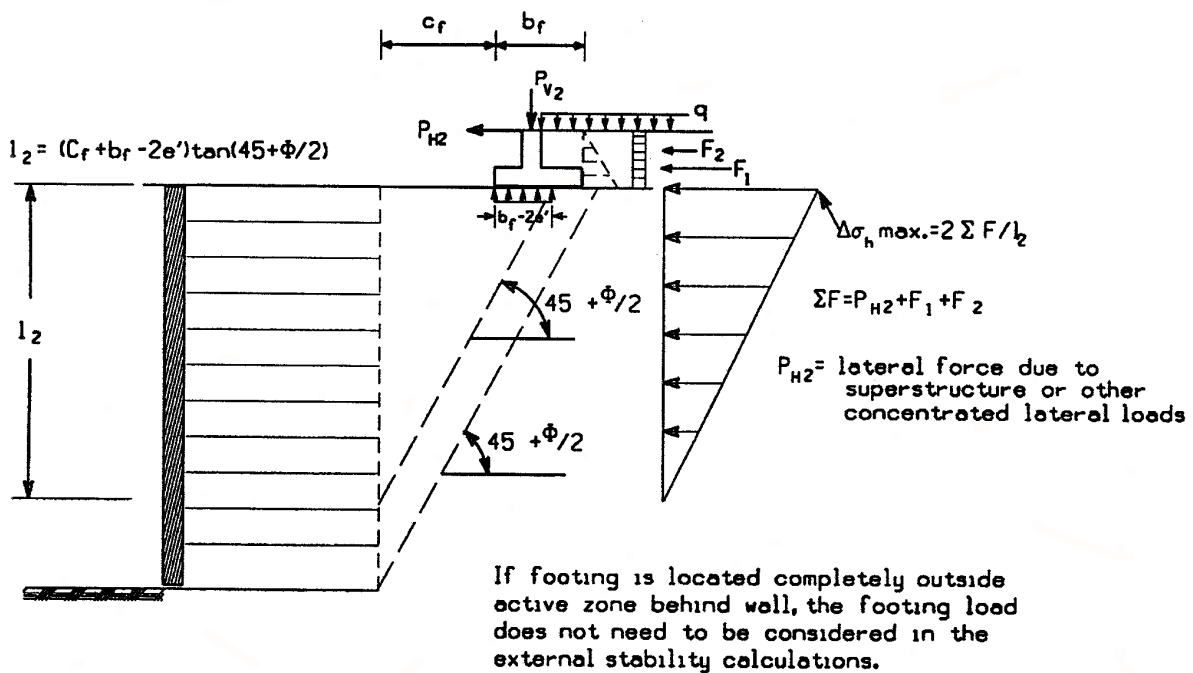

b. Distribution of Stress for External Stability Calculations.

Figure 32. Distribution of stresses from concentrated horizontal loads.

c. Internal Stability with Respect to Pullout Failure

Stability with respect to pullout of the reinforcements requires that the following criteria be satisfied:

$$T_{\max} \leq \frac{1}{FS_{PO}} F^* \gamma Z_p L_e C R_c \alpha \quad (42)$$

where: FS_{PO} = Safety factor against pullout ≥ 1.5 .

T_{\max} = Maximum reinforcement tension.

C = 2 for strip, grid, and sheet type reinforcement.

α = Scale correction factor.

F^* = Pullout resistance factor (see chapter 3).

R_c = Coverage ratio.

γZ_p = The overburden pressure, including distributed dead load surcharges, neglecting traffic loads. (See figure 30)

L_e = The length of embedment in the resisting zone. Note that the boundary between the resisting and active zones may be modified by concentrated loadings.

Therefore, the required embedment length in the resistance zone (i.e., beyond the potential failure surface) can be determined from:

$$L_e \geq \frac{1.5 T_{\max}}{C F^* \gamma Z_p R_c \alpha} \geq 1 \text{ m} \quad (43)$$

Note that traffic loads and other live loads are not included for pullout calculations as indicated on figure 23.

If the criterion is not satisfied for all reinforcement layers, the reinforcement length has to be increased and/or reinforcement with a greater pullout resistance per unit width must be used, or the vertical spacing may be reduced which would reduce T_{\max} .

The total length of reinforcement, L , required for internal stability is then determined from:

$$L = L_a + L_e \quad (44)$$

where: L_a is obtained from figure 28 for simple structures not supporting concentrated external loads such as bridge abutments. Based on this figure the following relationships can be obtained for L_a :

For MSE walls with **extensible** reinforcement, vertical face and horizontal backfill:

$$L_a = (H - Z) \tan (45 - \phi'/2) \quad (45)$$

where: Z is the depth to the reinforcement level.

For walls with **inextensible** reinforcement from the base up to $H/2$:

$$L_a = 0.6 (H-Z) \quad (46)$$

For the upper half of a wall with inextensible reinforcements:

$$L_a = 0.3H \quad (47)$$

For construction ease, a final uniform length is commonly chosen, based on the maximum length required. However, if internal stability controls the length, it could be varied from the base, increasing with the height of the wall to the maximum length requirement based on a combination of internal and maximum external stability requirements. See chapter 5, section 5.3 for additional guidance.

d. Seismic Loading

Seismic loads produce an inertial force P_1 (see figure 33) acting horizontally, in addition to the existing static forces.

This force will lead to incremental dynamic increases in the maximum tensile forces in the reinforcements. It is assumed that the location and slope of the maximum tensile force line does not change during seismic loading. Calculation steps for internal stability analyses with respect to seismic loading are as follows (see figure 33).

- (1) Calculate the maximum acceleration in the wall and the force P_1 per unit width acting above the base:

$$P_1 = A_m W_A \quad (48)$$

$$A_m = (1.45 - A) A \quad (30)$$

where: W_A is the weight of the active zone (shaded area on figure 33) and A is the AASHTO site acceleration coefficient and where A_m may be reduced based on the permissible lateral movement as discussed in 4.2.

- (2) Calculate the total maximum static load applied to the reinforcements horizontal T_{\max} as follows:

Calculate horizontal stress σ_H using K coefficient (previously developed)

$$\sigma_H = K\sigma_v + \Delta\sigma_h = K\gamma Z + \Delta\sigma_v K + \Delta\sigma_h \quad (39)$$

Calculate the maximum tensile load component T_{\max} per unit width:

$$T_{\max} = S_v \sigma_H \quad (40)$$

- (3) Calculate the dynamic increment T_{md} directly induced by the inertia force P_I in the reinforcements by distributing P_I in the different reinforcements proportionally to their "resistant area" (L_{ei}) on a load per unit wall width basis. This leads to:

$$T_{md} = P_I \frac{L_{ei}}{n \sum_{i=1} (L_{ei})} \quad (49)$$

which is the resistant length of the reinforcement at level i divided by the sum of the resistant length for all reinforcement levels.

- (4) The maximum tensile force is:

$$T_{total} = T_{\max} + T_{md} \quad (50)$$

Check stability with respect to breakage and pullout of the reinforcement, with seismic safety factors of 75 percent of the minimum allowable static safety factor. For rupture of steel reinforcements, this leads to:

$$T_a \geq \frac{T_{total} (0.75)}{R_c} \quad (51a)$$

For geosynthetic reinforcement rupture, the reinforcement must be designed to resist the static and dynamic component of the load as follows:

For the static component,

$$T_{\max} \leq \frac{S_{rs} \times R_c}{(0.75) RF \times FS} \quad (51b)$$

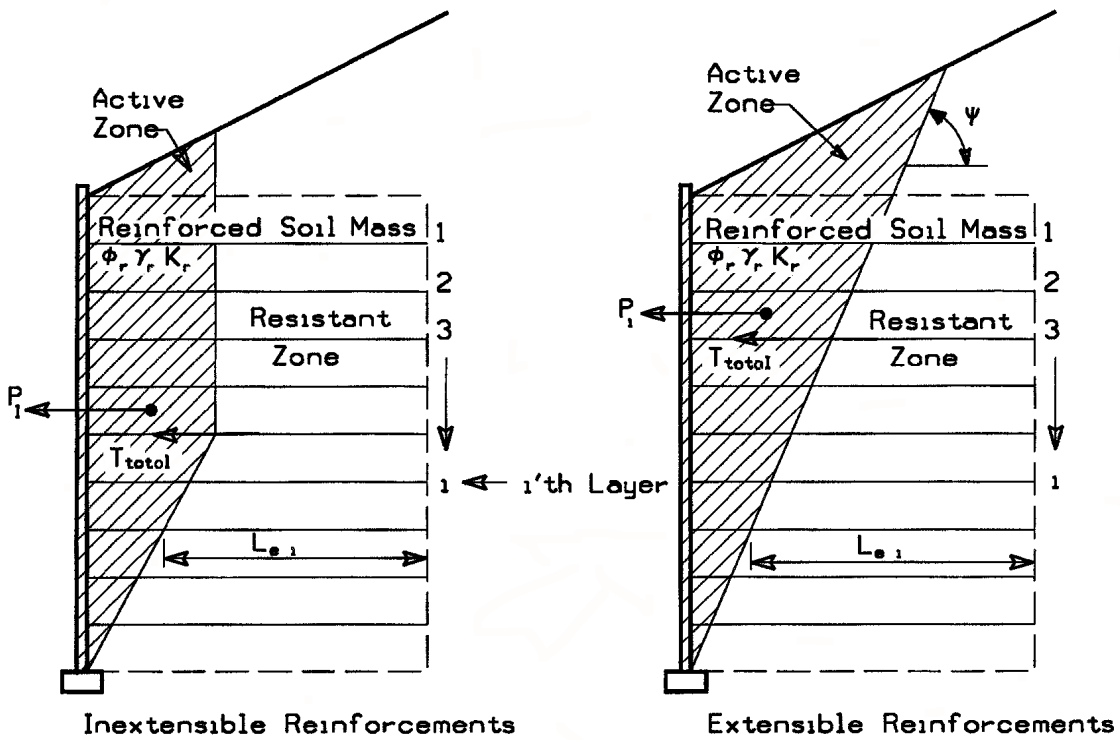

- P_i = Internal inertial force due to the weight of the backfill within the active zone.
- L_{e1} = The length of reinforcement in the resistant zone of the 1st layer.
- T_{max} = The load per unit wall width applied to each reinforcement due to static forces.
- T_{md} = The load per unit wall width applied to each reinforcement due to dynamic forces.
- The total load per unit wall width applied to each layer, $T_{total} = T_{max} + T_{md}$

Figure 33. Seismic internal stability of a MSE wall.

For the dynamic component, where the load is applied for a short time, creep reduction is not required and therefore,

$$T_{md} \leq \frac{S_{rt} \times R_c}{(0.75) FS \cdot RF_D \cdot RF_{ID}} \quad (51c)$$

Therefore, the ultimate strength of the geosynthetic reinforcement required is,

$$T_{ult} = S_{rs} + S_{rt} \quad (51d)$$

where S_{rs} is the reinforcement strength per unit width needed to resist the static component of load and S_{rt} the reinforcement strength needed to resist the dynamic or transient component of load.

For pullout under seismic loading, for all reinforcements, the friction coefficient F^* should be reduced to 80 percent of the static value, leading to:

$$T_{total} \leq \frac{P_r R_c}{0.75 FS_{PO}} = \frac{C \cdot (0.8F^*)}{0.75 \cdot 1.5} \cdot \gamma Z' \cdot L_e R_c \alpha \quad (52)$$

The recommended design method with respect to seismic loading was developed for inextensible reinforcements but it is also applicable to extensible reinforcements. The extensibility of the reinforcements affects the overall stiffness of the reinforced soil mass. As extensible reinforcement reduces the overall stiffness it is expected to have an influence on the design diagram of the lateral earth pressure induced by the seismic loading. As the overall stiffness decreases, damping should increase and amplification may also increase. Thus, the resulting inertia force may not be much different than for inextensible reinforcement. Additional research is needed to justify any variation based on reinforcement extensibility.

e. **Connection Strength**

The metallic reinforcements for MSE systems constructed with segmental precast panels are structurally connected to the facing by either bolting the reinforcement to a tie strip cast in the panel or connected with a bar connector to suitable anchorage devices in the panels. The capacity of the embedded connector as an anchorage must be checked by tests as required by Section 8.31 of 1992 AASHTO for each geometry used. The design load at the connection is equal the maximum load on the reinforcement.

Polyethylene geogrid reinforcements may be structurally connected to segmental precast panels by casting a tab of the geogrid into the panel and connecting to the full length of geogrid with a *bodkin* joint, as illustrated in figure 34. A slat of polyethylene may be used for the bodkin, though rigid PVC pipes have also been used. Extreme care should be exercised to eliminate slack from the connection. Alternatively, certain HDPE geogrids are

connected to the facing by inserting the thicker transverse members of the geogrids in a slot cast in the back face of the panels.

Polyester geogrids and geotextiles should not be cast into concrete for connections, due to potential chemical degradation. Other types of geotextiles also are not cast into concrete for connections due to fabrication and field connection requirements.

MSE walls constructed with MBW units are connected either by a structural connection subject to verification under AASHTO Article 8.31 or by friction between the units and the reinforcement, including the friction developed from the aggregate contained within the core of the units or by a combination of friction and shear from connection devices. This strength will vary with each unit depending on its geometry, unit batter, normal pressure and depth of unit. The connection strength is therefore specific to each unit/reinforcement combination and must be developed uniquely by test for each combination. Recommended test procedures are included in appendix A.

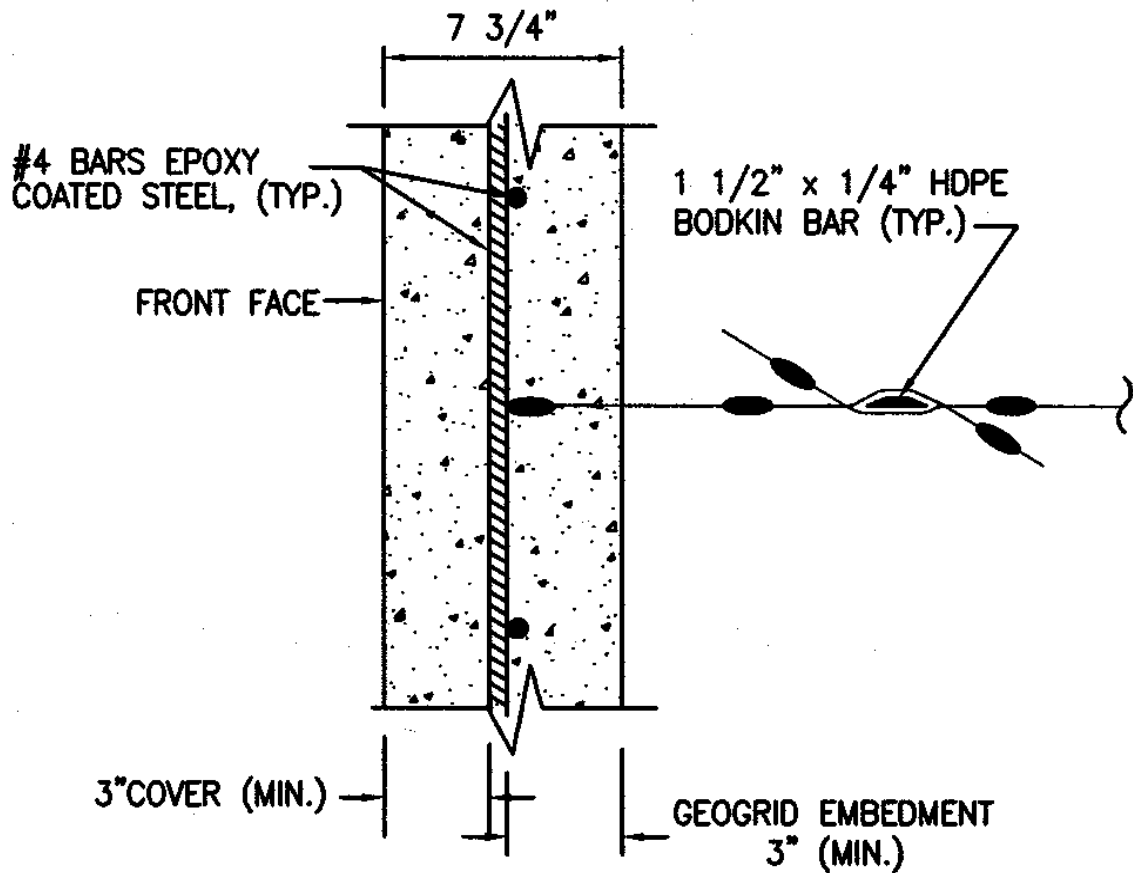

Figure 34. Bodkin connection detail.

The recommended procedure for developing allowable connection strength T_{ac} requires that this strength is the lesser of:

- ! The design allowable strength of the reinforcement (T_a) as developed in Chapter 3, *Establishment of Structural Design Properties*;
- ! The connection strength, T_{ac} developed by friction or structural means where CR_{cr} is as determined in appendix A.3 **based on long term pullout testing**. The connection strength as developed by long term pullout testing is reduced for long term environmental aging, and divided by a factor of safety of at least 1.5 for permanent structures, as follows:

$$T_{ac} \leq \frac{T_{ult} \cdot CR_{cr}}{RF_D \cdot FS} \quad (53a)$$

- ! Where bodkin joints or geotextile seams are used to connect reinforcement near the facing, a reduced connection strength based on ASTM D 4884 must be determined. T_{ac} for this situation is determined as follows:

$$T_{ac} \leq \frac{T_{ult} \cdot CR_u}{RF_{CR} \cdot RF_D \cdot FS} \quad (53b)$$

Note that the environment at the connection may not be the same as the environment within the MSE mass. Therefore, the long-term environmental aging factor (RF_D) may be significantly different than that used in computing the allowable reinforcement strength T_a .

The connection strength as developed above is a function of normal pressure which is developed by the weight of the units. Thus, it will vary from a minimum in the upper portion of the structure to a maximum near the bottom of the structure for walls with no batter. Further, since many MBW walls are constructed with a front batter, the column weight above the base of the wall or above any other interface may not correspond to the weight of the facing units above the reference elevation. The concept is shown in figure 35 which develops a hinge height concept.⁽²⁾ Hence, for walls with a nominal batter of more than 8 degrees, the normal stress is limited to the lesser of the hinge height or the height of the wall above the interface. This vertical pressure range should be used in developing CR_{cr} .

This recommendation is based on recent research findings which indicated that the hinge height concept is overly conservative for walls with small batters.⁽²²⁾

For geosynthetic connections subject to seismic loading, the long term connection strength must be greater than $T_{max} + T_{md}$. Where the long-term connection strength is partially or fully dependent on friction between the facing blocks and the reinforcement, and connection

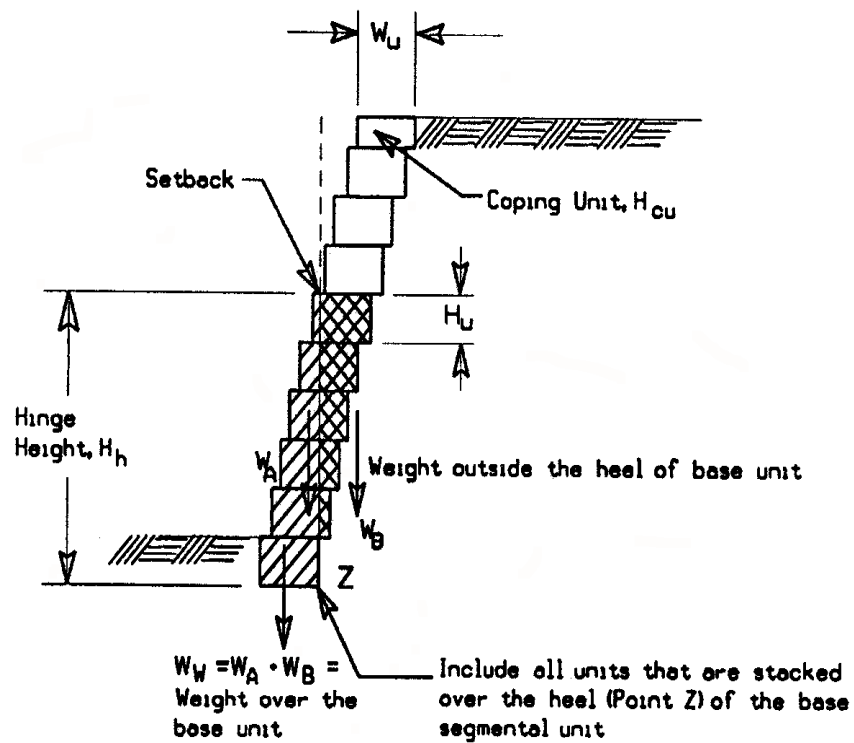

Hinge Height, H_h . The full weight of all segmental facing block units within H_h will be considered to act at the base of the lowermost segmental facing block.

$$H_h = 2 (W_u - G_u) \tan(\omega)$$

where:

- H_u = Segmental facing block unit height (m)
- W_u = Segmental facing block unit width, front to back (m)
- G_u = distance to the center of gravity of a horizontal segmental facing block unit, including aggregate fill, measured from the front of the unit (m)
- ω = wall batter due to setback per course (deg)
- H = total height of wall (m)
- H_h = hinge height (m)

Figure 35. Determination of hinge height for modular concrete block faced MSE walls.

pullout is the controlling failure mode, the long-term connection strength to resist seismic loads shall be reduced to 80 percent of its static value.

For the static component,

$$T_{\max} \leq \frac{S_{rs} \times CR_{cr}}{FS \times RF_D} \quad (54a)$$

For the dynamic component,

$$T_{md} \leq 0.8 \left(\frac{S_{rt} \times CR_{ult}}{FS \times RF_D} \right) \quad (54b)$$

The reinforcement strength required for the static component, S_{rs} , must be added to the reinforcement strength required for the dynamic component, S_{rt} , to determine the total ultimate strength required for the reinforcement, T_{ULT} . A factor of safety of 1.1 may be used for both the static and dynamic components in seismic design of the connection.

Therefore, it is presently recommended that fully frictional connections not be used in locations where the combined seismic performance category is C or higher ($A \geq 0.19$).

f. Reinforcement Spacing

Use of a constant reinforcement section and spacing for the full height of the wall usually gives more reinforcement near the top of the wall than is required for stability. Therefore, a more economical design may be possible by varying the reinforcement density with depth. However, to provide a coherent reinforced soil mass, vertical spacing of primary reinforcement should not exceed 800 mm (32 inches).

There are generally two practical ways to accomplish this for MSE walls with segmental precast concrete facings:

- ! For reinforcements consisting of strips, grids, or mats, the vertical spacing is maintained constant and the reinforcement density is increased with depth by increasing the number and/or the size of the reinforcements. For instance, the horizontal spacing of 50 mm (2-inch) x 4 mm (5/32-inch) strips is usually 0.75 m (30 inches), although the horizontal reinforcement spacing can be decreased by adding reinforcement locations.
- ! For continuous sheet reinforcements, made of geotextiles or geogrids, a common way of varying the reinforcement density T_a/S_v is to change the vertical spacing S_v , especially if wrapped facing is used, because it easily accommodates spacing variations. The range of acceptable spacings is governed by consideration of placement and compaction of the backfill (e.g. S_v taken as 1, 2 or 3 times the

compacted lift thickness). The reinforcement density T_a/S_v can also be varied by changing the strength (T_a) especially if wrapped facing techniques requiring a constant wrap height are used.

Low-to medium-height walls (e.g., <5 m) are usually constructed with one strength geosynthetic. Taller walls use multiple strength geosynthetics. For example the 12.6 m (41 ft) high Seattle preload wall used four strengths of geotextiles⁽³⁰⁾. A maximum spacing of 500 mm (20 inches) is typical for wrapped faced geosynthetic walls, although a smaller spacing is desirable to minimize bulging.

- ! For walls constructed with modular blocks and deriving their connection capacity by friction, the maximum vertical spacing of reinforcement should be limited to two times the block depth (front face to back face) to assure construction and long term stability. The top row of reinforcement should be at one-half the vertical spacing.

4.4 DESIGN OF FACING ELEMENTS

a. Design of Concrete, Steel and Timber Facings

Facing elements are designed to resist the horizontal forces developed in Section 4.3. Reinforcement is provided to resist the average loading conditions at each depth in accordance with structural design requirements in Section 8, 10 and 13 of AASHTO for concrete, steel and timber facings, respectively. Allowable stresses for seismic design may be increased by 50 percent for steel, 33 percent for concrete and 50 percent for timber. The embedment of the soil reinforcement to panel connector must be developed by test, to ensure that it can resist the design T_{max} forces.

As a minimum, temperature and shrinkage steel must be provided for segmental precast facing. Epoxy protection of panel reinforcement where salt spray is anticipated is recommended.

b. Design of Flexible Wall Facings

Welded wire or similar facing panels shall be designed in a manner which prevents the occurrence of excessive bulging as backfill behind the facing elements compresses due to compaction stresses, self weight of the backfill or lack of section modulus. Bulging at the face between soil reinforcement elements in both the horizontal and vertical direction should be limited to 25 to 50 mm (1 to 2 inches) as measured from the theoretical wall line. This may be accomplished by requiring the placement of a nominal 600 mm (2 ft) wide zone of rockfill or cobbles directly behind the facing, decreasing the spacing between reinforcements – vertically and horizontally, increasing the section modulus of the facing material and by providing sufficient overlap between adjacent facing panels. In addition, the reinforcements must not be restrained and have the ability to slide vertically with respect to the facing material. Furthermore, the top of the flexible facing panel at the top of the wall shall be attached to a soil reinforcement layer to provide stability to the top facing panel.

For modular concrete facing blocks (MBW), sufficient inter-unit shear capacity must be available, and the maximum spacing between reinforcement layers shall be limited to twice the front to back width, W_u (see figure 35), of the modular concrete facing unit or 0.8 m (32 inches) whichever is less. The maximum facing height above the uppermost reinforcement layer and the maximum depth of facing below the bottom reinforcement layer should be limited to the width, W_u (see figure 35), of the modular concrete facing unit used.

The inter-unit shear capacity as obtained by testing (Test Method SRWU-2, NCMA) at the appropriate normal load should exceed the horizontal earth pressure at the facing by a Factor of Safety of 2.⁽²⁾

For seismic performance categories "C" or higher (AASHTO Division 1A), facing connections in modular block faced walls (MBW) shall not be fully dependent on frictional resistance between the backfill reinforcement and facing blocks. Shear resisting devices between the facing blocks and soil reinforcement such as shear keys, pins, etc. shall be used. For connections partially or fully dependent on friction between the facing blocks and the soil reinforcement, the long-term connection strength T_{ac} , should be reduced to 80 percent of its static value. Further, the blocks above the uppermost layer soil reinforcement layer must be secured against toppling under all seismic events.

Geosynthetic facing elements should not be left exposed to sunlight (specifically ultraviolet radiation) for permanent walls. If geosynthetic facing elements must be left exposed permanently to sunlight, the geosynthetic shall be stabilized to be resistant to ultraviolet radiation. Furthermore, product specific test data should be provided which can be extrapolated to the intended design life and which proves that the product will be capable of performing as intended in an exposed environment. Alternately a protective facing shall be constructed in addition (e.g., concrete, shotcrete, etc.).

4.5 DESIGN DETAILS

The successful implementation of MSE wall projects often depends on certain design details not directly connected with internal or external stability considerations. Common details requiring consideration and analysis, with provided guidance, include:

di. Traffic Barriers

The impact traffic load on barriers constructed over the front face of MSE walls, must be designed to resist the overturning moment by their own mass in accordance with Article 5.8 of current AASHTO.

The current AASHTO impact force is 45 kN (10,000 lbs) applied at a height of 850 mm (33.4 inches) above the roadway. This impact force, adds an additional horizontal force of 29 kN per linear meter (2,000 lbs/foot) to the upper 2 rows of reinforcement, *which the reinforcements can resist over their full length*. This additional force should be apportioned **b** to the upper row and **a** to the second row. Where the impact barrier moment slab is cast integrally with a concrete pavement, the additional force may be neglected.

For geosynthetic reinforcements, the geosynthetic allowable strength used to structurally size the reinforcements to resist the impact load may be increased by eliminating the reduction factor for creep, as was done for internal seismic design in section 4.3d.

For the currently specified impact loads, the detail shown in figure 36 has been successfully used. Typically, the base slab length is 6 m (20 feet) and jointed to adjacent slabs with shear dowels. Parapet reinforcement shall be designed in accordance with AASHTO Article 2.7. The anchoring slab shall be strong enough to resist the ultimate strength of the standard parapet.

Flexible post and beam barriers, when used, shall be placed at a minimum distance of 1.0 m (3.3 ft) from the wall face, driven 1.5 m (5 ft) below grade, and spaced to miss the reinforcements where possible. If the reinforcements cannot be missed, the wall shall be designed accounting for the presence of an obstruction. The upper two rows of reinforcement shall be designed for an additional horizontal load of 4,400 N per linear meter (300 lb/ft) of wall, which should be apportioned **b** to the upper row and **a** to the second row.

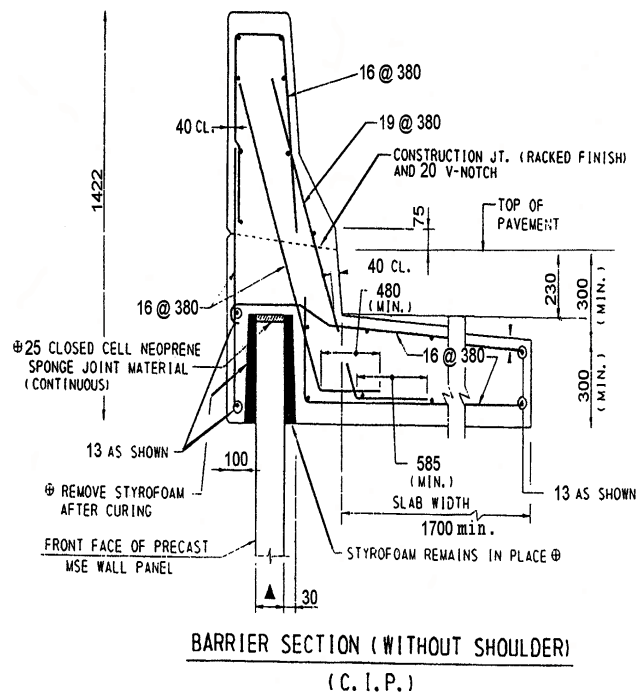

Note: All dimensions in mm.

Figure 36. Impact load barrier.

b. Drainage Systems

For side hill construction, drainage blankets are highly recommended to collect and divert groundwater from the reinforced soil mass. A common detail is shown on figure 37.

Where significant use of de-icing salts is anticipated, impervious barriers beneath the pavement structure and just above the reinforced fill zone have been used. A common detail is shown in figure 38.

Where utilities must be placed parallel to the face of the wall, interference with the reinforcement generally occurs. To be effective, the reinforcement can only be skewed vertically for the limited heights as shown in figure 39.

c. Termination to Cast-in-place Structures

The juncture of MSE walls and cast-in-place structures must be protected from loss of fines and must allow for differential settlement between the two types of construction. A common detail is shown in figure 40.

d. Hydrostatic Pressures

For structures along rivers and canals, a minimum differential hydrostatic pressure equal to 1.0 m (3.3 ft) of wall shall be applied at the high-water level for the design flood event. Effective unit weights shall be used in the calculations for internal and external stability beginning at levels just below the equivalent surface of the pressure head line.

Situations where the wall is influenced by tide or river fluctuations may require that the wall be designed for rapid drawdown conditions, which could result in differential hydrostatic pressure considerably greater than 1.0 m (3.3 ft) or alternatively rapidly draining backfill material such as shot rock or open graded coarse gravel be used as backfill. Backfill material meeting the gradation requirements in chapter 8, section 8.8 is not considered to be rapid draining.

e. Obstructions in Reinforced Soil Zone

If the placement of an obstruction in the wall soil reinforcement zone such as a catch basin, grate inlet, signal or sign foundation, guardrail post, or culvert cannot be avoided, the design of the wall near the obstruction shall be modified using one of the following alternatives:

- Assuming reinforcement layers must be partially or fully severed in the location of the obstruction, design the surrounding reinforcement layers to carry the additional load which would have been carried by the severed reinforcements.

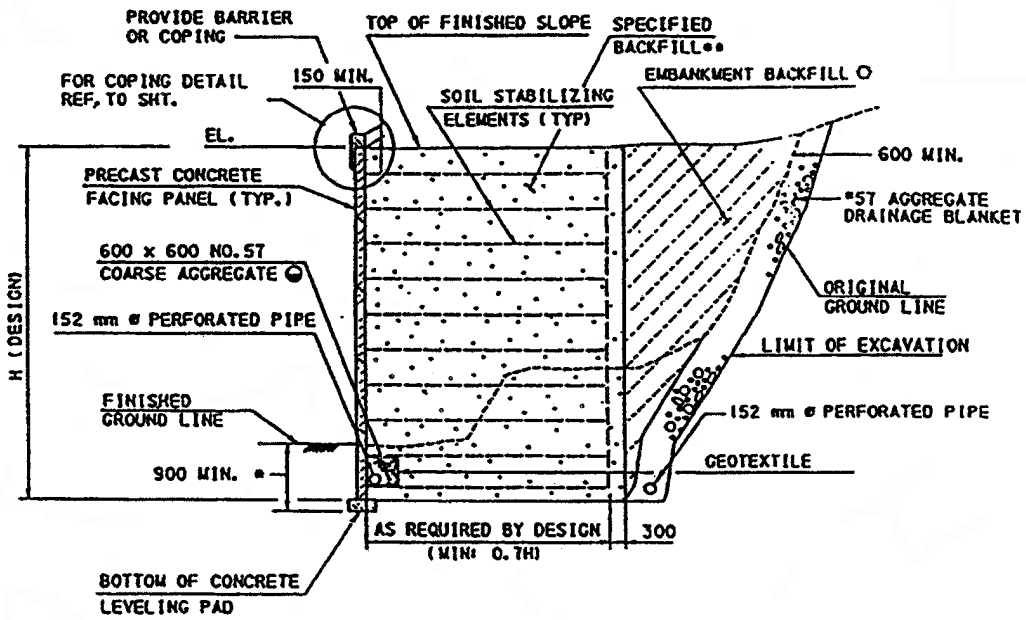

Figure 37. Drainage blanket detail.

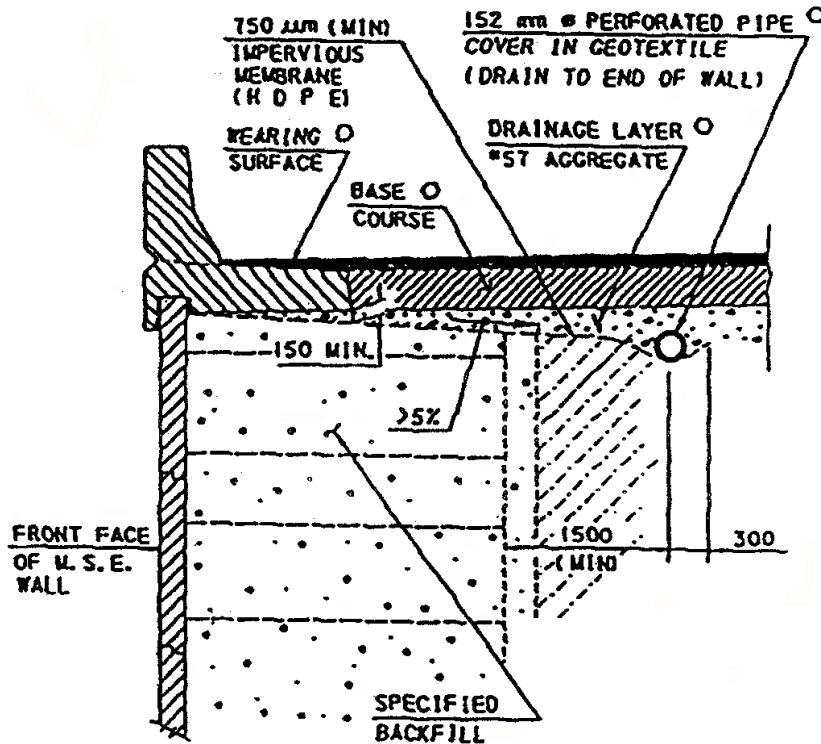
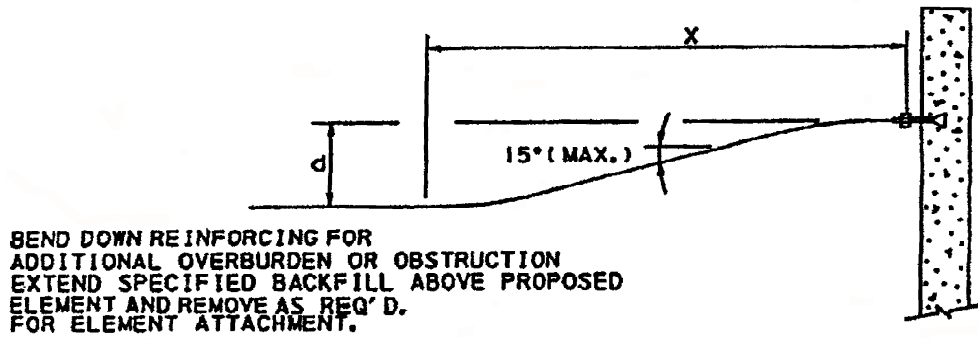
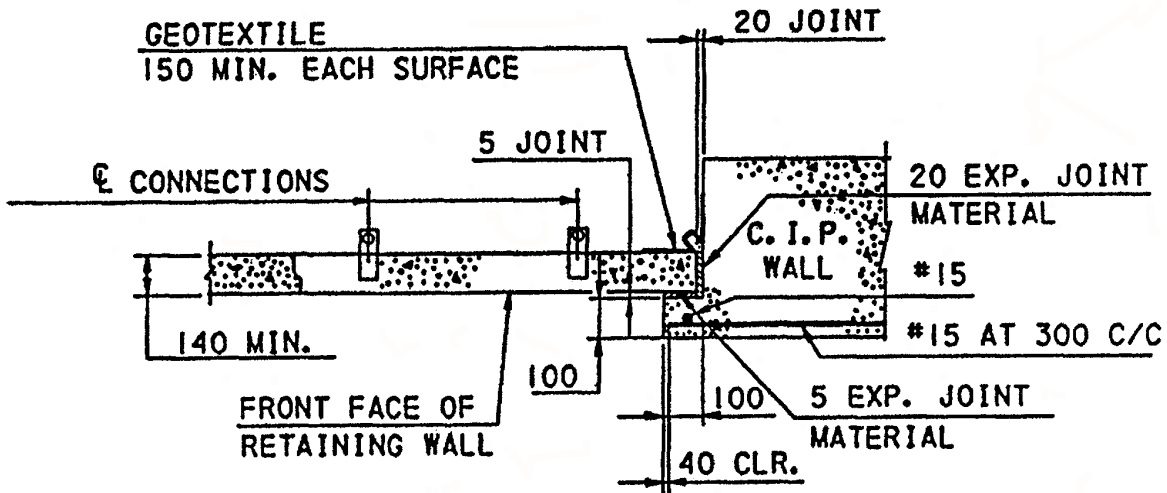

Figure 38. Impervious membrane details.



| ADDITIONAL DEPTH (d) OF REQUIRED | REQUIRED MINIMUM DISTANCE (X) TO ACHIEVE SMOOTH BEND |
|----------------------------------------|------------------------------------------------------------|
| 75 mm | 675 mm |
| 150 | 975 |
| 225 | 1200 |
| 300 | 1500 |
| 375 | 1800 |

Figure 39. Reinforcing strip or mesh bend detail.



Note: All dimensions in mm.

Figure 40. Connection detail of junctures of MSE walls and CIP structure.

- Place a structural frame around the obstruction which is capable of carrying the load from the reinforcements in front of the obstruction to reinforcement connected to the structural frame behind the obstruction. This is illustrated in figure 41.
- If the soil reinforcements consist of discrete strips or bar mats rather than continuous sheets, depending on the size and location of the obstruction, it may be possible to splay the reinforcements around the obstruction.

For the first alternative, the portion of the wall facing in front of the obstruction shall be made stable against a toppling (overturning) or sliding failure. If this cannot be accomplished, the soil reinforcements between the obstruction and the wall face can be structurally connected to the obstruction such that the wall face does not topple, or the facing elements can be structurally connected to adjacent facing elements to prevent this type of failure.

For the second alternative, the frame and connections shall be designed in accordance with AASHTO Article 10.32 for steel frames. Note that it may be feasible to connect the soil reinforcement directly to the obstruction depending on the reinforcement type and the nature of the obstruction.

For the third alternative, the splay angle, measured from a line perpendicular to the wall face, shall be small enough that the splaying does not generate moment in the reinforcement or the connection of the reinforcement to the wall face. The tensile capacity of the splayed reinforcement shall be reduced by the cosine of the splay angle.

If the obstruction must penetrate through the face of the wall, the wall facing elements shall be designed to fit around the obstruction such that the facing elements are stable (i.e., point loads should be avoided) and such that wall backfill soil cannot spill through the wall face where it joins the obstruction. To this end a collar next to the wall face around the obstruction may be needed.

f. Internal Details

Placement of well graded gravel immediately adjacent to modular blocks is recommended for several reasons. Gravel has a high permeability that will not impede water flow out of the reinforced mass and through the dry stacked modular blocks. Well graded gravel is not prone to piping through joints between modular blocks. Gravel is also easily placed and compacted, especially adjacent to elements such as modular blocks.

It is recommended that a minimum width of 0.3 m (1 ft) of well graded gravel be specified immediately behind *solid* modular block units, as illustrated in figure 42. A minimum volume of 0.3 m³ per m² (1 ft³ per 1 ft²) of wall face is recommended for modular units with cores, such as the unit illustrated in figure 43.

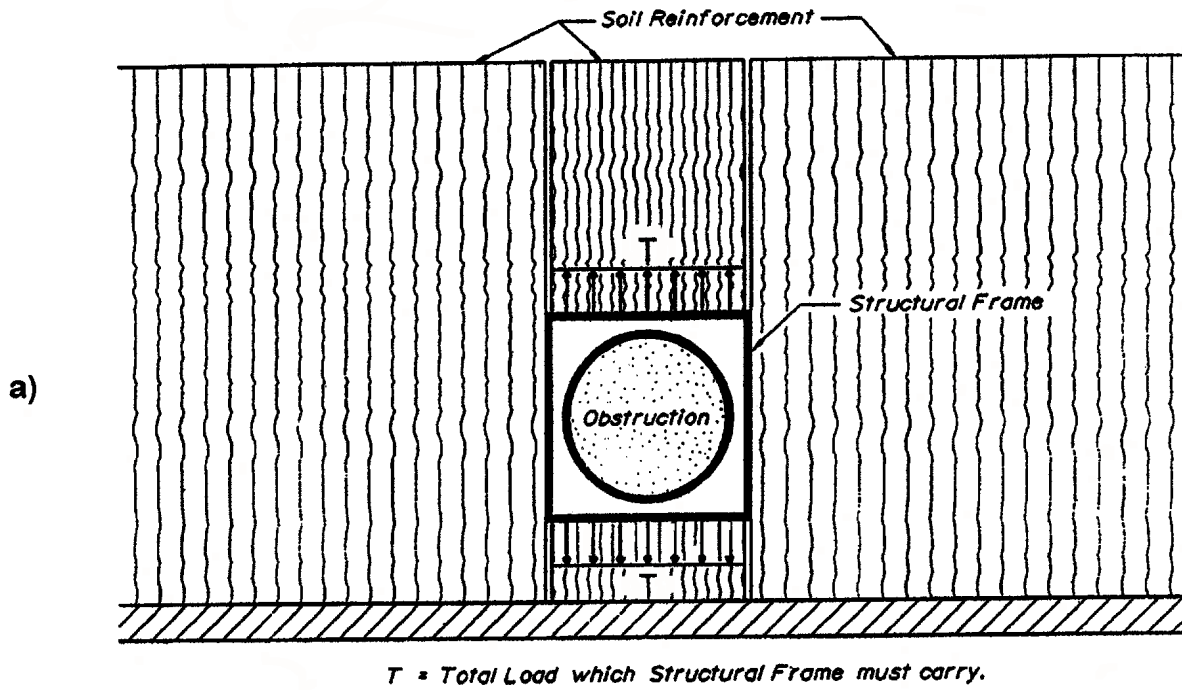

Plan View

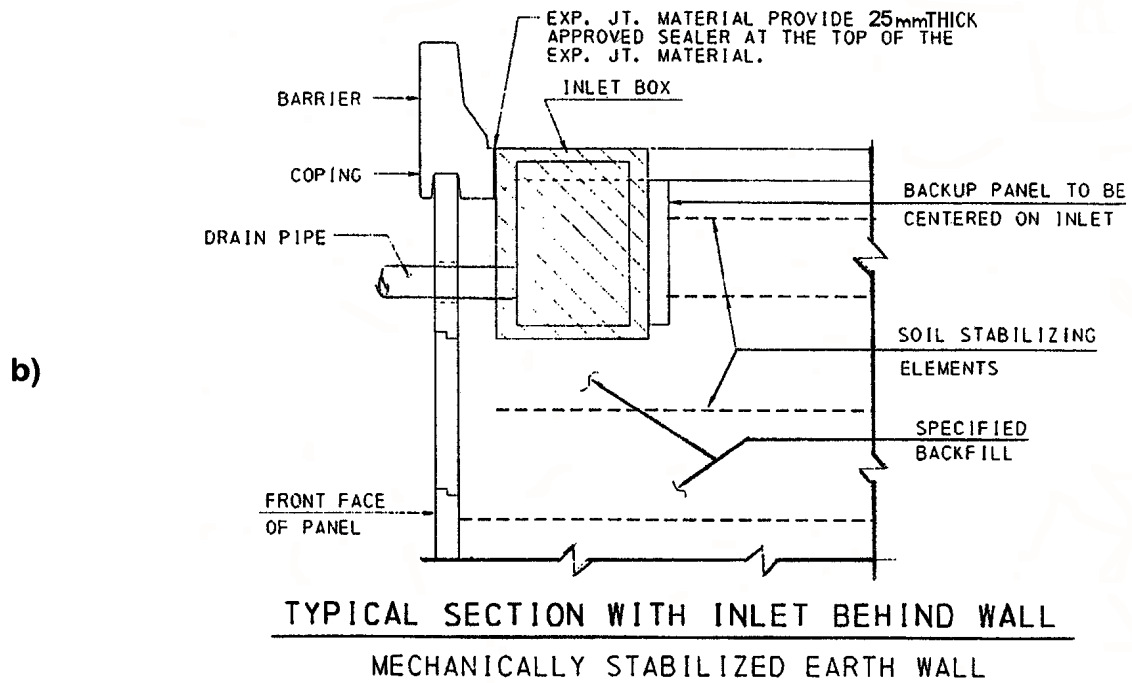
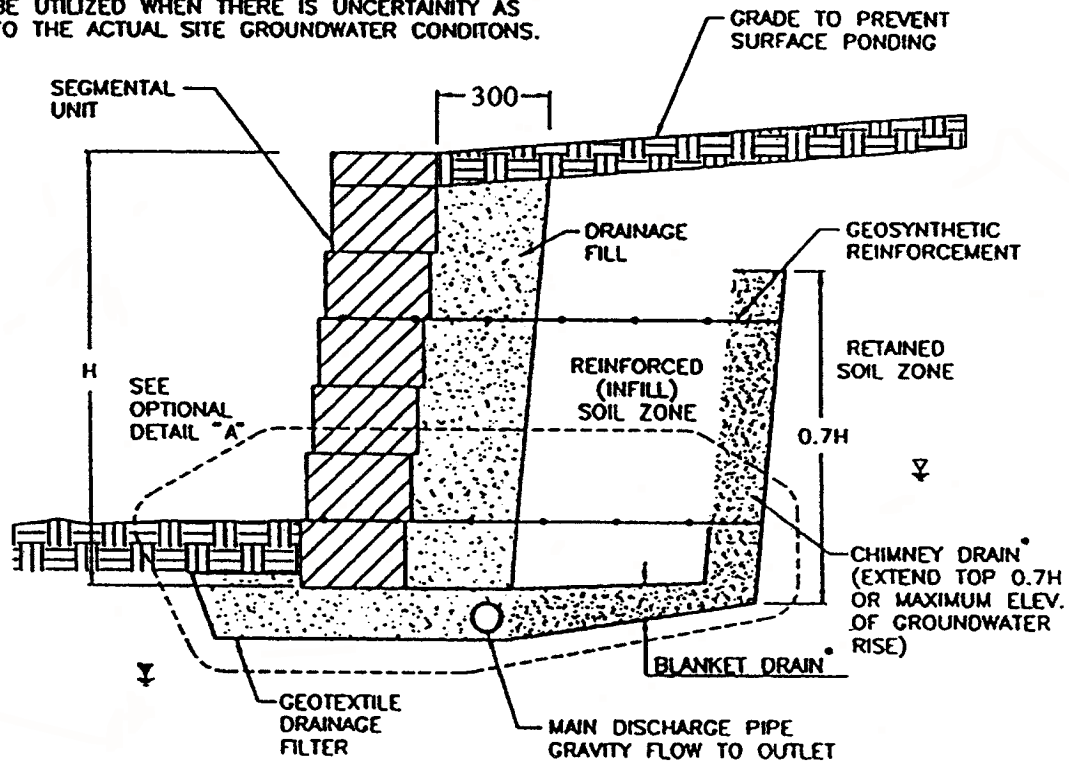

Figure 41. Obstruction details: a) conceptual; b) at inlet.

1. GROUNDWATER TABLE NEAR BOTTOM OF WALL (▽) OR POSSIBLE LATERAL (HORIZONTAL) FLOW INTO REINFORCED (INFILL) SOIL AND RETAINED SOIL ON A SEASONAL BASIS (▽).
2. LATERAL (HORIZONTAL) GROUNDWATER FLOW INTO REINFORCED SOIL WILL OCCUR.
3. THIS COMPLETE DRAINAGE SYSTEM PROVIDES MAXIMUM PROTECTION FOR SRWs AND SHOULD BE UTILIZED WHEN THERE IS UNCERTAINTY AS TO THE ACTUAL SITE GROUNDWATER CONDITIONS.



NOTE: CHIMNEY DRAIN AND/OR BLANKET DRAIN MAY BE REPLACED WITH AN APPROPRIATE GEOCOMPOSITE AT THE DISCRETION OF THE WALL DESIGN ENGINEER.

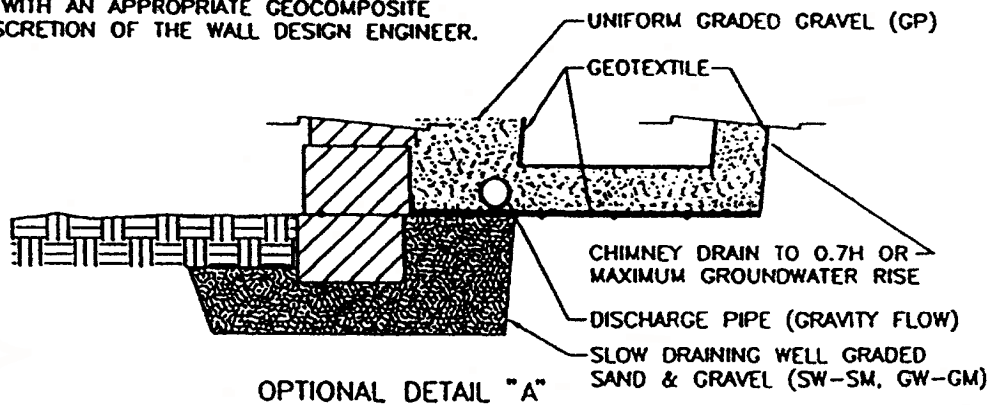

Figure 42. MBW drainage detail.

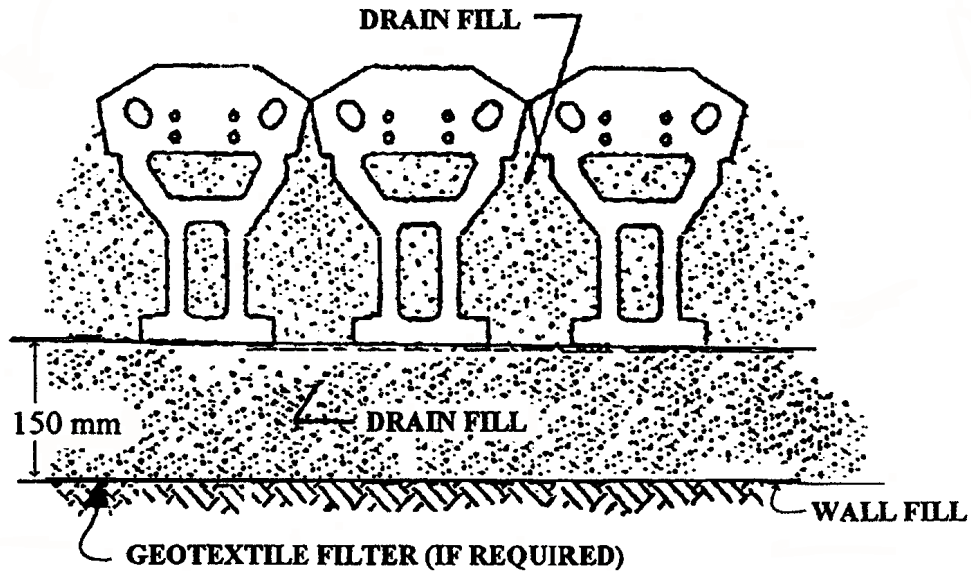

Figure 43. Drain fill placement for MBW with cores or tails.

Drainage gravel should be sized to be compatible with the MSE fill soil. Alternately, a geotextile filter may be used to meet filtration requirements, as illustrated in figure 43, if the gravel does not meet filtration criteria. Filtration design of geotextiles is addressed in the FHWA *Geosynthetic Design and Construction Guidelines* along with a review of soil filter criteria.

A reinforced fill with more than a few percent (3 to 5%) fines (i.e., % passing a 0.075 mm sieve) is not free draining. Therefore, to provide proper long term functionality, a drainage beneath and behind the reinforced zone it is strongly recommended where higher fines content is anticipated, and where infiltration or groundwater is anticipated (which is the case for most structures). An example of such a drainage system is illustrated in figure 42, for an MBW unit faced structure.

A drain pipe is normally placed at the bottom of the column of well graded gravel, as illustrated in figure 42, detail A. If a granular soil leveling pad is used in construction, the drain pipe is placed to drain this zone as well.

4.6 DESIGN EXAMPLE – Steel Strip Reinforcement

a. Hand Calculation Example

A typical urban highway retaining wall design with inextensible steel linear reinforcements and precast concrete panels will be illustrated using the sequential design procedure previously outlined.

Step 1: Establish design height, external loads.

- Total design height $H = 7.8$ m, to gutter grade.
- Required panel height = 7.5 m vertical.
- Traffic surcharge and barrier required.
Barrier will be cast integrally to the concrete pavement.
- Traffic surcharge = 9.4 kN/m^2 .
- Seismic coefficient = 0.05 g, therefore no seismic design required.

Step 2: Establish engineering properties of foundation soils.

- $\phi' = 30^\circ$. (clayey sand, dense)
- Allowable bearing capacity - 300 kPa.
- Differential settlements on the order of 1/300 are estimated.

Step 3: Establish engineering properties for retained and reinforced backfill.

- $\phi = 30^\circ$, $\gamma_T = 18.8 \text{ kN/m}^3$ for retained fill.
- $\phi = 34^\circ$, $\gamma_T = 18.8 \text{ kN/m}^3$ for reinforced backfill meeting the specifications in chapter 8, section 8.8.
- $F^* = 2.0$ based on $C_u > 7$.

Step 4: Establish design factors of safety.

- External Stability FS.
 - Sliding = 1.5.
 - Maximum foundation pressure \leq allowable bearing capacity.
 - Eccentricity $\leq L/6$

- Global stability ≥ 1.3 .
- Internal Stability FS.
 - Pullout ≥ 1.5 .
 - Allowable stress - $0.55 F_y$.
 - Design life = 75 years.

Step 5: Choose facing type, reinforcement spacing and type.

- Based on the urban location a precast concrete facing with an architectural finish is required. For aesthetic reasons a maximum panel dimensions of 1.5 x 1.5 m (5 ft x 5 ft) are required with joints no greater than 19 mm ($\frac{3}{4}$ -inch). Since the estimated differential settlements along the wall are 1/300, and precast panels are to be used, panel joints of 19 mm ($\frac{3}{4}$ -inch) are acceptable.
- Because of numerous subsurface drainage obstructions, linear galvanized ribbed strip reinforcements are preferable and used in the preliminary design. Other reinforcement types are technically feasible.
- Given the panel size, the most efficient vertical spacing is 0.75 m, allowing for 2 rows of reinforcements per panel. The first row is located 375 mm from the topmost panel plus 300 mm of barrier to pavement grade.

Step 6: Establish preliminary length for reinforcing strips.

- For horizontal backfill slopes, $L = 0.7 H$ is reasonable; therefore:

$$L = 0.7 H = 0.7 (7.8) = 5.5 \text{ m.}$$

Step 7: Check external stability for $L = 5.5 \text{ m}$.

- Compute K_a for retained the fill, with a $\phi = 30$ degrees

$$K_a = \tan^2 (45 - \phi/2) = 0.33$$

- Compute sliding FS at base:

$$FS = \frac{V_1 \cdot \tan \phi}{\Sigma F_H}$$

$$V_1 = HL\gamma = 7.8 \cdot 5.5 \cdot 18.8 = 806.5 \text{ kN/m}$$

$$V_2 = qL = 9.4 \cdot 5.5 = 51.7 \text{ kN/m}$$

$$F_1 = \frac{\gamma H^2 K_a}{2} = 18.8 \cdot \frac{(7.8)^2}{2} \cdot 0.33 = 188.7 \text{ kN/m}$$

$$F_2 = qHK_a = 9.4 \cdot 7.8 \cdot 0.33 = 24.2 \text{ kN/m}$$

$$FS = \frac{806.5 \tan 30}{212.9} = 2.19 > 1.5$$

- Compute eccentricity at base:

$$e = \frac{L}{2} - \left(\frac{\Sigma M_R - \Sigma M_O}{\Sigma V} \right)$$

with:

$$M_R = V_1 \cdot L/2 = 2218 \text{ kN/m}$$

$$M_O = F_1 \cdot H/3 + F_2 \cdot H/2 = 585 \text{ kN/m}$$

$$e = \frac{5.5}{2} - \left(\frac{2218 - 585}{806.5} \right)$$

$$e = 0.73 \text{ m} < \frac{L}{6} = 0.92 \text{ m}$$

- Compute bearing pressure at base

$$\sigma_v = \frac{\Sigma V}{L-2e} = \frac{V_1 + V_2}{L - 2e}$$

$$\sigma_v = \frac{858}{5.5 - (2 \cdot 0.73)} = 212 \text{ kPa} < 300 \text{ kPa}$$

Step 8: Determine internal stability at each reinforcement level and required horizontal spacing.

- Compute K at each level e.g. at Z = 2.92 m from surface
- $K_a = \tan^2 (45 - \phi/2) = 0.28$ for reinforced fill

from figure 29, and K at 2.92 m

$$K = 0.412$$

- Compute σ_H at this level per unit width

$$\sigma_v = Z \cdot \gamma + q = 2.92 \cdot 18.8 + 9.4$$

$$\sigma_v = 64.4 \text{ kPa}$$

$$\sigma_H = \sigma_v \cdot K = 64.4 \cdot 0.412 = 26.5 \text{ kPa}$$

The impact barrier will not transfer stress to reinforced volume because it is cast to the concrete pavement structure for the full width of the roadway.

- The horizontal spacing is initially determined from pullout considerations by using for convenience a distance over 2 panel widths centered by the reinforcements at each level rather than a unit wall width and the reinforcement coverage ratio R_c . The maximum force on this defined tributary area A_t is:

$$A_t = S_v \times 2 \text{ panel width} = 0.75 \cdot 2 (1.5) = 2.25 \text{ m}^2$$

The maximum force on this defined length or tributary area is:

$$T = \sigma_H \cdot A_t = 26.5 \cdot 2.25 = 59.6 \text{ kN}$$

if pullout FS ≥ 1.5 then the resistance P_R is:

$$P_R \geq \sigma_H \cdot A_t \cdot FS = 89.4 \text{ kN}$$

- The number of reinforcing strips, N, required to satisfy the minimum resistance can be calculated from:

$$N = \frac{P_R}{2b \cdot F^* L_e \cdot \sigma'_v}$$

where $b = 50 \text{ mm}$

$$L_e = 3.16 \text{ m (see figure 28)}$$

$$\sigma'_v = \gamma \cdot z \text{ (Neglect live load surcharge for pullout)}$$

$$F^* = 1.35 \text{ (Obtained by interpolation from 2.0 at } Z = 0 \text{ to } \tan \phi \text{ at 6 m)}$$

$$N = \frac{89.4}{2 (0.05) 1.35 (3.16) 18.8 (2.92)} = 3.8$$

$N = 4$ strips per tributary area for FS > 1.5 placed in a row over 2 panels.

- Check stress in reinforcement based on the thickness loss of E_s subtracted from the nominal thickness of 4 mm. The basis for the thickness losses per year are as follows:

$$\begin{aligned} \text{zinc loss} &= 15 \mu\text{m (first 2 years)} \\ &= 4 \mu\text{m (thereafter)} \\ \text{steel loss} &= 12 \mu\text{m} \end{aligned}$$

Service life of zinc coating (86 μm) is:

$$\text{Life} = 2 \text{ yrs.} + \frac{86 - 2(15)}{4} = 2 \text{ years} + 14 \text{ years} = 16 \text{ years}$$

The base carbon steel will lose section for:

75 years - 16 years = 59 years at a rate of 12 $\mu\text{m}/\text{year}/\text{side}$. Therefore, the anticipated loss is:

$$\begin{aligned} E_R &= 12(59)2 &= 1.416 \text{ mm and} \\ E_c &= 4.000 - 1.416 &= 2.584 \text{ mm} \\ \text{and the section area} & &= 129.2 \text{ mm}^2 \end{aligned}$$

$$\text{If 60 grade steel is used } F_y = 413.7 \text{ MPA}$$

$$\text{and } f_{\text{all}} = 0.55 (F_y) = 227.5 \text{ MPA}$$

The tensile stress in each strip can be calculated from:

$$f_s = \frac{T}{N \cdot E_c} = \frac{59.6}{4 (0.000129) 1000}$$

$$= 115.4 \text{ MPA} < 227.5 \text{ MPA}$$

Calculate internal stability at each layer and determine the number of reinforcing strips per tributary area.

The results for each depth of reinforcement are shown in the following table:

| Depth z(m) | Vertical Pressure kPa | K | F* | Hor. Pressure kPa | N strips per trib. area | Tensile stress/ MPA | FS pullout |
|------------|-----------------------|------|------|-------------------|-------------------------|---------------------|------------|
| 0.675 | 22.09 | 0.46 | 1.85 | 10.27 | 5 | 35.75 | 1.61 |
| 1.425 | 36.19 | 0.45 | 1.69 | 16.18 | 4 | 70.44 | 1.57 |
| 2.175 | 50.29 | 0.43 | 1.52 | 21.59 | 4 | 94.01 | 1.62 |
| 2.925 | 64.39 | 0.41 | 1.35 | 26.51 | 4 | 115.42 | 1.58 |
| 3.675 | 78.49 | 0.39 | 1.19 | 30.93 | 4 | 134.65 | 1.49 |
| 4.425 | 92.59 | 0.38 | 1.02 | 34.85 | 4 | 151.72 | 1.51 |
| 5.175 | 106.69 | 0.36 | 0.86 | 38.27 | 4 | 166.61 | 1.52 |
| 5.925 | 120.79 | 0.34 | 0.69 | 41.19 | 5 | 143.47 | 1.82 |
| 6.675 | 134.89 | 0.34 | 0.67 | 45.76 | 4 | 199.24 | 1.59 |
| 7.425 | 148.99 | 0.34 | 0.67 | 50.55 | 4 | 220.06 | 1.75 |

b. Computer-Aided Solution

The computer program MSEW⁽³²⁾ could also be used as a design aid. MSEW is a windows based interactive program specifically developed under sponsorship of the FHWA for the design and analysis of mechanically stabilized earth walls. It follows AASHTO '96 with 1998 Interims and this manual. Portions of this manual are incorporated in the Help menu. Version 1.0 has been designated exclusively for use by U.S. State Highway Agencies and by U.S. Federal agencies. Version 1.1 is available to the public through ADAMA Engineering (www.MSEW.com).

MSEW has two modes of operation: *Design* and *Analysis*. In the *Design* mode, the program computes the required layout (length and vertical spacing) corresponding to user's prescribed safety factors. In this mode, the program produces the *ideal* reinforcement values for strength or coverage ratio so that the designer can maximize reinforcement utilization. In the *Analysis* mode, MSEW computes the factors of safety corresponding to user's prescribed layout.

MSEW Design Check for Example 4.6

This section provides the steps and input necessary with MSEW in the Analysis mode to evaluate the external and internal design shown in steps 7 and 8 of the preceding example. The example problem will use the simple problem format on the initial screen. The steps are as follows:

- ▶ Load the MSEW Program.
- ▶ After the welcome screen, open the file menu, click on **new** and input the project information. Then click **OK**.

- ▶ The screens for input of design information and requirements should now be on the screen. These include the **PROGRAM MANAGER**, the **GEOMETRY/ SURCHARGE**, **SOILS AND SEISMICITY**, and **REINFORCEMENT**.
- ▶ Move to the **PROGRAM MANAGER** screen and choose the **Analysis** mode to evaluate given design results from example problem 4.6. Also choose the units to be used (e.g., metric units for this problem). The project information which was entered in the first step can be reviewed using the **ID** button.
- ▶ Next move to the **GEOMETRY/SURCHARGE SCREEN**. Click on **Simple** geometry and enter the design height and external loads on the structure from the example problem as follows.

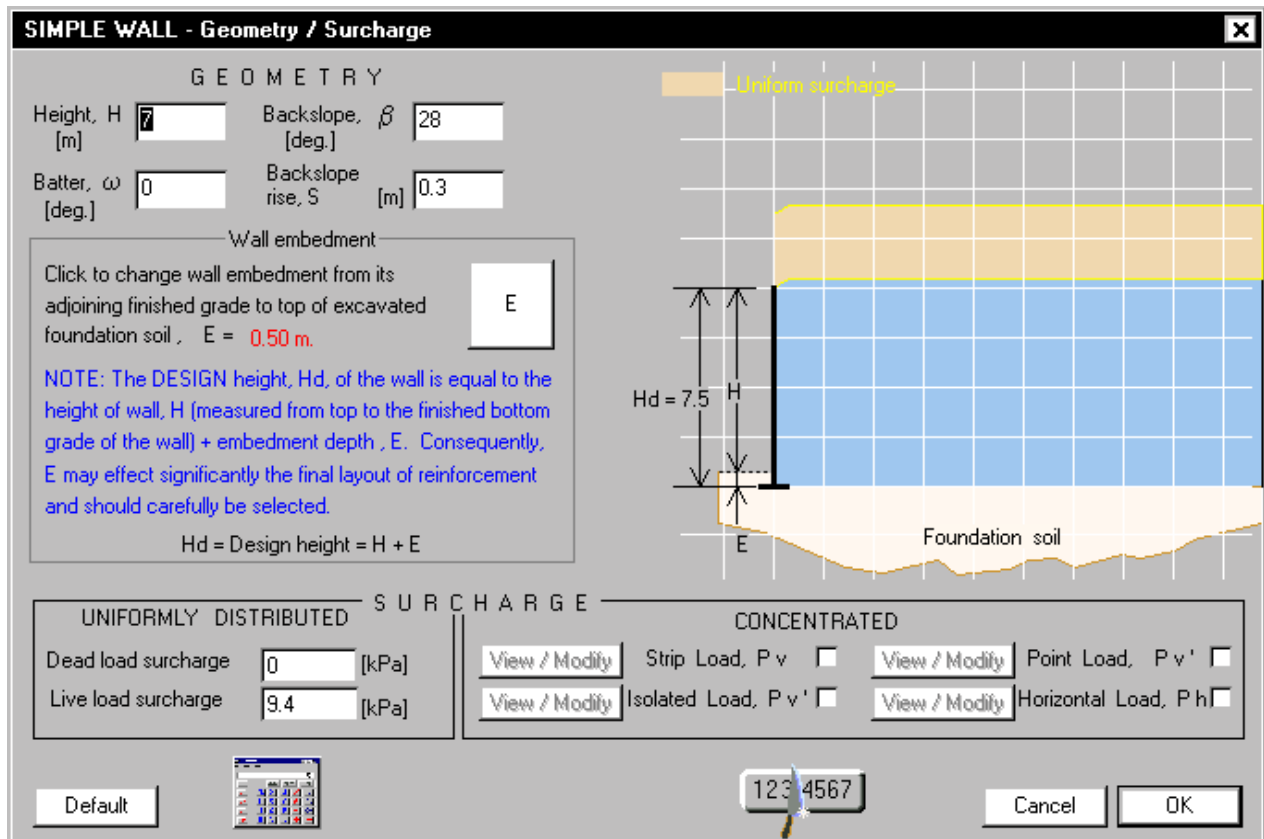
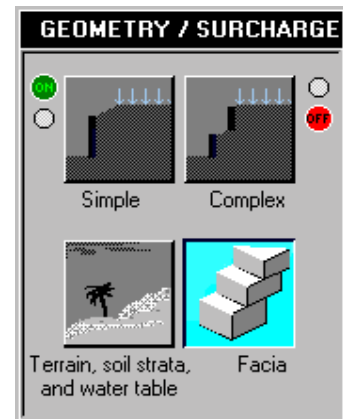
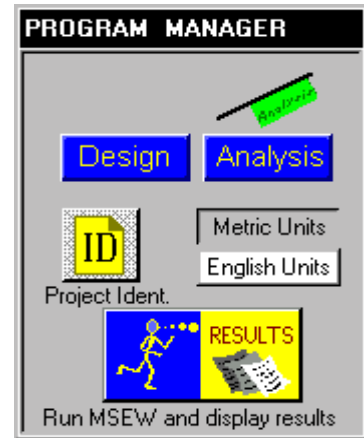

- Next, on the GEOMETRY/SURCHARGE screen, click on the **Facia – Analysis** button and select the **Segmental precast concrete panels** for this problem. Press **NEXT** and check/modify the default information provided as follows. Click on **NEXT** to advance each screen until the final screen, then click on **OK**.

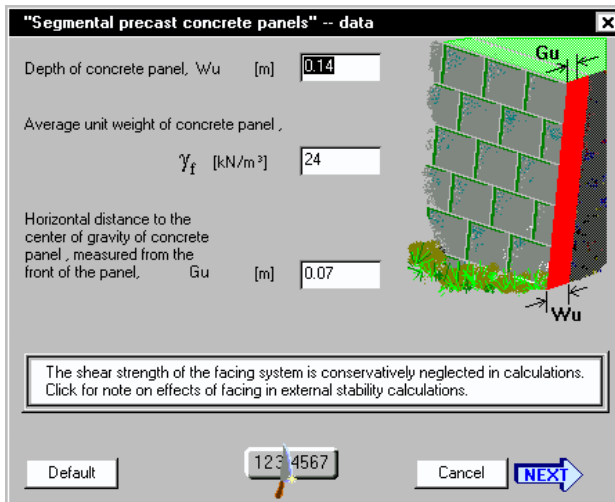
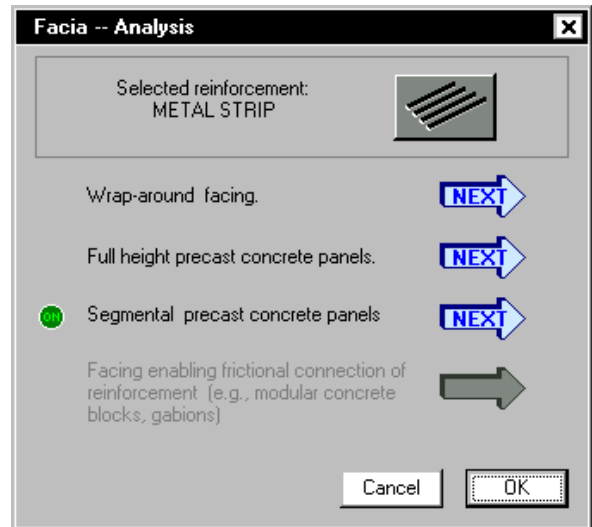

- Check the depth, unit weight and horizontal distance to the center of gravity.

- Two screens are included for reducing the stress at the facing connections. As indicated in Section 4.3e, AASHTO does not allow a reduction in strength at the connection and all values should be

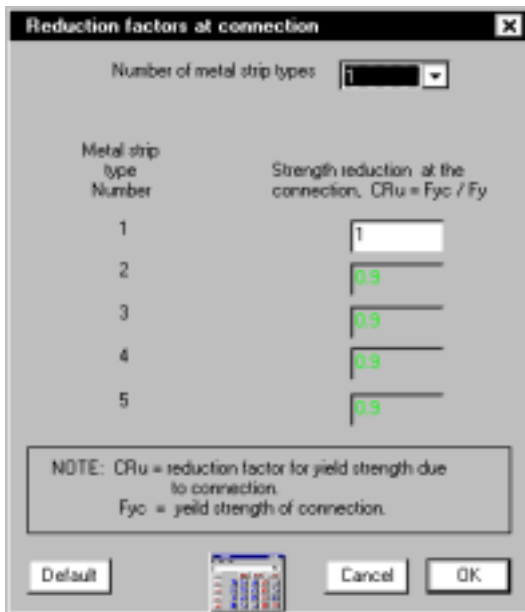
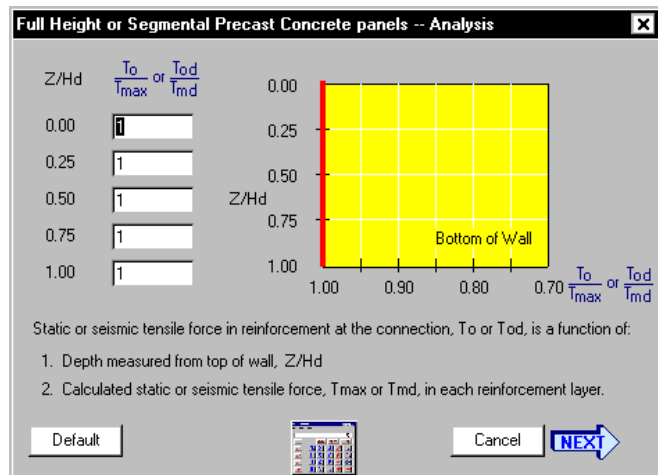

set to 1.

- Next, move to the **SOILS & SEISMICITY** screen and input the engineering properties of the reinforced soil, retained soil and foundation soil plus the seismic requirements. Note the default values must be changed for this problem. For the foundation soil, the computer program will either calculate the bearing capacity based on the soil properties or an ultimate bearing capacity can be input (e.g., where complex subsurface conditions exist). In the example problem - step 2, a 300 kPa allowable bearing capacity was given. Using a factor of safety of 2.5, a 750 kPa ultimate bearing capacity will be used in the computer analysis. Click on **Ultimate bearing capacity of foundation** is given and input the value (not shown).

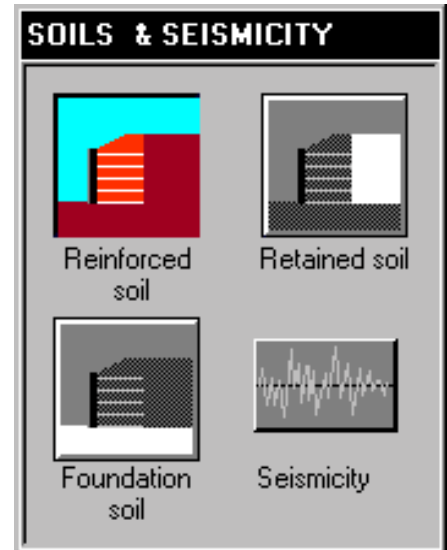

Reinforced soil properties dialog box. It contains three input fields:

- Unit weight, γ [kN/m³]: 18.4
- Design value of internal angle of friction, ϕ [deg.]: 34
- Cohesion, c [kN/m²]: 0

 At the bottom, there are buttons for Default, Cancel, and OK. A numeric keypad is also visible with the number 1234567 highlighted.

Retained soil properties dialog box. It contains three input fields:

- Unit weight, γ [kN/m³]: 18.4
- Design value of internal angle of friction, ϕ [deg.]: 30
- Cohesion, c [kN/m²]: 0

 At the bottom, there are buttons for Default, Cancel, and OK. A numeric keypad is also visible with the number 1234567 highlighted.

Foundation soil properties dialog box. It contains several input fields and radio button options:

- Unit weight, γ_{equiv} [kN/m³]: 18.4
- Equivalent internal angle of friction, ϕ_{equiv} [deg.]: 30
- Equivalent cohesion, c_{equiv} [kN/m²]: 0
- Water table is at wall base elevation:
- Water table does not affect bearing capacity:
- Ultimate bearing capacity of foundation is given:

 At the bottom, there are buttons for Default, Cancel, and OK. A numeric keypad is also visible with the number 1234567 highlighted.

Seismicity - Analysis dialog box. It contains:

- A checkbox labeled "Seismicity is NOT applicable" which is currently unchecked.
- Maximum ground acceleration coefficient, α_0 : 0.05
- Seismic soil-metal Slip friction coefficient, F^* , is: 80 % of its specified static value.

 At the bottom, there are buttons for Default, Cancel, and OK. A calculator icon is also present.

- ▶ Next on the main menu screen, move to the **REINFORCEMENT** screen to input the reinforcement requirement from the design example. The example problem uses metal strips, so click on the **Metal Strip** button.
- ▶ On the next screen, click on the **S** Button and enter the reinforcement strength, length and number of strips from the table in Step 8 of the example problem. Each screen will appear after clicking on **OK** for the preceding screen.
- ▶ Check the Cross sectional area corrected for corrosion loss and change it to 129 mm² based on the results from the **corrosion note**.

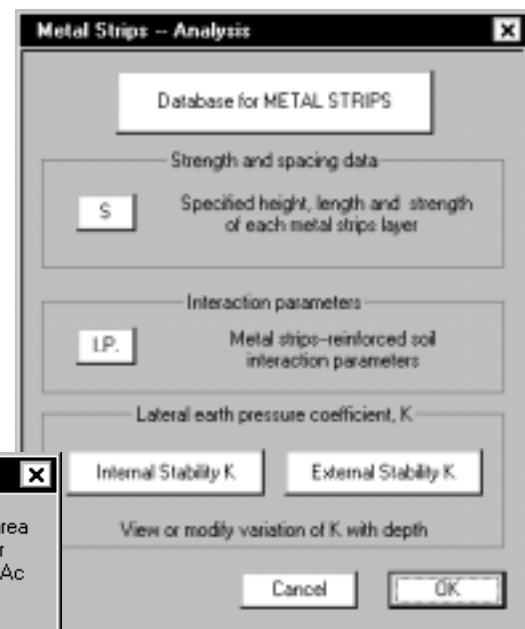
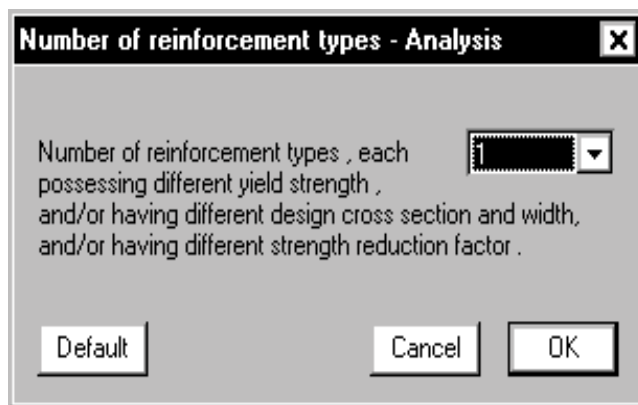
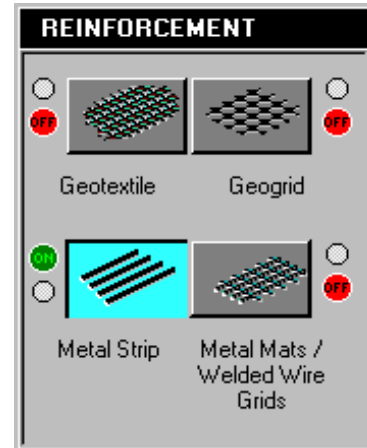

One type of REINFORCEMENT -- Analysis

| Retrieve data from: | Metal strip type # | Yield strength F _y [MPa] | Gross width of b [mm] | Cross-section area corrected for corrosion loss, A _c [mm ²] |
|---------------------|--------------------|-------------------------------------|-----------------------|------------------------------------------------------------------------------------|
| | 1 | 450 | 50 | 129 |
| | 2 | 450 | 50 | 150 |
| | 3 | 450 | 50 | 150 |
| | 4 | 450 | 50 | 150 |
| | 5 | 450 | 50 | 150 |

The factor of safety on yield strength, F_s, can be defined in a conventional geotechnical engineering fashion : F_s = (Yield strength) / (Actual stress). This is equivalent to the traditional value used in steel as follows : FS = 1/F_s

$$T_{\text{available}} = FS \cdot F_y \cdot \frac{A_c}{b} \cdot R_c = \frac{F_y}{F_s} \cdot \frac{A_c}{b} \cdot R_c \quad T_{\text{allowable}} \leq T_{\text{available}}$$

NOTE: T_{available} and T_{allowable} represent force per unit width

R_c = b / Sh = Coverage ratio

1234567

CORROSION NOTE

- On the **Specified heights, lengths, and strengths of reinforcement - Analysis** screen input the height above the top of the pad (h) and the horizontal spacing (Sh). Note that the height is referenced above the pad to the level of the specific reinforcement layer, where as in the table of results in step 8 of the design example, the depth is provided to the level of reinforcement (i.e., $h = 7.8\text{m} - z$). The horizontal spacing is modified to the layout required to accommodate the number of strips included in the design example (i.e., $S_h = 3\text{m} / N$ for the top row).

Specified heights, lengths and strengths of reinforcements -- Analysis

Data from "Reinf. strength and spacing data":

| Metal Strip type # | Fy |
|--------------------|--------|
| 1 | 450.00 |
| | |
| | |
| | |

$$T_{\text{available}} = FS \cdot F_y \cdot \frac{A_c}{b} \cdot R_c = \frac{F_y}{F_s} \cdot \frac{A_c}{b} \cdot R_c$$

$$T_{\text{Long-term strength}} = F_y \cdot \frac{A_c}{b} \cdot R_c \quad T_{\text{allowable}} \leq T_{\text{available}}$$

Click to add a layer at height and length indicated

Height =
 H d = 7.5

| | Height above top of pad, h [m] | Length [m] | Horizontal spacing, Sh [m] | Metal strip type # |
|----|--------------------------------|------------|----------------------------|--------------------|
| 1 | 0.38 | 5.50 | 0.75 | 1 |
| 2 | 1.13 | 5.50 | 0.75 | 1 |
| 3 | 1.88 | 5.50 | 0.60 | 1 |
| 4 | 2.63 | 5.50 | 0.75 | 1 |
| 5 | 3.38 | 5.50 | 0.75 | 1 |
| 6 | 4.13 | 5.50 | 0.75 | 1 |
| 7 | 4.88 | 5.50 | 0.75 | 1 |
| 8 | 5.63 | 5.50 | 0.75 | 1 |
| 9 | 6.38 | 5.50 | 0.75 | 1 |
| 10 | 7.13 | 5.50 | 0.60 | 1 |
| 11 | | | | |

Tip

H d = 0

L = 0

Length =

Default Cancel OK

- Back to the Metal Strips screen, click on the **I.F.** button to evaluate the interaction parameters.

Metal Strips -- Analysis

Database for METAL STRIPS

Strength and spacing data

Specified height, length and strength of each metal strips layer

Interaction parameters

Metal strips-reinforced soil interaction parameters

Lateral earth pressure coefficient, K

View or modify variation of K with depth

Cancel OK

- ▶ Check the Interface Friction information for ribbed metal strips with step 8 in the example problem as shown on the following screens. The default values are acceptable for this problem and no changes are required.

Metal Strip Data

Smooth steel strips
 Ribbed steel strips

Uniformity Coefficient of reinforced soil, $C_u = D_{60}/D_{10}$

Reinforcement-reinforced soil interaction parameters -- Analysis

RIBBED STEEL STRIPS

| Metal strip type | NOTE ρ [deg.] | | NOTE F^* | | α |
|------------------|--------------------|---------------|------------|---------------|----------|
| | Top | 6 m and below | Top | 6 m and below | |
| # 1 | 63.434 | 34 | 2 | 0.674 | 1 |
| # 2 | 63.434 | 34 | 2 | 0.674 | 1 |
| # 3 | 63.434 | 34 | 2 | 0.674 | 1 |
| # 4 | 63.434 | 34 | 2 | 0.674 | 1 |
| # 5 | 63.434 | 34 | 2 | 0.674 | 1 |

ρ = Friction angle along metal strip-soil interface (used in Direct Sliding analysis)
 F^* = Pullout resistance factor
 α = Scale effect correction factor

} (used in Pullout computations)

NOTE: At depths between 0 and 6 m, ρ or F^* are linearly interpolated.

Default values for the above variables are automatically assigned
 User prescribed values for the above variables

- Return to the **Metal Strips** screen and review the **Internal** and **External Stability** lateral earth pressure coefficient information. Again the default values are acceptable.

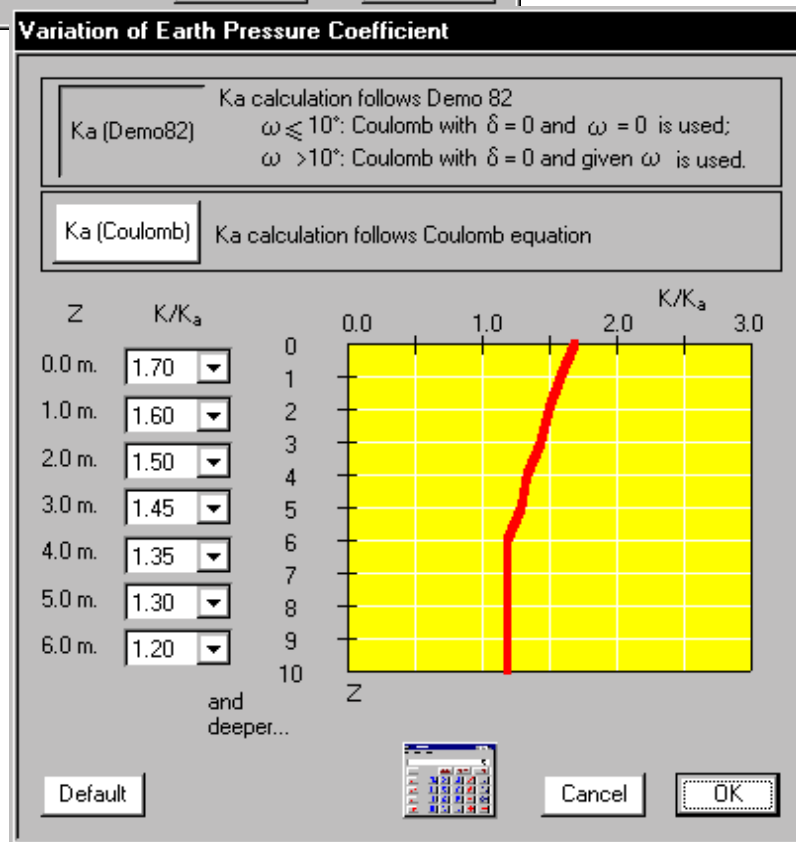
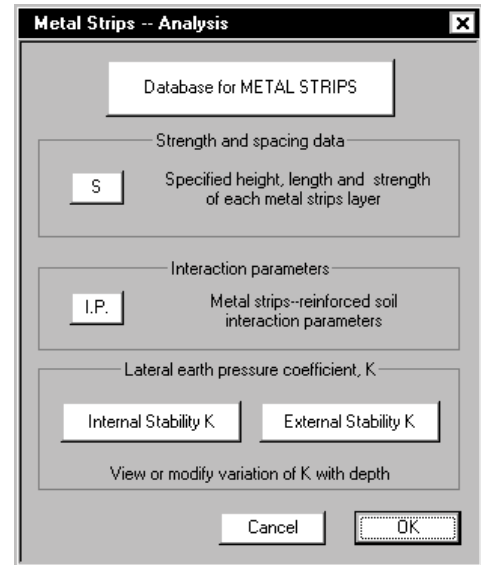
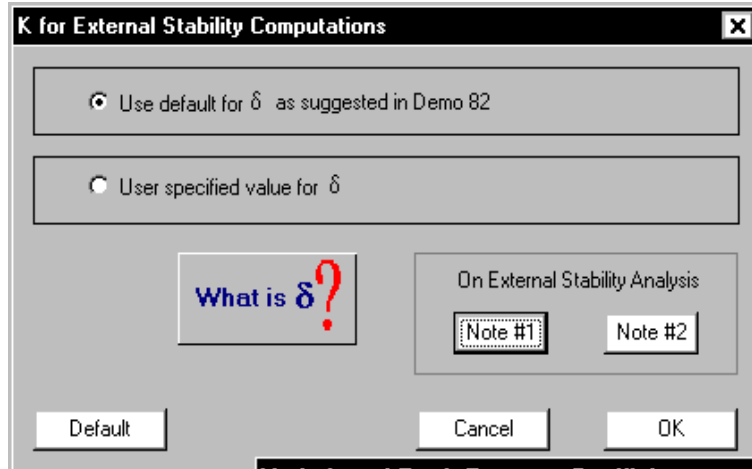

- The results of the analysis of the design information can now be viewed by returning to the **PROGRAM MANAGER** screen and pressing the **RESULTS** button. The following shows the screen for the static results of the analysis and an expanded “Results of analysis” table. The factor of safety for external analysis is shown on the screen and the complete analyses (not shown) can also be viewed from this screen by clicking on the appropriate **Bearing Capacity**, **Direct Sliding** or **Eccentricity** button. Additional detail for the **Strength**, **Connection** and **Pullout** internal stability calculations can also be viewed.

- ▶ The results show that the external factors of safety and the eccentricity agree with those obtained in step 7 of the design example. The internal stability results in terms of the factor of safety for reinforcement strength and pullout resistance also agree well with the results in step 8. A Global Stability Analysis using the methods discussed in Chapter 7 could also be performed using the MSEW program.

4.7 DESIGN EXAMPLE – Geosynthetic Reinforcement

Results of analysis

Soils, Loads, Seismicity, K_{se} , K_{int}

Compound / Global Results

Printout information

Bearing Capacity Direct sliding Eccentricity

Strength Connection Pullout

7.50

Bearing capacity : $F_s = 3.63$ (Based on length of bottom layer)
 Foundation interface: F_s -direct sliding = 2.171 $e/L = 0.1293$

Save results as text file *.txt

Save results as bitmap *.bmp

| # | Metal Strip | | | Connection strength | | | Results of Analysis | | | |
|---|---------------|------------|------|-------------------------------------|-----------------------------------|---------------------------------------|----------------------------|--------------------------|----------------------|--------------------|
| | Elevation [m] | Length [m] | Type | F_s -overall [pullout resistance] | F_s -overall [connection break] | F_s -overall [Metal strip strength] | Metal strip strength F_s | Pullout resistance F_s | Direct sliding F_s | Eccentricity e/L |
| 1 | 0.38 | 5.50 | 1 | N/A | 1.84 | 2.05 | 2.046 | 1.618 | 2.636 | 0.1179 |
| 2 | 1.13 | 5.50 | 1 | N/A | 2.03 | 2.26 | 2.260 | 1.471 | 2.892 | 0.0966 |
| 3 | 1.88 | 5.50 | 1 | N/A | 2.76 | 3.07 | 3.066 | 1.795 | 3.216 | 0.0774 |
| 4 | 2.63 | 5.50 | 1 | N/A | 2.38 | 2.64 | 2.643 | 1.468 | 3.606 | 0.0602 |
| 5 | 3.38 | 5.50 | 1 | N/A | 2.64 | 2.93 | 2.934 | 1.449 | 4.101 | 0.0449 |
| 6 | 4.13 | 5.50 | 1 | N/A | 2.98 | 3.31 | 3.313 | 1.419 | 4.753 | 0.0316 |

Click to **INVOKE** Compound/Global Stability

For Help, press F1

Deviation

Seismic results

Static results

Modify Reinforcement Input

RETURN

Live Load and Seismicity

Ideal value per layer :
 • b or R_c
 • Global efficiency

Analysis Layout -- extended table

| # | Metal Strip | | | Connection strength | | | Results of Analysis | | | |
|----|---------------|------------|------|-------------------------------------|-----------------------------------|---------------------------------------|----------------------------|--------------------------|----------------------|--------------------|
| | Elevation [m] | Length [m] | Type | F_s -overall [pullout resistance] | F_s -overall [connection break] | F_s -overall [Metal strip strength] | Metal strip strength F_s | Pullout resistance F_s | Direct sliding F_s | Eccentricity e/L |
| 1 | 0.38 | 5.50 | 1 | N/A | 1.84 | 2.05 | 2.046 | 1.618 | 2.636 | 0.1179 |
| 2 | 1.13 | 5.50 | 1 | N/A | 2.03 | 2.26 | 2.260 | 1.471 | 2.892 | 0.0966 |
| 3 | 1.88 | 5.50 | 1 | N/A | 2.76 | 3.07 | 3.066 | 1.795 | 3.216 | 0.0774 |
| 4 | 2.63 | 5.50 | 1 | N/A | 2.38 | 2.64 | 2.643 | 1.468 | 3.606 | 0.0602 |
| 5 | 3.38 | 5.50 | 1 | N/A | 2.64 | 2.93 | 2.934 | 1.449 | 4.101 | 0.0449 |
| 6 | 4.13 | 5.50 | 1 | N/A | 2.98 | 3.31 | 3.313 | 1.419 | 4.753 | 0.0316 |
| 7 | 4.88 | 5.50 | 1 | N/A | 3.46 | 3.84 | 3.840 | 1.479 | 5.652 | 0.0202 |
| 8 | 5.63 | 5.50 | 1 | N/A | 4.25 | 4.72 | 4.722 | 1.507 | 6.972 | 0.0105 |
| 9 | 6.38 | 5.50 | 1 | N/A | 5.72 | 6.36 | 6.360 | 1.466 | 9.090 | 0.0019 |
| 10 | 7.13 | 5.50 | 1 | N/A | 11.47 | 12.74 | 12.745 | 1.511 | 13.031 | -0.0087 |

The following example is from a Highway Innovative Technology Evaluation Center (HITEC) report⁽³¹⁾ on a modular block unit faced, geogrid soil reinforcement wall system. The hand calculation is directly from the report. The computerized analysis was performed using input parameters from the hand calculation.

I. Hand Calculation Example⁽³¹⁾

HORIZONTAL BACKSLOPE WITH TRAFFIC SURCHARGE - STATIC ANALYSIS
GEOGRID WITH 100% COVERAGE

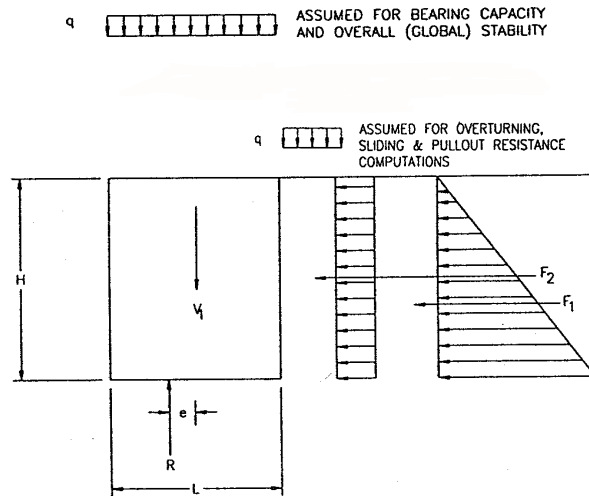

$H = 9 \text{ m}$

$V_1 = \gamma_r HL$

$F_1 = \frac{1}{2} \gamma_b H^2 K_a$

$F_2 = qHK_a$

$L = 7.5 \text{ m}$

$e = \text{Eccentricity}$

$q = \text{Traffic Surcharge} = 11.97 \text{ kN/m}$

$R = \text{Resultant of Vertical Forces}$
 $(V_1 + qL)$

SOIL PROPERTIES

REINFORCED SOILS

$\gamma_r = 19.6 \text{ kN/m}^3$

$\phi_r = 34^\circ$

$c = 0 \text{ kPa}$

$K_a = \tan^2 (45 - \phi/2)$

$= \tan^2 (45 - 34/2) = 0.28 = K_a$

(Section 4.3B FHWA - Demo 82)

HORIZONTAL BACKSLOPE WITH TRAFFIC SURCHARGE - STATIC ANALYSIS
GEOGRID WITH 100% COVERAGE

RETAINED BACKFILL SOILS

$$\gamma_b = 19.6 \text{ kN/m}^3 \quad \phi_b = 30^\circ \quad c = 0 \text{ kPa}$$

FOUNDATION SOILS

$$\gamma_f = 19.6 \text{ kN/m}^3 \quad \phi_f = 30^\circ \quad c = 0 \text{ kPa}$$

$$K_a = \tan^2(45 - \phi/2) = \tan^2(45 - 30/2) = K_a = 0.33$$

(Section 4.2d FHWA - Demo 82)

$$q = \gamma_{tr} h = (19.6 \text{ kN/m}^3)(0.610 \text{ m}) = 11.97 \text{ kN/m}^2$$

EXTERNAL STABILITY

$$H = 9 \text{ m}$$

$$B = L = 7.5 \text{ m (assumed } L > 0.7 H \text{ or } 2.44 \text{ m)}$$

LOADS

$$V_1 = \gamma_r HL = (19.6)(9)(7.5) = 1323.0 \text{ kN/m}$$

$$V_2 = qL = (11.97)(7.5) = 89.8 \text{ kN/m}$$

$$R = \Sigma V = V_1 + V_2 = 1323.0 + 89.8 = 1412.8 \text{ kN/m}$$

$$F_1 = \frac{1}{2} \gamma_b H^2 K_a = (0.5)(19.6)(9^2)(0.33) = 262.0 \text{ kN/m}$$

$$F_2 = q H K_a = (11.97)(9)(0.33) = 35.6 \text{ kN/m}$$

MOMENTS

$$M = \text{Overturning Moment} = F_1 (H/3) + F_2 (H/2)$$

$$= (262)(9/3) + (35.6)(9/2) = 946.2 \text{ kN m/m} = M_o$$

$$M_{RO} = \text{Resisting Moment} = V_1 (L/2) = (1323)(7.5/2)$$

$$= 4961.3 \text{ kN m/m}$$

$$M_{RBP} = \text{Resisting Moment in Applied Bearing Pressure Calculation}$$

$$= V_1 (L/2) + V_2 (L/2) = 1323(7.5/2) + 89.8(7.5/2)$$

$$= 5298 \text{ kN m/m}$$

$$\text{FS}_{\text{sliding}} = \frac{\Sigma P_R}{\Sigma p_d} \text{ (Section 4.2e of FHWA - Demo 82)} = \frac{V_1 \tan \phi_r}{(F_1 + F_2)}$$

where ϕ is the lesser of ϕ_r and ϕ_f

$$= \frac{1323 \tan 30}{(262+35.6)} = 2.6 > 1.5$$

$$\text{FS}_{\text{overturning}} = \frac{M_{RO}}{M_o} = \frac{4961.3}{946.2} = 5.2 \geq 2.0$$

HORIZONTAL BACKSLOPE WITH TRAFFIC SURCHARGE - STATIC ANALYSIS
GEOGRID WITH 100% COVERAGE

MAXIMUM APPLIED BEARING PRESSURE

$$L/6 = 7.5/6 = 1.25 \text{ m}$$

$$e = \frac{L}{2} - \frac{(M_{RBP} - M_O)}{V_1 + V_2}$$

$$= \frac{7.5}{2} - \frac{(5298 - 946.2)}{1323 + 89.8} = 0.67 \text{ m} \leq 1.25 \text{ m}$$

$$L' = L - 2e = 7.5 - 2(0.67) = 6.16 = L'$$

$$\sigma_v = \text{Max. Applied Bearing Pressure} = \frac{V_1 + qL}{L - 2e} = \frac{V_1 + V_2}{L'} \quad (\text{AASHTO 97 - Fig. 5.8.3A})$$

$$= \frac{1323 + 89.8}{6.16} = 229.4 \text{ kN/m}^2$$

$$q_{ult} = \text{Ult. Bearing Capacity of Fndn. Soil} = c_f N_c + 0.5 (L - 2e) \gamma_f N_\gamma$$

(Section 4.2f of FHWA - Demo 82)

$$c_f = \text{Cohesion} \quad N_c = \text{Dimensionless Bearing Capacity Coefficient}$$

$$= 0 \text{ kN/m}^2$$

$$q_{ult} = 0.5 L' \gamma_f N_\gamma = (0.5) (6.16) (19.6)(22.4) = 1352.2 \text{ kN/m}^2$$

$$FS_{\text{bearing capacity}} = q_{ult} / \sigma_v = \frac{1352.2}{229.4} = 5.89 > 2.5$$

FSsliding AT BASE OF FIRST GRID (Bottom of the wall)

$$F_1 \text{ @ FIRST GRID} = \frac{1}{2} \gamma_b d_{17}^2 K_a = (\frac{1}{2}) (19.6) (8.80)^2 (0.33) = 250.4 \text{ kN/m}$$

$$F_2 \text{ @ FIRST GRID} = q d_{17} K_a = (11.97) (8.80) (0.33) = 34.8 \text{ kN/m}$$

$$FS_{\text{sliding}} = \frac{\gamma_r d_{17} L \tan \phi_r C_i}{(F_1 + F_2)} = \frac{(19.6) (8.80) (7.5) (\tan 34^\circ) (0.8)}{(250.4 + 34.8)}$$

$$FS_{\text{sliding}} = 2.45 > 1.5$$

(at first grid)

HORIZONTAL BACKSLOPE WITH TRAFFIC SURCHARGE - STATIC ANALYSIS
GEOGRID WITH 100% COVERAGE

INTERNAL STABILITY

H = 9 m

B = L = 7.9 m (from external seismic stability analysis)

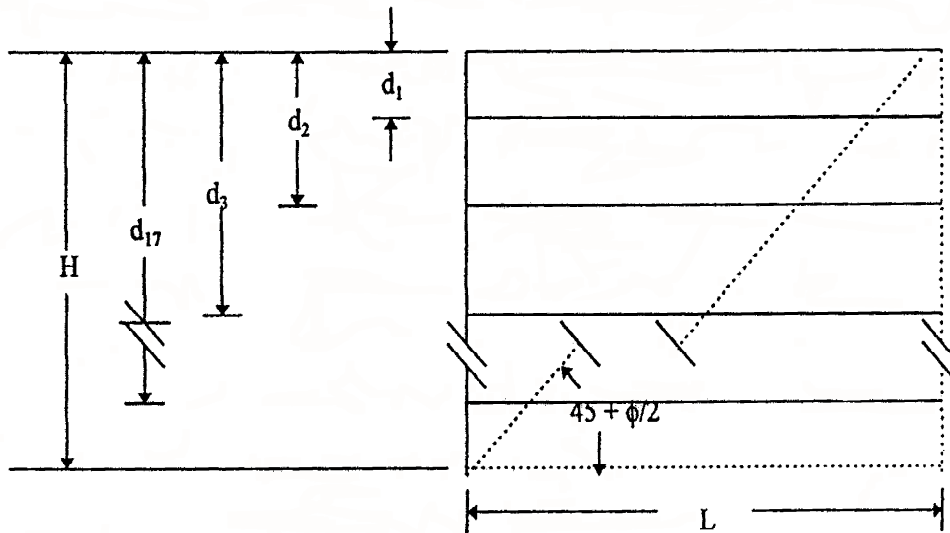

| | | |
|-------------------------------------------|-------------------------------------------------------|----------------------------------------------------------|
| $V_i = \text{Geogrid (i) Tributary Area}$ | $d_1 = 9 \text{ m} - 8.53 \text{ m} = 0.47 \text{ m}$ | $d_9 = 9 \text{ m} - 3.66 \text{ m} = 5.34 \text{ m}$ |
| $\beta = 0$ | $d_2 = 9 \text{ m} - 7.93 \text{ m} = 1.07 \text{ m}$ | $d_{10} = 9 \text{ m} - 3.05 \text{ m} = 5.95 \text{ m}$ |
| | $d_3 = 9 \text{ m} - 7.32 \text{ m} = 1.68 \text{ m}$ | $d_{11} = 9 \text{ m} - 2.64 \text{ m} = 6.36 \text{ m}$ |
| | $d_4 = 9 \text{ m} - 6.71 \text{ m} = 2.29 \text{ m}$ | $d_{12} = 9 \text{ m} - 2.24 \text{ m} = 6.76 \text{ m}$ |
| | $d_5 = 9 \text{ m} - 6.10 \text{ m} = 2.90 \text{ m}$ | $d_{13} = 9 \text{ m} - 1.83 \text{ m} = 7.17 \text{ m}$ |
| | $d_6 = 9 \text{ m} - 5.49 \text{ m} = 3.51 \text{ m}$ | $d_{14} = 9 \text{ m} - 1.42 \text{ m} = 7.58 \text{ m}$ |
| | $d_7 = 9 \text{ m} - 4.88 \text{ m} = 4.12 \text{ m}$ | $d_{15} = 9 \text{ m} - 1.02 \text{ m} = 7.98 \text{ m}$ |
| | $d_8 = 9 \text{ m} - 4.27 \text{ m} = 4.73 \text{ m}$ | $d_{16} = 9 \text{ m} - 0.61 \text{ m} = 8.39 \text{ m}$ |
| | | $d_{17} = 9 \text{ m} - 0.20 \text{ m} = 8.80 \text{ m}$ |

| | |
|-------------------------------------------------------------------------------------------------------------------|------------------------|
| $V_1 = d_1 + \frac{1}{2} (d_2 - d_1) = 0.47 + \frac{1}{2} (1.07 - 0.47)$ | $V_1 = 0.77 \text{ m}$ |
| $V_2 = \frac{1}{2} (d_2 - d_1) + \frac{1}{2} (d_3 - d_2) = \frac{1}{2} (1.07 - 0.47) + \frac{1}{2} (1.68 - 1.07)$ | $V_2 = 0.61 \text{ m}$ |
| $V_3 = \frac{1}{2} (d_3 - d_2) + \frac{1}{2} (d_4 - d_3) = \frac{1}{2} (1.68 - 1.07) + \frac{1}{2} (2.29 - 1.68)$ | $V_3 = 0.61 \text{ m}$ |
| $V_4 = \frac{1}{2} (d_4 - d_3) + \frac{1}{2} (d_5 - d_4) = \frac{1}{2} (2.29 - 1.68) + \frac{1}{2} (2.90 - 2.29)$ | $V_4 = 0.61 \text{ m}$ |
| $V_5 = \frac{1}{2} (d_5 - d_4) + \frac{1}{2} (d_6 - d_5) = \frac{1}{2} (2.90 - 2.29) + \frac{1}{2} (3.51 - 2.90)$ | $V_5 = 0.61 \text{ m}$ |
| $V_6 = \frac{1}{2} (d_6 - d_5) + \frac{1}{2} (d_7 - d_6) = \frac{1}{2} (3.51 - 2.90) + \frac{1}{2} (4.12 - 3.51)$ | $V_6 = 0.61 \text{ m}$ |
| $V_7 = \frac{1}{2} (d_7 - d_6) + \frac{1}{2} (d_8 - d_7) = \frac{1}{2} (4.12 - 3.51) + \frac{1}{2} (4.73 - 4.12)$ | $V_7 = 0.61 \text{ m}$ |
| $V_8 = \frac{1}{2} (d_8 - d_7) + \frac{1}{2} (d_9 - d_8) = \frac{1}{2} (4.73 - 4.12) + \frac{1}{2} (5.34 - 4.73)$ | $V_8 = 0.61 \text{ m}$ |

HORIZONTAL BACKSLOPE WITH TRAFFIC SURCHARGE - STATIC ANALYSIS
GEOGRID WITH 100% COVERAGE

$$\begin{aligned}
 V_9 &= \frac{1}{2} (d_9 - d_8) + \frac{1}{2} (d_{10} - d_9) = \frac{1}{2} (5.34 - 4.73) + \frac{1}{2} (5.95 - 5.34) & V_9 &= 0.61 \text{ m} \\
 V_{10} &= \frac{1}{2} (d_{10} - d_9) + \frac{1}{2} (d_{11} - d_{10}) = \frac{1}{2} (5.95 - 5.34) + \frac{1}{2} (6.36 - 5.95) & V_{10} &= 0.51 \text{ m} \\
 V_{11} &= \frac{1}{2} (d_{11} - d_{10}) + \frac{1}{2} (d_{12} - d_{11}) = \frac{1}{2} (6.36 - 5.95) + \frac{1}{2} (6.76 - 6.36) & V_{11} &= 0.41 \text{ m} \\
 V_{12} &= \frac{1}{2} (d_{12} - d_{11}) + \frac{1}{2} (d_{13} - d_{12}) = \frac{1}{2} (6.76 - 6.36) + \frac{1}{2} (7.17 - 6.76) & V_{12} &= 0.41 \text{ m} \\
 V_{13} &= \frac{1}{2} (d_{13} - d_{12}) + \frac{1}{2} (d_{14} - d_{13}) = \frac{1}{2} (7.17 - 6.76) + \frac{1}{2} (7.58 - 7.17) & V_{13} &= 0.41 \text{ m} \\
 V_{14} &= \frac{1}{2} (d_{14} - d_{13}) + \frac{1}{2} (d_{15} - d_{14}) = \frac{1}{2} (7.58 - 7.17) + \frac{1}{2} (7.98 - 7.58) & V_{14} &= 0.41 \text{ m} \\
 V_{15} &= \frac{1}{2} (d_{15} - d_{14}) + \frac{1}{2} (d_{16} - d_{15}) = \frac{1}{2} (7.98 - 7.58) + \frac{1}{2} (8.39 - 7.98) & V_{15} &= 0.41 \text{ m} \\
 V_{16} &= \frac{1}{2} (d_{16} - d_{15}) + \frac{1}{2} (d_{17} - d_{16}) = \frac{1}{2} (8.39 - 7.98) + \frac{1}{2} (8.80 - 8.39) & V_{16} &= 0.41 \text{ m} \\
 V_{17} &= \frac{1}{2} (d_{17} - d_{16}) + (H - d_{17}) = \frac{1}{2} (8.80 - 8.39) + (9.0 - 8.80) & V_{17} &= 0.41 \text{ m}
 \end{aligned}$$

TENSION CALCULATION AT EACH REINFORCEMENT LEVEL $T_{(MAX)}$

$$T_{MAX} = \sigma_H S_V = \sigma_H V_i \quad (\text{Section 4.3B - FHWA - Demo 82})$$

$$\sigma_H = K_{AR} (\gamma_R d_i + q) \quad (\text{Section 4.3B - FHWA - Demo 82})$$

Note: The geogrid strengths shown below were obtained using the following equation:

Allowable Strength = (Ultimate Strength x R_c) / ($FS_{uncertainties}$ x FS_{ID} x FS_D x Creep Reduction Factor) where: $FS_{uncertainties}$ = 1.5, FS_{ID} varies from 1.1 to 1.2 depending on geogrid type, and FS_D = 1.1. The Creep Reduction Factor = 3.10. R_c is the percent coverage ratio. (100% coverage was assumed for this example).

LAYER 1 $T_{MAX1} = (0.28)[(19.6)(0.47) + 11.97] (0.77) = 4.57 \text{ kN/m} = T_{MAX1}$
 Try UX1 @ 100% coverage: $T_{all} = 5.2 \text{ kN/m}$

LAYER 2 $T_{MAX2} = (0.28)[(19.6)(1.07) + 11.97] (0.61) = 5.63 \text{ kN/m} = T_{MAX2}$
 Try UX2 @ 100% coverage: $T_{all} = 6.9 \text{ kN/m}$

LAYER 3 $T_{MAX3} = (0.28)[(19.6)(1.68) + 11.97] (0.61) = 7.67 \text{ kN/m} = T_{MAX3}$
 Try UX3 @ 100% coverage: $T_{all} = 11.2 \text{ kN/m}$

LAYER 4 $T_{MAX4} = (0.28)[(19.6)(2.29) + 11.97] (0.61) = 9.71 \text{ kN/m} = T_{MAX4}$
 Try UX3 @ 100% coverage: $T_{all} = 11.2 \text{ kN/m}$

LAYER 5 $T_{MAX5} = (0.28)[(19.6)(2.90) + 11.97] (0.61) = 11.75 \text{ kN/m} = T_{MAX5}$
 Try UX4 @ 100% coverage: $T_{all} = 17.1 \text{ kN/m}$

LAYER 6 $T_{MAX6} = (0.28)[(19.6)(3.51) + 11.97] (0.61) = 13.79 \text{ kN/m} = T_{MAX6}$
 Try UX4 @ 100% coverage: $T_{all} = 17.1 \text{ kN/m}$

LAYER 7 $T_{MAX7} = (0.28)[(19.6)(4.12) + 11.97] (0.61) = 15.84 \text{ kN/m} = T_{MAX7}$
 Try UX4 @ 100% coverage: $T_{all} = 17.1 \text{ kN/m}$

LAYER 8 $T_{MAX8} = (0.28)[(19.6)(4.73) + 11.97] (0.61) = 17.88 \text{ kN/m} = T_{MAX8}$
 Try UX5 @ 100% coverage: $T_{all} = 21.4 \text{ kN/m}$

HORIZONTAL BACKSLOPE WITH TRAFFIC SURCHARGE - STATIC ANALYSIS
GEOGRID WITH 100% COVERAGE

| | |
|-----------------|---------------------------------------------------------------------------------------------------------------------------------------------|
| <u>LAYER 9</u> | $T_{MAX9} = (0.28)[(19.6)(5.34)+11.97](0.61) = 19.92 \text{ kN/m} = T_{MAX9}$ Try UX5 @ 100% coverage: $T_{all} = 21.4 \text{ kN/m}$ |
| <u>LAYER 10</u> | $T_{MAX10} = (0.28)[(19.6)(5.95)+11.97](0.51) = 18.36 \text{ kN/m} = T_{MAX10}$ Try UX5 @ 100% coverage: $T_{all} = 21.4 \text{ kN/m}$ |
| <u>LAYER 11</u> | $T_{MAX11} = (0.28)[(19.6)(6.36)+11.97](0.41) = 15.68 \text{ kN/m} = T_{MAX11}$ Try UX5 @ 100% coverage: $T_{all} = 21.4 \text{ kN/m}$ |
| <u>LAYER 12</u> | $T_{MAX12} = (0.28)[(19.6)(6.76)+11.97](0.41) = 16.58 \text{ kN/m} = T_{MAX11}$ Try UX5 @ 100% coverage: $T_{all} = 21.4 \text{ kN/m}$ |
| <u>LAYER 13</u> | $T_{MAX13} = (0.28)[(19.6)(7.17) + 11.97](0.41) = 17.51 \text{ kN/m} = T_{MAX13}$ Try UX5 @ 100% coverage: $T_{all} = 21.4 \text{ kN/m}$ |
| <u>LAYER 14</u> | $T_{MAX14} = (0.28)[(19.6)(7.58)+11.97](0.41) = 18.43 \text{ kN/m} = T_{MAX14}$ Try UX6 @ 100% coverage: $T_{all} = 27.9 \text{ kN/m}$ |
| <u>LAYER 15</u> | $T_{MAX15} = (0.28)[(19.6)(7.98)+11.97](0.41) = 19.33 \text{ kN/m} = T_{MAX15}$ Try UX6 @ 100% coverage: $T_{all} = 27.9 \text{ kN/m}$ |
| <u>LAYER 16</u> | $T_{MAX16} = (0.28)[(19.6)(8.39) + 11.97](0.41) = 20.25 \text{ kN/m} = T_{MAX16}$ Try UX6 @ 100% coverage: $T_{all} = 27.9 \text{ kN/m}$ |
| <u>LAYER 17</u> | $T_{MAX17} = (0.28)[(19.6)(8.80)+11.97](0.41) = 21.17 \text{ kN/m} = T_{MAX17}$ Try UX6 @ 100% coverage: $T_{all} = 27.9 \text{ kN/m}$ |

PULLOUT CALCULATIONS AT EACH LAYER

$$T_{max} \leq (1 / F_{SPO})(F^*)(\gamma)(z)(L_e)(C)(R_c)(\alpha)$$

Where $F_{SPO} = 1.5$ $F^* = \tan \phi C_i$

$R_c =$ % coverage of reinforcement (may vary from 100% to 71%). R_c assumed to be 100% for this example.

$C_i =$ interaction coefficient determined from pullout testing for a particular reinforcement type.

$C = 2$ for geogrids $C_i = 0.8$

$\gamma =$ unit weight of soil

$z =$ depth below top of wall

$L_e =$ length of reinforcement in resistance zone

$\alpha =$ scale effect correction factor ($\alpha = 1.0$ determined in laboratory tests performed on the geogrids used in this example)

HORIZONTAL BACKSLOPE WITH TRAFFIC SURCHARGE - STATIC ANALYSIS
GEOGRID WITH 100% COVERAGE

Layer 1

$$L_e \geq \frac{1.5T_{MAX}}{C \tan \theta C_i \gamma z R_c \alpha}$$

$$\geq \frac{(1.5)(4.57)}{(2)(\tan 34^\circ)(0.8)(19.6)(0.47)(1.0)(1.0)}$$

$$L_e > 0.688 \geq 1 \text{ m} \quad \text{use } L_e = 1 \text{ m}$$

Layer 2

$$L_e \geq \frac{(1.5)(5.63)}{(2)(\tan 34^\circ)(0.8)(19.6)(1.07)(1.0)(1.0)}$$

$$L_e > 0.17 \geq 1 \text{ m} \quad \text{use } L_e = 1 \text{ m}$$

Layer 3

$$L_e \geq \frac{(1.5)(7.67)}{(2)(\tan 34^\circ)(0.8)(19.6)(1.68)(1.0)(1.0)}$$

$$L_e > 0.32 \geq 1 \text{ m} \quad \text{use } L_e = 1 \text{ m}$$

Layer 4

$$L_e \geq \frac{(1.5)(9.71)}{(2)(\tan 34^\circ)(0.8)(19.6)(2.29)(1.0)(1.0)}$$

$$L_e > 0.30 \geq 1 \text{ m} \quad \text{use } L_e = 1 \text{ m}$$

Layer 5

$$L_e \geq \frac{(1.5)(11.75)}{(2)(\tan 34^\circ)(0.8)(19.6)(2.9)(1.0)(1.0)}$$

$$L_e > 0.29 \geq 1 \text{ m} \quad \text{use } L_e = 1 \text{ m}$$

Layer 6

$$L_e \geq \frac{(1.5)(13.79)}{(2)(\tan 34^\circ)(0.8)(19.6)(3.51)(1.0)(1.0)}$$

$$L_e > 0.28 \geq 1 \text{ m} \quad \text{use } L_e = 1 \text{ m}$$

HORIZONTAL BACKSLOPE WITH TRAFFIC SURCHARGE - STATIC ANALYSIS
GEOGRID WITH 100% COVERAGE

Layer 7

$$L_e \geq \frac{(1.5)(15.84)}{(2)(\tan 34^\circ)(0.8)(19.6)(4.12)(1.0)(1.0)}$$

$$L_e > 0.27 \geq 1 \text{ m} \quad \text{use } L_e = 1 \text{ m}$$

Layer 8

$$L_e \geq \frac{(1.5)(17.88)}{(2)(\tan 34^\circ)(0.8)(19.6)(4.73)(1.0)(1.0)}$$

$$L_e > 0.27 \geq 1 \text{ m} \quad \text{use } L_e = 1 \text{ m}$$

Layer 9

$$L_e \geq \frac{(1.5)(19.92)}{(2)(\tan 34^\circ)(0.8)(19.6)(5.34)(1.0)(1.0)}$$

$$L_e > 0.26 \geq 1 \text{ m} \quad \text{use } L_e = 1 \text{ m}$$

Layer 10

$$L_e \geq \frac{(1.5)(18.36)}{(2)(\tan 34^\circ)(0.8)(19.6)(5.95)(1.0)(1.0)}$$

$$L_e > 0.22 \geq 1 \text{ m} \quad \text{use } L_e = 1 \text{ m}$$

Layer 11

$$L_e \geq \frac{(1.5)(15.68)}{(2)(\tan 34^\circ)(0.8)(19.6)(6.36)(1.0)(1.0)}$$

$$L_e > 0.17 \geq 1 \text{ m} \quad \text{use } L_e = 1 \text{ m}$$

Layer 12

$$L_e \geq \frac{(1.5)(16.58)}{(2)(\tan 34^\circ)(0.8)(19.6)(6.76)(1.0)(1.0)}$$

$$L_e > 0.17 \geq 1 \text{ m} \quad \text{use } L_e = 1 \text{ m}$$

Layer 13

$$L_e \geq \frac{(1.5)(17.51)}{(2)(\tan 34^\circ)(0.8)(19.6)(7.17)(1.0)(1.0)}$$

$$L_e > 0.17 \geq 1 \text{ m} \quad \text{use } L_e = 1 \text{ m}$$

HORIZONTAL BACKSLOPE WITH TRAFFIC SURCHARGE - STATIC ANALYSIS
GEOGRID WITH 100% COVERAGE

Layer 14

$$L_e \geq \frac{(1.5)(18.43)}{(2)(\tan 34^\circ)(0.8)(19.6)(7.58)(1.0)(1.0)}$$

$$L_e > 0.17 \geq 1 \text{ m} \quad \text{use } L_e = 1 \text{ m}$$

Layer 15

$$L_e \geq \frac{(1.5)(19.33)}{(2)(\tan 34^\circ)(0.8)(19.6)(7.98)(1.0)(1.0)}$$

$$L_e > 0.17 \geq 1 \text{ m} \quad \text{use } L_e = 1 \text{ m}$$

Layer 16

$$L_e \geq \frac{(1.5)(20.25)}{(2)(\tan 34^\circ)(0.8)(19.6)(8.39)(1.0)(1.0)}$$

$$L_e > 0.17 \geq 1 \text{ m} \quad \text{use } L_e = 1 \text{ m}$$

Layer 14

$$L_e \geq \frac{(1.5)(21.17)}{(2)(\tan 34^\circ)(0.8)(19.6)(8.80)(1.0)(1.0)}$$

$$L_e > 0.17 \geq 1 \text{ m} \quad \text{use } L_e = 1 \text{ m}$$

CALCULATE L_A / LAYER

$$L_A = (H - d_i) \tan (45 - \phi/2) \text{ for geogrids} \quad (\tan (45 - \phi/2)) = 0.532$$

$$L_{A1} = (9 - 0.47)(0.532) = 4.54 \text{ m}$$

$$L_{A2} = (9 - 1.07)(0.532) = 4.22 \text{ m}$$

$$L_{A3} = (9 - 1.68)(0.532) = 3.89 \text{ m}$$

$$L_{A4} = (9 - 2.29)(0.532) = 3.57 \text{ m}$$

$$L_{A5} = (9 - 2.90)(0.532) = 3.24 \text{ m}$$

$$L_{A6} = (9 - 3.51)(0.532) = 2.92 \text{ m}$$

$$L_{A7} = (9 - 4.12)(0.532) = 2.59 \text{ m}$$

$$L_{A8} = (9 - 4.73)(0.532) = 2.27 \text{ m}$$

$$L_{A9} = (9 - 5.34)(0.532) = 1.95 \text{ m}$$

$$L_{A10} = (9 - 5.95)(0.532) = 1.62 \text{ m}$$

HORIZONTAL BACKSLOPE WITH TRAFFIC SURCHARGE - STATIC ANALYSIS
GEOGRID WITH 100% COVERAGE

$$\begin{aligned}L_{A11} &= (9 - 6.36) (0.532) = 1.40 \text{ m} \\L_{A12} &= (9 - 6.76) (0.532) = 1.19 \text{ m} \\L_{A13} &= (9 - 7.17) (0.532) = 0.973 \text{ m} \\L_{A14} &= (9 - 7.58) (0.532) = 0.755 \text{ m} \\L_{A15} &= (9 - 7.98) (0.532) = 0.542 \text{ m} \\L_{A6} &= (9 - 8.39) (0.532) = 0.324 \text{ m} \\L_{A17} &= (9 - 8.80) (0.532) = 0.106 \text{ m}\end{aligned}$$

CALCULATE L_T AND COMPARE TO DESIGN LENGTH

(Geogrid lengths of 7.9 m control from external seismic stability analysis)

| | | |
|-----------------|------------------------------------|------------------------|
| <u>Layer 1</u> | $L_{T1} = 4.54 + 1 = 5.54 < 7.9$ | \therefore use 7.9 m |
| <u>Layer 2</u> | $L_{T1} = 4.22 + 1 = 5.22 < 7.9$ | \therefore use 7.9 m |
| <u>Layer 3</u> | $L_{T1} = 3.89 + 1 = 4.89 < 7.9$ | \therefore use 7.9 m |
| <u>Layer 4</u> | $L_{T1} = 3.57 + 1 = 4.57 < 7.9$ | \therefore use 7.9 m |
| <u>Layer 5</u> | $L_{T1} = 3.24 + 1 = 4.24 < 7.9$ | \therefore use 7.9 m |
| <u>Layer 6</u> | $L_{T1} = 2.92 + 1 = 3.92 < 7.9$ | \therefore use 7.9 m |
| <u>Layer 7</u> | $L_{T1} = 2.59 + 1 = 3.59 < 7.9$ | \therefore use 7.9 m |
| <u>Layer 8</u> | $L_{T1} = 2.27 + 1 = 3.27 < 7.9$ | \therefore use 7.9 m |
| <u>Layer 9</u> | $L_{T1} = 1.95 + 1 = 2.95 < 7.9$ | \therefore use 7.9 m |
| <u>Layer 10</u> | $L_{T1} = 1.62 + 1 = 2.62 < 7.9$ | \therefore use 7.9 m |
| <u>Layer 11</u> | $L_{T1} = 1.40 + 1 = 2.40 < 7.9$ | \therefore use 7.9 m |
| <u>Layer 12</u> | $L_{T1} = 1.19 + 1 = 2.19 < 7.9$ | \therefore use 7.9 m |
| <u>Layer 13</u> | $L_{T1} = 0.973 + 1 = 1.97 < 7.9$ | \therefore use 7.9 m |
| <u>Layer 14</u> | $L_{T1} = 0.755 + 1 = 1.76 < 7.9$ | \therefore use 7.9 m |
| <u>Layer 15</u> | $L_{T1} = 0.542 + 1 = 1.542 < 7.9$ | \therefore use 7.9 m |
| <u>Layer 16</u> | $L_{T1} = 0.324 + 1 = 1.32 < 7.9$ | \therefore use 7.9 m |
| <u>Layer 17</u> | $L_{T1} = 0.106 + 1 = 1.11 < 7.9$ | \therefore use 7.9 m |

m. Computer-Aided Solution

MSEW Design Check for Example 4.7

The computer program MSEW could be used to check the design results in example 4.7. This section provides the steps and input necessary to evaluate the external and internal design shown in the preceding hand calculation example. The example problem will use the simple problem format on the initial screen. The steps are as follows:

- ▶ Load the MSEW Program.
- ▶ After the welcome screen, open the file menu, click on **new** and input the project information. Then click **OK**.
- ▶ The screens for input of design information and requirements should now be on the screen. These include the **PROGRAM MANAGER**, the **GEOMETRY/SURCHARGE**, **SOILS AND SEISMICITY**, and **REINFORCEMENT**.
- ▶ Move to the **PROGRAM MANAGER** screen and choose the **Analysis** mode to evaluate given design results from example problem 4.7. Also choose the units to be used (e.g., metric units for this problem). The project information which was entered in the first step can be reviewed using the **ID** button.
- ▶ Next move to the **GEOMETRY/SURCHARGE** SCREEN. Click on **Simple** geometry and enter the design height and external loads on the structure from the example problem as follows.

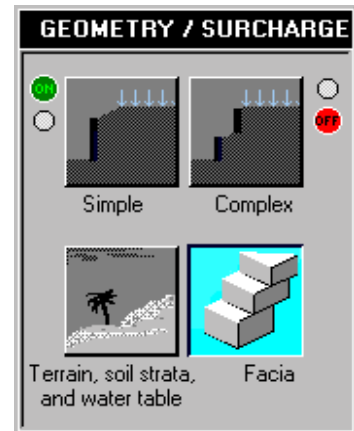
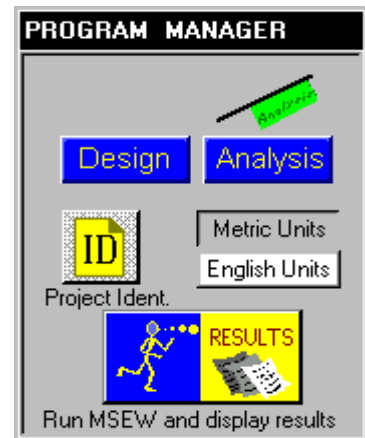

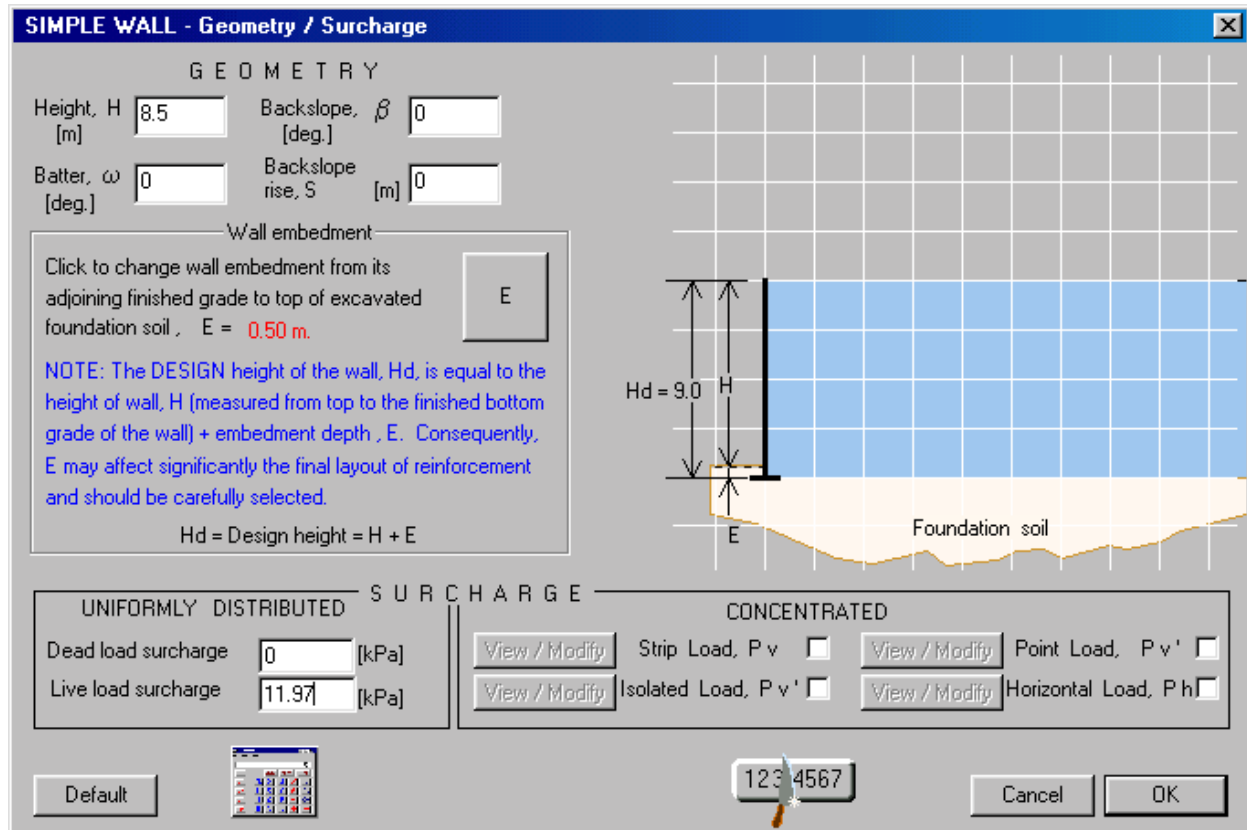

- ▶ Next, on the GEOMETRY/SURCHARGE screen, click on the **Facia – Analysis** button and select the **(modular concrete blocks)** for this problem. Press **NEXT** and input required properties of the modular concrete block facing unit. Press **NEXT** and check the **Connection force relationship**. Press **NEXT** and select how to input **Reduction factors at connection**. Press **NEXT** and input **Available Connection Strength** for geogrid used. Click on **OK** to advance.

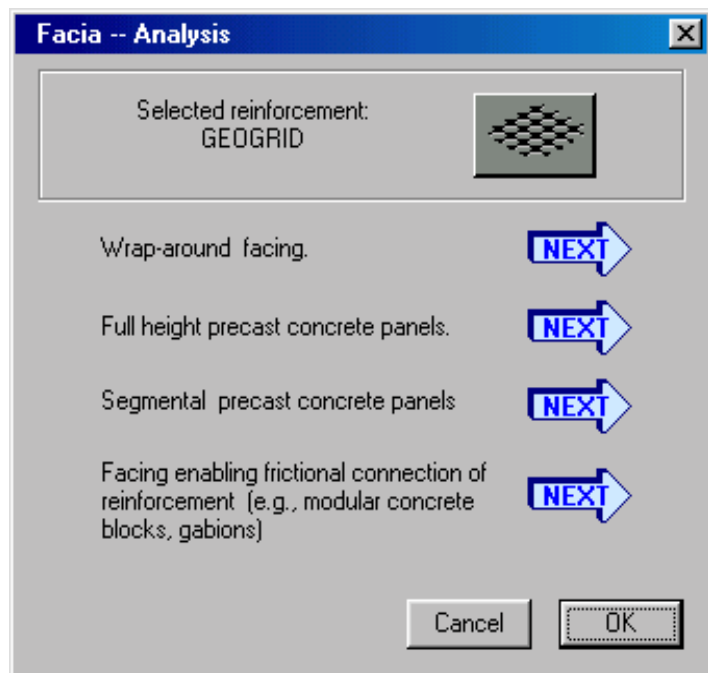

Frictional Connection

Depth of facing unit, W_u [m]

Height of facing unit, H_u [m]

Average unit weight of facing unit, γ_f [kN/m³]

Horizontal distance to the center of gravity of facing unit, including aggregate fill, measured from the front of the unit, G_u [m]

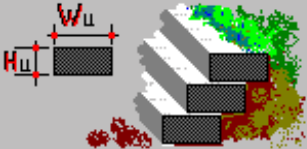

The shear strength of the facing system is conservatively neglected in calculations.
Click for note on effects of facing in external stability calculations.

Default Cancel **NEXT**

Connection force relationship -- Analysis

Z/Hd $\frac{T_o}{T_{max}}$ or $\frac{T_{od}}{T_{md}}$

0.00

0.25

0.50

0.75

1.00

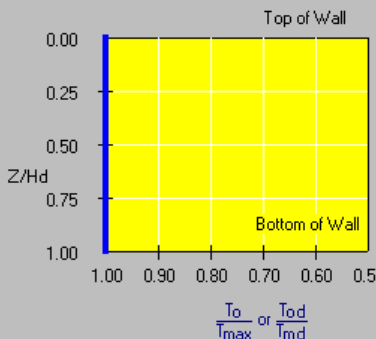

Top of Wall

Bottom of Wall

$\frac{T_o}{T_{max}}$ or $\frac{T_{od}}{T_{md}}$

T_o, T_{od} = static and seismic tensile force in the reinforcement at the connection with the facing, respectively

T_{max}, T_{md} = calculated static and seismic tensile force in the reinforcement, respectively.

Z / Hd = normalized depth measured from the top of the wall.

Default  Cancel **NEXT**

Reduction factors at connection

Number of geogrid types, each possessing different ultimate strength:

REINFORCEMENT:

Ultimate strength and reduction factors are given

Long-term available connection strength, T_c -available, is given

Geogrid type Number

1

2

3

4

5

In a seismic analysis (if applicable), reduce CRs to percent of its static value

Default  Cancel **NEXT**

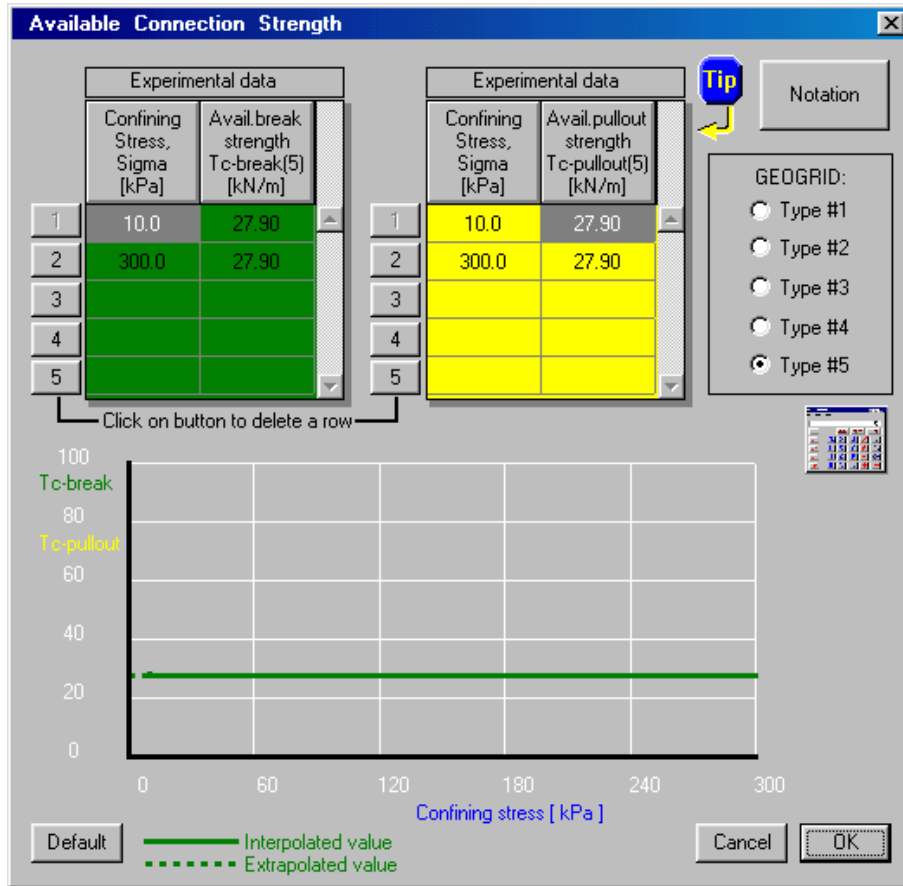

- Next, move to the **SOILS & SEISMICITY** screen and input the engineering properties of the reinforced soil, retained soil and foundation soil plus the seismic requirements. Note the default values must be changed for this problem. For the foundation soil, the computer program will either calculate the bearing capacity based on the soil properties or an ultimate bearing capacity can be input (e.g., where complex subsurface conditions exist). In the example problem - the soil properties are provided and therefore used as input.

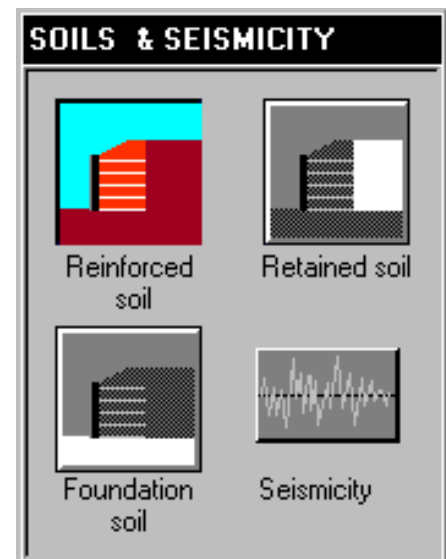

Reinforced soil properties [X]

Unit weight, γ [kN/m³]

Design value of internal angle of friction, ϕ [deg.]

Cohesion, c [kN/m²]

Default Cancel OK

Retained soil properties [X]

Unit weight, γ [kN/m³]

Design value of internal angle of friction, ϕ [deg.]

Cohesion, c [kN/m²]

Default Cancel OK

Foundation soil properties [X]

Properties of an equivalent homogeneous foundation for evaluation of bearing capacity and of direct sliding stability

Unit weight, γ_{equiv} [kN/m³]

Equivalent internal angle of friction, ϕ_{equiv} [deg.]

Equivalent cohesion, c_{equiv} [kN/m²]

Water table is at wall base elevation

Water table does not affect bearing capacity

Ultimate bearing capacity of foundation is given

Default Cancel OK

- ▶ Next on the main menu screen, move to the **REINFORCEMENT** screen to input the reinforcement requirement from the design example. The example problem uses geogrids, so click on the **Geogrid** button.
- ▶ On the next screen, enter the number of different reinforcement types that will be used (note that the hand calculation used 6 different types, but MSEW limits number to 5 maximum) click the **OK** Button.

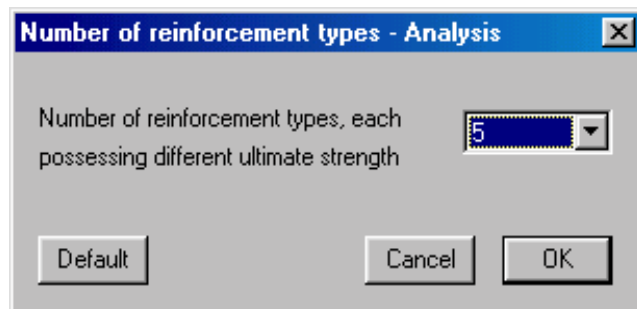
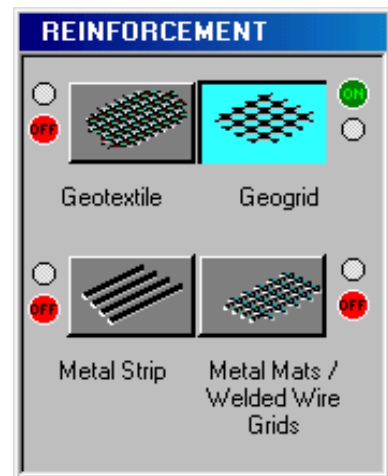

- ▶ Enter the strength information on the next screen. Either the allowable strength or ultimate strength and reduction values may be entered. The allowable strength option is used with this example. Coverage ratio is also entered on this screen. Enter data and click **OK** to move to the next screen, **Specified heights, lengths and strengths of reinforcement.**

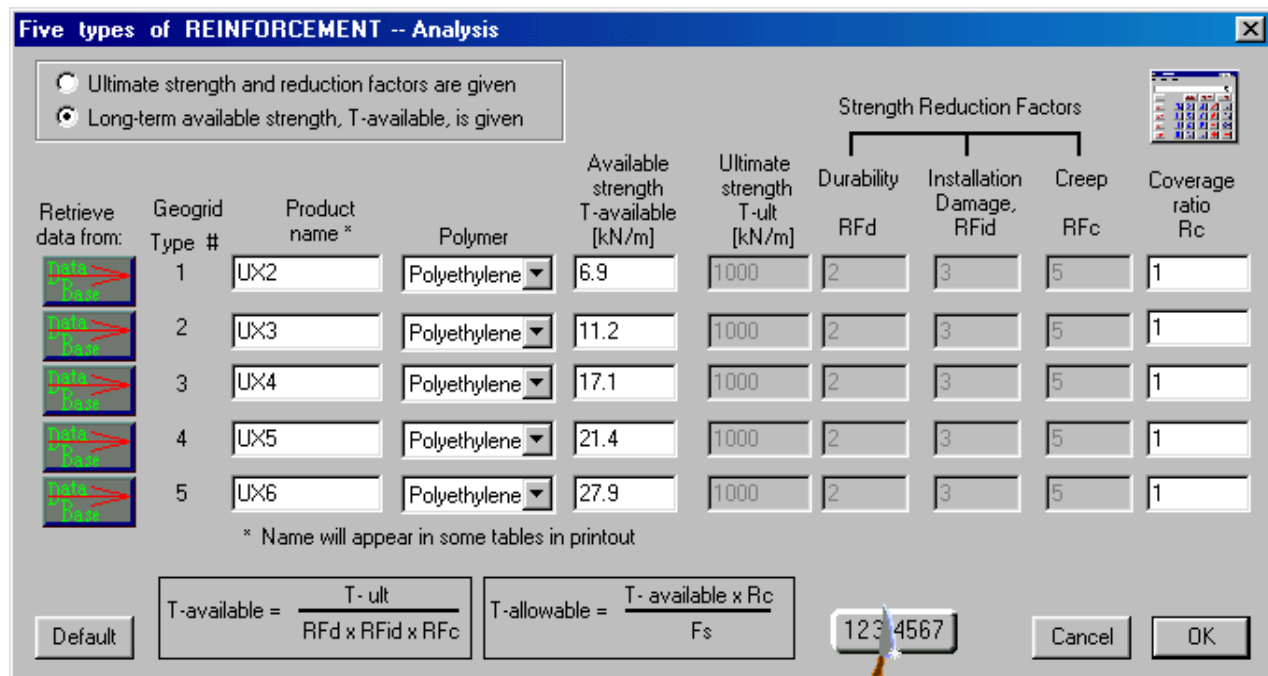

- ▶ On the **Specified heights, lengths and strengths of reinforcement** screen, enter the reinforcement height, length and type. Click **OK** after entering data.

Specified heights, lengths and strengths of reinforcements -- Analysis

Data from "Reinforcements strength and reduction factors" :

| Geogrid type # | T available | Strength reduction factors | | |
|----------------|-------------|----------------------------|--------------|-------|
| | | Durability | Installation | Creep |
| 1 | 6.90 | N/A | N/A | N/A |
| 2 | 11.20 | N/A | N/A | N/A |
| 3 | 17.10 | N/A | N/A | N/A |
| 4 | 21.40 | N/A | N/A | N/A |
| 5 | 27.90 | N/A | N/A | N/A |

Click to add a layer at height and length indicated

Height =
H d = 9.0

Tip →

| | Height [m] | Length [m] | Type # |
|----|------------|------------|--------|
| 1 | 0.20 | 7.50 | 5 |
| 2 | 0.61 | 7.50 | 5 |
| 3 | 1.02 | 7.50 | 5 |
| 4 | 1.42 | 7.50 | 5 |
| 5 | 1.83 | 7.50 | 4 |
| 6 | 2.24 | 7.50 | 4 |
| 7 | 2.64 | 7.50 | 4 |
| 8 | 3.05 | 7.50 | 4 |
| 9 | 3.66 | 7.50 | 4 |
| 10 | 4.27 | 7.50 | 4 |
| 11 | 4.88 | 7.50 | 3 |

H d = 0

L = 0

Default Cancel OK

- ▶ Back to the Geogrid screen, click on the **I.P.** button to input the soil-geogrid interaction parameters.

Geogrid -- Analysis

Modify database for GEOGRID

Strength and spacing data

Specified height, length and strength of each geogrid layer

Interaction parameters

Geogrid-reinforced soil interaction parameters

Lateral earth pressure coefficient, K

View or modify variation of K with depth

Cancel

- ▶ Check the Interface Friction information for the geogrid reinforcement in the example problem as shown on the following screen.

Reinforcement-reinforced soil interaction parameters -- Analysis

| Geogrid type | ρ [degrees] | $F^* = C_i \cdot \tan \phi$ | α |
|--------------|------------------|-----------------------------|----------|
| # 1 | 28.35 | $F^* = 0.8 \cdot \tan \phi$ | 1.0 |
| # 2 | 28.35 | $F^* = 0.8 \cdot \tan \phi$ | 1.0 |
| # 3 | 28.35 | $F^* = 0.8 \cdot \tan \phi$ | 1.0 |
| # 4 | 28.35 | $F^* = 0.8 \cdot \tan \phi$ | 1.0 |
| # 5 | 28.35 | $F^* = 0.8 \cdot \tan \phi$ | 1.0 |

ρ = Friction angle along geogrid-soil interface (used in Direct Sliding analysis)
 F^* = Pullout resistance factor
 α = Scale effect correction factor } (used in Pullout computations)

Default values for the above variables are automatically assigned
 User prescribed values for the above variables

Default Cancel OK

- ▶ Return to the **GEOGRID – Analysis** screen and review the **Internal** and **External Stability** lateral earth pressure coefficient information. Again the default values are acceptable.

K for External Stability Computations

Use default for δ as suggested in Demo 82
 User specified value for δ

Default Cancel OK

Geogrid -- Analysis

Strength and spacing data

Specified height, length and strength of each geogrid layer

Interaction parameters

Geogrid-reinforced soil interaction parameters

Lateral earth pressure coefficient, K

View or modify variation of K with depth

Cancel OK

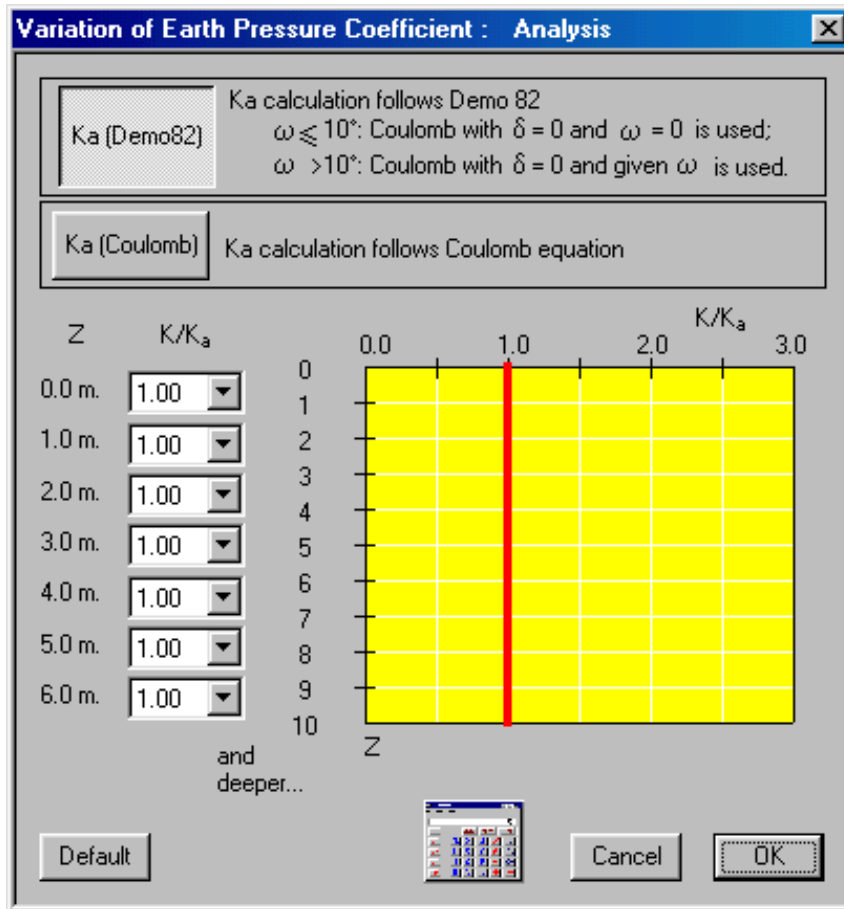

- ▶ The results of the analysis of the design information can now be viewed by returning to the **PROGRAM MANAGER** screen and pressing the **RESULTS** button to run MSEW and display results. The following shows the screen for the static results of the analysis and an expanded “Results of analysis” table. The factor of safety for external analysis is shown on the screen and the complete analyses (not shown) can also be viewed from this screen by clicking on the appropriate **Bearing Capacity**, **Direct Sliding** or **Eccentricity** button. Additional detail for the **Strength**, **Connection** and **Pullout** internal stability calculations can also be viewed.

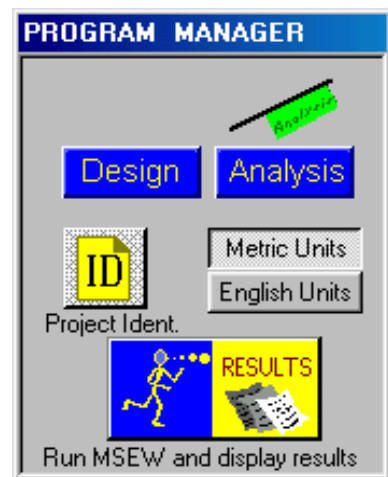

- ▶ The results show that the external factors of safety and the eccentricity agree with those obtained in the design example. The internal stability results in terms of the factor of safety for reinforcement strength and pullout resistance also agree well with the results in step 8. A Global Stability Analysis using the methods discussed in Chapter 7 could also be performed using the MSEW program.

Results of analysis

Soils, Loads, eccentricity, K_{qc}

Compound / Global Results

Printout information

Bearing Capacity Direct sliding Eccentricity

Strength Connection Pullout

Bearing capacity : $F_s = 5.87$ (Based on length of bottom layer)
 Foundation interface : F_s -direct sliding = 2.542 $e/L = 0.0963$

Save results as text file *.txt

Save results as bitmap *.bmp

| # | Geogrid | | | Connection strength | | | Results of Analysis | | | |
|---|---------------|------------|------|-------------------------------------|-----------------------------------|-----------------------------------|------------------------|--------------------------|----------------------|--------------------|
| | Elevation [m] | Length [m] | Type | F_s -overall [pullout resistance] | F_s -overall [connection break] | F_s -overall [Geogrid strength] | Geogrid strength F_s | Pullout resistance F_s | Direct sliding F_s | Eccentricity e/L |
| 1 | 0.20 | 7.50 | 5 | 1.32 | 1.32 | 1.98 | 1.982 | 65.162 | 2.423 | 0.0924 |
| 2 | 0.61 | 7.50 | 5 | 1.36 | 1.36 | 2.05 | 2.047 | 62.268 | 2.526 | 0.0847 |
| 3 | 1.02 | 7.50 | 5 | 1.45 | 1.45 | 2.17 | 2.170 | 60.879 | 2.639 | 0.0773 |
| 4 | 1.42 | 7.50 | 5 | 1.52 | 1.52 | 2.28 | 2.277 | 58.847 | 2.759 | 0.0705 |
| 5 | 1.83 | 7.50 | 4 | 1.21 | 1.21 | 1.82 | 1.816 | 55.983 | 2.894 | 0.0637 |
| 6 | 2.24 | 7.50 | 4 | 1.29 | 1.29 | 1.94 | 1.940 | 54.515 | 3.042 | 0.0574 |

Click to **INVOKE** Compound/Global Stability

For Help, press F1 **Deviation**

Seismic results Static results RETURN

Enlarge table

- Ideal value per layer : T-available or R_c
- Global efficiency

Modify Reinforcement Input

Analysis Layout -- extended table

| # | Geogrid | | | Connection strength | | | Results of Analysis | | | |
|----|---------------|------------|------|-------------------------------------|-----------------------------------|-----------------------------------|------------------------|--------------------------|----------------------|--------------------|
| | Elevation [m] | Length [m] | Type | F_s -overall [pullout resistance] | F_s -overall [connection break] | F_s -overall [Geogrid strength] | Geogrid strength F_s | Pullout resistance F_s | Direct sliding F_s | Eccentricity e/L |
| 1 | 0.20 | 7.50 | 5 | 1.32 | 1.32 | 1.98 | 1.982 | 65.162 | 2.423 | 0.0924 |
| 2 | 0.61 | 7.50 | 5 | 1.36 | 1.36 | 2.05 | 2.047 | 62.268 | 2.526 | 0.0847 |
| 3 | 1.02 | 7.50 | 5 | 1.45 | 1.45 | 2.17 | 2.170 | 60.879 | 2.639 | 0.0773 |
| 4 | 1.42 | 7.50 | 5 | 1.52 | 1.52 | 2.28 | 2.277 | 58.847 | 2.759 | 0.0705 |
| 5 | 1.83 | 7.50 | 4 | 1.21 | 1.21 | 1.82 | 1.816 | 55.983 | 2.894 | 0.0637 |
| 6 | 2.24 | 7.50 | 4 | 1.29 | 1.29 | 1.94 | 1.940 | 54.515 | 3.042 | 0.0574 |
| 7 | 2.64 | 7.50 | 4 | 1.37 | 1.37 | 2.05 | 2.053 | 52.431 | 3.203 | 0.0515 |
| 8 | 3.05 | 7.50 | 4 | 1.16 | 1.16 | 1.74 | 1.745 | 40.208 | 3.386 | 0.0457 |
| 9 | 3.66 | 7.50 | 4 | 1.06 | 1.06 | 1.60 | 1.596 | 31.177 | 3.701 | 0.0378 |
| 10 | 4.27 | 7.50 | 4 | 1.19 | 1.19 | 1.78 | 1.778 | 28.978 | 4.080 | 0.0307 |
| 11 | 4.88 | 7.50 | 3 | 1.07 | 1.07 | 1.60 | 1.604 | 26.732 | 4.546 | 0.0242 |
| 12 | 5.49 | 7.50 | 3 | 1.23 | 1.23 | 1.84 | 1.842 | 24.407 | 5.132 | 0.0185 |
| 13 | 6.10 | 7.50 | 3 | 1.44 | 1.44 | 2.16 | 2.162 | 21.997 | 5.891 | 0.0136 |
| 14 | 6.71 | 7.50 | 2 | 1.14 | 1.14 | 1.71 | 1.713 | 19.425 | 6.915 | 0.0093 |
| 15 | 7.32 | 7.50 | 2 | 1.45 | 1.45 | 2.17 | 2.170 | 16.548 | 8.369 | 0.0058 |
| 16 | 7.93 | 7.50 | 1 | 1.22 | 1.22 | 1.83 | 1.834 | 13.165 | 10.596 | 0.0031 |
| 17 | 8.53 | 7.50 | 1 | 1.62 | 1.62 | 2.44 | 2.436 | 6.937 | 14.355 | 0.0011 |

Seismic results Static results RETURN

4.8 STANDARD MSEW DESIGNS

MSEW structures are customarily designed on a project-specific basis. Most agencies use a line-and-grade contracting approach, with the contractor selected MSEW vendor providing the detailed design after contract bid and award. This approach works well for segmental and full-height panel faced walls, and can be used for MBW unit faced walls. However, standard designs can be developed and implemented by an agency for MSEW structures, somewhat similar to standard concrete cantilever wall designs used by many agencies.

Use of standard designs for MSEW structures could offer the following advantages over a line-and-grade approach:

- ! Agency is more responsible for design details and integrating wall design with other components.
- ! Pre evaluation and approval of materials and material combinations, as opposed to evaluating contractor submittal post bid.
- ! Economy of agency design versus vendor design/stamping of small walls.
- ! Agency makes design decisions versus vendors making design decisions.
- ! More equitable bid environment as agency is responsible for design details, and vendors are not making varying assumptions.
- ! Filters out substandard work, systems and designs with associated approved product lists.

The Minnesota Department of Transportation (MN/DOT), with support of the FHWA (via Demo 82 project) recently developed and implemented standardized MSEW designs⁽³⁴⁾ for MBW unit faced and geosynthetic reinforced MSEW structures. The use of these standard designs are limited by geometric, subsurface and economic constraints. Structures outside of these constraints should be designed on a project-specific basis. The general approach used in developing these standards could be followed by other agencies to develop their own, agency-specific standard designs.

Standardized designs require generic designs and generic materials. Generic designs require definition of wall geometry and surcharge loads, soil reinforcement strength, structure height limit, and MBW unit properties of width and batter. As an example, the MN/DOT standard designs address four geometric and surcharge loadings, and can be used for walls up to 7 m (23 feet) in height.

Definition of generic material properties for the standard designs requires the development of approved product lists for MBW units, soil reinforcement and MBW unit-soil reinforcement combinations. The combinations require a separate approved product list as the connection strength is specific to each unique combination of MBW unit and reinforcement, and often controls the

reinforcement design strength. An additional requirement for MBW units is an approved manufacturing quality control plan on file with the agency. This requirement is a result of the stringent durability (to freeze thaw and deicing salt conditions) specifications for the units and the long duration testing used to demonstrate durability.

An example design cross section and reinforcement layout table from the MN/DOT standard designs is presented in Figure 44. Note that the MN/DOT standard designs are not directly applicable to, nor should they be used by, other agencies.

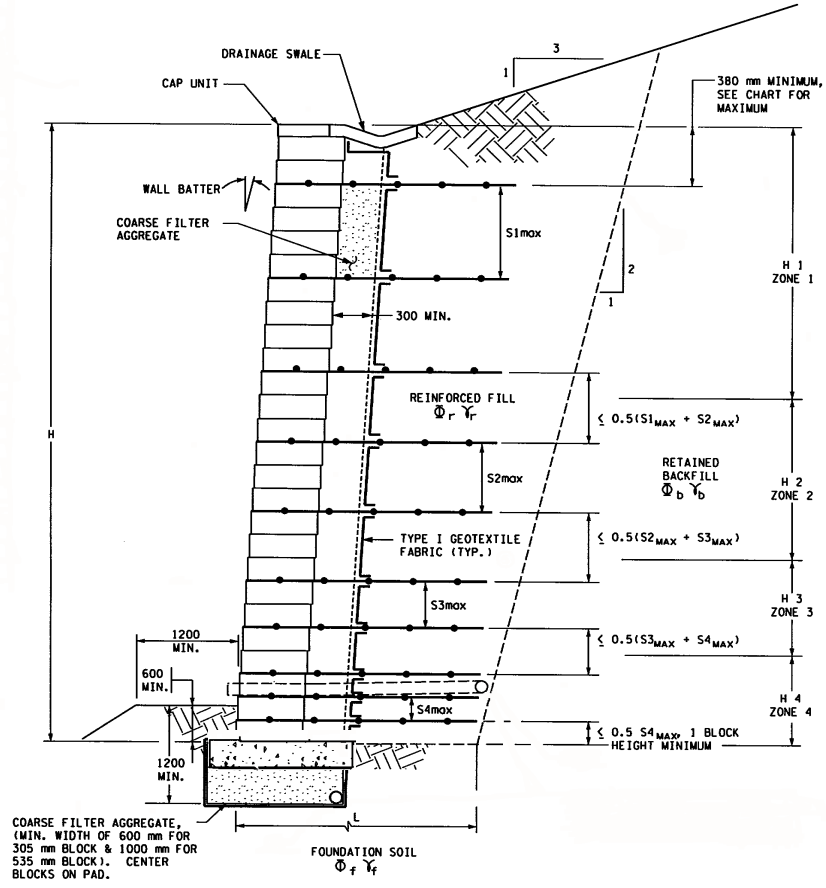

TYPICAL SECTION
CASE 4
NOT TO SCALE

| MODULAR BLOCK WALL REINFORCEMENT LAYOUT — CASE 4 - 1:3 FILL SLOPE — | | | | | | | | | | | | | | |
|------------------------------------------------------------------------|--------------------------------|-------------|-------------------------------------|-------------------------|--------------------------|-----------------------------|----|---------------------------------------|--------|------------------------|--------|------------------------|--------|------------------------|
| MBW Reinforcement Class | Strength of Soil Reinf. (kN/m) | | Minimum Reinforcement Length, L (m) | Maximum Wall Height (m) | Nominal Block Width (mm) | Wall Batter Range (degrees) | | Maximum Unreinforced Wall Height (mm) | Zone 1 | | Zone 2 | | Zone 3 | |
| | L. Term (Tal) | Design (Ta) | | | | ≥ | < | | H1 (m) | S1 _{max} (mm) | H2 (m) | S1 _{max} (mm) | H3 (m) | S1 _{max} (mm) |
| MBW-10 | 15 | 10 | 0.7 H | 6.8 | 305 | 0 | 3 | 610 | 2.6 | 610 | 1.6 | 410 | 2.6 | 205 |
| | | | | | | 3 | 7 | 610 | 2.8 | 610 | 2.0 | 410 | 2.0 | 205 |
| | | | | | | 7 | 10 | 610 | 3.4 | 610 | 2.1 | 410 | 1.5 | 205 |
| | | | | | | 10 | 15 | 610 | 3.6 | 610 | 2.4 | 410 | 1.0 | 205 |
| MBW-15 | 22.5 | 15 | 0.7 H | 7.0 | 305 | 0 | 3 | 610 | 4.4 | 610 | 1.8 | 460 | 0.8 | 305 |
| | | | | | | 3 | 7 | 610 | 4.8 | 610 | 1.7 | 460 | 0.5 | 305 |
| | | | | | | 7 | 10 | 610 | 5.4 | 610 | 1.6 | 410 | | |
| | | | | | | 10 | 15 | 610 | 5.9 | 610 | 1.1 | 410 | | |
| MBW-20 | 30 | 20 | 0.7 H | 7.0 | 305 | 0 | 3 | 610 | 5.4 | 610 | 0.8 | 460 | | |
| | | | | | | 3 | 7 | 610 | 5.8 | 610 | 1.2 | 460 | | |
| | | | | | | 7 | 10 | 610 | 7.0 | 610 | | | | |
| | | | | | | 10 | 15 | 610 | 7.0 | 610 | | | | |

Figure 44. Example of standard MSEW design. (after 34)

[BLANK]

CHAPTER 5

DESIGN OF MSE WALLS WITH COMPLEX GEOMETRICS

The basic design methods outlined in chapter 4 considers MSE structures with simple geometries with reinforcement layers of the same length supporting either a horizontal backfill or a surcharge slope. Although most MSE structures fall into this category, structures with more complex geometries or significant external loads are practical and require consideration during the selection process. They include:

- ! Bridge abutments.
- ! Superimposed walls.
- ! Walls with uneven length reinforcement.
- ! Back-to-back walls.

They are illustrated in figure 45.

The shape and location of the maximum tensile force line are generally altered by both the geometry and the loads applied on the complex MSE wall structure. It is possible to assume an approximate maximum tensile force line for each; however, supporting experience and analysis are more limited than for rectangular reinforced soil walls.

Moreover, for complex or compound structures, it is always difficult to separate internal stability from external stability because the most critical slip-failure surface may pass through both reinforced and unreinforced sections of the structure. For this reason, a global stability analysis is generally required for this type of structure. A rough estimate of the global factor of safety could be made using plane failure surfaces; however, the best method is to use a reinforced soil global stability computer method. The procedures detailed in chapter 7 for evaluating RSS embankments could be used to evaluate the global stability of Mechanically Stabilized Earth walls.

The following sections give guidelines for each case.

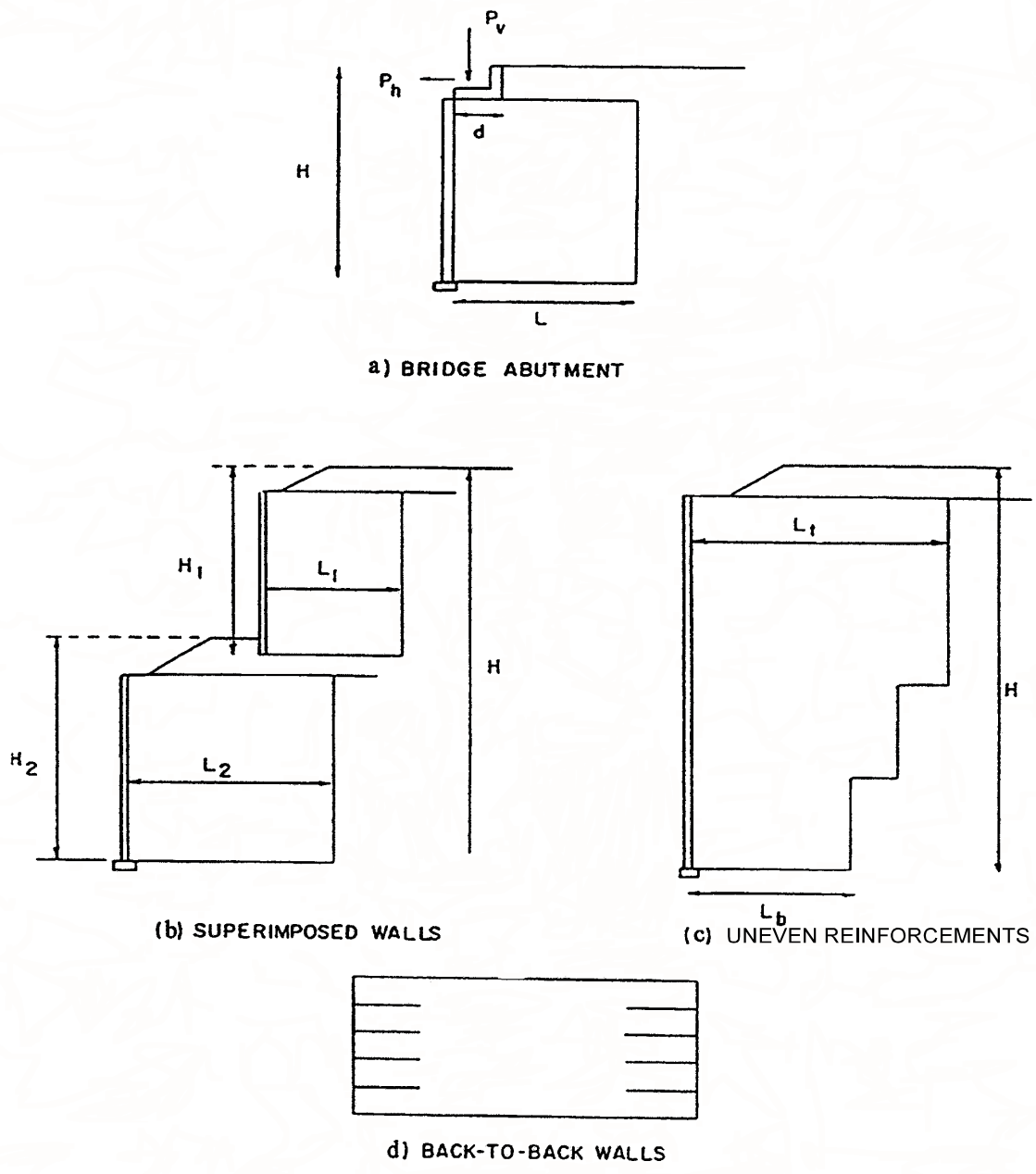

Figure 45. Types of complex MSE structures.

5.1 BRIDGE ABUTMENTS

Bridge abutments have been designed by supporting the bridge beams on a spread foundation constructed directly on the reinforced soil volume, or by supporting a smaller spread footing on deep foundations constructed thru the reinforced volume.

Abutments directly supported on the reinforced volume may be more economical, and should be considered when the projected settlement of the foundation and reinforced volume is rapid/small or essentially complete, prior to the erection of the bridge beams. Based on field studies of actual structures, 1996 AASHTO suggests, that tolerable angular distortions (i.e., *limiting differential settlements*) between abutments or between piers and abutments be limited to the following angular distortions:

- ! 0.005 for simple spans; and
- ! 0.004 for continuous spans.

This criteria, suggests that for a 30 m (100 ft) span for instance, differential settlements of 120 mm (4.8 inches) for a continuous span or 150 mm (6 inches) for a simple span, would be acceptable, with no ensuing overstress and damage to superstructure elements. On an individual project basis differential settlements of smaller amounts may be required from a functional or performance criteria.

a. MSEW Abutments on Spread Footings

Where fully supporting the bridge loads, MSEW bridge abutments are designed by considering them as rectangular walls with surcharge loads at the top. The design procedures for taking account of the surcharge loads for internal stability analysis have been outlined in chapter 4. The same type of procedure is used for the internal stability of bridge abutment structures, calculating the horizontal stress σ_h at each level by the following formula (equation 39):

$$\sigma_H = K (\gamma_r Z + \Delta\sigma_v) + \Delta\sigma_h$$

where: $\Delta\sigma_v$ is the increment of vertical stress due to the concentrated vertical surcharge P_v , assuming a 2V:1H pyramidal distribution (figure 31).

$\Delta\sigma_h$ is the increment of horizontal stress due to the horizontal loads P_h and calculated as shown in figure 32a, and γZ is the vertical stress at the base of the wall or layer in question due to the overburden pressure.

For large surcharge slabs (with a support width greater than $H/3$) at the top of reinforced soil wall, the shape of the maximum tensile force line has to be modified to extend to the back edge of the footing, as indicated in figure 46.

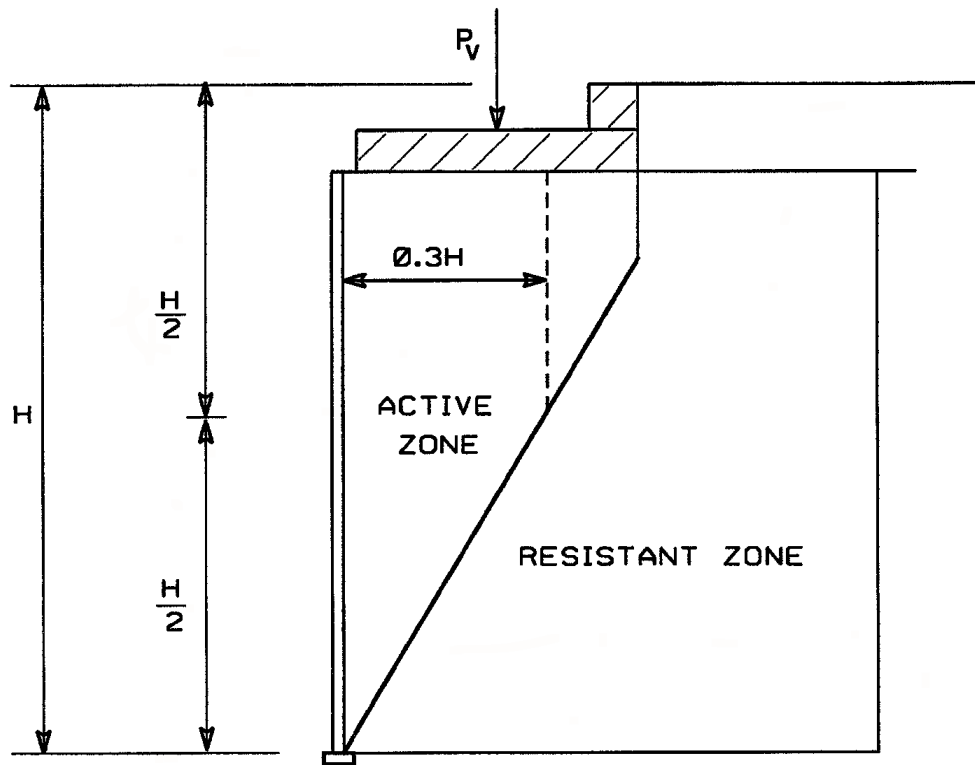

Figure 46. Location of maximum tensile force line in case of large surcharge slabs (inextensible reinforcements).

Note that MSEW bridge abutments have historically almost always used **inextensible** reinforcements. However, similar shifts in the maximum tension line to the back of large surcharge slabs have been observed for extensible reinforcement. Therefore, the maximum tensile force line should also be modified for extensible reinforcement if the back edge of the slab extends beyond $H \tan (45 - \phi/2)$ from the wall face.

Successful experience with MSEW abutment construction has suggested that the following additional details be implemented:

- ! Require a minimum offset from the front of the facing to the center line of bridge bearings of 1 m (3 ft).
- ! Require a clear distance of 150 mm (6 inches) between the back face of the facing panels and the front edge of footing.
- ! Where significant frost penetration is anticipated, place the abutment footing on a bed of compacted coarse aggregate, 1 m (3 ft) thick.
- ! Limit the bearing capacity on the reinforced volume to 200 kPa (4,000 psf).

- ! Use the maximum horizontal force at each reinforcement level, for the design of connections to the panels.
- ! Extend the density, length and cross-section of reinforcements of the abutment to wingwalls, for a horizontal distance equal to 50 percent of the height of the abutment wall.
- ! The seismic design forces should also include seismic forces transferred from the bridge through bearing supports which do not slide freely (e.g., elastomeric bearings).

The balance of the computations remain the same as for any MSE wall as outlined in chapter 4.

b. MSEW Abutments on Pile Foundations

Where this type of support is chosen, due to construction control, uncertainty or to limit superstructure deflection, the MSE wall is designed with no consideration to the vertical bridge loads, which are transmitted to an appropriate bearing strata by deep foundations. Typically, deep foundations have been vertical steel piles, which are driven prior to MSE wall erection.

Horizontal bridge and abutment backwall forces must be resisted, by methods dependent on the type of abutment support, namely:

For conventional abutments, the horizontal forces may be resisted by extending sufficient soil reinforcement (strips, grids) from the back edge of the abutment footing. The resistance is provided by soil/reinforcement interaction over the full length. A typical detail is shown on figure 47. Alternately the horizontal forces may be resisted by the pile lateral capacity or by other means.

For integral abutments, the horizontal force and its distribution with depth may be developed using pile load/deflection methods (p-y curves) and added as a supplementary horizontal force to be resisted by the wall reinforcements. This force will vary depending on the level of horizontal load, pile diameter, pile spacing and distance from the pile to the back of panels.

The following additional design details have been successfully used:

- ! Provide a clear horizontal distance of 0.5 m (18 inches) between the back of the panels and the front edge of the pile.
- ! Use a bond breaker on the pile, when negative skin friction is anticipated.
- ! Provide a casing around piles, thru the reinforced fill, where significant negative skin friction is anticipated. The casing is filled with sand just prior to footing construction.

Where pile locations interfere with the reinforcement, specific methods for field installation must be developed and presented on the plans. **Simple cutting of the reinforcements during construction is not permissible.**

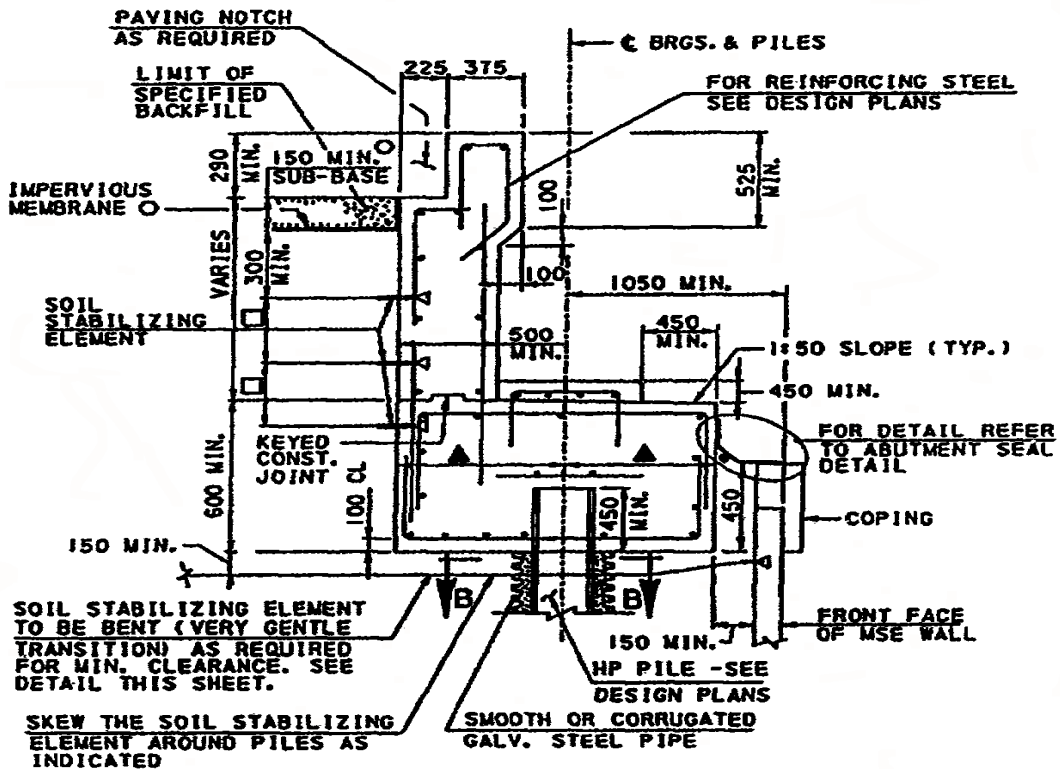
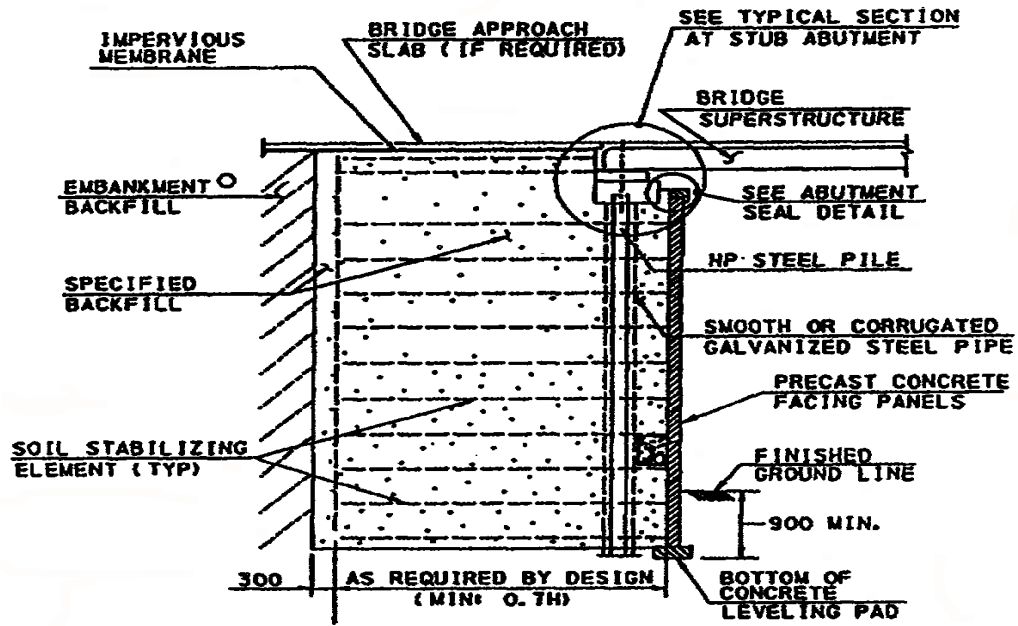

Note: All dimensions in mm.

Figure 47. Pile supported MSE abutment.

5.2 SUPERIMPOSED WALLS

The design of superimposed MSE walls is made in two steps:

- (1) A design using simplified design rules for calculating external stability and locating the internal failure plane for internal stability as shown in figure 48.
- (2) A stability analysis, including both compound and global stability using a reinforced soil global stability computer program outlined in chapter 6. This is an essential computation.

For **preliminary design**, the following minimum values for reinforcement length, of L_1 and L_2 , should be used for offsets (D) greater than $[1/20 (H_1 + H_2)]$:

$$\text{Upper wall: } L'_1 \geq 0.7 H_1$$

$$\text{Lower wall: } L'_2 \geq 0.6 H$$

where H = total height

Where the offset distance (D) is greater than $H_2 \tan (90-\phi_r)$, walls are not considered superimposed and are independently designed.

For a small upper wall offset; $D \leq [1/20 (H_1 + H_2)]$, it is assumed that the failure surface does not fundamentally change and it is simply adjusted laterally by the offset distance D. The walls should be designed as a single wall with a height H.

External stability calculations for the upper wall are conventionally performed as outlined in chapter 4. For the lower wall, consider the upper wall as a surcharge in computing bearing pressures. In lieu of a conventional external sliding stability computation, perform a slope stability analysis with failure circles exiting at the base. A minimum factor of safety of 1.5 is generally warranted.

For calculating the internal stability, the maximum tensile force lines are as indicated in figure 48a. These relationships are somewhat empirical and geometrically derived.

For intermediate offset distances, see figure 48a for the location of the failure surface and consider the vertical pressures in figure 48b for internal stress calculations.

For large setback distances, $[D \geq H_2 \tan (90-\phi_r)]$, the maximum tensile force lines are considered independently, without regard to the geometry of the two superimposed walls. For internal stability computations, the upper wall is neglected.

The balance of the computations remain identical as in chapter 4.

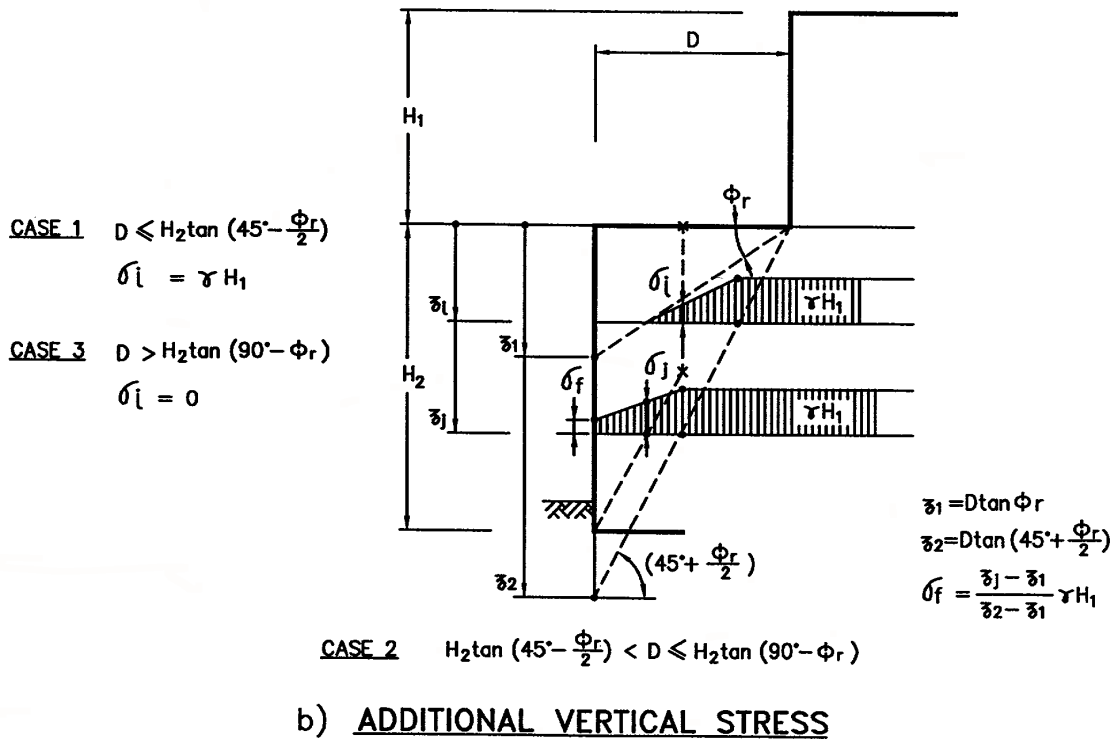
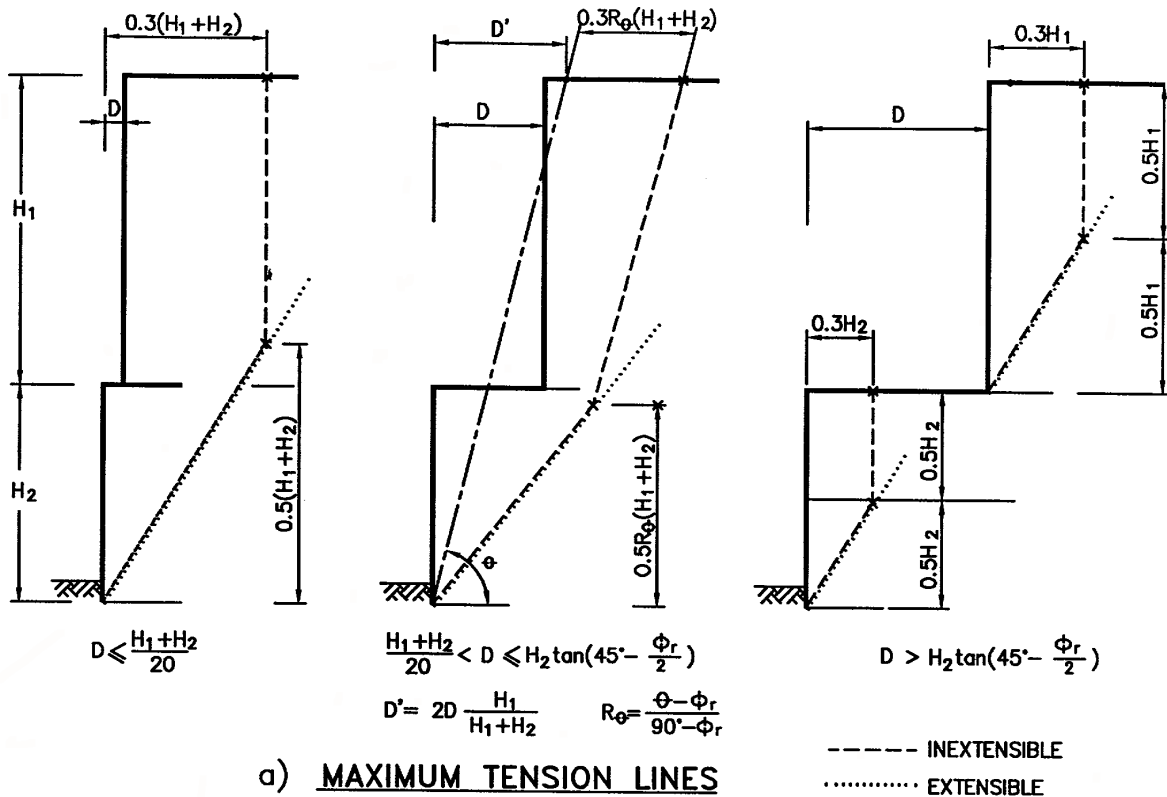

Figure 48. Design rules for superimposed walls.

5.3 WALLS WITH UNEVEN REINFORCEMENT LENGTHS

Use of this type of reinforcement geometry should be considered only if the base of the MSE structure is in rock or *competent foundation soil* (foundation materials which will exhibit minimal post construction settlements).

The design of these walls requires two analyses:

- (1) A design using simplified design rules for determining external stability.
- (2) A global stability analysis, performed using a reinforced soil stability program.

Simplified design rules for these structures are as follows:

- ! The wall is represented by a rectangular block (L_o , H) having the same total height and the same cross-sectional area as the trapezoidal section for external stability calculations. See figure 49.
- ! The maximum tensile force line is the same as in rectangular walls (bilinear or linear according to the extensibility of the reinforcements).
- ! Minimum base length (L_3) $\geq 0.4 H$, with the difference in length in each zones being less than $0.15 H$.
- ! For internal stability calculations, the wall is divided in rectangular sections and for each section the appropriate L (L_1 , L_2 , L_3), is used for pullout calculations, using methods developed in chapter 4.

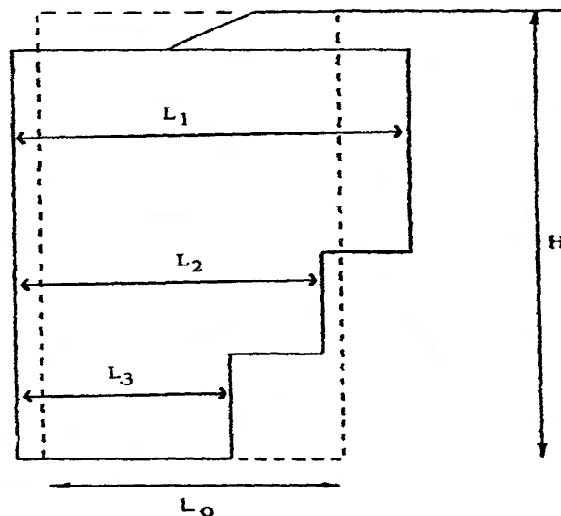

Figure 49. Dimensioning a MSE wall with uneven reinforcement lengths.

5.4 BACK-TO-BACK WALLS

For walls which are built back-to-back as shown in figure 50, a modified value of backfill thrust influences the external stability calculations. As indicated in figure 50, two cases can be considered.

- ! For Case I, the overall base width is large enough so that each wall behaves and can be designed independently. In particular, there is no overlapping of the reinforcements. Theoretically, if the distance, D , between the two walls is shorter than:

$$D = H_1 \tan (45^\circ - \phi/2) \quad (55)$$

then the active wedges at the back of each wall cannot fully spread out and the active thrust is reduced. However, it is assumed that for values of:

$$D > H_1 \tan (45^\circ - \phi/2) \approx 0.5 H_1 \quad (56)$$

full active thrust is mobilized.

- ! For Case II, there is an overlapping of the reinforcements such that the two walls interact. When the overlap, L_R , is greater than $0.3 H_2$, where H_2 is the shorter of the parallel walls, no active earth thrust from the backfill needs to be considered for external stability calculations. For intermediate geometries between Case I and Case II, the active earth thrust may be linearly interpolated from the full active case to zero. For Case II geometries with overlaps greater than $0.3 H_2$, L/H ratios for each wall as low as 0.6 may be considered.

Considering this case, designers might be tempted to use single reinforcements connected to both wall facings. This alternative completely changes the strain patterns in the structure and results in higher reinforcement tensions such that the design method in this manual is no longer applicable. In addition, difficulties in maintaining wall alignment could be encountered during construction, especially when the walls are not in a tangent section.

Based on a performance review, back-to-back walls with overlapping reinforcements may be designed for static load conditions with a distance between parallel facing as low as $L/H = 0.6$, where H is the height of each wall, and for conditions where the seismic horizontal accelerations at the foundation level is less than 0.05g. For walls in more seismically active areas (up to 0.19g) a distance of $1.1H_1$ is presently recommended. For walls subjected to significant seismic loading (up to 0.40g) successful performance has been observed when the distance between parallel facings was at least $1.2H_1$.

Justification of narrower back-to-back distances ($< 1.1H_1$) between faces in seismically active areas require a more detailed analysis be performed to include effects of potential non-uniform distribution of seismic and inertial forces within the wall, as suggested by numerical studies and not provided for in the present design methodology.

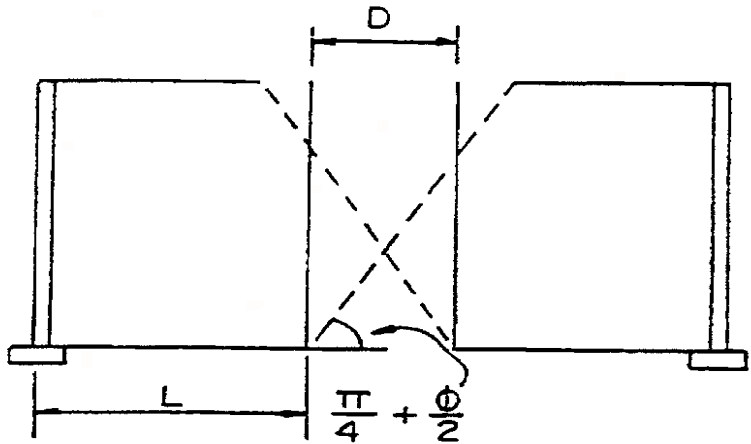

CASE I

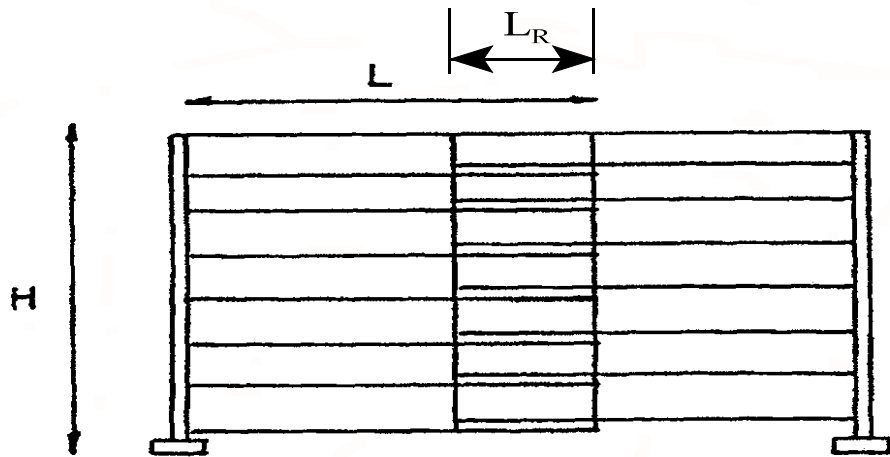

CASE II

Figure 50. Back-to-back wall.

5.5 DETAILS

At abutment locations, the permeation of salt-laden runoff through the expansion joints could result in a chloride rich environment near the face panel connection for a significant percentage of the wall height. To minimize this problem, seepage should be controlled as shown on figure 51.

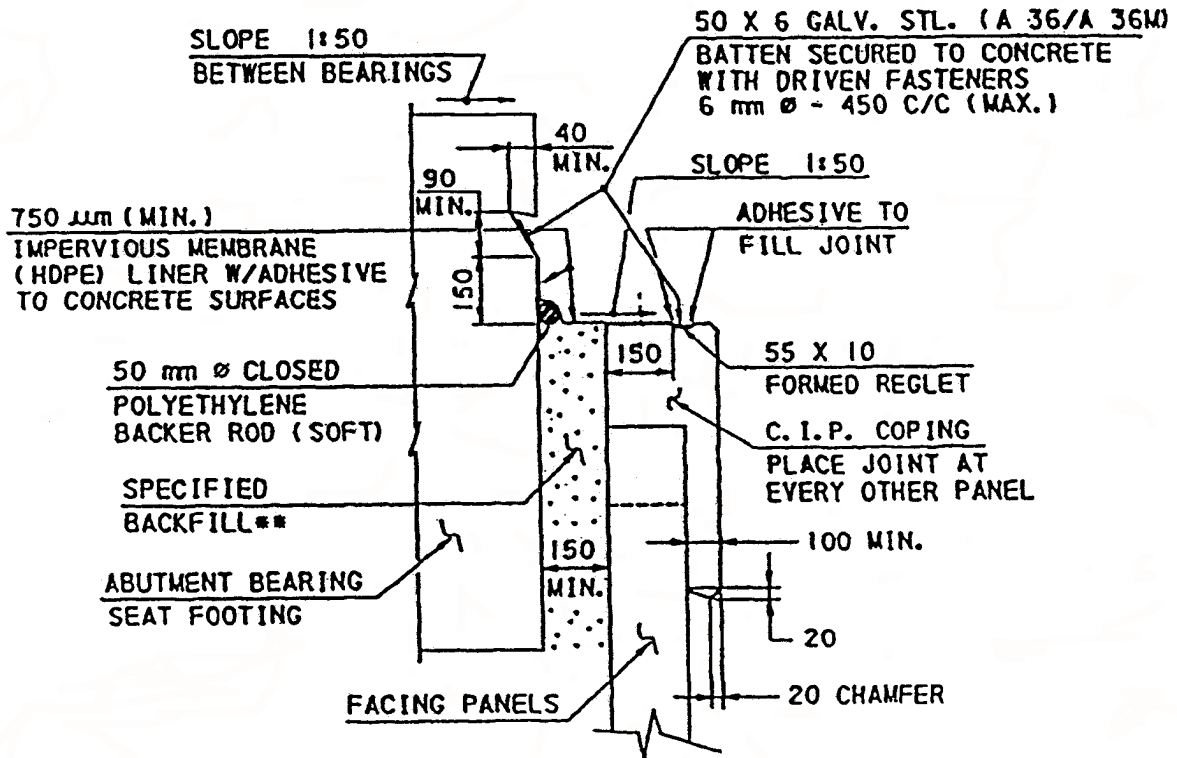

Figure 51. Abutment seat detail.

5.6 DESIGN EXAMPLE, BRIDGE ABUTMENT

v. Hand Calculation Example

A bridge abutment design as an alternate to a conventional abutment, will be illustrated using the sequential design procedures outlined in chapter 4. The bridge is at the end of the retaining wall in the example for chapter 4, and the same MSE system will be used.

Step 1: Establish design height, external loads (see figure 52)

- Total height, H' = 9.7 m
- Facing wall height, H = 7.5 m
- Traffic surcharge, q = 9.4 kN/m² (0.5 m equivalent height)
- Distance from front face to centerline of bearing = 1.0 m (minimum recommended)
- Bridge vertical dead load = 45 kN/m
- Bridge vertical live load = 50 kN/m
- Bridge horizontal load = 2.25 kN/m

Step 2: Establish engineering geotechnical properties.

- Foundations: $\phi = 30^\circ$, $q_a = 300$ kPa (clayey sand, dense)
- Retained Fill: $\phi = 30^\circ$, $\gamma = 18.8$ kN/m³
- Reinforced Fill: $\phi = 34^\circ$, $\gamma = 18.8$ kN/m³, $q_a = 200$ kPa, $F^* = 2.0$

Step 3: Establish design factor of safety.

! Design life = 75 years (If critical application, increase to 100 years).

! External Stability FS

- Sliding ≥ 1.5
- Eccentricity $\leq L/6$
- Maximum foundation pressure \leq allowable

! Internal Stability FS

- Pullout ≥ 1.5
- Allowable stress - $0.55 f_y$

Step 4: Choose facing type, reinforcement spacing and type.

- The project is at the same location as in the example for chapter 4. Therefore, precast panels 1.5×1.5 m and galvanized steel ribbed strips will be used at a vertical spacing of 0.75 m.

Step 5: Establish preliminary length for reinforcing strips.

- For abutments $0.7 (H_1)$ should be sufficient; $0.7 (9.7) = 6.8$ m, use 7 m as production is in one half meter length increments.

Step 6: Size abutment footing.

- With a minimum distance of 1.0 m from the front face to the centerline of bearing, the sizing shown on figure 52 appears reasonable as a first iteration. Assuming a unit weight of concrete at 23.6 kN/m^3 , the following can be computed per unit length.

| | | |
|-------|---|----------|
| V_1 | = | 23.01 kN |
| V_2 | = | 2.83 kN |
| V_3 | = | 13.69 kN |
| DL | = | 45 kN |
| LL | = | 50 kN |
| F_s | = | 6.89 kN |
| F_1 | = | 15.17 kN |
| F_2 | = | 2.25 kN |

- Check sliding, eccentricity and bearing pressure for the abutment footing.

$$FS_{sliding} = \frac{(\sum V_A - LL) \tan 34^\circ}{\sum F}$$

$$= \frac{(134.53 - 50.0) 0.6745}{24.31}$$

$$FS_{sliding} = 2.35 > 1.5 \quad \underline{ok}$$

GEOMETRY OF M.S.E. ABUTMENT AND APPLIED FORCES

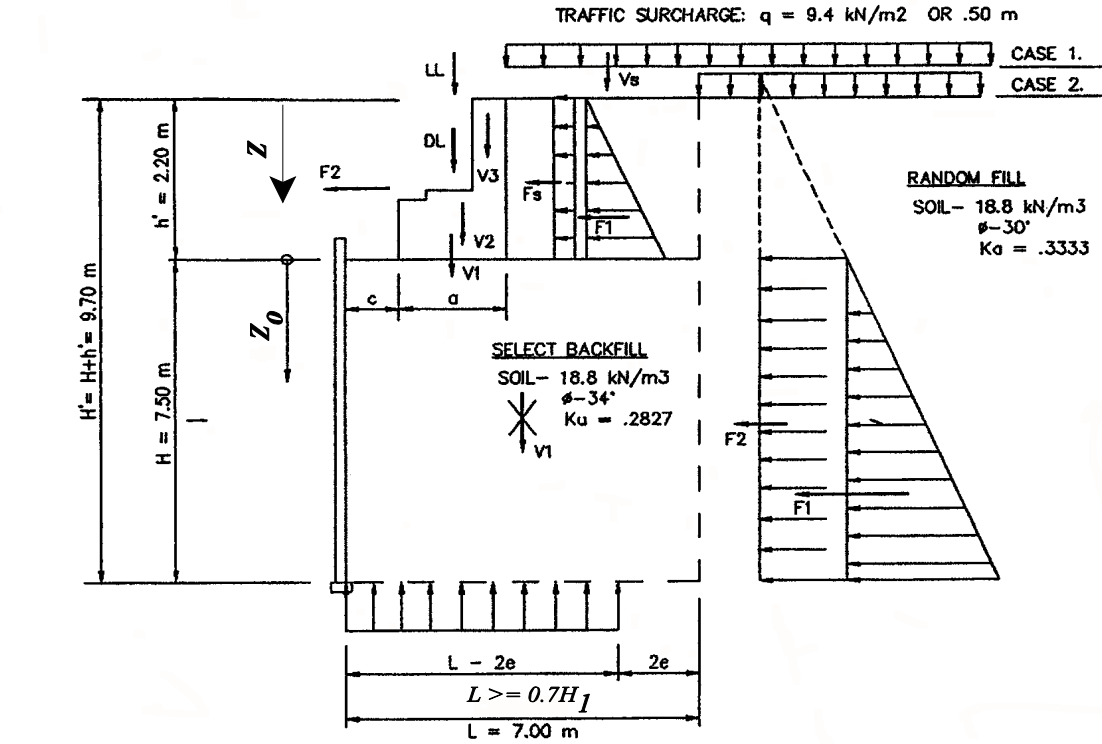

a) Loads on abutment

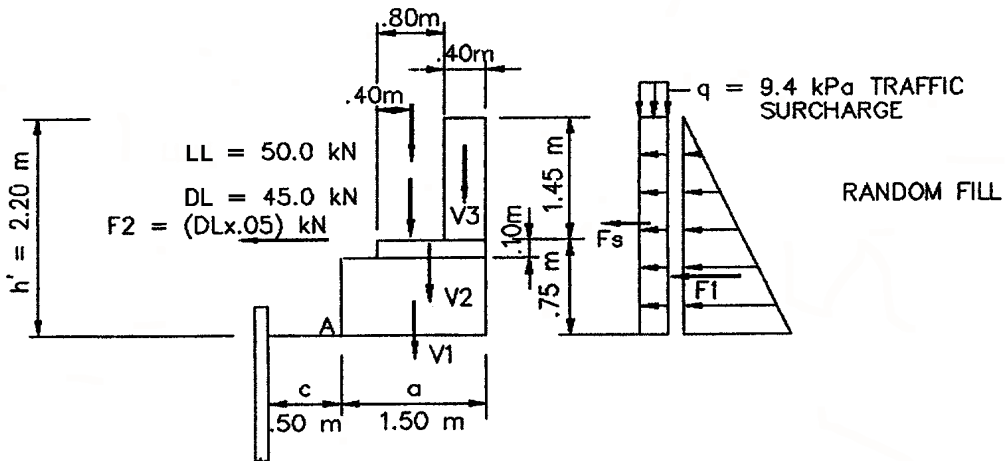

b) Abutment seat configuration

Figure 52. MSE abutment design example.

$$e' = \frac{b_f}{2} - \frac{\Sigma M_R - \Sigma M_O}{\Sigma V}$$

$$e' = \frac{1.50}{2} - \frac{104.1 - 20.39}{134.53}$$

$$e' = 0.13 < \frac{b_f}{6} = 0.25 \quad \underline{ok}$$

$$\sigma_v = \frac{\Sigma V}{b_f - 2e'} = \frac{134.53}{1.5 - (2 \cdot 0.13)}$$

$$\sigma_v = 108.5 \text{ kPa} < 200 \text{ kPa} \quad \underline{ok}$$

Step 7: Check external stability with a reinforcement length of 7 m.

Refer to figure 52 for loads and distances:

| | | | | |
|-----------------|---|--------------|---|-------------------------------------------|
| V_4 | = | 987 kN | - | Reinforced volume |
| V_s | = | 65.8 kN | - | Traffic surcharge |
| V_5 | = | 289.52 kN | - | Wt. of soil block above reinforced volume |
| F_4 | = | 176.23 kN | - | Horizontal earth pressure force component |
| F_3 | = | 126.89 kN | - | Horizontal earth pressure force component |
| ΣF_a | = | 24.31 kN | - | from abutment seat |
| ΣV_A | = | 134.53 kN | - | from abutment seat including DL and LL. |
| ΣM_{RA} | = | 104.1 kN · m | - | from abutment seat including DL and LL. |
| l_1 | = | 2.9 m | - | see figure 32a |

- Compute net load P' by removing the soil weight in abutment footing area:

$$\begin{aligned} P' &= \Sigma V_A - (h' + q) \cdot (b_f + c_p) \cdot \gamma \\ &= 134.53 - [(2.20 + 0.05)(0.3 + 1.5) 18.8] \\ &= 43.16 \text{ kN} \end{aligned}$$

- Compute ΣM_R and ΣM_o about B as follows:

$$\sum M_R = \frac{L}{2}(V_4 + V_5 + V_S) + P'(b_f + \sum M_{RA} / \sum V_A)$$

$$\sum M_R = \frac{7.0}{2}(987.0 + 289.52 + 65.80) + 43.16 \left[0.30 + \frac{104.10}{134.53} \right]$$

$$\sum M_R = 4744.47 \text{ kN} \cdot \text{m}$$

$$\sum M_O = F_4 \cdot \frac{H}{3} + F_3 \cdot \frac{H}{2} + \sum F_A \left(H - \frac{l_1}{3} \right)$$

$$\sum M_O = 176.23 \cdot \frac{7.5}{3} + 126.89 \cdot \frac{7.5}{2} + 24.31 \left(7.5 - \frac{2.9}{3} \right)$$

$$\sum M_O = 1075.25 \text{ kN} \cdot \text{m}$$

Separating the surcharge moment:

$$M_S = V_S \cdot \frac{L}{2} = 65.8 \cdot \frac{7.0}{2} = 230.3 \text{ kN} \cdot \text{m}$$

- therefore, taking moments about B at the base level and subtracting the surcharge moment for the worst case:

$$e = \frac{L}{2} - \frac{(\sum M_R - M_S) - \sum M_O}{\sum V - V_S}$$

$$e = \frac{7.0}{2} - \frac{(4744.47 - 230.3) - 1075.25}{1385.48 - 65.8}$$

$$e = 0.89 < \frac{7.00}{6} = 1.17 \quad \underline{ok}$$

- Compute bearing pressures at the foundation level:

$$\sigma_v = \frac{1385.48}{7 - (2 \cdot 0.89)}$$

$$\sigma_v = 265.42 \text{ kPa} < 300 \text{ kPa} \quad \underline{ok}$$

- Check sliding FS:

$$FS_{sliding} = \frac{[\Sigma V - V_s] \tan 30^\circ}{\Sigma F}$$

$$= \frac{(1385.48 - 65.8) 0.577}{327.43}$$

$$FS = 2.33 > 1.50 \quad \text{ok}$$

Step 8: Determine internal stability at each reinforcement level and required horizontal spacing.

- Compute coefficient of earth pressure at each level e.g. at 4.825 m from the top of backwall or 2.625 m from the top of the MSE wall.

$$K = 0.367 \text{ (see figure 29)}$$

- Compute vertical soil pressure at depth of 2.625 m from top of MSE wall.

$$\sigma_{vs} = \gamma (z + h' + q) = 18.8 (2.625 + 2.20 + 0.5)$$

$$= 100.11 \text{ kPa}$$

- Compute vertical pressure from abutment footing. (See figure 31)

$$\sigma_{VA} = \frac{43.16}{[(1.5 - 2 (0.13)] + (\frac{2.625}{2} + 0.3)}$$

$$= 15.13 \text{ kPa}$$

- Determine supplemental horizontal pressure (see figure 32a) at level $z_i = 2.625$ m.

$$l_1 = (b_f + c_f - 2e') \tan (45 + \phi/2)$$

$$= (1.5 + 0.3 - 2 \cdot 0.13) \tan 62 = 2.9m$$

- at level z_i therefore:

$$\Delta\sigma_H = \frac{2 F_A (l_1 - z_i)}{l_1^2} = \frac{2 \cdot 24.31 (2.9 - 2.625)}{(2.9)^2}$$

$$\Delta\sigma_H = 1.59 \text{ kPa}$$

- Compute horizontal pressure at the 2.625 m level.

$$\begin{aligned}\sigma_H &= (\sigma_{VS} \cdot K) + (\sigma_{VA} \cdot K) + \Delta\sigma_H \\ &= (100.11 \cdot 0.367) + (15.13 \cdot 0.367) + 1.59\end{aligned}$$

$$\sigma_H = 43.84 \text{ kPa}$$

Step 9: Determine required reinforcement at 2.625 m level based on a defined length of 2 panels in length and spacing S_v .

- Determine force on the tributary area:

$$T = 43.84 \cdot 2.25 = 98.64 \text{ kN}$$

- Determine the effective length L_e :

$$L_e = L - 0.3 H' = 7 - (0.3 \cdot 9.7) = 4.09 \text{ m}$$

- Determine number of strips required to satisfy pullout criteria:

$$\begin{aligned}N &= \frac{T \cdot FS}{2b \cdot F^* \cdot L_e \cdot \sigma_v} \\ &= \frac{98.64 \cdot 1.5}{2 \cdot 0.05 \cdot 0.934 \cdot 4.09 \cdot 18.8 (2.625 + 2.20)}\end{aligned}$$

$$N = 4.27 \text{ use 5 strips}$$

Place 3 strips in upper row, 2 in lower row.

- For design life of 75 years.

$$E_c = 4.00 - 1.416 = 2.584 \text{ mm}$$

- Maximum stress in each strip is:

$$f_s = \frac{T}{N \cdot E_c} = \frac{98.64}{5 (0.0001292) 1000}$$

$$= 152.7 \text{ MPa} < 227.5 \text{ MPa} \quad \underline{ok}$$

Calculate internal stability at each layer and determine the number of reinforcing strips per tributary area. The tabulated results are as follows:

| Depth z (m) | Vertical Pressure kPa | K | F* | Hor. Pressure kPa | N strips per trib. area | Tensile stress/ MPa | FS pullout |
|----------------|-----------------------------|--------|--------|-------------------------|-------------------------------|---------------------------|---------------|
| 0.375 | 82.73 | 0.4199 | 1.4311 | 49.32 | 6 | 143.15 | 1.53 |
| 1.125 | 92.40 | 0.4023 | 1.2655 | 47.42 | 5 | 165.18 | 1.52 |
| 1.875 | 103.40 | 0.3846 | 1.0998 | 45.70 | 5 | 159.18 | 1.68 |
| 2.625 | 115.22 | 0.3669 | 0.9341 | 43.89 | 5 | 152.87 | 1.75 |
| 3.375 | 127.56 | 0.3493 | 0.7684 | 44.55 | 5 | 155.18 | 1.82 |
| 4.125 | 140.28 | 0.3393 | 0.6745 | 47.59 | 5 | 165.75 | 1.86 |
| 4.875 | 153.25 | 0.3393 | 0.6745 | 51.99 | 5 | 181.08 | 2.08 |
| 5.625 | 166.42 | 0.3393 | 0.6745 | 56.46 | 5 | 196.64 | 2.29 |
| 6.375 | 179.73 | 0.3393 | 0.6745 | 60.98 | 5 | 212.38 | 2.51 |
| 7.125 | 193.16 | 0.3393 | 0.6745 | 65.53 | 6 | 190.20 | 3.26 |

b. Computer-Aided Solution - MSEW Design of Example 5.6

The bridge abutment design example could also be designed using the computer program MSEW. The input for the problem would be similar to Example 4.6 with the exception of inputting the bridge abutment configuration and loading. Using MSEW, the following shows the input for the bridge abutment and the results of the Design mode analysis.

- ▶ Load the MSEW program and input the project information as was done for example 4.6. On the **GEOMETRY/SURCHARGE** screen click on **Complex** geometry. On the next screen, click on the **Bridge Abutments**.

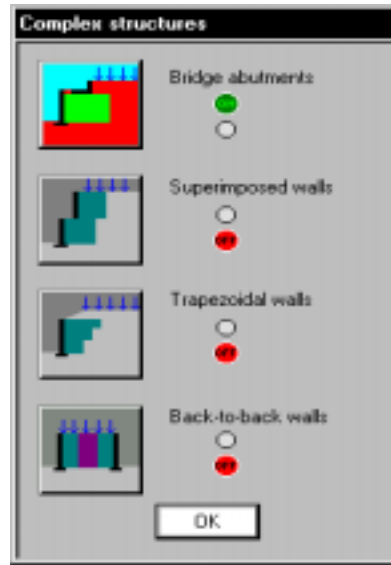
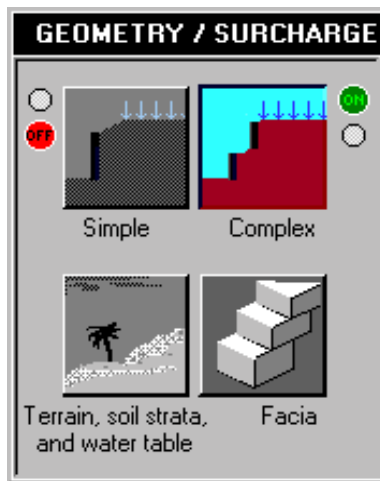

- ▶ Turning the bridge abutment on will then bring up the BRIDGE ABUTMENTS Data input screens. For this problem, use the abutment on spreading footing foundation option and input the information from step 1 and Figure 52 as follows.

- ▶ Click on each on the **View/Modify** button located in the middle of the wall schematic.

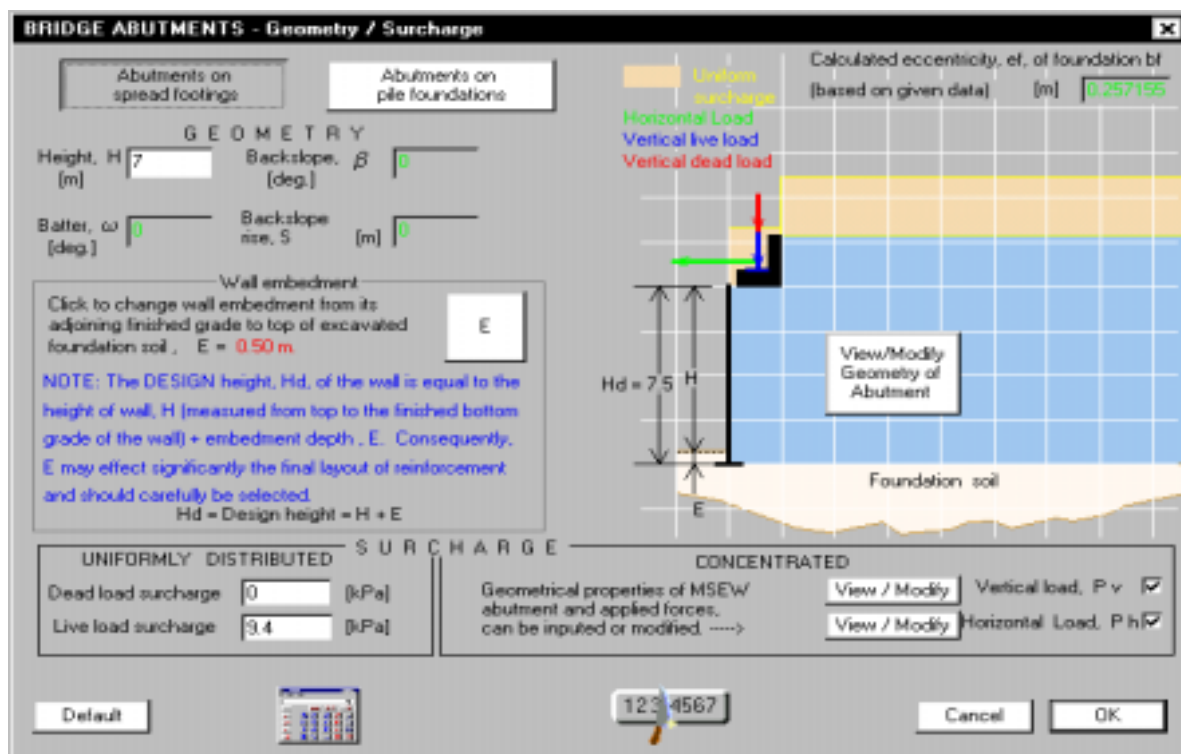

- ▶ Input the bridge geometry information and click on **OK**.

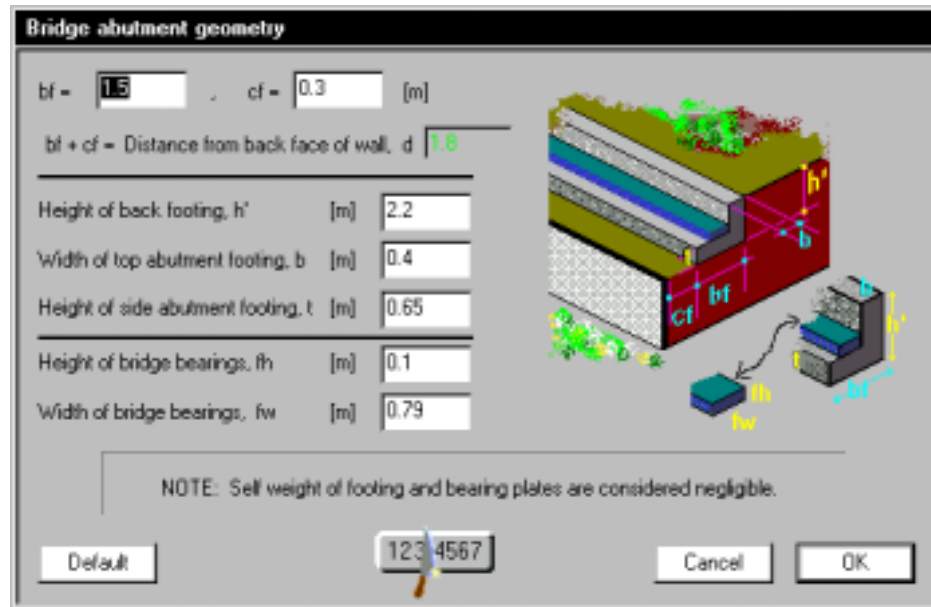

- ▶ Next click on each of the **View/Modify** buttons for vertical surcharge load and horizontal surcharge load located under the CONCENTRATED section of the BRIDGE ABUTMENT GEOMETRY screen. Enter the information from the example problem as demonstrate for the vertical load below.

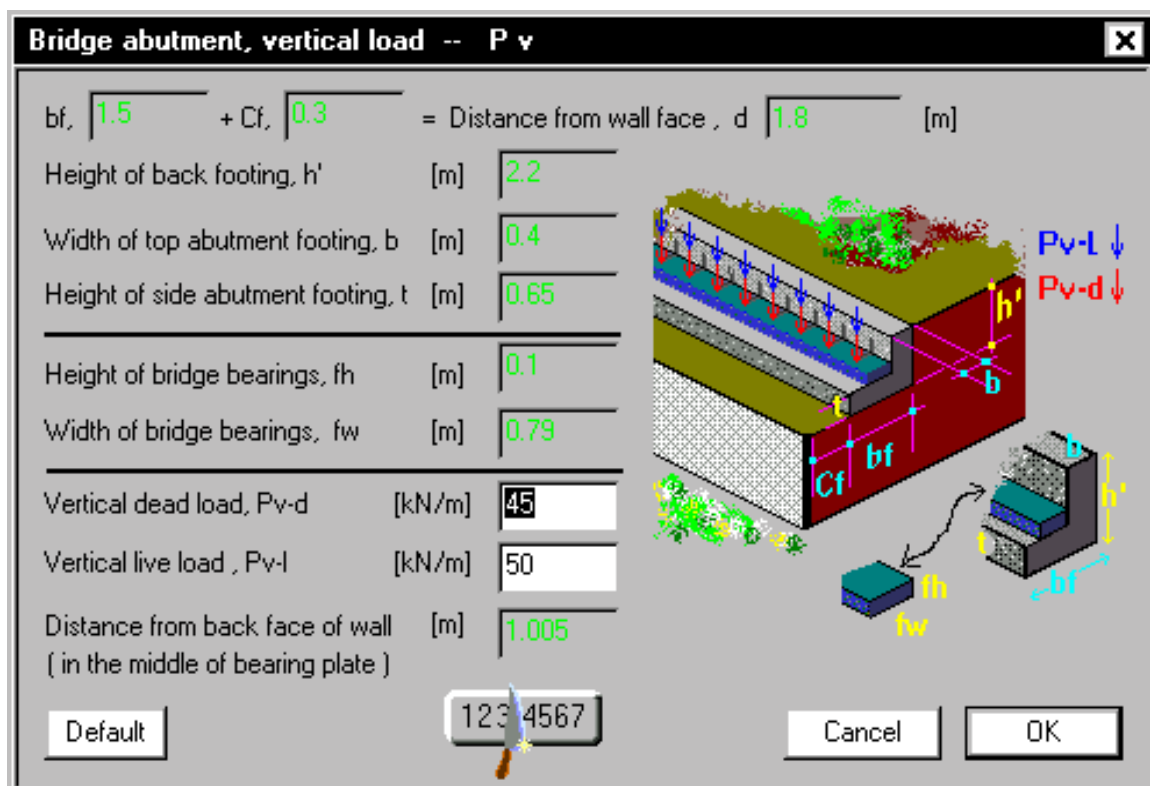

- Return to the main menu screens and input the information from the example problem for the **GEOMETRY/ SURCHARGE, SOILS AND SEISMICITY**, and **REINFORCEMENT** as was done in computer solution of example 4.6. For the **REINFORCEMENT**, in the initial design trial select “Uniform length of metal strip layers” and “equally spaced strips.” Also, check the minimum required length and the lateral earth pressure coefficients. The program provides a default value based on $0.7 H$ using $H = 7.5$. However, H_{TOTAL} is $H + h' = 9.7$ m. Change the default value to a length value of $0.7 H_{TOTAL} = 6.8$ m or 7.0 m as used in the example. The default values will be used for the lateral earth pressure coefficients.

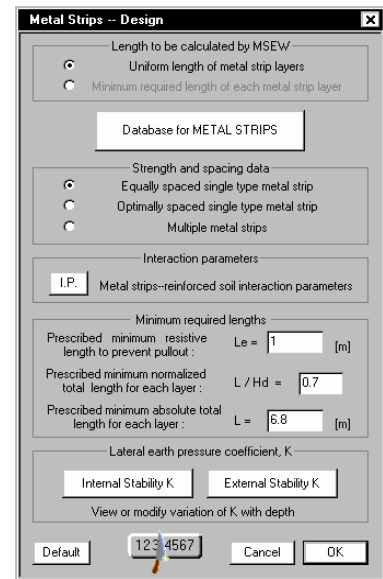

- The structural requirements for the reinforcement to support the wall and abutment can now be designed. The following shows the output screen for the analysis of the metallic strip type reinforcement, minimum length requirements and segmental concrete facing panel used in the example problem. The program checks that the layout meets the required factor of safety for each of the external and internal stability requirements. As can be seen from the screen, the single reinforcement type with uniform spacing of $S_v = 0.75$ m and $S_h = 0.75$ does not meet design strength requirements and the length is much longer than the minimum to achieve pullout. An iterative process would now be used to evaluate the number of reinforcing strips required in each layer (by adjusting the horizontal spacing) to meet the design requirements as was done in the example problems. Increasing the number of reinforcements in any given layer will also reduce the length required for that layer.

The external stability for each type of analysis mode can also be viewed from this screen with the bearing capacity analysis shown as an example below. The bearing capacity as well as the other external stability calculations match the calculations from the example problem.

| # | Elevation [m] | Length [m] | Type | Connection strength | Metal strip strength | Pullout resistance | Direct sliding | Eccentricity |
|----|---------------|------------|------|---------------------|----------------------|--------------------|----------------|--------------|
| 6 | 4.05 | 9.92 | N/A | ✓ | ✓ | ✓ | ✓ | ✓ |
| 7 | 4.80 | 9.92 | N/A | ✓ | ✓ | ✓ | ✓ | ✓ |
| 8 | 5.55 | 9.92 | N/A | ✓ | ✓ | ✓ | ✓ | ✓ |
| 9 | 6.30 | 9.92 | N/A | ✓ | ✓ | ✓ | ✓ | ✓ |
| 10 | 7.05 | 9.92 | N/A | ✓ | ✓ | ✓ | ✓ | ✓ |

Design Layout -- extended table

| # | Metal Strip | | | STATUS OF: | | | | |
|----|---------------|------------|------|-------------------------------------|-------------------------------------|-------------------------------------|-------------------------------------|-------------------------------------|
| | Elevation [m] | Length [m] | Type | Connection strength | Metal strip strength | Pullout resistance | Direct sliding | Eccentricity |
| 1 | 0.30 | 9.92 | N/A | <input checked="" type="checkbox"/> | <input checked="" type="checkbox"/> | <input checked="" type="checkbox"/> | <input checked="" type="checkbox"/> | <input checked="" type="checkbox"/> |
| 2 | 1.05 | 9.92 | N/A | <input type="checkbox"/> | <input type="checkbox"/> | <input checked="" type="checkbox"/> | <input checked="" type="checkbox"/> | <input checked="" type="checkbox"/> |
| 3 | 1.80 | 9.92 | N/A | <input checked="" type="checkbox"/> | <input checked="" type="checkbox"/> | <input checked="" type="checkbox"/> | <input checked="" type="checkbox"/> | <input checked="" type="checkbox"/> |
| 4 | 2.55 | 9.92 | N/A | <input checked="" type="checkbox"/> | <input checked="" type="checkbox"/> | <input checked="" type="checkbox"/> | <input checked="" type="checkbox"/> | <input checked="" type="checkbox"/> |
| 5 | 3.30 | 9.92 | N/A | <input checked="" type="checkbox"/> | <input checked="" type="checkbox"/> | <input checked="" type="checkbox"/> | <input checked="" type="checkbox"/> | <input checked="" type="checkbox"/> |
| 6 | 4.05 | 9.92 | N/A | <input checked="" type="checkbox"/> | <input checked="" type="checkbox"/> | <input checked="" type="checkbox"/> | <input checked="" type="checkbox"/> | <input checked="" type="checkbox"/> |
| 7 | 4.80 | 9.92 | N/A | <input checked="" type="checkbox"/> | <input checked="" type="checkbox"/> | <input checked="" type="checkbox"/> | <input checked="" type="checkbox"/> | <input checked="" type="checkbox"/> |
| 8 | 5.55 | 9.92 | N/A | <input checked="" type="checkbox"/> | <input checked="" type="checkbox"/> | <input checked="" type="checkbox"/> | <input checked="" type="checkbox"/> | <input checked="" type="checkbox"/> |
| 9 | 6.30 | 9.92 | N/A | <input checked="" type="checkbox"/> | <input checked="" type="checkbox"/> | <input checked="" type="checkbox"/> | <input checked="" type="checkbox"/> | <input checked="" type="checkbox"/> |
| 10 | 7.05 | 9.92 | N/A | <input type="checkbox"/> | <input type="checkbox"/> | <input checked="" type="checkbox"/> | <input checked="" type="checkbox"/> | <input checked="" type="checkbox"/> |

Bearing Capacity

Soils, Loads, Seismicity, K_{DE}

Horizontal Load
Strip Load (dead+live)

STATIC PARAMETERS

Maximum allowable eccentricity ratio: $e/L = 0.167$

Minimum specified F_s for bearing capacity: $F_s = 2.50$

Ultimate bearing capacity of foundation is given.

Type of bearing capacity failure: GENERAL shear

Results

| | STATIC | SEISMIC | UNITS |
|--------------------------------|--------|---------|-------|
| Given ultimate B.C., q_{ult} | 750.00 | 750.00 | [kPa] |
| Meyerhof stress, σ_v | 249.74 | 263.60 | [kPa] |
| Eccentricity, e | 0.84 | 0.98 | [m] |
| e/L | 0.120 | 0.140 | |
| F_s calculated | 3.00 | 2.85 | |
| Base length | 7.00 | 7.00 | [m] |

7.50

7.00

3.75

2.50

$F_H = 124.7 \text{ kN/m}$

$F_t = 172.5 \text{ kN/m}$ Angle of $F_t = 0.00^\circ$

$R = 1329.2 \text{ kN/m}$

Display resultants of external loads

Display Meyerhof and trapezoidal distributions

Seismic lengths

Static lengths

For Help, press F1

RETURN

CHAPTER 6

REINFORCED (STEEPENED) SOIL SLOPES PROJECT EVALUATION

6.1 INTRODUCTION

Where limited right of way is available and the cost of a MSE wall is high, a steepened slope should be considered. In this chapter the background and design requirements for evaluating a reinforced soil slope (RSS) alternative are reviewed. Step-by-step design procedures are presented later in chapter 7. Section 6.2 reviews the types of systems and the materials of construction. Section 6.3 provides a discussion of the internal stability design approach for use of reinforcement as compaction aids, steepening slopes and slope repair. Computer assisted methods for internal stability evaluation are also reviewed. The section concludes with a discussion of external stability requirements. Section 6.4 reviews the construction sequence. Section 6.5 covers treatment of the outward face of the slope to prevent erosion. Section 6.6 covers design details of appurtenant features including traffic barrier and drainage considerations. Finally, section 6.7 presents several case histories to demonstrate potential cost savings.

6.2 REINFORCED SOIL SLOPE SYSTEMS

a. Types of Systems

Reinforced soil systems consist of planar reinforcements arranged in nearly horizontal planes in the backfill to resist outward movement of the reinforced fill mass. Facing treatments ranging from vegetation to flexible armor systems are applied to prevent unraveling and sloughing of the face. These systems are generic in nature and can incorporate any of a variety of reinforcements and facing systems. Design assistance is often available through many of the reinforcement suppliers, many of which have proprietary computer programs.

This manual does not cover reinforcing the base section of an embankment for construction over soft soils, a different type reinforcement application. The user is referred to the FHWA *Geosynthetics Design and Construction Guidelines* for that application.

b. Construction Materials

! **Reinforcement types.** Reinforced soil slopes can be constructed with any of the reinforcements described in chapter 2. While discrete strip type reinforcing elements can be used, a majority of the systems are constructed with continuous sheets of geosynthetics (i.e., geotextiles or geogrids) or wire mesh. Small, discrete micro reinforcing elements such as fibers, yarns, and microgrids located very close to each other have also been used. However, the design is based on more conventional unreinforced design with cohesion added by the reinforcement (which is not covered in this manual).

- ! **Backfill Requirements.** Backfill requirements for reinforced soil slopes are discussed in chapter 3. Because a flexible facing (e.g. wrapped facing) is normally used, minor distortion at the face that may occur due to backfill settlement, freezing and thawing, or wetting and drying can be tolerated. Thus, lower quality backfill than recommended for MSE walls can be used. The recommended backfill is limited to low-plasticity, granular material (i.e., $PI \leq 20$ and ≤ 50 percent finer than 0.075 mm). However, with good drainage, careful evaluation of soil and soil-reinforcement interaction characteristics, field construction control, and performance monitoring (see chapter 9), most indigenous soil can be considered.

6.3 DESIGN APPROACH

a. Use Considerations

As reviewed in chapter 2, there are two main purposes for using reinforcement in slopes as follows:

- ! Improved stability for steepened slopes and slope repair.
- ! Compaction aids, for support of construction equipment and improved face stability.

The design of reinforcement for safe, steep slopes requires a rigorous analysis. The design of reinforcement for this application is critical, as failure of the reinforcement would result in failure of the slope.

The overall design requirements for reinforced slopes are similar to those for unreinforced slopes: The factor of safety must be adequate for both the short-term and long-term conditions and for all possible modes of failure.

As illustrated in figure 53, there are three failure modes for reinforced slopes:

- ! Internal, where the failure plane passes through the reinforcing elements.
- ! External, where the failure surface passes behind and underneath the reinforced mass.
- ! Compound, where the failure surface passes behind and through the reinforced soil mass.

In some cases, the calculated stability safety factor can be approximately equal in two or all three modes, if the reinforcement strengths, lengths and vertical spacing are optimized.⁽³⁾

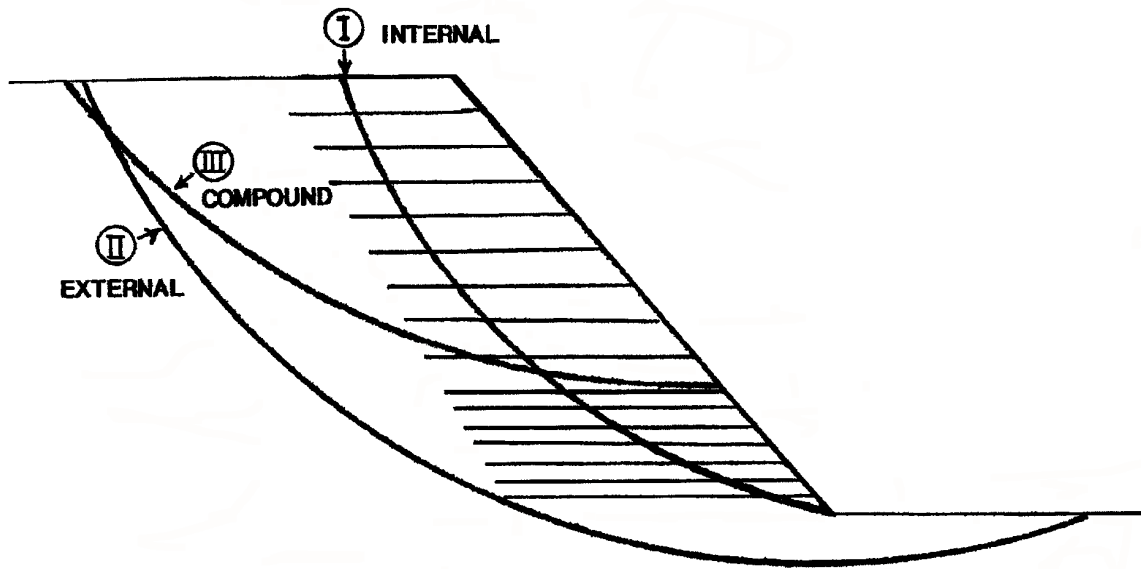

Figure 53. Failure modes for reinforced soil slopes.

b. Design of Reinforcement for Compaction Aid

For the use of geosynthetics as compaction aids, the design is relatively simple. Assuming the slope is safe without reinforcement, no reinforcement design is required. Place any geotextile or geogrid that will survive construction at every lift or every other lift in a continuous plane along the edge of the slope (see figure 4b). Only narrow strips, about 1.2 to 2 m (4 to 6 ft) in width, at 0.3 to 0.5 m (1 to 1.5 ft) vertical spacing are required. Where the slope angle approaches the angle of repose of the soil, it is recommended that a face stability analysis be performed using the method presented in the reinforcement design section of chapter 7. Where reinforcement is required by analysis, the geosynthetic may be considered as secondary reinforcement used to improve compaction and stabilize the slope face between primary reinforcing layers.

c. Design of Reinforcement for Steepening Slopes and Slope Repair

For steepened reinforced slopes (face inclination up to 70 degrees) and slope repair, design is based on modified versions of the classical limit equilibrium slope stability methods as shown in figure 54:

- ! Circular or wedge-type potential failure surface is assumed.
- ! The relationship between driving and resisting forces or moments determines the slope factor of safety.

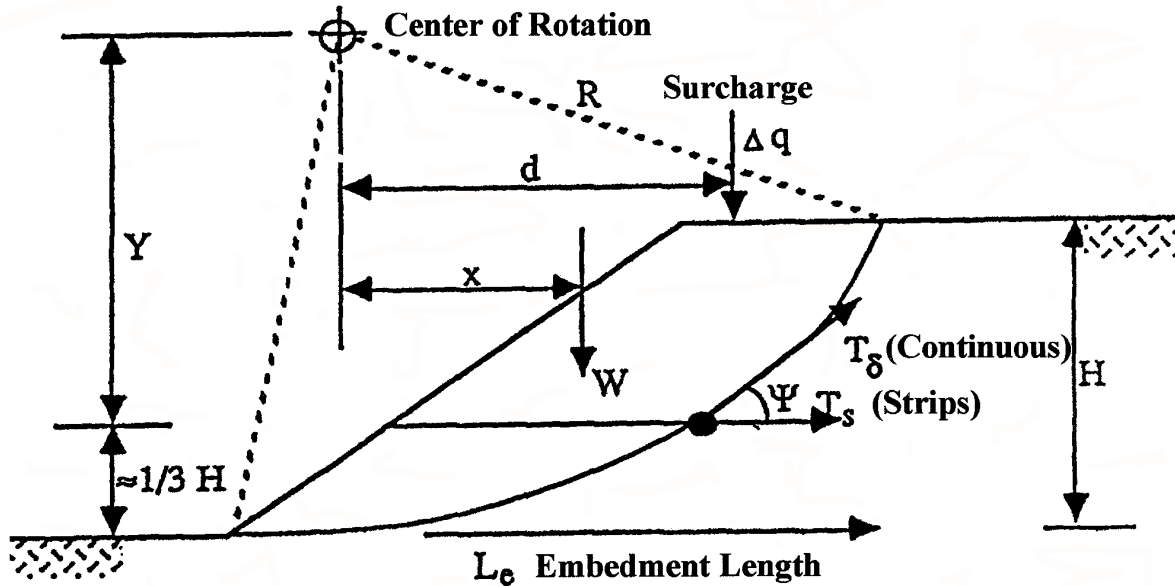

Figure 54. Modified limit equilibrium analysis for reinforced slope design.

- ! Reinforcement layers intersecting the potential failure surface are assumed to increase the resisting force or moment based on their tensile capacity and orientation. (Usually, the shear and bending strengths of stiff reinforcements are not taken into account.)
- ! The tensile capacity of a reinforcement layer is taken as the minimum of its allowable pullout resistance behind (or in front of) the potential failure surface and its long-term allowable design strength.

As shown in figure 53, a wide variety of potential failure surfaces must be considered, including deep-seated surfaces through or behind the reinforced zone. The critical slope stability factor of safety is taken from the unreinforced failure surface requiring the maximum reinforcement. This is the failure surface with the largest unbalance driving moment to resisting moment and not the surface with the minimum calculated unreinforced factor of safety. This failure surface is equivalent to the critical reinforced failure surface with the lowest factor of safety. Detailed design of reinforced slopes is performed by determining the factor of safety with successively modified reinforcement layouts until the target factor of safety is achieved.

For slope repair applications, it is also very important to identify the cause of the original failure to make sure that the new reinforced soil slope will not have the same problems. If a water table or erratic water flows exist, particular attention has to be paid to drainage. In natural soils, it is also necessary to identify any weak seams that might affect stability.

The method presented in this manual uses any conventional slope stability computer program and the steps necessary to manually calculate the reinforcement requirements for almost any condition. Figure 54 shows the conventional rotational slip surface method used in the analysis. Fairly complex conditions can be accommodated depending on the analytical method used (e.g., Modified Bishop, Spencer). The computer programs ReSSA and RSS were developed by the FHWA to specifically perform this analysis and is also presented.

The rotational slip surface approach is used for slopes up to 70 degrees, although technically it is a valid method for evaluating even steeper slopes. Slopes steeper than 70 degrees are defined as walls and lateral earth pressure procedures in chapter 4 apply.

The assumed orientation of the reinforcement tensile force influences the calculated slope safety factor. In a conservative approach, the deformability of the reinforcements is not taken into account, and thus, the tensile forces per unit width of reinforcement T_r are assumed to always be in the horizontal direction of the reinforcements. When close to failure, however, the reinforcements may elongate along the failure surface, and an inclination from the horizontal can be considered.

The above reinforcement orientations represent a simplifying assumption considering the reinforcement is not incorporated directly into the analysis of the slope. If a more rigorous evaluation is performed in which the vertical and horizontal components of the tension forces are included in the equations of equilibrium, then it can be seen that an increase in normal stress will occur for reinforcements with an orientation other than tangential to the failure surface.⁽⁴⁾ In effect, this increase in normal stress will result in practically the same reinforcement influence on the safety factor whether it is assumed to act tangentially or horizontally. Although these equilibrium considerations may indicate that the horizontal assumption is conservative for inextensible reinforcements, it should be recognized that the stress distribution near the point of intersection of the reinforcement and the failure surface is complicated. The conclusion concerning an increase in normal stress should only be considered for continuous and closely spaced reinforcements: it is questionable and should not be applied to reinforced slopes with widely spaced and/or discrete, strip type reinforcements.

Tensile force direction is, therefore, dependent on the extensibility and continuity of the reinforcements used, and the following inclination is suggested:

- ! Discrete, Strip Reinforcements: T parallel to the reinforcements.
- ! Continuous, Sheet Reinforcements: T tangent to the sliding surface.

d. Computer-Assisted Design

The ideal method for reinforced slope design is to use a conventional slope stability computer program that has been modified to account for the stabilizing effect of reinforcement. Such programs should account for reinforcement strength and pullout capacity, compute reinforced and unreinforced safety factors automatically, and have some searching routine to help locate critical surfaces. The method would also include the confinement effects of the reinforcement on the shear strength of the soil in the vicinity of the reinforcement.

A generic program RSS developed by FHWA for both reinforcement design and evaluation of almost any condition will be reviewed following the design methodology presentation. The program uses an extensively modified version of the STABL computer program originally developed at Purdue University and the guidelines for the design of soil reinforcement given in chapter 7. The input and output of RSS will be demonstrated for the example problems in chapter 7. It should be noted that this program has undergone extensive review and validation by engineers from state and federal agencies, industry, universities and private practice.

RSS may be downloaded free of charge from the FHWA Geotechnical Information Center at www.fhwa.dot.gov/bridge or a disk copy may be purchased from the Center for Microcomputers in Transportation (McTrans) at www.mctrans.ce.ufl.edu. The program is supported by FHWA for all state and federal agencies. For private sector users and others, a supported licensed version is available from the developer GEOCOMP through their web page at www.geocomp.com/software.htm.

A windows version of the reinforced soil slope program, ReSSA, is currently under development by FHWA and should be distributed in 2001.

Several other reinforced slope programs are commercially available. These programs generally do not design the reinforcement but allow for an evaluation of a given reinforcement layout. An iterative approach then follows to optimize either the reinforcement strength or layout. Most of the programs are limited to simple soil profiles and, in some cases, simple reinforcement layouts. Also, external stability evaluation is generally limited to specific soil and reinforcement conditions and a single mode of failure. In some cases, the programs are reinforcement- specific.

With computerized analyses, the actual factor of safety value FS is dependent upon how the specific program accounts for the reinforcement tension in the moment equilibrium equation. The method of analysis in chapter 7 and in FHWA's RSS program, as well as many others, assume the reinforcement force as contributing to the resisting moment, *i.e.*:

$$FS_R = \frac{M_R + T_S R}{M_D}$$

where, FS_R = the stability factor of safety required;
 M_R = resisting moment provided by the strength of the soil;
 M_D = driving moment about the center of the failure circle;
 T_S = sum of required tensile force per unit width of reinforcement (considering rupture and pullout) in all reinforcement layers intersecting the failure surface;
 R = the moment arm of T_S about the center of failure circle as shown in figure 54.

With this assumption, FS_R is applied to both the soil and the reinforcement as part of the analysis. As a result, as indicated in Chapter 3, the factor of safety applied to the ultimate

strength T_{ULT} to obtain the allowable tensile force per unit width T_a in equation 14 is equal to 1. T_a is thus equal to the long-term strength T_{al} and the factor of safety on the reinforcement is equal to FS_R .

Some computer programs use an assumption that the reinforcement force is a negative driving component, thus the FS is computed as:

$$FS = \frac{M_R}{M_D - T_S R}$$

With this assumption, the stability factor of safety is not applied to T_S . Therefore, the allowable design strength T_a should be computed as the ultimate tensile strength T_{ULT} divided by the required safety factor (i.e., target stability factor of safety) along with the appropriate reduction factors RF in equation 12 (i.e., $T_a = T_{ULT} / FS_R$). This provides an appropriate factor of safety for uncertainty in material strengths and reduction factors. The method used to develop design charts should likewise be carefully evaluated to determine FS used to obtain the allowable geosynthetic strength.

e. **Evaluation of External Stability**

The external stability of a reinforced soil mass depends on the ability of the mass to act as a stable block and withstand all external loads without failure. Failure possibilities as shown in figure 55 include sliding, deep-seated overall instability, local bearing capacity failure at the toe (lateral squeeze type failure), as well as excessive settlement from both short- and long-term conditions.

The reinforced mass must be sufficiently wide at any level to resist sliding. To evaluate sliding stability, a wedge type failure surface defined by the limits of the reinforcement can be analyzed using the conventional sliding block method of analysis as detailed in the FHWA *Soils and Foundations Workshop Reference Manual*, (2000).⁽²⁰⁾

Conventional soil mechanics stability methods should also be used to evaluate the global stability of the reinforced soil mass. Both rotational and wedge type failure surfaces extending behind and below the structure should be considered. Care should be taken to identify any weak soil layers in the soils behind or below the reinforced soil mass. Compound failure surfaces initiating externally and passing through or between reinforcement sections should also be evaluated, especially for complex slope or soil conditions. Evaluation of potential seepage forces is especially critical for global stability analysis.

Evaluation of deep-seated failure does not automatically check for bearing capacity of the foundation or failure at the toe of the slope. High lateral stresses in a confined soft stratum beneath the embankment could lead to a lateral squeeze type failure. The shear forces developed under the embankment should be compared to the corresponding shear strength of the soil. Approaches discussed by Jurgenson, Silvestri, and Bonaparte, Giroud, and Holtz

are appropriate. ^(5,6,7) The approach by Silvestri is demonstrated in example problem 2 in chapter 7.

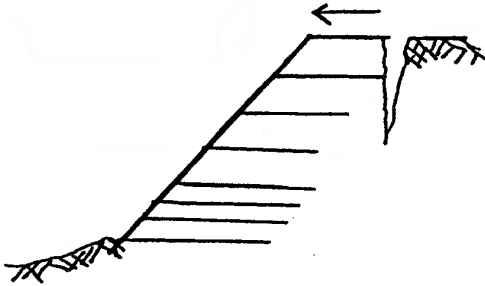

A) SLIDING INSTABILITY

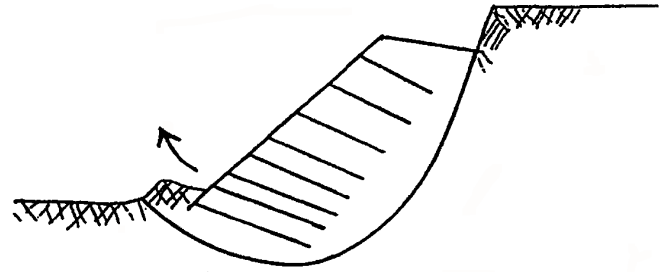

B) DEEP SEATED OVERALL INSTABILITY

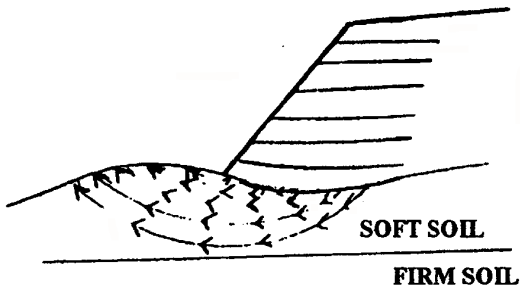

C) LOCAL BEARING CAPACITY (LATERAL SQUEEZE) FAILURE

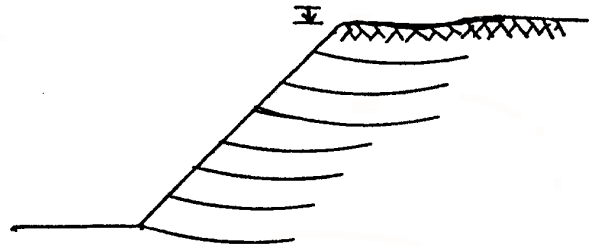

D) EXCESSIVE SETTLEMENT

Figure 55. External failure modes for reinforced soil slopes.

Settlement should be evaluated for both total and differential movement. While settlement of the reinforced slope is not of concern, adjacent structures or structures supported by the slope may not tolerate such movements. Differential movements can also effect decisions on facing elements as discussed previously in chapter 2.

In areas subject to potential seismic activity, a simple pseudo-static type analysis should be performed using a seismic coefficient obtained from Division 1A of the AASHTO Standard Specifications for Highway Bridges (1996) or using local practice. Reinforced slopes are flexible systems and unless used for bridge abutments they are not laterally restrained. Thus it is appropriate to use $A_m = A/2$ for seismic design in accordance with the AASHTO code. A_m is equivalent to the horizontal seismic coefficient K_h used in many slope stability programs.

If any of the external stability safety factors are less than the required factor of safety, the following foundation improvement options could be considered:

- ! Excavate and replace soft soil.
- ! Flatten the slope.
- ! Construct a berm at the toe of the slope to provide an equivalent flattened slope. The berm could be placed as a surcharge at the toe and removed after consolidation of the soil has occurred.
- ! Stage construct the slope to allow time for consolidation and improvement of the foundation soils.
- ! Embed the slope below grade (>1 m), or construct a shear key at the toe of the slope (evaluate based on active-passive resistance).
- ! Use ground improvement techniques (e.g., wick drains, stone columns, etc.)

Additional information on ground improvement techniques can be found in the FHWA's Ground Improvement Manual DP116.

6.4 CONSTRUCTION SEQUENCE

As the reinforcement layers are easily incorporated between the compacted lifts of fill, construction of reinforced slopes is very similar to normal slope construction. The elements of construction consist of simply:

1. Placing the soil.
2. Placing the reinforcement.

3. Constructing the face.

The following is the usual construction sequence as shown in figure 56:

! Site Preparation

- Clear and grub site.
- Remove all slide debris (for slope reinstatement projects).
- Prepare a level subgrade for placement of the first level of reinforcement.
- Proof-roll subgrade at the base of the slope with a roller or rubber-tired vehicle.
- Observe and approve foundation prior to fill placement.

! Reinforcing Layer Placement

- Reinforcement should be placed with the principal strength direction perpendicular to the face of the slope.
- Secure reinforcement with retaining pins to prevent movement during fill placement.
- A minimum overlap of 150 mm (6 inches) is recommended along the edges perpendicular to the slope for wrapped face structures. Alternatively, with geogrid reinforcement, the edges may be clipped or tied together. When geosynthetics are not required for face support, no overlap is required and edges should be butted.

! Reinforcement Backfill Placement

- Place fill to the required lift thickness on the reinforcement using a front end loader or dozer operating on previously placed fill or natural ground.
- Maintain a minimum of 150 mm (6 inches) of fill between the reinforcement and the wheels or tracks of construction equipment.
- Compact with a vibratory roller or plate type compactor for granular materials or a rubber-tired or smooth drum roller for cohesive materials.
- When placing and compacting the backfill material, care should be taken to avoid any deformation or movement of the reinforcement.
- Use lightweight compaction equipment near the slope face to help maintain face alignment.

WRAPPED FACE CONSTRUCTION

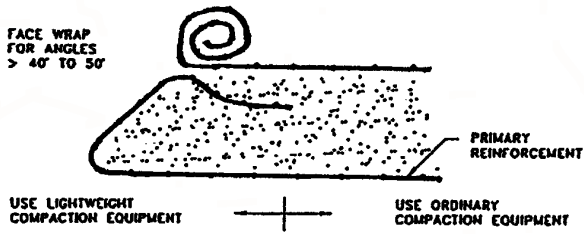

NO WRAP CONSTRUCTION

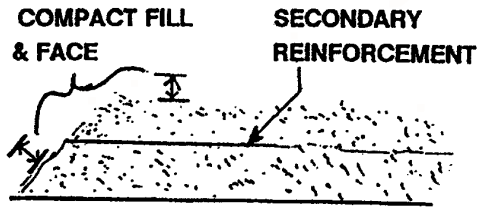

A) LIFT 1 PLUS REINFORCEMENT FOR LIFT 2

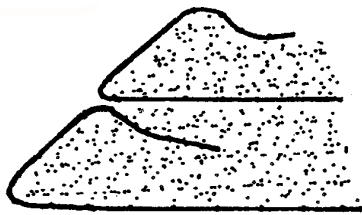

OPTIONAL FACE CONSTRUCTION: OVER EXTEND FILL, COMPACT AND CUT BACK OR USE A FORM

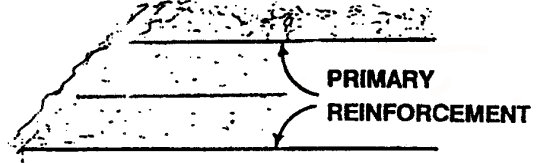

B) SECOND PRIMARY REINFORCEMENT LAYER

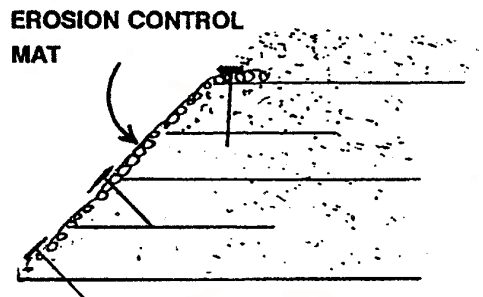
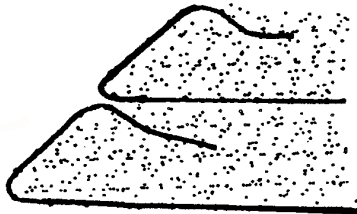

C) COMPLETION OF SECOND STAGE

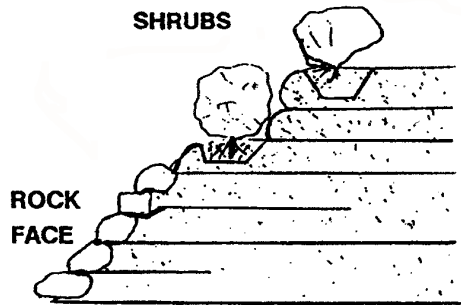
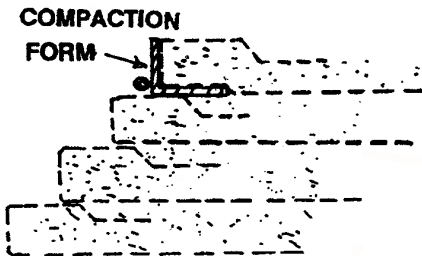

D) FACING ALTERNATIVES

Figure 56. Construction of reinforced soil slopes.

! Compaction Control

- Provide close control on the water content and density of the backfill. It should be compacted to at least 95 percent of the standard AASHTO T99 maximum density within 2 percent of optimum moisture.
- If the backfill is a coarse aggregate, then a relative density or a method type compaction specification should be used.

! Face Construction

Slope facing requirements will depend on soil type, slope angle and the reinforcement spacing as shown in table 13.

If slope facing is required to prevent sloughing (i.e., slope angle β is greater than ϕ_{soil}) or erosion, several options are available. Sufficient reinforcement lengths could be provided for wrapped faced structures. A face wrap may not be required for slopes up to 1H:1V as indicated in figure 56. In this case, the reinforcement can be simply extended to the face. For this option, a facing treatment as detailed under Treatment of Outward Face, should be applied at sufficient intervals during construction to prevent face erosion. For wrapped or no wrap construction, the reinforcement should be maintained at close spacing (i.e., every lift or every other lift but no greater than 400 mm (16 inches)). For armored, hard faced systems the maximum spacing should be no greater than 800 mm (32 inches). A positive frictional or mechanical connection should be provided between the reinforcement and armored type facing systems.

The following procedures are recommended for wrapping the face.

- Turn up reinforcement at the face of the slope and return the reinforcement a minimum of 1 m (3 ft) into the embankment below the next reinforcement layer (see figure 56).
- For steep slopes, form work may be required to support the face during construction, especially if lift thicknesses of 450 to 600 mm (18 to 24 inches) or greater are used.
- For geogrids, a fine mesh screen or geotextile may be required at the face to retain backfill materials.

Slopes steeper than approximately 1:1 typically require facing support during construction. Exact slope angles will vary with soil types, i.e., amount of cohesion. Removable facing supports (e.g., wooden forms) or left-in-place welded wire mesh forms are typically used. Facing support may also serve as permanent or temporary erosion protection, depending on the requirements of the slope.

Table 13. RSS slope facing options. (after 19)

| Slope Face Angle and Soil Type | Type of Facing | | | |
|-----------------------------------------------------------------------------------------------------------------------------|----------------------------------------------------------------------------------------------|----------------------------------------|------------------------------------------------|------------------------------------|
| | When Geosynthetic is not Wrapped at Face | | When Geosynthetic is Wrapped at Face | |
| | Vegetated Face ¹ | Hard Facing ² | Vegetated Face ¹ | Hard Facing ² |
| > 50° (> ~0.9H:1V) All Soil Types | Not Recommended | Gabions | Sod Permanent Erosion Blanket w/ seed | Wire Baskets Stone Shotcrete |
| 35° to 50° (~ 1.4H:1V to 0.9H:1V) Clean Sands (SP) ³ Rounded Gravel (GP) | Not Recommended | Gabions Soil-Cement | Sod Permanent Erosion Blanket w/ seed | Wire Baskets Stone Shotcrete |
| 35° to 50° (~ 1.4H:1V to 0.9H:1V) Silt (ML) Sandy Silts (ML) | Bioreinforcement Drainage Composites ⁴ | Gabions Soil-Cement Stone Veneer | Sod Permanent Erosion Blanket w/ seed | Wire Baskets Stone Shotcrete |
| 35° to 50° (~ 1.4H:1V to 0.9H:1V) Silty Sands (SM) Clayey Sands (SC) Well graded sands and gravels (SW & GW) | Temporary Erosion Blanket w/ Seed or Sod Permanent Erosion Mat w/ Seed or Sod | Hard Facing Not Needed | Geosynthetic Wrap Not Needed | Geosynthetic Wrap Not Needed |
| 25° to 35° (~ 2H:1V to 1.4H:1V) All Soil Types | Temporary Erosion Blanket w/ Seed or Sod Permanent Erosion Mat w/ Seed or Sod | Hard Facing Not Needed | Geosynthetic Wrap Not Needed | Geosynthetic Wrap Not Needed |

- Notes: 1. Vertical spacing of reinforcement (primary/secondary) shall be no greater than 400 mm with primary reinforcements spaced no greater than 800 mm when secondary reinforcement is used.
2. Vertical spacing of primary reinforcement shall be no greater than 800 mm.
3. Unified Soil Classification
4. Geosynthetic or natural horizontal drainage layers to intercept and drain the saturated soil at the face of the slope.

! Additional Reinforcing Materials and Backfill Placement

If drainage layers are required, they should be constructed directly behind or on the sides of the reinforced section.

6.5 TREATMENT OF OUTWARD FACE

a. Grass Type Vegetation

Stability of a slope can be threatened by erosion due to surface water runoff. Erosion control and revegetation measures must, therefore, be an integral part of all reinforced slope system designs and specifications. If not otherwise protected, reinforced slopes should be vegetated after construction to prevent or minimize erosion due to rainfall and runoff on the face. Vegetation requirements will vary by geographic and climatic conditions and are, therefore, project specific.

For the unwrapped face (the soil surface exposed), erosion control measures are necessary to prevent unraveling and sloughing of the face. A wrapped face helps reduce erosion problems; however, treatments are still required on the face to shade the geosynthetic and prevent ultraviolet light exposure that will degrade the geosynthetic over time. In either case, conventional vegetated facing treatments generally rely on low growth, grass type vegetation with more costly flexible armor occasionally used where vegetation can not be established. Geosynthetic reinforced slopes can be difficult sites to establish and maintain grass type vegetative cover due to the steep grades that can be achieved. The steepness of the grade limits the amount of water absorbed by the soil before runoff occurs. Although root penetration should not affect the reinforcement, the reinforcement will most likely restrict root growth. This can have an adverse influence on the growth of some plants. Grass is also frequently ineffective where slopes are impacted by waterways.

A synthetic (permanent) erosion control mat is normally used to improve the performance of grass cover. This mat must also be stabilized against ultra-violet light and should be inert to naturally occurring soil-born chemicals and bacteria. The erosion control mat serves to: 1) protect the bare soil face against erosion until the vegetation is established; 2) assist in reducing runoff velocity for increased water absorption by the soil, thus promoting long-term survival of the vegetative cover; and 3) reinforce the surficial root system of the vegetative cover.

Once vegetation is established on the face, it must be protected to ensure long-term survival. Maintenance issues, such as mowing, must also be carefully considered. The shorter, weaker root structure of most grasses may not provide adequate reinforcement and erosion protection. Grass is highly susceptible to fire, which can also destroy the synthetic erosion control mat. Downdrag from snow loads or upland slides may also strip matting and vegetation off the slope face. The low erosion tolerance combined with other factors previously mentioned creates a need to evaluate revegetation measures as an integral part of the design. Slope face protection should not be left to the construction contractor or vendor's discretion. Guidance should be obtained from maintenance and regional landscaping groups in the selection of the most appropriate low maintenance vegetation.

b. Soil Bioengineering (Woody Vegetation)

An alternative to low growth, grass type vegetation is the use of soil bioengineering methods to establish hardier, woody type vegetation in the face of the slope⁽²⁴⁾. Soil bioengineering uses living vegetation purposely arranged and imbedded in the ground to prevent shallow mass movement and surficial erosion. However, the use of soil bioengineering in itself is limited to stable slope masses. Combining this highly erosive system with geosynthetic reinforcement produces a very durable, low maintenance structure with exceptional aesthetic and environmental qualities.

Appropriately applied, soil bioengineering offers a cost-effective and attractive approach for stabilizing slopes against erosion and shallow mass movement, capitalizing on the benefits and advantages that vegetation offers. The value of vegetation in civil engineering and the role woody vegetation plays in the stabilization of slopes has gained considerable recognition

in recent years ⁽²⁵⁾. Woody vegetation improves the hydrology and mechanical stability of slopes through root reinforcement and surface protection. The use of deeply-installed and rooted woody plant materials, purposely arranged and imbedded during slope construction offers:

- ! Immediate erosion control for slopes; stream, and shoreline;
- ! Improved face stability through mechanical reinforcement by roots;
- ! Reduced maintenance costs, with less need to return to revegetate or cut grass;
- ! Modification of soil moisture regimes through improved drainage and depletion of soil moisture and increase of soil suction by root uptake and transpiration;
- ! Enhanced wildlife habitat and ecological diversity; and
- ! Improved aesthetic quality and naturalization.

The biological and mechanical elements must be analyzed and designed to work together in an integrated and complementary manner to achieve the required project goals. In addition to using engineering principles to analyze and design the slope stabilization systems, plant science and horticulture are needed to select and establish the appropriate vegetation for root reinforcement, erosion control, aesthetics and the environment. Numerous areas of expertise must integrate to provide the knowledge and awareness required for success. RSS systems require knowledge of the mechanisms involving mass and surficial stability of slopes. Likewise when the vegetative aspects are appropriate to serve as reinforcements and drains, an understanding of the hydraulic and mechanical effects of slope vegetation is necessary.

Figure 57 shows a cross section of the components of a vegetated reinforced slope (VRSS) system. The design details for face construction include vegetation selection, placement, and development as well as several agronomic and geotechnical design issues ⁽²⁴⁾.

! Vegetation Selection

The vegetation used in the VRSS system is typically in the form of live woody branch cuttings from species that root adventitiously or from, bare root and/or container plants. Plant materials may be selected for a variety of tolerances including: drought, salt, flooding, fire, deposition, and shade. They may be chosen for their environmental wildlife value, water cleansing capabilities, flower, branch and leaf color or fruits. Other interests for selection may include size, form, rate of growth rooting characteristics and ease of propagation. Time of year for construction of a VRSS system also plays a critical roll in plant selection.

! Vegetation Placement

The decision to use natives, naturalized or ornamental species is also an important consideration. The plant materials are placed on the frontal section of the formed terraces. Typically 150 to 300 mm (6 to 12 inches), protrudes beyond the constructed terrace edge or finished face, and 0.5 to 3 m (1.5 to 10 ft) of the live branch cuttings when used are embedded in the reinforced backfill behind, or as in the case of rooted plants, are placed 0.3 to 1 m (1 to 3 ft) in the backfill. The process of plant installation is best and least

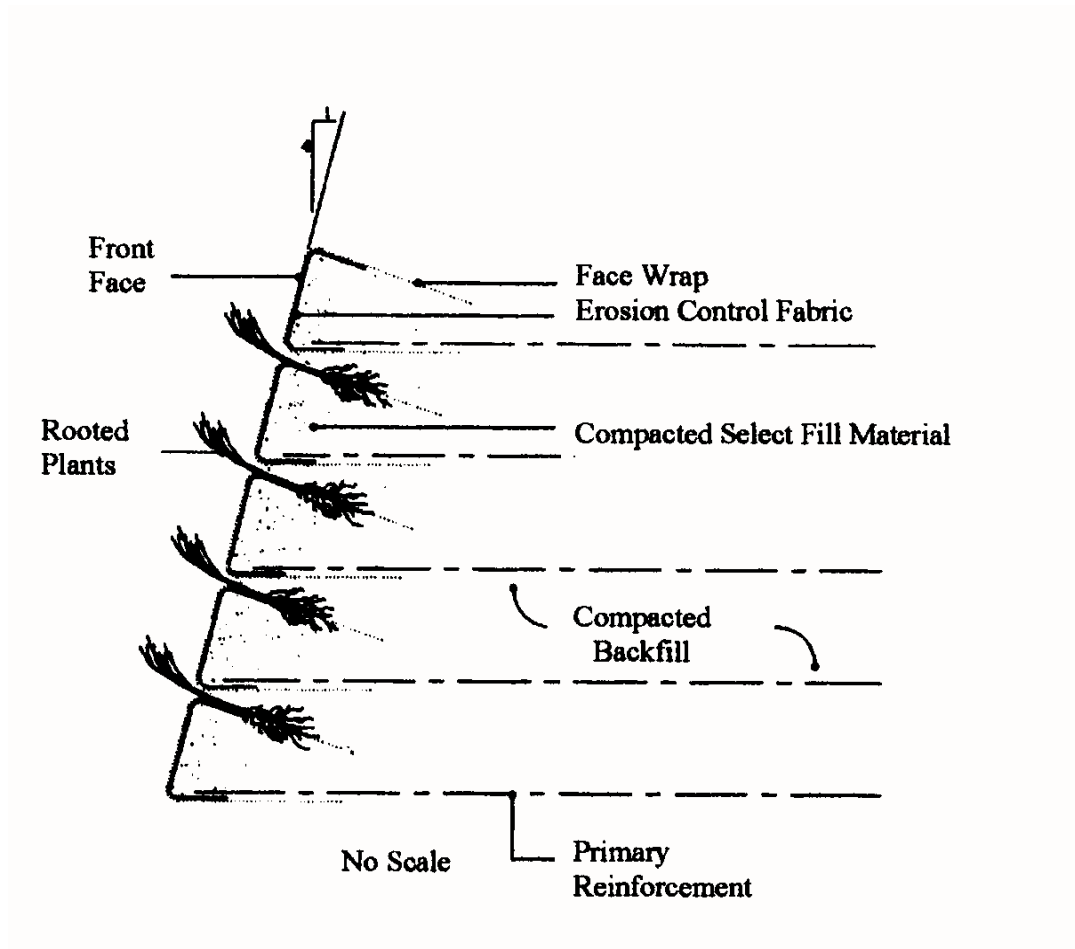

expensive when it occurs simultaneously with the conventional construction activities, but may be incorporated later if necessary.

Figure 57. Components of a vegetated reinforced slope (VRSS) system.

! Vegetation Development

Typically soil bioengineering VRSS systems offer immediate results from the surface erosion control structural/mechanical and hydraulic perspectives. Over time, (generally within the first year) they develop substantial top and root growth further enhancing those benefits, as well as providing aesthetic and environmental values.

! Design Issues

There are several agronomic and geotechnical design issues that must be considered, especially in relation to selection of geosynthetic reinforcement

and type of vegetation. Considerations include root and top growth potential. The root growth potential consideration is important when face reinforcement enhancement is required. This will require a review of the vertical spacing based on the anticipated root growth for the specific type of plant. In addition to spacing, the selected type of reinforcements is also important. Open-mesh geogrid-type reinforcements, for example, are excellent as the roots will grow through the grid and further "knit" the system together. On the other hand, geocomposites, providing both reinforcement and lateral drainage, offer enhanced water and oxygen opportunities for the healthy development of the woody vegetation. Dependent upon the species selected, aspect, climatic conditions, soils etc., dense woody vegetation can provide ultraviolet light protection within the first growing season and maintain the cover thereafter.

In arid regions, geosynthetics that will promote moisture movement into the slope such as non-woven geotextiles or geocomposites may be preferred. Likewise, the need for water and nutrients in the slope to sustain and promote vegetative growth must be balanced against the desire to remove water so as to reduce hydrostatic pressures. Plants can be installed to promote drainage toward geosynthetic drainage net composites placed at the back of the reinforced soil section.

Organic matter is not required; however, a medium that provides nourishment for plant growth and development is necessary. As mentioned earlier, the agronomic needs must be balanced with the geotechnical requirements, but these are typically compatible. For both, a well-drained backfill is needed. The plants also require sufficient fines to provide moisture and nutrients while this may be a limitation, under most circumstances, some slight modifications in the specifications to allow for some non-plastic fines in the backfill in the selected frontal zone offers a simple solution to this problem.

While many plants can be installed throughout the year, the most cost effective, highest rate of survival and best overall performance and function occurs when construction is planned around the dormant season for the plants, or just prior to the rainy season. This may require some specific construction coordination in relation to the placement of fill, and in some cases may preclude the use of a VRSS structure.

c. Armored

A permanent facing such as gunite or emulsified asphalt may be applied to a RSS slope face to provide long-term ultra-violet protection, if the geosynthetic UV resistance is not adequate for the life of the structure. Welded wire mesh or gabions may also be used to facilitate face construction and provide permanent facing systems.

! Other armored facing elements may include riprap, stone veneer, articulating modular units, or fabric-formed concrete.

! Structural elements

Structural facing elements (see MSE walls) may also be used, especially if discrete reinforcing elements such as metallic strips are used. These facing elements may include prefabricated concrete slabs, modular precast blocks, or precast slabs.

6.6 DESIGN DETAILS

As with MSE wall projects, certain design details must often be considered that are not directly connected with internal or external stability evaluation. These important details include:

! Guardrail and traffic barriers.

! Drainage considerations.

! Obstructions.

a. Guardrail and Traffic Barriers

Guardrails are usually necessary for steeper highway embankment slopes. Guardrail posts usually can be installed in their standard manner (i.e. drilling or driving) through geosynthetic reinforcements. Special wedge shaped shoes can be used to facilitate installation. This does not significantly impair the overall strength of the geosynthetic and no adjustments in the design are required. Alternatively, post or concrete form tubes at post locations can be installed during construction. Either this procedure or cantilever type guardrail systems are generally used for metallic reinforcement.

Impact traffic load on barriers constructed at the face of a reinforced soil slope is designed on the same basis as an unreinforced slope. The traffic barrier may be designed to resist the overturning moment in accordance with Article 2.7 in Division I of AASHTO Standard Specifications for Highway Bridges (1996 through 2000 interims) or as addressed in the 1989 AASHTO *Roadside Design Guide*, and will be covered in detail in Chapter 7.

b. Drainage Considerations

Uncontrolled subsurface water seepage can decrease stability of slopes and could ultimately result in slope failure.

! Hydrostatic forces on the back of the reinforced mass will decrease stability against sliding failure.

! Uncontrolled seepage into the reinforced mass will increase the weight of the reinforced mass and may decrease the shear strength of the soil, and decreasing stability.

- ! Seepage through the mass can reduce pullout capacity of the geosynthetic at the face and increase soil weight, creating erosion and sloughing problems.

Drains are typically placed at the rear of the reinforced soil mass to control subsurface water seepage as detailed in chapter 7. Surface runoff should also be diverted at the top of the slope to prevent it from flowing over the face.

c. Obstructions

If encountered in a design, guidance provided in chapter 4 should be considered.

6.7 CASE HISTORIES

The following case histories are presented to provide representative examples of cost-effective, successful reinforced slope projects. In several cases, instrumentation was used to confirm the performance of the structure. All project information was obtained from the indicated reference which, in most cases, contains additional details.

a. The Dickey Lake Roadway Grade Improvement Project ⁽⁸⁾

Dickey Lake is located in northern Montana approximately 40 km south of the Canadian border. Reconstruction of a portion of U.S. 93 around the shore of Dickey Lake required the use of an earth-retention system to maintain grade and alignment. The fill soils available in the area consist primarily of glacial till. Groundwater is active in the area. A slope stability factor of safety criteria of 1.5 was established for the embankments. A global stability analysis of reinforced concrete retaining walls to support the proposed embankment indicated a safety factor that was less than required. Analysis of a reinforced soil wall or slope indicated higher factors of safety. Based on an evaluation of several reinforcement systems, a decision was made to use a reinforced slope for construction of the embankment. MDOT decided that the embankment would not be designed “in-house,” due to their limited experience with this type of structure. Proposals were solicited from a variety of suppliers, who were required to design the embankment. An outside consultant, experienced in geosynthetic reinforcement design, was retained to review all submittals.

Plans and specifications for the geosynthetic reinforced embankments(s) were developed by MDOT, with the plans indicating the desired finished geometry. The slopes generally ranged from 9 m to 18 m (30 to 60 ft) in height. Face angles varied from 1.5H:1V to 0.84H:1V with the typical angle being 1H:1V. The chosen supplier provided a design that utilized both uniaxially and biaxially oriented geogrids. The resulting design called for primary reinforcing grids 4.6 to 18.3 m (15 to 60 ft) long and spaced 0.6 to 1.2 m (2 to 4 ft) vertically throughout the reinforced embankment. The ultimate strength of the primary reinforcement was on the order of 100 kN/m. The length of primary reinforcement was partially dictated

by global stability concerns. In addition, intermediate reinforcement consisting of lower strength, biaxial geogrids, was provided in lengths of 1.5 m (5 ft) with a vertical spacing of 0.3 m (1 ft) at the face of slopes 1H:1V or flatter. Erosion protection on the 1H:1V or flatter sections was accomplished by using an organic erosion blanket. Steeper sections (maximum 0.84H:1V) used L-shaped, welded wire forms with a biaxial grid wrap behind the wire. A design evaluation of this project is presented in chapter 7.

The design also incorporated subsurface drainage. This drainage was judged to be particularly important due to springs or seeps present along the backslope of the embankment. The design incorporated geocomposite prefabricated drains placed along the backslope, draining into a French drain at the toe of the backslope. Laterals extending under the embankment were used to "daylight" the French drain.

The project was constructed in 1989 at a cost of approximately \$180/m² of vertical face and has been periodically monitored by visual inspection and slope inclinometers. Project photos are shown in figure 58. To date, the embankment performance has been satisfactory with no major problems observed. Some minor problems have been reported with respect to the erosion control measures and some minor differential movement in one of the lower sections of the embankment.



Figure 58. Dickey Lake site.

b. Salmon-Lost Trail Roadway Widening Project ⁽⁹⁾

As part of a highway widening project in Idaho, the Federal Highway Administration designed and supervised the construction of a 172-m-long, 15.3-m-high, permanent geosynthetic-reinforced slope to compare its performance with retaining structures along the same alignment. Widening of the original road was achieved by turning the original 2H:1V unreinforced slope into a 1H:1V reinforced slope. Aesthetics was an important consideration in the selection of the retaining structures along scenic Highway 93, which has been recognized by a recent article in *National Geographic*. A vegetated facing was, therefore, used for the reinforced slope section. On-site soil consisting of decomposed granite was used as the backfill. An important factor in the design was to deal with seeps or weeps coming out of the existing slope. Geotextile reinforcements with an in plane transmissivity were selected to evaluate the potential of modifying the seepage regime in the slope.

The geotextile-reinforced slope was designed in accordance with the guidelines presented in chapters 6 and 7 of this manual. The final design consisted of two reinforced zones with a constant reinforcing spacing of 0.3 m (1 ft). The reinforcement in the lower zone had an ultimate tensile strength of 100 kN/m (6,850 plf), and the reinforcement in the upper zone had a reinforcement strength of 20 kN/m (1,370 plf). The reinforcement strength was reduced based on partial reduction factors which were reviewed in chapter 3. Field tests were used to reduce the reduction factor for construction damage from 2.0 to 1.1 at a substantial savings to the project (40 percent reduction in reinforcement).

The construction was completed in 1993 (see figure 59 for project photos). The structure was constructed as an experimental features project and was instrumented with inclinometers within the reinforced zone, extensometers on the reinforcement, and piezometers within and at the back of the reinforced section. Survey monitoring was also performed during construction. Total lateral displacements recorded during construction were on the order of 0.1 to 0.2 percent of the height of the slope, with maximum strains in the reinforcement measured at only 0.2 percent. Post construction movement has not been observed within the accuracy of the instruments. These measurements indicate the excellent performance of the structure as well as the conservative nature of the design. Long-term monitoring is continuing.

The steepened slope was constructed at a faster rate and proved more economical than the other retaining structures constructed along the same alignment. The constructed cost of the reinforced slope section was on the order of \$160/m² of vertical face. MSE wall costs in other areas of the site were on the order of \$240/m² of vertical face for similar or lower heights.



Figure 59. Salmon Lost Trail site.

c. **Cannon Creek Alternate Embankment Construction Project** ⁽¹⁰⁾

A large embankment was planned to carry Arkansas State Highway 16 over Cannon Creek. The proposed 77,000 m³ (100,000 yd³) embankment had a maximum height of 23 m (75 ft) and was to be constructed with on-site clay soils and 2H:1V side slopes (with questionable stability). A cast-in-place concrete box culvert was first constructed to carry the creek under the embankment. Embankment construction commenced but was halted quickly when several small slope failures occurred. It then became apparent that the embankment fill could not be safely constructed at 2H:1V.

With the box culvert in place, there were two options for continuation of embankment construction. A gravelly soil could be used for embankment fill, or the on-site soils could be used with geosynthetic reinforcement. Both options were bid as alternatives and the geosynthetic option was used in construction (see figure 60). The reinforcement used was a high-density polyethylene geogrid with a reported wide-width strength of 100 kN/m. The geogrid reinforcement option was estimated to be \$200,000 less expensive than the gravelly soil fill option.

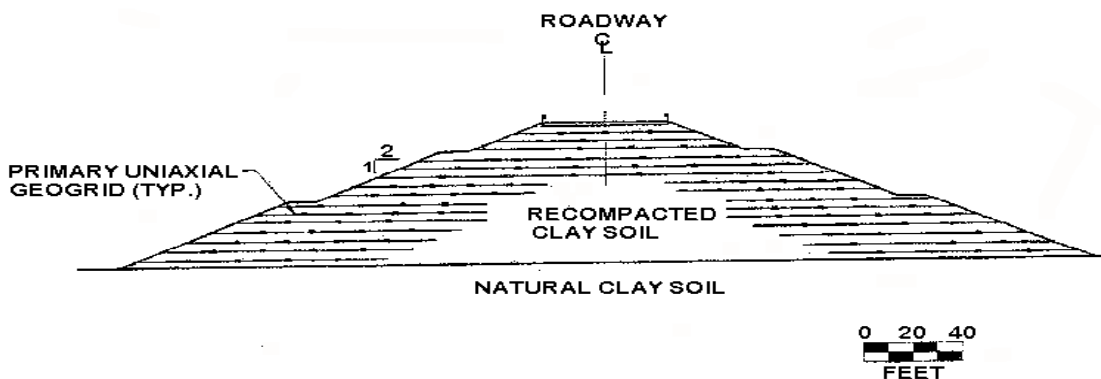
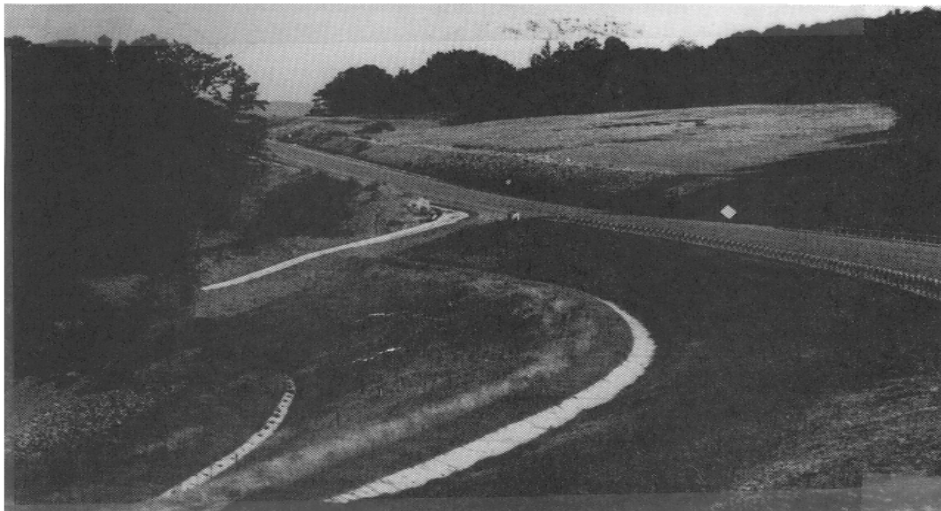

Figure 60. Cannon Creek project.

d. Pennsylvania SR 54 Roadway Repair Project ⁽¹¹⁾

During the winter of 1993 - 1994, a sinkhole formed in a section of State Route 54 in Pennsylvania. Further investigation revealed that an abandoned railroad tunnel had collapsed. The traditional repair would have involved the removal and replacement of the 15-m-high embankment. The native soil, a sandy clay, was deemed an unsuitable backfill soil due to its wet nature and potential stability and settlement problems with the embankment. Imported granular fill to replace the native soil was estimated to be \$16/m³. Due to the high cost of replacement materials, the Pennsylvania Department of Transportation decided to use geosynthetics to provide drainage of the native soil and reinforce the side slopes. A nonwoven geotextile was selected to allow for pore pressure dissipation of the native soil during compaction, thus accelerating consolidation settlement and improving its strength. Field tests were used to confirm pore pressure response.

With the geotextile placed at a compacted lift spacing of 0.3 m (1 ft) full pore pressure dissipation was provided within approximately 4 days as compared with a minimum dissipation (approximately 25 percent) without the geosynthetic during the same time period. By placing the geotextile at 0.3 m (1 ft) lift intervals, the effective drainage path was reduced from the full height of the slope (15 m) to 0.15 m (0.5 ft) or by a factor of over 100. This meant that consolidation of the embankment would essentially be completed by the end of construction as opposed to waiting almost a year for completion of the settlement without the geosynthetic.

The geotextile, with an ultimate strength of 16 kN/m and placed at every lift (0.3 m), also provided sufficient reinforcement to safely construct 1.5H:1V side slopes. Piezometers at the base and middle of the slope during construction were used to confirm the test pad results. Deformations of the geotextile in the side slope were also monitored and found to be less than the precision of the gages (± 1 percent strain). Project photos are shown in figure 61 along with the measurements of pore pressure dissipation during construction.

The contractor was paid on a time and material basis with the geotextile purchased by the agency and provided to the contractor for installation. The cost of the geotextile was approximately \$1/m². In-place costs of the geotextile, along with the on-site fill averaged just over \$4/m³ for a total cost of \$70,000, resulting in a savings of \$199,000 over the select-fill alternative. Additional savings resulted from not having to remove the on-site soils from the project site.

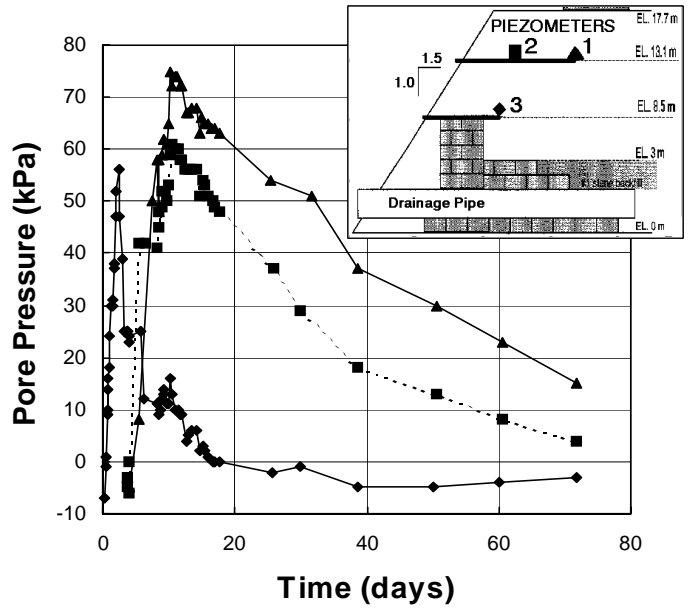

Figure 61. Pennsylvania SR54.

e. **Massachusetts Turnpike - Use of Soil Bioengineering** ^(26, 27)

The Massachusetts Turnpike in Charlton, Massachusetts is an example where a vegetated reinforced slope (VRSS) system was used to construct 1H:4V slopes to replace unstable 1.5H:1V slopes along a 150 m (500 ft) section of the Turnpike. This slope eroded for a number of years. The erosion was widening and threatening to move back into private property beyond the right-of-way. Eventually, the increased maintenance to clean up the sloughed material, the visual scar on the landscape and the threat of private property loss prompted the Turnpike Authority to seek a solution. The combined soil bioengineering and geosynthetic reinforcement approach was adopted to meet the narrow right-of-way requirement, assist in controlling internal drainage, and reconstruct an aesthetically pleasing and environmentally sound system that would blend into the natural landscape. The 3 to 18 m (10 to 60 ft) high 1H:4V slope was stabilized with layers of primary and secondary geogrids, erosion control blankets, brushlayers in the frontal geogrid wrapped portion of the face, and soil bioengineering treatments above the constructed slope.

The design was essentially the same as the soil bioengineering cross section shown in figure 57. The primary geogrid was designed to provide global, internal and compound stability to the slope. This grid extends approximately 6.1 m (20 ft) from the face to the back of the slope. The vertical spacing of the primary geogrid is 0.6 m (2 ft) and 1.2 m (4 ft), respectively, over the lower and upper halves of the slope. The face wrap extends approximately 0.9 m (3 ft) into the slope at the bottom of each vertical lift and 1.5 m (5 ft) at the top to form 0.9 m (3 ft) thick earthen terraces. Brushlayers consisting of 2.4 m to 3 m (8 to 10 ft) long willow (*Salix* sp.) and dogwood (*Cornus* sp.) live cut branches were placed on each constructed wrapped section at a vertical spacing of 0.9 m (1 ft), extending back to approximately the mid point of the slope. The branches and geogrids were sloped back to promote drainage to backdrains placed in the slopes while providing moisture for the plants. Live fascine bundles (see figure 62) were installed above the reinforced slope in a 3H:1V cut section to prevent surface erosion and assist in revegetating that portion of the slope.

The backdrain system consisted of 1 m (3.3 ft) wide geocomposite panels spaced 4.6 m (15 ft) on center. Design of the panels and spacing was based on the anticipated groundwater flow and surface infiltration conditions. The panels connect into a 0.3 m (1 ft) thick crushed-stone drainage layer at the base of the slope, which extends the full length and width of the slope. The backfill soils consisted of granular borrow, ordinary borrow, 50/50 mix and specified fill. The first three materials constitute the structurally competent core while the specified fill was placed at the face to provide a media amenable to plant growth. The specified fill consisted of fertilizers and a blend of four parts ordinary borrow to one part organic loam by volume and was used in the front 3 m (10 ft) of each lift for the installed brushlayers to optimize the growing conditions. This was a modification from the normal geotechnical specification to accommodate the soil bioengineering.

The VRSS slope was constructed in the winter/spring of 1995/96 at a cost of US \$270 per square face meter. The slope is currently (March 2000) in its fourth growing season. The vegetated slope face performed as intended, initially protecting the surface from erosion while providing a pleasing aesthetic look (see figure 62). Natural invasion from the

surrounding plant community is occurring, causing the system to blend into the naturally wooded scenic setting of the area and meeting the long-term aesthetic and ecological goals. Lessons Learned: In the future on similar projects, the use of more rooted plants rather than all live cut branches is recommended to provide greater diversity and to improve construction efficiency. Reducing the height of the wrapped earth terraces would allow for the vegetation to be more evenly distributed with less densities, and possibly using a preformed wire form in the front. These items would all reduce construction costs by improving efficiency.



Figure 62. Massachusetts Turnpike during construction, immediately after construction and after the second growing season.

6.8 STANDARD RSS DESIGNS

RSS structures are customarily designed on a project-specific basis. Most agencies use a line-and-grade contracting approach, thus the contractor selected RSS vendor provides the detailed design after contract bid and award. This approach works well. However, standard designs can be developed and implemented by an agency for RSS structures.

Use of standard designs for RSS structures offers the following advantages over a line-and-grade approach:

- ! Agency is more responsible for design details and integrating slope design with other components.
- ! Pre evaluation and approval of materials and material combinations, as opposed to evaluating contractor submittal post bid.
- ! Economy of agency design versus vendor design/stamping of small reinforced slopes.
- ! Agency makes design decisions versus vendors making design decisions.
- ! More equitable bid environment as agency is responsible for design details, and vendors are not making varying assumptions.
- ! Filters out substandard work, systems and designs with associated approved product lists.

The Minnesota Department of Transportation (MN/DOT) recently developed and implemented (in-house) standardized RSS designs.⁽³⁴⁾ The use of these standard designs are limited by geometric, subsurface and economic constraints. Structures outside of these constraints should be designed on a project-specific basis. The general approach used in developing these standards could be followed by other agencies to develop their own, agency-specific standard designs.

Standardized designs require generic designs and generic materials. Generic designs require definition of slope geometry and surcharge loads, soil reinforcement strength, structure height limit, and slope facing treatment. As an example, the MN/DOT standard designs address two geometric and surcharge loadings, two reinforced soil fills, and can be used for slopes up to 8 m (26.2 feet) in height. Three reinforcement long-term strengths, T_{al} , of 10, 15 and 20 kN/m (700, 1050 and 1400 plf) are used in the standard designs, though a structure must use the same reinforcement throughout its height and length.

Generic material properties used definitions of shear strength and unit weight of the reinforced fill, retained backfill and foundation soils applicable to the agency's specifications and regional geology. Definition of generic material properties requires the development of approved product lists for soil reinforcements and face erosion control materials. A standard face treatment is provided, however, it is footnoted with *Develop site specific recommendations for highly shaded areas, highly visible urban applications, or in sensitive areas.*

An example design cross section and reinforcement layout table from the MN/DOT standard designs is presented in Figure 63. Note that the MN/DOT standard designs are not directly applicable to, nor should they be used by, other agencies.

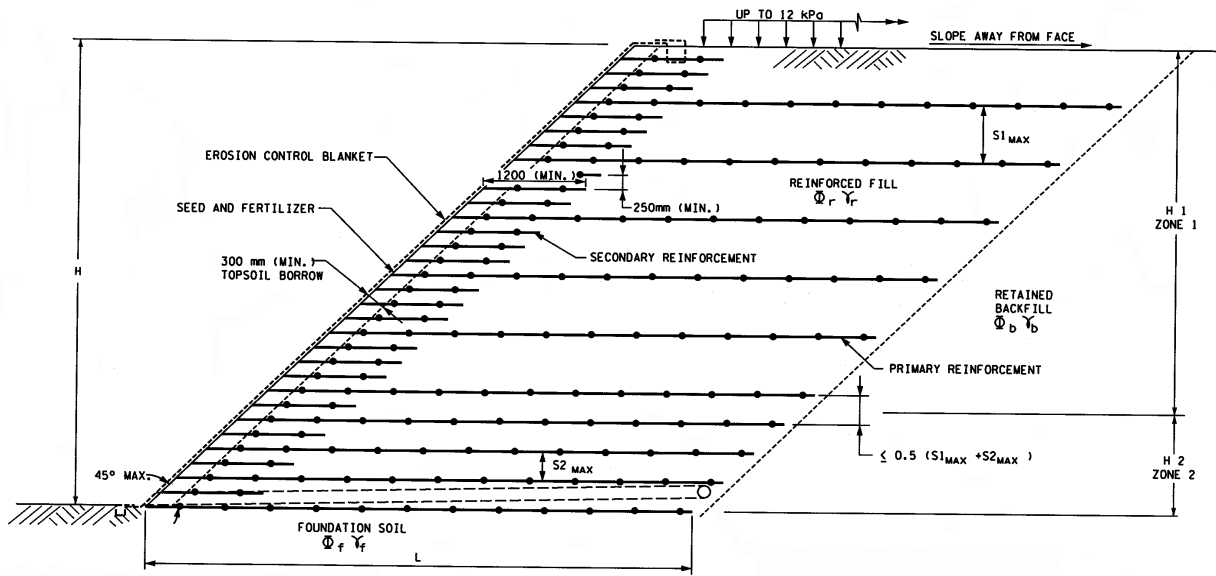

TYPICAL SECTION
CASE 1a & 1b

| REINFORCED SOIL SLOPES | | | | | | | | | |
|--------------------------------------------------------------------------------------------|-----------------------------------------------|-------------------------------------|----------------------------|----------------------------------------------|--------------------------|--------|-----------------------|--------|-----------------------|
| CASE 1a - 45° Maximum Slope Angle, Granular Borrow Reinforced Soil Fill | | | | | | | | | |
| Max. Slope Angle (degrees) | Reinforced Soil Fill Friction Angle (degrees) | Minimum Reinforcement Length, L (m) | Primary Soil Reinforcement | | Maximum Slope Height (m) | Zone 1 | | Zone 2 | |
| | | | Type | Long Term Strength (T _{al}) (kN/m) | | H1 (m) | S1 _{max} (m) | H2 (m) | S2 _{max} (m) |
| 45 | 30 | 1.1 H | Type I | 10 | 8.0 | 3.5 | 1.0 | 4.5 | 0.5 |
| | | | | | 8.0 | 8.0 | 0.6 | - | - |
| | | | Type II | 15 | 8.0 | 6.5 | 1.0 | 1.5 | 0.5 |
| | | | | | 8.0 | 5.4 | 1.2 | 2.6 | 0.6 |
| Type III | 20 | 8.0 | 8.0 | 1.2 | - | - | | | |
| CASE 1b - 45° Maximum Slope Angle, Modified Select Granular Borrow Reinforced Soil Fill | | | | | | | | | |
| Max. Slope Angle (degrees) | Reinforced Soil Fill Friction Angle (degrees) | Minimum Reinforcement Length, L (m) | Primary Soil Reinforcement | | Maximum Slope Height (m) | Zone 1 | | Zone 2 | |
| | | | Type | Long Term Strength (T _{al}) (kN/m) | | H1 (m) | S1 _{max} (m) | H2 (m) | S2 _{max} (m) |
| 45 | 35 | 0.8 H | Type I | 10 | 8.0 | 8.0 | 1.0 | - | - |
| | | | | | 8.0 | 5.4 | 1.2 | 2.6 | 0.6 |
| | | | Type II | 15 | 8.0 | 8.0 | 1.2 | - | - |
| | | | | | 8.0 | 8.0 | 1.2 | - | - |
| Type III | 20 | 8.0 | 8.0 | 1.2 | - | - | | | |

NOTE:
SECONDARY REINFORCEMENT SHALL HAVE A MINIMUM LONG TERM STRENGTH OF 6 kN/m.

Figure 63. Example of standard RSS design. (after 34)

CHAPTER 7

DESIGN OF REINFORCED SOIL SLOPES

7.1 INTRODUCTION

This chapter provides step-by-step procedures for the design of reinforced soil slopes. Design and analysis of existing design using the computer program RSS is also presented. The design approach principally assumes that the slope is to be constructed on a stable foundation. Recommendations for deep seated failure analysis are included. The user is referred to standard soil mechanics texts and FHWA *Geosynthetics Design and Construction Guidelines (1995)* in cases where the stability of the foundation is at issue.

As indicated in chapter 6, there are several approaches to the design of reinforced steepened slopes. The method presented in this chapter uses the classical rotational, limit equilibrium slope stability method as was shown in figure 54. As for the unreinforced case, a circular arc failure surface (not location) is assumed for the reinforced slope. This geometry provides a simple means of directly increasing the resistance to failure from the inclusion of reinforcement, is directly adaptable to most available conventional slope stability computer programs, and agrees well with experimental results.

The reinforcement is represented by a concentrated force within the soil mass that intersects the potential failure surface. By adding the failure resistance provided by this force to the resistance already provided by the soil, a factor of safety equal to the rotational stability safety factor is inherently applied to the reinforcement. The tensile capacity of a reinforcement layer is taken as the minimum of its allowable pullout resistance behind the potential failure surface or its long-term allowable design strength. The slope stability factor of safety is taken from the critical surface requiring the maximum amount of reinforcement. Final design is performed by distributing the reinforcement over the height of the slope and evaluating the external stability of the reinforced section.

The suitability of this design approach has been verified through extensive experimental evaluation by the FHWA and found to be somewhat conservative. A chart solution developed for simplistic structures is provided as a check for the results. The method for evaluating a given reinforced soil profile is also presented. The following flow chart shows the steps required for design of reinforced soil slopes.

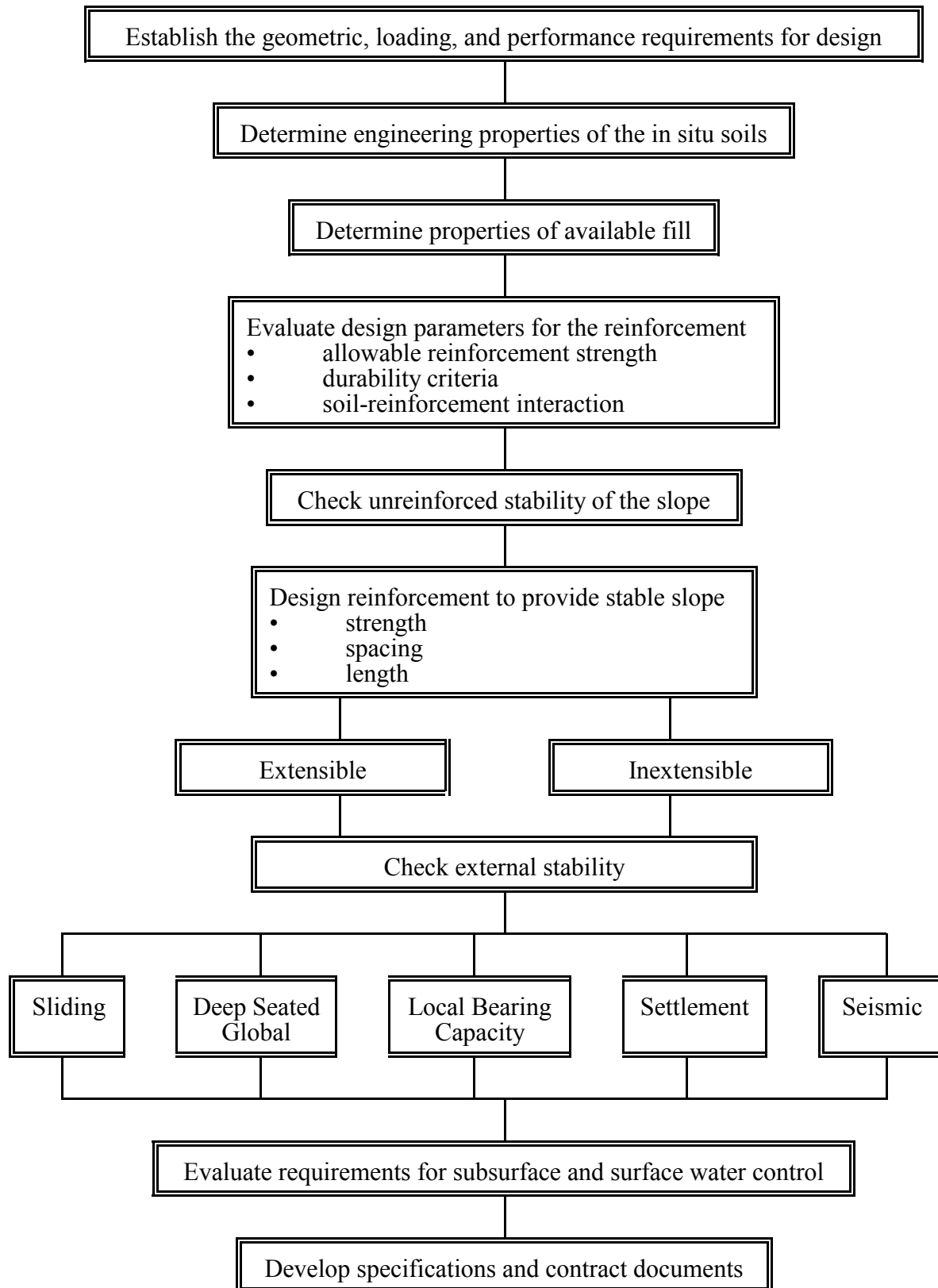

7.2 REINFORCED SLOPE DESIGN GUIDELINES

The design steps outlined in the flow chart are as follows:

Step 1. Establish the geometric, loading, and performance requirements for design.

a. Geometric and loading requirements (see figure 64).

! Slope height, H .

! Slope angle, θ .

! External (surcharge) loads:

- Surcharge load, q
- Temporary live load, Δq
- Design seismic acceleration, A_m (See Division 1A, *AASHTO Standard Specifications for Highway Bridges*).

! Traffic Barrier

- See article 2.7 of 1992 *AASHTO Standard Specifications for Highway Bridges* and *AASHTO 1989 Roadside Design Guide*.

b. Performance requirements.

! External stability and settlement.

- Sliding: $F.S. \geq 1.3$.
- Deep seated (overall stability): $F.S. \geq 1.3$.
- Local bearing failure (lateral squeeze) : $F.S. \geq 1.3$.
- Dynamic loading: $F.S. \geq 1.1$.
- Settlement-post construction magnitude and time rate based on project requirements.

! Compound failure: $F.S. \geq 1.3$.

! Internal slope stability: $F.S. \geq 1.3$.

Step 2. Determine the engineering properties of the in situ soils. (see recommendations in chapter 3, section 3.4.)

! The foundation and retained soil (i.e., soil beneath and behind reinforced zone) profiles.

! Strength parameters c_u and ϕ_u , or c' and ϕ' for each soil layer.

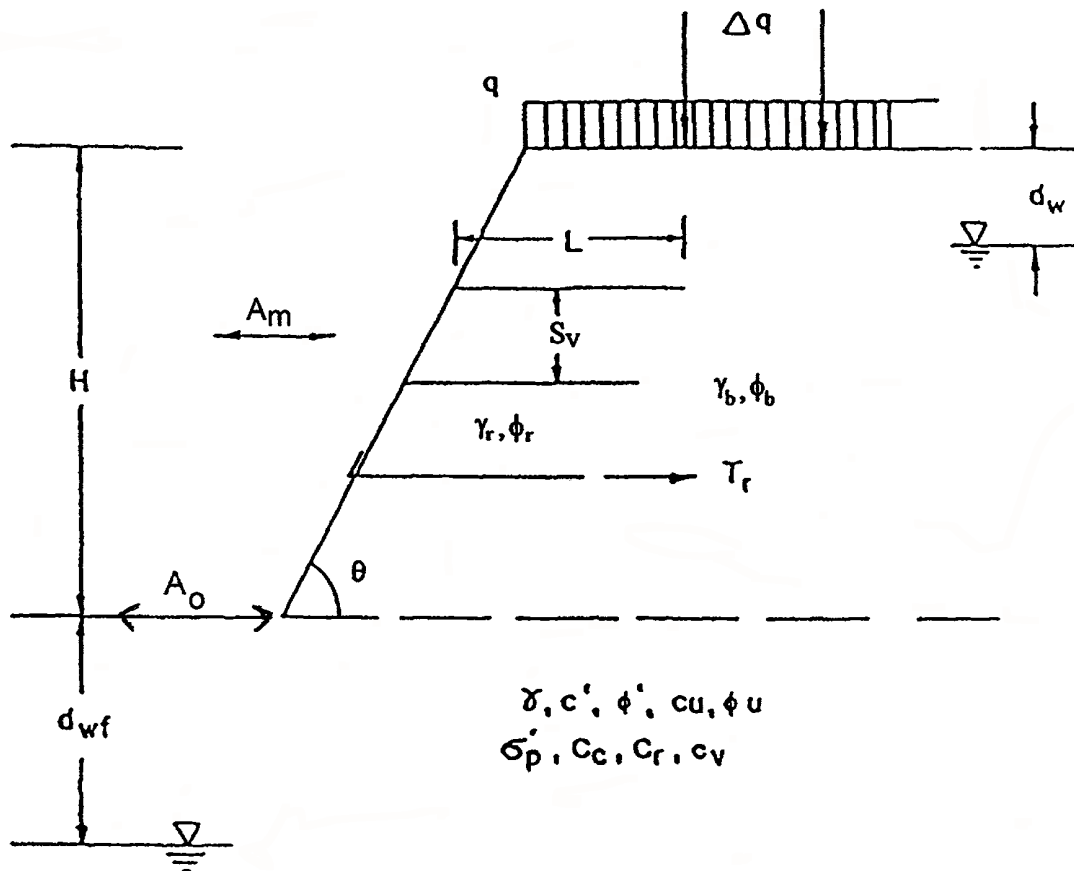

Notations:

- H = slope height
- θ = slope angle
- T_r = strength of reinforcement
- L = length of reinforcement
- S_v = vertical spacing of reinforcement
- q = surcharge load, q
- Δq = temporary live load, Δq
- A_m = design seismic acceleration
- d_w = depth to the ground water table in slope
- d_{wf} = depth to the ground water table in foundation
- c_u and ϕ_u , or c' and ϕ' = strength parameters for each soil layer.
- γ_{wet} and γ_{dry} = unit weights for each soil layer
- C_c , C_r , c_v and σ'_p = consolidation parameters for each soil layer
- A_0 = ground acceleration coefficient
- g = acceleration due to gravity

Figure 64. Requirements for design of reinforced soil slopes.

- ! Unit weights γ_{wet} and γ_{dry} .
- ! Consolidation parameters (C_c , C_r , c_v and σ'_p).
- ! Location of the ground water table d_w , and piezometric surfaces.
- ! For failure repair, identify location of previous failure surface and cause of failure.

Step 3. Determine the properties of reinforced fill and, if different, the retained fill. (see recommendations in chapter 3, section 3.4.)

- ! Gradation and plasticity index.
- ! Compaction characteristics based on 95% AASHTO T-99, γ_d and $\pm 2\%$ of optimum moisture, W_{opt} .
- ! Compacted lift thickness.
- ! Shear strength parameters, c_u , ϕ_u or c' , and ϕ' .
- ! Chemical composition of soil (pH).

Step 4. Evaluate design parameters for the reinforcement. (see recommendations in chapter 3, section 3.4.)

- ! Allowable geosynthetic strength, $T_{\text{al}} = \text{ultimate strength } (T_{\text{TULT}}) \div \text{reduction factor (RF) for creep, installation damage and durability}$:

For granular backfill meeting the recommended gradation in chapter 3, and electrochemical properties in chapter 3, $\text{RF} = 7$, may be conservatively used for preliminary design and routine, noncritical structures where the minimum test requirements outlined in table 11 are satisfied.

Remember, there is a significant cost advantage in obtaining lower RF from test data supplied by the manufacture and/or from agency evaluation!

- ! Pullout Resistance: (See recommendations in chapter 3 and appendix A.)
 - F.S. = 1.5 for granular soils.
 - Use F.S. = 2 for cohesive soils.
 - Minimum anchorage length, $L_{e_s} = 1 \text{ m (3 ft)}$.

Step 5. Check unreinforced stability.

see discussion in Chapter 6.

- a. Evaluate unreinforced stability to determine: if reinforcement is required; critical nature of the design (i.e., unreinforced F.S. \leq or \geq 1); potential deep-seated failure problems; and the extent of the reinforced zone.

! Perform a stability analysis using conventional stability methods (see FHWA *Soils and Foundations Workshop Reference Manual*, 2000) to determine safety factors and driving moments for potential failure surfaces.

! Use both circular-arc and sliding-wedge methods, and consider failure through the toe, through the face (at several elevations), and deep-seated below the toe.

(A number of stability analysis computer programs are available for rapid evaluation, e.g., the STABL family of programs developed at Purdue University including the current version, STABL4M, FHWA's ReSSA program, and the program XSTABL developed at the University of Idaho. In all cases, a few calculations should be made by hand to be sure the computer program is giving reasonable results.)

- b. Determine the size of the critical zone to be reinforced.

! Examine the full range of potential failure surfaces found to have:

$$\text{Unreinforced safety factor } FS_U \leq \text{Required safety factor } FS_R$$

! Plot all of these surfaces on the cross-section of the slope.

! The surfaces that just meet the required safety factor roughly envelope the limits of the critical zone to be reinforced as shown in figure 65.

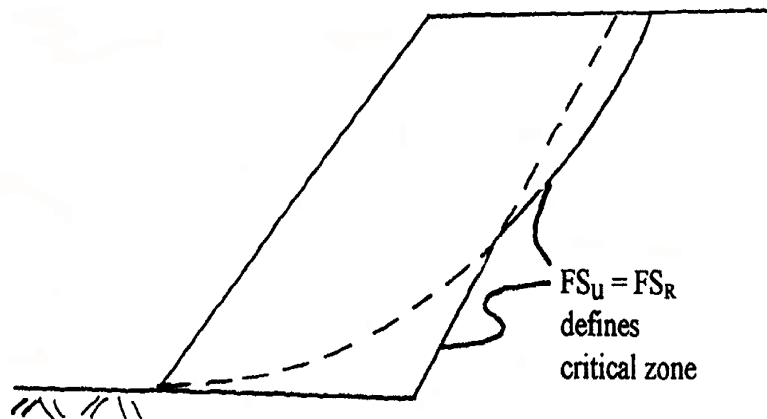

Figure 65. Critical zone defined by rotational and sliding surface that meet the required safety factor.

- c. Critical failure surfaces extending below the toe of the slope are indications of deep foundation and edge bearing capacity problems that must be addressed prior to completing the design. For such cases, a more extensive foundation analysis is warranted, and foundation improvement measures should be considered as reviewed in chapter 6.

Step 6. Design reinforcement to provide a stable slope. (see figure 66, and discussion in chapter 6.)

- a. Calculate the total reinforcement tension per unit width of slope T_S required to obtain the required factor of safety FS_R for each potential failure surface inside the critical zone in step 5 that extends through or below the toe of the slope using the following equation:

$$T_S = (FS_R - FS_U) \frac{M_D}{D} \quad (57)$$

where:

T_S = the sum of the required tensile force per unit width of reinforcement (considering rupture and pullout) in all reinforcement layers intersecting the failure surface.

M_D = driving moment about the center of the failure circle.

D = the moment arm of T_S about the center of failure circle.

= radius of circle R for **continuous, sheet type extensible reinforcement** (i.e., assumed to act tangentially to the circle).

= radius of circle R for **continuous, sheet type inextensible reinforcement** (e.g., wire mesh reinforcement) to account for normal stress increase on adjacent soil.

= vertical distance, Y , to the centroid of T_S for **discrete element, strip type reinforcement**. Assume $H/3$ above slope base for preliminary calculations (i.e. assumed to act in a horizontal plane intersecting the failure surface at $H/3$ above the slope base).

FS_U = unreinforced slope safety factor.

FS_R = target minimum slope factor of safety which is applied to both the soil and reinforcement.

! T_{S-MAX} the largest T_S calculated and establishes the total design tension.

! **Note: the minimum safety factor usually does not control the location of T_{S-MAX} ; the most critical surface is the surface requiring the largest magnitude of reinforcement.**

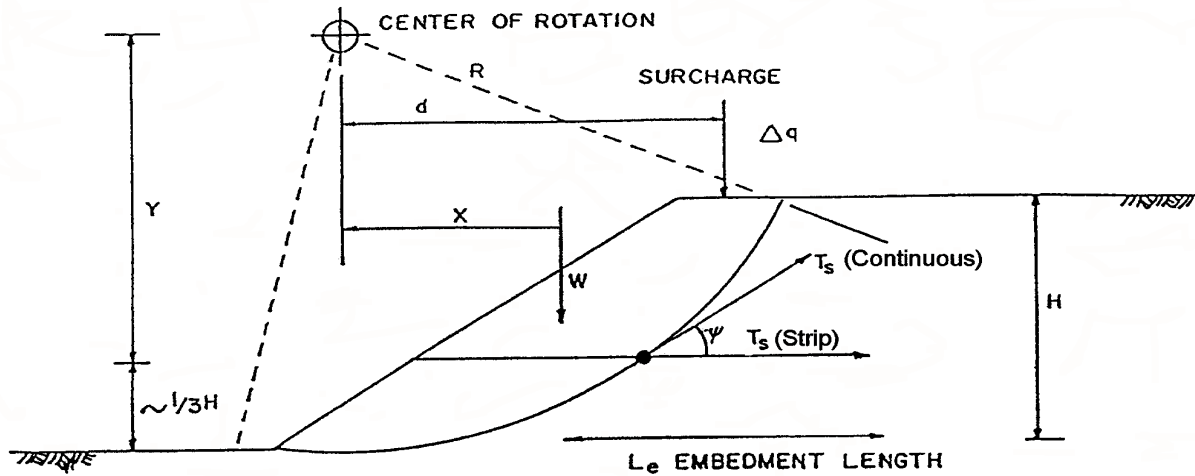

Factor of safety of unreinforced slope:

$$F.S._u = \frac{\text{Resisting Moment } (M_R)}{\text{Driving Moment } (M_D)} = \frac{\int_0^{L_{sp}} \tau_f \cdot R \cdot dL}{(Wx + \Delta q \cdot d)}$$

where: W = weight of sliding earth mass
 L_{sp} = length of slip plane
 Δq = surcharge
 τ_f = shear strength of soil

Factor of safety of reinforced slope:

$$F.S. = F.S._u + \frac{T_s \cdot D}{M_D}$$

where: T_s = sum of available tensile force per width of reinforcement for all reinforcement layers
 D = moment arm of T_s about the center of rotation
= R for continuous extensible and inextensible reinforcement
= Y for discrete reinforcement

Figure 66. Rotational shear approach to determine required strength of reinforcement.

- b. Determine the total design tension per unit width of slope, T_{S-MAX} , using the charts in figure 67 and compare with T_{S-MAX} from step 6a. If significantly different, check the validity of the charts based on the limiting assumptions listed in the figure and recheck calculations in steps 5 and equation 50.

! Figure 67 is provided for a quick check of computer-generated results. The figure presents a simplified method based on a two-part wedge type failure surface and is limited by the assumptions noted on the figure.

! Note that figure 67 is not intended to be a single design tool. Other design charts available from the literature could also be used.^(12,13,14,15) As indicated in chapter 6, several computer programs are also available for analyzing a slope with given reinforcement and can be used as a check. Judgment in selection of other appropriate design methods (i.e., most conservative or experience) is required.

- c. Determine the distribution of reinforcement:

! For low slopes ($H \leq 6\text{m}$) assume a uniform reinforcement distribution and use T_{S-MAX} to determine spacing or the required tension T_{max} requirements for each reinforcement layer.

! For high slopes ($H > 6\text{m}$), divide the slope into two (top and bottom) or three (top, middle, and bottom) reinforcement zones of equal height and use a factored T_{S-MAX} in each zone for spacing or design tension requirements (see figure 68). The total required tension in each zone is found from:

For 2 zones:

$$T_{\text{Bottom}} = 3/4 T_{S-MAX} \quad (58)$$

$$T_{\text{Top}} = 1/4 T_{S-MAX} \quad (59)$$

For 3 zones:

$$T_{\text{Bottom}} = 1/2 T_{S-MAX} \quad (60)$$

$$T_{\text{Middle}} = 1/3 T_{S-MAX} \quad (61)$$

$$T_{\text{Top}} = 1/6 T_{S-MAX} \quad (62)$$

The force is assumed to be uniformly distributed over the entire zone.

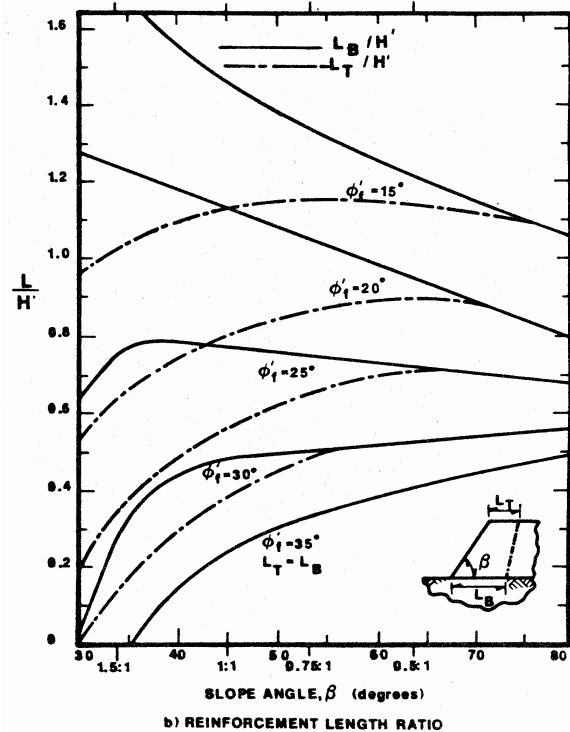
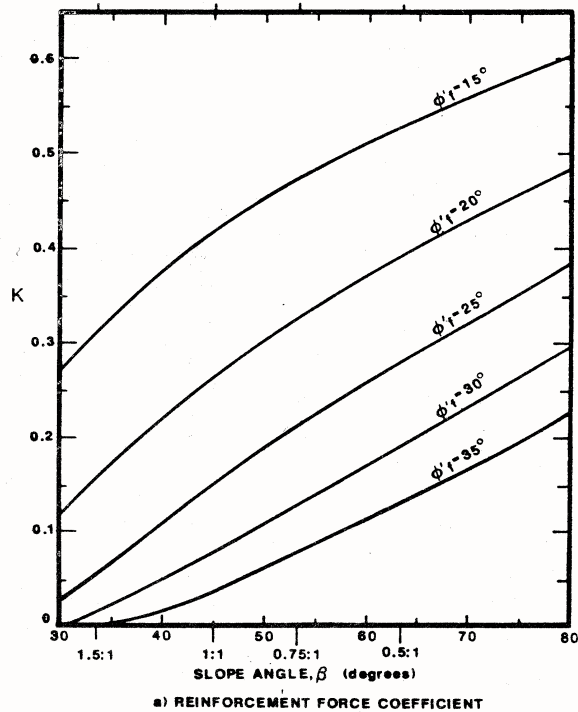

CHART PROCEDURE:

- 1) Determine force coefficient K from figure above, where $\phi_r =$ friction angle of reinforced fill:

$$\phi_f = \tan^{-1} \left(\frac{\tan \phi_r}{FS_R} \right)$$

- 2) Determine:

$$T_{S-MAX} = 0.5 K \gamma_r (H')^2$$

where: $H' = H + q/\gamma_r$
 $q =$ a uniform load

- 3) Determine the required reinforcement length at the top L_T and bottom L_B of the slope from the figure above.

LIMITING ASSUMPTIONS

- ! Extensible reinforcement.
- ! Slopes constructed with uniform, cohesionless soil, $c = 0$.
- ! No pore pressures within slope.
- ! Competent, level foundation soils.
- ! No seismic forces.
- ! Uniform surcharge not greater than $0.2 \gamma_r H$.
- ! Relatively high soil/reinforcement interface friction angle, $\phi_{sg} = 0.9 \phi_r$ (may not be appropriate for some geotextiles).

Figure 67. Chart solution for determining the reinforcement strength requirements (after Schmertmann, et. al., 1987).

NOTE: Charts © The Tensar Corporation

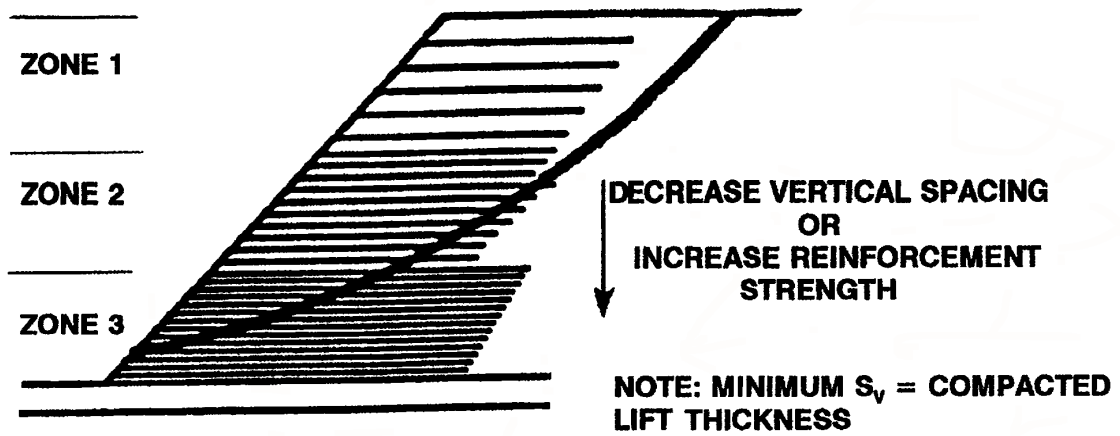

A) SPACING VERSUS REINFORCEMENT STRENGTH

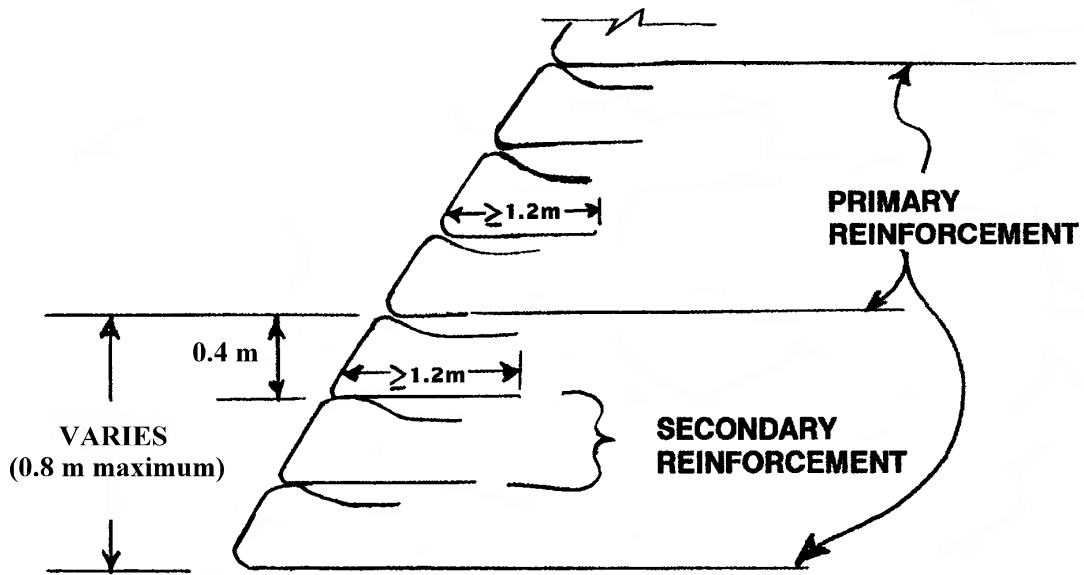

B) PRIMARY AND SECONDARY REINFORCEMENT APPROACH

Figure 68. Reinforcement spacing considerations for high slopes.

d. Determine reinforcement vertical spacing S_v or the maximum design tension T_{\max} requirements for each reinforcement layer.

! For each zone, calculate T_{\max} for each reinforcing layer in that zone based on an assumed S_v or, if the allowable reinforcement strength is known, calculate the minimum vertical spacing and number of reinforcing layers N required for each zone based on:

$$T_{\max} = \frac{T_{\text{zone}} S_v}{H_{\text{zone}}} = \frac{T_{\text{zone}}}{N} \leq T_a R_c \quad (63)$$

where:

R_c = coverage ratio of the reinforcement which equals the width of the reinforcement b divided by the horizontal spacing S_h .

S_v = vertical spacing of reinforcement in meters; multiples of compacted layer thickness for ease of construction.

T_{zone} = maximum reinforcement tension required for each zone.
= $T_{S\text{-MAX}}$ for low slopes ($H < 6\text{m}$).

T_a = T_{al} .

H_{zone} = height of zone.
= T_{top} , T_{middle} , and T_{Bottom} for high slopes ($H > 6\text{m}$).

N = number of reinforcement layers.

! Use short (1.2 to 2 m) lengths of intermediate reinforcement layers to maintain a maximum vertical spacing of 400 mm (16 inches) or less for face stability and compaction quality (see figure 68b).

- For slopes flatter than 1H:1V, closer spaced reinforcements (i.e., every lift or every other lift, but no greater than 400 mm) preclude having to wrap the face in well graded soils (e.g., sandy gravel and silty and clayey sands). Wrapped faces are required for steeper slopes and uniformly graded soils to prevent face sloughing. Alternative vertical spacings could be used to prevent face sloughing, but in these cases a face stability analysis should be performed either using the method presented in this chapter or by evaluating the face as an infinite slope using: ⁽¹⁹⁾

$$F.S. = \frac{c' / H + (\gamma_g - \gamma_w) H z \cos^2 \beta \tan \phi' + F_g (\cos \beta \sin \beta + \sin^2 \beta \tan \phi')}{\gamma_g H z \cos \beta \sin \beta} \quad (64)$$

where: c' = effective cohesion
 ϕ' = effective friction angle
 γ_g = saturated unit weight of soil
 γ_w = unit weight of water
 z = vertical depth to failure plane defined by the depth of saturation
 H = vertical slope height
 β = slope angle
 F_g = summation of geosynthetic resisting force

- Intermediate reinforcement should be placed in continuous layers and needs not be as strong as the primary reinforcement, but it must be strong enough to survive construction (e.g. minimum survivability requirements for geotextiles in road stabilization applications in AASHTO M-288) and provide localized tensile reinforcement to the surficial soils.
- If the interface friction angle of the intermediate reinforcement ρ_{sr} is less than that of the primary reinforcement ρ_r , then ρ_{sr} should be used in the analysis for the portion of the failure surface intersecting the reinforced soil zone.

e. To ensure that the rule-of-thumb reinforcement force distribution is adequate for critical or complex structures, recalculate T_s using equation 57 to determine potential failure above each layer of primary reinforcement.

f. Determine the reinforcement lengths required:

! The embedment length L_e of each reinforcement layer beyond the most critical sliding surface (i.e., circle found for T_{S-MAX}) must be sufficient to provide adequate pullout resistance based on:

$$L_e = \frac{T_{max} FS}{F^* \cdot \alpha \cdot \sigma'_v \cdot 2 \cdot R_c \cdot C} \quad (65)$$

where F^* , α , R_c , C and σ'_v are defined in chapter 3, section 3.3.

! Minimum value of L_e is 1m. For cohesive soils, check L_e for both short- and long-term pullout conditions, when using the semi empirical equations in chapter 3 to obtain F^* .

For long-term design, use ϕ'_r with $c_r = 0$.

For short-term evaluation, conservatively use ϕ_r with $c_r = 0$ from consolidated undrained triaxial or direct shear tests or run pullout tests.

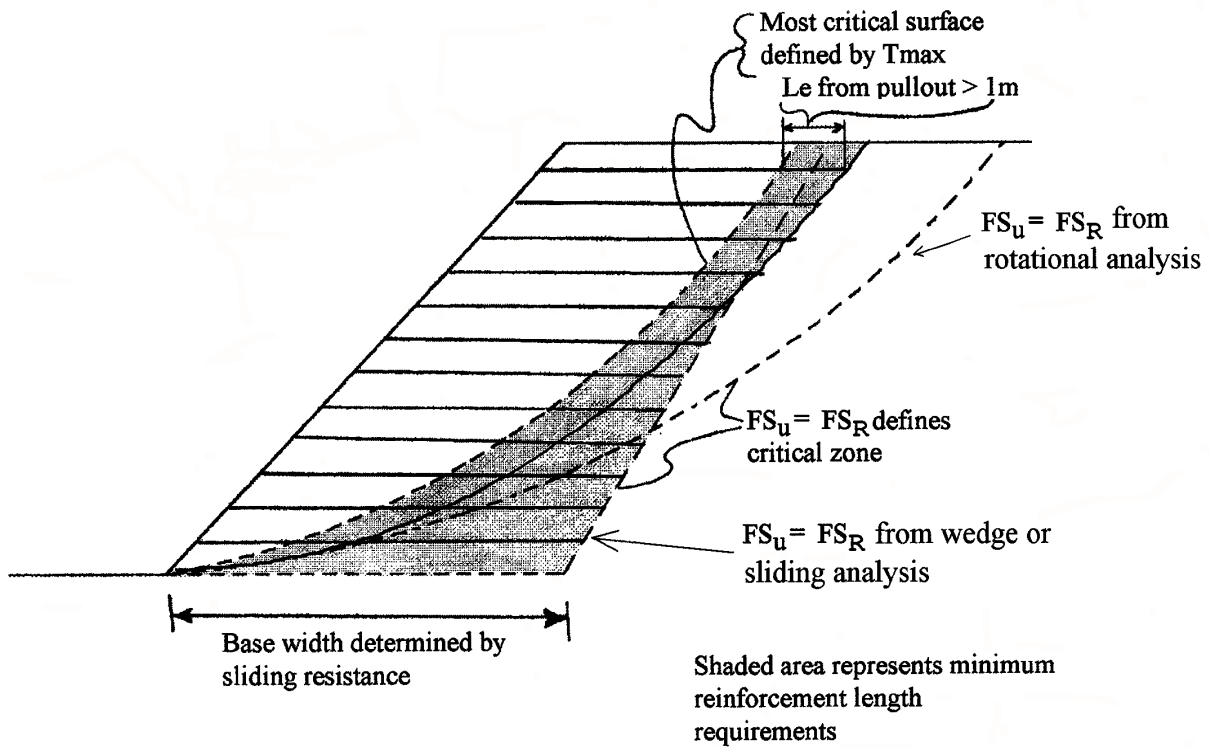

Figure 69. Developing reinforcement lengths.

- ! Plot the reinforcement lengths as obtained from the pullout evaluation on a slope cross section containing the rough limits of the critical zone determined in step 5 (see figure 69).
 - The length required for sliding stability at the base will generally control the length of the lower reinforcement levels.
 - Lower layer lengths must extend at least to the limits of the critical zone as shown in figure 69. Longer reinforcements may be required to resolve deep seated failure problems (see step 7).
 - Upper levels of reinforcement may not be required to extend to the limits of the critical zone provided sufficient reinforcement exists in the lower levels to provide the FS_R for all circles within the critical zone as shown in figure 69.
- ! Check that the sum of the reinforcement forces passing through each failure surface is greater than T_s required for that surface.
 - Only count reinforcement that extends 1m beyond the surface to account for pullout resistance.

- If the available reinforcement force is not sufficient, increase the length of reinforcement not passing through the surface or increase the strength of lower-level reinforcement.
 - ! Simplify the layout by lengthening some reinforcement layers to create two or three sections of equal reinforcement length for ease of construction and inspection.
 - ! Reinforcement layers do not generally need to extend to the limits of the critical zone, except for the lowest levels of each reinforcement section.
 - ! Check the length obtained using chart b in figure 67. Note: L_c is already included in the total length, L_t and L_B from chart B.
- g. Check design lengths of complex designs.
- ! When checking a design that has zones of different reinforcement length, lower zones may be over reinforced to provide reduced lengths of upper reinforcement levels.
 - ! In evaluating the length requirements for such cases, the pullout stability for the reinforcement must be carefully checked in each zone for the critical surfaces exiting at the base of each length zone.

Step 7. Check external stability. (see discussion in chapter 6.)

- ! Sliding resistance (figure 70)
 - Evaluate the width of the reinforced soil mass **at any level** to resist sliding along the reinforcement. A wedge type failure surface defined by the limits of the reinforcement (the length of the reinforcement at the depth of evaluation defined in step 5). The analysis can best be performed using a computerized method which takes into account all soil strata and interface friction values. The back of the wedge should be angled at $45 + \phi/2$. or parallel to the back of the reinforced zone, which ever is flatter (i.e., the wedge should not pass through layers of reinforcement to avoid an overly conservative analysis). A simple analysis using a sliding block method can be performed as a check. In this method, an active wedge is assumed at the back of the reinforced soil mass with the back of the wedge extending up at an angle of $45 + \phi/2$. Using this assumption, the driving force is equal to the active earth pressure and the resisting force is the frictional resistance provided by the weakest layer, either the reinforced soil, the foundation soil or the soil-reinforcement interface. The following relationships are then used:

$$\text{Resisting Force} = F.S. \times \text{Sliding Force}$$

$$(W + P_a \sin \phi_b) \tan \phi_{\min} = FS P_a \cos \phi_b \quad (66)$$

$$\text{with: } W = 1/2 L^2 \gamma_r \tan \theta_r \quad \text{for } L < H \quad (67)$$

$$W = [LH - H^2/(2\tan\theta)]\gamma_r \quad \text{for } L > H \quad (68)$$

$$P_a = 1/2 \gamma_b H^2 K_a \quad (69)$$

where:

L = length of bottom reinforcing layer in each level where there is a reinforcement length change.

H = height of slope.

FS = factor of safety criterion for sliding (>1.3).

P_A = active earth pressure.

φ_{min} = minimum angle of shearing friction either between reinforced soil and reinforcement or the friction angle of the foundation soil.

θ = slope angle.

γ_r & γ_b = unit weight of the reinforced and retained backfill respectively.

φ_b = friction angle of retained fill.

(note: if drains/filters are placed on the backslope, then φ_b equals the interface friction angle between the geosynthetic and retained fill.)

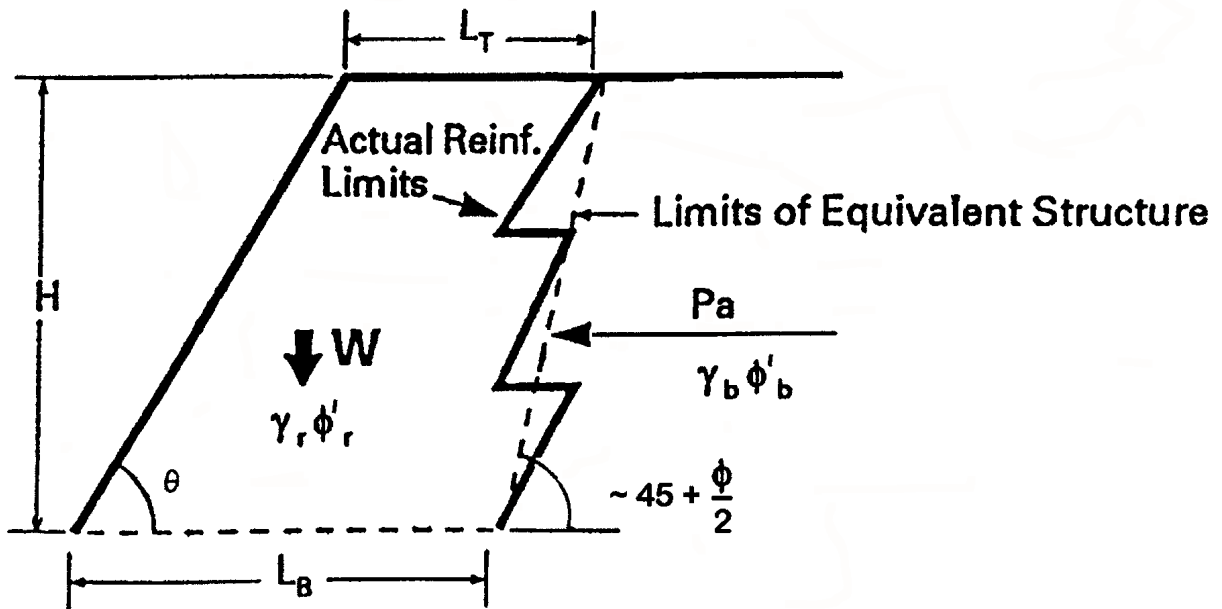

Figure 70. Sliding stability analysis.

! Deep seated global stability (figure 71a).

- Evaluate potential deep-seated failure surfaces behind the reinforced soil mass to provide:

$$F.S. = M_D/M_R \geq 1.3 \quad (70)$$

The analysis performed in step 5 should provide this information. However, as a check, classical rotational slope stability methods such as simplified Bishop, Morgenstern and Price, Spencer, or others may be used (see FHWA *Soils and Foundations Workshop Reference Manual*, 2000). Appropriate computer programs also may be used.

! Local bearing failure at the toe (lateral squeeze) (figure 71b).

- If a weak soil layer exists beneath the embankment to a limited depth D_s which is less than the width of the slope b' , the factor of safety against failure by squeezing may be calculated from:⁽¹⁶⁾

$$FS_{squeezing} = \frac{2 c_u}{\gamma D_s \tan \theta} + \frac{4.14 c_u}{H \gamma} \geq 1.3 \quad (71)$$

where:

θ = angle of slope.

γ = unit weight of soil in slope.

D_s = depth of soft soil beneath slope base of the embankment.

H = height of slope.

c_u = undrained shear strength of soft soil beneath slope.

Caution is advised and rigorous analysis (e.g, numerical modeling) should be performed when $FS < 2$. This approach is somewhat conservative as it does not provide any influence from the reinforcement. When the depth of the soft layer, D_s , is greater than the base width of the slope, b' , general slope stability will govern the design.

! Foundation settlement.

- Determine the magnitude and rate of total and differential foundation settlements using classical geotechnical engineering procedures (see FHWA *Soils and Foundations Workshop Reference Manual*, 2000).⁽²⁰⁾

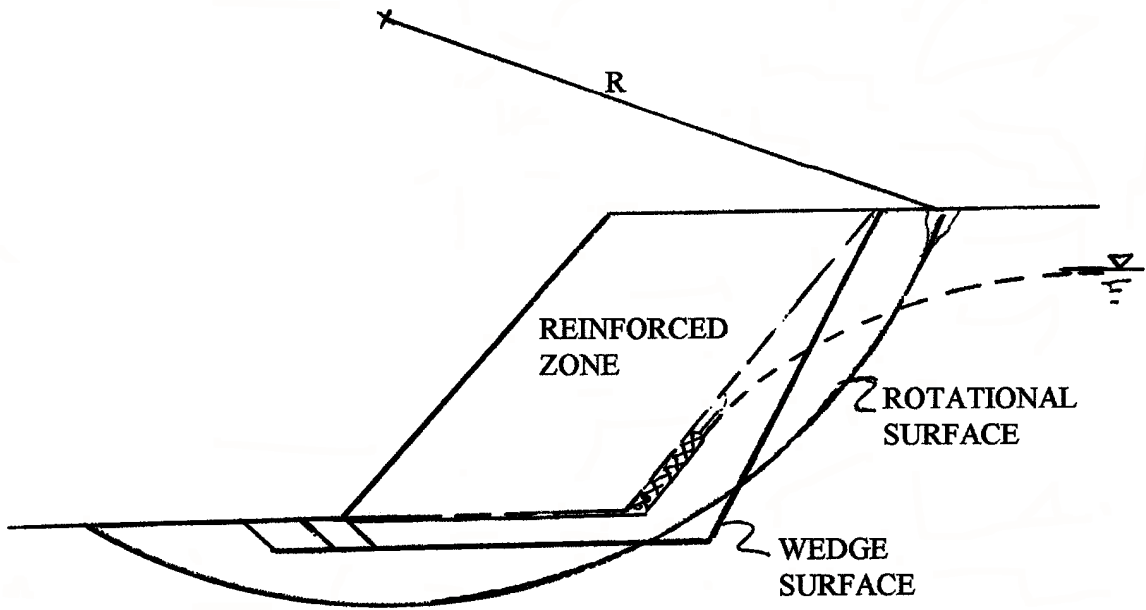

a) Deep seated (global) stability analysis.

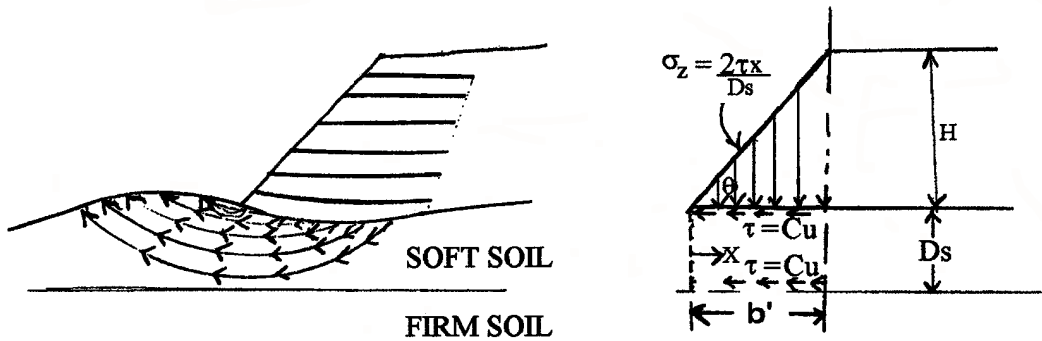

$$FS = \frac{2 c_u}{\gamma D_s \tan \theta} + \frac{4.14 c_u}{H \gamma}$$

b) Local bearing failure (lateral squeeze)

Figure 71. Failure through the foundation.

Step 8. Seismic stability.

! Dynamic stability (figure 72).

- Perform a pseudo-static type analysis using a seismic ground coefficient A , obtained from local building code and a design seismic acceleration A_m equal to $A_m = A/2$. Reinforced soil slopes are clearly yielding type structures, more so than walls. As such, A_m can be taken as $A/2$ as allowed by *AASHTO Standard Specifications for Highway Bridges* (Division 1A-Seismic Design, 6.4.3 Abutments.)

F.S. dynamic ≥ 1.1

In the pseudo-static method, seismic stability is determined by adding a horizontal and/or vertical force at the centroid of each slice to the moment equilibrium equation (see figure 72). The additional force is equal to the seismic coefficient times the total weight of the sliding mass. It is assumed that this force has no influence on the normal force and resisting moment, so that only the driving moment is affected. The liquefaction potential of the foundation soil should also be evaluated.

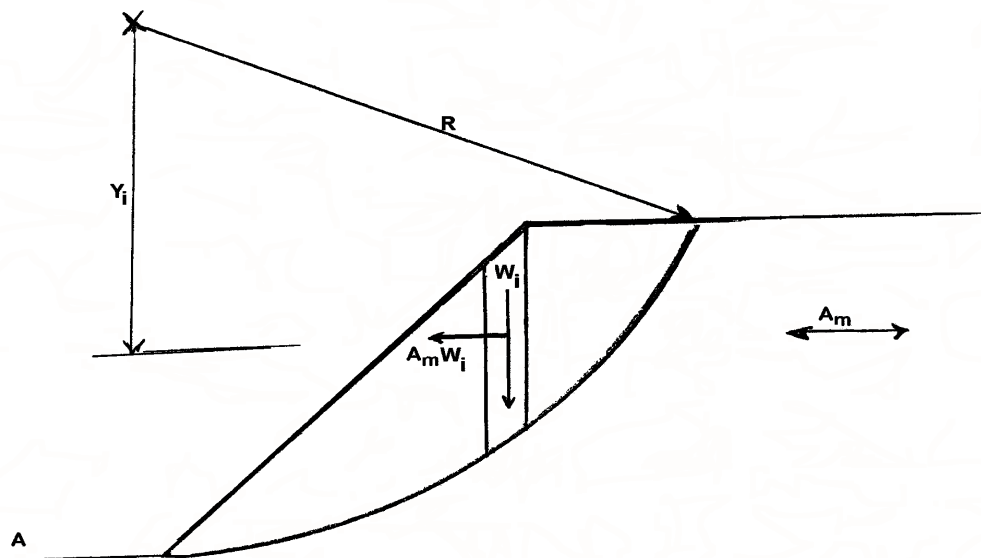
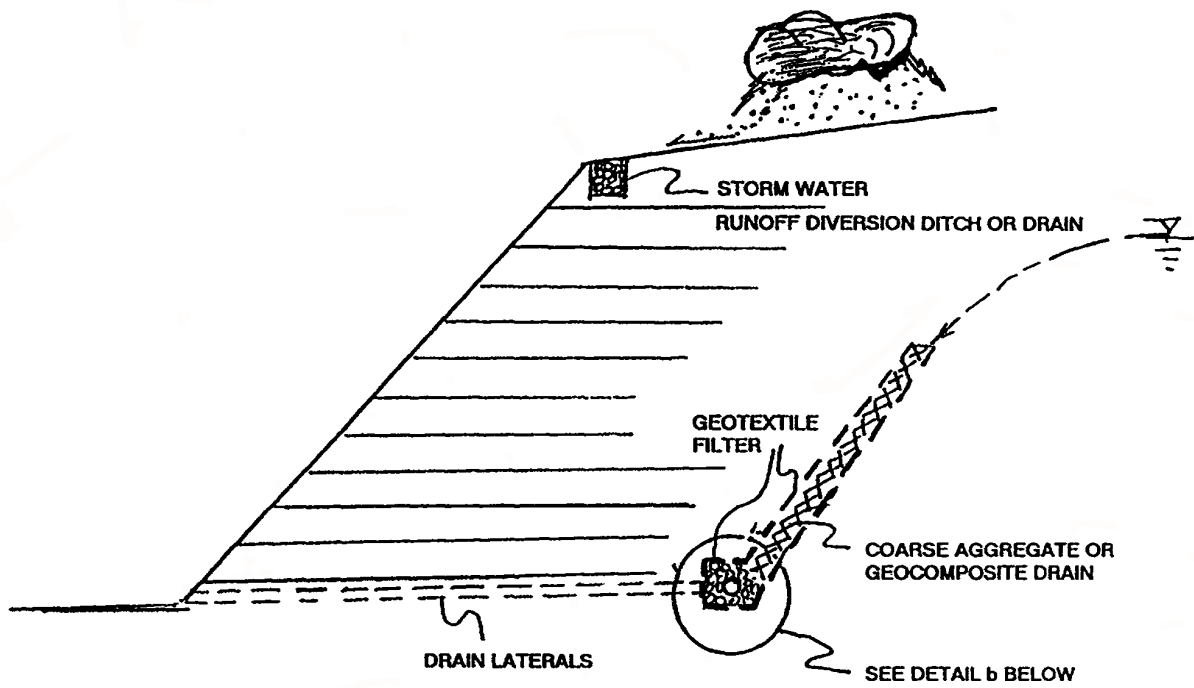
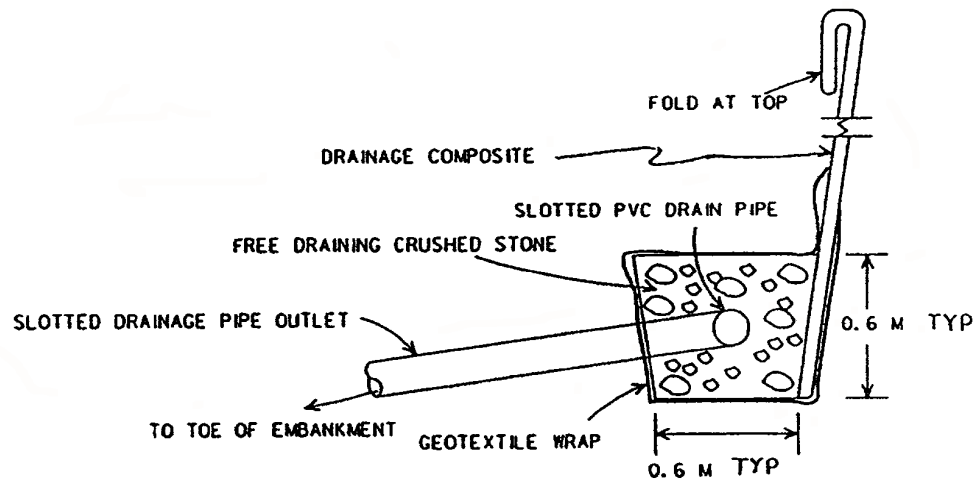

Figure 72. Seismic stability analysis.



a) GROUND WATER AND SURFACE DRAINAGE



b) TYPICAL DRAIN DETAILS

Figure 73. Subsurface drainage considerations.

Step 9. Evaluate requirements for subsurface and surface water runoff control.

! Subsurface water control.

- Design of subsurface water drainage features should address flow rate, filtration, placement, and outlet details.
- Drains are typically placed at the rear of the reinforced mass as shown in figure 73. Geocomposite drainage systems or conventional granular blanket and trench drains could be used. Granular drainage systems are not addressed in this document, as it is assumed that criteria for these systems already exists within state agencies.
- Lateral spacing of outlets is dictated by site geometry, estimated flow, and existing agency standards. Outlet design should address long-term performance and maintenance requirements.
- Geosynthetic drainage composites can be used in subsurface water drainage design. Drainage composites should be designed with consideration of:

! Geotextile filtration/clogging.

! Long-term compressive strength of polymeric core.

! Reduction of flow capacity due to intrusion of geotextile into the core.

! Long-term inflow/outflow capacity.

Procedures for checking geotextile permeability and filtration/clogging criteria were presented in FHWA *Geosynthetic Design and Construction Guidelines* (1995). Long-term compressive stress and eccentric loadings on the core of a geocomposite should be considered during design and selection. Though not yet addressed in standardized test methods or standards of practice, the following criteria are suggested by the authors for addressing core compression. The design pressure on a geocomposite core should be limited to either:

! the maximum pressure sustained on the core in a test of 10,000 hour minimum duration.

! the crushing pressure of a core, as defined with a quick loading test, divided by a factor of safety of 5.

Note that crushing pressure can only be defined for some core types. For cases where a crushing pressure cannot be defined, suitability should be based on the maximum load resulting in a residual thickness of the core adequate to provide the required flow after 10,000 hours, or the maximum load resulting in a residual thickness of the

core adequate to provide the required flow as defined with the quick loading test divided by a factor of safety of 5.

Intrusion of the geotextiles into the core and long-term outflow capacity should be measured with a sustained transmissivity test. The ASTM D-4716 test procedure *Constant Head Hydraulic Transmissivity of Geotextiles and Geotextile Related Products*, should be followed. The test procedure should be modified for sustained testing and for use of sand sub-stratum and super-stratum in lieu of closed cell foam rubber. Load should be maintained for 100 hours or until equilibrium is reached, whichever is greater.

- Slope stability analyses should account for interface shear strength along a geocomposite drain. The geocomposite/soil interface will most likely have a friction value that is lower than that of the soil. Thus, a potential failure surface may be induced along the interface.
- Geotextile reinforcements (primary and intermediate layers) must be more permeable than the reinforced fill material to prevent a hydraulic build up above the geotextile layers during precipitation.

Special emphasis on the design and construction of subsurface drainage features is recommended for structures where drainage is critical for maintaining slope stability. Redundancy in the drainage system is also recommended for these cases.

! Surface water runoff.

- Surface water runoff should be collected above the reinforced slope and channeled or piped below the base of the slope. Standard Agency drainage details should be utilized.
- Wrapped faces and/or intermediate layers of secondary reinforcement may be required at the face of reinforced slopes to prevent local sloughing. Guidance is provided in Chapter 6 and table 13. Intermediate layers of reinforcement help achieve compaction at the face, thus increasing soil shear strength and erosion resistance. These layers also act as reinforcement against shallow or sloughing types of slope failures. Intermediate reinforcement is typically placed on each or every other soil lift, except at lifts where primary structural reinforcement is placed. Intermediate reinforcement also is placed horizontally, adjacent to primary reinforcement, and at the same elevation as the primary reinforcement when primary reinforcement is placed at less than 100 percent coverage in plan view. The intermediate reinforcement should extend 1.2 to 2 m (4 to 6.6 ft) back into the fill from the face.
- Select a long-term facing system to prevent or minimize erosion due to rainfall and runoff on the face.

- Calculated flow-induced tractive shear stress on the face of the reinforced slope by:

$$\lambda = d \cdot \gamma_w \cdot s \quad (72)$$

where:

- λ = tractive shear stress, kPa.
- d = depth of water flow, m.
- γ_w = unit weight of water, kN/m³.
- s = the vertical to horizontal angle of slope face, m/m.

For $\lambda < 100$ Pa, consider vegetation with temporary or permanent erosion control mat

For $\lambda > 100$ Pa, consider vegetation with permanent erosion control mat or other armor type systems (e.g., riprap, gunite, prefab modular units, fabric-formed concrete, etc.)

- Select vegetation based on local horticultural and agronomic considerations and maintenance.
- Select a synthetic (permanent) erosion control mat that is stabilized against ultra-violet light and is inert to naturally occurring soil-born chemicals and bacteria.

Erosion control mats and blankets vary widely in type, cost, and, more importantly, applicability to project conditions. **Slope protection should not be left to the construction contractor or vendor's discretion.** Guideline material specifications for synthetic permanent erosion control mats are provided in chapter 8.

7.3 COMPUTER ASSISTED DESIGN

An alternative to reinforcement design, step 6 in the previous section, is to develop a trial layout of reinforcement and analyze the reinforced slope with a computer program such as the FHWA ReSSA program. Layout includes number, length, design strength, and vertical distribution of the geosynthetic reinforcement. The charts presented in figure 67 provide a method for generating a preliminary layout. Note that these charts were developed with the specific assumptions noted on the figure.

Analyze the reinforced soil slope with the trial geosynthetic reinforcement layouts. **The most economical reinforcement layout must provide the minimum required stability safety factors for internal, external, and compound failure planes.** A contour plot of lowest safety factor values about the trial failure circle centroids is recommended to map and locate the minimum safety factor values for the three modes of failure.

The method of analysis in section 7.2 assumed that the reinforcing force contributed to the resisting moment and thus inherently applies the required factor of safety to the reinforcement (i.e., $T_a = T_{al}$).

However, some computer programs (and design charts) are based on the assumption that the reinforcement force reduces the driving moment with the stability factor of safety FS calculated as:

$$FS = \frac{M_R}{M_D - T_S D}$$

With this assumption, the stability factor of safety is not applied to the reinforcement. For such computations, the allowable strength of the reinforcement T_{al} must be divided by the required factor of safety FS_R , as was done for MSE walls (i.e., $T_a = T_{al}/1.3$).

External stability analysis as was previously shown in step 7 will include an evaluation of local bearing capacity, foundation settlement, and dynamic stability.

7.4 DESIGN EXAMPLES

a. Example 1. Reinforced Slope Design -Road Widening

A 1 km long, 5-m high, 2.5H:1V side slope road embankment in a suburban area is to be widened by one lane. At least a 6-m width extension is required to allow for the additional lane plus shoulder improvements. A 1H:1V reinforced soil slope up from the toe of the existing slope will provide 7.5-m width to the alignment. The following provides the steps necessary to perform a preliminary design for determining the quantity of reinforcement to evaluate the feasibility and cost of this option. The reader is referred to the design steps in section 7.2 to more clearly follow the meaning of the design sequence.

Step 1. Slope description.

a. Geometric and load requirements

- $H = 5 \text{ m}$
- $\beta = 45^\circ$
- $q = 10 \text{ kPa}$ (for dead weight of pavement section) + 2% road grade

b. Performance requirements

- External Stability:
Sliding Stability: $FS_{min} = 1.3$
Overall slope stability and deep seated: $FS_{min} = 1.3$
Dynamic loading: no requirement
Settlement: analysis required
- Compound Failure: $FS_{min} = 1.3$

- Internal Stability: $FS_{\min} = 1.3$

Step 2. Engineering properties of foundation soils.

- Review of soil borings from the original embankment construction indicates foundation soils consisting of stiff to very stiff, low-plasticity, silty clay with interbedded seams of sand and gravel. The soils tend to increase in density and strength with depth.
- $\gamma_d = 19 \text{ kN/m}^3$, $\omega_{\text{opt}} = 15\%$, $c_u = 100 \text{ kPa}$, $\phi' = 28^\circ$, and $c' = 0$
- At the time of the borings, $d_w = 2 \text{ m}$ below the original ground surface.

Step 3. Properties of reinforced and embankment fill.

The existing embankment fill is a clayey sand and gravel. For preliminary evaluation, the properties of the embankment fill are assumed for the reinforced section as follows:

- Sieve Size Percent passing

| | |
|--------------------|-----|
| 100 mm | 100 |
| 20 mm | 99 |
| 4.75 mm | 63 |
| 0.425 mm | 45 |
| 0.075 mm | 25 |
| PI (of fines) = 10 | |
| Gravel is durable | |
| pH = 7.5 | |
- $\gamma_r = 21 \text{ kN/m}^3$, $\omega_{\text{opt}} = 15$
- $\phi' = 33^\circ$, $c' = 0$
- Soil is relatively inert, based on neutral pH tests for backfill and geology of area.

**Step 4. Design parameters for reinforcement
For preliminary analysis use default values.**

- Allowable Strength: $T_a = T_{al}/FS$, since $FS = 1$ for this analytical approach,
 $T_a = T_{al} = T_{ULT}/RF$
- Pullout Factor of Safety: $FS_{\text{PO}} = 1.5$

Step 5. Check unreinforced stability

Using STABL4M, a search was made to find the minimum unreinforced safety factor and to define the critical zone. Both rotational and wedge stability evaluations were performed with figure 74a showing the rotational search. The minimum unreinforced safety factor was 0.68 with the critical zone defined by the target factor of safety FS_R as shown in figure 74b. Remember that the critical zone from the unreinforced analysis roughly defines the zone needing reinforcement.

Step 6. Calculate T_s for the FS_R .

From the computer runs, obtain FS_U , M_D , and R for each failure surface within the critical zone and calculate T_s from equation 57 as follows. (Note: with minor code modification, this could easily be done as part of the computer analysis.)

- a. Calculate the total reinforcement tension T_s , required:

$$T_s = (1.3 - FS_U) \frac{M_D}{R} \quad (73)$$

Evaluating all of the surfaces in the critical zone indicates maximum total tension $T_{s-MAX} = 49.7 \text{ kN/m}$ for $FS_U = 0.89$ as shown in figure 74c.

- b. Checking T_{s-MAX} by using the design charts in figure 67:

$$\phi_f = \tan^{-1} \left(\frac{\tan \phi_r}{FS_R} \right) = \tan^{-1} \left(\frac{\tan 33^\circ}{1.3} \right) = 26.5^\circ \quad (74)$$

From figure 67a, $K \approx 0.14$

and,

$$\begin{aligned} H' &= H + q/\gamma_r + 0.1 \text{ m (for 2\% road grade)} \\ &= 5 \text{ m} + (10 \text{ kN/m}^2 \div 21 \text{ kN/m}^3) + 0.1 \text{ m} = 5.6 \text{ m} \end{aligned}$$

then,

$$\begin{aligned} T_{s-MAX} &= 0.5 K \gamma_r H'^2 \\ &= 0.5 (0.14) (21 \text{ kN/m}^3) (5.6 \text{ m})^2 \\ &= 46.1 \text{ kN/m} \end{aligned} \quad (75)$$

The evaluation using figure 67 appears to be in reasonably good agreement with the computer analysis for this simple problem.

- c. Determine the distribution of reinforcement.

Since $H < 6$ m, use a uniform spacing. Due to the cohesive nature of the backfill, maximum compaction lifts of 200 mm are recommended.

- d. As was discussed in the design section, to avoid wrapping the face and surficial stability issues, use $S_v = 400$ mm reinforcement spacing; therefore, $N = 5 \text{ m}/0.4 \text{ m} = 12.5$, use 12 layers with the bottom layer placed after the first lift of embankment fill.

$$T_{\max} = \frac{T_{S-MAX}}{N} = \frac{49.7 \text{ kN/m}}{12} = 4.14 \text{ kN/m} \quad (76)$$

(Note: Other reinforcement options such as using short secondary reinforcements at every lift with spacing and strength increased for primary reinforcements, may be considered and evaluated in order to select the most cost-effective final design.)

- e. Since this is a simple structure, rechecking T_s above each layer or reinforcement is not performed.
- f. For preliminary analysis of the required reinforcement lengths, the critical zone found in the computer analysis (figure 74b) could be used to define the limits of the reinforcement. This is especially true for this problem since the sliding failure surface with $FS \geq 1.3$ encompasses the rotational failure surface with $FS \geq 1.3$.

From direct measurement at the bottom and top of the sliding surface in figure 74b, the required lengths of reinforcement are:

$$\begin{aligned} L_{\text{bottom}} &= 5.3 \text{ m} \\ L_{\text{top}} &= 2.9 \text{ m} \end{aligned}$$

Check length of embedment beyond the critical surface L_e and factor of safety against pullout.

Since the most critical location for pullout is the reinforcement near the top of the slope (depth $Z = 0.2$ m), subtract the distance from the critical surface to the face of the slope in figure 74c from L_{top} . This gives L_e at top = 1.3 m.

Assuming the most conservative assumption for pullout factors F^* and α from chapter 3, section 3.3 gives $F^* = 0.67 \tan \phi$ and $\alpha = 0.6$. Therefore,

$$FS = \frac{L_e F^* \alpha \sigma_v C}{T_{\max}} = \frac{1.3 (0.67 \tan 33^\circ) (0.6) (0.2 \text{ m} \times 21 \text{ kN/m}^3 + 10 \text{ kN/m}^2) (2)}{4.14 \text{ kN/m}} \quad (77)$$

$$FS_{PO} = 2.3 > 1.5 \text{ required}$$

Check the length requirement using figure 67b.

For L_B , use ϕ_{\min} from foundation soil

$$\phi'_f = \tan^{-1} \left(\frac{\tan 28^\circ}{1.3} \right) = 22.2^\circ \quad (78)$$

From figure 67: $L_B/H' = 0.96$

thus, $L_B = 5.6 \text{ m} (0.96) = 5.4 \text{ m}$

For L_T , use ϕ_{\min} from reinforced fill

$$\phi'_f = \tan^{-1} \left(\frac{\tan 33^\circ}{1.3} \right) = 26.5^\circ \quad (79)$$

From figure 67: $L_T/H' = 0.52$

thus, $L_T = 5.6 \text{ m} (0.52) = 2.9 \text{ m}$

The evaluation again, using figure 67, is in good agreement with the computer analysis.

- g. This is a simple structure and additional evaluation of design lengths is not required. For a preliminary analysis, and a fairly simple problem, figure 67 or any number of proprietary computer programs could be used for a rapid evaluation of T_{S-MAX} and T_{max} .

In summary, 12 layers of reinforcement are required with a design strength T_a and thus an allowable material strength T_{al} of 4.14 kN/m and an average length of 4 m over the full height of embankment.

Bishop Circular Surfaces - Search for Critical Surfaces

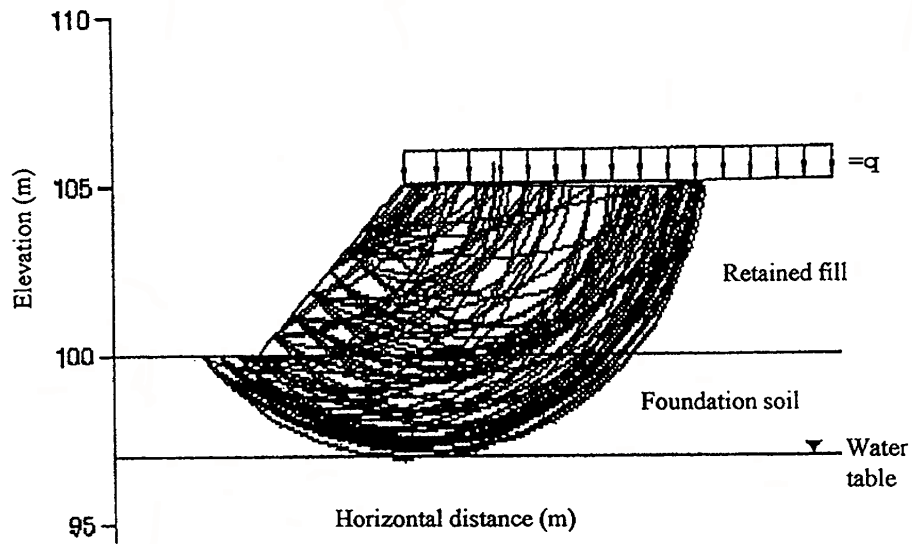

A) Unreinforced stability analysis.

Minimum Factor of Safety

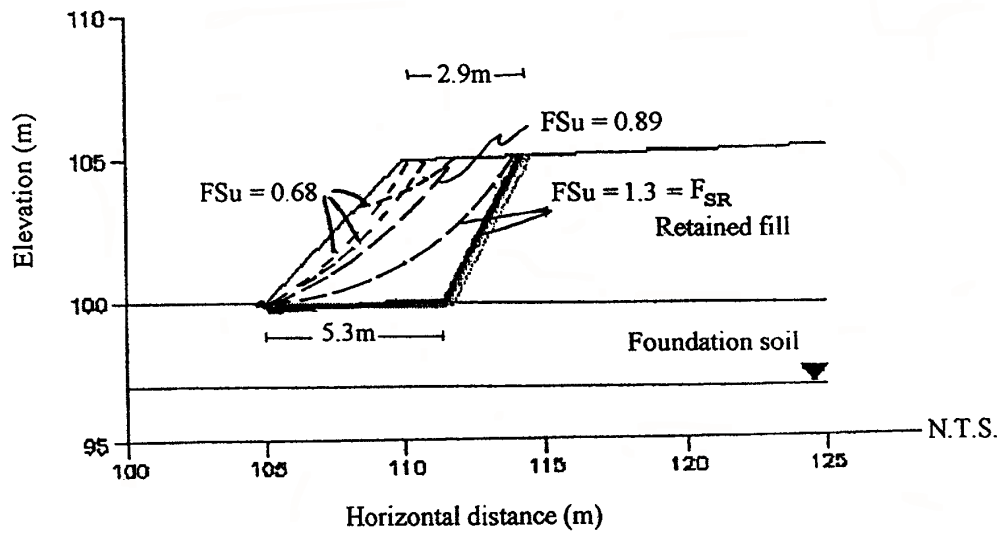

B) Results of unreinforced stability analysis.

Figure 74. Design example 1.

Strength Design - Reinforcement for Critical Surface

Factor of safety for circle with $T_{s-\max}$ 0.89
Total required reinforcement: 49.7 kN/m

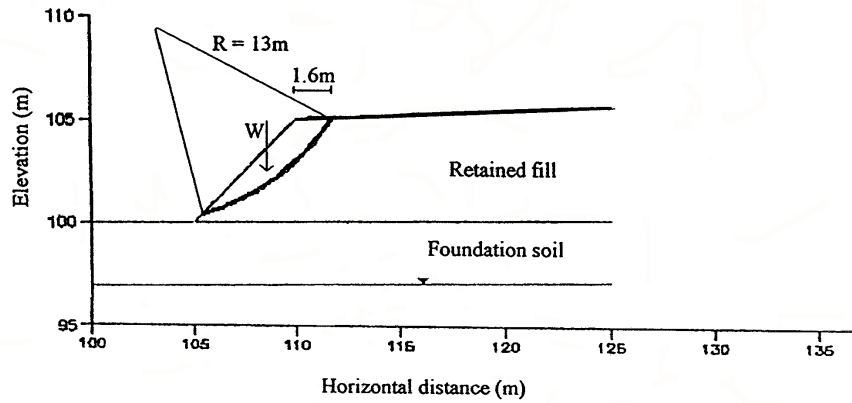

for $R = 13\text{m}$, $M_d = 1575\text{ kN/m}$

C) Surface requiring maximum reinforcement (i.e. most critical reinforced surface)

Figure 74. Design example 1 (continued).

b. Example 2. Reinforced Slope Design -New Road Construction

An embankment will be constructed to elevate an existing roadway that currently exists at the toe of a slope with a stable 1.6H: 1V configuration. The maximum height of the proposed embankment will be 19 m and the desired slope of the elevated embankment is 0.84H:10V. A geogrid with an ultimate tensile strength of 100 kN/m (ASTM D4595 wide width method) is desired for reinforcing the new slope. A uniform surcharge of 12.5 kN is to be used for the traffic loading condition. Available information indicated that the natural foundation soils have a drained friction angle of 34° and effective cohesion of 12.5 kPa. The backfill to be used in the reinforced section will have a minimum friction angle of 34°.

The reinforced slope design must have a minimum factor of safety of 1.5 for slope stability. The minimum design life of the new embankment is 75 years.

Determine the number of layers, vertical spacing, and total length required for the reinforced section.

Step 1. Geometric and loading requirements for design.

a. Slope description:

- Slope height, $H = 19$ m
- Reinforced slope angle, $\theta = \tan^{-1}(1.0/0.84) = 50^\circ$
- Existing slope angle, $\beta = \tan^{-1}(0.61/1.0) = 31.4^\circ$
- Surcharge load, $q = 12.5$ kN/m²

b. Performance requirements:

- External stability
 - Sliding: $FS \geq 1.5$
 - Deep Seated (overall stability): $FS \geq 1.5$
 - Dynamic loading: no requirement
 - Settlement: analysis required
- Internal stability
 - Slope stability: $FS \geq 1.5$

Step 2. Engineering properties of the natural soils in the slope.

For this project, the foundation and existing embankment soils have the following strength parameters:

$$\phi' = 34^\circ, c' = 12.5 \text{ kPa}$$

Depth of water table, $d_w = 1.5 \text{ m}$ below base of embankment

Step 3. Properties of available fill.

The backfill material to be used in the reinforced section was reported to have the following properties:

$$\gamma = 18.8 \text{ kN/m}^3, \phi' = 34^\circ, c' = 0$$

Step 4. Reinforcement performance requirement.

Allowable tensile force per unit width of reinforcement, T_a , with respect to service life and durability requirements:

$$T_a = T_{ULT}/RF \text{ and } RF = RF_{CR} \times RF_{ID} \times RF_D \times FS \quad (80)$$

For the proposed geogrid to be used in the design of the project, the following factors are used:

$FS = 1$ (note: $FS = 1.5$ on reinforcement is included in stability equation).

$RF_D =$ durability factor of safety = 1.25.

$RF_{ID} =$ construction damage factor of safety = 1.2.

$RF_{CR} =$ creep reduction factor = 3.0.

Reduction factors were determined by the owner based on evaluation of project conditions and geogrid tests and field performance data submitted by the manufacturer. If this information is not available, a global default value defined in chapter 3, could have been used.

Therefore:

$$T_a = \frac{(100 \text{ kN/m})}{(1.25)(1.2)(3)(1)} = 22 \text{ kN/m}$$

Pullout Resistance: $FS = 1.5$ for granular soils with a 1 m minimum length in the resisting zone.

Step 5. Check unreinforced stability .

The unreinforced slope stability was checked using the rotational slip surface method, as well as the wedge shaped failure surface method, to determine the limits of the reinforced zone and the required total reinforcement tension to obtain a factor of safety of 1.5.

The proposed new slope was first analyzed without reinforcement using a hand solution (e.g., the FHWA *Soils and Foundations Reference Manual*, 2000) or computer programs such as XSTABL, STABL4M, ReSSA or RSS. The computer program calculates factors of safety (FS) using the Modified Bishop Method for circular failure surface. Failure is considered through the toe of the slope and the crest of the new slope as shown in the design example figure 75a. Note that the minimum factor of safety for the unreinforced slope is less than 1.0. The failure surfaces are forced to exit beyond the crest until a factor of safety of 1.5 or more is obtained. Several failure surfaces should be evaluated using the computer program.

Next, the Janbu Method for wedge shaped failure surfaces is used to check sliding of the reinforced section for a factor of safety of 1.5, as shown on the design example figure 75a. Based on the wedge shaped failure surface analysis, the limits of the critical zone to be reinforced are reduced to 14 m at the top and 17 m at the bottom for the required factor of safety.

Step 6. Calculate T_S for $FS_R = 1.5$.

- a. The total reinforcement tension T_S required to obtain a $FS_R = 1.5$ is then evaluated for each failure surface. The most critical surface is the surface requiring the maximum reinforced tension T_{S-MAX} . An evaluation of all the surfaces in the critical zone indicated $T_{S-MAX} = 1000$ kN/m as determined using the equation 73:

$$T_S = (FS_R - FS_U) \frac{M_D}{D} = (1.5 - FS_U) \frac{M_D}{R}$$

The most critical circle is where the largest $T_S = T_{S-MAX}$. As shown on the design example figure 75a, T_{S-MAX} is obtained for $FS_U = 0.935$.

For this surface, $M_D = 67,800$ kN-m/m (as determined stability analysis).

$D = R$ for geosynthetics = radius of critical circle
 $R = 38.3$ m

$$T_{S-MAX} = (1.5 - 0.935) \frac{67,800 \text{ kN-m/m}}{38.3 \text{ m}} = 1000 \text{ kN/m}$$

- b. Check using chart design procedure:

For $\theta = 50^\circ$, and
 $\phi'_f = \tan^{-1} (\tan \phi_r / FS_R) = \tan^{-1} (\tan 34^\circ / 1.5) = 24.2^\circ$

Force coefficient, $K = 0.21$ (from figure 67a)
and,

$H' = H + q/\gamma_r = 19 \text{ m} + (12.5 \text{ kN/m}^2)/(18.8 \text{ kN/m}^3) = 19.7 \text{ m}$
then,

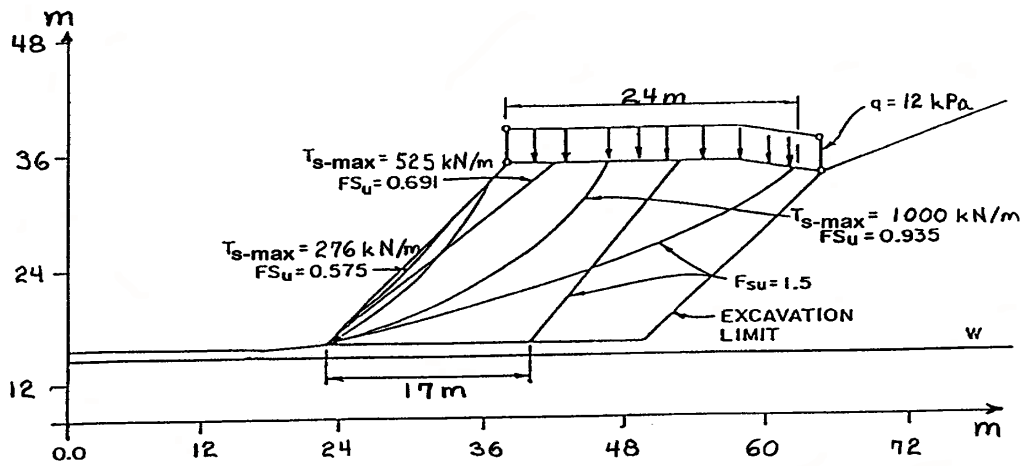

A) Step 5a : Preliminary design length
 Step 5b : Determine T_{max}

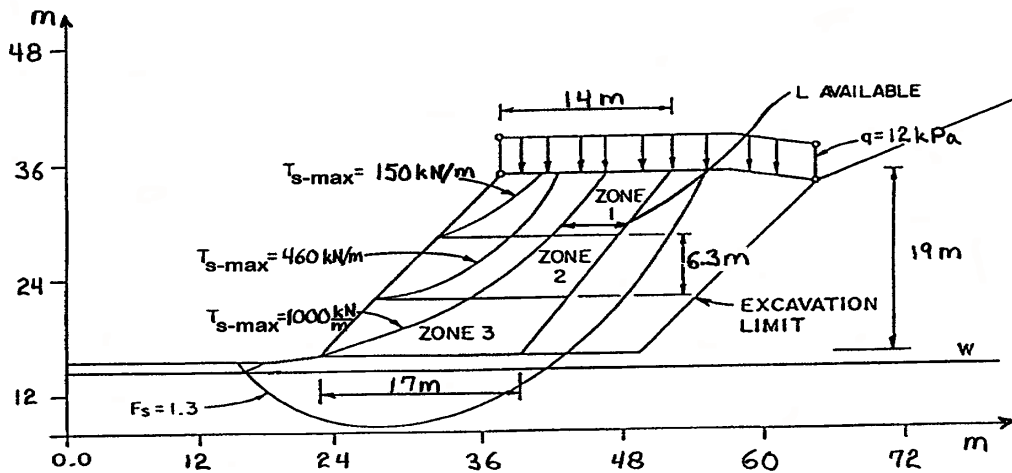

B) Step 5b : Determine T_{max}
 Step 5f : Check reinforcement in upper 2/3 & 1/3 of slope

Reinforcement alternatives:

From computer program:

$$T_{Bottom} = 1000 - 460 = 540 \text{ kN/m}$$

$$T_{Middle} = 460 - 150 = 310 \text{ kN/m}$$

$$T_{Top} = 150 \text{ kN/m}$$

Simplified distribution:

$$T_{Bottom} = \frac{1}{2} T_{s-max} = 500 \text{ kN/m}$$

$$T_{Bottom} = \frac{1}{3} T_{s-max} = 330 \text{ kN/m}$$

$$T_{Bottom} = \frac{1}{6} T_{s-max} = 170 \text{ kN/m}$$

Figure 75. Design example 2: stability analysis.

$$T_{S-MAX} = 0.5 K \gamma_r (H')^2 = 0.5(0.21)(18.8 \text{ kN/m}^3)(19.7 \text{ m})^2 \\ = 766 \text{ kN/m}$$

Values obtained from both procedures are comparable within 25 percent. Since the chart procedure does not include the influence of water, use $T_{S-MAX} = 1000 \text{ kN/m}$.

- c. Determine the distribution of reinforcement

Based on the overall embankment height divide the slope into three reinforcement zones of equal height as in equations 60 through 62.

$$T_{\text{bottom}} = \frac{1}{2} T_{S-MAX} = (\frac{1}{2})(1000 \text{ kN/m}) = 500 \text{ kN/m}$$

$$T_{\text{middle}} = \frac{1}{3} T_{S-MAX} = (\frac{1}{3})(1000 \text{ kN/m}) = 330 \text{ kN/m}$$

$$T_{\text{top}} = \frac{1}{6} T_{S-MAX} = (\frac{1}{6})(1000 \text{ kN/m}) = 170 \text{ kN/m}$$

- d. Determine reinforcement vertical spacing S_v .

Minimum number of layers,
$$N = \frac{T_{S-MAX}}{T_{\text{allowable}}} = \frac{1000 \text{ kN/m}}{22 \text{ kN/m}} = 45.5$$

Distribute at bottom 1/3 of slope:

$$N_B = \frac{500 \text{ kN/m}}{22 \text{ kN/m}} = 22.7 \text{ use } 23 \text{ layers}$$

At middle 1/3 of slope:

$$N_M = \frac{330 \text{ kN/m}}{22 \text{ kN/m}} = 15 \text{ layers}$$

At upper 1/3 of slope:

$$N_T = \frac{170 \text{ kN/m}}{22 \text{ kN/m}} = 7.7 \text{ use } 8 \text{ layers}$$

Total number of layers: $46 > 45.5$ OK

Vertical spacing:

Total height of slope = 19 m

Height for each zone = $19/3 = 6.3$ m

Required spacing:

At bottom 1/3 of slope:

$$S_{required} = \frac{6.3 \text{ m}}{23 \text{ layers}} = 0.27 \text{ m use } 250 \text{ mm spacing}$$

At middle 1/3 of slope:

$$S_{required} = \frac{6.3 \text{ m}}{15 \text{ layers}} = 0.42 \text{ m use } 400 \text{ mm spacing}$$

At top 1/3 of slope:

$$S_{required} = \frac{6.3 \text{ m}}{8 \text{ layers}} = 0.79 \text{ m use } 800 \text{ mm spacing}$$

Provide 2 m length of intermediate reinforcement layers in the upper 1/3 of the slope, between primary layers (based on primary reinforcement spacing at a 400 mm vertical spacing).

- e. The reinforcement tension required within the middle and upper 1/3 of the unreinforced slope is then calculated using the slope stability program to check that reinforcement provided is adequate as shown in the design example figure 75b.

Top 2/3 of slope: $T_{S-MAX} = 460 \text{ kN/m} < N \cdot T_a = 23 \text{ layers} \times 22 \text{ kN/m} = 506 \text{ kN/m}$

Top 1/3 of slope: $T_{S-MAX} = 150 \text{ kN/m} < N \cdot T_a = 8 \text{ layers} \times 22 \text{ kN/m} = 176 \text{ kN/m}$

- f. Determine the reinforcement length required beyond the critical surface for the entire slope from figure 75a, used to determine T_{max} from equation 77,

$$L_e = \frac{T_{max} FS}{F^* \alpha \sigma_v C} = \frac{(22 \text{ kN/m})(1.5)}{(0.8 \tan 34^\circ)(0.66)(18.8 \text{ kN/m}^2 \cdot Z)(2)} = \frac{2.5 \text{ m}}{Z}$$

At depth Z , from the top of the crest, L_e is found and compared to the available length of reinforcement that extends behind the T_{DESIGN} failure surface, as determined by the sliding wedge analysis:

$Z = 0.6$ m, $L_e = 4.2$ m, available length, $L_e = 5.2$ m OK

$Z = 1.2$ m, $L_e = 2.1$ m, available length, $L_e = 4.9$ m OK

$Z = 1.8$ m, $L_e = 1.4$ m, available length, $L_e = 4.9$ m OK

$Z = 2.0$ m, $L_e = 1.3$ m, available length, $L_e = 4.9$ m OK

$Z = 2.8 \text{ m}$, $L_e = 0.9 \text{ m}$, available length, $L_e = > 5 \text{ m}$ OK

Further checks of Z are unnecessary.

Checking the length using figure 67b for $\phi_f = 24^\circ$

$$L_T/H' = 0.65 \Rightarrow L_T = 12.8 \text{ m}$$

$$L_B/H' = 0.80 \Rightarrow L_B = 15.6 \text{ m}$$

Results from both procedures check well against the wedge failure analysis in step 5a. Realizing the chart solution does not account for the water table use top length $L_T = 14 \text{ m}$ and bottom length $L_B = 17 \text{ m}$ as determined by the computer analyses in step 5a.

- g. The available reinforcement strength and length were checked using the slope stability program for failure surfaces extending beyond the T_{S-MAX} failure surface and found to be greater than required.

Step 7. Check External Stability.

- a. Sliding Stability.

The external stability was checked using the computer program for wedge shaped failure surfaces. The FS obtained for the failure surface outside the reinforced section, defined with a 14 m length at the top and a 17 m length at the bottom, was 1.5.

- b. Deep Seated Global Stability.

The overall deep-seated failure analysis indicated that a factor of safety of 1.3 exists for failure surfaces extending outside the reinforced section (as shown in the design example figure 75b). This is due to the grade at the toe of the slope that slopes down into the lake. The factor of safety for deep-seated failure does not meet requirements. Therefore, either the reinforcement would have to be extended to a greater length, the toe of the new slope should be regraded, or the slope would have to be constructed at a flatter angle.

For the option of extending the reinforcement length, local bearing must be checked. Local bearing (lateral squeeze) failure does not appear to be a problem as the foundation soils are granular and will increase in shear strength due to confinement. Also, the foundation soil profile is consistent across the embankment such that global bearing and local bearing will essentially result in the same factor of safety. For these conditions, the lower level reinforcements could simply be extended back to an external stability surface that would provide $FS = 1.5$ as shown in figure 76.

If the foundation soils were cohesive and limited to a depth of less than 2 times the base width of the slope, then local stability should be evaluated. As an example, assume that the foundation soils had an undrained shear strength of 100 kPa and extended to a depth of 10 m, at which point the granular soils were encountered.

Then, in accordance with equation 71,

$$FS_{squeezing} = \frac{2 c_u}{\gamma D_s \tan \theta} + \frac{4.14 c_u}{H \gamma} =$$

$$FS_{squeezing} = \frac{2 (50 \text{ kPa})}{(18.8 \text{ kN/m}^3)(10.0 \text{ m})(\tan 50^\circ)} + \frac{4.14 (50 \text{ kPa})}{19 \text{ m} (18.8 \text{ kN/m}^3)} = 1.03$$

Since $FS_{squeezing}$ is lower than the required 1.3, extending the length of the reinforcement would not be an option without improving the stability conditions. This could be accomplished by either reducing the slope angle or by placing a surcharge at the toe, which effectively reduces the slope angle.

c. Foundation settlement.

Due to the granular nature of the foundation soils, long term settlement is not of concern.

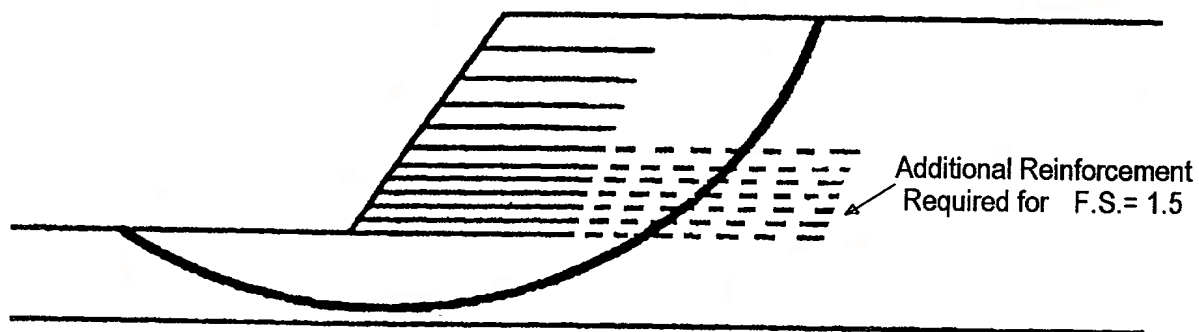

Figure 76. Design example 2: global stability.

c. Example 3. Computer-Aided Solution

ReSSA Design Check for Example 1 Reinforced Slope Design - Road Widening

The computer program ReSSA⁽³³⁾ could be used to check the design results of hand calculation example. ReSSA is a windows based interactive program specifically developed under sponsorship of the FHWA for the design and analysis of reinforced soil slopes. It follows this manual and portions of the manual are incorporated in the Help menu.

ReSSA has two modes of operation: *Design* and *Analysis*. In the *Design* mode, the program computes the required layout (length and vertical spacing) corresponding to user's prescribed safety factors. In this mode, the program produces the *ideal* reinforcement values for strength or coverage ratio so that the designer can maximize reinforcement utilization. In the *Analysis* mode, ReSSA computes the factors of safety corresponding to user's prescribed layout.

This section provides the steps and input necessary to evaluate the design shown in the first hand calculation example. [A design check with the predecessor FHWA reinforced slope program, RSS, is attached in appendix E.] The example problem will use the simple problem format on the initial screen*. The steps are as follows:

- ▶ Load the ReSSA Program.
- ▶ After the welcome screen, open the file menu, click on **new** and input the project information.
- ▶ On the **Main Menu** screen select **Analysis** under Mode of Operation, **Simple** under Geometry, **Geosynthetic** under Reinforcing Material, and then click on **Input Data**.

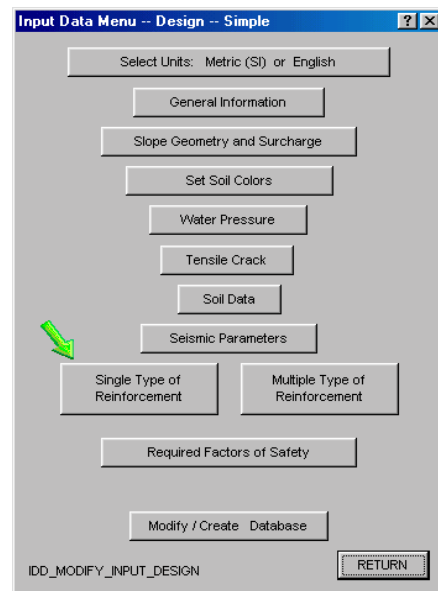
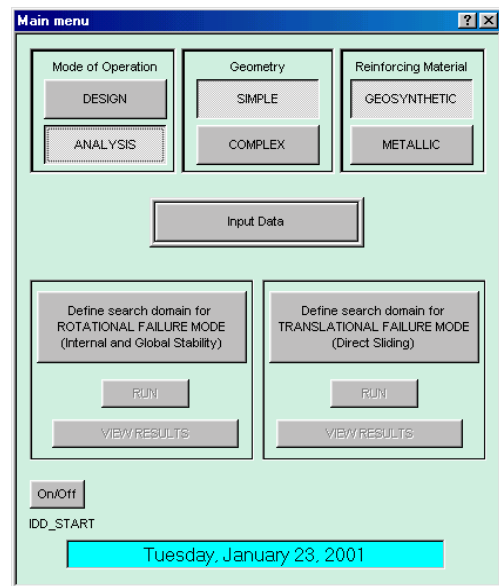

* Note that this output is from a pre-beta version of ReSSA, and therefore may not fully match output of released version.

Move to the **INPUT DATA MENU** screen and choose the **Select Units** and choose the units to be used (e.g., metric units for this problem).

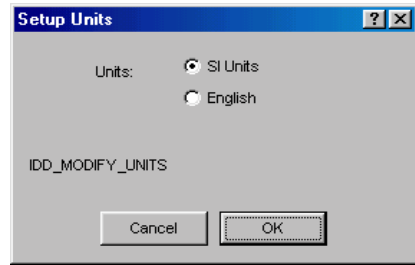

- ▶ Back to the **INPUT DATA MENU** screen and choose the **General Information** and input the **PROJECT IDENTIFICATION**.

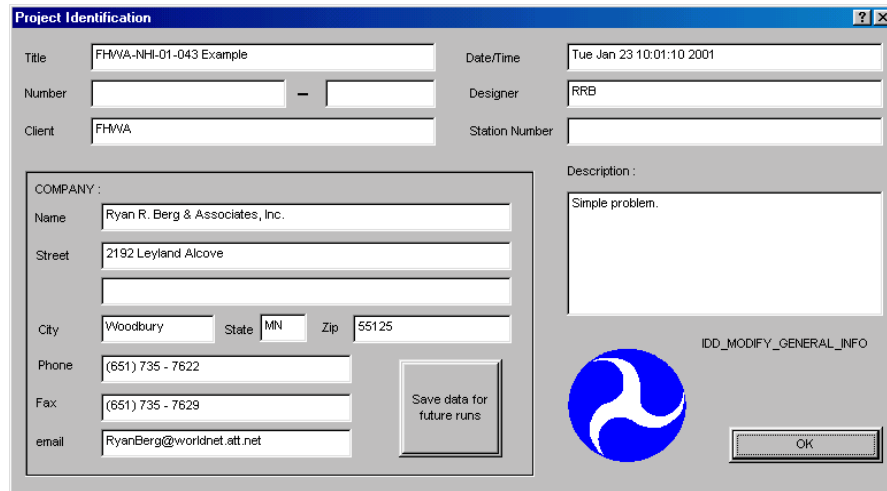

- ▶ Back to the **INPUT DATA MENU** screen and click on **Slope Geometry and Surcharge** and under the **SLOPE GEOMETRY – SIMPLE** input height, slope angle and surcharge load.

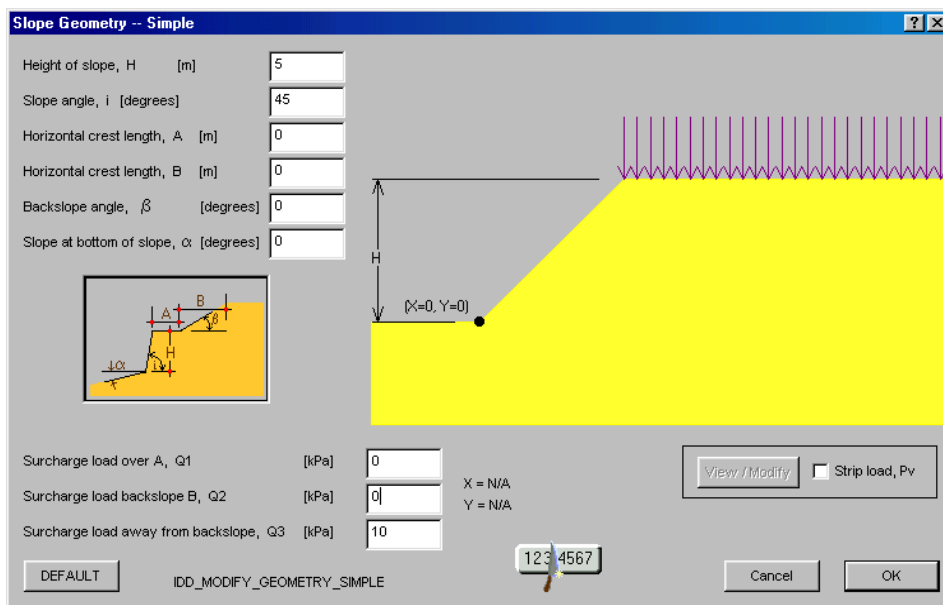

- ▶ Back to the **INPUT DATA MENU** screen and click on **Water Pressure** and under the **WATER PRESSURE** input depth to the phreatic line.

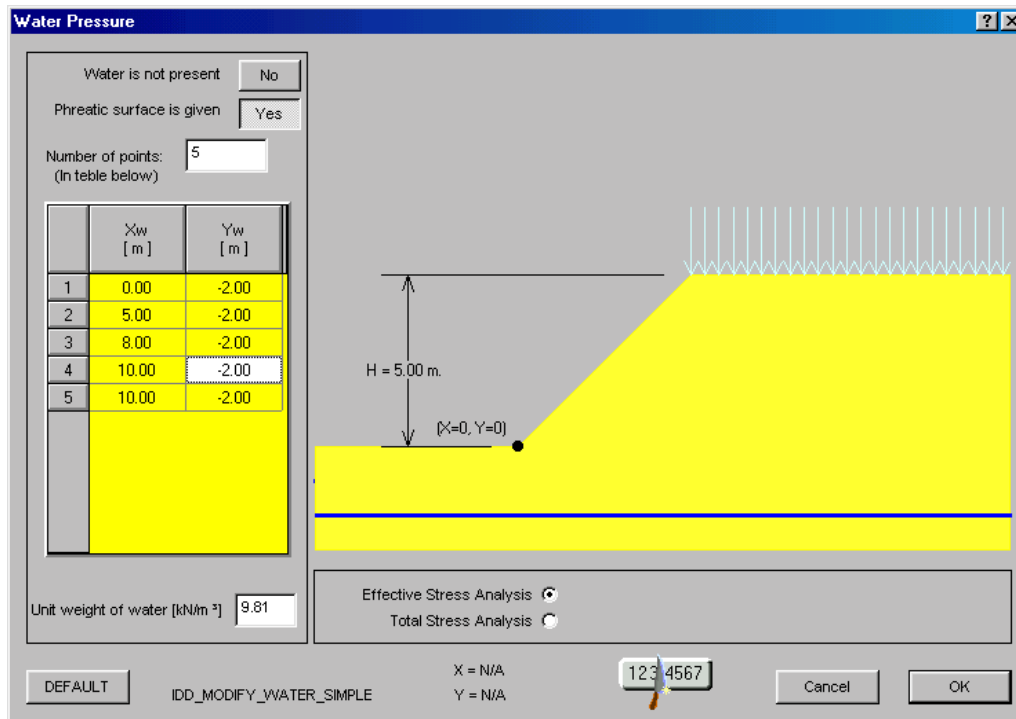

- ▶ Back to the **INPUT DATA MENU** screen and click on **Soil Data** and under the **SOIL DATA** input the soil shear strength parameters and unit weights.

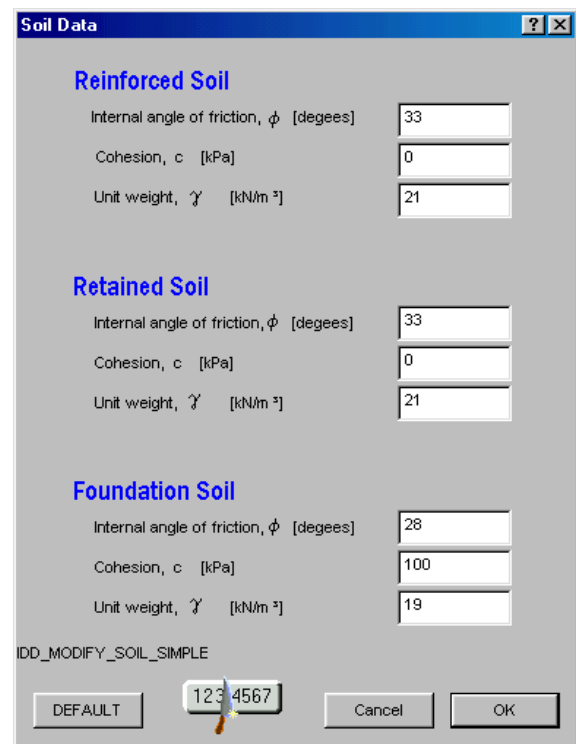

- Next back to the **INPUT DATA MENU** screen and click on **Single Type of Reinforcement**. Under **GEOSYNTHETIC REINFORCEMENT – ANALYSIS – SINGLE TYPE** enter the geosynthetic ultimate strength, installation damage reduction factor, durability reduction factor, creep reduction factor and coverage ratio.

Geosynthetic Reinforcement -- Analysis -- Single Type

? % of Tavailable at front-end

Slope and Reinforcement configuration

Number of equally spaced reinforcement layers, n
 Fixed spacing between layers [m]

Elevation of bottom geosynthetic layer [i.e., D] [m]

Uniform length of reinforcement [m]
 User specified length of each layer

Optional data retrival from :

| Geosynthetic Designated Name | Geosynthetic Ultimate Sterngh Tult. [kN/m] | Reduction factor for installation damage, RFid | Reduction factor for durability, RFD | Reduction factor for creep, RFC | Coverage ratio, Rfc |
|------------------------------|--------------------------------------------|------------------------------------------------|--------------------------------------|---------------------------------|---------------------|
| Geosynthetic type #1 | 11.90 | 1.25 | 1.15 | 2.00 | 1.00 |

Interaction Parameters

1234567

Cancel OK

- Under **GEOSYNTHETIC REINFORCEMENT – ANALYSIS – SINGLE TYPE** click on **FIXED SPACING BETWEEN LAYERS** and input spacing value and elevation to bottom geosynthetic layer. Then click on **USER SPECIFIED LENGTH OF EACH LAYER** and the **Manual Input of Lengths** screen opens. Enter the reinforcement lengths for each layer.

Manual Input of Lengths

| Layer | Elevation [m] | Length [m] |
|-------|---------------|------------|
| 1 | 0.20 | 5.40 |
| 2 | 0.60 | 5.40 |
| 3 | 1.00 | 5.40 |
| 4 | 1.40 | 5.40 |
| 5 | 1.80 | 4.20 |
| 6 | 2.20 | 4.20 |
| 7 | 2.60 | 4.20 |
| 8 | 3.00 | 4.20 |
| 9 | 3.40 | 2.90 |
| 10 | 3.80 | 2.90 |
| 11 | 4.20 | 2.90 |
| 12 | 4.60 | 2.90 |

IDD_SIMPLE_LENGTH_INPUT

DEFAULT Cancel OK

- Under **GEOSYNTHETIC REINFORCEMENT – ANALYSIS – SINGLE TYPE** click on **INTERACTION PARAMETERS** and the **Interaction Parameters – Analysis – Simple Geometry** screen opens. Enter the interaction values for reinforcement - reinforced fill and reinforcement - foundation soil, the relative orientation of reinforcement force (ROR) (a value of 1.0 is recommended for geosynthetic reinforcement), and required pullout factor of safety.

| Geosynthetic Type # | ρ [degrees] | $F^* = C_i \cdot \tan \phi$ | α |
|---------------------|------------------|------------------------------|----------|
| #1 | 22.0 | $F^* = 0.67 \cdot \tan \phi$ | 0.6 |

ρ = Friction angle along geosynthetic-soil interface. (Used in Direct Sliding analysis)
 F^* = Pullout resistance factor
 α = Scale effect correction factor } (Used in pullout computations)

In case the bottom layer interfaces with the foundation soil, the following data will be used along this interface:

ρ [degrees] = 18.6 $F^* = 0.67 \cdot \tan \phi$ $\alpha = 0.6$

Relative Orientation of Reinforcement Force (ROR), used only in rotational analysis, is prescribed as : ROR = 1

Assigned factor of Safety to resist pullout, $F_s - p_o = 1.5$

 IDD_MODIFY_DESIGN_PARAM_SINGLE

- Next back to the **MAIN MENU** screen and click on **Define search domain for ROTATIONAL FAILURE MODE.** The **SEARCH DOMAIN FOR ROTATIONAL ANALYSIS - SIMPLE SLOPE** screen opens, and for this example the default values were used. click **OK** and return to the **MAIN MENU**.

 Wednesday, January 24, 2001

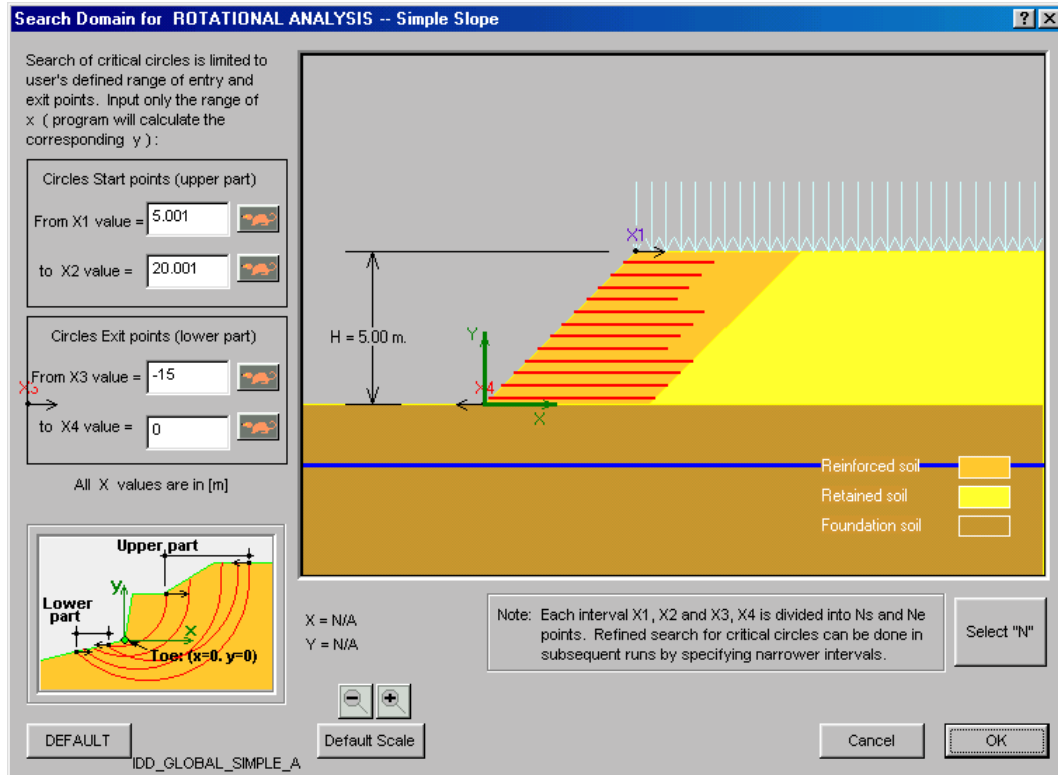

- ▶ Click on **RUN** and then on **VIEW RESULTS** under **DEFINE SEARCH DOMAIN FOR ROTATIONAL ANALYSIS - SIMPLE SLOPE**. The results of the rotational analysis are shown in the following screen (tabulated results also may be viewed).

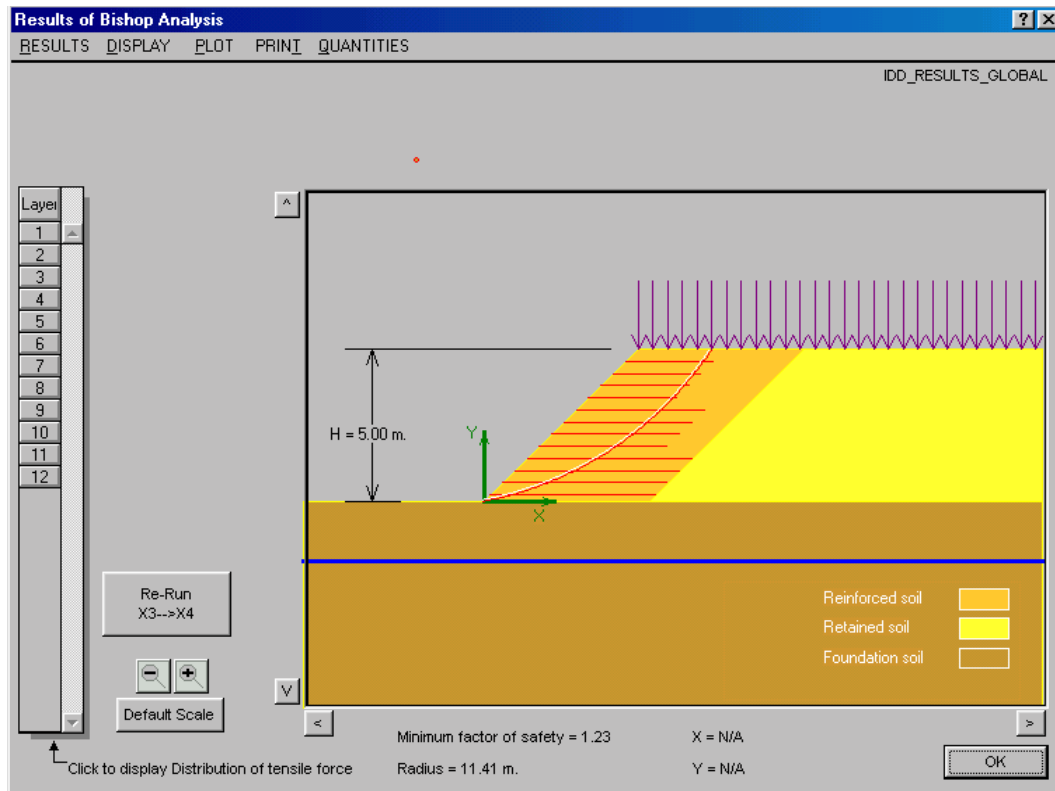

- Next back to the MAIN MENU screen and click on **Define search domain for TRANSLATIONAL FAILURE MODE (Direct Sliding)**. The SEARCH DOMAIN FOR TRANSLATIONAL ANALYSIS - SIMPLE SLOPE screen opens, and for this example the default values were used. click **OK** and return to the MAIN MENU.

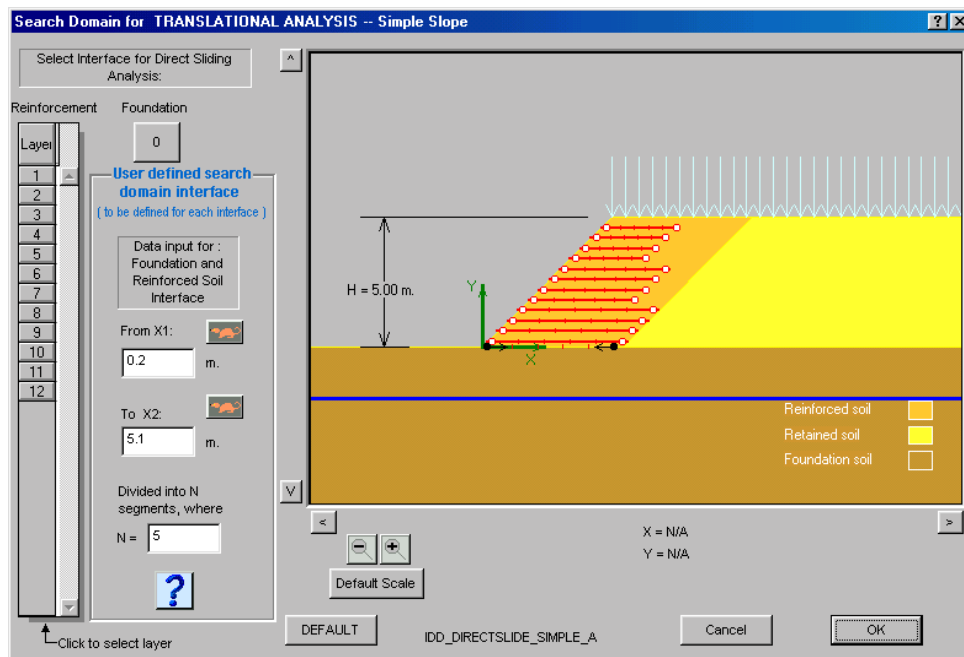
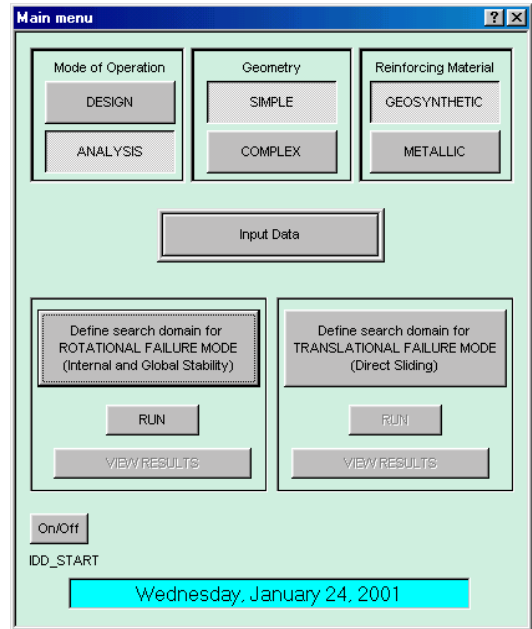

- Click on **RUN** and then on **VIEW RESULTS** under **DEFINE SEARCH DOMAIN FOR TRANSLATIONAL ANALYSIS - SIMPLE SLOPE**. The results of the rotational analysis are shown in the following screen (tabulated results also may be viewed).

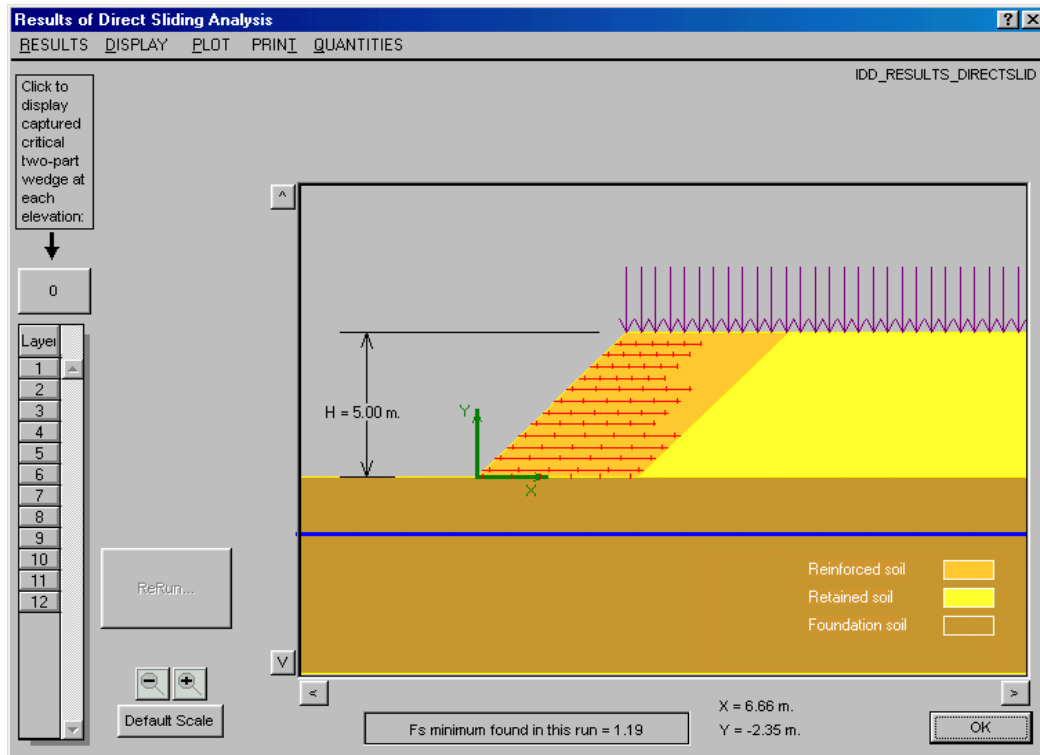

- ▶ Safety factor values of 1.23 for rotational and 1.19 for translational failure modes were computed. These are less than the safety factor values of 1.3 for rotational and 1.3 for translational failure modes used in the preliminary design hand calculation. One reason for the difference is that the reinforcement interaction values did not match those assumed for the design charts of Figure 67.
- ▶ Revising the reinforcement interaction values, to match the value assumed in Figure 67 design charts, as shown on the following screen, and rerunning the analyses produces different results.

| Geosynthetic Type # | ρ [degrees] | $F^* = C_i \cdot \tan \phi$ | α |
|---------------------|------------------|-----------------------------|----------|
| #1 | 30.3 | $F^* = 0.9 \cdot \tan \phi$ | 1.0 |

ρ = Friction angle along geosynthetic-soil interface. (Used in Direct Sliding analysis)
 F^* = Pullout resistance factor } (Used in pullout computations)
 α = Scale effect correction factor }

In case the bottom layer interfaces with the foundation soil, the following data will be used along this interface:

ρ [degrees] = 25.6 $F^* = 0.9 \cdot \tan \phi$ $\alpha = 1.0$

Relative Orientation of Reinforcement Force (ROR), used only in rotational analysis, is prescribed as : ROR = 1

Assigned factor of Safety to resist pullout, $F_s-po = 1.5$

- ▶ Click on **RUN** and then on **VIEW RESULTS** under **DEFINE SEARCH DOMAIN FOR TRANSLATIONAL ANALYSIS - SIMPLE SLOPE** and under **DEFINE SEARCH DOMAIN FOR ROTATIONAL ANALYSIS - SIMPLE SLOPE**. The results of the rotational analysis are shown in the following screens.
- ▶ Minimum safety factor values of 1.25 for rotational and 1.32 for translational failure modes were computed with the revised interaction values. The translational failure value is significantly different from the other computed value. Thus, highlighting the need to verify assumptions when using design charts of Figure 67 and the importance of accurate definition of interaction parameters.

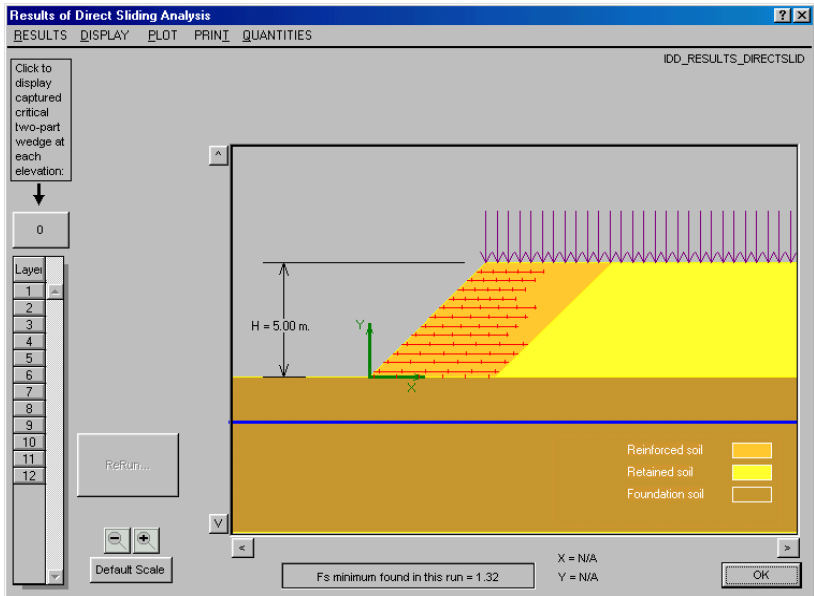
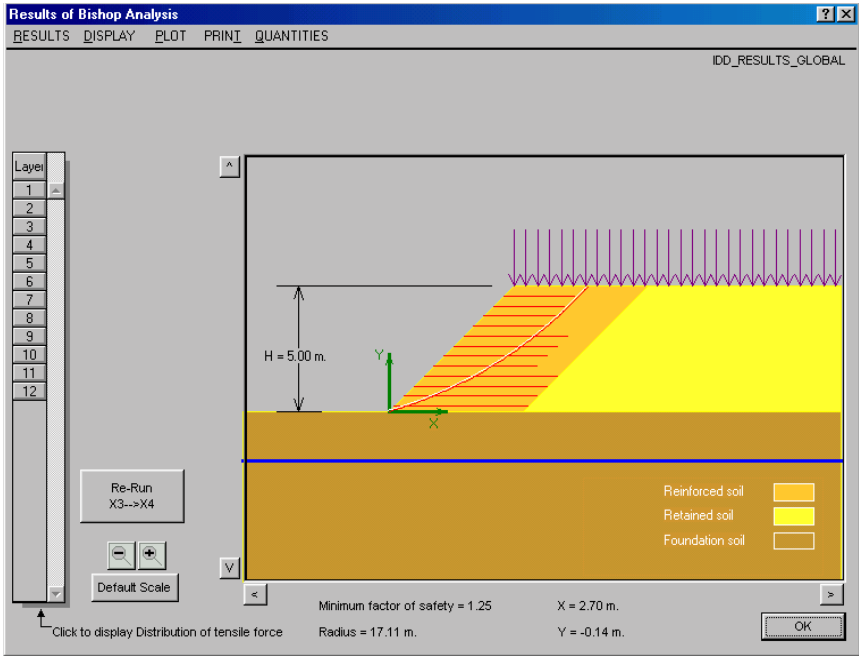

d. Example 4. Facing Stability Calculation

Economies can sometimes be achieved by using higher strength primary reinforcement at wider spacing combined with short intermediate reinforcement layers to meet maximum spacing requirements, provide compaction aids and face stability. The calculations for face stability evaluation of slopes using intermediate reinforcement will be demonstrated for the slope in Example 1, with modified primary reinforcement. The guidelines for intermediate reinforcement presented under Step 6 of section 7.2 Reinforced Slope Design Guidelines will be followed.

To evaluate cost alternatives in Example 1, modify primary reinforcement by doubling strength to 8.3 kN/m and doubling vertical spacing. Intermediate reinforcement will be placed at 800 mm vertical spacing, centered between the primary reinforcement (at 800 mm spacing). The length of intermediate reinforcement will be set at 1.2 m and minimum long term tensile strength, T_{al} , of 5.5 kN/m will be used to meet constructability requirements.

Surficial failure planes may extend to a depth of about 3 to 6% of the slope height. Therefore, the stability safety factor will be checked for depths up to 6% of slope height, for dry conditions. Also, checks will be performed at various depths assuming saturation to that depth, to see if project conditions (e.g., local rainfall) need to be further evaluated.

4. Check stability safety factor for various depths to potential failure plane. Compute depth equal to 6% of slope height.

$$(0.06) 5 \text{ m} = 0.5 \text{ m}$$

Check stability at 0.15 m, 0.3 m, and 0.6 m depths to potential failure plane. Use Equation 64 with the following parameters.

$$F.S. = \frac{c' H + (\gamma_g - \gamma_w) H z \cos^2 \beta \tan \phi' + F_g (\cos \beta \sin \beta + \sin^2 \beta \tan \phi')}{\gamma_g H z \cos \beta \sin \beta}$$

- where c' = effective cohesion — assume equal to zero, which conservatively neglects vegetative reinforcement. See guidance in Gray and Sotir⁽²⁵⁾, for guidance of estimating strength of vegetation, if desired to include in analysis.
- ϕ' = effective friction angle — 33°
- γ = unit weight of fill soil — 21 kN/m^3
- z = vertical depth to failure plane — 0.15 m, 0.3 m, and 0.6 m
- H = vertical slope height — 5 m
- β = slope angle — 45°
- F_g = summation of geosynthetic resisting force — varies by z , as strength at shallow embedments will likely be controlled by pullout resistance, therefore, compute by failure plane depth

Geosynthetic available reinforcement strength is based on pullout toward the front face of the slope (i.e., the geosynthetic resistance to the outward movement of the wedge of soil above and below the geosynthetic).

Primary reinforcement –

$$T_a (= T_{al}) = 8.3 \text{ kN/m}$$

Strength limited by pullout resistance near the face, with $FS_{PO} = 1.0$, equals

$$T = F^* \alpha \sigma_v C L_e$$

where F^* and α are as assumed for the geogrid in Example 1, and

$\sigma_v =$ the weight of the triangular wedge of soil over the geosynthetic $= \frac{1}{2}\gamma z$

$$L_e = z / \tan 45^\circ = z$$

$$C = 2$$

$$T = (0.8 \tan 33^\circ) (0.66) [\frac{1}{2} (21 \text{ kN/m}^2) (z)] (2) (z)$$

$$T = 7.2 z^2 \text{ kN/m}$$

Therefore, @ 0.15 m, $T = 0.16 \text{ kN/m}$

@ 0.3 m, $T = 0.65 \text{ kN/m}$

@ 0.6 m, $T = 2.6 \text{ kN/m}$

Intermediate reinforcement –

$$T_a (= T_{al}) = 5.5 \text{ kN/m}$$

Strength limited by pullout resistance, with $FS_{PO} = 1.0$, equals

$$T = F^* \alpha \sigma_v C L_e$$

assuming F^* and α parameters equal to those of the primary reinforcement again leads to,

@ 0.15 m, $T = 0.16 \text{ kN/m}$

@ 0.3 m, $T = 0.65 \text{ kN/m}$

@ 0.6 m, $T = 2.6 \text{ kN/m}$

The slope contains 6 layers of primary reinforcement and 6 layers of intermediate reinforcement. Therefore,

$$@ 0.15 \text{ m} - F_g = 6 (0.16 \text{ kN/m}) + 6 (0.16 \text{ kN/m}) = 1.9 \text{ kN/m}$$

$$@ 0.3 \text{ m} - F_g = 6 (0.65 \text{ kN/m}) + 6 (0.65 \text{ kN/m}) = 7.8 \text{ kN/m}$$

$$@ 0.6 \text{ m} - F_g = 6 (2.6 \text{ kN/m}) + 6 (2.6 \text{ kN/m}) = 31.2 \text{ kN/m}$$

With $c = 0$ and dry conditions, equation (64) reduces to

$$F.S. = \frac{\gamma H z \cos^2 \beta \tan \phi' + F_g (\cos \beta \sin \beta + \sin^2 \beta \tan \phi')}{\gamma H z \cos \beta \sin \beta}$$

$$F.S. = \frac{(21 \text{ kN/m}^3)(5 \text{ m})(\cos^2 45^\circ)(\tan 33^\circ) z + F_g [(\cos 45^\circ)(\sin 45^\circ) + (\sin^2 45^\circ)(\tan 33^\circ)]}{(21 \text{ kN/m}^3)(5 \text{ m})(\cos 45^\circ)(\sin 45^\circ) z}$$

$$F.S. = \frac{34.1 z + F_g (0.82)}{52.5 z}$$

Therefore,

$$@ 0.15 \text{ m, FS} = 0.85$$

$$@ 0.3 \text{ m, FS} = 1.1$$

$$@ 0.6 \text{ m, FS} = 1.5$$

Thus, assuming cohesion equal to zero, it is computed that the slope face is unstable at shallow depths (0.15 m to 0.3 m). A small amount of cohesion may be provided by the soil fill and/or vegetation. Assume a nominal amount of cohesion (e.g., 2 kPa), and recompute factors of safety.

$$cH = 2 \text{ kPa} (5 \text{ m}) = 10 \text{ kN/m}$$

Then, the factor of safety is equal to

$$F.S. = \frac{10 + 34.1 z + F_g (0.82)}{52.5 z}$$

and

$$@ 0.15 \text{ m, FS} = 2.1$$

$$@ 0.3 \text{ m, FS} = 1.7$$

$$@ 0.6 \text{ m, FS} = 1.8$$

Thus, with only a small amount of cohesion the slope face would be stable.

5. Check the safety factor for various depths to potential failure plane assuming saturation to that depth, to see if reasonable for project conditions.

With parameters of $\gamma_g - \gamma_w = 14 \text{ kN/m}^3$ and cohesion of 2 kPa (implies cohesion is derived from vegetation, and is retained under saturated conditions)

Then, the factor of safety is equal to

$$F.S. = \frac{10 + 22.7 z + F_g (0.82)}{52.5 z}$$

and

@ 0.15 m, FS = 1.9

@ 0.3 m, FS = 1.5

@ 0.6 m, FS = 1.6

Again, the slope is stable provided vegetation is established on the slope face. A geosynthetic erosion mat would also help maintain the face stability.

7.5 PROJECT COST ESTIMATES

Cost estimates for reinforced slope systems are generally per square meter of vertical face. Table 14 can be used to develop a cost estimate.

As an example, the following provides a cost estimate for design example 1 in chapter 7. Considering the 12 layers of reinforcement at a length of 5 m, the reinforced section would require a total reinforcement of 60 m² per meter length of embankment or 12 m² per vertical meter of height. Adding 10 percent to 15 percent for overlaps and overages results in an anticipated reinforcement quantity of 13.5 m² per meter embankment height. Based on the cost information in appendix C, reinforcement with an allowable strength $T_a \geq 4.14$ kN/m would cost on the order of \$1.00 to \$1.50/m². Assuming \$0.50/m² for handling and placement, the in-place cost of reinforcement would be approximately \$25/m² of vertical embankment face. Approximately 18.8 m³ of additional backfill would be required for the reinforced section per meter of embankment length. Using a typical in-place cost for locally available fill with some hauling of \$8/m³ (about \$4 per 1000 kg), \$30/m² will be added to the cost. In addition, overexcavation and backfill of existing embankment material will be required to allow for placement of the reinforcement. Assuming \$2/m³ for overexcavation and replacement will add approximately \$4/m² of vertical face. The erosion protection for the face would also add a cost of \$5/m² of vertical face plus seeding and mulching. Thus, the total estimated cost for this option would be on the order of \$64/m² of vertical embankment face. Alternative facing systems such as soil bioengineered treatment and/or the use of wire baskets for face would each add approximately \$20 to \$30/m² to the construction costs, but reduction in long-term maintenance will most likely offset these costs.

Table 14. Estimated Project Costs.

| Item | Total Volume | Unit Cost | Extension | per Vertical square meter |
|-------------------------------------|----------------|-----------|-----------|---------------------------|
| Backfill (in place) | m ³ | | | |
| Overexcavation | m ³ | | | |
| Reinforcement (in place) | m ² | | | |
| Facing system | | | | |
| Support | | | | |
| Vegetation | m ² | | | |
| Permanent erosion control mat | m ² | | | |
| Alternate facing systems | m ² | | | |
| Groundwater control system | m ² | | | |
| Guardrail | m | | | |
| Total | ----- | ----- | | |
| Unit cost per vertical square meter | | | | |

Note Slope Dimensions:

Height H =

Length L =

Face Surface Area, A =

Reinforcement Area = $L_{\text{reinforcement}} * \text{Number of Layers}$

CHAPTER 8

CONTRACTING METHODS AND SPECIFICATIONS FOR MSE WALLS AND SLOPES

From its introduction in the early 1970s, it is estimated that the total construction value of MSE walls is in excess of \$2 billion. This estimate does not include reinforced slope construction, for which estimates are not available.

Since the early 1980s, hundreds of millions of dollars have been saved on our Nation's highways by bidding **alternates** for selection of earth retaining structures. During that time, the number of available MSE systems or components and the frequency of design and construction problems have increased. Some problem areas that have been identified include misapplication of wall technology; poor specifications; lack of specification enforcement; inequitable bidding procedures; and inconsistent selection, review, and acceptance practices on the part of public agencies. Although the actual causes of each particular problem are unique, the lack of formal agency procedures that address the design and construction of earth retaining systems has repeatedly been an indirect cause.

MSE wall and RSS systems are contracted using two different approaches:

- ! Agency or material supplier designs with system components, drainage details, erosion measures, and construction execution explicitly specified in the contracting documents; or
- ! Performance or end-result approach using approved or generic systems or components, with lines and grades noted on the drawings and geometric and design criteria specified. In this case, a project-specific design review and detail plan submittal occurs in conjunction with a normal working drawing submittal.

Some user agencies prefer one approach over the other or a mixed use of approaches developed based upon criticality of a particular structure. Both contracting approaches are valid if properly implemented. Each approach has advantages and disadvantages.

This chapter will outline the necessary elements of each contracting procedure, the approval process and current material and construction specifications.

While this chapter specifically addresses the need for formal policy and procedures for MSE and RSS structures, the recommendations and need for uniformity of practice applies to all types of retaining structures.

8.1 POLICY DEVELOPMENT

It is desirable that each agency develop a formal policy with respect to design and contracting of MSE wall and RSS systems.

The general objectives of such a policy are to:

- ! Obtain agency uniformity.
- ! Establish standard policies and procedures for design technical review and acceptance of MSEW and RSS systems or components.
- ! Establish responsibility for the acceptance of new retaining wall and reinforced slope systems and or components.
- ! Delineate responsibility in house for the preparation of plans, design review and construction control.
- ! Delineate design responsibility for plans prepared by consultants and material suppliers.
- ! Develop design and performance criteria standards to be used on all projects.
- ! Develop and or update material and construction specifications to be used on all projects.
- ! Establish contracting procedures by weighing the advantages/disadvantages of proscriptive or end-result methods.

8.2 SYSTEM OR COMPONENT APPROVALS

The recent expiration of most process or material patents associated with MSE systems has led to introduction by numerous suppliers of a variety of complete systems or components that are applicable for use. Alternatively, it opens the possibility of agency-generic designs that may incorporate proprietary and generic elements.

Approval of systems or components is a highly desirable feature of any policy for reinforced soil systems prior to their inclusion during the design phase or as part of a value engineering alternate, subsequently offered.

For the purpose of prior approval, it is desirable that the supplier submit data that satisfactorily addresses the following items as a minimum:

- ! System development or component and year it was commercialized.
- ! Systems or component supplier organizational structure, specifically engineering and construction support staff.

- ! Limitations and disadvantages of system or component.
- ! Prior list of users including contact persons, addresses and telephone numbers.
- ! Sample material and construction control specifications showing material type, quality, certifications, field testing, acceptance and rejection criteria and placement procedures.
- ! A documented field construction manual describing in detail, with illustrations as necessary, the step-by-step construction sequence and the contractors quality control plan.
- ! Detailed design calculations for typical applications in conformance with current practice or AASHTO, whenever applicable.
- ! Typical unit costs, supported by data from actual projects.
- ! Independent performance evaluations of a typical project by a professional engineer.

The development, submittal, and approval of such a technical package provides a complete benchmark for comparison with systems that have been in successful use and a standard when checking project-specific designs.

For the purpose of review and approval of geosynthetics (systems or components) used for reinforcement applications, the manufacturer/supplier submittal must satisfactorily address the following items that are related to the establishment of an allowable tensile strength used in design:

- ! Laboratory test results documenting creep performance over a range of load levels for minimum duration of 10,000 hr. in accordance with ASTM D-5262.
- ! Laboratory test results and methodology for extrapolation of creep data for 75- and 100- year design life as described in appendix B.
- ! Laboratory test results documenting ultimate strength in accordance with ASTM D-4595, or GRI-GG1 for geogrids. Tests to be conducted at a strain rate of 10 percent per minute.
- ! Laboratory test results and extrapolation techniques, documenting the hydrolysis resistance of PET, oxidative resistance of PP and HDPE, and stress cracking resistance of HDPE for all components of geosynthetic and values for partial factor of safety for aging degradation calculated for a 75- and 100-year design life. Recommended methods are outlined in FHWA RD 97-144.
- ! Field and laboratory test results along with literature review documenting values for partial factor of safety for installation damage as a function of backfill gradation.

- ! For projects where a potential for biological degradation exists, laboratory test results and extrapolation techniques, documenting biological resistance of all material components of the geosynthetic and values for partial factor of safety for biological degradation.
- ! Laboratory test results documenting joint (seams and connections) strength and values for partial factor of safety for joints and seams (ASTM D-4884 and GRI: GG2).
- ! Laboratory tests documenting pullout interaction coefficients for various soil types or site-specific soils in accordance with GRI: GG5 and GT7. Appendix A details analysis procedures and methods.
- ! Laboratory tests documenting direct sliding coefficients for various soil types or project specific soils in accordance with ASTM D-5321.
- ! Manufacturing quality control program and data indicating minimum test requirements, test methods, test frequency, and lot size for each product. Further minimum conformance requirements as proscribed by the manufacturer shall be indicated. The following is a minimum list of conformance criteria required for approval:

| <u>Test</u> | <u>Test Procedure</u> | <u>Minimum Conformance Requirement</u> |
|----------------------------------|-----------------------|-----------------------------------------------------------------|
| Wide Width Tensile (geotextiles) | ASTM D-4595 | <i>To be provided by material supplier or specialty company</i> |
| Specific Gravity (HDPE only) | ASTM D-1505 | |
| Melt Flow index (PP & HDPE) | ASTM D-1238 | |
| Intrinsic Viscosity (PET only) | ASTM D-4603 | |
| Carboxyl End Group (PET only) | ASTM D-2455 | |
| Single Rib Tensile (geogrids) | GRI:GG1 | |

- ! The primary resin used in manufacturing shall be identified as to its ASTM type, class, grade, and category.

For HDPE resin type, class, grade and category in accordance with ASTM D-1248 shall be identified. For example type III, class A, grade E5, category 5.

For PP resins, group, class and grade in accordance with ASTM D-4101 shall be identified. For example group 1, class 1, grade 4.

For Polyester (PET) resins minimum production intrinsic viscosity (ASTM-4603) and maximum carboxyl end groups (ASTM D-2455) shall be identified.

For all products the minimum UV resistance as measured by ASTM D-4355 shall be identified.

Prior approval should be based on agency evaluations with respect on the following:

- ! The conformance of the design method and construction specifications to current agency requirements for MSE walls and RSS slopes and deviations to current engineering practice. For reinforced slope systems to current geotechnical practice.
- ! Past experience in construction and performance of the proposed system.
- ! The adequacy of the data in support of allowable strength (T_a) for geosynthetic reinforcements.
- ! The adequacy of the QA/QC plan for the manufacture of geosynthetic reinforcements.

8.3 DESIGN AND PERFORMANCE CRITERIA

It is highly desirable that each agency formalize its design and performance criteria as part of a design manual that may be incorporated in the *Bridge Design Manual* under *Retaining Structures for MSE walls* and/or a *Highway Design Manual* for reinforced slope structures. This would ensure that all designs whether Agency/Consultant or Supplier prepared, are based on equal, sound principles.

The design manual may adopt current AASHTO Section 5.8 *Mechanically Stabilized Earth (MSE) Walls*, or methods outlined in this manual as a primary basis for design and performance criteria and list under appropriate sections any deviations, additions and clarification to this practice that are relevant to each particular agency, based on its experience. Construction material specifications for MSE walls may be modeled on Section 7 of Division II of current AASHTO, *Earth Retaining Systems*, or the complete specifications contained in this chapter.

With respect to reinforced slope design, the performance criteria should be developed based on data outlined in chapter 7. Material and construction specifications for RSS are provided in this chapter as well as for drainage and erosion control materials usually required for such construction.

8.4 AGENCY OR SUPPLIER DESIGN

This contracting approach includes the development of a detailed set of MSE wall or RSS slope plans and material specifications in the bidding documents.

The advantage of this approach is that the complete design, details, and material specifications can be developed and reviewed over a much longer design period. This approach further empowers agency engineers to examine more options during design but requires an engineering staff trained in MSE and RSS technology. This trained staff is also a valuable asset during construction, when questions arise or design modifications are required.

The disadvantage is that for alternate bids, additional sets of designs and plans must be processed, although only one will be constructed. A further disadvantage is that newer and potentially less expensive systems or components may not be considered during the design stage.

The fully detailed plans shall include but not be limited to, the following items:

a. Plan and Elevation Sheets

- ! Plan view to reflect the horizontal alignment and offset from the horizontal control line to the face of wall or slope. Beginning and end stations for the reinforced soil construction and transition areas, and all utilities, signs, lights, etc. that affect the construction should be shown.
- ! For MBW unit faced walls, the plan view should show alignment baseline, limits of bottom of wall alignment and limits of top of wall alignment, as alignments vary with the batter of MBW system actually supplied.
- ! Elevation views indicating elevations at top and bottom of walls or slopes, beginning and end stations, horizontal and vertical break points, location and elevation of copings and barriers, and whole station points. Location and elevation of final ground line shall be indicated.
- ! Length, size, and type of soil reinforcement and where changes in length or type occur shall be shown.
- ! Panel and MBW unit layout and the designation of the type or module, the elevation of the top of leveling pad and footings, the distance along the face of the wall to all steps in the footings and leveling pads.
- ! Internal drainage alignment, elevation, and method of passing reinforcements around such structures.
- ! Any general notes required for construction.
- ! Cross sections showing limits of construction, fill requirements, and excavation limits. Mean high water level, design high water level, and drawdown conditions shall be shown where applicable.
- ! Limits and extent of reinforced soil volume.
- ! All construction constraints, such as staged construction, vertical clearance, right-of-way limits, etc.
- ! Payment limits and quantities.

b. Facing/Panel Details

- ! Facing details for erosion control for reinforced slopes and all details for facing modules, showing all dimensions necessary to construct the element, reinforcing steel, and the location of reinforcing attachment devices embedded in the panels.
- ! All details of the architectural treatment or surface finishes.

c. Drainage Facilities/Special Details

- ! All details for construction around drainage facilities, overhead sign footings, and abutments.
- ! All details for connection to traffic barriers, copings, parapets, noise walls, and attached lighting.
- ! All details for temporary support including slope face support where warranted.

d. Design Computations

The plans shall be supported by detailed computations for internal and external stability and life expectancy for the reinforcement.

For plans prepared by material suppliers, deep seated global stability is normally determined by the Owner and/or their consultant. Responsibility for compound stability analysis, when applicable, must be defined by the Owner.

e. Geotechnical Report

The plans shall be prepared based on a geotechnical report that details the following:

- ! Engineering properties of the foundation soils including shear strength and consolidation parameters used to establish settlement and stability potential for the proposed construction. Maximum bearing pressures must be established for MSE wall construction.
- ! Engineering properties of the reinforced soil including shear strength parameters (ϕ , c) compaction criteria, gradation, and electrochemical limits.
- ! Engineering properties of the fill or in situ soil behind the reinforced soil mass, including shear strength parameters (ϕ , c) and for fills compaction criteria.
- ! Groundwater or free water conditions and required drainage schemes if required.

f. Construction Specifications

Construction and material specifications for the applicable system or component as detailed later in this chapter, which include testing requirements for all materials used.

8.5 END RESULT DESIGN APPROACH

Under this approach, often referred as "line and grade" or "two line drawing," the agency prepares drawings of the geometric requirements for the structure or reinforced slope and material specifications for the components or systems that may be used. The components or systems that are permitted are specified or are from a pre-approved list maintained by the agency, from its prequalification process.

The end-result approach, with sound specifications and prequalification of suppliers and materials, offers several benefits. Design of the MSE structure is performed by trained and experienced staff. The prequalified material components (facing, reinforcement, and miscellaneous) have been successfully and routinely used together, which may not be the case for in-house design with generic specifications for components. Also, the system specification approach lessens engineering costs and manpower for an agency and transfers some of the project's design cost to construction.

The disadvantage is that agency engineers may not fully understand the technology at first and, therefore may not be fully qualified to review and approve construction modifications. Newer and potentially less expensive systems may not be considered due to the lack of confidence of agency personnel to review and accept these systems. In addition, complex phasing and special details are not addressed until after the contract has been awarded.

The bid quantities are obtained from specified pay limits denoted on the "line and grade" drawings and can be bid on a lump-sum or unit- price basis. The basis for detailed designs to be submitted after contract award are contained either as complete special provisions or by reference to AASHTO or agency manuals, as a special provision.

Plans, furnished as part of the contract documents, contain the geometric, geotechnical and design-specific information listed below:

a. Geometric Requirements

- ! Plan and elevation of the areas to be retained, including beginning and end stations.
- ! For MBW unit faced walls, the plan view should show alignment baseline, limits of bottom of wall alignment and limits of top of wall alignment, as alignments vary with the batter of MBW system actually supplied.
- ! Typical cross section that indicates face batter, pay limits, drainage requirements, excavation limits, etc.

- ! Elevation view of each structure showing original ground line, minimum foundation level, finished grade at ground surface, and top of wall or slope line.
- ! Location of utilities, signs, etc., and the loads imposed by each such appurtenance, if any.
- ! Construction constraints such as staged construction, right-of-way, construction easements, etc.
- ! Mean high water level, design high water level, and drawdown conditions where applicable.

b. Geotechnical Requirements

They are the same as in Section 8.4 except that the design responsibility is clearly delineated as to areas of contractor/supplier and agency responsibility.

Typically, the agency would assume design responsibility for developing stability, allowable bearing and settlement analyses, as they would be the same regardless of the system used. The contractor/supplier would assume responsibility for both internal and external stability for the designed structures.

c. Structural and Design Requirements

- ! Reference to specific governing sections of the agency design manual (materials, structural, hydraulic and geotechnical), construction specifications and special provisions. If none is available for MSE walls, refer to current AASHTO, both Division I, Design and Division II, Specifications.
- ! Magnitude, location, and direction of external loads due to bridges, overhead signs and lights, and traffic surcharges.
- ! Limits and requirements of drainage features beneath, behind, above, or through the reinforced soil structure.
- ! Slope erosion protection requirements for reinforced slopes.
- ! Size and architectural treatment of concrete panels for MSE walls.

d. Performance Requirements

- ! Tolerable movement of the structure both horizontal and vertical.
- ! Tolerable face panel movement.
- ! Monitoring and measurement requirements.

8.6 STANDARD DESIGNS

The development and use of standard MSEW and RSS designs are discussed in sections 4.8 and 6.8, respectively. With standard design, the agency has certain responsibilities in preparation of the project plans and the vendor has certain responsibilities. For the example standard designs⁽³⁴⁾, the following Agency responsibilities are noted on the standard plans.

a. MSEW Standard Designs

Agency Responsibilities:

In addition to the standard sheets, plan and front elevation views of the modular block retaining walls shall be included in the plans. The plan view must show alignment baseline, limits of bottom of wall alignment, and limits of top of all alignment as alignments vary with batter of wall system actually supplied. The front elevation must identify bottom and top of wall elevations, existing grades, and finished grades.

If the wall is curved, show the radius at the bottom and the top of each wall segment and the P.C. and P.T. station points off of baseline and limits of bottom and top of wall alignment.

Reference standard plates and provide details for traffic barriers, curb and gutter, handrails and fencing as required by project conditions. See AASHTO and Agency design manuals, standard plates and details for requirements.

Surface drainage patterns shall be shown in the plan view. Provide dimensions for width and depth of the drainage swale as well as the type of impervious liner material. Surface water runoff should be collected above and diverted around wall face.

Detail lines and grades of the internal drainage collection pipe. Detail or note the destination of internal wall drains as well as the method of termination (daylight end of pipe or connection into hydraulic structure).

Soft soils and/or high water conditions may not be suitable for application of standard designs and may require a project specific design.

Standard design charts are not applicable to:

- ! Project/sites where foundation soils shear strength and/or bearing capacity do not meet or exceed values used in the development of standard design charts.
- ! Projects with a large (Agency defined) quantity of face area where project specific designs are recommended.
- ! Where slopes in front of wall are steeper than 1:3.
- ! Where maximum wall height exceeds 7.0 m.
- ! Where walls are tiered.
- ! Walls with soundwalls.

Contractor Responsibilities:

Approved combinations of modular block unit and soil reinforcement products list with MBW reinforcement class noted are held and maintained by the Agency. Only approved product combinations may be used in standard designs.

Provide detailed drawings for construction containing:

- ! Elevation view with reinforcement placement requirements, wall facing layout, and geometric information. Top of wall may extend up to 100 mm (4 inches) above plan top of wall elevation.
- ! Plan view with bottom and top of wall alignment, and plan limits of wall alignment.
- ! Cross sections detailing batter, reinforcement, vertical spacing. Reinforcement lengths. Subsurface drainage, surface drainage, and water runoff collection above wall.
- ! Reinforcement layouts reinforcement shall be placed at 100% coverage ratio. Reinforcement elevations shall be consistent across length of wall structure.
- ! Note block, reinforcement, and fill placement methods and requirements.
- ! Detail all wall fill penetrations and wall face penetrations. Detail reinforcement and/or wall facing unit placement around penetrations.
- ! Details that are specific to vendor products and their interaction with other project components.
- ! List information on approved combination of MBW unit and geosynthetic reinforcement, including Agency classification code, nominal block width, properties for field identification, and installation instructions.
- ! Details of cap units and installation/fastening instructions for the caps. Cap units shall be set in a bed of adhesive designed to withstand moisture and temperature extremes, remain flexible, and shall be specifically formulated for bonding masonry to masonry.
- ! Certification by professional engineer that the construction layout meets the requirements of plans and Agency MSEW standards. Deviation from standard design tables by value engineering submittal only.

b. RSS Standard Designs

Agency Responsibilities:

Review by Turf and Erosion Prevention Unit and the Office of Environmental Services, shall be performed for all RSS applications. Turf establishment and maintenance items, hydroseeding over erosion control blanket, use of turf reinforcement mat in channelized flow areas, modification of seed mix, turf maintenance contract items, in addition to the details contained on these drawings, should be evaluated on a project basis.

In addition to the standard sheets, typical cross sections of the soil slopes shall be included in the plans as well as including soil slopes on the project cross sections.

Detail transition of RSS to adjacent slopes or structures.

Reference standard plates and provide details for traffic barriers, curb and cutter, handrails and fencing as required by project conditions. See AASHTO and Agency design manuals, standard plates, and details for requirements.

Detail lines and grades of the internal drainage collection pipe. Detail or note the destination of internal drains as well as the method of termination (daylight end of pipe or connection into adjacent hydraulic structure).

Surface drainage patterns shall be shown in the plan view. Surface water runoff should be collected above and diverted around slope face.

Define reinforced soil slope angle and define construction limits on the plan view based on this angle. Standard slope angles are 45 and 70 degrees.

Soft soils and/or high water conditions (defined as groundwater within a depth equal to the slope height H) may not be suitable for application of standard designs and requires special consideration by the Agency.

Standard designs are not applicable for projects with large quantity (Agency defined) of vertical face area where project specific designs are recommended.

Designs based on level backfill, zero toe slope and traffic surcharge. Slopes above or below the oversteepened reinforced slope are not suitable for application of standard designs and require special consideration by the Agency.

Refer to Case 1A and 1B for soil slopes between 1:2 (26.5°) and 45° maximum. Use Case 2 for soil slopes greater than 45° and up to 70° maximum.

Geotechnical investigation shall be performed for all RSS applications.

Agency Responsibilities:

Approved soil reinforcement products list, with type noted, and approved erosion control products list, are held and maintained by the Agency. Only approved products may be used in standard designs.

Provide detailed drawings for construction, containing:

- ! Elevation view with reinforcement placement requirements, soil slope layout and geometric information.
- ! Cross sections detailing slope face angle, reinforcement vertical spacing, reinforcement lengths, subsurface drainage, surface drainage, and slope face erosion protection.
- ! Detail all reinforced fill penetrations and face penetrations. Detail reinforcement and erosion protection placement around penetrations.
- ! List information on approved geosynthetic reinforcement, including Agency classification code, properties for field identification and installation

directions. List product and installation information on welded wire mesh facing forms if utilized.

- ! Certification by Professional Engineer that construction layout meets the requirements of plans and Agency RSS standards. Deviation from standard design tables by value engineering submittal only.

8.7 REVIEW AND APPROVALS

Where agency design is based on suppliers plans, it should be approved for incorporation in the contract documents following a rigorous evaluation by agency structural and geotechnical engineers. The following is a checklist of items requiring review:

- ! Conformance to the project line and grade.
- ! Conformance of the design calculations to agency standards or codes such as current AASHTO with respect to design methods, allowable bearing capacity, allowable tensile strength, connection design, pullout parameters, surcharge loads, and factors of safety.
- ! Development of design details at obstructions such as drainage structures or other appurtenances, traffic barriers, cast-in-place junctions, etc.
- ! Facing details and architectural treatment.

For end result contracting methods, the special provisions should contain a requirement that complete design drawings and calculations be submitted within 60 days of contract award for agency review.

The review process should be similar to the supplier design outlined above and be conducted by the agency's structural and geotechnical engineers.

8.8 CONSTRUCTION SPECIFICATIONS AND SPECIAL PROVISIONS FOR MSEW AND RSS CONSTRUCTION

A successful reinforced soil project will require sound, well-prepared material and construction specifications to communicate project requirements as well as construction guidance to both the contractor and inspection personnel. Poorly prepared specifications often result in disputes between the contractor and owner representatives.

A frequently occurring problem with MSE systems is the application of different or unequal construction specifications for similar MSE systems. Users are encouraged to utilize a single unified specification that applies to all systems, regardless of the contracting method used. The construction and material requirements for MSE systems are sufficiently well developed and understood to allow for unified material specifications and common construction methods.

Guide construction and material specifications are presented in this chapter for the following types of construction:

- ! Section 8.9 - Guide specifications for MSE walls with segmental precast concrete facings and steel reinforcements (grid or strip).
- ! Section 8.10 - Guide specifications for concrete modular block (MBW) facing.
- ! Section 8.10 - Guide specifications for geosynthetic reinforcement materials.
- ! Section 8.11 - Construction specifications and special provisions for RSS systems.

These guide specifications should serve as the technical basis for agency developed standard specifications for these items. Local experience and practice should be incorporated as applicable. The contractor should be required to submit a quality control plan detailing measurements and documentation that will be maintained during construction to assure consistency in meeting specification requirement.

8.9 GUIDE SPECIFICATIONS FOR MSE WALLS WITH SEGMENTAL PRECAST CONCRETE FACINGS

Description

This work shall consist of mechanically stabilized walls and abutments constructed in accordance with these specifications in reasonably close conformity with the lines, grades, and dimensions shown on the plans or established by the Engineer. Design details for these structures such as specified strip or mesh length, concrete panel thickness, and loading appurtenances shall be as shown on the plans. This specification is intended to cover all steel strip or mesh stabilized earth wall systems utilizing discrete concrete face panels, some of which may be proprietary.

Working Drawings

Working drawings and design calculations shall be submitted to the Engineer for review and approval at least 4 weeks before work is to begin. Such submittals shall be required (1) for each alternative proprietary or nonproprietary earth retaining system proposed as permitted or specified in the contract, (2) when complete details for the system to be constructed are not included in the plans, and (3) when otherwise required by the special provisions of these specifications. Working drawings and design calculations shall include the following:

- (1) Existing ground elevations that have been verified by the Contractor for each location involving construction wholly or partially in original ground.
- (2) Layout of wall that will effectively retain the earth but not less in height or length than that shown for the wall system in the plans.

- (3) Complete design calculations substantiating that the proposed design satisfies the design parameters in the plans and in the special provisions.
- (4) Complete details of all elements required for the proper construction of the system, including complete material specifications.
- (5) Earthwork requirements including specifications for material and compaction of backfill.
- (6) Details of revisions or additions to drainage systems or other facilities required to accommodate the system.
- (7) Other information required in the plans or special provisions or requested by the Engineer.

The contractor shall not start work on any earth retaining system for which working drawings are required until such drawings have been approved by the Engineer. Approval of the contractor's working drawings shall not relieve the contractor of any of his responsibility under the contract for the successful completion of the work.

Materials

General. The contractor shall make arrangements to purchase or manufacture the facing elements, reinforcing mesh or strips, attachment devices, joint filler, and all other necessary components. Materials not conforming to this section of the specifications or from sources not listed in the contract document shall not be used without written consent from the Engineer.

Reinforced Concrete Facing Panels. The panels shall be fabricated in accordance with Section 8.13 of AASHTO, Division II, with the following exceptions and additions.

- (1) The Portland cement concrete shall conform to Class A, (AE) with a minimum 27.6 MPa compressive strength at 28 days. All concrete shall have air entrainment of 6 percent \pm 1.5 percent with no other additives.
- (2) The units shall be fully supported until the concrete reaches a minimum compressive strength of 6.9 MPa. The units may be shipped after reaching a minimum compressive strength of 23.4 MPa. At the option of the contractor, the units may be installed after the concrete reaches a minimum compressive strength of 23.4 MPa.
- (3) Unless otherwise indicated on the plans or elsewhere in the specification, the concrete surface for the front face shall have a Class 1 finish as defined by section 8.12 and for the rear face a uniform surface finish. The rear face of the panel shall be screened to eliminate open pockets of aggregate and surface distortions in excess of 6 mm. The panels shall be cast on a flat area. the strips or other galvanized attachment devices shall not contact or be attached to the face panel reinforcement steel.
- (4) Marking - The date of manufacture, the production lot number, and the piece mark shall be clearly scribed on an unexposed face of each panel.

- (5) Handling, Storage, and Shipping - All units shall be handled, stored, and shipped in such a manner as to eliminate the dangers of chipping, discoloration, cracks, fractures, and excessive bending stresses. Panels in storage shall be supported in firm blocking to protect the panel connection devices and the exposed exterior finish.
- (6) Tolerances - All units shall be manufactured within the following tolerances:
- Panel Dimensions - Position panel connection devices within 25 mm (1-inch), except for all other dimensions within 5 mm (3/16-inch).
 - Panel Squareness - Squareness as determined by the difference between the two diagonals shall not exceed 13 mm (1/2-inch).
 - Panel Surface Finish - Surface defects on smooth formed surfaces measured over a length of 1.5 m (5 ft) shall not exceed 3 mm (C-inch). Surface defects on the textured-finish surfaces measured over a length of 1.5 m (5 ft) shall not exceed 8 mm (5/16-inch).
- (7) Steel - In accordance with section 9.
- (8) Compressive Strength - Acceptance of concrete panels with respect to compressive strength will be determined on the basis of production lots. A production lot is defined as a group of panels that will be represented by a single compressive strength sample and will consist of either 40 panels or a single day's production, whichever is less.

During the production of the concrete panels, the manufacturer will randomly sample the concrete in accordance with AASHTO T-141. A single compressive strength sample, consisting of a minimum of four cylinders, will be randomly selected for every production lot.

Compression tests shall be made on a standard 152 mm by 305 mm test specimen prepared in accordance with AASHTO T-23. Compressive strength testing shall be conducted in accordance with AASHTO T-22.

Air content testing will be performed in accordance with AASHTO T-152 or AASHTO T-196. Air content samples will be taken at the beginning of each day's production and at the same time as compressive samples are taken to ensure compliance.

The slump test will be performed in accordance with AASHTO T-119. The slump will be determined at the beginning of each day's production and at the same time as the compressive strength samples are taken.

For every compressive strength sample, a minimum of two cylinders shall be cured in accordance with AASHTO T-23 and tested at 28 days. The average compressive strength of these cylinders, when tested in accordance with AASHTO T-22, will provide a compressive strength test result that will determine the compressive strength of the production lot.

If the contractor wishes to remove forms or ship the panels prior to 28 days, a minimum of two additional cylinders will be cured in the same manner as the panels. The average compressive strength of these cylinders when tested in accordance with AASHTO T-22 will determine whether the forms can be removed or the panels shipped.

Acceptance of a production lot will be made if the compressive strength test result is greater than or equal to 27.6 MPa. If the compressive strength test result is less than 27.6 MPa, then acceptance of the production lot will be based on its meeting the following acceptance criteria in their entirety:

- Ninety percent of the compressive strength test results for the overall production shall exceed 28.6 MPa.
- The average of any six consecutive compressive strength test results shall exceed 29.3 MPa.
- No individual compressive strength test result shall fall below 24.8 MPa.

Rejection. Units shall be rejected because of failure to meet any of the requirements specified above. In addition, any or all of the following defects shall be sufficient cause for rejection:

- Defects that indicate imperfect molding.
- Defects indicating honeycombing or open texture concrete.
- Cracked or severely chipped panels.
- Color variation on front face of panel due to excess form oil or other reasons.

Soil Reinforcing and Attachment Devices. All reinforcing and attachment devices shall be carefully inspected to ensure they are true to size and free from defects that may impair their strength and durability.

- (1) Reinforcing Strips - Reinforcing strips shall be hot rolled from bars to the required shape and dimensions. Their physical and mechanical properties shall conform to either ASTM A-36 or ASTM A-572 grade 65 (AASHTO M-223) or equal. Galvanization shall conform to the minimum requirements or ASTM A-123 (AASHTO M-111).
- (2) Reinforcing Mesh - Reinforcing mesh shall be shop-fabricated of cold drawn steel wire conforming to the minimum requirements of ASTM A-82 (AASHTO M-32) and shall be welded into the finished mesh fabric in accordance with ASTM A-185 (AASHTO M-55). Galvanization shall be applied after the mesh is fabricated and conform to the minimum requirements of ASTM A-123 (AASHTO M-111).
- (3) Tie Strips - The tie strips shall be shop-fabricated of a hot rolled steel conforming to the minimum requirements of ASTM 570, Grade 50 or equivalent. Galvanization shall conform to ASTM A-123 (AASHTO M-111).

- (4) Fasteners - Fasteners shall consist of hexagonal cap screw bolts and nuts, which are galvanized and conform to the requirements of ASTM A-325 (AASHTO M-164) or equivalent.
- (5) Connector Pins - Connector pins and mat bars shall be fabricated from A-36 steel and welded to the soil reinforcement mats as shown on the plans. Galvanization shall conform to ASTM A-123 (AASHTO M-111). Connector bars shall be fabricated of cold drawn steel wire conforming to the requirements of ASTM A-82 (AASHTO M-32) and galvanized in accordance with ASTM A-123 (AASHTO M-111).

Joint Materials. Installed to the dimensions and thicknesses in accordance with the plans or approved shop drawings.

- (1) If required, provide flexible foam strips for filler for vertical joints between panels, and in horizontal joints where pads are used, where indicated on the plans.
- (2) Provide in horizontal joints between panels preformed EPDM rubber pads conforming to ASTM D-2000 for 4AA, 812 rubbers, neoprene elastomeric pads having a Durometer Hardness of 55 ±5, or high density polyethylene pads with a minimum density of 0.946 g/cm³ in accordance with ASTM 1505.
- (3) Cover all joints between panels on the back side of the wall with a geotextile meeting the minimum requirements for filtration applications as specified by AASHTO M-288. The minimum width and lap shall be 300 mm.

Select Granular Backfill Material. All backfill material used in the structure volume shall be reasonably free from organic or otherwise deleterious materials and shall conform to the following gradation limits as determined by AASHTO T-27.

| <u>U.S. Sieve Size</u> | <u>Percent Passing</u> |
|------------------------|------------------------|
| 102 mm | 100 |
| No. 40 mesh sieve | 0 - 60 |
| No. 200 mesh sieve | 0 - 15 |

The backfill shall conform to the following additional requirements:

- (1) The plasticity index (P.I.) as determined by AASHTO T-90 shall not exceed 6.
- (2) The material shall exhibit an angle of internal friction of not less than 34°, as determined by the standard direct shear test AASHTO T-236 on the portion finer than the No. 10 sieve, using a sample of the material compacted to 95 percent of AASHTO T-99, Methods C or D (with oversized correction as outlined in Note 7 at optimum moisture content). No testing is required for backfills where 80 percent of sizes are greater than 19 mm.

- (3) Soundness - The materials shall be substantially free of shale or other soft, poor- durability particles. The material shall have a magnesium sulfate soundness loss of less than 30 percent after four cycles, measured in accordance with AASHTO T-104, or a sodium sulfate loss of less than 15 percent after five cycles determined in accordance with AASHTO T-104.
- (4) Electrochemical Requirements - The backfill materials shall meet the following criteria:

| <u>Requirements</u> | <u>Test Methods</u> |
|----------------------------------|---------------------|
| Resistivity >3,000 ohm-cm | AASHTO T-288-91 |
| pH 5-10 | AASHTO T-289-91 |
| Chlorides <100 parts per million | AASHTO T-291-91 |
| Sulfates <200 parts per million | AASHTO T-290-91 |
| Organic Content <1% | AASHTO T-267-86 |

If the resistivity is greater or equal to 5000 ohm-cm, the chloride and sulfates requirements may be waived.

Concrete Leveling Pad. The concrete footing shall conform to AASHTO Division II, section 8.2 for Class B concrete.

Acceptance of Material. The contractor shall furnish the Engineer a Certificate of Compliance certifying the above materials, comply with the applicable contract specifications. A copy of all test results performed by the contractor necessary to assure contract compliance shall be furnished to the Engineer.

Acceptance will be based on the Certificate of Compliance, accompanying test reports, and visual inspection by the Engineer, or tests performed independently by the Engineer.

Construction

Wall Excavation. Unclassified excavation shall be in accordance with the requirements of AASHTO Division II, Section 1 and in reasonably close conformity to the limits and construction stages shown on the plans. Temporary excavation support as required shall be the responsibility of the contractor.

Foundation Preparation. The foundation for the structure shall be graded level for a width equal to the length of reinforcement elements plus 300 mm or as shown on the plans. Prior to wall construction, except where constructed on rock, the foundation shall be compacted with a smooth wheel vibratory roller. Any foundation soils found to be unsuitable shall be removed and replaced with select granular backfill as per Materials of these specifications.

At each panel foundation level, a precast reinforced or a cast-in-place unreinforced concrete leveling pad of the type shown on the plans shall be provided. The leveling pad shall be cured a minimum of 12 hours before placement of wall panels.

Wall Erection. Where a proprietary wall system is used, a field representative shall be available during the erection of the wall to assist the fabricator, contractor, and engineer.

Precast concrete panels shall be placed so that their final position is vertical or battered as shown on the plans. For erection, panels are handled by means of lifting devices connected to the upper edge of the panel. Panels should be placed in successive horizontal lifts in the sequence shown on the plans as backfill placement proceeds. As backfill material is placed behind the panels, the panels shall be maintained in position by means of temporary wedges or bracing according to the wall supplier's recommendations. Concrete facing vertical tolerances and horizontal alignment tolerances shall not exceed 20 mm when measured with a 3 m straight edge. During construction, the maximum allowable offset in any panel joint shall be 20 mm. The completed wall shall have overall vertical tolerance of the wall (top to bottom) shall not exceed 13 mm per 3 m of wall height. Reinforcement elements shall be placed normal to the face of the wall, unless otherwise shown on the plans. Prior to placement of the reinforcing elements, backfill shall be compacted in accordance with these specifications.

Backfill Placement. Backfill placement shall closely follow erection of each course of panels. Backfill shall be placed in such a manner as to avoid any damage or disturbance of the wall materials or misalignment of the facing panels or reinforcing element. Any wall materials that become damaged during backfill placement shall be removed and replaced at the contractor's expense. Any misalignment or distortion of the wall facing panels due to placement of backfill outside the limits of this specification shall be corrected at the contractor's expense. At each reinforcement level, the backfill shall be placed and compacted to the level of the connection. Backfill placement methods near the facing shall assure that no voids exist directly beneath the reinforcing elements.

Backfill shall be compacted to 95 percent of the maximum density as determined by AASHTO T-99, Method C or D (with oversize corrections as outlined in Note 7 of that test). For backfills containing more than 30 percent retained on the 19 mm sieve, a method compaction consisting of at least four passes by a heavy roller shall be used. For applications where spread footings are used to support bridge or other structural loads, the top 1.5 m below the footing elevation should be compacted to 100 percent AASHTO T-99.

The moisture content of the backfill material prior to and during compaction shall be uniformly distributed throughout each layer. Backfill materials shall be placed at a moisture content not more than 2 percentage points less than or equal to the optimum moisture content. Backfill material with a placement moisture content in excess of the optimum moisture content shall be removed and reworked until the moisture content is uniformly acceptable throughout the entire lift.

The maximum lift thickness before compaction shall not exceed 300 mm. The contractor shall decrease this lift thickness, if necessary, to obtain the specified density. Compaction within 1 m of the back face of the wall shall be achieved by at least three passes of a lightweight mechanical tamper, roller, or vibratory system.

At the end of each day's operation, the contractor shall slope the level of the backfill away from the wall facing to rapidly direct runoff away from the face. The contractor shall not allow surface runoff from adjacent areas to enter the wall construction site.

Measurement

Wall Materials. The unit of measurement for furnishing and fabricating all materials for the walls, including facing materials, reinforcement elements, attachment devices, joint materials, and incidentals will be the square meter of wall face constructed.

Wall Erection. The unit of measurement for wall erection will be per square meter of wall face. The quantity to be paid for will be the actual quantity erected in place at the site. Payment shall include compensation for foundation preparation, technical representatives, reinforcement elements, and erection of the panel elements to the lines and grade shown on the plans.

Concrete Leveling Pad. The unit of measurement for the concrete leveling pad will be the number of linear meters, complete in place and accepted, measured along the lines and grade of the footing.

Select Granular Backfill. The unit of measurement for select granular backfill will be the embankment plan quantity in cubic meters.

Payment

The quantities, determined as described above, will be paid for at the contract price per unit of measurement, respectively, for each pay item listed below and shown in the bid schedule, which prices and payment will be full compensation for the work prescribed in this section, except as provided below:

Excavation of unsuitable foundation materials will be measured and paid for as provided in AASHTO Division II, Section 1. Select backfill for replacement of unsuitable foundation materials will be paid for under item (4).

Payment will be made under:

| | <u>Pay Item</u> | <u>Pay Unit</u> |
|----|--------------------------|-----------------|
| 1. | Wall materials | Square meter |
| 2. | Wall erection | Square meter |
| 3. | Concrete leveling pad | Linear meter |
| 4. | Select granular backfill | Cubic meter |
| 5. | Coping barrier | Linear meter |
| 6. | Traffic barriers | Linear meter |

MSE walls have been contracted on a lump sum or per wall basis to include compensation for all excavation, temporary support as required, materials, labor and incidental construction. For equitable bidding this method requires accurate quantity determinations and a method of compensation for changed conditions and or overruns/underruns of quantities.

8.10 GUIDE SPECIFICATIONS FOR CONCRETE MODULAR BLOCK (MBW) FACING AND UNIT FILL

Where MBW units are specified for a project, the primary specification detailed in Section 8.11, requires a deletion of *Reinforced Concrete Facing Panels* and the insertion of a new section detailed below. *Wall erection* requires the deletion of the first two sentences from the second paragraph. A specification for unit fill placed within the MBW units must be added.

It is presently recommended that ASTM C 1372, Standard Specification for Segmental Retaining Wall Units specifications be used as a model, except that the compressive strength for units should be increased to 28 MPa (4,000 psi) to increase durability, maximum water absorption be limited to 5 percent, requirements for freeze-thaw testing modified, and tolerance limits expanded.

Note that more stringent durability requirements are being used by the Minnesota Department of Transportation (MN/DOT) based upon their experience, research, climatic conditions and deicing salt usage. The MN/DOT criteria wall and cap units shall conform to ASTM C1372, except for the items in the following table.

| Item | Test Standard | Requirement |
|--------------------------------------|--------------------------------------------------------------------------------------------------------------------------------------------------------------------------------------------------------------------------------------------------------------------------------------------------------------------|----------------------------------------------------------------------------------------------------------------------------------------------------------------------------------------------------------------------------------------------------------------------------------------------------------------------------------------|
| Compressive strength | ASTM C 140 | 38 MPA min. 40 MPA min. Ave. for 3 units |
| Water absorption | ASTM C 140 | ≤ 5% after 24 hours |
| Freeze-thaw durability of wall units | ASTM C 1262 – Test in a 3% saline solution. Continue testing (and report results of) until (1) weight loss of each of 5 specimens exceeds 2% of its initial weight; OR (2) weight loss of 1 of the 5 test specimens exceeds 2.5% of its initial weight; OR (3) specimens have been tested for at least 100 cycles. | (1) Weight loss of each of 5 test specimens at the conclusion of 90 cycles shall not exceed 1% of its initial weight; OR (2) Weight loss of 4 out of 5 test specimens at the conclusion of 100 cycles shall not exceed 1.5% of its initial weight, with the maximum allowable loss for the 5 th specimen to not exceed 10%. |
| Freeze-thaw durability of cap units | – same as for wall units – | – same as for wall units, except (1) is at conclusion of 40 cycles and (2) is at conclusion of 50 cycles for – |
| Cap unit | — | Top surface sloped at 1 mm fall per 10 mm run front to back or crowned at the center. |
| Surface sealer | Contact MN/DOT Concrete Engineering Unit for requirements. | Apply surface sealer to the top, exposed front face and back side of the upper three courses. |

The full amended specification is included as follows:

Scope

This specification covers hollow and solid concrete structural retaining wall units, machine made from Portland cement, water, and suitable mineral aggregates with or without the inclusion of other materials. The units are intended for use in the construction of mortarless, modular block (MBW) retaining walls.

Referenced ASTM Documents

- C-33 Specifications for Concrete Aggregates
- C-140 Methods of Sampling and Testing Concrete Masonry Units
- C-150 Specification for Portland Cement
- C-331 Specification for Lightweight Aggregates for Concrete Masonry Units
- C-595M Specification for Blended Hydraulic Cements
- C-618 Specification for Fly Ash and Raw or Calcined Natural Pozzolan for Use as a Mineral Admixture in Portland Cement Concrete.
- C-989 Specification for Ground Granulated Blast Furnace Slag Cement
- C-1262 Test Method for Evaluating the Freeze-Thaw Durability of Manufactured Concrete Masonry Units and Related Concrete Products

Materials

- 1.0 Cementitious Materials - Materials shall conform to the following applicable specifications:
 - 1.1 Portland Cement - Specification C-150.
 - 1.2 Modified Portland Cement - Portland Cement conforming to Specification C-150, modified as follows:
 - 1.2.1 Limestone - Calcium carbonate, with a minimum 85% (CaCO_3) content, may be added to the cement, provided the requirements of Specification C 150 as modified are met:
 - 1) Limitation on Insoluble Residue - 1.5%
 - 2) Limitation on Air Content of Mortar - Volume percent, 22% max.
 - 3) Limitation on Loss of Ignition - 7%
 - 1.3 Blended Cements - Specification C-595M or C1157C .
 - 1.4 Pozzolans - Specification C-618.
 - 1.5 Blast Furnace Slag Cement - Specification C-989.

NOTE: *Sulphate resistant cement should be used in the manufacture of units to be used in areas where the soil has high sulphate content such as arid regions of the western United States.*

- 2.0 Aggregates - Aggregates shall conform to the following specifications, except that grading requirements shall not necessarily apply:
 - 2.1 Normal Weight Aggregates - Specification C-33.
 - 2.2 Lightweight Aggregates - Specification C-331.
 - 2.3 Aggregate Soundness - Aggregate soundness shall be determined in accordance with AASHTO T-103 and/or T-104. *Acceptance shall be based on the Agency requirements for hydraulic cement concrete.*
- 3.0 Other Constituents - Air-entraining agents, coloring pigments, integral water repellents, finely ground silica, and other constituents shall be previously established as suitable for use in concrete MBW units shall conform to applicable ASTM Standards or, shall be shown by test or experience to be not detrimental to the durability of the MBW units or any material customarily used in masonry construction.

Physical Requirements

- 1.0 At the time of delivery to the work site, the units shall conform to the following physical requirements:

Table 1. Physical Requirements

| | | |
|------------------------------------------------------------------|---|----------|
| Minimum required compressive strength (Average 3 coupons) MPA | = | 28 MPA |
| Minimum required compressive strength (Individual coupon) MPA | = | 24.5 MPA |
| Maximum water absorption | = | 5% |
| Maximum number of blocks per lot | = | 2,000 |

- 2.0 Freeze-Thaw Durability. In areas where repeated freezing and thawing under saturated conditions occur, the units shall be tested to demonstrate freeze-thaw durability in accordance with Test Method ASTM C 1262. Freeze-thaw durability shall be based on tests from five specimens made with the same materials, concrete mix design, manufacturing process, and curing method, conducted not more than 24 months prior to delivery.
- 2.1 Acceptance Criteria. Specimens shall comply with either of the following:

- The weight loss of four out of five specimens at the conclusion of 150 cycles shall not exceed 1% of its initial weight when tested in water.
- The weight loss of each of four of the five test specimens at the conclusion of 50 cycles shall not exceed 1.5% of its initial mass when tested in a 3% saline solution. *The agency may require that either or both acceptance criteria be met depending on the severity of the project location.*

3.0 Tolerances. Blocks shall be manufactured within the following tolerances:

3.1 The length and width of each individual block shall be within ± 3.2 mm of the specified dimension. Hollow units shall have a minimum wall thickness of 32 mm.

3.2 The height of each individual block shall be within ± 1.6 mm of the specified dimension.

3.3 When a broken face finish is required, the dimension of the front face shall be within ± 25 mm of the theoretical dimension of the unit.

3.4 Finish and Appearance. All units shall be sound and free of cracks or other defects that would interfere with the proper placing of the unit or significantly impair the strength or permanence of the construction. Minor cracks (e.g. no greater than 0.5 mm in width and no longer than 25% of the unit height) incidental to the usual method of manufacture or minor chipping resulting from shipment and delivery, are not grounds for rejection.

The face or faces of units that are to be exposed shall be free of chips, cracks or other imperfections when viewed from a distance of 10 m under diffused lighting. Up to five percent of a shipment may contain slight cracks or small chips not larger than 25 mm.

Color and finish shall be as shown on the plans and shall be erected with a running bond configuration.

3.5 If pins are required to align MBW units, they shall consist of a nondegrading polymer or galvanized steel and be made for the express use with the MBW units supplied.

3.6 Cap units shall be cast to or attached to the top MBW units in strict accordance with the manufacturer's requirements and the adhesive manufacturer's recommended procedures. Contractor shall provide a written 10 year warranty, acceptable to the Owner, that the integrity of the materials used to attach the cap blocks will preclude separation and displacement of the cap blocks for the warranty period.

4.0 Sampling and Testing. Acceptance of the concrete block with respect to compressive strength, will be determined on a lot basis. The lot will be randomly sampled in accordance with ASTM C-140. Compressive strength tests shall be performed by the manufacturer and submitted to the Owner. Compressive strength test specimens shall be cored or shall conform to the saw-cut coupon provisions of section 5.2.4 of ASTM C-140. Blocks represented by test coupons that do not reach an average compressive strength of 28 MPA will be rejected.

4.1 Rejection. Blocks shall be rejected because of failure to meet any of the requirements specified above. In addition, any or all of the following defects shall be sufficient cause for rejection.

- Defects that indicate imperfect molding.
- Defects indicating honeycomb or open texture concrete.
- Cracked or severely chipped blocks.
- Color variation on front face of block due to excess form oil or other reasons.

Unit Fill

The unit fill and drainage aggregate shall be a well graded crushed stone or granular fill meeting the following gradation:

| <u>U.S. Sieve Size</u> | <u>Percent Passing</u> |
|------------------------|------------------------|
| 25 mm | 100-75 |
| 19 mm | 50-75 |
| No. 4 | 0-60 |
| No. 40 | 0-50 |
| No.200 | 0-5 |

8.11 GUIDE SPECIFICATIONS FOR GEOSYNTHETIC REINFORCEMENT MATERIALS

Where geosynthetic reinforcements are used for the construction of MSE walls with either modular block facings (MBW) or segmental precast concrete units, the primary specification under *Materials, Soil Reinforcement and Attachment Devices* should be replaced as follows:

Materials

1.0 *Geotextiles and Thread for Sewing*

Woven or nonwoven geotextiles shall consist only of long chain polymeric filaments or yarns formed into a stable network such that the filaments or yarns retain their position relative to each other during handling, placement, and design service life. At least 95 percent by weight of the long chain polymer shall be a polyolefin or polyester. The material shall be free of defects and tears. The geotextile shall conform as a minimum to the properties indicated for Class 1 under AASHTO M-288, Geotextile Specification for Highway Applications.

2.0 *Geogrids*

The geogrid shall be a regular network of integrally connected polymer tensile elements with aperture geometry sufficient to permit significant mechanical interlock with the surrounding

soil or rock. The geogrid structure shall be dimensionally stable and able to retain its geometry under manufacture, transport and installation.

3.0 *Required Properties*

The specific geosynthetic material(s) shall be preapproved by the agency and shall have long-term strength (T_{al}) as listed on table 1 for each geosynthetic specified and for the fill type shown.

4.0 Certification: The Contractor shall submit a manufacturer's certification that the geosynthetics supplied meet the respective index criteria set when the geosynthetic was approved by the agency, measured in full accordance with all test methods and standards specified and as set forth in these specifications.

Table 1. Required Geosynthetic Reinforcement Properties.

| Geosynthetic ⁽¹⁾ | Ultimate Strength (T_{ULT}) ASTM 4595 ⁽²⁾ or GRI:GG1 | Long-Term Strength ⁽³⁾ (T_{al}) | For use with these Fills ⁽⁴⁾ |
|-----------------------------|---------------------------------------------------------------------------|------------------------------------------------------|--------------------------------------------|
| A | | | GW-GM |
| A | | | SW-SM-SC |
| B | | | GW-GM |
| B | | | SW-SM-SC |

NOTES:

⁽¹⁾ For geotextiles, minimum permeability \geq ___ m/s \geq reinforced soil permeability. Minimum survivability properties – Class 1 per AASHTO M-288 specification.

⁽²⁾ Based on minimum average roll values (MARV) (kN/m). Use D-4595 for geotextiles. D-4595 OR GRI:GG1 can be used for geogrids, however, the same test method must be used for definition of the reduction factors.

⁽³⁾ Long-Term strength (T_{al}) based on (kN/m)

$$T_{al} = \frac{T_{ULT}}{RF_D \cdot RF_{ID} \cdot RF_{CR}}$$

where RF_{CR} is developed from creep tests performed in accordance with ASTM D-5262, RF_{ID} obtained from site installation damage testing and RF_D from hydrolysis or oxidative degradation testing extrapolated to 75 or 100 year design life. For default reduction factors, include the durability requirements in table 9, chapter 3 as additional reinforcement property requirements.

⁽⁴⁾ Unified Soil Classification.

The manufacturer's certificate shall state that the furnished geosynthetic meets the requirements of the specifications as evaluated by the manufacturer's quality control program. The certificates shall be attested to by a person having legal authority to bond the manufacturer. In case of dispute over validity of values, the Engineer can require the Contractor to supply test data from an agency approved laboratory to support the certified values submitted, at the Contractor's cost.

5.0 Manufacturing Quality Control: The geosynthetic reinforcement shall be manufactured with a high degree of quality control. The Manufacturer is responsible for establishing and maintaining a quality control program to ensure compliance with the requirements of the specification. The purpose of the QC testing program is to verify that the reinforcement geosynthetic being supplied to the project is representative of the material used for performance testing and approval by the agency.

Conformance testing shall be performed as part of the manufacturing process and may vary for each type of product. As a minimum the following index tests shall be considered as applicable for an acceptable QA/QC program:

| <u>Property</u> | <u>Test Procedure</u> |
|--------------------------------|-----------------------|
| Specific Gravity (HDPE only) | ASTM D-1505 |
| Ultimate Tensile Strength | ASTM D-4595; GRI:GG1 |
| Melt Flow (HDPE and PP only) | ASTM D-1238 |
| Intrinsic Viscosity (PET only) | ASTM D-4603 |
| Carboxyl End Group (PET only) | ASTM D-2455 |

6.0 Sampling, Testing, and Acceptance

Sampling and conformance testing shall be in accordance with ASTM D-4354. Conformance testing procedures shall be as established under 5.0. Geosynthetic product acceptance shall be based on ASTM D-4759.

The quality control certificate shall include:

- Roll numbers and identification
- Sampling procedures
- Result of quality control tests, including a description of test methods used.

7.0 Granular Backfill

The backfill shall conform to the specified fill under section 8.11 except that the maximum size of backfill shall be 20 mm, unless full scale installation damage tests are conducted in accordance with ASTM D-5818.

Note that additional pH requirements for the backfill may be warranted depending on the geosynthetic used.

8.12 CONSTRUCTION SPECIFICATIONS FOR REINFORCED SLOPE SYSTEMS

The recent availability of many different geosynthetic reinforcement materials as well as drainage and erosion control products requires consideration of different alternatives prior to preparation of contract documents so that contractors are given an opportunity to bid using feasible, cost-effective materials. Any proprietary material should undergo an agency review prior to inclusion as either an alternate offered during design (in-house) or construction (value engineering or end result) phase.

It is highly recommended that each agency develop documented procedures for:

- ! Review and approval of geosynthetic soil reinforcing materials.
- ! Review and approval of drainage composite materials.
- ! Review and approval of erosion control materials.
- ! Review and approval of geosynthetic reinforced slope systems and suppliers.
- ! In-house design and performance criteria for reinforced slopes.

The following guidelines are recommended as the basis for specifications or special provisions for the furnishing and construction of reinforced soil slopes on the basis of pre approved reinforcement materials. Specification guidelines are presented for each of the following topics:

- (a) Specification Guidelines for RSS Construction (Agency design).
- (b) Specifications for Erosion Control Mat or Blanket.
- (c) Specifications for Geosynthetic Drainage Composite.
- (d) Specification Guidelines for Proprietary Geosynthetic RSS Systems.

a. Specification Guidelines For RSS Construction (Agency Design)

Description

Work shall consist of furnishing and placing geosynthetic soil reinforcement for construction of reinforced soil slopes.

Geosynthetic Reinforcement Material

The specific geosynthetic reinforcement material and supplier shall be pre approved by the agency as outlined in the agency's reinforced soil slope policy.

The geosynthetic reinforcement shall consist of a geogrid or a geotextile that can develop sufficient mechanical interlock with the surrounding soil or rock. The geosynthetic reinforcement structure shall be dimensionally stable and able to retain its geometry under construction stresses and shall have high resistance to damage during construction,

ultraviolet degradation, and all forms of chemical and biological degradation encountered in the soil being reinforced.

The geosynthetics shall have a Long-Term Strength (T_{al}) and Pullout Resistance, for the soil type(s) indicated, as listed in table S1 for geotextiles and/or table S2 for geogrids.

The Contractor shall submit a manufacturer's certification that the geosynthetics supplied meet the respective index criteria set when the geosynthetic was approved by the agency, measured in full accordance with all test methods and standards specified. In case of dispute over validity of values, the Engineer can require the Contractor to supply test data from an agency approved laboratory to support the certified values submitted, the Contractor's cost.

Table S-1. Required Geotextile Reinforcement Properties.

| Geotextile ⁽¹⁾ | Ultimate Strength (T_{ULT}) ASTM 4595 ⁽²⁾ | Long-Term Strength ⁽³⁾ (T_{al}) | For use with these Fills ⁽⁴⁾ |
|---------------------------|-------------------------------------------------------------|---------------------------------------------------|-----------------------------------------|
| A | | | GW-GM |
| A | | | SW-SM-SC |
| B | | | GW-GM |
| B | | | SW-SM-SC |

NOTES:

(1) Minimum permeability \geq ___ m/s \geq reinforced soil permeability. Minimum survivability properties – Class 1 per AASHTO M-288 specification.

(2) Based on minimum average roll values (MARV) (kN/m).

(3) Long-Term strength (T_{al}) based on (kN/m)

$$T_{al} = \frac{T_{ULT}}{RF_D \cdot RF_{ID} \cdot RF_{CR}}$$

where RF_{CR} is developed from creep tests performed in accordance with ASTM D-5262, RF_{ID} obtained from site installation damage testing and RF_D from hydrolysis or oxidative degradation testing extrapolated to 75 or 100 year design life. For default reduction factors, include the durability requirements in table 9, chapter 3 as additional reinforcement property requirements.

(4) Unified Soil Classification.

Table S-2. Required Geogrid Properties.

| Geogrid | Ultimate Strength (T_{ULT}) ASTM 4595 ⁽¹⁾ or GRI:GG1 | Long-Term Strength ⁽²⁾ (T_{al}) | For use with these Fills ⁽³⁾ |
|---------|---------------------------------------------------------------------------|------------------------------------------------------|--------------------------------------------|
| A | | | GW-GM |
| A | | | SW-SM-SC |
| B | | | GW-GM |
| B | | | SW-SM-SC |

NOTES:

⁽¹⁾ Based on minimum average roll values (MARV) (kN/m). Use D-4595 for geotextiles. D-4595 OR GRI:GG1 can be used for geogrids, however, the same test method must be used for definition of the reduction factors.

⁽²⁾ Long-Term strength (T_{al}) based on (kN/m)

$$T_{al} = \frac{T_{ULT}}{RF_D \cdot RF_{ID} \cdot RF_{CR}}$$

where RF_{CR} is developed from creep tests performed in accordance with ASTM D-5262, RF_{ID} obtained from site installation damage testing and RF_D from hydrolysis or oxidative degradation testing extrapolated to 75 or 100 year design life. For default reduction factors, include the durability requirements in table 9, chapter 3 as additional reinforcement property requirements.

⁽³⁾ Unified Soil Classification.

Quality Assurance/Index Properties: Testing procedures for measuring design properties require elaborate equipment, tedious set up procedures and long durations for testing. These tests are inappropriate for quality assurance (QA) testing of geosynthetic reinforcements received on site. In lieu of these tests for design properties, a series of index criteria may be established for QA testing. These index criteria include mechanical and geometric properties that directly impact the design strength and soil interaction behavior of geosynthetics. **It is likely each family of products will have varying index properties and QC/QA test procedures.** QA testing should measure the respective index criteria set when the geosynthetic was approved by the agency. Minimum average roll values, per ASTM D 4759, shall be used for conformance.

Construction

Delivery, Storage, and Handling - Follow requirements set forth under materials specifications for geosynthetic reinforcement, drainage composite, and geosynthetic erosion mat.

Site Excavation - All areas immediately beneath the installation area for the geosynthetic reinforcement shall be properly prepared as detailed on the plans, specified elsewhere within the specifications, or directed by the Engineer. Subgrade surface shall be level, free from deleterious materials, loose, or otherwise unsuitable soils. Prior to placement of geosynthetic reinforcement, subgrade shall be proof-rolled to provide a uniform and firm surface. Any soft areas, as determined by the Owner's Engineer, shall be excavated and replaced with suitable compacted soils. The foundation surface shall be inspected and approved by the Owner's Geotechnical Engineer prior to fill placement. Benching the backcut into competent soil shall be performed as shown on the plans or as directed, in a manner that ensures stability.

Geosynthetic Placement - The geosynthetic reinforcement shall be installed in accordance with the manufacturer's recommendations, unless otherwise modified by these specifications. The geosynthetic reinforcement shall be placed within the layers of the compacted soil as shown on the plans or as directed.

- The geosynthetic reinforcement shall be placed in continuous longitudinal strips in the direction of main reinforcement. Joints in the design strength direction (perpendicular to the slope) shall not be permitted with geotextile or geogrid, except as indicated on the drawings.

Horizontal coverage of less than 100 percent shall not be allowed unless specifically detailed in the construction drawings. In the case of 100% coverage in plan view adjacent strips need not be overlapped.

- Adjacent rolls of geosynthetic reinforcement shall be overlapped or mechanically connected where exposed in a wrap-around face system, as applicable.
- Place only that amount of geosynthetic reinforcement required for immediately pending work to prevent undue damage. After a layer of geosynthetic reinforcement has been placed, the next succeeding layer of soil shall be placed and compacted as appropriate. After the specified soil layer has been placed, the next geosynthetic reinforcement layer shall be installed. The process shall be repeated for each subsequent layer of geosynthetic reinforcement and soil.
- Geosynthetic reinforcement shall be placed to lay flat and pulled tight prior to backfilling. After a layer of geosynthetic reinforcement has been placed, suitable means, such as pins or small piles of soil, shall be used to hold the geosynthetic reinforcement in position until the subsequent soil layer can be placed. Under no circumstances shall a track-type vehicle be allowed on the geosynthetic reinforcement before at least 150 mm of soil has been placed. Sudden braking and sharp turning – sufficient to displace fill – shall be avoided.
- During construction, the surface of the fill should be kept approximately horizontal. Geosynthetic reinforcement shall be placed directly on the compacted horizontal fill surface. Geosynthetic reinforcements are to be placed within 75 mm of the design elevations and extend the length as shown on the elevation view unless otherwise directed

by the Owner's Engineer. Correct orientation of the geosynthetic reinforcement shall be verified by the Contractor.

Fill Placement - Fill shall be compacted as specified by project specifications or to at least 95 percent of the maximum density determined in accordance with AASHTO T-99, whichever is greater.

- Density testing shall be made every 500 m³ of soil placement or as otherwise specified by the Owner's Engineer or contract documents.
- Backfill shall be placed, spread, and compacted in such a manner to minimize the development of wrinkles and/or displacement of the geosynthetic reinforcement.
- Fill shall be placed in 300 mm maximum lift thickness where heavy compaction equipment is to be used, and 150 mm maximum uncompacted lift thickness where hand operated equipment is used.
- Backfill shall be graded away from the slope crest and rolled at the end of each work day to prevent ponding of water on surface of the reinforced soil mass.
- Tracked construction equipment shall not be operated directly upon the geosynthetic reinforcement. A minimum fill thickness of 150 mm is required prior to operation of tracked vehicles over the geosynthetic reinforcement. Turning of tracked vehicles should be kept to a minimum to prevent tracks from displacing the fill and the geosynthetic reinforcement.
- If approved by the Engineer, rubber-tired equipment may pass over the geosynthetic reinforcement at speeds of less than 16 km/h. Sudden braking and sharp turning shall be avoided.

Erosion Control Material Installation. See *Erosion Control Material Specification* for installation notes.

Geosynthetic Drainage Composite. See *Geocomposite Drainage Composite Material Specification* for installation notes.

Final Slope Geometry Verification. Contractor shall confirm that as-built slope geometries conform to approximate geometries shown on construction drawings.

Method of Measurement

Measurement of geosynthetic reinforcement is on a square meter basis and will be computed on the total area of geosynthetic reinforcement shown on the construction drawings, exclusive of the area of geosynthetics used in any overlaps. Overlaps are an incidental item.

Basis of Payment

The accepted quantities of geosynthetic reinforcement by Type will be paid for per square meter in-place.

Payment will be made under:

| <u>Pay Item</u> | | <u>Pay Unit</u> |
|-------------------------------|----------|-----------------|
| Geogrid Soil Reinforcement | - Type A | square meter |
| Geogrid Soil Reinforcement | - Type B | square meter |
| | or | |
| Geotextile Soil Reinforcement | - Type A | square meter |
| Geotextile Soil Reinforcement | - Type B | square meter |

b. Specification for Erosion Control Mat or Blanket

Description

Work shall consist of furnishing and placing a synthetic erosion control mat and/or degradable erosion control blanket for slope face protection and lining of runoff channels for use in construction of reinforced soil slopes as shown on the plans or as specified by the Engineer.

Materials

(1) Erosion Control

The specific erosion control material and supplier shall be prequalified by the Agency prior to use.

Prequalification procedures and a current list of prequalified materials may be obtained by writing to the Agency. A 0.3 m x 0.3 m sample of the material may be required by the Engineer in order to verify prequalification.

The soil erosion control mat shall be a Class __ material and be one (1) of the following types as shown on the plans:

- (i) Type __. Long-term duration (Longer than 2 Years)
Shear Stress (σ) > 95 to < 240 Pa

Prequalified Type __ products are:

| | |
|-------|-------|
| _____ | _____ |
| _____ | _____ |

- (ii) Type __. Long-term duration (Longer than 2 Years)
Shear Stress (τ_D) greater than or equal to 240 Pa

Prequalified Type __ products are:

Certification. The Contractor shall submit a manufacturer's certification that the erosion mat/blanket supplied meets the property criteria specified when the material was approved by the agency. The manufacturer's certification shall include a submittal package of documented test results that confirm the property values. In case of dispute over validity of property values, the Engineer can require the Contractor to supply property test data from an approved laboratory to support the certified values submitted. Minimum average roll values, per ASTM D-4759, shall be used for conformance.

(2) Staples.

Staples for anchoring the soil erosion control mat shall be U-shaped, made of 3 mm or large diameter steel wire, or other approved material, have a width of 25 to 50 mm, and a length of not less than 450 mm for the face of RSS, and not less than 300 mm for runoff channels.

Construction Methods

(1) General.

The soil erosion control mat shall conform to the class and type shown on the plans. The Contractor has the option of selecting an approved soil erosion control mat conforming to the class and type shown on the plans, and according to the current approved material list.

(2) Installation.

The soil erosion control mat, whether installed as slope protection or as flexible channel liner in accordance with the approved materials list, shall be placed within 24 hours after seeding or sodding operations have been completed, or as approved by the Engineer. Prior to placing the mat, the area to be covered shall be relatively free of all rocks or clods over 1-1/2 inches in maximum dimension and all sticks or other foreign material which will prevent the close contact of the mat with the soil. The area shall be smooth and free of ruts or depressions exist for any reason, the Contractor shall be required to rework the soil until it is smooth and to reseed or resod the area at the Contractor's expense.

Installation and anchorage of the soil erosion control mat shall be in accordance with the project construction drawings unless otherwise specified in the contract or directed by the Engineer.

The erosion control material shall be placed and anchored on a smooth graded, firm surface approved by the Engineer. Anchoring terminal ends of the erosion control material shall be accomplished through use of key trenches. The material in the trenches shall be anchored to the soil with staples on maximum 0.5 m centers.

Erosion control material shall be anchored, overlapped, and otherwise constructed to ensure performance until vegetation is well established. Pins shall be as designated on the construction drawings, with a maximum spacing of 1.25 m recommended.

Soil Filling. If noted on the construction drawings, the erosion control mat shall be filled with a fine grained topsoil, as recommended by the manufacturer. Soil shall be lightly raked or brushed on/into the mat to fill mat thickness or to a maximum depth of 25 mm.

Method of Measurement

Measurement of erosion mat and erosion blanket material is on a square meter basis and will be computed on the projected slope face area from defined plan lines, exclusive of the area of material used in any overlaps, or from payment lines established in writing by the Engineer. Overlaps, anchors, checks, terminals or junction slots, and wire staples or wood stakes are incidental items.

Quantities of erosion control material as shown on the plans may be increased or decreased at the direction of the Engineer based on construction procedures and actual site conditions. Such variations in quantity will not be considered as alterations in the details of construction or a change in the character of work.

Basis of Payment

The accepted quantities of erosion control material will be paid for per square meter in place.

Payment will be made under:

| <u>Pay Item</u> | <u>Pay Unit</u> |
|------------------------------------------------|-----------------|
| Geosynthetic (Permanent) Erosion Control Mat | square meter |
| and/or | |
| Degradable (Temporary) Erosion Control Blanket | square meter |

c. Specification for Geosynthetic Drainage Composite

Description

Work shall consist of furnishing and placing a geosynthetic drainage system as a subsurface drainage media for reinforced soil slopes.

Drainage Composite Materials

The specific drainage composite material and supplier shall be preapproved by the Agency.

The geocomposite drain shall be:

[insert approved materials that meet the project requirements. Geocomposites should be designed on a project specific basis. Design criteria for flow capacity, filtration, and permeability are summarized in the FHWA Geosynthetic, Design and Construction Guidelines (1998).]

OR

The geocomposite drain shall be a composite construction consisting of a supporting structure or drainage core material surrounded by a geotextile. The geotextile shall encapsulate the drainage core and prevent random soil intrusion into the drainage structure. The drainage core material shall consist of a three dimensional polymeric material with a structure that permits flow along the core laterally. The core structure shall also be constructed to permit flow regardless of the water inlet surface. The drainage core shall provide support to the geotextile. The core and fabric shall meet the minimum property requirements listed in table S3.

A geotextile flap shall be provided along all drainage core edges. This flap shall be of sufficient width for sealing the geotextile to the adjacent drainage structure edge to prevent soil intrusion into the structure during and after installation. The geotextile shall cover the full length of the core.

The geocomposite core shall be furnished with an approved method of constructing and connecting with outlet pipes or weepholes as shown on the plans. Any fittings shall allow entry of water from the core but prevent intrusion of backfill material into the core material.

Certification and Acceptance. The Contractor shall submit a manufacturer's certification that the geosynthetic drainage composite supplied meets the design properties and respective index criteria measured in full accordance with all test methods and standards specified. The manufacturer's certification shall include a submittal package of documented test results that confirm the design values. In case of dispute over validity of design values, the Engineer can require the Contractor to supply design property test data from an approved laboratory, to support the certified values submitted. Minimum average roll values, per ASTM D-4759, shall be used for conformance.

Construction

Delivery, Storage, and Handling. The Contractor shall check the geosynthetic drainage composite upon delivery to ensure that the proper material has been received. During all periods of shipment and storage, the geosynthetic drainage composite shall be protected from temperatures greater than 60° C, mud, dirt, and debris. Follow manufacturer's recommendations in regards to protection from direct sunlight. At the time of installation, the geosynthetic drainage composite shall be rejected if it has defects, tears, punctures, flaws, deterioration, or damage incurred during manufacture, transportation, or storage. If approved by the Engineer, torn or punctured sections may be removed or repaired. Any geosynthetic drainage composite damaged during storage of installation shall be replaced by the Contractor at no additional cost to the Owner.

**Table S3
Minimum Physical Property Criteria
For Geosynthetic Drainage Composites In
Reinforced Soil Slopes**

| PROPERTY | TEST METHOD | VALUE ¹ |
|------------------------------------------------------------------|--------------------------|-------------------------------------|
| <u>Composite</u> | | |
| Flow Capacity ² | ASTM D 4716 | _____ m ² /s width (min) |
| <u>Geotextile</u> | | |
| AOS ³ | ASTM D 4751 | _____ Max. Diameter (mm) |
| Permeability ⁴ | ASTM D 4491 ⁵ | _____ m/s |
| Trapezoidal Tear CLASS 2 ⁶ CLASS 3 ⁷ | ASTM D 4533 | 250 N 180 N |
| Grab Strength CLASS 2 ⁶ CLASS 3 ⁷ | ASTM D 4632 | 700 N 500 N |
| Puncture CLASS 2 ⁶ CLASS 3 ⁷ | ASTM D 4833 | 250 N 180 N |
| Burst CLASS 2 ⁶ CLASS 3 ⁷ | ASTM D 3786 | 1300 kPa 950 KPa |

Notes:

1. Values are minimum unless noted otherwise. Use value in weaker principal direction, as applicable. All numeric values represent minimum average roll values.
2. The flow capacity requirements for the project shall be determined with consideration of design flow rate, compressive load on the drainage material, and slope of drainage composite installation.
3. Both a maximum and a minimum AOS may be specified. Sometimes a minimum diameter is used as a criteria for improved clogging resistance. See FHWA Geosynthetic Design and Construction Guidelines (1995) for further information.
4. Permeability is project specific. A nominal coefficient of permeability may be determined by multiplying permittivity value by nominal thickness. The k value of the geotextile should be greater than the k value of the soil.
5. Standard Test Methods for Water Permeability (hydraulic conductivity) of Geotextiles by Permittivity.
6. CLASS 2 geotextiles are recommended where construction conditions are unknown or where sharp angular aggregate is used and a heavy degree of compaction (95% AASHTO T99) is specified.
7. CLASS 3 geotextiles (from AASHTO M-288) may be used with smooth graded surfaces having no sharp angular projections, no sharp aggregate is used, and compaction requirements are light (<95% AASHTO T99).

Placement. The soil surface against which the geosynthetic drainage composite is to be placed shall be free of debris and inordinate irregularities that will prevent intimate contact between the soil surface and the drain.

Seams. Edge seams shall be formed by utilizing the flap of geotextile extending from the geocomposite's edge and lapping over the top of the geotextile of the adjacent course. The geotextile flap shall be securely fastened to the adjacent fabric by means of plastic tape or non-water-soluble construction adhesive, as recommended by the supplier. Where vertical

splices are necessary at the end of a geocomposite roll or panel, a 200-mm-wide continuous strip of geotextile may be placed, centered over the seam and continuously fastened on both sides with plastic tape or non water soluble construction adhesive. As an alternative, rolls of geocomposite drain material may be joined together by turning back the geotextile at the roll edges and interlocking the cuspidations approximately 50 mm. For overlapping in this manner, the geotextile shall be lapped over and tightly taped beyond the seam with tape or adhesive. Interlocking of the core shall always be made with the upstream edge on top in the direction of water flow. To prevent soil intrusion, all exposed edges of the geocomposite drainage core shall be covered by tucking the geotextile flap over and behind the core edge. Alternatively, a 300 mm wide strip of geotextile may be used in the same manner, fastening it to the exposed fabric 200 mm in from the edge and fold the remaining flap over the core edge.

Repairs. Should the geocomposite be damaged during installation by tearing or puncturing, the damaged section shall be cut out and replaced completely or repaired by placing a piece of geotextile that is large enough to cover the damaged area and provide a sufficient overlap on all sides to fasten.

Soil Fill Placement. Structural backfill shall be placed immediately over the geocomposite drain. Care shall be taken during the backfill operation not to damage the geotextile surface of the drain. Care shall also be taken to avoid excessive settlement of the backfill material. The geocomposite drain, once installed, shall not be exposed for more than seven days prior to backfilling.

Method of Measurement

Measurement of geosynthetic drainage composite is on a square meter basis and will be computed on the total area of geosynthetic drainage composite shown on the construction drawings, exclusive of the area of drainage composite used in any overlaps. Overlaps, connections, and outlets are incidental items.

Quantities of drainage composite material as shown on the plans may be increased or decreased at the direction of the Engineer based on construction procedures and actual site conditions. Such variations in quantity will not be considered as alterations in the details of construction or a change in the character of work.

Basis of Payment

The accepted quantities of drainage composite material will be paid for per square meter in place.

Payment will be made under:

| <u>Pay Item</u> | <u>Pay Unit</u> |
|---------------------------------|-----------------|
| Geosynthetic Drainage Composite | square meter |

d. Specification Guidelines for Geosynthetic Reinforced Soil Slope Systems

Description

Work shall consist of design, furnishing materials, and construction of geosynthetic reinforced soil slope structure. Supply of geosynthetic reinforcement, drainage composite, and erosion control materials, and site assistance are all to be furnished by the slope system supplier.

Reinforced Slope System

Acceptable Suppliers - The following suppliers can provide agency approved system:

- (1) _____
- (2) _____
- (3) _____

Materials. Only geosynthetic reinforcement, drainage composite, and erosion mat materials approved by the contracting agency prior to project advertisement shall be utilized in the slope construction. Geogrid Soil Reinforcement, Geotextile Soil Reinforcement, Drainage Composite, and Geosynthetic Erosion Mat materials are specified under respective material specifications.

Design Submittal. The Contractor shall submit six sets of detailed design calculations, construction drawings, and shop drawings for approval within 30 days of authorization to proceed and at least 60 days prior to the beginning of reinforced slope construction. The calculations and drawings shall be prepared and sealed by a Professional Engineer, licensed in the State. Submittal shall conform to agency requirements for RSS.

Material Submittals. The Contractor shall submit six sets of manufacturer's certification that indicate the geosynthetic soil reinforcement, drainage composite, and geosynthetic erosion mat meet the requirements set forth in the respective material specifications, for approval at least 60 days prior to start of RSS.

Construction

(Should follow the specifications details in this chapter)

Method of Measurement

Measurement of geosynthetic RSS Systems is on a vertical square meter basis.

Payment shall include reinforced slope design and supply and installation of geosynthetic soil reinforcement, reinforced soil fill, drainage composite, and geosynthetic erosion mat. Excavation of any unsuitable materials and replacement with select fill, as directed by the Engineer shall be paid under a separate pay item.

Quantities of reinforced soil slope system as shown on the plans may be increased or decreased at the direction of the Engineer based on construction procedures and actual site conditions.

Basis of Payment

The accepted quantities of geosynthetic RSS system will be paid for per vertical square meter in place.

Payment will be made under:

Pay Item

Pay Unit

Geosynthetic RSS System

Vertical square meter

[BLANK]

CHAPTER 9

FIELD INSPECTION AND PERFORMANCE MONITORING

Construction of MSE and RSS systems is relatively simple and rapid. The construction sequence consists mainly of preparing the subgrade, placing and compacting backfill in normal lift operations, laying the reinforcing layer into position, and installing the facing elements (*tensioning of the reinforcement may also be required*) or outward facing for RSS slopes. Special skills or equipment are usually not required, and locally available labor can be used. Most material suppliers provide training for construction of their systems. A checklist of general requirements for monitoring and inspecting MSE and RSS systems is provided in table 15.

There are some special construction considerations that the designer, construction personnel, and inspection team need to be aware of so that potential performance problems can be avoided. These considerations relate to the type of system to be constructed, to specific site conditions, the backfill material used and facing requirements. The following sections review items relating to:

- ! Section 9.1, preconstruction reviews.
- ! Section 9.2, prefabricated materials inspection.
- ! Section 9.3, construction control.
- ! Section 9.4, performance monitoring programs.

9.1 PRECONSTRUCTION REVIEWS

Prior to erection of the structure, personnel responsible for observing the field construction of the retaining structure should become thoroughly familiar with the following items:

- ! The plans and specifications.
- ! The site conditions relevant to construction requirements.
- ! Material requirements.
- ! Construction sequences for the specific reinforcement system.

Table 15. MSE/RSS field inspection checklist.

- 1. Read the specifications and become familiar with:**
 - material requirements
 - construction procedures
 - soil compaction procedures
 - alignment tolerances
 - acceptance/rejection criteria
- 2. Review the construction plans and become familiar with:**
 - construction sequence
 - corrosion protection systems
 - special placement to reduce damage
 - soil compaction restrictions
 - details for drainage requirements
 - details for utility construction
 - construction of slope face
 - contractor's documents
- 3. Review material requirements and approval submittals. Review construction sequence for the reinforcement system.**
- 4. Check site conditions and foundation requirements. Observe:**
 - preparation of foundations
 - facing pad construction (check level and alignment)
 - site accessibility
 - limits of excavation
 - construction dewatering
 - drainage features; seeps, adjacent streams, lakes, etc.
- 5. On site, check reinforcements and prefabricated units. Perform inspection of prefabricated elements (i.e. casting yard) as required. Reject precast facing elements if:**
 - compressive strength < specification requirements
 - imperfect molding
 - honey-combing
 - severe cracking, chipping or spalling
 - color of finish variation
 - out-of-tolerance dimensions
 - misaligned connections
- 6. Check reinforcement labels to verify whether they match certification documents.**
- 7. Observe materials in batch of reinforcements to make sure they are the same. Observe reinforcements for flaws and nonuniformity.**
- 8. Obtain test samples according to specification requirements from randomly selected reinforcements.**
- 9. Observe construction to see that the contractor complies with specification requirements for installation.**
- 10. If possible, check reinforcements after aggregate or riprap placement for possible damage. This can be done either by constructing a trial installation, or by removing a small section of aggregate or riprap and observing the reinforcement after placement and compaction of the aggregate, at the beginning of the project. If damage has occurred, contact the design engineer.**
- 11. Check all reinforcement and prefabricated facing units against the initial approved shipment and collect additional test samples.**
- 12. Monitor facing alignment:**
 - adjacent facing panel joints (typically $19 \text{ mm} \pm 6 \text{ mm}$)
 - precast face panels: (6 mm per m horizontal and vertical; 4 mm per m overall vertical)
 - wrapped face walls: (15 mm per m horizontal and vertical; 8 mm overall vertical)
 - line and grade

a. Plans and Specifications

Specification requirements for MSE and RSS are reviewed in chapter 8. The owner's field representatives should carefully read the specification requirements for the specific type of system to be constructed, with special attention given to material requirements, construction procedures, soil compaction procedures, alignment tolerances, and acceptance/rejection criteria. Plans should be reviewed and unique and complex project details identified and reviewed with the designer and contractor, if possible. Special attention should be given to the construction sequence, corrosion protection systems for metallic reinforcement, special placement requirements to reduce construction damage for polymeric reinforcement, soil compaction restrictions, details for drainage requirements and utility construction, and construction of the outward slope. The contractor's documents should be checked to make sure that the latest issue of the approved plans, specifications, and contract documents are being used.

b. Review of Site Conditions and Foundation Requirements

The site conditions should be reviewed to determine if there will be any special construction procedures required for preparation of the foundations, site accessibility, excavation for obtaining the required reinforcement length, and construction dewatering and other drainage features.

Foundation preparation involves the removal of unsuitable materials from the area to be occupied by the retaining structure including all organic matter, vegetation, and slide debris, if any. This is most important in the facing area to reduce facing system movements and, therefore, to aid in maintaining facing alignment along the length of the structure. The field personnel should review the borings to determine the anticipated extent of the removal required.

Where construction of reinforced fill will require a side slope cut, a temporary earth support system may be required to maintain stability. The contractor's method and design should be reviewed with respect to safety and the influence of its performance on adjacent structures. Caution is also advised for excavation of utilities or removal of temporary bracing or sheeting in front of the completed MSE structures. Loss of ground from these activities could result in settlement and lateral displacement of the retaining structure.

The groundwater level found in the site investigation should be reviewed along with levels of any nearby bodies of water that might affect drainage requirements. Slopes into which a cut is to be made should be carefully observed, especially following periods of precipitation, for any signs of seeping water (often missed in borings). Construction dewatering operations should be required for any excavations performed below the water table to prevent a reduction in shear strength due to hydrostatic water pressure.

MSE/RSS structures should be designed to permit drainage of any seepage or trapped groundwater in the retained soil. If water levels intersect the structure, it is also likely that a drainage structure behind and beneath the wall will be required. Surface water infiltration

into the retained fill and reinforced fill should be minimized by providing an impermeable cap and adequate slopes to nearby surface drain pipes or paved ditches with outlets to storm sewers or to natural drains.

Internal drainage of the reinforced fill can be attained by use of a free-draining granular material that is free of fines (material passing No. 200 sieve should be less than 5 percent). Because of its high permeability, this type of fill will prevent retention of any water in the soil fill as long as a drainage outlet is available. Arrangement is generally provided for drainage to the base of the fill as shown on figures 42 and 71, to prevent water exiting the face of the wall and causing erosion and/or face stains. The drains will, of course, require suitable outlets for discharge of seepage away from the reinforced soil structure. Care should be taken to avoid creating planes of weakness within the structure with drainage layers.

9.2 PREFABRICATED MATERIALS INSPECTION

Material components should be examined at the casting yard (for systems with precast elements) and on site. Typical casting operations are shown on figure 77. Material acceptance should be based on a combination of material testing, certification, and visual observations.

When delivered to the project site, the inspector should carefully inspect all material (precast facing elements, reinforcing elements, bearing pads, facing joint materials, and reinforced backfill). On site, all system components should be satisfactorily stored and handled to avoid damage. The material supplier's construction manual should contain additional information on this matter.

- a. **Precast Concrete Elements.** At the casting yard, the inspector should assure the facing elements are being fabricated in accordance with the agency's standard specifications. For example, precast concrete facing panels should be cast on a flat surface. To minimize corrosion, it is especially important that coil embeds, tie strip guides, and other connection devices do not contact or be attached to the facing element reinforcing steel.

Facing elements delivered to the project site should be examined prior to erection. Panels should be rejected on the basis of the following deficiencies or defects:

- ! Insufficient compressive strength.
- ! Imperfect molding.
- ! Honey-combing.
- ! Severe cracking, chipping, or spalling.
- ! Color of finish variation on the front face.



Figure 77. Casting yard for precast facing elements.

! Out-of-tolerance dimensions.

! Misalignment of connections.

The following maximum facing element dimension tolerances are usually specified for precast concrete:

! Overall dimensions - 13 mm (½-inch).

! Connection device locations - 25 mm (1-inch).

! Element squareness - 13 mm (½-inch) difference between diagonals.

! Surface finish - 2 mm in 1 m (⅞-inch in 5 ft) (smooth surface).

! Surface finish - 5 mm in 1 m (5/16-inch in 5 ft) (textured surface)

In cases where repair to damaged facing elements is possible, it should be accomplished to the satisfaction of the inspector.

For drycast modular blocks, it is essential that compressive strengths and water absorption be carefully checked on a lot basis. The following dimensional tolerances are usually specified:

! Overall dimensions - ± 3.2 mm (⅜-inch)

! Height of each block - ± 1.6 mm (1/16-inch)

- b. Reinforcing Elements.** Reinforcing elements (strips, mesh, sheets) should arrive at the project site securely bundled or packaged to avoid damage (see figure 78). These materials are available in a variety of types, configurations, and sizes (gauge, length, product styles), and even a simple structure may have different reinforcement elements at different locations. The inspector should verify that the material is properly identified and check the specified designation (AASHTO, ASTM, or agency specifications). Material verification is especially important for geotextiles and geogrids where many product styles look similar but have different properties. Mesh reinforcement should be checked for gross area and length, width, and spacing of transverse members. For strip reinforcements, the length and thickness should be checked. Geogrids or geotextile samples should be sent to the laboratory for verification testing.

Protective coatings, i.e., galvanization (thickness 610 gm/m) or epoxy (thickness 18 mils [457 µm]), should be verified by certification or agency conducted tests and checked for defects.



Figure 78. Inspect reinforcing elements.

- c. **Facing Joint Materials.** Bearing pads (cork, neoprene, SBR rubber), joint filler and joint cover (geotextile) should be properly packaged to minimize damage in unloading and handling. For example, polymer filler material and geotextiles must be protected from sunlight during storage.

Although these items are often considered as miscellaneous, it is important for the inspector to recognize that use of the wrong material or its incorrect placement can result in significant structure distress.

- d. **Reinforced Backfill.** The backfill in MSE/RSS structures is the key element in satisfactory performance. Both use of the appropriate material and its correct placement are important properties. Reinforced backfill is normally specified to meet certain gradation, plasticity, soundness, and electrochemical requirements. Depending on the type of contract, tests to ensure compliance may be performed by either the contractor or the owner. The tests conducted prior to construction and periodically during construction for quality assurance form the basis for approval. During construction these tests include, gradation and plasticity index testing at the rate of one test per 1500 m³ (2000 yd³) of material placed and whenever the appearance and behavior of the backfill changes noticeably.

9.3 CONSTRUCTION CONTROL

Each of the steps in the sequential construction of MSE and RSS systems is controlled by certain method requirements and tolerances. Construction manuals for proprietary MSE systems should be obtained from the contractor to provide guidance during construction monitoring and inspection. A detailed description of general construction requirements follows with requirements that apply to RSS systems noted.

a. **Leveling Pad**

A concrete leveling pad should have minimum dimensions of 150 mm (6 inches) thick by 300 mm (1 ft) wide and should have a minimum 13.8 MPa (3,000 psi) compressive strength. Cast-in-place pads should cure a minimum of 12 hours before facing panels are placed. Careful inspection of the leveling pad to assure correct line, grade, and offset is important. A vertical tolerance of 3 mm (C-inch) to the design elevation is recommended. If the leveling pad is not at the correct elevation, the top of the wall will not be at the correct elevation. An improperly placed leveling pad can result in subsequent panel misalignment, cracking, and spalling. Full height precast facing elements may require a larger leveling pad to maintain alignment and provide temporary foundation support. Gravel pads of suitable dimensions may be used with modular block wall construction. Typical installations are shown on figure 79.

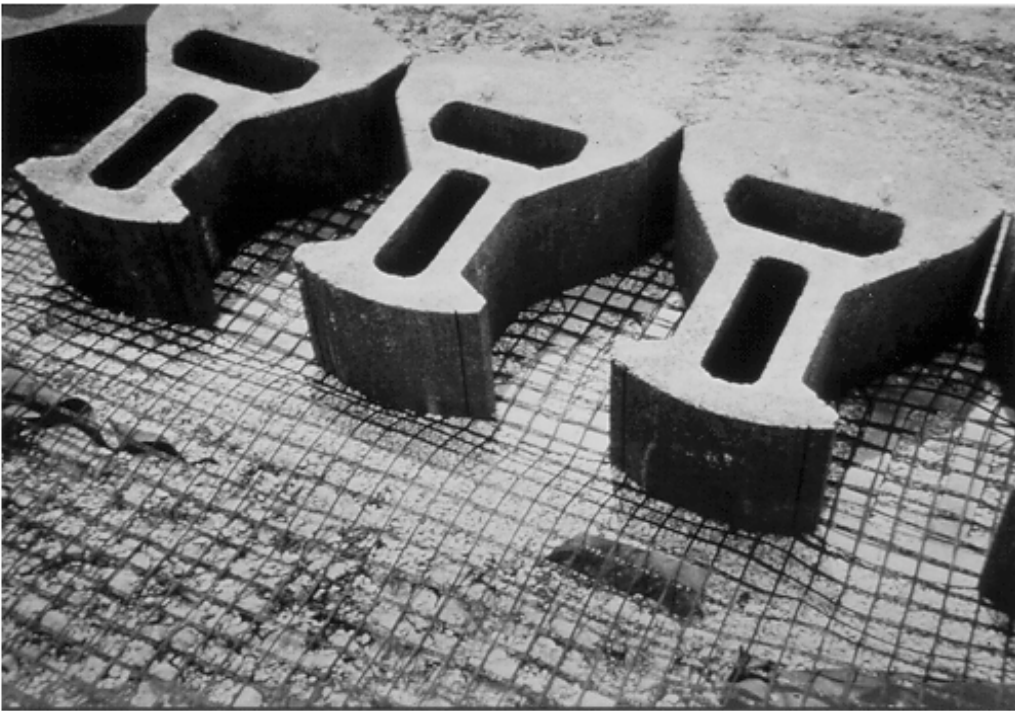

Figure 79. Leveling pads: a) concrete pad; b) compacted gravel pad.

b. Erection of Facing Elements

Precast facing panels are purposely set at a slight backward batter (toward the reinforced fill) in order to assure correct final vertical alignment after backfill placement as shown on figure 80. Minor outward movement of the facing elements from wall fill placement and compaction cannot be avoided and is expected as the interaction between the reinforcement and reinforced backfill occurs. Most systems with segmental precast panels also have some form of construction alignment dowels between adjacent elements that aid in proper erection. Typical backward batter for segmental precast panels is 20 mm per meter (1/4-inch per foot) of panel height.

Full height precast panels as shown on figure 81 are more susceptible to misalignment difficulties than segmental panels. When using full-height panels, the construction procedure should be carefully controlled to maintain tolerances. Special construction procedures such as additional bracing and larger face panel batter may be necessary.

First Row of Facing Elements. Setting the first row of facing elements is a key detail as shown on figure 82. Construction should always begin adjacent to any existing structure and proceed toward the open end of the wall. The panels should be set directly on the concrete leveling pad. Horizontal joint material or wooden shims should not be permitted between the first course of panels and the leveling pad. Temporary wood wedges may be used between the first course of panels and the leveling pad to set panel batter, but they must be removed during subsequent construction. Some additional important details are:

- ! For segmental panel walls, panel spacing bars, which set the horizontal spacing between panels, should be used so that subsequent panel rows will fit correctly.
- ! The first row of panels must be continuously braced until several layers of reinforcements and backfills have been placed. Adjacent panels should be clamped together to prevent individual panel displacement.
- ! After setting the battering the first row of panels, horizontal alignment should be visually checked with survey instruments or with a stringline.
- ! When using full-height panels, initial bracing alignment and clamping are even more critical because small misalignments cannot be easily corrected as construction continues.
- ! Most MSE systems use a variety of panel types on the same project to accommodate geometric and design requirements (geometric shape, size, finish, connection points). The facing element types must be checked to make sure that they are installed exactly as shown on the plans.



Figure 80. Checking facing element batter and alignment.



Figure 81. Full height facing panels require special alignment care.



Figure 82. Setting first row of precast facing elements.

c. Reinforced Fill Placement, Compaction

Moisture and density control is imperative for construction of MSE and RSS systems. Even when using high-quality granular materials, problems can occur if compaction control is not exercised. Reinforced wall fill material should be placed and compacted at or within 2 percent dry of the optimum moisture content. If the reinforced fill is free draining with less than 5 percent passing a No. 200 U.S. Sieve, water content of the fill may be within ± 3 percentage points of the optimum. Placement moisture content can have a significant effect on reinforcement-soil interaction. Moisture content wet of optimum makes it increasingly difficult to maintain an acceptable facing alignment, especially if the fines content is high. Moisture contents that are too dry could result in significant settlement during periods of precipitation.

A density of 95 percent of T-99 maximum value is recommended for retaining walls and slopes, and 100 percent of T-99 is recommended for abutments and walls or slopes supporting structural foundations abutments. A procedural specification is preferable where a significant percentage of coarse material, generally 30 percent or greater retained on the 19 mm ($\frac{3}{4}$ -inch) sieve, prevents the use of the AASHTO T-99 or T-180 test methods. In this situation, typically three to five passes with conventional vibratory roller compaction equipment is adequate to attain the maximum practical density. The actual requirements should be determined based on field trials.

Reinforced backfill should be dumped onto or parallel to the rear and middle of the reinforcements and bladed toward the front face as shown on figure 83. At no time should any construction equipment be in direct contact with the reinforcements because protective coatings and reinforcements can be damaged. Soil layers should be compacted up to or even slightly above the elevation of each level of reinforcement connections prior to placing that layer of reinforcing elements.

Compaction Equipment - With the exception of the 1-m zone directly behind the facing elements or slope face, large, smooth-drum, vibratory rollers should generally be used to obtain the desired compaction as shown on figure 84a. Sheepsfoot rollers should not be permitted because of possible damage to the reinforcements. When compacting uniform medium to fine sands (in excess of 60 percent passing a No. 40 sieve) use a smooth-drum static roller or lightweight (walk behind) vibratory roller. The use of large vibratory compaction equipment with this type of backfill material will make wall alignment control difficult.

Within 1 m (3 ft) of the wall or slope face, use small single or double drum, walk-behind vibratory rollers or vibratory plate compactors as shown on figure 84b. Placement of the reinforced backfill near the front should not lag behind the remainder of the structure by more than one lift. Poor fill placement and compaction in this area has in some cases resulted in a chimney-shaped vertical void immediately behind the facing elements. Within this 1 m (3 ft) zone, quality control should be maintained by a methods specification such as three passes of a light drum compactor. Higher quality fill is sometimes used in this zone so that the desired properties can be achieved with less compactive effort. Excessive



Figure 83. Placement of reinforced backfill.



Figure 84. Compaction equipment showing: a) large equipment permitted away from face; and b) lightweight equipment within 1 m of the face.

compactive effort or use of too heavy equipment near the wall face could result in excessive face panel movement (modular panels) or structural damage (full-height, precast panels), and overstressing of reinforcement layers.

Inconsistent compaction and undercompaction caused by insufficient compactive effort or allowing the contractor to "compact" backfill with trucks and dozers will lead to gross misalignments and settlement problems and should not be permitted. Flooding of the backfill to facilitate compaction should not be permitted. Compaction control testing of the reinforced backfill should be performed on a regular basis during the entire construction project. A minimum frequency of one test within the reinforced soil zone per every 1.5 m (5 ft) of wall height for every 30 m (100 ft) of wall is recommended.

d. Placement of Reinforcing Elements

Reinforcing elements for MSE and RSS systems should be installed in strict compliance with spacing and length requirements shown on the plans. Reinforcements should generally be placed perpendicular to the back of the facing panel. In specific situations, abutments and curved walls, for example, it may be permissible to skew the reinforcements from their design location in either the horizontal or vertical direction. In all cases, overlapping layers of reinforcements should be separated by a 75 mm (3-inch) minimum thickness of fill.

Curved walls create special problems with MSE panel and reinforcement details. Different placement procedures are generally required for convex and concave curves. For reinforced fill systems with precast panels, joints will either be further closed or opened by normal facing movements depending on whether the curve is concave or convex.

Other difficulties arise when constructing MSE/RSS structures around deep foundation elements or drainage structures. For deep foundations either drive piles prior to face construction or use hollow sleeves at proposed pile locations during reinforced fill erection. The latter method is generally preferred. Predrilling for pile installation through the reinforced soil structure between reinforcements can also be performed but is risky and may damage reinforcing elements.

Connections. Each MSE system has a unique facing connection detail. Several types of connections are shown on figure 85. All connections must be made in accordance with the manufacturer's recommendations. For example on Reinforced Earth structures bolts must fit and be located between tie strips, be perpendicular to the steel surfaces, and be seated flush against the flange to have full bearing of the bolt head. Nuts are to be securely tightened.

Flexible reinforcements, such as geotextiles and geogrids, usually require pretensioning to remove any slack in the reinforcement or in the panel. The tension is then maintained by staking or by placing fill during tensioning. Tensioning and staking will reduce subsequent horizontal movements of the panel as the wall fill is placed.

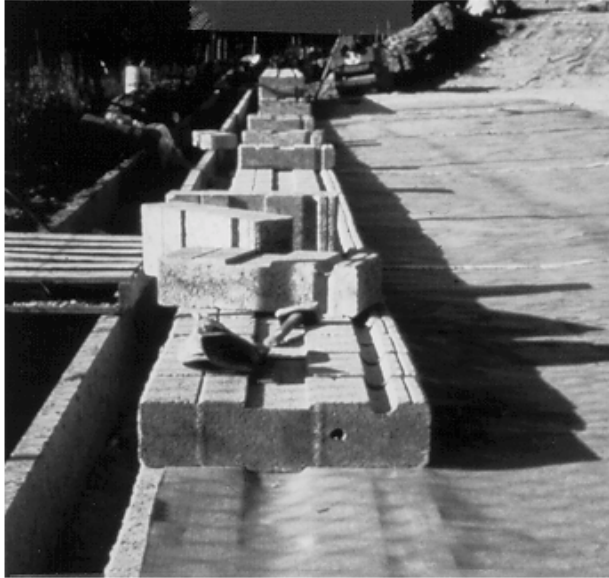

Figure 85. Facing connection examples.

e. Placement of Subsequent Facing Courses (Segmental Facings)

Throughout construction of segmental panel walls, facing panels should only be set at grade. Placement of a panel on top of one not completely backfilled should not be permitted.

Alignment Tolerances. The key to a satisfactory end product is maintaining reasonable horizontal and vertical alignments during construction. Generally, the degree of difficulty in maintaining vertical and horizontal alignment increases as the vertical distance between reinforcement layers increases.

The following alignment tolerances are recommended:

! Adjacent facing panel joint gaps (all reinforcements) - 19 mm \pm 6 mm ($\frac{3}{4}$ -inch \pm $\frac{1}{4}$ -inch)

! Precast face panel (all reinforcements) - 6 mm per m (horizontal and vertical directions) ($\frac{1}{8}$ -inch per 5 ft).

! Wrapped face walls and slopes (e.g., welded wire or geosynthetic facing) - 15 mm per m (horizontal and vertical directions) (1-inch per 5 ft).

! Wrapped face walls and slopes (e.g., welded wire or geosynthetic facing) overall vertical - 8 mm per m ($\frac{1}{2}$ -inch per 5 ft).

! Wrapped face walls and slopes (e.g., welded wire or geosynthetic facing) bulging - 25 to 50 mm (1 to 2 inches) maximum.

! Reinforcement placement elevations - 25 mm (1-inch) of connection elevation.

Failure to attain these tolerances when following suggested construction practices indicates that changes in the contractor's procedures are necessary. These might include changes in reinforced backfill placement and compaction techniques, construction equipment, and facing panel batter.

Facing elements that are out of alignment should not be pulled back into place because this may damage the panels and reinforcements and, hence, weaken the system. Appropriate measures to correct an alignment problem are the removal of reinforced fill and reinforcing elements, followed by the resetting of the panels. Decisions to reject structure sections that are out of alignment should be made rapidly because panel resetting and reinforced fill handling are time consuming and expensive. Occasionally, lower modular panels may experience some movement after several lifts of panels have been placed. This could be due to foundation settlement, excess moisture content following heavy rain, or excessive compaction. Construction should be stopped immediately and the situation evaluated by qualified geotechnical specialists when these "post erection" deformations occur.

Improper horizontal and vertical joint openings can result in face panel misalignment, and cracking and spalling due to point stresses. Wedging of stones or concrete pieces to level face panels should not be permitted. All material suppliers use bearing pads on horizontal joints between segmental facing panels to prevent point stresses (cork, neoprene, or rubber are typically used). These materials should be installed in strict accordance with the plans and specifications, especially with regard to thickness and quantity. Other joint materials are used to prevent point stresses and erosion of fill through the facing joints (synthetic foam and geotextiles details are typically used). Excessively large panel joint spacings or joint openings that are highly variable result in a very unattractive end product. Bearing pads and geotextile joint covers are shown on figure 86.

Wooden wedges shown on figure 82 placed during erection to aid in alignment should remain in place until the third layer of modular panels are set, at which time the bottom layer of wedges should be removed. Each succeeding layer of wedges should be removed as the succeeding panel layer is placed. When the wall is completed, all temporary wedges should be removed.

At the completion of each day's work, the contractor should grade the wall fill away from the face and lightly compact the surface to reduce the infiltration of surface water from precipitation. At the beginning of the next day's work, the contractor should scarify the backfill surface.

Table 16 gives a summary of several out-of-tolerance conditions and their possible causes.



Figure 86. Geotextile joint cover and neoprene pads.

Table 16. Out-of-Tolerance conditions and possible causes.

MSEW structures are to be erected in strict compliance with the structural and aesthetic requirements of the plans, specifications, and contract documents. The desired results can generally be achieved through the use of quality materials, correct construction/erection procedures, and proper inspection. However, there may be occasions when dimensional tolerances and/or aesthetic limits are exceeded. Corrective measures should quickly be taken to bring the work within acceptable limits.

Presented below are several out-of-tolerance conditions and their possible causes.

| <u>CONDITION</u> | <u>POSSIBLE CAUSE</u> |
|-----------------------------------------------------------------------------------------------------------------------------------------------------------------------------------------------------------------------------------------------------------------------------------------------------|--------------------------------------------------------------------------------------------------------------------------------------------------------------------------------------------------------------------------------------------------------------------------------------------------------------------------------------------------------------------------------------------------------------------------------------------------------------------------------------------------------------------------------------------------------------------------|
| <p>1. Distress in wall:</p> <p style="padding-left: 20px;">a. Differential settlement or low spot in wall.</p> <p style="padding-left: 20px;">b. Overall wall leaning beyond vertical alignment tolerance.</p> <p style="padding-left: 20px;">c. Panel contact, resulting in spalling/chipping.</p> | <p>1. a. Foundation (subgrade) material too soft or wet for proper bearing. Fill material of poor quality or not properly compacted.</p> |
| <p>2. First panel course difficult (impossible) to set and/or maintain level. Panel-to-panel contact resulting in spalling and/or chipping.</p> | <p>2. a. Leveling pad not within tolerance.</p> |
| <p>3. Wall out of vertical alignment tolerance (plumbness), or leaning out.</p> | <p>3. a. Panel not battered sufficiently.</p> <p style="padding-left: 20px;">b. Oversized backfill and/or compaction equipment working within 1 m (3 ft) zone of back of wall facing panels.</p> <p style="padding-left: 20px;">c. Backfill material placed wet of optimum moisture content. Backfill contains excessive fine materials (beyond the specifications for percent of materials passing a No. 200 sieve).</p> <p style="padding-left: 20px;">d. Backfill material pushed against back of facing panel before being compacted above reinforcing elements.</p> |

(cont'd.)

CONDITION

POSSIBLE CAUSE

- | | | |
|----|---------------------------------------------------------------------|-----------------------------------------------------------------------------------------------------------------------------------------------------------------------|
| 4. | Wall out of vertical alignment tolerance (plumbness) or leaning in. | e. Excessive or vibratory compaction of uniform, medium-fine sand (more than 60 percent passing a No. 40 sieve). |
| | | f. Backfill material dumped close to free end of reinforcing elements, then spread toward back of wall, causing displacement of reinforcements and pushing panel out. |
| | | g. Shoulder wedges not seated securely. |
| | | h. Shoulder clamps not tight. |
| | | i. Slack in reinforcement to facing connections. |
| | | j. Inconsistent tensioning of geosynthetic reinforcement to MBW unit. |
| | | k. Localized over-compaction adjacent to MBW unit. |
| 4. | | a. Excessive batter set in panels for select granular backfill material being used. |
| | | b. Inadequate compaction of backfill. |
| | | c. Possible bearing capacity failure. |
| | | d. MBW unit manufactured out of vertical tolerance. |
| 5. | Wall out of horizontal alignment tolerance, or bulging. | a. See <u>Causes</u> 3c, 3d, 3e, 3j, 3k. Backfill saturated by heavy rain or improper grading of backfill after each day's operations. |

(cont'd.)

| <u>CONDITION</u> | <u>POSSIBLE CAUSE</u> |
|------------------------------------------------------------|-------------------------------------------------------------------------------------------------------------------------------------------------|
| 6. Panels do not fit properly in their intended locations. | 6. a. Panels are not level. Differential settlement (see <u>Cause 1</u>). b. Panel cast beyond tolerances. c. Failure to use spacer bar. |
| 7. Large variations in movement of adjacent panels. | 7. a. Backfill material not uniform. b. Backfill compaction not uniform. c. Inconsistent setting of facing panels |

9.4 PERFORMANCE MONITORING PROGRAMS

Since MSE technology is well established, the need for monitoring programs should be limited to cases in which new features or materials have been incorporated in the design, substantial post construction settlements are anticipated and/or construction rates require control and where degradation/corrosion rates of reinforcements require monitoring because of the use of marginal fills or anticipated changes in the in situ regime. Under the outlined conditions the monitoring can be used to:

- ! Confirm design stress levels and monitor safety during construction.
- ! Allow construction procedures to be modified for safety or economy.
- ! Control construction rates.
- ! Enhance knowledge of the behavior of MSEW or RSS structures to provide a base reference for future designs, with the possibility of improving design procedures and/or reducing costs.
- ! Provide insight into maintenance requirements, by long-term performance monitoring.

Degradation/Corrosion monitoring schemes are fully outlined in the companion *Corrosion/Degradation* document.

a. Purpose of Monitoring Program

The first step in planning a monitoring program is to define the purpose of the measurements. Every instrument on a project should be selected and placed to assist in answering a specific question.

If there is no question, there should be no instrumentation. Both the questions that need to be answered and the clear purpose of the instrumentation in answering those questions should be established.

The most significant parameters of interest should be selected, with care taken to identify secondary parameters that should be measured if they may influence primary parameters.

For all structures, important parameters that should be considered include:

- ! Horizontal movements of the face (for MSEW structures).
- ! Vertical movements of the surface of the overall structure.
- ! Local movements or deterioration of the facing elements.
- ! Drainage behavior of the backfill.
- ! Performance of any structure supported by the reinforced soil, such as approach slabs for bridge abutments or footings.
- ! Horizontal movements within the overall structure.
- ! Vertical movements within the overall structure.
- ! Lateral earth pressure at the back of facing elements.
- ! Vertical stress distribution at the base of the structure.
- ! Stresses in the reinforcement, with special attention to the magnitude and location of the maximum stress.
- ! Stress distribution in the reinforcement due to surcharge loads.
- ! Relationship between settlement and stress-strain distribution.
- ! Stress relaxation in the reinforcement with time.
- ! Total horizontal stress within the backfill and at the back of the reinforced wall section.
- ! Aging condition of reinforcement such as corrosion losses or degradation of polymeric reinforcements.
- ! Pore pressure response below structure.
- ! Temperature which often is a cause of real changes in other parameters, and also may affect instrument readings.

! Rainfall which often is a cause of real changes in other parameters.

! Barometric pressure, which may affect readings of earth pressure and pore pressure measuring instruments.

The characteristics of the subsurface, backfill material, reinforcement, and facing elements in relation to their effects on the behavior of the structure must be assessed prior to developing the instrumentation program. It should be remembered that foundation settlement will affect stress distribution within the structure. Also, the stiffness of the reinforcement will affect the anticipated lateral stress conditions within the retained soil mass.

b. Limited Monitoring Program

Limited observations and monitoring will typically include:

! Horizontal movements of the face (for MSEW structures).

! Vertical movements of the surface of the overall structure.

! Local movements or deterioration of the facing elements.

! Performance of any structure supported by the reinforced soil, such as approach slabs for bridge abutments or footings.

Horizontal and vertical movements can be monitored by surveying methods, using suitable measuring points on the retaining wall facing elements or on the pavement or surface of the retained soil. Permanent benchmarks are required for vertical control. For horizontal control, one horizontal control station should be provided at each end of the structure.

The **maximum** lateral movement of the wall face during construction is anticipated to be on the order of $H/250$ for rigid reinforcement and $H/75$ for flexible reinforcement. Tilting due to differential lateral movement from the bottom to the top of the wall would be anticipated to be less than 4 mm per m ($1/4$ -inch per 5 ft) of wall height for either system. Postconstruction horizontal movements are anticipated to be very small. Post construction vertical movements should be estimated from foundation settlement analyses, and measurements of actual foundation settlement during and after construction should be made.

c. Comprehensive Monitoring Program

Comprehensive studies involve monitoring of surface behavior as well as internal behavior of the reinforced soil. A comprehensive program may involve the measurement of nearly all of the parameters enumerated above and the prediction of the magnitude of each parameter at working stress to establish the range of accuracy for each instrument.

Whenever measurements are made for construction control or safety purposes, or when used to support less conservative designs, a predetermination of warning levels should be made. An action plan must be established, including notification of key personnel and design alternatives so that remedial action can be discussed or implemented at any time.

A comprehensive program may involve all or some of the following key purposes:

- ! Deflection monitoring to establish gross structure performance and as an indicator of the location and magnitude of potential local distress to be more fully investigated.
- ! Structural performance monitoring to primarily establish tensile stress levels in the reinforcement and or connections. A second type of structural performance monitoring would measure or establish degradation rates of the reinforcements.
- ! Pullout resistance proof testing to establish the level of pullout resistance within a reinforced mass as a function of depth and elongation.

The possible instruments for monitoring are outlined in Table 17.

d. Program Implementation

Selection of instrument locations involves three steps. First, sections containing unique design features are identified. For example, sections with surcharge or sections with the highest stress. Appropriate instrumentation is located at these sections. Second, a selection is made of cross sections where predicted behavior is considered representative of behavior as a whole. These cross sections are then regarded as primary instrumented sections, and instruments are located to provide comprehensive performance data. There should be at least two "primary instrumented sections." Third, because the selection of representative zones may not be representative of all points in the structure, simple instrumentation should be installed at a number of "secondary instrumented sections" to serve as indices of comparative behavior. For example, surveying the face of the wall in secondary cross sections would examine whether comprehensive survey and inclinometer measurements at primary sections are representative of the behavior of the wall.

Access to instrumentation locations and considerations for survivability during construction are also important. Locations should be selected, when possible, to provide cross checks between instrument types. For example, when multipoint extensometers (multiple telltales) are installed on reinforcement to provide indications of global (macro) strains, and strain gauges are installed to monitor local (micro) strains, strain gauges should be located midway between adjacent extensometer attachment points.

Most instruments measure conditions at a point. In most cases, however, parameters are of interest over an entire section of the structure. Therefore, a large number of measurement points may be required to evaluate such parameters as distribution of stresses in the

Table 17. Possible instruments for monitoring reinforced soil structures.

| <u>PARAMETERS</u> | <u>POSSIBLE INSTRUMENTS</u> |
|-------------------------------------------------------|---------------------------------------------------------------------------------------------------------------------------------------------------------|
| Horizontal movements of face | Visual observation Surveying methods Horizontal control stations Tiltmeters |
| Vertical movements of overall structure | Visual observation Surveying methods Benchmarks Tiltmeters |
| Local movements or deterioration of facing elements | Visual observation Crack gauges |
| Drainage behavior of backfill | Visual observation at outflow points Open standpipe piezometers |
| Horizontal movements within overall structure | Surveying methods (e.g. transit) Horizontal control stations Probe extensometers Fixed embankment extensometers Inclinometers Tiltmeters |
| Vertical movements within overall structure | Surveying methods Benchmarks Probe extensometers Horizontal inclinometers Liquid level gauges |
| Performance of structure supported by reinforced soil | Numerous possible instruments (depends on details of structure) |
| Lateral earth pressure at the back of facing elements | Earth pressure cells Strain gauges at connections Load cells at connections |
| Stress distribution at base of structure | Earth pressure cells |

(cont'd)

| <u>PARAMETERS</u> | <u>POSSIBLE INSTRUMENTS</u> |
|---------------------------------------------------------------------|----------------------------------------------------------------------------------------------------------------------------------------------------------------------------------------------------------------------------------------------------|
| Stress in reinforcement | Resistance strain gauges Induction coil gauges Hydraulic strain gauges Vibrating wire strain gauges Multiple telltales |
| Stress distribution in reinforcement due to surcharge loads | Same instruments as for stress in reinforcement |
| Relationship between settlement and stress-strain distribution | Same instruments as for: <ul style="list-style-type: none">• vertical movements of surface of overall structure• vertical movements within mass of overall structure• stress in reinforcement Earth pressure cells |
| Stress relaxation in reinforcement | Same instruments as for stress in reinforcement |
| Total stress within backfill and at back of reinforced wall section | Earth pressure cells |
| Pore pressure response below structures | Open standpipe piezometers Pneumatic piezometers Vibrating wire piezometers |
| Temperature | Ambient temperature record Thermocouples Thermistors Resistance temperature devices Frost gauges |
| Rainfall | Rainfall gauge |
| Barometric pressure | Barometric pressure gauge |

reinforcement and stress levels below the retaining structure. For example, accurate location of the locus of the maximum stress in the reinforced soil mass will require a significant number of gauge points, usually spaced on the order of 30 cm apart in the critical zone. Reduction in the number of gauge points will make interpretation difficult, if not impossible, and may compromise the objectives of the program.

In preparing the installation plan, consideration should be given to the compatibility of the installation schedule and the construction schedule. If possible, the construction contractor should be consulted concerning details that might affect his operation or schedule.

Step-by-step installation procedures should be prepared well in advance of scheduled installation dates for installing all instruments. Detailed guidelines for choosing instrument types, locations and installation procedures are given in FHWA RD89-043.

e. Data Interpretation

Monitoring programs have failed because the data generated was never used. If there is a clear sense of purpose for a monitoring program, the method of data interpretation will be guided by that sense of purpose. Without a purpose, there can be no interpretation.

When collecting data during the construction phase, communication channels between design and field personnel should remain open so that discussions can be held between design engineers who planned the monitoring program and field engineers who provide the data.

Early data interpretation steps should have already been taken, including evaluation of data, to determine reading correctness and also to detect changes requiring immediate action. The essence of subsequent data interpretation steps is to correlate the instrument readings with other factors (cause and effect relationships) and to study the deviation of the readings from the predicted behavior.

After each set of data has been interpreted, conclusions should be reported in the form of an interim monitoring report and submitted to personnel responsible for implementation of action. The report should include updated summary plots, a brief commentary that draws attention to all significant changes that have occurred in the measured parameters since the previous interim monitoring report, probable causes of these changes, and recommended action.

A final report is often prepared to document key aspects of the monitoring program and to support any remedial actions. The report also forms a valuable bank of experience and should be distributed to the owner and design consultant so that any lessons may be incorporated into subsequent designs.

REFERENCES

1. Elias V. "Corrosion/Durability of Soil Reinforced Structures" *FHWA RD 89-186*. Washington D.C., 1989, 105 p.
2. Simac, M.R., Bathurst R.J. Berg R.R., Lothspeich S.E. "Design Manual for Segmental Retaining Walls" *National Concrete Masonry Association*. Herndon, VA, 1993, 336 p.
3. Berg, R.R., Chouery-Curtis, V.E., and Watson, C.H., "Critical Failure Planes in Analysis of Reinforced Slopes," *Proceedings of Geosynthetics '89, Volume 1*, San Diego, February, 1989.
4. Wright, S.G. and Duncan, J.M., "Limit Equilibrium Stability Analyses for Reinforced Slopes," presented at the *Transportation Research Board 70th Annual Meeting*, January 13-17, Washington D.C., 1990.
5. Jurgenson, L., "The Shearing Resistance of Soils", *Journal of the Boston Society of Civil Engineers*, Also in *Contribution to Soil Mechanics, 1925-1940*, Boston Society of Civil Engineers, 1934, pp 134-217.
6. Silvestri, V., "The Bearing Capacity of Dykes and Fills Founded on Soft Soils of Limited Thickness", *Canadian Geotechnical Journal, Volume 20*, Number 3, 1983, pp. 428-436.
7. Bonarparte, R., Holtz, R.D. and Giroud, J.P., "Soil Reinforcement Design Using Geotextiles and Geogrids", *Geotextile Testing and The Design Engineer, ASTM, Special Technical Publication 952*, 1987.
8. Yarger and Barne "Montana Department of Transportation's Introduction to Geogrid Use for Steepened Embankment Design", *Proceedings of Geosynthetics '93*, Vancouver, B.C., Canada, 1993.
9. Zornberg, Barrows, Christopher and Wayne "Construction and Instrumentation of a Highway Slope Reinforced with High-Strength Geotextiles", *Proceedings of Geosynthetics '95*, Nashville, Tenn., 1995.
10. _____ "Reinforced Soil Highway Slopes" *Tensar Technical Note*. Tensar Earth Technologies, Atlanta, GA, 1990.
11. Wayne and Wilcosky "An innovative use of a nonwoven geotextile in the repair of Pennsylvania State Route 54", *Geotechnical Fabrics Report*, Volume 13, Number 2, 1995.
12. Werner, G. and Resl, S., "Stability Mechanisms in Geotextile Reinforced Earth-Structures", *Proceedings of the 3rd International Conference on Geotextiles*, Vienna, Austria, Volume II, 1986, pp. 465-470.

13. Ruegger, R., "Geotextile Reinforced Soil Structures on which Vegetation can be Established", *Proceedings of the 3rd International Conference on Geotextiles*, Vienna, Austria, Volume II, 1986, pp. 453-458.
14. Leshchinsky, E. and Boedeker, R.H., "Geosynthetic Reinforced Soil Structures", *Journal of Geotechnical Engineering, ASCE, Volume 115, Number 10*, 1989, pp. 1459-1478.
15. Jewell, R.A., "Revised Design Charts for Steep Reinforced Slopes, Reinforced Embankments: Theory and Practice in the British Isles", *Thomas Telford*, London, U.K., 1990.
16. Silvestri, V. " The Bearing Capacity of Dikes and Fills Founded on Soft Soils of Limited Thickness" *Canadian Geotechnical Journal Vol. 20 No. 3*, 1983.
17. Chen, Y-H and G.K. Cotton, "Design of Roadside Channels with Flexible Linings", *FHWA-IP-87-7, HEC15, PB89-122584*, 1987.
18. Chen, Y-H and Anderson, B.A., Final Report - "Development of a Methodology for Estimating Embankment Damage Due to Flood Overtopping", *DTFH61-82-00104*, FHWA, Washington D.C., 1986.
19. Collin, J.G., "Controlling Surficial Stability Problems on Reinforced Steepened Slopes" *Geotechnical Fabrics Report IFAI*, 1996.
20. Cheney, R, and Chassie, R., "Soils and Foundations Workshop Reference Manual" *FHWA, NHI-00-045*, 2000.
21. Elias, V., Salman, A., Juran, I., Pearce, E., Lu, S., "Testing Protocols for Oxidation and Hydrolysis of Geosynthetics," *FHWA RD-97-144*, Washington, D.C., 1999.
22. Bathurst, R.J., Walters, D., Vlachopoulos, N., Burgess P., and Allan, T.H., "Fullscale Testing of Geosynthetic Reinforced Walls," *Proceedings of GeoDenver 2000. ASCE Special Publication*, 2000.
23. Koerner, J., Soong, T-Y, and Koerner, R. M., *Earth Retaining Wall Costs in the USA*, GRI Report #20, Geosynthetics Institute, Folsom, PA, 1998.
24. Sotir, R.B. and Christopher, B.R., "Soil Bioengineering and Geosynthetics for Slope Stabilization," *Proceedings, Geosynthetics Asia 2000*, Selangor Daruf, Ehsan Malaysia, 2000.
25. Gray, D.H. and Sotir, R., *Biotechnical and Soil Bioengineering Slope Stabilization, A Practical Guide for Erosion Control*, John Wiley & Sons, New York, NY, 1995.

26. Sotir, R.B., Difini, J.T. and McKown, A.F., "Soil Bioengineering Biotechnical Stabilization of a Slope Failure," *Proceedings, The Sixth International Conference on Geosynthetics*, Atlanta, Georgia, 1998.
27. Sotir, R.B. and Stulgis, R.P., "Slope Stabilization Using Soil Bioengineering Case Studies", *Proceedings ASCE International Water Resource Engineering Conference Program*, Seattle, Washington, 1999.
28. Newmark, N.M., "Effects of Earthquakes on Dams and Embankments," *Geotechnique*, Vol. 14, No. 2, pp. 139-160, 1965.
29. Kavazanjian, E., Matasovic, N., Hadj-Hamou, T. and Sabatini, P.J., *Geotechnical Engineering Circular #3 – Design Guidance: Geotechnical Earthquake Engineering for Highways, Volume 1 – Design Principles*, FHWA-SA-97-076, 1997.
30. Allen, T.M., Christopher, B.R. and Holtz, R.D., "Performance of a 12.6 m High Geotextile Wall in Seattle, Washington," *Geosynthetics Reinforced Soil Retaining Walls*, J.T.H. Wu Editor, A.A. Balkema, Rotterdam, 1992, pp. 81-100.
31. HITEC, *Technical Evaluation Report, Evaluation of The TENSAR MESA Retaining Wall System*, CERF Report: #40358 , Highway Innovative Technology Evaluation Center, Civil Engineering Research Foundation (CERF), American Society of Civil Engineers, Washington, D.C., 2000.
32. ADAMA Engineering, Inc., *Mechanically Stabilized Earth Walls: Program MSEW*, developed under contract with Federal Highway Administration, www.msew.com, Newark, DE, 1998-2000.
33. ADAMA Engineering, Inc., *ReSSA: Reinforced Slope Stability Analysis*, developed under contract with Federal Highway Administration, www.msew.com, Newark, DE, 2001.
34. Berg, R.R., *Minnesota Department of Transportation Standard MSEW and RSS Designs, Project Report – Volume I, Summary Report*, Minnesota Department of Transportation, Oakdale, MN, June 2000, 98 p.
35. Koerner, G.R., Hsuan, Y.G. and Hart, M., *Field Monitoring and Laboratory Study of Geosynthetics in Reinforcement Applications, Tasks B1 and B2*, Geosynthetic Research Institute, Philadelphia, PA, 2000, 116 p.
36. Elias, V., "Corrosion/Degradation of Soil Reinforcements for Mechanically Stabilized Earth Walls and Reinforced Soil Slopes," *FHWA-NHI-00-044*, September 2000, 94 p.
37. MNDOT, *Technical Memorandum No.: 01-05-MR-01*, Program Support Group, Minnesota Department of Transportation, 8 February 2001, 8 p.

[BLANK]

APPENDIX A

DETERMINATION OF PULLOUT RESISTANCE FACTORS

Pullout resistance of soil reinforcement is defined by the ultimate pullout resistance required to cause outward sliding of the reinforcement through the soil. Reinforcement specific data has been developed and is presented in chapter 3. The empirical data uses different interaction parameters, and it is therefore difficult to compare the pullout performance of different reinforcements.

The method for determining reinforcement pullout presented herein, consists of the normalized approach recommended in the FHWA manual FHWA-RD-89-043 (1990). The pullout resistance, F^* is a function of both frictional and passive resistance, depending on the specific reinforcement type. The scale effect correction factor, α , is a function of the nonlinearity in the pullout load - mobilized reinforcement length relationship observed in pullout tests. Inextensible reinforcements usually have little, if any nonlinearity in this relationship, resulting in α equal to 1.0, whereas extensible reinforcements can exhibit substantial nonlinearity due to a decreasing shear displacement over the length of the reinforcement, resulting in an α of less than 1.0.

Both F^* and α must be determined through product specific tests, or empirically/theoretically using the procedures provided herein and in Section 3.3, in particular table 5. It should be noted that the empirical procedures provided in this appendix for the determination of F^* reduce, for the most part, to the equations currently provided in 1992 AASHTO for pullout design.

The pullout resistance of partial/full friction facing/reinforcement connections is defined as the load required to cause sliding of the reinforcement relative to the facing blocks or reinforcement rupture at the facing connection, whichever occurs first.

A.1 EMPIRICAL PROCEDURES TO DETERMINE F^* AND α

Pullout resistance can be estimated empirically/theoretically using the method provided in chapter 3. F^* using this method, is calculated as follows:

$$\begin{aligned} F^* &= \text{Frictional Resistance} + \text{Passive Resistance} \\ &= \text{Tan } \rho + F_q \alpha_\beta \end{aligned}$$

where $\text{Tan } \rho$ is an apparent friction coefficient for the specific reinforcement, ρ is the soil-reinforcement interface friction angle, F_q is the embedment (or surcharge) bearing capacity factor, and α_β is a structural geometric factor for passive resistance. The determination of each of these parameters is provided in table 5, chapter 3, with α estimated analytically using direct shear test data and the "t-z" method used in the design of friction piles. However, since some test data is required and the analytical method is complex, it is better to obtain α directly from pullout test data or use conservative default values for α . If pullout test data is not available, a default value of 1.0 can be used for α for inextensible reinforcements and a default value of 0.6 to 0.8 can be used for extensible reinforcements.

A.2 EXPERIMENTAL PROCEDURES TO DETERMINE F^* AND α

Two types of tests are used to obtain pullout resistance parameters: the direct shear test, and the pullout test. The direct shear test is useful for obtaining the peak or residual interface friction angle between the soil and the reinforcement material. ASTM D-5321 should be used for this purpose. In this case, F^* would be equal to $\tan \rho_{\text{peak}}$. F^* can be obtained directly from this test for sheet and strip type reinforcements. However, the value for α must be assumed or analytically derived, as α cannot be determined directly from direct shear tests. A pullout test can also be used to obtain pullout parameters for these types of soil reinforcement. A pullout test must be used to obtain pullout parameters for bar mat and grid type reinforcements, and to obtain values for α for all types of reinforcements. In general, the pullout test is preferred over the direct shear test for obtaining pullout parameters for all soil reinforcement types. An ASTM standard for pullout testing is currently under development. Until this standard is finalized, it is recommended that test procedures GRI GG-5 and GRI GT-6 using the controlled strain rate method, be used in the interim as pullout test procedures. For long-term interaction coefficients, the constant stress (creep) method can be used. For extensible reinforcements, it is recommended that specimen deformation be measured at several locations along the length of the specimen (e.g., three to four points) in addition to the deformation at the front of the specimen. For all reinforcement materials, it is recommended that the specimen tested for pullout have a minimum embedded length of 600 mm (24 inches). Additional guidance is provided herein regarding interpretation of pullout test results.

For geogrids, the grid joint, or junction strength, must be adequate to allow the passive resistance on the transverse ribs to develop without failure of the grid joint throughout the design life of the structure. To account for this, F^* for geogrids should be determined using one of the following approaches:

- ! Using quick effective stress pullout tests (i.e., "Controlled Strain Rate Method for Short-Term Testing" per GGI:GG5 and GRI:GT6) and through-the-junction creep testing of the geogrid per GRI:GG3a.
- ! Using quick effective stress pullout tests (i.e., "Controlled Strain Rate Method for Short-Term Testing" per GRI:GG5 and GRI:GT6), but with the geogrid transverse ribs severed.
- ! Using quick effective stress pullout tests (i.e., "Controlled Strain Rate Method for Short-Term Testing" per GRI:GG5 and GRI:GT6) if the summation of the shear strengths of the joints occurring in a 300 mm (1 ft) length of grid sample is equal to or greater than the ultimate strength of the grid element to which they are attached. If this joint strength criteria is used, grid joint shear strength should be measured in accordance with GRI:GG2 (Koerner, 1988).
- ! Conduct long-term effective stress pullout tests of the entire geogrid structure in accordance with the constant stress (creep) method of GRI:GG5 (Koerner, 1991).

For pullout tests, a normalized pullout versus mobilized reinforcement length curve should be established as shown in figure A.1. Different mobilized lengths can be obtained by instrumenting the reinforcement specimen. Strain or deformation measuring devices such as wire extensometers

attached to the reinforcement surface at various points back from the grips should be used for this purpose. A section of the reinforcement is considered to be mobilized when the deformation measuring device indicates movement at its end. Note that the displacement versus mobilized length plot (uppermost plot in figure) represents a single confining pressure. Tests must be run at several confining pressures to develop the P_r versus $\sigma_v L_p$ plot (middle plot in figure). The value of P_r selected at each confining pressure to be plotted versus $\sigma_v L_p$ is the lesser of either the maximum value of P_r (i.e., maximum sustainable load), the load which causes rupture of the specimen, or the value of P_r obtained at a predefined maximum deflection measured at either the front or the back of the specimen. Note that P_r is measured in terms of load per unit reinforcement width.

It is recommended that for inextensible reinforcements, a maximum deflection of 20 mm (3/4-inch) measured at the front of the specimen be used to select P_r if the maximum value for P_r or rupture of the specimen does not occur first. For extensible reinforcements, it is recommended that a maximum deflection of 15 mm (5/8-inch) measured at the back of the specimen be used to select P_r if the maximum value for P_r or rupture of the specimen does not occur first. Note that it is acceptable, as an alternative, to define P_r for inextensible reinforcements based on a maximum deflection of 15 mm (5/8-inch) measured at the back of the specimen as is recommended for extensible reinforcements.

F_{peak}^* and F_m^* are determined from the pullout data as shown in figure A.1. The method provided in this figure is known as the corrected area method (Bonczkiewicz, et. al., 1988). The determination of α is also illustrated in figure A.1. Typical values of F^* and α for various types of reinforcements are provided by Christopher (1993).

Note that the conceptualized curves provided in figure A.1 represent a relatively extensible material. For inextensible materials, the deflection at the front of the specimen will be nearly equal to the deflection at the back of the specimen, making the curves in the uppermost plot in the figure nearly horizontal. Therefore, whether the deflection criteria to determine P_r for inextensible reinforcements is applied at the front of the specimen or at the back of the specimen makes little difference. For extensible materials, the deflection at the front of the specimen can be considerably greater than the deflection at the back of the specimen. The goal of the deflection criteria is to establish when pullout occurs, not to establish some arbitrary serviceability criteria. For extensible materials, the pullout test does not model well the reinforcement deflections which occur in full scale structures. Therefore, just because relatively large deflections occur at the front of an extensible reinforcement material in a pullout test when applying the deflection criteria to the back of the specimen does not mean that unacceptable deflections will occur in the full scale structure.

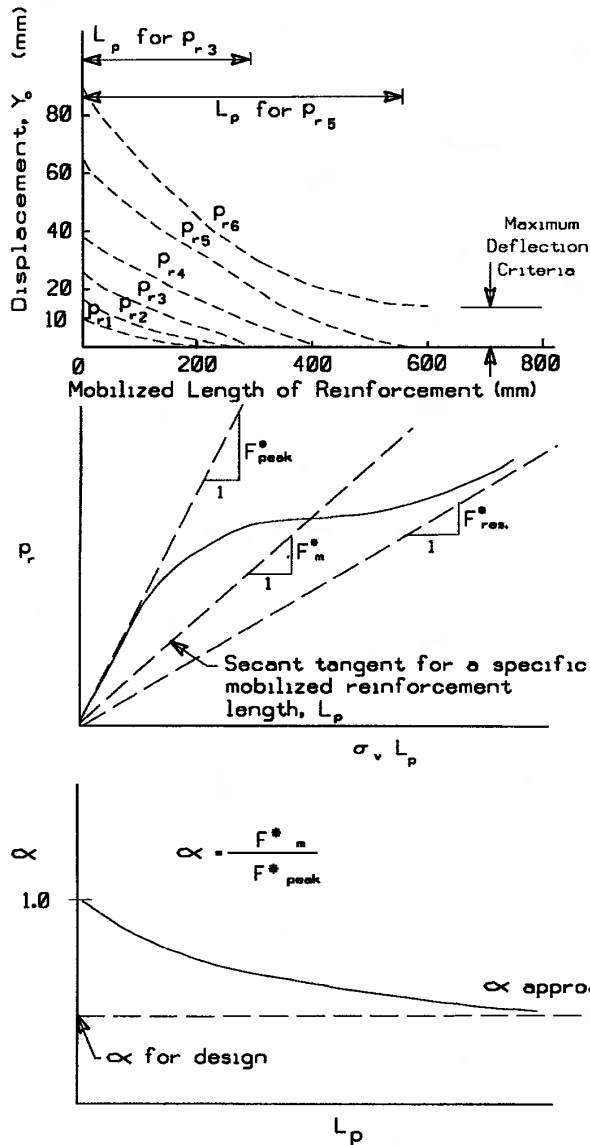

P_R = applied pullout load per unit width of reinforcement

L_p = mobilized length of reinforcement

Y_o = displacement of reinforcement

σ_v = vertical Stress on the reinforcement

F^*_{peak} = peak pullout resistance factor

F^*_m = ave. pullout resistance factor

$F^*_{res.}$ = residual pullout resistance factor

F^* = $\tan \rho$ if frictional resistance controls pullout capacity (sheet and strip reinforcement, and grids if $S_t \leq S_{opt.}$)

F^* = $F_0 \alpha_\beta$ if passive resistance controls pullout capacity (grids if $S_t \geq S_{opt.}$)

F_q = embedment bearing capacity factor

α_β = structural geometric factor for passive resistance

Figure A.1 Experimental procedure to determine F^* and α for soil reinforcement using pullout test.

A.3 CONNECTION RESISTANCE AND STRENGTH OF PARTIAL AND FULL FRICTION SEGMENTAL BLOCK/REINFORCEMENT FACING CONNECTIONS

For reinforcement connected to the facing through embedment between facing elements using a partial or full friction connection (e.g., segmental concrete block faced walls), the connection strength resulting can be determined directly through long-term testing of the connection to failure. The test set up should be in general accordance with NCMA Test Method SRWU-1 with the modifications as described in the interim Long-Term Connection Strength Testing Protocol described below. Extrapolation of test data should be conducted in general accordance with appendix B. Tests should be conducted at a confining stress that is greater than or equal to the highest confining stress considered for the wall system, and as necessary at additional confining stresses below that level to determine behavior for the full range of confining stresses anticipated.

Regardless of the mode of failure extrapolation of the time to failure envelope must be determined. Once the failure envelope has been determined, a direct comparison between the short-term ultimate strength of the connection and the rupture envelope for the geosynthetic reinforcement in isolation can be accomplished to determine RF_{CR} . The connection strength obtained from the failure envelope must also be reduced by the durability reduction factor RF_D . This reduction factor should be based on the durability of the reinforcement or the connector, whichever is failing in the test.

If it is determined that the connectors failed during the connection test and not the geosynthetic, the durability of the connector, not the geosynthetic, should be used to determine the reduction factors for the long-term connection strength in this case. If the connectors between blocks are intended to be used for maintaining block alignment during wall construction and are not intended for long-term connection shear capacity, the alignment connectors should be removed before assessing the connection capacity for the selected block-geosynthetic combination. If the pins or other connection devices are to be relied upon for long-term capacity, the durability of the connector material must be established.

The connection strength reduction factor resulting from long term testing, CR_{cr} , is evaluated as follows:

$$CR_{cr} = \frac{T_{crc}}{T_{lot}} \quad (A-1)$$

where T_{crc} is the extrapolated (75 - 100 year) connection test strength and T_{lot} is the ultimate wide width tensile strength (ASTM D 4595) for the reinforcement material lot used for connection strength testing.

The connection strength reduction factor resulting from quick tests, CR_{ult} , is evaluated as follows:

$$CR_{ult} = \frac{T_{ultconn}}{T_{lot}} \quad (A-2)$$

where $T_{ultconn}$ is the peak connection load at each normal load.

Testing Protocol

Objective: Determine the sustained load capacity of the connection between a modular block wall (MBW) facing element and a geosynthetic reinforcing material.

Method: Construct a test apparatus of full-scale MBW units and geosynthetic reinforcing material in a laboratory. Perform a series of tests at different normal loads (confining pressures) to model different wall heights, varying the applied load from 95 percent of the peak connection capacity determined from the quick connection test (SRWU-1) to 50 percent of the peak connection capacity. Measure and record the deflections and time to pullout or rupture of the connection.

Procedure:

- 8) Determine index properties of the geosynthetic reinforcing roll being tested:
 - a. Wide width tensile strength (ASTM D 4595)

Note: it is preferable to perform the D 4595 test on the roll sample being tested and to perform the test in the same apparatus being used for the long-term connection testing. This will help remove uncertainty in the test results from using different lots of the geosynthetic reinforcement material and from comparing test results from different test equipment.

- b. Creep rupture envelope for geosynthetic: develop a rupture envelope for the specific geosynthetic being tested based on creep rupture tests, appendix B, using the same longitudinal strip of reinforcement.

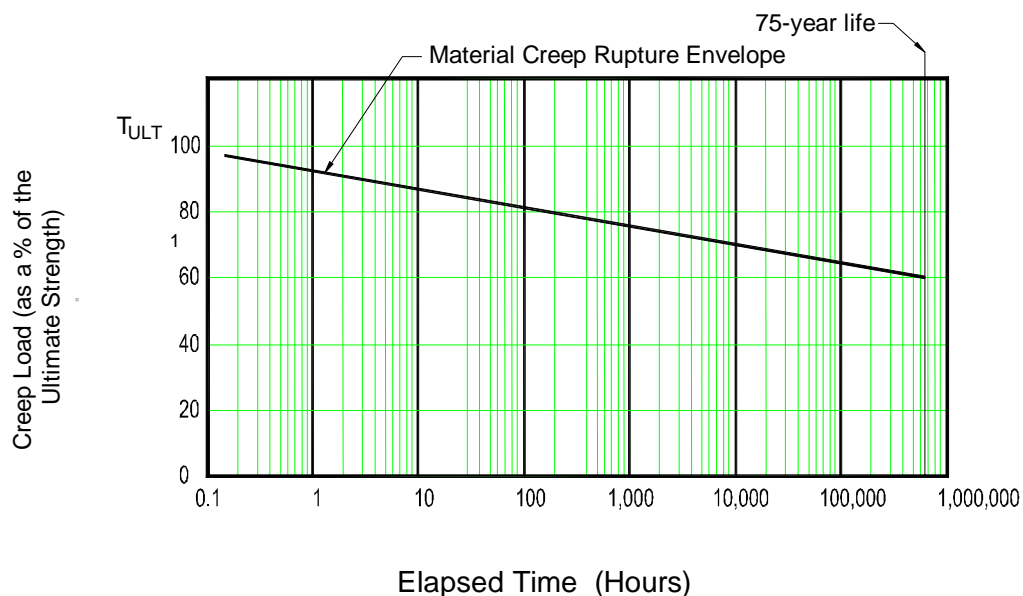

Figure A.2

Creep Rupture Envelope for Geosynthetic Reinforcement

2) Determine short-term (quick test) connection properties of the MBW unit/geosynthetic reinforcement combination, per NCMA SRWU-1, as modified below.

A. Construct a test setup in general accordance with the NCMA SRWU-1 test method with the following revisions:

- 1) Testing shall be carried out on a single width block specimen. Setup shall consist of two MBW units at the base with one MBW unit centered over the two base units.
- 2) Geosynthetic reinforcement width shall be as close as possible to the length of the MBW unit (for geogrids this is dependent on the transverse aperture). In no case shall the geosynthetic be wider than the length of the MBW unit.
- 3) Geosynthetic specimen shall have sufficient length to cover the interface surface as specified by the user. The specimen must be trimmed to provide sufficient anchorage at the geosynthetic loading clamp and a free length between the back of the MBW units and loading clamp ranging from a minimum of 203 mm to a maximum of 610 mm (8 to 24 inches). The same free length used for the short-term test shall be used for the long-term test. The same longitudinal strip of reinforcement shall be used for all short-term and long-term connection tests.
- 4) The temperature in the test space, especially close to the gage length of the specimen shall be maintained within $\pm 2^{\circ}\text{C}$ ($\pm 4^{\circ}\text{F}$) of the targeted value.
- 5) Where granular infill is required in the connection, half units may be used to provide confinement for the granular fill on each side of the single top unit. Granular fill may or may not be used in the short-term and long-term test as desired. Whichever condition (with or without infill) is selected for the short-term tests shall be the same for the long-term tests. Where granular infill is not required as part of the connection, the single unit may be used.
- 6) Normal load shall be applied to the top of the MBW unit to provide the desired confining pressure by a mechanism capable of maintaining the desired load for a period of not less than one year. *(It has been observed that under rapid loading some blocks may rotate and short-term instantaneous high normal loads can result if the vertical loading system does not have the mechanical compliance necessary to dilate. Tests shall be run for a period of 1,000 hours, however the apparatus should be capable of sustaining loads for longer periods if determined later during the test.)*
- 7) Tension loads shall be applied to the reinforcing member in a direction parallel to the connection interface, and in the plane of the connection interface. *(The mechanism for applying the tensile loads shall be*

capable of sustaining an applied load for periods of not less than one-year.)

- B. Perform a series of quick tests in accordance with SRWU-1, as modified above, on the MBW unit/ geosynthetic reinforcement combination at different normal loads to establish the $T_{ultconn}/Normal$ Load connection curve.

3.) Determine the normal and tensile load levels for sustained load testing on the MBW unit/geosynthetic reinforcement combination.

- A. The highest normal load for the sustained load test may not exceed point A (figure A.3) when the $T_{ultconn}/Normal$ load curve is bilinear or multilinear or point B (figure A.3) when the slope of the curve is linear. $T_{ultconn}$ is defined as the ultimate connection strength determined from NCMA SRWU-1. Additional normal loads may be evaluated to determine the long-term connection strength as a function of normal load.

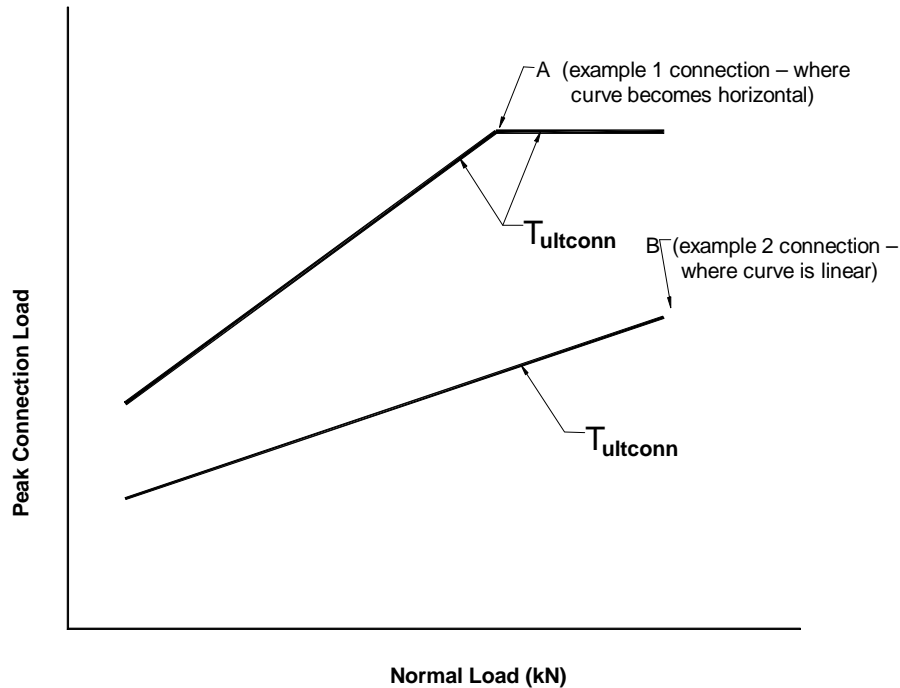

Figure A.3 Connection Strength (NCMA SRWU-1) verses Normal Load

- B. From the connection strength versus displacement curve (figure A.4) for the quick test, using the normal load determined in step A, determine the applied tensions loads for a range of percentages of the Peak Connection Capacity (e.g., 95, 90, 85, 80, 75, 66 and 50 percent of Peak Connection capacity). The tensile loads should be selected to define the connection rupture curve for 1000 hours.
- 4.) Perform sustained load testing on the MBW unit/geosynthetic reinforcement combination at the normal and tensile load levels determined from step 3 using the same test apparatus used to determine the short-term connection properties. A different test apparatus may be used to perform the long-term tests as long as a correlation is made between the two test machines. Unless otherwise agreed upon, a minimum of four normal load levels shall be used to develop the connection rupture curve.
- Assemble the MBW unit/geosynthetic reinforcement test as done in step 3, and apply the normal load desired to the top MBW unit.
 - Apply the full load (e.g., 95, 90, 85, and 80 percent of $T_{ultconn}$) tensile load rapidly and smoothly to the specimen, preferably at a strain rate of $10 \pm 3\%/min$. Record the total time for loading.
 - Measure the extension/deflection of the connection, at the back of the MBW unit in accordance with the following approximate time schedule: 1,2,6,10,30 min, and 1,2,5,10,30,100,200,500 and 1000 hrs (Note: shorter reading times may be required).

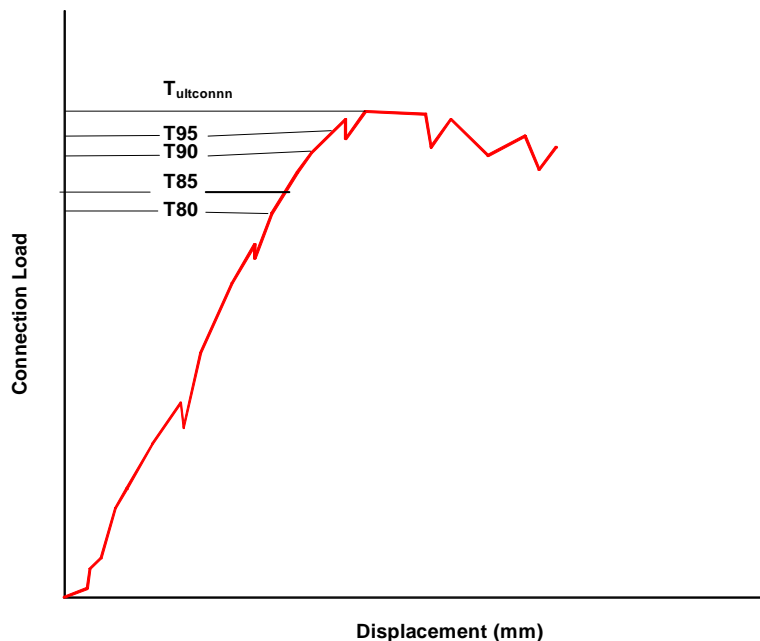

Figure A.4 Connection Strength versus Displacement (NCMA SRWU-1)

Record the time to failure of the connection.

D. Repeat steps A through C for the other normal load levels recording the loads and time to failure.

5.) Presentation of data.

A. Plot the results of the creep rupture test on a log time plot extrapolated to a minimum of 75 years, per Appendix B. The extrapolated load is the (75 - 100 year) connection load, T_{cr}

B. On the same graph, plot the time to failure for the results of the sustained load tests on the reinforcement itself from Step 1.

C. From the data plot, extrapolate to 75 years (670,000 hrs), per Appendix B.

D. All deviations from the connection test setup from the actual connection used for construction shall be noted in the test report.

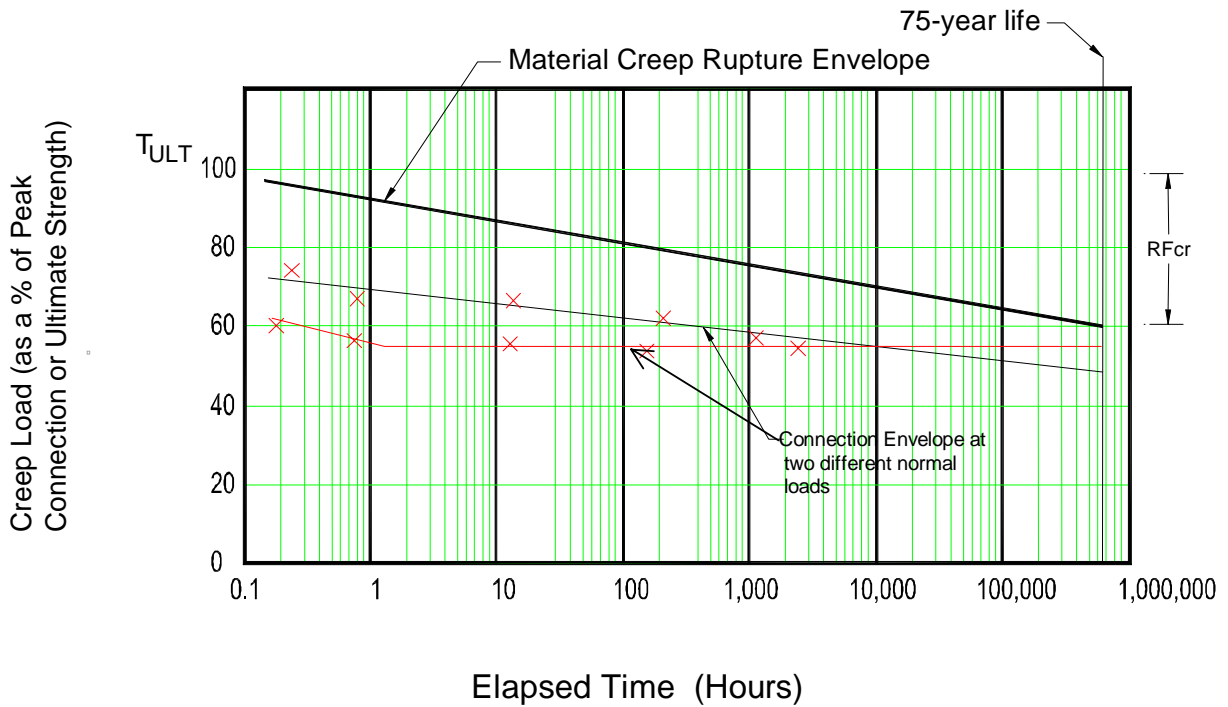

Figure A.5 Connection Strength Rupture Curve

APPENDIX A REFERENCES

- AASHTO, 1996, *Standard Specifications for Highway Bridges, with 2000 Interims*, American Association of State Highway and Transportation Officials, Fifteenth Edition, Washington, D.C., USA, 686 p.
- American Society for Testing and Materials (ASTM), 1994, *Annual Book of Standards*, Vol. 4.08 and 4.09, Soil and Rock, ASTM, Philadelphia, PA, USA.
- Bonczkiewicz, C., Christopher, B. R., and Atmatzidis, D. K., 1988, "Evaluation of Soil Reinforcement Interaction by Large-Scale Pullout Tests," *Transportation Research Record 1188*, pp. 1-18.
- Christopher, B. R., 1993, *Deformation Response and Wall Stiffness in Relation to Reinforced Soil Wall Design*, Ph.D. Dissertation, Purdue University, 352 pp.
- Christopher, B. R., Gill, S. A., Giroud, J. P., Juran, I., Mitchell, J. K., Schlosser, F., and Dunncliff, J., 1990, Reinforced Soil Structures, Vol. 1, Design and Construction Guidelines, Report to Federal Highway Administration, No. FHWA-RD-89-043.
- Elias, V. and Christopher, B.R., 1997, *Mechanically Stabilized Earth Walls and Reinforced Soil Slopes Design and Construction Guidelines*, FHWA No. FHWA-SA-96-071.
- Koerner, R. M., 1991, "Determination of the Pullout Resistance of Geogrids," *GRI Standard Practice GG-5*.
- Koerner, R. M., 1991, "Determination of the Pullout Resistance of Geotextiles," *GRI Standard Practice GT-6*.
- Collin, J.G., editor, 1997, *Design Manual for Segmental Retaining Walls*, Second Edition, National Concrete Masonry Association, Herndon, Virginia.

[BLANK]

APPENDIX B

DETERMINATION OF CREEP STRENGTH REDUCTION FACTOR (RF_{CR})

B.1 BACKGROUND

The effect of long-term load/stress on geosynthetic reinforcement strength and deformation characteristics should be determined from the results of product specific, controlled, long-term laboratory creep tests conducted for a minimum duration of 10,000 hours for a range of load levels in accordance with ASTM D 5262. Specimens should be tested in the direction in which the load will be applied in use. Test results should be extrapolated to the required structure design life. Based on the extrapolated test results, the following is to be determined:

- For limit state design, the highest load level, designated T_j , which precludes both ductile and brittle creep rupture.
- For the limit state design, creep test results should be extrapolated to the required design life and design site temperature in general accordance with the procedures outlined in this Appendix.
- The creep reduction factor, RF_{CR} , is determined by comparing the long-term creep strength, T_j , to the ultimate tensile strength (ASTM D 4595) of the sample tested for creep. The sample tested for ultimate strength should be taken from the same lot, and preferably the same roll, of material which is used for the creep testing. For ultimate limit state design, the strength reduction factor to prevent long-term creep rupture is determined as follows:

$$RF_{CR} = \frac{T_{ultlot}}{T_1} \quad (B-1)$$

where, T_{ultlot} is the average lot specific ultimate tensile strength (ASTM D 4595) for the lot of material used for the creep testing.

At present, creep tests are conducted in-isolation (ASTM D 5262) rather than confined in-soil, even though in-isolation creep tests tend to overpredict creep strains and underpredict the true creep strength when used in a structure.

Considering that typical design lives for permanent MSE structures are 75 years or more, extrapolation of creep data is required. No standardized method of geosynthetic creep data modeling and extrapolation exists at present, though a number of extrapolation and creep

modeling methods have been reported in the literature (Findley, et. al., 1976; Wilding and Ward, 1978; Wilding and Ward, 1981, Takaku, 1981; McGown, et. al., 1984; Andrawes, et. al., 1986; Murray and McGown, 1988; Bush, 1990; Popelar, et. al., 1991; Helwany and Wu, 1992). Many of the methods discussed in the literature are quite involved and mathematically complex. Therefore, rather than attempting to develop mathematical models which also have physical significance to characterize and extrapolate creep, as is often the case in the literature (for example, using Rate Process Theory to develop rheological models of the material), *a simplified visual/graphical approach will be taken.* This does not mean that the more complex mathematical modeling techniques cannot be used to extrapolate creep of geosynthetics; they are simply not outlined in this appendix.

The determination of T_1 can be accomplished through the use of either stress rupture data or creep strain data. The specific steps required to determine T_1 differ substantially depending on which type of data is available. Creep strains are not typically monitored in stress rupture testing, although creep strain tests can be carried to rupture. Rupture data is necessary if the creep reduction factor for ultimate limit state conditions is to be determined. Stress rupture test results, if properly accelerated and extrapolated can be used to investigate the effects of stress cracking and the potential for a ductile to brittle transition to occur.

Since the primary focus of creep evaluation in current practice is at rupture, *only extrapolation of stress rupture data will be explained in this appendix.* Creep strain data can be used to estimate T_1 , provided that the creep strain data is not extrapolated beyond the estimated long-term rupture strain. However, extrapolation of creep strain data is complex and not fully defined. Therefore, no guidance is provided regarding extrapolation of creep strain data to determine T_1 .

Single ribs for geogrids or yarns for woven geotextiles may be used for creep testing for ultimate limit state design provided that it can be shown through a limited 1,000 hour creep testing program that the rupture behavior and envelope for the single ribs or yarns are the same as that for the full product.

Current practice allows creep data to be extrapolated up to one log cycle of time beyond the available data without some form of accelerated creep testing, or possibly other corroborating evidence (Jewell and Greenwood, 1988; Koerner, 1990). Based on this, unless one is prepared to obtain 7 to 10 years of creep data, temperature accelerated creep data, or possibly other corroborating evidence, must be obtained.

It is well known that temperature accelerates many chemical and physical processes in a predictable manner. In the case of creep, this means that the creep strains under a given applied load at a relatively high temperature and relatively short times will be approximately the same as the creep strains observed under the same applied load at a relatively low temperature and relatively long times. Temperature affects time to rupture at a given load in a similar manner. This means that the time to a given creep strain or to rupture measured at an elevated temperature can be made equivalent to the time expected to reach a given creep strain or to rupture at in-situ temperature through the use of a time shift factor.

The ability to accelerate creep with temperature for polyolefins such as polypropylene (PP) or high density polyethylene (HDPE) has been relatively well defined (Takaku, 1981; Bush, 1990; Popelar, et. al., 1991). Also for polyolefins, there is some risk that a "knee" in the stress rupture envelope due to a ductile to brittle transition could occur at some time beyond the available data (Takaku, 1981; Popelar, et. al., 1991). Therefore, temperature accelerated creep data is strongly recommended for polyolefins. For polyester (PET) geosynthetics, limited evidence does appear to indicate that temperature increases of at least twice that needed for polyolefins to produce a given time acceleration may be feasible, based on data provided by den Hoedt, et. al., 1994. However, the stress rupture envelopes for PET geosynthetics tend to be flatter than polyolefin stress rupture envelopes, and accurate determination of time-shift factors may be difficult for PET geosynthetics. This may require greater accuracy in the PET stress rupture data than would be required for polyolefin geosynthetics to perform accurate extrapolations using elevated temperature data. This should be considered if using elevated temperature data to extrapolate PET stress rupture data. A two log cycle extrapolation without elevated temperature data is an acceptable alternative for PET geosynthetics, provided an appropriate extrapolation safety factor is applied to account for any minor curvature in the long-term rupture envelope not observed in the data. Note that a "knee" in the stress rupture envelope of PET does not appear to be likely based on the available data and the molecular structure of polyester. A two log cycle extrapolation without elevated temperature data is not recommended for polyolefin geosynthetics due to the potential for a "knee" to be present in the stress rupture envelope.

If elevated temperature is used to obtain accelerated creep data, it is recommended that minimum increments of 10° C be used to select temperatures for elevated temperature creep testing for polyolefins and 20° C for PET geosynthetics. The highest temperature tested, however, should be below any transitions for the polymer in question. If one uses test temperatures below 80° C for polypropylene (PP) and high density polyethylene (HDPE) and below 70° C for PET geosynthetics, significant polymer transitions will be avoided. One should also keep in mind that at these high temperatures, significant chemical interactions with the surrounding environment are possible, necessitating that somewhat lower temperatures or appropriate environmental controls be used. These chemical interactions are likely to cause the creep test results to be conservative. Therefore, from the user's point of view, potential for chemical interactions is not detrimental to the validity of the data for predicting creep limits.

B.2 STEP-BY-STEP PROCEDURES FOR EXTRAPOLATING STRESS RUPTURE DATA

Step 1: Plot the stress rupture data on a plot of log time to rupture versus log load level, as shown in figure B.1. Do this for each temperature in which creep rupture data is available. For some materials, a semi-log plot could rather than a log-log plot could be used. In general, 12 to 18 data points are required to establish a rupture envelope (Jewell and Greenwood, 1988; ASTM D 2837). The data points should be evenly distributed through each log cycle of time. Rupture points with a time to rupture of less than 5 to 10 hours should in general not be used, and at least one or two data points should have a time to rupture of 10,000 hours or more, before time shifting.

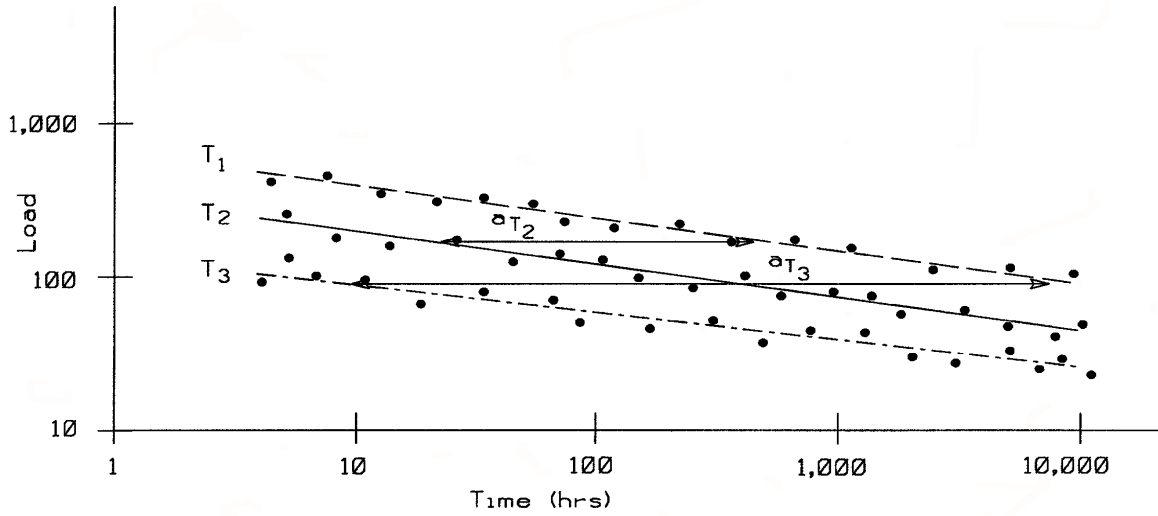

(a) Stress rupture envelope without "knee"

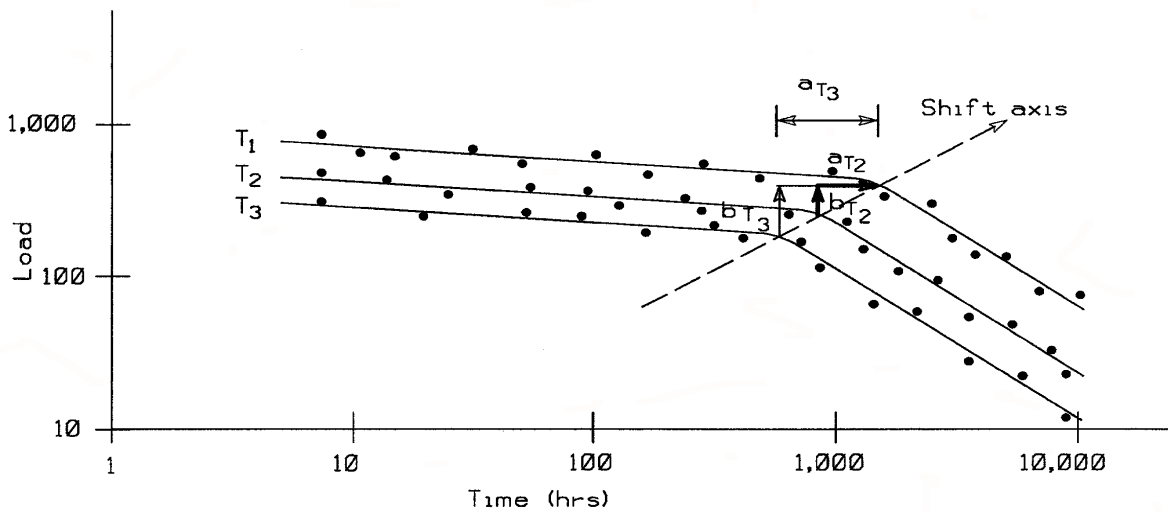

(b) Stress rupture envelope with "knee"

Figure B.1 Typical stress rupture data and the determination of shift factors for time-temperature superposition.

It is acceptable to establish rupture points for times of 10,000 hours or more by assuming that specimens subjected to a given load level which have not yet ruptured to be near a state of rupture. Therefore, the time to rupture for those particular specimens would be assumed equal to the time the load has been in place. Note that this is likely to produce conservative results.

For the elevated temperature rupture envelopes, it may not be necessary to establish the complete rupture envelope. If a knee is already present in the rupture envelope obtained at the design (ambient) temperature, only a few long-term rupture points need to be obtained at elevated temperature(s) to establish the slope of the envelope beyond the knee out to the desired design life. If a knee is not present in the ambient temperature rupture envelope, the elevated temperature stress rupture envelope(s) must be well enough defined to determine whether or not a knee is present.

Step 2: Extrapolate the stress rupture data. Stress rupture data can be extrapolated statistically using regression analysis (i.e., curve fitting) without elevated temperature up to one log cycle for all geosynthetic polymers and up to 2 log cycles for PET geosynthetics. For PP and HDPE geosynthetics, stress rupture data at elevated temperatures should be obtained to allow time-temperature superposition principles to be used. Elevated temperature stress rupture data can be used to extrapolate the rupture envelope at the design temperature through the use of a time shift factor, a_T . If the rupture envelope is approximately linear as illustrated in figure B.1(a), the single time shift factor a_T will be adequate to perform the time-temperature superposition. If, however, the rupture envelope exhibits a "knee", resulting in a bilinear or curved envelope as illustrated in figure B.1(b), a vertical shift factor " b_T " along the load axis will also be required to make sure that the "knees" line up properly. In essence, the shift is performed along the shift axis shown in figure B.1(b). The shift axis simply connects the knee for each rupture envelope together.

The time to rupture for the elevated temperature rupture data is shifted in accordance with the following equation:

$$t_{amb} = (t_{elev})(a_T) \quad (B-2)$$

where, t_{amb} is the predicted time at in-situ temperature to reach rupture under the specified load, t_{elev} is the measured time at elevated temperature to reach a rupture under the specified load, and a_T is the time shift factor. If a knee is present in the stress rupture envelope, the load for each elevated temperature rupture data point is also shifted using the following equation:

$$P_{amb} = (P_{elev})(b_T) \quad (B-3)$$

where, p_{amb} is the equivalent load level at in-situ (i.e., design) temperature at a given time to rupture, P_{elev} is the measured load level at elevated temperature at a given time to rupture, and b_T is the load level shift factor. The magnitude of the time shift and load shift factors can be determined graphically as illustrated in figure B.1(b). Adjust a_T and b_T such that the stress rupture envelopes at elevated temperature line up with the stress rupture envelope at the design (in-situ) temperature. If a knee in the stress rupture envelope only appears for the data obtained

at the highest temperature, it must be assumed that a knee in the rupture envelope must be possible at times beyond the available data for the lower temperature data as well. In this case, two options are available to determine a_T and b_T , considering that the slope of the shift axis must be determined:

- Obtain creep data at a temperature higher than the highest temperature previously tested.
- Assume that a knee in the rupture envelope occurs right at the end of the available data at the next lower temperature below the envelope which exhibited a knee.

Once rupture envelope knee locations at two temperatures have been established, the slope of the shift axis can be determined, and a_T and b_T can be determined as shown in figure B.1(b).

Step 3: Once the creep data has been extrapolated, determine the design, lot specific, creep limit load by taking the load level at the desired design life directly from the extrapolated stress rupture envelope as shown in figure B.2. If statistical extrapolation beyond the time shifted stress rupture envelopes (PP or HDPE), or beyond the actual data if temperature accelerated creep data is not available, is necessary to reach the specified design life, the calculated creep load T_1 should be reduced by an extrapolation uncertainty factor as follows:

$$T_1 = P_{cl} / (1.2)^{x-1} \quad (\text{B-4})$$

where P_{cl} is the creep limit load taken directly from the extrapolated stress rupture envelope, and "x" is the number of log cycles of time the rupture envelope must be extrapolated beyond the actual or time shifted data. The factor $(1.2)^{x-1}$ is the extrapolation uncertainty factor. If extrapolating beyond the actual or time shifted data less than 1 log cycle, set the exponent equal to zero. This extrapolation uncertainty factor only applies to statistical extrapolation beyond the actual or time shifted data using regression analysis and assumes that a knee in the rupture envelope beyond the actual or time shifted data does not occur. This extrapolation uncertainty factor also assumes that the data quality is good, scatter reasonable, and that a minimum of 12 to 18 data points, well distributed, define each stress rupture envelope. If the above criteria is not met, the uncertainty factor may be increased. This extrapolation uncertainty factor should be increased to $(1.4)^x$ if there is a potential for a "knee" in the stress rupture envelope to occur beyond the actual time shift data, or if the data quality, scatter, distribution of data, or amount is inadequate.

Step 4: The creep reduction factor, RF_{CR} , is determined by comparing the long-term creep strength, T_1 , to the ultimate tensile strength (ASTM D 4595) of the sample tested for creep. The sample tested for ultimate tensile strength should be taken from the same lot, and preferably the same roll, of material which is used for the creep testing. For ultimate limit state design, the strength reduction factor to prevent long-term creep rupture is determined as follows:

$$RF_{CR} = \frac{T_{ultlot}}{T_1} \tag{B-1}$$

where, T_{ultlot} is the average lot specific ultimate tensile strength (ASTM D 4595) for the lot of material used for the creep testing. Note that this creep reduction factor takes extrapolation uncertainty into account, but does not take into account variability in the strength of the material. Material strength variability is taken into account when RF_{CR} , along with RF_{ID} and RF_D , are applied to T_{ult} to determine the long-term allowable tensile strength, as T_{ult} is a minimum average roll value. The minimum average roll value is essentially the value which is two standard deviations below the average value.

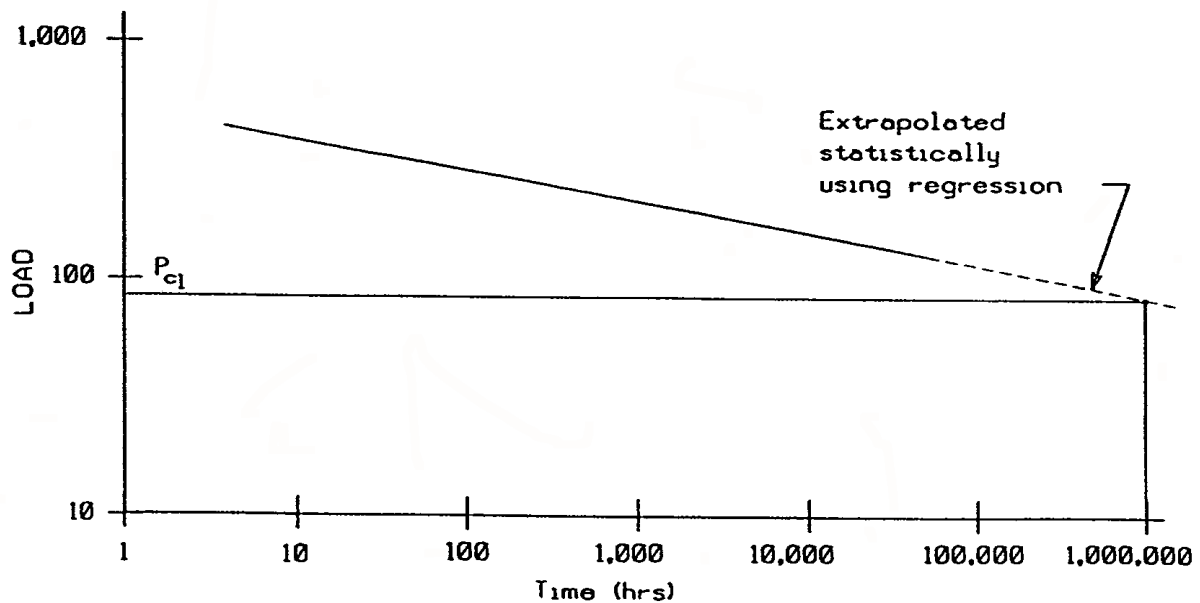

Figure B.2 Extrapolation of stress rupture data and the determination of creep limit load.

B.3. USE OF CREEP DATA FROM "SIMILAR" PRODUCTS

Long-term creep data obtained from tests performed on older product lines, or other products within the same product line, may be applied to new product lines, or a similar product within the same product line, if one or both of the following conditions are met:

- The chemical and physical characteristics of tested products and proposed products are shown to be similar. Research data, though not necessarily developed by the product manufacturer, should be provided which shows that the minor differences between the tested and the untested products will result in equal or greater creep resistance for the untested products.
- A limited testing program is conducted on the new or similar product in question and compared with the results of the previously conducted full testing program.

For polyolefins, similarity could be judged based on molecular weight and structure of the main polymer (i.e., is the polymer branched or crosslinked, is it a homopolymer or a blend, percent crystallinity, etc.), percentage of material reprocessed, tenacity of the fibers and processing history, and polymer additives used (i.e., type and quantity of antioxidants or other additives used). For polyesters, similarity could be judged based on molecular weight or intrinsic viscosity of the main polymer, carboxyl end group content, percent crystallinity, or other molecular structure variables, tenacity of the fibers and processing history, percentage of material reprocessed or recycled, and polymer additives used (e.g., pigments, etc.). The untested products should also have a similar macrostructure (i.e., woven, nonwoven, extruded grid, needlepunched, yarn structure, etc.), relative to the tested products. It should be noted that percent crystallinity is not a controlled property and there is presently no indication of what an acceptable value for percent crystallinity should be.

For creep evaluation, this limited testing program should include creep tests taken to at least 1,000 to 2,000 hours in length. These limited creep test results must show that the performance of the new or similar product is equal to or better than the performance of the product previously tested. If so, the results from the full testing program on the older or similar product could be used for the new/similar product. If not, then a full testing and evaluation program for the new product should be conducted.

B.4 CREEP EXTRAPOLATION EXAMPLES USING STRESS RUPTURE DATA

Two creep extrapolation examples using stress rupture data are provided. The first example uses hypothetical stress rupture data which is possible for PET geosynthetics to illustrate the simplest extrapolation case. The second example uses hypothetical stress rupture data which is possible for polyolefin geosynthetics to illustrate the most complex stress rupture data extrapolation situation, a stress rupture envelope which exhibits a "knee" in the envelope.

B.4.1 Stress Rupture Extrapolation Example 1

The following example utilizes hypothetical stress rupture data for a PET geosynthetic. The data provided in this example is for illustration purposes only.

Given: A PET geosynthetic proposed for use as soil reinforcement in a geosynthetic MSE wall. A design life of 1,000,000 hours is desired. The manufacturer of the geogrid has provided stress rupture data at one temperature for use in establishing the creep limit for the material. The stress rupture data came from the same lot of material as was used for the wide width load-strain tests. The wide width ultimate strength data for the lot is as provided in figure B.3. The stress rupture data is provided in figure B.4.

Find: The long-term creep strength, T_1 , at a design life of 1,000,000 hours and a design temperature of 20° C, and the design reduction factor for creep, RF_{CR} using the stress rupture data.

Solution: The step-by-step procedures provided for stress rupture data extrapolation will be followed. Step 1 has already been accomplished (figure B.4).

Step 2: Extrapolate the stress rupture data. Use regression analysis to establish the best fit line through the stress rupture data. Extend the best fit line to 1,000,000 hours as shown in figure B.4.

Step 3: Determine the design, lot specific, creep limit load from the stress rupture envelope provided in figure B.4. The load taken directly from the rupture envelope at 1,000,000 hours is 63.4 kN/m. This value has been extrapolated 1.68 log cycles beyond the available data. Using equation B.4,

$$T_1 = (63.4 \text{ kN/m}) / (1.2)^{1.68-1} = \underline{56.0 \text{ kN/m}}$$

Step 4: The strength reduction factor to prevent long-term creep rupture RF_{CR} is determined as follows (see equation B.1):

$$RF_{CR} = T_{\text{utlot}} / T_1$$

where, T_{utlot} is the average lot specific ultimate tensile strength for the lot material used for creep testing. From figure B.3, T_{utlot} is 110 kN/m. Therefore,

$$RF_{CR} = (110 \text{ kN/m}) / (56.0 \text{ kN/m}) = \underline{2.0}$$

In summary, using rupture based creep extrapolation, $T_1 = 56.0 \text{ kN/m}$, and $RF_{CR} = 2.0$

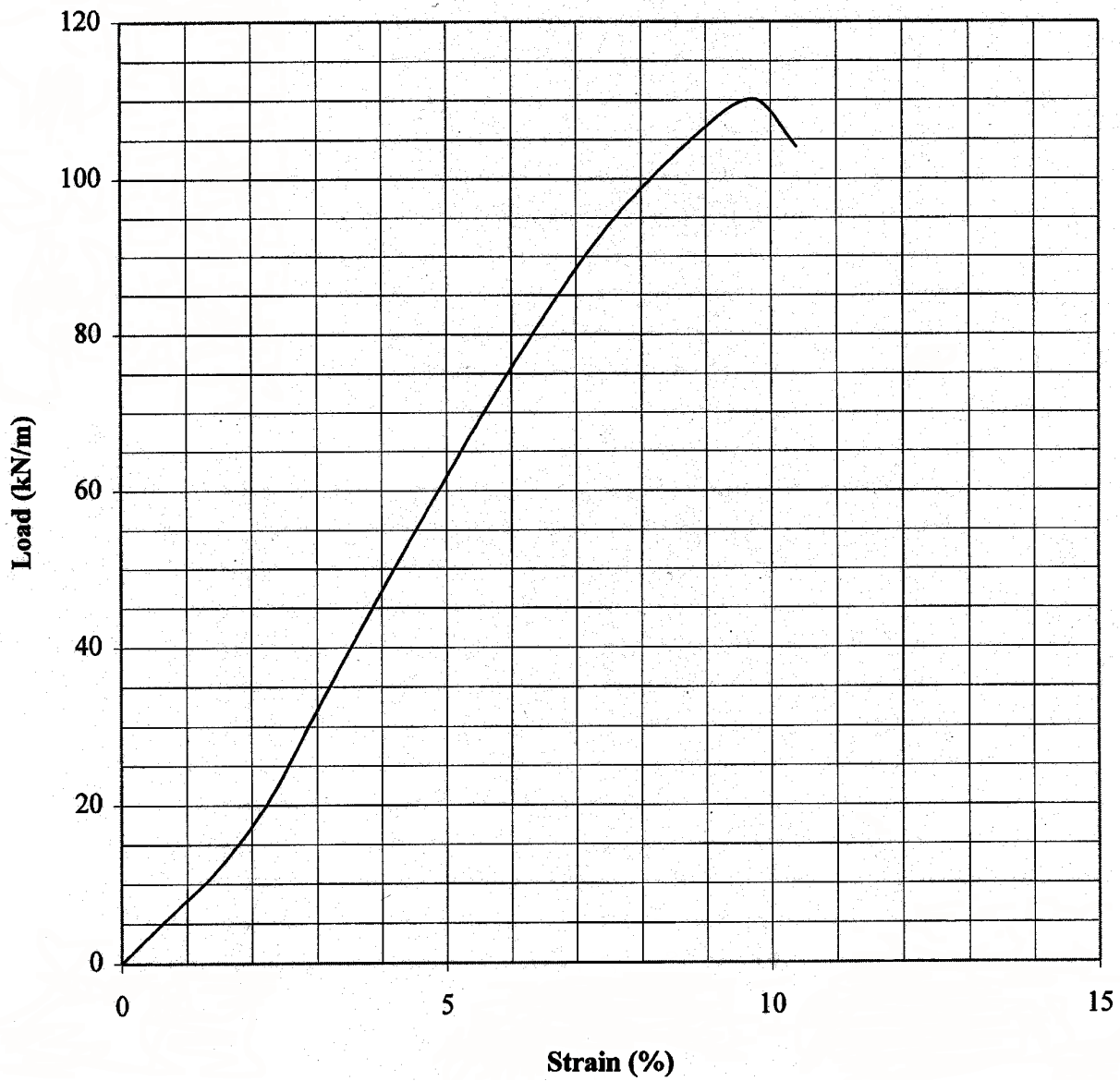

Figure B.3 Wide width load-strain data for PET geosynthetic at 20°C.

B.4.2 Stress Rupture Extrapolation Example 2

The following example utilizes hypothetical stress rupture data for a polyolefin geosynthetic. The data provided in this example is for illustration purposes only.

Given: A polyolefin geosynthetic is proposed for use as soil reinforcement in a geosynthetic MSE wall. A design life of 1,000,000 hours is desired. The manufacturer of the geosynthetic has provided stress rupture data at three temperatures for use in establishing the creep limit for the material. The stress rupture data came from the same lot of material as was used for the creep strain tests. The wide width ultimate strength data for the lot is provided in figure B.5. The stress rupture data is provided in figure B.6.

Find: The long-term creep strength, T_1 , at a design life of 1,000,000 hours and a design temperature of 20° C, and the design reduction factor for creep, RF_{CR} using the stress rupture data.

Solution: The step-by-step procedures provided in Appendix B for stress rupture data extrapolation will be followed. Step 1 has already been accomplished (figure B.6).

Step 2: Extrapolate the stress rupture data. Using time-temperature superposition, shift the elevated temperature stress rupture envelopes along the shift axis as shown in figure B.6, since there is a "knee" present in the elevated temperature stress rupture envelopes, so that the elevated temperature rupture envelopes line up with the rupture envelope at 20° C. Doing this visually by trial and error results in the following shift factors:

| Temperature (°C) | a_T | b_T |
|------------------|-------|-------|
| 30° C | 6.0 | 1.03 |
| 40° C | 25.0 | 1.06 |

Using Equations B-2 and B-3, time and load levels for each of the elevated temperature rupture points are shifted to equivalent 20° C data as shown in table B-1.

The combined 20° C stress rupture envelope resulting from this shifting is shown in figure B.7.

Step 3: Determine the design, lot specific, creep limit load from the stress rupture envelope provided in figure B.7. The load taken directly from the rupture envelope at 1,000,000 hours is 23.9 kN/m. Since no extrapolation beyond the temperature shifted data was necessary, set the exponent to 0. Using Equation B-4,

$$T_1 = (23.9 \text{ kN/m}) / (1.2)^0 = \underline{23.9 \text{ kN/m}}$$

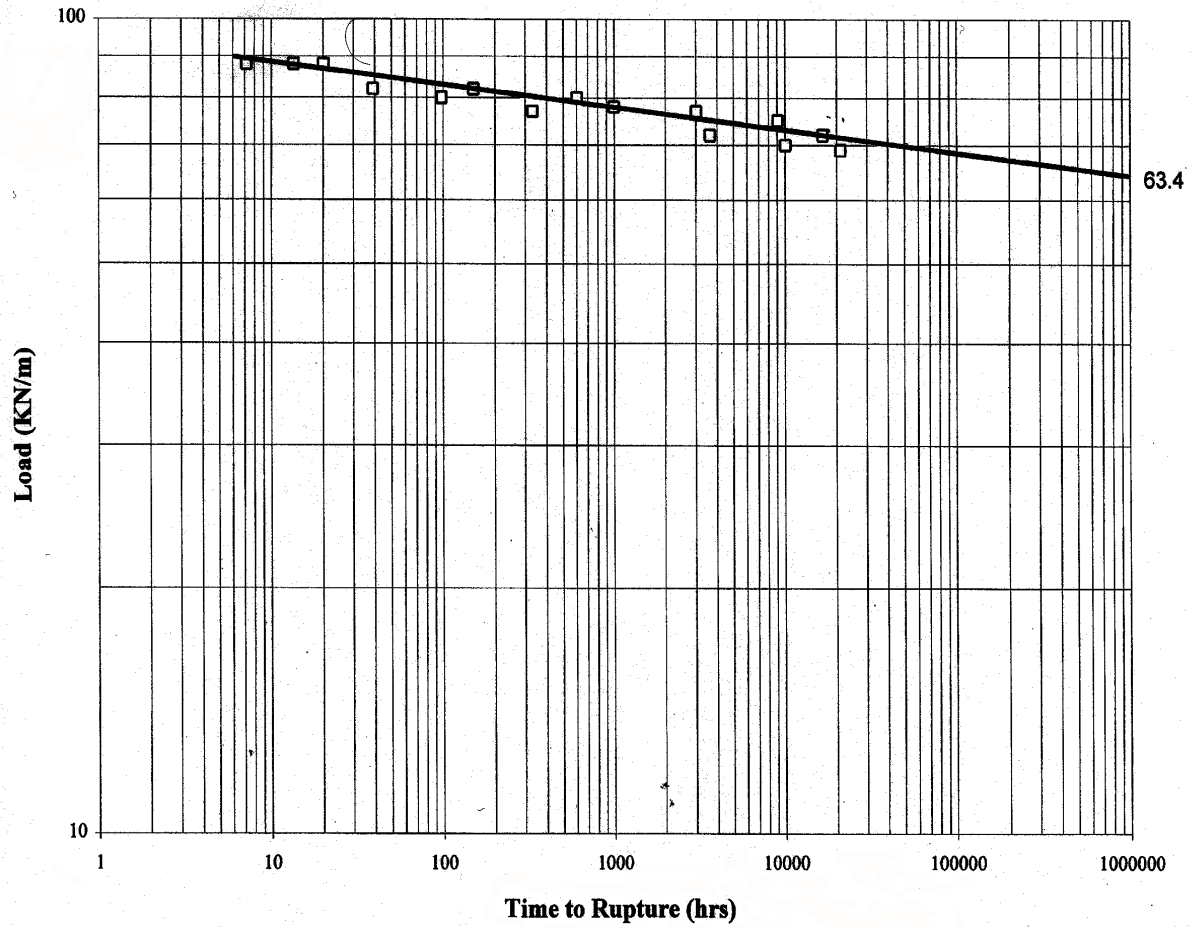

Figure B.4 Stress rupture data for PET geosynthetic at 20°C.

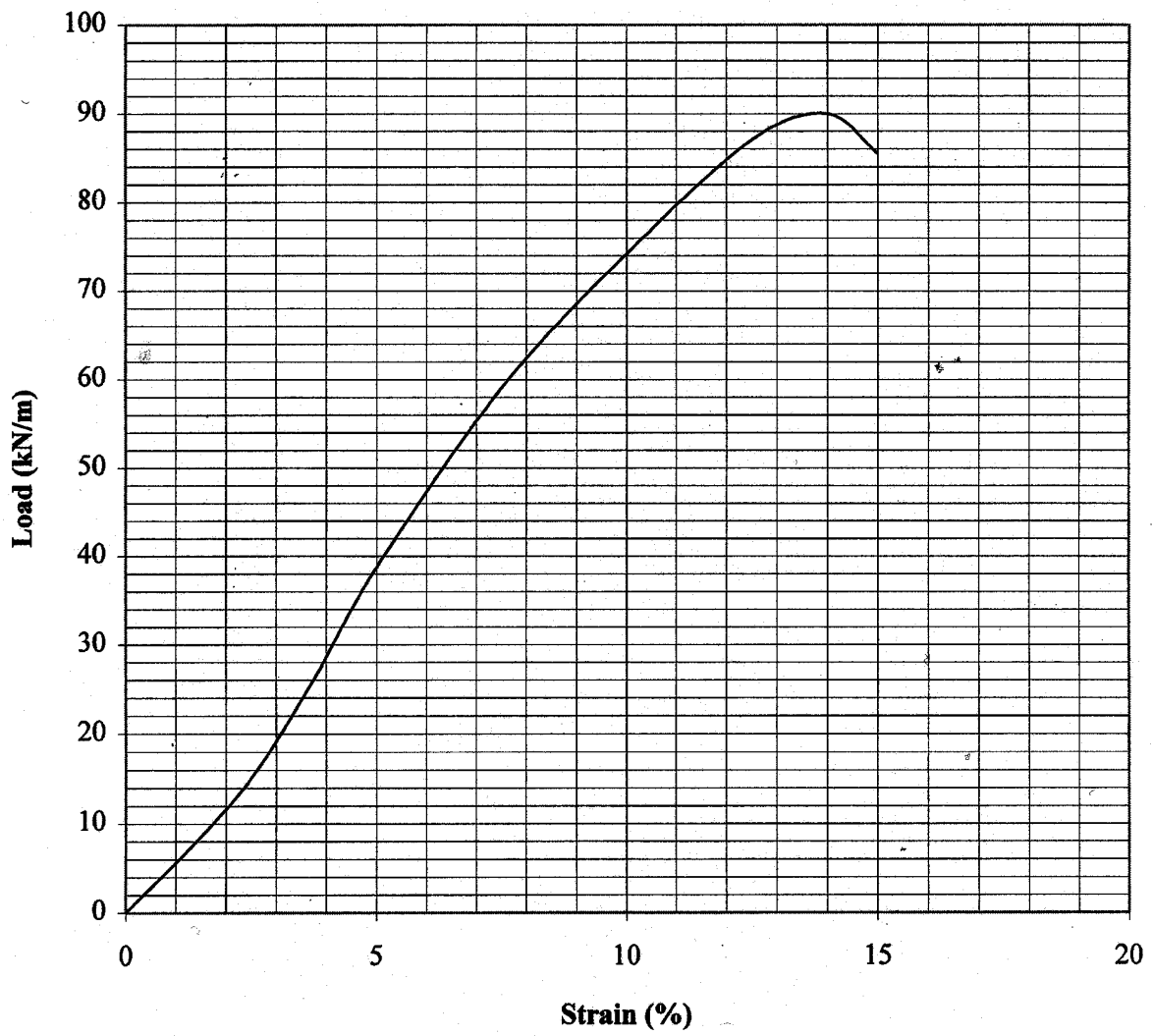

Figure B.5 Wide width load-strain data for polyolefin geosynthetic at 20°C.

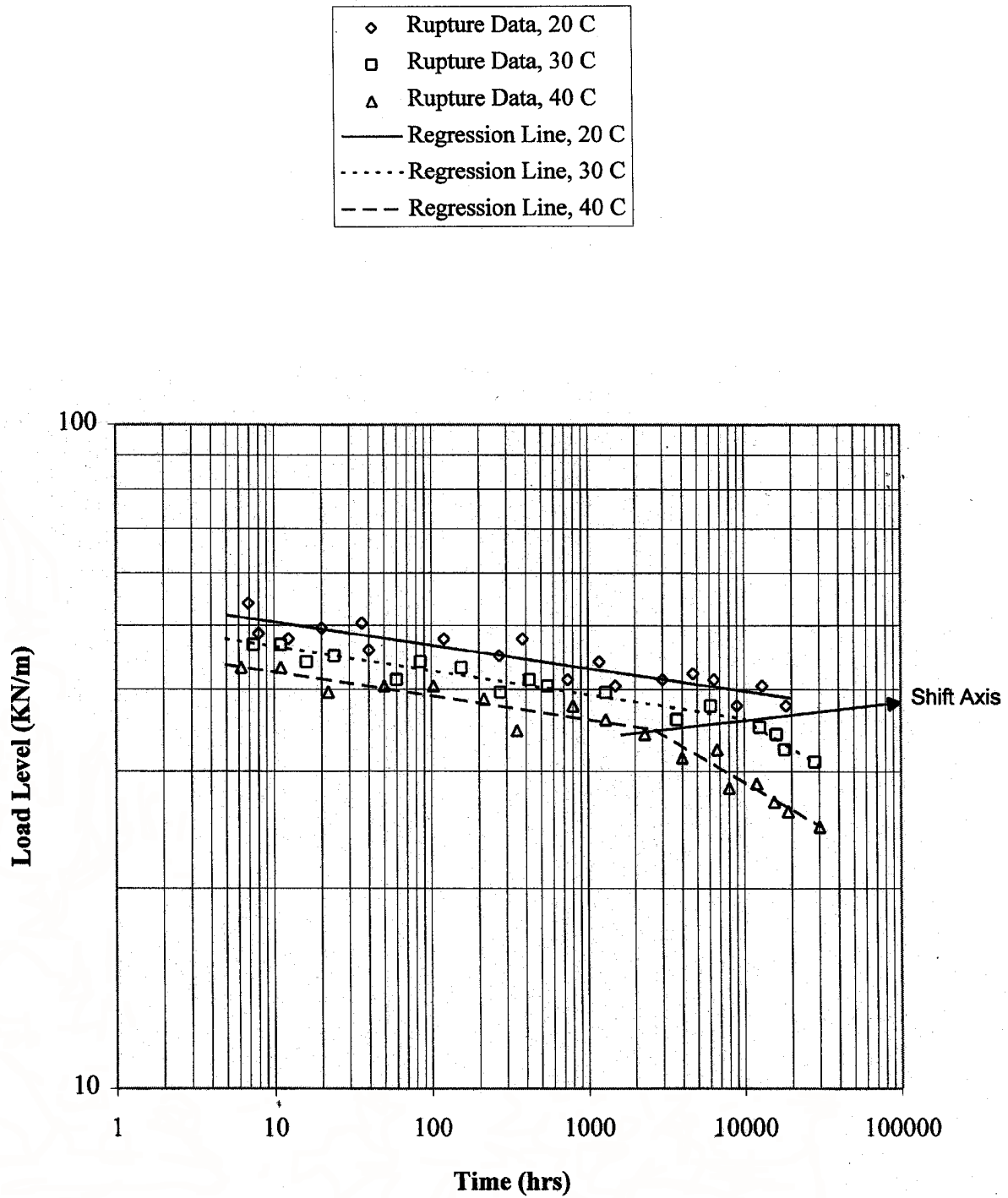

Figure B.6 Stress rupture data for polyolefin geosynthetic.

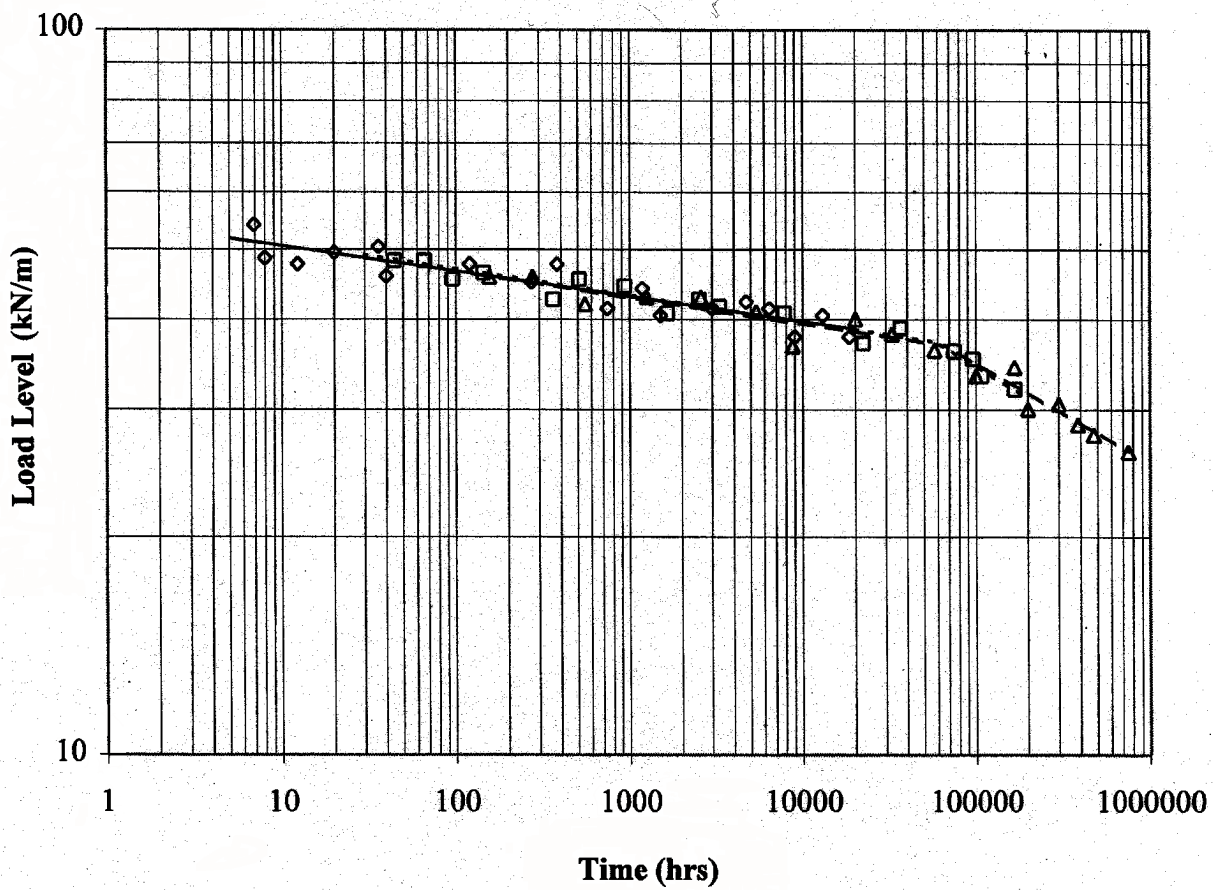
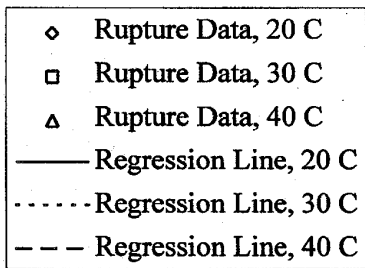

Figure B.7 Stress rupture data for polyolefin geosynthetic after time/load shifting.

Table B-1: Stress Rupture Data Before and After Time/Load Shifting to Equivalent 20° C Data for Polyolefin Geosynthetic

| Original Stress Rupture Data | | | | | | Rupture Data at 30° C After Shifting | | Rupture Data at 40° C After Shifting | |
|------------------------------|-------------------|-----------------------|-------------------|-----------------------|-------------------|--------------------------------------|-------------------|--------------------------------------|-------------------|
| Rupture Data at 20° C | | Rupture Data at 30° C | | Rupture Data at 40° C | | Time Shift = 6.0 | Load Shift = 1.03 | Time Shift = 25 | Load Shift = 1.06 |
| Time (hrs) | Load level (kN/m) | Time (hrs) | Load level (kN/m) | Time (hrs) | Load level (kN/m) | Time (hrs) | Load level (kN/m) | Time (hrs) | Load level (kN/m) |
| 6.9 | 54 | 7.4 | 46.8 | 6.2 | 43.2 | 44.4 | 48.204 | 155 | 45.792 |
| 8 | 48.6 | 11 | 46.8 | 11 | 43.2 | 66 | 48.204 | 275 | 45.792 |
| 12.3 | 47.7 | 16 | 44.1 | 22 | 39.6 | 96 | 45.423 | 550 | 41.976 |
| 20 | 49.5 | 24 | 45 | 50 | 40.5 | 144 | 46.35 | 1250 | 42.93 |
| 36 | 50.4 | 60 | 41.4 | 103 | 40.5 | 360 | 42.642 | 2575 | 42.93 |
| 40 | 45.9 | 85 | 44.1 | 215 | 38.7 | 510 | 45.423 | 5375 | 41.022 |
| 120 | 47.7 | 155 | 43.2 | 350 | 34.65 | 930 | 44.496 | 8750 | 36.729 |
| 270 | 45 | 275 | 39.6 | 800 | 37.8 | 1650 | 40.788 | 20000 | 40.068 |
| 380 | 47.7 | 420 | 41.4 | 1300 | 36 | 2520 | 42.642 | 32500 | 38.16 |
| 740 | 41.4 | 550 | 40.5 | 2300 | 34.2 | 3300 | 41.715 | 57500 | 36.252 |
| 1180 | 44.1 | 1300 | 39.6 | 4000 | 31.5 | 7800 | 40.788 | 100000 | 33.39 |
| 1500 | 40.5 | 3700 | 36 | 6700 | 32.4 | 22200 | 37.08 | 167500 | 34.344 |
| 3000 | 41.4 | 6100 | 37.8 | 8000 | 28.35 | 36600 | 39.964 | 200000 | 30.051 |
| 4700 | 42.3 | 12500 | 35.1 | 12000 | 28.8 | 75000 | 36.153 | 300000 | 30.528 |
| 6400 | 41.4 | 16000 | 34.2 | 15500 | 27 | 96000 | 35.226 | 387500 | 28.62 |
| 9000 | 37.8 | 18000 | 32.4 | 19000 | 26.1 | 108000 | 33.372 | 475000 | 27.666 |
| 13000 | 40.5 | 28000 | 31.05 | 30000 | 24.75 | 168000 | 31.9815 | 750000 | 26.235 |
| 18500 | 37.8 | | | | | | | | |

Step 4: The strength reduction factor to prevent long-term creep rupture RF_{CR} is determined as follows:

$$RF_{CR} = T_{ultlot} / T_1$$

where, T_{ultlot} is the average lot specific ultimate tensile strength for the lot of material used for creep testing. From figure B.5, T_{ultlot} is 90 kN/m. Therefore,

$$RF_{CR} = (90 \text{ kN/m}) / (23.9 \text{ kN/m}) = \underline{3.8}$$

In summary, using rupture based creep extrapolation, $T_1 = 23.9$ kN/m, and $RF_{CR} = 3.8$

APPENDIX B REFERENCES

- Andrawes, K.Z., McGown, A., and Murray, R. T., 1986, "The Load-Strain-Time Behavior of Geotextiles and Geogrids," *Proceedings of the Third International Conference on Geotextiles*, Vienna, Austria, pp. 707-712
- Bush, D.I., 1990, "Variation of Long-Term Design Strength of Geosynthetics in Temperatures up to 40° C", *Proceedings of the Fourth International Conference on Geotextiles, Geomembranes, and Related Products*, The Hague, Netherlands, pp. 673-676.
- den Hoedt, G., Voskamp, W., van den Heuvel, C.J.M., 1994, "Creep and Time-to-Rupture of Polyester Geogrids at Elevated Temperatures," *Proceedings of the Fifth International Conference on Geotextiles, Geomembranes, and Related Products*, Singapore, pp. 1125-1130.
- Helwany, B., Wu, J.T.H., 1992, "A Generalized Creep Model for Geosynthetics," *International Symposium on Earth Reinforcement Practice*, Japan, pp.
- Jewell, R.A. and Greenwood, J.H., 1988, "Long-Term Strength and Safety in Steep Soil Slopes Reinforced by Polymer Materials", *Geotextiles and Geomembranes*, Vol. 7, Nos. 1 and 2, pp. 81-118.
- Koerner, R.M., 1990, "Determination of the Long-Term Design Strength of Stiff Geogrids," *GRI Standard Practice GG4(a)*.
- McGown, A., Andrawes, K. Z., and Kabir, M. H., 1982, "Load-Extension Testing of Geosynthetics Confined In-Soil," *Proceedings Second International Conference on Geotextiles*, Las Vegas, NV, Vol. III, pp. 793-798.
- McGown, A., Paine, N., and DuBois, D.D., 1984, "Use of Geogrid Properties in Limit Equilibrium Analysis", *Proceedings of the Symposium on Polymer Grid Reinforcement in Civil Engineering*, Paper No. 1.4, pp. 1-5.
- Murray, R. T., McGown, A., 1988, "Assessment of the Time Dependent Behavior of Geotextiles for Reinforced Soil Applications," *Durability of Geotextiles RILEM*, Chapman and Hall.
- Popelar, C. H., Kenner, V.H., and Wooster, J.P., 1991, "An Accelerated Method for Establishing the Long-Term Performance of Polyethylene Gas Pipe Materials," *Polymer Engineering and Science*, Vol. 31, pp. 1693-1700.
- Takaku, A., 1981, "Effect of Drawing on Creep Fracture of Polypropylene Fibers", *Journal Applied Polymer Science*, Vol. 26, pp. 3565-3573.

Wilding, M.A. and Ward, I.M., 1978, "Tensile and Creep Recovery in Ultra-High Modulus Polyethylenes," *Polymer*, Vol. 19, pp.

Wilding, M.A. and Ward, I.M., 1981, "Creep and Recovery of Ultra High Modulus Polyethylene", *Polymer*, Vol. 22, pp. 870-876.

[BLANK }

APPENDIX C

APPROXIMATE COST RANGE OF GEOTEXTILES AND GEOGRIDS

| Geosynthetic | Material Cost ^(1,2) (\$/m ²) |
|------------------------------------------------------------------------------------------------------------------------------------------------------------------------------------------------------------------------------------------------------------------------------------------------------------------------------------------------------------------------------------------------------------------------------------------------------------------------------------------------------------------------------------------------------------------------------------------------------------------------------------------------------------------------------------------------------------------------------|--------------------------------------------------------|
| Filtration Geotextiles - Class 2 - AASHTO M-288-96 | 1.25 - 1.75 |
| Erosion Control Mats | 3.50 - 6.00 |
| Temporary Erosion Control Blankets | 1.25 - 2.50 |
| Roadway Geotextile Separators - Class 2- AASHTO M-288-96 | 1.25 - 1.75 |
| Asphalt Overlay Geotextiles | 0.60 - 1.25 |
| Geotextile Embankment Reinforcement ³ | 2.50 - 12.00 |
| Geogrid/Geotextile Wall and Slope Reinforcement ^{4,5} - per 15 KN/m long term allowable strength, T_{al} | 1.50 - 3.50 |
| NOTES: | |
| <ol style="list-style-type: none"> 1. Typical costs for materials delivered on-site, for use in engineer's estimate. Costs are exclusive of installation and contractor's markup. 2. Installation cost of geosynthetics typically are \$0.30 to \$0.90, except for very soft ground and underwater placement. 3. Assumes design strength is based upon a 5% to 10% strain criteria with an ASTM D 4595 test. 4. Assumes allowable design strength is based upon a complete evaluation of partial safety factors. 5. Material costs of \$2.00 to \$6.00 should be anticipated if using the default procedure for determination of long-term design strength. | |

[BLANK]

APPENDIX D

TYPICAL DIMENSIONS OF STEEL REINFORCEMENTS

Linear Strips

| Reinforcement Type | Reinforcement Dimensions | F_y/F_u | Vertical Spacing | Horizontal Spacing |
|-----------------------|--------------------------|-------------|------------------|-------------------------------------|
| Steel Strips (ribbed) | 4 mm thick by 50 mm wide | 450/520 MPa | 750 mm | Varies, but typically 300 to 750 mm |

Welded Wire

| Wire Designation | Wire Area (mm ²) | Wire Diameter (mm) | F_y/F_u | Longitudinal Wire Spacing | Transverse Wire Spacing | Mat Spacing |
|----------------------------------------|------------------------------|--------------------|-------------|---------------------------|-----------------------------------|-------------------------------------------------------------------------------------------------------------------------------------------------------------------------------------------------------------------------------------------------------|
| W3.5 | 22.6 | 5.4 | 450/550 MPa | Typically 150 mm | Typically varies 230 mm to 600 mm | For welded wire faced walls, vertically 300 mm, 450 mm, or 600 mm and continuous horizontally. For precast concrete faced walls, vertically 600 mm to 750 mm, horizontally 1.1 m to 1.2 m wide mats spaced at 1.9 m center-to-center or continuous |
| W4 | 25.8 | 5.7 | | | | |
| W4.5* | 29.0 | 6.0 | | | | |
| W5 | 32.3 | 6.4 | | | | |
| W7 | 45.2 | 7.6 | | | | |
| W9.5 | 61.3 | 8.8 | | | | |
| W11 | 71.0 | 9.5 | | | | |
| W12 | 77.4 | 9.9 | | | | |
| W14 | 90.3 | 10.7 | | | | |
| W16 | 103 | 11.5 | | | | |
| W20 | 129 | 12.8 | | | | |
| *Typical min. size for permanent walls | | | | | | |

Bar Mats

| Wire Designation | Wire Area (mm ²) | Wire Diameter (mm) | F_y/F_u | Longitudinal Wire Spacing | Transverse Wire Spacing | Mat Spacing |
|------------------|------------------------------|--------------------|-------------|---------------------------------------------------------|----------------------------|---------------------------------------------------------------------|
| W11 | 71.0 | 9.5 | 450/520 MPa | Typically 150 mm, with 4 to 7 longitudinal bars per mat | Typically 150 mm to 600 mm | Typically 750 mm vertically and 1.5 m center-to-center horizontally |
| W15 | 96.8 | 11.1 | | | | |
| W20 | 129 | 12.8 | | | | |

Specific wall manufacturers may be able to provide a much wider range of reinforcement configurations depending on the design needs.

[BLANK]

APPENDIX E

EXAMPLE REINFORCED

SOIL SLOPE ANALYSIS

with

RSS COMPUTER PROGRAM

Step 8. Design Slope using the Computer Program RSS.

This example, the problem is relatively simple a could be evaluated using the simple program routine in the FHWA computer program RSS. This section provides the steps and input necessary to run this analysis and presents the computer generated results. The steps are as follows:

- ! Load the RSS program and go to the main menu.
- ! Hold the Alt key and press E to display the Edit submenu.
- ! Move the cursor to the option Simple Problem and press Enter.
- ! Enter in the input values for parameters requested on the menu as shown of the following screen:



```

RSS
Auto
Erase Generate elp/F1
SIMPLE PROBLEM
X-Coordinate for Toe of Slope, m : 100
Y-Coordinate for Toe of Slope, m : 100.
Height of Slope, m : 5.
Angle of Slope, deg : 45.
Angle Above Crest of Slope, deg : 1.15
Surcharge Above Crest of Slope, kPa : 10.
Depth to Piezometric Surface from Crest of Slope, m : 6.
Unit Weight of Soil in Slope, kN/m^3 : 21.
Cohesion for Soil in Slope, kPa : 0.
Friction Angle for Soil in Slope, deg : 33.
Unit Weight of Soil in Foundation, kN/m^3 : 19.
Cohesion for Soil in Foundation, kPa : 0.
Friction Angle for Soil in Foundation, deg : 28.
Required Internal Factor of Safety : 1.3
Required Sliding Factor of Safety : 1.3
100.
INPUT OUR
ESC = Previous Screen
```

- ! If an explanation of any of the input parameters is required, move the cursor to that item and press the F! key.
- ! Hold the Alt key and press G to generate all information required for geometry, soil properties and water data. You want see anything different on the screen but if you work through the other various Edit submenu items (e.g. Top Boundary), you will see that all of the required data have been automatically inserted.
- ! Hold the Alt key and press M to return to the main menu or press the Esc key

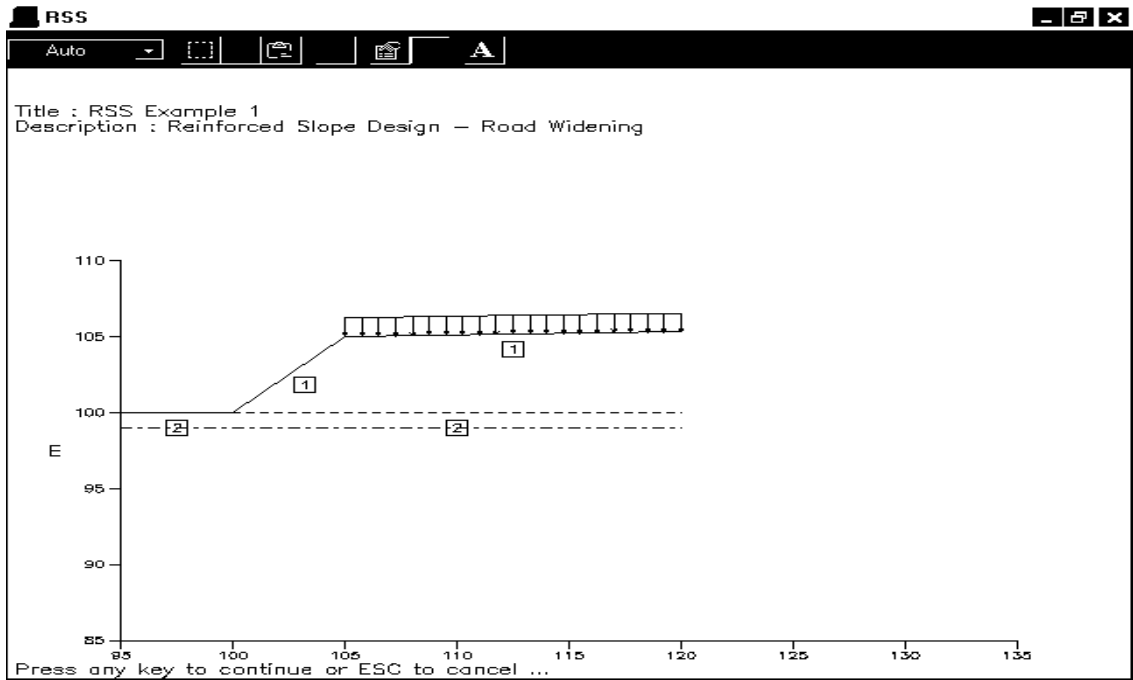

- ! For a view of the input, press Alt V.
- ! Hold the Alt key and press D to select the design option. This problem requires a determination of the required strength of the reinforcement for a fixed vertical spacing. Therefore, the Reinforcement Strength option is selected (by moving the cursor to that option and pressing enter) and the vertical spacing discussed in Step 3c and 3e of the example are input on the following screen. (Note: If the reinforcement strength was known, i.e., from a preapproved products list, the program could also be used to calculate the required spacing.)
- ! Most of the other listed information is already set to match the inputted information and preset default values.
- ! For this example, it is assumed that continuous reinforcement will be used so 1.0 is entered for the case of full extension.

```

RSS
Auto
Erase Calculate Summary
elp/F1
REINFORCEMENT STRENGTH DESIGN
Required Internal Factor of Safety : 1.3
Required Sliding Factor of Safety : 1.3
Lowest Elevation of Reinforcement, m : 100.0
Highest Elevation of Reinforcement, m : 105.0
Minimum Embedment Length, m : 1.0
Vertical Spacing, m : .4
Extension Factor : 1.0
Reduction Factor : 1.0
Pullout Factor of Safety : 1.0
Pullout Resistance Factor : .000000
Embedment Scale Factor : .000000
Coefficient of Friction between Reinforcement and Slope : .300000
Coefficient of Friction between Reinforcement and Foundation : .300000
1.3
INPUT OUR
ESC = Previous Screen

```

- ! Constants for the reinforcement must also be entered. As discussed in Step 4 of the example, default reduction factors are used for the reinforcement strength and as discussed in Step 6f, default values are also used for interaction parameters. Note the factors in the program are intentionally conservative and generally require adjustment to current practice and project conditions.
- ! The design analysis can now be performed. Hold the Alt key and press C to calculate. A box will pop up asking for the Output File Name. This file is where the detailed results for the analysis is to be written.

A graph will appear on the screen showing each trial circle as it is analyzed. When this part finishes, press any key to continue the analysis. A new graph shows the location of reinforcement required for the most critical circle. Press any key to continue. The next graph shows each sliding block as it is analyzed. Press any key to continue and see the location of reinforcement required for the most critical circle modified in the bottom third for the location of the critical sliding block. This process is repeated for sliding blocks in the middle and top thirds of the slope. Press any key to continue and see trial surfaces displayed again as they are analyzed for adequate reinforcement. Press any key one more time to see the final reinforcement spacing and length required. The final graph and summary output screens appear as follow:

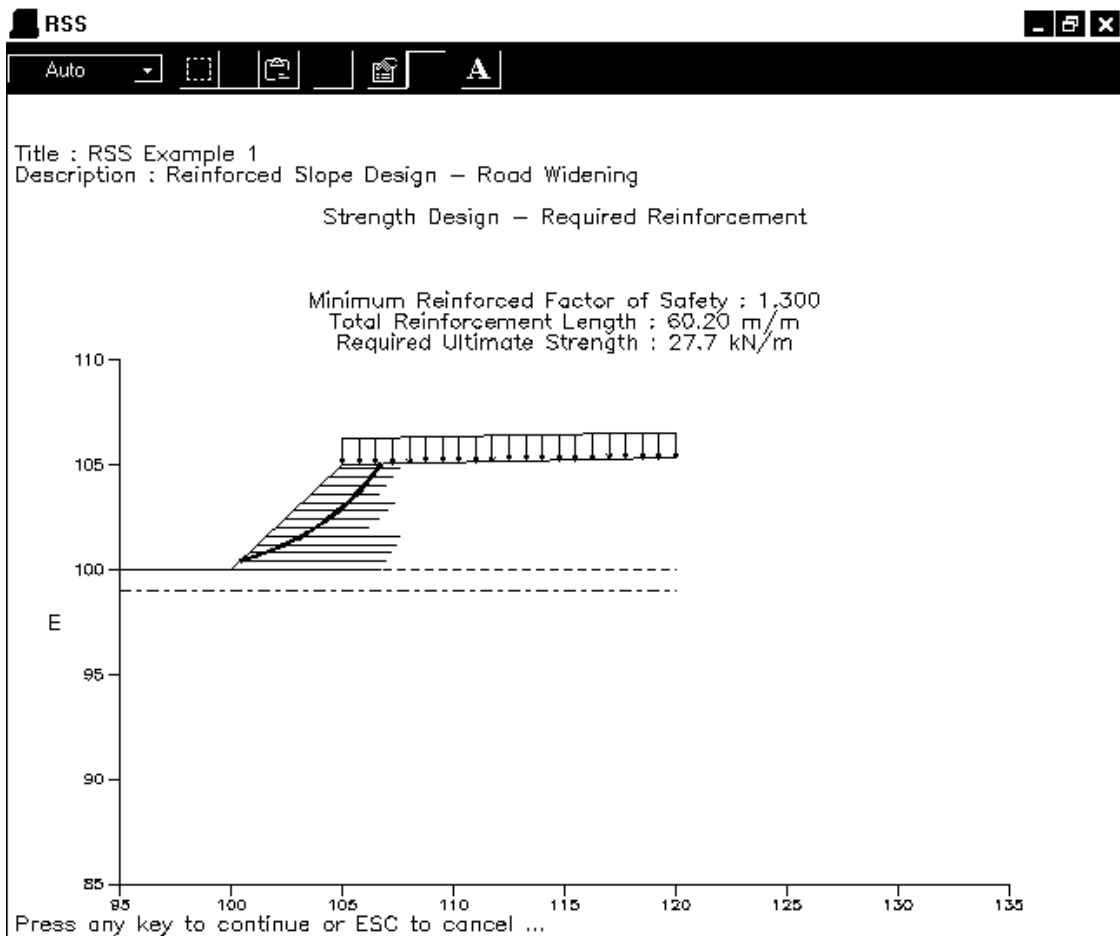

```

*****
*****          R S S          *****
***** Reinforced Slope Stability *****
***** (c)1995 by GEOCOMP Corp, Concord, MA *****
***** licensed to FHWA for distribution by FHWA only *****
*****

```

```

File :
Date : Fri 04-21-:0, 09:39:32
Name :
Problem Title : RSS Example 1
Description : Reinforced Slope Design - Road Widening
Remarks : Simple Example Problem

```

```

*****
*****          INPUT DATA          *****
*****

```

Data for Generating Simple Problem

Note: The following data reflect the data used by Simple Problem to automatically generate a data file. Changes made by editing that data are not reflected in the Simple Problem data.

```

X-Coordinate for Toe of Slope : 100.00 m
Y-Coordinate for Toe of Slope : 100.00 m
Height of Slope : 5.00 m
Angle of Slope : 45.0 deg
Angle Above Crest of Slope : 0.0 deg
Surcharge Above Crest of Slope : 10.0 kPa
Depth to Water from Crest of Slope : 6.00 m
Unit Weight of Soil in Slope : 21.00 kN/m^3
Cohesion for Soil in Slope : 0.00 kPa
Fiction Angle for Soil in Slope : 33.0 deg
Unit Weight of Soil in Foundation : 19.00 kN/m^3
Cohesion for Soil in Foundation : 0.00 kPa
Friction Angle for Soil in Foundation : 28.0 deg
Required Internal Factor of Safety : 1.30
Required Sliding Factor of Safety : 1.30

```

Profile Boundaries

```

Number of Boundaries : 4
Number of Top Boundaries : 3

```

Soil Parameters

```

Number of Soil Types : 2

```

Piezometric Surfaces

```

Number of Surfaces : 1
Unit Weight of Water : 9.81 kN/m^3

```

Boundary Loads

```

Number of Loads : 1

```

***** TRIAL SURFACE GENERATION *****

Data for Generating Circular Surfaces

Number of Initiation Points : 10
Number of Surfaces From Each Point : 10
Left Initiation Point : 100.00 m
Right Initiation Point : 103.75 m
Left Termination Point : 105.00 m
Right Termination Point : 115.47 m
Minimum Elevation : 0.00 m
Segment Length : 0.71 m
Positive Angle Limit : 40.50 deg
Negative Angle Limit : 0.00 deg

***** TRIAL SURFACE GENERATION *****

Data for Generating Rankine Block Surfaces

Number of Trial Surfaces : 100
Number of Boxes : 2
Segment Length : 5.00 m

***** REINFORCEMENT DATA *****

Data for Reinforcement Strength Design

Required Internal Factor of Safety : 1.30
Required Sliding Factor of Safety : 1.30
Lowest Elevation for Reinforcement : 100.20 m
Highest Elevation for Reinforcement : 104.80 m
Minimum Embedment Length : 1.00 m
Vertical Spacing : 0.40 m
Extension Factor : 1.00
Reduction Factor : 7.00
Pullout Factor of Safety : 1.50
Pullout Resistance Factor : 0.43
Embedded Scale Factor : 0.67
Slope Coefficient of Friction : 0.43
Foundation Coefficient of Friction : 0.43

***** RESULTS *****

Unreinforced Circular Surface Tmax

Circle Center X : 97.52 m
Circle Center Y : 111.02 m
Circle Radius : 10.99 m
Surface Height : 4.38 m
Factor of Safety : 0.892

Driving Moment : 1.169350E+003 kN-m/m
 Required Reinforcement : 43.5 kN/m

Bottom Critical Zone Factor of Safety : 1.327
 Middle Critical Zone Factor of Safety : 1.312
 Top Critical Zone Factor of Safety : 1.415

 ***** REINFORCEMENT DESIGN *****

Reinforcement Length per Layer

| Layer No. | Elevation (m) | Length (m) |
|-----------|---------------|------------|
| 1 | 100.20 | 5.34 |
| 2 | 100.60 | 5.30 |
| 3 | 101.00 | 5.27 |
| 4 | 101.40 | 5.09 |
| 5 | 101.80 | 4.12 |
| 6 | 102.20 | 4.21 |
| 7 | 102.60 | 4.21 |
| 8 | 103.00 | 4.16 |
| 9 | 103.40 | 3.03 |
| 10 | 103.80 | 3.00 |
| 11 | 104.20 | 2.93 |
| 12 | 104.60 | 2.83 |

NOTE: The lengths of reinforcement at each height are the minimum lengths of reinforcement necessary to obtain the required factor of safety. For final design, these lengths should be adjusted to values convenient for construction with a given material. If this adjustment results in shorter lengths than computed for some layers, the Reinforcement Analysis option of the program should be used to determine the factor of safety for the adjusted reinforcement pattern.

Minimum Reinforced Factor of Safety : 1.300
 Total Reinforcement Length : 49.95 m/m
 Required Ultimate Strength : 27.7 kN/m

NOTE: The total required length of reinforcement per unit width of slope results from the minimum lengths of reinforcement at each height necessary to obtain the required factor of safety. This value is provided to help compare reinforcement requirements from alternate analyses. Since additional reinforcement will be required for overlaps, face wraps and construction tolerances, this value should not be used directly to estimate construction quantities.

[BLANK]